

FCC PART 15.247



TEST AND MEASUREMENT REPORT

For

Sunrise Telecom, Inc.

302 Enzo Drive, San Jose, CA 95138, USA

FCC ID: UEBXTT5000

Report Type: Original Report	Product Type: Ethernet Tester with Wi-Fi and Bluetooth
Test Engineer(s): Jerry Wang	
Report Number: R0903262-247WiFi	
Report Date: 2009-05-15	
Reviewed By: Sr. RF Engineer	Boni Baniqued 
Prepared By: (66)	Bay Area Compliance Laboratories Corp. 1274 Anvilwood Ave. Sunnyvale, CA 94089, USA Tel: (408) 732-9162 Fax: (408) 732-9164

Note: This test report is prepared for the customer shown above and for the device described herein. It may not be duplicated or used in part without prior written consent from Bay Area Compliance Laboratories Corp. This report **must not** be used by the customer to claim product certification, approval, or endorsement by NVLAP*, NIST, or any agency of the Federal Government.

* This report may contain data that are not covered by the NVLAP accreditation and are marked with an asterisk "*" see 2

TABLE OF CONTENTS

1	GENERAL INFORMATION.....	5
1.1	PRODUCT DESCRIPTION FOR EQUIPMENT UNDER TEST (EUT).....	5
1.2	MECHANICAL DESCRIPTION OF EUT.....	5
1.3	ANTENNA DESCRIPTION.....	5
1.4	EUT PHOTO.....	5
1.5	OBJECTIVE.....	6
1.6	RELATED SUBMITTAL(S)/GRANT(S).....	6
1.7	TEST METHODOLOGY.....	6
1.8	MEASUREMENT UNCERTAINTY.....	6
1.9	TEST FACILITY.....	6
2	SYSTEM TEST CONFIGURATION.....	8
2.1	JUSTIFICATION.....	8
2.2	EUT EXERCISE SOFTWARE.....	8
2.3	SPECIAL ACCESSORIES.....	8
2.4	EQUIPMENT MODIFICATIONS.....	8
2.5	LOCAL SUPPORT EQUIPMENT LIST AND DETAILS.....	8
2.6	INTERFACE PORTS AND CABLING.....	8
2.7	TEST SETUP BLOCK DIAGRAMS.....	9
3	SUMMARY OF TEST RESULTS.....	10
4	§15.247 (i) and § 2.1091 - RF EXPOSURE.....	11
4.1	MPE PREDICTION.....	11
4.2	RESULTS.....	12
5	§15.203 - ANTENNA REQUIREMENT.....	13
5.1	APPLICABLE STANDARD.....	13
5.2	ANTENNA CONNECTOR CONSTRUCTION.....	13
6	§15.207 - CONDUCTED EMISSIONS.....	14
6.1	APPLICABLE STANDARD.....	14
6.2	TEST SETUP.....	14
6.3	TEST EQUIPMENT LIST AND DETAILS.....	14
6.4	TEST PROCEDURE.....	15
6.5	TEST ENVIRONMENTAL CONDITIONS.....	15
6.6	SUMMARY OF TEST RESULTS.....	15
6.7	CONDUCTED EMISSIONS TEST PLOTS AND DATA.....	16
7	FCC §15.205, §15.209 & §15.247(d) - RADIATED SPURIOUS EMISSIONS.....	18
7.1	APPLICABLE STANDARD.....	18
7.2	TEST SETUP.....	19
7.3	EUT SETUP.....	19
7.4	TEST EQUIPMENT LIST AND DETAILS.....	19
7.5	TEST PROCEDURE.....	20
7.6	CORRECTED AMPLITUDE & MARGIN CALCULATION.....	20
7.7	TEST ENVIRONMENTAL CONDITIONS.....	20
7.8	SUMMARY OF TEST RESULTS.....	21
7.9	RADIATED EMISSIONS TEST PLOT & DATA.....	22
8	EXHIBIT A – FCC ID LABELING REQUIREMENTS.....	28
8.1	FCC ID LABELING REQUIREMENT.....	28
8.2	FCC ID LABEL.....	28
8.3	PROPOSED FCC ID LABEL LOCATION.....	29

9	EXHIBIT B - TEST SETUP PHOTOGRAPHS	30
9.1	CONDUCTED EMISSIONS – FRONT VIEW	30
9.2	CONDUCTED EMISSIONS – SIDE VIEW.....	30
9.3	RADIATED EMISSIONS (30 MHz TO 1 GHz) REAR VIEW	31
9.4	RADIATED EMISSIONS (ABOVE 1 GHz) FRONT VIEW	31
9.5	RADIATED EMISSIONS (ABOVE 1 GHz) REAR VIEW	32
10	EXHIBIT C - EUT PHOTOGRAPHS	33
10.1	EUT FRONT VIEW	33
10.2	EUT BACK VIEW	33
10.3	EUT – PORT VIEW	34
10.4	EUT – AC/DC ADAPTOR VIEW	34
10.5	EUT –COVER OFF VIEW	35
10.6	EUT – ANTENNA VIEW.....	35
10.7	EUT –MAIN BOARD ASSEMBLY TOP VIEW	36
10.8	EUT – MAIN BOARD ASSEMBLY BOTTOM VIEW	36
10.9	EUT- SUB-BOARD ASSEMBLY (WITH RF MODULE) TOP VIEW	37
10.10	EUT- SUB-BOARD ASSEMBLY BOTTOM (WITH PORTS) VIEW	37
10.11	EUT- SUB-BOARD ASSEMBLY PORTS VIEW	38

DOCUMENT REVISION HISTORY

Revision Number	Report Number	Description of Revision	Date of Revision
0	R0903262-247WiFi	Original	2009-05-15

1 GENERAL INFORMATION

1.1 Product Description for Equipment under Test (EUT)

This test and measurement report has been compiled on behalf of the company *Sunrise Telecom, Inc* and their product, *FCC ID: UEBXTT5000*, model: XTT-5000 or EUT (Equipment Under Test) as in this report is a 10G/1G Ethernet Tester. The EUT is powered by AC/DC adapter, output: 15VDC/5.33A.

1.2 Mechanical Description of EUT

The *EUT* is of metal construction and measures approximately 230 mm (**L**) x 180 mm (**W**) x 55 mm (**H**), weighing approximately 3.25kg.

** The test data gathered are from typical production sample, serial number: PV01 provided by the customer.*

1.3 Antenna Description

Item Number	Model/Type	
Antenna	Model number:	SUB-23038-001
	Antenna Manufacturer:	Sunrise Telecom
	Frequency :	2.45 GHz
	Maximum Gain	0
	Antenna Type:	Asymmetrical quarter-wave monopoles with 50-ohm U.FL coaxial cables
	Terminations:	U.FL 50-ohm plug
	Measurement:	0.68 mm (D) x 29.0 mm (L)

1.4 EUT Photo



Please refer to Exhibit C for addition EUT photographs.

1.5 Objective

This report is prepared on behalf of *Sunrise Telecom, Inc.* in accordance with Part 2, Subpart J, Part 15, Subparts A, B and C of the Federal Communication Commissions rules.

The objective is to determine compliance with FCC standards, rules and limits for this device including:

- Radiated Spurious Emission [Restricted bands, Harmonics & Spurious]
- AC line Conducted Emission

1.6 Related Submittal(s)/Grant(s)

- 1) Bluetooth submittal with same FCC ID: UEBXTT5000.
- 2) 802.11 b/g + Bluetooth Module: FCC ID: U9R-W2CBW003; Report #: R0703307-247 802.11

1.7 Test Methodology

All measurements contained in this report were conducted in accordance with ANSI C63.4-2003, American National Standard for Methods of Measurement of Radio-Noise Emissions from Low-Voltage Electrical and Electronic Equipment in the range of 9 kHz to 40 GHz.

1.8 Measurement Uncertainty

All measurements involve certain levels of uncertainties, especially in field of EMC. The factors contributing to uncertainties are spectrum analyzer, cable loss, antenna factor calibration, antenna directivity, antenna factor variation with height, antenna phase center variation, antenna factor frequency interpolation, measurement distance variation, site imperfections, mismatch (average), and system repeatability.

Based on NIS 81, The Treatment of Uncertainty in EMC Measurements, the values range from ± 2.0 for Conducted Emissions tests and ± 4.0 dB for Radiated Emissions tests are the most accurate estimates pertaining to uncertainty of EMC measurements at BACL.

Detailed instrumentation measurement uncertainties can be found in BACL report QAP-018.

All radiated and conducted emissions measurement was performed at Bay Area Compliance Laboratory, Corp. The radiated testing was performed at an antenna-to-EUT distance of 3 meters.

1.9 Test Facility

The test site used by BACL Corp. to collect radiated and conducted emissions measurement data is located at its facility in Sunnyvale, California, USA.

The test sites at BACL have been fully described in reports submitted to the Federal Communication Commission (FCC) and Voluntary Control Council for Interference (VCCI). The details of these reports has been found to be in compliance with the requirements of Section 2.948 of the FCC Rules on February 11 and

December 10, 1997 and Article 8 of the VCCI regulations on December 25, 1997. The facility also complies with the radiated and AC line conducted test site criteria set forth in ANSI C63.4-2003.

The Federal Communications Commission, Industry Canada, and Voluntary Control Council for Interference has the reports on file and is listed under FCC registration number: 90464, IC registration number: 3062A, and VCCI Registration Number: C-2463 and R-2698. The test site has been approved by the FCC, IC, and VCCI for public use and is listed in the FCC Public Access Link (PAL) database.

Additionally, BACL is a National Institute of Standards and Technology (NIST) accredited laboratory, under the National Voluntary Laboratory Accredited Program (Lab Code 200167-0). The current scope of accreditations can be found at <http://ts.nist.gov/Standards/scopes/2001670.htm>.

2 SYSTEM TEST CONFIGURATION

2.1 Justification

The host system was configured for testing according to ANSI C63.4-2003.

The EUT was tested in the testing mode to represent *worst-case* results during the final qualification test.

2.2 EUT Exercise Software

The EUT is programmed with the following data rate settings that were used during testing:

Type	Modulation / Data Rates	Frequency (MHz)		
		Low	Middle	High
802.11 b	CCK / 1Mbps	2412	2437	2462
802.11 g	OFDM / 6Mbps	2412	2437	2462

2.3 Special Accessories

There were no special accessories were required, included, or intended for use with EUT during these tests.

2.4 Equipment Modifications

No modifications were made to the EUT.

2.5 Local Support Equipment List and Details

Manufacturer	Description	Model	Serial Number
Lenovo	Laptop	6460	64607EU

2.6 Interface Ports and Cabling

Cable Description	Length (m)	Serial Number	From	To
Unshielded CAT5 cable	1	N/A	EUT	Laptop
Fiber Loopback x 2	0.1	AL-974-11-02300 LC	EUT	EUT
Fiber Loopback x 1	0.1	AL-671-07-01200 LC	EUT	EUT

2.7 Test Setup Block Diagrams

AC Line Conducted Emissions

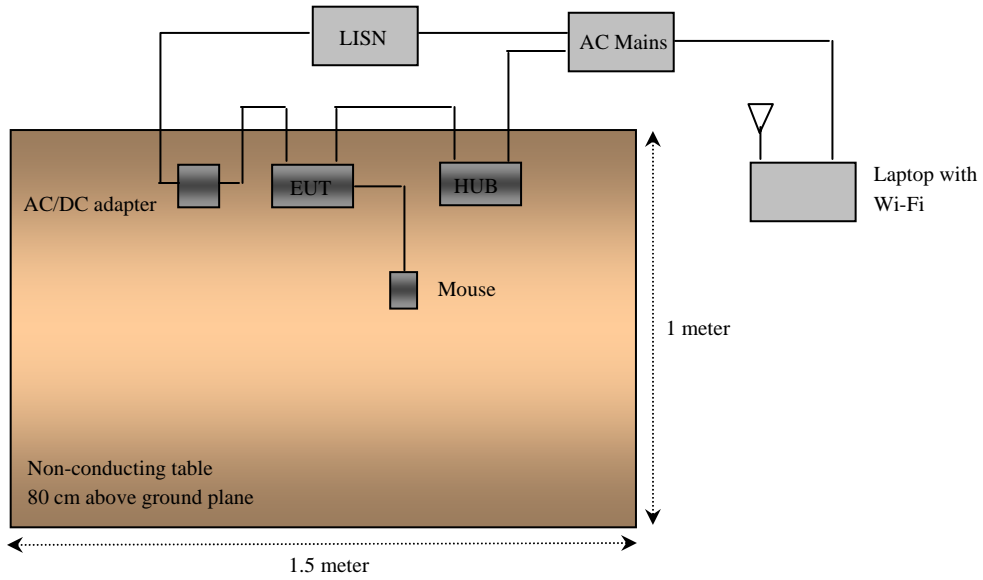

Transmitter Spurious Radiated Emissions

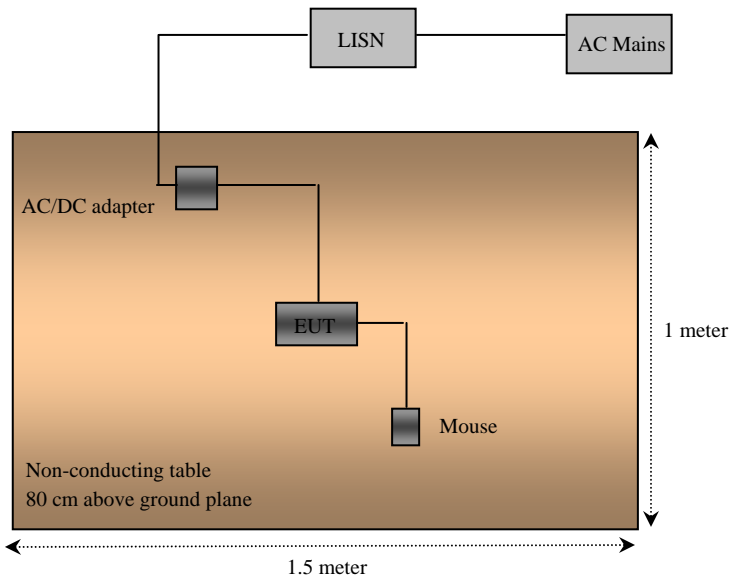

3 SUMMARY OF TEST RESULTS

Results reported relate only to the product tested.

FCC Rules	Description of Test	Results
§15.247 (i) §2.1091	RF Exposure	Compliant
§15.203	Antenna Requirement	Compliant
§ 15.207 (a)	Conducted Emissions	Compliant
§2.1051 §15.247 (d)	Spurious Emissions at Antenna Port	N/A*
§15.205	Restricted Bands	Compliant
§15.209 (a) §15.247 (d)	Radiated Spurious Emissions	Compliant
§15.247 (a)(2)	6 dB Bandwidth	N/A*
§15.247 (b)(3)	Maximum Peak Output Power	N/A*
§ 15.247 (d)	100 kHz Bandwidth of Frequency Band Edge	N/A*
§15.247 (e)	Power Spectral Density	N/A*

Note: N/A* Refer to Wi-Fi 802.11b/g module: FCC ID: U9R-W2CBW003; Report #: R0703307-247 802.11

4 §15.247 (i) and § 2.1091 - RF EXPOSURE

According to §15.247(i) and §1.1307(b)(1), systems operating under the provisions of this section shall be operated in a manner that ensures that the public is not exposed to radio frequency energy level in excess of the Commission's guidelines.

According to §1.1310 and §2.1091 RF exposure is calculated.

Limits for General Population/Uncontrolled Exposure

Frequency Range (MHz)	Electric Field Strength (V/m)	Magnetic Field Strength (A/m)	Power Density (mW/cm ²)	Averaging Time (minutes)
Limits for General Population/Uncontrolled Exposure				
0.3-1.34	614	1.63	*(100)	30
1.34-30	824/f	2.19/f	*(180/f ²)	30
30-300	27.5	0.073	0.2	30
300-1500	/	/	f/1500	30
1500-100,000	/	/	1.0	30

f = frequency in MHz

* = Plane-wave equivalent power density

4.1 MPE Prediction

Predication of MPE limit at a given distance

Equation from page 18 of OET Bulletin 65, Edition 97-01

$$S = PG/4\pi R^2$$

Where: S = power density

P = power input to antenna

G = power gain of the antenna in the direction of interest relative to an isotropic radiator

R = distance to the center of radiation of the antenna

802.11b Mode:

Maximum peak output power at antenna input terminal (dBm):	<u>15.24</u>
Maximum peak output power at antenna input terminal (mW):	<u>33.42</u>
Prediction distance(cm):	<u>20</u>
Prediction frequency(MHz):	<u>2437</u>
Antenna Gain (Maximum)(dBi):	<u>0</u>
Maximum Antenna Gain(numeric):	<u>1.0</u>
Power density at prediction frequency at 20 cm (mW/cm ²):	<u>0.00665</u>
MPE limit for uncontrolled exposure at predication frequency(mW/cm ²):	<u>1.0</u>

802.11g Mode:

Maximum peak output power at antenna input terminal (dBm):	<u>12.85</u>
Maximum peak output power at antenna input terminal (mW):	<u>19.28</u>
Prediction distance(cm):	<u>20</u>
Prediction frequency(MHz):	<u>2437</u>
Antenna Gain (maximum)(dBi):	<u>0</u>
Maximum Antenna Gain(numeric):	<u>1.0</u>
Power density at prediction frequency at 20 cm (mW/cm ²):	<u>0.00384</u>
MPE limit for uncontrolled exposure at predication frequency(mW/cm ²):	<u>1.0</u>

4.2 Results

The predicted power density level at 20 cm are 0.00665 mW/cm² for 802.11b mode and 0.00384 mW/cm² for 802.11g mode respectively and both are below the uncontrolled exposure limit of 1.0 mW/cm² at 2437 MHz. The EUT is used at least 20 cm away from user's body. It is determined as mobile equipment and complies with the MPE limit.

5 §15.203 - ANTENNA REQUIREMENT

5.1 Applicable Standard

According to § 15.203, an intentional radiator shall be designed to ensure that no antenna other than that furnished by the responsible party shall be used with the device. The use of a permanently attached antenna or of an antenna that uses a unique coupling to the intentional radiator shall be considered sufficient to comply with the provisions of this Section. The manufacturer may design the unit so that a broken antenna can be replaced by the user, but the use of a standard antenna jack or electrical connector is prohibited.

And according to § 15.247 (b) (4), if transmitting antennas of directional gain greater than 6 dBi are used the power shall be reduced by the amount in dB that the directional gain of the antenna exceeds 6 dBi.

5.2 Antenna Connector Construction

EUT has Transmitter/Receiver integral antenna which and features a permanent attachment to the EUT chassis as well as non-standard connector. The Transmitter antenna has a max gain of 0 dBi which fulfills the requirements of FCC rule 15.203, and the directional gain is less than 6 dBi thus not requiring reduction of the EUT output power.

Antenna Photo

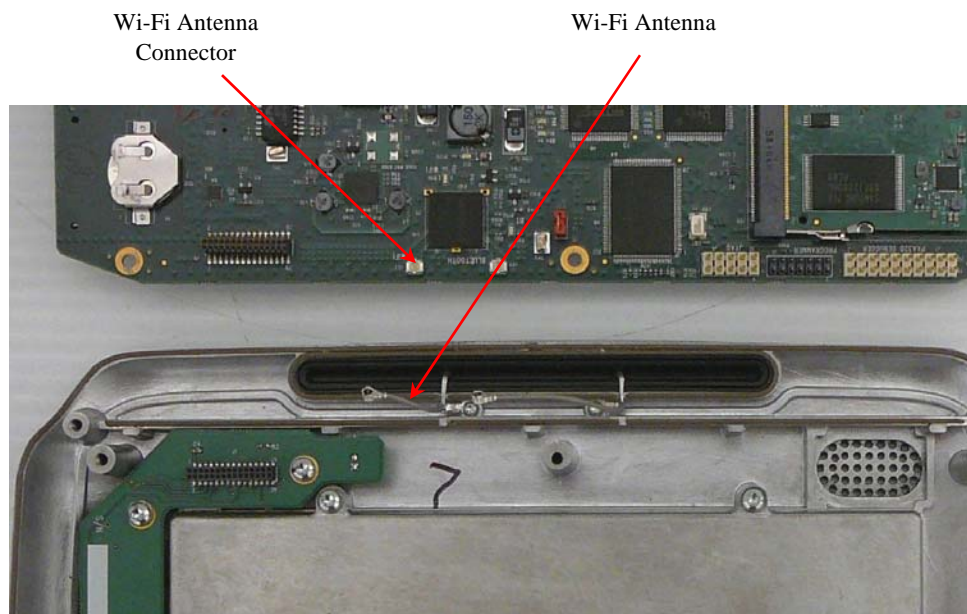

6 §15.207 - CONDUCTED EMISSIONS

6.1 Applicable Standard

Section 15.207 Conducted limits:

For an intentional radiator that is designed to be connected to the public utility (AC) power line, the radio frequency voltage that is conducted back onto the AC power line on any frequency or frequencies within the band 150 kHz to 30 MHz shall not exceed the limits in the following table, as measured using a 50 μ H/50 ohms line impedance stabilization network (LISN). Compliance with the provisions of this paragraph shall be based on the measurement of the radio frequency voltage between each power line and ground at the power terminal. The lower limit applies at the boundary between the frequencies ranges.

Frequency of Emission (MHz)	Conducted Limit (dBuV)	
	Quasi-Peak	Average
0.15-0.5	66 to 56 *	56 to 46 *
0.5-5	56	46
5-30	60	50

* Decreases with the logarithm of the frequency.

6.2 Test Setup

The measurement was performed at shield room, using the setup per ANSI C63.4 – 2003 measurement procedure. The specification used was FCC Part15.207 limits.

External I/O cables were draped along the edge of the test table and bundle when necessary.

The EUT AC/DC power adapter was connected with LISN-1 which provided 120 V / 60 Hz AC power.

6.3 Test Equipment List and Details

Manufacturer	Description	Model	Serial Number	Calibration Date
Solar Electronics	LISN	9252-R-24-BNC	511205	2008-07-31
Rohde & Schwarz	EMI Test Receiver	ESCI 1166.5950K03	100337	2009-04-21

* **Statement of Traceability: BACL Corp.** attests that all calibrations have been performed per the NVLAP requirements, traceable to the NIST.

6.4 Test Procedure

During the conducted emissions test, the power cord of the EUT host system was connected to the mains outlet of the LISN-2.

Maximizing procedure was performed on the six (6) highest emissions of the EUT.

All data was recorded in the peak detection mode, quasi-peak and average. Quasi-Peak readings are distinguished with a “QP”. Average readings are distinguished with an “Ave”.

6.5 Test Environmental Conditions

Temperature:	18-22 °C
Relative Humidity:	40-44 %
ATM Pressure:	101-103 kPa

**The testing was performed by Jerry Wang on 2009-04-16.*

6.6 Summary of Test Results

According to the recorded data in following table, the EUT complied with the FCC standard's conducted emissions limits, with the *worst* margin reading of:

Worst Case: 802.11b mode

Connection: AC/DC adapter connected to 120 V/60 Hz AC			
Margin (dB)	Frequency (MHz)	Conductor Mode (Line/Neutral)	Range (MHz)
-4.2	0.158	Line	0.15 to 30 MHz
-1.1	0.222	Neutral	0.15 to 30 MHz

6.7 Conducted Emissions Test Plots and Data

120V, 60Hz – Line

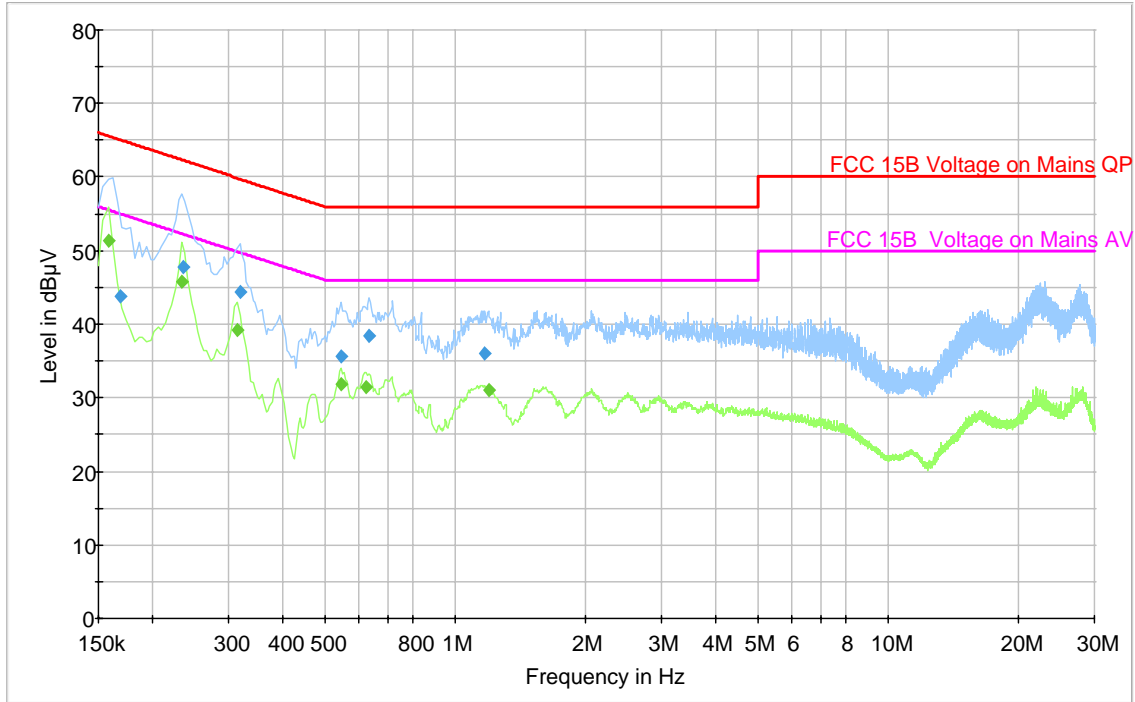

Quasi-Peak Measurement

Frequency (MHz)	Corrected Reading (dBuV)	Measurement Type	Conductor (L/N)	Limit (dBuV)	Margin (dB)
0.235	47.8	Quasi-Peak	L	62.3	-14.5
0.318	44.3	Quasi-Peak	L	59.8	-15.5
0.634	38.4	Quasi-Peak	L	56.0	-17.6
1.174	36.1	Quasi-Peak	L	56.0	-19.9
0.546	35.7	Quasi-Peak	L	56.0	-20.3
0.168	43.8	Quasi-Peak	L	65.4	-21.6

Average Measurement

Frequency (MHz)	Corrected Reading (dBuV)	Measurement Type	Conductor (L/N)	Limit (dBuV)	Margin (dB)
0.158	51.4	Average	L	55.6	-4.2
0.234	45.7	Average	L	52.3	-6.6
0.314	39.2	Average	L	49.9	-10.7
0.546	31.8	Average	L	46.0	-14.2
0.622	31.4	Average	L	46.0	-14.6
1.198	31.1	Average	L	46.0	-14.9

120V, 60Hz – Neutral

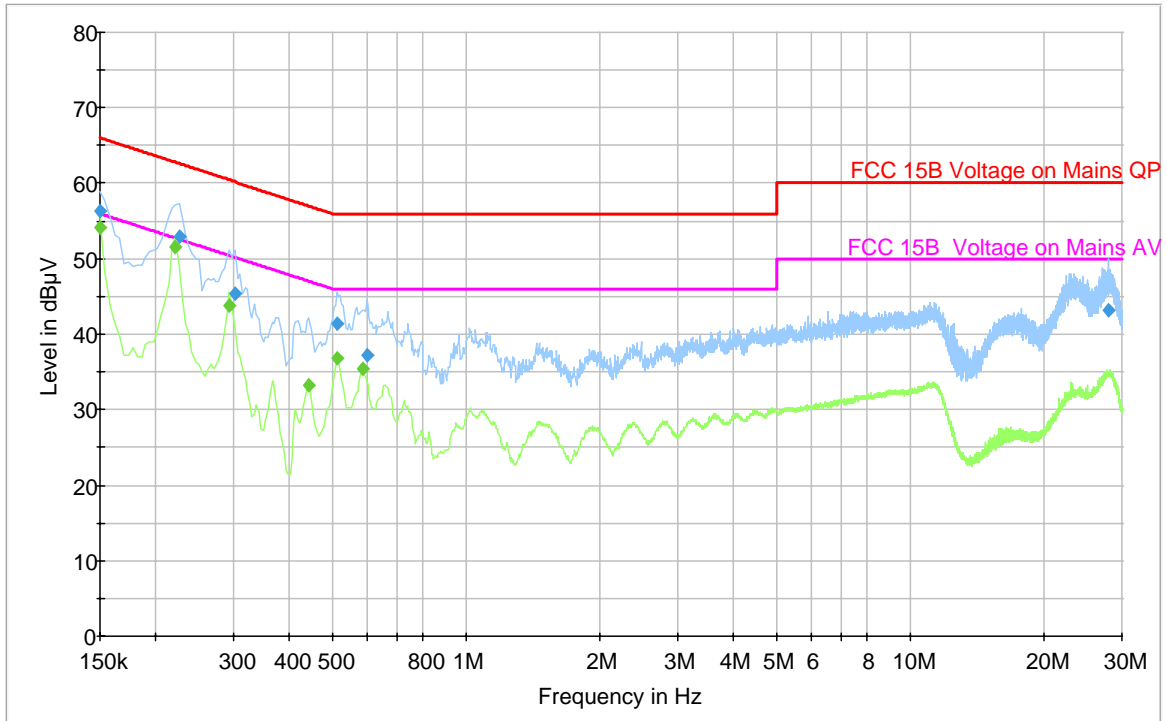

Quasi-Peak Measurement

Frequency (MHz)	Corrected Reading (dBµV)	Measurement Type	Conductor (L/N)	Limit (dBµV)	Margin (dB)
0.150	56.3	Quasi-Peak	N	66.0	-9.7
0.226	52.9	Quasi-Peak	N	62.6	-9.7
0.514	41.4	Quasi-Peak	N	56.0	-14.6
0.302	45.4	Quasi-Peak	N	60.2	-14.8
27.882	43.2	Quasi-Peak	N	60.0	-16.8
0.598	37.2	Quasi-Peak	N	56.0	-18.8

Average Measurement

Frequency (MHz)	Corrected Reading (dBµV)	Measurement Type	Conductor (L/N)	Limit (dBµV)	Margin (dB)
0.222	51.6	Average	N	52.7	-1.1
0.150	54.1	Average	N	56.0	-1.9
0.294	43.7	Average	N	50.4	-6.7
0.514	36.8	Average	N	46.0	-9.2
0.586	35.5	Average	N	46.0	-10.5
0.442	33.2	Average	N	47.0	-13.8

7 FCC §15.205, §15.209 & §15.247(d) - RADIATED SPURIOUS EMISSIONS

7.1 Applicable Standard

As per FCC §15.35(d): Unless otherwise specified, on any frequency or frequencies above 1000 MHz, the radiated emission limits are based on the use of measurement instrumentation employing an average detector function. Unless otherwise specified, measurements above 1000 MHz shall be performed using a minimum resolution bandwidth of 1 MHz.

As per FCC §15.209(a): Except as provided elsewhere in this Subpart, the emissions from an intentional radiator shall not exceed the field strength levels specified in the following table

Frequency (MHz)	Field Strength (micro volts/meter)	Measurement Distance (meters)
0.009 - 0.490	2400/F(kHz)	300
0.490 - 1.705	24000/F(kHz)	30
1.705 - 30.0	30	30
30 - 88	100**	3
88 - 216	150**	3
216 - 960	200**	3
Above 960	500	3

** Except as provided in paragraph (g), fundamental emissions from intentional radiators operating under this Section shall not be located in the frequency bands 54-72 MHz, 76-88 MHz, 174-216 MHz or 470-806 MHz. However, operation within these frequency bands is permitted under other sections of this Part, e.g., Sections 15.231 and 15.241.

As Per FCC §15.205(a) except as show in paragraph (d) of this section, only spurious emissions are permitted in any of the frequency bands listed below:

f (MHz)	f (MHz)	f (MHz)	f (GHz)
0.090 – 0.110	16.42 – 16.423	960 – 1240	4.5 – 5.15
0.495 – 0.505	16.69475 – 16.69525	1300 – 1427	5.35 – 5.46
2.1735 – 2.1905	25.5 – 25.67	1435 – 1626.5	7.25 – 7.75
4.125 – 4.128	37.5 – 38.25	1645.5 – 1646.5	8.025 – 8.5
4.17725 – 4.17775	73 – 74.6	1660 – 1710	9.0 – 9.2
4.20725 – 4.20775	74.8 – 75.2	1718.8 – 1722.2	9.3 – 9.5
6.215 – 6.218	108 – 121.94	2200 – 2300	10.6 – 12.7
6.26775 – 6.26825	123 – 138	2310 – 2390	13.25 – 13.4
6.31175 – 6.31225	149.9 – 150.05	2483.5 – 2500	14.47 – 14.5
8.291 – 8.294	156.52475 – 156.52525	2690 – 2900	15.35 – 16.2
8.362 – 8.366	156.7 – 156.9	3260 – 3267	17.7 – 21.4
8.37625 – 8.38675	162.0125 – 167.17	3.332 – 3.339	22.01 – 23.12
8.41425 – 8.41475	167.72 – 173.2	3 3458 – 3 358	23.6 – 24.0
12.29 – 12.293	240 – 285	3.600 – 4.400	31.2 – 31.8
12.51975 – 12.52025	322 – 335.4		36.43 – 36.5
12.57675 – 12.57725	399.9 – 410		Above 38.6
13.36 – 13.41	608 – 614		

As per FCC §15.247 (d) In any 100 kHz bandwidth outside the frequency band in which the spread spectrum or digitally modulated intentional radiator is operating, the radio frequency power that is produced by the intentional radiator shall be at least 20 dB below that in the 100 kHz bandwidth within the band that contains the highest level of the desired power, based on either an RF conducted or a radiated measurement, provided the

transmitter demonstrates compliance with the peak conducted power limits. If the transmitter complies with the conducted power limits based on the use of RMS averaging over a time interval, as permitted under paragraph (b)(3) of this section, the attenuation required under this paragraph shall be 30 dB instead of 20 dB. Attenuation below the general limits specified in §15.209(a) is not required. In addition, radiated emissions which fall in the restricted bands, as defined in §15.205(a), must also comply with the radiated emission limits specified in §15.209(a) (see §15.205(c)).

7.2 Test Setup

The radiated emissions tests were performed in the 5-meter Chamber, using the setup in accordance with ANSI C63.4-2003. The specification used was the FCC 15 Subpart C limits.

7.3 EUT Setup

The radiated emissions tests were performed using the setup accordance with the ANSI C63.4-2003. The specification used was the FCC 15C limits.

The spacing between the peripherals was 10 centimeters.

External I/O cables were draped along the edge of the test table and bundle when necessary.

7.4 Test Equipment List and Details

Manufacturers	Descriptions	Models	Serial Numbers	Calibration Dates
Mini-Circuits	Pre amplifier	ZKL-2	7786100643	2009-03-03
HP	Pre amplifier	8449B	3147A00400	2008-10-22
Sunol Science Corp	Combination Antenna	JB1 Antenna	A103105-3	2009-03-25
A. H. Systems	Antenna, Horn, DRG	DRG-118/A	1132	2008-07-28
Agilent	Spectrum Analyzer	E4440A	MY44303352	2008-04-28

* **Statement of Traceability:** BACL attests that all calibrations have been performed per the NVLAP requirements, traceable to NIST.

7.5 Test Procedure

Maximizing procedure was performed on the highest emissions to ensure that the EUT complied with all installation combinations.

The EUT is set 3 meters away from the testing antenna, which is varied from 1-4 meters, and the EUT is placed on a turntable, which is 0.8 meter above ground plane, the table shall be rotated for 360 degrees to find out the highest emission. The receiving antenna should be changed the polarization both of horizontal and vertical.

The spectrum analyzer or receiver is set as:

Below 1000MHz:

$$\text{RBW} = 100 \text{ kHz} / \text{VBW} = 300 \text{ kHz} / \text{Sweep} = \text{Auto}$$

Above 1000MHz:

- (1) Peak: RBW = 1MHz / VBW = 1MHz / Sweep = Auto
- (2) Average: RBW = 1MHz / VBW = 10Hz / Sweep = Auto

7.6 Corrected Amplitude & Margin Calculation

The Corrected Amplitude is calculated by adding the Antenna Factor and Cable Factor, and subtracting the Amplifier Gain from the Amplitude reading. The basic equation is as follows:

$$\text{Corrected Amplitude} = \text{Indicated Reading} + \text{Antenna Factor} + \text{Cable Factor} - \text{Amplifier Gain}$$

The “**Margin**” column of the following data tables indicates the degree of compliance with the applicable limit. For example, a margin of -7dB means the emission is 7dB below the maximum limit. The equation for margin calculation is as follows:

$$\text{Margin} = \text{Corrected Amplitude} - \text{Limit}$$

7.7 Test Environmental Conditions

Temperature:	21 °C
Relative Humidity:	40 %
ATM Pressure:	102.1 kPa

**The testing was performed by Jerry Wang from 2009-04-14 to 2009-04-17*

7.8 Summary of Test Results

According to the data hereinafter, the EUT complied with the FCC requirements, and had the worst margin readings of:

802.11b mode:

Harmonics & Spurious, (30 MHz – 25 GHz)

Mode: Transmitting			
Margin (dB)	Frequency (MHz)	Polarization (Horizontal/Vertical)	Channel, Range
-8.34	4824	Vertical	Low, 30 MHz – 25 GHz
-5.94	4874	Vertical	Mid, 30 MHz – 25 GHz
-7.20	4924	Vertical	High, 30 MHz – 25 GHz

802.11g mode:

Harmonics & Spurious, (30 MHz – 25 GHz)

Mode: Transmitting			
Margin (dB)	Frequency (MHz)	Polarization (Horizontal/Vertical)	Channel, Range
-11.80	4824	Vertical	Low, 30 MHz – 25 GHz
-10.87	4874	Vertical	Mid, 30 MHz – 25 GHz
-11.89	4924	Vertical	High, 30 MHz – 25 GHz

7.9 Radiated Emissions Test plot & data

1) 802.11b mode, Measured at 3 meters, 30 MHz -1 GHz

Low Channel 2412 MHz

Frequency (MHz)	Quasi-Peak (dB μ V/m)	Antenna Height (cm)	Correction Factor (dB)	Antenna Polarity (H/V)	Azimuth (degrees)	Limit (dB μ V/m)	Margin (dB)
-	-	-	-	-	-	-	-

Note: All Emission which is in the listed band according to FCC 15.205 (a) are at noise floor level.

Middle Channel 2437 MHz

Frequency (MHz)	Quasi-Peak (dB μ V/m)	Antenna Height (cm)	Correction Factor (dB)	Antenna Polarity (H/V)	Azimuth (degrees)	Limit (dB μ V/m)	Margin (dB)
-	-	-	-	-	-	-	-

Note: All Emission which is in the listed band according to FCC 15.205 (a) are at noise floor level.

High Channel 2462 MHz

Frequency (MHz)	Quasi-Peak (dB μ V/m)	Antenna Height (cm)	Correction Factor (dB)	Antenna Polarity (H/V)	Azimuth (degrees)	Limit (dB μ V/m)	Margin (dB)
-	-	-	-	-	-	-	-

Note: All Emission which is in the listed band according to FCC 15.205 (a) are at noise floor level.

2) 802.11b mode, Measured at 3 meters, 1-25 GHz

Low Channel 2412 MHz

Frequency (MHz)	S.A. Reading (dB μ V)	Azimuth Degrees	Ant. Height (m)	Ant. Polar. (H/V)	Ant. Factor (dB/m)	Cable Loss (dB)	Pre-Amp. (dB)	Cord. Reading (dB μ V/m)	Limit (dB μ V/m)	Margin (dB)	Comments
4824	40.91	121	1.08	V	33.5	9.79	38.54	45.66	54	-8.34	Ave.
4824	33.64	128	1.01	H	33.5	9.79	38.54	38.39	54	-15.61	Ave
4824	50.16	121	1.08	V	33.5	9.79	38.54	54.91	74	-19.09	Peak
4824	42.59	128	1.01	H	33.5	9.79	38.54	47.34	74	-26.66	Peak

Middle Channel 2437 MHz

Frequency (MHz)	S.A. Reading (dB μ V)	Azimuth Degrees	Ant. Height (m)	Ant. Polar. (H/V)	Ant. Factor (dB/m)	Cable Loss (dB)	Pre-Amp. (dB)	Cord. Reading (dB μ V/m)	Limit (dB μ V/m)	Margin (dB)	Comments
4874	43.27	220	1	V	33.4	9.79	38.4	48.06	54	-5.94	Ave.
4874	38.74	157	1	H	38	9.79	36.17	50.36	54	-3.64	Ave
4874	52.25	220	1	V	33.4	9.79	38.4	57.04	74	-16.96	Peak
4874	42.51	157	1	H	38	9.79	36.17	54.13	74	-19.87	Peak

High Channel 2462 MHz

Frequency (MHz)	S.A. Reading (dB μ V)	Azimuth Degrees	Ant. Height (m)	Ant. Polar. (H/V)	Ant. Factor (dB/m)	Cable Loss (dB)	Pre-Amp. (dB)	Cord. Reading (dB μ V/m)	Limit (dB μ V/m)	Margin (dB)	Comments
4924	41.81	120	1.2	V	33.6	9.79	38.4	46.8	54	-7.20	Ave.
4924	39.26	170	1	H	33.6	9.79	38.4	44.25	54	-9.75	Ave
4924	49.21	220	1.2	V	33.6	9.79	38.4	54.2	74	-19.80	Peak
4924	47.85	170	1	H	33.6	9.79	38.4	52.84	74	-21.16	Peak

3) Restricted Band Edge

Lowest Channel band edge

Frequency (MHz)	S.A. Reading (dB μ V)	Azimuth Degrees	Ant. Height (m)	Ant. Polar. (H/V)	Ant. Factor (dB/m)	Cable Loss (dB)	Pre-Amp. (dB)	Cord. Reading (dB μ V/m)	Limit (dB μ V/m)	Margin (dB)	Comments
2389.75	41.64	158	1.28	V	29	6.21	39.02	37.83	54	-16.17	Ave
2389.03	40.45	108	1.17	H	29	6.21	39.02	36.64	54	-17.36	Ave
2389.75	46.65	158	1.28	V	29	6.21	39.02	42.84	74	-31.16	Peak
2389.03	45.45	108	1.17	H	29	6.21	39.02	41.64	74	-32.36	Peak

Highest Channel band edge

Frequency (MHz)	S.A. Reading (dB μ V)	Azimuth Degrees	Ant. Height (m)	Ant. Polar. (H/V)	Ant. Factor (dB/m)	Cable Loss (dB)	Pre-Amp. (dB)	Cord. Reading (dB μ V/m)	Limit (dB μ V/m)	Margin (dB)	Comments
2489.73	41.87	180	1.1	V	29.2	6.34	39.25	38.16	54	-15.84	Ave
2488.69	40.78	160	1.32	H	29.2	6.34	39.25	37.07	54	-16.93	Ave
2489.73	46.24	180	1.1	V	29.2	6.34	39.25	42.53	74	-31.47	Peak
2488.69	45.65	160	1.32	H	29.2	6.34	39.25	41.94	74	-32.06	Peak

4) 802.11g mode, Measured at 3 meters, 30 MHz -1 GHz

Low Channel 2412 MHz

Frequency (MHz)	Quasi-Peak (dB μ V/m)	Antenna Height (cm)	Correction Factor (dB)	Antenna Polarity (H/V)	Azimuth (degrees)	Limit (dB μ V/m)	Margin (dB)
-	-	-	-	-	-	-	-

Note: All Emission which is in the listed band according to FCC 15.205 (a) are at noise floor level.

Middle Channel 2437 MHz

Frequency (MHz)	Quasi-Peak (dB μ V/m)	Antenna Height (cm)	Correction Factor (dB)	Antenna Polarity (H/V)	Azimuth (degrees)	Limit (dB μ V/m)	Margin (dB)
-	-	-	-	-	-	-	-

Note: All Emission which is in the listed band according to FCC 15.205 (a) are at noise floor level.

High Channel 2462 MHz

Frequency (MHz)	Quasi-Peak (dB μ V/m)	Antenna Height (cm)	Correction Factor (dB)	Antenna Polarity (H/V)	Azimuth (degrees)	Limit (dB μ V/m)	Margin (dB)
-	-	-	-	-	-	-	-

Note: All Emission which is in the listed band according to FCC 15.205 (a) are at noise floor level.

5) 802.11g mode, Measured at 3 meters, 1 GHz – 25 GHz

Low Channel 2412 MHz

Frequency (MHz)	S.A. Reading (dB μ V)	Azimuth Degrees	Ant. Height (m)	Ant. Polar. (H/V)	Ant. Factor (dB/m)	Cable Loss (dB)	Pre-Amp. (dB)	Cord. Reading (dB μ V/m)	Limit (dB μ V/m)	Margin (dB)	Comments
4824	37.45	210	1.19	V	33.5	9.79	38.54	42.20	54	-11.80	Ave.
4824	36.78	118	1.65	H	33.5	9.79	38.54	41.53	54	-12.47	Ave
4824	46.24	210	1.19	V	33.5	9.79	38.54	50.99	74	-23.01	Peak
4824	45.45	118	1.65	H	33.5	9.79	38.54	50.20	74	-23.80	Peak

Middle Channel 2437 MHz

Frequency (MHz)	S.A. Reading (dB μ V)	Azimuth Degrees	Ant. Height (m)	Ant. Polar. (H/V)	Ant. Factor (dB/m)	Cable Loss (dB)	Pre-Amp. (dB)	Cord. Reading (dB μ V/m)	Limit (dB μ V/m)	Margin (dB)	Comments
4874	38.34	218	1.2	V	33.4	9.79	38.4	43.13	54	-10.87	Ave.
4874	36.67	117	1.9	H	33.4	9.79	38.4	41.46	54	-12.54	Ave
4874	47.28	218	1.2	V	33.4	9.79	38.4	52.07	74	-21.93	Peak
4874	44.67	117	1.9	H	33.4	9.79	38.4	49.46	74	-24.54	Peak

High Channel 2462 MHz

Frequency (MHz)	S.A. Reading (dB μ V)	Azimuth Degrees	Ant. Height (m)	Ant. Polar. (H/V)	Ant. Factor (dB/m)	Cable Loss (dB)	Pre-Amp. (dB)	Cord. Reading (dB μ V/m)	Limit (dB μ V/m)	Margin (dB)	Comments
4924	37.12	102	1.46	V	33.6	9.79	-38.4	42.11	54	-11.89	Ave.
4924	36.12	180	1.2	H	33.6	9.79	-38.4	41.11	54	-12.89	Ave
4924	46.02	102	1.46	V	33.6	9.79	-38.4	51.01	74	-22.99	Peak
4924	45.45	180	1.2	H	33.6	9.79	-38.4	50.44	74	-23.56	Peak

6) Restricted Band Edge

Lowest Channel band edge

Frequency (MHz)	S.A. Reading (dB μ V)	Azimuth Degrees	Ant. Height (m)	Ant. Polar. (H/V)	Ant. Factor (dB/m)	Cable Loss (dB)	Pre-Amp. (dB)	Cord. Reading (dB μ V/m)	Limit (dB μ V/m)	Margin (dB)	Comments
2390.45	33.56	217	1.24	V	29	6.21	39.02	29.75	54	-24.25	Ave
2389.17	35.23	265	1.32	H	29	6.21	39.02	31.42	54	-22.58	Ave
2390.45	46.82	217	1.24	V	29	6.21	39.02	43.01	74	-30.99	Peak
2389.17	44.77	265	1.32	H	29	6.21	39.02	40.96	74	-33.04	Peak

Highest Channel band edge

Frequency (MHz)	S.A. Reading (dB μ V)	Azimuth Degrees	Ant. Height (m)	Ant. Polar. (H/V)	Ant. Factor (dB/m)	Cable Loss (dB)	Pre-Amp. (dB)	Cord. Reading (dB μ V/m)	Limit (dB μ V/m)	Margin (dB)	Comments
2487.13	35.12	120	1.33	V	29.2	6.34	39.25	31.41	54	-22.59	Ave
2488.52	34.76	180	1.08	H	29.2	6.34	39.25	31.05	54	-22.95	Ave
2487.13	43.26	120	1.33	V	29.2	6.34	39.25	39.55	74	-34.45	Peak
2488.52	43.78	180	1.08	H	29.2	6.34	39.25	40.07	74	-33.93	Peak