



FCC TEST REPORT

REPORT NO.: RF960705H04
MODEL NO.: Meraki Outdoor
RECEIVED: May 07, 2007
TESTED: Aug. 08 to Sep. 06, 2007
ISSUED: Sep. 07, 2007

APPLICANT: Meraki Networks, Inc.

ADDRESS: 313 West Evelyn Ave. Mountain View, CA 94041

ISSUED BY: Advance Data Technology Corporation

TEST LOCATION: No. 81-1, Lu Liao Keng, 9 Ling, Wu Lung
Tsuen, Chiung Lin Hsiang, Hsin Chu Hsien,
Taiwan, R.O.C.

This test report consists of 169 pages in total. It may be duplicated completely for legal use with the approval of the applicant. It should not be reproduced except in full, without the written approval of our laboratory. The client should not use it to claim product endorsement by TAF, A2LA or any government agencies. The test results in the report only apply to the tested sample.



No. 2177-01

Table of Contents

1.	CERTIFICATION	4
2.	SUMMARY OF TEST RESULTS	5
2.1	MEASUREMENT UNCERTAINTY	5
3.	GENERAL INFORMATION	6
3.1	GENERAL DESCRIPTION OF EUT	6
3.2	DESCRIPTION OF TEST MODES	8
3.2.1	TEST MODE APPLICABILITY AND TESTED CHANNEL DETAIL:	9
3.3	GENERAL DESCRIPTION OF APPLIED STANDARDS	11
3.4	DESCRIPTION OF SUPPORT UNITS	12
3.5	CONFIGURATION OF SYSTEM UNDER TEST	13
4.	TEST TYPES AND RESULTS	15
4.1	CONDUCTED EMISSION MEASUREMENT	15
4.1.1	LIMITS OF CONDUCTED EMISSION MEASUREMENT	15
4.1.2	TEST INSTRUMENTS	15
4.1.3	TEST PROCEDURES	16
4.1.4	DEVIATION FROM TEST STANDARD	16
4.1.5	TEST SETUP	17
4.1.6	EUT OPERATING CONDITIONS	17
4.1.7	TEST RESULTS – Adapter Mode with adapter 1	18
4.1.8	TEST RESULTS – PoE Mode with Adapter 1	20
4.1.9	TEST RESULTS – Adapter Mode with adapter 2	22
4.1.10	TEST RESULTS – PoE Mode with Adapter 2	24
4.2	RADIATED EMISSION MEASUREMENT	26
4.2.1	LIMITS OF RADIATED EMISSION MEASUREMENT	26
4.2.2	TEST INSTRUMENTS	27
4.2.3	TEST PROCEDURES	28
4.2.4	DEVIATION FROM TEST STANDARD	28
4.2.5	TEST SETUP	29
4.2.6	EUT OPERATING CONDITIONS	29
4.2.7	TEST RESULTS (Antenna 1)	30
4.2.8	TEST RESULTS (Antenna 2)	45
4.2.9	TEST RESULTS (Antenna 3)	60
4.2.10	TEST RESULTS (Antenna 4)	75
4.3	6dB BANDWIDTH MEASUREMENT	90
4.3.1	LIMITS OF 6dB BANDWIDTH MEASUREMENT	90
4.3.2	TEST INSTRUMENTS	90
4.3.3	TEST PROCEDURE	91
4.3.4	DEVIATION FROM TEST STANDARD	91
4.3.5	TEST SETUP	91



4.3.6	EUT OPERATING CONDITIONS.....	91
4.3.7	TEST RESULTS (ANTENNA 1).....	92
4.3.8	TEST RESULTS (ANTENNA 2).....	98
4.3.9	TEST RESULTS (ANTENNA 3).....	104
4.3.10	TEST RESULTS (ANTENNA 4).....	110
4.4	MAXIMUM PEAK OUTPUT POWER.....	116
4.4.1	LIMITS OF MAXIMUM PEAK OUTPUT POWER MEASUREMENT.....	116
4.4.2	INSTRUMENTS.....	116
4.4.3	TEST PROCEDURES.....	117
4.4.4	DEVIATION FROM TEST STANDARD.....	117
4.4.5	TEST SETUP.....	117
4.4.6	EUT OPERATING CONDITIONS.....	117
4.4.7	TEST RESULTS.....	118
4.5	POWER SPECTRAL DENSITY MEASUREMENT.....	120
4.5.1	LIMITS OF POWER SPECTRAL DENSITY MEASUREMENT.....	120
4.5.2	TEST INSTRUMENTS.....	120
4.5.3	TEST PROCEDURE.....	121
4.5.4	DEVIATION FROM TEST STANDARD.....	121
4.5.5	TEST SETUP.....	121
4.5.6	EUT OPERATING CONDITION.....	121
4.5.7	TEST RESULTS (ANTENNA 1).....	122
4.5.8	TEST RESULTS (ANTENNA 2).....	128
4.5.9	TEST RESULTS (ANTENNA 3).....	134
4.5.10	TEST RESULTS (ANTENNA 4).....	140
4.6	BAND EDGES MEASUREMENT.....	146
4.6.1	LIMITS OF BAND EDGES MEASUREMENT.....	146
4.6.2	TEST INSTRUMENTS.....	146
4.6.3	TEST PROCEDURE.....	146
4.6.4	EUT OPERATING CONDITION.....	146
4.6.5	TEST RESULTS (ANTENNA 1).....	147
4.6.6	TEST RESULTS (ANTENNA 2).....	152
4.6.7	TEST RESULTS (ANTENNA 3).....	157
4.6.8	TEST RESULTS (ANTENNA 4).....	162
4.7	ANTENNA REQUIREMENT.....	167
4.7.1	STANDARD APPLICABLE.....	167
4.7.2	ANTENNA CONNECTED CONSTRUCTION.....	167
5.	INFORMATION ON THE TESTING LABORATORIES.....	168
6.	APPENDIX A - MODIFICATIONS RECORDERS FOR ENGINEERING CHANGES TO THE EUT BY THE LAB.....	169



1. CERTIFICATION

PRODUCT: 802.11b/g Wireless Access Point
BRAND NAME: Meraki
MODEL NO.: Meraki Outdoor
TEST SAMPLE: R&D SAMPLE
TESTED: Aug. 08 to Sep. 06, 2007
APPLICANT: Meraki Networks, Inc.
STANDARDS: FCC Part 15, Subpart C (Section 15.247),
ANSI C63.4-2003

The above equipment (Model: Meraki Outdoor) has been tested by **Advance Data Technology Corporation**, and found compliance with the requirement of the above standards. The test record, data evaluation & Equipment Under Test (EUT) configurations represented herein are true and accurate accounts of the measurements of the sample's EMC characteristics under the conditions specified in this report.

PREPARED BY :  , **DATE:** Sep. 07, 2007
(Sunny Wen, Specialist)

TECHNICAL ACCEPTANCE :  , **DATE:** Sep. 07, 2007
Responsible for RF (Hank Chung, Deputy Manager)

APPROVED BY :  , **DATE:** Sep. 07, 2007
(May Chen, Deputy Manager)

2. SUMMARY OF TEST RESULTS

The EUT has been tested according to the following specifications:

APPLIED STANDARD: FCC Part 15, Subpart C (Section 15.247)			
Standard Section	Test Type and Limit	Result	Remark
15.207	AC Power Conducted Emission	PASS	Meet the requirement of limit Minimum passing margin is -3.15 dB at 0.248 MHz
15.247(a)(2)	Spectrum Bandwidth of a Direct Sequence Spread Spectrum System Limit: min. 500kHz	PASS	Meet the requirement of limit
15.247(b)	Maximum Peak Output Power Limit: max. 30dBm	PASS	Meet the requirement of limit
15.247(c)	Transmitter Radiated Emissions Limit: Table 15.209	PASS	Meet the requirement of limit Minimum passing margin is -0.20 dB at 2483.50 MHz
15.247(d)	Power Spectral Density Limit: max. 8dBm	PASS	Meet the requirement of limit
15.247(c)	Band Edge Measurement Limit: 20 dB less than the peak value of fundamental frequency	PASS	Meet the requirement of limit

2.1 MEASUREMENT UNCERTAINTY

Where relevant, the following measurement uncertainty levels have been estimated for tests performed on the EUT as specified in CISPR 16-4:

This uncertainty represents an expanded uncertainty expressed at approximately the 95% confidence level using a coverage factor of k=2.

Measurement	Value
Conducted emissions	2.41 dB
Radiated emissions (30MHz-1GHz)	3.89 dB
Radiated emissions (1GHz -18GHz)	2.21 dB
Radiated emissions (18GHz -40GHz)	1.88 dB



3. GENERAL INFORMATION

3.1 GENERAL DESCRIPTION OF EUT

EUT	802.11b/g Wireless Access Point
MODEL NO.	Meraki Outdoor
FCC ID	UDX-MERAKI-OTDR
POWER SUPPLY	DC 15V from Adapter or PoE (Power over Ethernet)
MODULATION TYPE	CCK, DQPSK, DBPSK for DSSS 64QAM, 16QAM, QPSK, BPSK for OFDM
MODULATION TECHNOLOGY	DSSS, OFDM
TRANSFER RATE	802.11b: 11/5.5/2/1Mbps 802.11g: 54/48/36/24/18/12/9/6Mbps
FREQUENCY RANGE	2412 ~ 2462MHz
NUMBER OF CHANNEL	11
CHANNEL SPACING	5MHz
OUTPUT POWER	802.11b: 193.642mW 802.11g: 248.886mW
DATA CABLE	UTP cable (unshielded, 50m)
POWER CORE	NA
ANTENNA TYPE	Please see note 2 (on next page)
I/O PORTS	RJ45 port x 2
ASSOCIATED DEVICES	NA

NOTE:

- The EUT was operated with the following power adapters or PoE:

Power adapter 1	
BRAND:	DVE
MODEL:	DSA-15P-15 US 150120
INPUT:	AC 100~240V, 0.5A, 50~60Hz
OUTPUT:	DC 15V, 0.8A, 1.8m / nonshield
Power adapter 2	
BRAND:	LEI
MODEL:	MU12-2150080-A1
INPUT:	AC 100~240V, 0.5A, 50~60Hz
OUTPUT:	DC 15V, 0.8A, 1.5m / nonshield

For radiated emission, the EUT was pre-tested with above adapters, the worse case was found in Adapter 1. Its test data was recorded in this report individually.

PoE	
BRAND:	PCH
MODEL:	72-112BFE101
INPUT:	DC15V, 0.8A
OUTPUT:	DC 15V, 0.8A

- There are four antennas provided to this EUT, please refer to the following table:

No.	Model No.	Gain (dBi)	Cable lose (dB)	Net Gain (dBi)	Antenna Type	Connector
1	RFANT5220110A0T	2	0	2	Chip	NA
2	ODU-OA-24-0201-A-W	2	0	2	Omni-Directional (Dipole)	RP SMA Plug
3	ODU-OA-24-0701-A	7	0	7	Omni-Directional (Dipole)	RP SMA Plug
4	ODU-DA-24-0904-A2	9	1.5	7.5	Directional (Panel)	RP SMA Jack

- The EUT operates in the 2.4GHz frequency spectrum with throughput of up to 54Mbps.
- The EUT complies with IEEE 802.11g standards, and backwards compatible with IEEE 802.11b products.
- The above EUT information was declared by the manufacturer and for more detailed features description, please refer to the manufacturer's specifications or User's Manual.

3.2 DESCRIPTION OF TEST MODES

Operated in 2400 ~ 2483.5MHz band:

For 802.11b/g: Eleven channels are provided to this EUT.

Channel	Frequency	Channel	Frequency
1	2412 MHz	7	2442 MHz
2	2417 MHz	8	2447 MHz
3	2422 MHz	9	2452 MHz
4	2427 MHz	10	2457 MHz
5	2432 MHz	11	2462 MHz
6	2437 MHz		

3.2.1 TEST MODE APPLICABILITY AND TESTED CHANNEL DETAIL:

EUT configure mode	Applicable to				Description
	PLC	RE<1G	RE≥1G	APCM	
-	√	√	√	√	NA

Where PLC: Power Line Conducted Emission

RE<1G RE: Radiated Emission below 1GHz

RE≥1G: Radiated Emission above 1GHz

APCM: Antenna Port Conducted Measurement

Power Line Conducted Emission Test:

- Pre-Scan has been conducted to determine the worst-case mode from all possible combinations between available modulations, data rates and antenna ports (if EUT with antenna diversity architecture).
- Following channel(s) was (were) selected for the final test as listed below.

Mode	Available Channel	Tested Channel	Modulation Technology	Modulation Type	Data Rate (Mbps)
802.11b	1 to 11	1	DSSS	CCK	1

- The EUT was tested as the following test modes:

Test Mode	Description
Mode 1	Adapter Mode with adapter 1
Mode 2	PoE Mode with adapter 1
Mode 3	Adapter Mode with adapter 2
Mode 4	PoE Mode with adapter 2

Radiated Emission Test (Below 1 GHz):

- Pre-Scan has been conducted to determine the worst-case mode from all possible combinations between available modulations, data rates and antenna ports (if EUT with antenna diversity architecture).
- Following channel(s) was (were) selected for the final test as listed below.

Mode	Available Channel	Tested Channel	Modulation Technology	Modulation Type	Data Rate (Mbps)
802.11b	1 to 11	1	DSSS	CCK	1

- For spurious emissions (below 1GHz), the EUT was pre-tested in chamber as the following test modes:

Test Mode	Description
Mode 1	With Adapter
Mode 2	With PoE

Mode 1, the worse case one, was chosen for final test.

Radiated Emission Test (Above 1 GHz):

- Pre-Scan has been conducted to determine the worst-case mode from all possible combinations between available modulations, data rates and antenna ports (if EUT with antenna diversity architecture).
- Following channel(s) was (were) selected for the final test as listed below.

Mode	Available Channel	Tested Channel	Modulation Technology	Modulation Type	Data Rate (Mbps)
802.11b	1 to 11	1, 6, 11	DSSS	CCK	1
802.11g	1 to 11	1, 6, 11	OFDM	BPSK	6

Bandedge Measurement:

- Pre-Scan has been conducted to determine the worst-case mode from all possible combinations between available modulations, data rates and antenna ports (if EUT with antenna diversity architecture).
- Following channel(s) was (were) selected for the final test as listed below.

Mode	Available Channel	Tested Channel	Modulation Technology	Modulation Type	Data Rate (Mbps)
802.11b	1 to 11	1, 11	DSSS	CCK	1
802.11g	1 to 11	1, 11	OFDM	BPSK	6

Antenna Port Conducted Measurement:

- Pre-Scan has been conducted to determine the worst-case mode from all possible combinations between available modulations, data rates and antenna ports (if EUT with antenna diversity architecture).
- Following channel(s) was (were) selected for the final test as listed below.

Mode	Available Channel	Tested Channel	Modulation Technology	Modulation Type	Data Rate (Mbps)
802.11b	1 to 11	1, 6, 11	DSSS	CCK	11
802.11g	1 to 11	1, 6, 11	OFDM	BPSK	6



3.3 GENERAL DESCRIPTION OF APPLIED STANDARDS

The EUT is an 802.11b/g Wireless Access Point. According to the specifications of the manufacturer, it must comply with the requirements of the following standards:

FCC Part 15, Subpart C. (15.247)

ANSI C63.4-2003

All test items have been performed and recorded as per the above standards.

NOTE: The EUT is also considered as a kind of computer peripheral, because the connection to computer is necessary for typical use. It has been verified to comply with the requirements of FCC Part 15, Subpart B, Class B (DoC). The test report has been issued separately.



3.4 DESCRIPTION OF SUPPORT UNITS

The EUT has been tested as an independent unit together with other necessary accessories or support units. The following support units or accessories were used to form a representative test configuration during the tests.

NO.	PRODUCT	BRAND	MODEL NO.	SERIAL NO.	FCC ID
1	NOTEBOOK COMPUTER	DELL	PP18L	6976685584	DoC
2	NOTEBOOK COMPUTER	DELL	PP19L	CN-OHC416-70166- 5CA-0448	PIW632500516610

NO.	SIGNAL CABLE DESCRIPTION OF THE ABOVE SUPPORT UNITS
1	NA
2	NA

NOTE: All power cords of the above support units are non shielded (1.8m).

3.5 CONFIGURATION OF SYSTEM UNDER TEST

For Adapter Mode :

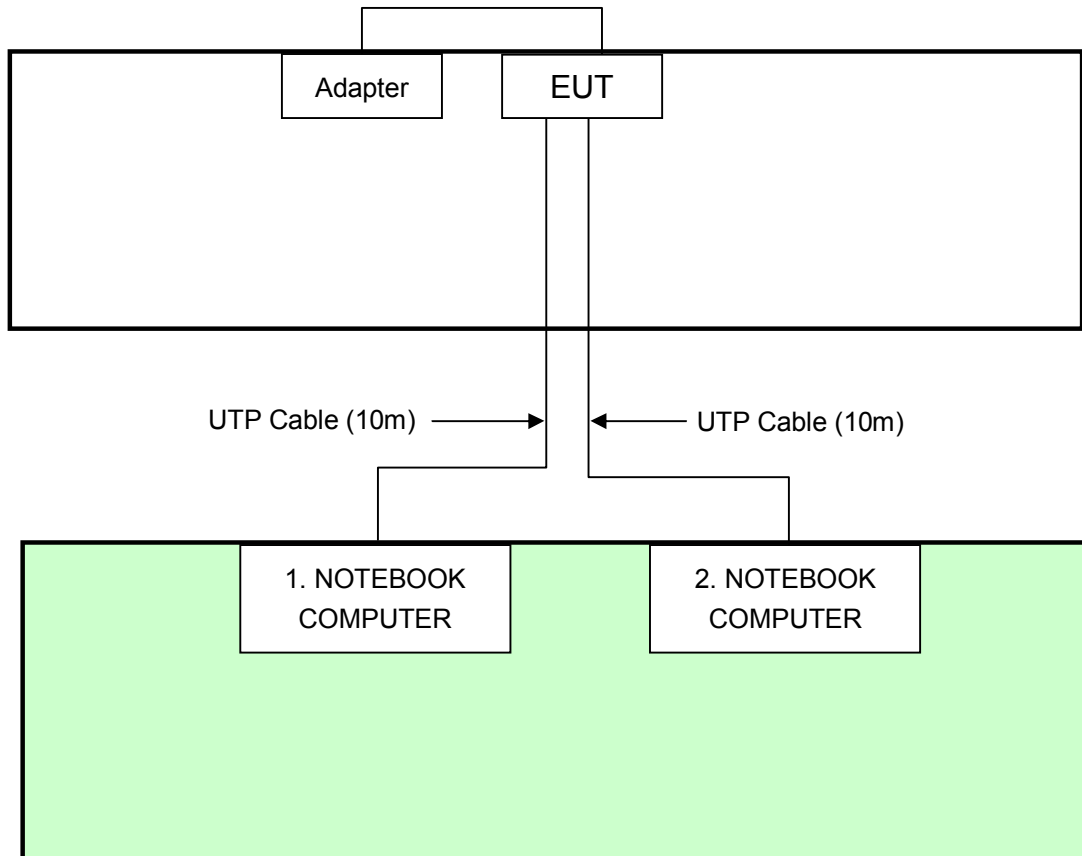

For PoE Mode :

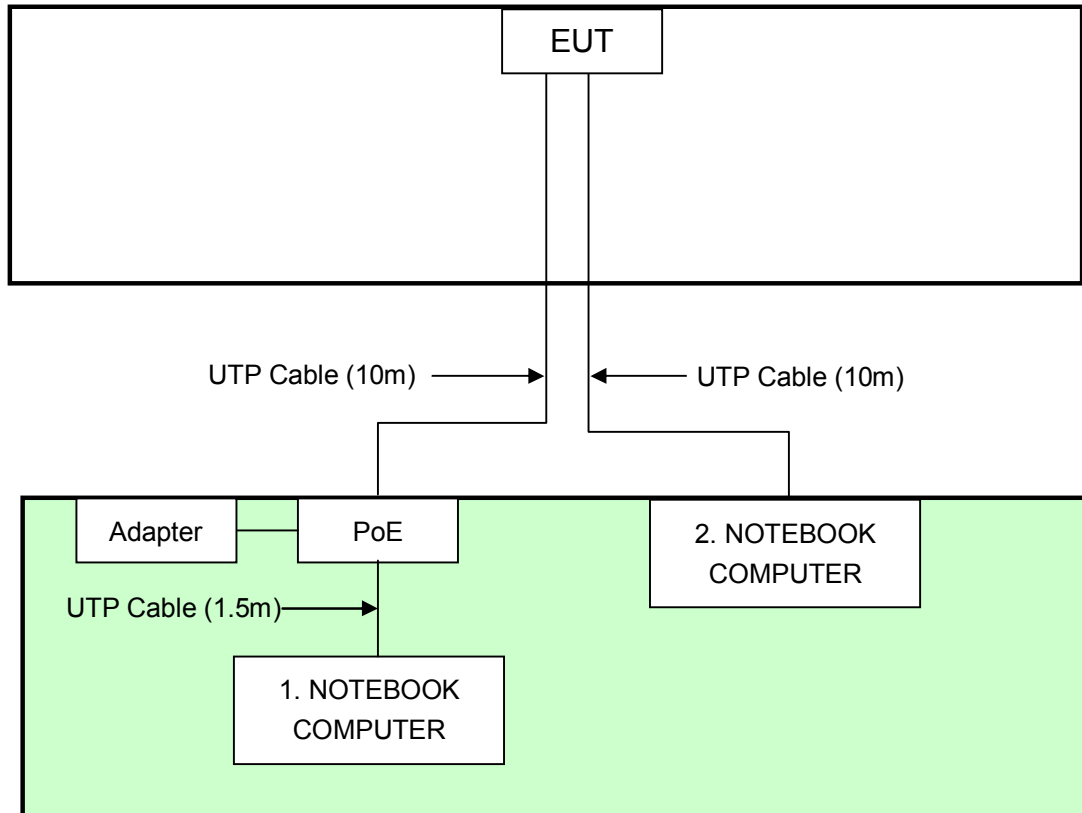

4. TEST TYPES AND RESULTS

4.1 CONDUCTED EMISSION MEASUREMENT

4.1.1 LIMITS OF CONDUCTED EMISSION MEASUREMENT

FREQUENCY OF EMISSION (MHz)	CONDUCTED LIMIT (dB μ V)	
	Quasi-peak	Average
0.15-0.5	66 to 56	56 to 46
0.5-5	56	46
5-30	60	50

- NOTE:**
1. The lower limit shall apply at the transition frequencies.
 2. The limit decreases in line with the logarithm of the frequency in the range of 0.15 to 0.50 MHz.
 3. All emanations from a class A/B digital device or system, including any network of conductors and apparatus connected thereto, shall not exceed the level of field strengths specified above.

4.1.2 TEST INSTRUMENTS

DESCRIPTION & MANUFACTURER	MODEL NO.	SERIAL NO.	CALIBRATED UNTIL
ROHDE & SCHWARZ Test Receiver	ESCS 30	100287	Mar. 06, 2008
Line-Impedance Stabilization Network(for EUT)	ENV-216	100072	Oct. 20, 2007
Line-Impedance Stabilization Network(for Peripheral)	KNW-407	8-1395-12	Aug. 19, 2008
RF Cable (JETBAO)	RG5B/U-6m	COACAB-9KHz-30MHz	Aug. 15, 2008
Terminator	50	1	Oct. 30, 2007
Software	ADT_Cond_V7.3.2	NA	NA

- NOTE:**
1. The calibration interval of the above test instruments is 12 months and the calibrations are traceable to NML/ROC and NIST/USA.
 2. The test was performed in ADT Shielded Room No. A.
 3. The VCCI Con A Registration No. is C-817.



4.1.3 TEST PROCEDURES

- a. The EUT was placed 0.4 meters from the conducting wall of the shielded room with EUT being connected to the power mains through a line impedance stabilization network (LISN). Other support units were connected to the power mains through another LISN. The two LISNs provide 50 ohm/ 50uH of coupling impedance for the measuring instrument.
- b. Both lines of the power mains connected to the EUT were checked for maximum conducted interference.
- c. The frequency range from 150kHz to 30MHz was searched. Emission levels under (Limit - 20dB) were not recorded.

4.1.4 DEVIATION FROM TEST STANDARD

No deviation

4.1.5 TEST SETUP

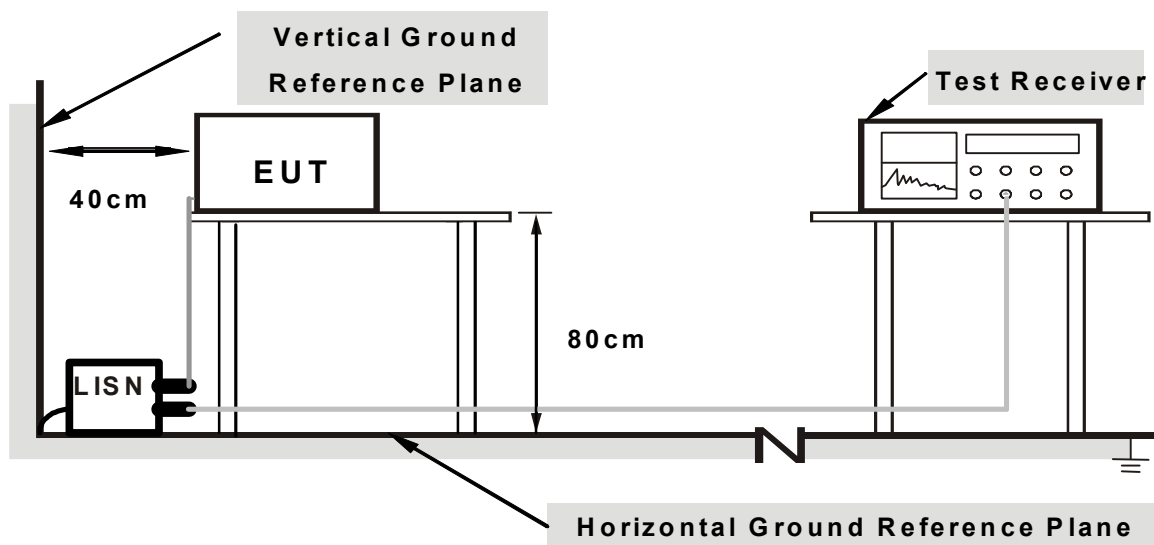

Note: 1. Support units were connected to second LISN.

2. Both of LISNs (AMN) are 80 cm from EUT and at least 80 from other units and other metal planes

For the actual test configuration, please refer to the related item – Photographs of the Test Configuration.

4.1.6 EUT OPERATING CONDITIONS

- a. Placed the EUT on the testing table.
- b. Prepared other computer systems to act as a communication partner and placed them outside of testing area.
- c. The communication partner run test program “ART 53 Build 58” to enable EUT under transmission/receiving condition continuously at specific channel frequency via UTP cable.

4.1.7 TEST RESULTS – Adapter Mode with adapter 1 Conducted Worst-Case Data

MODULATION TYPE	CCK	6dB BANDWIDTH	9 kHz
INPUT POWER (SYSTEM)	120Vac, 60 Hz	TRANSFER RATE	1Mbps
ENVIRONMENTAL CONDITIONS	27 deg. C, 60 %RH, 961 hPa	PHASE	Line (L)
TESTED BY	Kevin Huang		

No	Freq. [MHz]	Corr. Factor (dB)	Reading Value [dB (uV)]		Emission Level [dB (uV)]		Limit [dB (uV)]		Margin (dB)	
			Q.P.	AV.	Q.P.	AV.	Q.P.	AV.	Q.P.	AV.
			1	0.248	0.38	53.17	48.31	53.55	48.69	61.84
2	0.295	0.35	49.31	-	49.66	-	60.40	50.40	-10.73	-
3	0.392	0.30	47.03	-	47.33	-	58.02	48.02	-10.68	-
4	0.505	0.30	43.68	-	43.98	-	56.00	46.00	-12.02	-
5	9.578	0.49	50.58	44.77	51.07	45.26	60.00	50.00	-8.93	-4.74
6	11.691	0.60	50.43	44.29	51.03	44.89	60.00	50.00	-8.97	-5.11

- REMARKS:**
1. Q.P. and AV. are abbreviations of quasi-peak and average individually.
 2. "-": The Quasi-peak reading value also meets average limit and measurement with the average detector is unnecessary.
 3. The emission levels of other frequencies were very low against the limit.
 4. Margin value = Emission level - Limit value
 5. Correction factor = Insertion loss + Cable loss
 6. Emission Level = Correction Factor + Reading Value.

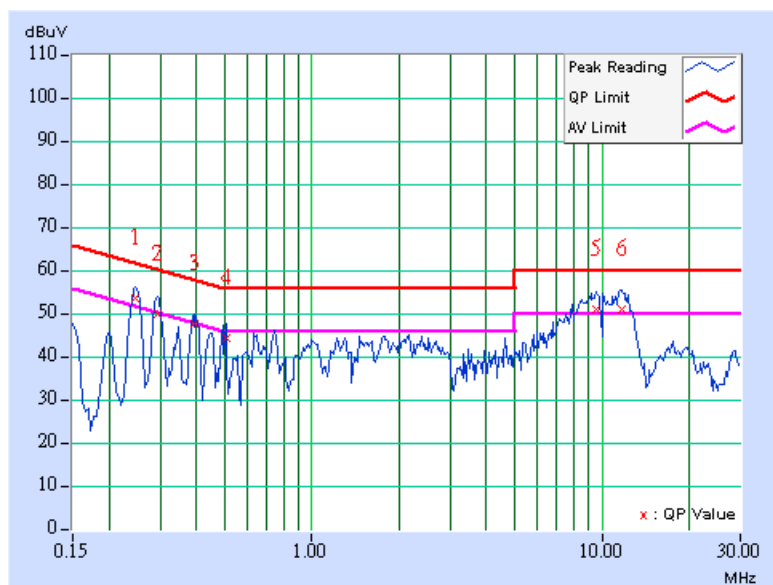

MODULATION TYPE	CCK	6dB BANDWIDTH	9 kHz
INPUT POWER (SYSTEM)	120Vac, 60 Hz	TRANSFER RATE	1Mbps
ENVIRONMENTAL CONDITIONS	27 deg. C, 60 %RH, 961 hPa	PHASE	Neutral (N)
TESTED BY	Kevin Huang		

No	Freq. [MHz]	Corr. Factor (dB)	Reading Value [dB (uV)]		Emission Level [dB (uV)]		Limit [dB (uV)]		Margin (dB)	
			Q.P.	AV.	Q.P.	AV.	Q.P.	AV.	Q.P.	AV.
			1	0.244	0.38	50.38	-	50.76	-	61.97
2	0.249	0.38	50.42	-	50.80	-	61.78	51.78	-10.99	-
3	0.500	0.30	38.23	-	38.53	-	56.00	46.00	-17.47	-
4	9.301	0.58	48.90	-	49.48	-	60.00	50.00	-10.52	-
5	11.793	0.67	47.53	-	48.20	-	60.00	50.00	-11.80	-
6	17.855	0.86	35.36	-	36.22	-	60.00	50.00	-23.78	-

- REMARKS:**
1. Q.P. and AV. are abbreviations of quasi-peak and average individually.
 2. "-": The Quasi-peak reading value also meets average limit and measurement with the average detector is unnecessary.
 3. The emission levels of other frequencies were very low against the limit.
 4. Margin value = Emission level - Limit value
 5. Correction factor = Insertion loss + Cable loss
 6. Emission Level = Correction Factor + Reading Value.

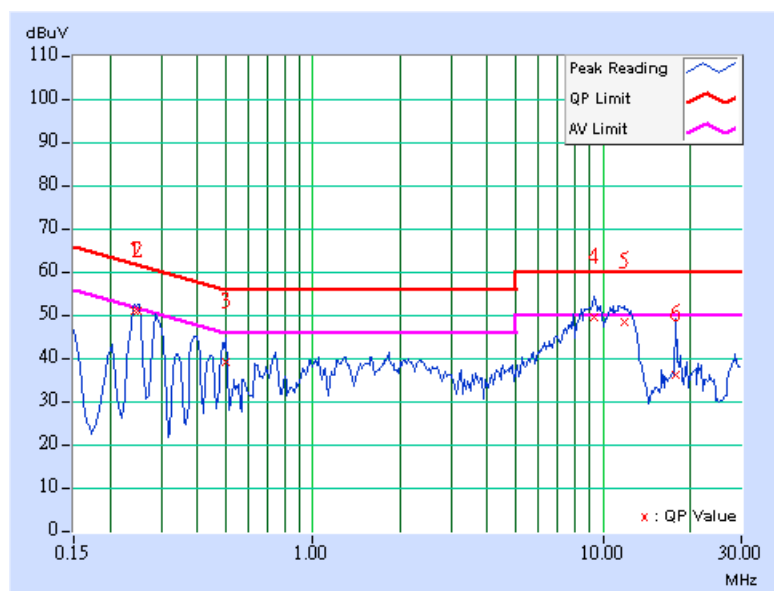

4.1.8 TEST RESULTS – PoE Mode with Adapter 1

Conducted Worst-Case Data

MODULATION TYPE	CCK	6dB BANDWIDTH	9 kHz
INPUT POWER (SYSTEM)	120Vac, 60 Hz	TRANSFER RATE	1Mbps
ENVIRONMENTAL CONDITIONS	28 deg. C, 68 %RH, 961 hPa	PHASE	Line (L)
TESTED BY	Wen Yu		

No	Freq. [MHz]	Corr. Factor (dB)	Reading Value		Emission Level		Limit		Margin	
			[dB (uV)]		[dB (uV)]		[dB (uV)]		(dB)	
			Q.P.	AV.	Q.P.	AV.	Q.P.	AV.	Q.P.	AV.
1	0.271	0.60	49.82	-	50.42	-	61.08	51.08	-10.66	-
2	0.334	0.60	47.88	-	48.48	-	59.36	49.36	-10.88	-
3	0.500	0.62	40.79	-	41.41	-	56.00	46.00	-14.59	-
4	0.560	0.63	40.89	-	41.52	-	56.00	46.00	-14.48	-
5	9.406	0.98	44.95	-	45.93	-	60.00	50.00	-14.07	-
6	11.500	1.12	47.94	-	49.06	-	60.00	50.00	-10.94	-

- REMARKS:**
1. Q.P. and AV. are abbreviations of quasi-peak and average individually.
 2. "-": The Quasi-peak reading value also meets average limit and measurement with the average detector is unnecessary.
 3. The emission levels of other frequencies were very low against the limit.
 4. Margin value = Emission level - Limit value
 5. Correction factor = Insertion loss + Cable loss
 6. Emission Level = Correction Factor + Reading Value.

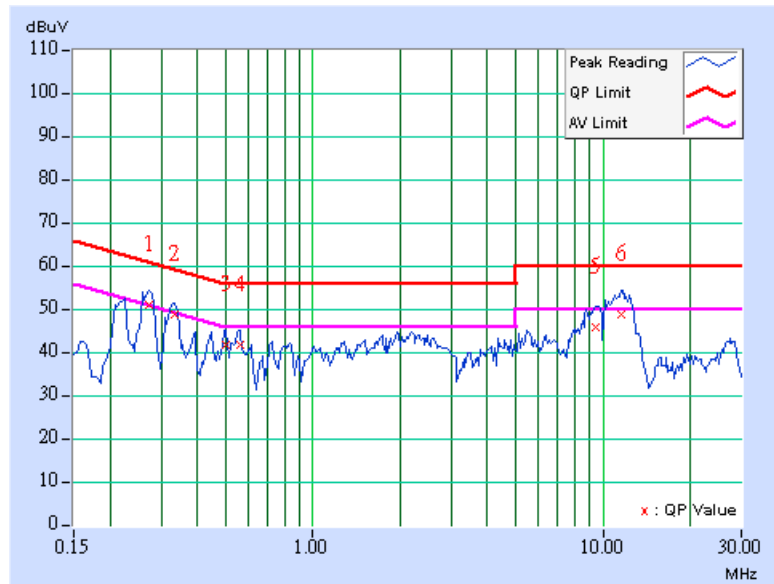

MODULATION TYPE	CCK	6dB BANDWIDTH	9 kHz
INPUT POWER (SYSTEM)	120Vac, 60 Hz	TRANSFER RATE	1Mbps
ENVIRONMENTAL CONDITIONS	28 deg. C, 68 %RH, 961 hPa	PHASE	Neutral (N)
TESTED BY	Wen Yu		

No	Freq. [MHz]	Corr. Factor (dB)	Reading Value [dB (uV)]		Emission Level [dB (uV)]		Limit [dB (uV)]		Margin (dB)	
			Q.P.	AV.	Q.P.	AV.	Q.P.	AV.	Q.P.	AV.
			1	0.266	0.40	47.15	-	47.55	-	61.25
2	0.334	0.40	43.98	-	44.38	-	59.36	49.36	-14.98	-
3	0.451	0.42	32.43	-	32.85	-	56.86	46.86	-24.01	-
4	2.189	0.61	34.83	-	35.44	-	56.00	46.00	-20.56	-
5	9.461	1.06	42.42	-	43.48	-	60.00	50.00	-16.52	-
6	11.180	1.19	45.19	-	46.38	-	60.00	50.00	-13.62	-

- REMARKS:**
1. Q.P. and AV. are abbreviations of quasi-peak and average individually.
 2. "-": The Quasi-peak reading value also meets average limit and measurement with the average detector is unnecessary.
 3. The emission levels of other frequencies were very low against the limit.
 4. Margin value = Emission level - Limit value
 5. Correction factor = Insertion loss + Cable loss
 6. Emission Level = Correction Factor + Reading Value.

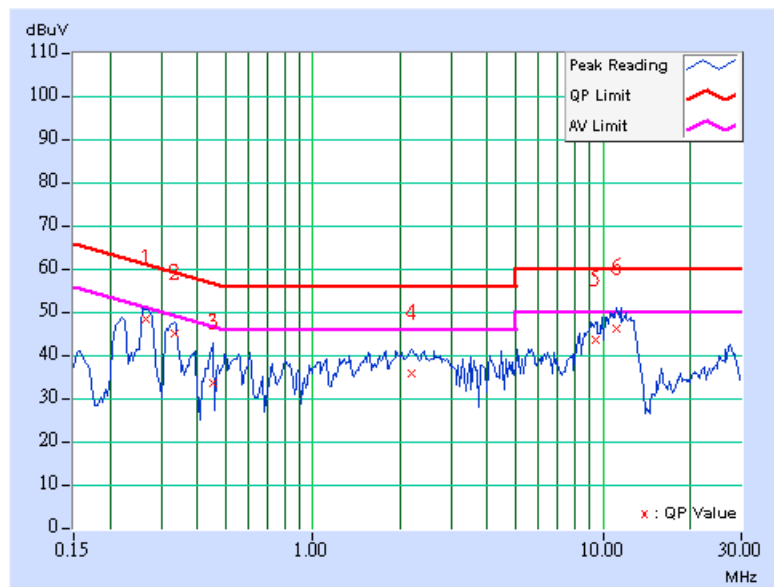

4.1.9 TEST RESULTS – Adapter Mode with adapter 2 Conducted Worst-Case Data

MODULATION TYPE	CCK	6dB BANDWIDTH	9 kHz
INPUT POWER (SYSTEM)	120Vac, 60 Hz	TRANSFER RATE	1Mbps
ENVIRONMENTAL CONDITIONS	28 deg. C, 68 %RH, 961 hPa	PHASE	Line (L)
TESTED BY	Wen Yu		

No	Freq. [MHz]	Corr. Factor (dB)	Reading Value [dB (uV)]		Emission Level [dB (uV)]		Limit [dB (uV)]		Margin (dB)	
			Q.P.	AV.	Q.P.	AV.	Q.P.	AV.	Q.P.	AV.
			1	0.150	0.55	45.05	-	45.60	-	66.00
2	0.213	0.60	50.37	-	50.97	-	63.11	53.11	-12.14	-
3	0.287	0.60	38.71	-	39.31	-	60.62	50.62	-21.31	-
4	0.357	0.60	34.84	-	35.44	-	58.80	48.80	-23.36	-
5	2.341	0.72	34.98	-	35.70	-	56.00	46.00	-20.30	-
6	26.734	1.27	41.89	-	43.16	-	60.00	50.00	-16.84	-

- REMARKS:**
1. Q.P. and AV. are abbreviations of quasi-peak and average individually.
 2. "-": The Quasi-peak reading value also meets average limit and measurement with the average detector is unnecessary.
 3. The emission levels of other frequencies were very low against the limit.
 4. Margin value = Emission level - Limit value
 5. Correction factor = Insertion loss + Cable loss
 6. Emission Level = Correction Factor + Reading Value.

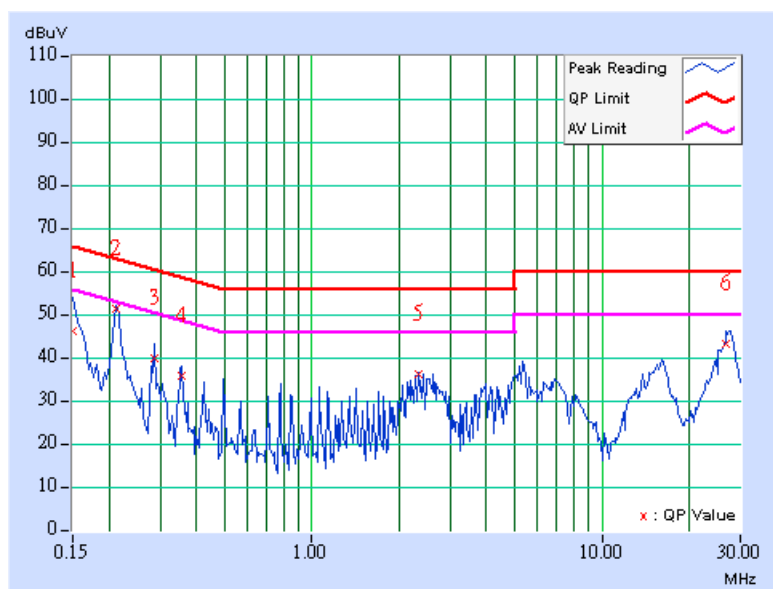

MODULATION TYPE	CCK	6dB BANDWIDTH	9 kHz
INPUT POWER (SYSTEM)	120Vac, 60 Hz	TRANSFER RATE	1Mbps
ENVIRONMENTAL CONDITIONS	28 deg. C, 68 %RH, 961 hPa	PHASE	Neutral (N)
TESTED BY	Wen Yu		

No	Freq. [MHz]	Corr. Factor (dB)	Reading Value		Emission Level		Limit		Margin	
			[dB (uV)]		[dB (uV)]		[dB (uV)]		(dB)	
			Q.P.	AV.	Q.P.	AV.	Q.P.	AV.	Q.P.	AV.
1	0.150	0.35	44.53	-	44.88	-	66.00	56.00	-21.12	-
2	0.213	0.40	47.27	-	47.67	-	63.11	53.11	-15.44	-
3	0.283	0.40	39.25	-	39.65	-	60.73	50.73	-21.08	-
4	2.588	0.63	28.50	-	29.13	-	56.00	46.00	-26.87	-
5	5.671	0.81	42.82	-	43.63	-	60.00	50.00	-16.37	-
6	27.713	1.65	41.93	-	43.58	-	60.00	50.00	-16.42	-

- REMARKS:**
1. Q.P. and AV. are abbreviations of quasi-peak and average individually.
 2. "-": The Quasi-peak reading value also meets average limit and measurement with the average detector is unnecessary.
 3. The emission levels of other frequencies were very low against the limit.
 4. Margin value = Emission level - Limit value
 5. Correction factor = Insertion loss + Cable loss
 6. Emission Level = Correction Factor + Reading Value.

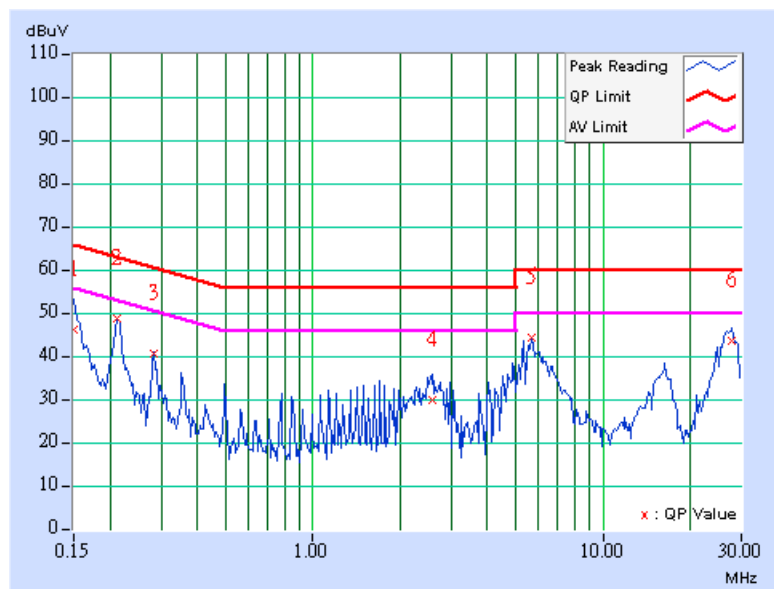

4.1.10 TEST RESULTS – PoE Mode with Adapter 2

Conducted Worst-Case Data

MODULATION TYPE	CCK	6dB BANDWIDTH	9 kHz
INPUT POWER (SYSTEM)	120Vac, 60 Hz	TRANSFER RATE	1Mbps
ENVIRONMENTAL CONDITIONS	28 deg. C, 68 %RH, 961 hPa	PHASE	Line (L)
TESTED BY	Wen Yu		

No	Freq. [MHz]	Corr. Factor (dB)	Reading Value		Emission Level		Limit		Margin	
			[dB (uV)]		[dB (uV)]		[dB (uV)]		(dB)	
			Q.P.	AV.	Q.P.	AV.	Q.P.	AV.	Q.P.	AV.
1	0.150	0.55	41.37	-	41.92	-	66.00	56.00	-24.08	-
2	0.214	0.60	48.22	-	48.82	-	63.07	53.07	-14.25	-
3	0.353	0.60	35.81	-	36.41	-	58.89	48.89	-22.48	-
4	2.334	0.72	34.64	-	35.36	-	56.00	46.00	-20.64	-
5	4.668	0.82	35.30	-	36.12	-	56.00	46.00	-19.88	-
6	25.685	1.29	45.62	-	46.91	-	60.00	50.00	-13.09	-

- REMARKS:**
1. Q.P. and AV. are abbreviations of quasi-peak and average individually.
 2. "-": The Quasi-peak reading value also meets average limit and measurement with the average detector is unnecessary.
 3. The emission levels of other frequencies were very low against the limit.
 4. Margin value = Emission level - Limit value
 5. Correction factor = Insertion loss + Cable loss
 6. Emission Level = Correction Factor + Reading Value.

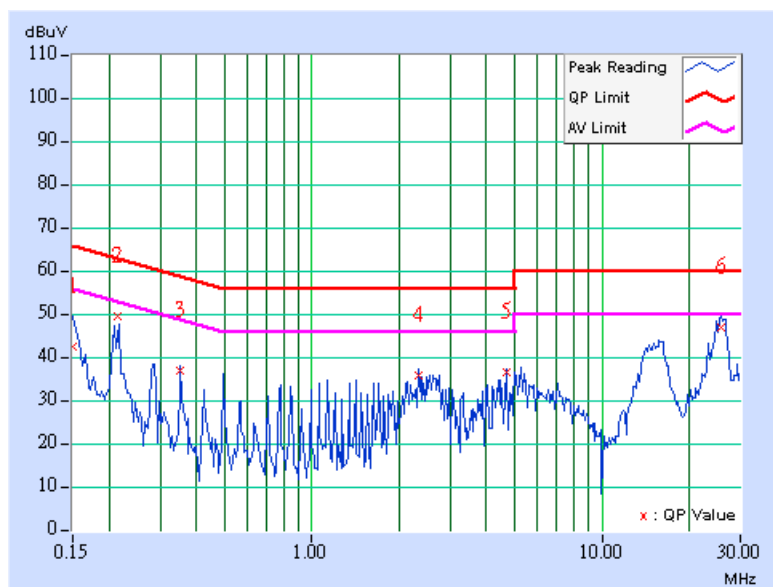

MODULATION TYPE	CCK	6dB BANDWIDTH	9 kHz
INPUT POWER (SYSTEM)	120Vac, 60 Hz	TRANSFER RATE	1Mbps
ENVIRONMENTAL CONDITIONS	28 deg. C, 68 %RH, 961 hPa	PHASE	Neutral (N)
TESTED BY	Wen Yu		

No	Freq. [MHz]	Corr. Factor (dB)	Reading Value [dB (uV)]		Emission Level [dB (uV)]		Limit [dB (uV)]		Margin (dB)	
			Q.P.	AV.	Q.P.	AV.	Q.P.	AV.	Q.P.	AV.
			1	0.150	0.35	41.57	-	41.92	-	66.00
2	0.213	0.40	45.01	-	45.41	-	63.11	53.11	-17.70	-
3	1.767	0.60	33.83	-	34.43	-	56.00	46.00	-21.57	-
4	4.668	0.74	37.44	-	38.18	-	56.00	46.00	-17.82	-
5	15.988	1.52	39.57	-	41.09	-	60.00	50.00	-18.91	-
6	25.396	1.69	46.43	-	48.12	-	60.00	50.00	-11.88	-

- REMARKS:**
1. Q.P. and AV. are abbreviations of quasi-peak and average individually.
 2. "-": The Quasi-peak reading value also meets average limit and measurement with the average detector is unnecessary.
 3. The emission levels of other frequencies were very low against the limit.
 4. Margin value = Emission level - Limit value
 5. Correction factor = Insertion loss + Cable loss
 6. Emission Level = Correction Factor + Reading Value.

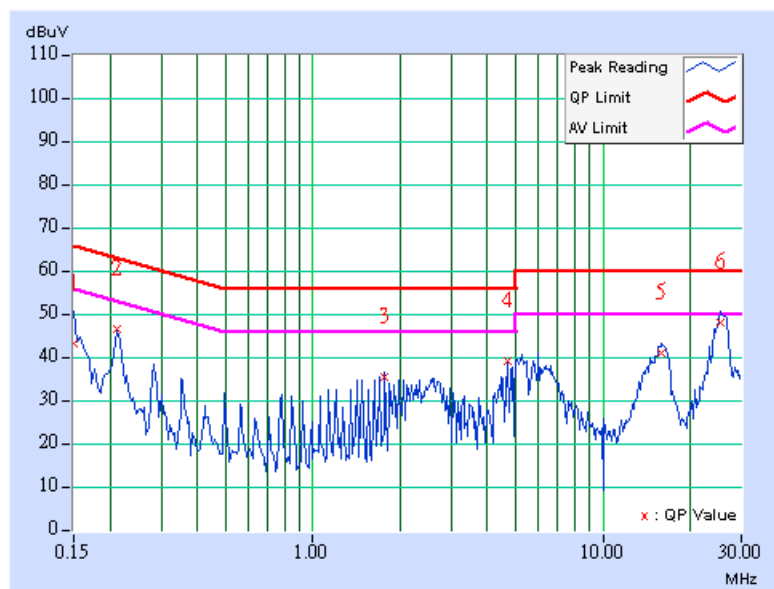

4.2 RADIATED EMISSION MEASUREMENT

4.2.1 LIMITS OF RADIATED EMISSION MEASUREMENT

Emissions radiated outside of the specified bands, shall be according to the general radiated limits in 15.209 as following:

Frequencies (MHz)	Field strength (microvolts/meter)	Measurement distance (meters)
0.009-0.490	2400/F(kHz)	300
0.490-1.705	24000/F(kHz)	30
1.705-30.0	30	30
30-88	100	3
88-216	150	3
216-960	200	3
Above 960	500	3

NOTE:

1. The lower limit shall apply at the transition frequencies.
2. Emission level (dBuV/m) = 20 log Emission level (uV/m).
3. As shown in 15.35(b), for frequencies above 1000MHz, the field strength limits are based on average detector, however, the peak field strength of any emission shall not exceed the maximum permitted average limits, specified above by more than 20dB under any condition of modulation.



4.2.2 TEST INSTRUMENTS

DESCRIPTION & MANUFACTURER	MODEL NO.	SERIAL NO.	CALIBRATED UNTIL
ADVANTEST Spectrum Analyzer	R3271A	85060311	July 15, 2008
HP Pre_Amplifier	8449B	3008A01922	Sep. 18, 2007
ROHDE & SCHWARZ Test Receiver	ESCS30	100375	Sep. 20, 2007
CHASE Broadband Antenna	VULB 9168	138	July 26, 2008
Schwarzbeck Horn_Antenna	BBHA9120	D124	Jan. 01, 2008
Schwarzbeck Horn_Antenna	BBHA 9170	BBHA9170153	Jan. 25, 2008
SCHWARZBECK Biconical Antenna	VHBA9123	459	Jun. 08, 2009
SCHWARZBECK Periodic Antenna	UPA6108	1148	Jun. 08, 2009
R&S Loop Antenna	HFH2-Z2	881058/15	Nov. 29, 2007
RF Switches (ARNITSU)	CS-201	1565157	Aug. 13, 2008
RF CABLE (Chaintek)	SF102	22054-2	Nov. 14. 2007
RF Cable(RICHTEC)	9913-30M N-N Cable	STCCAB-30M-1 GHz	Aug. 13, 2008
Software	ADT_Radiated_V 7.6.15.7	NA	NA
CHANCE MOST Antenna Tower	AT-100	0203	NA
CHANCE MOST Turn Table	TT-100	0203	NA

- Note: 1. The calibration interval of the above test instruments is 12 months (36 months for Biconical and Periodic Antenna) and the calibrations are traceable to NML/ROC and NIST/USA.
2. The horn antenna, HP preamplifier (model: 8449B) and Spectrum Analyzer (model: R3271A) are used only for the measurement of emission frequency above 1GHz if tested.
3. The test was performed in ADT Open Site No. C.
4. The FCC Site Registration No. is 656396.
5. The VCCI Site Registration No. is R-1626.
6. The CANADA Site Registration No. is IC 4824A-3.

4.2.3 TEST PROCEDURES

- a. The EUT was placed on the top of a rotating table 0.8 meters above the ground at a 3 meter semi- anechoic. The table was rotated 360 degrees to determine the position of the highest radiation.
- b. The EUT was set 3 meters away from the interference-receiving antenna, which was mounted on the top of a variable-height antenna tower.
- c. The antenna is a broadband antenna, and its height is varied from one meter to four meters above the ground to determine the maximum value of the field strength. Both horizontal and vertical polarizations of the antenna are set to make the measurement.
- d. For each suspected emission, the EUT was arranged to its worst case and then the antenna was tuned to heights from 1 meter to 4 meters and the rotatable table was turned from 0 degrees to 360 degrees to find the maximum reading.
- e. The test-receiver system was set to Peak Detect Function and Specified Bandwidth with Maximum Hold Mode.
- f. If the emission level of the EUT in peak mode was 10 dB lower than the limit specified, then testing could be stopped and the peak values of the EUT would be reported. Otherwise the emissions that did not have 10 dB margin would be re-tested one by one using the quasi-peak method or average method as specified and then reported in Data sheet peak mode and QP mode.

NOTE:

1. The resolution bandwidth and video bandwidth of test receiver/spectrum analyzer is 120kHz for Peak detection (PK) and Quasi-peak detection (QP) at frequency below 1GHz.
2. The resolution bandwidth of test receiver/spectrum analyzer is 1 MHz and the video bandwidth is 3 MHz for Peak detection (PK) at frequency above 1GHz.
3. The resolution bandwidth of test receiver/spectrum analyzer is 1 MHz and the video bandwidth is 10 Hz for Average detection (AV) at frequency above 1GHz.

4.2.4 DEVIATION FROM TEST STANDARD

No deviation

4.2.5 TEST SETUP

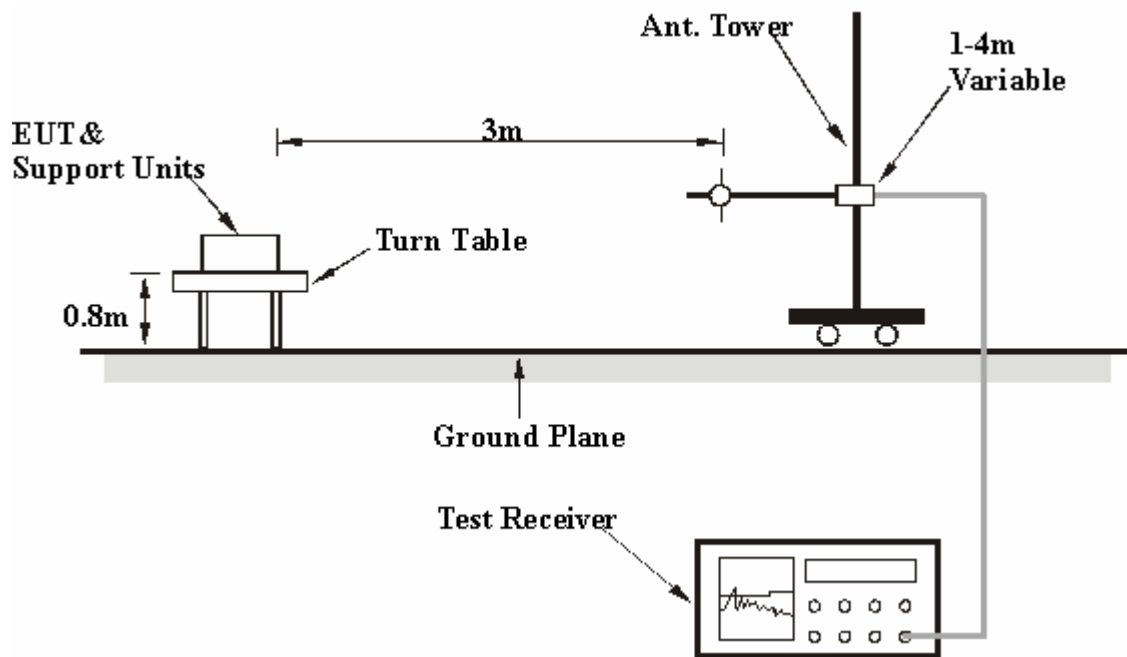

For the actual test configuration, please refer to the related item – Photographs of the Test Configuration.

4.2.6 EUT OPERATING CONDITIONS

Same as 4.1.6

4.2.7 TEST RESULTS (ANTENNA 1)

Below 1GHz Worst-Case Data

TEST MODE	With adapter	FREQUENCY RANGE	Below 1000MHz
MODULATION TYPE	CCK	TRANSFER RATE	1Mbps
INPUT POWER (SYSTEM)	120Vac, 60 Hz	DETECTOR FUNCTION	Quasi-Peak
ENVIRONMENTAL CONDITIONS	25 deg. C, 65 %RH, 961 hPa	TESTED BY	Phoenix Huang

ANTENNA POLARITY & TEST DISTANCE: HORIZONTAL AT 3 M

No.	Freq. (MHz)	Emission Level (dBuV/m)	Limit (dBuV/m)	Margin (dB)	Antenna Height (m)	Table Angle (Degree)	Raw Value (dBuV)	Correction Factor (dB/m)
1	250.00	35.21 QP	46.00	-10.79	1.25 H	245	21.43	13.78
2	300.00	36.85 QP	46.00	-9.15	1.17 H	152	20.02	16.83
3	375.00	37.85 QP	46.00	-8.15	1.32 H	274	19.65	18.20
4	500.04	33.25 QP	46.00	-12.75	1.57 H	57	11.49	21.76
5	625.00	37.52 QP	46.00	-8.48	1.24 H	6	12.77	24.76
6	750.00	34.12 QP	46.00	-11.88	1.65 H	241	6.77	27.35

ANTENNA POLARITY & TEST DISTANCE: VERTICAL AT 3 M

No.	Freq. (MHz)	Emission Level (dBuV/m)	Limit (dBuV/m)	Margin (dB)	Antenna Height (m)	Table Angle (Degree)	Raw Value (dBuV)	Correction Factor (dB/m)
1	250.00	36.74 QP	46.00	-9.26	1.00 V	241	22.96	13.78
2	375.00	35.85 QP	46.00	-10.15	1.18 V	174	17.65	18.20
3	625.00	37.52 QP	46.00	-8.48	1.36 V	241	12.77	24.76
4	675.02	37.41 QP	46.00	-8.59	1.27 V	41	11.99	25.42
5	750.04	35.12 QP	46.00	-10.88	1.54 V	26	7.77	27.35
6	875.12	34.11 QP	46.00	-11.89	1.32 V	65	5.48	28.63

- REMARKS:**
1. Emission level(dBuV/m)=Raw Value(dBuV) + Correction Factor(dB/m)
 2. Correction Factor(dB/m) = Antenna Factor (dB/m) + Cable Factor (dB)
 3. The other emission levels were very low against the limit.
 4. Margin value = Emission level – Limit value



802.11b DSSS modulation

CHANNEL	Channel 1	FREQUENCY RANGE	1 ~ 25GHz
MODULATION TYPE	CCK	TRANSFER RATE	1Mbps
INPUT POWER (SYSTEM)	120Vac, 60 Hz	DETECTOR FUNCTION	Peak(PK) Average (AV)
ENVIRONMENTAL CONDITIONS	25 deg. C, 65 %RH, 961 hPa	TESTED BY	Phoenix Huang

ANTENNA POLARITY & TEST DISTANCE: HORIZONTAL AT 3 M

No.	Freq. (MHz)	Emission Level (dBuV/m)	Limit (dBuV/m)	Margin (dB)	Antenna Height (m)	Table Angle (Degree)	Raw Value (dBuV)	Correction Factor (dB/m)
1	2390.00	59.60 PK	74.00	-14.40	1.03 H	215	29.28	30.32
2	2390.00	45.70 AV	54.00	-8.30	1.03 H	215	15.38	30.32
3	*2412.00	105.70 PK			1.01 H	216	75.29	30.41
4	*2412.00	100.10 AV			1.01 H	216	69.69	30.41
5	4824.00	56.10 PK	74.00	-17.90	1.34 H	65	20.31	35.79
6	4824.00	53.00 AV	54.00	-1.00	1.34 H	65	17.21	35.79
7	7236.00	52.11 PK	74.00	-21.89	1.37 H	151	10.51	41.60
8	7236.00	39.30 AV	54.00	-14.70	1.37 H	151	-2.30	41.60

ANTENNA POLARITY & TEST DISTANCE: VERTICAL AT 3 M

No.	Freq. (MHz)	Emission Level (dBuV/m)	Limit (dBuV/m)	Margin (dB)	Antenna Height (m)	Table Angle (Degree)	Raw Value (dBuV)	Correction Factor (dB/m)
1	2390.00	60.60 PK	74.00	-13.40	1.09 V	282	30.28	30.32
2	2390.00	46.60 AV	54.00	-7.40	1.09 V	282	16.28	30.32
3	*2412.00	104.90 PK			1.14 V	195	74.49	30.41
4	*2412.00	99.80 AV			1.14 V	195	69.39	30.41
5	4824.00	51.20 PK	74.00	-22.80	1.46 V	349	15.41	35.79
6	4824.00	45.70 AV	54.00	-8.30	1.46 V	349	9.91	35.79
7	7236.00	52.50 PK	74.00	-21.50	1.29 V	127	10.90	41.60
8	7236.00	39.50 AV	54.00	-14.50	1.29 V	127	-2.10	41.60

- REMARKS:**
1. Emission level(dBuV/m)=Raw Value(dBuV) + Correction Factor(dB/m)
 2. Correction Factor(dB/m) = Antenna Factor (dB/m) + Cable Factor (dB)
 3. The other emission levels were very low against the limit.
 4. Margin value = Emission level – Limit value.
 5. The limit value is defined as per 15.247
 6. “ * “ : Fundamental frequency



CHANNEL	Channel 6	FREQUENCY RANGE	1 ~ 25GHz
MODULATION TYPE	CCK	TRANSFER RATE	1Mbps
INPUT POWER (SYSTEM)	120Vac, 60 Hz	DETECTOR FUNCTION	Peak(PK) Average (AV)
ENVIRONMENTAL CONDITIONS	25 deg. C, 65 %RH, 961 hPa	TESTED BY	Phoenix Huang

ANTENNA POLARITY & TEST DISTANCE: HORIZONTAL AT 3 M

No.	Freq. (MHz)	Emission Level (dBuV/m)	Limit (dBuV/m)	Margin (dB)	Antenna Height (m)	Table Angle (Degree)	Raw Value (dBuV)	Correction Factor (dB/m)
1	*2437.00	105.50 PK			1.01 H	214	74.98	30.52
2	*2437.00	100.30 AV			1.01 H	214	69.78	30.52
3	4874.00	55.80 PK	74.00	-18.20	1.31 H	317	19.88	35.92
4	4874.00	52.90 AV	54.00	-1.10	1.31 H	317	16.98	35.92
5	7311.00	52.60 PK	74.00	-21.40	1.28 H	162	10.79	41.81
6	7311.00	39.70 AV	54.00	-14.30	1.28 H	162	-2.11	41.81

ANTENNA POLARITY & TEST DISTANCE: VERTICAL AT 3 M

No.	Freq. (MHz)	Emission Level (dBuV/m)	Limit (dBuV/m)	Margin (dB)	Antenna Height (m)	Table Angle (Degree)	Raw Value (dBuV)	Correction Factor (dB/m)
1	*2437.00	106.50 PK			1.11 V	294	75.98	30.52
2	*2437.00	101.30 AV			1.11 V	294	70.78	30.52
3	4874.00	53.10 PK	74.00	-20.90	1.72 V	145	17.18	35.92
4	4874.00	50.20 AV	54.00	-3.80	1.72 V	145	14.28	35.92
5	7311.00	53.50 PK	74.00	-20.50	1.22 V	314	11.69	41.81
6	7311.00	40.30 AV	54.00	-13.70	1.22 V	314	-1.51	41.81

- REMARKS:**
1. Emission level(dBuV/m)=Raw Value(dBuV) + Correction Factor(dB/m)
 2. Correction Factor(dB/m) = Antenna Factor (dB/m) + Cable Factor (dB)
 3. The other emission levels were very low against the limit.
 4. Margin value = Emission level – Limit value.
 5. The limit value is defined as per 15.247
 6. " * " : Fundamental frequency



CHANNEL	Channel 11	FREQUENCY RANGE	1 ~ 25GHz
MODULATION TYPE	CCK	TRANSFER RATE	1Mbps
INPUT POWER (SYSTEM)	120Vac, 60 Hz	DETECTOR FUNCTION	Peak(PK) Average (AV)
ENVIRONMENTAL CONDITIONS	25 deg. C, 65 %RH, 961 hPa	TESTED BY	Phoenix Huang

ANTENNA POLARITY & TEST DISTANCE: HORIZONTAL AT 3 M

No.	Freq. (MHz)	Emission Level (dBuV/m)	Limit (dBuV/m)	Margin (dB)	Antenna Height (m)	Table Angle (Degree)	Raw Value (dBuV)	Correction Factor (dB/m)
1	*2462.00	105.20 PK			1.04 H	219	74.57	30.63
2	*2462.00	99.80 AV			1.04 H	219	69.17	30.63
3	2483.50	63.80 PK	74.00	-10.20	1.02 H	215	33.08	30.72
4	2483.50	44.30 AV	54.00	-9.70	1.02 H	215	13.58	30.72
5	4924.00	55.50 PK	74.00	-18.50	1.36 H	68	19.44	36.06
6	4924.00	52.80 AV	54.00	-1.20	1.36 H	68	16.74	36.06
7	7386.00	52.40 PK	74.00	-21.60	1.43 H	122	10.39	42.01
8	7386.00	39.30 AV	54.00	-14.70	1.43 H	122	-2.71	42.01

ANTENNA POLARITY & TEST DISTANCE: VERTICAL AT 3 M

No.	Freq. (MHz)	Emission Level (dBuV/m)	Limit (dBuV/m)	Margin (dB)	Antenna Height (m)	Table Angle (Degree)	Raw Value (dBuV)	Correction Factor (dB/m)
1	*2462.00	106.60 PK			1.38 V	296	75.97	30.63
2	*2462.00	101.70 AV			1.38 V	296	71.07	30.63
3	2483.50	63.40 PK	74.00	-10.60	1.15 V	271	32.68	30.72
4	2483.50	44.40 AV	54.00	-9.60	1.15 V	271	13.68	30.72
5	4924.00	51.80 PK	74.00	-22.20	1.36 V	103	15.74	36.06
6	4924.00	48.50 AV	54.00	-5.50	1.36 V	103	12.44	36.06
7	7386.00	53.10 PK	74.00	-20.90	1.23 V	147	11.09	42.01
8	7386.00	39.70 AV	54.00	-14.30	1.23 V	147	-2.31	42.01

REMARKS:

1. Emission level(dBuV/m)=Raw Value(dBuV) + Correction Factor(dB/m)
2. Correction Factor(dB/m) = Antenna Factor (dB/m) + Cable Factor (dB)
3. The other emission levels were very low against the limit.
4. Margin value = Emission level – Limit value.
5. The limit value is defined as per 15.247
6. “ * “ : Fundamental frequency

RESTRICTED BANDEDGE (802.11b MODE, CH1, HORIZONTAL)

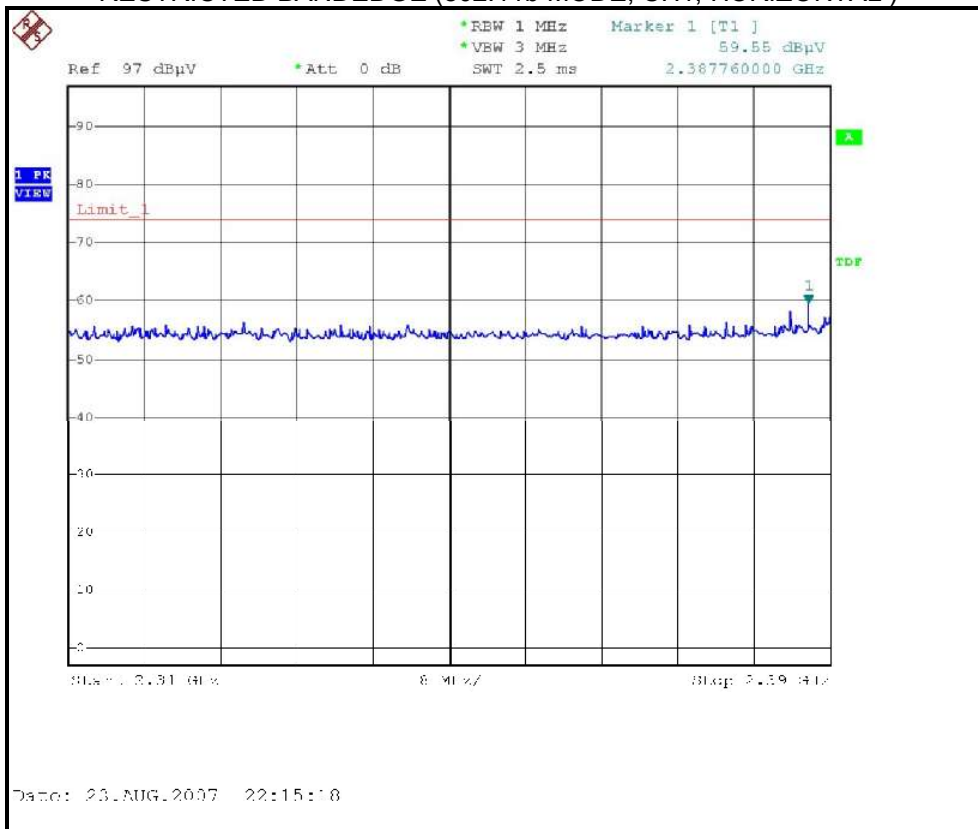

RESTRICTED BANDEDGE (802.11b MODE, CH1, VERTICAL)

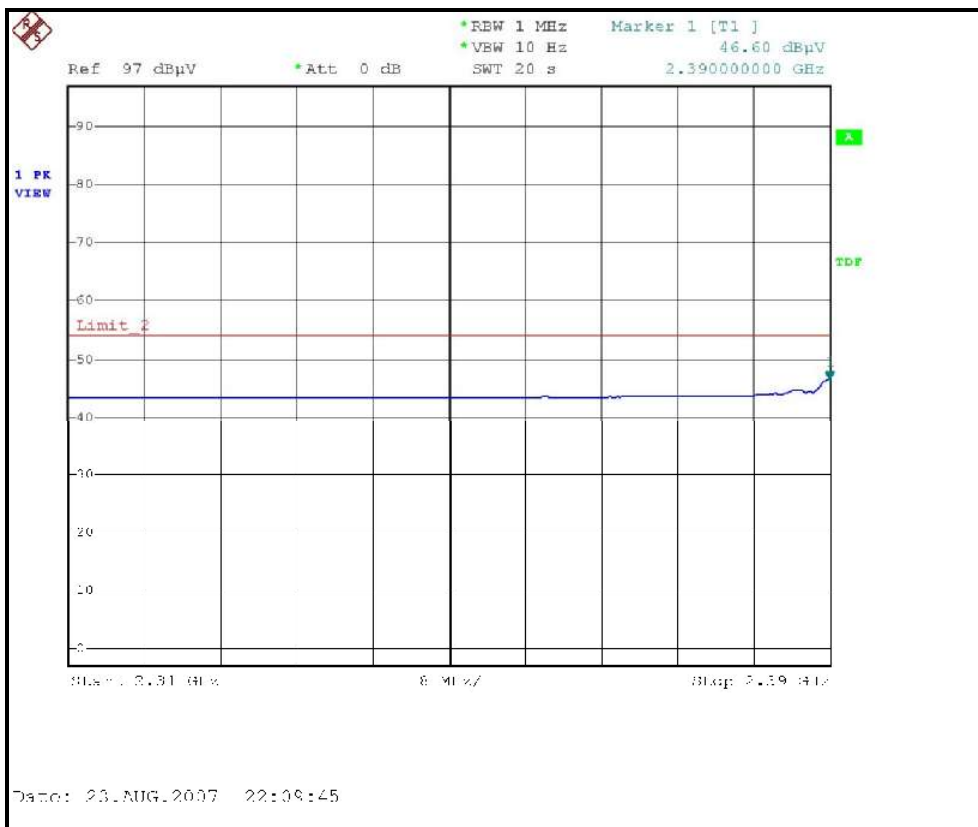
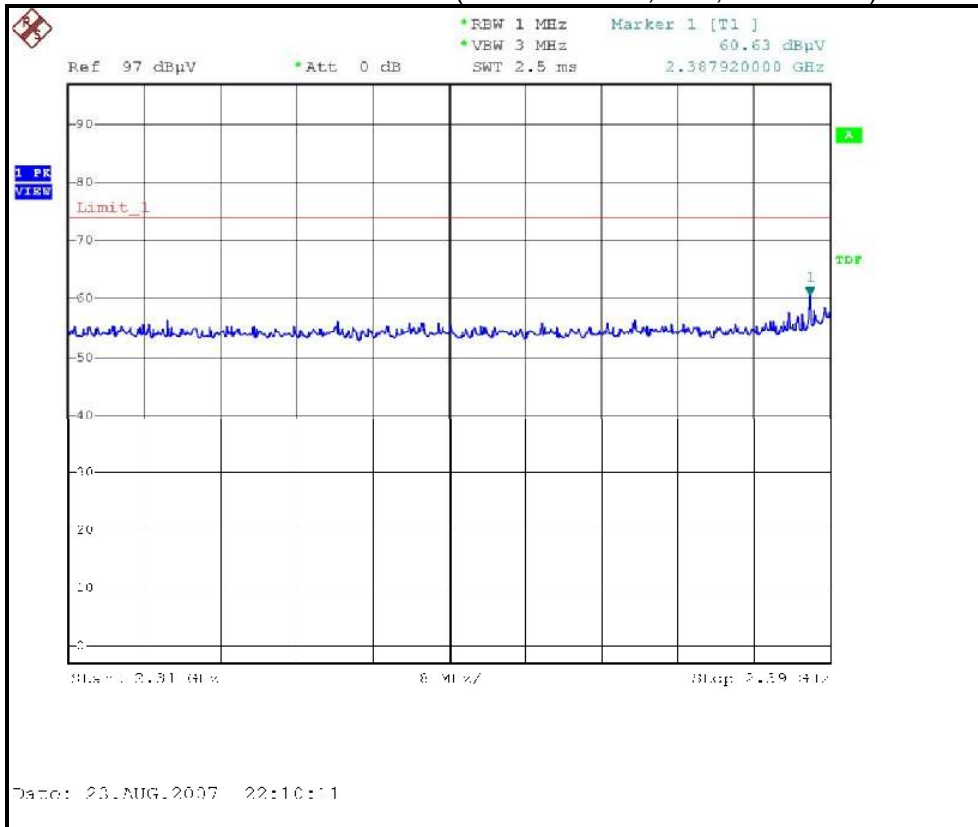

RESTRICTED BANDEDGE (802.11b MODE, CH11, HORIZONTAL)

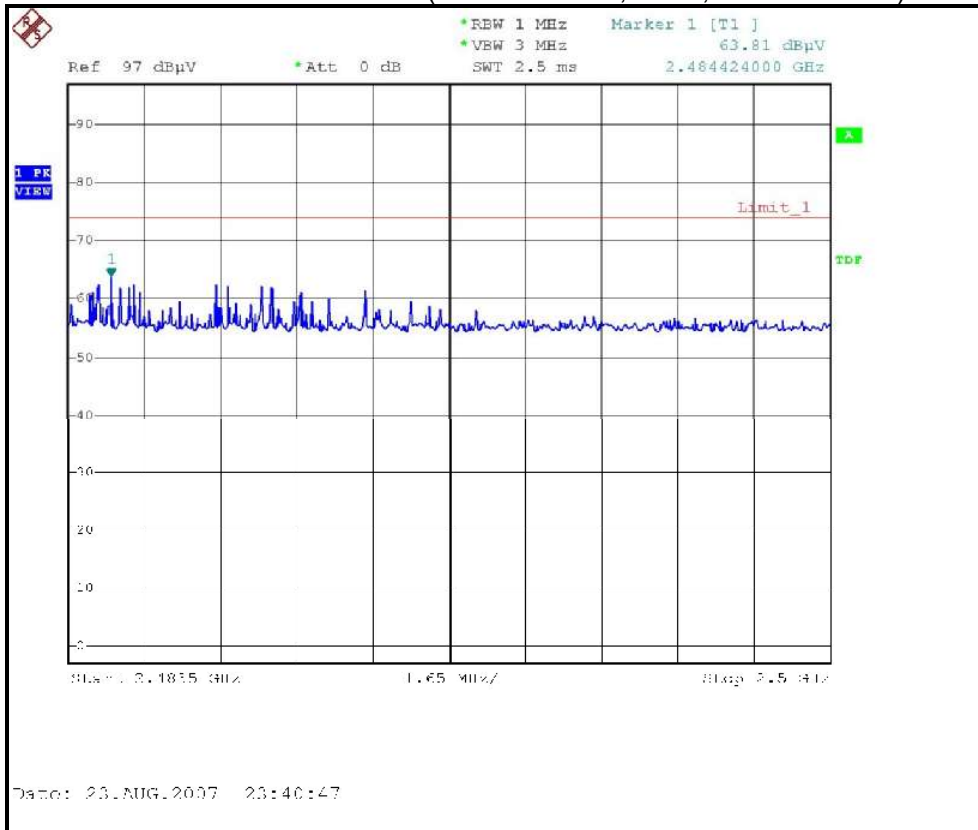

RESTRICTED BANDEDGE (802.11b MODE, CH11, VERTICAL)

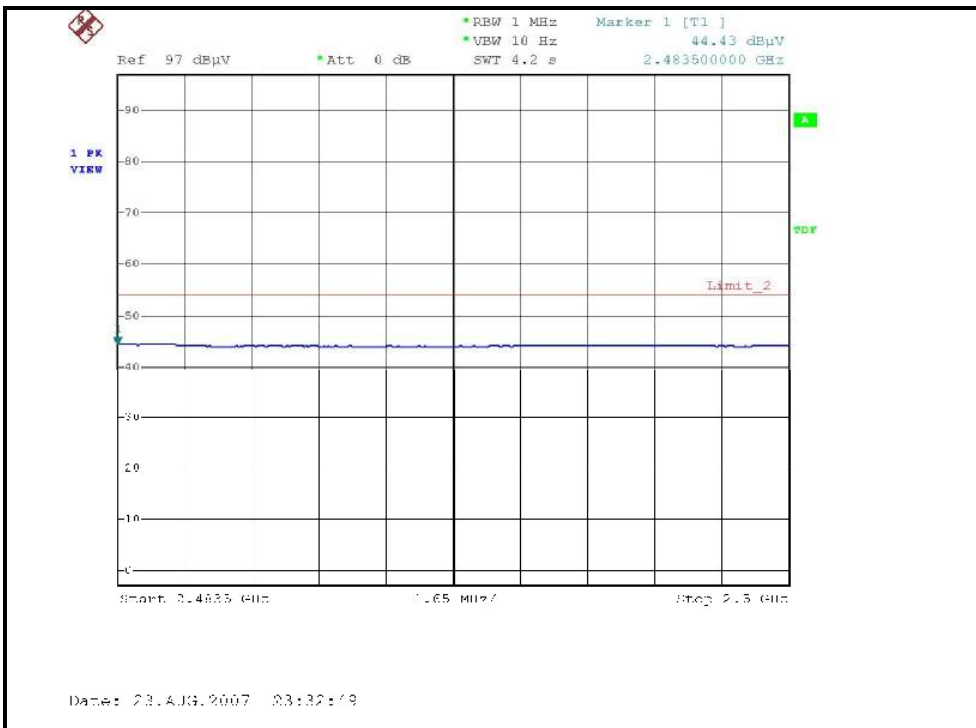
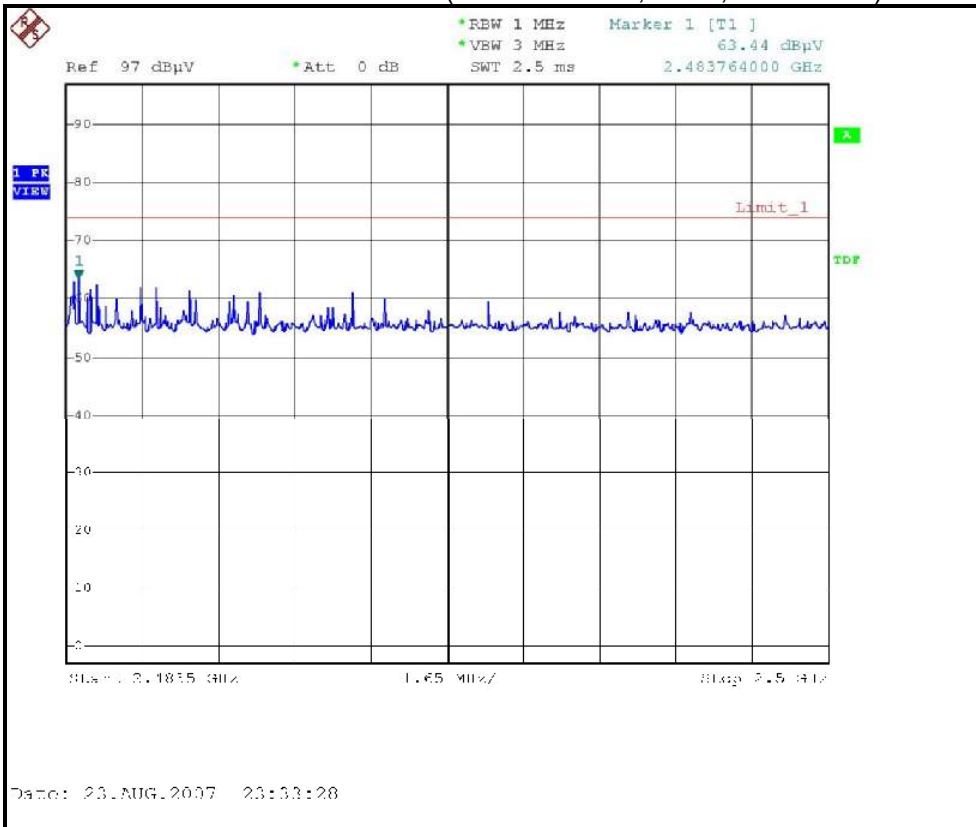



802.11g OFDM modulation

CHANNEL	Channel 1	FREQUENCY RANGE	1 ~ 25GHz
MODULATION TYPE	BPSK	TRANSFER RATE	6Mbps
INPUT POWER (SYSTEM)	120Vac, 60 Hz	DETECTOR FUNCTION	Peak(PK) Average (AV)
ENVIRONMENTAL CONDITIONS	25 deg. C, 65 %RH, 961 hPa	TESTED BY	Phoenix Huang

ANTENNA POLARITY & TEST DISTANCE: HORIZONTAL AT 3 M

No.	Freq. (MHz)	Emission Level (dBuV/m)	Limit (dBuV/m)	Margin (dB)	Antenna Height (m)	Table Angle (Degree)	Raw Value (dBuV)	Correction Factor (dB/m)
1	2390.00	71.40 PK	74.00	-2.60	1.00 H	317	41.08	30.32
2	2390.00	52.10 AV	54.00	-1.90	1.00 H	317	21.78	30.32
3	*2412.00	109.60 PK			1.00 H	317	79.19	30.41
4	*2412.00	98.50 AV			1.00 H	317	68.09	30.41
5	4824.00	60.80 PK	74.00	-13.20	1.36 H	66	25.01	35.79
6	4824.00	45.70 AV	54.00	-8.30	1.36 H	66	9.91	35.79
7	7236.00	53.10 PK	74.00	-20.90	1.52 H	173	11.50	41.60
8	7236.00	38.50 AV	54.00	-15.50	1.52 H	173	-3.10	41.60

ANTENNA POLARITY & TEST DISTANCE: VERTICAL AT 3 M

No.	Freq. (MHz)	Emission Level (dBuV/m)	Limit (dBuV/m)	Margin (dB)	Antenna Height (m)	Table Angle (Degree)	Raw Value (dBuV)	Correction Factor (dB/m)
1	2390.00	73.00 PK	74.00	-1.00	1.11 V	284	42.68	30.32
2	2390.00	52.40 AV	54.00	-1.60	1.11 V	284	22.08	30.32
3	*2412.00	110.30 PK			1.10 V	257	79.89	30.41
4	*2412.00	98.70 AV			1.10 V	257	68.29	30.41
5	4824.00	56.40 PK	74.00	-17.60	1.62 V	338	20.61	35.79
6	4824.00	41.00 AV	54.00	-13.00	1.62 V	338	5.21	35.79
7	7236.00	53.80 PK	74.00	-20.20	1.52 V	167	12.20	41.60
8	7236.00	39.30 AV	54.00	-14.70	1.52 V	167	-2.30	41.60

- REMARKS:**
1. Emission level(dBuV/m)=Raw Value(dBuV) + Correction Factor(dB/m)
 2. Correction Factor(dB/m) = Antenna Factor (dB/m) + Cable Factor (dB)
 3. The other emission levels were very low against the limit.
 4. Margin value = Emission level – Limit value.
 5. The limit value is defined as per 15.247
 6. “ * “ : Fundamental frequency

CHANNEL	Channel 6	FREQUENCY RANGE	1 ~ 25GHz
MODULATION TYPE	BPSK	TRANSFER RATE	6Mbps
INPUT POWER (SYSTEM)	120Vac, 60 Hz	DETECTOR FUNCTION	Peak(PK) Average (AV)
ENVIRONMENTAL CONDITIONS	25 deg. C, 65 %RH, 961 hPa	TESTED BY	Phoenix Huang

ANTENNA POLARITY & TEST DISTANCE: HORIZONTAL AT 3 M

No.	Freq. (MHz)	Emission Level (dBuV/m)	Limit (dBuV/m)	Margin (dB)	Antenna Height (m)	Table Angle (Degree)	Raw Value (dBuV)	Correction Factor (dB/m)
1	*2437.00	112.00 PK			1.22 H	216	81.48	30.52
2	*2437.00	100.80 AV			1.22 H	216	70.28	30.52
3	4874.00	65.40 PK	74.00	-8.60	1.35 H	72	29.48	35.92
4	4874.00	51.00 AV	54.00	-3.00	1.35 H	72	15.08	35.92
5	7311.00	54.30 PK	74.00	-19.70	1.53 H	323	12.49	41.81
6	7311.00	40.30 AV	54.00	-13.70	1.53 H	323	-1.51	41.81

ANTENNA POLARITY & TEST DISTANCE: VERTICAL AT 3 M

No.	Freq. (MHz)	Emission Level (dBuV/m)	Limit (dBuV/m)	Margin (dB)	Antenna Height (m)	Table Angle (Degree)	Raw Value (dBuV)	Correction Factor (dB/m)
1	*2437.00	112.30 PK			1.60 V	184	81.78	30.52
2	*2437.00	101.20 AV			1.60 V	184	70.68	30.52
3	4874.00	60.50 PK	74.00	-13.50	1.41 V	103	24.58	35.92
4	4874.00	45.70 AV	54.00	-8.30	1.41 V	103	9.78	35.92
5	7311.00	54.70 PK	74.00	-19.30	1.17 V	231	12.89	41.81
6	7311.00	40.70 AV	54.00	-13.30	1.17 V	231	-1.11	41.81

- REMARKS:**
1. Emission level(dBuV/m)=Raw Value(dBuV) + Correction Factor(dB/m)
 2. Correction Factor(dB/m) = Antenna Factor (dB/m) + Cable Factor (dB)
 3. The other emission levels were very low against the limit.
 4. Margin value = Emission level – Limit value.
 5. The limit value is defined as per 15.247
 6. " * " : Fundamental frequency



CHANNEL	Channel 11	FREQUENCY RANGE	1 ~ 25GHz
MODULATION TYPE	BPSK	TRANSFER RATE	6Mbps
INPUT POWER (SYSTEM)	120Vac, 60 Hz	DETECTOR FUNCTION	Peak(PK) Average (AV)
ENVIRONMENTAL CONDITIONS	25 deg. C, 65 %RH, 961 hPa	TESTED BY	Phoenix Huang

ANTENNA POLARITY & TEST DISTANCE: HORIZONTAL AT 3 M

No.	Freq. (MHz)	Emission Level (dBuV/m)	Limit (dBuV/m)	Margin (dB)	Antenna Height (m)	Table Angle (Degree)	Raw Value (dBuV)	Correction Factor (dB/m)
1	*2462.00	109.30 PK			1.20 H	318	78.67	30.63
2	*2462.00	98.00 AV			1.20 H	318	67.37	30.63
3	2483.50	72.40 PK	74.00	-1.60	1.19 H	215	41.68	30.72
4	2483.50	51.20 AV	54.00	-2.80	1.19 H	215	20.48	30.72
5	4924.00	59.40 PK	74.00	-14.60	1.33 H	72	23.34	36.06
6	4924.00	44.50 AV	54.00	-9.50	1.33 H	72	8.44	36.06
7	7386.00	53.00 PK	74.00	-21.00	1.43 H	42	10.99	42.01
8	7386.00	38.20 AV	54.00	-15.80	1.43 H	42	-3.81	42.01

ANTENNA POLARITY & TEST DISTANCE: VERTICAL AT 3 M

No.	Freq. (MHz)	Emission Level (dBuV/m)	Limit (dBuV/m)	Margin (dB)	Antenna Height (m)	Table Angle (Degree)	Raw Value (dBuV)	Correction Factor (dB/m)
1	*2462.00	110.10 PK			1.08 V	295	79.47	30.63
2	*2462.00	99.50 AV			1.08 V	295	68.87	30.63
3	2483.50	73.50 PK	74.00	-0.50	1.06 V	282	42.78	30.72
4	2483.50	53.30 AV	54.00	-0.70	1.06 V	282	22.58	30.72
5	4924.00	55.70 PK	74.00	-18.30	1.37 V	105	19.64	36.06
6	4924.00	40.20 AV	54.00	-13.80	1.37 V	105	4.14	36.06
7	7386.00	53.70 PK	74.00	-20.30	1.36 V	278	11.69	42.01
8	7386.00	38.70 AV	54.00	-15.30	1.36 V	278	-3.31	42.01

REMARKS:

1. Emission level(dBuV/m)=Raw Value(dBuV) + Correction Factor(dB/m)
2. Correction Factor(dB/m) = Antenna Factor (dB/m) + Cable Factor (dB)
3. The other emission levels were very low against the limit.
4. Margin value = Emission level – Limit value.
5. The limit value is defined as per 15.247
6. “ * ” : Fundamental frequency

RESTRICTED BANDEDGE (802.11g MODE, CH1, HORIZONTAL)

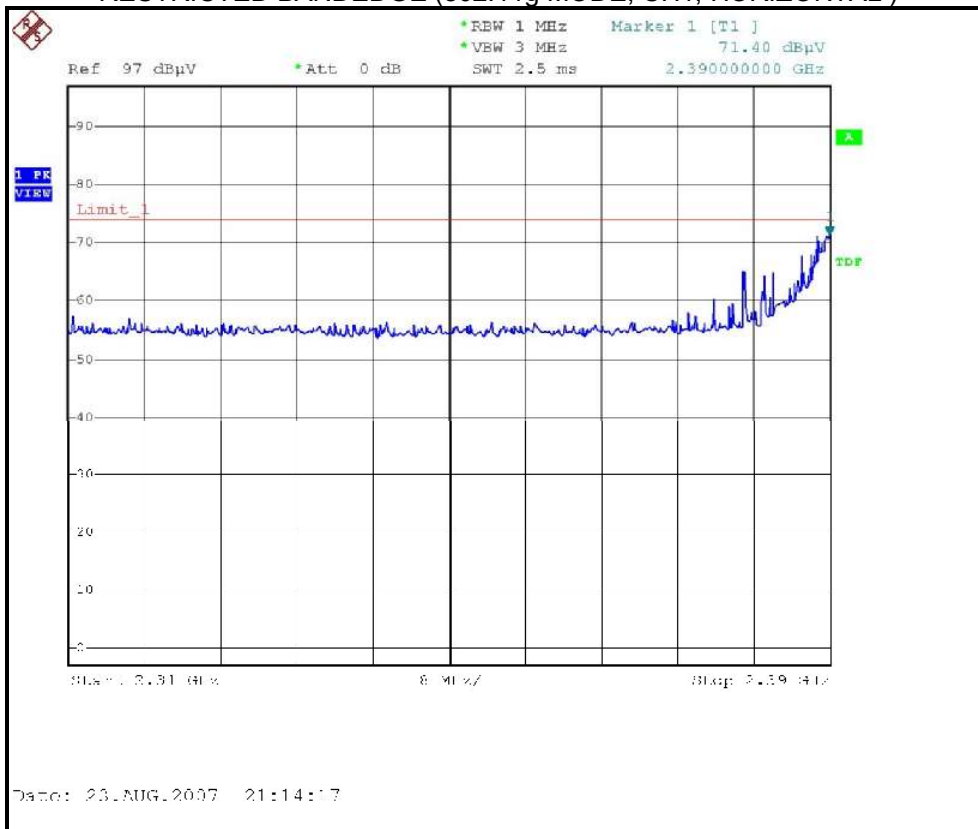

RESTRICTED BANDEDGE (802.11g MODE, CH1, VERTICAL)

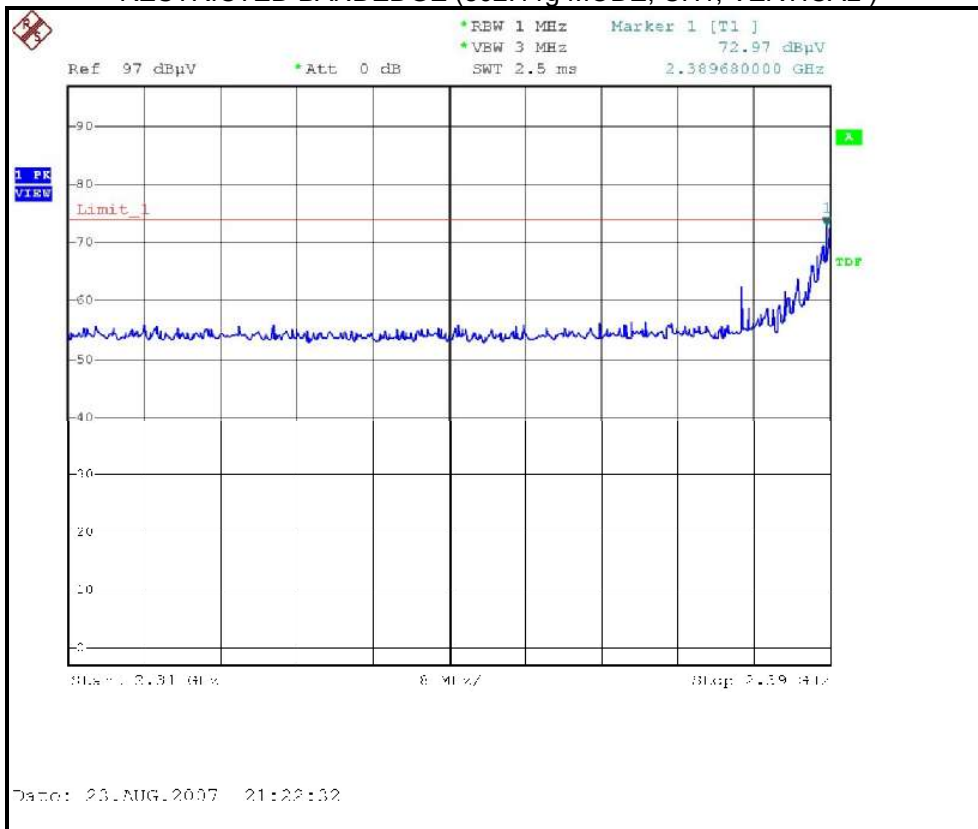

RESTRICTED BANDEDGE (802.11g MODE, CH11, HORIZONTAL)

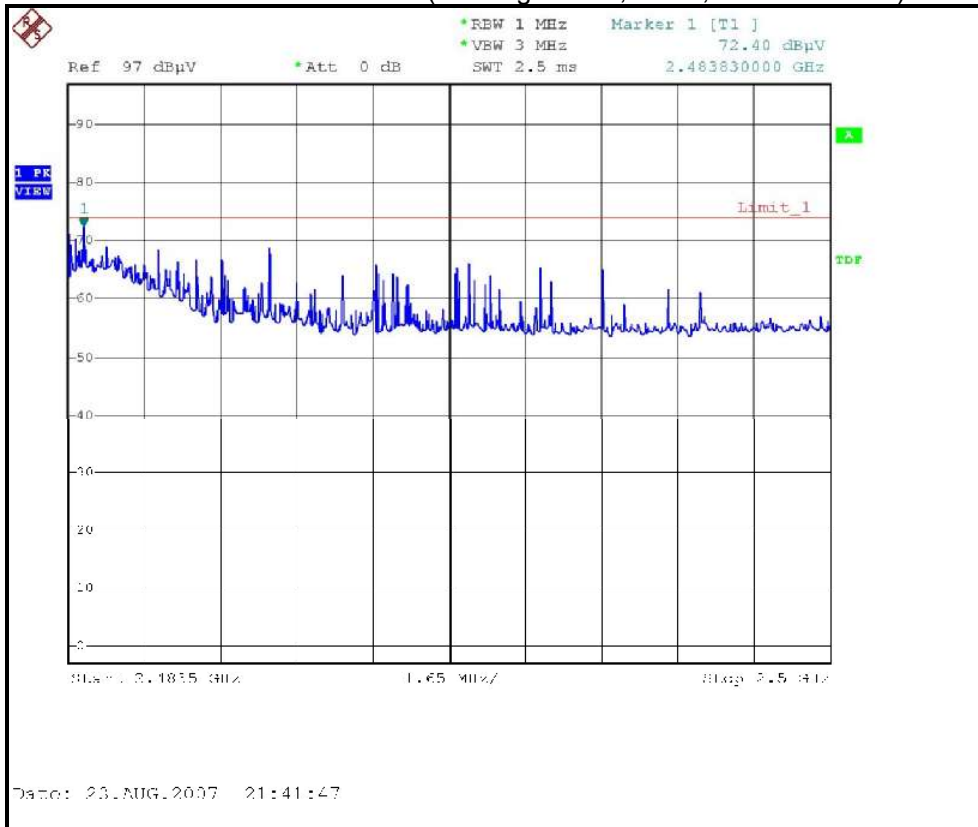

RESTRICTED BANDEDGE (802.11g MODE, CH11, VERTICAL)

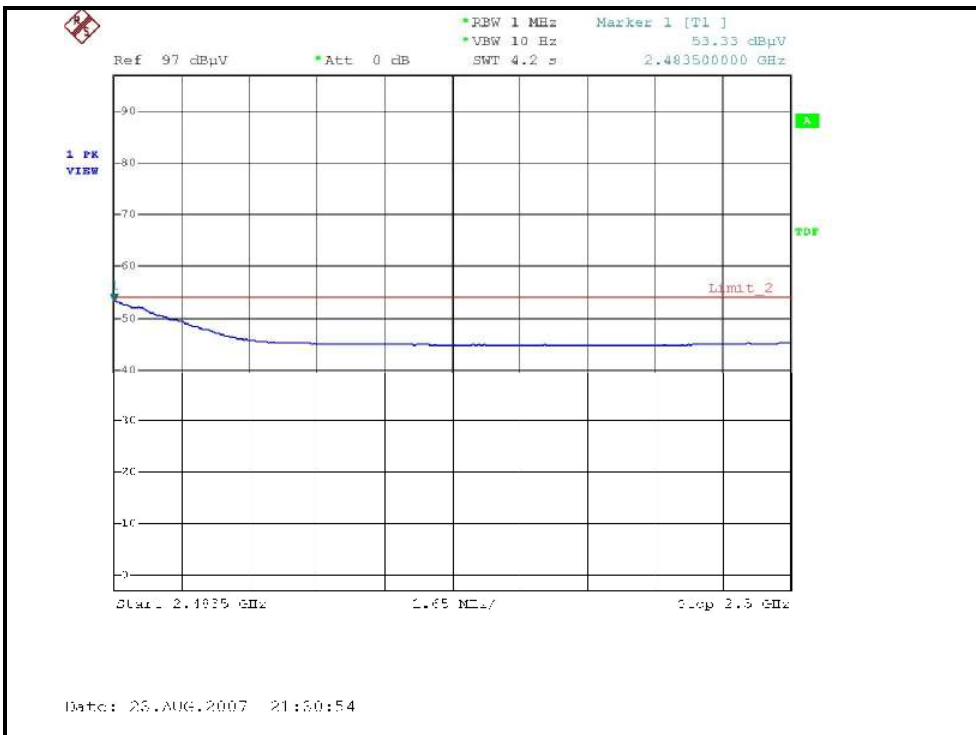
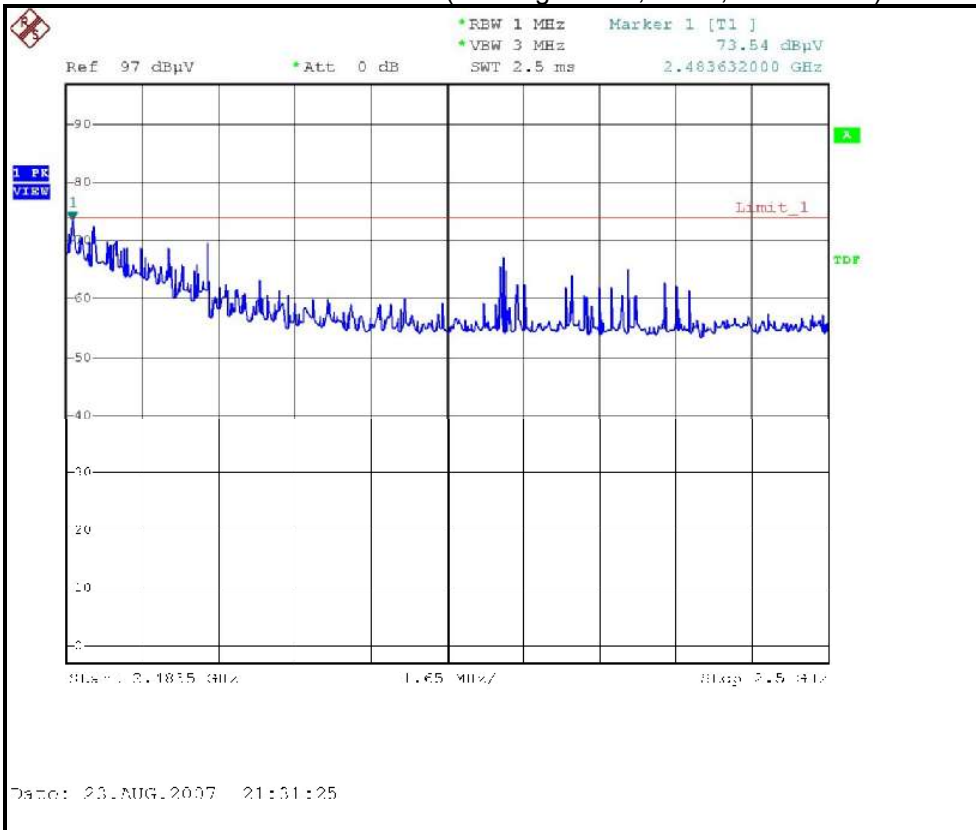

4.2.8 TEST RESULTS (ANTENNA 2)

Below 1GHz Worst-Case Data

TEST MODE	With adapter	FREQUENCY RANGE	Below 1000MHz
MODULATION TYPE	CCK	TRANSFER RATE	1Mbps
INPUT POWER (SYSTEM)	120Vac, 60 Hz	DETECTOR FUNCTION	Quasi-Peak
ENVIRONMENTAL CONDITIONS	25 deg. C, 60 %RH, 961 hPa	TESTED BY	Wen Yu

ANTENNA POLARITY & TEST DISTANCE: HORIZONTAL AT 3 M

No.	Freq. (MHz)	Emission Level (dBuV/m)	Limit (dBuV/m)	Margin (dB)	Antenna Height (m)	Table Angle (Degree)	Raw Value (dBuV)	Correction Factor (dB/m)
1	250.01	32.31 QP	46.00	-13.69	1.03 H	64	17.96	14.35
2	275.00	33.67 QP	46.00	-12.33	1.00 H	61	18.33	15.34
3	276.00	35.30 QP	46.00	-10.70	1.00 H	69	19.93	15.37
4	375.01	36.04 QP	46.00	-9.96	1.00 H	299	17.62	18.42
5	500.01	31.92 QP	46.00	-14.08	1.65 H	44	9.88	22.04
6	600.01	29.70 QP	46.00	-16.30	1.68 H	83	6.28	23.42
7	625.00	37.50 QP	46.00	-8.50	1.26 H	321	13.67	23.83
8	750.01	33.59 QP	46.00	-12.41	1.66 H	323	6.89	26.70

ANTENNA POLARITY & TEST DISTANCE: VERTICAL AT 3 M

No.	Freq. (MHz)	Emission Level (dBuV/m)	Limit (dBuV/m)	Margin (dB)	Antenna Height (m)	Table Angle (Degree)	Raw Value (dBuV)	Correction Factor (dB/m)
1	175.00	28.94 QP	43.50	-14.56	1.00 V	146	17.79	11.15
2	250.01	28.07 QP	46.00	-17.93	1.00 V	0	13.72	14.35
3	275.00	30.41 QP	46.00	-15.59	1.30 V	12	15.07	15.34
4	276.00	31.63 QP	46.00	-14.37	1.30 V	12	16.26	15.37
5	375.01	36.10 QP	46.00	-9.90	1.00 V	137	17.68	18.42
6	400.00	30.05 QP	46.00	-15.95	1.00 V	353	10.78	19.27
7	500.01	34.55 QP	46.00	-11.45	1.28 V	129	12.51	22.04
8	625.01	39.64 QP	46.00	-6.36	1.00 V	257	15.81	23.83

- REMARKS:**
1. Emission level(dBuV/m)=Raw Value(dBuV) + Correction Factor(dB/m)
 2. Correction Factor(dB/m) = Antenna Factor (dB/m) + Cable Factor (dB)
 3. The other emission levels were very low against the limit.
 4. Margin value = Emission level – Limit value



802.11b DSSS modulation

CHANNEL	Channel 1	FREQUENCY RANGE	1 ~ 25GHz
MODULATION TYPE	CCK	TRANSFER RATE	1Mbps
INPUT POWER (SYSTEM)	120Vac, 60 Hz	DETECTOR FUNCTION	Peak(PK) Average (AV)
ENVIRONMENTAL CONDITIONS	24 deg. C, 63 %RH, 961 hPa	TESTED BY	Rex Huang

ANTENNA POLARITY & TEST DISTANCE: HORIZONTAL AT 3 M

No.	Freq. (MHz)	Emission Level (dBuV/m)	Limit (dBuV/m)	Margin (dB)	Antenna Height (m)	Table Angle (Degree)	Raw Value (dBuV)	Correction Factor (dB/m)
1	2288.00	43.50 PK	74.00	-30.50	1.06 H	221	11.96	31.54
2	2288.00	37.20 AV	54.00	-16.80	1.06 H	221	5.66	31.54
3	2390.00	57.70 PK	74.00	-16.30	1.16 H	289	25.77	31.93
4	2390.00	44.90 AV	54.00	-9.10	1.16 H	289	12.97	31.93
5	*2412.00	101.40 PK			1.16 H	289	69.38	32.02
6	*2412.00	95.40 AV			1.16 H	289	63.38	32.02
7	2760.00	44.30 PK	74.00	-29.70	1.18 H	245	11.53	32.77
8	2760.00	34.10 AV	54.00	-19.90	1.18 H	245	1.33	32.77
9	4824.00	52.10 PK	74.00	-21.90	1.02 H	137	16.13	35.97
10	4824.00	46.80 AV	54.00	-7.20	1.02 H	137	10.83	35.97
11	7236.00	53.30 PK	74.00	-20.70	1.25 H	274	11.06	42.24
12	7236.00	40.20 AV	54.00	-13.80	1.25 H	274	-2.04	42.24

ANTENNA POLARITY & TEST DISTANCE: VERTICAL AT 3 M

No.	Freq. (MHz)	Emission Level (dBuV/m)	Limit (dBuV/m)	Margin (dB)	Antenna Height (m)	Table Angle (Degree)	Raw Value (dBuV)	Correction Factor (dB/m)
1	2288.00	49.70 PK	74.00	-24.30	1.00 V	9	18.16	31.54
2	2288.00	44.90 AV	54.00	-9.10	1.00 V	9	13.36	31.54
3	2390.00	72.80 PK	74.00	-1.20	1.00 V	162	40.87	31.93
4	2390.00	53.30 AV	54.00	-0.70	1.00 V	162	21.37	31.93
5	*2412.00	116.80 PK			1.24 V	110	84.78	32.02
6	*2412.00	112.00 AV			1.24 V	110	79.98	32.02
7	2760.00	50.80 PK	74.00	-23.20	1.18 V	98	18.03	32.77
8	2760.00	47.00 AV	54.00	-7.00	1.18 V	98	14.23	32.77
9	4824.00	50.50 PK	74.00	-23.50	1.00 V	209	14.53	35.97
10	4824.00	44.00 AV	54.00	-10.00	1.00 V	209	8.03	35.97
11	7236.00	53.60 PK	74.00	-20.40	1.24 V	86	11.36	42.24
12	7236.00	40.40 AV	54.00	-13.60	1.24 V	86	-1.84	42.24

- REMARKS:**
1. Emission level(dBuV/m)=Raw Value(dBuV) + Correction Factor(dB/m)
 2. Correction Factor(dB/m) = Antenna Factor (dB/m) + Cable Factor (dB)
 3. The other emission levels were very low against the limit.
 4. Margin value = Emission level – Limit value.
 5. The limit value is defined as per 15.247
 6. “ * “ : Fundamental frequency



CHANNEL	Channel 6	FREQUENCY RANGE	1 ~ 25GHz
MODULATION TYPE	CCK	TRANSFER RATE	1Mbps
INPUT POWER (SYSTEM)	120Vac, 60 Hz	DETECTOR FUNCTION	Peak(PK) Average (AV)
ENVIRONMENTAL CONDITIONS	24 deg. C, 63 %RH, 961 hPa	TESTED BY	Rex Huang

ANTENNA POLARITY & TEST DISTANCE: HORIZONTAL AT 3 M

No.	Freq. (MHz)	Emission Level (dBuV/m)	Limit (dBuV/m)	Margin (dB)	Antenna Height (m)	Table Angle (Degree)	Raw Value (dBuV)	Correction Factor (dB/m)
1	2288.00	43.60 PK	74.00	-30.40	1.05 H	226	12.06	31.54
2	2288.00	37.40 AV	54.00	-16.60	1.05 H	226	5.86	31.54
3	*2437.00	103.70 PK			1.09 H	278	71.59	32.11
4	*2437.00	98.60 AV			1.09 H	278	66.49	32.11
5	2760.00	44.10 PK	74.00	-29.90	1.21 H	243	11.33	32.77
6	2760.00	34.00 AV	54.00	-20.00	1.21 H	243	1.23	32.77
7	4874.00	56.30 PK	74.00	-17.70	1.02 H	138	20.22	36.08
8	4874.00	53.50 AV	54.00	-0.50	1.02 H	138	17.42	36.08
9	7311.00	53.40 PK	74.00	-20.60	1.29 H	279	10.88	42.52
10	7311.00	40.10 AV	54.00	-13.90	1.29 H	279	-2.42	42.52

ANTENNA POLARITY & TEST DISTANCE: VERTICAL AT 3 M

No.	Freq. (MHz)	Emission Level (dBuV/m)	Limit (dBuV/m)	Margin (dB)	Antenna Height (m)	Table Angle (Degree)	Raw Value (dBuV)	Correction Factor (dB/m)
1	2288.00	49.90 PK	74.00	-24.10	1.00 V	9	18.36	31.54
2	2288.00	44.80 AV	54.00	-9.20	1.00 V	9	13.26	31.54
3	*2437.00	117.30 PK			1.19 V	84	85.19	32.11
4	*2437.00	112.50 AV			1.19 V	84	80.39	32.11
5	2760.00	50.20 PK	74.00	-23.80	1.18 V	98	17.43	32.77
6	2760.00	46.30 AV	54.00	-7.70	1.18 V	98	13.53	32.77
7	4874.00	54.90 PK	74.00	-19.10	1.00 V	273	18.82	36.08
8	4874.00	51.60 AV	54.00	-2.40	1.00 V	273	15.52	36.08
9	7311.00	53.20 PK	74.00	-20.80	1.21 V	134	10.68	42.52
10	7311.00	40.30 AV	54.00	-13.70	1.21 V	134	-2.22	42.52

- REMARKS:**
1. Emission level(dBuV/m)=Raw Value(dBuV) + Correction Factor(dB/m)
 2. Correction Factor(dB/m) = Antenna Factor (dB/m) + Cable Factor (dB)
 3. The other emission levels were very low against the limit.
 4. Margin value = Emission level – Limit value.
 5. The limit value is defined as per 15.247
 6. “ * “ : Fundamental frequency



CHANNEL	Channel 11	FREQUENCY RANGE	1 ~ 25GHz
MODULATION TYPE	CCK	TRANSFER RATE	1Mbps
INPUT POWER (SYSTEM)	120Vac, 60 Hz	DETECTOR FUNCTION	Peak(PK) Average (AV)
ENVIRONMENTAL CONDITIONS	24 deg. C, 63 %RH, 961 hPa	TESTED BY	Rex Huang

ANTENNA POLARITY & TEST DISTANCE: HORIZONTAL AT 3 M

No.	Freq. (MHz)	Emission Level (dBuV/m)	Limit (dBuV/m)	Margin (dB)	Antenna Height (m)	Table Angle (Degree)	Raw Value (dBuV)	Correction Factor (dB/m)
1	2288.00	43.80 PK	74.00	-30.20	1.06 H	273	12.26	31.54
2	2288.00	37.50 AV	54.00	-16.50	1.06 H	273	5.96	31.54
3	*2462.00	103.00 PK			1.08 H	235	70.79	32.21
4	*2462.00	97.30 AV			1.08 H	235	65.09	32.21
5	2483.50	58.20 PK	74.00	-15.80	1.08 H	235	25.91	32.29
6	2483.50	45.47 AV	54.00	-8.53	1.08 H	235	13.18	32.29
7	2760.00	44.20 PK	74.00	-29.80	1.20 H	242	11.43	32.77
8	2760.00	34.30 AV	54.00	-19.70	1.20 H	242	1.53	32.77
9	4924.00	57.80 PK	74.00	-16.20	1.10 H	247	21.61	36.19
10	4924.00	53.60 AV	54.00	-0.40	1.10 H	247	17.41	36.19
11	7386.00	53.70 PK	74.00	-20.30	1.24 H	286	10.90	42.80
12	7386.00	40.30 AV	54.00	-13.70	1.24 H	286	-2.50	42.80

ANTENNA POLARITY & TEST DISTANCE: VERTICAL AT 3 M

No.	Freq. (MHz)	Emission Level (dBuV/m)	Limit (dBuV/m)	Margin (dB)	Antenna Height (m)	Table Angle (Degree)	Raw Value (dBuV)	Correction Factor (dB/m)
1	2288.00	49.90 PK	74.00	-24.10	1.00 V	10	18.36	31.54
2	2288.00	45.10 AV	54.00	-8.90	1.00 V	10	13.56	31.54
3	*2462.00	115.30 PK			1.18 V	95	83.09	32.21
4	*2462.00	110.30 AV			1.18 V	95	78.09	32.21
5	2483.50	71.30 PK	74.00	-2.70	1.00 V	160	39.01	32.29
6	2483.50	50.20 AV	54.00	-3.80	1.00 V	160	17.91	32.29
7	2760.00	49.60 PK	74.00	-24.40	1.18 V	98	16.83	32.77
8	2760.00	45.20 AV	54.00	-8.80	1.18 V	98	12.43	32.77
9	4924.00	54.00 PK	74.00	-20.00	1.01 V	273	17.81	36.19
10	4924.00	51.30 AV	54.00	-2.70	1.01 V	273	15.11	36.19
11	7386.00	54.10 PK	74.00	-19.90	1.25 V	67	11.30	42.80
12	7386.00	40.90 AV	54.00	-13.10	1.25 V	67	-1.90	42.80

- REMARKS:**
1. Emission level(dBuV/m)=Raw Value(dBuV) + Correction Factor(dB/m)
 2. Correction Factor(dB/m) = Antenna Factor (dB/m) + Cable Factor (dB)
 3. The other emission levels were very low against the limit.
 4. Margin value = Emission level – Limit value.
 5. The limit value is defined as per 15.247
 6. “ * “ : Fundamental frequency

RESTRICTED BANDEDGE (802.11b MODE, CH1, HORIZONTAL)

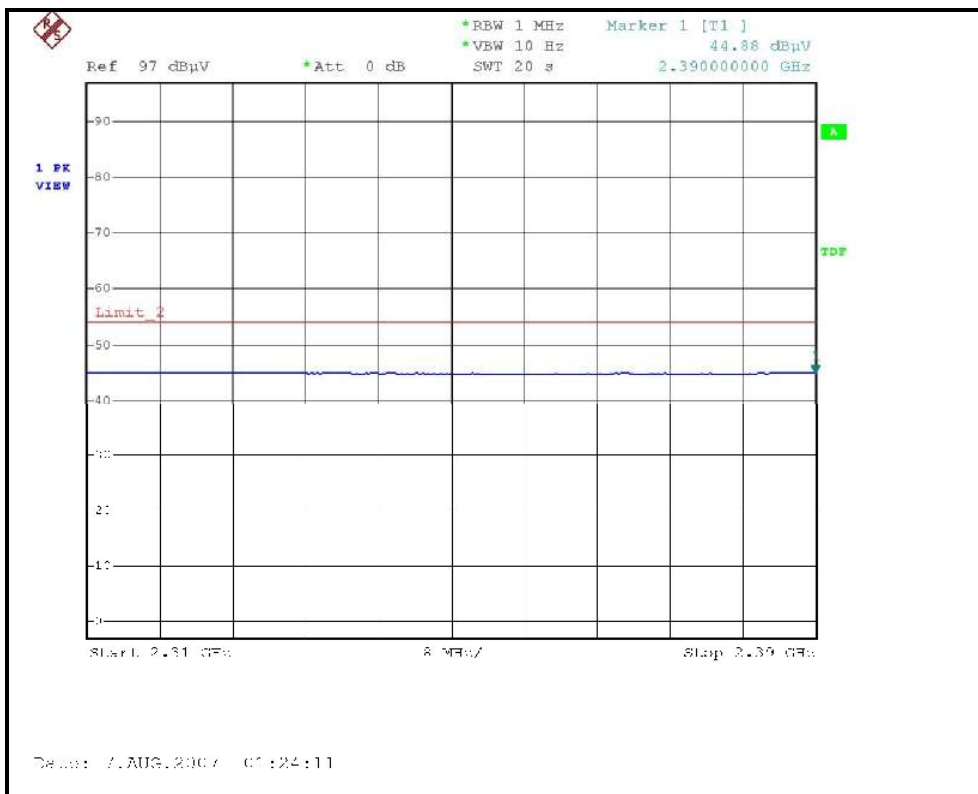
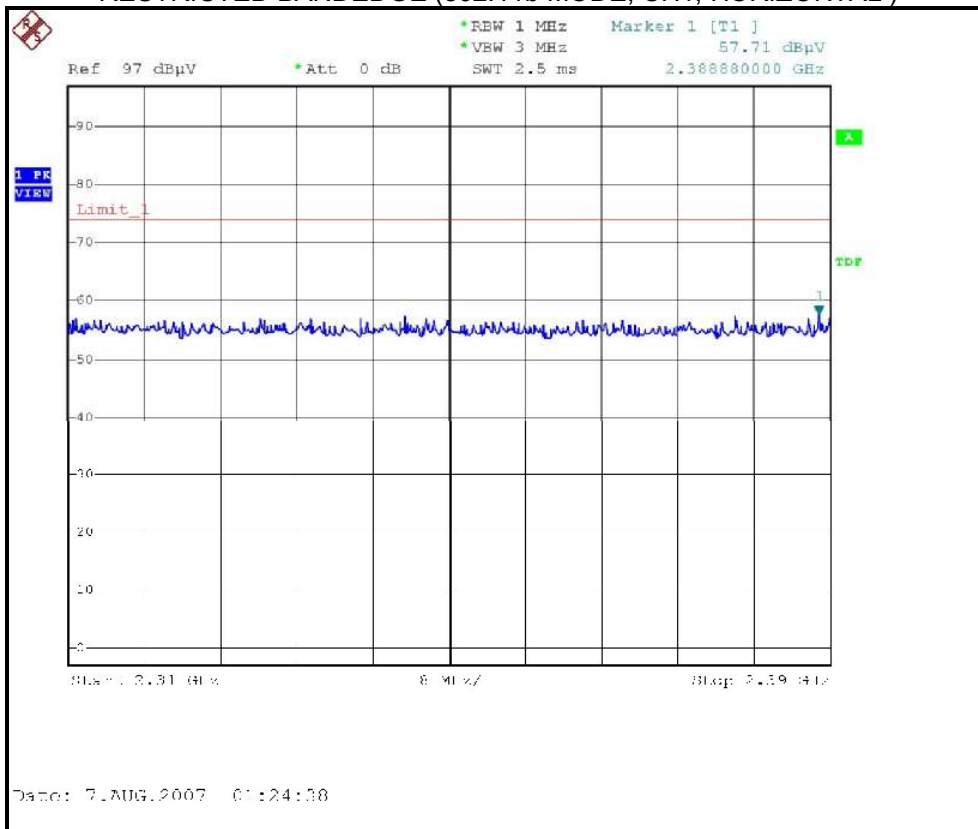

RESTRICTED BANDEDGE (802.11b MODE, CH1, VERTICAL)

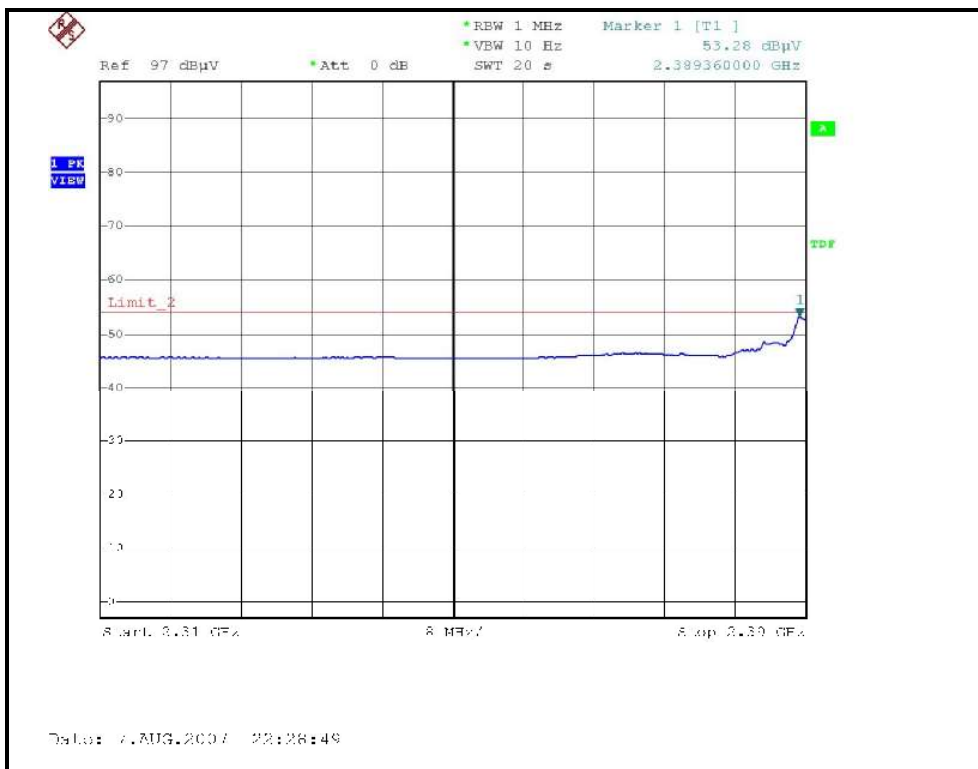
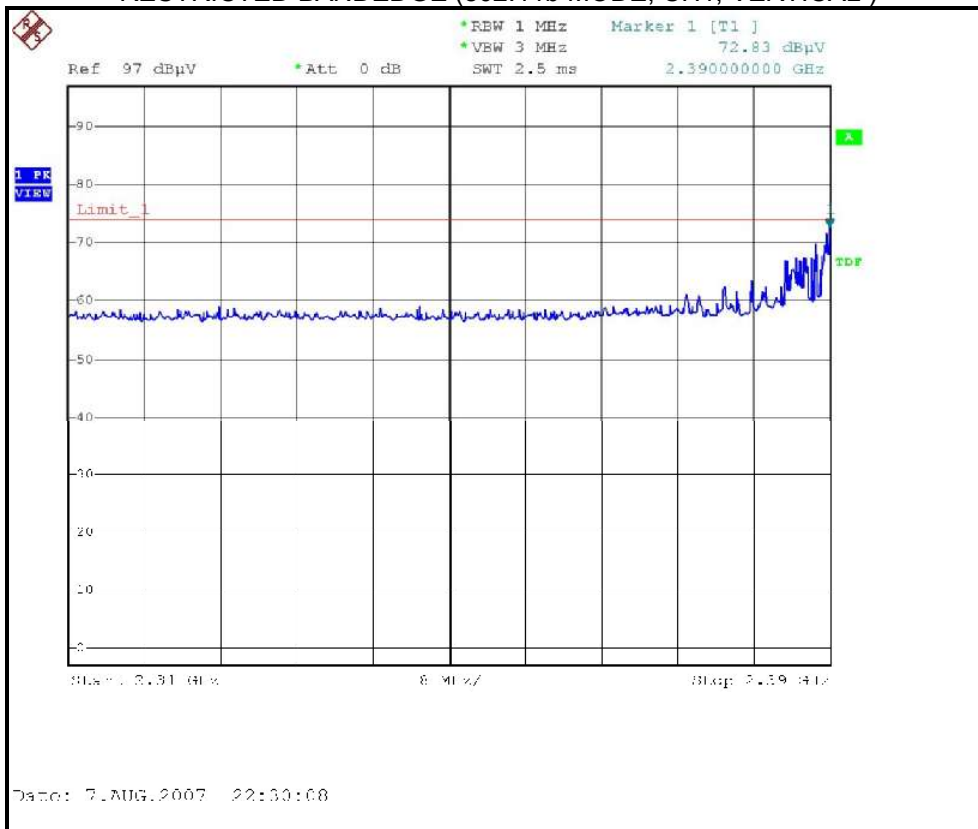

RESTRICTED BANDEDGE (802.11b MODE, CH11, HORIZONTAL)

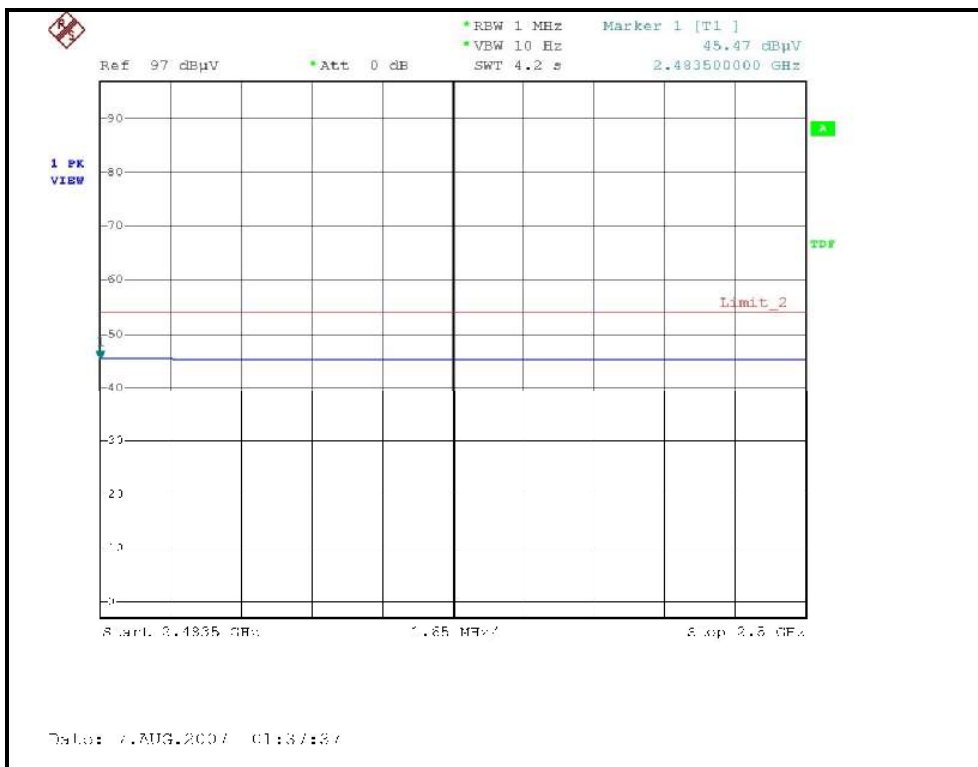
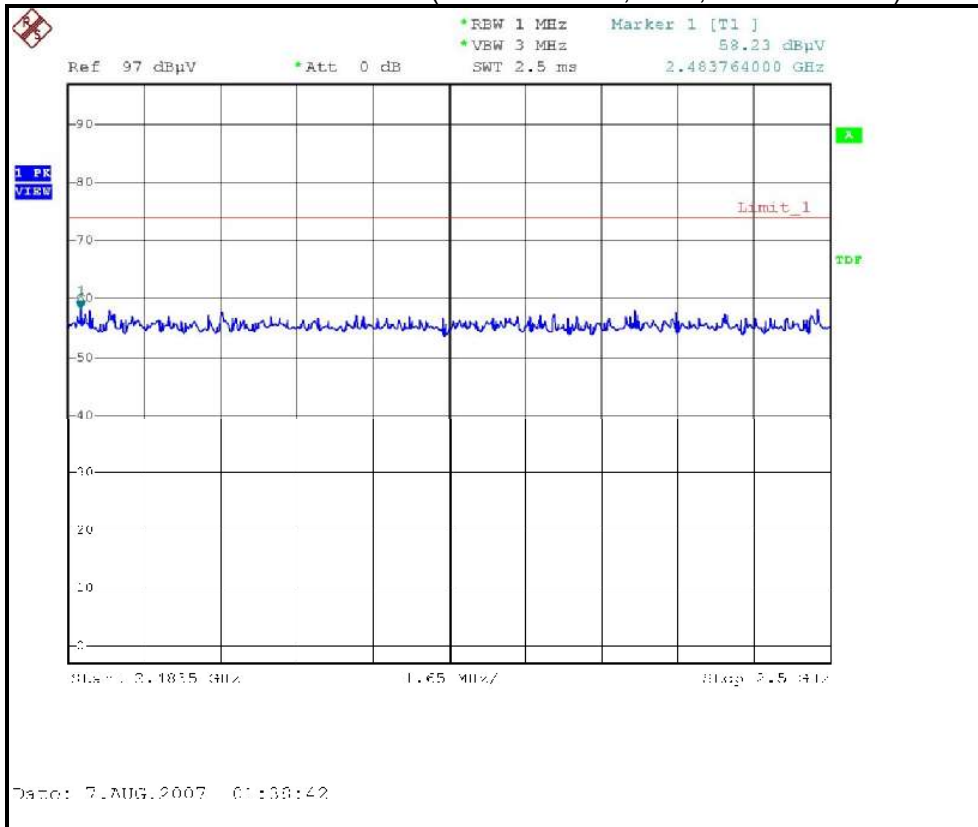

RESTRICTED BANDEDGE (802.11b MODE, CH11, VERTICAL)

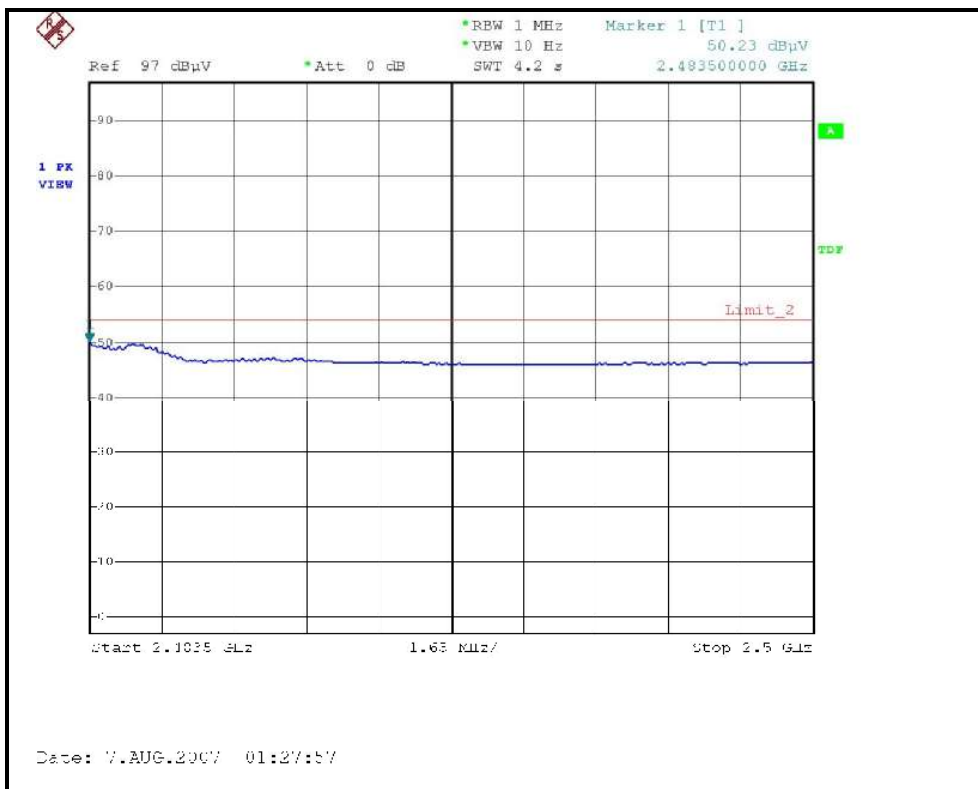
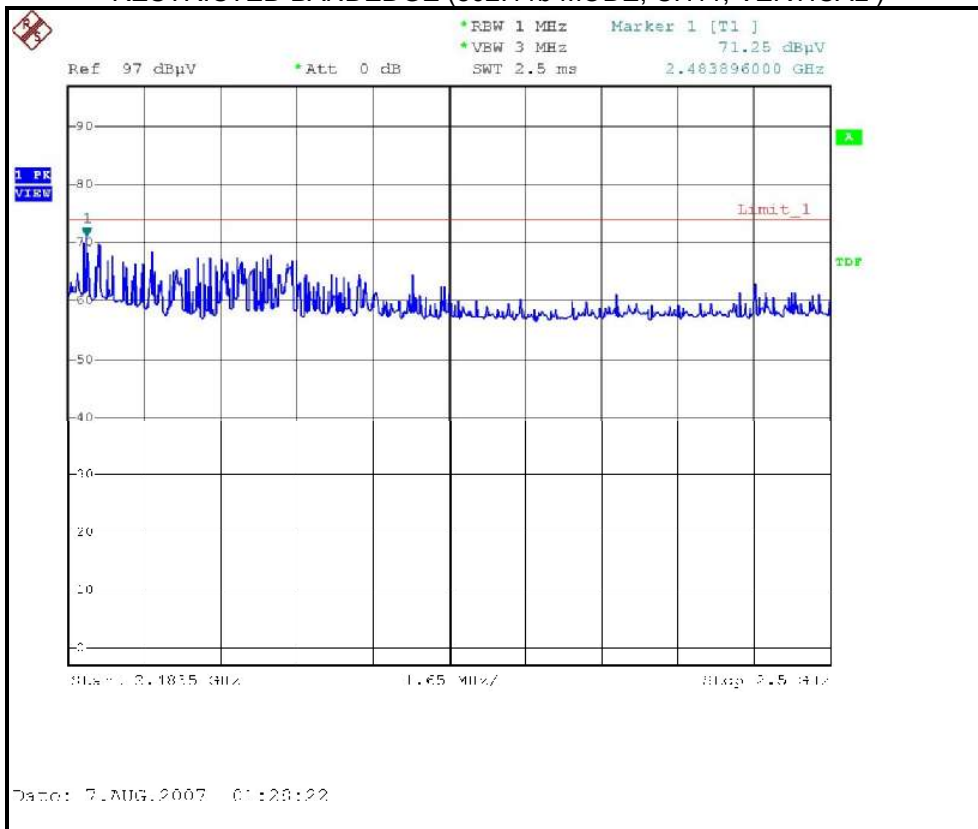



802.11g OFDM modulation

CHANNEL	Channel 1	FREQUENCY RANGE	1 ~ 25GHz
MODULATION TYPE	BPSK	TRANSFER RATE	6Mbps
INPUT POWER (SYSTEM)	120Vac, 60 Hz	DETECTOR FUNCTION	Peak(PK) Average (AV)
ENVIRONMENTAL CONDITIONS	24 deg. C, 63 %RH, 961 hPa	TESTED BY	Rex Huang

ANTENNA POLARITY & TEST DISTANCE: HORIZONTAL AT 3 M

No.	Freq. (MHz)	Emission Level (dBuV/m)	Limit (dBuV/m)	Margin (dB)	Antenna Height (m)	Table Angle (Degree)	Raw Value (dBuV)	Correction Factor (dB/m)
1	2288.00	44.70 PK	74.00	-29.30	1.03 H	211	13.16	31.54
2	2288.00	38.70 AV	54.00	-15.30	1.03 H	211	7.16	31.54
3	2390.00	59.80 PK	74.00	-14.20	1.10 H	105	27.87	31.93
4	2390.00	45.80 AV	54.00	-8.20	1.10 H	105	13.87	31.93
5	*2412.00	99.30 PK			1.07 H	106	67.28	32.02
6	*2412.00	88.00 AV			1.07 H	106	55.98	32.02
7	2760.00	44.20 PK	74.00	-29.80	1.17 H	236	11.43	32.77
8	2760.00	33.90 AV	54.00	-20.10	1.17 H	236	1.13	32.77
9	4824.00	51.70 PK	74.00	-22.30	1.10 H	133	15.73	35.97
10	4824.00	36.20 AV	54.00	-17.80	1.10 H	133	0.23	35.97
11	7236.00	53.78 PK	74.00	-20.22	1.26 H	269	11.54	42.24
12	7236.00	39.80 AV	54.00	-14.20	1.26 H	269	-2.44	42.24

ANTENNA POLARITY & TEST DISTANCE: VERTICAL AT 3 M

No.	Freq. (MHz)	Emission Level (dBuV/m)	Limit (dBuV/m)	Margin (dB)	Antenna Height (m)	Table Angle (Degree)	Raw Value (dBuV)	Correction Factor (dB/m)
1	2288.00	51.20 PK	74.00	-22.80	1.00 V	10	19.66	31.54
2	2288.00	47.30 AV	54.00	-6.70	1.00 V	10	15.76	31.54
3	2390.00	73.50 PK	74.00	-0.50	1.25 V	63	41.57	31.93
4	2390.00	53.20 AV	54.00	-0.80	1.25 V	63	21.27	31.93
5	*2412.00	114.70 PK			1.23 V	108	82.68	32.02
6	*2412.00	103.40 AV			1.23 V	108	71.38	32.02
7	2760.00	56.00 PK	74.00	-18.00	1.23 V	74	23.23	32.77
8	2760.00	46.30 AV	54.00	-7.70	1.23 V	74	13.53	32.77
9	4824.00	50.80 PK	74.00	-23.20	1.56 V	27	14.83	35.97
10	4824.00	35.50 AV	54.00	-18.50	1.56 V	27	-0.47	35.97
11	7236.00	52.90 PK	74.00	-21.10	1.32 V	78	10.66	42.24
12	7236.00	39.30 AV	54.00	-14.70	1.32 V	78	-2.94	42.24

- REMARKS:**
1. Emission level(dBuV/m)=Raw Value(dBuV) + Correction Factor(dB/m)
 2. Correction Factor(dB/m) = Antenna Factor (dB/m) + Cable Factor (dB)
 3. The other emission levels were very low against the limit.
 4. Margin value = Emission level – Limit value.
 5. The limit value is defined as per 15.247
 6. “ * “ : Fundamental frequency

CHANNEL	Channel 6	FREQUENCY RANGE	1 ~ 25GHz
MODULATION TYPE	BPSK	TRANSFER RATE	6Mbps
INPUT POWER (SYSTEM)	120Vac, 60 Hz	DETECTOR FUNCTION	Peak(PK) Average (AV)
ENVIRONMENTAL CONDITIONS	24 deg. C, 63 %RH, 961 hPa	TESTED BY	Rex Huang

ANTENNA POLARITY & TEST DISTANCE: HORIZONTAL AT 3 M

No.	Freq. (MHz)	Emission Level (dBuV/m)	Limit (dBuV/m)	Margin (dB)	Antenna Height (m)	Table Angle (Degree)	Raw Value (dBuV)	Correction Factor (dB/m)
1	2288.00	45.10 PK	74.00	-28.90	1.04 H	223	13.56	31.54
2	2288.00	39.20 AV	54.00	-14.80	1.04 H	223	7.66	31.54
3	*2437.00	113.90 PK			1.40 H	92	81.79	32.11
4	*2437.00	102.40 AV			1.40 H	92	70.29	32.11
5	2760.00	46.70 PK	74.00	-27.30	1.23 H	242	13.93	32.77
6	2760.00	35.30 AV	54.00	-18.70	1.23 H	242	2.53	32.77
7	4874.00	54.30 PK	74.00	-19.70	1.11 H	134	18.22	36.08
8	4874.00	39.30 AV	54.00	-14.70	1.11 H	134	3.22	36.08
9	7311.00	55.30 PK	74.00	-18.70	1.30 H	266	12.78	42.52
10	7311.00	39.20 AV	54.00	-14.80	1.30 H	266	-3.32	42.52

ANTENNA POLARITY & TEST DISTANCE: VERTICAL AT 3 M

No.	Freq. (MHz)	Emission Level (dBuV/m)	Limit (dBuV/m)	Margin (dB)	Antenna Height (m)	Table Angle (Degree)	Raw Value (dBuV)	Correction Factor (dB/m)
1	2288.00	52.20 PK	74.00	-21.80	1.21 V	131	20.66	31.54
2	2288.00	48.30 AV	54.00	-5.70	1.21 V	131	16.76	31.54
3	*2437.00	117.60 PK			1.12 V	93	85.49	32.11
4	*2437.00	107.40 AV			1.12 V	93	75.29	32.11
5	2760.00	58.00 PK	74.00	-16.00	1.00 V	76	25.23	32.77
6	2760.00	51.50 AV	54.00	-2.50	1.00 V	76	18.73	32.77
7	4874.00	53.20 PK	74.00	-20.80	1.07 V	299	17.12	36.08
8	4874.00	38.20 AV	54.00	-15.80	1.07 V	299	2.12	36.08
9	7311.00	54.70 PK	74.00	-19.30	1.36 V	288	12.18	42.52
10	7311.00	38.80 AV	54.00	-15.20	1.36 V	288	-3.72	42.52

- REMARKS:**
1. Emission level(dBuV/m)=Raw Value(dBuV) + Correction Factor(dB/m)
 2. Correction Factor(dB/m) = Antenna Factor (dB/m) + Cable Factor (dB)
 3. The other emission levels were very low against the limit.
 4. Margin value = Emission level – Limit value.
 5. The limit value is defined as per 15.247
 6. “ * “ : Fundamental frequency

CHANNEL	Channel 11	FREQUENCY RANGE	1 ~ 25GHz
MODULATION TYPE	BPSK	TRANSFER RATE	6Mbps
INPUT POWER (SYSTEM)	120Vac, 60 Hz	DETECTOR FUNCTION	Peak(PK) Average (AV)
ENVIRONMENTAL CONDITIONS	24 deg. C, 63 %RH, 961 hPa	TESTED BY	Rex Huang

ANTENNA POLARITY & TEST DISTANCE: HORIZONTAL AT 3 M

No.	Freq. (MHz)	Emission Level (dBuV/m)	Limit (dBuV/m)	Margin (dB)	Antenna Height (m)	Table Angle (Degree)	Raw Value (dBuV)	Correction Factor (dB/m)
1	2288.00	44.70 PK	74.00	-29.30	1.17 H	211	13.16	31.54
2	2288.00	38.50 AV	54.00	-15.50	1.17 H	211	6.96	31.54
3	*2462.00	100.40 PK			1.40 H	235	68.19	32.21
4	*2462.00	89.20 AV			1.40 H	235	56.99	32.21
5	2483.50	63.50 PK	74.00	-10.50	1.37 H	233	31.21	32.29
6	2483.50	46.50 AV	54.00	-7.50	1.37 H	233	14.21	32.29
7	2760.00	44.80 PK	74.00	-29.20	1.13 H	286	12.03	32.77
8	2760.00	34.20 AV	54.00	-19.80	1.13 H	286	1.43	32.77
9	4924.00	54.00 PK	74.00	-20.00	1.60 H	242	17.81	36.19
10	4924.00	38.00 AV	54.00	-16.00	1.60 H	242	1.81	36.19
11	7386.00	52.20 PK	74.00	-21.80	1.27 H	293	9.40	42.80
12	7386.00	39.40 AV	54.00	-14.60	1.27 H	293	-3.40	42.80

ANTENNA POLARITY & TEST DISTANCE: VERTICAL AT 3 M

No.	Freq. (MHz)	Emission Level (dBuV/m)	Limit (dBuV/m)	Margin (dB)	Antenna Height (m)	Table Angle (Degree)	Raw Value (dBuV)	Correction Factor (dB/m)
1	2288.00	52.00 PK	74.00	-22.00	1.22 V	73	20.46	31.54
2	2288.00	48.10 AV	54.00	-5.90	1.22 V	73	16.56	31.54
3	*2462.00	115.30 PK			1.10 V	275	83.09	32.21
4	*2462.00	104.10 AV			1.10 V	275	71.89	32.21
5	2483.50	73.10 PK	74.00	-0.90	1.35 V	98	40.81	32.29
6	2483.50	53.20 AV	54.00	-0.80	1.35 V	98	20.91	32.29
7	2760.00	57.10 PK	74.00	-16.90	1.00 V	102	24.33	32.77
8	2760.00	48.00 AV	54.00	-6.00	1.00 V	102	15.23	32.77
9	4924.00	51.50 PK	74.00	-22.50	1.05 V	297	15.31	36.19
10	4924.00	36.70 AV	54.00	-17.30	1.05 V	297	0.51	36.19
11	7386.00	52.10 PK	74.00	-21.90	1.30 V	283	9.30	42.80
12	7386.00	39.00 AV	54.00	-15.00	1.30 V	283	-3.80	42.80

- REMARKS:**
1. Emission level(dBuV/m)=Raw Value(dBuV) + Correction Factor(dB/m)
 2. Correction Factor(dB/m) = Antenna Factor (dB/m) + Cable Factor (dB)
 3. The other emission levels were very low against the limit.
 4. Margin value = Emission level – Limit value.
 5. The limit value is defined as per 15.247
 6. “ * “ : Fundamental frequency

RESTRICTED BANDEDGE (802.11g MODE, CH1, HORIZONTAL)

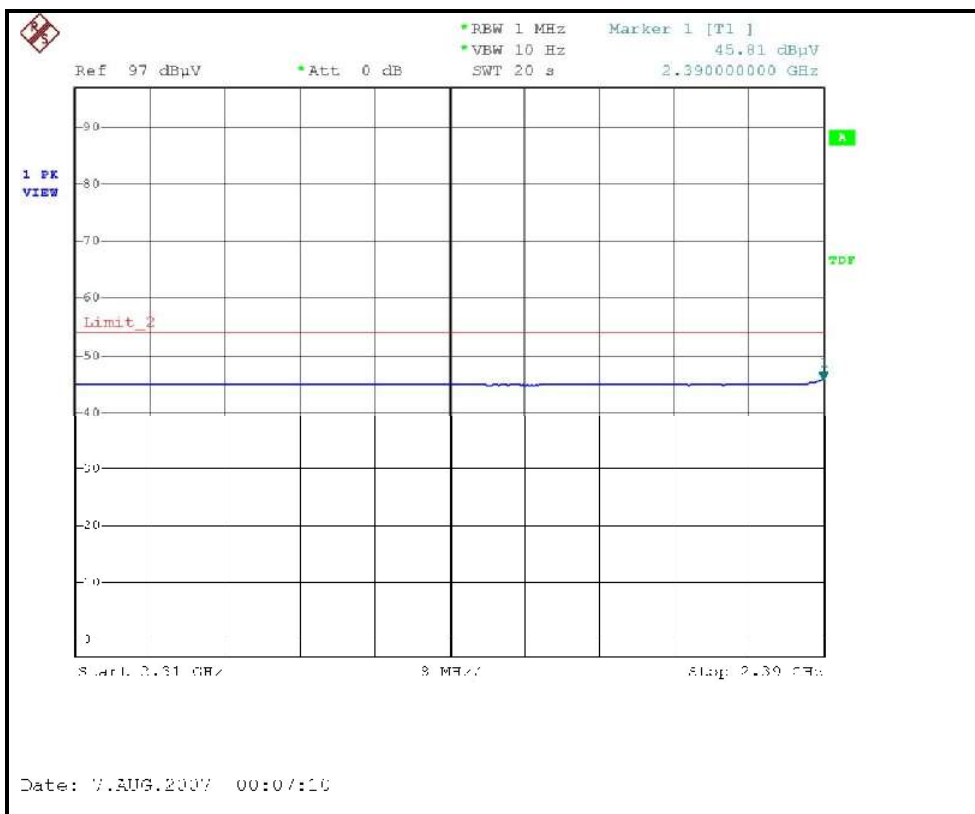
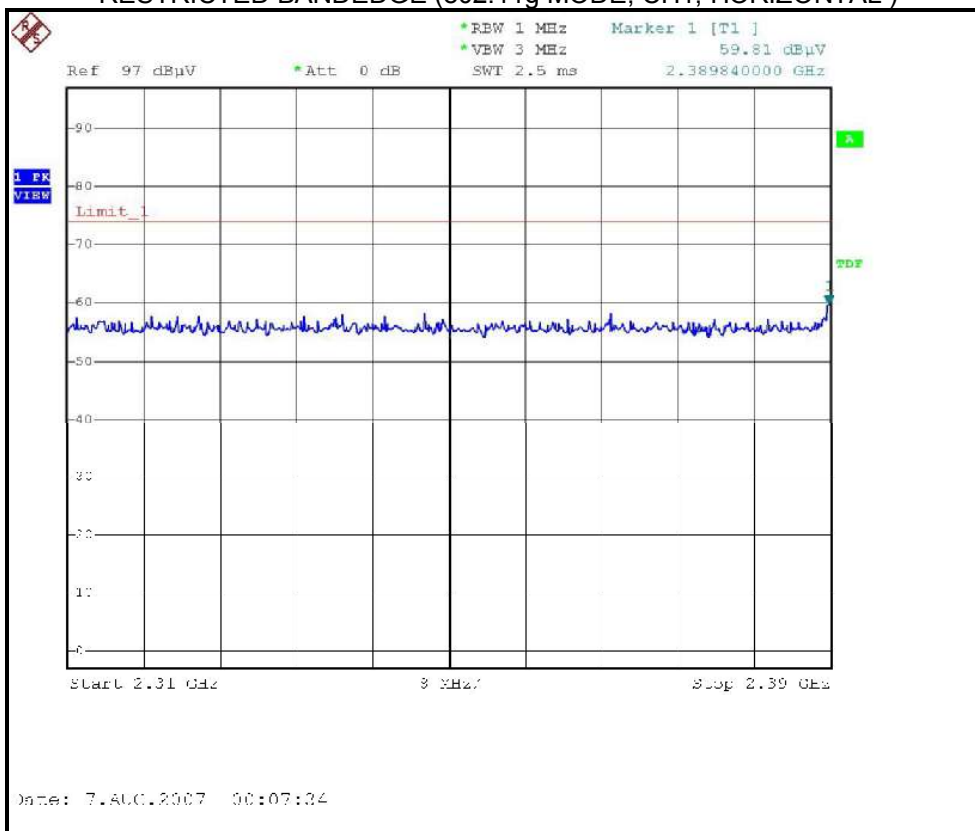

RESTRICTED BANDEDGE (802.11g MODE, CH1, VERTICAL)

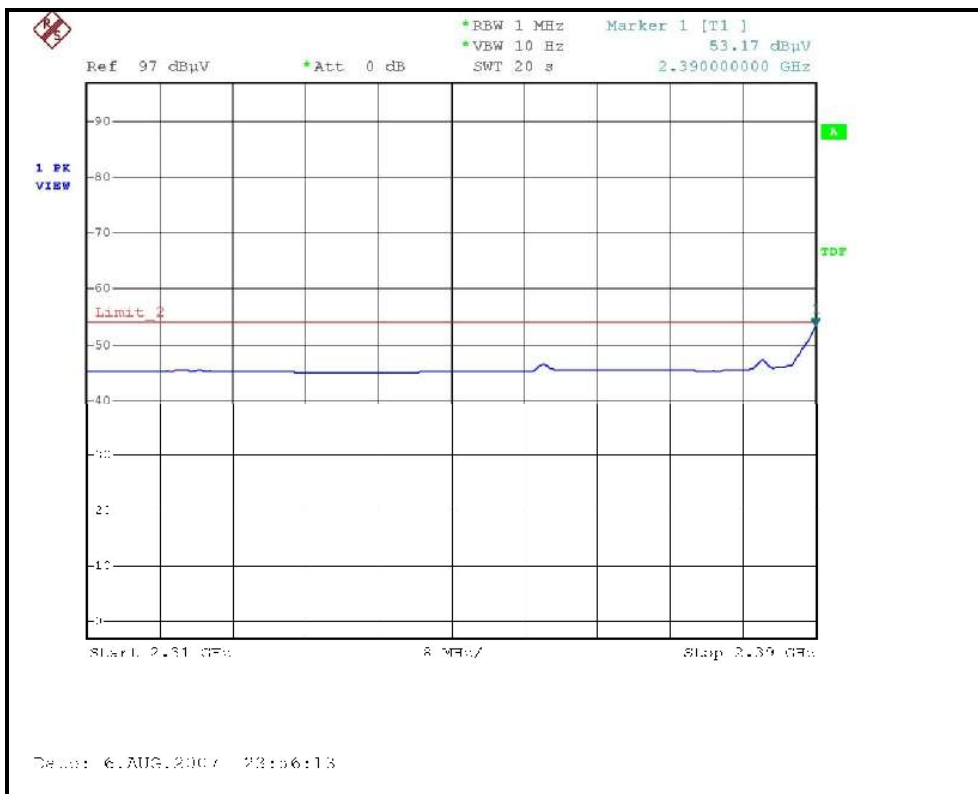
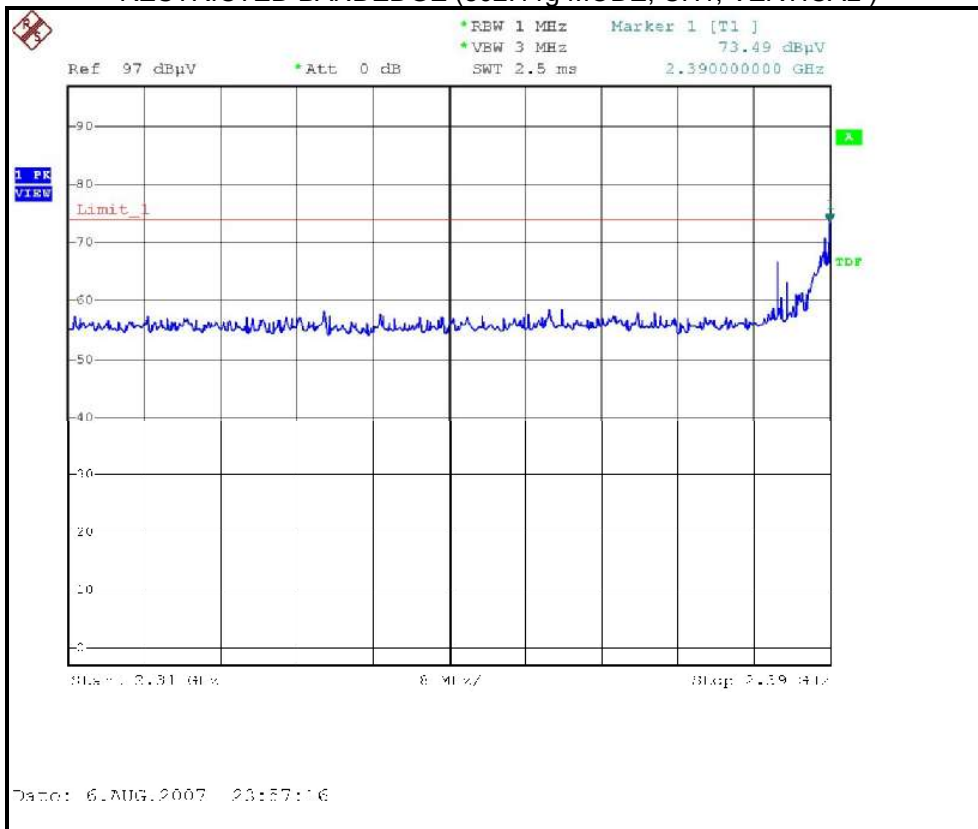

RESTRICTED BANDEDGE (802.11g MODE, CH11, HORIZONTAL)

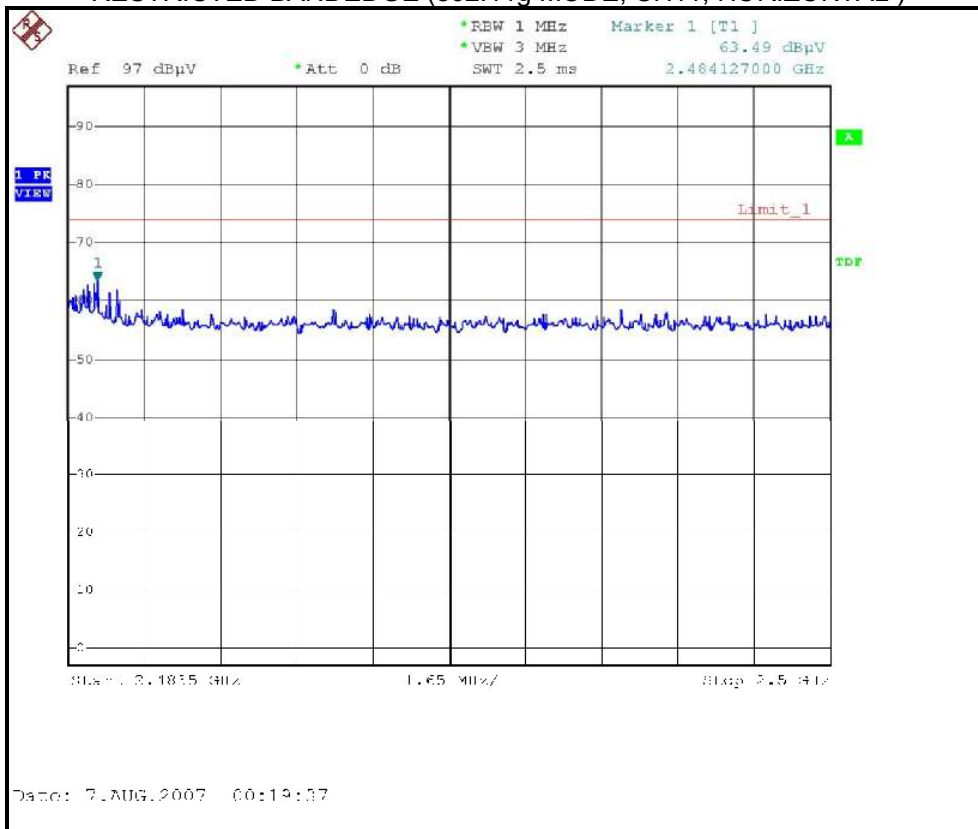

RESTRICTED BANDEDGE (802.11g MODE, CH11, VERTICAL)

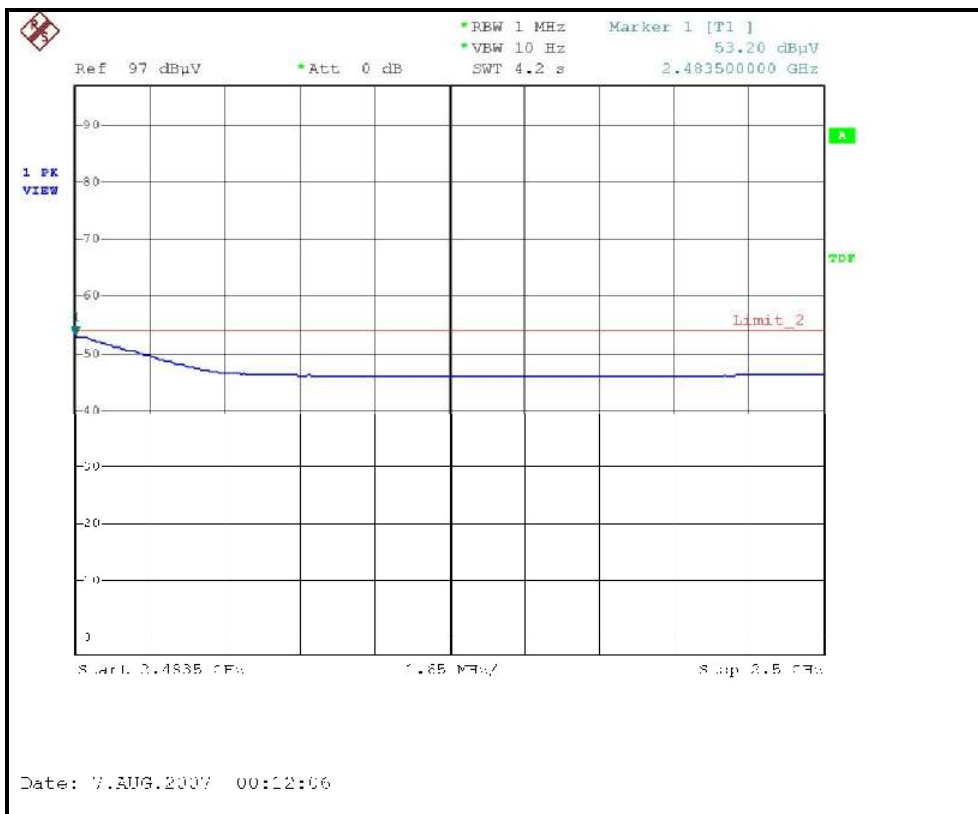
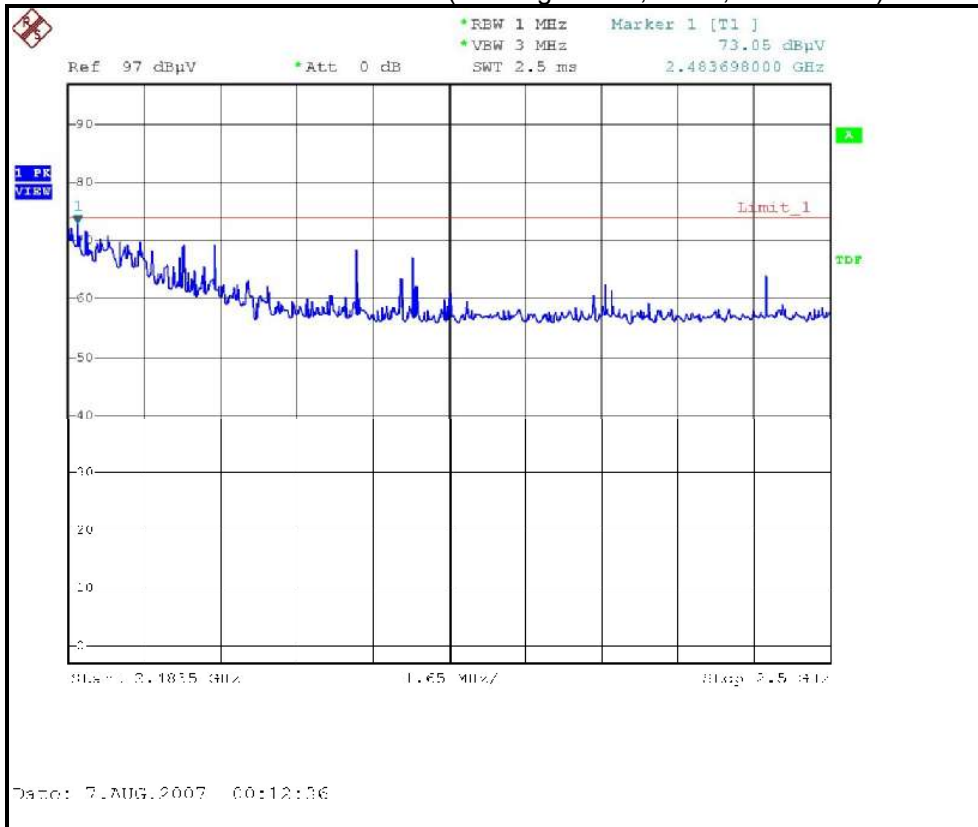

4.2.9 TEST RESULTS (ANTENNA 3)

Below 1GHz Worst-Case Data

TEST MODE	With adapter	FREQUENCY RANGE	Below 1000MHz
MODULATION TYPE	CCK	TRANSFER RATE	1Mbps
INPUT POWER (SYSTEM)	120Vac, 60 Hz	DETECTOR FUNCTION	Quasi-Peak
ENVIRONMENTAL CONDITIONS	25 deg. C, 60 %RH, 961 hPa	TESTED BY	Wen Yu

ANTENNA POLARITY & TEST DISTANCE: HORIZONTAL AT 3 M

No.	Freq. (MHz)	Emission Level (dBuV/m)	Limit (dBuV/m)	Margin (dB)	Antenna Height (m)	Table Angle (Degree)	Raw Value (dBuV)	Correction Factor (dB/m)
1	225.00	30.82 QP	46.00	-15.18	1.15 H	285	18.77	12.05
2	250.03	33.98 QP	46.00	-12.02	1.00 H	59	19.63	14.35
3	276.00	35.04 QP	46.00	-10.96	1.00 H	55	19.67	15.37
4	375.02	36.75 QP	46.00	-9.25	1.00 H	128	18.33	18.42
5	499.99	31.75 QP	46.00	-14.25	1.86 H	58	9.71	22.04
6	600.00	29.84 QP	46.00	-16.16	1.24 H	27	6.42	23.42
7	625.00	36.27 QP	46.00	-9.73	1.15 H	322	12.44	23.83
8	750.00	32.49 QP	46.00	-13.51	1.67 H	0	5.79	26.70

ANTENNA POLARITY & TEST DISTANCE: VERTICAL AT 3 M

No.	Freq. (MHz)	Emission Level (dBuV/m)	Limit (dBuV/m)	Margin (dB)	Antenna Height (m)	Table Angle (Degree)	Raw Value (dBuV)	Correction Factor (dB/m)
1	175.00	36.26 QP	43.50	-7.24	1.00 V	152	25.11	11.15
2	184.00	36.38 QP	43.50	-7.12	1.06 V	179	25.72	10.66
3	247.91	30.08 QP	46.00	-15.92	1.77 V	231	15.92	14.16
4	276.00	34.18 QP	46.00	-11.82	1.50 V	182	18.81	15.37
5	375.00	34.91 QP	46.00	-11.09	1.16 V	162	16.49	18.42
6	500.00	33.21 QP	46.00	-12.79	1.31 V	132	11.17	22.04
7	625.01	37.22 QP	46.00	-8.78	2.07 V	316	13.39	23.83
8	750.04	33.05 QP	46.00	-12.95	1.63 V	319	6.35	26.70
9	875.00	32.03 QP	46.00	-13.97	1.53 V	321	4.02	28.01

- REMARKS:**
1. Emission level(dBuV/m)=Raw Value(dBuV) + Correction Factor(dB/m)
 2. Correction Factor(dB/m) = Antenna Factor (dB/m) + Cable Factor (dB)
 3. The other emission levels were very low against the limit.
 4. Margin value = Emission level – Limit value



802.11b DSSS modulation

CHANNEL	Channel 1	FREQUENCY RANGE	1 ~ 25GHz
MODULATION TYPE	CCK	TRANSFER RATE	1Mbps
INPUT POWER (SYSTEM)	120Vac, 60 Hz	DETECTOR FUNCTION	Peak(PK) Average (AV)
ENVIRONMENTAL CONDITIONS	24 deg. C, 63 %RH, 961 hPa	TESTED BY	Rex Huang

ANTENNA POLARITY & TEST DISTANCE: HORIZONTAL AT 3 M

No.	Freq. (MHz)	Emission Level (dBuV/m)	Limit (dBuV/m)	Margin (dB)	Antenna Height (m)	Table Angle (Degree)	Raw Value (dBuV)	Correction Factor (dB/m)
1	2288.00	46.30 PK	74.00	-27.70	1.15 H	231	14.76	31.54
2	2288.00	39.70 AV	54.00	-14.30	1.15 H	231	8.16	31.54
3	2390.00	57.50 PK	74.00	-16.50	1.42 H	17	25.57	31.93
4	2390.00	45.20 AV	54.00	-8.80	1.42 H	17	13.27	31.93
5	*2412.00	103.70 PK			1.40 H	13	71.68	32.02
6	*2412.00	98.80 AV			1.40 H	13	66.78	32.02
7	2760.00	45.30 PK	74.00	-28.70	1.22 H	221	12.53	32.77
8	2760.00	35.60 AV	54.00	-18.40	1.22 H	221	2.83	32.77
9	4824.00	51.30 PK	74.00	-22.70	1.22 H	33	15.33	35.97
10	4824.00	46.70 AV	54.00	-7.30	1.22 H	33	10.73	35.97
11	7236.00	54.90 PK	74.00	-19.10	1.43 H	314	12.66	42.24
12	7236.00	40.50 AV	54.00	-13.50	1.43 H	314	-1.74	42.24

ANTENNA POLARITY & TEST DISTANCE: VERTICAL AT 3 M

No.	Freq. (MHz)	Emission Level (dBuV/m)	Limit (dBuV/m)	Margin (dB)	Antenna Height (m)	Table Angle (Degree)	Raw Value (dBuV)	Correction Factor (dB/m)
1	2288.00	49.20 PK	74.00	-24.80	1.41 V	16	22.66	31.54
2	2288.00	42.70 AV	54.00	-11.30	1.41 V	16	19.26	31.54
3	2390.00	71.80 PK	74.00	-2.20	1.61 V	346	39.87	31.93
4	2390.00	52.50 AV	54.00	-1.50	1.61 V	346	20.57	31.93
5	*2412.00	118.00 PK			1.61 V	346	85.98	32.02
6	*2412.00	113.30 AV			1.61 V	346	81.28	32.02
7	2760.00	57.20 PK	74.00	-16.80	1.22 V	263	24.43	32.77
8	2760.00	50.40 AV	54.00	-3.60	1.22 V	263	17.63	32.77
9	4824.00	49.20 PK	74.00	-24.80	1.25 V	35	13.23	35.97
10	4824.00	42.70 AV	54.00	-11.30	1.25 V	35	6.73	35.97
11	7236.00	54.30 PK	74.00	-19.70	1.31 V	172	12.06	42.24
12	7236.00	40.20 AV	54.00	-13.80	1.31 V	172	-2.04	42.24

- REMARKS:**
1. Emission level(dBuV/m)=Raw Value(dBuV) + Correction Factor(dB/m)
 2. Correction Factor(dB/m) = Antenna Factor (dB/m) + Cable Factor (dB)
 3. The other emission levels were very low against the limit.
 4. Margin value = Emission level – Limit value.
 5. The limit value is defined as per 15.247
 6. “ * “ : Fundamental frequency



CHANNEL	Channel 6	FREQUENCY RANGE	1 ~ 25GHz
MODULATION TYPE	CCK	TRANSFER RATE	1Mbps
INPUT POWER (SYSTEM)	120Vac, 60 Hz	DETECTOR FUNCTION	Peak(PK) Average (AV)
ENVIRONMENTAL CONDITIONS	24 deg. C, 63 %RH, 961 hPa	TESTED BY	Rex Huang

ANTENNA POLARITY & TEST DISTANCE: HORIZONTAL AT 3 M

No.	Freq. (MHz)	Emission Level (dBuV/m)	Limit (dBuV/m)	Margin (dB)	Antenna Height (m)	Table Angle (Degree)	Raw Value (dBuV)	Correction Factor (dB/m)
1	2288.00	45.90 PK	74.00	-28.10	1.13 H	233	14.36	31.54
2	2288.00	38.60 AV	54.00	-15.40	1.13 H	233	7.06	31.54
3	*2437.00	103.50 PK			1.20 H	251	71.39	32.11
4	*2437.00	98.30 AV			1.20 H	251	66.19	32.11
5	2760.00	45.20 PK	74.00	-28.80	1.27 H	220	12.43	32.77
6	2760.00	34.70 AV	54.00	-19.30	1.27 H	220	1.93	32.77
7	4874.00	56.80 PK	74.00	-17.20	1.45 H	243	20.72	36.08
8	4874.00	53.70 AV	54.00	-0.30	1.45 H	243	17.62	36.08
9	7311.00	53.20 PK	74.00	-20.80	1.45 H	2	10.68	42.52
10	7311.00	40.20 AV	54.00	-13.80	1.45 H	2	-2.32	42.52

ANTENNA POLARITY & TEST DISTANCE: VERTICAL AT 3 M

No.	Freq. (MHz)	Emission Level (dBuV/m)	Limit (dBuV/m)	Margin (dB)	Antenna Height (m)	Table Angle (Degree)	Raw Value (dBuV)	Correction Factor (dB/m)
1	2288.00	48.60 PK	74.00	-25.40	1.00 V	64	24.06	31.54
2	2288.00	42.50 AV	54.00	-11.50	1.00 V	64	20.96	31.54
3	2437.00	117.70 PK			1.00 V	274	85.59	32.11
4	2437.00	112.80 AV			1.00 V	274	80.69	32.11
5	2760.00	56.80 PK	74.00	-17.20	1.22 V	252	24.03	32.77
6	2760.00	48.20 AV	54.00	-5.80	1.22 V	252	15.43	32.77
7	4874.00	51.80 PK	74.00	-22.20	1.23 V	155	15.72	36.08
8	4874.00	46.50 AV	54.00	-7.50	1.23 V	155	10.42	36.08
9	7311.00	52.70 PK	74.00	-21.30	1.30 V	67	10.18	42.52
10	7311.00	39.50 AV	54.00	-14.50	1.30 V	67	-3.02	42.52

- REMARKS:**
1. Emission level(dBuV/m)=Raw Value(dBuV) + Correction Factor(dB/m)
 2. Correction Factor(dB/m) = Antenna Factor (dB/m) + Cable Factor (dB)
 3. The other emission levels were very low against the limit.
 4. Margin value = Emission level – Limit value.
 5. The limit value is defined as per 15.247
 6. “ * “ : Fundamental frequency

CHANNEL	Channel 11	FREQUENCY RANGE	1 ~ 25GHz
MODULATION TYPE	CCK	TRANSFER RATE	1Mbps
INPUT POWER (SYSTEM)	120Vac, 60 Hz	DETECTOR FUNCTION	Peak(PK) Average (AV)
ENVIRONMENTAL CONDITIONS	24 deg. C, 63 %RH, 961 hPa	TESTED BY	Rex Huang

ANTENNA POLARITY & TEST DISTANCE: HORIZONTAL AT 3 M

No.	Freq. (MHz)	Emission Level (dBuV/m)	Limit (dBuV/m)	Margin (dB)	Antenna Height (m)	Table Angle (Degree)	Raw Value (dBuV)	Correction Factor (dB/m)
1	2288.00	45.50 PK	74.00	-28.50	1.00 H	232	13.96	31.54
2	2288.00	38.20 AV	54.00	-15.80	1.00 H	232	6.66	31.54
3	*2462.00	103.70 PK			1.06 H	238	71.49	32.21
4	*2462.00	98.20 AV			1.06 H	238	65.99	32.21
5	2483.50	59.70 PK	74.00	-14.30	1.07 H	239	27.41	32.29
6	2483.50	45.90 AV	54.00	-8.10	1.07 H	239	13.61	32.29
7	2760.00	45.00 PK	74.00	-29.00	1.31 H	47	12.23	32.77
8	2760.00	33.20 AV	54.00	-20.80	1.31 H	47	0.43	32.77
9	4924.00	56.10 PK	74.00	-17.90	1.60 H	237	19.91	36.19
10	4924.00	53.20 AV	54.00	-0.80	1.60 H	237	17.01	36.19
11	7386.00	54.20 PK	74.00	-19.80	1.00 H	312	11.40	42.80
12	7386.00	41.50 AV	54.00	-12.50	1.00 H	312	-1.30	42.80

ANTENNA POLARITY & TEST DISTANCE: VERTICAL AT 3 M

No.	Freq. (MHz)	Emission Level (dBuV/m)	Limit (dBuV/m)	Margin (dB)	Antenna Height (m)	Table Angle (Degree)	Raw Value (dBuV)	Correction Factor (dB/m)
1	2288.00	55.70 PK	74.00	-18.30	1.00 V	64	24.16	31.54
2	2288.00	52.20 AV	54.00	-1.80	1.00 V	64	20.66	31.54
3	*2462.00	117.00 PK			1.02 V	264	84.79	32.21
4	*2462.00	111.90 AV			1.02 V	264	79.69	32.21
5	2483.50	72.60 PK	74.00	-1.40	1.10 V	250	40.31	32.29
6	2483.50	53.50 AV	54.00	-0.50	1.10 V	250	21.21	32.29
7	2760.00	54.90 PK	74.00	-19.10	1.21 V	202	22.13	32.77
8	2760.00	45.40 AV	54.00	-8.60	1.21 V	202	12.63	32.77
9	4924.00	51.20 PK	74.00	-22.80	1.22 V	31	15.01	36.19
10	4924.00	47.60 AV	54.00	-6.40	1.22 V	31	11.41	36.19
11	7386.00	53.80 PK	74.00	-20.20	1.21 V	262	11.00	42.80
12	7386.00	41.20 AV	54.00	-12.80	1.21 V	262	-1.60	42.80

- REMARKS:**
1. Emission level(dBuV/m)=Raw Value(dBuV) + Correction Factor(dB/m)
 2. Correction Factor(dB/m) = Antenna Factor (dB/m) + Cable Factor (dB)
 3. The other emission levels were very low against the limit.
 4. Margin value = Emission level – Limit value.
 5. The limit value is defined as per 15.247
 6. “ * “ : Fundamental frequency

RESTRICTED BANDEDGE (802.11b MODE, CH1, HORIZONTAL)

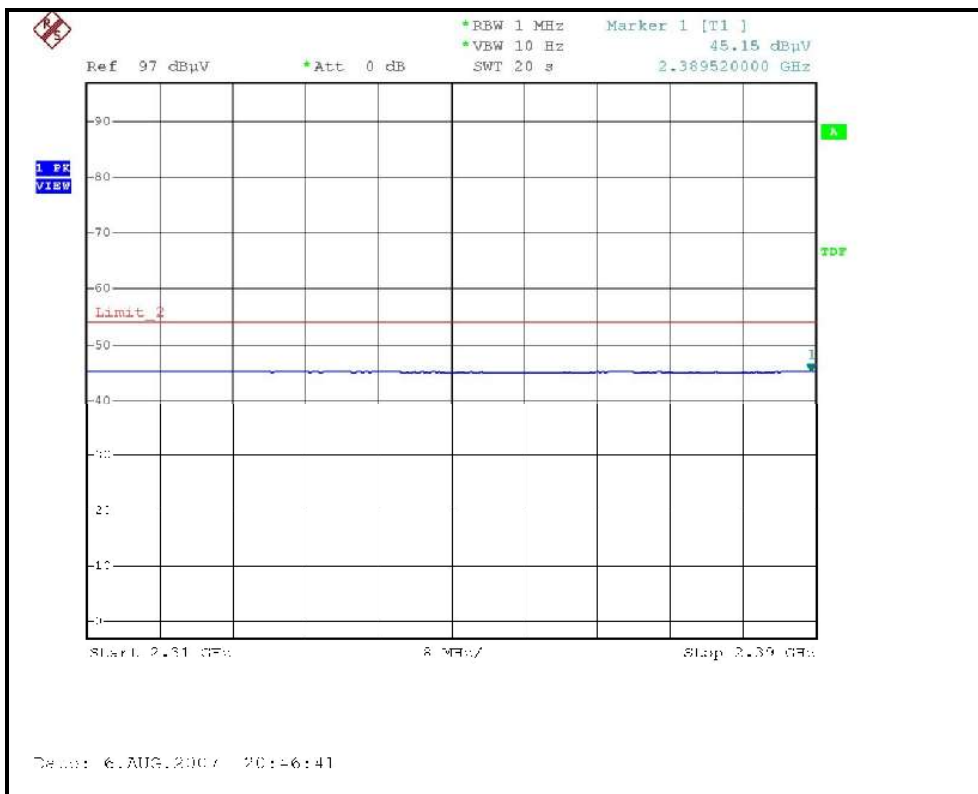
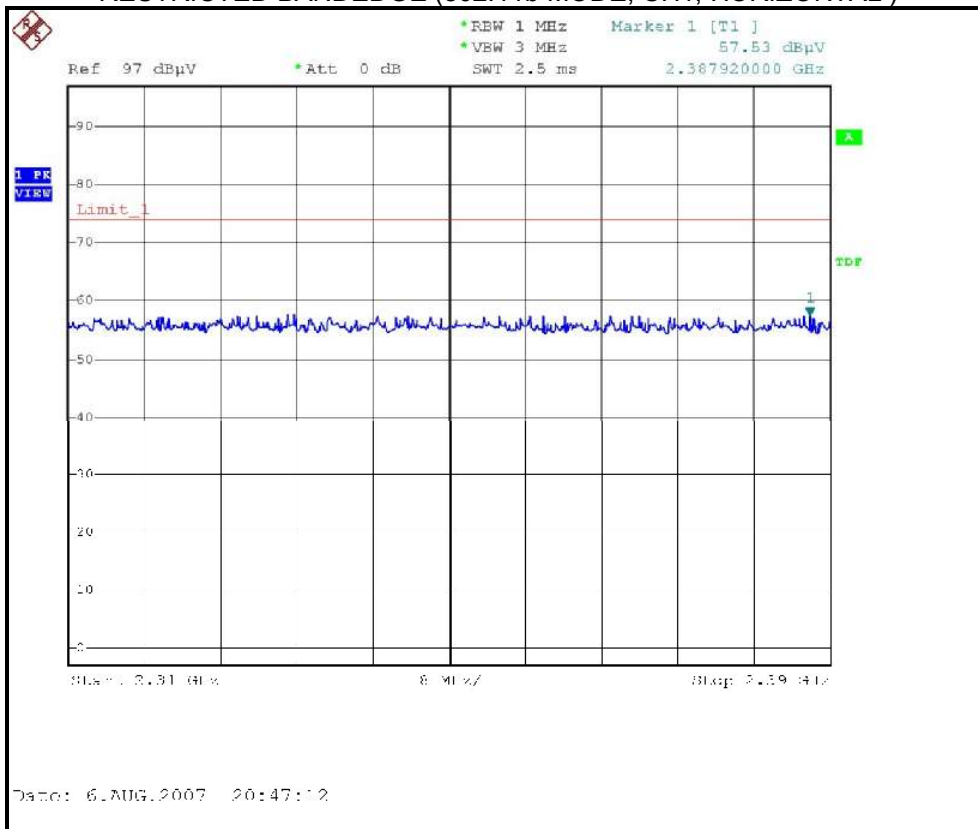

RESTRICTED BANDEDGE (802.11b MODE, CH1, VERTICAL)

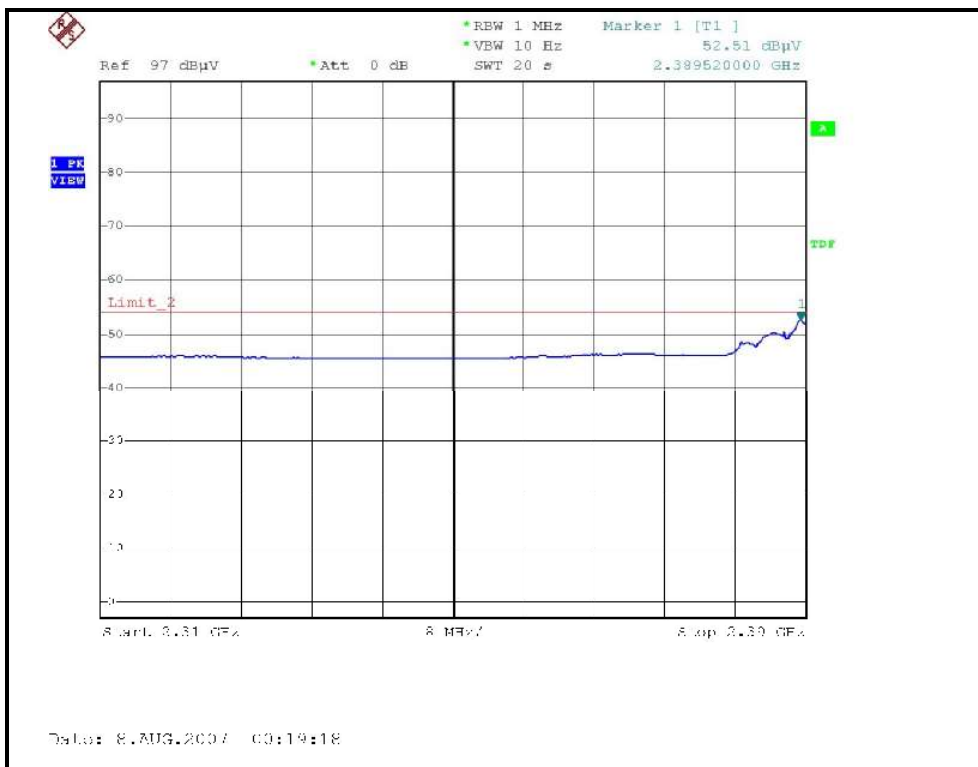
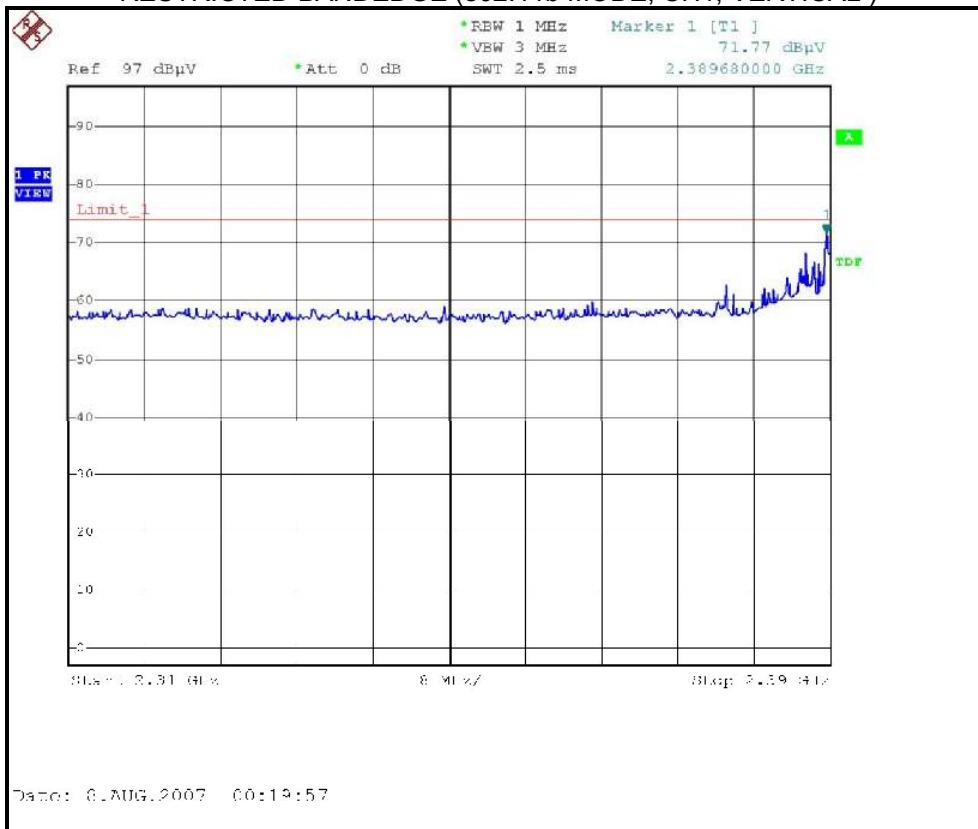

RESTRICTED BANDEDGE (802.11b MODE, CH11, VERTICAL)

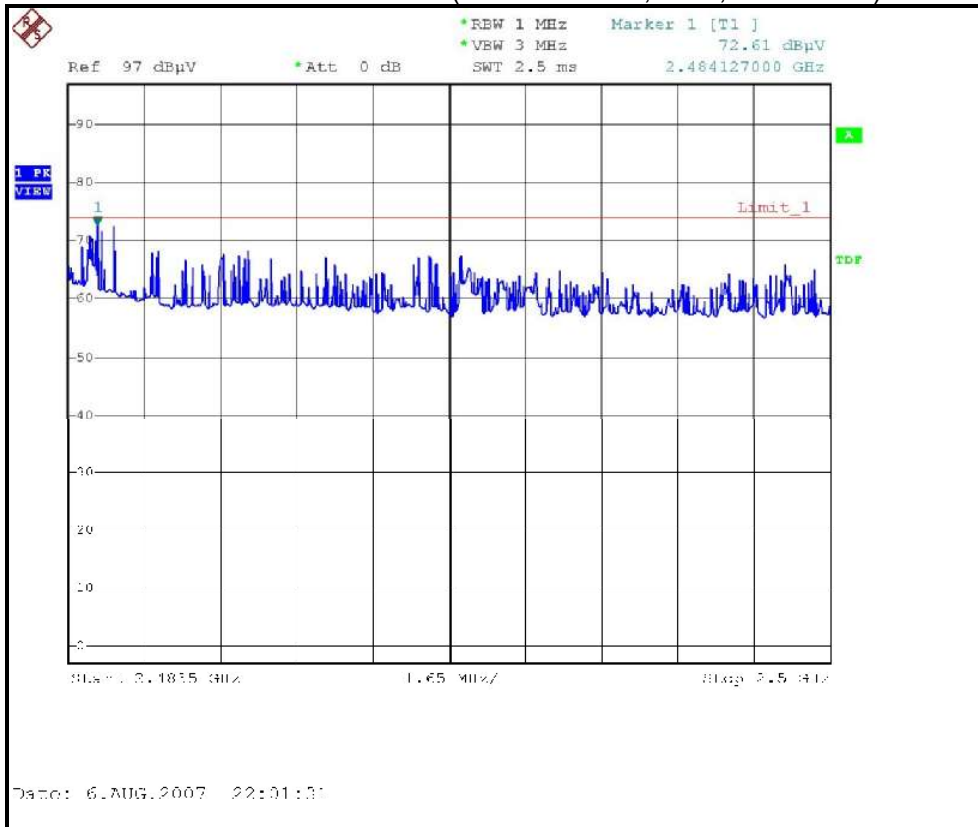



802.11g OFDM modulation

CHANNEL	Channel 1	FREQUENCY RANGE	1 ~ 25GHz
MODULATION TYPE	BPSK	TRANSFER RATE	6Mbps
INPUT POWER (SYSTEM)	120Vac, 60 Hz	DETECTOR FUNCTION	Peak(PK) Average (AV)
ENVIRONMENTAL CONDITIONS	24 deg. C, 63 %RH, 961 hPa	TESTED BY	Rex Huang

ANTENNA POLARITY & TEST DISTANCE: HORIZONTAL AT 3 M

No.	Freq. (MHz)	Emission Level (dBuV/m)	Limit (dBuV/m)	Margin (dB)	Antenna Height (m)	Table Angle (Degree)	Raw Value (dBuV)	Correction Factor (dB/m)
1	2288.00	46.70 PK	74.00	-27.30	1.00 H	217	15.16	31.54
2	2288.00	40.20 AV	54.00	-13.80	1.00 H	217	8.66	31.54
3	2390.00	60.00 PK	74.00	-14.00	1.45 H	11	28.07	31.93
4	2390.00	45.60 AV	54.00	-8.40	1.45 H	11	13.67	31.93
5	*2412.00	100.30 PK			1.40 H	12	68.28	32.02
6	*2412.00	88.90 AV			1.40 H	12	56.88	32.02
7	2760.00	45.50 PK	74.00	-28.50	1.18 H	299	12.73	32.77
8	2760.00	35.10 AV	54.00	-18.90	1.18 H	299	2.33	32.77
9	4824.00	46.50 PK	74.00	-27.50	1.17 H	236	10.53	35.97
10	4824.00	33.90 AV	54.00	-20.10	1.17 H	236	-2.07	35.97
11	7236.00	52.60 PK	74.00	-21.40	1.48 H	172	10.36	42.24
12	7236.00	39.70 AV	54.00	-14.30	1.48 H	172	-2.54	42.24

ANTENNA POLARITY & TEST DISTANCE: VERTICAL AT 3 M

No.	Freq. (MHz)	Emission Level (dBuV/m)	Limit (dBuV/m)	Margin (dB)	Antenna Height (m)	Table Angle (Degree)	Raw Value (dBuV)	Correction Factor (dB/m)
1	2288.00	46.70 PK	74.00	-27.30	1.00 V	64	25.16	31.54
2	2288.00	43.20 AV	54.00	-10.80	1.00 V	64	21.66	31.54
3	2390.00	73.60 PK	74.00	-0.40	1.51 V	273	41.67	31.93
4	2390.00	52.40 AV	54.00	-1.60	1.51 V	273	20.47	31.93
5	*2412.00	114.80 PK			1.58 V	41	82.78	32.02
6	*2412.00	103.60 AV			1.58 V	41	71.58	32.02
7	2760.00	57.70 PK	74.00	-16.30	1.21 V	286	24.93	32.77
8	2760.00	48.70 AV	54.00	-5.30	1.21 V	286	15.93	32.77
9	4824.00	45.70 PK	74.00	-28.30	1.04 V	355	9.73	35.97
10	4824.00	32.80 AV	54.00	-21.20	1.04 V	355	-3.17	35.97
11	7236.00	52.10 PK	74.00	-21.90	1.21 V	167	9.86	42.24
12	7236.00	39.20 AV	54.00	-14.80	1.21 V	167	-3.04	42.24

- REMARKS:**
1. Emission level(dBuV/m)=Raw Value(dBuV) + Correction Factor(dB/m)
 2. Correction Factor(dB/m) = Antenna Factor (dB/m) + Cable Factor (dB)
 3. The other emission levels were very low against the limit.
 4. Margin value = Emission level – Limit value.
 5. The limit value is defined as per 15.247
 6. “ * “ : Fundamental frequency

CHANNEL	Channel 6	FREQUENCY RANGE	1 ~ 25GHz
MODULATION TYPE	BPSK	TRANSFER RATE	6Mbps
INPUT POWER (SYSTEM)	120Vac, 60 Hz	DETECTOR FUNCTION	Peak(PK) Average (AV)
ENVIRONMENTAL CONDITIONS	24 deg. C, 63 %RH, 961 hPa	TESTED BY	Rex Huang

ANTENNA POLARITY & TEST DISTANCE: HORIZONTAL AT 3 M

No.	Freq. (MHz)	Emission Level (dBuV/m)	Limit (dBuV/m)	Margin (dB)	Antenna Height (m)	Table Angle (Degree)	Raw Value (dBuV)	Correction Factor (dB/m)
1	2288.00	46.80 PK	74.00	-27.20	1.02 H	215	15.26	31.54
2	2288.00	40.30 AV	54.00	-13.70	1.02 H	215	8.76	31.54
3	*2437.00	113.10 PK			1.24 H	265	80.99	32.11
4	*2437.00	101.90 AV			1.24 H	265	69.79	32.11
5	2760.00	45.70 PK	74.00	-28.30	1.19 H	286	12.93	32.77
6	2760.00	35.30 AV	54.00	-18.70	1.19 H	286	2.53	32.77
7	4874.00	49.10 PK	74.00	-24.90	1.15 H	233	13.02	36.08
8	4874.00	36.20 AV	54.00	-17.80	1.15 H	233	0.12	36.08
9	7311.00	53.20 PK	74.00	-20.80	1.44 H	177	10.68	42.52
10	7311.00	40.10 AV	54.00	-13.90	1.44 H	177	-2.42	42.52

ANTENNA POLARITY & TEST DISTANCE: VERTICAL AT 3 M

No.	Freq. (MHz)	Emission Level (dBuV/m)	Limit (dBuV/m)	Margin (dB)	Antenna Height (m)	Table Angle (Degree)	Raw Value (dBuV)	Correction Factor (dB/m)
1	2288.00	46.50 PK	74.00	-57.50	1.00 V	64	24.96	31.54
2	2288.00	43.20 AV	54.00	-10.80	1.00 V	64	21.66	31.54
3	*2437.00	116.90 PK			1.00 V	263	84.79	32.11
4	*2437.00	106.70 AV			1.00 V	263	74.59	32.11
5	2760.00	59.10 PK	74.00	-14.90	1.20 V	254	26.33	32.77
6	2760.00	53.50 AV	54.00	-0.50	1.20 V	254	20.73	32.77
7	4874.00	48.20 PK	74.00	-25.80	1.17 V	236	12.12	36.08
8	4874.00	35.10 AV	54.00	-18.90	1.17 V	236	-0.98	36.08
9	7311.00	52.70 PK	74.00	-21.30	1.43 V	182	10.18	42.52
10	7311.00	39.30 AV	54.00	-14.70	1.43 V	182	-3.22	42.52

- REMARKS:**
1. Emission level(dBuV/m)=Raw Value(dBuV) + Correction Factor(dB/m)
 2. Correction Factor(dB/m) = Antenna Factor (dB/m) + Cable Factor (dB)
 3. The other emission levels were very low against the limit.
 4. Margin value = Emission level – Limit value.
 5. The limit value is defined as per 15.247
 6. “ * “ : Fundamental frequency

CHANNEL	Channel 11	FREQUENCY RANGE	1 ~ 25GHz
MODULATION TYPE	BPSK	TRANSFER RATE	6Mbps
INPUT POWER (SYSTEM)	120Vac, 60 Hz	DETECTOR FUNCTION	Peak(PK) Average (AV)
ENVIRONMENTAL CONDITIONS	24 deg. C, 63 %RH, 961 hPa	TESTED BY	Rex Huang

ANTENNA POLARITY & TEST DISTANCE: HORIZONTAL AT 3 M

No.	Freq. (MHz)	Emission Level (dBuV/m)	Limit (dBuV/m)	Margin (dB)	Antenna Height (m)	Table Angle (Degree)	Raw Value (dBuV)	Correction Factor (dB/m)
1	2288.00	45.20 PK	74.00	-28.80	1.00 H	216	13.66	31.54
2	2288.00	39.10 AV	54.00	-14.90	1.00 H	216	7.56	31.54
3	*2462.00	101.10 PK			1.05 H	239	68.89	32.21
4	*2462.00	89.70 AV			1.05 H	239	57.49	32.21
5	2483.50	63.60 PK	74.00	-10.40	1.04 H	239	31.31	32.29
6	2483.50	46.50 AV	54.00	-7.50	1.04 H	239	14.21	32.29
7	2760.00	45.00 PK	74.00	-29.00	1.17 H	291	12.23	32.77
8	2760.00	34.60 AV	54.00	-19.40	1.17 H	291	1.83	32.77
9	4924.00	48.80 PK	74.00	-25.20	1.50 H	51	12.61	36.19
10	4924.00	34.50 AV	54.00	-19.50	1.50 H	51	-1.69	36.19
11	7236.00	51.90 PK	74.00	-22.10	1.22 H	3	9.66	42.24
12	7236.00	38.90 AV	54.00	-15.10	1.22 H	3	-3.34	42.24

ANTENNA POLARITY & TEST DISTANCE: VERTICAL AT 3 M

No.	Freq. (MHz)	Emission Level (dBuV/m)	Limit (dBuV/m)	Margin (dB)	Antenna Height (m)	Table Angle (Degree)	Raw Value (dBuV)	Correction Factor (dB/m)
1	2288.00	47.40 PK	74.00	-26.60	1.00 V	65	25.56	31.54
2	2288.00	43.60 AV	54.00	-10.40	1.00 V	65	22.06	31.54
3	*2462.00	114.70 PK			1.12 V	286	82.49	32.21
4	*2462.00	103.60 AV			1.12 V	286	71.39	32.21
5	2483.50	73.60 PK	74.00	-0.40	1.52 V	14	41.31	32.29
6	2483.50	53.80 AV	54.00	-0.20	1.52 V	14	21.51	32.29
7	2760.00	58.80 PK	74.00	-15.20	1.22 V	236	26.03	32.77
8	2760.00	51.30 AV	54.00	-2.70	1.22 V	236	18.53	32.77
9	4924.00	48.50 PK	74.00	-25.50	1.22 V	143	12.31	36.19
10	4924.00	33.40 AV	54.00	-20.60	1.22 V	143	-2.79	36.19
11	7386.00	51.80 PK	74.00	-22.20	1.27 V	308	9.00	42.80
12	7386.00	38.70 AV	54.00	-15.30	1.27 V	308	-4.10	42.80

- REMARKS:**
1. Emission level(dBuV/m)=Raw Value(dBuV) + Correction Factor(dB/m)
 2. Correction Factor(dB/m) = Antenna Factor (dB/m) + Cable Factor (dB)
 3. The other emission levels were very low against the limit.
 4. Margin value = Emission level – Limit value.
 5. The limit value is defined as per 15.247
 6. “ * “ : Fundamental frequency

RESTRICTED BANDEDGE (802.11g MODE, CH1, HORIZONTAL)

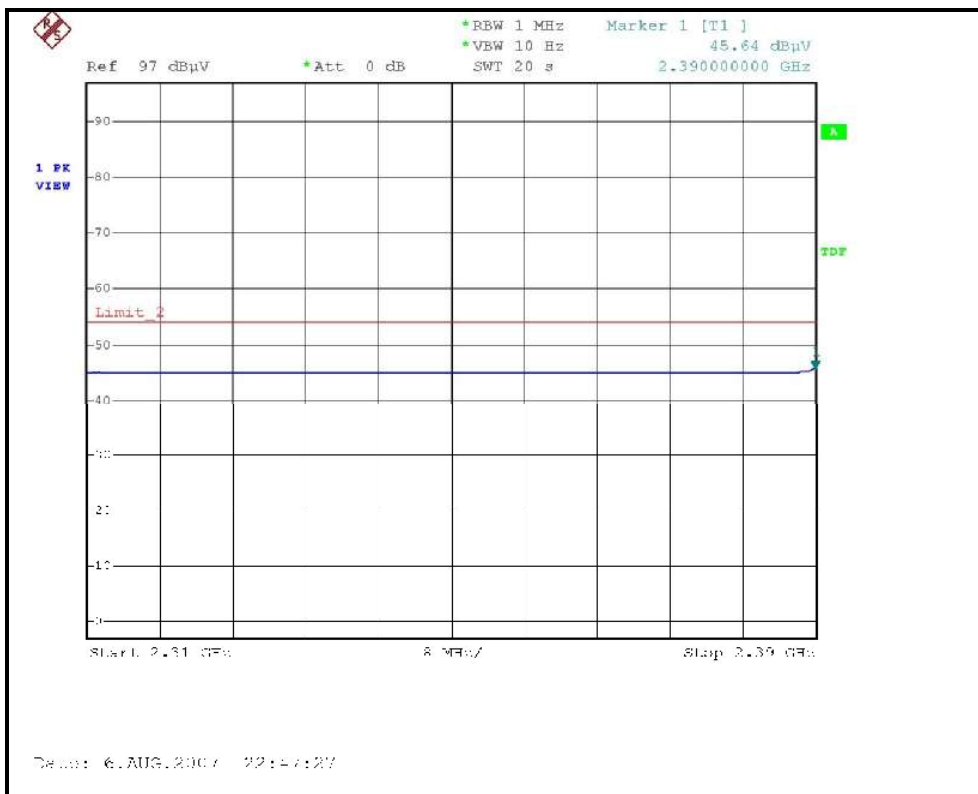
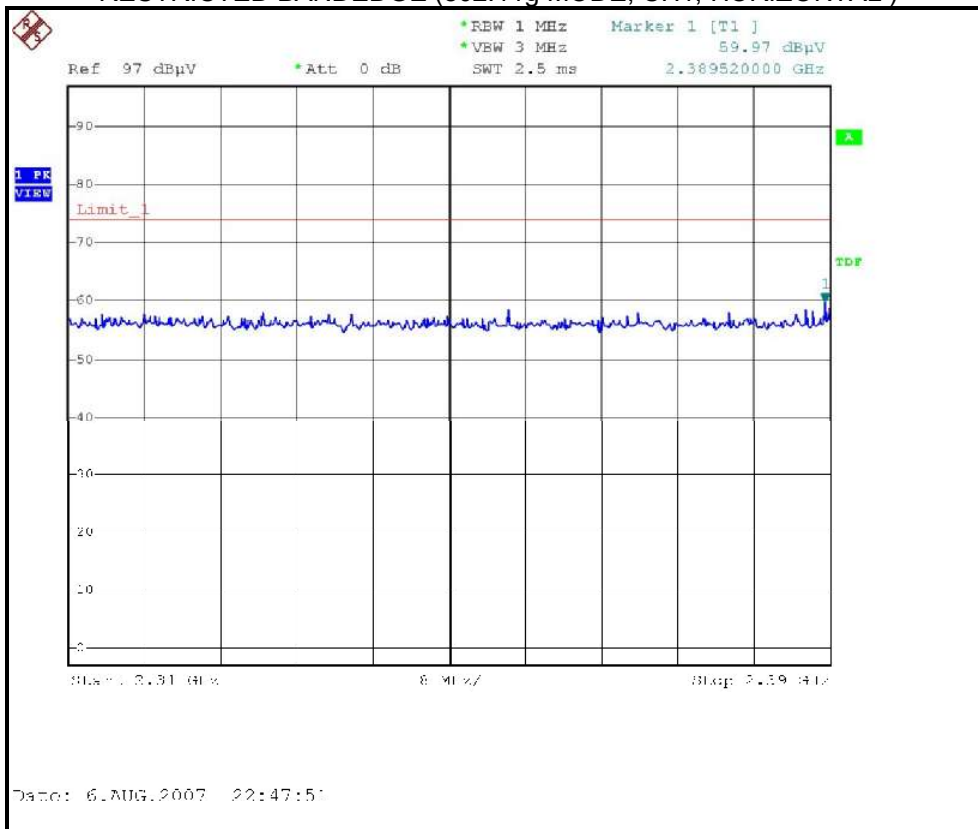

RESTRICTED BANDEDGE (802.11g MODE, CH1, VERTICAL)

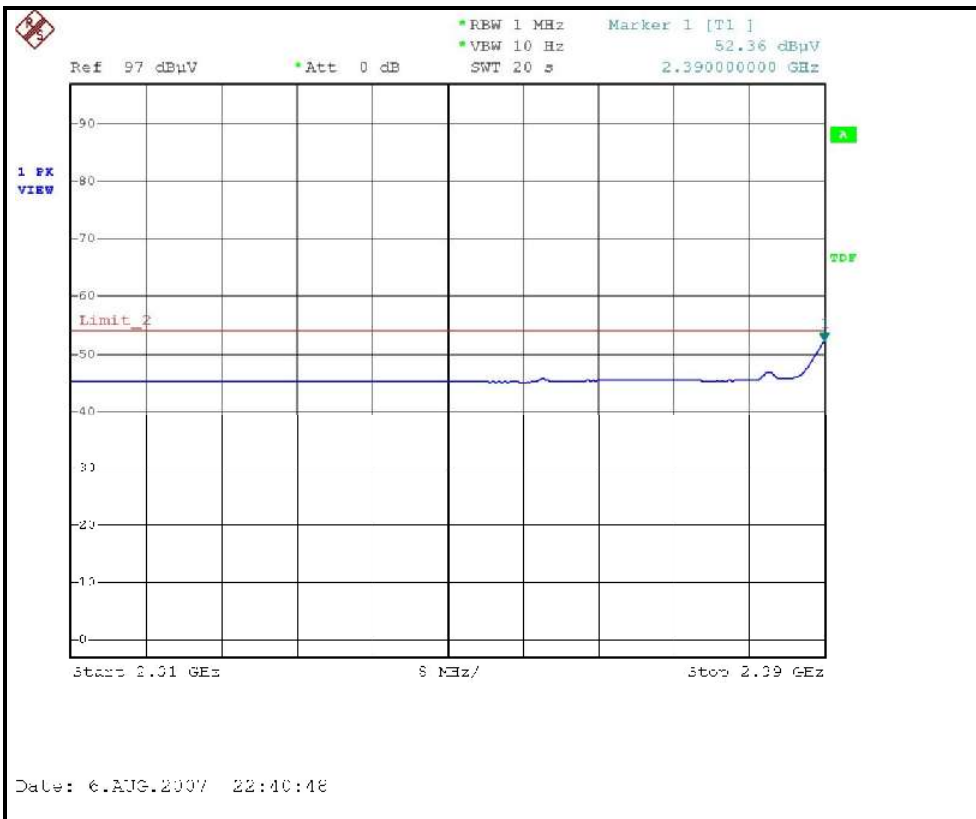
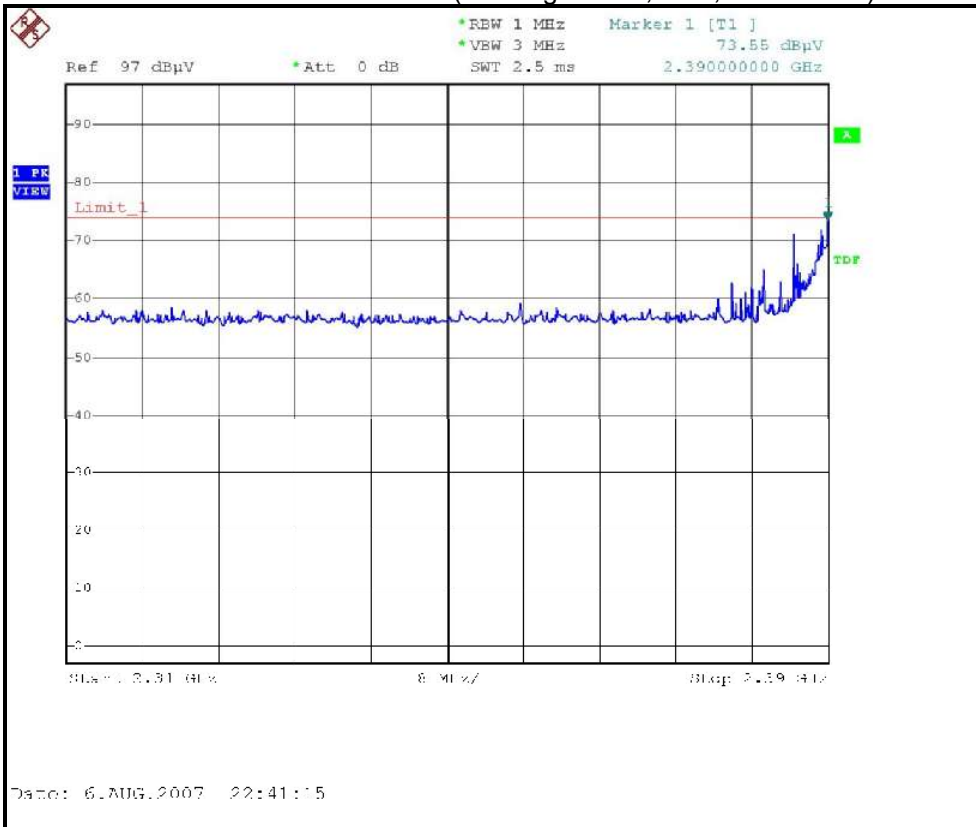

RESTRICTED BANDEDGE (802.11g MODE, CH11, HORIZONTAL)

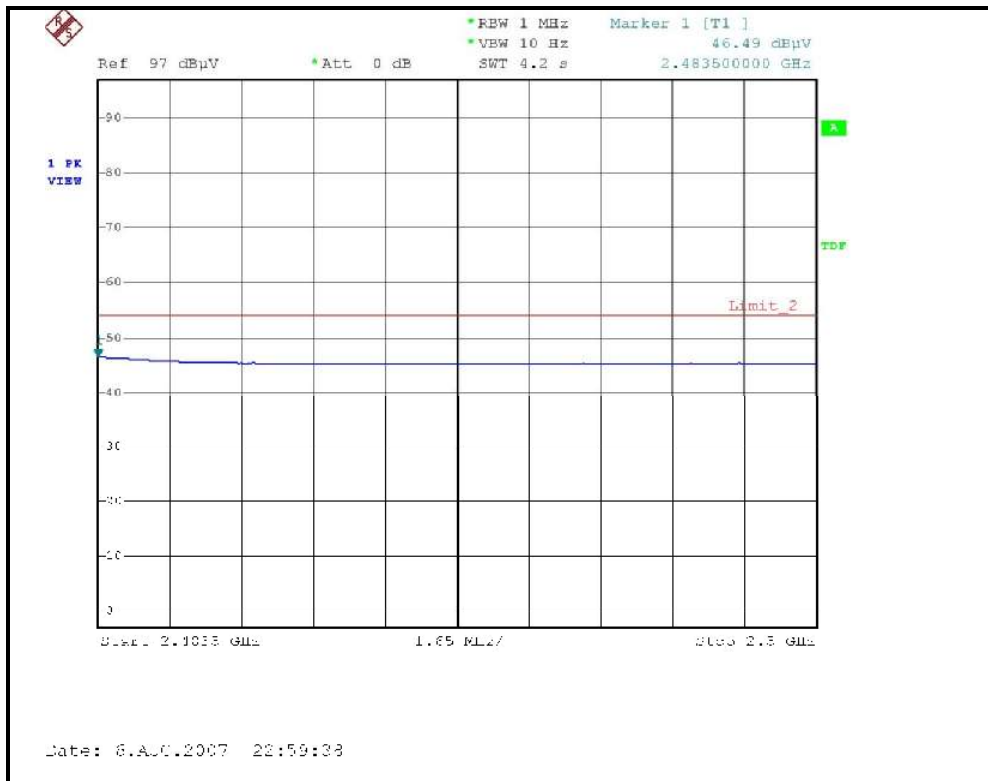
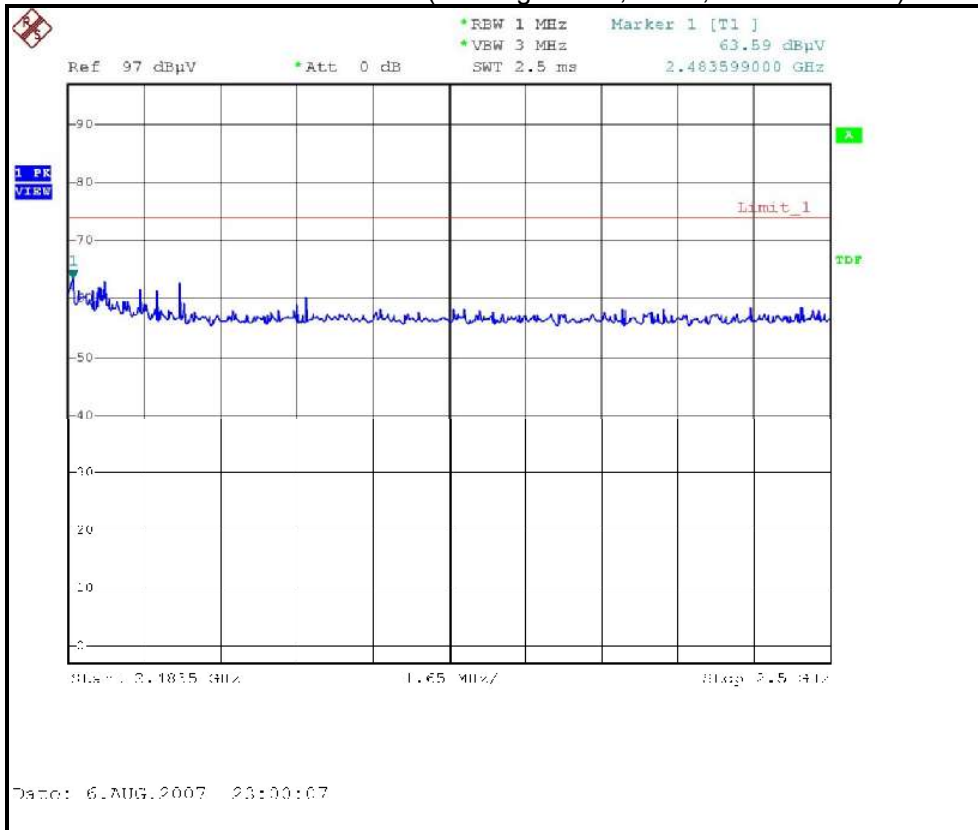

RESTRICTED BANDEDGE (802.11g MODE, CH11, VERTICAL)

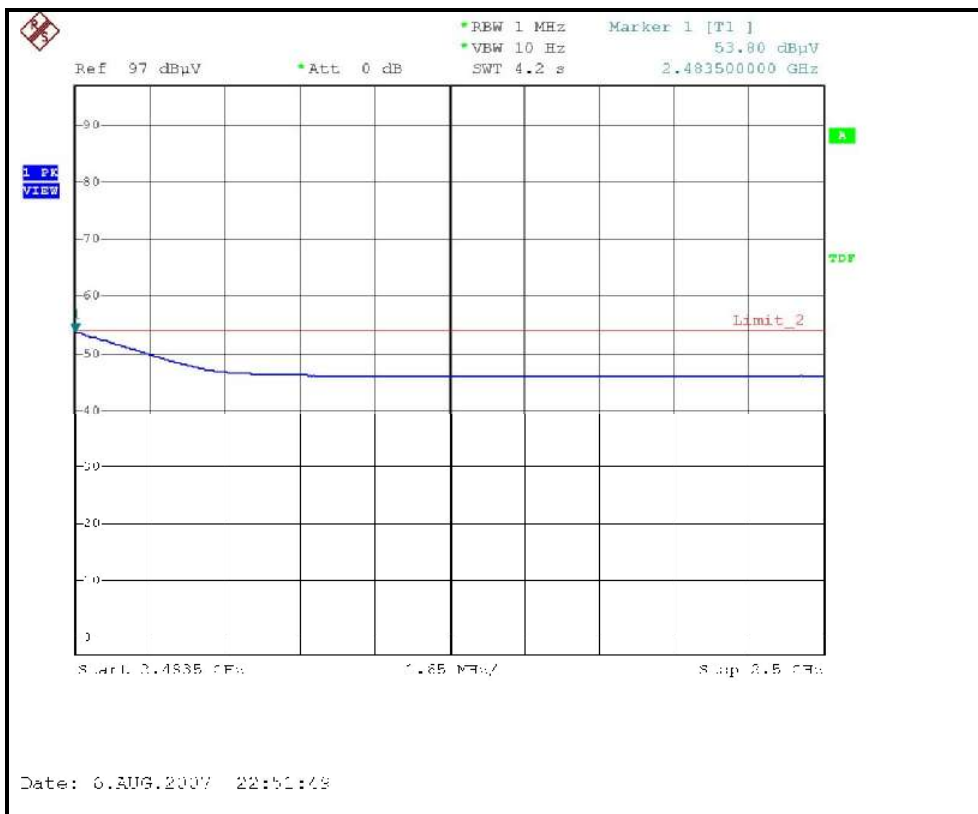
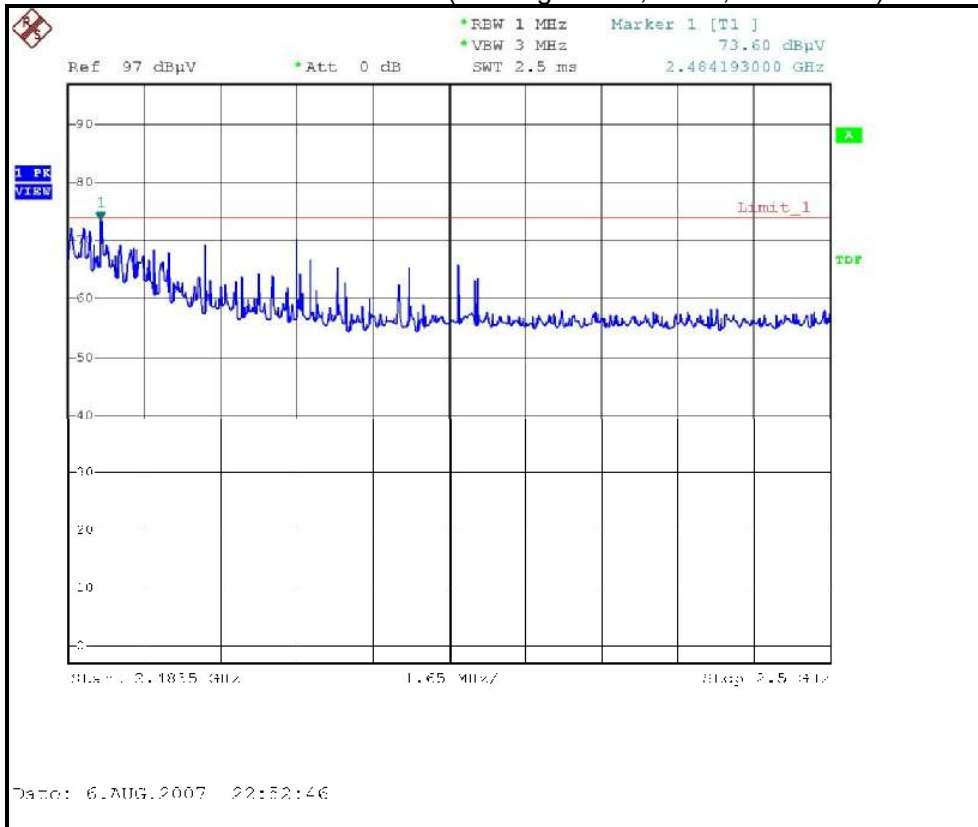

4.2.10 TEST RESULTS (ANTENNA 4)

Below 1GHz Worst-Case Data

TEST MODE	With adapter	FREQUENCY RANGE	Below 1000MHz
MODULATION TYPE	CCK	TRANSFER RATE	1Mbps
INPUT POWER (SYSTEM)	120Vac, 60 Hz	DETECTOR FUNCTION	Quasi-Peak
ENVIRONMENTAL CONDITIONS	25 deg. C, 60 %RH, 961 hPa	TESTED BY	Wen Yu

ANTENNA POLARITY & TEST DISTANCE: HORIZONTAL AT 3 M

No.	Freq. (MHz)	Emission Level (dBuV/m)	Limit (dBuV/m)	Margin (dB)	Antenna Height (m)	Table Angle (Degree)	Raw Value (dBuV)	Correction Factor (dB/m)
1	175.00	35.09 QP	43.50	-8.41	1.28 H	294	23.94	11.15
2	225.00	32.02 QP	46.00	-13.98	1.28 H	3	19.96	12.06
3	250.01	32.69 QP	46.00	-13.31	1.00 H	261	18.34	14.35
4	276.00	33.78 QP	46.00	-12.22	1.00 H	304	18.41	15.37
5	375.01	38.71 QP	46.00	-7.29	1.00 H	314	20.29	18.42
6	425.01	35.59 QP	46.00	-10.41	1.00 H	146	15.70	19.89
7	500.01	33.74 QP	46.00	-12.26	1.87 H	89	11.70	22.04
8	625.01	35.97 QP	46.00	-10.03	1.25 H	252	12.14	23.83
9	750.01	36.60 QP	46.00	-9.40	1.00 H	19	9.90	26.70

ANTENNA POLARITY & TEST DISTANCE: VERTICAL AT 3 M

No.	Freq. (MHz)	Emission Level (dBuV/m)	Limit (dBuV/m)	Margin (dB)	Antenna Height (m)	Table Angle (Degree)	Raw Value (dBuV)	Correction Factor (dB/m)
1	175.00	37.54 QP	43.50	-5.96	1.00 V	145	26.39	11.15
2	275.00	30.92 QP	46.00	-15.08	1.63 V	333	15.58	15.34
3	276.00	33.69 QP	46.00	-12.31	1.65 V	356	18.32	15.37
4	375.01	36.50 QP	46.00	-9.50	1.00 V	141	18.08	18.42
5	425.00	31.67 QP	46.00	-14.33	1.66 V	343	11.78	19.89
6	500.01	31.62 QP	46.00	-14.38	1.57 V	127	9.58	22.04
7	625.01	38.41 QP	46.00	-7.59	1.00 V	259	14.58	23.83
8	750.01	32.35 QP	46.00	-13.65	1.16 V	164	5.65	26.70

- REMARKS:**
1. Emission level(dBuV/m)=Raw Value(dBuV) + Correction Factor(dB/m)
 2. Correction Factor(dB/m) = Antenna Factor (dB/m) + Cable Factor (dB)
 3. The other emission levels were very low against the limit.
 4. Margin value = Emission level – Limit value



802.11b DSSS modulation

CHANNEL	Channel 1	FREQUENCY RANGE	1 ~ 25GHz
MODULATION TYPE	CCK	TRANSFER RATE	1Mbps
INPUT POWER (SYSTEM)	120Vac, 60 Hz	DETECTOR FUNCTION	Peak(PK) Average (AV)
ENVIRONMENTAL CONDITIONS	25 deg. C, 66 %RH, 961 hPa	TESTED BY	Tony Chen

ANTENNA POLARITY & TEST DISTANCE: HORIZONTAL AT 3 M

No.	Freq. (MHz)	Emission Level (dBuV/m)	Limit (dBuV/m)	Margin (dB)	Antenna Height (m)	Table Angle (Degree)	Raw Value (dBuV)	Correction Factor (dB/m)
1	2288.00	43.80 PK	74.00	-30.20	1.54 H	4	13.92	29.88
2	2288.00	35.70 AV	54.00	-18.30	1.54 H	4	5.82	29.88
3	2390.00	56.08 PK	74.00	-17.92	1.32 H	31	25.76	30.32
4	2390.00	44.39 AV	54.00	-9.61	1.32 H	31	14.07	30.32
5	*2412.00	102.60 PK			1.32 H	30	72.19	30.41
6	*2412.00	97.50 AV			1.32 H	30	67.09	30.41
7	4824.00	49.10 PK	74.00	-24.90	1.48 H	296	13.31	35.79
8	4824.00	43.60 AV	54.00	-10.40	1.48 H	296	7.81	35.79
9	7236.00	52.00 PK	74.00	-22.00	1.35 H	146	10.40	41.60
10	7236.00	39.30 AV	54.00	-14.70	1.35 H	146	-2.30	41.60

ANTENNA POLARITY & TEST DISTANCE: VERTICAL AT 3 M

No.	Freq. (MHz)	Emission Level (dBuV/m)	Limit (dBuV/m)	Margin (dB)	Antenna Height (m)	Table Angle (Degree)	Raw Value (dBuV)	Correction Factor (dB/m)
1	2288.00	53.10 PK	74.00	-20.90	1.06 V	190	23.22	29.88
2	2288.00	49.30 AV	54.00	-4.70	1.06 V	190	19.42	29.88
3	2389.30	62.57 PK	74.00	-11.43	1.46 V	11	32.26	30.31
4	2389.30	53.38 AV	54.00	-0.62	1.46 V	11	23.07	30.31
5	*2412.00	118.00 PK			1.46 V	9	87.59	30.41
6	*2412.00	113.00 AV			1.46 V	9	82.59	30.41
7	4824.00	49.40 PK	74.00	-24.60	1.33 V	186	13.61	35.79
8	4824.00	42.60 AV	54.00	-11.40	1.33 V	186	6.81	35.79
9	7236.00	52.00 PK	74.00	-22.00	1.14 V	20	10.40	41.60
10	7236.00	38.20 AV	54.00	-15.80	1.14 V	20	-3.40	41.60

- REMARKS:**
1. Emission level(dBuV/m)=Raw Value(dBuV) + Correction Factor(dB/m)
 2. Correction Factor(dB/m) = Antenna Factor (dB/m) + Cable Factor (dB)
 3. The other emission levels were very low against the limit.
 4. Margin value = Emission level – Limit value.
 5. The limit value is defined as per 15.247
 6. " * " : Fundamental frequency



CHANNEL	Channel 6	FREQUENCY RANGE	1 ~ 25GHz
MODULATION TYPE	CCK	TRANSFER RATE	1Mbps
INPUT POWER (SYSTEM)	120Vac, 60 Hz	DETECTOR FUNCTION	Peak(PK) Average (AV)
ENVIRONMENTAL CONDITIONS	25 deg. C, 66 %RH, 961 hPa	TESTED BY	Tony Chen

ANTENNA POLARITY & TEST DISTANCE: HORIZONTAL AT 3 M

No.	Freq. (MHz)	Emission Level (dBuV/m)	Limit (dBuV/m)	Margin (dB)	Antenna Height (m)	Table Angle (Degree)	Raw Value (dBuV)	Correction Factor (dB/m)
1	2288.00	43.50 PK	74.00	-30.50	1.55 H	4	13.62	29.88
2	2288.00	35.60 AV	54.00	-18.40	1.55 H	4	5.72	29.88
3	*2437.00	103.50 PK			1.28 H	32	72.98	30.52
4	*2437.00	98.00 AV			1.28 H	32	67.48	30.52
5	4874.00	53.90 PK	74.00	-20.10	1.48 H	316	17.98	35.92
6	4874.00	50.60 AV	54.00	-3.40	1.48 H	316	14.68	35.92
7	7311.00	52.70 PK	74.00	-21.30	1.40 H	145	10.89	41.81
8	7311.00	41.00 AV	54.00	-13.00	1.40 H	145	-0.81	41.81

ANTENNA POLARITY & TEST DISTANCE: VERTICAL AT 3 M

No.	Freq. (MHz)	Emission Level (dBuV/m)	Limit (dBuV/m)	Margin (dB)	Antenna Height (m)	Table Angle (Degree)	Raw Value (dBuV)	Correction Factor (dB/m)
1	2288.00	52.50 PK	74.00	-21.50	1.04 V	177	22.62	29.88
2	2288.00	49.20 AV	54.00	-4.80	1.04 V	177	19.32	29.88
3	*2437.00	118.40 PK			1.16 V	0	87.88	30.52
4	*2437.00	113.00 AV			1.16 V	0	82.48	30.52
5	4874.00	53.40 PK	74.00	-20.60	1.10 V	184	17.48	35.92
6	4874.00	50.10 AV	54.00	-3.90	1.10 V	184	14.18	35.92
7	7311.00	52.50 PK	74.00	-21.50	1.08 V	33	10.69	41.81
8	7311.00	38.50 AV	54.00	-15.50	1.08 V	33	-3.31	41.81

- REMARKS:**
1. Emission level(dBuV/m)=Raw Value(dBuV) + Correction Factor(dB/m)
 2. Correction Factor(dB/m) = Antenna Factor (dB/m) + Cable Factor (dB)
 3. The other emission levels were very low against the limit.
 4. Margin value = Emission level – Limit value.
 5. The limit value is defined as per 15.247
 6. “ * “ : Fundamental frequency



CHANNEL	Channel 11	FREQUENCY RANGE	1 ~ 25GHz
MODULATION TYPE	CCK	TRANSFER RATE	1Mbps
INPUT POWER (SYSTEM)	120Vac, 60 Hz	DETECTOR FUNCTION	Peak(PK) Average (AV)
ENVIRONMENTAL CONDITIONS	25 deg. C, 66 %RH, 961 hPa	TESTED BY	Tony Chen

ANTENNA POLARITY & TEST DISTANCE: HORIZONTAL AT 3 M

No.	Freq. (MHz)	Emission Level (dBuV/m)	Limit (dBuV/m)	Margin (dB)	Antenna Height (m)	Table Angle (Degree)	Raw Value (dBuV)	Correction Factor (dB/m)
1	2288.00	43.20 PK	74.00	-30.80	1.54 H	5	13.32	29.88
2	2288.00	36.10 AV	54.00	-17.90	1.54 H	5	6.22	29.88
3	*2462.00	103.20 PK			1.50 H	40	72.57	30.63
4	*2462.00	97.80 AV			1.50 H	40	67.17	30.63
5	2483.50	55.62 PK	74.00	-18.38	1.45 H	4	24.90	30.72
6	2483.50	44.19 AV	54.00	-9.81	1.45 H	4	13.47	30.72
7	4924.00	55.90 PK	74.00	-18.10	1.80 H	173	19.84	36.06
8	4924.00	52.40 AV	54.00	-1.60	1.80 H	173	16.34	36.06
9	7386.00	52.20 PK	74.00	-21.80	1.42 H	144	10.19	42.01
10	7386.00	39.50 AV	54.00	-14.50	1.42 H	144	-2.51	42.01

ANTENNA POLARITY & TEST DISTANCE: VERTICAL AT 3 M

No.	Freq. (MHz)	Emission Level (dBuV/m)	Limit (dBuV/m)	Margin (dB)	Antenna Height (m)	Table Angle (Degree)	Raw Value (dBuV)	Correction Factor (dB/m)
1	2288.00	53.60 PK	74.00	-20.40	1.05 V	182	23.72	29.88
2	2288.00	49.90 AV	54.00	-4.10	1.05 V	182	20.02	29.88
3	*2462.00	117.40 PK			1.16 V	1	86.77	30.63
4	*2462.00	112.30 AV			1.16 V	1	81.67	30.63
5	2483.50	63.60 PK	74.00	-10.40	1.17 V	1	32.88	30.72
6	2483.50	53.04 AV	54.00	-0.96	1.17 V	1	22.32	30.72
7	4924.00	53.70 PK	74.00	-20.30	1.52 V	22	17.64	36.06
8	4924.00	49.50 AV	54.00	-4.50	1.52 V	22	13.44	36.06
9	7386.00	52.00 PK	74.00	-22.00	1.26 V	25	9.99	42.01
10	7386.00	38.40 AV	54.00	-15.60	1.26 V	25	-3.61	42.01

- REMARKS:**
1. Emission level(dBuV/m)=Raw Value(dBuV) + Correction Factor(dB/m)
 2. Correction Factor(dB/m) = Antenna Factor (dB/m) + Cable Factor (dB)
 3. The other emission levels were very low against the limit.
 4. Margin value = Emission level – Limit value.
 5. The limit value is defined as per 15.247
 6. “ * “ : Fundamental frequency

RESTRICTED BANDEDGE (802.11b MODE, CH1, HORIZONTAL)

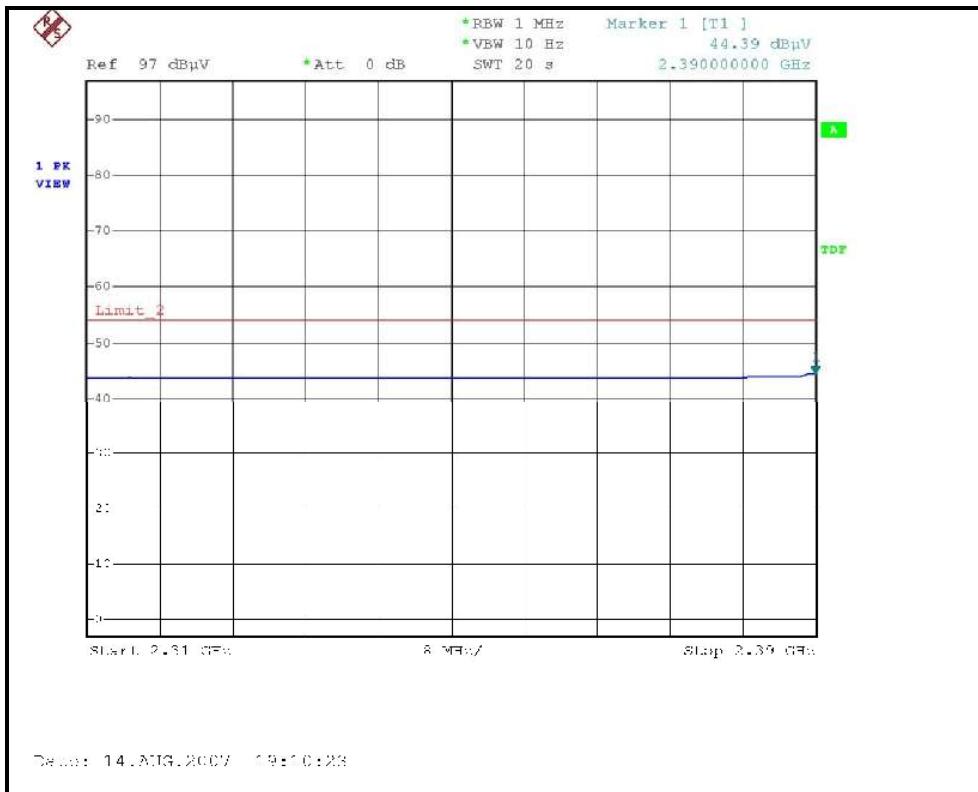
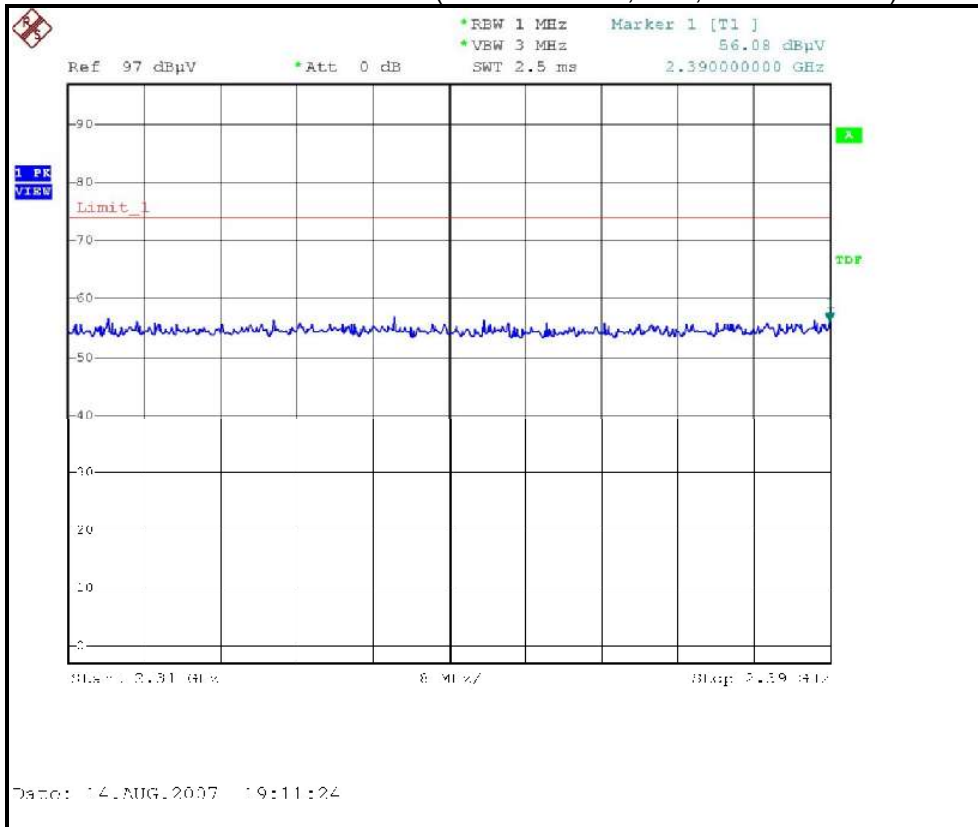

RESTRICTED BANDEDGE (802.11b MODE, CH1, VERTICAL)

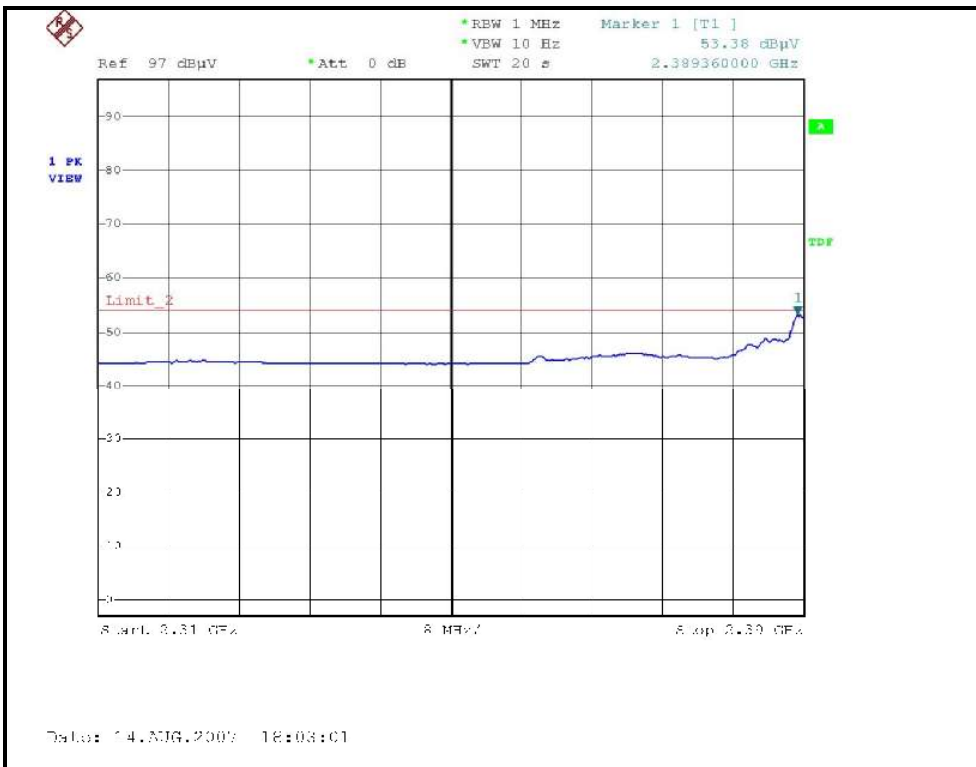
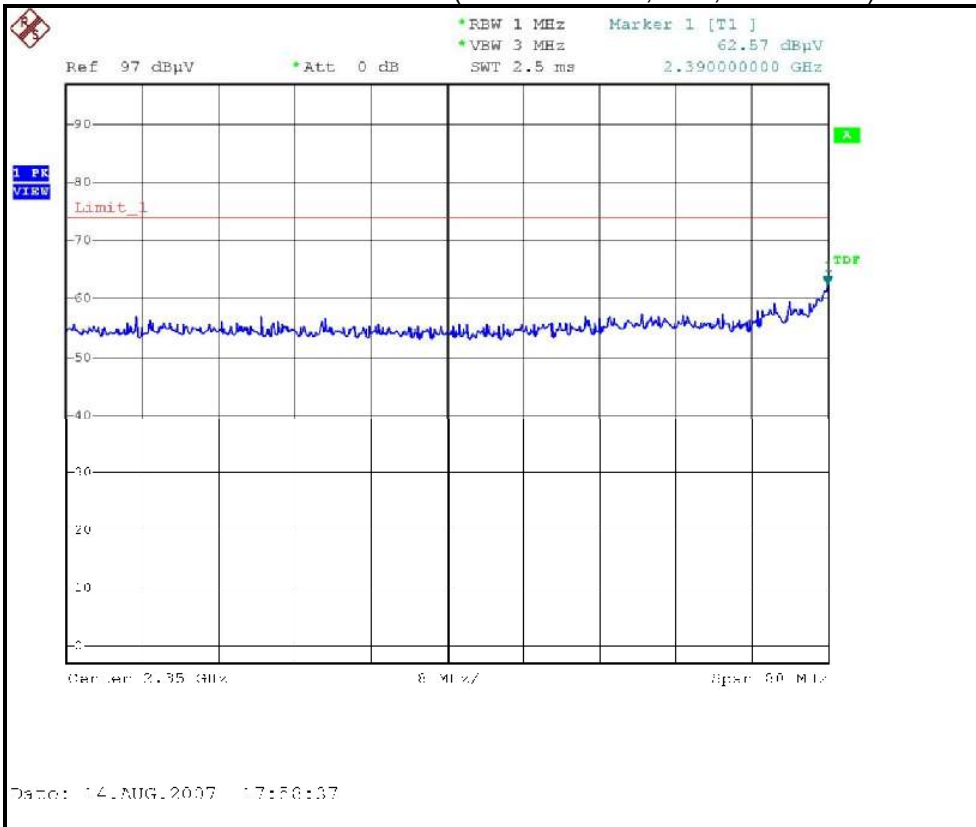



802.11g OFDM modulation

CHANNEL	Channel 1	FREQUENCY RANGE	1 ~ 25GHz
MODULATION TYPE	BPSK	TRANSFER RATE	6Mbps
INPUT POWER (SYSTEM)	120Vac, 60 Hz	DETECTOR FUNCTION	Peak(PK) Average (AV)
ENVIRONMENTAL CONDITIONS	25 deg. C, 66 %RH, 961 hPa	TESTED BY	Tony Chen

ANTENNA POLARITY & TEST DISTANCE: HORIZONTAL AT 3 M

No.	Freq. (MHz)	Emission Level (dBuV/m)	Limit (dBuV/m)	Margin (dB)	Antenna Height (m)	Table Angle (Degree)	Raw Value (dBuV)	Correction Factor (dB/m)
1	2288.00	44.10 PK	74.00	-29.90	1.55 H	4	14.22	29.88
2	2288.00	36.90 AV	54.00	-17.10	1.55 H	4	7.02	29.88
3	2390.00	54.80 PK	74.00	-19.20	1.60 H	8	24.48	30.32
4	2390.00	44.10 AV	54.00	-9.90	1.60 H	8	13.78	30.32
5	*2412.00	100.40 PK			1.60 H	8	69.99	30.41
6	*2412.00	89.40 AV			1.60 H	8	58.99	30.41
7	4824.00	46.50 PK	74.00	-27.50	1.50 H	325	10.71	35.79
8	4824.00	33.90 AV	54.00	-20.10	1.50 H	325	-1.89	35.79
9	7236.00	51.10 PK	74.00	-22.90	1.40 H	142	9.50	41.60
10	7236.00	38.10 AV	54.00	-15.90	1.40 H	142	-3.50	41.60

ANTENNA POLARITY & TEST DISTANCE: VERTICAL AT 3 M

No.	Freq. (MHz)	Emission Level (dBuV/m)	Limit (dBuV/m)	Margin (dB)	Antenna Height (m)	Table Angle (Degree)	Raw Value (dBuV)	Correction Factor (dB/m)
1	2288.00	54.20 PK	74.00	-19.80	1.03 V	178	24.32	29.88
2	2288.00	51.00 AV	54.00	-3.00	1.03 V	178	21.12	29.88
3	2390.00	67.18 PK	74.00	-6.82	1.00 V	10	36.86	30.32
4	2390.00	52.98 AV	54.00	-1.02	1.00 V	10	22.66	30.32
5	*2412.00	114.70 PK			1.00 V	10	84.29	30.41
6	*2412.00	104.40 AV			1.00 V	10	73.99	30.41
7	4824.00	45.80 PK	74.00	-28.20	1.15 V	72	10.01	35.79
8	4824.00	33.50 AV	54.00	-20.50	1.15 V	72	-2.29	35.79
9	7236.00	51.20 PK	74.00	-22.80	1.08 V	45	9.60	41.60
10	7236.00	38.40 AV	54.00	-15.60	1.08 V	45	-3.20	41.60

- REMARKS:**
1. Emission level(dBuV/m)=Raw Value(dBuV) + Correction Factor(dB/m)
 2. Correction Factor(dB/m) = Antenna Factor (dB/m) + Cable Factor (dB)
 3. The other emission levels were very low against the limit.
 4. Margin value = Emission level – Limit value.
 5. The limit value is defined as per 15.247
 6. “ * “ : Fundamental frequency

CHANNEL	Channel 6	FREQUENCY RANGE	1 ~ 25GHz
MODULATION TYPE	BPSK	TRANSFER RATE	6Mbps
INPUT POWER (SYSTEM)	120Vac, 60 Hz	DETECTOR FUNCTION	Peak(PK) Average (AV)
ENVIRONMENTAL CONDITIONS	25 deg. C, 66 %RH, 961 hPa	TESTED BY	Tony Chen

ANTENNA POLARITY & TEST DISTANCE: HORIZONTAL AT 3 M

No.	Freq. (MHz)	Emission Level (dBuV/m)	Limit (dBuV/m)	Margin (dB)	Antenna Height (m)	Table Angle (Degree)	Raw Value (dBuV)	Correction Factor (dB/m)
1	2288.00	45.40 PK	74.00	-28.60	1.53 H	4	15.52	29.88
2	2288.00	38.20 AV	54.00	-15.80	1.53 H	4	8.32	29.88
3	*2437.00	104.30 PK			1.60 H	6	73.78	30.52
4	*2437.00	93.40 AV			1.60 H	6	62.88	30.52
5	4874.00	52.30 PK	74.00	-21.70	1.00 H	292	16.38	35.92
6	4874.00	37.10 AV	54.00	-16.90	1.00 H	292	1.18	35.92
7	7311.00	52.80 PK	74.00	-21.20	1.40 H	140	10.99	41.81
8	7311.00	39.00 AV	54.00	-15.00	1.40 H	140	-2.81	41.81

ANTENNA POLARITY & TEST DISTANCE: VERTICAL AT 3 M

No.	Freq. (MHz)	Emission Level (dBuV/m)	Limit (dBuV/m)	Margin (dB)	Antenna Height (m)	Table Angle (Degree)	Raw Value (dBuV)	Correction Factor (dB/m)
1	2288.00	55.70 PK	74.00	-18.30	1.05 V	188	25.82	29.88
2	2288.00	52.10 AV	54.00	-1.90	1.05 V	188	22.22	29.88
3	*2437.00	119.00 PK			1.16 V	2	88.48	30.52
4	*2437.00	108.10 AV			1.16 V	2	77.58	30.52
5	4874.00	52.10 PK	74.00	-21.90	1.12 V	70	16.18	35.92
6	4874.00	36.40 AV	54.00	-17.60	1.12 V	70	0.48	35.92
7	7311.00	52.50 PK	74.00	-21.50	1.02 V	22	10.69	41.81
8	7311.00	38.80 AV	54.00	-15.20	1.02 V	22	-3.01	41.81

- REMARKS:**
1. Emission level(dBuV/m)=Raw Value(dBuV) + Correction Factor(dB/m)
 2. Correction Factor(dB/m) = Antenna Factor (dB/m) + Cable Factor (dB)
 3. The other emission levels were very low against the limit.
 4. Margin value = Emission level – Limit value.
 5. The limit value is defined as per 15.247
 6. “ * “ : Fundamental frequency



CHANNEL	Channel 11	FREQUENCY RANGE	1 ~ 25GHz
MODULATION TYPE	BPSK	TRANSFER RATE	6Mbps
INPUT POWER (SYSTEM)	120Vac, 60 Hz	DETECTOR FUNCTION	Peak(PK) Average (AV)
ENVIRONMENTAL CONDITIONS	25 deg. C, 66 %RH, 961 hPa	TESTED BY	Tony Chen

ANTENNA POLARITY & TEST DISTANCE: HORIZONTAL AT 3 M

No.	Freq. (MHz)	Emission Level (dBuV/m)	Limit (dBuV/m)	Margin (dB)	Antenna Height (m)	Table Angle (Degree)	Raw Value (dBuV)	Correction Factor (dB/m)
1	2288.00	43.50 PK	74.00	-30.50	1.53 H	4	13.62	29.88
2	2288.00	36.20 AV	54.00	-17.80	1.53 H	4	6.32	29.88
3	*2462.00	98.20 PK			1.60 H	5	67.57	30.63
4	*2462.00	87.10 AV			1.60 H	5	56.47	30.63
5	2483.50	55.96 PK	74.00	-18.04	1.12 H	306	25.24	30.72
6	2483.50	44.36 AV	54.00	-9.64	1.12 H	306	13.64	30.72
7	4924.00	49.80 PK	74.00	-24.20	1.12 H	306	13.74	36.06
8	4924.00	36.20 AV	54.00	-17.80	1.12 H	306	0.14	36.06
9	7386.00	51.00 PK	74.00	-23.00	1.44 H	136	8.99	42.01
10	7386.00	38.20 AV	54.00	-15.80	1.44 H	136	-3.81	42.01

ANTENNA POLARITY & TEST DISTANCE: VERTICAL AT 3 M

No.	Freq. (MHz)	Emission Level (dBuV/m)	Limit (dBuV/m)	Margin (dB)	Antenna Height (m)	Table Angle (Degree)	Raw Value (dBuV)	Correction Factor (dB/m)
1	2288.00	53.30 PK	74.00	-20.70	1.03 V	185	23.42	29.88
2	2288.00	50.40 AV	54.00	-3.60	1.03 V	185	20.52	29.88
3	*2462.00	114.20 PK			1.16 V	2	83.57	30.63
4	*2462.00	103.30 AV			1.16 V	2	72.67	30.63
5	2483.50	69.71 PK	74.00	-4.29	1.15 V	1	38.99	30.72
6	2483.50	52.54 AV	54.00	-1.46	1.15 V	1	21.82	30.72
7	4924.00	48.80 PK	74.00	-25.20	1.10 V	70	12.74	36.06
8	4924.00	35.20 AV	54.00	-18.80	1.10 V	70	-0.86	36.06
9	7386.00	51.70 PK	74.00	-22.30	1.06 V	28	9.69	42.01
10	7386.00	38.40 AV	54.00	-15.60	1.06 V	28	-3.61	42.01

- REMARKS:**
1. Emission level(dBuV/m)=Raw Value(dBuV) + Correction Factor(dB/m)
 2. Correction Factor(dB/m) = Antenna Factor (dB/m) + Cable Factor (dB)
 3. The other emission levels were very low against the limit.
 4. Margin value = Emission level – Limit value.
 5. The limit value is defined as per 15.247
 6. " * " : Fundamental frequency

RESTRICTED BANDEDGE (802.11g MODE, CH1, HORIZONTAL)

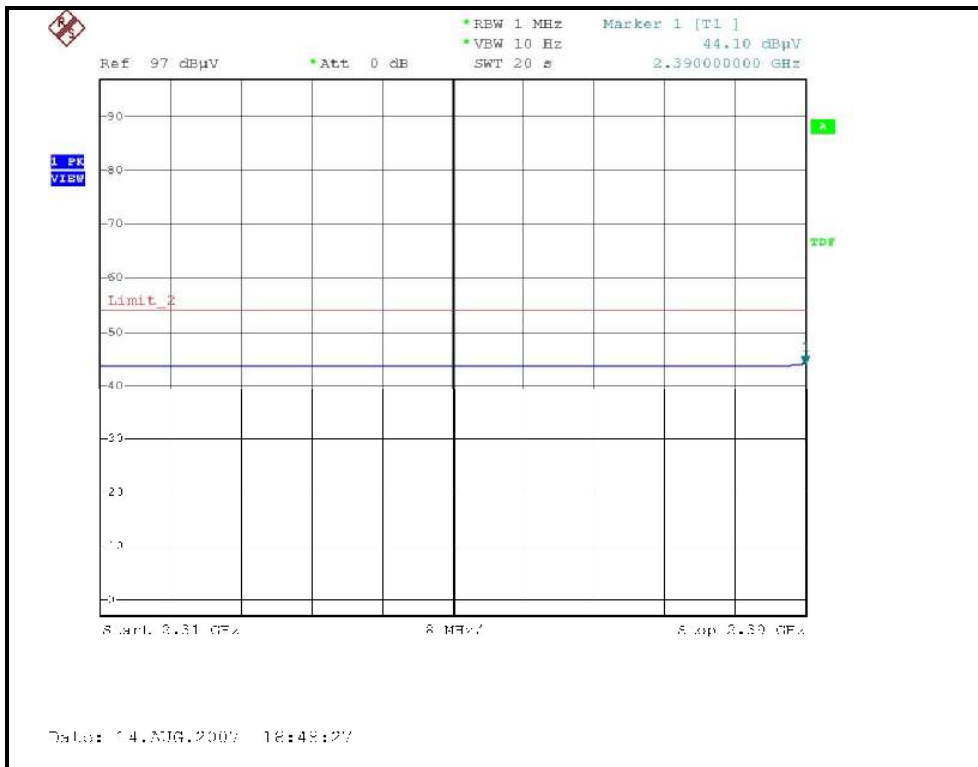
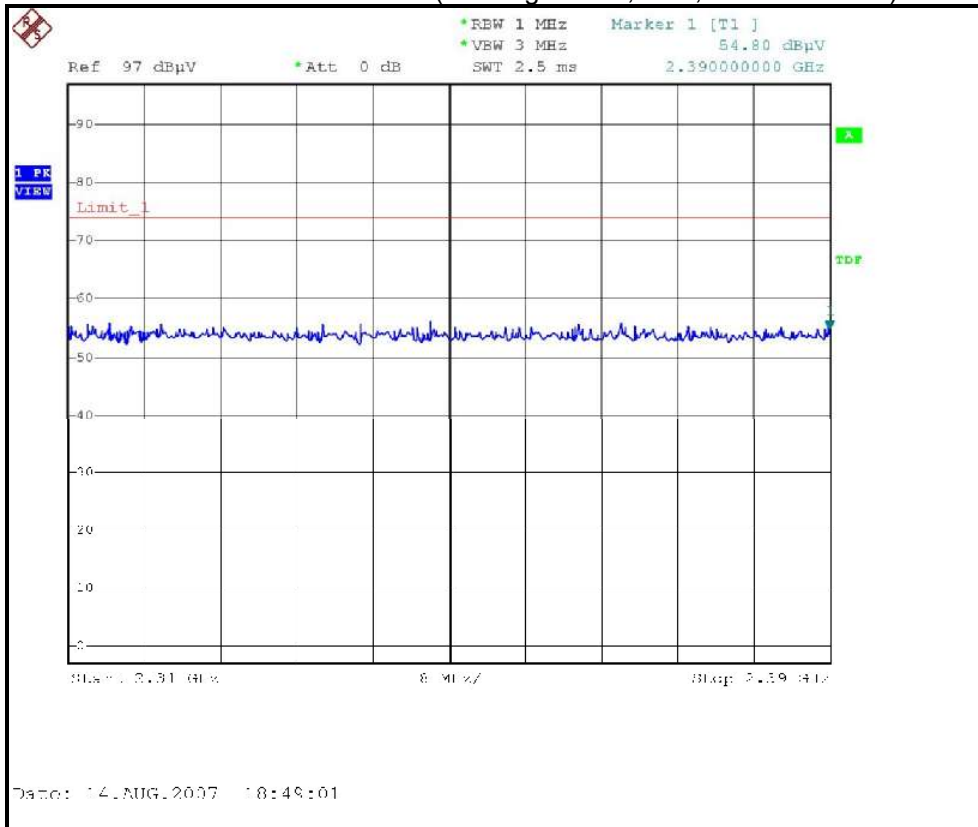

RESTRICTED BANDEDGE (802.11g MODE, CH1, VERTICAL)

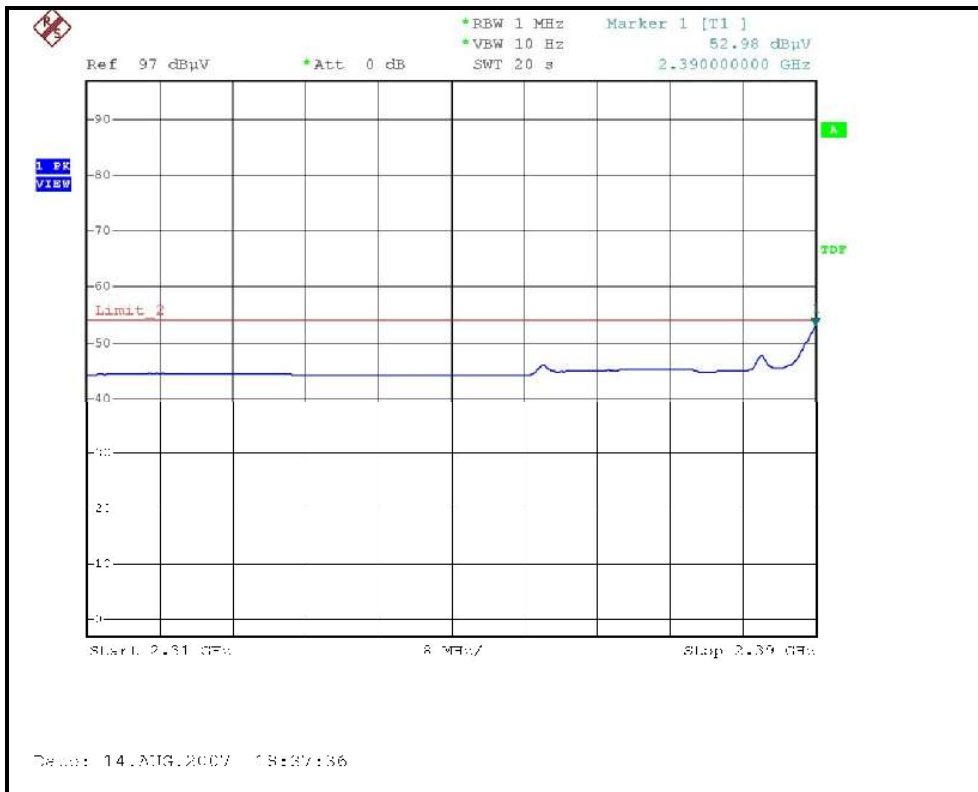
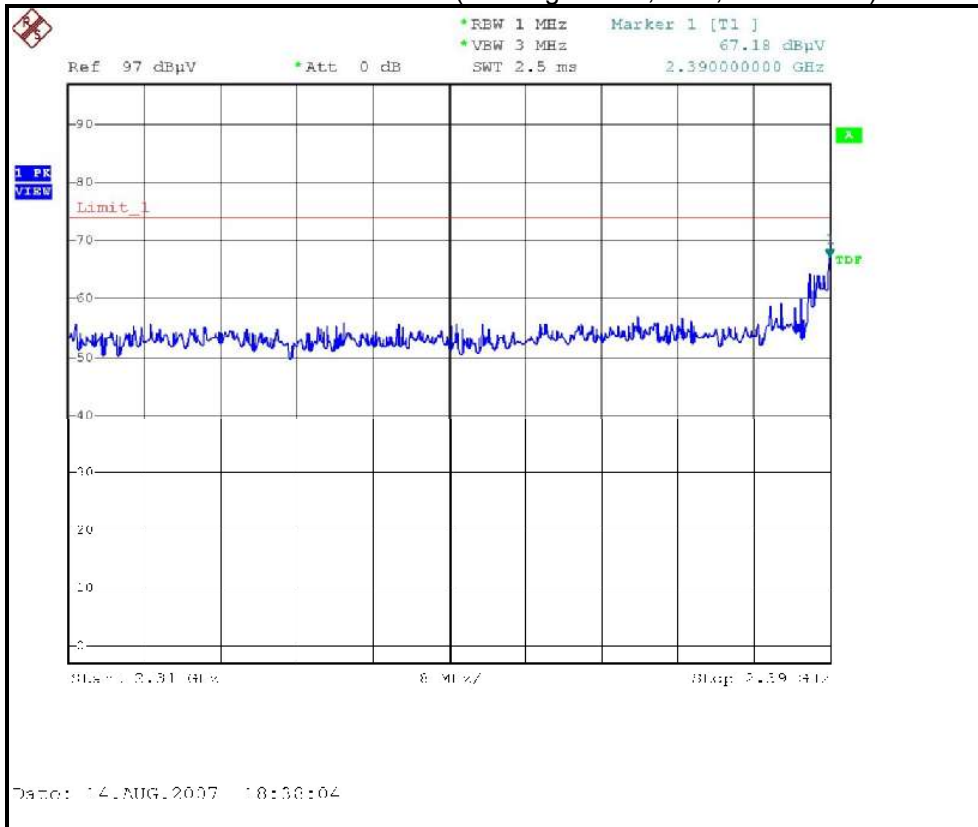

RESTRICTED BANDEDGE (802.11g MODE, CH11, HORIZONTAL)

