

# TEST REPORT

## CERTIFICATE OF CONFORMITY

**Standard:** 47 CFR FCC Part 15, Subpart C (Section 15.247)

**Report No.:** RFBCKS-WTW-P21030823A-2

**FCC ID:** UDX-60094011

**Model No.:** MR86-HW

**Received Date:** 2022/8/3

**Test Date:** 2022/8/11 ~ 2022/8/15

**Issued Date:** 2022/11/3

**Applicant:** Cisco Systems, Inc.

**Address:** 170 West Tasman Drive, San Jose, CA 95134 USA

**Issued By:** Bureau Veritas Consumer Products Services (H.K.) Ltd., Taoyuan Branch  
Hsin Chu Laboratory

**Lab Address:** E-2, No.1, Li Hsin 1st Road, Hsinchu Science Park, Hsinchu City 300, Taiwan

**Test Location:** E-2, No.1, Li Hsin 1st Road, Hsinchu Science Park, Hsinchu City 300, Taiwan

**FCC Registration /** 723255 / TW2022

**Designation Number:**

**Approved by:**  , **Date:** 2022/11/3  
May Chen / Manager

This test report consists of 49 pages in total. It may be duplicated completely for legal use with the approval of the applicant. It should not be reproduced except in full, without the written approval of our laboratory. The test results in the report only apply to the tested sample. The test results in this report are traceable to the national or international standards.

Prepared by : Vito Lung / Specialist



This report is governed by, and incorporates by reference, the Conditions of Testing as posted at the date of issuance of this report at <http://www.bureauveritas.com/home/about-us/our-business/cps/about-us/terms-conditions/> and is intended for your exclusive use. Any copying or replication of this report to or for any other person or entity, or use of our name or trademark, is permitted only with our prior written permission. This report sets forth our findings solely with respect to the test samples identified herein. The results set forth in this report are not indicative or representative of the quality or characteristics of the lot from which a test sample was taken or any similar or identical product unless specifically and expressly noted. Our report includes all of the tests requested by you and the results thereof based upon the information that you provided to us. Measurement uncertainty is only provided upon request for accredited tests. Statements of conformity are based on simple acceptance criteria without taking measurement uncertainty into account, unless otherwise requested in writing. You have 60 days from date of issuance of this report to notify us of any material error or omission caused by our negligence or if you require measurement uncertainty; provided, however, that such notice shall be in writing and shall specifically address the issue you wish to raise. A failure to raise such issue within the prescribed time shall constitute your unqualified acceptance of the completeness of this report, the tests conducted and the correctness of the report contents.

## Table of Contents

<b>Release Control Record .....</b>	<b>4</b>
<b>1 Certificate.....</b>	<b>5</b>
<b>2 Summary of Test Results .....</b>	<b>6</b>
2.1 Measurement Uncertainty .....	6
2.2 Supplementary Information .....	6
<b>3 General Information .....</b>	<b>7</b>
3.1 General Description .....	7
3.2 Antenna Description of EUT .....	8
3.3 Channel List.....	9
3.4 Test Mode Applicability and Tested Channel Detail.....	10
3.5 Duty Cycle of Test Signal.....	11
3.6 Test Program Used and Operation Descriptions .....	12
3.7 Connection Diagram of EUT and Peripheral Devices .....	12
3.8 Configuration of Peripheral Devices and Cable Connections .....	13
<b>4 Test Instruments .....</b>	<b>14</b>
4.1 RF Output Power .....	14
4.2 Power Spectral Density .....	14
4.3 6 dB Bandwidth .....	14
4.4 Conducted Out of Band Emissions .....	14
4.5 AC Power Conducted Emissions .....	15
4.6 Unwanted Emissions below 1 GHz .....	15
4.7 Unwanted Emissions above 1 GHz.....	16
<b>5 Limits of Test Items.....</b>	<b>17</b>
5.1 RF Output Power .....	17
5.2 Power Spectral Density .....	17
5.3 6 dB Bandwidth .....	17
5.4 Conducted Out of Band Emissions .....	17
5.5 AC Power Conducted Emissions .....	17
5.6 Unwanted Emissions below 1 GHz .....	17
5.7 Unwanted Emissions above 1 GHz.....	18
<b>6 Test Arrangements.....</b>	<b>19</b>
6.1 RF Output Power .....	19
6.1.1 Test Setup .....	19
6.1.2 Test Procedure.....	19
6.2 Power Spectral Density .....	19
6.2.1 Test Setup .....	19
6.2.2 Test Procedure.....	19
6.3 6 dB Bandwidth .....	20
6.3.1 Test Setup .....	20
6.3.2 Test Procedure.....	20
6.4 Conducted Out of Band Emissions .....	20
6.4.1 Test Setup .....	20
6.4.2 Test Procedure.....	20
6.5 AC Power Conducted Emissions .....	21
6.5.1 Test Setup .....	21
6.5.2 Test Procedure.....	21
6.6 Unwanted Emissions below 1 GHz .....	22
6.6.1 Test Setup .....	22
6.6.2 Test Procedure.....	23
6.7 Unwanted Emissions above 1 GHz.....	24
6.7.1 Test Setup .....	24
6.7.2 Test Procedure.....	24
<b>7 Test Results of Test Item .....</b>	<b>25</b>



7.1	RF Output Power .....	25
7.2	Power Spectral Density .....	26
7.3	6 dB Bandwidth .....	27
7.4	Conducted Out of Band Emissions .....	28
7.5	AC Power Conducted Emissions .....	30
7.6	Unwanted Emissions below 1 GHz .....	32
7.7	Unwanted Emissions above 1 GHz.....	34
<b>8</b>	<b>Pictures of Test Arrangements .....</b>	<b>48</b>
<b>9</b>	<b>Information of the Testing Laboratories .....</b>	<b>49</b>



## Release Control Record

Issue No.	Description	Date Issued
RFBCKS-WTW-P21030823A-2	Original release.	2022/11/3

## 1 Certificate

**Product:** 4x4 WiFi6 Outdoor Access Point

**Brand:** Cisco

**Test Model:** MR86-HW

**Sample Status:** Engineering sample

**Applicant:** Cisco Systems, Inc.

**Test Date:** 2022/8/11 ~ 2022/8/15

**Standard:** 47 CFR FCC Part 15, Subpart C (Section 15.247)

**Measurement** ANSI C63.10-2013

**procedure:** KDB 558074 D01 15.247 Meas Guidance v05r02

The above equipment has been tested by **Bureau Veritas Consumer Products Services (H.K.) Ltd., Taoyuan Branch**, and found compliance with the requirement of the above standards. The test record, data evaluation & Equipment Under Test (EUT) configurations represented herein are true and accurate accounts of the measurements of the sample's RF characteristics under the conditions specified in this report.

## 2 Summary of Test Results

47 CFR FCC Part 15, Subpart C (Section 15.247)			
Standard / Clause	Test Item	Result	Remark
15.247(b)	RF Output Power	Pass	Meet the requirement of limit.
15.247(e)	Power Spectral Density	Pass	Meet the requirement of limit.
15.247(a)(2)	6 dB Bandwidth	Pass	Meet the requirement of limit.
15.247(d)	Conducted Out of Band Emissions	Pass	Meet the requirement of limit.
15.207	AC Power Conducted Emissions	Pass	Minimum passing margin is -6.00 dB at 0.15023 MHz
15.205 / 15.209 / 15.247(d)	Unwanted Emissions below 1 GHz	Pass	Minimum passing margin is -3.7 dB at 48.79 MHz
15.205 / 15.209 / 15.247(d)	Unwanted Emissions above 1 GHz	Pass	Minimum passing margin is -0.5 dB at 2483.50 MHz
15.203	Antenna Requirement	Pass	Antenna connector is I-PEX not a standard connector.

Note: Determining compliance based on the results of the compliance measurement, not taking into account measurement instrumentation uncertainty.

### 2.1 Measurement Uncertainty

Where relevant, the following measurement uncertainty levels have been estimated for tests performed on the EUT as specified in CISPR 16-4-2:

Measurement	Specification	Expanded Uncertainty (k=2) (±)
Conducted Out of Band Emissions	9 kHz ~ 40 GHz	2.5 dB
AC Power Conducted Emissions	150 kHz ~ 30 MHz	1.9 dB
Unwanted Emissions below 1 GHz	9 kHz ~ 30 MHz	3.1 dB
	30 MHz ~ 1 GHz	5.5 dB
Unwanted Emissions above 1 GHz	1 GHz ~ 18 GHz	5.1 dB
	18 GHz ~ 40 GHz	5.3 dB

The other instruments specified are routine verified to remain within the calibrated levels, no measurement uncertainty is required to be calculated.

### 2.2 Supplementary Information

There is not any deviation from the test standards for the test method, and no modifications required for compliance.

### 3 General Information

#### 3.1 General Description

Product	4x4 WiFi6 Outdoor Access Point
Brand	Cisco
Test Model	MR86-HW
Status of EUT	Engineering sample
Power Supply Rating	55Vdc or 56Vdc from PoE adapter
Modulation Type	GFSK
Modulation Technology	DTS
Transfer Rate	Up to 2 Mbps
Operating Frequency	2.402 GHz ~ 2.48 GHz
Number of Channel	40
Output Power	<b>BT-LE 1M:</b> 86.298 mW (19.36 dBm) <b>BT-LE 2M:</b> 87.096 mW (19.4 dBm)

Note:

- There are WLAN, Bluetooth technology used for the EUT.
- The EUT power needs to be supplied from a PoE adapter, the information is as below table:

Only for test, not for sale			
No.	Brand	Model No.	Spec.
1	PHIHONG	POEA30U-1ATE	Input: 100-240Vac, 50/60Hz, 0.8A Output: 56V, 0.536A DC Output Cable: shielded, 1.5 m
2	CISCO	MA-INJ-5	Input: 100-240Vac, 50/60Hz, 1.5A Output: 55V, 0.63A DC Output Cable: shielded, 1.5 m
3	CISCO	MA-INJ-4	Input: 100-240Vac, 50/60Hz, 0.67A Output: 55V, 0.6A DC Output Cable: shielded, 1.5 m

#### 3. Simultaneously transmission condition

Condition	Technology		
1	WLAN 2.4GHz		WLAN 5GHz
2	WLAN 2.4GHz	WLAN 5GHz	Bluetooth

Note: The emission of the simultaneous operation has been evaluated and no non-compliance was found.

#### 4. There are WLAN, Bluetooth technology used for the EUT. The EUT has below radios as following table:

Radio 1	Radio 2	Radio 3	Radio 4
WLAN2.4G	WLAN 5G	2.4G/5G 1x1 scanning radio	Bluetooth

#### 5. The EUT could be supplied with components and following different brand names could be chosen:

PART DES	Main source		2nd source	
	Vendor	Vendor PN	Vendor	Vendor PN
DDR	MICRON	MT40A512M16LY-062E IT:E	SAMSUNG	K4A8G165WC-BITD
NAND	WINBOND	W29N02GZBJBF	CYPRESS	S34MS02G200BHV000
M-SMART CONN	GTT	1020G00000340	UDE	R65-MK-0002

From the above sources, the Emissions worse case was found in **Main source**. Therefore only the test data of the mode was recorded in this report.

#### 6. The above EUT information is declared by manufacturer and for more detailed features description, please refer to the manufacturer's specifications or User's Manual.

### 3.2 Antenna Description of EUT

1. The antenna information is listed as below.

WLAN 2.4GHz + WLAN 5GHz							
Antenna set	Chain No.	Brand	Model	Antenna Gain (dBi)	Frequency Range (GHz)	Antenna Type	Connector Type
1	Chain 0/1 Chain 2/3	Cisco	AIR-ANT2513P4M-N	13	2.4~2.4835	Dual-Band Polarization Diverse Patch Array	N type(F)
				13	5.15~5.85		
2	Chain 0/1 Chain 2/3	Cisco	MA-ANT-20	4	2.4~2.4835	omni-directional	
				7	5.15~5.85		
3	Chain 0/1 Chain 2/3	Cisco	MA-ANT-25	8	2.4~2.4835	Patch Array	
				6.5	5.15~5.85		
4	Chain 0/1 Chain 2/3	Cisco	MA-ANT-27	9	2.4~2.4835	Sector	
				12	5.15~5.85		
Scanning Radio							
-	-	Brand	Model	Antenna Gain (dBi)	Frequency Range (GHz)	Antenna Type	Connector Type
-	-	WNC	MR86-HW	4	2.4~2.4835	PIFA	I-PEX
				6.63	5.15~5.85		
Bluetooth							
-	-	Brand	Model	Antenna Gain (dBi)	Frequency Range (GHz)	Antenna Type	Connector Type
-	-	WNC	MR86-HW	4.13	2.4~2.4835	PIFA	I-PEX

\* Detail antenna specification please refer to antenna datasheet and/or antenna measurement report.



### 3.3 Channel List

40 channels are provided for BT-LE:

Channel	Frequency (MHz)	Channel	Frequency (MHz)	Channel	Frequency (MHz)	Channel	Frequency (MHz)
0	2402	10	2422	20	2442	30	2462
1	2404	11	2424	21	2444	31	2464
2	2406	12	2426	22	2446	32	2466
3	2408	13	2428	23	2448	33	2468
4	2410	14	2430	24	2450	34	2470
5	2412	15	2432	25	2452	35	2472
6	2414	16	2434	26	2454	36	2474
7	2416	17	2436	27	2456	37	2476
8	2418	18	2438	28	2458	38	2478
9	2420	19	2440	29	2460	39	2480

### 3.4 Test Mode Applicability and Tested Channel Detail

Pre-Scan:	1. EUT can be used in the following ways: X-axis/ Y-axis/ Z-axis. Pre-scan these ways and find the worst case as a representative test condition. 2. The Power has the following models: MA-INJ-5/MA-INJ4/POEA30U-1ATE Pre-scan these models of Powers and find the worst case as a representative test condition.
Worst Case:	1. X-axis/ Y-axis/ Z-axis Worst Condition: Z-axis 2. Worst Condition: POEA30U-1ATE 3. Pre-Scan has been conducted to determine the worst-case mode from all possible combinations between available modulations, data rates and antenna ports (if EUT with antenna diversity architecture).

Following channel(s) was (were) selected for the final test as listed below:

Test Item	Mode	Tested Channel	Modulation	Data Rate Parameter
RF Output Power / Power Spectral Density	BT-LE 1M	0, 19, 39	GFSK	1Mb/s
	BT-LE 2M	0, 19, 39	GFSK	1Mb/s
6 dB Bandwidth / Conducted Out of Band Emissions	BT-LE 1M	0, 19, 39	GFSK	1Mb/s
	BT-LE 2M	0, 19, 39	GFSK	1Mb/s
AC Power Conducted Emissions	BT-LE 2M	0	GFSK	2Mb/s
Unwanted Emissions below 1 GHz	BT-LE 2M	0	GFSK	2Mb/s
Unwanted Emissions above 1 GHz	BT-LE 1M	0, 19, 39	GFSK	1Mb/s
	BT-LE 2M	0, 19, 39	GFSK	1Mb/s

### 3.5 Duty Cycle of Test Signal

Duty cycle of test signal is  $\geq 98\%$ , duty factor is not required.  
 Duty cycle of test signal is  $< 98\%$ , duty factor shall be considered.

**BT-LE 1M:** Duty cycle =  $0.432 \text{ ms} / 0.63 \text{ ms} \times 100\% = 68.6\%$ , duty factor =  $10 * \log (1/\text{Duty cycle}) = 1.64 \text{ dB}$

**BT-LE 2M:** Duty cycle =  $1.123 \text{ ms} / 1.875 \text{ ms} \times 100\% = 59.9\%$ , duty factor =  $10 * \log (1/\text{Duty cycle}) = 2.23 \text{ dB}$

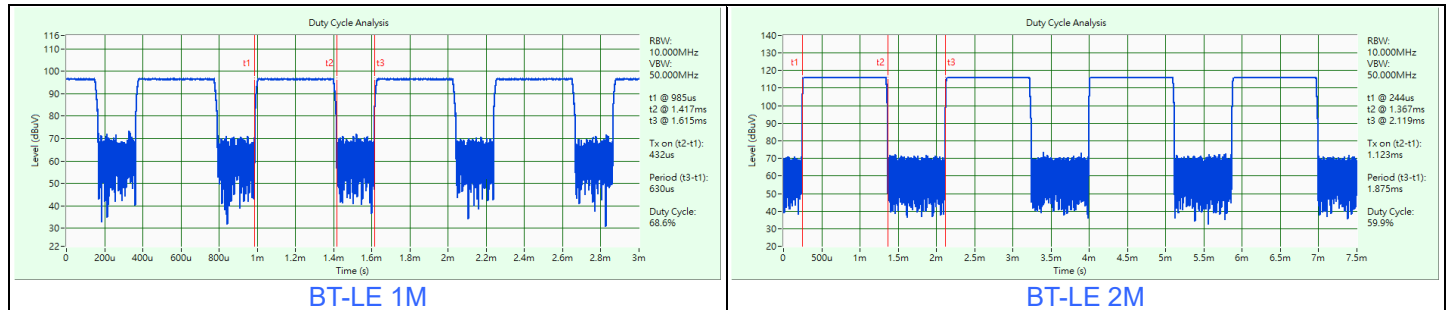

### 3.6 Test Program Used and Operation Descriptions

Controlling software (Telnet paste MR86 BLE command.txt) has been activated to set the EUT under transmission condition continuously at specific channel frequency.

### 3.7 Connection Diagram of EUT and Peripheral Devices

For AC Power Conducted Emission test

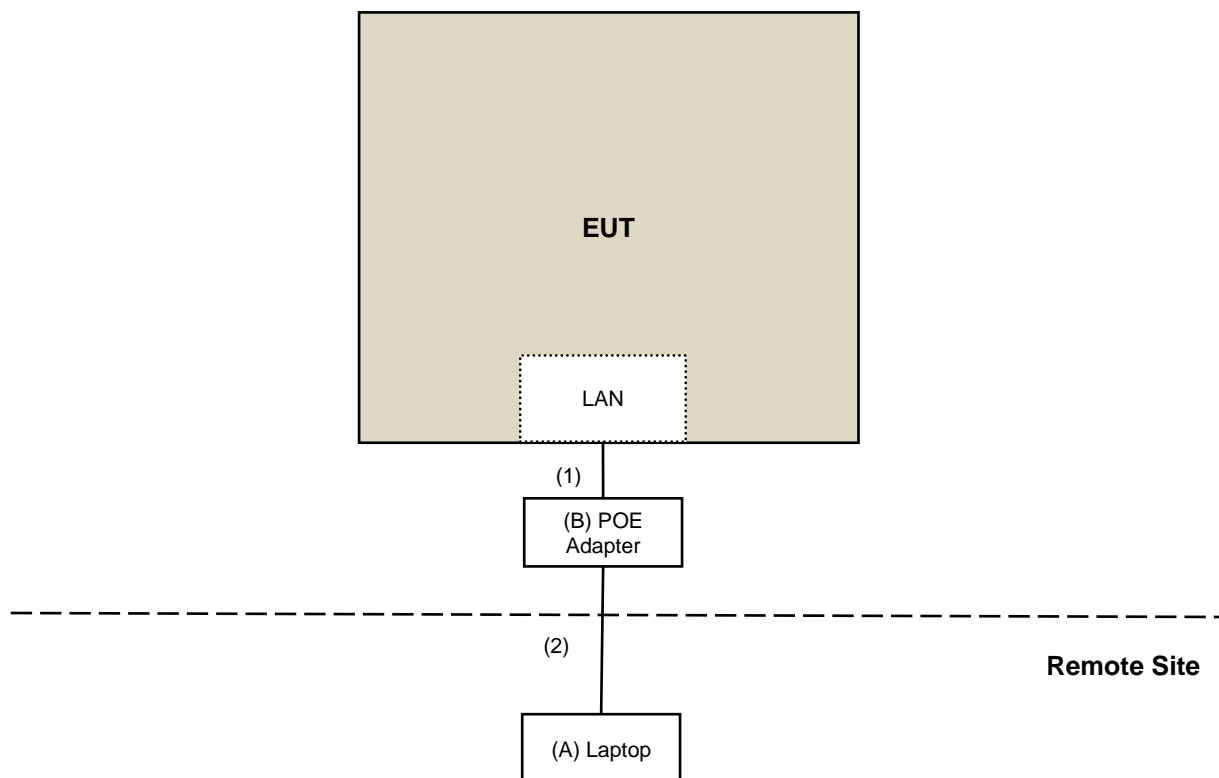

## For Unwanted Emission test

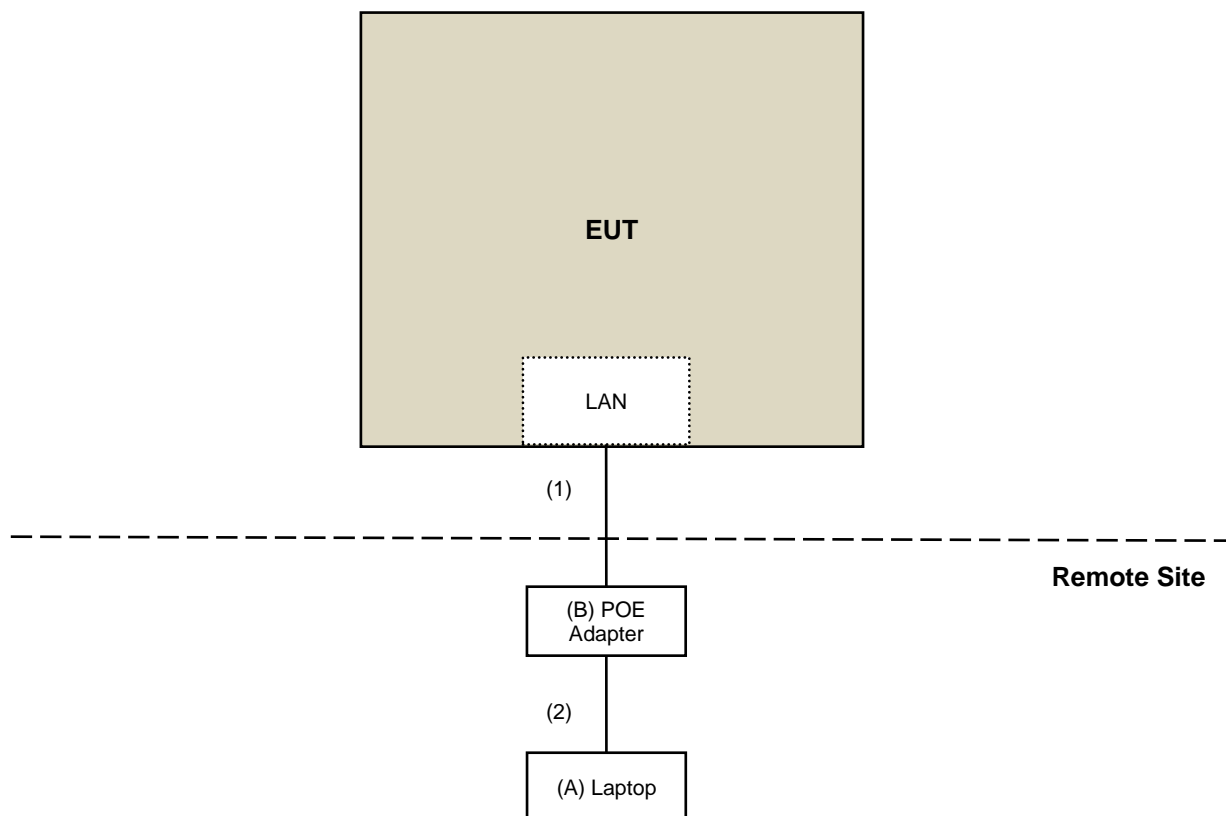

### 3.8 Configuration of Peripheral Devices and Cable Connections

ID	Product	Brand	Model No.	Serial No.	FCC ID	Remarks
A	Laptop	DELL	E6420	B92T3R1	QDS-BRCM1005-D	Provided by Lab
B	POE Adapter	PHIHONG	POEA30U-1ATE	N/A	N/A	Supplied by applicant

ID	Cable Descriptions	Qty.	Length (m)	Shielding (Yes/No)	Cores (Qty.)	Remarks
1	RJ-45 Cable	1	10	No	0	Provided by Lab
2	RJ-45 Cable	1	1.4	No	0	Provided by Lab

## 4 Test Instruments

The calibration interval of the all test instruments are 12 months and the calibrations are traceable to NML/ROC and NIST/USA.

### 4.1 RF Output Power

Description Manufacturer	Model No.	Serial No.	Calibrated Date	Calibrated Until
Power Meter Anritsu	ML2495A	1529002	2022/6/22	2023/6/21
Pulse Power Sensor Anritsu	MA2411B	1726434	2022/6/22	2023/6/21
Pulse Power Sensor Anritsu	MA2411B	1726434	2022/6/22	2023/6/21
Software	ADT_RF Test Software V6.6.5.4	N/A	N/A	N/A

Notes:

1. The test was performed in Oven room 2.
2. Tested Date: 2022/8/12

### 4.2 Power Spectral Density

Description Manufacturer	Model No.	Serial No.	Calibrated Date	Calibrated Until
Attenuator WOKEN	MDCS18N-10	MDCS18N-10-01	2022/4/5	2023/4/4
Software	ADT_RF Test Software V6.6.5.4	N/A	N/A	N/A
Spectrum Analyzer R&S	FSV40	101516	2022/3/7	2023/3/6

Notes:

1. The test was performed in Oven room 2.
2. Tested Date: 2022/8/12

### 4.3 6 dB Bandwidth

Refer to section 4.2 to get information of the instruments.

### 4.4 Conducted Out of Band Emissions

Refer to section 4.2 to get information of the instruments.

#### 4.5 AC Power Conducted Emissions

Description Manufacturer	Model No.	Serial No.	Calibrated Date	Calibrated Until
50 ohms Terminator	50	3	2021/10/27	2022/10/26
Fixed attenuator STI	STI02-2200-10	005	2021/8/27	2022/8/26
LISN R&S	ESH3-Z5	848773/004	2021/10/29	2022/10/28
RF Coaxial Cable JYEBO	5D-FB	COCCAB-001	2021/9/25	2022/9/24
Software BVADT	BVADT_Cond_V7.3.7.4	N/A	N/A	N/A
TEST RECEIVER R&S	ESCS 30	847124/029	2021/10/13	2022/10/12

Notes:

1. The test was performed in Conduction 1
2. Tested Date: 2022/8/11

#### 4.6 Unwanted Emissions below 1 GHz

Description Manufacturer	Model No.	Serial No.	Calibrated Date	Calibrated Until
Boresight Antenna Tower & Turn Table Max-Full	MF-7802BS	MF780208530	N/A	N/A
Fixed attenuator Mini-Circuits	UNAT-5+	PAD-ATT5-03	2022/1/10	2023/1/9
LOOP ANTENNA Electro-Metrics	EM-6879	264	2022/3/18	2023/3/17
Pre_Amplifier Agilent	8447D	2944A10636	2022/3/19	2023/3/18
Pre_Amplifier EMCI	EMC330N	980701	2022/3/8	2023/3/7
RF Coaxial Cable COMMATE/PEWC	8D	966-4-1	2022/3/8	2023/3/7
		966-4-2	2022/3/8	2023/3/7
		966-4-3	2022/3/8	2023/3/7
RF Coaxial Cable JYEBO	5D-FB	LOOPCAB-001	2022/1/6	2023/1/5
		LOOPCAB-002	2022/1/6	2023/1/5
Software	ADT_Radiated_V8.7.08	N/A	N/A	N/A
Test Receiver Agilent	N9038A	MY51210202	2021/11/19	2022/11/18
Trilog Broadband Antenna Schwarzbeck	VULB 9168	9168-406	2021/10/27	2022/10/26

Notes:

1. The test was performed in 966 Chamber No. 4.
2. Tested Date: 2022/8/12

#### 4.7 Unwanted Emissions above 1 GHz

Description Manufacturer	Model No.	Serial No.	Calibrated Date	Calibrated Until
Boresight Antenna Tower & Turn Table Max-Full	MF-7802BS	MF780208530	N/A	N/A
Horn Antenna Schwarzbeck	BBHA 9120D	9120D-783	2021/11/14	2022/11/13
	BBHA 9170	9170-739	2021/11/14	2022/11/13
Pre_Amplifier EMCI	EMC 12630 SE	980638	2022/4/5	2023/4/4
	EMC184045SE	980387	2022/1/10	2023/1/9
RF Cable-Frequency Range : 1- 26.5GHz EMCI	EMC104-SM-SM-1200	160922	2021/12/24	2022/12/23
RF Cable-Frequency range: 1- 40GHz EMCI	EMC102-KM-KM-1200	160924	2022/1/10	2023/1/9
RF Coaxial Cable EMCI	EMC-KM-KM-4000	200214	2022/3/8	2023/3/7
	EMC104-SM-SM-2000	180502	2022/4/25	2023/4/24
	EMC104-SM-SM-6000	210704	2021/11/9	2022/11/8
Software	ADT_Radiated_V8.7.08	N/A	N/A	N/A
Test Receiver Agilent	N9038A	MY51210202	2021/11/19	2022/11/18

Notes:

1. The test was performed in 966 Chamber No. 4.
2. Tested Date: 2022/8/11 ~ 2022/8/15



## 5 Limits of Test Items

### 5.1 RF Output Power

For systems using digital modulation in the 2400–2483.5 MHz bands: 1 Watt (30 dBm)

### 5.2 Power Spectral Density

The Maximum of Power Spectral Density Measurement is 8 dBm in any 3 kHz.

### 5.3 6 dB Bandwidth

The minimum of 6 dB Bandwidth Measurement is 0.5 MHz.

### 5.4 Conducted Out of Band Emissions

Below 20 dB of the highest emission level of operating band (in 100 kHz Resolution Bandwidth).

### 5.5 AC Power Conducted Emissions

Frequency (MHz)	Conducted Limit (dBuV)	
	Quasi-peak	Average
0.15 - 0.5	66 - 56	56 - 46
0.50 - 5.0	56	46
5.0 - 30.0	60	50

Notes:

1. The lower limit shall apply at the transition frequencies.
2. The limit decreases in line with the logarithm of the frequency in the range of 0.15 to 0.50 MHz.

### 5.6 Unwanted Emissions below 1 GHz

Radiated emissions up to 1 GHz which fall in the restricted bands must comply with the radiated emission limits specified as below table. Other emissions shall be at least 30 dB below the highest level of the desired power:

Frequencies (MHz)	Field Strength (microvolts/meter)	Measurement Distance (meters)
0.009 ~ 0.490	2400/F(kHz)	300
0.490 ~ 1.705	24000/F(kHz)	30
1.705 ~ 30.0	30	30
30 ~ 88	100	3
88 ~ 216	150	3
216 ~ 960	200	3
Above 960	500	3

Notes:

1. The lower limit shall apply at the transition frequencies.
2. Emission level (dBuV/m) = 20 log Emission level (uV/m).

## 5.7 Unwanted Emissions above 1 GHz

Radiated emissions above 1 GHz which fall in the restricted bands must comply with the radiated emission limits specified as below table. Other emissions shall be at least 30 dB below the highest level of the desired power:

Frequencies (MHz)	Field Strength (microvolts/meter)	Measurement Distance (meters)
Above 960	500	3

### Notes:

1. The lower limit shall apply at the transition frequencies.
2. Emission level (dBuV/m) = 20 log Emission level (uV/m).
3. For frequencies above 1000 MHz, the field strength limits are based on average detector, however, the peak field strength of any emission shall not exceed the maximum permitted average limits, specified above by more than 20 dB under any condition of modulation.

## 6 Test Arrangements

### 6.1 RF Output Power

#### 6.1.1 Test Setup

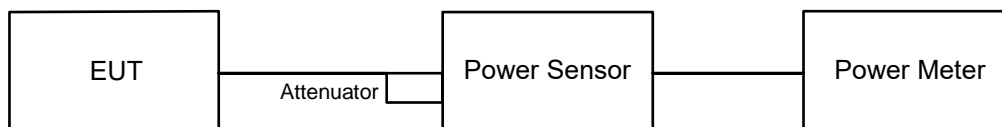

#### 6.1.2 Test Procedure

##### Peak Power:

A peak power sensor was used on the output port of the EUT. A power meter was used to read the response of the peak power sensor. Record the power level.

##### Average Power:

Average power sensor was used to perform output power measurement, trigger and gating function of wide band power meter is enabled to measure max output power of TX on burst. Duty factor is not added to measured value.

### 6.2 Power Spectral Density

#### 6.2.1 Test Setup

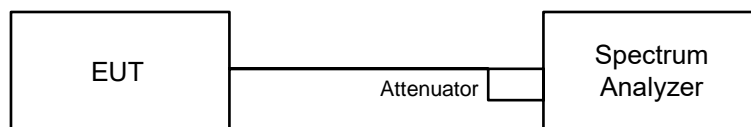

#### 6.2.2 Test Procedure

- a. Set analyzer center frequency to DTS channel center frequency.
- b. Set the span to 1.5 times the DTS bandwidth.
- c. Set the RBW to: 3 kHz.
- d. Set the VBW  $\geq 3 \times$  RBW.
- e. Detector = peak.
- f. Sweep time = auto couple.
- g. Trace mode = max hold.
- h. Allow trace to fully stabilize.
- i. Use the peak marker function to determine the maximum amplitude level within the RBW.

## 6.3 6 dB Bandwidth

### 6.3.1 Test Setup

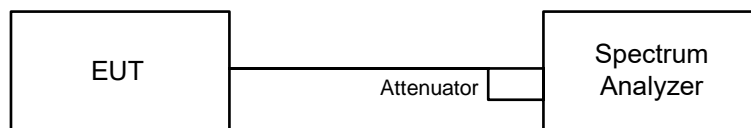

### 6.3.2 Test Procedure

- Set resolution bandwidth (RBW) = 100 kHz.
- Set the video bandwidth (VBW)  $\geq 3 \times$  RBW, Detector = Peak.
- Trace mode = max hold.
- Sweep = auto couple.
- Measure the maximum width of the emission that is constrained by the frequencies associated with the two amplitude points (upper and lower) that are attenuated by 6 dB relative to the maximum level measured in the fundamental emission.

## 6.4 Conducted Out of Band Emissions

### 6.4.1 Test Setup

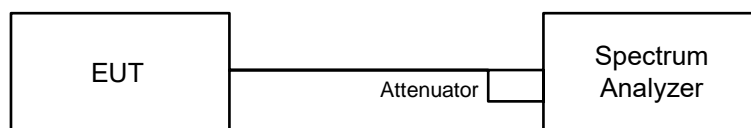

### 6.4.2 Test Procedure

#### MEASUREMENT PROCEDURE REF

- Set the RBW = 100 kHz.
- Set the VBW  $\geq 300$  kHz.
- Detector = peak.
- Sweep time = auto couple.
- Trace mode = max hold.
- Allow trace to fully stabilize.
- Use the peak marker function to determine the maximum power level in any 100 kHz band segment within the fundamental EBW.

#### MEASUREMENT PROCEDURE OOBE

- Set RBW = 100 kHz.
- Set VBW  $\geq 300$  kHz.
- Detector = peak.
- Sweep = auto couple.
- Trace Mode = max hold.
- Allow trace to fully stabilize.
- Use the peak marker function to determine the maximum amplitude level.

## 6.5 AC Power Conducted Emissions

### 6.5.1 Test Setup

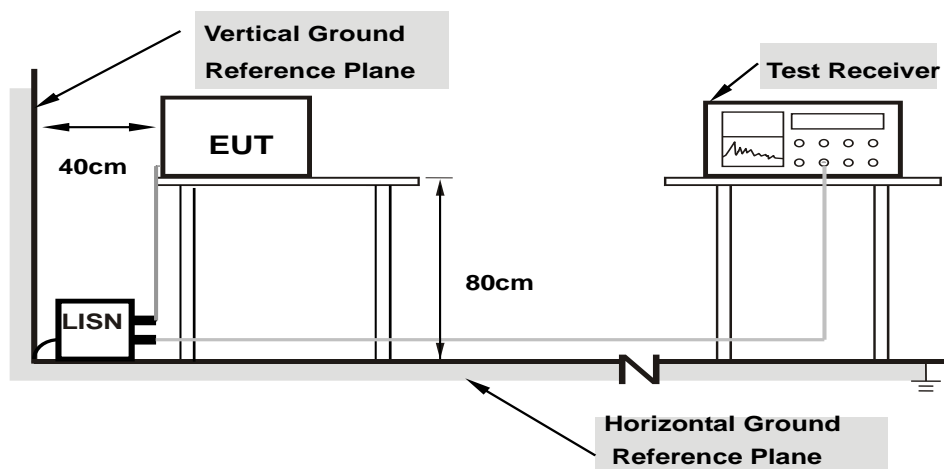

**Note: 1.Support units were connected to second LISN.**

For the actual test configuration, please refer to the attached file (Test Setup Photo).

### 6.5.2 Test Procedure

- The EUT was placed on a 0.8 meter to the top of table and placed 0.4 meters from the conducting wall of the shielded room with EUT being connected to the power mains through a line impedance stabilization network (LISN). Other support units were connected to the power mains through another LISN. The two LISNs provide 50 ohm/ 50 uH of coupling impedance for the measuring instrument.
- Both lines of the power mains connected to the EUT were checked for maximum conducted interference.
- The frequency range from 150 kHz to 30 MHz was searched. Emission levels under (Limit – 20 dB) was not recorded.

Note: The resolution bandwidth and video bandwidth of test receiver is 9 kHz for quasi-peak detection (QP) and average detection (AV) at frequency 0.15 MHz-30 MHz.

## 6.6 Unwanted Emissions below 1 GHz

### 6.6.1 Test Setup

#### For Radiated emission below 30 MHz

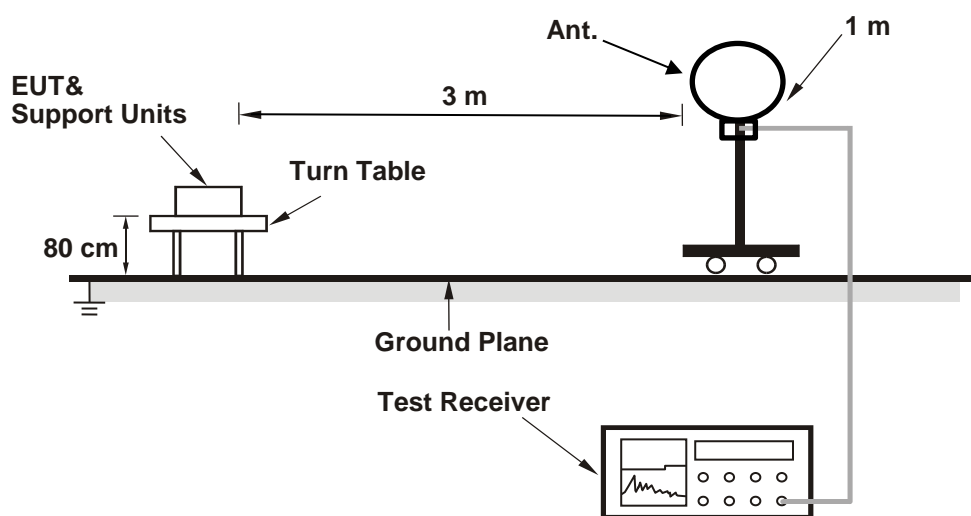

#### For Radiated emission above 30 MHz

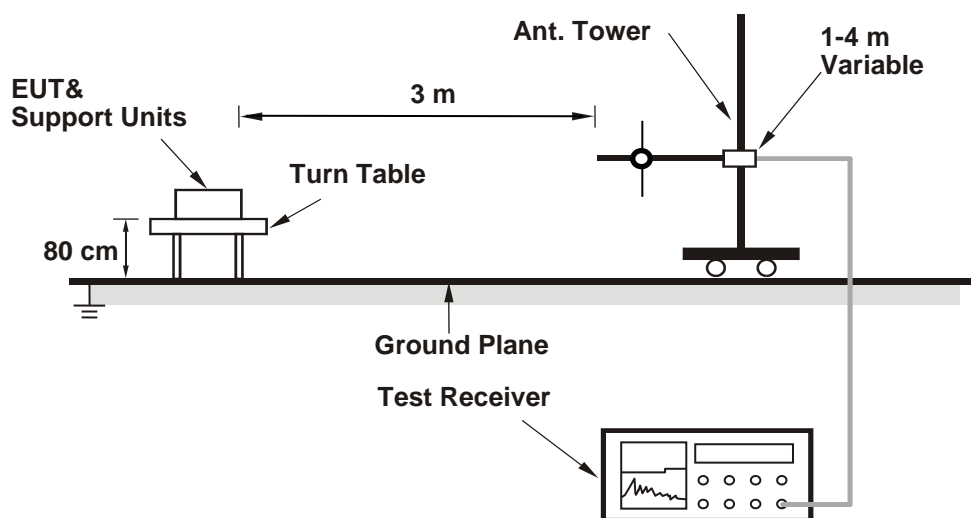

For the actual test configuration, please refer to the attached file (Test Setup Photo).

## 6.6.2 Test Procedure

### For Radiated emission below 30 MHz

- a. The EUT was placed on the top of a rotating table 0.8 meters above the ground at 3 meter chamber room for test. The table was rotated 360 degrees to determine the position of the highest radiation.
- b. The EUT was set 3 meters away from the interference-receiving antenna, which was mounted on the top of a variable-height antenna tower.
- c. Parallel, perpendicular, and ground-parallel orientations of the antenna are set to make the measurement.
- d. For each suspected emission, the EUT was arranged to its worst case and the rotatable table was turned from 0 degrees to 360 degrees to find the maximum reading.
- e. The test-receiver system was set to Quasi-Peak Detect Function and Specified Bandwidth with Maximum Hold Mode, except for the frequency band (9 kHz to 90 kHz and 110 kHz to 490 kHz) set to average detect function and peak detect function.

#### Notes:

1. The resolution bandwidth and video bandwidth of test receiver/spectrum analyzer is 200 Hz at frequency below 150 kHz.
2. The resolution bandwidth and video bandwidth of test receiver/spectrum analyzer is 9 kHz or 10 kHz at frequency (150 kHz to 30 MHz).
3. All modes of operation were investigated and the worst-case emissions are reported.

### For Radiated emission above 30 MHz

- a. The EUT was placed on the top of a rotating table 0.8 meters above the ground at 3 meter chamber room for test. The table was rotated 360 degrees to determine the position of the highest radiation.
- b. The EUT was set 3 meters away from the interference-receiving antenna, which was mounted on the top of a variable-height antenna tower.
- c. The height of antenna is varied from one meter to four meters above the ground to determine the maximum value of the field strength. Both horizontal and vertical polarizations of the antenna are set to make the measurement.
- d. For each suspected emission, the EUT was arranged to its worst case and then the antenna was tuned to heights from 1 meter to 4 meters and the rotatable table was turned from 0 degrees to 360 degrees to find the maximum reading.
- e. The test-receiver system was set to quasi-peak detect function and specified bandwidth with maximum hold mode when the test frequency is below 1 GHz.

#### Notes:

1. The resolution bandwidth and video bandwidth of test receiver/spectrum analyzer is 120 kHz for Quasi-peak detection (QP) at frequency below 1 GHz.
2. All modes of operation were investigated and the worst-case emissions are reported.

## 6.7 Unwanted Emissions above 1 GHz

### 6.7.1 Test Setup

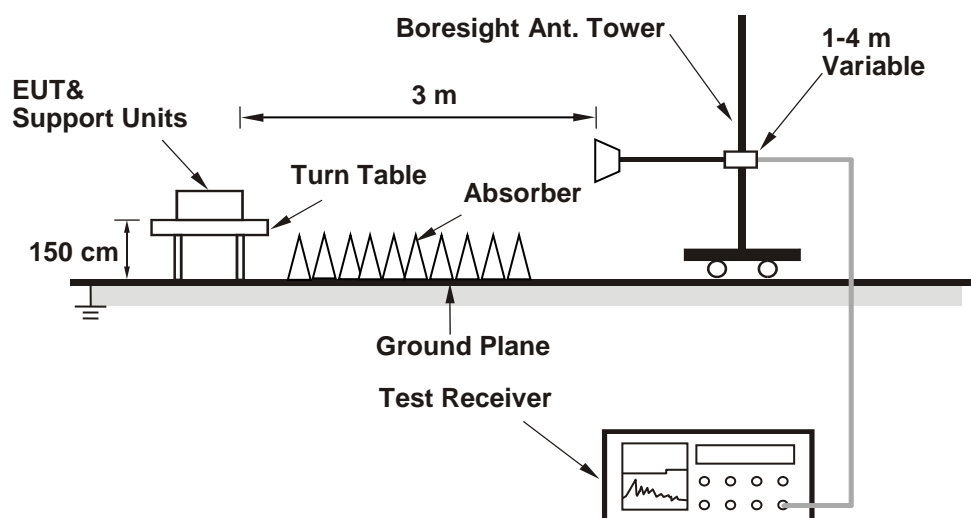

For the actual test configuration, please refer to the attached file (Test Setup Photo).

### 6.7.2 Test Procedure

- The EUT was placed on the top of a rotating table 1.5 meters above the ground at 3 meter chamber room for test. The table was rotated 360 degrees to determine the position of the highest radiation.
- The EUT was set 3 meters away from the interference-receiving antenna, which was mounted on the top of a variable-height antenna tower.
- The height of antenna is varied from one meter to four meters above the ground to determine the maximum value of the field strength. Both horizontal and vertical polarizations of the antenna are set to make the measurement.
- For each suspected emission, the EUT was arranged to its worst case and then the antenna was tuned to heights from 1 meter to 4 meters and the rotatable table was turned from 0 degrees to 360 degrees to find the maximum reading.
- The test-receiver system was set to peak and average detects function and specified bandwidth with maximum hold mode when the test frequency is above 1 GHz. If the peak reading value also meets average limit, measurement with the average detector is unnecessary.

#### Notes:

- The resolution bandwidth of test receiver/spectrum analyzer is 1 MHz and the video bandwidth is 3 MHz for Peak detection (PK) and Average detection (AV) at frequency above 1 GHz.
- For fundamental and harmonic signal measurement, the resolution bandwidth of test receiver/spectrum analyzer is 1 MHz and the video bandwidth is  $\geq 1/T$  (Duty cycle  $< 98\%$ ) or 10 Hz (Duty cycle  $\geq 98\%$ ) for Average detection (AV) at frequency above 1 GHz.
- All modes of operation were investigated and the worst-case emissions are reported.



## 7 Test Results of Test Item

### 7.1 RF Output Power

Input Power:	120 Vac, 60 Hz	Environmental Conditions:	25°C, 60% RH	Tested By:	John Peng
--------------	----------------	---------------------------	--------------	------------	-----------

#### For Peak Power

##### BT-LE 1M

Chan.	Chan. Freq. (MHz)	Peak Power (mW)	Peak Power (dBm)	Power Limit (dBm)	Test Result
0	2402	86.298	19.36	30	Pass
19	2440	83.946	19.24	30	Pass
39	2480	35.237	15.47	30	Pass

Note: The antenna gain is 4.13 dBi < 6 dBi, so the output power limit shall not be reduced.

##### BT-LE 2M

Chan.	Chan. Freq. (MHz)	Peak Power (mW)	Peak Power (dBm)	Power Limit (dBm)	Test Result
0	2402	87.096	19.40	30	Pass
19	2440	83.753	19.23	30	Pass
39	2480	16.827	12.26	30	Pass

Note: The antenna gain is 4.13 dBi < 6 dBi, so the output power limit shall not be reduced.

#### For Average Power

##### BT-LE 1M

Chan.	Chan. Freq. (MHz)	Average Power (mW)	Average Power (dBm)
0	2402	85.704	19.33
19	2440	83.753	19.23
39	2480	34.995	15.44

##### BT-LE 2M

Chan.	Chan. Freq. (MHz)	Average Power (mW)	Average Power (dBm)
0	2402	86.497	19.37
19	2440	83.56	19.22
39	2480	16.52	12.18

## 7.2 Power Spectral Density

Input Power:	120 Vac, 60 Hz	Environmental Conditions:	25°C, 60% RH	Tested By:	John Peng
--------------	----------------	---------------------------	--------------	------------	-----------

### BT-LE 1M

Chan.	Chan. Freq. (MHz)	PSD (dBm/3kHz)	PSD Limit (dBm/3kHz)	Test Result
0	2402	4.41	8.00	Pass
19	2440	4.34	8.00	Pass
39	2480	0.36	8.00	Pass

Note: The antenna gain is 4.13 dBi < 6 dBi, so the power density limit shall not be reduced.

### BT-LE 2M

Chan.	Chan. Freq. (MHz)	PSD (dBm/3kHz)	PSD Limit (dBm/3kHz)	Test Result
0	2402	4.03	8.00	Pass
19	2440	3.95	8.00	Pass
39	2480	-2.93	8.00	Pass

Note: The antenna gain is 4.13 dBi < 6 dBi, so the power density limit shall not be reduced.

Spectrum Plot of Maximum Value

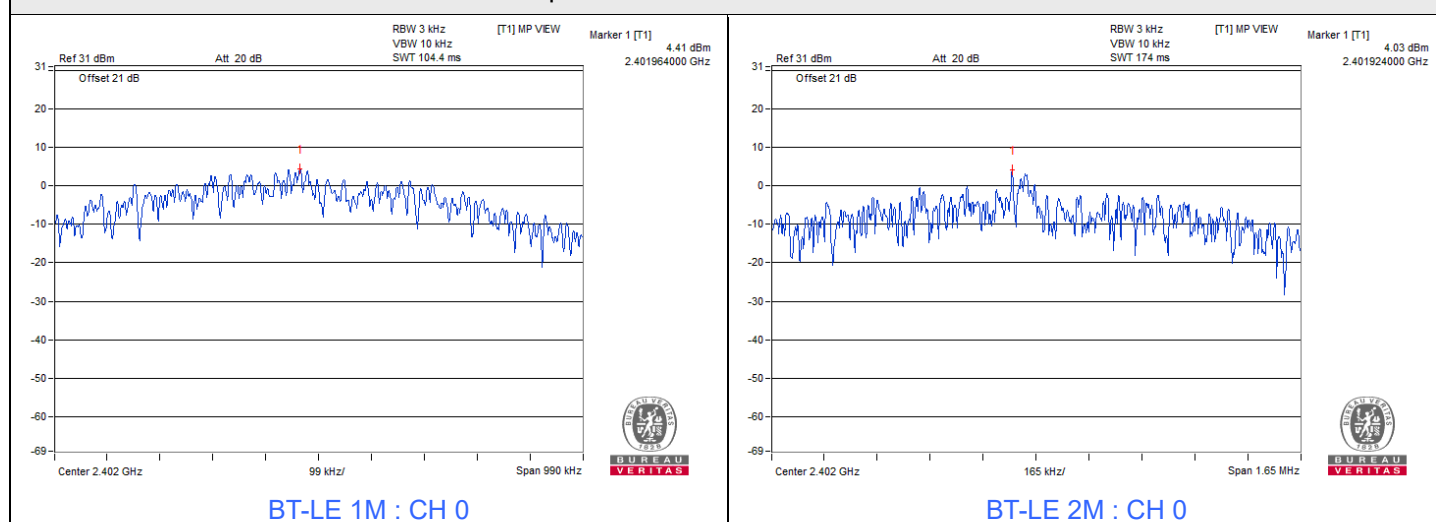

### 7.3 6 dB Bandwidth

Input Power:	120 Vac, 60 Hz	Environmental Conditions:	25°C, 60% RH	Tested By:	John Peng
--------------	----------------	---------------------------	--------------	------------	-----------

#### BT-LE 1M

Channel	Frequency (MHz)	6dB Bandwidth (MHz)	Minimum Limit (MHz)	Test Result
0	2402	0.66	0.5	Pass
19	2440	0.65	0.5	Pass
39	2480	0.65	0.5	Pass

#### BT-LE 2M

Channel	Frequency (MHz)	6dB Bandwidth (MHz)	Minimum Limit (MHz)	Test Result
0	2402	1.1	0.5	Pass
19	2440	1.1	0.5	Pass
39	2480	1.09	0.5	Pass

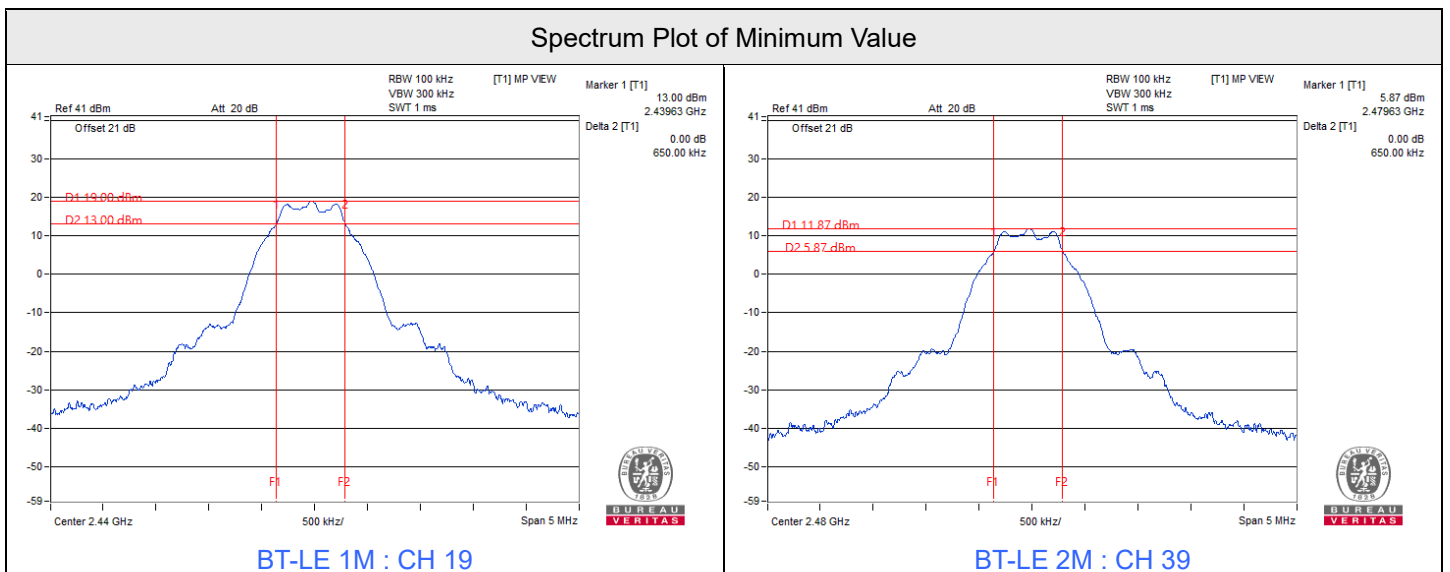



### 7.4 Conducted Out of Band Emissions

Input Power:	120 Vac, 60 Hz	Environmental Conditions:	25°C, 60% RH	Tested By:	John Peng
--------------	----------------	---------------------------	--------------	------------	-----------

#### BT-LE 1M





BT-LE 2M

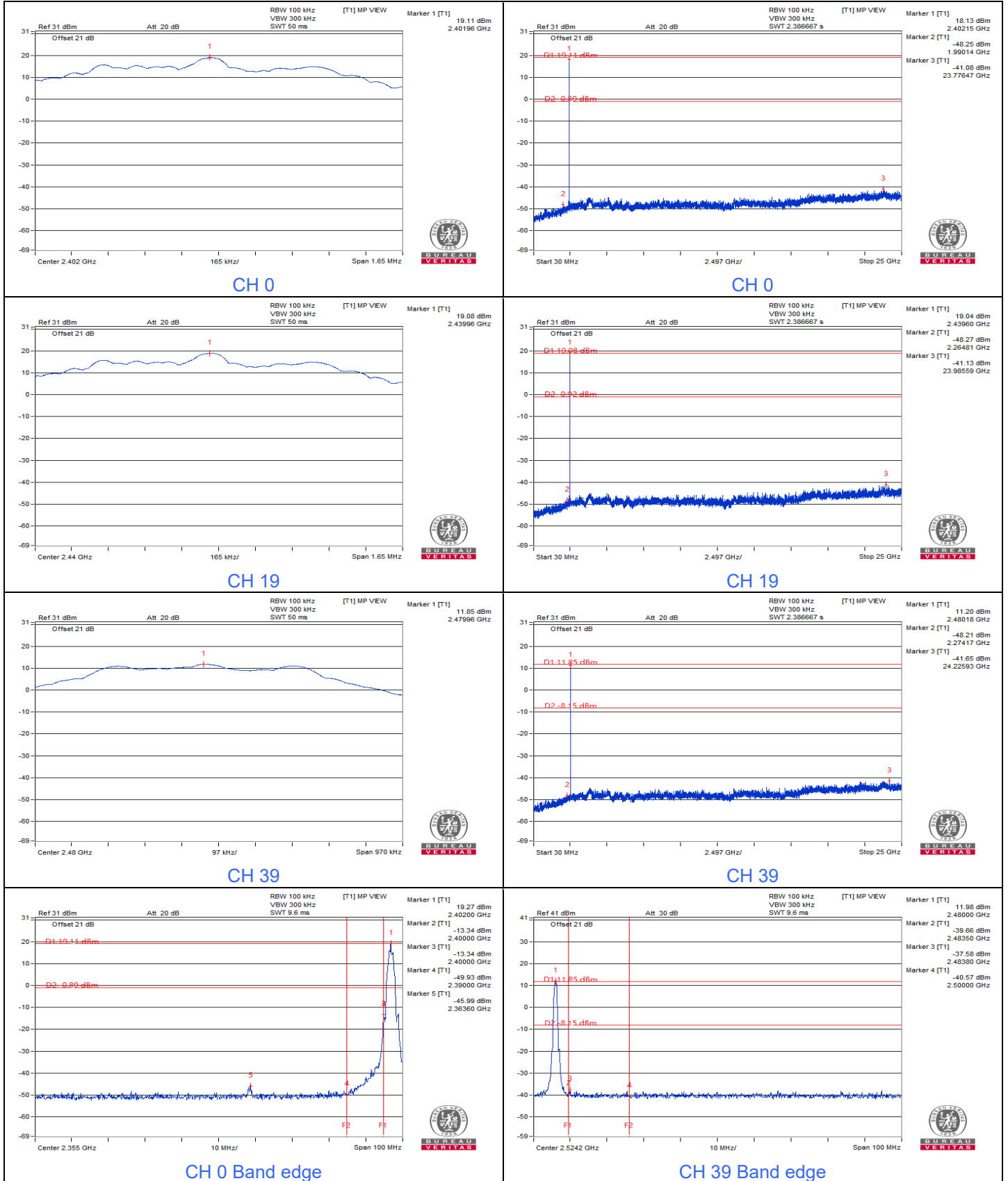

## 7.5 AC Power Conducted Emissions

RF Mode	TX BT-LE 2M	Channel	CH 0 : 2402 MHz
Frequency Range	150 kHz ~ 30 MHz	Detector Function & Resolution Bandwidth	Quasi-Peak (QP) / Average (AV), 9 kHz
Input Power (System)	120 Vac, 60 Hz	Environmental Conditions	24°C, 71% RH
Tested By	Sampson Chen		

### Phase Of Power : Line (L)

No	Frequency (MHz)	Correction Factor (dB)	Reading Value (dBuV)		Emission Level (dBuV)		Limit (dBuV)		Margin (dB)	
			Q.P.	AV.	Q.P.	AV.	Q.P.	AV.	Q.P.	AV.
1	0.15031	10.05	49.58	33.10	59.63	43.15	65.98	55.98	-6.35	-12.83
2	0.17567	10.05	43.12	27.67	53.17	37.72	64.69	54.69	-11.52	-16.97
3	0.20701	10.05	38.98	23.13	49.03	33.18	63.32	53.32	-14.29	-20.14
4	0.48402	10.07	28.23	24.97	38.30	35.04	56.27	46.27	-17.97	-11.23
5	13.79413	10.85	27.90	23.01	38.75	33.86	60.00	50.00	-21.25	-16.14
6	24.12891	11.29	37.05	32.67	48.34	43.96	60.00	50.00	-11.66	-6.04

#### Remarks:

1. Q.P. and AV. are abbreviations of quasi-peak and average individually.
2. The emission levels of other frequencies were very low against the limit.
3. Margin value = Emission level – Limit value
4. Correction factor = Insertion loss + Cable loss
5. Emission Level = Correction Factor + Reading Value

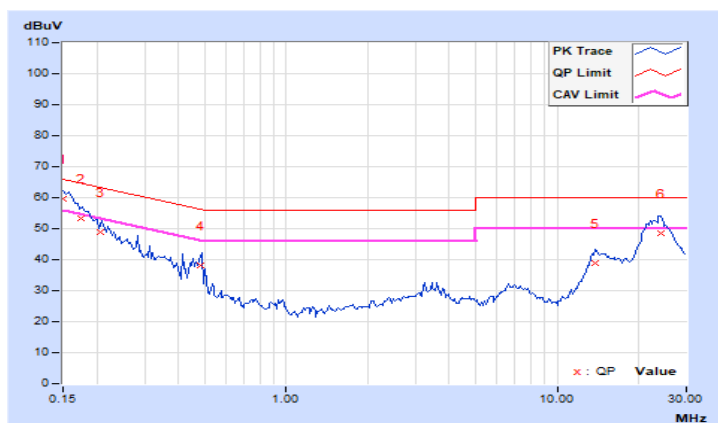

<b>RF Mode</b>	TX BT-LE 2M	<b>Channel</b>	CH 0 : 2402 MHz
<b>Frequency Range</b>	150 kHz ~ 30 MHz	<b>Detector Function &amp; Resolution Bandwidth</b>	Quasi-Peak (QP) / Average (AV), 9 kHz
<b>Input Power (System)</b>	120 Vac, 60 Hz	<b>Environmental Conditions</b>	24°C, 71% RH
<b>Tested By</b>	Sampson Chen		

Phase Of Power : Neutral (N)										
No	Frequency (MHz)	Correction Factor (dB)	Reading Value (dBuV)		Emission Level (dBuV)		Limit (dBuV)		Margin (dB)	
			Q.P.	AV.	Q.P.	AV.	Q.P.	AV.	Q.P.	AV.
1	0.15023	10.02	49.97	33.05	59.99	43.07	65.99	55.99	-6.00	-12.92
2	0.17621	10.03	44.56	28.74	54.59	38.77	64.66	54.66	-10.07	-15.89
3	0.23506	10.03	35.63	21.56	45.66	31.59	62.27	52.27	-16.61	-20.68
4	14.53118	10.70	23.10	18.97	33.80	29.67	60.00	50.00	-26.20	-20.33
5	21.62321	10.96	34.09	28.26	45.05	39.22	60.00	50.00	-14.95	-10.78
6	24.19561	10.97	35.20	31.00	46.17	41.97	60.00	50.00	-13.83	-8.03

**Remarks:**

1. Q.P. and AV. are abbreviations of quasi-peak and average individually.
2. The emission levels of other frequencies were very low against the limit.
3. Margin value = Emission level – Limit value
4. Correction factor = Insertion loss + Cable loss
5. Emission Level = Correction Factor + Reading Value

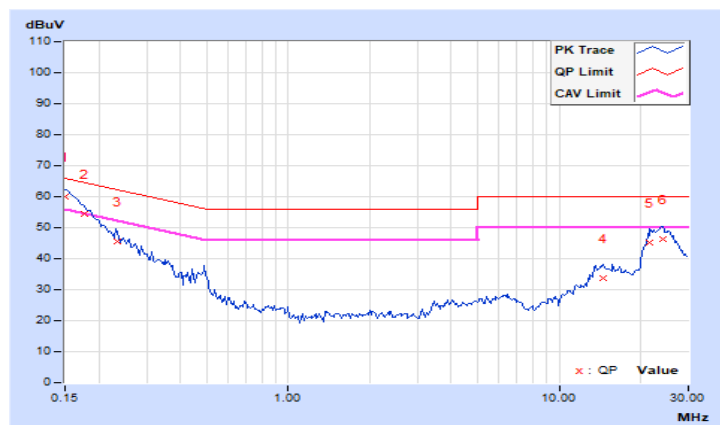

## 7.6 Unwanted Emissions below 1 GHz

RF Mode	TX BT-LE 2M	Channel	CH 0 : 2402 MHz
Frequency Range	9 kHz ~ 1 GHz	Detector Function & Bandwidth	(QP) RB = 120kHz
Input Power (System)	120 Vac, 60 Hz	Environmental Conditions	25°C, 75% RH
Tested By	Sampson Chen		

### Antenna Polarity & Test Distance : Horizontal at 3 m

No	Frequency (MHz)	Emission Level (dBuV/m)	Limit (dBuV/m)	Margin (dB)	Antenna Height (m)	Table Angle (Degree)	Raw Value (dBuV)	Correction Factor (dB/m)
1	51.89	35.1 QP	40.0	-4.9	1.50 H	183	47.5	-12.4
2	78.42	35.0 QP	40.0	-5.0	1.00 H	314	51.6	-16.6
3	93.75	36.6 QP	43.5	-6.9	1.00 H	110	54.0	-17.4
4	149.56	30.8 QP	43.5	-12.7	1.00 H	86	42.4	-11.6
5	203.75	33.2 QP	43.5	-10.3	1.00 H	110	47.9	-14.7
6	303.33	27.6 QP	46.0	-18.4	3.00 H	202	37.9	-10.3

### Remarks:

1. Emission Level(dBuV/m) = Raw Value(dBuV) + Correction Factor(dB/m)
2. Correction Factor(dB/m) = Antenna Factor(dB/m) + Cable Factor(dB) – Pre-Amplifier Factor(dB)
3. Margin value = Emission Level – Limit value
4. The other emission levels were very low against the limit of frequency range 30 MHz ~ 1 GHz.
5. The emission levels were very low against the limit of frequency range 9 kHz ~ 30 MHz: the amplitude of spurious emissions attenuated more than 20 dB below the permissible value to be report.

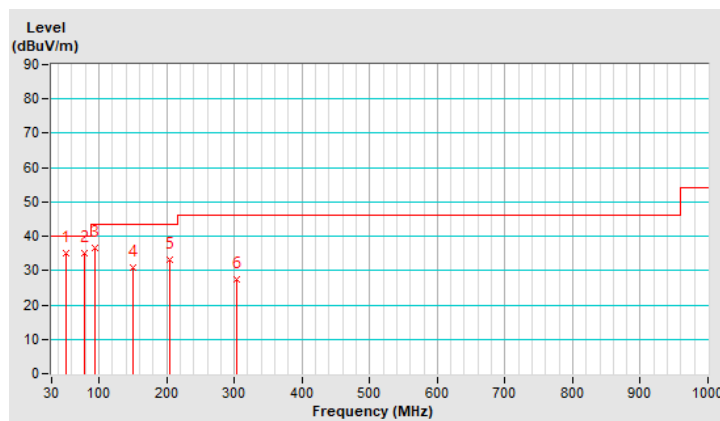



<b>RF Mode</b>	TX BT-LE 2M	<b>Channel</b>	CH 0 : 2402 MHz
<b>Frequency Range</b>	9 kHz ~ 1 GHz	<b>Detector Function &amp; Bandwidth</b>	(QP) RB = 120kHz
<b>Input Power (System)</b>	120 Vac, 60 Hz	<b>Environmental Conditions</b>	25°C, 75% RH
<b>Tested By</b>	Sampson Chen		

Antenna Polarity & Test Distance : Vertical at 3 m								
No	Frequency (MHz)	Emission Level (dBuV/m)	Limit (dBuV/m)	Margin (dB)	Antenna Height (m)	Table Angle (Degree)	Raw Value (dBuV)	Correction Factor (dB/m)
1	48.79	36.3 QP	40.0	-3.7	2.00 V	93	48.5	-12.2
2	78.49	34.9 QP	40.0	-5.1	1.50 V	133	51.5	-16.6
3	107.28	35.0 QP	43.5	-8.5	2.00 V	184	50.0	-15.0
4	176.32	30.6 QP	43.5	-12.9	1.00 V	93	43.3	-12.7
5	199.78	30.3 QP	43.5	-13.2	1.50 V	150	45.0	-14.7
6	334.70	25.9 QP	46.0	-20.1	3.00 V	182	35.3	-9.4

**Remarks:**

1. Emission Level(dBuV/m) = Raw Value(dBuV) + Correction Factor(dB/m)
2. Correction Factor(dB/m) = Antenna Factor(dB/m) + Cable Factor(dB) – Pre-Amplifier Factor(dB)
3. Margin value = Emission Level – Limit value
4. The other emission levels were very low against the limit of frequency range 30 MHz ~ 1 GHz.
5. The emission levels were very low against the limit of frequency range 9 kHz ~ 30 MHz: the amplitude of spurious emissions attenuated more than 20 dB below the permissible value to be report.

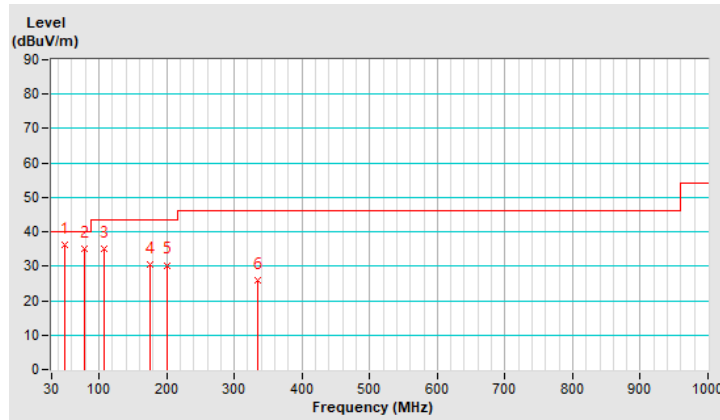

## 7.7 Unwanted Emissions above 1 GHz

<b>RF Mode</b>	TX BT-LE 1M	<b>Channel</b>	CH 0 : 2402 MHz
<b>Frequency Range</b>	1 GHz ~ 25 GHz	<b>Detector Function &amp; Bandwidth</b>	(PK) RB = 1 MHz, VB = 3 MHz (AV) RB = 1 MHz, VB = 3 kHz
<b>Input Power (System)</b>	120 Vac, 60 Hz	<b>Environmental Conditions</b>	22°C, 69% RH
<b>Tested By</b>	Sampson Chen		

Antenna Polarity & Test Distance : Horizontal at 3 m								
No	Frequency (MHz)	Emission Level (dBuV/m)	Limit (dBuV/m)	Margin (dB)	Antenna Height (m)	Table Angle (Degree)	Raw Value (dBuV)	Correction Factor (dB/m)
1	2390.00	56.7 PK	74.0	-17.3	1.22 H	317	61.2	-4.5
2	2390.00	45.8 AV	54.0	-8.2	1.22 H	317	50.3	-4.5
3	*2402.00	116.5 PK			1.22 H	317	121.0	-4.5
4	*2402.00	115.5 AV			1.22 H	317	120.0	-4.5
5	4804.00	42.6 PK	74.0	-31.4	2.92 H	343	42.8	-0.2
6	4804.00	34.1 AV	54.0	-19.9	2.92 H	343	34.3	-0.2

### Remarks:

1. Emission Level(dBuV/m) = Raw Value(dBuV) + Correction Factor(dB/m)
2. Correction Factor(dB/m) = Antenna Factor(dB/m) + Cable Factor(dB) – Pre-Amplifier Factor(dB)
3. Margin value = Emission Level – Limit value
4. The other emission levels were very low against the limit.
5. " \* ": Fundamental frequency, the limit was restricted at the RF Output Power.

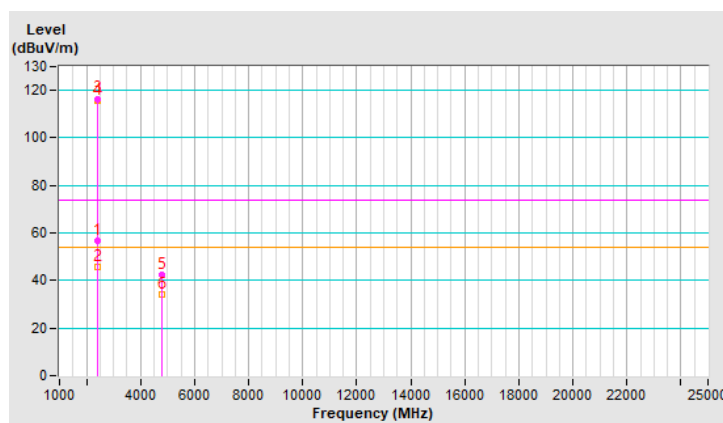

<b>RF Mode</b>	TX BT-LE 1M	<b>Channel</b>	CH 0 : 2402 MHz
<b>Frequency Range</b>	1 GHz ~ 25 GHz	<b>Detector Function &amp; Bandwidth</b>	(PK) RB = 1 MHz, VB = 3 MHz (AV) RB = 1 MHz, VB = 3 kHz
<b>Input Power (System)</b>	120 Vac, 60 Hz	<b>Environmental Conditions</b>	22°C, 69% RH
<b>Tested By</b>	Sampson Chen		

Antenna Polarity & Test Distance : Vertical at 3 m								
No	Frequency (MHz)	Emission Level (dBuV/m)	Limit (dBuV/m)	Margin (dB)	Antenna Height (m)	Table Angle (Degree)	Raw Value (dBuV)	Correction Factor (dB/m)
1	2390.00	55.3 PK	74.0	-18.7	3.12 V	348	59.8	-4.5
2	2390.00	44.8 AV	54.0	-9.2	3.12 V	348	49.3	-4.5
3	*2402.00	110.6 PK			3.12 V	348	115.1	-4.5
4	*2402.00	109.5 AV			3.12 V	348	114.0	-4.5
5	4804.00	39.2 PK	74.0	-34.8	3.25 V	323	39.4	-0.2
6	4804.00	30.1 AV	54.0	-23.9	3.25 V	323	30.3	-0.2

**Remarks:**

1. Emission Level(dBuV/m) = Raw Value(dBuV) + Correction Factor(dB/m)
2. Correction Factor(dB/m) = Antenna Factor(dB/m) + Cable Factor(dB) – Pre-Amplifier Factor(dB)
3. Margin value = Emission Level – Limit value
4. The other emission levels were very low against the limit.
5. " \* " : Fundamental frequency, the limit was restricted at the RF Output Power.

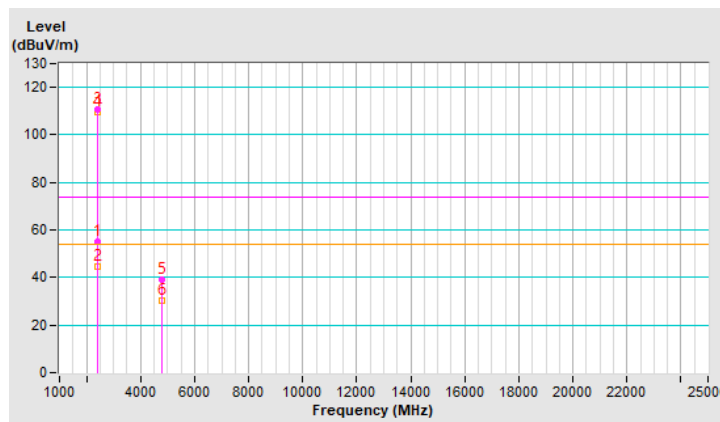

<b>RF Mode</b>	TX BT-LE 1M	<b>Channel</b>	CH 19 : 2440 MHz
<b>Frequency Range</b>	1 GHz ~ 25 GHz	<b>Detector Function &amp; Bandwidth</b>	(PK) RB = 1 MHz, VB = 3 MHz (AV) RB = 1 MHz, VB = 3 kHz
<b>Input Power (System)</b>	120 Vac, 60 Hz	<b>Environmental Conditions</b>	22°C, 69% RH
<b>Tested By</b>	Sampson Chen		

Antenna Polarity & Test Distance : Horizontal at 3 m								
No	Frequency (MHz)	Emission Level (dBuV/m)	Limit (dBuV/m)	Margin (dB)	Antenna Height (m)	Table Angle (Degree)	Raw Value (dBuV)	Correction Factor (dB/m)
1	*2440.00	114.4 PK			1.05 H	312	118.9	-4.5
2	*2440.00	113.0 AV			1.05 H	312	117.5	-4.5
3	4880.00	42.4 PK	74.0	-31.6	2.98 H	352	42.6	-0.2
4	4880.00	33.9 AV	54.0	-20.1	2.98 H	352	34.1	-0.2
5	7320.00	48.5 PK	74.0	-25.5	1.53 H	345	42.3	6.2
6	7320.00	38.3 AV	54.0	-15.7	1.53 H	345	32.1	6.2

**Remarks:**

1. Emission Level(dBuV/m) = Raw Value(dBuV) + Correction Factor(dB/m)
2. Correction Factor(dB/m) = Antenna Factor(dB/m) + Cable Factor(dB) – Pre-Amplifier Factor(dB)
3. Margin value = Emission Level – Limit value
4. The other emission levels were very low against the limit.
5. " \* " : Fundamental frequency, the limit was restricted at the RF Output Power.

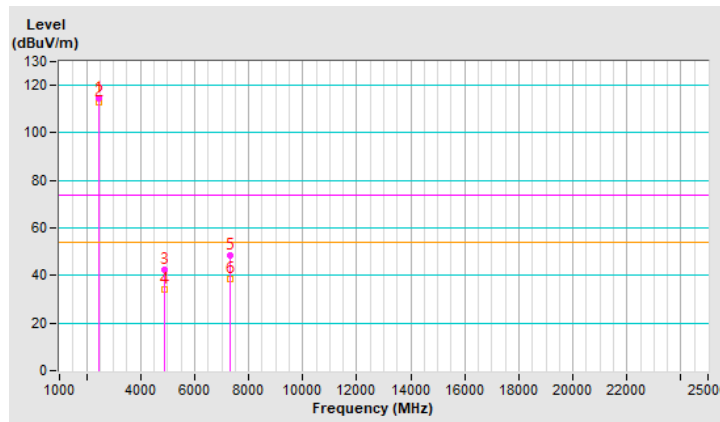

<b>RF Mode</b>	TX BT-LE 1M	<b>Channel</b>	CH 19 : 2440 MHz
<b>Frequency Range</b>	1 GHz ~ 25 GHz	<b>Detector Function &amp; Bandwidth</b>	(PK) RB = 1 MHz, VB = 3 MHz (AV) RB = 1 MHz, VB = 3 kHz
<b>Input Power (System)</b>	120 Vac, 60 Hz	<b>Environmental Conditions</b>	22°C, 69% RH
<b>Tested By</b>	Sampson Chen		

Antenna Polarity & Test Distance : Vertical at 3 m								
No	Frequency (MHz)	Emission Level (dBuV/m)	Limit (dBuV/m)	Margin (dB)	Antenna Height (m)	Table Angle (Degree)	Raw Value (dBuV)	Correction Factor (dB/m)
1	*2440.00	108.7 PK			2.60 V	56	113.2	-4.5
2	*2440.00	107.9 AV			2.60 V	56	112.4	-4.5
3	4880.00	39.5 PK	74.0	-34.5	3.30 V	322	39.7	-0.2
4	4880.00	30.1 AV	54.0	-23.9	3.30 V	322	30.3	-0.2
5	7320.00	47.1 PK	74.0	-26.9	2.94 V	314	40.9	6.2
6	7320.00	37.8 AV	54.0	-16.2	2.94 V	314	31.6	6.2

**Remarks:**

1. Emission Level(dBuV/m) = Raw Value(dBuV) + Correction Factor(dB/m)
2. Correction Factor(dB/m) = Antenna Factor(dB/m) + Cable Factor(dB) – Pre-Amplifier Factor(dB)
3. Margin value = Emission Level – Limit value
4. The other emission levels were very low against the limit.
5. " \* " : Fundamental frequency, the limit was restricted at the RF Output Power.

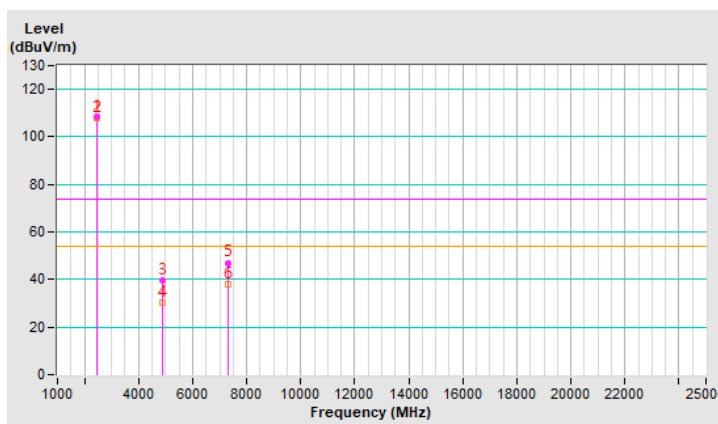

<b>RF Mode</b>	TX BT-LE 1M	<b>Channel</b>	CH 39 : 2480 MHz
<b>Frequency Range</b>	1 GHz ~ 25 GHz	<b>Detector Function &amp; Bandwidth</b>	(PK) RB = 1 MHz, VB = 3 MHz (AV) RB = 1 MHz, VB = 3 kHz
<b>Input Power (System)</b>	120 Vac, 60 Hz	<b>Environmental Conditions</b>	22°C, 69% RH
<b>Tested By</b>	Sampson Chen		

Antenna Polarity & Test Distance : Horizontal at 3 m								
No	Frequency (MHz)	Emission Level (dBuV/m)	Limit (dBuV/m)	Margin (dB)	Antenna Height (m)	Table Angle (Degree)	Raw Value (dBuV)	Correction Factor (dB/m)
1	*2480.00	114.0 PK			1.00 H	304	118.5	-4.5
2	*2480.00	112.7 AV			1.00 H	304	117.2	-4.5
3	2483.50	63.9 PK	74.0	-10.1	1.00 H	304	68.4	-4.5
4	2483.50	53.2 AV	54.0	-0.8	1.00 H	304	57.7	-4.5
5	4960.00	42.4 PK	74.0	-31.6	2.92 H	360	42.2	0.2
6	4960.00	33.9 AV	54.0	-20.1	2.92 H	360	33.7	0.2
7	7440.00	48.5 PK	74.0	-25.5	1.56 H	340	41.8	6.7
8	7440.00	38.2 AV	54.0	-15.8	1.56 H	340	31.5	6.7

**Remarks:**

1. Emission Level(dBuV/m) = Raw Value(dBuV) + Correction Factor(dB/m)
2. Correction Factor(dB/m) = Antenna Factor(dB/m) + Cable Factor(dB) – Pre-Amplifier Factor(dB)
3. Margin value = Emission Level – Limit value
4. The other emission levels were very low against the limit.
5. " \* " : Fundamental frequency, the limit was restricted at the RF Output Power.

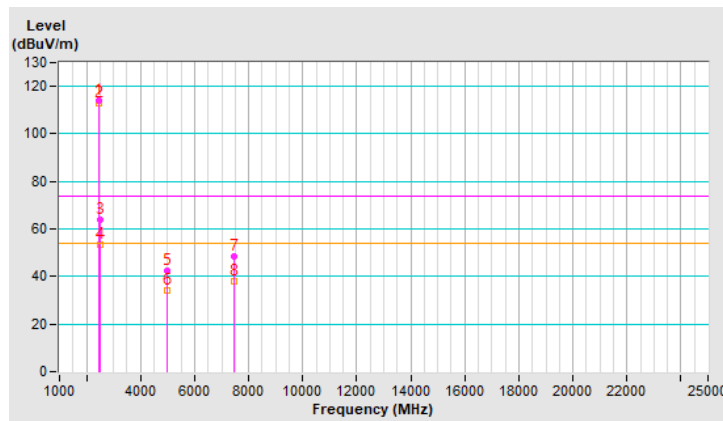

<b>RF Mode</b>	TX BT-LE 1M	<b>Channel</b>	CH 39 : 2480 MHz
<b>Frequency Range</b>	1 GHz ~ 25 GHz	<b>Detector Function &amp; Bandwidth</b>	(PK) RB = 1 MHz, VB = 3 MHz (AV) RB = 1 MHz, VB = 3 kHz
<b>Input Power (System)</b>	120 Vac, 60 Hz	<b>Environmental Conditions</b>	22°C, 69% RH
<b>Tested By</b>	Sampson Chen		

Antenna Polarity & Test Distance : Vertical at 3 m								
No	Frequency (MHz)	Emission Level (dBuV/m)	Limit (dBuV/m)	Margin (dB)	Antenna Height (m)	Table Angle (Degree)	Raw Value (dBuV)	Correction Factor (dB/m)
1	*2480.00	109.4 PK			2.54 V	42	113.9	-4.5
2	*2480.00	108.4 AV			2.54 V	42	112.9	-4.5
3	2483.50	61.7 PK	74.0	-12.3	2.54 V	42	66.2	-4.5
4	2483.50	50.3 AV	54.0	-3.7	2.54 V	42	54.8	-4.5
5	4960.00	40.0 PK	74.0	-34.0	3.35 V	315	39.8	0.2
6	4960.00	30.6 AV	54.0	-23.4	3.35 V	315	30.4	0.2
7	7440.00	46.5 PK	74.0	-27.5	2.97 V	314	39.8	6.7
8	7440.00	37.3 AV	54.0	-16.7	2.97 V	314	30.6	6.7

**Remarks:**

1. Emission Level(dBuV/m) = Raw Value(dBuV) + Correction Factor(dB/m)
2. Correction Factor(dB/m) = Antenna Factor(dB/m) + Cable Factor(dB) – Pre-Amplifier Factor(dB)
3. Margin value = Emission Level – Limit value
4. The other emission levels were very low against the limit.
5. " \* ": Fundamental frequency, the limit was restricted at the RF Output Power.

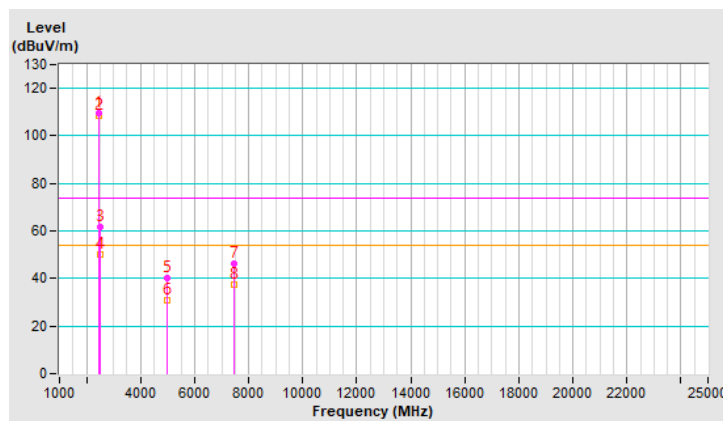

<b>RF Mode</b>	TX BT-LE 2M	<b>Channel</b>	CH 0 : 2402 MHz
<b>Frequency Range</b>	1 GHz ~ 25 GHz	<b>Detector Function &amp; Bandwidth</b>	(PK) RB = 1 MHz, VB = 3 MHz (AV) RB = 1 MHz, VB = 1 kHz
<b>Input Power (System)</b>	120 Vac, 60 Hz	<b>Environmental Conditions</b>	22°C, 69% RH
<b>Tested By</b>	Sampson Chen		

Antenna Polarity & Test Distance : Horizontal at 3 m								
No	Frequency (MHz)	Emission Level (dBuV/m)	Limit (dBuV/m)	Margin (dB)	Antenna Height (m)	Table Angle (Degree)	Raw Value (dBuV)	Correction Factor (dB/m)
1	2363.40	56.9 PK	74.0	-17.1	1.18 H	314	61.4	-4.5
2	2363.40	47.2 AV	54.0	-6.8	1.18 H	314	51.7	-4.5
3	*2402.00	117.7 PK			1.18 H	314	122.2	-4.5
4	*2402.00	114.5 AV			1.18 H	314	119.0	-4.5
5	4804.00	42.9 PK	74.0	-31.1	3.06 H	357	43.1	-0.2
6	4804.00	31.4 AV	54.0	-22.6	3.06 H	357	31.6	-0.2

**Remarks:**

1. Emission Level(dBuV/m) = Raw Value(dBuV) + Correction Factor(dB/m)
2. Correction Factor(dB/m) = Antenna Factor(dB/m) + Cable Factor(dB) – Pre-Amplifier Factor(dB)
3. Margin value = Emission Level – Limit value
4. The other emission levels were very low against the limit.
5. " \* " : Fundamental frequency, the limit was restricted at the RF Output Power.

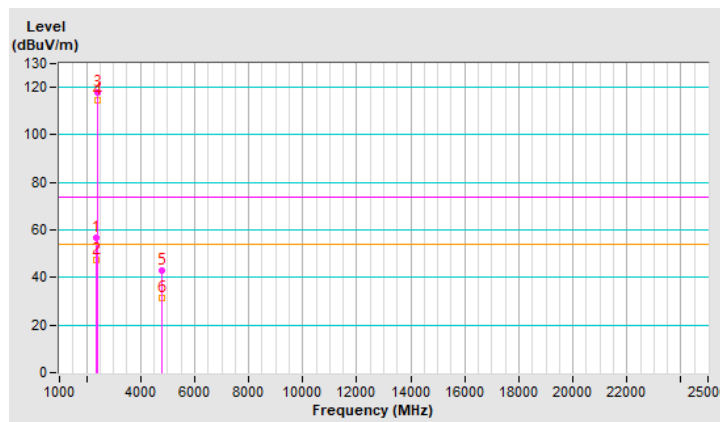



<b>RF Mode</b>	TX BT-LE 2M	<b>Channel</b>	CH 0 : 2402 MHz
<b>Frequency Range</b>	1 GHz ~ 25 GHz	<b>Detector Function &amp; Bandwidth</b>	(PK) RB = 1 MHz, VB = 3 MHz (AV) RB = 1 MHz, VB = 1 kHz
<b>Input Power (System)</b>	120 Vac, 60 Hz	<b>Environmental Conditions</b>	22°C, 69% RH
<b>Tested By</b>	Sampson Chen		

Antenna Polarity & Test Distance : Vertical at 3 m								
No	Frequency (MHz)	Emission Level (dBuV/m)	Limit (dBuV/m)	Margin (dB)	Antenna Height (m)	Table Angle (Degree)	Raw Value (dBuV)	Correction Factor (dB/m)
1	2363.40	56.6 PK	74.0	-17.4	3.11 V	354	61.1	-4.5
2	2363.40	45.1 AV	54.0	-8.9	3.11 V	354	49.6	-4.5
3	*2402.00	113.1 PK			3.11 V	354	117.6	-4.5
4	*2402.00	110.3 AV			3.11 V	354	114.8	-4.5
5	4804.00	41.1 PK	74.0	-32.9	2.38 V	320	41.3	-0.2
6	4804.00	30.2 AV	54.0	-23.8	2.38 V	320	30.4	-0.2

**Remarks:**

1. Emission Level(dBuV/m) = Raw Value(dBuV) + Correction Factor(dB/m)
2. Correction Factor(dB/m) = Antenna Factor(dB/m) + Cable Factor(dB) – Pre-Amplifier Factor(dB)
3. Margin value = Emission Level – Limit value
4. The other emission levels were very low against the limit.
5. " \* " : Fundamental frequency, the limit was restricted at the RF Output Power.

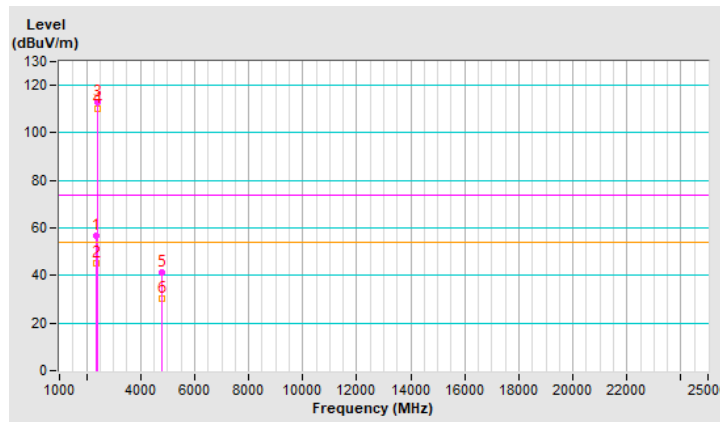

<b>RF Mode</b>	TX BT-LE 2M	<b>Channel</b>	CH 19 : 2440 MHz
<b>Frequency Range</b>	1 GHz ~ 25 GHz	<b>Detector Function &amp; Bandwidth</b>	(PK) RB = 1 MHz, VB = 3 MHz (AV) RB = 1 MHz, VB = 1 kHz
<b>Input Power (System)</b>	120 Vac, 60 Hz	<b>Environmental Conditions</b>	22°C, 69% RH
<b>Tested By</b>	Sampson Chen		

Antenna Polarity & Test Distance : Horizontal at 3 m								
No	Frequency (MHz)	Emission Level (dBuV/m)	Limit (dBuV/m)	Margin (dB)	Antenna Height (m)	Table Angle (Degree)	Raw Value (dBuV)	Correction Factor (dB/m)
1	*2440.00	116.0 PK			1.38 H	307	120.5	-4.5
2	*2440.00	113.2 AV			1.38 H	307	117.7	-4.5
3	4880.00	42.9 PK	74.0	-31.1	3.01 H	360	43.1	-0.2
4	4880.00	31.6 AV	54.0	-22.4	3.01 H	360	31.8	-0.2
5	7320.00	48.6 PK	74.0	-25.4	1.67 H	348	42.4	6.2
6	7320.00	38.4 AV	54.0	-15.6	1.67 H	348	32.2	6.2

**Remarks:**

1. Emission Level(dBuV/m) = Raw Value(dBuV) + Correction Factor(dB/m)
2. Correction Factor(dB/m) = Antenna Factor(dB/m) + Cable Factor(dB) – Pre-Amplifier Factor(dB)
3. Margin value = Emission Level – Limit value
4. The other emission levels were very low against the limit.
5. " \* " : Fundamental frequency, the limit was restricted at the RF Output Power.

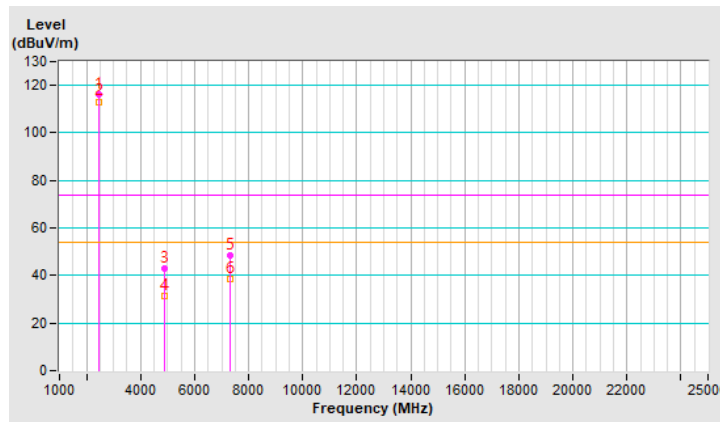

<b>RF Mode</b>	TX BT-LE 2M	<b>Channel</b>	CH 19 : 2440 MHz
<b>Frequency Range</b>	1 GHz ~ 25 GHz	<b>Detector Function &amp; Bandwidth</b>	(PK) RB = 1 MHz, VB = 3 MHz (AV) RB = 1 MHz, VB = 1 kHz
<b>Input Power (System)</b>	120 Vac, 60 Hz	<b>Environmental Conditions</b>	22°C, 69% RH
<b>Tested By</b>	Sampson Chen		

Antenna Polarity & Test Distance : Vertical at 3 m								
No	Frequency (MHz)	Emission Level (dBuV/m)	Limit (dBuV/m)	Margin (dB)	Antenna Height (m)	Table Angle (Degree)	Raw Value (dBuV)	Correction Factor (dB/m)
1	*2440.00	107.1 PK			2.58 V	60	111.6	-4.5
2	*2440.00	104.2 AV			2.58 V	60	108.7	-4.5
3	4880.00	40.4 PK	74.0	-33.6	2.41 V	330	40.6	-0.2
4	4880.00	29.8 AV	54.0	-24.2	2.41 V	330	30.0	-0.2
5	7320.00	46.5 PK	74.0	-27.5	2.95 V	316	40.3	6.2
6	7320.00	37.4 AV	54.0	-16.6	2.95 V	316	31.2	6.2

**Remarks:**

1. Emission Level(dBuV/m) = Raw Value(dBuV) + Correction Factor(dB/m)
2. Correction Factor(dB/m) = Antenna Factor(dB/m) + Cable Factor(dB) – Pre-Amplifier Factor(dB)
3. Margin value = Emission Level – Limit value
4. The other emission levels were very low against the limit.
5. " \* " : Fundamental frequency, the limit was restricted at the RF Output Power.

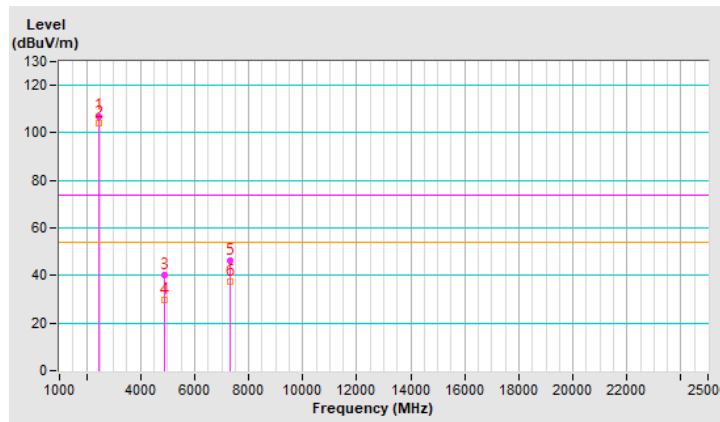

<b>RF Mode</b>	TX BT-LE 2M	<b>Channel</b>	CH 39 : 2480 MHz
<b>Frequency Range</b>	1 GHz ~ 25 GHz	<b>Detector Function &amp; Bandwidth</b>	(PK) RB = 1 MHz, VB = 3 MHz (AV) RB = 1 MHz, VB = 1 kHz
<b>Input Power (System)</b>	120 Vac, 60 Hz	<b>Environmental Conditions</b>	22°C, 69% RH
<b>Tested By</b>	Sampson Chen		

Antenna Polarity & Test Distance : Horizontal at 3 m								
No	Frequency (MHz)	Emission Level (dBuV/m)	Limit (dBuV/m)	Margin (dB)	Antenna Height (m)	Table Angle (Degree)	Raw Value (dBuV)	Correction Factor (dB/m)
1	*2480.00	110.9 PK			1.01 H	304	115.4	-4.5
2	*2480.00	108.2 AV			1.01 H	304	112.7	-4.5
3	2483.50	63.9 PK	74.0	-10.1	1.01 H	304	68.4	-4.5
<b>4</b>	<b>2483.50</b>	<b>53.5 AV</b>	<b>54.0</b>	<b>-0.5</b>	<b>1.01 H</b>	<b>304</b>	<b>58.0</b>	<b>-4.5</b>
5	4960.00	43.1 PK	74.0	-30.9	2.95 H	356	42.9	0.2
6	4960.00	31.6 AV	54.0	-22.4	2.95 H	356	31.4	0.2
7	7440.00	48.6 PK	74.0	-25.4	1.73 H	352	41.9	6.7
8	7440.00	38.6 AV	54.0	-15.4	1.73 H	352	31.9	6.7

**Remarks:**

1. Emission Level(dBuV/m) = Raw Value(dBuV) + Correction Factor(dB/m)
2. Correction Factor(dB/m) = Antenna Factor(dB/m) + Cable Factor(dB) – Pre-Amplifier Factor(dB)
3. Margin value = Emission Level – Limit value
4. The other emission levels were very low against the limit.
5. " \* " : Fundamental frequency, the limit was restricted at the RF Output Power.

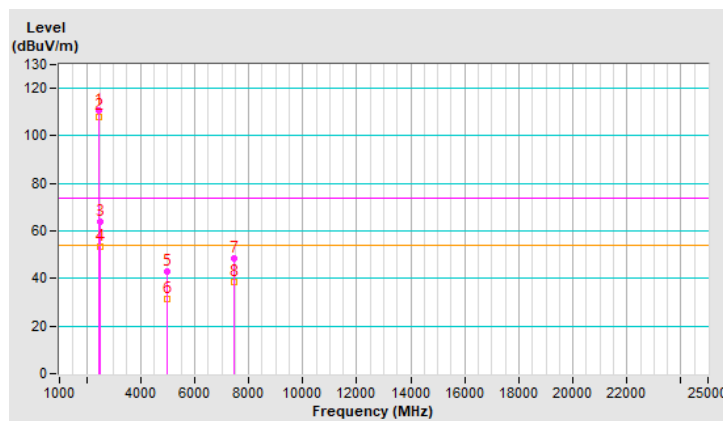

<b>RF Mode</b>	TX BT-LE 2M	<b>Channel</b>	CH 39 : 2480 MHz
<b>Frequency Range</b>	1 GHz ~ 25 GHz	<b>Detector Function &amp; Bandwidth</b>	(PK) RB = 1 MHz, VB = 3 MHz (AV) RB = 1 MHz, VB = 1 kHz
<b>Input Power (System)</b>	120 Vac, 60 Hz	<b>Environmental Conditions</b>	22°C, 69% RH
<b>Tested By</b>	Sampson Chen		

Antenna Polarity & Test Distance : Vertical at 3 m								
No	Frequency (MHz)	Emission Level (dBuV/m)	Limit (dBuV/m)	Margin (dB)	Antenna Height (m)	Table Angle (Degree)	Raw Value (dBuV)	Correction Factor (dB/m)
1	*2480.00	106.5 PK			2.56 V	45	111.0	-4.5
2	*2480.00	103.8 AV			2.56 V	45	108.3	-4.5
3	2483.50	60.4 PK	74.0	-13.6	2.56 V	45	64.9	-4.5
4	2483.50	50.7 AV	54.0	-3.3	2.56 V	45	55.2	-4.5
5	4960.00	40.2 PK	74.0	-33.8	2.43 V	326	40.0	0.2
6	4960.00	29.3 AV	54.0	-24.7	2.43 V	326	29.1	0.2
7	7440.00	46.6 PK	74.0	-27.4	2.96 V	309	39.9	6.7
8	7440.00	37.6 AV	54.0	-16.4	2.96 V	309	30.9	6.7

**Remarks:**

1. Emission Level(dBuV/m) = Raw Value(dBuV) + Correction Factor(dB/m)
2. Correction Factor(dB/m) = Antenna Factor(dB/m) + Cable Factor(dB) – Pre-Amplifier Factor(dB)
3. Margin value = Emission Level – Limit value
4. The other emission levels were very low against the limit.
5. " \* ": Fundamental frequency, the limit was restricted at the RF Output Power.

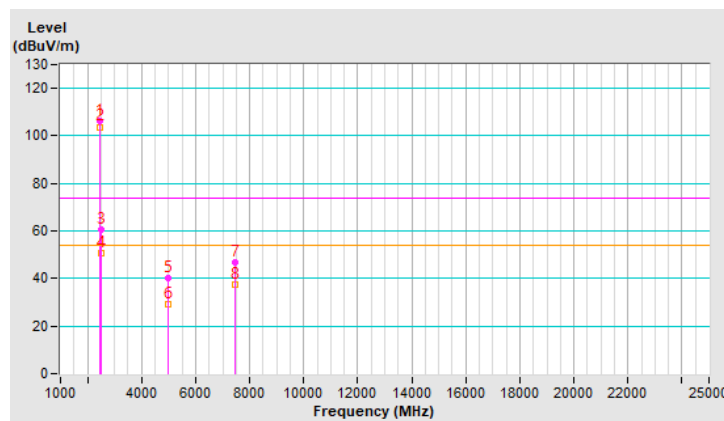

### Plot of Band Edge

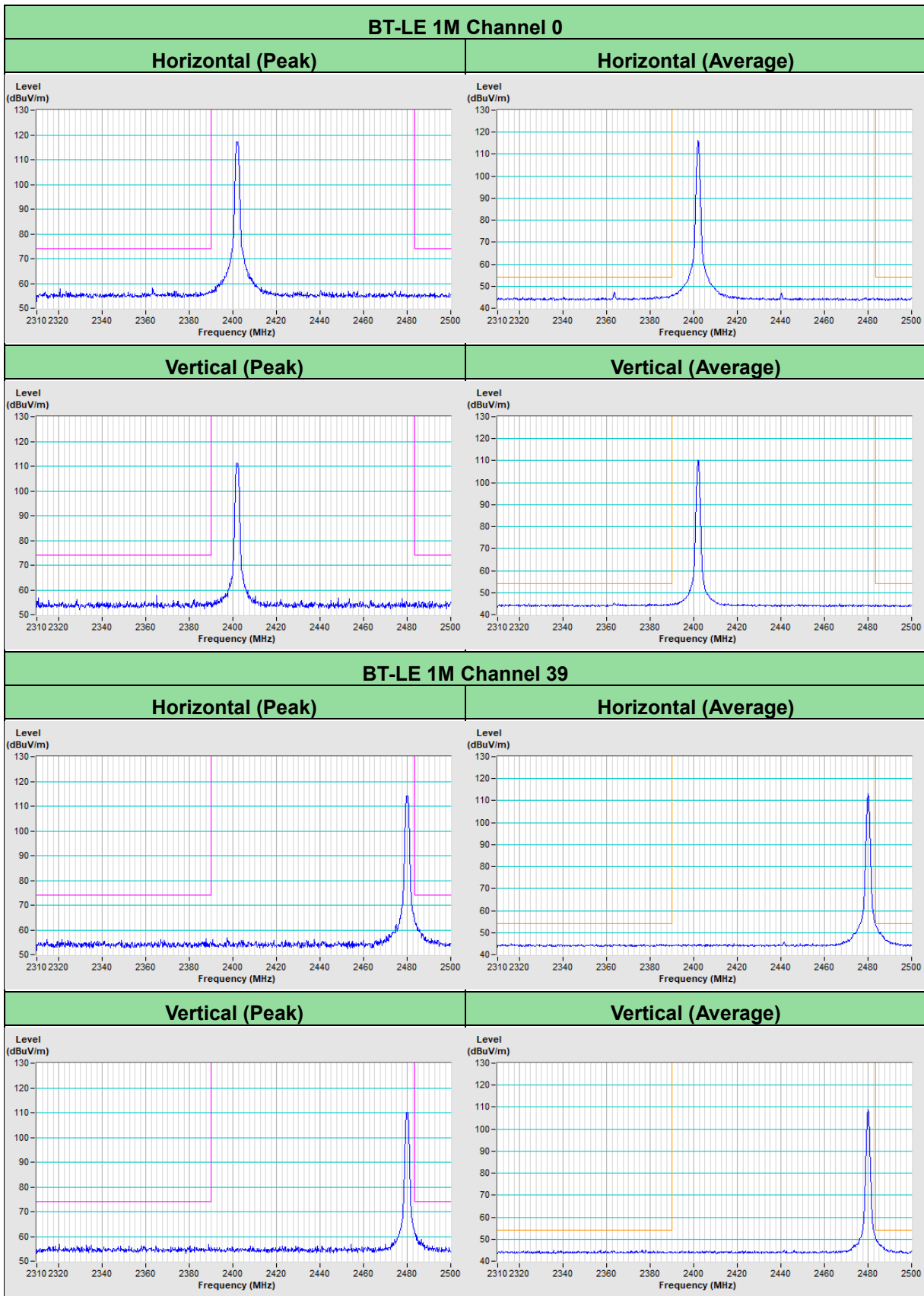

### BT-LE 2M Channel 0

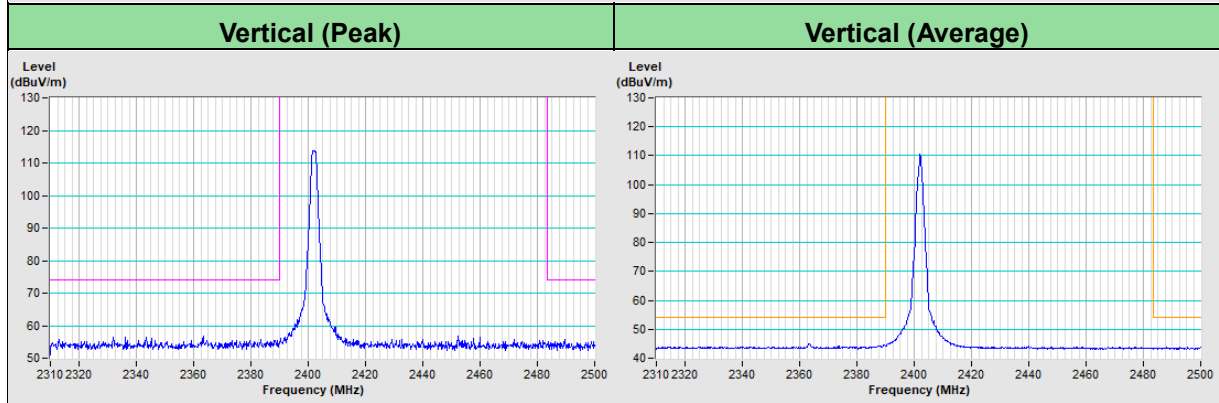
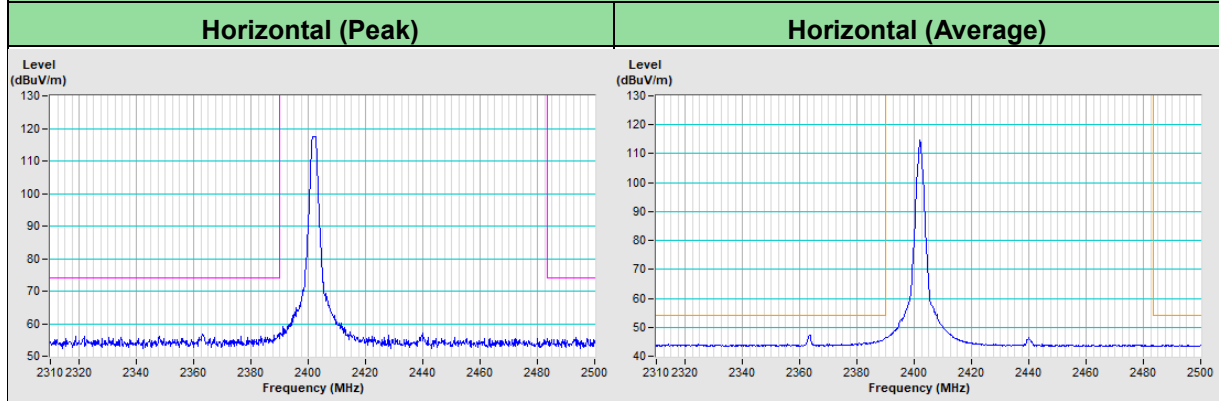

### BT-LE 2M Channel 39

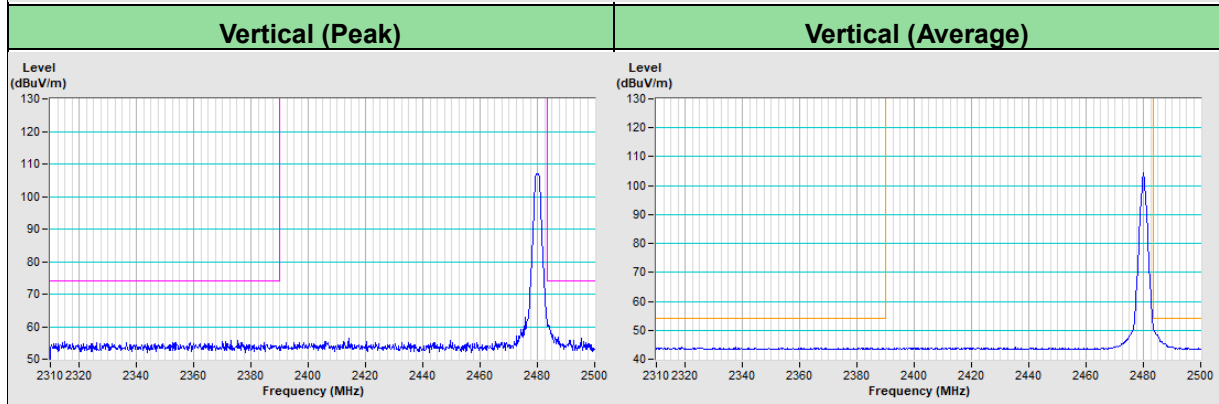
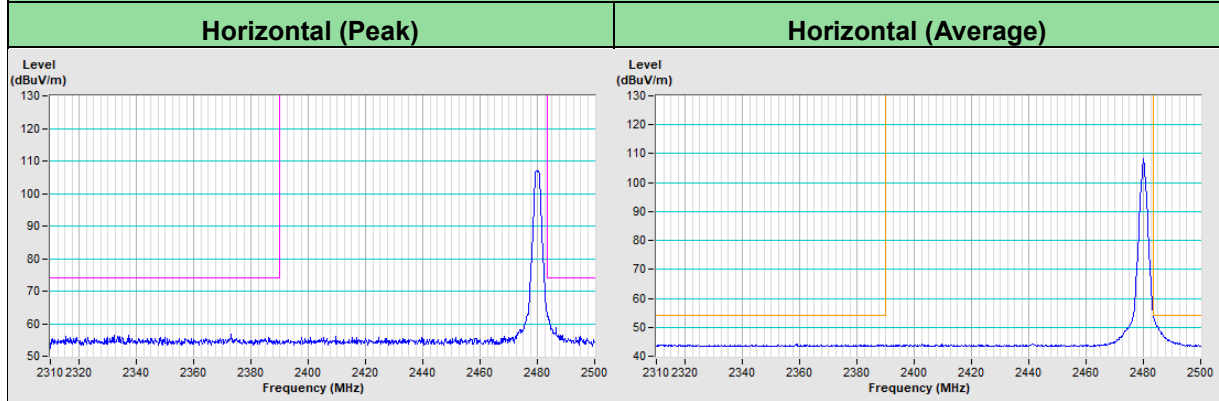

## 8 Pictures of Test Arrangements

Please refer to the attached file (Test Setup Photo)



## 9 Information of the Testing Laboratories

We, Bureau Veritas Consumer Products Services (H.K.) Ltd., Taoyuan Branch, were founded in 1988 to provide our best service in EMC, Radio, Telecom and Safety consultation. Our laboratories are FCC recognized accredited test firms and accredited according to ISO/IEC 17025.

If you have any comments, please feel free to contact us at the following:

**Lin Kou EMC/RF Lab**

Tel: 886-2-26052180

Fax: 886-2-26051924

**Hsin Chu EMC/RF/Telecom Lab**

Tel: 886-3-6668565

Fax: 886-3-6668323

**Hwa Ya EMC/RF/Safety Lab**

Tel: 886-3-3183232

Fax: 886-3-3270892

**Email:** [service.adt@bureauveritas.com](mailto:service.adt@bureauveritas.com)

**Web Site:** <http://ee.bureauveritas.com.tw>

The address and road map of all our labs can be found in our web site also.

--- END ---