

TEST REPORT (SPOT CHECK)

CERTIFICATE OF CONFORMITY

Standard: 47 CFR FCC Part 15, Subpart E (Section 15.407)

Report No.: RFBCKS-WTW-P21030822A-1

FCC ID: UDX-60083011

Original FCC ID: UDX-60083010

Model No.: MR56-HW

Received Date: 2022/8/3

Test Date: 2022/8/10 ~ 2022/9/22

Issued Date: 2022/11/3

Applicant: Cisco Systems, Inc.

Address: 170 West Tasman Drive, San Jose, CA 95134 USA

Issued By: Bureau Veritas Consumer Products Services (H.K.) Ltd., Taoyuan Branch
Hsin Chu Laboratory

Lab Address: E-2, No.1, Li Hsin 1st Road, Hsinchu Science Park, Hsinchu City 300, Taiwan

Test Location: E-2, No.1, Li Hsin 1st Road, Hsinchu Science Park, Hsinchu City 300, Taiwan

FCC Registration / 723255 / TW2022

Designation Number:

Approved by: _____

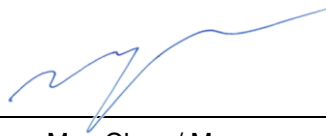

May Chen / Manager

Date: _____

2022/11/3

This test report consists of 31 pages in total. It may be duplicated completely for legal use with the approval of the applicant. It should not be reproduced except in full, without the written approval of our laboratory. The test results in the report only apply to the tested sample. The test results in this report are traceable to the national or international standards.



Prepared by : Vito Lung / Specialist

This report is governed by, and incorporates by reference, the Conditions of Testing as posted at the date of issuance of this report at <http://www.bureauveritas.com/home/about-us/our-business/cps/about-us/terms-conditions/> and is intended for your exclusive use. Any copying or replication of this report to or for any other person or entity, or use of our name or trademark, is permitted only with our prior written permission. This report sets forth our findings solely with respect to the test samples identified herein. The results set forth in this report are not indicative or representative of the quality or characteristics of the lot from which a test sample was taken or any similar or identical product unless specifically and expressly noted. Our report includes all of the tests requested by you and the results thereof based upon the information that you provided to us. Measurement uncertainty is only provided upon request for accredited tests. Statements of conformity are based on simple acceptance criteria without taking measurement uncertainty into account, unless otherwise requested in writing. You have 60 days from date of issuance of this report to notify us of any material error or omission caused by our negligence or if you require measurement uncertainty; provided, however, that such notice shall be in writing and shall specifically address the issue you wish to raise. A failure to raise such issue within the prescribed time shall constitute your unqualified acceptance of the completeness of this report, the tests conducted and the correctness of the report contents.

Table of Contents

Release Control Record	3
1 Certificate.....	4
2 Summary of Test Results	5
2.1 Measurement Uncertainty	5
2.2 Supplementary Information	5
3 General Information	6
3.1 General Description of EUT	6
3.2 Antenna Description of EUT	7
3.3 Channel List.....	10
3.4 Test Mode Applicability and Tested Channel Detail.....	12
3.5 Duty Cycle of Test Signal.....	13
3.6 Test Program Used and Operation Descriptions	14
3.7 Connection Diagram of EUT and Peripheral Devices	14
3.8 Configuration of Peripheral Devices and Cable Connections	15
4 Test Instruments	16
4.1 RF Output Power.....	16
4.2 Unwanted Emissions below 1 GHz	16
4.3 Unwanted Emissions above 1 GHz.....	17
5 Limits of Test Items.....	18
5.1 RF Output Power.....	18
5.2 Unwanted Emissions below 1 GHz	18
5.3 Unwanted Emissions above 1 GHz.....	19
6 Test Arrangements.....	20
6.1 RF Output Power.....	20
6.1.1 Test Setup	20
6.1.2 Test Procedure.....	20
6.2 Unwanted Emissions below 1 GHz	21
6.2.1 Test Setup	21
6.2.2 Test Procedure.....	22
6.3 Unwanted Emissions above 1 GHz.....	23
6.3.1 Test Setup	23
6.3.2 Test Procedure.....	23
7 Test Results of Test Item	24
7.1 RF Output Power.....	24
7.2 Unwanted Emissions below 1 GHz	25
7.3 Unwanted Emissions above 1 GHz.....	27
8 Pictures of Test Arrangements	30
9 Information of the Testing Laboratories	31



Release Control Record

Issue No.	Description	Date Issued
RFBCKS-WTW-P21030822A-1	Original release.	2022/11/3

1 Certificate

Product: 8x8 Wi-Fi 6 Access Point

Brand: Cisco

Test Model: MR56-HW

Sample Status: Engineering sample

Applicant: Cisco Systems, Inc.

Test Date: 2022/8/10 ~ 2022/9/22

Standard: 47 CFR FCC Part 15, Subpart E (Section 15.407)

Measurement ANSI C63.10-2013

procedure: KDB 789033 D02 General UNII Test Procedure New Rules v02r01

KDB 662911 D01 Multiple Transmitter Output v02r01

The above equipment has been tested by **Bureau Veritas Consumer Products Services (H.K.) Ltd., Taoyuan Branch**, and found compliance with the requirement of the above standards. The test record, data evaluation & Equipment Under Test (EUT) configurations represented herein are true and accurate accounts of the measurements of the sample's RF characteristics under the conditions specified in this report.

2 Summary of Test Results

47 CFR FCC Part 15, Subpart E (Section 15.407)			
Clause	Test Item	Result	Remark
15.407(a)(2)	26 dB Bandwidth	NA	Refer to Note 1 below
15.407(a)(1/2/3)	RF Output Power	Pass	Meet the requirement of limit.
15.407(a)(1/2/3)	Power Spectral Density	NA	Refer to Note 1 below
15.407(e)	6 dB Bandwidth	NA	Refer to Note 1 below
---	Occupied Bandwidth	NA	Refer to Note 1 below
15.407(g)	Frequency Stability	NA	Refer to Note 1 below
15.407(b)(9)	AC Power Conducted Emissions	NA	Refer to Note 1 below
15.407(b)(9)	Unwanted Emissions below 1 GHz	Pass	Minimum passing margin is -9.7 dB at 162.76 MHz
15.407(b)(1/2/3/4(i)/10)	Unwanted Emissions above 1 GHz	Pass	Minimum passing margin is -8.7 dB at 11650.00 MHz
15.203	Antenna Requirement	Pass	Antenna connector is i-pex(MHF) not a standard connector.

Notes:

1. RF Output Power & Unwanted Emissions Measurement were performed for this addendum. The others testing data refer to original test report.
2. Determining compliance based on the results of the compliance measurement, not taking into account measurement instrumentation uncertainty.

2.1 Measurement Uncertainty

Where relevant, the following measurement uncertainty levels have been estimated for tests performed on the EUT as specified in CISPR 16-4-2:

Parameter	Specification	Expanded Uncertainty (k=2) (±)
Unwanted Emissions below 1 GHz	9 kHz ~ 30 MHz	3.1 dB
	30 MHz ~ 1 GHz	5.5 dB
Unwanted Emissions above 1 GHz	1 GHz ~ 18 GHz	5.1 dB
	18 GHz ~ 40 GHz	5.3 dB

The other instruments specified are routine verified to remain within the calibrated levels, no measurement uncertainty is required to be calculated.

2.2 Supplementary Information

There is not any deviation from the test standards for the test method, and no modifications required for compliance.

3 General Information

3.1 General Description of EUT

Product	8x8 Wi-Fi 6 Access Point
Brand	Cisco
Test Model	MR56-HW
Status of EUT	Engineering sample
Power Supply Rating	12Vdc from power adapter or 55Vdc from PoE
Modulation Type	64QAM, 16QAM, QPSK, BPSK for OFDM 256QAM for OFDM in 11ac mode 1024QAM for OFDMA in 11ax mode
Modulation Technology	OFDM, OFDMA
Transfer Rate	802.11a: up to 54Mbps 802.11n: up to 600Mbps 802.11ac: up to 3466.7Mbps 802.11ax: up to 4803.9Mbps
Operating Frequency	5.18GHz ~ 5.24GHz, 5.26 ~ 5.32GHz, 5.50 ~ 5.72GHz, 5.745GHz ~ 5.825GHz
Number of Channel	802.11a, 802.11n (HT20), 802.11ac (VHT20), 802.11ax (HE20): 25 802.11n (HT40), 802.11ac (VHT40), 802.11ax (HE40): 12 802.11ac (VHT80), 802.11ax (HE80): 6 802.11ac (VHT80+80), 802.11ax (HE80+80): 1 set
Output Power	881.517 mW (29.45 dBm)

Note:

- Exhibit prepared for Spot Check Verification report, the format, test items and amount of spot-check test data are decided by applicant's engineering judgment, for more details please refer to the declaration letter exhibit. (Original FCC ID: UDX-60083010, Report No.: RF180704E02L-1)
- The EUT has below radios as following table:

Radio 1	Radio 2	Radio 3	Radio 4
WLAN (2.4GHz)	WLAN (5GHz)	2.4GHz / 5GHz Scanning (only RX)	Bluetooth

- Simultaneously transmission condition.

Condition	Technology		
1	WLAN (2.4GHz)	WLAN (5GHz)	Bluetooth

Note: The emission of the simultaneous operation has been evaluated and no non-compliance was found.

- The EUT uses following accessories.

Adapter (Option)			
No.	Brand	Model No.	Spec.
1	UMEC	MA-PWR-30W-US	Input: 100-240Vac, 0.8A, 50/60Hz Output: 12Vdc, 2.5A DC Output cable: Unshielded, 1.4m
2	Ktec	KSAS0361200250HU	Input: 100-240Vac, 1.0A, 50/60Hz Output: 12Vdc, 2.5A DC Output cable: Unshielded, 1.8m

- The above EUT information is declared by manufacturer and for more detailed features description, please refers to the manufacturer's specifications or user's manual.

3.2 Antenna Description of EUT

1. The antenna information is listed as below.

Antenna No.	Antenna Net Gain (dBi)	Frequency range (GHz)	Antenna Type	Connector Type
Dual_Ant 1 (Red)	5.44	2.4~2.4835	PIFA	i-pex
	4.88	5.15~5.25		
	5.45	5.25~5.35		
	5.54	5.47~5.725		
	5.87	5.725~5.85		
Dual_Ant 2 (Orange)	4.67	2.4~2.4835	PIFA	i-pex
	6.2	5.15~5.25		
	6.44	5.25~5.35		
	5.69	5.47~5.725		
	6.39	5.725~5.85		
Dual_Ant 3 (Yellow)	4.9	2.4~2.4835	PIFA	i-pex
	5.18	5.15~5.25		
	5.94	5.25~5.35		
	5.34	5.47~5.725		
	5.58	5.725~5.85		
Dual_Ant 4 (Green)	5.54	2.4~2.4835	PIFA	i-pex
	5.25	5.15~5.25		
	5.5	5.25~5.35		
	4.27	5.47~5.725		
	5.16	5.725~5.85		
5G_Ant 1 (Blue)	5.35	5.15~5.25	PIFA	i-pex
	5.28	5.25~5.35		
	4.96	5.47~5.725		
	5.66	5.725~5.85		
5G_Ant 2 (White)	5.95	5.15~5.25	PIFA	i-pex
	5.81	5.25~5.35		
	5.29	5.47~5.725		
	5.57	5.725~5.85		
5G_Ant 3 (Grey)	4.65	5.15~5.25	PIFA	i-pex
	5.4	5.25~5.35		
	4.92	5.47~5.725		
	4.27	5.725~5.85		
5G_Ant 4 (Black)	5.67	5.15~5.25	PIFA	i-pex
	5.19	5.25~5.35		
	5.8	5.47~5.725		
	5.7	5.725~5.85		
Scanning Ant.	3.69	2.4~2.4835	PIFA	i-pex
	5.43	5.15~5.25		
	4.97	5.25~5.35		
	4,71	5.47~5.725		
	5.01	5.725~5.85		
Bluetooth Ant.	3.61	2.4~2.4835	PIFA	i-pex

WLAN Directional gain table – 8TX				
Frequency range (GHz)	Directional Antenna Gain (dBi)	Antenna Type	Antenna Connector	
5.15 ~ 5.25	9.29	PIFA	i-pec(MHF)	
5.25 ~ 5.35	9.34			
5.47 ~ 5.725	8.88			
5.725 ~ 5.85	9.2			
WLAN Directional gain table – 4TX				
Frequency range (GHz)	Antenna Combine Type	Directional Antenna Gain (dBi)	Antenna Type	Antenna Connector
2.4 ~ 2.4835	Dual_1+Dual_2+Dual_3+Dual_4	6.57	PIFA	i-pec(MHF)
5.15 ~ 5.25	Single_1+Single_2+Single_3+Single_4	10.73		
5.25 ~ 5.35		10.71		
5.47 ~ 5.725		10.33		
5.725 ~ 5.85		10.68		
WLAN Directional gain table – 2TX				
Frequency range (GHz)	Antenna Combine Type	Directional Antenna Gain (dBi)	Antenna Type	Antenna Connector
2.4 ~ 2.4835	Dual_1+Dual_3	6.33	PIFA	i-pec(MHF)
5.15 ~ 5.25	Dual_2+Dual_3	8.47		
5.25 ~ 5.35		8.92		
5.47 ~ 5.725		8.16		
5.725 ~ 5.85		8.59		
Bluetooth antenna spec.				
Antenna Net Gain (dBi)	Frequency range (GHz)	Antenna Type	Antenna Connector	
3.61	2.4~2.4835	PIFA	i-pec(MHF)	

* Detail antenna specification please refer to antenna datasheet and/or antenna measurement report.

2. The EUT incorporates a MIMO function:

5GHz Band		
MODULATION MODE	TX & RX CONFIGURATION	
802.11a	8TX	8RX
802.11n (HT20)	8TX	8RX
802.11n (HT40)	8TX	8RX
802.11ac (VHT20)	8TX	8RX
802.11ac (VHT40)	8TX	8RX
802.11ac (VHT80)	8TX	8RX
802.11ac (VHT80+VHT80)	4TX+4TX	4RX +4RX
802.11ax (HE20)	8TX	8RX
802.11ax (HE40)	8TX	8RX
802.11ax (HE80)	8TX	8RX
802.11ax (HE80+HE80)	4TX+4TX	4RX +4RX

Note:

1. All of modulation mode support beamforming function except 802.11a modulation mode.
2. The EUT support Beamforming and Non-Beamforming mode, therefore both mode were investigated and the worst case scenario was identified. The worst case data were presented in test report.

5GHz Scanning		
MODULATION MODE	RX CONFIGURATION	
802.11a	1RX	
802.11n (HT20)	1RX	
802.11n (HT40)	1RX	
802.11ac (VHT20)	1RX	
802.11ac (VHT40)	1RX	
802.11ac (VHT80)	1RX	

3.3 Channel List

FOR 5180 ~ 5320 MHz

8 channels are provided for 802.11a, 802.11n (HT20), 802.11ac (VHT20) and 802.11ax (HE20):

Channel	Frequency	Channel	Frequency
36	5180 MHz	52	5260 MHz
40	5200 MHz	56	5280 MHz
44	5220 MHz	60	5300 MHz
48	5240 MHz	64	5320 MHz

4 channels are provided for 802.11n (HT40), 802.11ac (VHT40) and 802.11ax (HE40):

Channel	Frequency	Channel	Frequency
38	5190 MHz	54	5270 MHz
46	5230 MHz	62	5310 MHz

2 channels are provided for 802.11ac (VHT80) and 802.11ax (HE80):

Channel	Frequency	Channel	Frequency
42	5210 MHz	58	5290 MHz

FOR 5500 ~ 5720 MHz

12 channels are provided for 802.11a, 802.11n (HT20), 802.11ac (VHT20) and 802.11ax (HE20):

Channel	Frequency	Channel	Frequency
100	5500 MHz	124	5620 MHz
104	5520 MHz	128	5640 MHz
108	5540 MHz	132	5660 MHz
112	5560 MHz	136	5680 MHz
116	5580 MHz	140	5700 MHz
120	5600 MHz	144	5720 MHz

6 channels are provided for 802.11n (HT40), 802.11ac (VHT40) and 802.11ax (HE40):

Channel	Frequency	Channel	Frequency
102	5510 MHz	126	5630 MHz
110	5550 MHz	134	5670 MHz
118	5590 MHz	142	5710 MHz

3 channels are provided for 802.11ac (VHT80) and 802.11ax (HE80):

Channel	Frequency	Channel	Frequency
106	5530 MHz	138	5690 MHz
122	5610 MHz		

FOR 5745 ~ 5825 MHz:

5 channels are provided for 802.11a, 802.11n (HT20), 802.11ac (VHT20) and 802.11ax (HE20):

Channel	Frequency	Channel	Frequency
149	5745 MHz	161	5805 MHz
153	5765 MHz	165	5825 MHz
157	5785 MHz		

2 channels are provided for 802.11n (HT40), 802.11ac (VHT40) and 802.11ax (HE40):

Channel	Frequency	Channel	Frequency
151	5755 MHz	159	5795 MHz

1 channel is provided for 802.11ac (VHT80) and 802.11ax (HE80):

Channel	Frequency
155	5775 MHz

For simultaneous transmission:

1 set is provided for 802.11ac (VHT80+80), 802.11ax (HE80+80):

Channel	Frequency
42+155	5210 MHz + 5775 MHz

Note: The transmission is for noncontiguous transmission using two nonadjacent 80MHz channels.

3.4 Test Mode Applicability and Tested Channel Detail

Worst Case:	In the original report: 1.AC Adapter Worst Condition: KSAS0361200250HU 2.X-axis/ Y-axis/ Z-axis Worst Condition: LB X-Y worst & HB X-Z Worst.
-------------	---

Following channel(s) was (were) selected for the final test as listed below:

Test Item	Mode	Signal Mode	Tested Channel	Modulation	Data Rate Parameter
RF Output Power	802.11a	CDD	165	BPSK	6Mb/s
Unwanted Emissions below 1 GHz	802.11a	CDD	165	BPSK	6Mb/s
Unwanted Emissions above 1 GHz	802.11a	CDD	165	BPSK	6Mb/s

Note: The worse case power condition is 4Tx for all test item in this report.

3.5 Duty Cycle of Test Signal

Duty cycle of test signal is $\geq 98\%$, duty factor is not required.

Duty cycle of test signal is $< 98\%$, duty factor shall be considered.

802.11a: Duty cycle = $1.432 \text{ ms} / 1.557 \text{ ms} \times 100\% = 92\%$, duty factor = $10 * \log (1/\text{Duty cycle}) = 0.36 \text{ dB}$

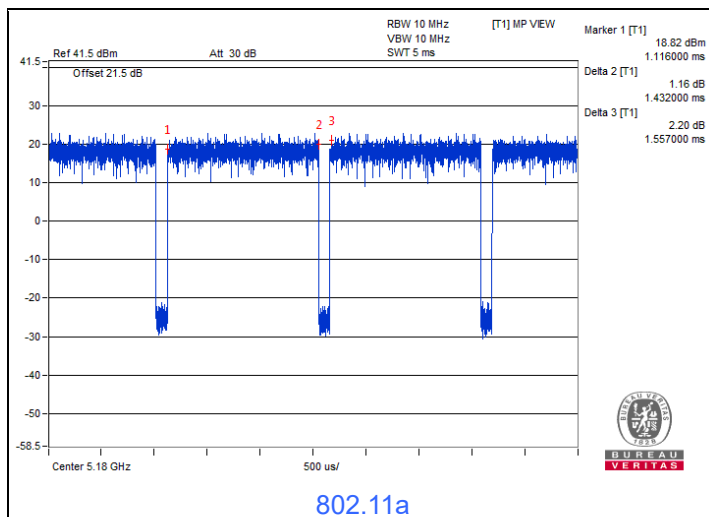

3.6 Test Program Used and Operation Descriptions

Controlling software (QSPR (5.0-00161)) has been activated to set the EUT under transmission condition continuously at specific channel frequency.

3.7 Connection Diagram of EUT and Peripheral Devices

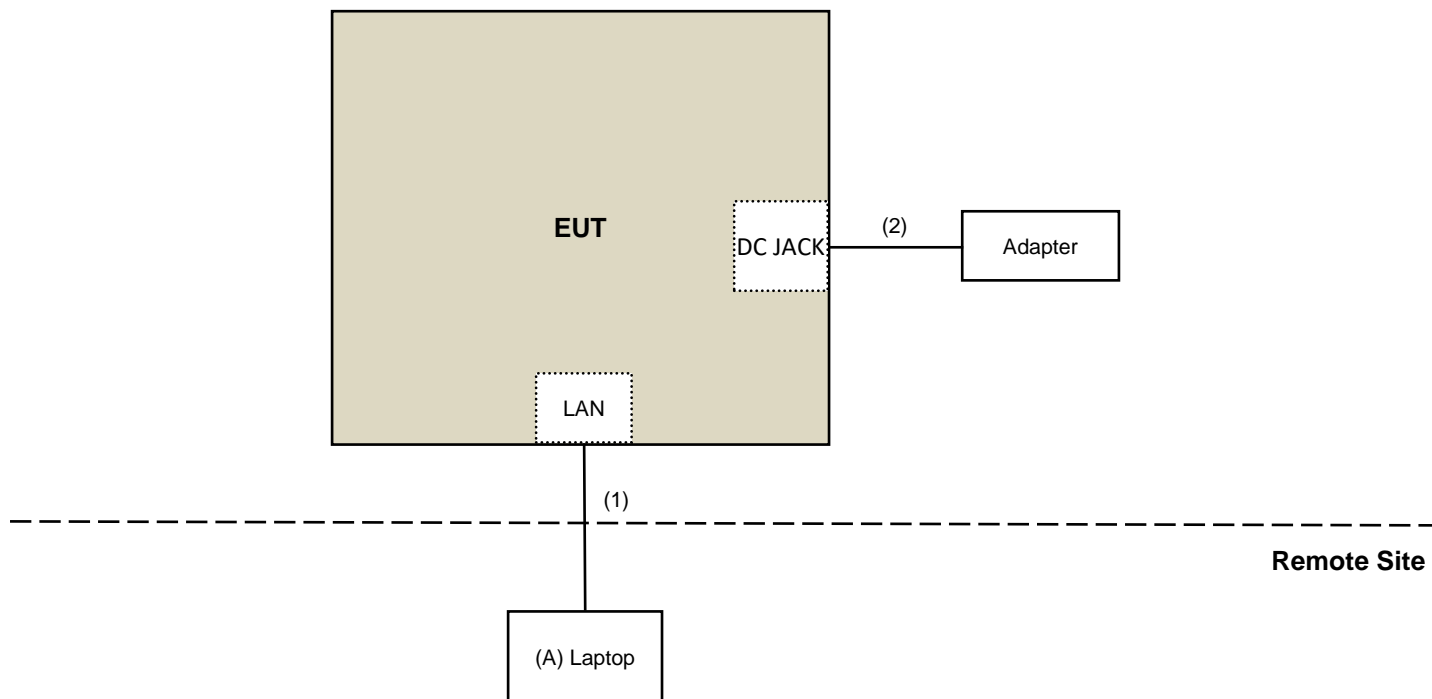

3.8 Configuration of Peripheral Devices and Cable Connections

ID	Product	Brand	Model No.	Serial No.	FCC ID	Remarks
A	Laptop	DELL	E6420	B92T3R1	QDS- BRCM1005- D	Provided by Lab

ID	Cable Descriptions	Qty.	Length (m)	Shielding (Yes/No)	Cores (Qty.)	Remarks
1	RJ-45 Cable	1	10	No	0	Provided by Lab
2	DC Cable	1	1.8	No	0	Supplied by applicant
3	RJ-45 Cable	1	0.5	No	0	Provided by Lab

4 Test Instruments

The calibration interval of the all test instruments are 12 months and the calibrations are traceable to NML/ROC and NIST/USA.

4.1 RF Output Power

Description Manufacturer	Model No.	Serial No.	Calibrated Date	Calibrated Until
Power Meter Anritsu	ML2495A	1529002	2022/6/22	2023/6/21
Pulse Power Sensor Anritsu	MA2411B	1726434	2022/6/22	2023/6/21
Attenuator WOKEN	MDCS18N-10	MDCS18N-10-01	2022/4/5	2023/4/4
Software	ADT_RF Test Software V6.6.5.4	N/A	N/A	N/A

Notes:

1. The test was performed in Oven room 2.
2. Tested Date: 2022/9/22

4.2 Unwanted Emissions below 1 GHz

Description Manufacturer	Model No.	Serial No.	Calibrated Date	Calibrated Until
Boresight Antenna Tower & Turn Table Max-Full	MF-7802BS	MF780208530	N/A	N/A
Fixed attenuator Mini-Circuits	UNAT-5+	PAD-ATT5-03	2022/1/10	2023/1/9
LOOP ANTENNA Electro-Metrics	EM-6879	264	2022/3/18	2023/3/17
Pre_Amplifier Agilent	8447D	2944A10636	2022/3/19	2023/3/18
Pre_Amplifier EMCI	EMC330N	980701	2022/3/8	2023/3/7
RF Coaxial Cable COMMATE/PEWC	8D	966-4-1	2022/3/8	2023/3/7
		966-4-2	2022/3/8	2023/3/7
		966-4-3	2022/3/8	2023/3/7
RF Coaxial Cable JYEBO	5D-FB	LOOPCAB-001	2022/1/6	2023/1/5
		LOOPCAB-002	2022/1/6	2023/1/5
Software	ADT_Radiated_V8.7.08	N/A	N/A	N/A
Test Receiver Agilent	N9038A	MY51210202	2021/11/19	2022/11/18
Trilog Broadband Antenna Schwarzbeck	VULB 9168	9168-406	2021/10/27	2022/10/26

Notes:

1. The test was performed in 966 Chamber No. 4.
2. Tested Date: 2022/8/10

4.3 Unwanted Emissions above 1 GHz

Description Manufacturer	Model No.	Serial No.	Calibrated Date	Calibrated Until
Boresight Antenna Tower & Turn Table Max-Full	MF-7802BS	MF780208530	N/A	N/A
Horn Antenna Schwarzbeck	BBHA 9120D	9120D-783	2021/11/14	2022/11/13
	BBHA 9170	9170-739	2021/11/14	2022/11/13
Pre_Amplifier EMCI	EMC 12630 SE	980638	2022/4/5	2023/4/4
	EMC184045SE	980387	2022/1/10	2023/1/9
RF Cable-Frequency Range : 1- 26.5GHz EMCI	EMC104-SM-SM-1200	160922	2021/12/24	2022/12/23
RF Cable-Frequency range: 1- 40GHz EMCI	EMC102-KM-KM-1200	160924	2022/1/10	2023/1/9
RF Coaxial Cable EMCI	EMC-KM-KM-4000	200214	2022/3/8	2023/3/7
	EMC104-SM-SM-2000	180502	2022/4/25	2023/4/24
	EMC104-SM-SM-6000	210704	2021/11/9	2022/11/8
Software	ADT_Radiated_V8.7.08	N/A	N/A	N/A
Test Receiver Agilent	N9038A	MY51210202	2021/11/19	2022/11/18

Notes:

1. The test was performed in 966 Chamber No. 4.
2. Tested Date: 2022/8/23

5 Limits of Test Items

5.1 RF Output Power

Operation Band	EUT Category	Limit
U-NII-1	Outdoor Access Point	1 Watt (30 dBm) (Max. e.i.r.p \leq 125mW(21 dBm) at any elevation angle above 30 degrees as measured from the horizon)
	Fixed point-to-point Access Point	1 Watt (30 dBm)
	Indoor Access Point	1 Watt (30 dBm)
	Mobile and Portable client device	250mW (24 dBm)

Operation Band	Limit
U-NII-2A	250mW (24 dBm) or 11 dBm+10 log B*
U-NII-2C	250mW (24 dBm) or 11 dBm+10 log B*
U-NII-3	1 Watt (30 dBm)

*B is the 26 dB emission bandwidth in megahertz

Per KDB 662911 D01 Multiple Transmitter Output Method of conducted output power measurement on IEEE 802.11 devices,

Array Gain = 0 dB (i.e., no array gain) for $N_{ANT} \leq 4$;

Array Gain = 0 dB (i.e., no array gain) for channel widths ≥ 40 MHz for any N_{ANT} ;

Array Gain = $5 \log(N_{ANT}/N_{SS})$ dB or 3 dB, whichever is less, for 20-MHz channel widths with $N_{ANT} \geq 5$.

For power measurements on all other devices: Array Gain = $10 \log(N_{ANT}/N_{SS})$ dB.

5.2 Unwanted Emissions below 1 GHz

Radiated emissions which fall in the restricted bands must comply with the radiated emission limits specified as below table.

Frequencies (MHz)	Field Strength (microvolts/meter)	Measurement Distance (meters)
0.009 ~ 0.490	2400/F(kHz)	300
0.490 ~ 1.705	24000/F(kHz)	30
1.705 ~ 30.0	30	30
30 ~ 88	100	3
88 ~ 216	150	3
216 ~ 960	200	3
Above 960	500	3

Notes:

1. The lower limit shall apply at the transition frequencies.
2. Emission level (dBuV/m) = $20 \log$ Emission level (uV/m).

5.3 Unwanted Emissions above 1 GHz

Radiated emissions which fall in the restricted bands must comply with the radiated emission limits specified as below table.

Frequencies (MHz)	Field Strength (microvolts/meter)	Measurement Distance (meters)
Above 960	500	3

Notes:

1. The lower limit shall apply at the transition frequencies.
2. Emission level (dBuV/m) = 20 log Emission level (uV/m).
3. For frequencies above 1000 MHz, the field strength limits are based on average detector, however, the peak field strength of any emission shall not exceed the maximum permitted average limits, specified above by more than 20 dB under any condition of modulation.

Limits of unwanted emission out of the restricted bands

Applicable To		Limit	
789033 D02 General UNII Test Procedure New Rules v02r01		Field Strength at 3 m	
		PK: 74 (dBµV/m)	AV: 54 (dBµV/m)
Frequency Band	Applicable To	EIRP Limit	Equivalent Field Strength at 3 m
5150~5250 MHz	15.407(b)(1)	PK: -27 (dBm/MHz)	PK: 68.2 (dBµV/m)
5250~5350 MHz	15.407(b)(2)		
5470~5725 MHz	15.407(b)(3)		
5725~5850 MHz	15.407(b)(4)(i)	PK: -27 (dBm/MHz) ^{*1} PK: 10 (dBm/MHz) ^{*2} PK: 15.6 (dBm/MHz) ^{*3} PK: 27 (dBm/MHz) ^{*4}	PK: 68.2 (dBµV/m) ^{*1} PK: 105.2 (dBµV/m) ^{*2} PK: 110.8 (dBµV/m) ^{*3} PK: 122.2 (dBµV/m) ^{*4}
*1 beyond 75 MHz or more above of the band edge.		*2 below the band edge increasing linearly to 10 dBm/MHz at 25 MHz above.	
*3 below the band edge increasing linearly to a level of 15.6 dBm/MHz at 5 MHz above.		*4 from 5 MHz above or below the band edge increasing linearly to a level of 27 dBm/MHz at the band edge.	

Note: The following formula is used to convert the equipment isotropic radiated power (eirp) to field strength:

$$E = \frac{1000000\sqrt{30P}}{3} \mu\text{V/m, where P is the eirp (Watts).}$$

6 Test Arrangements

6.1 RF Output Power

6.1.1 Test Setup

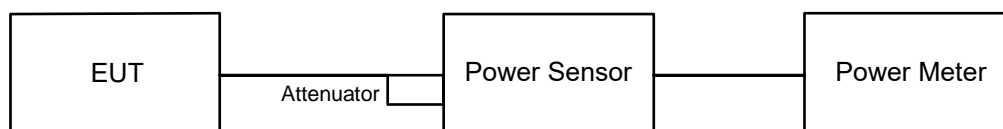

6.1.2 Test Procedure

Method PM is used to perform output power measurement, trigger and gating function of wide band power meter is enabled to measure max output power of TX on burst and set the detector to average. Duty factor is not added to measured value.

6.2 Unwanted Emissions below 1 GHz

6.2.1 Test Setup

For Radiated emission below 30 MHz

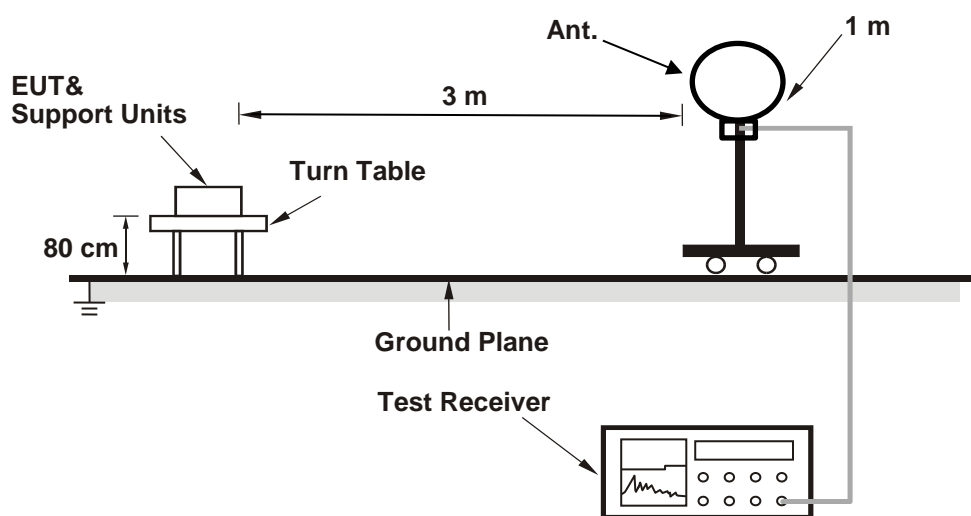

For Radiated emission above 30 MHz

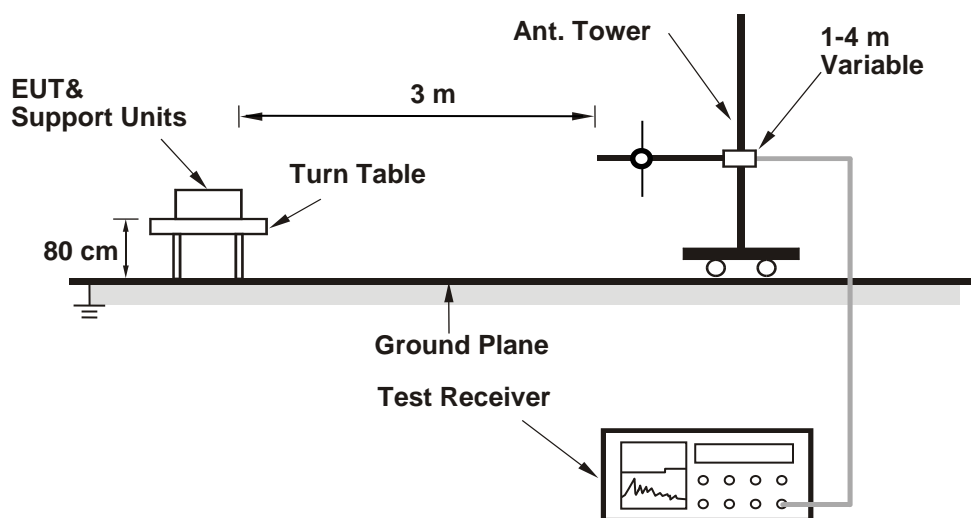

For the actual test configuration, please refer to the attached file (Test Setup Photo).

6.2.2 Test Procedure

For Radiated emission below 30 MHz

- a. The EUT was placed on the top of a rotating table 0.8 meters above the ground at 3 meter chamber room for test. The table was rotated 360 degrees to determine the position of the highest radiation.
- b. The EUT was set 3 meters away from the interference-receiving antenna, which was mounted on the top of a variable-height antenna tower.
- c. Parallel, perpendicular, and ground-parallel orientations of the antenna are set to make the measurement.
- d. For each suspected emission, the EUT was arranged to its worst case and the rotatable table was turned from 0 degrees to 360 degrees to find the maximum reading.
- e. The test-receiver system was set to Quasi-Peak Detect Function and Specified Bandwidth with Maximum Hold Mode, except for the frequency band (9 kHz to 90 kHz and 110 kHz to 490 kHz) set to average detect function and peak detect function.

Notes:

1. The resolution bandwidth and video bandwidth of test receiver/spectrum analyzer is 200 Hz at frequency below 150 kHz.
2. The resolution bandwidth and video bandwidth of test receiver/spectrum analyzer is 9 kHz or 10 kHz at frequency (150 kHz to 30 MHz).
3. All modes of operation were investigated and the worst-case emissions are reported.

For Radiated emission above 30 MHz

- a. The EUT was placed on the top of a rotating table 0.8 meters above the ground at 3 meter chamber room for test. The table was rotated 360 degrees to determine the position of the highest radiation.
- b. The EUT was set 3 meters away from the interference-receiving antenna, which was mounted on the top of a variable-height antenna tower.
- c. The height of antenna is varied from one meter to four meters above the ground to determine the maximum value of the field strength. Both horizontal and vertical polarizations of the antenna are set to make the measurement.
- d. For each suspected emission, the EUT was arranged to its worst case and then the antenna was tuned to heights from 1 meter to 4 meters and the rotatable table was turned from 0 degrees to 360 degrees to find the maximum reading.
- e. The test-receiver system was set to quasi-peak detect function and specified bandwidth with maximum hold mode when the test frequency is below 1 GHz.

Notes:

1. The resolution bandwidth and video bandwidth of test receiver/spectrum analyzer is 120 kHz for Quasi-peak detection (QP) at frequency below 1 GHz.
2. All modes of operation were investigated and the worst-case emissions are reported.

6.3 Unwanted Emissions above 1 GHz

6.3.1 Test Setup

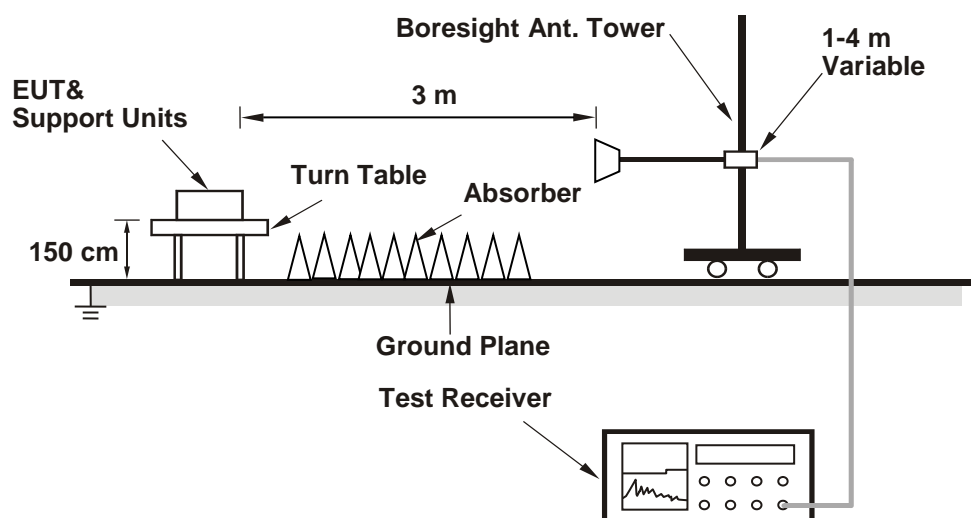

For the actual test configuration, please refer to the attached file (Test Setup Photo).

6.3.2 Test Procedure

- The EUT was placed on the top of a rotating table 1.5 meters above the ground at 3 meter chamber room for test. The table was rotated 360 degrees to determine the position of the highest radiation.
- The EUT was set 3 meters away from the interference-receiving antenna, which was mounted on the top of a variable-height antenna tower.
- The height of antenna is varied from one meter to four meters above the ground to determine the maximum value of the field strength. Both horizontal and vertical polarizations of the antenna are set to make the measurement.
- For each suspected emission, the EUT was arranged to its worst case and then the antenna was tuned to heights from 1 meter to 4 meters and the rotatable table was turned from 0 degrees to 360 degrees to find the maximum reading.
- The test-receiver system was set to peak and average detects function and specified bandwidth with maximum hold mode when the test frequency is above 1 GHz. If the peak reading value also meets average limit, measurement with the average detector is unnecessary.

Notes:

- The resolution bandwidth of test receiver/spectrum analyzer is 1 MHz and the video bandwidth is 3 MHz for Peak detection (PK) and Average detection (AV) at frequency above 1 GHz.
- For fundamental and harmonic signal measurement, the resolution bandwidth of test receiver/spectrum analyzer is 1 MHz and the video bandwidth is $\geq 1/T$ (Duty cycle $< 98\%$) or 10 Hz (Duty cycle $\geq 98\%$) for Average detection (AV) at frequency above 1 GHz.
- All modes of operation were investigated and the worst-case emissions are reported.

7 Test Results of Test Item

7.1 RF Output Power

Input Power:	120 Vac, 60 Hz	Environmental Conditions:	25°C, 60% RH	Tested By:	Eric Peng
--------------	----------------	---------------------------	--------------	------------	-----------

802.11a

Chan.	Chan. Freq. (MHz)	Average Power (dBm)				Total Power (mW)	Total Power (dBm)	Power Limit (dBm)	Test Result
		Chain 0	Chain 1	Chain 2	Chain 3				
165	5825	23.23	22.91	23.49	24.02	881.517	29.45	30	Pass

Notes:

1. Directional gain is the maximum gain of antennas.
2. For U-NII-3, the directional gain is 5.7 dBi < 6 dBi, so the output power limit shall not be reduced.

7.2 Unwanted Emissions below 1 GHz

RF Mode	TX 802.11a	Channel	CH 165 : 5825 MHz
Frequency Range	9 kHz ~ 1 GHz	Detector Function & Bandwidth	(QP) RB = 120kHz
Input Power	120 Vac, 60 Hz	Environmental Conditions	25°C, 66% RH
Tested By	Tom Yang		

Antenna Polarity & Test Distance : Horizontal at 3 m								
No	Frequency (MHz)	Emission Level (dBuV/m)	Limit (dBuV/m)	Margin (dB)	Antenna Height (m)	Table Angle (Degree)	Raw Value (dBuV)	Correction Factor (dB/m)
1	35.49	28.8 QP	40.0	-11.2	1.50 H	283	42.0	-13.2
2	98.16	30.5 QP	43.5	-13.0	1.00 H	223	47.2	-16.7
3	162.76	33.8 QP	43.5	-9.7	2.00 H	138	45.5	-11.7
4	236.86	30.5 QP	46.0	-15.5	1.50 H	148	43.7	-13.2
5	322.87	30.6 QP	46.0	-15.4	1.00 H	56	40.3	-9.7
6	546.89	33.0 QP	46.0	-13.0	1.00 H	359	36.7	-3.7

Remarks:

1. Emission Level(dBuV/m) = Raw Value(dBuV) + Correction Factor(dB/m)
2. Correction Factor(dB/m) = Antenna Factor(dB/m) + Cable Factor(dB) – Pre-Amplifier Factor(dB)
3. Margin value = Emission Level – Limit value
4. The other emission levels were very low against the limit of frequency range 30 MHz ~ 1 GHz.
5. The emission levels were very low against the limit of frequency range 9 kHz ~ 30 MHz: the amplitude of spurious emissions attenuated more than 20 dB below the permissible value to be report.

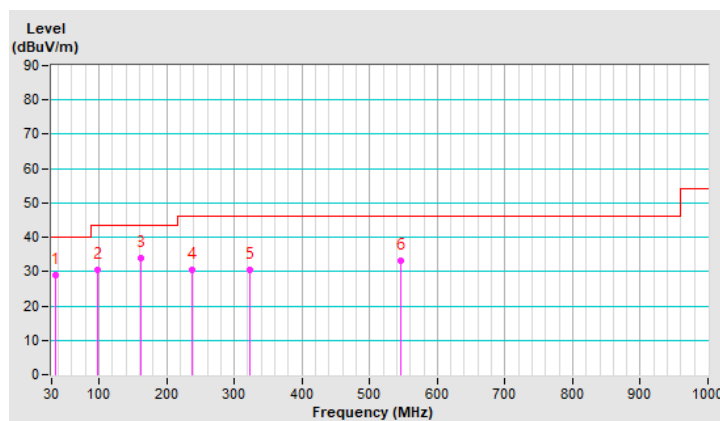

RF Mode	TX 802.11a	Channel	CH 165 : 5825 MHz
Frequency Range	9 kHz ~ 1 GHz	Detector Function & Bandwidth	(QP) RB = 120kHz
Input Power	120 Vac, 60 Hz	Environmental Conditions	25°C, 66% RH
Tested By	Tom Yang		

Antenna Polarity & Test Distance : Vertical at 3 m								
No	Frequency (MHz)	Emission Level (dBuV/m)	Limit (dBuV/m)	Margin (dB)	Antenna Height (m)	Table Angle (Degree)	Raw Value (dBuV)	Correction Factor (dB/m)
1	116.29	32.3 QP	43.5	-11.2	1.00 V	144	46.5	-14.2
2	159.03	31.4 QP	43.5	-12.1	2.00 V	95	43.0	-11.6
3	215.62	26.7 QP	43.5	-16.8	1.50 V	174	41.5	-14.8
4	318.22	28.3 QP	46.0	-17.7	1.00 V	92	38.1	-9.8
5	405.57	26.2 QP	46.0	-19.8	1.00 V	300	33.5	-7.3
6	511.25	31.3 QP	46.0	-14.7	1.00 V	68	35.6	-4.3

Remarks:

1. Emission Level(dBuV/m) = Raw Value(dBuV) + Correction Factor(dB/m)
2. Correction Factor(dB/m) = Antenna Factor(dB/m) + Cable Factor(dB) – Pre-Amplifier Factor(dB)
3. Margin value = Emission Level – Limit value
4. The other emission levels were very low against the limit of frequency range 30 MHz ~ 1 GHz.
5. The emission levels were very low against the limit of frequency range 9 kHz ~ 30 MHz: the amplitude of spurious emissions attenuated more than 20 dB below the permissible value to be report.

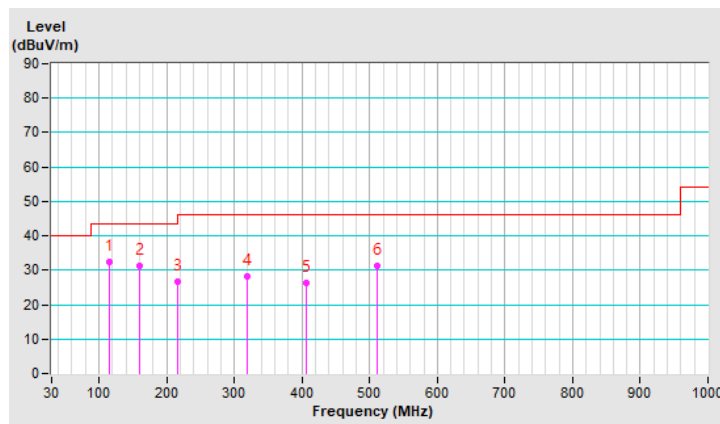

7.3 Unwanted Emissions above 1 GHz

RF Mode	TX 802.11a	Channel	CH 165 : 5825 MHz
Frequency Range	1 GHz ~ 40 GHz	Detector Function & Bandwidth	(PK) RB = 1 MHz, VB = 3 MHz (AV) RB = 1 MHz, VB = 1 kHz
Input Power	120 Vac, 60 Hz	Environmental Conditions	25°C, 75% RH
Tested By	Tom Yang		

Antenna Polarity & Test Distance : Horizontal at 3 m								
No	Frequency (MHz)	Emission Level (dBuV/m)	Limit (dBuV/m)	Margin (dB)	Antenna Height (m)	Table Angle (Degree)	Raw Value (dBuV)	Correction Factor (dB/m)
1	#5631.37	58.5 PK	68.2	-9.7	1.53 H	265	57.6	0.9
2	*5825.00	124.1 PK			1.53 H	265	122.9	1.2
3	*5825.00	114.2 AV			1.53 H	265	113.0	1.2
4	#6014.88	57.3 PK	68.2	-10.9	1.53 H	265	55.6	1.7
5	11650.00	51.1 PK	74.0	-22.9	2.14 H	163	39.9	11.2
6	11650.00	45.2 AV	54.0	-8.8	2.14 H	163	34.0	11.2
7	#17475.00	53.3 PK	68.2	-14.9	1.40 H	215	35.2	18.1

Remarks:

1. Emission Level(dBuV/m) = Raw Value(dBuV) + Correction Factor(dB/m)
2. Correction Factor(dB/m) = Antenna Factor(dB/m) + Cable Factor(dB) – Pre-Amplifier Factor(dB)
3. Margin value = Emission Level – Limit value
4. The other emission levels were very low against the limit.
5. " * " : Fundamental frequency, the limit was restricted at the RF Output Power.
6. " # " : The radiated frequency is out of the restricted band.

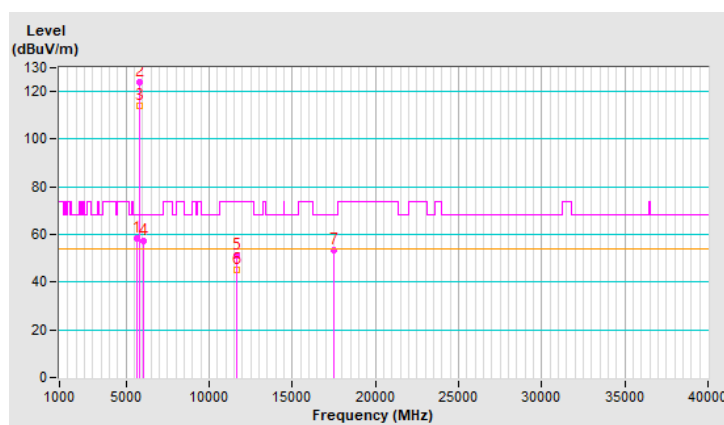

RF Mode	TX 802.11a	Channel	CH 165 : 5825 MHz
Frequency Range	1 GHz ~ 40 GHz	Detector Function & Bandwidth	(PK) RB = 1 MHz, VB = 3 MHz (AV) RB = 1 MHz, VB = 1 kHz
Input Power	120 Vac, 60 Hz	Environmental Conditions	25°C, 75% RH
Tested By	Tom Yang		

Antenna Polarity & Test Distance : Vertical at 3 m								
No	Frequency (MHz)	Emission Level (dBuV/m)	Limit (dBuV/m)	Margin (dB)	Antenna Height (m)	Table Angle (Degree)	Raw Value (dBuV)	Correction Factor (dB/m)
1	#5639.11	56.6 PK	68.2	-11.6	1.57 V	283	55.7	0.9
2	*5825.00	122.2 PK			1.57 V	283	121.0	1.2
3	*5825.00	112.5 AV			1.57 V	283	111.3	1.2
4	#5928.03	55.8 PK	68.2	-12.4	1.57 V	283	54.3	1.5
5	11650.00	52.2 PK	74.0	-21.8	1.78 V	318	41.0	11.2
6	11650.00	45.3 AV	54.0	-8.7	1.78 V	318	34.1	11.2
7	#17475.00	54.2 PK	68.2	-14.0	1.48 V	163	36.1	18.1

Remarks:

1. Emission Level(dBuV/m) = Raw Value(dBuV) + Correction Factor(dB/m)
2. Correction Factor(dB/m) = Antenna Factor(dB/m) + Cable Factor(dB) – Pre-Amplifier Factor(dB)
3. Margin value = Emission Level – Limit value
4. The other emission levels were very low against the limit.
5. " * ": Fundamental frequency, the limit was restricted at the RF Output Power.
6. " # ": The radiated frequency is out of the restricted band.

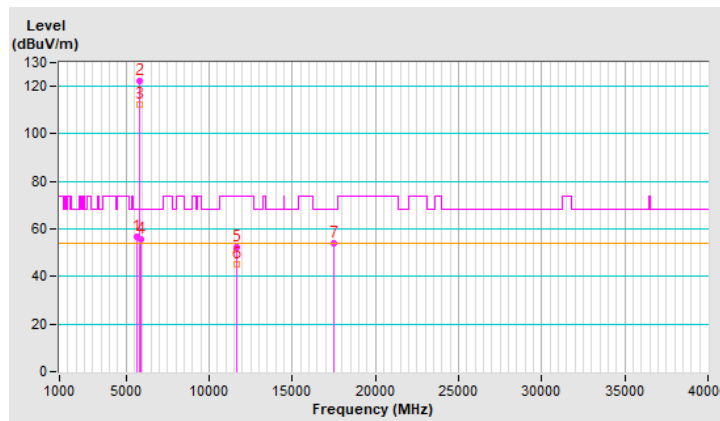

Plot of Band Edge

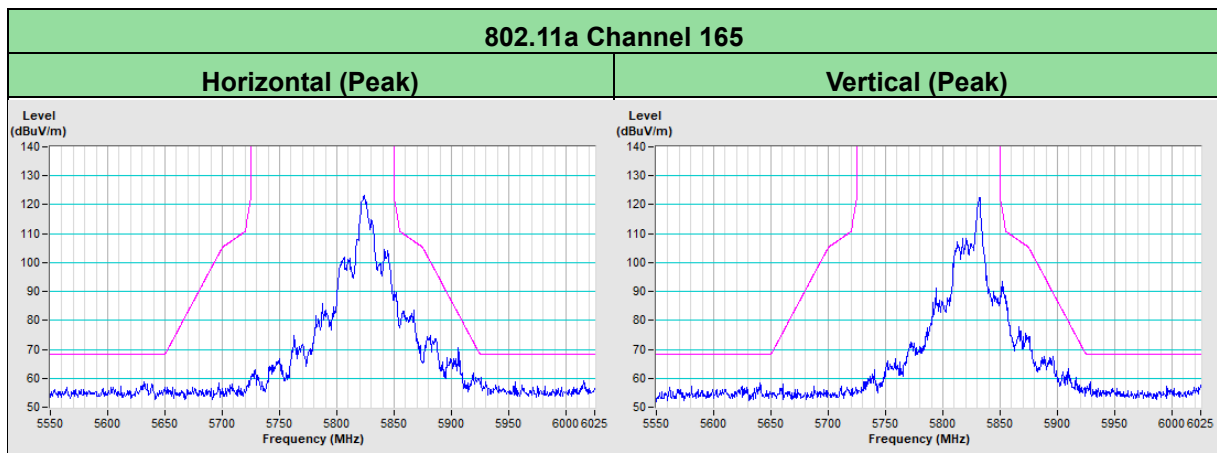

8 Pictures of Test Arrangements

Please refer to the attached file (Test Setup Photo)

9 Information of the Testing Laboratories

We, Bureau Veritas Consumer Products Services (H.K.) Ltd., Taoyuan Branch, were founded in 1988 to provide our best service in EMC, Radio, Telecom and Safety consultation. Our laboratories are FCC recognized accredited test firms and accredited according to ISO/IEC 17025.

If you have any comments, please feel free to contact us at the following:

Lin Kou EMC/RF Lab

Tel: 886-2-26052180

Fax: 886-2-26051924

Hsin Chu EMC/RF/Telecom Lab

Tel: 886-3-6668565

Fax: 886-3-6668323

Hwa Ya EMC/RF/Safety Lab

Tel: 886-3-3183232

Fax: 886-3-3270892

Email: service.adt@bureauveritas.com

Web Site: <http://ee.bureauveritas.com.tw>

The address and road map of all our labs can be found in our web site also.

--- END ---