

FCC Test Report (DFS Band)

Report No.: RF180704E02F-1

FCC ID: UDX-60083010

Test Model: MR55-HW

Received Date: Aug. 30, 2018

Test Date: Aug. 30, 2018 to Jan. 02, 2019

Issued Date: Mar. 12, 2019

Applicant: Cisco Systems, Inc.

Address: 170 West Tasman Drive, San Jose, CA 95134 USA

Issued By: Bureau Veritas Consumer Products Services (H.K.) Ltd., Taoyuan Branch
Hsin Chu Laboratory

Lab Address: E-2, No.1, Li Hsin 1st Road, Hsinchu Science Park, Hsinchu City 300,
Taiwan R.O.C.

Test Location: E-2, No.1, Li Hsin 1st Road, Hsinchu Science Park, Hsinchu City 300,
Taiwan R.O.C.

**FCC Registration /
Designation Number:** 723255 / TW2022



This report is for your exclusive use. Any copying or replication of this report to or for any other person or entity, or use of our name or trademark, is permitted only with our prior written permission. This report sets forth our findings solely with respect to the test samples identified herein. The results set forth in this report are not indicative or representative of the quality or characteristics of the lot from which a test sample was taken or any similar or identical product unless specifically and expressly noted. Our report includes all of the tests requested by you and the results thereof based upon the information that you provided to us. You have 60 days from date of issuance of this report to notify us of any material error or omission caused by our negligence, provided, however, that such notice shall be in writing and shall specifically address the issue you wish to raise. A failure to raise such issue within the prescribed time shall constitute your unqualified acceptance of the completeness of this report, the tests conducted and the correctness of the report contents. Unless specific mention, the uncertainty of measurement has been explicitly taken into account to declare the compliance or non-compliance to the specification. The report must not be used by the client to claim product certification, approval, or endorsement by TAF or any government agencies.

Table of Contents

Release Control Record	4
1 Certificate of Conformity	5
2 Summary of Test Results	6
2.1 Measurement Uncertainty	6
2.2 Modification Record	6
3 General Information	7
3.1 General Description of EUT (DFS Band)	7
3.2 Description of Test Modes	12
3.2.1 Test Mode Applicability and Tested Channel Detail	13
3.3 Duty Cycle of Test Signal	16
3.4 Description of Support Units	18
3.4.1 Configuration of System under Test	19
3.5 General Description of Applied Standard	21
4 Test Types and Results	22
4.1 Radiated Emission and Bandedge Measurement.....	22
4.1.1 Limits of Radiated Emission and Bandedge Measurement	22
4.1.2 Test Instruments	23
4.1.3 Test Procedure	25
4.1.4 Deviation from Test Standard	25
4.1.5 Test Setup.....	26
4.1.6 EUT Operating Condition	27
4.1.7 Test Results (Mode 1).....	28
4.1.8 Test Results (Mode 2).....	54
4.1.9 Test Results (Mode 3).....	78
4.1.10 Test Results (Mode 4).....	102
4.2 Conducted Emission Measurement	126
4.2.1 Limits of Conducted Emission Measurement	126
4.2.2 Test Instruments	126
4.2.3 Test Procedure	127
4.2.4 Deviation from Test Standard	127
4.2.5 Test Setup.....	127
4.2.6 EUT Operating Condition	127
4.2.7 Test Results	128
4.3 Transmit Power Measurement	130
4.3.1 Limits of Transmit Power Measurement	130
4.3.2 Test Setup.....	131
4.3.3 Test Instruments	131
4.3.4 Test Procedure	131
4.3.5 Deviation from Test Standard	132
4.3.6 EUT Operating Condition	132
4.3.7 Test Results (Mode 1).....	133
4.3.8 Test Results (Mode 2).....	157
4.3.9 Test Results (Mode 3).....	181
4.3.10 Test Results (Mode 4).....	205
4.4 Occupied Bandwidth Measurement	219
4.4.1 Test Setup.....	219
4.4.2 Test Instruments	219
4.4.3 Test Procedure	219
4.4.4 Test Results (Mode 1).....	220
4.4.5 Test Results (Mode 2).....	223
4.4.6 Test Results (Mode 3).....	226
4.4.7 Test Results (Mode 4).....	228
4.5 Peak Power Spectral Density Measurement	230

4.5.1	Limits of Peak Power Spectral Density Measurement	230
4.5.2	Test Setup	230
4.5.3	Test Instruments	230
4.5.4	Test Procedure	230
4.5.5	Deviation from Test Standard	231
4.5.6	EUT Operating Condition	231
4.5.7	Test Results (Mode 1).....	232
4.5.8	Test Results (Mode 2).....	241
4.5.9	Test Results (Mode 3).....	250
4.5.10	Test Results (Mode 4).....	258
4.6	Frequency Stability Measurement	266
4.6.1	Limits of Frequency Stability Measurement	266
4.6.2	Test Setup	266
4.6.3	Test Instruments	266
4.6.4	Test Procedure	266
4.6.5	Deviation from Test Standard	266
4.6.6	EUT Operating Condition	266
4.6.7	Test Results	267
4.7	6dB Bandwidth Measurement.....	268
4.7.1	Limits of 6dB Bandwidth Measurement.....	268
4.7.2	Test Setup.....	268
4.7.3	Test Instruments	268
4.7.4	Test Procedure	268
4.7.5	Deviation from Test Standard	268
4.7.6	EUT Operating Condition	268
4.7.7	Test Results (Mode 1).....	269
4.7.8	Test Results (Mode 2).....	271
4.7.9	Test Results (Mode 3).....	273
4.7.10	Test Results (Mode 4).....	275
5	Pictures of Test Arrangements.....	277
	Appendix – Information of the Testing Laboratories	278

Release Control Record

Issue No.	Description	Date Issued
RF180704E02F-1	Original release.	Mar. 12, 2019

1 Certificate of Conformity

Product: 8x8 802.11a/b/g/n/ac/ax Access Point

Brand: Cisco

Test Model: MR55-HW

Sample Status: ENGINEERING SAMPLE

Applicant: Cisco Systems, Inc.

Test Date: Aug. 30, 2018 to Jan. 02, 2019

Standard: 47 CFR FCC Part 15, Subpart E (Section 15.407)
ANSI C63.10: 2013

The above equipment has been tested by **Bureau Veritas Consumer Products Services (H.K.) Ltd., Taoyuan Branch**, and found compliance with the requirement of the above standards. The test record, data evaluation & Equipment Under Test (EUT) configurations represented herein are true and accurate accounts of the measurements of the sample's EMC characteristics under the conditions specified in this report.

Prepared by : Phoenix Huang , **Date:** Mar. 12, 2019
Phoenix Huang / Specialist

Approved by : May Chen , **Date:** Mar. 12, 2019
May Chen / Manager

2 Summary of Test Results

47 CFR FCC Part 15, Subpart E (Section 15.407)			
FCC Clause	Test Item	Result	Remarks
15.407(b)(6)	AC Power Conducted Emissions	Pass	Meet the requirement of limit. Minimum passing margin is -5.28dB at 28.68359MHz.
15.407(b) (1/2/3/4(i/ii)/6)	Radiated Emissions & Band Edge Measurement	Pass	Meet the requirement of limit. Minimum passing margin is -0.1dB at 5350.00MHz, 5390.00MHz and 5470.00MHz.
15.407(a)(1/2/3)	Max Average Transmit Power	Pass	Meet the requirement of limit.
---	Occupied Bandwidth Measurement	-	Reference only.
15.407(a)(1/2/3)	Peak Power Spectral Density	Pass	Meet the requirement of limit.
15.407(e)	6dB bandwidth	Pass	Meet the requirement of limit. (U-NII-3 Band only)
15.407(g)	Frequency Stability	Pass	Meet the requirement of limit.
15.203	Antenna Requirement	Pass	Antenna connector is i-pex(MHF) not a standard connector.

Note:

Determining compliance based on the results of the compliance measurement, not taking into account measurement instrumentation uncertainty.

2.1 Measurement Uncertainty

Where relevant, the following measurement uncertainty levels have been estimated for tests performed on the EUT as specified in CISPR 16-4-2:

Measurement	Frequency	Expanded Uncertainty (k=2) (±)
Conducted Emissions at mains ports	150kHz ~ 30MHz	1.84 dB
Radiated Emissions up to 1 GHz	30MHz ~ 1GHz	5.53 dB
Radiated Emissions above 1 GHz	1GHz ~ 6GHz	5.08 dB
	6GHz ~ 18GHz	4.98 dB
	18GHz ~ 40GHz	5.19 dB

2.2 Modification Record

There were no modifications required for compliance.

3 General Information

3.1 General Description of EUT (DFS Band)

Product	8x8 802.11a/b/g/n/ac/ax Access Point
Brand	Cisco
Test Model	MR55-HW
Status of EUT	ENGINEERING SAMPLE
Power Supply Rating	12Vdc from power adapter or 55Vdc from PoE
Modulation Type	64QAM, 16QAM, QPSK, BPSK for OFDM 256QAM for OFDM in 11ac mode 1024QAM for OFDMA in 11ax HE mode
Modulation Technology	OFDM, OFDMA
Transfer Rate	802.11a: up to 54Mbps 802.11n: up to 600Mbps 802.11ac: up to 3466.7Mbps 802.11ax: up to 4803.9Mbps
Operating Frequency	5.26~ 5.32GHz, 5.5 ~ 5.72GHz
Number of Channel	802.11a, 802.11n (HT20), 802.11ac (VHT20), 802.11ax (HE20): 16 802.11n (HT40), 802.11ac (VHT40), 802.11ax (HE40): 8 802.11ac (VHT80), 802.11ax (HE80): 4
Output Power	5.26 ~ 5.32GHz: Non-Beamforming Mode: 8TX: 112.582mW 4TX: 156.395mW 2TX: 224.418mW 1TX: 110.662mW Beamforming Mode 8TX: 112.582mW 4TX: 79.617mW 2TX: 126.199mW 5.5 ~ 5.72GHz: Non-Beamforming Mode: 8TX: 127.845mW 4TX: 238.486mW 2TX: 227.318mW 1TX: 110.662mW Beamforming Mode 8TX: 127.845mW 4TX: 89.423mW 2TX: 143.428mW
Antenna Type	Refer to Note
Antenna Connector	Refer to Note
Accessory Device	Adapter x 1 (option)
Data Cable Supplied	NA

Note:

1. This report is prepared for FCC class III change. The difference compared with the Report No.: RF180704E02-1 as the following information:

- ◆ Add DFS band <5.26~ 5.32GHz, 5.50 ~ 5.72GHz>.

2. According to above condition, all test items need to be performed. And all data were verified to meet the requirements.

3. The EUT has below radios as following table:

Radio 1	Radio 2	Radio 3	Radio 4
WLAN (2.4GHz)	WLAN (5GHz)	2.4GHz / 5GHz Scanning (only RX)	Bluetooth

4. Simultaneously transmission condition.

Condition	Technology		
1	WLAN (2.4GHz)	WLAN (5GHz)	Bluetooth

Note: The emission of the simultaneous operation has been evaluated and no non-compliance was found.

5. The EUT must be supplied with a power adapter or POE as following table:

Adapter (Option)

No.	Brand	Model No.	Spec.
1	UMEC	MA-PWR-30W-US	Input: 100-240Vac, 0.8A, 50/60Hz Output: 12Vdc, 2.5A DC Output cable: Unshielded, 1.4m
2	Ktec	KSAS0361200250HU	Input: 100-240Vac, 1.0A, 50/60Hz Output: 12Vdc, 2.5A DC Output cable: Unshielded, 1.8m

POE (Only for test not for sale)

No.	Brand	Model No.	Spec.
1	CISCO	MA-INJ-5	Input: 100-240Vac, 1.5A, 50-60Hz Output: 55Vdc, 0.63A
2	CISCO	MA-INJ-4	Input: 100-240Vac, 0.67A, 50/60Hz Output: 55Vdc, 0.6A

Note:

1. In original report: from the above conditions, the conducted emissions worse case was found in **POE No. 2**. Therefore only the test data of the mode was recorded in this report.
2. In original report: from the above conditions, the radiated emissions worse case was found in **Adapter No. 2**. Therefore only the test data of the mode was recorded in this report.

6. The antennas provided to the EUT, please refer to the following table:

WLAN Directional gain table – 8TX

Frequency range (GHz)	Directional Antenna Gain (dBi)	Antenna Type	Antenna Connector
5.15 ~ 5.25	9.29	PIFA	i-pex(MHF)
5.25 ~ 5.35	9.34		
5.47 ~ 5.725	8.88		
5.725 ~ 5.85	9.2		

WLAN Directional gain table – 4TX

Frequency range (GHz)	Antenna Combine Type	Directional Antenna Gain (dBi)	Antenna Type	Antenna Connector
2.4 ~ 2.4835	Dual_1+Dual_2+Dual_3+Dual_4	5.43	PIFA	i-pex(MHF)
5.15 ~ 5.25	Single_1+Single_2+Single_3+Single_4	10.73		
5.25 ~ 5.35		10.71		
5.47 ~ 5.725		10.33		
5.725 ~ 5.85		10.68		

WLAN Directional gain table – 2TX

Frequency range (GHz)	Antenna Combine Type	Directional Antenna Gain (dBi)	Antenna Type	Antenna Connector
2.4 ~ 2.4835	Dual_1+Dual_3	6.33	PIFA	i-pex(MHF)
5.15 ~ 5.25	Dual_2+Dual_3	8.47		
5.25 ~ 5.35		8.92		
5.47 ~ 5.725		8.16		
5.725 ~ 5.85		8.59		

Bluetooth antenna spec.

Antenna Net Gain (dBi)	Frequency range (GHz)	Antenna Type	Antenna Connector
3.61	2.4~2.4835	PIFA	i-pex(MHF)

Note: More detailed information, please refer to operating description.

7. The EUT incorporates a MIMO function.

2.4GHz Band

MODULATION MODE	DATA RATE (MCS)	TX & RX CONFIGURATION	
802.11b	1 ~ 11Mbps	4TX	4RX
802.11g	6 ~ 54Mbps	4TX	4RX
802.11n (HT20)	MCS 0~7	4TX	4RX
	MCS 8~15	4TX	4RX
	MCS 16~23	4TX	4RX
	MCS 24~31	4TX	4RX
802.11n (HT40)	MCS 0~7	4TX	4RX
	MCS 8~15	4TX	4RX
	MCS 16~23	4TX	4RX
	MCS 24~31	4TX	4RX
VHT20	MCS 0~8, Nss=1	4TX	4RX
	MCS 0~8, Nss=2	4TX	4RX
	MCS 0~9, Nss=3	4TX	4RX
	MCS 0~8, Nss=4	4TX	4RX
VHT40	MCS 0~9, Nss=1	4TX	4RX
	MCS 0~9, Nss=2	4TX	4RX
	MCS 0~9, Nss=3	4TX	4RX
	MCS 0~9, Nss=4	4TX	4RX
802.11ax (HE20)	MCS 0~11, Nss=1	4TX	4RX
	MCS 0~11, Nss=2	4TX	4RX
	MCS 0~11, Nss=3	4TX	4RX
	MCS 0~11, Nss=4	4TX	4RX
802.11ax (HE40)	MCS 0~11, Nss=1	4TX	4RX
	MCS 0~11, Nss=2	4TX	4RX
	MCS 0~11, Nss=3	4TX	4RX
	MCS 0~11, Nss=4	4TX	4RX

5GHz Band

MODULATION MODE	DATA RATE (MCS)	TX & RX CONFIGURATION	
802.11a	6 ~ 54Mbps	8TX	8RX
802.11n (HT20)	MCS 0~7	8TX	8RX
	MCS 8~15	8TX	8RX
	MCS 16~23	8TX	8RX
	MCS 24~31	8TX	8RX
802.11n (HT40)	MCS 0~7	8TX	8RX
	MCS 8~15	8TX	8RX
	MCS 16~23	8TX	8RX
	MCS 24~31	8TX	8RX

802.11ac (VHT20)	MCS 0~8, Nss=1	8TX	8RX
	MCS 0~8, Nss=2	8TX	8RX
	MCS 0~9, Nss=3	8TX	8RX
	MCS 0~8, Nss=4	8TX	8RX
	MCS 0~8, Nss=5	8TX	8RX
	MCS 0~9, Nss=6	8TX	8RX
	MCS 0~8, Nss=7	8TX	8RX
	MCS 0~8, Nss=8	8TX	8RX
802.11ac (VHT40)	MCS 0~9, Nss=1	8TX	8RX
	MCS 0~9, Nss=2	8TX	8RX
	MCS 0~9, Nss=3	8TX	8RX
	MCS 0~9, Nss=4	8TX	8RX
	MCS 0~9, Nss=5	8TX	8RX
	MCS 0~9, Nss=6	8TX	8RX
	MCS 0~9, Nss=7	8TX	8RX
	MCS 0~9, Nss=8	8TX	8RX
802.11ac (VHT80)	MCS 0~9, Nss=1	8TX	8RX
	MCS 0~9, Nss=2	8TX	8RX
	MCS 0~9, Nss=3	8TX	8RX
	MCS 0~9, Nss=4	8TX	8RX
	MCS 0~9, Nss=5	8TX	8RX
	MCS 0~8, Nss=6	8TX	8RX
	MCS 0~9, Nss=7	8TX	8RX
	MCS 0~9, Nss=8	8TX	8RX
802.11ac (VHT80+VHT80) (for U-NII-1 & U-NII-3)	MCS 0~9, Nss=1	4TX+4TX	4RX +4RX
	MCS 0~9, Nss=2	4TX+4TX	4RX +4RX
	MCS 0~9, Nss=3	4TX+4TX	4RX +4RX
	MCS 0~9, Nss=4	4TX+4TX	4RX +4RX
802.11ax (HE20)	MCS 0~11, Nss=1	8TX	8RX
	MCS 0~11, Nss=2	8TX	8RX
	MCS 0~11, Nss=3	8TX	8RX
	MCS 0~11, Nss=4	8TX	8RX
	MCS 0~11, Nss=5	8TX	8RX
	MCS 0~11, Nss=6	8TX	8RX
	MCS 0~11, Nss=7	8TX	8RX
	MCS 0~11, Nss=8	8TX	8RX
802.11ax (HE40)	MCS 0~11, Nss=1	8TX	8RX
	MCS 0~11, Nss=2	8TX	8RX
	MCS 0~11, Nss=3	8TX	8RX
	MCS 0~11, Nss=4	8TX	8RX
	MCS 0~11, Nss=5	8TX	8RX
	MCS 0~11, Nss=6	8TX	8RX
	MCS 0~11, Nss=7	8TX	8RX
	MCS 0~11, Nss=8	8TX	8RX
802.11ax (HE80)	MCS 0~11, Nss=1	8TX	8RX
	MCS 0~11, Nss=2	8TX	8RX
	MCS 0~11, Nss=3	8TX	8RX
	MCS 0~11, Nss=4	8TX	8RX
	MCS 0~11, Nss=5	8TX	8RX
	MCS 0~11, Nss=6	8TX	8RX
	MCS 0~11, Nss=7	8TX	8RX
	MCS 0~11, Nss=8	8TX	8RX

802.11ax (HE80+HE80) (for U-NII-1 & U-NII-3)	MCS 0~11, Nss=1	4TX+4TX	4RX +4RX
	MCS 0~11, Nss=2	4TX+4TX	4RX +4RX
	MCS 0~11, Nss=3	4TX+4TX	4RX +4RX
	MCS 0~11, Nss=4	4TX+4TX	4RX +4RX

Note:

1. All of modulation mode support beamforming function except 802.11a/b/g modulation mode.
2. The EUT support Beamforming and Non-Beamforming mode, therefore both mode were investigated and the worst case scenario was identified. The worst case data were presented in test report.
3. The modulation and bandwidth are similar for 802.11n mode for 20MHz (40MHz) and 802.11ac mode for 20MHz (40MHz), therefore investigated worst case to representative mode in test report. (Final test mode refer section 3.2.1)

2.4GHz Scanning

MODULATION MODE	RX CONFIGURATION
802.11b	1RX
802.11g	1RX
802.11n (HT20)	1RX
802.11n (HT40)	1RX
VHT20	1RX
VHT40	1RX

5GHz Scanning

MODULATION MODE	RX CONFIGURATION
802.11a	1RX
802.11n (HT20)	1RX
802.11n (HT40)	1RX
802.11ac (VHT20)	1RX
802.11ac (VHT40)	1RX
802.11ac (VHT80)	1RX

8. The above EUT information is declared by manufacturer and for more detailed features description, please refers to the manufacturer's specifications or user's manual.

3.2 Description of Test Modes

FOR 5260 ~ 5320MHz

4 channels are provided for 802.11a, 802.11n (HT20), 802.11ac (VHT20), 802.11ax (HE20):

Channel	Frequency	Channel	Frequency
52	5260 MHz	60	5300 MHz
56	5280 MHz	64	5320 MHz

2 channels are provided for 802.11n (HT40), 802.11ac (VHT40), 802.11ax (HE40):

Channel	Frequency	Channel	Frequency
54	5270 MHz	62	5310 MHz

1 channel is provided for 802.11ac (VHT80), 802.11ax (HE80):

Channel	Frequency
58	5290 MHz

FOR 5500 ~ 5720MHz

12 channels are provided for 802.11a, 802.11n (HT20), 802.11ac (VHT20), 802.11ax (HE20):

Channel	Frequency	Channel	Frequency
100	5500 MHz	124	5620 MHz
104	5520 MHz	128	5640 MHz
108	5540 MHz	132	5660 MHz
112	5560 MHz	136	5680 MHz
116	5580 MHz	140	5700 MHz
120	5600 MHz	144	5720 MHz

6 channels are provided for 802.11n (HT40), 802.11ac (VHT40), 802.11ax (HE40):

Channel	Frequency	Channel	Frequency
102	5510 MHz	126	5630 MHz
110	5550 MHz	134	5670 MHz
118	5590 MHz	142	5710 MHz

3 channels are provided for 802.11ac (VHT80), 802.11ax (HE80):

Channel	Frequency	Channel	Frequency
106	5530 MHz	138	5690 MHz
122	5610 MHz		

3.2.1 Test Mode Applicability and Tested Channel Detail

EUT Configure Mode	Applicable To				Description
	RE \geq 1G	RE<1G	PLC	APCM	
1	√	√	√	√	8TX (PLC: POE mode; RE: adapter mode)
2	√	-	-	√	4TX (RE: adapter mode)
3	√	-	-	√	2TX (RE: adapter mode)
4	√	-	-	√	1TX (RE: adapter mode)

Where **RE \geq 1G**: Radiated Emission above 1GHz

RE<1G: Radiated Emission below 1GHz

PLC: Power Line Conducted Emission

APCM: Antenna Port Conducted Measurement

Note: 1. In original report: the EUT had been pre-tested on the positioned of each 3 axis. The worst case was found when positioned on **X-plane (below 1GHz) & Z-plane (above 1GHz)**.

2. "-" means no effect.

Radiated Emission Test (Above 1GHz):

- Pre-Scan has been conducted to determine the worst-case mode from all possible combinations between available modulations, data rates and antenna ports (if EUT with antenna diversity architecture).
- Following channel(s) was (were) selected for the final test as listed below.

Non-Beamforming Mode						
Mode	FREQ. Band (MHz)	Available Channel	Tested Channel	Modulation Technology	Modulation Type	Data Rate Parameter
802.11a	5260-5320	52 to 64	52, 60, 64	OFDM	BPSK	6Mb/s
802.11ax (HE20)		52 to 64	52, 60, 64	OFDMA	BPSK	MCS0
802.11ax (HE40)		54 to 62	54, 62	OFDMA	BPSK	MCS0
802.11ax (HE80)		58	58	OFDMA	BPSK	MCS0
802.11a	5500-5720	100 to 144	100, 116, 140, 144	OFDM	BPSK	6Mb/s
802.11ax (HE20)		100 to 144	100, 116, 140, 144	OFDMA	BPSK	MCS0
802.11ax (HE40)		102 to 142	102, 110, 134, 142	OFDMA	BPSK	MCS0
802.11ax (HE80)		106 to 138	106, 122, 138	OFDMA	BPSK	MCS0

Radiated Emission Test (Below 1GHz):

- Pre-Scan has been conducted to determine the worst-case mode from all possible combinations between available modulations, data rates and antenna ports (if EUT with antenna diversity architecture).
- Following channel(s) was (were) selected for the final test as listed below.

Non-Beamforming Mode						
Mode	FREQ. Band (MHz)	Available Channel	Tested Channel	Modulation Technology	Modulation Type	Data Rate Parameter
802.11a	5260-5320 5500-5720	52 to 64, 100 to 144	140	OFDM	BPSK	6Mb/s

Power Line Conducted Emission Test:

- Pre-Scan has been conducted to determine the worst-case mode from all possible combinations between available modulations, data rates and antenna ports (if EUT with antenna diversity architecture).
- Following channel(s) was (were) selected for the final test as listed below.

Non-Beamforming Mode						
Mode	FREQ. Band (MHz)	Available Channel	Tested Channel	Modulation Technology	Modulation Type	Data Rate Parameter
802.11a	5260-5320 5500-5720	52 to 64, 100 to 144	140	OFDM	BPSK	6Mb/s

Antenna Port Conducted Measurement:

- This item includes all test value of each mode, but only includes spectrum plot of worst value of each mode.
- Pre-Scan has been conducted to determine the worst-case mode from all possible combinations between available modulations, data rates and antenna ports (if EUT with antenna diversity architecture).
- Following channel(s) was (were) selected for the final test as listed below.

Non-Beamforming Mode						
Mode	FREQ. Band (MHz)	Available Channel	Tested Channel	Modulation Technology	Modulation Type	Data Rate Parameter
802.11a	5260-5320	52 to 64	52, 60, 64	OFDM	BPSK	6Mb/s
802.11ac (VHT20)		52 to 64	52, 60, 64	OFDM	BPSK	MCS0
802.11ac (VHT40)		54 to 62	54, 62	OFDM	BPSK	MCS0
802.11ac (VHT80)		58	58	OFDM	BPSK	MCS0
802.11ax (HE20)		52 to 64	52, 60, 64	OFDMA	BPSK	MCS0
802.11ax (HE40)		54 to 62	54, 62	OFDMA	BPSK	MCS0
802.11ax (HE80)		58	58	OFDMA	BPSK	MCS0
802.11a	5500-5720	100 to 144	100, 116, 140, 144	OFDM	BPSK	6Mb/s
802.11ac (VHT20)		100 to 144	100, 116, 140, 144	OFDM	BPSK	MCS0
802.11ac (VHT40)		102 to 142	102, 110, 134, 142	OFDM	BPSK	MCS0
802.11ac (VHT80)		106 to 138	106, 122, 138	OFDM	BPSK	MCS0
802.11ax (HE20)		100 to 144	100, 116, 140, 144	OFDMA	BPSK	MCS0
802.11ax (HE40)		102 to 142	102, 110, 134, 142	OFDMA	BPSK	MCS0
802.11ax (HE80)		106 to 138	106, 122, 138	OFDMA	BPSK	MCS0

Beamforming Mode (output power only)

Mode	FREQ. Band (MHz)	Available Channel	Tested Channel	Modulation Technology	Modulation Type	Data Rate Parameter
802.11ac (VHT20)	5260-5320	52 to 64	52, 60, 64	OFDM	BPSK	MCS0
802.11ac (VHT40)		54 to 62	54, 62	OFDM	BPSK	MCS0
802.11ac (VHT80)		58	58	OFDM	BPSK	MCS0
802.11ax (HE20)		52 to 64	52, 60, 64	OFDMA	BPSK	MCS0
802.11ax (HE40)		54 to 62	54, 62	OFDMA	BPSK	MCS0
802.11ax (HE80)		58	58	OFDMA	BPSK	MCS0
802.11ac (VHT20)	5500-5720	100 to 144	100, 116, 140, 144	OFDM	BPSK	MCS0
802.11ac (VHT40)		102 to 142	102, 110, 134, 142	OFDM	BPSK	MCS0
802.11ac (VHT80)		106 to 138	106, 122, 138	OFDM	BPSK	MCS0
802.11ax (HE20)		100 to 144	100, 116, 140, 144	OFDMA	BPSK	MCS0
802.11ax (HE40)		102 to 142	102, 110, 134, 142	OFDMA	BPSK	MCS0
802.11ax (HE80)		106 to 138	106, 122, 138	OFDMA	BPSK	MCS0

Test Condition:

Applicable To	Environmental Conditions	Input Power	Tested By
RE \geq 1G	23deg. C, 66%RH	120Vac, 60Hz	Rey Chen
RE $<$ 1G	22deg. C, 68%RH	120Vac, 60Hz	Frank Chuang
PLC	24deg. C, 76%RH	120Vac, 60Hz	Andy Ho
APCM	25deg. C, 60%RH	120Vac, 60Hz	Jyunchun Lin

3.3 Duty Cycle of Test Signal

Duty cycle of test signal is < 98%, duty factor shall be considered.

- 802.11a:** Duty cycle = 1.432 ms/1.557 ms = 0.92, Duty factor = $10 * \log(1/\text{Duty cycle}) = 0.36$
- 802.11ac (VHT20):** Duty cycle = 5.418 ms/5.678 ms = 0.954, Duty factor = $10 * \log(1/\text{Duty cycle}) = 0.2$
- 802.11ac (VHT40):** Duty cycle = 5.423 ms/5.7 ms = 0.951, Duty factor = $10 * \log(1/\text{Duty cycle}) = 0.22$
- 802.11ac (VHT80):** Duty cycle = 5.419 ms/5.657 ms = 0.958, Duty factor = $10 * \log(1/\text{Duty cycle}) = 0.19$
- 802.11ax (HE20):** Duty cycle = 5.447 ms/5.705 ms = 0.955, Duty factor = $10 * \log(1/\text{Duty cycle}) = 0.2$
- 802.11ax (HE40):** Duty cycle = 5.45 ms/5.655 ms = 0.964, Duty factor = $10 * \log(1/\text{Duty cycle}) = 0.16$
- 802.11ax (HE80):** Duty cycle = 5.447 ms/5.682 ms = 0.959, Duty factor = $10 * \log(1/\text{Duty cycle}) = 0.18$

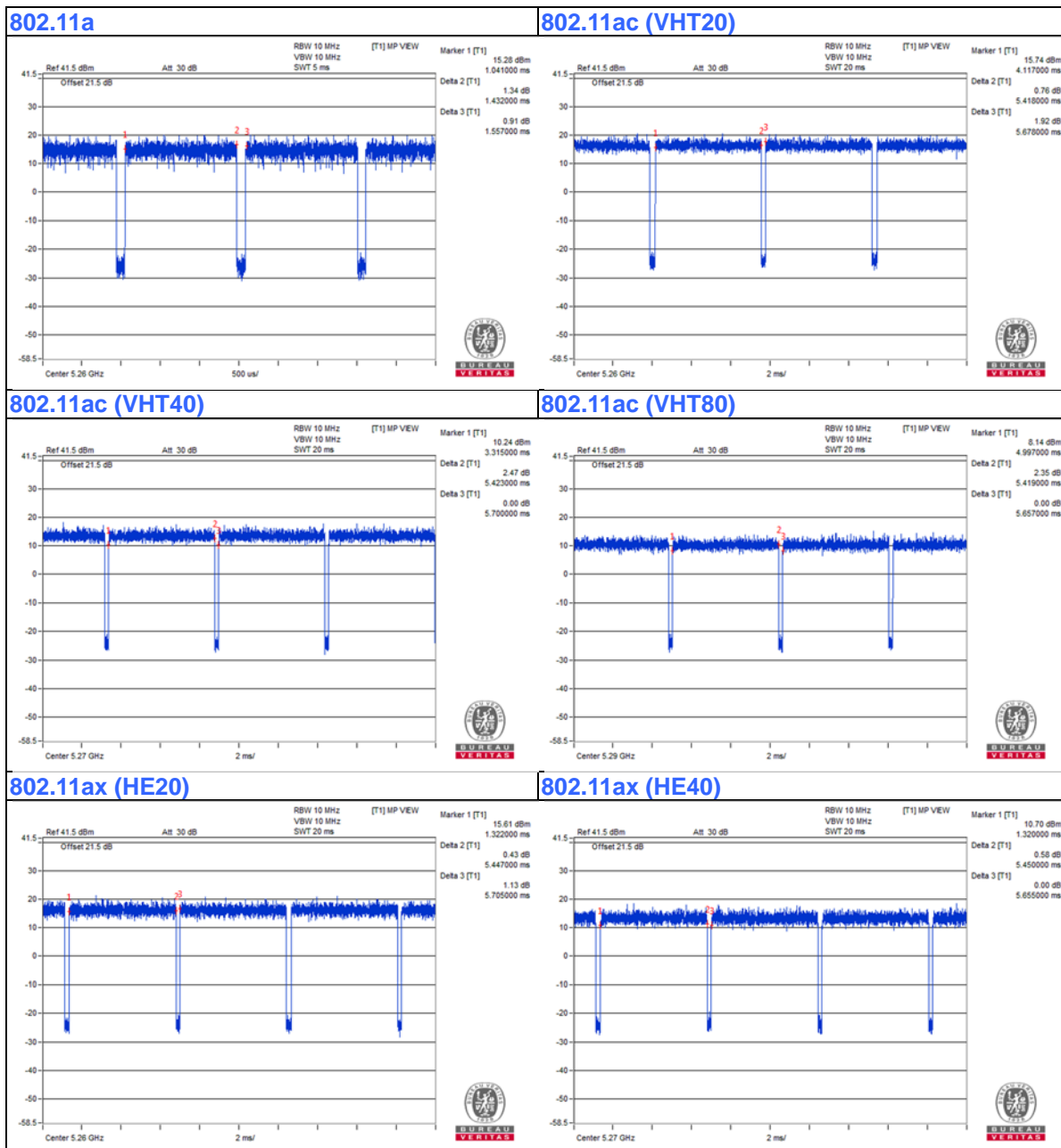

802.11ax (HE80)

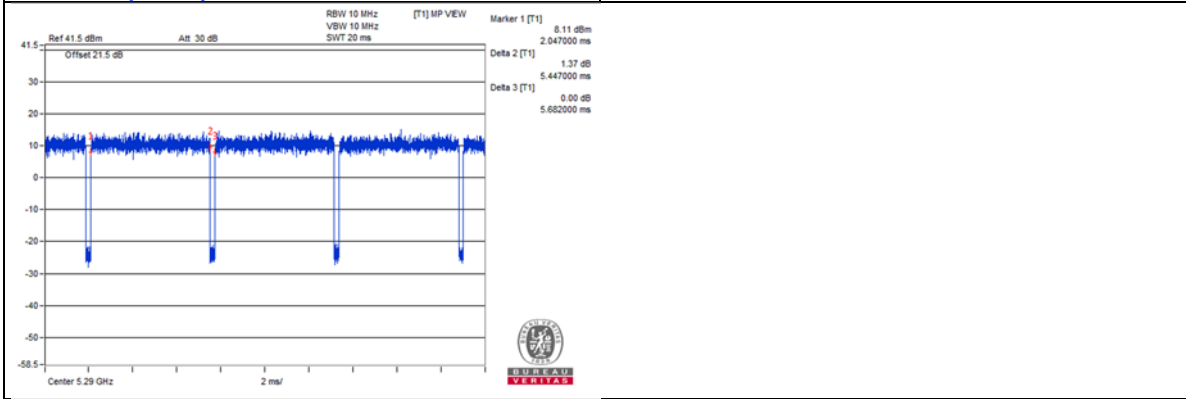

3.4 Description of Support Units

The EUT has been tested as an independent unit together with other necessary accessories or support units. The following support units or accessories were used to form a representative test configuration during the tests.

ID	Product	Brand	Model No.	Serial No.	FCC ID	Remarks
A.	Laptop	DELL	E6420	B92T3R1	FCC DoC	Provided by Lab
B.	POE Adapter	CISCO	MA-INJ-4	NA	NA	Supplied by client

Note:

1. All power cords of the above support units are non-shielded (1.8m).

ID	Descriptions	Qty.	Length (m)	Shielding (Yes/No)	Cores (Qty.)	Remarks
1.	RJ-45 Cable	1	10	No	0	Provided by Lab
2.	DC Cable	1	1.8	No	0	Supplied by client
3.	RJ-45 Cable	1	0.5	No	0	Provided by Lab

3.4.1 Configuration of System under Test

POE mode:

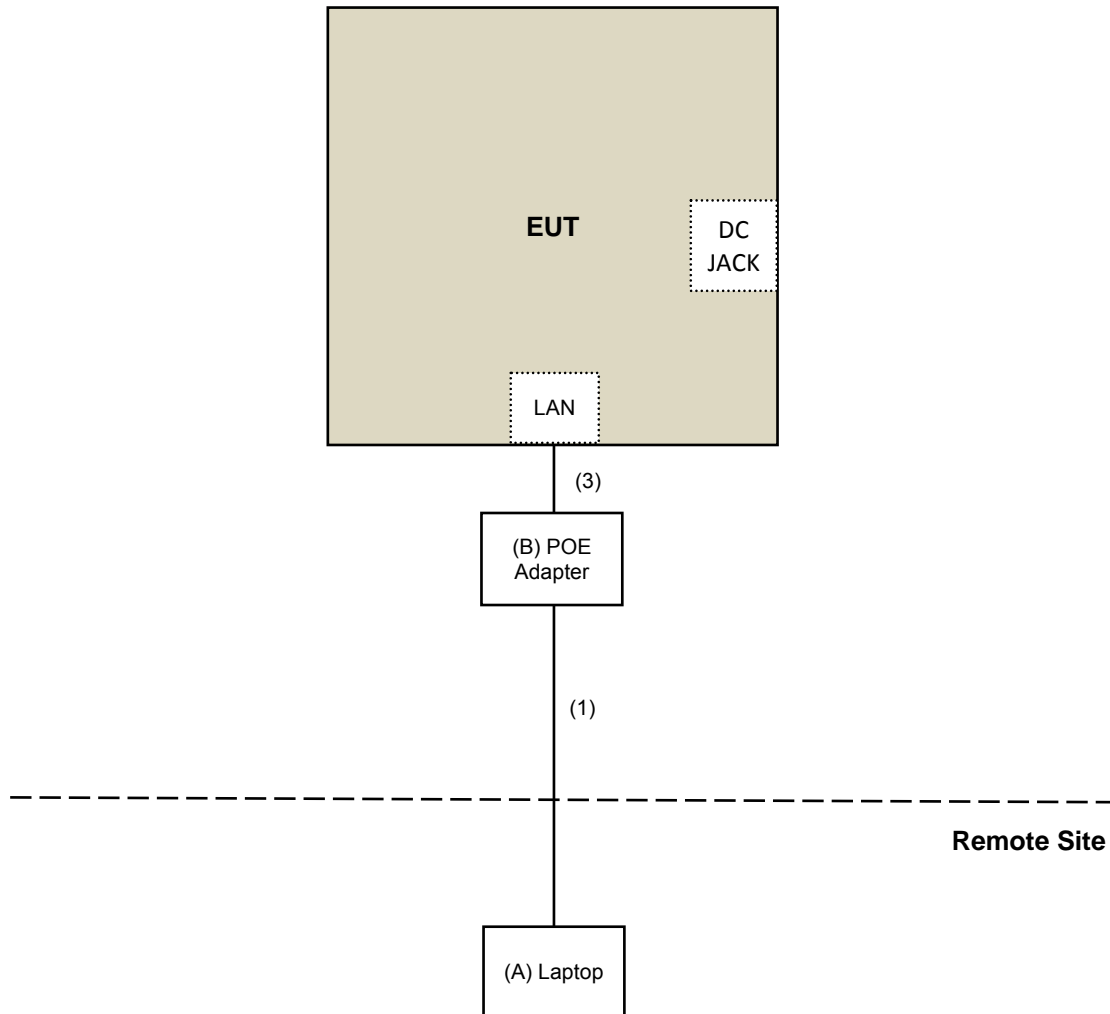

Adapter mode:

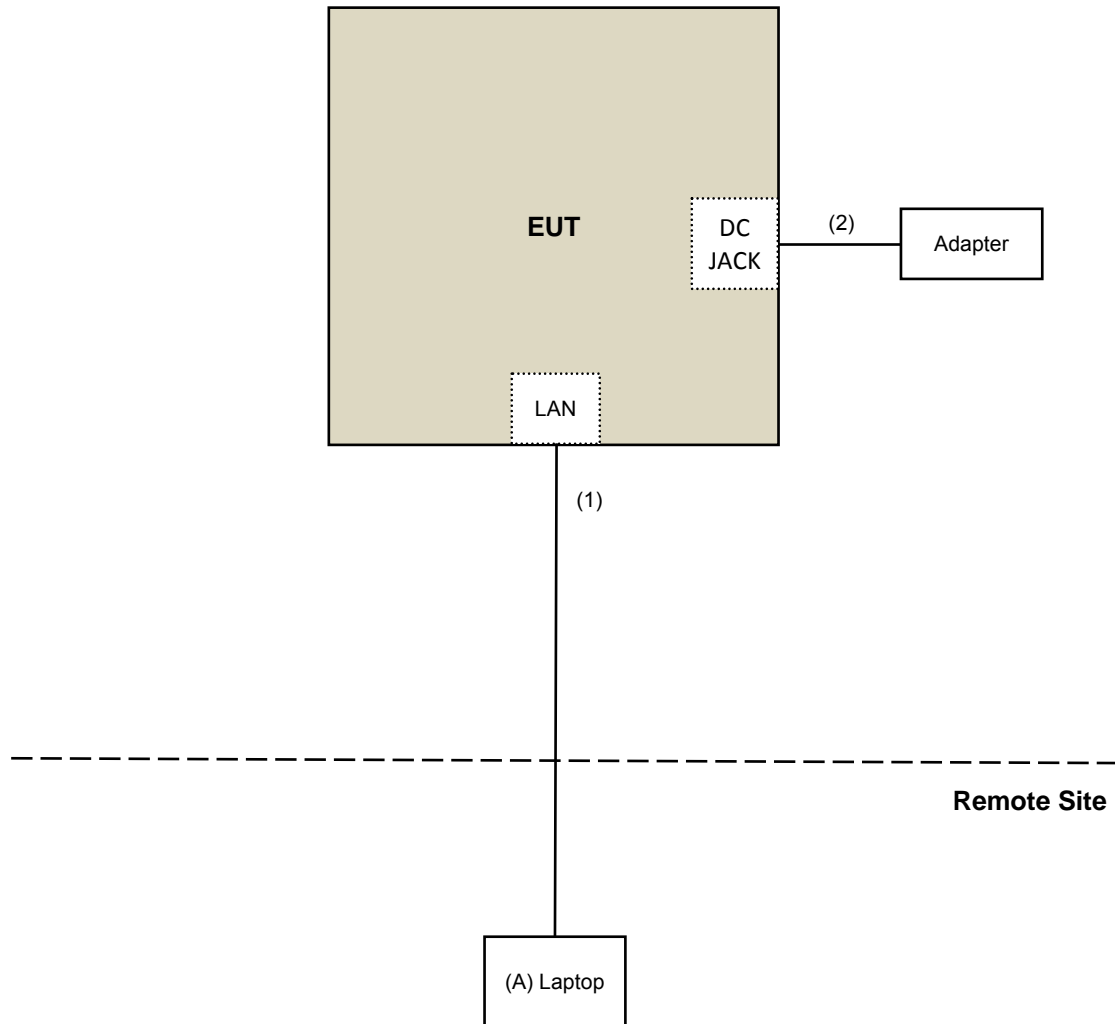

3.5 General Description of Applied Standard

The EUT is a RF Product. According to the specifications of the manufacturer, it must comply with the requirements of the following standards:

FCC Part 15, Subpart E (15.407)

KDB 789033 D02 General UNII Test Procedure New Rules v02r01

KDB 662911 D01 Multiple Transmitter Output v02r01

ANSI C63.10-2013

All test items have been performed and recorded as per the above standards.

4 Test Types and Results

4.1 Radiated Emission and Bandedge Measurement

4.1.1 Limits of Radiated Emission and Bandedge Measurement

Radiated emissions which fall in the restricted bands must comply with the radiated emission limits specified as below table.

Frequencies (MHz)	Field Strength (microvolts/meter)	Measurement Distance (meters)
0.009 ~ 0.490	2400/F(kHz)	300
0.490 ~ 1.705	24000/F(kHz)	30
1.705 ~ 30.0	30	30
30 ~ 88	100	3
88 ~ 216	150	3
216 ~ 960	200	3
Above 960	500	3

NOTE:

1. The lower limit shall apply at the transition frequencies.
2. Emission level (dBuV/m) = 20 log Emission level (uV/m).
3. For frequencies above 1000MHz, the field strength limits are based on average detector, however, the peak field strength of any emission shall not exceed the maximum permitted average limits, specified above by more than 20dB under any condition of modulation.

Limits of unwanted emission out of the restricted bands

Applicable To		Limit	
789033 D02 General UNII Test Procedure New Rules v02r01		Field Strength at 3m	
		PK:74 (dBuV/m)	AV:54 (dBuV/m)
Frequency Band	Applicable To	EIRP Limit	Equivalent Field Strength at 3m
5150~5250 MHz	15.407(b)(1)	PK:-27 (dBm/MHz)	PK:68.2(dBuV/m)
5250~5350 MHz	15.407(b)(2)		
5470~5725 MHz	15.407(b)(3)		
5725~5850 MHz	<input checked="" type="checkbox"/> 15.407(b)(4)(i)	PK:-27 (dBm/MHz) ^{*1} PK:10 (dBm/MHz) ^{*2} PK:15.6 (dBm/MHz) ^{*3} PK:27 (dBm/MHz) ^{*4}	PK: 68.2(dBuV/m) ^{*1} PK:105.2 (dBuV/m) ^{*2} PK: 110.8(dBuV/m) ^{*3} PK:122.2 (dBuV/m) ^{*4}
	<input type="checkbox"/> 15.407(b)(4)(ii)	Emission limits in section 15.247(d)	
*1 beyond 75 MHz or more above of the band edge.		*2 below the band edge increasing linearly to 10 dBm/MHz at 25 MHz above.	
*3 below the band edge increasing linearly to a level of 15.6 dBm/MHz at 5 MHz above.		*4 from 5 MHz above or below the band edge increasing linearly to a level of 27 dBm/MHz at the band edge.	

Note:

The following formula is used to convert the equipment isotropic radiated power (eirp) to field strength:

$$E = \frac{1000000\sqrt{30P}}{3} \mu\text{V/m, where } P \text{ is the eirp (Watts).}$$

4.1.2 Test Instruments

For radiated emission test (Below 1GHz test):

DESCRIPTION & MANUFACTURER	MODEL NO.	SERIAL NO.	CALIBRATED DATE	CALIBRATED UNTIL
Test Receiver Agilent	N9038A	MY50010156	July 12, 2018	July 11, 2019
Pre-Amplifier EMCI	EMC001340	980142	Feb. 09, 2018	Feb. 08, 2019
Loop Antenna(*) Electro-Metrics	EM-6879	264	Dec. 16, 2016	Dec. 15, 2018
RF Cable	NA	LOOPCAB-001	Jan. 15, 2018	Jan. 14, 2019
RF Cable	NA	LOOPCAB-002	Jan. 15, 2018	Jan. 14, 2019
Pre-Amplifier Mini-Circuits	ZFL-1000VH2B	AMP-ZFL-05	May 05, 2018	May 04, 2019
Trilog Broadband Antenna SCHWARZBECK	VULB 9168	9168-361	Nov. 29, 2017	Nov. 28, 2018
RF Cable	8D	966-3-1	Mar. 20, 2018	Mar. 19, 2019
RF Cable	8D	966-3-2	Mar. 20, 2018	Mar. 19, 2019
RF Cable	8D	966-3-3	Mar. 20, 2018	Mar. 19, 2019
Fixed attenuator Mini-Circuits	UNAT-5+	PAD-3m-3-01	Oct. 03, 2017	Oct. 02, 2018
Software	ADT_Radiated_V8.7.08	NA	NA	NA
Antenna Tower & Turn Table Max-Full	MF-7802	MF780208406	NA	NA

Note:

1. The calibration interval of the above test instruments is 12 months and the calibrations are traceable to NML/ROC and NIST/USA.
2. *The calibration interval of the above test instruments is 24 months and the calibrations are traceable to NML/ROC and NIST/USA.
3. The test was performed in 966 Chamber No. 3.
4. The CANADA Site Registration No. is 20331-1
5. Loop antenna was used for all emissions below 30 MHz.
6. Tested Date: Aug. 30, 2018

For other test:

DESCRIPTION & MANUFACTURER	MODEL NO.	SERIAL NO.	CALIBRATED DATE	CALIBRATED UNTIL
Test Receiver Agilent	N9038A	MY50010156	July 12, 2018	July 11, 2019
Horn_Antenna SCHWARZBECK	BBHA9120-D	9120D-406	Nov. 25, 2018	Nov. 24, 2019
Pre-Amplifier EMCI	EMC12630SE	980384	Jan. 29, 2018	Jan. 28, 2019
RF Cable	EMC104-SM-SM-1200	160922	Jan. 29, 2018	Jan. 28, 2019
RF Cable	EMC104-SM-SM-2000	150317	Jan. 29, 2018	Jan. 28, 2019
RF Cable	EMC104-SM-SM-5000	150322	Jan. 29, 2018	Jan. 28, 2019
Spectrum Analyzer Keysight	N9030A	MY54490679	July 23, 2018	July 22, 2019
Pre-Amplifier EMCI	EMC184045SE	980386	Jan. 29, 2018	Jan. 28, 2019
Horn_Antenna SCHWARZBECK	BBHA 9170	BBHA9170608	Nov. 25, 2018	Nov. 24, 2019
RF Cable	EMC102-KM-KM-1200	160924	Jan. 29, 2018	Jan. 28, 2019
Software	ADT_Radiated_V8.7.08	NA	NA	NA
Antenna Tower & Turn Table Max-Full	MF-7802	MF780208406	NA	NA
Boresight Antenna Fixture	FBA-01	FBA-SIP01	NA	NA
Spectrum Analyzer R&S	FSV40	100964	June 20, 2018	June 19, 2019
Power meter Anritsu	ML2495A	1014008	May 09, 2018	May 08, 2019
Power sensor Anritsu	MA2411B	0917122	May 09, 2018	May 08, 2019
Attenuator STI	STI02-3310-10	013	Feb. 12, 2018	Feb. 11, 2019
AC Power Source Extech Electronics	6205	1440452	NA	NA
Temperature & Humidity Chamber Giant Force	GTH-150-40-SP-AR	MAA0812-008	Jan. 10, 2018	Jan. 09, 2019
True RMS Clamp Meter FLUKE	325	31130711WS	May 22, 2018	May 21, 2019

Note:

1. The calibration interval of the above test instruments is 12 months and the calibrations are traceable to NML/ROC and NIST/USA.
2. The test was performed in 966 Chamber No. 3.
3. The CANADA Site Registration No. is 20331-1
4. Loop antenna was used for all emissions below 30 MHz.
5. Tested Date: Dec. 17, 2018 to Jan. 02, 2019

4.1.3 Test Procedure

For Radiated emission below 30MHz

- a. The EUT was placed on the top of a rotating table 0.8 meters above the ground at a 3 meter chamber room. The table was rotated 360 degrees to determine the position of the highest radiation.
- b. The EUT was set 3 meters away from the interference-receiving antenna, which was mounted on the top of a variable-height antenna tower.
- c. Parallel, perpendicular, and ground-parallel orientations of the antenna are set to make the measurement.
- d. For each suspected emission, the EUT was arranged to its worst case and the rotatable table was turned from 0 degrees to 360 degrees to find the maximum reading.
- e. The test-receiver system was set to Quasi-Peak Detect Function and Specified Bandwidth with Maximum Hold Mode.

Note:

1. The resolution bandwidth and video bandwidth of test receiver/spectrum analyzer is 9kHz at frequency below 30MHz.

For Radiated emission above 30MHz

- a. The EUT was placed on the top of a rotating table 0.8 meters (for 30MHz ~ 1GHz) / 1.5 meters (for above 1GHz) above the ground at 3 meter chamber room for test. The table was rotated 360 degrees to determine the position of the highest radiation.
- b. The EUT was set 3 meters away from the interference-receiving antenna, which was mounted on the top of a variable-height antenna tower.
- c. The height of antenna is varied from one meter to four meters above the ground to determine the maximum value of the field strength. Both horizontal and vertical polarizations of the antenna are set to make the measurement.
- d. For each suspected emission, the EUT was arranged to its worst case and then the antenna was tuned to heights from 1 meter to 4 meters and the rotatable table was turned from 0 degrees to 360 degrees to find the maximum reading.
- e. The test-receiver system was set to quasi-peak detect function and specified bandwidth with maximum hold mode when the test frequency is below 1 GHz.
- f. The test-receiver system was set to peak and average detects function and specified bandwidth with maximum hold mode when the test frequency is above 1 GHz. If the peak reading value also meets average limit, measurement with the average detector is unnecessary.

Note:

1. The resolution bandwidth and video bandwidth of test receiver/spectrum analyzer is 120kHz for Quasi-peak detection (QP) at frequency below 1GHz.
2. The resolution bandwidth of test receiver/spectrum analyzer is 1 MHz and the video bandwidth is 3 MHz for Peak detection (PK) at frequency above 1GHz.
3. The resolution bandwidth of test receiver/spectrum analyzer is 1MHz and the video bandwidth is $\geq 1/T$ (Duty cycle < 98%) or 10Hz (Duty cycle $\geq 98\%$) for Average detection (AV) at frequency above 1GHz.
4. All modes of operation were investigated and the worst-case emissions are reported.

4.1.4 Deviation from Test Standard

No deviation.

4.1.5 Test Setup

For Radiated emission below 30MHz

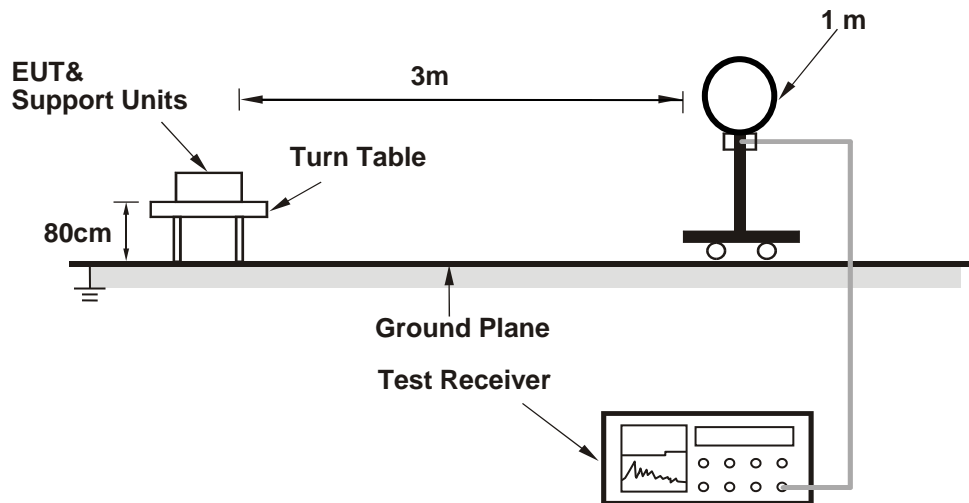

For Radiated emission 30MHz to 1GHz

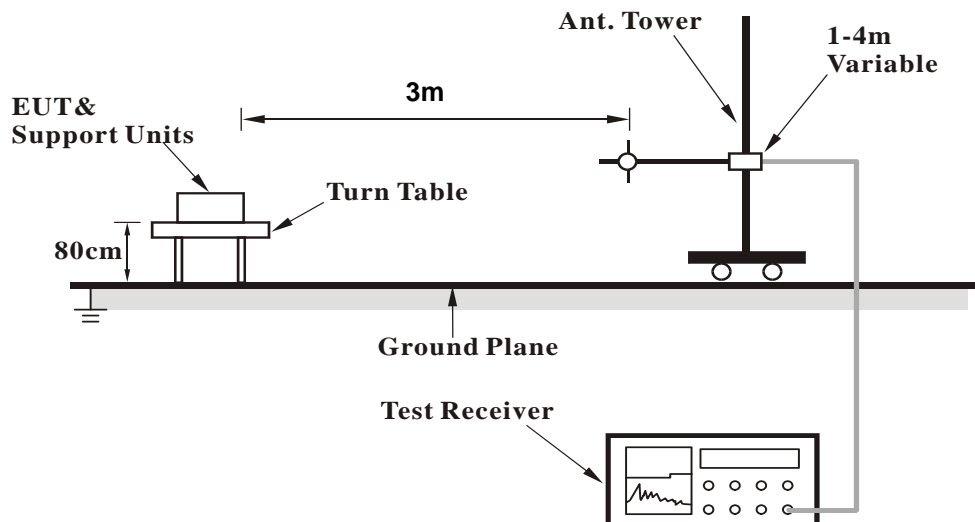

For Radiated emission above 1GHz

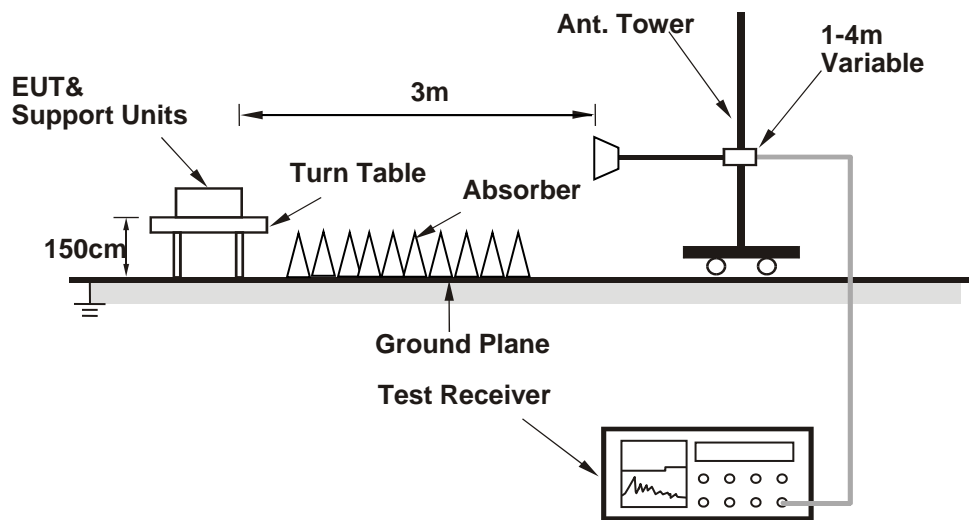

For the actual test configuration, please refer to the attached file (Test Setup Photo).

4.1.6 EUT Operating Condition

- a. Connected the EUT with the Laptop which is placed on remote site.
- b. Controlling software (QSPR (5.0-00161)) has been activated to set the EUT on specific status.

4.1.7 Test Results (Mode 1)

Above 1GHz Data:

802.11a

CHANNEL	TX Channel 52	DETECTOR FUNCTION	Peak (PK)
FREQUENCY RANGE	1GHz ~ 40GHz		Average (AV)

ANTENNA POLARITY & TEST DISTANCE: HORIZONTAL AT 3 M								
NO.	FREQ. (MHz)	EMISSION LEVEL (dBuV/m)	LIMIT (dBuV/m)	MARGIN (dB)	ANTENNA HEIGHT (m)	TABLE ANGLE (Degree)	RAW VALUE (dBuV)	CORRECTION FACTOR (dB/m)
1	5150.00	66.0 PK	74.0	-8.0	1.71 H	253	63.1	2.9
2	5150.00	50.9 AV	54.0	-3.1	1.71 H	253	48.0	2.9
3	*5260.00	115.1 PK			1.71 H	253	112.7	2.4
4	*5260.00	102.6 AV			1.71 H	253	100.2	2.4
5	#10520.00	49.1 PK	68.2	-19.1	1.58 H	189	36.8	12.3
6	15780.00	52.7 PK	74.0	-21.3	1.92 H	34	40.7	12.0
7	15780.00	40.7 AV	54.0	-13.3	1.92 H	34	28.7	12.0

ANTENNA POLARITY & TEST DISTANCE: VERTICAL AT 3 M								
NO.	FREQ. (MHz)	EMISSION LEVEL (dBuV/m)	LIMIT (dBuV/m)	MARGIN (dB)	ANTENNA HEIGHT (m)	TABLE ANGLE (Degree)	RAW VALUE (dBuV)	CORRECTION FACTOR (dB/m)
1	5150.00	56.5 PK	74.0	-17.5	1.92 V	246	53.6	2.9
2	5150.00	43.0 AV	54.0	-11.0	1.92 V	246	40.1	2.9
3	*5260.00	113.8 PK			1.92 V	246	111.4	2.4
4	*5260.00	101.1 AV			1.92 V	246	98.7	2.4
5	#10520.00	49.3 PK	68.2	-18.9	1.22 V	229	37.0	12.3
6	15780.00	57.5 PK	74.0	-16.5	3.02 V	266	45.5	12.0
7	15780.00	47.1 AV	54.0	-6.9	3.02 V	266	35.1	12.0

REMARKS:

1. Emission Level(dBuV/m) = Raw Value(dBuV) + Correction Factor(dB/m)
2. Correction Factor(dB/m) = Antenna Factor(dB/m) + Cable Factor(dB) – Pre-Amplifier Factor(dB)
3. The other emission levels were very low against the limit.
4. Margin value = Emission Level – Limit value
5. " * ": Fundamental frequency.
6. " # ": The radiated frequency is out of the restricted band.

CHANNEL	TX Channel 60	DETECTOR FUNCTION	Peak (PK)
FREQUENCY RANGE	1GHz ~ 40GHz		Average (AV)

ANTENNA POLARITY & TEST DISTANCE: HORIZONTAL AT 3 M

NO.	FREQ. (MHz)	EMISSION LEVEL (dBuV/m)	LIMIT (dBuV/m)	MARGIN (dB)	ANTENNA HEIGHT (m)	TABLE ANGLE (Degree)	RAW VALUE (dBuV)	CORRECTION FACTOR (dB/m)
1	*5300.00	115.4 PK			1.69 H	260	112.8	2.6
2	*5300.00	102.7 AV			1.69 H	260	100.1	2.6
3	10600.00	49.6 PK	74.0	-24.4	1.65 H	184	37.5	12.1
4	10600.00	43.2 AV	54.0	-10.8	1.65 H	184	31.1	12.1
5	15900.00	52.3 PK	74.0	-21.7	1.95 H	39	40.5	11.8
6	15900.00	40.6 AV	54.0	-13.4	1.95 H	39	28.8	11.8

ANTENNA POLARITY & TEST DISTANCE: VERTICAL AT 3 M

NO.	FREQ. (MHz)	EMISSION LEVEL (dBuV/m)	LIMIT (dBuV/m)	MARGIN (dB)	ANTENNA HEIGHT (m)	TABLE ANGLE (Degree)	RAW VALUE (dBuV)	CORRECTION FACTOR (dB/m)
1	*5300.00	113.5 PK			1.92 V	250	110.9	2.6
2	*5300.00	100.8 AV			1.92 V	250	98.2	2.6
3	10600.00	49.6 PK	74.0	-24.4	1.22 V	242	37.5	12.1
4	10600.00	45.1 AV	54.0	-8.9	1.22 V	242	33.0	12.1
5	15900.00	57.5 PK	74.0	-16.5	3.02 V	258	45.7	11.8
6	15900.00	46.9 AV	54.0	-7.1	3.02 V	258	35.1	11.8

REMARKS:

1. Emission Level(dBuV/m) = Raw Value(dBuV) + Correction Factor(dB/m)
2. Correction Factor(dB/m) = Antenna Factor(dB/m) + Cable Factor(dB) – Pre-Amplifier Factor(dB)
3. The other emission levels were very low against the limit.
4. Margin value = Emission Level – Limit value
5. " * ": Fundamental frequency.

CHANNEL	TX Channel 64	DETECTOR FUNCTION	Peak (PK)
FREQUENCY RANGE	1GHz ~ 40GHz		Average (AV)

ANTENNA POLARITY & TEST DISTANCE: HORIZONTAL AT 3 M

NO.	FREQ. (MHz)	EMISSION LEVEL (dBuV/m)	LIMIT (dBuV/m)	MARGIN (dB)	ANTENNA HEIGHT (m)	TABLE ANGLE (Degree)	RAW VALUE (dBuV)	CORRECTION FACTOR (dB/m)
1	*5320.00	114.9 PK			1.66 H	243	112.3	2.6
2	*5320.00	102.5 AV			1.66 H	243	99.9	2.6
3	5350.00	64.2 PK	74.0	-9.8	1.66 H	243	61.5	2.7
4	5350.00	49.3 AV	54.0	-4.7	1.66 H	243	46.6	2.7
5	10640.00	48.9 PK	74.0	-25.1	1.62 H	185	37.0	11.9
6	10640.00	42.5 AV	54.0	-11.5	1.62 H	185	30.6	11.9
7	15960.00	52.7 PK	74.0	-21.3	1.87 H	16	40.6	12.1
8	15960.00	40.7 AV	54.0	-13.3	1.87 H	16	28.6	12.1

ANTENNA POLARITY & TEST DISTANCE: VERTICAL AT 3 M

NO.	FREQ. (MHz)	EMISSION LEVEL (dBuV/m)	LIMIT (dBuV/m)	MARGIN (dB)	ANTENNA HEIGHT (m)	TABLE ANGLE (Degree)	RAW VALUE (dBuV)	CORRECTION FACTOR (dB/m)
1	*5320.00	112.8 PK			1.81 V	242	110.2	2.6
2	*5320.00	100.2 AV			1.81 V	242	97.6	2.6
3	5350.00	53.6 PK	74.0	-20.4	1.81 V	242	50.9	2.7
4	5350.00	40.3 AV	54.0	-13.7	1.81 V	242	37.6	2.7
5	10640.00	49.3 PK	74.0	-24.7	1.22 V	237	37.4	11.9
6	10640.00	44.9 AV	54.0	-9.1	1.22 V	237	33.0	11.9
7	15960.00	57.5 PK	74.0	-16.5	3.04 V	282	45.4	12.1
8	15960.00	47.0 AV	54.0	-7.0	3.04 V	282	34.9	12.1

REMARKS:

1. Emission Level(dBuV/m) = Raw Value(dBuV) + Correction Factor(dB/m)
2. Correction Factor(dB/m) = Antenna Factor(dB/m) + Cable Factor(dB) – Pre-Amplifier Factor(dB)
3. The other emission levels were very low against the limit.
4. Margin value = Emission Level – Limit value
5. " * ": Fundamental frequency.

CHANNEL	TX Channel 100	DETECTOR FUNCTION	Peak (PK)
FREQUENCY RANGE	1GHz ~ 40GHz		Average (AV)

ANTENNA POLARITY & TEST DISTANCE: HORIZONTAL AT 3 M

NO.	FREQ. (MHz)	EMISSION LEVEL (dBuV/m)	LIMIT (dBuV/m)	MARGIN (dB)	ANTENNA HEIGHT (m)	TABLE ANGLE (Degree)	RAW VALUE (dBuV)	CORRECTION FACTOR (dB/m)
1	5460.00	63.3 PK	74.0	-10.7	1.68 H	238	60.3	3.0
2	5460.00	44.5 AV	54.0	-9.5	1.68 H	238	41.5	3.0
3	#5470.00	65.2 PK	68.2	-3.0	1.68 H	238	62.2	3.0
4	*5500.00	115.6 PK			1.68 H	238	112.7	2.9
5	*5500.00	103.1 AV			1.68 H	238	100.2	2.9
6	11000.00	49.3 PK	74.0	-24.7	1.65 H	190	36.5	12.8
7	11000.00	42.9 AV	54.0	-11.1	1.65 H	190	30.1	12.8
8	#16500.00	57.1 PK	68.2	-11.1	1.85 H	27	42.7	14.4

ANTENNA POLARITY & TEST DISTANCE: VERTICAL AT 3 M

NO.	FREQ. (MHz)	EMISSION LEVEL (dBuV/m)	LIMIT (dBuV/m)	MARGIN (dB)	ANTENNA HEIGHT (m)	TABLE ANGLE (Degree)	RAW VALUE (dBuV)	CORRECTION FACTOR (dB/m)
1	5460.00	55.4 PK	74.0	-18.6	1.88 V	254	52.4	3.0
2	5460.00	42.1 AV	54.0	-11.9	1.88 V	254	39.1	3.0
3	#5470.00	56.7 PK	68.2	-11.5	1.88 V	254	53.7	3.0
4	*5500.00	114.3 PK			1.88 V	254	111.4	2.9
5	*5500.00	101.6 AV			1.88 V	254	98.7	2.9
6	11000.00	49.3 PK	74.0	-24.7	1.19 V	214	36.5	12.8
7	11000.00	44.6 AV	54.0	-9.4	1.19 V	214	31.8	12.8
8	#16500.00	52.4 PK	68.2	-15.8	3.05 V	275	38.0	14.4

REMARKS:

1. Emission Level(dBuV/m) = Raw Value(dBuV) + Correction Factor(dB/m)
2. Correction Factor(dB/m) = Antenna Factor(dB/m) + Cable Factor(dB) – Pre-Amplifier Factor(dB)
3. The other emission levels were very low against the limit.
4. Margin value = Emission Level – Limit value
5. " * ": Fundamental frequency.
6. " # ": The radiated frequency is out of the restricted band.

CHANNEL	TX Channel 116	DETECTOR FUNCTION	Peak (PK)
FREQUENCY RANGE	1GHz ~ 40GHz		Average (AV)

ANTENNA POLARITY & TEST DISTANCE: HORIZONTAL AT 3 M

NO.	FREQ. (MHz)	EMISSION LEVEL (dBuV/m)	LIMIT (dBuV/m)	MARGIN (dB)	ANTENNA HEIGHT (m)	TABLE ANGLE (Degree)	RAW VALUE (dBuV)	CORRECTION FACTOR (dB/m)
1	*5580.00	115.7 PK			1.64 H	235	112.7	3.0
2	*5580.00	103.3 AV			1.64 H	235	100.3	3.0
3	11160.00	49.4 PK	74.0	-24.6	1.61 H	208	37.1	12.3
4	11160.00	42.9 AV	54.0	-11.1	1.61 H	208	30.6	12.3
5	#16740.00	51.9 PK	68.2	-16.3	1.88 H	21	37.2	14.7

ANTENNA POLARITY & TEST DISTANCE: VERTICAL AT 3 M

NO.	FREQ. (MHz)	EMISSION LEVEL (dBuV/m)	LIMIT (dBuV/m)	MARGIN (dB)	ANTENNA HEIGHT (m)	TABLE ANGLE (Degree)	RAW VALUE (dBuV)	CORRECTION FACTOR (dB/m)
1	*5580.00	114.8 PK			1.78 V	235	111.8	3.0
2	*5580.00	101.7 AV			1.78 V	235	98.7	3.0
3	11160.00	48.8 PK	74.0	-25.2	1.27 V	221	36.5	12.3
4	11160.00	44.3 AV	54.0	-9.7	1.27 V	221	32.0	12.3
5	#16740.00	57.0 PK	68.2	-11.2	3.02 V	265	42.3	14.7

REMARKS:

1. Emission Level(dBuV/m) = Raw Value(dBuV) + Correction Factor(dB/m)
2. Correction Factor(dB/m) = Antenna Factor(dB/m) + Cable Factor(dB) – Pre-Amplifier Factor(dB)
3. The other emission levels were very low against the limit.
4. Margin value = Emission Level – Limit value
5. " * ": Fundamental frequency.
6. " # ": The radiated frequency is out of the restricted band.

CHANNEL	TX Channel 140	DETECTOR FUNCTION	Peak (PK)
FREQUENCY RANGE	1GHz ~ 40GHz		Average (AV)

ANTENNA POLARITY & TEST DISTANCE: HORIZONTAL AT 3 M

NO.	FREQ. (MHz)	EMISSION LEVEL (dBuV/m)	LIMIT (dBuV/m)	MARGIN (dB)	ANTENNA HEIGHT (m)	TABLE ANGLE (Degree)	RAW VALUE (dBuV)	CORRECTION FACTOR (dB/m)
1	*5700.00	116.2 PK			1.66 H	244	113.0	3.2
2	*5700.00	103.4 AV			1.66 H	244	100.2	3.2
3	#5725.00	64.0 PK	68.2	-4.2	1.66 H	244	60.8	3.2
4	11400.00	48.8 PK	74.0	-25.2	1.61 H	190	35.8	13.0
5	11400.00	42.6 AV	54.0	-11.4	1.61 H	190	29.6	13.0
6	#17100.00	51.8 PK	68.2	-16.4	1.86 H	17	35.3	16.5

ANTENNA POLARITY & TEST DISTANCE: VERTICAL AT 3 M

NO.	FREQ. (MHz)	EMISSION LEVEL (dBuV/m)	LIMIT (dBuV/m)	MARGIN (dB)	ANTENNA HEIGHT (m)	TABLE ANGLE (Degree)	RAW VALUE (dBuV)	CORRECTION FACTOR (dB/m)
1	*5700.00	114.5 PK			1.90 V	259	111.3	3.2
2	*5700.00	101.7 AV			1.90 V	259	98.5	3.2
3	#5725.00	53.7 PK	68.2	-14.5	1.90 V	259	50.5	3.2
4	11400.00	49.3 PK	74.0	-24.7	1.23 V	237	36.3	13.0
5	11400.00	44.6 AV	54.0	-9.4	1.23 V	237	31.6	13.0
6	#17100.00	57.8 PK	68.2	-10.4	3.01 V	261	41.3	16.5

REMARKS:

1. Emission Level(dBuV/m) = Raw Value(dBuV) + Correction Factor(dB/m)
2. Correction Factor(dB/m) = Antenna Factor(dB/m) + Cable Factor(dB) – Pre-Amplifier Factor(dB)
3. The other emission levels were very low against the limit.
4. Margin value = Emission Level – Limit value
5. " * ": Fundamental frequency.
6. " # ": The radiated frequency is out of the restricted band.

CHANNEL	TX Channel 144	DETECTOR FUNCTION	Peak (PK)
FREQUENCY RANGE	1GHz ~ 40GHz		Average (AV)

ANTENNA POLARITY & TEST DISTANCE: HORIZONTAL AT 3 M

NO.	FREQ. (MHz)	EMISSION LEVEL (dBuV/m)	LIMIT (dBuV/m)	MARGIN (dB)	ANTENNA HEIGHT (m)	TABLE ANGLE (Degree)	RAW VALUE (dBuV)	CORRECTION FACTOR (dB/m)
1	5460.00	57.7 PK	74.0	-16.3	1.72 H	237	54.7	3.0
2	5460.00	50.5 AV	54.0	-3.5	1.72 H	237	47.5	3.0
3	#5470.00	59.8 PK	68.2	-8.4	1.72 H	237	56.8	3.0
4	*5720.00	115.6 PK			1.72 H	237	112.4	3.2
5	*5720.00	103.0 AV			1.72 H	237	99.8	3.2
6	#5850.00	50.2 PK	68.2	-18.0	1.72 H	237	46.6	3.6
7	11440.00	49.8 PK	74.0	-24.2	1.64 H	208	36.9	12.9
8	11440.00	43.1 AV	54.0	-10.9	1.64 H	208	30.2	12.9
9	#17160.00	52.7 PK	68.2	-15.5	1.88 H	16	36.6	16.1

ANTENNA POLARITY & TEST DISTANCE: VERTICAL AT 3 M

NO.	FREQ. (MHz)	EMISSION LEVEL (dBuV/m)	LIMIT (dBuV/m)	MARGIN (dB)	ANTENNA HEIGHT (m)	TABLE ANGLE (Degree)	RAW VALUE (dBuV)	CORRECTION FACTOR (dB/m)
1	5460.00	53.8 PK	74.0	-20.2	1.83 V	250	50.8	3.0
2	5460.00	48.6 AV	54.0	-5.4	1.83 V	250	45.6	3.0
3	#5470.00	56.2 PK	68.2	-12.0	1.83 V	250	53.2	3.0
4	*5720.00	114.2 PK			1.83 V	250	111.0	3.2
5	*5720.00	101.4 AV			1.83 V	250	98.2	3.2
6	#5850.00	61.5 PK	68.2	-6.7	1.83 V	250	57.9	3.6
7	11440.00	49.4 PK	74.0	-24.6	1.16 V	239	36.5	12.9
8	11440.00	44.7 AV	54.0	-9.3	1.16 V	239	31.8	12.9
9	#17160.00	57.5 PK	68.2	-10.7	3.03 V	263	41.4	16.1

REMARKS:

1. Emission Level(dBuV/m) = Raw Value(dBuV) + Correction Factor(dB/m)
2. Correction Factor(dB/m) = Antenna Factor(dB/m) + Cable Factor(dB) – Pre-Amplifier Factor(dB)
3. The other emission levels were very low against the limit.
4. Margin value = Emission Level – Limit value
5. " * ": Fundamental frequency.
6. " # ": The radiated frequency is out of the restricted band.

802.11ax (HE20)

CHANNEL	TX Channel 52	DETECTOR FUNCTION	Peak (PK)
FREQUENCY RANGE	1GHz ~ 40GHz		Average (AV)

ANTENNA POLARITY & TEST DISTANCE: HORIZONTAL AT 3 M

NO.	FREQ. (MHz)	EMISSION LEVEL (dBuV/m)	LIMIT (dBuV/m)	MARGIN (dB)	ANTENNA HEIGHT (m)	TABLE ANGLE (Degree)	RAW VALUE (dBuV)	CORRECTION FACTOR (dB/m)
1	5150.00	66.6 PK	74.0	-7.4	1.75 H	252	63.7	2.9
2	5150.00	51.2 AV	54.0	-2.8	1.75 H	252	48.3	2.9
3	*5260.00	114.8 PK			1.75 H	252	112.4	2.4
4	*5260.00	102.4 AV			1.75 H	252	100.0	2.4
5	#10520.00	49.7 PK	68.2	-18.5	1.68 H	204	37.4	12.3
6	15780.00	52.0 PK	74.0	-22.0	1.85 H	18	40.0	12.0
7	15780.00	40.3 AV	54.0	-13.7	1.85 H	18	28.3	12.0

ANTENNA POLARITY & TEST DISTANCE: VERTICAL AT 3 M

NO.	FREQ. (MHz)	EMISSION LEVEL (dBuV/m)	LIMIT (dBuV/m)	MARGIN (dB)	ANTENNA HEIGHT (m)	TABLE ANGLE (Degree)	RAW VALUE (dBuV)	CORRECTION FACTOR (dB/m)
1	5150.00	56.8 PK	74.0	-17.2	1.86 V	256	53.9	2.9
2	5150.00	43.3 AV	54.0	-10.7	1.86 V	256	40.4	2.9
3	*5260.00	113.5 PK			1.86 V	256	111.1	2.4
4	*5260.00	100.6 AV			1.86 V	256	98.2	2.4
5	#10520.00	49.2 PK	68.2	-19.0	1.17 V	236	36.9	12.3
6	15780.00	57.2 PK	74.0	-16.8	3.05 V	275	45.2	12.0
7	15780.00	47.0 AV	54.0	-7.0	3.05 V	275	35.0	12.0

REMARKS:

- Emission Level(dBuV/m) = Raw Value(dBuV) + Correction Factor(dB/m)
- Correction Factor(dB/m) = Antenna Factor(dB/m) + Cable Factor(dB) – Pre-Amplifier Factor(dB)
- The other emission levels were very low against the limit.
- Margin value = Emission Level – Limit value
- " * ": Fundamental frequency.
- " # ": The radiated frequency is out of the restricted band.

CHANNEL	TX Channel 60	DETECTOR FUNCTION	Peak (PK)
FREQUENCY RANGE	1GHz ~ 40GHz		Average (AV)

ANTENNA POLARITY & TEST DISTANCE: HORIZONTAL AT 3 M

NO.	FREQ. (MHz)	EMISSION LEVEL (dBuV/m)	LIMIT (dBuV/m)	MARGIN (dB)	ANTENNA HEIGHT (m)	TABLE ANGLE (Degree)	RAW VALUE (dBuV)	CORRECTION FACTOR (dB/m)
1	*5300.00	115.0 PK			1.69 H	253	112.4	2.6
2	*5300.00	102.3 AV			1.69 H	253	99.7	2.6
3	10600.00	48.5 PK	74.0	-25.5	1.68 H	178	36.4	12.1
4	10600.00	42.3 AV	54.0	-11.7	1.68 H	178	30.2	12.1
5	15900.00	53.2 PK	74.0	-20.8	1.84 H	40	41.4	11.8
6	15900.00	41.1 AV	54.0	-12.9	1.84 H	40	29.3	11.8

ANTENNA POLARITY & TEST DISTANCE: VERTICAL AT 3 M

NO.	FREQ. (MHz)	EMISSION LEVEL (dBuV/m)	LIMIT (dBuV/m)	MARGIN (dB)	ANTENNA HEIGHT (m)	TABLE ANGLE (Degree)	RAW VALUE (dBuV)	CORRECTION FACTOR (dB/m)
1	*5300.00	113.8 PK			1.90 V	257	111.2	2.6
2	*5300.00	101.1 AV			1.90 V	257	98.5	2.6
3	10600.00	49.1 PK	74.0	-24.9	1.22 V	229	37.0	12.1
4	10600.00	44.4 AV	54.0	-9.6	1.22 V	229	32.3	12.1
5	15900.00	57.1 PK	74.0	-16.9	3.02 V	265	45.3	11.8
6	15900.00	46.7 AV	54.0	-7.3	3.02 V	265	34.9	11.8

REMARKS:

1. Emission Level(dBuV/m) = Raw Value(dBuV) + Correction Factor(dB/m)
2. Correction Factor(dB/m) = Antenna Factor(dB/m) + Cable Factor(dB) – Pre-Amplifier Factor(dB)
3. The other emission levels were very low against the limit.
4. Margin value = Emission Level – Limit value
5. " * ": Fundamental frequency.

CHANNEL	TX Channel 64	DETECTOR FUNCTION	Peak (PK)
FREQUENCY RANGE	1GHz ~ 40GHz		Average (AV)

ANTENNA POLARITY & TEST DISTANCE: HORIZONTAL AT 3 M

NO.	FREQ. (MHz)	EMISSION LEVEL (dBuV/m)	LIMIT (dBuV/m)	MARGIN (dB)	ANTENNA HEIGHT (m)	TABLE ANGLE (Degree)	RAW VALUE (dBuV)	CORRECTION FACTOR (dB/m)
1	*5320.00	115.0 PK			1.72 H	237	112.4	2.6
2	*5320.00	102.8 AV			1.72 H	237	100.2	2.6
3	5350.00	64.6 PK	74.0	-9.4	1.72 H	237	61.9	2.7
4	5350.00	49.8 AV	54.0	-4.2	1.72 H	237	47.1	2.7
5	10640.00	49.5 PK	74.0	-24.5	1.66 H	179	37.6	11.9
6	10640.00	43.3 AV	54.0	-10.7	1.66 H	179	31.4	11.9
7	15960.00	52.9 PK	74.0	-21.1	1.92 H	19	40.8	12.1
8	15960.00	41.0 AV	54.0	-13.0	1.92 H	19	28.9	12.1

ANTENNA POLARITY & TEST DISTANCE: VERTICAL AT 3 M

NO.	FREQ. (MHz)	EMISSION LEVEL (dBuV/m)	LIMIT (dBuV/m)	MARGIN (dB)	ANTENNA HEIGHT (m)	TABLE ANGLE (Degree)	RAW VALUE (dBuV)	CORRECTION FACTOR (dB/m)
1	*5320.00	113.1 PK			1.90 V	268	110.5	2.6
2	*5320.00	100.3 AV			1.90 V	268	97.7	2.6
3	5350.00	53.4 PK	74.0	-20.6	1.90 V	268	50.7	2.7
4	5350.00	40.1 AV	54.0	-13.9	1.90 V	268	37.4	2.7
5	10640.00	49.4 PK	74.0	-24.6	1.25 V	221	37.5	11.9
6	10640.00	44.7 AV	54.0	-9.3	1.25 V	221	32.8	11.9
7	15960.00	57.1 PK	74.0	-16.9	3.02 V	271	45.0	12.1
8	15960.00	47.0 AV	54.0	-7.0	3.02 V	271	34.9	12.1

REMARKS:

1. Emission Level(dBuV/m) = Raw Value(dBuV) + Correction Factor(dB/m)
2. Correction Factor(dB/m) = Antenna Factor(dB/m) + Cable Factor(dB) – Pre-Amplifier Factor(dB)
3. The other emission levels were very low against the limit.
4. Margin value = Emission Level – Limit value
5. " * ": Fundamental frequency.

CHANNEL	TX Channel 100	DETECTOR FUNCTION	Peak (PK)
FREQUENCY RANGE	1GHz ~ 40GHz		Average (AV)

ANTENNA POLARITY & TEST DISTANCE: HORIZONTAL AT 3 M

NO.	FREQ. (MHz)	EMISSION LEVEL (dBuV/m)	LIMIT (dBuV/m)	MARGIN (dB)	ANTENNA HEIGHT (m)	TABLE ANGLE (Degree)	RAW VALUE (dBuV)	CORRECTION FACTOR (dB/m)
1	5460.00	63.0 PK	74.0	-11.0	1.70 H	235	60.0	3.0
2	5460.00	44.1 AV	54.0	-9.9	1.70 H	235	41.1	3.0
3	#5470.00	65.9 PK	68.2	-2.3	1.70 H	235	62.9	3.0
4	*5500.00	115.3 PK			1.70 H	235	112.4	2.9
5	*5500.00	103.1 AV			1.70 H	235	100.2	2.9
6	11000.00	48.9 PK	74.0	-25.1	1.60 H	194	36.1	12.8
7	11000.00	42.5 AV	54.0	-11.5	1.60 H	194	29.7	12.8
8	#16500.00	52.8 PK	68.2	-15.4	1.91 H	40	38.4	14.4

ANTENNA POLARITY & TEST DISTANCE: VERTICAL AT 3 M

NO.	FREQ. (MHz)	EMISSION LEVEL (dBuV/m)	LIMIT (dBuV/m)	MARGIN (dB)	ANTENNA HEIGHT (m)	TABLE ANGLE (Degree)	RAW VALUE (dBuV)	CORRECTION FACTOR (dB/m)
1	5460.00	56.0 PK	74.0	-18.0	1.84 V	244	53.0	3.0
2	5460.00	42.6 AV	54.0	-11.4	1.84 V	244	39.6	3.0
3	#5470.00	55.8 PK	68.2	-12.4	1.84 V	244	52.8	3.0
4	*5500.00	114.3 PK			1.84 V	244	111.4	2.9
5	*5500.00	101.4 AV			1.84 V	244	98.5	2.9
6	11000.00	49.6 PK	74.0	-24.4	1.28 V	226	36.8	12.8
7	11000.00	44.8 AV	54.0	-9.2	1.28 V	226	32.0	12.8
8	#16500.00	57.5 PK	68.2	-10.7	2.96 V	254	43.1	14.4

REMARKS:

1. Emission Level(dBuV/m) = Raw Value(dBuV) + Correction Factor(dB/m)
2. Correction Factor(dB/m) = Antenna Factor(dB/m) + Cable Factor(dB) – Pre-Amplifier Factor(dB)
3. The other emission levels were very low against the limit.
4. Margin value = Emission Level – Limit value
5. " * ": Fundamental frequency.
6. " # ": The radiated frequency is out of the restricted band.

CHANNEL	TX Channel 116	DETECTOR FUNCTION	Peak (PK)
FREQUENCY RANGE	1GHz ~ 40GHz		Average (AV)

ANTENNA POLARITY & TEST DISTANCE: HORIZONTAL AT 3 M

NO.	FREQ. (MHz)	EMISSION LEVEL (dBuV/m)	LIMIT (dBuV/m)	MARGIN (dB)	ANTENNA HEIGHT (m)	TABLE ANGLE (Degree)	RAW VALUE (dBuV)	CORRECTION FACTOR (dB/m)
1	*5580.00	115.3 PK			1.71 H	235	112.3	3.0
2	*5580.00	103.1 AV			1.71 H	235	100.1	3.0
3	11160.00	49.0 PK	74.0	-25.0	1.66 H	179	36.7	12.3
4	11160.00	42.7 AV	54.0	-11.3	1.66 H	179	30.4	12.3
5	#16740.00	52.2 PK	68.2	-16.0	1.85 H	24	37.5	14.7

ANTENNA POLARITY & TEST DISTANCE: VERTICAL AT 3 M

NO.	FREQ. (MHz)	EMISSION LEVEL (dBuV/m)	LIMIT (dBuV/m)	MARGIN (dB)	ANTENNA HEIGHT (m)	TABLE ANGLE (Degree)	RAW VALUE (dBuV)	CORRECTION FACTOR (dB/m)
1	*5580.00	114.0 PK			1.88 V	251	111.0	3.0
2	*5580.00	101.1 AV			1.88 V	251	98.1	3.0
3	11160.00	49.0 PK	74.0	-25.0	1.22 V	224	36.7	12.3
4	11160.00	44.5 AV	54.0	-9.5	1.22 V	224	32.2	12.3
5	#16740.00	57.4 PK	68.2	-10.8	3.07 V	251	42.7	14.7

REMARKS:

1. Emission Level(dBuV/m) = Raw Value(dBuV) + Correction Factor(dB/m)
2. Correction Factor(dB/m) = Antenna Factor(dB/m) + Cable Factor(dB) – Pre-Amplifier Factor(dB)
3. The other emission levels were very low against the limit.
4. Margin value = Emission Level – Limit value
5. " * ": Fundamental frequency.
6. " # ": The radiated frequency is out of the restricted band.

CHANNEL	TX Channel 140	DETECTOR FUNCTION	Peak (PK)
FREQUENCY RANGE	1GHz ~ 40GHz		Average (AV)

ANTENNA POLARITY & TEST DISTANCE: HORIZONTAL AT 3 M

NO.	FREQ. (MHz)	EMISSION LEVEL (dBuV/m)	LIMIT (dBuV/m)	MARGIN (dB)	ANTENNA HEIGHT (m)	TABLE ANGLE (Degree)	RAW VALUE (dBuV)	CORRECTION FACTOR (dB/m)
1	*5700.00	115.3 PK			1.71 H	247	112.1	3.2
2	*5700.00	102.7 AV			1.71 H	247	99.5	3.2
3	#5725.00	64.3 PK	68.2	-3.9	1.71 H	247	61.1	3.2
4	11400.00	49.7 PK	74.0	-24.3	1.62 H	204	36.7	13.0
5	11400.00	43.1 AV	54.0	-10.9	1.62 H	204	30.1	13.0
6	#17100.00	52.6 PK	68.2	-15.6	1.93 H	18	36.1	16.5

ANTENNA POLARITY & TEST DISTANCE: VERTICAL AT 3 M

NO.	FREQ. (MHz)	EMISSION LEVEL (dBuV/m)	LIMIT (dBuV/m)	MARGIN (dB)	ANTENNA HEIGHT (m)	TABLE ANGLE (Degree)	RAW VALUE (dBuV)	CORRECTION FACTOR (dB/m)
1	*5700.00	114.0 PK			1.89 V	238	110.8	3.2
2	*5700.00	101.4 AV			1.89 V	238	98.2	3.2
3	#5725.00	53.4 PK	68.2	-14.8	1.89 V	238	50.2	3.2
4	11400.00	48.6 PK	74.0	-25.4	1.28 V	242	35.6	13.0
5	11400.00	44.2 AV	54.0	-9.8	1.28 V	242	31.2	13.0
6	#17100.00	57.5 PK	68.2	-10.7	3.03 V	250	41.0	16.5

REMARKS:

1. Emission Level(dBuV/m) = Raw Value(dBuV) + Correction Factor(dB/m)
2. Correction Factor(dB/m) = Antenna Factor(dB/m) + Cable Factor(dB) – Pre-Amplifier Factor(dB)
3. The other emission levels were very low against the limit.
4. Margin value = Emission Level – Limit value
5. " * ": Fundamental frequency.
6. " # ": The radiated frequency is out of the restricted band.

CHANNEL	TX Channel 144	DETECTOR FUNCTION	Peak (PK)
FREQUENCY RANGE	1GHz ~ 40GHz		Average (AV)

ANTENNA POLARITY & TEST DISTANCE: HORIZONTAL AT 3 M

NO.	FREQ. (MHz)	EMISSION LEVEL (dBuV/m)	LIMIT (dBuV/m)	MARGIN (dB)	ANTENNA HEIGHT (m)	TABLE ANGLE (Degree)	RAW VALUE (dBuV)	CORRECTION FACTOR (dB/m)
1	5460.00	57.6 PK	74.0	-16.4	1.71 H	248	54.6	3.0
2	5460.00	50.2 AV	54.0	-3.8	1.71 H	248	47.2	3.0
3	#5470.00	59.9 PK	68.2	-8.3	1.71 H	248	56.9	3.0
4	*5720.00	115.0 PK			1.71 H	248	111.8	3.2
5	*5720.00	102.6 AV			1.71 H	248	99.4	3.2
6	#5850.00	50.2 PK	68.2	-18.0	1.71 H	248	46.6	3.6
7	11440.00	49.5 PK	74.0	-24.5	1.69 H	179	36.6	12.9
8	11440.00	43.2 AV	54.0	-10.8	1.69 H	179	30.3	12.9
9	#17160.00	52.7 PK	68.2	-15.5	1.87 H	44	36.6	16.1

ANTENNA POLARITY & TEST DISTANCE: VERTICAL AT 3 M

NO.	FREQ. (MHz)	EMISSION LEVEL (dBuV/m)	LIMIT (dBuV/m)	MARGIN (dB)	ANTENNA HEIGHT (m)	TABLE ANGLE (Degree)	RAW VALUE (dBuV)	CORRECTION FACTOR (dB/m)
1	5460.00	54.4 PK	74.0	-19.6	1.83 V	241	51.4	3.0
2	5460.00	49.0 AV	54.0	-5.0	1.83 V	241	46.0	3.0
3	#5470.00	56.9 PK	68.2	-11.3	1.83 V	241	53.9	3.0
4	*5720.00	114.6 PK			1.83 V	241	111.4	3.2
5	*5720.00	101.6 AV			1.83 V	241	98.4	3.2
6	#5850.00	61.2 PK	68.2	-7.0	1.83 V	241	57.6	3.6
7	11440.00	48.8 PK	74.0	-25.2	1.24 V	215	35.9	12.9
8	11440.00	44.3 AV	54.0	-9.7	1.24 V	215	31.4	12.9
9	#17160.00	57.8 PK	68.2	-10.4	3.00 V	254	41.7	16.1

REMARKS:

1. Emission Level(dBuV/m) = Raw Value(dBuV) + Correction Factor(dB/m)
2. Correction Factor(dB/m) = Antenna Factor(dB/m) + Cable Factor(dB) – Pre-Amplifier Factor(dB)
3. The other emission levels were very low against the limit.
4. Margin value = Emission Level – Limit value
5. " * ": Fundamental frequency.
6. " # ": The radiated frequency is out of the restricted band.

802.11ax (HE40)

CHANNEL	TX Channel 54	DETECTOR FUNCTION	Peak (PK)
FREQUENCY RANGE	1GHz ~ 40GHz		Average (AV)

ANTENNA POLARITY & TEST DISTANCE: HORIZONTAL AT 3 M

NO.	FREQ. (MHz)	EMISSION LEVEL (dBuV/m)	LIMIT (dBuV/m)	MARGIN (dB)	ANTENNA HEIGHT (m)	TABLE ANGLE (Degree)	RAW VALUE (dBuV)	CORRECTION FACTOR (dB/m)
1	5150.00	66.4 PK	74.0	-7.6	1.15 H	282	63.5	2.9
2	5150.00	51.0 AV	54.0	-3.0	1.15 H	282	48.1	2.9
3	*5270.00	114.5 PK			1.15 H	282	112.1	2.4
4	*5270.00	103.1 AV			1.15 H	282	100.7	2.4
5	5350.00	59.9 PK	74.0	-14.1	1.15 H	282	57.2	2.7
6	5350.00	45.8 AV	54.0	-8.2	1.15 H	282	43.1	2.7
7	#10540.00	49.4 PK	68.2	-18.8	1.65 H	209	37.2	12.2
8	15810.00	52.7 PK	74.0	-21.3	1.91 H	28	40.9	11.8
9	15810.00	41.0 AV	54.0	-13.0	1.91 H	28	29.2	11.8

ANTENNA POLARITY & TEST DISTANCE: VERTICAL AT 3 M

NO.	FREQ. (MHz)	EMISSION LEVEL (dBuV/m)	LIMIT (dBuV/m)	MARGIN (dB)	ANTENNA HEIGHT (m)	TABLE ANGLE (Degree)	RAW VALUE (dBuV)	CORRECTION FACTOR (dB/m)
1	5150.00	55.1 PK	74.0	-18.9	2.15 V	250	52.2	2.9
2	5150.00	42.1 AV	54.0	-11.9	2.15 V	250	39.2	2.9
3	*5270.00	114.4 PK			2.15 V	250	112.0	2.4
4	*5270.00	102.6 AV			2.15 V	250	100.2	2.4
5	5350.00	55.9 PK	74.0	-18.1	2.15 V	250	53.2	2.7
6	5350.00	41.7 AV	54.0	-12.3	2.15 V	250	39.0	2.7
7	#10540.00	49.5 PK	68.2	-18.7	1.24 V	241	37.3	12.2
8	15810.00	57.2 PK	74.0	-16.8	2.98 V	270	45.4	11.8
9	15810.00	47.1 AV	54.0	-6.9	2.98 V	270	35.3	11.8

REMARKS:

- Emission Level(dBuV/m) = Raw Value(dBuV) + Correction Factor(dB/m)
- Correction Factor(dB/m) = Antenna Factor(dB/m) + Cable Factor(dB) – Pre-Amplifier Factor(dB)
- The other emission levels were very low against the limit.
- Margin value = Emission Level – Limit value
- " * ": Fundamental frequency.
- " # ": The radiated frequency is out of the restricted band.

CHANNEL	TX Channel 62	DETECTOR FUNCTION	Peak (PK)
FREQUENCY RANGE	1GHz ~ 40GHz		Average (AV)

ANTENNA POLARITY & TEST DISTANCE: HORIZONTAL AT 3 M

NO.	FREQ. (MHz)	EMISSION LEVEL (dBuV/m)	LIMIT (dBuV/m)	MARGIN (dB)	ANTENNA HEIGHT (m)	TABLE ANGLE (Degree)	RAW VALUE (dBuV)	CORRECTION FACTOR (dB/m)
1	5070.00	58.6 PK	74.0	-15.4	1.18 H	274	55.8	2.8
2	5070.00	46.0 AV	54.0	-8.0	1.18 H	274	43.2	2.8
3	*5310.00	115.1 PK			1.18 H	274	112.5	2.6
4	*5310.00	103.5 AV			1.18 H	274	100.9	2.6
5	5350.00	64.4 PK	74.0	-9.6	1.18 H	274	61.7	2.7
6	5350.00	51.4 AV	54.0	-2.6	1.18 H	274	48.7	2.7
7	10620.00	49.7 PK	74.0	-24.3	1.58 H	201	37.7	12.0
8	10620.00	43.1 AV	54.0	-10.9	1.58 H	201	31.1	12.0
9	15930.00	52.1 PK	74.0	-21.9	1.86 H	22	40.3	11.8
10	15930.00	40.2 AV	54.0	-13.8	1.86 H	22	28.4	11.8

ANTENNA POLARITY & TEST DISTANCE: VERTICAL AT 3 M

NO.	FREQ. (MHz)	EMISSION LEVEL (dBuV/m)	LIMIT (dBuV/m)	MARGIN (dB)	ANTENNA HEIGHT (m)	TABLE ANGLE (Degree)	RAW VALUE (dBuV)	CORRECTION FACTOR (dB/m)
1	5150.00	54.6 PK	74.0	-19.4	2.14 V	255	51.7	2.9
2	5150.00	41.6 AV	54.0	-12.4	2.14 V	255	38.7	2.9
3	*5310.00	115.0 PK			2.14 V	255	112.4	2.6
4	*5310.00	103.1 AV			2.14 V	255	100.5	2.6
5	5350.00	54.3 PK	74.0	-19.7	2.14 V	255	51.6	2.7
6	5350.00	42.0 AV	54.0	-12.0	2.14 V	255	39.3	2.7
7	10620.00	49.0 PK	74.0	-25.0	1.23 V	221	37.0	12.0
8	10620.00	44.4 AV	54.0	-9.6	1.23 V	221	32.4	12.0
9	15930.00	57.5 PK	74.0	-16.5	2.99 V	256	45.7	11.8
10	15930.00	47.3 AV	54.0	-6.7	2.99 V	256	35.5	11.8

REMARKS:

1. Emission Level(dBuV/m) = Raw Value(dBuV) + Correction Factor(dB/m)
2. Correction Factor(dB/m) = Antenna Factor(dB/m) + Cable Factor(dB) – Pre-Amplifier Factor(dB)
3. The other emission levels were very low against the limit.
4. Margin value = Emission Level – Limit value
5. " * ": Fundamental frequency.

CHANNEL	TX Channel 102	DETECTOR FUNCTION	Peak (PK)
FREQUENCY RANGE	1GHz ~ 40GHz		Average (AV)

ANTENNA POLARITY & TEST DISTANCE: HORIZONTAL AT 3 M

NO.	FREQ. (MHz)	EMISSION LEVEL (dBuV/m)	LIMIT (dBuV/m)	MARGIN (dB)	ANTENNA HEIGHT (m)	TABLE ANGLE (Degree)	RAW VALUE (dBuV)	CORRECTION FACTOR (dB/m)
1	5460.00	59.8 PK	74.0	-14.2	1.20 H	295	56.8	3.0
2	5460.00	52.4 AV	54.0	-1.6	1.20 H	295	49.4	3.0
3	#5470.00	59.9 PK	68.2	-8.3	1.20 H	295	56.9	3.0
4	*5510.00	114.9 PK			1.20 H	295	112.0	2.9
5	*5510.00	103.7 AV			1.20 H	295	100.8	2.9
6	#5725.00	50.1 PK	68.2	-18.1	1.20 H	295	46.9	3.2
7	11020.00	49.1 PK	74.0	-24.9	1.60 H	203	36.3	12.8
8	11020.00	42.6 AV	54.0	-11.4	1.60 H	203	29.8	12.8
9	#16530.00	52.5 PK	68.2	-15.7	1.95 H	33	37.9	14.6

ANTENNA POLARITY & TEST DISTANCE: VERTICAL AT 3 M

NO.	FREQ. (MHz)	EMISSION LEVEL (dBuV/m)	LIMIT (dBuV/m)	MARGIN (dB)	ANTENNA HEIGHT (m)	TABLE ANGLE (Degree)	RAW VALUE (dBuV)	CORRECTION FACTOR (dB/m)
1	5460.00	57.0 PK	74.0	-17.0	2.11 V	271	54.0	3.0
2	5460.00	49.0 AV	54.0	-5.0	2.11 V	271	46.0	3.0
3	#5470.00	56.3 PK	68.2	-11.9	2.11 V	271	53.3	3.0
4	*5510.00	115.4 PK			2.11 V	271	112.5	2.9
5	*5510.00	103.5 AV			2.11 V	271	100.6	2.9
6	#5725.00	61.1 PK	68.2	-7.1	2.11 V	271	57.9	3.2
7	11020.00	49.6 PK	74.0	-24.4	1.20 V	222	36.8	12.8
8	11020.00	44.7 AV	54.0	-9.3	1.20 V	222	31.9	12.8
9	#16530.00	57.1 PK	68.2	-11.1	3.03 V	264	42.5	14.6

REMARKS:

1. Emission Level(dBuV/m) = Raw Value(dBuV) + Correction Factor(dB/m)
2. Correction Factor(dB/m) = Antenna Factor(dB/m) + Cable Factor(dB) – Pre-Amplifier Factor(dB)
3. The other emission levels were very low against the limit.
4. Margin value = Emission Level – Limit value
5. " * ": Fundamental frequency.
6. " # ": The radiated frequency is out of the restricted band.

CHANNEL	TX Channel 110	DETECTOR FUNCTION	Peak (PK)
FREQUENCY RANGE	1GHz ~ 40GHz		Average (AV)

ANTENNA POLARITY & TEST DISTANCE: HORIZONTAL AT 3 M

NO.	FREQ. (MHz)	EMISSION LEVEL (dBuV/m)	LIMIT (dBuV/m)	MARGIN (dB)	ANTENNA HEIGHT (m)	TABLE ANGLE (Degree)	RAW VALUE (dBuV)	CORRECTION FACTOR (dB/m)
1	*5550.00	115.2 PK			1.20 H	286	112.2	3.0
2	*5550.00	103.8 AV			1.20 H	286	100.8	3.0
3	11100.00	49.3 PK	74.0	-24.7	1.58 H	204	37.0	12.3
4	11100.00	42.8 AV	54.0	-11.2	1.58 H	204	30.5	12.3
5	#16650.00	52.0 PK	68.2	-16.2	1.93 H	24	37.3	14.7

ANTENNA POLARITY & TEST DISTANCE: VERTICAL AT 3 M

NO.	FREQ. (MHz)	EMISSION LEVEL (dBuV/m)	LIMIT (dBuV/m)	MARGIN (dB)	ANTENNA HEIGHT (m)	TABLE ANGLE (Degree)	RAW VALUE (dBuV)	CORRECTION FACTOR (dB/m)
1	*5550.00	115.8 PK			2.07 V	266	112.8	3.0
2	*5550.00	103.6 AV			2.07 V	266	100.6	3.0
3	11100.00	49.5 PK	74.0	-24.5	1.27 V	219	37.2	12.3
4	11100.00	45.0 AV	54.0	-9.0	1.27 V	219	32.7	12.3
5	#16650.00	57.7 PK	68.2	-10.5	3.10 V	253	43.0	14.7

REMARKS:

1. Emission Level(dBuV/m) = Raw Value(dBuV) + Correction Factor(dB/m)
2. Correction Factor(dB/m) = Antenna Factor(dB/m) + Cable Factor(dB) – Pre-Amplifier Factor(dB)
3. The other emission levels were very low against the limit.
4. Margin value = Emission Level – Limit value
5. " * ": Fundamental frequency.
6. " # ": The radiated frequency is out of the restricted band.

CHANNEL	TX Channel 134	DETECTOR FUNCTION	Peak (PK)
FREQUENCY RANGE	1GHz ~ 40GHz		Average (AV)

ANTENNA POLARITY & TEST DISTANCE: HORIZONTAL AT 3 M

NO.	FREQ. (MHz)	EMISSION LEVEL (dBuV/m)	LIMIT (dBuV/m)	MARGIN (dB)	ANTENNA HEIGHT (m)	TABLE ANGLE (Degree)	RAW VALUE (dBuV)	CORRECTION FACTOR (dB/m)
1	*5670.00	114.5 PK			1.23 H	299	111.3	3.2
2	*5670.00	103.3 AV			1.23 H	299	100.1	3.2
3	#5725.00	64.3 PK	68.2	-3.9	1.23 H	299	61.1	3.2
4	11340.00	49.2 PK	74.0	-24.8	1.69 H	191	36.1	13.1
5	11340.00	42.8 AV	54.0	-11.2	1.69 H	191	29.7	13.1
6	#17010.00	52.0 PK	68.2	-16.2	1.92 H	36	35.6	16.4

ANTENNA POLARITY & TEST DISTANCE: VERTICAL AT 3 M

NO.	FREQ. (MHz)	EMISSION LEVEL (dBuV/m)	LIMIT (dBuV/m)	MARGIN (dB)	ANTENNA HEIGHT (m)	TABLE ANGLE (Degree)	RAW VALUE (dBuV)	CORRECTION FACTOR (dB/m)
1	*5670.00	115.4 PK			2.11 V	271	112.2	3.2
2	*5670.00	103.5 AV			2.11 V	271	100.3	3.2
3	#5725.00	60.3 PK	68.2	-7.9	2.11 V	271	57.1	3.2
4	11340.00	49.1 PK	74.0	-24.9	1.25 V	218	36.0	13.1
5	11340.00	44.7 AV	54.0	-9.3	1.25 V	218	31.6	13.1
6	#17010.00	57.8 PK	68.2	-10.4	3.06 V	252	41.4	16.4

REMARKS:

1. Emission Level(dBuV/m) = Raw Value(dBuV) + Correction Factor(dB/m)
2. Correction Factor(dB/m) = Antenna Factor(dB/m) + Cable Factor(dB) – Pre-Amplifier Factor(dB)
3. The other emission levels were very low against the limit.
4. Margin value = Emission Level – Limit value
5. " * ": Fundamental frequency.
6. " # ": The radiated frequency is out of the restricted band.

CHANNEL	TX Channel 142	DETECTOR FUNCTION	Peak (PK)
FREQUENCY RANGE	1GHz ~ 40GHz		Average (AV)

ANTENNA POLARITY & TEST DISTANCE: HORIZONTAL AT 3 M

NO.	FREQ. (MHz)	EMISSION LEVEL (dBuV/m)	LIMIT (dBuV/m)	MARGIN (dB)	ANTENNA HEIGHT (m)	TABLE ANGLE (Degree)	RAW VALUE (dBuV)	CORRECTION FACTOR (dB/m)
1	5460.00	54.5 PK	74.0	-19.5	1.24 H	303	51.5	3.0
2	5460.00	41.6 AV	54.0	-12.4	1.24 H	303	38.6	3.0
3	#5470.00	52.8 PK	68.2	-15.4	1.24 H	303	49.8	3.0
4	*5710.00	115.5 PK			1.24 H	303	112.2	3.3
5	*5710.00	104.0 AV			1.24 H	303	100.7	3.3
6	#5850.00	63.2 PK	68.2	-5.0	1.24 H	303	59.6	3.6
7	11420.00	49.5 PK	74.0	-24.5	1.60 H	197	36.5	13.0
8	11420.00	43.1 AV	54.0	-10.9	1.60 H	197	30.1	13.0
9	#17130.00	52.6 PK	68.2	-15.6	1.89 H	14	36.3	16.3

ANTENNA POLARITY & TEST DISTANCE: VERTICAL AT 3 M

NO.	FREQ. (MHz)	EMISSION LEVEL (dBuV/m)	LIMIT (dBuV/m)	MARGIN (dB)	ANTENNA HEIGHT (m)	TABLE ANGLE (Degree)	RAW VALUE (dBuV)	CORRECTION FACTOR (dB/m)
1	5460.00	54.8 PK	74.0	-19.2	2.11 V	271	51.8	3.0
2	5460.00	42.8 AV	54.0	-11.2	2.11 V	271	39.8	3.0
3	#5470.00	62.2 PK	68.2	-6.0	2.11 V	271	59.2	3.0
4	*5710.00	115.4 PK			2.11 V	271	112.1	3.3
5	*5710.00	103.5 AV			2.11 V	271	100.2	3.3
6	#5850.00	59.2 PK	68.2	-9.0	2.11 V	271	55.6	3.6
7	11420.00	49.5 PK	74.0	-24.5	1.27 V	217	36.5	13.0
8	11420.00	45.1 AV	54.0	-8.9	1.27 V	217	32.1	13.0
9	#17130.00	57.2 PK	68.2	-11.0	3.08 V	277	40.9	16.3

REMARKS:

1. Emission Level(dBuV/m) = Raw Value(dBuV) + Correction Factor(dB/m)
2. Correction Factor(dB/m) = Antenna Factor(dB/m) + Cable Factor(dB) – Pre-Amplifier Factor(dB)
3. The other emission levels were very low against the limit.
4. Margin value = Emission Level – Limit value
5. " * ": Fundamental frequency.
6. " # ": The radiated frequency is out of the restricted band.

802.11ax (HE80)

CHANNEL	TX Channel 58	DETECTOR FUNCTION	Peak (PK)
FREQUENCY RANGE	1GHz ~ 40GHz		Average (AV)

ANTENNA POLARITY & TEST DISTANCE: HORIZONTAL AT 3 M

NO.	FREQ. (MHz)	EMISSION LEVEL (dBuV/m)	LIMIT (dBuV/m)	MARGIN (dB)	ANTENNA HEIGHT (m)	TABLE ANGLE (Degree)	RAW VALUE (dBuV)	CORRECTION FACTOR (dB/m)
1	5150.00	54.1 PK	74.0	-19.9	1.68 H	278	51.2	2.9
2	5150.00	41.8 AV	54.0	-12.2	1.68 H	278	38.9	2.9
3	*5290.00	106.1 PK			1.68 H	278	103.7	2.4
4	*5290.00	94.0 AV			1.68 H	278	91.6	2.4
5	5350.00	64.1 PK	74.0	-9.9	1.68 H	278	61.4	2.7
6	5350.00	51.7 AV	54.0	-2.3	1.68 H	278	49.0	2.7
7	#10580.00	49.1 PK	68.2	-19.1	1.68 H	191	37.0	12.1
8	15870.00	53.1 PK	74.0	-20.9	1.84 H	44	41.4	11.7
9	15870.00	41.0 AV	54.0	-13.0	1.84 H	44	29.3	11.7

ANTENNA POLARITY & TEST DISTANCE: VERTICAL AT 3 M

NO.	FREQ. (MHz)	EMISSION LEVEL (dBuV/m)	LIMIT (dBuV/m)	MARGIN (dB)	ANTENNA HEIGHT (m)	TABLE ANGLE (Degree)	RAW VALUE (dBuV)	CORRECTION FACTOR (dB/m)
1	5150.00	52.7 PK	74.0	-21.3	1.44 V	284	49.8	2.9
2	5150.00	39.5 AV	54.0	-14.5	1.44 V	284	36.6	2.9
3	*5290.00	108.7 PK			1.44 V	284	106.3	2.4
4	*5290.00	96.2 AV			1.44 V	284	93.8	2.4
5	5350.00	56.7 PK	74.0	-17.3	1.44 V	284	54.0	2.7
6	5350.00	42.9 AV	54.0	-11.1	1.44 V	284	40.2	2.7
7	#10580.00	49.1 PK	68.2	-19.1	1.17 V	229	37.0	12.1
8	15870.00	57.4 PK	74.0	-16.6	3.03 V	254	45.7	11.7
9	15870.00	46.8 AV	54.0	-7.2	3.03 V	254	35.1	11.7

REMARKS:

- Emission Level(dBuV/m) = Raw Value(dBuV) + Correction Factor(dB/m)
- Correction Factor(dB/m) = Antenna Factor(dB/m) + Cable Factor(dB) – Pre-Amplifier Factor(dB)
- The other emission levels were very low against the limit.
- Margin value = Emission Level – Limit value
- " * ": Fundamental frequency.
- " # ": The radiated frequency is out of the restricted band.

CHANNEL	TX Channel 106	DETECTOR FUNCTION	Peak (PK)
FREQUENCY RANGE	1GHz ~ 40GHz		Average (AV)

ANTENNA POLARITY & TEST DISTANCE: HORIZONTAL AT 3 M

NO.	FREQ. (MHz)	EMISSION LEVEL (dBuV/m)	LIMIT (dBuV/m)	MARGIN (dB)	ANTENNA HEIGHT (m)	TABLE ANGLE (Degree)	RAW VALUE (dBuV)	CORRECTION FACTOR (dB/m)
1	5457.71	66.9 PK	74.0	-7.1	1.69 H	277	63.9	3.0
2	5457.71	49.8 AV	54.0	-4.2	1.69 H	277	46.8	3.0
3	#5462.87	64.5 PK	68.2	-3.7	1.69 H	277	61.5	3.0
4	*5530.00	106.4 PK			1.69 H	277	103.5	2.9
5	*5530.00	94.2 AV			1.69 H	277	91.3	2.9
6	#5736.37	54.2 PK	68.2	-14.0	1.69 H	277	50.9	3.3
7	11060.00	49.5 PK	74.0	-24.5	1.60 H	209	37.0	12.5
8	11060.00	43.2 AV	54.0	-10.8	1.60 H	209	30.7	12.5
9	#16590.00	52.5 PK	68.2	-15.7	1.92 H	34	37.8	14.7

ANTENNA POLARITY & TEST DISTANCE: VERTICAL AT 3 M

NO.	FREQ. (MHz)	EMISSION LEVEL (dBuV/m)	LIMIT (dBuV/m)	MARGIN (dB)	ANTENNA HEIGHT (m)	TABLE ANGLE (Degree)	RAW VALUE (dBuV)	CORRECTION FACTOR (dB/m)
1	5459.80	62.0 PK	74.0	-12.0	1.49 V	285	59.0	3.0
2	5459.80	48.7 AV	54.0	-5.3	1.49 V	285	45.7	3.0
3	#5470.00	59.6 PK	68.2	-8.6	1.49 V	285	56.6	3.0
4	*5530.00	109.5 PK			1.49 V	285	106.6	2.9
5	*5530.00	97.0 AV			1.49 V	285	94.1	2.9
6	#5725.46	53.6 PK	68.2	-14.6	1.49 V	285	50.4	3.2
7	11060.00	49.0 PK	74.0	-25.0	1.28 V	218	36.5	12.5
8	11060.00	44.2 AV	54.0	-9.8	1.28 V	218	31.7	12.5
9	#16590.00	57.6 PK	68.2	-10.6	3.06 V	280	42.9	14.7

REMARKS:

1. Emission Level(dBuV/m) = Raw Value(dBuV) + Correction Factor(dB/m)
2. Correction Factor(dB/m) = Antenna Factor(dB/m) + Cable Factor(dB) – Pre-Amplifier Factor(dB)
3. The other emission levels were very low against the limit.
4. Margin value = Emission Level – Limit value
5. " * ": Fundamental frequency.
6. " # ": The radiated frequency is out of the restricted band.

CHANNEL	TX Channel 122	DETECTOR FUNCTION	Peak (PK)
FREQUENCY RANGE	1GHz ~ 40GHz		Average (AV)

ANTENNA POLARITY & TEST DISTANCE: HORIZONTAL AT 3 M

NO.	FREQ. (MHz)	EMISSION LEVEL (dBuV/m)	LIMIT (dBuV/m)	MARGIN (dB)	ANTENNA HEIGHT (m)	TABLE ANGLE (Degree)	RAW VALUE (dBuV)	CORRECTION FACTOR (dB/m)
1	*5610.00	105.9 PK			1.65 H	266	102.9	3.0
2	*5610.00	94.0 AV			1.65 H	266	91.0	3.0
3	#5725.00	61.0 PK	68.2	-7.2	1.65 H	266	57.8	3.2
4	11220.00	48.7 PK	74.0	-25.3	1.57 H	182	36.2	12.5
5	11220.00	42.4 AV	54.0	-11.6	1.57 H	182	29.9	12.5
6	#16830.00	52.1 PK	68.2	-16.1	1.85 H	35	37.1	15.0

ANTENNA POLARITY & TEST DISTANCE: VERTICAL AT 3 M

NO.	FREQ. (MHz)	EMISSION LEVEL (dBuV/m)	LIMIT (dBuV/m)	MARGIN (dB)	ANTENNA HEIGHT (m)	TABLE ANGLE (Degree)	RAW VALUE (dBuV)	CORRECTION FACTOR (dB/m)
1	*5610.00	109.8 PK			1.53 V	296	106.8	3.0
2	*5610.00	97.2 AV			1.53 V	296	94.2	3.0
3	#5725.00	58.8 PK	68.2	-9.4	1.53 V	296	55.6	3.2
4	11220.00	49.8 PK	74.0	-24.2	1.28 V	236	37.3	12.5
5	11220.00	45.1 AV	54.0	-8.9	1.28 V	236	32.6	12.5
6	#16830.00	57.6 PK	68.2	-10.6	3.00 V	270	42.6	15.0

REMARKS:

1. Emission Level(dBuV/m) = Raw Value(dBuV) + Correction Factor(dB/m)
2. Correction Factor(dB/m) = Antenna Factor(dB/m) + Cable Factor(dB) – Pre-Amplifier Factor(dB)
3. The other emission levels were very low against the limit.
4. Margin value = Emission Level – Limit value
5. " * ": Fundamental frequency.
6. " # ": The radiated frequency is out of the restricted band.

CHANNEL	TX Channel 138	DETECTOR FUNCTION	Peak (PK)
FREQUENCY RANGE	1GHz ~ 40GHz		Average (AV)

ANTENNA POLARITY & TEST DISTANCE: HORIZONTAL AT 3 M

NO.	FREQ. (MHz)	EMISSION LEVEL (dBuV/m)	LIMIT (dBuV/m)	MARGIN (dB)	ANTENNA HEIGHT (m)	TABLE ANGLE (Degree)	RAW VALUE (dBuV)	CORRECTION FACTOR (dB/m)
1	5460.00	55.0 PK	74.0	-19.0	1.67 H	283	52.0	3.0
2	5460.00	42.3 AV	54.0	-11.7	1.67 H	283	39.3	3.0
3	#5470.00	54.5 PK	68.2	-13.7	1.67 H	283	51.5	3.0
4	*5690.00	106.0 PK			1.67 H	283	102.8	3.2
5	*5690.00	94.1 AV			1.67 H	283	90.9	3.2
6	#5850.00	63.1 PK	68.2	-5.1	1.67 H	283	59.5	3.6
7	11380.00	49.7 PK	74.0	-24.3	1.68 H	179	36.7	13.0
8	11380.00	43.2 AV	54.0	-10.8	1.68 H	179	30.2	13.0
9	#17070.00	53.1 PK	68.2	-15.1	1.91 H	24	36.6	16.5

ANTENNA POLARITY & TEST DISTANCE: VERTICAL AT 3 M

NO.	FREQ. (MHz)	EMISSION LEVEL (dBuV/m)	LIMIT (dBuV/m)	MARGIN (dB)	ANTENNA HEIGHT (m)	TABLE ANGLE (Degree)	RAW VALUE (dBuV)	CORRECTION FACTOR (dB/m)
1	5460.00	54.4 PK	74.0	-19.6	1.49 V	280	51.4	3.0
2	5460.00	42.1 AV	54.0	-11.9	1.49 V	280	39.1	3.0
3	#5470.00	54.9 PK	68.2	-13.3	1.49 V	280	51.9	3.0
4	*5690.00	109.5 PK			1.49 V	280	106.3	3.2
5	*5690.00	96.8 AV			1.49 V	280	93.6	3.2
6	#5850.00	58.5 PK	68.2	-9.7	1.49 V	280	54.9	3.6
7	11380.00	49.6 PK	74.0	-24.4	1.23 V	223	36.6	13.0
8	11380.00	45.0 AV	54.0	-9.0	1.23 V	223	32.0	13.0
9	#17070.00	57.8 PK	68.2	-10.4	3.01 V	252	41.3	16.5

REMARKS:

1. Emission Level(dBuV/m) = Raw Value(dBuV) + Correction Factor(dB/m)
2. Correction Factor(dB/m) = Antenna Factor(dB/m) + Cable Factor(dB) – Pre-Amplifier Factor(dB)
3. The other emission levels were very low against the limit.
4. Margin value = Emission Level – Limit value
5. " * ": Fundamental frequency.
6. " # ": The radiated frequency is out of the restricted band.

Below 1GHz Data:

802.11a

CHANNEL	TX Channel 140	DETECTOR FUNCTION	Quasi-Peak (QP)
FREQUENCY RANGE	9kHz ~ 1GHz		

ANTENNA POLARITY & TEST DISTANCE: HORIZONTAL AT 3 M

NO.	FREQ. (MHz)	EMISSION LEVEL (dBuV/m)	LIMIT (dBuV/m)	MARGIN (dB)	ANTENNA HEIGHT (m)	TABLE ANGLE (Degree)	RAW VALUE (dBuV)	CORRECTION FACTOR (dB/m)
1	99.59	32.2 QP	43.5	-11.3	1.50 H	232	44.6	-12.4
2	149.90	34.5 QP	43.5	-9.0	2.00 H	49	42.0	-7.5
3	220.50	35.0 QP	46.0	-11.0	1.50 H	287	45.8	-10.8
4	274.29	30.7 QP	46.0	-15.3	1.00 H	42	38.6	-7.9
5	460.19	30.3 QP	46.0	-15.7	1.50 H	280	33.0	-2.7
6	629.35	31.9 QP	46.0	-14.1	1.00 H	8	30.9	1.0

REMARKS:

1. Emission Level(dBuV/m) = Raw Value(dBuV) + Correction Factor(dB/m)
2. Correction Factor(dB/m) = Antenna Factor(dB/m) + Cable Factor(dB) – Pre-Amplifier Factor(dB)
3. Margin value = Emission Level – Limit value
4. The emission levels were very low against the limit of frequency range 9kHz~30MHz: the amplitude of spurious emissions attenuated more than 20 dB below the permissible value to be report.

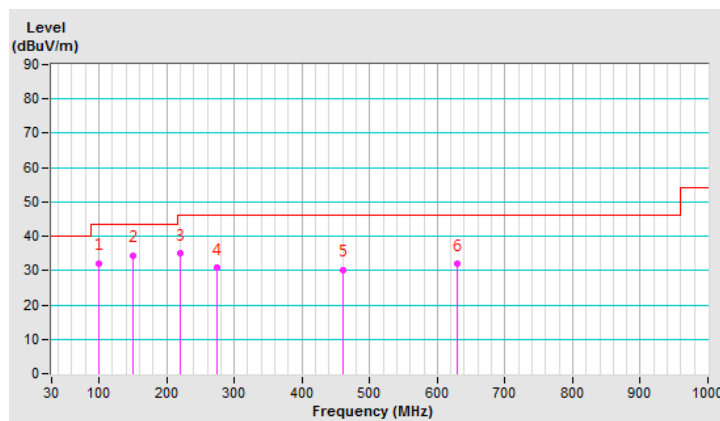

CHANNEL	TX Channel 140	DETECTOR FUNCTION	Quasi-Peak (QP)
FREQUENCY RANGE	9kHz ~ 1GHz		

ANTENNA POLARITY & TEST DISTANCE: VERTICAL AT 3 M

NO.	FREQ. (MHz)	EMISSION LEVEL (dBuV/m)	LIMIT (dBuV/m)	MARGIN (dB)	ANTENNA HEIGHT (m)	TABLE ANGLE (Degree)	RAW VALUE (dBuV)	CORRECTION FACTOR (dB/m)
1	116.32	31.9 QP	43.5	-11.6	1.50 V	130	41.8	-9.9
2	158.77	31.1 QP	43.5	-12.4	1.00 V	70	38.8	-7.7
3	215.70	26.7 QP	43.5	-16.8	2.00 V	222	37.5	-10.8
4	306.18	28.7 QP	46.0	-17.3	1.00 V	126	35.4	-6.7
5	470.31	29.4 QP	46.0	-16.6	1.50 V	40	32.0	-2.6
6	615.46	32.6 QP	46.0	-13.4	1.50 V	248	32.0	0.6

REMARKS:

1. Emission Level(dBuV/m) = Raw Value(dBuV) + Correction Factor(dB/m)
2. Correction Factor(dB/m) = Antenna Factor(dB/m) + Cable Factor(dB) – Pre-Amplifier Factor(dB)
3. Margin value = Emission Level – Limit value
4. The emission levels were very low against the limit of frequency range 9kHz~30MHz: the amplitude of spurious emissions attenuated more than 20 dB below the permissible value to be report.

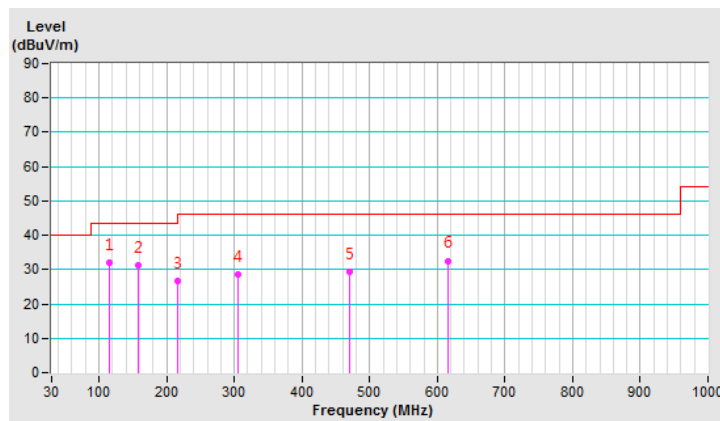

4.1.8 Test Results (Mode 2)

Above 1GHz Data:

802.11a

CHANNEL	TX Channel 52	DETECTOR FUNCTION	Peak (PK)
FREQUENCY RANGE	1GHz ~ 40GHz		Average (AV)

ANTENNA POLARITY & TEST DISTANCE: HORIZONTAL AT 3 M

NO.	FREQ. (MHz)	EMISSION LEVEL (dBuV/m)	LIMIT (dBuV/m)	MARGIN (dB)	ANTENNA HEIGHT (m)	TABLE ANGLE (Degree)	RAW VALUE (dBuV)	CORRECTION FACTOR (dB/m)
1	5150.00	67.3 PK	74.0	-6.7	1.67 H	245	64.4	2.9
2	5150.00	52.2 AV	54.0	-1.8	1.67 H	245	49.3	2.9
3	*5260.00	113.4 PK			1.67 H	245	111.0	2.4
4	*5260.00	100.7 AV			1.67 H	245	98.3	2.4
5	#10520.00	49.2 PK	68.2	-19.0	1.63 H	194	36.9	12.3
6	15780.00	52.4 PK	74.0	-21.6	1.89 H	29	40.4	12.0
7	15780.00	40.6 AV	54.0	-13.4	1.89 H	29	28.6	12.0

ANTENNA POLARITY & TEST DISTANCE: VERTICAL AT 3 M

NO.	FREQ. (MHz)	EMISSION LEVEL (dBuV/m)	LIMIT (dBuV/m)	MARGIN (dB)	ANTENNA HEIGHT (m)	TABLE ANGLE (Degree)	RAW VALUE (dBuV)	CORRECTION FACTOR (dB/m)
1	5150.00	56.8 PK	74.0	-17.2	1.88 V	241	53.9	2.9
2	5150.00	43.5 AV	54.0	-10.5	1.88 V	241	40.6	2.9
3	*5260.00	112.0 PK			1.88 V	241	109.6	2.4
4	*5260.00	99.6 AV			1.88 V	241	97.2	2.4
5	#10520.00	49.9 PK	68.2	-18.3	1.21 V	213	37.6	12.3
6	15780.00	57.0 PK	74.0	-17.0	3.01 V	264	45.0	12.0
7	15780.00	46.8 AV	54.0	-7.2	3.01 V	264	34.8	12.0

REMARKS:

1. Emission Level(dBuV/m) = Raw Value(dBuV) + Correction Factor(dB/m)
2. Correction Factor(dB/m) = Antenna Factor(dB/m) + Cable Factor(dB) – Pre-Amplifier Factor(dB)
3. The other emission levels were very low against the limit.
4. Margin value = Emission Level – Limit value
5. " * ": Fundamental frequency.
6. " # ": The radiated frequency is out of the restricted band.

CHANNEL	TX Channel 60	DETECTOR FUNCTION	Peak (PK)
FREQUENCY RANGE	1GHz ~ 40GHz		Average (AV)

ANTENNA POLARITY & TEST DISTANCE: HORIZONTAL AT 3 M

NO.	FREQ. (MHz)	EMISSION LEVEL (dBuV/m)	LIMIT (dBuV/m)	MARGIN (dB)	ANTENNA HEIGHT (m)	TABLE ANGLE (Degree)	RAW VALUE (dBuV)	CORRECTION FACTOR (dB/m)
1	*5300.00	114.0 PK			1.72 H	245	111.4	2.6
2	*5300.00	101.2 AV			1.72 H	245	98.6	2.6
3	10600.00	49.7 PK	74.0	-24.3	1.69 H	207	37.6	12.1
4	10600.00	43.2 AV	54.0	-10.8	1.69 H	207	31.1	12.1
5	15900.00	52.8 PK	74.0	-21.2	1.87 H	34	41.0	11.8
6	15900.00	40.8 AV	54.0	-13.2	1.87 H	34	29.0	11.8

ANTENNA POLARITY & TEST DISTANCE: VERTICAL AT 3 M

NO.	FREQ. (MHz)	EMISSION LEVEL (dBuV/m)	LIMIT (dBuV/m)	MARGIN (dB)	ANTENNA HEIGHT (m)	TABLE ANGLE (Degree)	RAW VALUE (dBuV)	CORRECTION FACTOR (dB/m)
1	*5300.00	111.6 PK			1.87 V	250	109.0	2.6
2	*5300.00	99.3 AV			1.87 V	250	96.7	2.6
3	10600.00	50.4 PK	74.0	-23.6	1.18 V	205	38.3	12.1
4	10600.00	45.7 AV	54.0	-8.3	1.18 V	205	33.6	12.1
5	15900.00	57.2 PK	74.0	-16.8	3.05 V	255	45.4	11.8
6	15900.00	47.0 AV	54.0	-7.0	3.05 V	255	35.2	11.8

REMARKS:

1. Emission Level(dBuV/m) = Raw Value(dBuV) + Correction Factor(dB/m)
2. Correction Factor(dB/m) = Antenna Factor(dB/m) + Cable Factor(dB) – Pre-Amplifier Factor(dB)
3. The other emission levels were very low against the limit.
4. Margin value = Emission Level – Limit value
5. " * ": Fundamental frequency.

CHANNEL	TX Channel 64	DETECTOR FUNCTION	Peak (PK)
FREQUENCY RANGE	1GHz ~ 40GHz		Average (AV)

ANTENNA POLARITY & TEST DISTANCE: HORIZONTAL AT 3 M

NO.	FREQ. (MHz)	EMISSION LEVEL (dBuV/m)	LIMIT (dBuV/m)	MARGIN (dB)	ANTENNA HEIGHT (m)	TABLE ANGLE (Degree)	RAW VALUE (dBuV)	CORRECTION FACTOR (dB/m)
1	*5320.00	113.1 PK			1.66 H	226	110.5	2.6
2	*5320.00	100.4 AV			1.66 H	226	97.8	2.6
3	5350.00	66.4 PK	74.0	-7.6	1.66 H	226	63.7	2.7
4	5350.00	51.6 AV	54.0	-2.4	1.66 H	226	48.9	2.7
5	10640.00	49.2 PK	74.0	-24.8	1.64 H	201	37.3	11.9
6	10640.00	42.9 AV	54.0	-11.1	1.64 H	201	31.0	11.9
7	15960.00	53.1 PK	74.0	-20.9	1.94 H	13	41.0	12.1
8	15960.00	41.3 AV	54.0	-12.7	1.94 H	13	29.2	12.1

ANTENNA POLARITY & TEST DISTANCE: VERTICAL AT 3 M

NO.	FREQ. (MHz)	EMISSION LEVEL (dBuV/m)	LIMIT (dBuV/m)	MARGIN (dB)	ANTENNA HEIGHT (m)	TABLE ANGLE (Degree)	RAW VALUE (dBuV)	CORRECTION FACTOR (dB/m)
1	*5320.00	112.0 PK			1.83 V	233	109.4	2.6
2	*5320.00	99.4 AV			1.83 V	233	96.8	2.6
3	5350.00	55.9 PK	74.0	-18.1	1.83 V	233	53.2	2.7
4	5350.00	42.7 AV	54.0	-11.3	1.83 V	233	40.0	2.7
5	10640.00	50.3 PK	74.0	-23.7	1.19 V	187	38.4	11.9
6	10640.00	45.4 AV	54.0	-8.6	1.19 V	187	33.5	11.9
7	15960.00	57.9 PK	74.0	-16.1	3.01 V	251	45.8	12.1
8	15960.00	47.7 AV	54.0	-6.3	3.01 V	251	35.6	12.1

REMARKS:

1. Emission Level(dBuV/m) = Raw Value(dBuV) + Correction Factor(dB/m)
2. Correction Factor(dB/m) = Antenna Factor(dB/m) + Cable Factor(dB) – Pre-Amplifier Factor(dB)
3. The other emission levels were very low against the limit.
4. Margin value = Emission Level – Limit value
5. " * ": Fundamental frequency.

CHANNEL	TX Channel 100	DETECTOR FUNCTION	Peak (PK)
FREQUENCY RANGE	1GHz ~ 40GHz		Average (AV)

ANTENNA POLARITY & TEST DISTANCE: HORIZONTAL AT 3 M

NO.	FREQ. (MHz)	EMISSION LEVEL (dBuV/m)	LIMIT (dBuV/m)	MARGIN (dB)	ANTENNA HEIGHT (m)	TABLE ANGLE (Degree)	RAW VALUE (dBuV)	CORRECTION FACTOR (dB/m)
1	5460.00	63.0 PK	74.0	-11.0	1.75 H	250	60.0	3.0
2	5460.00	44.3 AV	54.0	-9.7	1.75 H	250	41.3	3.0
3	#5470.00	67.5 PK	68.2	-0.7	1.75 H	250	64.5	3.0
4	*5500.00	114.5 PK			1.75 H	250	111.6	2.9
5	*5500.00	101.6 AV			1.75 H	250	98.7	2.9
6	11000.00	49.3 PK	74.0	-24.7	1.71 H	198	36.5	12.8
7	11000.00	43.0 AV	54.0	-11.0	1.71 H	198	30.2	12.8
8	#16500.00	52.9 PK	68.2	-15.3	1.86 H	30	38.5	14.4

ANTENNA POLARITY & TEST DISTANCE: VERTICAL AT 3 M

NO.	FREQ. (MHz)	EMISSION LEVEL (dBuV/m)	LIMIT (dBuV/m)	MARGIN (dB)	ANTENNA HEIGHT (m)	TABLE ANGLE (Degree)	RAW VALUE (dBuV)	CORRECTION FACTOR (dB/m)
1	5460.00	55.1 PK	74.0	-18.9	1.84 V	224	52.1	3.0
2	5460.00	42.1 AV	54.0	-11.9	1.84 V	224	39.1	3.0
3	#5470.00	56.6 PK	68.2	-11.6	1.84 V	224	53.6	3.0
4	*5500.00	112.2 PK			1.84 V	224	109.3	2.9
5	*5500.00	99.6 AV			1.84 V	224	96.7	2.9
6	11000.00	50.3 PK	74.0	-23.7	1.24 V	196	37.5	12.8
7	11000.00	45.7 AV	54.0	-8.3	1.24 V	196	32.9	12.8
8	#16500.00	57.2 PK	68.2	-11.0	3.03 V	251	42.8	14.4

REMARKS:

1. Emission Level(dBuV/m) = Raw Value(dBuV) + Correction Factor(dB/m)
2. Correction Factor(dB/m) = Antenna Factor(dB/m) + Cable Factor(dB) – Pre-Amplifier Factor(dB)
3. The other emission levels were very low against the limit.
4. Margin value = Emission Level – Limit value
5. " * ": Fundamental frequency.
6. " # ": The radiated frequency is out of the restricted band.

CHANNEL	TX Channel 116	DETECTOR FUNCTION	Peak (PK)
FREQUENCY RANGE	1GHz ~ 40GHz		Average (AV)

ANTENNA POLARITY & TEST DISTANCE: HORIZONTAL AT 3 M

NO.	FREQ. (MHz)	EMISSION LEVEL (dBuV/m)	LIMIT (dBuV/m)	MARGIN (dB)	ANTENNA HEIGHT (m)	TABLE ANGLE (Degree)	RAW VALUE (dBuV)	CORRECTION FACTOR (dB/m)
1	*5580.00	114.3 PK			1.75 H	237	111.3	3.0
2	*5580.00	101.2 AV			1.75 H	237	98.2	3.0
3	11160.00	49.6 PK	74.0	-24.4	1.66 H	199	37.3	12.3
4	11160.00	43.3 AV	54.0	-10.7	1.66 H	199	31.0	12.3
5	#16740.00	52.6 PK	68.2	-15.6	1.87 H	23	37.9	14.7

ANTENNA POLARITY & TEST DISTANCE: VERTICAL AT 3 M

NO.	FREQ. (MHz)	EMISSION LEVEL (dBuV/m)	LIMIT (dBuV/m)	MARGIN (dB)	ANTENNA HEIGHT (m)	TABLE ANGLE (Degree)	RAW VALUE (dBuV)	CORRECTION FACTOR (dB/m)
1	*5580.00	112.4 PK			1.80 V	225	109.4	3.0
2	*5580.00	100.1 AV			1.80 V	225	97.1	3.0
3	11160.00	50.4 PK	74.0	-23.6	1.24 V	216	38.1	12.3
4	11160.00	45.4 AV	54.0	-8.6	1.24 V	216	33.1	12.3
5	#16740.00	57.6 PK	68.2	-10.6	3.01 V	249	42.9	14.7

REMARKS:

1. Emission Level(dBuV/m) = Raw Value(dBuV) + Correction Factor(dB/m)
2. Correction Factor(dB/m) = Antenna Factor(dB/m) + Cable Factor(dB) – Pre-Amplifier Factor(dB)
3. The other emission levels were very low against the limit.
4. Margin value = Emission Level – Limit value
5. " * ": Fundamental frequency.
6. " # ": The radiated frequency is out of the restricted band.

CHANNEL	TX Channel 140	DETECTOR FUNCTION	Peak (PK)
FREQUENCY RANGE	1GHz ~ 40GHz		Average (AV)

ANTENNA POLARITY & TEST DISTANCE: HORIZONTAL AT 3 M

NO.	FREQ. (MHz)	EMISSION LEVEL (dBuV/m)	LIMIT (dBuV/m)	MARGIN (dB)	ANTENNA HEIGHT (m)	TABLE ANGLE (Degree)	RAW VALUE (dBuV)	CORRECTION FACTOR (dB/m)
1	*5700.00	113.8 PK			1.80 H	249	110.6	3.2
2	*5700.00	100.9 AV			1.80 H	249	97.7	3.2
3	#5725.00	66.6 PK	68.2	-1.6	1.80 H	249	63.4	3.2
4	11400.00	49.5 PK	74.0	-24.5	1.61 H	200	36.5	13.0
5	11400.00	43.0 AV	54.0	-11.0	1.61 H	200	30.0	13.0
6	#17100.00	53.2 PK	68.2	-15.0	1.83 H	26	36.7	16.5

ANTENNA POLARITY & TEST DISTANCE: VERTICAL AT 3 M

NO.	FREQ. (MHz)	EMISSION LEVEL (dBuV/m)	LIMIT (dBuV/m)	MARGIN (dB)	ANTENNA HEIGHT (m)	TABLE ANGLE (Degree)	RAW VALUE (dBuV)	CORRECTION FACTOR (dB/m)
1	*5700.00	112.5 PK			1.86 V	243	109.3	3.2
2	*5700.00	99.9 AV			1.86 V	243	96.7	3.2
3	#5725.00	56.1 PK	68.2	-12.1	1.86 V	243	52.9	3.2
4	11400.00	50.0 PK	74.0	-24.0	1.14 V	200	37.0	13.0
5	11400.00	45.0 AV	54.0	-9.0	1.14 V	200	32.0	13.0
6	#17100.00	58.2 PK	68.2	-10.0	2.95 V	259	41.7	16.5

REMARKS:

1. Emission Level(dBuV/m) = Raw Value(dBuV) + Correction Factor(dB/m)
2. Correction Factor(dB/m) = Antenna Factor(dB/m) + Cable Factor(dB) – Pre-Amplifier Factor(dB)
3. The other emission levels were very low against the limit.
4. Margin value = Emission Level – Limit value
5. " * ": Fundamental frequency.
6. " # ": The radiated frequency is out of the restricted band.

CHANNEL	TX Channel 144	DETECTOR FUNCTION	Peak (PK)
FREQUENCY RANGE	1GHz ~ 40GHz		Average (AV)

ANTENNA POLARITY & TEST DISTANCE: HORIZONTAL AT 3 M

NO.	FREQ. (MHz)	EMISSION LEVEL (dBuV/m)	LIMIT (dBuV/m)	MARGIN (dB)	ANTENNA HEIGHT (m)	TABLE ANGLE (Degree)	RAW VALUE (dBuV)	CORRECTION FACTOR (dB/m)
1	5460.00	62.8 PK	74.0	-11.2	1.67 H	259	59.8	3.0
2	5460.00	44.3 AV	54.0	-9.7	1.67 H	259	41.3	3.0
3	#5470.00	64.0 PK	68.2	-4.2	1.67 H	259	61.0	3.0
4	*5720.00	113.8 PK			1.67 H	259	110.6	3.2
5	*5720.00	101.0 AV			1.67 H	259	97.8	3.2
6	#5850.00	63.6 PK	68.2	-4.6	1.67 H	259	60.0	3.6
7	11440.00	49.0 PK	74.0	-25.0	1.65 H	207	36.1	12.9
8	11440.00	42.7 AV	54.0	-11.3	1.65 H	207	29.8	12.9
9	#17160.00	52.1 PK	68.2	-16.1	1.84 H	42	36.0	16.1

ANTENNA POLARITY & TEST DISTANCE: VERTICAL AT 3 M

NO.	FREQ. (MHz)	EMISSION LEVEL (dBuV/m)	LIMIT (dBuV/m)	MARGIN (dB)	ANTENNA HEIGHT (m)	TABLE ANGLE (Degree)	RAW VALUE (dBuV)	CORRECTION FACTOR (dB/m)
1	5460.00	59.0 PK	74.0	-15.0	1.80 V	240	56.0	3.0
2	5460.00	45.6 AV	54.0	-8.4	1.80 V	240	42.6	3.0
3	#5470.00	62.9 PK	68.2	-5.3	1.80 V	240	59.9	3.0
4	*5720.00	111.6 PK			1.80 V	240	108.4	3.2
5	*5720.00	99.5 AV			1.80 V	240	96.3	3.2
6	#5850.00	59.7 PK	68.2	-8.5	1.80 V	240	56.1	3.6
7	11440.00	50.6 PK	74.0	-23.4	1.13 V	194	37.7	12.9
8	11440.00	45.7 AV	54.0	-8.3	1.13 V	194	32.8	12.9
9	#17160.00	58.0 PK	68.2	-10.2	2.95 V	270	41.9	16.1

REMARKS:

1. Emission Level(dBuV/m) = Raw Value(dBuV) + Correction Factor(dB/m)
2. Correction Factor(dB/m) = Antenna Factor(dB/m) + Cable Factor(dB) – Pre-Amplifier Factor(dB)
3. The other emission levels were very low against the limit.
4. Margin value = Emission Level – Limit value
5. " * ": Fundamental frequency.
6. " # ": The radiated frequency is out of the restricted band.

802.11ax (HE20)

CHANNEL	TX Channel 52	DETECTOR FUNCTION	Peak (PK)
FREQUENCY RANGE	1GHz ~ 40GHz		Average (AV)

ANTENNA POLARITY & TEST DISTANCE: HORIZONTAL AT 3 M

NO.	FREQ. (MHz)	EMISSION LEVEL (dBuV/m)	LIMIT (dBuV/m)	MARGIN (dB)	ANTENNA HEIGHT (m)	TABLE ANGLE (Degree)	RAW VALUE (dBuV)	CORRECTION FACTOR (dB/m)
1	5150.00	67.2 PK	74.0	-6.8	1.70 H	233	64.3	2.9
2	5150.00	51.9 AV	54.0	-2.1	1.70 H	233	49.0	2.9
3	*5260.00	113.6 PK			1.70 H	233	111.2	2.4
4	*5260.00	100.7 AV			1.70 H	233	98.3	2.4
5	#10520.00	49.1 PK	68.2	-19.1	1.67 H	206	36.8	12.3
6	15780.00	52.2 PK	74.0	-21.8	1.83 H	43	40.2	12.0
7	15780.00	40.5 AV	54.0	-13.5	1.83 H	43	28.5	12.0

ANTENNA POLARITY & TEST DISTANCE: VERTICAL AT 3 M

NO.	FREQ. (MHz)	EMISSION LEVEL (dBuV/m)	LIMIT (dBuV/m)	MARGIN (dB)	ANTENNA HEIGHT (m)	TABLE ANGLE (Degree)	RAW VALUE (dBuV)	CORRECTION FACTOR (dB/m)
1	5150.00	56.9 PK	74.0	-17.1	1.87 V	240	54.0	2.9
2	5150.00	43.6 AV	54.0	-10.4	1.87 V	240	40.7	2.9
3	*5260.00	111.9 PK			1.87 V	240	109.5	2.4
4	*5260.00	99.4 AV			1.87 V	240	97.0	2.4
5	#10520.00	50.3 PK	68.2	-17.9	1.21 V	194	38.0	12.3
6	15780.00	57.4 PK	74.0	-16.6	3.01 V	261	45.4	12.0
7	15780.00	47.3 AV	54.0	-6.7	3.01 V	261	35.3	12.0

REMARKS:

1. Emission Level(dBuV/m) = Raw Value(dBuV) + Correction Factor(dB/m)
2. Correction Factor(dB/m) = Antenna Factor(dB/m) + Cable Factor(dB) – Pre-Amplifier Factor(dB)
3. The other emission levels were very low against the limit.
4. Margin value = Emission Level – Limit value
5. " * ": Fundamental frequency.
6. " # ": The radiated frequency is out of the restricted band.

CHANNEL	TX Channel 60	DETECTOR FUNCTION	Peak (PK)
FREQUENCY RANGE	1GHz ~ 40GHz		Average (AV)

ANTENNA POLARITY & TEST DISTANCE: HORIZONTAL AT 3 M

NO.	FREQ. (MHz)	EMISSION LEVEL (dBuV/m)	LIMIT (dBuV/m)	MARGIN (dB)	ANTENNA HEIGHT (m)	TABLE ANGLE (Degree)	RAW VALUE (dBuV)	CORRECTION FACTOR (dB/m)
1	*5300.00	113.9 PK			1.66 H	233	111.3	2.6
2	*5300.00	100.7 AV			1.66 H	233	98.1	2.6
3	10600.00	49.7 PK	74.0	-24.3	1.63 H	200	37.6	12.1
4	10600.00	43.1 AV	54.0	-10.9	1.63 H	200	31.0	12.1
5	15900.00	53.1 PK	74.0	-20.9	1.84 H	23	41.3	11.8
6	15900.00	41.1 AV	54.0	-12.9	1.84 H	23	29.3	11.8

ANTENNA POLARITY & TEST DISTANCE: VERTICAL AT 3 M

NO.	FREQ. (MHz)	EMISSION LEVEL (dBuV/m)	LIMIT (dBuV/m)	MARGIN (dB)	ANTENNA HEIGHT (m)	TABLE ANGLE (Degree)	RAW VALUE (dBuV)	CORRECTION FACTOR (dB/m)
1	*5300.00	111.7 PK			1.91 V	238	109.1	2.6
2	*5300.00	99.3 AV			1.91 V	238	96.7	2.6
3	10600.00	50.2 PK	74.0	-23.8	1.19 V	197	38.1	12.1
4	10600.00	45.6 AV	54.0	-8.4	1.19 V	197	33.5	12.1
5	15900.00	57.7 PK	74.0	-16.3	3.05 V	255	45.9	11.8
6	15900.00	47.2 AV	54.0	-6.8	3.05 V	255	35.4	11.8

REMARKS:

1. Emission Level(dBuV/m) = Raw Value(dBuV) + Correction Factor(dB/m)
2. Correction Factor(dB/m) = Antenna Factor(dB/m) + Cable Factor(dB) – Pre-Amplifier Factor(dB)
3. The other emission levels were very low against the limit.
4. Margin value = Emission Level – Limit value
5. " * ": Fundamental frequency.

CHANNEL	TX Channel 64	DETECTOR FUNCTION	Peak (PK)
FREQUENCY RANGE	1GHz ~ 40GHz		Average (AV)

ANTENNA POLARITY & TEST DISTANCE: HORIZONTAL AT 3 M

NO.	FREQ. (MHz)	EMISSION LEVEL (dBuV/m)	LIMIT (dBuV/m)	MARGIN (dB)	ANTENNA HEIGHT (m)	TABLE ANGLE (Degree)	RAW VALUE (dBuV)	CORRECTION FACTOR (dB/m)
1	*5320.00	113.7 PK			1.71 H	245	111.1	2.6
2	*5320.00	100.6 AV			1.71 H	245	98.0	2.6
3	5350.00	66.1 PK	74.0	-7.9	1.71 H	245	63.4	2.7
4	5350.00	51.3 AV	54.0	-2.7	1.71 H	245	48.6	2.7
5	10640.00	49.2 PK	74.0	-24.8	1.63 H	203	37.3	11.9
6	10640.00	42.9 AV	54.0	-11.1	1.63 H	203	31.0	11.9
7	15960.00	52.4 PK	74.0	-21.6	1.89 H	19	40.3	12.1
8	15960.00	40.6 AV	54.0	-13.4	1.89 H	19	28.5	12.1

ANTENNA POLARITY & TEST DISTANCE: VERTICAL AT 3 M

NO.	FREQ. (MHz)	EMISSION LEVEL (dBuV/m)	LIMIT (dBuV/m)	MARGIN (dB)	ANTENNA HEIGHT (m)	TABLE ANGLE (Degree)	RAW VALUE (dBuV)	CORRECTION FACTOR (dB/m)
1	*5320.00	112.1 PK			1.84 V	243	109.5	2.6
2	*5320.00	99.8 AV			1.84 V	243	97.2	2.6
3	5350.00	55.5 PK	74.0	-18.5	1.84 V	243	52.8	2.7
4	5350.00	42.4 AV	54.0	-11.6	1.84 V	243	39.7	2.7
5	10640.00	50.6 PK	74.0	-23.4	1.14 V	189	38.7	11.9
6	10640.00	45.7 AV	54.0	-8.3	1.14 V	189	33.8	11.9
7	15960.00	57.1 PK	74.0	-16.9	3.00 V	246	45.0	12.1
8	15960.00	46.9 AV	54.0	-7.1	3.00 V	246	34.8	12.1

REMARKS:

1. Emission Level(dBuV/m) = Raw Value(dBuV) + Correction Factor(dB/m)
2. Correction Factor(dB/m) = Antenna Factor(dB/m) + Cable Factor(dB) – Pre-Amplifier Factor(dB)
3. The other emission levels were very low against the limit.
4. Margin value = Emission Level – Limit value
5. " * ": Fundamental frequency.

CHANNEL	TX Channel 100	DETECTOR FUNCTION	Peak (PK)
FREQUENCY RANGE	1GHz ~ 40GHz		Average (AV)

ANTENNA POLARITY & TEST DISTANCE: HORIZONTAL AT 3 M

NO.	FREQ. (MHz)	EMISSION LEVEL (dBuV/m)	LIMIT (dBuV/m)	MARGIN (dB)	ANTENNA HEIGHT (m)	TABLE ANGLE (Degree)	RAW VALUE (dBuV)	CORRECTION FACTOR (dB/m)
1	5460.00	63.5 PK	74.0	-10.5	1.71 H	244	60.5	3.0
2	5460.00	44.5 AV	54.0	-9.5	1.71 H	244	41.5	3.0
3	#5470.00	67.2 PK	68.2	-1.0	1.71 H	244	64.2	3.0
4	*5500.00	114.2 PK			1.71 H	244	111.3	2.9
5	*5500.00	101.2 AV			1.71 H	244	98.3	2.9
6	11000.00	49.5 PK	74.0	-24.5	1.60 H	209	36.7	12.8
7	11000.00	43.2 AV	54.0	-10.8	1.60 H	209	30.4	12.8
8	#16500.00	53.0 PK	68.2	-15.2	1.89 H	38	38.6	14.4

ANTENNA POLARITY & TEST DISTANCE: VERTICAL AT 3 M

NO.	FREQ. (MHz)	EMISSION LEVEL (dBuV/m)	LIMIT (dBuV/m)	MARGIN (dB)	ANTENNA HEIGHT (m)	TABLE ANGLE (Degree)	RAW VALUE (dBuV)	CORRECTION FACTOR (dB/m)
1	5460.00	54.7 PK	74.0	-19.3	1.84 V	240	51.7	3.0
2	5460.00	41.9 AV	54.0	-12.1	1.84 V	240	38.9	3.0
3	#5470.00	57.1 PK	68.2	-11.1	1.84 V	240	54.1	3.0
4	*5500.00	112.3 PK			1.84 V	240	109.4	2.9
5	*5500.00	100.0 AV			1.84 V	240	97.1	2.9
6	11000.00	50.1 PK	74.0	-23.9	1.23 V	199	37.3	12.8
7	11000.00	45.1 AV	54.0	-8.9	1.23 V	199	32.3	12.8
8	#16500.00	58.0 PK	68.2	-10.2	3.00 V	276	43.6	14.4

REMARKS:

1. Emission Level(dBuV/m) = Raw Value(dBuV) + Correction Factor(dB/m)
2. Correction Factor(dB/m) = Antenna Factor(dB/m) + Cable Factor(dB) – Pre-Amplifier Factor(dB)
3. The other emission levels were very low against the limit.
4. Margin value = Emission Level – Limit value
5. " * ": Fundamental frequency.
6. " # ": The radiated frequency is out of the restricted band.

CHANNEL	TX Channel 116	DETECTOR FUNCTION	Peak (PK)
FREQUENCY RANGE	1GHz ~ 40GHz		Average (AV)

ANTENNA POLARITY & TEST DISTANCE: HORIZONTAL AT 3 M

NO.	FREQ. (MHz)	EMISSION LEVEL (dBuV/m)	LIMIT (dBuV/m)	MARGIN (dB)	ANTENNA HEIGHT (m)	TABLE ANGLE (Degree)	RAW VALUE (dBuV)	CORRECTION FACTOR (dB/m)
1	*5580.00	113.9 PK			1.75 H	242	110.9	3.0
2	*5580.00	101.0 AV			1.75 H	242	98.0	3.0
3	11160.00	49.4 PK	74.0	-24.6	1.67 H	211	37.1	12.3
4	11160.00	43.1 AV	54.0	-10.9	1.67 H	211	30.8	12.3
5	#16740.00	52.5 PK	68.2	-15.7	1.86 H	20	37.8	14.7

ANTENNA POLARITY & TEST DISTANCE: VERTICAL AT 3 M

NO.	FREQ. (MHz)	EMISSION LEVEL (dBuV/m)	LIMIT (dBuV/m)	MARGIN (dB)	ANTENNA HEIGHT (m)	TABLE ANGLE (Degree)	RAW VALUE (dBuV)	CORRECTION FACTOR (dB/m)
1	*5580.00	112.1 PK			1.82 V	224	109.1	3.0
2	*5580.00	99.9 AV			1.82 V	224	96.9	3.0
3	11160.00	49.8 PK	74.0	-24.2	1.21 V	211	37.5	12.3
4	11160.00	44.9 AV	54.0	-9.1	1.21 V	211	32.6	12.3
5	#16740.00	57.5 PK	68.2	-10.7	3.00 V	261	42.8	14.7

REMARKS:

1. Emission Level(dBuV/m) = Raw Value(dBuV) + Correction Factor(dB/m)
2. Correction Factor(dB/m) = Antenna Factor(dB/m) + Cable Factor(dB) – Pre-Amplifier Factor(dB)
3. The other emission levels were very low against the limit.
4. Margin value = Emission Level – Limit value
5. " * ": Fundamental frequency.
6. " # ": The radiated frequency is out of the restricted band.

CHANNEL	TX Channel 140	DETECTOR FUNCTION	Peak (PK)
FREQUENCY RANGE	1GHz ~ 40GHz		Average (AV)

ANTENNA POLARITY & TEST DISTANCE: HORIZONTAL AT 3 M

NO.	FREQ. (MHz)	EMISSION LEVEL (dBuV/m)	LIMIT (dBuV/m)	MARGIN (dB)	ANTENNA HEIGHT (m)	TABLE ANGLE (Degree)	RAW VALUE (dBuV)	CORRECTION FACTOR (dB/m)
1	*5700.00	114.5 PK			1.74 H	252	111.3	3.2
2	*5700.00	101.6 AV			1.74 H	252	98.4	3.2
3	#5725.00	66.1 PK	68.2	-2.1	1.74 H	252	62.9	3.2
4	11400.00	49.3 PK	74.0	-24.7	1.70 H	197	36.3	13.0
5	11400.00	43.0 AV	54.0	-11.0	1.70 H	197	30.0	13.0
6	#17100.00	52.7 PK	68.2	-15.5	1.83 H	38	36.2	16.5

ANTENNA POLARITY & TEST DISTANCE: VERTICAL AT 3 M

NO.	FREQ. (MHz)	EMISSION LEVEL (dBuV/m)	LIMIT (dBuV/m)	MARGIN (dB)	ANTENNA HEIGHT (m)	TABLE ANGLE (Degree)	RAW VALUE (dBuV)	CORRECTION FACTOR (dB/m)
1	*5700.00	112.7 PK			1.78 V	236	109.5	3.2
2	*5700.00	100.2 AV			1.78 V	236	97.0	3.2
3	#5725.00	55.4 PK	68.2	-12.8	1.78 V	236	52.2	3.2
4	11400.00	50.3 PK	74.0	-23.7	1.24 V	215	37.3	13.0
5	11400.00	45.4 AV	54.0	-8.6	1.24 V	215	32.4	13.0
6	#17100.00	57.8 PK	68.2	-10.4	3.02 V	253	41.3	16.5

REMARKS:

1. Emission Level(dBuV/m) = Raw Value(dBuV) + Correction Factor(dB/m)
2. Correction Factor(dB/m) = Antenna Factor(dB/m) + Cable Factor(dB) – Pre-Amplifier Factor(dB)
3. The other emission levels were very low against the limit.
4. Margin value = Emission Level – Limit value
5. " * ": Fundamental frequency.
6. " # ": The radiated frequency is out of the restricted band.

CHANNEL	TX Channel 144	DETECTOR FUNCTION	Peak (PK)
FREQUENCY RANGE	1GHz ~ 40GHz		Average (AV)

ANTENNA POLARITY & TEST DISTANCE: HORIZONTAL AT 3 M

NO.	FREQ. (MHz)	EMISSION LEVEL (dBuV/m)	LIMIT (dBuV/m)	MARGIN (dB)	ANTENNA HEIGHT (m)	TABLE ANGLE (Degree)	RAW VALUE (dBuV)	CORRECTION FACTOR (dB/m)
1	5460.00	62.9 PK	74.0	-11.1	1.77 H	251	59.9	3.0
2	5460.00	44.7 AV	54.0	-9.3	1.77 H	251	41.7	3.0
3	#5470.00	64.7 PK	68.2	-3.5	1.77 H	251	61.7	3.0
4	*5720.00	114.0 PK			1.77 H	251	110.8	3.2
5	*5720.00	101.3 AV			1.77 H	251	98.1	3.2
6	#5850.00	63.1 PK	68.2	-5.1	1.77 H	251	59.5	3.6
7	11440.00	49.1 PK	74.0	-24.9	1.59 H	209	36.2	12.9
8	11440.00	42.6 AV	54.0	-11.4	1.59 H	209	29.7	12.9
9	#17160.00	53.3 PK	68.2	-14.9	1.88 H	15	37.2	16.1

ANTENNA POLARITY & TEST DISTANCE: VERTICAL AT 3 M

NO.	FREQ. (MHz)	EMISSION LEVEL (dBuV/m)	LIMIT (dBuV/m)	MARGIN (dB)	ANTENNA HEIGHT (m)	TABLE ANGLE (Degree)	RAW VALUE (dBuV)	CORRECTION FACTOR (dB/m)
1	5460.00	59.5 PK	74.0	-14.5	1.80 V	240	56.5	3.0
2	5460.00	45.8 AV	54.0	-8.2	1.80 V	240	42.8	3.0
3	#5470.00	62.6 PK	68.2	-5.6	1.80 V	240	59.6	3.0
4	*5720.00	112.9 PK			1.80 V	240	109.7	3.2
5	*5720.00	100.3 AV			1.80 V	240	97.1	3.2
6	#5850.00	59.3 PK	68.2	-8.9	1.80 V	240	55.7	3.6
7	11440.00	50.3 PK	74.0	-23.7	1.23 V	212	37.4	12.9
8	11440.00	45.6 AV	54.0	-8.4	1.23 V	212	32.7	12.9
9	#17160.00	57.7 PK	68.2	-10.5	2.95 V	254	41.6	16.1

REMARKS:

1. Emission Level(dBuV/m) = Raw Value(dBuV) + Correction Factor(dB/m)
2. Correction Factor(dB/m) = Antenna Factor(dB/m) + Cable Factor(dB) – Pre-Amplifier Factor(dB)
3. The other emission levels were very low against the limit.
4. Margin value = Emission Level – Limit value
5. " * ": Fundamental frequency.
6. " # ": The radiated frequency is out of the restricted band.

802.11ax (HE40)

CHANNEL	TX Channel 54	DETECTOR FUNCTION	Peak (PK)
FREQUENCY RANGE	1GHz ~ 40GHz		Average (AV)

ANTENNA POLARITY & TEST DISTANCE: HORIZONTAL AT 3 M

NO.	FREQ. (MHz)	EMISSION LEVEL (dBuV/m)	LIMIT (dBuV/m)	MARGIN (dB)	ANTENNA HEIGHT (m)	TABLE ANGLE (Degree)	RAW VALUE (dBuV)	CORRECTION FACTOR (dB/m)
1	5150.00	67.3 PK	74.0	-6.7	1.19 H	267	64.4	2.9
2	5150.00	52.2 AV	54.0	-1.8	1.19 H	267	49.3	2.9
3	*5270.00	114.7 PK			1.19 H	267	112.3	2.4
4	*5270.00	103.3 AV			1.19 H	267	100.9	2.4
5	5350.00	61.4 PK	74.0	-12.6	1.19 H	267	58.7	2.7
6	5350.00	47.1 AV	54.0	-6.9	1.19 H	267	44.4	2.7
7	#10540.00	49.3 PK	68.2	-18.9	1.64 H	209	37.1	12.2
8	15810.00	52.4 PK	74.0	-21.6	1.87 H	39	40.6	11.8
9	15810.00	41.0 AV	54.0	-13.0	1.87 H	39	29.2	11.8

ANTENNA POLARITY & TEST DISTANCE: VERTICAL AT 3 M

NO.	FREQ. (MHz)	EMISSION LEVEL (dBuV/m)	LIMIT (dBuV/m)	MARGIN (dB)	ANTENNA HEIGHT (m)	TABLE ANGLE (Degree)	RAW VALUE (dBuV)	CORRECTION FACTOR (dB/m)
1	5150.00	56.2 PK	74.0	-17.8	2.15 V	247	53.3	2.9
2	5150.00	43.2 AV	54.0	-10.8	2.15 V	247	40.3	2.9
3	*5270.00	114.3 PK			2.15 V	247	111.9	2.4
4	*5270.00	102.6 AV			2.15 V	247	100.2	2.4
5	5350.00	56.8 PK	74.0	-17.2	2.15 V	247	54.1	2.7
6	5350.00	42.9 AV	54.0	-11.1	2.15 V	247	40.2	2.7
7	#10540.00	50.2 PK	68.2	-18.0	1.25 V	201	38.0	12.2
8	15810.00	57.7 PK	74.0	-16.3	2.98 V	276	45.9	11.8
9	15810.00	47.1 AV	54.0	-6.9	2.98 V	276	35.3	11.8

REMARKS:

1. Emission Level(dBuV/m) = Raw Value(dBuV) + Correction Factor(dB/m)
2. Correction Factor(dB/m) = Antenna Factor(dB/m) + Cable Factor(dB) – Pre-Amplifier Factor(dB)
3. The other emission levels were very low against the limit.
4. Margin value = Emission Level – Limit value
5. " * ": Fundamental frequency.
6. " # ": The radiated frequency is out of the restricted band.

CHANNEL	TX Channel 62	DETECTOR FUNCTION	Peak (PK)
FREQUENCY RANGE	1GHz ~ 40GHz		Average (AV)

ANTENNA POLARITY & TEST DISTANCE: HORIZONTAL AT 3 M

NO.	FREQ. (MHz)	EMISSION LEVEL (dBuV/m)	LIMIT (dBuV/m)	MARGIN (dB)	ANTENNA HEIGHT (m)	TABLE ANGLE (Degree)	RAW VALUE (dBuV)	CORRECTION FACTOR (dB/m)
1	5070.00	59.6 PK	74.0	-14.4	1.18 H	263	56.8	2.8
2	5070.00	46.9 AV	54.0	-7.1	1.18 H	263	44.1	2.8
3	*5310.00	114.8 PK			1.18 H	263	112.2	2.6
4	*5310.00	103.4 AV			1.18 H	263	100.8	2.6
5	5350.00	65.1 PK	74.0	-8.9	1.18 H	263	62.4	2.7
6	5350.00	52.4 AV	54.0	-1.6	1.18 H	263	49.7	2.7
7	10620.00	48.8 PK	74.0	-25.2	1.67 H	219	36.8	12.0
8	10620.00	42.5 AV	54.0	-11.5	1.67 H	219	30.5	12.0
9	15930.00	52.5 PK	74.0	-21.5	1.92 H	32	40.7	11.8
10	15930.00	41.0 AV	54.0	-13.0	1.92 H	32	29.2	11.8

ANTENNA POLARITY & TEST DISTANCE: VERTICAL AT 3 M

NO.	FREQ. (MHz)	EMISSION LEVEL (dBuV/m)	LIMIT (dBuV/m)	MARGIN (dB)	ANTENNA HEIGHT (m)	TABLE ANGLE (Degree)	RAW VALUE (dBuV)	CORRECTION FACTOR (dB/m)
1	5150.00	55.5 PK	74.0	-18.5	2.12 V	237	52.6	2.9
2	5150.00	42.8 AV	54.0	-11.2	2.12 V	237	39.9	2.9
3	*5310.00	113.8 PK			2.12 V	237	111.2	2.6
4	*5310.00	102.1 AV			2.12 V	237	99.5	2.6
5	5350.00	55.7 PK	74.0	-18.3	2.12 V	237	53.0	2.7
6	5350.00	42.9 AV	54.0	-11.1	2.12 V	237	40.2	2.7
7	10620.00	50.6 PK	74.0	-23.4	1.17 V	203	38.6	12.0
8	10620.00	45.7 AV	54.0	-8.3	1.17 V	203	33.7	12.0
9	15930.00	57.6 PK	74.0	-16.4	3.01 V	262	45.8	11.8
10	15930.00	47.3 AV	54.0	-6.7	3.01 V	262	35.5	11.8

REMARKS:

1. Emission Level(dBuV/m) = Raw Value(dBuV) + Correction Factor(dB/m)
2. Correction Factor(dB/m) = Antenna Factor(dB/m) + Cable Factor(dB) – Pre-Amplifier Factor(dB)
3. The other emission levels were very low against the limit.
4. Margin value = Emission Level – Limit value
5. " * ": Fundamental frequency.

CHANNEL	TX Channel 102	DETECTOR FUNCTION	Peak (PK)
FREQUENCY RANGE	1GHz ~ 40GHz		Average (AV)

ANTENNA POLARITY & TEST DISTANCE: HORIZONTAL AT 3 M

NO.	FREQ. (MHz)	EMISSION LEVEL (dBuV/m)	LIMIT (dBuV/m)	MARGIN (dB)	ANTENNA HEIGHT (m)	TABLE ANGLE (Degree)	RAW VALUE (dBuV)	CORRECTION FACTOR (dB/m)
1	5390.00	59.6 PK	74.0	-14.4	1.17 H	274	56.8	2.8
2	5390.00	52.2 AV	54.0	-1.8	1.17 H	274	49.4	2.8
3	#5470.00	59.8 PK	68.2	-8.4	1.17 H	274	56.8	3.0
4	*5510.00	115.2 PK			1.17 H	274	112.3	2.9
5	*5510.00	103.8 AV			1.17 H	274	100.9	2.9
6	#5725.00	49.8 PK	68.2	-18.4	1.17 H	274	46.6	3.2
7	11020.00	49.7 PK	74.0	-24.3	1.71 H	214	36.9	12.8
8	11020.00	43.1 AV	54.0	-10.9	1.71 H	214	30.3	12.8
9	#16530.00	53.3 PK	68.2	-14.9	1.84 H	27	38.7	14.6

ANTENNA POLARITY & TEST DISTANCE: VERTICAL AT 3 M

NO.	FREQ. (MHz)	EMISSION LEVEL (dBuV/m)	LIMIT (dBuV/m)	MARGIN (dB)	ANTENNA HEIGHT (m)	TABLE ANGLE (Degree)	RAW VALUE (dBuV)	CORRECTION FACTOR (dB/m)
1	5390.00	56.9 PK	74.0	-17.1	2.09 V	256	54.1	2.8
2	5390.00	48.7 AV	54.0	-5.3	2.09 V	256	45.9	2.8
3	#5470.00	56.5 PK	68.2	-11.7	2.09 V	256	53.5	3.0
4	*5510.00	114.7 PK			2.09 V	256	111.8	2.9
5	*5510.00	103.0 AV			2.09 V	256	100.1	2.9
6	#5725.00	61.1 PK	68.2	-7.1	2.09 V	256	57.9	3.2
7	11020.00	49.9 PK	74.0	-24.1	1.14 V	199	37.1	12.8
8	11020.00	45.0 AV	54.0	-9.0	1.14 V	199	32.2	12.8
9	#16530.00	57.8 PK	68.2	-10.4	2.94 V	248	43.2	14.6

REMARKS:

1. Emission Level(dBuV/m) = Raw Value(dBuV) + Correction Factor(dB/m)
2. Correction Factor(dB/m) = Antenna Factor(dB/m) + Cable Factor(dB) – Pre-Amplifier Factor(dB)
3. The other emission levels were very low against the limit.
4. Margin value = Emission Level – Limit value
5. " * ": Fundamental frequency.
6. " # ": The radiated frequency is out of the restricted band.

CHANNEL	TX Channel 110	DETECTOR FUNCTION	Peak (PK)
FREQUENCY RANGE	1GHz ~ 40GHz		Average (AV)

ANTENNA POLARITY & TEST DISTANCE: HORIZONTAL AT 3 M

NO.	FREQ. (MHz)	EMISSION LEVEL (dBuV/m)	LIMIT (dBuV/m)	MARGIN (dB)	ANTENNA HEIGHT (m)	TABLE ANGLE (Degree)	RAW VALUE (dBuV)	CORRECTION FACTOR (dB/m)
1	*5550.00	115.3 PK			1.16 H	272	112.3	3.0
2	*5550.00	104.1 AV			1.16 H	272	101.1	3.0
3	11100.00	49.4 PK	74.0	-24.6	1.64 H	206	37.1	12.3
4	11100.00	43.0 AV	54.0	-11.0	1.64 H	206	30.7	12.3
5	#16650.00	52.9 PK	68.2	-15.3	1.84 H	42	38.2	14.7

ANTENNA POLARITY & TEST DISTANCE: VERTICAL AT 3 M

NO.	FREQ. (MHz)	EMISSION LEVEL (dBuV/m)	LIMIT (dBuV/m)	MARGIN (dB)	ANTENNA HEIGHT (m)	TABLE ANGLE (Degree)	RAW VALUE (dBuV)	CORRECTION FACTOR (dB/m)
1	*5550.00	114.5 PK			2.04 V	257	111.5	3.0
2	*5550.00	103.1 AV			2.04 V	257	100.1	3.0
3	11100.00	49.8 PK	74.0	-24.2	1.13 V	192	37.5	12.3
4	11100.00	45.0 AV	54.0	-9.0	1.13 V	192	32.7	12.3
5	#16650.00	56.9 PK	68.2	-11.3	3.04 V	257	42.2	14.7

REMARKS:

1. Emission Level(dBuV/m) = Raw Value(dBuV) + Correction Factor(dB/m)
2. Correction Factor(dB/m) = Antenna Factor(dB/m) + Cable Factor(dB) – Pre-Amplifier Factor(dB)
3. The other emission levels were very low against the limit.
4. Margin value = Emission Level – Limit value
5. " * ": Fundamental frequency.
6. " # ": The radiated frequency is out of the restricted band.

CHANNEL	TX Channel 134	DETECTOR FUNCTION	Peak (PK)
FREQUENCY RANGE	1GHz ~ 40GHz		Average (AV)

ANTENNA POLARITY & TEST DISTANCE: HORIZONTAL AT 3 M

NO.	FREQ. (MHz)	EMISSION LEVEL (dBuV/m)	LIMIT (dBuV/m)	MARGIN (dB)	ANTENNA HEIGHT (m)	TABLE ANGLE (Degree)	RAW VALUE (dBuV)	CORRECTION FACTOR (dB/m)
1	*5670.00	115.4 PK			1.21 H	288	112.2	3.2
2	*5670.00	104.0 AV			1.21 H	288	100.8	3.2
3	#5725.00	65.3 PK	68.2	-2.9	1.21 H	288	62.1	3.2
4	11340.00	49.3 PK	74.0	-24.7	1.61 H	194	36.2	13.1
5	11340.00	42.9 AV	54.0	-11.1	1.61 H	194	29.8	13.1
6	#17010.00	52.5 PK	68.2	-15.7	1.89 H	22	36.1	16.4

ANTENNA POLARITY & TEST DISTANCE: VERTICAL AT 3 M

NO.	FREQ. (MHz)	EMISSION LEVEL (dBuV/m)	LIMIT (dBuV/m)	MARGIN (dB)	ANTENNA HEIGHT (m)	TABLE ANGLE (Degree)	RAW VALUE (dBuV)	CORRECTION FACTOR (dB/m)
1	*5670.00	114.6 PK			2.04 V	253	111.4	3.2
2	*5670.00	102.9 AV			2.04 V	253	99.7	3.2
3	#5725.00	60.6 PK	68.2	-7.6	2.04 V	253	57.4	3.2
4	11340.00	49.8 PK	74.0	-24.2	1.13 V	207	36.7	13.1
5	11340.00	45.2 AV	54.0	-8.8	1.13 V	207	32.1	13.1
6	#17010.00	57.4 PK	68.2	-10.8	3.03 V	262	41.0	16.4

REMARKS:

1. Emission Level(dBuV/m) = Raw Value(dBuV) + Correction Factor(dB/m)
2. Correction Factor(dB/m) = Antenna Factor(dB/m) + Cable Factor(dB) – Pre-Amplifier Factor(dB)
3. The other emission levels were very low against the limit.
4. Margin value = Emission Level – Limit value
5. " * ": Fundamental frequency.
6. " # ": The radiated frequency is out of the restricted band.

CHANNEL	TX Channel 142	DETECTOR FUNCTION	Peak (PK)
FREQUENCY RANGE	1GHz ~ 40GHz		Average (AV)

ANTENNA POLARITY & TEST DISTANCE: HORIZONTAL AT 3 M

NO.	FREQ. (MHz)	EMISSION LEVEL (dBuV/m)	LIMIT (dBuV/m)	MARGIN (dB)	ANTENNA HEIGHT (m)	TABLE ANGLE (Degree)	RAW VALUE (dBuV)	CORRECTION FACTOR (dB/m)
1	5460.00	54.7 PK	74.0	-19.3	1.24 H	272	51.7	3.0
2	5460.00	41.8 AV	54.0	-12.2	1.24 H	272	38.8	3.0
3	#5470.00	52.7 PK	68.2	-15.5	1.24 H	272	49.7	3.0
4	*5710.00	115.8 PK			1.24 H	272	112.5	3.3
5	*5710.00	104.4 AV			1.24 H	272	101.1	3.3
6	#5850.00	62.8 PK	68.2	-5.4	1.24 H	272	59.2	3.6
7	11420.00	49.4 PK	74.0	-24.6	1.60 H	211	36.4	13.0
8	11420.00	42.7 AV	54.0	-11.3	1.60 H	211	29.7	13.0
9	#17130.00	52.0 PK	68.2	-16.2	1.92 H	14	35.7	16.3

ANTENNA POLARITY & TEST DISTANCE: VERTICAL AT 3 M

NO.	FREQ. (MHz)	EMISSION LEVEL (dBuV/m)	LIMIT (dBuV/m)	MARGIN (dB)	ANTENNA HEIGHT (m)	TABLE ANGLE (Degree)	RAW VALUE (dBuV)	CORRECTION FACTOR (dB/m)
1	5460.00	54.9 PK	74.0	-19.1	2.12 V	249	51.9	3.0
2	5460.00	42.8 AV	54.0	-11.2	2.12 V	249	39.8	3.0
3	#5470.00	62.4 PK	68.2	-5.8	2.12 V	249	59.4	3.0
4	*5710.00	114.3 PK			2.12 V	249	111.0	3.3
5	*5710.00	102.7 AV			2.12 V	249	99.4	3.3
6	#5850.00	58.8 PK	68.2	-9.4	2.12 V	249	55.2	3.6
7	11420.00	49.8 PK	74.0	-24.2	1.23 V	194	36.8	13.0
8	11420.00	45.3 AV	54.0	-8.7	1.23 V	194	32.3	13.0
9	#17130.00	58.2 PK	68.2	-10.0	2.96 V	263	41.9	16.3

REMARKS:

1. Emission Level(dBuV/m) = Raw Value(dBuV) + Correction Factor(dB/m)
2. Correction Factor(dB/m) = Antenna Factor(dB/m) + Cable Factor(dB) – Pre-Amplifier Factor(dB)
3. The other emission levels were very low against the limit.
4. Margin value = Emission Level – Limit value
5. " * ": Fundamental frequency.
6. " # ": The radiated frequency is out of the restricted band.

802.11ax (HE80)

CHANNEL	TX Channel 58	DETECTOR FUNCTION	Peak (PK)
FREQUENCY RANGE	1GHz ~ 40GHz		Average (AV)

ANTENNA POLARITY & TEST DISTANCE: HORIZONTAL AT 3 M

NO.	FREQ. (MHz)	EMISSION LEVEL (dBuV/m)	LIMIT (dBuV/m)	MARGIN (dB)	ANTENNA HEIGHT (m)	TABLE ANGLE (Degree)	RAW VALUE (dBuV)	CORRECTION FACTOR (dB/m)
1	5150.00	53.9 PK	74.0	-20.1	1.65 H	278	51.0	2.9
2	5150.00	41.4 AV	54.0	-12.6	1.65 H	278	38.5	2.9
3	*5290.00	105.2 PK			1.65 H	278	102.8	2.4
4	*5290.00	93.0 AV			1.65 H	278	90.6	2.4
5	5350.00	66.4 PK	74.0	-7.6	1.65 H	278	63.7	2.7
6	5350.00	53.9 AV	54.0	-0.1	1.65 H	278	51.2	2.7
7	#10580.00	49.4 PK	68.2	-18.8	1.68 H	198	37.3	12.1
8	15870.00	52.6 PK	74.0	-21.4	1.87 H	33	40.9	11.7
9	15870.00	41.1 AV	54.0	-12.9	1.87 H	33	29.4	11.7

ANTENNA POLARITY & TEST DISTANCE: VERTICAL AT 3 M

NO.	FREQ. (MHz)	EMISSION LEVEL (dBuV/m)	LIMIT (dBuV/m)	MARGIN (dB)	ANTENNA HEIGHT (m)	TABLE ANGLE (Degree)	RAW VALUE (dBuV)	CORRECTION FACTOR (dB/m)
1	5150.00	52.6 PK	74.0	-21.4	1.46 V	297	49.7	2.9
2	5150.00	39.5 AV	54.0	-14.5	1.46 V	297	36.6	2.9
3	*5290.00	108.8 PK			1.46 V	297	106.4	2.4
4	*5290.00	96.5 AV			1.46 V	297	94.1	2.4
5	5350.00	56.9 PK	74.0	-17.1	1.46 V	297	54.2	2.7
6	5350.00	42.9 AV	54.0	-11.1	1.46 V	297	40.2	2.7
7	#10580.00	50.2 PK	68.2	-18.0	1.22 V	204	38.1	12.1
8	15870.00	57.3 PK	74.0	-16.7	2.95 V	274	45.6	11.7
9	15870.00	47.3 AV	54.0	-6.7	2.95 V	274	35.6	11.7

REMARKS:

- Emission Level(dBuV/m) = Raw Value(dBuV) + Correction Factor(dB/m)
- Correction Factor(dB/m) = Antenna Factor(dB/m) + Cable Factor(dB) – Pre-Amplifier Factor(dB)
- The other emission levels were very low against the limit.
- Margin value = Emission Level – Limit value
- " * ": Fundamental frequency.
- " # ": The radiated frequency is out of the restricted band.

CHANNEL	TX Channel 106	DETECTOR FUNCTION	Peak (PK)
FREQUENCY RANGE	1GHz ~ 40GHz		Average (AV)

ANTENNA POLARITY & TEST DISTANCE: HORIZONTAL AT 3 M

NO.	FREQ. (MHz)	EMISSION LEVEL (dBuV/m)	LIMIT (dBuV/m)	MARGIN (dB)	ANTENNA HEIGHT (m)	TABLE ANGLE (Degree)	RAW VALUE (dBuV)	CORRECTION FACTOR (dB/m)
1	5457.71	69.1 PK	74.0	-4.9	1.67 H	297	66.1	3.0
2	5457.71	49.8 AV	54.0	-4.2	1.67 H	297	46.8	3.0
3	#5462.90	68.0 PK	68.2	-0.2	1.67 H	297	65.0	3.0
4	*5530.00	105.6 PK			1.67 H	297	102.7	2.9
5	*5530.00	93.2 AV			1.67 H	297	90.3	2.9
6	#5736.37	53.3 PK	68.2	-14.9	1.67 H	297	50.0	3.3
7	11060.00	49.4 PK	74.0	-24.6	1.64 H	194	36.9	12.5
8	11060.00	43.1 AV	54.0	-10.9	1.64 H	194	30.6	12.5
9	#16590.00	53.1 PK	68.2	-15.1	1.82 H	40	38.4	14.7

ANTENNA POLARITY & TEST DISTANCE: VERTICAL AT 3 M

NO.	FREQ. (MHz)	EMISSION LEVEL (dBuV/m)	LIMIT (dBuV/m)	MARGIN (dB)	ANTENNA HEIGHT (m)	TABLE ANGLE (Degree)	RAW VALUE (dBuV)	CORRECTION FACTOR (dB/m)
1	5459.80	61.8 PK	74.0	-12.2	1.45 V	307	58.8	3.0
2	5459.80	49.6 AV	54.0	-4.4	1.45 V	307	46.6	3.0
3	#5470.00	63.1 PK	68.2	-5.1	1.45 V	307	60.1	3.0
4	*5530.00	108.8 PK			1.45 V	307	105.9	2.9
5	*5530.00	96.8 AV			1.45 V	307	93.9	2.9
6	#5725.46	53.9 PK	68.2	-14.3	1.45 V	307	50.7	3.2
7	11060.00	50.0 PK	74.0	-24.0	1.15 V	198	37.5	12.5
8	11060.00	45.5 AV	54.0	-8.5	1.15 V	198	33.0	12.5
9	#16590.00	57.8 PK	68.2	-10.4	2.95 V	257	43.1	14.7

REMARKS:

1. Emission Level(dBuV/m) = Raw Value(dBuV) + Correction Factor(dB/m)
2. Correction Factor(dB/m) = Antenna Factor(dB/m) + Cable Factor(dB) – Pre-Amplifier Factor(dB)
3. The other emission levels were very low against the limit.
4. Margin value = Emission Level – Limit value
5. " * ": Fundamental frequency.
6. " # ": The radiated frequency is out of the restricted band.

CHANNEL	TX Channel 122	DETECTOR FUNCTION	Peak (PK)
FREQUENCY RANGE	1GHz ~ 40GHz		Average (AV)

ANTENNA POLARITY & TEST DISTANCE: HORIZONTAL AT 3 M

NO.	FREQ. (MHz)	EMISSION LEVEL (dBuV/m)	LIMIT (dBuV/m)	MARGIN (dB)	ANTENNA HEIGHT (m)	TABLE ANGLE (Degree)	RAW VALUE (dBuV)	CORRECTION FACTOR (dB/m)
1	*5610.00	108.8 PK			1.72 H	284	105.8	3.0
2	*5610.00	96.4 AV			1.72 H	284	93.4	3.0
3	#5725.00	62.5 PK	68.2	-5.7	1.72 H	284	59.3	3.2
4	11220.00	49.1 PK	74.0	-24.9	1.64 H	220	36.6	12.5
5	11220.00	42.7 AV	54.0	-11.3	1.64 H	220	30.2	12.5
6	#16830.00	52.7 PK	68.2	-15.5	1.93 H	29	37.7	15.0

ANTENNA POLARITY & TEST DISTANCE: VERTICAL AT 3 M

NO.	FREQ. (MHz)	EMISSION LEVEL (dBuV/m)	LIMIT (dBuV/m)	MARGIN (dB)	ANTENNA HEIGHT (m)	TABLE ANGLE (Degree)	RAW VALUE (dBuV)	CORRECTION FACTOR (dB/m)
1	*5610.00	111.6 PK			1.48 V	292	108.6	3.0
2	*5610.00	99.9 AV			1.48 V	292	96.9	3.0
3	#5725.00	59.1 PK	68.2	-9.1	1.48 V	292	55.9	3.2
4	11220.00	50.6 PK	74.0	-23.4	1.23 V	210	38.1	12.5
5	11220.00	45.7 AV	54.0	-8.3	1.23 V	210	33.2	12.5
6	#16830.00	57.4 PK	68.2	-10.8	3.05 V	275	42.4	15.0

REMARKS:

1. Emission Level(dBuV/m) = Raw Value(dBuV) + Correction Factor(dB/m)
2. Correction Factor(dB/m) = Antenna Factor(dB/m) + Cable Factor(dB) – Pre-Amplifier Factor(dB)
3. The other emission levels were very low against the limit.
4. Margin value = Emission Level – Limit value
5. " * ": Fundamental frequency.
6. " # ": The radiated frequency is out of the restricted band.

CHANNEL	TX Channel 138	DETECTOR FUNCTION	Peak (PK)
FREQUENCY RANGE	1GHz ~ 40GHz		Average (AV)

ANTENNA POLARITY & TEST DISTANCE: HORIZONTAL AT 3 M

NO.	FREQ. (MHz)	EMISSION LEVEL (dBuV/m)	LIMIT (dBuV/m)	MARGIN (dB)	ANTENNA HEIGHT (m)	TABLE ANGLE (Degree)	RAW VALUE (dBuV)	CORRECTION FACTOR (dB/m)
1	5460.00	54.9 PK	74.0	-19.1	1.00 H	0	51.9	3.0
2	5460.00	42.1 AV	54.0	-11.9	1.00 H	0	39.1	3.0
3	#5470.00	58.2 PK	68.2	-10.0	1.76 H	276	55.2	3.0
4	*5690.00	108.3 PK			1.76 H	276	105.1	3.2
5	*5690.00	96.2 AV			1.76 H	276	93.0	3.2
6	#5850.00	63.1 PK	68.2	-5.1	1.76 H	276	59.5	3.6
7	11380.00	49.2 PK	74.0	-24.8	1.61 H	201	36.2	13.0
8	11380.00	42.6 AV	54.0	-11.4	1.61 H	201	29.6	13.0
9	#17070.00	52.1 PK	68.2	-16.1	1.88 H	37	35.6	16.5

ANTENNA POLARITY & TEST DISTANCE: VERTICAL AT 3 M

NO.	FREQ. (MHz)	EMISSION LEVEL (dBuV/m)	LIMIT (dBuV/m)	MARGIN (dB)	ANTENNA HEIGHT (m)	TABLE ANGLE (Degree)	RAW VALUE (dBuV)	CORRECTION FACTOR (dB/m)
1	5460.00	54.4 PK	74.0	-19.6	1.00 V	0	51.4	3.0
2	5460.00	42.3 AV	54.0	-11.7	1.00 V	0	39.3	3.0
3	#5470.00	59.0 PK	68.2	-9.2	1.49 V	286	56.0	3.0
4	*5690.00	111.4 PK			1.49 V	286	108.2	3.2
5	*5690.00	99.5 AV			1.49 V	286	96.3	3.2
6	#5850.00	58.7 PK	68.2	-9.5	1.49 V	286	55.1	3.6
7	11380.00	49.9 PK	74.0	-24.1	1.14 V	194	36.9	13.0
8	11380.00	45.0 AV	54.0	-9.0	1.14 V	194	32.0	13.0
9	#17070.00	57.6 PK	68.2	-10.6	2.95 V	253	41.1	16.5

REMARKS:

1. Emission Level(dBuV/m) = Raw Value(dBuV) + Correction Factor(dB/m)
2. Correction Factor(dB/m) = Antenna Factor(dB/m) + Cable Factor(dB) – Pre-Amplifier Factor(dB)
3. The other emission levels were very low against the limit.
4. Margin value = Emission Level – Limit value
5. " * ": Fundamental frequency.
6. " # ": The radiated frequency is out of the restricted band.

4.1.9 Test Results (Mode 3)

Above 1GHz Data:

802.11a

CHANNEL	TX Channel 52	DETECTOR FUNCTION	Peak (PK)
FREQUENCY RANGE	1GHz ~ 40GHz		Average (AV)

ANTENNA POLARITY & TEST DISTANCE: HORIZONTAL AT 3 M								
NO.	FREQ. (MHz)	EMISSION LEVEL (dBuV/m)	LIMIT (dBuV/m)	MARGIN (dB)	ANTENNA HEIGHT (m)	TABLE ANGLE (Degree)	RAW VALUE (dBuV)	CORRECTION FACTOR (dB/m)
1	5150.00	67.4 PK	74.0	-6.6	1.59 H	187	64.5	2.9
2	5150.00	52.6 AV	54.0	-1.4	1.59 H	187	49.7	2.9
3	*5260.00	111.0 PK			1.59 H	187	108.6	2.4
4	*5260.00	101.4 AV			1.59 H	187	99.0	2.4
5	#10520.00	49.3 PK	68.2	-18.9	1.65 H	207	37.0	12.3
6	15780.00	52.6 PK	74.0	-21.4	1.88 H	27	40.6	12.0
7	15780.00	40.9 AV	54.0	-13.1	1.88 H	27	28.9	12.0

ANTENNA POLARITY & TEST DISTANCE: VERTICAL AT 3 M								
NO.	FREQ. (MHz)	EMISSION LEVEL (dBuV/m)	LIMIT (dBuV/m)	MARGIN (dB)	ANTENNA HEIGHT (m)	TABLE ANGLE (Degree)	RAW VALUE (dBuV)	CORRECTION FACTOR (dB/m)
1	5150.00	56.4 PK	74.0	-17.6	1.44 V	154	53.5	2.9
2	5150.00	43.2 AV	54.0	-10.8	1.44 V	154	40.3	2.9
3	*5260.00	104.8 PK			1.44 V	154	102.4	2.4
4	*5260.00	93.5 AV			1.44 V	154	91.1	2.4
5	#10520.00	50.0 PK	68.2	-18.2	1.19 V	202	37.7	12.3
6	15780.00	57.6 PK	74.0	-16.4	3.00 V	261	45.6	12.0
7	15780.00	47.3 AV	54.0	-6.7	3.00 V	261	35.3	12.0

REMARKS:

1. Emission Level(dBuV/m) = Raw Value(dBuV) + Correction Factor(dB/m)
2. Correction Factor(dB/m) = Antenna Factor(dB/m) + Cable Factor(dB) – Pre-Amplifier Factor(dB)
3. The other emission levels were very low against the limit.
4. Margin value = Emission Level – Limit value
5. " * ": Fundamental frequency.
6. " # ": The radiated frequency is out of the restricted band.

CHANNEL	TX Channel 60	DETECTOR FUNCTION	Peak (PK)
FREQUENCY RANGE	1GHz ~ 40GHz		Average (AV)

ANTENNA POLARITY & TEST DISTANCE: HORIZONTAL AT 3 M

NO.	FREQ. (MHz)	EMISSION LEVEL (dBuV/m)	LIMIT (dBuV/m)	MARGIN (dB)	ANTENNA HEIGHT (m)	TABLE ANGLE (Degree)	RAW VALUE (dBuV)	CORRECTION FACTOR (dB/m)
1	*5300.00	110.3 PK			1.58 H	192	107.7	2.6
2	*5300.00	101.0 AV			1.58 H	192	98.4	2.6
3	10600.00	49.2 PK	74.0	-24.8	1.60 H	202	37.1	12.1
4	10600.00	42.8 AV	54.0	-11.2	1.60 H	202	30.7	12.1
5	15900.00	53.1 PK	74.0	-20.9	1.92 H	40	41.3	11.8
6	15900.00	41.2 AV	54.0	-12.8	1.92 H	40	29.4	11.8

ANTENNA POLARITY & TEST DISTANCE: VERTICAL AT 3 M

NO.	FREQ. (MHz)	EMISSION LEVEL (dBuV/m)	LIMIT (dBuV/m)	MARGIN (dB)	ANTENNA HEIGHT (m)	TABLE ANGLE (Degree)	RAW VALUE (dBuV)	CORRECTION FACTOR (dB/m)
1	*5300.00	104.4 PK			1.44 V	156	101.8	2.6
2	*5300.00	93.3 AV			1.44 V	156	90.7	2.6
3	10600.00	50.2 PK	74.0	-23.8	1.25 V	211	38.1	12.1
4	10600.00	45.5 AV	54.0	-8.5	1.25 V	211	33.4	12.1
5	15900.00	57.9 PK	74.0	-16.1	3.05 V	256	46.1	11.8
6	15900.00	47.6 AV	54.0	-6.4	3.05 V	256	35.8	11.8

REMARKS:

1. Emission Level(dBuV/m) = Raw Value(dBuV) + Correction Factor(dB/m)
2. Correction Factor(dB/m) = Antenna Factor(dB/m) + Cable Factor(dB) – Pre-Amplifier Factor(dB)
3. The other emission levels were very low against the limit.
4. Margin value = Emission Level – Limit value
5. " * ": Fundamental frequency.

CHANNEL	TX Channel 64	DETECTOR FUNCTION	Peak (PK)
FREQUENCY RANGE	1GHz ~ 40GHz		Average (AV)

ANTENNA POLARITY & TEST DISTANCE: HORIZONTAL AT 3 M

NO.	FREQ. (MHz)	EMISSION LEVEL (dBuV/m)	LIMIT (dBuV/m)	MARGIN (dB)	ANTENNA HEIGHT (m)	TABLE ANGLE (Degree)	RAW VALUE (dBuV)	CORRECTION FACTOR (dB/m)
1	*5320.00	110.8 PK			1.56 H	195	108.2	2.6
2	*5320.00	101.0 AV			1.56 H	195	98.4	2.6
3	5350.00	67.4 PK	74.0	-6.6	1.56 H	195	64.7	2.7
4	5350.00	52.6 AV	54.0	-1.4	1.56 H	195	49.9	2.7
5	10640.00	49.3 PK	74.0	-24.7	1.61 H	194	37.4	11.9
6	10640.00	43.0 AV	54.0	-11.0	1.61 H	194	31.1	11.9
7	15960.00	52.9 PK	74.0	-21.1	1.92 H	42	40.8	12.1
8	15960.00	41.2 AV	54.0	-12.8	1.92 H	42	29.1	12.1

ANTENNA POLARITY & TEST DISTANCE: VERTICAL AT 3 M

NO.	FREQ. (MHz)	EMISSION LEVEL (dBuV/m)	LIMIT (dBuV/m)	MARGIN (dB)	ANTENNA HEIGHT (m)	TABLE ANGLE (Degree)	RAW VALUE (dBuV)	CORRECTION FACTOR (dB/m)
1	*5320.00	105.0 PK			1.49 V	158	102.4	2.6
2	*5320.00	93.8 AV			1.49 V	158	91.2	2.6
3	5350.00	55.4 PK	74.0	-18.6	1.49 V	158	52.7	2.7
4	5350.00	42.3 AV	54.0	-11.7	1.49 V	158	39.6	2.7
5	10640.00	50.1 PK	74.0	-23.9	1.18 V	209	38.2	11.9
6	10640.00	45.5 AV	54.0	-8.5	1.18 V	209	33.6	11.9
7	15960.00	57.4 PK	74.0	-16.6	3.08 V	259	45.3	12.1
8	15960.00	47.5 AV	54.0	-6.5	3.08 V	259	35.4	12.1

REMARKS:

1. Emission Level(dBuV/m) = Raw Value(dBuV) + Correction Factor(dB/m)
2. Correction Factor(dB/m) = Antenna Factor(dB/m) + Cable Factor(dB) – Pre-Amplifier Factor(dB)
3. The other emission levels were very low against the limit.
4. Margin value = Emission Level – Limit value
5. " * ": Fundamental frequency.

CHANNEL	TX Channel 100	DETECTOR FUNCTION	Peak (PK)
FREQUENCY RANGE	1GHz ~ 40GHz		Average (AV)

ANTENNA POLARITY & TEST DISTANCE: HORIZONTAL AT 3 M

NO.	FREQ. (MHz)	EMISSION LEVEL (dBuV/m)	LIMIT (dBuV/m)	MARGIN (dB)	ANTENNA HEIGHT (m)	TABLE ANGLE (Degree)	RAW VALUE (dBuV)	CORRECTION FACTOR (dB/m)
1	5460.00	62.6 PK	74.0	-11.4	1.58 H	185	59.6	3.0
2	5460.00	44.0 AV	54.0	-10.0	1.58 H	185	41.0	3.0
3	#5470.00	68.0 PK	68.2	-0.2	1.58 H	185	65.0	3.0
4	*5500.00	110.0 PK			1.58 H	185	107.1	2.9
5	*5500.00	100.6 AV			1.58 H	185	97.7	2.9
6	11000.00	50.0 PK	74.0	-24.0	1.65 H	214	37.2	12.8
7	11000.00	43.2 AV	54.0	-10.8	1.65 H	214	30.4	12.8
8	#16500.00	52.9 PK	68.2	-15.3	1.87 H	12	38.5	14.4

ANTENNA POLARITY & TEST DISTANCE: VERTICAL AT 3 M

NO.	FREQ. (MHz)	EMISSION LEVEL (dBuV/m)	LIMIT (dBuV/m)	MARGIN (dB)	ANTENNA HEIGHT (m)	TABLE ANGLE (Degree)	RAW VALUE (dBuV)	CORRECTION FACTOR (dB/m)
1	5460.00	59.2 PK	74.0	-14.8	1.47 V	171	56.2	3.0
2	5460.00	45.4 AV	54.0	-8.6	1.47 V	171	42.4	3.0
3	#5470.00	67.5 PK	68.2	-0.7	1.47 V	171	64.5	3.0
4	*5500.00	104.3 PK			1.47 V	171	101.4	2.9
5	*5500.00	93.2 AV			1.47 V	171	90.3	2.9
6	11000.00	50.4 PK	74.0	-23.6	1.17 V	207	37.6	12.8
7	11000.00	45.7 AV	54.0	-8.3	1.17 V	207	32.9	12.8
8	#16500.00	58.4 PK	68.2	-9.8	3.08 V	238	44.0	14.4

REMARKS:

1. Emission Level(dBuV/m) = Raw Value(dBuV) + Correction Factor(dB/m)
2. Correction Factor(dB/m) = Antenna Factor(dB/m) + Cable Factor(dB) – Pre-Amplifier Factor(dB)
3. The other emission levels were very low against the limit.
4. Margin value = Emission Level – Limit value
5. " * ": Fundamental frequency.
6. " # ": The radiated frequency is out of the restricted band.

CHANNEL	TX Channel 116	DETECTOR FUNCTION	Peak (PK)
FREQUENCY RANGE	1GHz ~ 40GHz		Average (AV)

ANTENNA POLARITY & TEST DISTANCE: HORIZONTAL AT 3 M

NO.	FREQ. (MHz)	EMISSION LEVEL (dBuV/m)	LIMIT (dBuV/m)	MARGIN (dB)	ANTENNA HEIGHT (m)	TABLE ANGLE (Degree)	RAW VALUE (dBuV)	CORRECTION FACTOR (dB/m)
1	*5580.00	111.9 PK			1.61 H	191	108.9	3.0
2	*5580.00	102.2 AV			1.61 H	191	99.2	3.0
3	11160.00	49.9 PK	74.0	-24.1	1.81 H	212	37.6	12.3
4	11160.00	43.6 AV	54.0	-10.4	1.81 H	212	31.3	12.3
5	#16740.00	54.4 PK	68.2	-13.8	2.03 H	35	39.7	14.7

ANTENNA POLARITY & TEST DISTANCE: VERTICAL AT 3 M

NO.	FREQ. (MHz)	EMISSION LEVEL (dBuV/m)	LIMIT (dBuV/m)	MARGIN (dB)	ANTENNA HEIGHT (m)	TABLE ANGLE (Degree)	RAW VALUE (dBuV)	CORRECTION FACTOR (dB/m)
1	*5580.00	105.1 PK			1.46 V	168	102.1	3.0
2	*5580.00	93.9 AV			1.46 V	168	90.9	3.0
3	11160.00	51.7 PK	74.0	-22.3	1.23 V	216	39.4	12.3
4	11160.00	46.5 AV	54.0	-7.5	1.23 V	216	34.2	12.3
5	#16740.00	60.1 PK	68.2	-8.1	3.04 V	226	45.4	14.7

REMARKS:

1. Emission Level(dBuV/m) = Raw Value(dBuV) + Correction Factor(dB/m)
2. Correction Factor(dB/m) = Antenna Factor(dB/m) + Cable Factor(dB) – Pre-Amplifier Factor(dB)
3. The other emission levels were very low against the limit.
4. Margin value = Emission Level – Limit value
5. " * ": Fundamental frequency.
6. " # ": The radiated frequency is out of the restricted band.

CHANNEL	TX Channel 140	DETECTOR FUNCTION	Peak (PK)
FREQUENCY RANGE	1GHz ~ 40GHz		Average (AV)

ANTENNA POLARITY & TEST DISTANCE: HORIZONTAL AT 3 M

NO.	FREQ. (MHz)	EMISSION LEVEL (dBuV/m)	LIMIT (dBuV/m)	MARGIN (dB)	ANTENNA HEIGHT (m)	TABLE ANGLE (Degree)	RAW VALUE (dBuV)	CORRECTION FACTOR (dB/m)
1	*5700.00	110.5 PK			1.58 H	188	107.3	3.2
2	*5700.00	100.7 AV			1.58 H	188	97.5	3.2
3	#5725.00	68.0 PK	68.2	-0.2	1.58 H	188	64.8	3.2
4	11400.00	48.7 PK	74.0	-25.3	1.71 H	214	35.7	13.0
5	11400.00	42.3 AV	54.0	-11.7	1.71 H	214	29.3	13.0
6	#17100.00	53.2 PK	68.2	-15.0	1.86 H	22	36.7	16.5

ANTENNA POLARITY & TEST DISTANCE: VERTICAL AT 3 M

NO.	FREQ. (MHz)	EMISSION LEVEL (dBuV/m)	LIMIT (dBuV/m)	MARGIN (dB)	ANTENNA HEIGHT (m)	TABLE ANGLE (Degree)	RAW VALUE (dBuV)	CORRECTION FACTOR (dB/m)
1	*5700.00	104.3 PK			1.44 V	176	101.1	3.2
2	*5700.00	93.3 AV			1.44 V	176	90.1	3.2
3	#5725.00	66.4 PK	68.2	-1.8	1.44 V	176	63.2	3.2
4	11400.00	50.8 PK	74.0	-23.2	1.22 V	197	37.8	13.0
5	11400.00	45.9 AV	54.0	-8.1	1.22 V	197	32.9	13.0
6	#17100.00	57.6 PK	68.2	-10.6	2.97 V	247	41.1	16.5

REMARKS:

1. Emission Level(dBuV/m) = Raw Value(dBuV) + Correction Factor(dB/m)
2. Correction Factor(dB/m) = Antenna Factor(dB/m) + Cable Factor(dB) – Pre-Amplifier Factor(dB)
3. The other emission levels were very low against the limit.
4. Margin value = Emission Level – Limit value
5. " * ": Fundamental frequency.
6. " # ": The radiated frequency is out of the restricted band.

CHANNEL	TX Channel 144	DETECTOR FUNCTION	Peak (PK)
FREQUENCY RANGE	1GHz ~ 40GHz		Average (AV)

ANTENNA POLARITY & TEST DISTANCE: HORIZONTAL AT 3 M

NO.	FREQ. (MHz)	EMISSION LEVEL (dBuV/m)	LIMIT (dBuV/m)	MARGIN (dB)	ANTENNA HEIGHT (m)	TABLE ANGLE (Degree)	RAW VALUE (dBuV)	CORRECTION FACTOR (dB/m)
1	5460.00	63.0 PK	74.0	-11.0	1.62 H	186	60.0	3.0
2	5460.00	44.5 AV	54.0	-9.5	1.62 H	186	41.5	3.0
3	#5470.00	64.0 PK	68.2	-4.2	1.62 H	186	61.0	3.0
4	*5720.00	111.5 PK			1.62 H	186	108.3	3.2
5	*5720.00	101.9 AV			1.62 H	186	98.7	3.2
6	#5850.00	63.6 PK	68.2	-4.6	1.62 H	186	60.0	3.6
7	11440.00	49.6 PK	74.0	-24.4	1.79 H	207	36.7	12.9
8	11440.00	43.3 AV	54.0	-10.7	1.79 H	207	30.4	12.9
9	#17160.00	54.1 PK	68.2	-14.1	1.97 H	29	38.0	16.1

ANTENNA POLARITY & TEST DISTANCE: VERTICAL AT 3 M

NO.	FREQ. (MHz)	EMISSION LEVEL (dBuV/m)	LIMIT (dBuV/m)	MARGIN (dB)	ANTENNA HEIGHT (m)	TABLE ANGLE (Degree)	RAW VALUE (dBuV)	CORRECTION FACTOR (dB/m)
1	5460.00	58.7 PK	74.0	-15.3	1.48 V	167	55.7	3.0
2	5460.00	45.2 AV	54.0	-8.8	1.48 V	167	42.2	3.0
3	#5470.00	62.4 PK	68.2	-5.8	1.48 V	167	59.4	3.0
4	*5720.00	104.9 PK			1.48 V	167	101.7	3.2
5	*5720.00	93.6 AV			1.48 V	167	90.4	3.2
6	#5850.00	59.3 PK	68.2	-8.9	1.48 V	167	55.7	3.6
7	11440.00	52.1 PK	74.0	-21.9	1.15 V	197	39.2	12.9
8	11440.00	46.7 AV	54.0	-7.3	1.15 V	197	33.8	12.9
9	#17160.00	59.7 PK	68.2	-8.5	3.05 V	232	43.6	16.1

REMARKS:

1. Emission Level(dBuV/m) = Raw Value(dBuV) + Correction Factor(dB/m)
2. Correction Factor(dB/m) = Antenna Factor(dB/m) + Cable Factor(dB) – Pre-Amplifier Factor(dB)
3. The other emission levels were very low against the limit.
4. Margin value = Emission Level – Limit value
5. " * ": Fundamental frequency.
6. " # ": The radiated frequency is out of the restricted band.

802.11ax (HE20)

CHANNEL	TX Channel 52	DETECTOR FUNCTION	Peak (PK)
FREQUENCY RANGE	1GHz ~ 40GHz		Average (AV)

ANTENNA POLARITY & TEST DISTANCE: HORIZONTAL AT 3 M

NO.	FREQ. (MHz)	EMISSION LEVEL (dBuV/m)	LIMIT (dBuV/m)	MARGIN (dB)	ANTENNA HEIGHT (m)	TABLE ANGLE (Degree)	RAW VALUE (dBuV)	CORRECTION FACTOR (dB/m)
1	5150.00	67.5 PK	74.0	-6.5	1.63 H	186	64.6	2.9
2	5150.00	52.9 AV	54.0	-1.1	1.63 H	186	50.0	2.9
3	*5260.00	110.9 PK			1.63 H	186	108.5	2.4
4	*5260.00	101.1 AV			1.63 H	186	98.7	2.4
5	#10520.00	48.9 PK	68.2	-19.3	1.60 H	209	36.6	12.3
6	15780.00	52.5 PK	74.0	-21.5	1.92 H	20	40.5	12.0
7	15780.00	41.0 AV	54.0	-13.0	1.92 H	20	29.0	12.0

ANTENNA POLARITY & TEST DISTANCE: VERTICAL AT 3 M

NO.	FREQ. (MHz)	EMISSION LEVEL (dBuV/m)	LIMIT (dBuV/m)	MARGIN (dB)	ANTENNA HEIGHT (m)	TABLE ANGLE (Degree)	RAW VALUE (dBuV)	CORRECTION FACTOR (dB/m)
1	5150.00	56.1 PK	74.0	-17.9	1.46 V	149	53.2	2.9
2	5150.00	42.7 AV	54.0	-11.3	1.46 V	149	39.8	2.9
3	*5260.00	104.6 PK			1.46 V	149	102.2	2.4
4	*5260.00	93.1 AV			1.46 V	149	90.7	2.4
5	#10520.00	49.8 PK	68.2	-18.4	1.24 V	208	37.5	12.3
6	15780.00	57.4 PK	74.0	-16.6	2.99 V	254	45.4	12.0
7	15780.00	47.4 AV	54.0	-6.6	2.99 V	254	35.4	12.0

REMARKS:

- Emission Level(dBuV/m) = Raw Value(dBuV) + Correction Factor(dB/m)
- Correction Factor(dB/m) = Antenna Factor(dB/m) + Cable Factor(dB) – Pre-Amplifier Factor(dB)
- The other emission levels were very low against the limit.
- Margin value = Emission Level – Limit value
- " * ": Fundamental frequency.
- " # ": The radiated frequency is out of the restricted band.

CHANNEL	TX Channel 60	DETECTOR FUNCTION	Peak (PK)
FREQUENCY RANGE	1GHz ~ 40GHz		Average (AV)

ANTENNA POLARITY & TEST DISTANCE: HORIZONTAL AT 3 M

NO.	FREQ. (MHz)	EMISSION LEVEL (dBuV/m)	LIMIT (dBuV/m)	MARGIN (dB)	ANTENNA HEIGHT (m)	TABLE ANGLE (Degree)	RAW VALUE (dBuV)	CORRECTION FACTOR (dB/m)
1	*5300.00	110.9 PK			1.59 H	193	108.3	2.6
2	*5300.00	101.4 AV			1.59 H	193	98.8	2.6
3	10600.00	49.2 PK	74.0	-24.8	1.66 H	195	37.1	12.1
4	10600.00	42.5 AV	54.0	-11.5	1.66 H	195	30.4	12.1
5	15900.00	52.4 PK	74.0	-21.6	1.86 H	32	40.6	11.8
6	15900.00	40.9 AV	54.0	-13.1	1.86 H	32	29.1	11.8

ANTENNA POLARITY & TEST DISTANCE: VERTICAL AT 3 M

NO.	FREQ. (MHz)	EMISSION LEVEL (dBuV/m)	LIMIT (dBuV/m)	MARGIN (dB)	ANTENNA HEIGHT (m)	TABLE ANGLE (Degree)	RAW VALUE (dBuV)	CORRECTION FACTOR (dB/m)
1	*5300.00	104.9 PK			1.41 V	161	102.3	2.6
2	*5300.00	93.8 AV			1.41 V	161	91.2	2.6
3	10600.00	50.4 PK	74.0	-23.6	1.17 V	204	38.3	12.1
4	10600.00	45.4 AV	54.0	-8.6	1.17 V	204	33.3	12.1
5	15900.00	57.5 PK	74.0	-16.5	3.02 V	243	45.7	11.8
6	15900.00	47.5 AV	54.0	-6.5	3.02 V	243	35.7	11.8

REMARKS:

1. Emission Level(dBuV/m) = Raw Value(dBuV) + Correction Factor(dB/m)
2. Correction Factor(dB/m) = Antenna Factor(dB/m) + Cable Factor(dB) – Pre-Amplifier Factor(dB)
3. The other emission levels were very low against the limit.
4. Margin value = Emission Level – Limit value
5. " * ": Fundamental frequency.

CHANNEL	TX Channel 64	DETECTOR FUNCTION	Peak (PK)
FREQUENCY RANGE	1GHz ~ 40GHz		Average (AV)

ANTENNA POLARITY & TEST DISTANCE: HORIZONTAL AT 3 M

NO.	FREQ. (MHz)	EMISSION LEVEL (dBuV/m)	LIMIT (dBuV/m)	MARGIN (dB)	ANTENNA HEIGHT (m)	TABLE ANGLE (Degree)	RAW VALUE (dBuV)	CORRECTION FACTOR (dB/m)
1	*5320.00	111.5 PK			1.66 H	182	108.9	2.6
2	*5320.00	101.7 AV			1.66 H	182	99.1	2.6
3	5350.00	67.0 PK	74.0	-7.0	1.66 H	182	64.3	2.7
4	5350.00	52.2 AV	54.0	-1.8	1.66 H	182	49.5	2.7
5	10640.00	50.0 PK	74.0	-24.0	1.84 H	211	38.1	11.9
6	10640.00	43.7 AV	54.0	-10.3	1.84 H	211	31.8	11.9
7	15960.00	54.3 PK	74.0	-19.7	1.97 H	34	42.2	12.1
8	15960.00	41.6 AV	54.0	-12.4	1.97 H	34	29.5	12.1

ANTENNA POLARITY & TEST DISTANCE: VERTICAL AT 3 M

NO.	FREQ. (MHz)	EMISSION LEVEL (dBuV/m)	LIMIT (dBuV/m)	MARGIN (dB)	ANTENNA HEIGHT (m)	TABLE ANGLE (Degree)	RAW VALUE (dBuV)	CORRECTION FACTOR (dB/m)
1	*5320.00	105.3 PK			1.51 V	180	102.7	2.6
2	*5320.00	93.8 AV			1.51 V	180	91.2	2.6
3	5350.00	55.4 PK	74.0	-18.6	1.51 V	180	52.7	2.7
4	5350.00	42.6 AV	54.0	-11.4	1.51 V	180	39.9	2.7
5	10640.00	51.7 PK	74.0	-22.3	1.09 V	204	39.8	11.9
6	10640.00	46.7 AV	54.0	-7.3	1.09 V	204	34.8	11.9
7	15960.00	60.1 PK	74.0	-13.9	3.14 V	212	48.0	12.1
8	15960.00	49.6 AV	54.0	-4.4	3.14 V	212	37.5	12.1

REMARKS:

1. Emission Level(dBuV/m) = Raw Value(dBuV) + Correction Factor(dB/m)
2. Correction Factor(dB/m) = Antenna Factor(dB/m) + Cable Factor(dB) – Pre-Amplifier Factor(dB)
3. The other emission levels were very low against the limit.
4. Margin value = Emission Level – Limit value
5. " * ": Fundamental frequency.

CHANNEL	TX Channel 100	DETECTOR FUNCTION	Peak (PK)
FREQUENCY RANGE	1GHz ~ 40GHz		Average (AV)

ANTENNA POLARITY & TEST DISTANCE: HORIZONTAL AT 3 M

NO.	FREQ. (MHz)	EMISSION LEVEL (dBuV/m)	LIMIT (dBuV/m)	MARGIN (dB)	ANTENNA HEIGHT (m)	TABLE ANGLE (Degree)	RAW VALUE (dBuV)	CORRECTION FACTOR (dB/m)
1	5460.00	62.8 PK	74.0	-11.2	1.60 H	181	59.8	3.0
2	5460.00	44.0 AV	54.0	-10.0	1.60 H	181	41.0	3.0
3	#5470.00	68.0 PK	68.2	-0.2	1.60 H	181	65.0	3.0
4	*5500.00	109.9 PK			1.60 H	181	107.0	2.9
5	*5500.00	100.8 AV			1.60 H	181	97.9	2.9
6	11000.00	49.5 PK	74.0	-24.5	1.66 H	198	36.7	12.8
7	11000.00	42.7 AV	54.0	-11.3	1.66 H	198	29.9	12.8
8	#16500.00	53.2 PK	68.2	-15.0	1.91 H	29	38.8	14.4

ANTENNA POLARITY & TEST DISTANCE: VERTICAL AT 3 M

NO.	FREQ. (MHz)	EMISSION LEVEL (dBuV/m)	LIMIT (dBuV/m)	MARGIN (dB)	ANTENNA HEIGHT (m)	TABLE ANGLE (Degree)	RAW VALUE (dBuV)	CORRECTION FACTOR (dB/m)
1	5460.00	58.8 PK	74.0	-15.2	1.43 V	162	55.8	3.0
2	5460.00	45.1 AV	54.0	-8.9	1.43 V	162	42.1	3.0
3	#5470.00	67.5 PK	68.2	-0.7	1.43 V	162	64.5	3.0
4	*5500.00	103.7 PK			1.43 V	162	100.8	2.9
5	*5500.00	92.8 AV			1.43 V	162	89.9	2.9
6	11000.00	50.1 PK	74.0	-23.9	1.26 V	204	37.3	12.8
7	11000.00	45.0 AV	54.0	-9.0	1.26 V	204	32.2	12.8
8	#16500.00	57.2 PK	68.2	-11.0	3.05 V	252	42.8	14.4

REMARKS:

1. Emission Level(dBuV/m) = Raw Value(dBuV) + Correction Factor(dB/m)
2. Correction Factor(dB/m) = Antenna Factor(dB/m) + Cable Factor(dB) – Pre-Amplifier Factor(dB)
3. The other emission levels were very low against the limit.
4. Margin value = Emission Level – Limit value
5. " * ": Fundamental frequency.
6. " # ": The radiated frequency is out of the restricted band.

CHANNEL	TX Channel 116	DETECTOR FUNCTION	Peak (PK)
FREQUENCY RANGE	1GHz ~ 40GHz		Average (AV)

ANTENNA POLARITY & TEST DISTANCE: HORIZONTAL AT 3 M

NO.	FREQ. (MHz)	EMISSION LEVEL (dBuV/m)	LIMIT (dBuV/m)	MARGIN (dB)	ANTENNA HEIGHT (m)	TABLE ANGLE (Degree)	RAW VALUE (dBuV)	CORRECTION FACTOR (dB/m)
1	*5580.00	110.9 PK			1.65 H	180	107.9	3.0
2	*5580.00	101.6 AV			1.65 H	180	98.6	3.0
3	11160.00	49.3 PK	74.0	-24.7	1.81 H	210	37.0	12.3
4	11160.00	43.1 AV	54.0	-10.9	1.81 H	210	30.8	12.3
5	#16740.00	54.1 PK	68.2	-14.1	2.04 H	36	39.4	14.7

ANTENNA POLARITY & TEST DISTANCE: VERTICAL AT 3 M

NO.	FREQ. (MHz)	EMISSION LEVEL (dBuV/m)	LIMIT (dBuV/m)	MARGIN (dB)	ANTENNA HEIGHT (m)	TABLE ANGLE (Degree)	RAW VALUE (dBuV)	CORRECTION FACTOR (dB/m)
1	*5580.00	105.3 PK			1.48 V	179	102.3	3.0
2	*5580.00	93.8 AV			1.48 V	179	90.8	3.0
3	11160.00	52.0 PK	74.0	-22.0	1.15 V	209	39.7	12.3
4	11160.00	46.8 AV	54.0	-7.2	1.15 V	209	34.5	12.3
5	#16740.00	60.0 PK	68.2	-8.2	3.09 V	221	45.3	14.7

REMARKS:

1. Emission Level(dBuV/m) = Raw Value(dBuV) + Correction Factor(dB/m)
2. Correction Factor(dB/m) = Antenna Factor(dB/m) + Cable Factor(dB) – Pre-Amplifier Factor(dB)
3. The other emission levels were very low against the limit.
4. Margin value = Emission Level – Limit value
5. " * ": Fundamental frequency.
6. " # ": The radiated frequency is out of the restricted band.

CHANNEL	TX Channel 140	DETECTOR FUNCTION	Peak (PK)
FREQUENCY RANGE	1GHz ~ 40GHz		Average (AV)

ANTENNA POLARITY & TEST DISTANCE: HORIZONTAL AT 3 M

NO.	FREQ. (MHz)	EMISSION LEVEL (dBuV/m)	LIMIT (dBuV/m)	MARGIN (dB)	ANTENNA HEIGHT (m)	TABLE ANGLE (Degree)	RAW VALUE (dBuV)	CORRECTION FACTOR (dB/m)
1	5460.00	62.8 PK	74.0	-11.2	1.59 H	183	59.8	3.0
2	5460.00	43.8 AV	54.0	-10.2	1.59 H	183	40.8	3.0
3	#5470.00	64.7 PK	68.2	-3.5	1.59 H	183	61.7	3.0
4	*5700.00	109.9 PK			1.59 H	183	106.7	3.2
5	*5700.00	100.3 AV			1.59 H	183	97.1	3.2
6	#5725.00	68.0 PK	68.2	-0.2	1.59 H	183	64.8	3.2
7	11400.00	49.7 PK	74.0	-24.3	1.66 H	214	36.7	13.0
8	11400.00	43.0 AV	54.0	-11.0	1.66 H	214	30.0	13.0
9	#17100.00	52.4 PK	68.2	-15.8	1.89 H	35	35.9	16.5

ANTENNA POLARITY & TEST DISTANCE: VERTICAL AT 3 M

NO.	FREQ. (MHz)	EMISSION LEVEL (dBuV/m)	LIMIT (dBuV/m)	MARGIN (dB)	ANTENNA HEIGHT (m)	TABLE ANGLE (Degree)	RAW VALUE (dBuV)	CORRECTION FACTOR (dB/m)
1	5460.00	58.7 PK	74.0	-15.3	1.48 V	157	55.7	3.0
2	5460.00	45.2 AV	54.0	-8.8	1.48 V	157	42.2	3.0
3	#5470.00	60.6 PK	68.2	-7.6	1.48 V	157	57.6	3.0
4	*5700.00	104.1 PK			1.48 V	157	100.9	3.2
5	*5700.00	93.0 AV			1.48 V	157	89.8	3.2
6	#5725.00	66.8 PK	68.2	-1.4	1.48 V	157	63.6	3.2
7	11400.00	49.7 PK	74.0	-24.3	1.22 V	213	36.7	13.0
8	11400.00	45.0 AV	54.0	-9.0	1.22 V	213	32.0	13.0
9	#17100.00	57.1 PK	68.2	-11.1	2.99 V	233	40.6	16.5

REMARKS:

1. Emission Level(dBuV/m) = Raw Value(dBuV) + Correction Factor(dB/m)
2. Correction Factor(dB/m) = Antenna Factor(dB/m) + Cable Factor(dB) – Pre-Amplifier Factor(dB)
3. The other emission levels were very low against the limit.
4. Margin value = Emission Level – Limit value
5. " * ": Fundamental frequency.
6. " # ": The radiated frequency is out of the restricted band.

CHANNEL	TX Channel 144	DETECTOR FUNCTION	Peak (PK)
FREQUENCY RANGE	1GHz ~ 40GHz		Average (AV)

ANTENNA POLARITY & TEST DISTANCE: HORIZONTAL AT 3 M

NO.	FREQ. (MHz)	EMISSION LEVEL (dBuV/m)	LIMIT (dBuV/m)	MARGIN (dB)	ANTENNA HEIGHT (m)	TABLE ANGLE (Degree)	RAW VALUE (dBuV)	CORRECTION FACTOR (dB/m)
1	5460.00	62.8 PK	74.0	-11.2	1.67 H	195	59.8	3.0
2	5460.00	43.8 AV	54.0	-10.2	1.67 H	195	40.8	3.0
3	#5470.00	64.0 PK	68.2	-4.2	1.67 H	195	61.0	3.0
4	*5720.00	111.4 PK			1.67 H	195	108.2	3.2
5	*5720.00	102.1 AV			1.67 H	195	98.9	3.2
6	#5850.00	62.9 PK	68.2	-5.3	1.67 H	195	59.3	3.6
7	11440.00	50.4 PK	74.0	-23.6	1.79 H	202	37.5	12.9
8	11440.00	43.9 AV	54.0	-10.1	1.79 H	202	31.0	12.9
9	#17160.00	54.6 PK	68.2	-13.6	2.09 H	33	38.5	16.1

ANTENNA POLARITY & TEST DISTANCE: VERTICAL AT 3 M

NO.	FREQ. (MHz)	EMISSION LEVEL (dBuV/m)	LIMIT (dBuV/m)	MARGIN (dB)	ANTENNA HEIGHT (m)	TABLE ANGLE (Degree)	RAW VALUE (dBuV)	CORRECTION FACTOR (dB/m)
1	5460.00	59.2 PK	74.0	-14.8	1.51 V	163	56.2	3.0
2	5460.00	45.5 AV	54.0	-8.5	1.51 V	163	42.5	3.0
3	#5470.00	63.5 PK	68.2	-4.7	1.51 V	163	60.5	3.0
4	*5720.00	105.0 PK			1.51 V	163	101.8	3.2
5	*5720.00	93.9 AV			1.51 V	163	90.7	3.2
6	#5850.00	59.8 PK	68.2	-8.4	1.51 V	163	56.2	3.6
7	11440.00	52.3 PK	74.0	-21.7	1.15 V	190	39.4	12.9
8	11440.00	47.1 AV	54.0	-6.9	1.15 V	190	34.2	12.9
9	#17160.00	59.4 PK	68.2	-8.8	3.00 V	210	43.3	16.1

REMARKS:

1. Emission Level(dBuV/m) = Raw Value(dBuV) + Correction Factor(dB/m)
2. Correction Factor(dB/m) = Antenna Factor(dB/m) + Cable Factor(dB) – Pre-Amplifier Factor(dB)
3. The other emission levels were very low against the limit.
4. Margin value = Emission Level – Limit value
5. " * ": Fundamental frequency.
6. " # ": The radiated frequency is out of the restricted band.

802.11ax (HE40)

CHANNEL	TX Channel 54	DETECTOR FUNCTION	Peak (PK)
FREQUENCY RANGE	1GHz ~ 40GHz		Average (AV)

ANTENNA POLARITY & TEST DISTANCE: HORIZONTAL AT 3 M

NO.	FREQ. (MHz)	EMISSION LEVEL (dBuV/m)	LIMIT (dBuV/m)	MARGIN (dB)	ANTENNA HEIGHT (m)	TABLE ANGLE (Degree)	RAW VALUE (dBuV)	CORRECTION FACTOR (dB/m)
1	5150.00	66.9 PK	74.0	-7.1	1.78 H	289	64.0	2.9
2	5150.00	52.1 AV	54.0	-1.9	1.78 H	289	49.2	2.9
3	*5270.00	117.0 PK			1.78 H	289	114.6	2.4
4	*5270.00	104.0 AV			1.78 H	289	101.6	2.4
5	5350.00	61.7 PK	74.0	-12.3	1.78 H	289	59.0	2.7
6	5350.00	47.2 AV	54.0	-6.8	1.78 H	289	44.5	2.7
7	#10540.00	50.6 PK	68.2	-17.6	1.79 H	215	38.4	12.2
8	15810.00	54.6 PK	74.0	-19.4	2.06 H	26	42.8	11.8
9	15810.00	41.7 AV	54.0	-12.3	2.06 H	26	29.9	11.8

ANTENNA POLARITY & TEST DISTANCE: VERTICAL AT 3 M

NO.	FREQ. (MHz)	EMISSION LEVEL (dBuV/m)	LIMIT (dBuV/m)	MARGIN (dB)	ANTENNA HEIGHT (m)	TABLE ANGLE (Degree)	RAW VALUE (dBuV)	CORRECTION FACTOR (dB/m)
1	5150.00	56.3 PK	74.0	-17.7	1.65 V	282	53.4	2.9
2	5150.00	43.0 AV	54.0	-11.0	1.65 V	282	40.1	2.9
3	*5270.00	108.4 PK			1.65 V	282	106.0	2.4
4	*5270.00	94.3 AV			1.65 V	282	91.9	2.4
5	5350.00	56.7 PK	74.0	-17.3	1.65 V	282	54.0	2.7
6	5350.00	43.1 AV	54.0	-10.9	1.65 V	282	40.4	2.7
7	#10540.00	51.7 PK	68.2	-16.5	1.24 V	204	39.5	12.2
8	15810.00	60.4 PK	74.0	-13.6	3.07 V	217	48.6	11.8
9	15810.00	49.4 AV	54.0	-4.6	3.07 V	217	37.6	11.8

REMARKS:

- Emission Level(dBuV/m) = Raw Value(dBuV) + Correction Factor(dB/m)
- Correction Factor(dB/m) = Antenna Factor(dB/m) + Cable Factor(dB) – Pre-Amplifier Factor(dB)
- The other emission levels were very low against the limit.
- Margin value = Emission Level – Limit value
- " * ": Fundamental frequency.
- " # ": The radiated frequency is out of the restricted band.

CHANNEL	TX Channel 62	DETECTOR FUNCTION	Peak (PK)
FREQUENCY RANGE	1GHz ~ 40GHz		Average (AV)

ANTENNA POLARITY & TEST DISTANCE: HORIZONTAL AT 3 M

NO.	FREQ. (MHz)	EMISSION LEVEL (dBuV/m)	LIMIT (dBuV/m)	MARGIN (dB)	ANTENNA HEIGHT (m)	TABLE ANGLE (Degree)	RAW VALUE (dBuV)	CORRECTION FACTOR (dB/m)
1	5150.00	61.7 PK	74.0	-12.3	1.61 H	202	58.8	2.9
2	5150.00	49.2 AV	54.0	-4.8	1.61 H	202	46.3	2.9
3	*5310.00	109.1 PK			1.61 H	202	106.5	2.6
4	*5310.00	96.1 AV			1.61 H	202	93.5	2.6
5	5350.00	66.7 PK	74.0	-7.3	1.61 H	202	64.0	2.7
6	5350.00	53.9 AV	54.0	-0.1	1.61 H	202	51.2	2.7
7	10620.00	49.5 PK	74.0	-24.5	1.62 H	216	37.5	12.0
8	10620.00	43.2 AV	54.0	-10.8	1.62 H	216	31.2	12.0
9	15930.00	52.2 PK	74.0	-21.8	1.90 H	28	40.4	11.8
10	15930.00	40.6 AV	54.0	-13.4	1.90 H	28	28.8	11.8

ANTENNA POLARITY & TEST DISTANCE: VERTICAL AT 3 M

NO.	FREQ. (MHz)	EMISSION LEVEL (dBuV/m)	LIMIT (dBuV/m)	MARGIN (dB)	ANTENNA HEIGHT (m)	TABLE ANGLE (Degree)	RAW VALUE (dBuV)	CORRECTION FACTOR (dB/m)
1	5150.00	57.8 PK	74.0	-16.2	1.64 V	267	54.9	2.9
2	5150.00	45.0 AV	54.0	-9.0	1.64 V	267	42.1	2.9
3	*5310.00	101.4 PK			1.64 V	267	98.8	2.6
4	*5310.00	87.8 AV			1.64 V	267	85.2	2.6
5	5350.00	57.6 PK	74.0	-16.4	1.64 V	267	54.9	2.7
6	5350.00	44.7 AV	54.0	-9.3	1.64 V	267	42.0	2.7
7	10620.00	49.9 PK	74.0	-24.1	1.19 V	216	37.9	12.0
8	10620.00	45.0 AV	54.0	-9.0	1.19 V	216	33.0	12.0
9	15930.00	57.9 PK	74.0	-16.1	3.05 V	242	46.1	11.8
10	15930.00	47.9 AV	54.0	-6.1	3.05 V	242	36.1	11.8

REMARKS:

1. Emission Level(dBuV/m) = Raw Value(dBuV) + Correction Factor(dB/m)
2. Correction Factor(dB/m) = Antenna Factor(dB/m) + Cable Factor(dB) – Pre-Amplifier Factor(dB)
3. The other emission levels were very low against the limit.
4. Margin value = Emission Level – Limit value
5. " * ": Fundamental frequency.

CHANNEL	TX Channel 102	DETECTOR FUNCTION	Peak (PK)
FREQUENCY RANGE	1GHz ~ 40GHz		Average (AV)

ANTENNA POLARITY & TEST DISTANCE: HORIZONTAL AT 3 M

NO.	FREQ. (MHz)	EMISSION LEVEL (dBuV/m)	LIMIT (dBuV/m)	MARGIN (dB)	ANTENNA HEIGHT (m)	TABLE ANGLE (Degree)	RAW VALUE (dBuV)	CORRECTION FACTOR (dB/m)
1	5390.00	52.6 PK	74.0	-21.4	1.55 H	211	49.8	2.8
2	5390.00	61.3 PK	74.0	-12.7	1.55 H	211	58.5	2.8
3	5390.00	53.9 AV	54.0	-0.1	1.55 H	211	51.1	2.8
4	#5470.00	67.7 PK	68.2	-0.5	1.55 H	211	64.7	3.0
5	*5510.00	108.0 PK			1.55 H	211	105.1	2.9
6	*5510.00	95.8 AV			1.55 H	211	92.9	2.9
7	11020.00	49.6 PK	74.0	-24.4	1.61 H	202	36.8	12.8
8	11020.00	43.1 AV	54.0	-10.9	1.61 H	202	30.3	12.8
9	#16530.00	52.8 PK	68.2	-15.4	1.92 H	20	38.2	14.6

ANTENNA POLARITY & TEST DISTANCE: VERTICAL AT 3 M

NO.	FREQ. (MHz)	EMISSION LEVEL (dBuV/m)	LIMIT (dBuV/m)	MARGIN (dB)	ANTENNA HEIGHT (m)	TABLE ANGLE (Degree)	RAW VALUE (dBuV)	CORRECTION FACTOR (dB/m)
1	5390.00	58.9 PK	74.0	-15.1	1.63 V	276	56.1	2.8
2	5390.00	50.8 AV	54.0	-3.2	1.63 V	276	48.0	2.8
3	#5470.00	64.4 PK	68.2	-3.8	1.63 V	276	61.4	3.0
4	*5510.00	100.5 PK			1.63 V	276	97.6	2.9
5	*5510.00	86.7 AV			1.63 V	276	83.8	2.9
6	#5725.00	64.6 PK	68.2	-3.6	1.63 V	276	61.4	3.2
7	11020.00	49.8 PK	74.0	-24.2	1.19 V	204	37.0	12.8
8	11020.00	45.2 AV	54.0	-8.8	1.19 V	204	32.4	12.8
9	#16530.00	57.9 PK	68.2	-10.3	3.05 V	235	43.3	14.6

REMARKS:

1. Emission Level(dBuV/m) = Raw Value(dBuV) + Correction Factor(dB/m)
2. Correction Factor(dB/m) = Antenna Factor(dB/m) + Cable Factor(dB) – Pre-Amplifier Factor(dB)
3. The other emission levels were very low against the limit.
4. Margin value = Emission Level – Limit value
5. " * ": Fundamental frequency.
6. " # ": The radiated frequency is out of the restricted band.

CHANNEL	TX Channel 110	DETECTOR FUNCTION	Peak (PK)
FREQUENCY RANGE	1GHz ~ 40GHz		Average (AV)

ANTENNA POLARITY & TEST DISTANCE: HORIZONTAL AT 3 M

NO.	FREQ. (MHz)	EMISSION LEVEL (dBuV/m)	LIMIT (dBuV/m)	MARGIN (dB)	ANTENNA HEIGHT (m)	TABLE ANGLE (Degree)	RAW VALUE (dBuV)	CORRECTION FACTOR (dB/m)
1	*5550.00	117.3 PK			1.83 H	303	114.3	3.0
2	*5550.00	104.5 AV			1.83 H	303	101.5	3.0
3	11100.00	49.9 PK	74.0	-24.1	1.83 H	227	37.6	12.3
4	11100.00	43.5 AV	54.0	-10.5	1.83 H	227	31.2	12.3
5	#16650.00	53.8 PK	68.2	-14.4	1.99 H	27	39.1	14.7

ANTENNA POLARITY & TEST DISTANCE: VERTICAL AT 3 M

NO.	FREQ. (MHz)	EMISSION LEVEL (dBuV/m)	LIMIT (dBuV/m)	MARGIN (dB)	ANTENNA HEIGHT (m)	TABLE ANGLE (Degree)	RAW VALUE (dBuV)	CORRECTION FACTOR (dB/m)
1	*5550.00	108.2 PK			1.63 V	270	105.2	3.0
2	*5550.00	94.2 AV			1.63 V	270	91.2	3.0
3	11100.00	51.7 PK	74.0	-22.3	1.21 V	198	39.4	12.3
4	11100.00	46.3 AV	54.0	-7.7	1.21 V	198	34.0	12.3
5	#16650.00	59.9 PK	68.2	-8.3	3.03 V	211	45.2	14.7

REMARKS:

1. Emission Level(dBuV/m) = Raw Value(dBuV) + Correction Factor(dB/m)
2. Correction Factor(dB/m) = Antenna Factor(dB/m) + Cable Factor(dB) – Pre-Amplifier Factor(dB)
3. The other emission levels were very low against the limit.
4. Margin value = Emission Level – Limit value
5. " * ": Fundamental frequency.
6. " # ": The radiated frequency is out of the restricted band.

CHANNEL	TX Channel 134	DETECTOR FUNCTION	Peak (PK)
FREQUENCY RANGE	1GHz ~ 40GHz		Average (AV)

ANTENNA POLARITY & TEST DISTANCE: HORIZONTAL AT 3 M

NO.	FREQ. (MHz)	EMISSION LEVEL (dBuV/m)	LIMIT (dBuV/m)	MARGIN (dB)	ANTENNA HEIGHT (m)	TABLE ANGLE (Degree)	RAW VALUE (dBuV)	CORRECTION FACTOR (dB/m)
1	*5670.00	116.9 PK			1.83 H	286	113.7	3.2
2	*5670.00	103.7 AV			1.83 H	286	100.5	3.2
3	#5725.00	65.1 PK	68.2	-3.1	1.83 H	286	61.9	3.2
4	11340.00	49.5 PK	74.0	-24.5	1.79 H	215	36.4	13.1
5	11340.00	43.5 AV	54.0	-10.5	1.79 H	215	30.4	13.1
6	#17010.00	54.4 PK	68.2	-13.8	2.07 H	45	38.0	16.4

ANTENNA POLARITY & TEST DISTANCE: VERTICAL AT 3 M

NO.	FREQ. (MHz)	EMISSION LEVEL (dBuV/m)	LIMIT (dBuV/m)	MARGIN (dB)	ANTENNA HEIGHT (m)	TABLE ANGLE (Degree)	RAW VALUE (dBuV)	CORRECTION FACTOR (dB/m)
1	*5670.00	108.8 PK			1.67 V	275	105.6	3.2
2	*5670.00	94.6 AV			1.67 V	275	91.4	3.2
3	#5725.00	60.4 PK	68.2	-7.8	1.67 V	275	57.2	3.2
4	11340.00	51.4 PK	74.0	-22.6	1.17 V	221	38.3	13.1
5	11340.00	46.3 AV	54.0	-7.7	1.17 V	221	33.2	13.1
6	#17010.00	59.8 PK	68.2	-8.4	3.02 V	237	43.4	16.4

REMARKS:

1. Emission Level(dBuV/m) = Raw Value(dBuV) + Correction Factor(dB/m)
2. Correction Factor(dB/m) = Antenna Factor(dB/m) + Cable Factor(dB) – Pre-Amplifier Factor(dB)
3. The other emission levels were very low against the limit.
4. Margin value = Emission Level – Limit value
5. " * ": Fundamental frequency.
6. " # ": The radiated frequency is out of the restricted band.

CHANNEL	TX Channel 142	DETECTOR FUNCTION	Peak (PK)
FREQUENCY RANGE	1GHz ~ 40GHz		Average (AV)

ANTENNA POLARITY & TEST DISTANCE: HORIZONTAL AT 3 M

NO.	FREQ. (MHz)	EMISSION LEVEL (dBuV/m)	LIMIT (dBuV/m)	MARGIN (dB)	ANTENNA HEIGHT (m)	TABLE ANGLE (Degree)	RAW VALUE (dBuV)	CORRECTION FACTOR (dB/m)
1	5460.00	58.9 PK	74.0	-15.1	1.78 H	292	55.9	3.0
2	5460.00	45.8 AV	54.0	-8.2	1.78 H	292	42.8	3.0
3	#5470.00	63.5 PK	68.2	-4.7	1.78 H	292	60.5	3.0
4	*5710.00	116.3 PK			1.78 H	292	113.0	3.3
5	*5710.00	103.2 AV			1.78 H	292	99.9	3.3
6	#5850.00	62.5 PK	68.2	-5.7	1.78 H	292	58.9	3.6
7	11420.00	50.0 PK	74.0	-24.0	1.78 H	209	37.0	13.0
8	11420.00	43.4 AV	54.0	-10.6	1.78 H	209	30.4	13.0
9	#17130.00	53.9 PK	68.2	-14.3	1.99 H	20	37.6	16.3

ANTENNA POLARITY & TEST DISTANCE: VERTICAL AT 3 M

NO.	FREQ. (MHz)	EMISSION LEVEL (dBuV/m)	LIMIT (dBuV/m)	MARGIN (dB)	ANTENNA HEIGHT (m)	TABLE ANGLE (Degree)	RAW VALUE (dBuV)	CORRECTION FACTOR (dB/m)
1	5460.00	57.1 PK	74.0	-16.9	1.58 V	288	54.1	3.0
2	5460.00	44.0 AV	54.0	-10.0	1.58 V	288	41.0	3.0
3	#5470.00	62.4 PK	68.2	-5.8	1.58 V	288	59.4	3.0
4	*5710.00	108.4 PK			1.58 V	288	105.1	3.3
5	*5710.00	94.4 AV			1.58 V	288	91.1	3.3
6	#5850.00	58.8 PK	68.2	-9.4	1.58 V	288	55.2	3.6
7	11420.00	52.3 PK	74.0	-21.7	1.14 V	191	39.3	13.0
8	11420.00	47.1 AV	54.0	-6.9	1.14 V	191	34.1	13.0
9	#17130.00	60.3 PK	68.2	-7.9	2.98 V	221	44.0	16.3

REMARKS:

1. Emission Level(dBuV/m) = Raw Value(dBuV) + Correction Factor(dB/m)
2. Correction Factor(dB/m) = Antenna Factor(dB/m) + Cable Factor(dB) – Pre-Amplifier Factor(dB)
3. The other emission levels were very low against the limit.
4. Margin value = Emission Level – Limit value
5. " * ": Fundamental frequency.
6. " # ": The radiated frequency is out of the restricted band.

802.11ax (HE80)

CHANNEL	TX Channel 58	DETECTOR FUNCTION	Peak (PK)
FREQUENCY RANGE	1GHz ~ 40GHz		Average (AV)

ANTENNA POLARITY & TEST DISTANCE: HORIZONTAL AT 3 M								
NO.	FREQ. (MHz)	EMISSION LEVEL (dBuV/m)	LIMIT (dBuV/m)	MARGIN (dB)	ANTENNA HEIGHT (m)	TABLE ANGLE (Degree)	RAW VALUE (dBuV)	CORRECTION FACTOR (dB/m)
1	5150.00	53.9 PK	74.0	-20.1	1.44 H	213	51.0	2.9
2	5150.00	41.4 AV	54.0	-12.6	1.44 H	213	38.5	2.9
3	*5290.00	106.2 PK			1.44 H	213	103.8	2.4
4	*5290.00	93.2 AV			1.44 H	213	90.8	2.4
5	5350.00	66.4 PK	74.0	-7.6	1.44 H	213	63.7	2.7
6	5350.00	53.6 AV	54.0	-0.4	1.44 H	213	50.9	2.7
7	#10580.00	49.4 PK	68.2	-18.8	1.61 H	200	37.3	12.1
8	15870.00	52.9 PK	74.0	-21.1	1.83 H	24	41.2	11.7
9	15870.00	41.0 AV	54.0	-13.0	1.83 H	24	29.3	11.7

ANTENNA POLARITY & TEST DISTANCE: VERTICAL AT 3 M								
NO.	FREQ. (MHz)	EMISSION LEVEL (dBuV/m)	LIMIT (dBuV/m)	MARGIN (dB)	ANTENNA HEIGHT (m)	TABLE ANGLE (Degree)	RAW VALUE (dBuV)	CORRECTION FACTOR (dB/m)
1	5085.00	52.6 PK	74.0	-21.4	1.72 V	279	49.8	2.8
2	5085.00	39.5 AV	54.0	-14.5	1.72 V	279	36.7	2.8
3	*5290.00	100.0 PK			1.72 V	279	97.6	2.4
4	*5290.00	85.6 AV			1.72 V	279	83.2	2.4
5	5350.00	56.9 PK	74.0	-17.1	1.72 V	279	54.2	2.7
6	5350.00	42.9 AV	54.0	-11.1	1.72 V	279	40.2	2.7
7	#10580.00	49.8 PK	68.2	-18.4	1.20 V	192	37.7	12.1
8	15870.00	58.3 PK	74.0	-15.7	3.07 V	244	46.6	11.7
9	15870.00	48.0 AV	54.0	-6.0	3.07 V	244	36.3	11.7

REMARKS:

1. Emission Level(dBuV/m) = Raw Value(dBuV) + Correction Factor(dB/m)
2. Correction Factor(dB/m) = Antenna Factor(dB/m) + Cable Factor(dB) – Pre-Amplifier Factor(dB)
3. The other emission levels were very low against the limit.
4. Margin value = Emission Level – Limit value
5. " * ": Fundamental frequency.
6. " # ": The radiated frequency is out of the restricted band.

CHANNEL	TX Channel 106	DETECTOR FUNCTION	Peak (PK)
FREQUENCY RANGE	1GHz ~ 40GHz		Average (AV)

ANTENNA POLARITY & TEST DISTANCE: HORIZONTAL AT 3 M

NO.	FREQ. (MHz)	EMISSION LEVEL (dBuV/m)	LIMIT (dBuV/m)	MARGIN (dB)	ANTENNA HEIGHT (m)	TABLE ANGLE (Degree)	RAW VALUE (dBuV)	CORRECTION FACTOR (dB/m)
1	5460.00	69.1 PK	74.0	-4.9	1.46 H	205	66.1	3.0
2	5460.00	49.8 AV	54.0	-4.2	1.46 H	205	46.8	3.0
3	#5470.00	68.1 PK	68.2	-0.1	1.46 H	205	65.1	3.0
4	*5530.00	106.2 PK			1.46 H	205	103.3	2.9
5	*5530.00	92.8 AV			1.46 H	205	89.9	2.9
6	#5725.00	53.3 PK	68.2	-14.9	1.46 H	205	50.1	3.2
7	11060.00	49.2 PK	74.0	-24.8	1.63 H	217	36.7	12.5
8	11060.00	42.4 AV	54.0	-11.6	1.63 H	217	29.9	12.5
9	#16590.00	51.9 PK	68.2	-16.3	1.86 H	17	37.2	14.7

ANTENNA POLARITY & TEST DISTANCE: VERTICAL AT 3 M

NO.	FREQ. (MHz)	EMISSION LEVEL (dBuV/m)	LIMIT (dBuV/m)	MARGIN (dB)	ANTENNA HEIGHT (m)	TABLE ANGLE (Degree)	RAW VALUE (dBuV)	CORRECTION FACTOR (dB/m)
1	5460.00	61.8 PK	74.0	-12.2	1.67 V	270	58.8	3.0
2	5460.00	49.6 AV	54.0	-4.4	1.67 V	270	46.6	3.0
3	#5470.00	63.1 PK	68.2	-5.1	1.67 V	270	60.1	3.0
4	*5530.00	97.8 PK			1.67 V	270	94.9	2.9
5	*5530.00	83.8 AV			1.67 V	270	80.9	2.9
6	#5725.00	53.9 PK	68.2	-14.3	1.67 V	270	50.7	3.2
7	11060.00	50.6 PK	74.0	-23.4	1.16 V	198	38.1	12.5
8	11060.00	45.8 AV	54.0	-8.2	1.16 V	198	33.3	12.5
9	#16590.00	57.6 PK	68.2	-10.6	3.03 V	249	42.9	14.7

REMARKS:

1. Emission Level(dBuV/m) = Raw Value(dBuV) + Correction Factor(dB/m)
2. Correction Factor(dB/m) = Antenna Factor(dB/m) + Cable Factor(dB) – Pre-Amplifier Factor(dB)
3. The other emission levels were very low against the limit.
4. Margin value = Emission Level – Limit value
5. " * ": Fundamental frequency.
6. " # ": The radiated frequency is out of the restricted band.

CHANNEL	TX Channel 122	DETECTOR FUNCTION	Peak (PK)
FREQUENCY RANGE	1GHz ~ 40GHz		Average (AV)

ANTENNA POLARITY & TEST DISTANCE: HORIZONTAL AT 3 M

NO.	FREQ. (MHz)	EMISSION LEVEL (dBuV/m)	LIMIT (dBuV/m)	MARGIN (dB)	ANTENNA HEIGHT (m)	TABLE ANGLE (Degree)	RAW VALUE (dBuV)	CORRECTION FACTOR (dB/m)
1	*5610.00	113.0 PK			1.60 H	294	110.0	3.0
2	*5610.00	100.0 AV			1.60 H	294	97.0	3.0
3	#5725.00	62.1 PK	68.2	-6.1	1.60 H	294	58.9	3.2
4	11220.00	49.9 PK	74.0	-24.1	1.80 H	221	37.4	12.5
5	11220.00	43.7 AV	54.0	-10.3	1.80 H	221	31.2	12.5
6	#16830.00	54.6 PK	68.2	-13.6	2.01 H	38	39.6	15.0

ANTENNA POLARITY & TEST DISTANCE: VERTICAL AT 3 M

NO.	FREQ. (MHz)	EMISSION LEVEL (dBuV/m)	LIMIT (dBuV/m)	MARGIN (dB)	ANTENNA HEIGHT (m)	TABLE ANGLE (Degree)	RAW VALUE (dBuV)	CORRECTION FACTOR (dB/m)
1	*5610.00	104.4 PK			1.59 V	261	101.4	3.0
2	*5610.00	91.1 AV			1.59 V	261	88.1	3.0
3	#5725.00	59.0 PK	68.2	-9.2	1.59 V	261	55.8	3.2
4	11220.00	52.0 PK	74.0	-22.0	1.22 V	221	39.5	12.5
5	11220.00	46.7 AV	54.0	-7.3	1.22 V	221	34.2	12.5
6	#16830.00	60.2 PK	68.2	-8.0	3.09 V	238	45.2	15.0

REMARKS:

1. Emission Level(dBuV/m) = Raw Value(dBuV) + Correction Factor(dB/m)
2. Correction Factor(dB/m) = Antenna Factor(dB/m) + Cable Factor(dB) – Pre-Amplifier Factor(dB)
3. The other emission levels were very low against the limit.
4. Margin value = Emission Level – Limit value
5. " * ": Fundamental frequency.
6. " # ": The radiated frequency is out of the restricted band.

CHANNEL	TX Channel 138	DETECTOR FUNCTION	Peak (PK)
FREQUENCY RANGE	1GHz ~ 40GHz		Average (AV)

ANTENNA POLARITY & TEST DISTANCE: HORIZONTAL AT 3 M

NO.	FREQ. (MHz)	EMISSION LEVEL (dBuV/m)	LIMIT (dBuV/m)	MARGIN (dB)	ANTENNA HEIGHT (m)	TABLE ANGLE (Degree)	RAW VALUE (dBuV)	CORRECTION FACTOR (dB/m)
1	5460.00	58.8 PK	74.0	-15.2	1.54 H	296	55.8	3.0
2	5460.00	45.9 AV	54.0	-8.1	1.54 H	296	42.9	3.0
3	#5470.00	64.0 PK	68.2	-4.2	1.54 H	296	61.0	3.0
4	*5690.00	113.3 PK			1.54 H	296	110.1	3.2
5	*5690.00	100.1 AV			1.54 H	296	96.9	3.2
6	#5850.00	63.0 PK	68.2	-5.2	1.54 H	296	59.4	3.6
7	11380.00	49.7 PK	74.0	-24.3	1.83 H	209	36.7	13.0
8	11380.00	43.4 AV	54.0	-10.6	1.83 H	209	30.4	13.0
9	#17070.00	54.0 PK	68.2	-14.2	2.08 H	36	37.5	16.5

ANTENNA POLARITY & TEST DISTANCE: VERTICAL AT 3 M

NO.	FREQ. (MHz)	EMISSION LEVEL (dBuV/m)	LIMIT (dBuV/m)	MARGIN (dB)	ANTENNA HEIGHT (m)	TABLE ANGLE (Degree)	RAW VALUE (dBuV)	CORRECTION FACTOR (dB/m)
1	5460.00	57.4 PK	74.0	-16.6	1.52 V	268	54.4	3.0
2	5460.00	44.2 AV	54.0	-9.8	1.52 V	268	41.2	3.0
3	#5470.00	64.6 PK	68.2	-3.6	1.52 V	268	61.6	3.0
4	*5690.00	104.2 PK			1.52 V	268	101.0	3.2
5	*5690.00	91.1 AV			1.52 V	268	87.9	3.2
6	#5850.00	58.8 PK	68.2	-9.4	1.52 V	268	55.2	3.6
7	11380.00	51.4 PK	74.0	-22.6	1.19 V	216	38.4	13.0
8	11380.00	46.3 AV	54.0	-7.7	1.19 V	216	33.3	13.0
9	#17070.00	59.7 PK	68.2	-8.5	3.07 V	236	43.2	16.5

REMARKS:

1. Emission Level(dBuV/m) = Raw Value(dBuV) + Correction Factor(dB/m)
2. Correction Factor(dB/m) = Antenna Factor(dB/m) + Cable Factor(dB) – Pre-Amplifier Factor(dB)
3. The other emission levels were very low against the limit.
4. Margin value = Emission Level – Limit value
5. " * ": Fundamental frequency.
6. " # ": The radiated frequency is out of the restricted band.

4.1.10 Test Results (Mode 4)

Above 1GHz Data:

802.11a

CHANNEL	TX Channel 52	DETECTOR FUNCTION	Peak (PK)
FREQUENCY RANGE	1GHz ~ 40GHz		Average (AV)

ANTENNA POLARITY & TEST DISTANCE: HORIZONTAL AT 3 M								
NO.	FREQ. (MHz)	EMISSION LEVEL (dBuV/m)	LIMIT (dBuV/m)	MARGIN (dB)	ANTENNA HEIGHT (m)	TABLE ANGLE (Degree)	RAW VALUE (dBuV)	CORRECTION FACTOR (dB/m)
1	5150.00	67.3 PK	74.0	-6.7	1.86 H	17	64.4	2.9
2	5150.00	52.7 AV	54.0	-1.3	1.86 H	17	49.8	2.9
3	*5260.00	108.8 PK			1.86 H	17	106.4	2.4
4	*5260.00	100.5 AV			1.86 H	17	98.1	2.4
5	#10520.00	49.4 PK	68.2	-18.8	1.77 H	201	37.1	12.3
6	15780.00	54.6 PK	74.0	-19.4	1.97 H	11	42.6	12.0
7	15780.00	41.7 AV	54.0	-12.3	1.97 H	11	29.7	12.0

ANTENNA POLARITY & TEST DISTANCE: VERTICAL AT 3 M								
NO.	FREQ. (MHz)	EMISSION LEVEL (dBuV/m)	LIMIT (dBuV/m)	MARGIN (dB)	ANTENNA HEIGHT (m)	TABLE ANGLE (Degree)	RAW VALUE (dBuV)	CORRECTION FACTOR (dB/m)
1	5150.00	56.9 PK	74.0	-17.1	2.10 V	24	54.0	2.9
2	5150.00	43.5 AV	54.0	-10.5	2.10 V	24	40.6	2.9
3	*5260.00	105.2 PK			2.10 V	24	102.8	2.4
4	*5260.00	95.6 AV			2.10 V	24	93.2	2.4
5	#10520.00	52.0 PK	68.2	-16.2	1.26 V	202	39.7	12.3
6	15780.00	60.2 PK	74.0	-13.8	3.03 V	236	48.2	12.0
7	15780.00	49.1 AV	54.0	-4.9	3.03 V	236	37.1	12.0

REMARKS:

1. Emission Level(dBuV/m) = Raw Value(dBuV) + Correction Factor(dB/m)
2. Correction Factor(dB/m) = Antenna Factor(dB/m) + Cable Factor(dB) – Pre-Amplifier Factor(dB)
3. The other emission levels were very low against the limit.
4. Margin value = Emission Level – Limit value
5. " * ": Fundamental frequency.
6. " # ": The radiated frequency is out of the restricted band.

CHANNEL	TX Channel 60	DETECTOR FUNCTION	Peak (PK)
FREQUENCY RANGE	1GHz ~ 40GHz		Average (AV)

ANTENNA POLARITY & TEST DISTANCE: HORIZONTAL AT 3 M

NO.	FREQ. (MHz)	EMISSION LEVEL (dBuV/m)	LIMIT (dBuV/m)	MARGIN (dB)	ANTENNA HEIGHT (m)	TABLE ANGLE (Degree)	RAW VALUE (dBuV)	CORRECTION FACTOR (dB/m)
1	*5300.00	108.8 PK			1.88 H	19	106.2	2.6
2	*5300.00	100.4 AV			1.88 H	19	97.8	2.6
3	10600.00	48.9 PK	74.0	-25.1	1.79 H	186	36.8	12.1
4	10600.00	42.7 AV	54.0	-11.3	1.79 H	186	30.6	12.1
5	15900.00	54.2 PK	74.0	-19.8	1.93 H	10	42.4	11.8
6	15900.00	41.3 AV	54.0	-12.7	1.93 H	10	29.5	11.8

ANTENNA POLARITY & TEST DISTANCE: VERTICAL AT 3 M

NO.	FREQ. (MHz)	EMISSION LEVEL (dBuV/m)	LIMIT (dBuV/m)	MARGIN (dB)	ANTENNA HEIGHT (m)	TABLE ANGLE (Degree)	RAW VALUE (dBuV)	CORRECTION FACTOR (dB/m)
1	*5300.00	104.6 PK			2.17 V	22	102.0	2.6
2	*5300.00	95.5 AV			2.17 V	22	92.9	2.6
3	10600.00	52.1 PK	74.0	-21.9	1.25 V	210	40.0	12.1
4	10600.00	46.9 AV	54.0	-7.1	1.25 V	210	34.8	12.1
5	15900.00	59.7 PK	74.0	-14.3	2.98 V	238	47.9	11.8
6	15900.00	48.7 AV	54.0	-5.3	2.98 V	238	36.9	11.8

REMARKS:

1. Emission Level(dBuV/m) = Raw Value(dBuV) + Correction Factor(dB/m)
2. Correction Factor(dB/m) = Antenna Factor(dB/m) + Cable Factor(dB) – Pre-Amplifier Factor(dB)
3. The other emission levels were very low against the limit.
4. Margin value = Emission Level – Limit value
5. " * ": Fundamental frequency.

CHANNEL	TX Channel 64	DETECTOR FUNCTION	Peak (PK)
FREQUENCY RANGE	1GHz ~ 40GHz		Average (AV)

ANTENNA POLARITY & TEST DISTANCE: HORIZONTAL AT 3 M

NO.	FREQ. (MHz)	EMISSION LEVEL (dBuV/m)	LIMIT (dBuV/m)	MARGIN (dB)	ANTENNA HEIGHT (m)	TABLE ANGLE (Degree)	RAW VALUE (dBuV)	CORRECTION FACTOR (dB/m)
1	*5320.00	107.0 PK			1.82 H	9	104.4	2.6
2	*5320.00	98.9 AV			1.82 H	9	96.3	2.6
3	5350.00	68.3 PK	74.0	-5.7	1.82 H	9	65.6	2.7
4	5350.00	53.7 AV	54.0	-0.3	1.82 H	9	51.0	2.7
5	10640.00	47.5 PK	74.0	-26.5	1.74 H	182	35.6	11.9
6	10640.00	41.6 AV	54.0	-12.4	1.74 H	182	29.7	11.9
7	15960.00	52.6 PK	74.0	-21.4	1.92 H	15	40.5	12.1
8	15960.00	39.9 AV	54.0	-14.1	1.92 H	15	27.8	12.1

ANTENNA POLARITY & TEST DISTANCE: VERTICAL AT 3 M

NO.	FREQ. (MHz)	EMISSION LEVEL (dBuV/m)	LIMIT (dBuV/m)	MARGIN (dB)	ANTENNA HEIGHT (m)	TABLE ANGLE (Degree)	RAW VALUE (dBuV)	CORRECTION FACTOR (dB/m)
1	*5320.00	103.7 PK			2.08 V	31	101.1	2.6
2	*5320.00	94.5 AV			2.08 V	31	91.9	2.6
3	5350.00	56.9 PK	74.0	-17.1	2.08 V	31	54.2	2.7
4	5350.00	43.6 AV	54.0	-10.4	2.08 V	31	40.9	2.7
5	10640.00	51.3 PK	74.0	-22.7	1.25 V	216	39.4	11.9
6	10640.00	46.1 AV	54.0	-7.9	1.25 V	216	34.2	11.9
7	15960.00	58.6 PK	74.0	-15.4	2.94 V	232	46.5	12.1
8	15960.00	47.5 AV	54.0	-6.5	2.94 V	232	35.4	12.1

REMARKS:

1. Emission Level(dBuV/m) = Raw Value(dBuV) + Correction Factor(dB/m)
2. Correction Factor(dB/m) = Antenna Factor(dB/m) + Cable Factor(dB) – Pre-Amplifier Factor(dB)
3. The other emission levels were very low against the limit.
4. Margin value = Emission Level – Limit value
5. " * ": Fundamental frequency.

CHANNEL	TX Channel 100	DETECTOR FUNCTION	Peak (PK)
FREQUENCY RANGE	1GHz ~ 40GHz		Average (AV)

ANTENNA POLARITY & TEST DISTANCE: HORIZONTAL AT 3 M

NO.	FREQ. (MHz)	EMISSION LEVEL (dBuV/m)	LIMIT (dBuV/m)	MARGIN (dB)	ANTENNA HEIGHT (m)	TABLE ANGLE (Degree)	RAW VALUE (dBuV)	CORRECTION FACTOR (dB/m)
1	5460.00	63.1 PK	74.0	-10.9	1.68 H	341	60.1	3.0
2	5460.00	44.4 AV	54.0	-9.6	1.68 H	341	41.4	3.0
3	#5470.00	67.9 PK	68.2	-0.3	1.68 H	341	64.9	3.0
4	*5500.00	107.5 PK			1.68 H	341	104.6	2.9
5	*5500.00	99.0 AV			1.68 H	341	96.1	2.9
6	11000.00	47.9 PK	74.0	-26.1	1.78 H	203	35.1	12.8
7	11000.00	41.8 AV	54.0	-12.2	1.78 H	203	29.0	12.8
8	#16500.00	52.6 PK	68.2	-15.6	1.99 H	12	38.2	14.4

ANTENNA POLARITY & TEST DISTANCE: VERTICAL AT 3 M

NO.	FREQ. (MHz)	EMISSION LEVEL (dBuV/m)	LIMIT (dBuV/m)	MARGIN (dB)	ANTENNA HEIGHT (m)	TABLE ANGLE (Degree)	RAW VALUE (dBuV)	CORRECTION FACTOR (dB/m)
1	5460.00	59.0 PK	74.0	-15.0	2.16 V	360	56.0	3.0
2	5460.00	45.1 AV	54.0	-8.9	2.16 V	360	42.1	3.0
3	#5470.00	67.7 PK	68.2	-0.5	2.16 V	360	64.7	3.0
4	*5500.00	103.5 PK			2.16 V	360	100.6	2.9
5	*5500.00	94.3 AV			2.16 V	360	91.4	2.9
6	11000.00	50.8 PK	74.0	-23.2	1.27 V	204	38.0	12.8
7	11000.00	45.9 AV	54.0	-8.1	1.27 V	204	33.1	12.8
8	#16500.00	58.4 PK	68.2	-9.8	2.94 V	226	44.0	14.4

REMARKS:

1. Emission Level(dBuV/m) = Raw Value(dBuV) + Correction Factor(dB/m)
2. Correction Factor(dB/m) = Antenna Factor(dB/m) + Cable Factor(dB) – Pre-Amplifier Factor(dB)
3. The other emission levels were very low against the limit.
4. Margin value = Emission Level – Limit value
5. " * ": Fundamental frequency.
6. " # ": The radiated frequency is out of the restricted band.

CHANNEL	TX Channel 116	DETECTOR FUNCTION	Peak (PK)
FREQUENCY RANGE	1GHz ~ 40GHz		Average (AV)

ANTENNA POLARITY & TEST DISTANCE: HORIZONTAL AT 3 M

NO.	FREQ. (MHz)	EMISSION LEVEL (dBuV/m)	LIMIT (dBuV/m)	MARGIN (dB)	ANTENNA HEIGHT (m)	TABLE ANGLE (Degree)	RAW VALUE (dBuV)	CORRECTION FACTOR (dB/m)
1	*5580.00	109.5 PK			1.59 H	360	106.5	3.0
2	*5580.00	101.0 AV			1.59 H	360	98.0	3.0
3	11160.00	48.9 PK	74.0	-25.1	1.80 H	203	36.6	12.3
4	11160.00	42.6 AV	54.0	-11.4	1.80 H	203	30.3	12.3
5	#16740.00	54.1 PK	68.2	-14.1	2.03 H	15	39.4	14.7

ANTENNA POLARITY & TEST DISTANCE: VERTICAL AT 3 M

NO.	FREQ. (MHz)	EMISSION LEVEL (dBuV/m)	LIMIT (dBuV/m)	MARGIN (dB)	ANTENNA HEIGHT (m)	TABLE ANGLE (Degree)	RAW VALUE (dBuV)	CORRECTION FACTOR (dB/m)
1	*5580.00	105.5 PK			2.06 V	360	102.5	3.0
2	*5580.00	96.3 AV			2.06 V	360	93.3	3.0
3	11160.00	52.1 PK	74.0	-21.9	1.22 V	207	39.8	12.3
4	11160.00	47.1 AV	54.0	-6.9	1.22 V	207	34.8	12.3
5	#16740.00	60.0 PK	68.2	-8.2	3.00 V	225	45.3	14.7

REMARKS:

1. Emission Level(dBuV/m) = Raw Value(dBuV) + Correction Factor(dB/m)
2. Correction Factor(dB/m) = Antenna Factor(dB/m) + Cable Factor(dB) – Pre-Amplifier Factor(dB)
3. The other emission levels were very low against the limit.
4. Margin value = Emission Level – Limit value
5. " * ": Fundamental frequency.
6. " # ": The radiated frequency is out of the restricted band.

CHANNEL	TX Channel 140	DETECTOR FUNCTION	Peak (PK)
FREQUENCY RANGE	1GHz ~ 40GHz		Average (AV)

ANTENNA POLARITY & TEST DISTANCE: HORIZONTAL AT 3 M

NO.	FREQ. (MHz)	EMISSION LEVEL (dBuV/m)	LIMIT (dBuV/m)	MARGIN (dB)	ANTENNA HEIGHT (m)	TABLE ANGLE (Degree)	RAW VALUE (dBuV)	CORRECTION FACTOR (dB/m)
1	*5700.00	108.0 PK			1.58 H	357	104.8	3.2
2	*5700.00	99.3 AV			1.58 H	357	96.1	3.2
3	#5725.00	68.0 PK	68.2	-0.2	1.58 H	357	64.8	3.2
4	11400.00	47.6 PK	74.0	-26.4	1.84 H	195	34.6	13.0
5	11400.00	41.5 AV	54.0	-12.5	1.84 H	195	28.5	13.0
6	#17100.00	52.6 PK	68.2	-15.6	2.00 H	0	36.1	16.5

ANTENNA POLARITY & TEST DISTANCE: VERTICAL AT 3 M

NO.	FREQ. (MHz)	EMISSION LEVEL (dBuV/m)	LIMIT (dBuV/m)	MARGIN (dB)	ANTENNA HEIGHT (m)	TABLE ANGLE (Degree)	RAW VALUE (dBuV)	CORRECTION FACTOR (dB/m)
1	*5700.00	104.0 PK			2.15 V	360	100.8	3.2
2	*5700.00	94.6 AV			2.15 V	360	91.4	3.2
3	#5725.00	66.0 PK	68.2	-2.2	2.15 V	360	62.8	3.2
4	11400.00	50.9 PK	74.0	-23.1	1.27 V	208	37.9	13.0
5	11400.00	46.0 AV	54.0	-8.0	1.27 V	208	33.0	13.0
6	#17100.00	58.9 PK	68.2	-9.3	2.95 V	236	42.4	16.5

REMARKS:

1. Emission Level(dBuV/m) = Raw Value(dBuV) + Correction Factor(dB/m)
2. Correction Factor(dB/m) = Antenna Factor(dB/m) + Cable Factor(dB) – Pre-Amplifier Factor(dB)
3. The other emission levels were very low against the limit.
4. Margin value = Emission Level – Limit value
5. " * ": Fundamental frequency.
6. " # ": The radiated frequency is out of the restricted band.

CHANNEL	TX Channel 144	DETECTOR FUNCTION	Peak (PK)
FREQUENCY RANGE	1GHz ~ 40GHz		Average (AV)

ANTENNA POLARITY & TEST DISTANCE: HORIZONTAL AT 3 M

NO.	FREQ. (MHz)	EMISSION LEVEL (dBuV/m)	LIMIT (dBuV/m)	MARGIN (dB)	ANTENNA HEIGHT (m)	TABLE ANGLE (Degree)	RAW VALUE (dBuV)	CORRECTION FACTOR (dB/m)
1	5460.00	62.8 PK	74.0	-11.2	1.00 H	0	59.8	3.0
2	5460.00	45.2 AV	54.0	-8.8	1.00 H	0	42.2	3.0
3	#5470.00	63.8 PK	68.2	-4.4	1.58 H	360	60.8	3.0
4	*5720.00	109.5 PK			1.58 H	360	106.3	3.2
5	*5720.00	100.8 AV			1.58 H	360	97.6	3.2
6	#5850.00	63.4 PK	68.2	-4.8	1.58 H	360	59.8	3.6
7	11440.00	49.8 PK	74.0	-24.2	1.75 H	193	36.9	12.9
8	11440.00	43.4 AV	54.0	-10.6	1.75 H	193	30.5	12.9
9	#17160.00	54.9 PK	68.2	-13.3	1.99 H	5	38.8	16.1

ANTENNA POLARITY & TEST DISTANCE: VERTICAL AT 3 M

NO.	FREQ. (MHz)	EMISSION LEVEL (dBuV/m)	LIMIT (dBuV/m)	MARGIN (dB)	ANTENNA HEIGHT (m)	TABLE ANGLE (Degree)	RAW VALUE (dBuV)	CORRECTION FACTOR (dB/m)
1	5460.00	58.9 PK	74.0	-15.1	1.00 V	0	55.9	3.0
2	5460.00	43.6 AV	54.0	-10.4	1.00 V	0	40.6	3.0
3	#5470.00	62.8 PK	68.2	-5.4	2.14 V	360	59.8	3.0
4	*5720.00	105.5 PK			2.14 V	360	102.3	3.2
5	*5720.00	96.1 AV			2.14 V	360	92.9	3.2
6	#5850.00	59.2 PK	68.2	-9.0	2.14 V	360	55.6	3.6
7	#7160.00	60.5 PK	68.2	-7.7	3.01 V	236	52.7	7.8
8	11440.00	51.6 PK	74.0	-22.4	1.32 V	206	38.7	12.9
9	11440.00	46.5 AV	54.0	-7.5	1.32 V	206	33.6	12.9

REMARKS:

1. Emission Level(dBuV/m) = Raw Value(dBuV) + Correction Factor(dB/m)
2. Correction Factor(dB/m) = Antenna Factor(dB/m) + Cable Factor(dB) – Pre-Amplifier Factor(dB)
3. The other emission levels were very low against the limit.
4. Margin value = Emission Level – Limit value
5. " * ": Fundamental frequency.
6. " # ": The radiated frequency is out of the restricted band.

802.11ax (HE20)

CHANNEL	TX Channel 52	DETECTOR FUNCTION	Peak (PK)
FREQUENCY RANGE	1GHz ~ 40GHz		Average (AV)

ANTENNA POLARITY & TEST DISTANCE: HORIZONTAL AT 3 M

NO.	FREQ. (MHz)	EMISSION LEVEL (dBuV/m)	LIMIT (dBuV/m)	MARGIN (dB)	ANTENNA HEIGHT (m)	TABLE ANGLE (Degree)	RAW VALUE (dBuV)	CORRECTION FACTOR (dB/m)
1	5150.00	67.3 PK	74.0	-6.7	1.88 H	10	64.4	2.9
2	5150.00	52.7 AV	54.0	-1.3	1.88 H	10	49.8	2.9
3	*5260.00	108.6 PK			1.88 H	10	106.2	2.4
4	*5260.00	100.0 AV			1.88 H	10	97.6	2.4
5	#10520.00	48.7 PK	68.2	-19.5	1.82 H	202	36.4	12.3
6	15780.00	54.7 PK	74.0	-19.3	1.93 H	7	42.7	12.0
7	15780.00	42.0 AV	54.0	-12.0	1.93 H	7	30.0	12.0

ANTENNA POLARITY & TEST DISTANCE: VERTICAL AT 3 M

NO.	FREQ. (MHz)	EMISSION LEVEL (dBuV/m)	LIMIT (dBuV/m)	MARGIN (dB)	ANTENNA HEIGHT (m)	TABLE ANGLE (Degree)	RAW VALUE (dBuV)	CORRECTION FACTOR (dB/m)
1	5150.00	56.4 PK	74.0	-17.6	2.16 V	17	53.5	2.9
2	5150.00	43.2 AV	54.0	-10.8	2.16 V	17	40.3	2.9
3	*5260.00	104.9 PK			2.16 V	17	102.5	2.4
4	*5260.00	95.3 AV			2.16 V	17	92.9	2.4
5	#10520.00	52.1 PK	68.2	-16.1	1.24 V	206	39.8	12.3
6	15780.00	60.6 PK	74.0	-13.4	3.03 V	222	48.6	12.0
7	15780.00	49.4 AV	54.0	-4.6	3.03 V	222	37.4	12.0

REMARKS:

1. Emission Level(dBuV/m) = Raw Value(dBuV) + Correction Factor(dB/m)
2. Correction Factor(dB/m) = Antenna Factor(dB/m) + Cable Factor(dB) – Pre-Amplifier Factor(dB)
3. The other emission levels were very low against the limit.
4. Margin value = Emission Level – Limit value
5. " * ": Fundamental frequency.
6. " # ": The radiated frequency is out of the restricted band.

CHANNEL	TX Channel 60	DETECTOR FUNCTION	Peak (PK)
FREQUENCY RANGE	1GHz ~ 40GHz		Average (AV)

ANTENNA POLARITY & TEST DISTANCE: HORIZONTAL AT 3 M

NO.	FREQ. (MHz)	EMISSION LEVEL (dBuV/m)	LIMIT (dBuV/m)	MARGIN (dB)	ANTENNA HEIGHT (m)	TABLE ANGLE (Degree)	RAW VALUE (dBuV)	CORRECTION FACTOR (dB/m)
1	*5300.00	109.2 PK			1.83 H	16	106.6	2.6
2	*5300.00	100.9 AV			1.83 H	16	98.3	2.6
3	10600.00	49.7 PK	74.0	-24.3	1.74 H	195	37.6	12.1
4	10600.00	43.4 AV	54.0	-10.6	1.74 H	195	31.3	12.1
5	15900.00	54.8 PK	74.0	-19.2	2.03 H	15	43.0	11.8
6	15900.00	41.7 AV	54.0	-12.3	2.03 H	15	29.9	11.8

ANTENNA POLARITY & TEST DISTANCE: VERTICAL AT 3 M

NO.	FREQ. (MHz)	EMISSION LEVEL (dBuV/m)	LIMIT (dBuV/m)	MARGIN (dB)	ANTENNA HEIGHT (m)	TABLE ANGLE (Degree)	RAW VALUE (dBuV)	CORRECTION FACTOR (dB/m)
1	*5300.00	105.5 PK			2.08 V	27	102.9	2.6
2	*5300.00	95.9 AV			2.08 V	27	93.3	2.6
3	10600.00	51.4 PK	74.0	-22.6	1.32 V	202	39.3	12.1
4	10600.00	46.2 AV	54.0	-7.8	1.32 V	202	34.1	12.1
5	15900.00	60.4 PK	74.0	-13.6	2.98 V	243	48.6	11.8
6	15900.00	49.3 AV	54.0	-4.7	2.98 V	243	37.5	11.8

REMARKS:

1. Emission Level(dBuV/m) = Raw Value(dBuV) + Correction Factor(dB/m)
2. Correction Factor(dB/m) = Antenna Factor(dB/m) + Cable Factor(dB) – Pre-Amplifier Factor(dB)
3. The other emission levels were very low against the limit.
4. Margin value = Emission Level – Limit value
5. " * ": Fundamental frequency.

CHANNEL	TX Channel 64	DETECTOR FUNCTION	Peak (PK)
FREQUENCY RANGE	1GHz ~ 40GHz		Average (AV)

ANTENNA POLARITY & TEST DISTANCE: HORIZONTAL AT 3 M

NO.	FREQ. (MHz)	EMISSION LEVEL (dBuV/m)	LIMIT (dBuV/m)	MARGIN (dB)	ANTENNA HEIGHT (m)	TABLE ANGLE (Degree)	RAW VALUE (dBuV)	CORRECTION FACTOR (dB/m)
1	*5320.00	107.1 PK			1.78 H	5	104.5	2.6
2	*5320.00	98.8 AV			1.78 H	5	96.2	2.6
3	5350.00	67.8 PK	74.0	-6.2	1.78 H	5	65.1	2.7
4	5350.00	53.8 AV	54.0	-0.2	1.78 H	5	51.1	2.7
5	10640.00	47.5 PK	74.0	-26.5	1.78 H	177	35.6	11.9
6	10640.00	41.9 AV	54.0	-12.1	1.78 H	177	30.0	11.9
7	15960.00	52.8 PK	74.0	-21.2	1.91 H	15	40.7	12.1
8	15960.00	39.9 AV	54.0	-14.1	1.91 H	15	27.8	12.1

ANTENNA POLARITY & TEST DISTANCE: VERTICAL AT 3 M

NO.	FREQ. (MHz)	EMISSION LEVEL (dBuV/m)	LIMIT (dBuV/m)	MARGIN (dB)	ANTENNA HEIGHT (m)	TABLE ANGLE (Degree)	RAW VALUE (dBuV)	CORRECTION FACTOR (dB/m)
1	*5320.00	103.6 PK			2.55 V	50	101.0	2.6
2	*5320.00	94.6 AV			2.55 V	50	92.0	2.6
3	5350.00	56.4 PK	74.0	-17.6	2.55 V	50	53.7	2.7
4	5350.00	43.7 AV	54.0	-10.3	2.55 V	50	41.0	2.7
5	10640.00	51.4 PK	74.0	-22.6	1.19 V	211	39.5	11.9
6	10640.00	46.4 AV	54.0	-7.6	1.19 V	211	34.5	11.9
7	15960.00	59.1 PK	74.0	-14.9	2.97 V	231	47.0	12.1
8	15960.00	47.8 AV	54.0	-6.2	2.97 V	231	35.7	12.1

REMARKS:

1. Emission Level(dBuV/m) = Raw Value(dBuV) + Correction Factor(dB/m)
2. Correction Factor(dB/m) = Antenna Factor(dB/m) + Cable Factor(dB) – Pre-Amplifier Factor(dB)
3. The other emission levels were very low against the limit.
4. Margin value = Emission Level – Limit value
5. " * ": Fundamental frequency.

CHANNEL	TX Channel 100	DETECTOR FUNCTION	Peak (PK)
FREQUENCY RANGE	1GHz ~ 40GHz		Average (AV)

ANTENNA POLARITY & TEST DISTANCE: HORIZONTAL AT 3 M

NO.	FREQ. (MHz)	EMISSION LEVEL (dBuV/m)	LIMIT (dBuV/m)	MARGIN (dB)	ANTENNA HEIGHT (m)	TABLE ANGLE (Degree)	RAW VALUE (dBuV)	CORRECTION FACTOR (dB/m)
1	5460.00	63.1 PK	74.0	-10.9	1.63 H	348	60.1	3.0
2	5460.00	44.4 AV	54.0	-9.6	1.63 H	348	41.4	3.0
3	#5470.00	68.1 PK	68.2	-0.1	1.63 H	348	65.1	3.0
4	*5500.00	107.6 PK			1.63 H	348	104.7	2.9
5	*5500.00	98.8 AV			1.63 H	348	95.9	2.9
6	11000.00	47.4 PK	74.0	-26.6	1.82 H	210	34.6	12.8
7	11000.00	41.4 AV	54.0	-12.6	1.82 H	210	28.6	12.8
8	#16500.00	52.7 PK	68.2	-15.5	1.96 H	18	38.3	14.4

ANTENNA POLARITY & TEST DISTANCE: VERTICAL AT 3 M

NO.	FREQ. (MHz)	EMISSION LEVEL (dBuV/m)	LIMIT (dBuV/m)	MARGIN (dB)	ANTENNA HEIGHT (m)	TABLE ANGLE (Degree)	RAW VALUE (dBuV)	CORRECTION FACTOR (dB/m)
1	5460.00	59.2 PK	74.0	-14.8	2.11 V	360	56.2	3.0
2	5460.00	45.6 AV	54.0	-8.4	2.11 V	360	42.6	3.0
3	#5470.00	63.6 PK	68.2	-4.6	2.11 V	360	60.6	3.0
4	*5500.00	103.6 PK			2.11 V	360	100.7	2.9
5	*5500.00	94.1 AV			2.11 V	360	91.2	2.9
6	11000.00	50.8 PK	74.0	-23.2	1.25 V	198	38.0	12.8
7	11000.00	46.0 AV	54.0	-8.0	1.25 V	198	33.2	12.8
8	#16500.00	58.8 PK	68.2	-9.4	2.94 V	236	44.4	14.4

REMARKS:

1. Emission Level(dBuV/m) = Raw Value(dBuV) + Correction Factor(dB/m)
2. Correction Factor(dB/m) = Antenna Factor(dB/m) + Cable Factor(dB) – Pre-Amplifier Factor(dB)
3. The other emission levels were very low against the limit.
4. Margin value = Emission Level – Limit value
5. " * ": Fundamental frequency.
6. " # ": The radiated frequency is out of the restricted band.

CHANNEL	TX Channel 116	DETECTOR FUNCTION	Peak (PK)
FREQUENCY RANGE	1GHz ~ 40GHz		Average (AV)

ANTENNA POLARITY & TEST DISTANCE: HORIZONTAL AT 3 M

NO.	FREQ. (MHz)	EMISSION LEVEL (dBuV/m)	LIMIT (dBuV/m)	MARGIN (dB)	ANTENNA HEIGHT (m)	TABLE ANGLE (Degree)	RAW VALUE (dBuV)	CORRECTION FACTOR (dB/m)
1	*5580.00	109.5 PK			1.55 H	360	106.5	3.0
2	*5580.00	101.1 AV			1.55 H	360	98.1	3.0
3	11160.00	49.5 PK	74.0	-24.5	1.77 H	194	37.2	12.3
4	11160.00	43.2 AV	54.0	-10.8	1.77 H	194	30.9	12.3
5	#16740.00	54.4 PK	68.2	-13.8	2.03 H	13	39.7	14.7

ANTENNA POLARITY & TEST DISTANCE: VERTICAL AT 3 M

NO.	FREQ. (MHz)	EMISSION LEVEL (dBuV/m)	LIMIT (dBuV/m)	MARGIN (dB)	ANTENNA HEIGHT (m)	TABLE ANGLE (Degree)	RAW VALUE (dBuV)	CORRECTION FACTOR (dB/m)
1	*5580.00	105.5 PK			2.10 V	360	102.5	3.0
2	*5580.00	96.4 AV			2.10 V	360	93.4	3.0
3	11160.00	51.7 PK	74.0	-22.3	1.30 V	194	39.4	12.3
4	11160.00	46.6 AV	54.0	-7.4	1.30 V	194	34.3	12.3
5	#16740.00	60.5 PK	68.2	-7.7	3.03 V	227	45.8	14.7

REMARKS:

1. Emission Level(dBuV/m) = Raw Value(dBuV) + Correction Factor(dB/m)
2. Correction Factor(dB/m) = Antenna Factor(dB/m) + Cable Factor(dB) – Pre-Amplifier Factor(dB)
3. The other emission levels were very low against the limit.
4. Margin value = Emission Level – Limit value
5. " * ": Fundamental frequency.
6. " # ": The radiated frequency is out of the restricted band.

CHANNEL	TX Channel 140	DETECTOR FUNCTION	Peak (PK)
FREQUENCY RANGE	1GHz ~ 40GHz		Average (AV)

ANTENNA POLARITY & TEST DISTANCE: HORIZONTAL AT 3 M

NO.	FREQ. (MHz)	EMISSION LEVEL (dBuV/m)	LIMIT (dBuV/m)	MARGIN (dB)	ANTENNA HEIGHT (m)	TABLE ANGLE (Degree)	RAW VALUE (dBuV)	CORRECTION FACTOR (dB/m)
1	*5700.00	108.3 PK			1.60 H	360	105.1	3.2
2	*5700.00	99.6 AV			1.60 H	360	96.4	3.2
3	#5725.00	67.9 PK	68.2	-0.3	1.60 H	360	64.7	3.2
4	11400.00	47.6 PK	74.0	-26.4	1.80 H	202	34.6	13.0
5	11400.00	41.8 AV	54.0	-12.2	1.80 H	202	28.8	13.0
6	#17100.00	53.3 PK	68.2	-14.9	1.95 H	4	36.8	16.5

ANTENNA POLARITY & TEST DISTANCE: VERTICAL AT 3 M

NO.	FREQ. (MHz)	EMISSION LEVEL (dBuV/m)	LIMIT (dBuV/m)	MARGIN (dB)	ANTENNA HEIGHT (m)	TABLE ANGLE (Degree)	RAW VALUE (dBuV)	CORRECTION FACTOR (dB/m)
1	*5700.00	104.3 PK			2.06 V	360	101.1	3.2
2	*5700.00	94.9 AV			2.06 V	360	91.7	3.2
3	#5725.00	66.4 PK	68.2	-1.8	2.06 V	360	63.2	3.2
4	11400.00	50.7 PK	74.0	-23.3	1.23 V	215	37.7	13.0
5	11400.00	45.7 AV	54.0	-8.3	1.23 V	215	32.7	13.0
6	#17100.00	57.9 PK	68.2	-10.3	2.99 V	239	41.4	16.5

REMARKS:

1. Emission Level(dBuV/m) = Raw Value(dBuV) + Correction Factor(dB/m)
2. Correction Factor(dB/m) = Antenna Factor(dB/m) + Cable Factor(dB) – Pre-Amplifier Factor(dB)
3. The other emission levels were very low against the limit.
4. Margin value = Emission Level – Limit value
5. " * ": Fundamental frequency.
6. " # ": The radiated frequency is out of the restricted band.

CHANNEL	TX Channel 144	DETECTOR FUNCTION	Peak (PK)
FREQUENCY RANGE	1GHz ~ 40GHz		Average (AV)

ANTENNA POLARITY & TEST DISTANCE: HORIZONTAL AT 3 M

NO.	FREQ. (MHz)	EMISSION LEVEL (dBuV/m)	LIMIT (dBuV/m)	MARGIN (dB)	ANTENNA HEIGHT (m)	TABLE ANGLE (Degree)	RAW VALUE (dBuV)	CORRECTION FACTOR (dB/m)
1	5460.00	61.7 PK	74.0	-12.3	1.60 H	360	58.7	3.0
2	5460.00	51.6 AV	54.0	-2.4	1.60 H	360	48.6	3.0
3	#5470.00	63.4 PK	68.2	-4.8	1.60 H	360	60.4	3.0
4	*5720.00	109.8 PK			1.60 H	360	106.6	3.2
5	*5720.00	101.0 AV			1.60 H	360	97.8	3.2
6	#5850.00	63.3 PK	68.2	-4.9	1.60 H	360	59.7	3.6
7	11440.00	49.3 PK	74.0	-24.7	1.82 H	192	36.4	12.9
8	11440.00	42.8 AV	54.0	-11.2	1.82 H	192	29.9	12.9
9	#17160.00	55.2 PK	68.2	-13.0	1.95 H	9	39.1	16.1

ANTENNA POLARITY & TEST DISTANCE: VERTICAL AT 3 M

NO.	FREQ. (MHz)	EMISSION LEVEL (dBuV/m)	LIMIT (dBuV/m)	MARGIN (dB)	ANTENNA HEIGHT (m)	TABLE ANGLE (Degree)	RAW VALUE (dBuV)	CORRECTION FACTOR (dB/m)
1	5460.00	58.7 PK	74.0	-15.3	2.08 V	359	55.7	3.0
2	5460.00	50.9 AV	54.0	-3.1	2.08 V	359	47.9	3.0
3	#5470.00	63.0 PK	68.2	-5.2	2.08 V	359	60.0	3.0
4	*5720.00	105.8 PK			2.08 V	359	102.6	3.2
5	*5720.00	96.3 AV			2.08 V	359	93.1	3.2
6	#5850.00	59.8 PK	68.2	-8.4	2.08 V	359	56.2	3.6
7	11440.00	52.6 PK	74.0	-21.4	1.32 V	202	39.7	12.9
8	11440.00	47.1 AV	54.0	-6.9	1.32 V	202	34.2	12.9
9	#17160.00	60.4 PK	68.2	-7.8	3.00 V	247	44.3	16.1

REMARKS:

1. Emission Level(dBuV/m) = Raw Value(dBuV) + Correction Factor(dB/m)
2. Correction Factor(dB/m) = Antenna Factor(dB/m) + Cable Factor(dB) – Pre-Amplifier Factor(dB)
3. The other emission levels were very low against the limit.
4. Margin value = Emission Level – Limit value
5. " * ": Fundamental frequency.
6. " # ": The radiated frequency is out of the restricted band.

802.11ax (HE40)

CHANNEL	TX Channel 54	DETECTOR FUNCTION	Peak (PK)
FREQUENCY RANGE	1GHz ~ 40GHz		Average (AV)

ANTENNA POLARITY & TEST DISTANCE: HORIZONTAL AT 3 M

NO.	FREQ. (MHz)	EMISSION LEVEL (dBuV/m)	LIMIT (dBuV/m)	MARGIN (dB)	ANTENNA HEIGHT (m)	TABLE ANGLE (Degree)	RAW VALUE (dBuV)	CORRECTION FACTOR (dB/m)
1	5150.00	67.2 PK	74.0	-6.8	1.74 H	359	64.3	2.9
2	5150.00	52.5 AV	54.0	-1.5	1.74 H	359	49.6	2.9
3	*5270.00	110.8 PK			1.74 H	359	108.4	2.4
4	*5270.00	98.0 AV			1.74 H	359	95.6	2.4
5	#10540.00	49.5 PK	68.2	-18.7	1.75 H	187	37.3	12.2
6	15810.00	54.7 PK	74.0	-19.3	2.00 H	14	42.9	11.8
7	15810.00	41.7 AV	54.0	-12.3	2.00 H	14	29.9	11.8

ANTENNA POLARITY & TEST DISTANCE: VERTICAL AT 3 M

NO.	FREQ. (MHz)	EMISSION LEVEL (dBuV/m)	LIMIT (dBuV/m)	MARGIN (dB)	ANTENNA HEIGHT (m)	TABLE ANGLE (Degree)	RAW VALUE (dBuV)	CORRECTION FACTOR (dB/m)
1	5150.00	56.5 PK	74.0	-17.5	2.08 V	20	53.6	2.9
2	5150.00	43.1 AV	54.0	-10.9	2.08 V	20	40.2	2.9
3	*5270.00	106.8 PK			2.08 V	20	104.4	2.4
4	*5270.00	93.5 AV			2.08 V	20	91.1	2.4
5	#10540.00	51.8 PK	68.2	-16.4	1.28 V	196	39.6	12.2
6	15810.00	60.1 PK	74.0	-13.9	3.00 V	226	48.3	11.8
7	15810.00	49.0 AV	54.0	-5.0	3.00 V	226	37.2	11.8

REMARKS:

- Emission Level(dBuV/m) = Raw Value(dBuV) + Correction Factor(dB/m)
- Correction Factor(dB/m) = Antenna Factor(dB/m) + Cable Factor(dB) – Pre-Amplifier Factor(dB)
- The other emission levels were very low against the limit.
- Margin value = Emission Level – Limit value
- " * ": Fundamental frequency.
- " # ": The radiated frequency is out of the restricted band.

CHANNEL	TX Channel 62	DETECTOR FUNCTION	Peak (PK)
FREQUENCY RANGE	1GHz ~ 40GHz		Average (AV)

ANTENNA POLARITY & TEST DISTANCE: HORIZONTAL AT 3 M

NO.	FREQ. (MHz)	EMISSION LEVEL (dBuV/m)	LIMIT (dBuV/m)	MARGIN (dB)	ANTENNA HEIGHT (m)	TABLE ANGLE (Degree)	RAW VALUE (dBuV)	CORRECTION FACTOR (dB/m)
1	*5310.00	107.9 PK			1.82 H	360	105.3	2.6
2	*5310.00	95.1 AV			1.82 H	360	92.5	2.6
3	5350.00	66.9 PK	74.0	-7.1	1.82 H	360	64.2	2.7
4	5350.00	53.8 AV	54.0	-0.2	1.82 H	360	51.1	2.7
5	10620.00	47.4 PK	74.0	-26.6	1.73 H	170	35.4	12.0
6	10620.00	41.2 AV	54.0	-12.8	1.73 H	170	29.2	12.0
7	15930.00	52.9 PK	74.0	-21.1	1.93 H	10	41.1	11.8
8	15930.00	40.0 AV	54.0	-14.0	1.93 H	10	28.2	11.8

ANTENNA POLARITY & TEST DISTANCE: VERTICAL AT 3 M

NO.	FREQ. (MHz)	EMISSION LEVEL (dBuV/m)	LIMIT (dBuV/m)	MARGIN (dB)	ANTENNA HEIGHT (m)	TABLE ANGLE (Degree)	RAW VALUE (dBuV)	CORRECTION FACTOR (dB/m)
1	*5310.00	103.4 PK			2.12 V	21	100.8	2.6
2	*5310.00	90.0 AV			2.12 V	21	87.4	2.6
3	5350.00	58.0 PK	74.0	-16.0	2.12 V	21	55.3	2.7
4	5350.00	45.2 AV	54.0	-8.8	2.12 V	21	42.5	2.7
5	10620.00	51.2 PK	74.0	-22.8	1.20 V	229	39.2	12.0
6	10620.00	46.3 AV	54.0	-7.7	1.20 V	229	34.3	12.0
7	15930.00	58.4 PK	74.0	-15.6	2.95 V	242	46.6	11.8
8	15930.00	47.3 AV	54.0	-6.7	2.95 V	242	35.5	11.8

REMARKS:

1. Emission Level(dBuV/m) = Raw Value(dBuV) + Correction Factor(dB/m)
2. Correction Factor(dB/m) = Antenna Factor(dB/m) + Cable Factor(dB) – Pre-Amplifier Factor(dB)
3. The other emission levels were very low against the limit.
4. Margin value = Emission Level – Limit value
5. " * ": Fundamental frequency.

CHANNEL	TX Channel 102	DETECTOR FUNCTION	Peak (PK)
FREQUENCY RANGE	1GHz ~ 40GHz		Average (AV)

ANTENNA POLARITY & TEST DISTANCE: HORIZONTAL AT 3 M

NO.	FREQ. (MHz)	EMISSION LEVEL (dBuV/m)	LIMIT (dBuV/m)	MARGIN (dB)	ANTENNA HEIGHT (m)	TABLE ANGLE (Degree)	RAW VALUE (dBuV)	CORRECTION FACTOR (dB/m)
1	5460.00	61.5 PK	74.0	-12.5	1.60 H	346	58.5	3.0
2	5460.00	51.7 AV	54.0	-2.3	1.60 H	346	48.7	3.0
3	#5470.00	68.0 PK	68.2	-0.2	1.60 H	346	65.0	3.0
4	*5510.00	107.9 PK			1.60 H	346	105.0	2.9
5	*5510.00	94.8 AV			1.60 H	346	91.9	2.9
6	#5725.00	52.6 PK	68.2	-15.6	1.60 H	346	49.4	3.2
7	11020.00	48.4 PK	74.0	-25.6	1.75 H	205	35.6	12.8
8	11020.00	42.0 AV	54.0	-12.0	1.75 H	205	29.2	12.8
9	#16530.00	52.4 PK	68.2	-15.8	1.94 H	13	37.8	14.6

ANTENNA POLARITY & TEST DISTANCE: VERTICAL AT 3 M

NO.	FREQ. (MHz)	EMISSION LEVEL (dBuV/m)	LIMIT (dBuV/m)	MARGIN (dB)	ANTENNA HEIGHT (m)	TABLE ANGLE (Degree)	RAW VALUE (dBuV)	CORRECTION FACTOR (dB/m)
1	5460.00	58.8 PK	74.0	-15.2	2.07 V	14	55.8	3.0
2	5460.00	51.0 AV	54.0	-3.0	2.07 V	14	48.0	3.0
3	#5470.00	63.8 PK	68.2	-4.4	2.07 V	14	60.8	3.0
4	*5510.00	104.1 PK			2.07 V	14	101.2	2.9
5	*5510.00	90.6 AV			2.07 V	14	87.7	2.9
6	#5725.00	63.8 PK	68.2	-4.4	2.07 V	14	60.6	3.2
7	11020.00	51.2 PK	74.0	-22.8	1.23 V	224	38.4	12.8
8	11020.00	46.0 AV	54.0	-8.0	1.23 V	224	33.2	12.8
9	#16530.00	57.9 PK	68.2	-10.3	2.95 V	253	43.3	14.6

REMARKS:

1. Emission Level(dBuV/m) = Raw Value(dBuV) + Correction Factor(dB/m)
2. Correction Factor(dB/m) = Antenna Factor(dB/m) + Cable Factor(dB) – Pre-Amplifier Factor(dB)
3. The other emission levels were very low against the limit.
4. Margin value = Emission Level – Limit value
5. " * ": Fundamental frequency.
6. " # ": The radiated frequency is out of the restricted band.

CHANNEL	TX Channel 110	DETECTOR FUNCTION	Peak (PK)
FREQUENCY RANGE	1GHz ~ 40GHz		Average (AV)

ANTENNA POLARITY & TEST DISTANCE: HORIZONTAL AT 3 M

NO.	FREQ. (MHz)	EMISSION LEVEL (dBuV/m)	LIMIT (dBuV/m)	MARGIN (dB)	ANTENNA HEIGHT (m)	TABLE ANGLE (Degree)	RAW VALUE (dBuV)	CORRECTION FACTOR (dB/m)
1	*5550.00	111.4 PK			1.70 H	282	108.4	3.0
2	*5550.00	98.3 AV			1.70 H	282	95.3	3.0
3	11100.00	48.8 PK	74.0	-25.2	1.83 H	201	36.5	12.3
4	11100.00	42.6 AV	54.0	-11.4	1.83 H	201	30.3	12.3
5	#16650.00	54.1 PK	68.2	-14.1	1.91 H	21	39.4	14.7

ANTENNA POLARITY & TEST DISTANCE: VERTICAL AT 3 M

NO.	FREQ. (MHz)	EMISSION LEVEL (dBuV/m)	LIMIT (dBuV/m)	MARGIN (dB)	ANTENNA HEIGHT (m)	TABLE ANGLE (Degree)	RAW VALUE (dBuV)	CORRECTION FACTOR (dB/m)
1	*5550.00	107.6 PK			2.86 V	275	104.6	3.0
2	*5550.00	94.1 AV			2.86 V	275	91.1	3.0
3	11100.00	52.1 PK	74.0	-21.9	1.28 V	192	39.8	12.3
4	11100.00	47.1 AV	54.0	-6.9	1.28 V	192	34.8	12.3
5	#16650.00	60.3 PK	68.2	-7.9	3.03 V	233	45.6	14.7

REMARKS:

1. Emission Level(dBuV/m) = Raw Value(dBuV) + Correction Factor(dB/m)
2. Correction Factor(dB/m) = Antenna Factor(dB/m) + Cable Factor(dB) – Pre-Amplifier Factor(dB)
3. The other emission levels were very low against the limit.
4. Margin value = Emission Level – Limit value
5. " * ": Fundamental frequency.
6. " # ": The radiated frequency is out of the restricted band.

CHANNEL	TX Channel 134	DETECTOR FUNCTION	Peak (PK)
FREQUENCY RANGE	1GHz ~ 40GHz		Average (AV)

ANTENNA POLARITY & TEST DISTANCE: HORIZONTAL AT 3 M

NO.	FREQ. (MHz)	EMISSION LEVEL (dBuV/m)	LIMIT (dBuV/m)	MARGIN (dB)	ANTENNA HEIGHT (m)	TABLE ANGLE (Degree)	RAW VALUE (dBuV)	CORRECTION FACTOR (dB/m)
1	*5670.00	108.5 PK			1.61 H	359	105.3	3.2
2	*5670.00	95.2 AV			1.61 H	359	92.0	3.2
3	#5725.00	68.0 PK	68.2	-0.2	1.61 H	359	64.8	3.2
4	11340.00	48.0 PK	74.0	-26.0	1.80 H	198	34.9	13.1
5	11340.00	41.8 AV	54.0	-12.2	1.80 H	198	28.7	13.1
6	#17010.00	52.9 PK	68.2	-15.3	1.97 H	8	36.5	16.4

ANTENNA POLARITY & TEST DISTANCE: VERTICAL AT 3 M

NO.	FREQ. (MHz)	EMISSION LEVEL (dBuV/m)	LIMIT (dBuV/m)	MARGIN (dB)	ANTENNA HEIGHT (m)	TABLE ANGLE (Degree)	RAW VALUE (dBuV)	CORRECTION FACTOR (dB/m)
1	*5670.00	104.7 PK			2.10 V	18	101.5	3.2
2	*5670.00	91.1 AV			2.10 V	18	87.9	3.2
3	#5725.00	63.1 PK	68.2	-5.1	2.10 V	18	59.9	3.2
4	11340.00	50.5 PK	74.0	-23.5	1.20 V	229	37.4	13.1
5	11340.00	45.5 AV	54.0	-8.5	1.20 V	229	32.4	13.1
6	#17010.00	57.6 PK	68.2	-10.6	2.94 V	254	41.2	16.4

REMARKS:

1. Emission Level(dBuV/m) = Raw Value(dBuV) + Correction Factor(dB/m)
2. Correction Factor(dB/m) = Antenna Factor(dB/m) + Cable Factor(dB) – Pre-Amplifier Factor(dB)
3. The other emission levels were very low against the limit.
4. Margin value = Emission Level – Limit value
5. " * ": Fundamental frequency.
6. " # ": The radiated frequency is out of the restricted band.

CHANNEL	TX Channel 142	DETECTOR FUNCTION	Peak (PK)
FREQUENCY RANGE	1GHz ~ 40GHz		Average (AV)

ANTENNA POLARITY & TEST DISTANCE: HORIZONTAL AT 3 M

NO.	FREQ. (MHz)	EMISSION LEVEL (dBuV/m)	LIMIT (dBuV/m)	MARGIN (dB)	ANTENNA HEIGHT (m)	TABLE ANGLE (Degree)	RAW VALUE (dBuV)	CORRECTION FACTOR (dB/m)
1	5460.00	61.7 PK	74.0	-12.3	1.00 H	0	58.7	3.0
2	5460.00	49.8 AV	54.0	-4.2	1.00 H	0	46.8	3.0
3	#5470.00	63.2 PK	68.2	-5.0	1.67 H	290	60.2	3.0
4	*5710.00	111.8 PK			1.67 H	290	108.5	3.3
5	*5710.00	98.9 AV			1.67 H	290	95.6	3.3
6	#5850.00	63.5 PK	68.2	-4.7	1.67 H	290	59.9	3.6
7	11420.00	49.3 PK	74.0	-24.7	1.76 H	193	36.3	13.0
8	11420.00	43.1 AV	54.0	-10.9	1.76 H	193	30.1	13.0
9	#17130.00	54.6 PK	68.2	-13.6	1.91 H	15	38.3	16.3

ANTENNA POLARITY & TEST DISTANCE: VERTICAL AT 3 M

NO.	FREQ. (MHz)	EMISSION LEVEL (dBuV/m)	LIMIT (dBuV/m)	MARGIN (dB)	ANTENNA HEIGHT (m)	TABLE ANGLE (Degree)	RAW VALUE (dBuV)	CORRECTION FACTOR (dB/m)
1	5460.00	57.8 PK	74.0	-16.2	1.00 V	0	54.8	3.0
2	5460.00	49.3 AV	54.0	-4.7	1.00 V	0	46.3	3.0
3	#5470.00	59.2 PK	68.2	-9.0	2.85 V	263	56.2	3.0
4	*5710.00	107.9 PK			2.85 V	263	104.6	3.3
5	*5710.00	94.3 AV			2.85 V	263	91.0	3.3
6	#5850.00	59.3 PK	68.2	-8.9	2.85 V	263	55.7	3.6
7	11420.00	52.4 PK	74.0	-21.6	1.24 V	197	39.4	13.0
8	11420.00	46.8 AV	54.0	-7.2	1.24 V	197	33.8	13.0
9	#17130.00	60.6 PK	68.2	-7.6	3.01 V	238	44.3	16.3

REMARKS:

1. Emission Level(dBuV/m) = Raw Value(dBuV) + Correction Factor(dB/m)
2. Correction Factor(dB/m) = Antenna Factor(dB/m) + Cable Factor(dB) – Pre-Amplifier Factor(dB)
3. The other emission levels were very low against the limit.
4. Margin value = Emission Level – Limit value
5. " * ": Fundamental frequency.
6. " # ": The radiated frequency is out of the restricted band.

802.11ax (HE80)

CHANNEL	TX Channel 58	DETECTOR FUNCTION	Peak (PK)
FREQUENCY RANGE	1GHz ~ 40GHz		Average (AV)

ANTENNA POLARITY & TEST DISTANCE: HORIZONTAL AT 3 M

NO.	FREQ. (MHz)	EMISSION LEVEL (dBuV/m)	LIMIT (dBuV/m)	MARGIN (dB)	ANTENNA HEIGHT (m)	TABLE ANGLE (Degree)	RAW VALUE (dBuV)	CORRECTION FACTOR (dB/m)
1	5150.00	54.0 PK	74.0	-20.0	1.73 H	353	51.1	2.9
2	5150.00	41.6 AV	54.0	-12.4	1.73 H	353	38.7	2.9
3	*5290.00	102.7 PK			1.73 H	353	100.3	2.4
4	*5290.00	90.3 AV			1.73 H	353	87.9	2.4
5	5350.00	68.1 PK	74.0	-5.9	1.73 H	353	65.4	2.7
6	5350.00	53.9 AV	54.0	-0.1	1.73 H	353	51.2	2.7
7	#10580.00	47.7 PK	68.2	-20.5	1.78 H	189	35.6	12.1
8	15870.00	52.9 PK	74.0	-21.1	1.89 H	26	41.2	11.7
9	15870.00	40.3 AV	54.0	-13.7	1.89 H	26	28.6	11.7

ANTENNA POLARITY & TEST DISTANCE: VERTICAL AT 3 M

NO.	FREQ. (MHz)	EMISSION LEVEL (dBuV/m)	LIMIT (dBuV/m)	MARGIN (dB)	ANTENNA HEIGHT (m)	TABLE ANGLE (Degree)	RAW VALUE (dBuV)	CORRECTION FACTOR (dB/m)
1	5150.00	52.4 PK	74.0	-21.6	2.68 V	23	49.5	2.9
2	5150.00	39.3 AV	54.0	-14.7	2.68 V	23	36.4	2.9
3	*5290.00	98.8 PK			2.68 V	23	96.4	2.4
4	*5290.00	85.5 AV			2.68 V	23	83.1	2.4
5	5350.00	56.9 PK	74.0	-17.1	2.68 V	23	54.2	2.7
6	5350.00	42.7 AV	54.0	-11.3	2.68 V	23	40.0	2.7
7	#10580.00	51.2 PK	68.2	-17.0	1.31 V	213	39.1	12.1
8	15870.00	58.5 PK	74.0	-15.5	2.99 V	237	46.8	11.7
9	15870.00	47.5 AV	54.0	-6.5	2.99 V	237	35.8	11.7

REMARKS:

1. Emission Level(dBuV/m) = Raw Value(dBuV) + Correction Factor(dB/m)
2. Correction Factor(dB/m) = Antenna Factor(dB/m) + Cable Factor(dB) – Pre-Amplifier Factor(dB)
3. The other emission levels were very low against the limit.
4. Margin value = Emission Level – Limit value
5. " * ": Fundamental frequency.
6. " # ": The radiated frequency is out of the restricted band.

CHANNEL	TX Channel 106	DETECTOR FUNCTION	Peak (PK)
FREQUENCY RANGE	1GHz ~ 40GHz		Average (AV)

ANTENNA POLARITY & TEST DISTANCE: HORIZONTAL AT 3 M

NO.	FREQ. (MHz)	EMISSION LEVEL (dBuV/m)	LIMIT (dBuV/m)	MARGIN (dB)	ANTENNA HEIGHT (m)	TABLE ANGLE (Degree)	RAW VALUE (dBuV)	CORRECTION FACTOR (dB/m)
1	5460.00	69.3 PK	74.0	-4.7	1.77 H	296	66.3	3.0
2	5460.00	49.8 AV	54.0	-4.2	1.77 H	296	46.8	3.0
3	#5470.00	68.0 PK	68.2	-0.2	1.77 H	296	65.0	3.0
4	*5530.00	104.4 PK			1.77 H	296	101.5	2.9
5	*5530.00	91.7 AV			1.77 H	296	88.8	2.9
6	#5725.00	53.7 PK	68.2	-14.5	1.77 H	296	50.5	3.2
7	11060.00	49.0 PK	74.0	-25.0	1.70 H	196	36.5	12.5
8	11060.00	42.3 AV	54.0	-11.7	1.70 H	196	29.8	12.5
9	#16590.00	52.3 PK	68.2	-15.9	1.93 H	13	37.6	14.7

ANTENNA POLARITY & TEST DISTANCE: VERTICAL AT 3 M

NO.	FREQ. (MHz)	EMISSION LEVEL (dBuV/m)	LIMIT (dBuV/m)	MARGIN (dB)	ANTENNA HEIGHT (m)	TABLE ANGLE (Degree)	RAW VALUE (dBuV)	CORRECTION FACTOR (dB/m)
1	5460.00	62.2 PK	74.0	-11.8	2.88 V	270	59.2	3.0
2	5460.00	49.9 AV	54.0	-4.1	2.88 V	270	46.9	3.0
3	#5470.00	63.5 PK	68.2	-4.7	2.88 V	270	60.5	3.0
4	*5530.00	100.1 PK			2.88 V	270	97.2	2.9
5	*5530.00	86.7 AV			2.88 V	270	83.8	2.9
6	#5725.00	54.2 PK	68.2	-14.0	2.88 V	270	51.0	3.2
7	11060.00	50.3 PK	74.0	-23.7	1.21 V	202	37.8	12.5
8	11060.00	45.5 AV	54.0	-8.5	1.21 V	202	33.0	12.5
9	#16590.00	57.7 PK	68.2	-10.5	3.02 V	249	43.0	14.7

REMARKS:

1. Emission Level(dBuV/m) = Raw Value(dBuV) + Correction Factor(dB/m)
2. Correction Factor(dB/m) = Antenna Factor(dB/m) + Cable Factor(dB) – Pre-Amplifier Factor(dB)
3. The other emission levels were very low against the limit.
4. Margin value = Emission Level – Limit value
5. " * ": Fundamental frequency.
6. " # ": The radiated frequency is out of the restricted band.

CHANNEL	TX Channel 122	DETECTOR FUNCTION	Peak (PK)
FREQUENCY RANGE	1GHz ~ 40GHz		Average (AV)

ANTENNA POLARITY & TEST DISTANCE: HORIZONTAL AT 3 M

NO.	FREQ. (MHz)	EMISSION LEVEL (dBuV/m)	LIMIT (dBuV/m)	MARGIN (dB)	ANTENNA HEIGHT (m)	TABLE ANGLE (Degree)	RAW VALUE (dBuV)	CORRECTION FACTOR (dB/m)
1	*5610.00	109.0 PK			3.29 H	282	106.0	3.0
2	*5610.00	96.2 AV			3.29 H	282	93.2	3.0
3	#5725.00	62.4 PK	68.2	-5.8	3.29 H	282	59.2	3.2
4	11220.00	49.5 PK	74.0	-24.5	1.77 H	203	37.0	12.5
5	11220.00	43.3 AV	54.0	-10.7	1.77 H	203	30.8	12.5
6	#16830.00	54.5 PK	68.2	-13.7	2.00 H	2	39.5	15.0

ANTENNA POLARITY & TEST DISTANCE: VERTICAL AT 3 M

NO.	FREQ. (MHz)	EMISSION LEVEL (dBuV/m)	LIMIT (dBuV/m)	MARGIN (dB)	ANTENNA HEIGHT (m)	TABLE ANGLE (Degree)	RAW VALUE (dBuV)	CORRECTION FACTOR (dB/m)
1	*5610.00	100.5 PK			2.40 V	257	97.5	3.0
2	*5610.00	89.0 AV			2.40 V	257	86.0	3.0
3	#5725.00	58.8 PK	68.2	-9.4	2.40 V	257	55.6	3.2
4	11220.00	52.0 PK	74.0	-22.0	1.20 V	206	39.5	12.5
5	11220.00	46.7 AV	54.0	-7.3	1.20 V	206	34.2	12.5
6	#16830.00	60.0 PK	68.2	-8.2	3.03 V	223	45.0	15.0

REMARKS:

1. Emission Level(dBuV/m) = Raw Value(dBuV) + Correction Factor(dB/m)
2. Correction Factor(dB/m) = Antenna Factor(dB/m) + Cable Factor(dB) – Pre-Amplifier Factor(dB)
3. The other emission levels were very low against the limit.
4. Margin value = Emission Level – Limit value
5. " * ": Fundamental frequency.
6. " # ": The radiated frequency is out of the restricted band.

CHANNEL	TX Channel 138	DETECTOR FUNCTION	Peak (PK)
FREQUENCY RANGE	1GHz ~ 40GHz		Average (AV)

ANTENNA POLARITY & TEST DISTANCE: HORIZONTAL AT 3 M

NO.	FREQ. (MHz)	EMISSION LEVEL (dBuV/m)	LIMIT (dBuV/m)	MARGIN (dB)	ANTENNA HEIGHT (m)	TABLE ANGLE (Degree)	RAW VALUE (dBuV)	CORRECTION FACTOR (dB/m)
1	5460.00	54.6 PK	74.0	-19.4	3.36 H	291	51.6	3.0
2	5460.00	43.6 AV	54.0	-10.4	3.36 H	291	40.6	3.0
3	#5470.00	64.6 PK	68.2	-3.6	3.36 H	291	61.6	3.0
4	*5690.00	109.5 PK			3.36 H	291	106.3	3.2
5	*5690.00	96.6 AV			3.36 H	291	93.4	3.2
6	#5850.00	63.1 PK	68.2	-5.1	3.36 H	291	59.5	3.6
7	11380.00	48.9 PK	74.0	-25.1	1.73 H	216	35.9	13.0
8	11380.00	42.7 AV	54.0	-11.3	1.73 H	216	29.7	13.0
9	#17070.00	55.1 PK	68.2	-13.1	2.02 H	12	38.6	16.5

ANTENNA POLARITY & TEST DISTANCE: VERTICAL AT 3 M

NO.	FREQ. (MHz)	EMISSION LEVEL (dBuV/m)	LIMIT (dBuV/m)	MARGIN (dB)	ANTENNA HEIGHT (m)	TABLE ANGLE (Degree)	RAW VALUE (dBuV)	CORRECTION FACTOR (dB/m)
1	5460.00	52.3 PK	74.0	-21.7	2.38 V	246	49.3	3.0
2	5460.00	42.0 AV	54.0	-12.0	2.38 V	246	39.0	3.0
3	#5470.00	64.0 PK	68.2	-4.2	2.38 V	246	61.0	3.0
4	*5690.00	99.9 PK			2.38 V	246	96.7	3.2
5	*5690.00	88.4 AV			2.38 V	246	85.2	3.2
6	#5850.00	58.8 PK	68.2	-9.4	2.38 V	246	55.2	3.6
7	11380.00	51.8 PK	74.0	-22.2	1.22 V	212	38.8	13.0
8	11380.00	46.3 AV	54.0	-7.7	1.22 V	212	33.3	13.0
9	#17070.00	60.5 PK	68.2	-7.7	3.05 V	238	44.0	16.5

REMARKS:

1. Emission Level(dBuV/m) = Raw Value(dBuV) + Correction Factor(dB/m)
2. Correction Factor(dB/m) = Antenna Factor(dB/m) + Cable Factor(dB) – Pre-Amplifier Factor(dB)
3. The other emission levels were very low against the limit.
4. Margin value = Emission Level – Limit value
5. " * ": Fundamental frequency.
6. " # ": The radiated frequency is out of the restricted band.

4.2 Conducted Emission Measurement

4.2.1 Limits of Conducted Emission Measurement

Frequency (MHz)	Conducted Limit (dBuV)	
	Quasi-peak	Average
0.15 - 0.5	66 - 56	56 - 46
0.50 - 5.0	56	46
5.0 - 30.0	60	50

Note: 1. The lower limit shall apply at the transition frequencies.

2. The limit decreases in line with the logarithm of the frequency in the range of 0.15 to 0.50MHz.

4.2.2 Test Instruments

DESCRIPTION & MANUFACTURER	MODEL NO.	SERIAL NO.	CALIBRATED DATE	CALIBRATED UNTIL
Test Receiver R&S	ESCS 30	847124/029	Oct. 24, 2018	Oct. 23, 2019
Line-Impedance Stabilization Network (for EUT) R&S	ESH3-Z5	848773/004	Oct. 22, 2018	Oct. 21, 2019
Line-Impedance Stabilization Network (for Peripheral) R&S	ESH3-Z5	835239/001	Mar. 06, 2018	Mar. 05, 2019
50 ohms Terminator	N/A	3	Oct. 22, 2018	Oct. 21, 2019
RF Cable	5D-FB	COCCAB-001	Sep. 28, 2018	Sep. 27, 2019
Fixed attenuator EMCI	STI02-2200-10	003	Mar. 16, 2018	Mar. 15, 2019
Software BVADT	BVADT_Cond_ V7.3.7.4	NA	NA	NA

Note:

1. The calibration interval of the above test instruments are 12 months and the calibrations are traceable to NML/ROC and NIST/USA.
2. The test was performed in Conduction 1.
- 3 Tested Date: Dec. 18, 2018

4.2.3 Test Procedure

- The EUT was placed 0.4 meters from the conducting wall of the shielded room with EUT being connected to the power mains through a line impedance stabilization network (LISN). Other support units were connected to the power mains through another LISN. The two LISNs provide 50 ohm/ 50uH of coupling impedance for the measuring instrument.
- Both lines of the power mains connected to the EUT were checked for maximum conducted interference.
- The frequency range from 150kHz to 30MHz was searched. Emission levels under (Limit - 20dB) was not recorded.

Note: All modes of operation were investigated and the worst-case emissions are reported.

4.2.4 Deviation from Test Standard

No deviation.

4.2.5 Test Setup

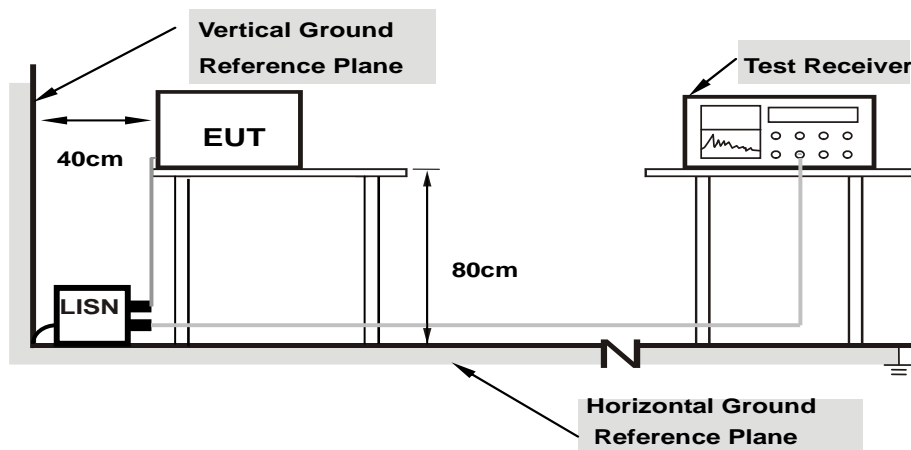

Note: 1.Support units were connected to second LISN.

For the actual test configuration, please refer to the attached file (Test Setup Photo).

4.2.6 EUT Operating Condition

Same as 4.1.6.

4.2.7 Test Results

Phase	Line (L)	Detector Function	Quasi-Peak (QP) / Average (AV)
-------	----------	-------------------	--------------------------------

No	Freq. [MHz]	Corr.	Reading Value		Emission Level		Limit		Margin	
		Factor	[dB (uV)]		[dB (uV)]		[dB (uV)]		(dB)	
	(dB)	Q.P.	AV.	Q.P.	AV.	Q.P.	AV.	Q.P.	AV.	
1	0.17734	10.03	36.92	27.33	46.95	37.36	64.61	54.61	-17.66	-17.25
2	0.21250	10.04	30.65	19.04	40.69	29.08	63.11	53.11	-22.42	-24.03
3	0.40391	10.07	28.97	19.83	39.04	29.90	57.77	47.77	-18.73	-17.87
4	3.61328	10.23	16.47	8.57	26.70	18.80	56.00	46.00	-29.30	-27.20
5	24.44922	11.14	31.14	28.71	42.28	39.85	60.00	50.00	-17.72	-10.15
6	28.68359	11.21	36.35	33.51	47.56	44.72	60.00	50.00	-12.44	-5.28

Remarks:

1. Q.P. and AV. are abbreviations of quasi-peak and average individually.
2. The emission levels of other frequencies were very low against the limit.
3. Margin value = Emission level – Limit value
4. Correction factor = Insertion loss + Cable loss
5. Emission Level = Correction Factor + Reading Value

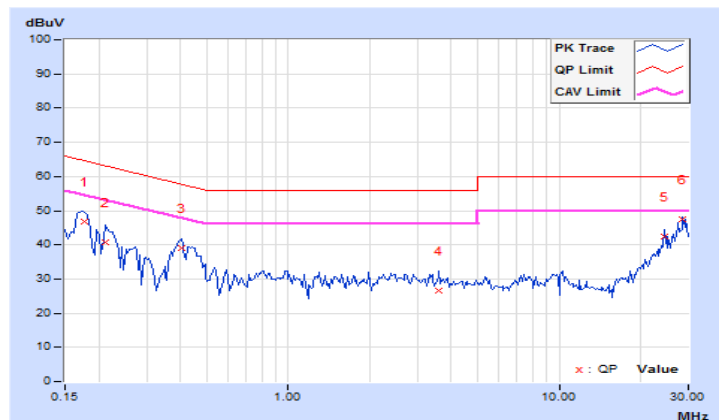

Phase	Neutral (N)	Detector Function	Quasi-Peak (QP) / Average (AV)
-------	-------------	-------------------	--------------------------------

No	Freq. [MHz]	Corr. Factor	Reading Value [dB (uV)]		Emission Level [dB (uV)]		Limit [dB (uV)]		Margin (dB)	
		(dB)	Q.P.	AV.	Q.P.	AV.	Q.P.	AV.	Q.P.	AV.
	1	0.15000	9.93	37.11	24.57	47.04	34.50	66.00	56.00	-18.96
2	0.17734	9.94	37.04	26.69	46.98	36.63	64.61	54.61	-17.63	-17.98
3	0.20469	9.94	22.02	5.28	31.96	15.22	63.42	53.42	-31.46	-38.20
4	0.40000	9.96	27.46	20.03	37.42	29.99	57.85	47.85	-20.43	-17.86
5	5.42188	10.18	15.12	7.99	25.30	18.17	60.00	50.00	-34.70	-31.83
6	24.45313	10.91	30.86	29.32	41.77	40.23	60.00	50.00	-18.23	-9.77
7	28.68750	10.96	35.97	33.11	46.93	44.07	60.00	50.00	-13.07	-5.93

Remarks:

1. Q.P. and AV. are abbreviations of quasi-peak and average individually.
2. The emission levels of other frequencies were very low against the limit.
3. Margin value = Emission level – Limit value
4. Correction factor = Insertion loss + Cable loss
5. Emission Level = Correction Factor + Reading Value

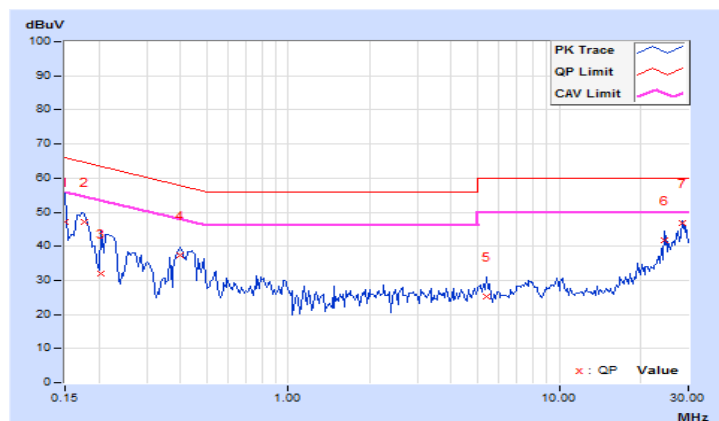

4.3 Transmit Power Measurement

4.3.1 Limits of Transmit Power Measurement

Operation Band	EUT Category		Limit
U-NII-1		Outdoor Access Point	1 Watt (30 dBm) (Max. e.i.r.p \leq 125mW(21 dBm) at any elevation angle above 30 degrees as measured from the horizon)
		Fixed point-to-point Access Point	1 Watt (30 dBm)
		Indoor Access Point	1 Watt (30 dBm)
		Client device	250mW (24 dBm)
U-NII-2A		√	250mW (24 dBm) or 11 dBm+10 log B*
U-NII-2C		√	250mW (24 dBm) or 11 dBm+10 log B*
U-NII-3		√	1 Watt (30 dBm)

*B is the 26 dB emission bandwidth in megahertz

Per KDB 662911 Method of conducted output power measurement on IEEE 802.11 devices,

Array Gain = 0 dB (i.e., no array gain) for $N_{ANT} \leq 4$;

Array Gain = 0 dB (i.e., no array gain) for channel widths ≥ 40 MHz for any N_{ANT} ;

Array Gain = $5 \log(N_{ANT}/N_{SS})$ dB or 3 dB, whichever is less for 20-MHz channel widths with $N_{ANT} \geq 5$.

For power measurements on all other devices: Array Gain = $10 \log(N_{ANT}/N_{SS})$ dB.

4.3.2 Test Setup

FOR POWER OUTPUT MEASUREMENT

For channel straddling 5725MHz:

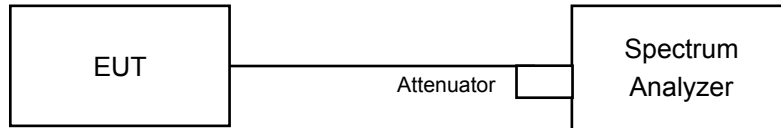

For other channels:

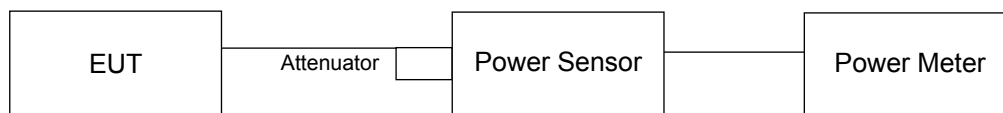

FOR 26dB OCCUPIED BANDWIDTH

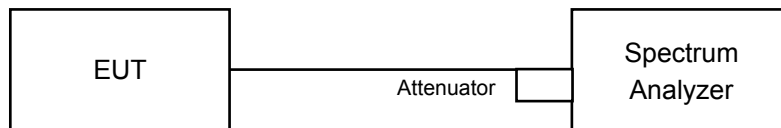

4.3.3 Test Instruments

Refer to section 4.1.2 to get information of above instrument.

4.3.4 Test Procedure

FOR POWER OUTPUT MEASUREMENT

For channel straddling 5725MHz:

Follow FCC KDB 789033 UNII test procedure:

Method SA-2

1. Set span to encompass the emission bandwidth (EBW) of the signal.
2. Set RBW =1MHz.
3. Set the VBW $\geq 3 \times$ RBW.
4. Number of points in sweep ≥ 2 Span / RBW.
5. Sweep time = auto.
6. Detector = RMS.
7. Trace average at least 100 traces in power averaging mode
8. Compute power by integrating the spectrum across the 26 dB EBW of the signal.
9. Duty factor need added to measured value (duty cycle < 98 percent).

For other channels:

Method PM is used to perform output power measurement, trigger and gating function of wide band power meter is enabled to measure max output power of TX on burst. Duty factor is not added to measured value.

FOR 26dB OCCUPIED BANDWIDTH

1. Set RBW = approximately 1% of the emission bandwidth.
2. Set the VBW > RBW.
3. Detector = Peak.
4. Trace mode = max hold.
5. Measure the maximum width of the emission that is 26 dB down from the peak of the emission. Compare this with the RBW setting of the analyzer. Readjust RBW and repeat measurement as needed until the RBW/EBW ratio is approximately 1%.

4.3.5 Deviation from Test Standard

No deviation.

4.3.6 EUT Operating Condition

The software provided by client to enable the EUT under transmission condition continuously at lowest, middle and highest channel frequencies individually.

4.3.7 Test Results (Mode 1)

Non-Beamforming Mode

802.11a

POWER OUTPUT

Chan.	Freq. (MHz)	Maximum Conducted Power (dBm)								Total Power (mW)	Total Power (dBm)	Limit (dBm)	Pass / Fail
		Chain 0	Chain 1	Chain 2	Chain 3	Chain 4	Chain 5	Chain 6	Chain 7				
52	5260	11.25	11.36	11.49	11.42	11.36	11.25	11.35	11.42	109.499	20.39	20.66	Pass
60	5300	11.32	11.45	11.47	11.47	11.42	11.51	11.4	11.66	112.057	20.49	20.66	Pass
64	5320	11.17	11.56	11.63	11.41	11.22	11.47	11.62	11.46	111.592	20.48	20.66	Pass
100	5500	11.50	11.79	11.85	12.33	12.35	11.95	11.89	11.85	125.247	20.98	21.12	Pass
116	5580	11.50	11.65	12.09	12.41	12.32	11.78	12.16	11.75	125.879	21.00	21.12	Pass
140	5700	11.50	12.05	11.97	12.33	12.42	11.96	11.86	12.09	127.687	21.06	21.12	Pass
*144 (U-NII-2C Band)	5720	6.51	6.34	6.71	7.13	6.88	6.98	6.82	7	41.664	16.20	19.93	Pass
*144 (U-NII-3 Band)	5720	0.66	0.48	0.96	1.34	1.2	1.41	0.83	1.18	10.997	10.41	26.80	Pass

Note: * Test was performed in accordance with Measurement follow FCC KDB 789033 UNII test procedure Method SA-2 and use spectrum analyzer test.

1. For U-NII-2A: The directional gain is 9.34dBi > 6dBi, so the power limit shall be reduced to "Determined Conducted Limit -(9.34-6)".
2. For U-NII-2C: The directional gain is 8.88dBi > 6dBi, so the power limit shall be reduced to "Determined Conducted Limit -(8.88-6)".
3. For U-NII-3: The directional gain is 9.2dBi > 6dBi, so the power limit shall be reduced to 30-(9.2-6) = 26.8dBm.

The Total Power for the straddle channel:

Chan.	Chan. Freq. (MHz)	Average Power (mW)	Average Power (dBm)
144	5720	52.661	17.21

Note: The total power was calculated through formula and record the value for reference only.

26dB OCCUPIED BANDWIDTH

Channel	Frequency (MHz)	26dBc Bandwidth (MHz)							
		Chain 0	Chain 1	Chain 2	Chain 3	Chain 4	Chain 5	Chain 6	Chain 7
52	5260	21.26	22.57	21.78	22.84	20.47	20.73	20.56	21.99
60	5300	21.20	22.58	21.55	22.46	20.62	20.81	20.69	22.17
64	5320	21.27	22.38	21.33	22.64	20.82	20.86	20.61	21.78
100	5500	21.29	22.35	21.16	22.44	20.69	20.79	20.60	22.41
116	5580	21.38	22.45	21.30	22.41	20.84	20.79	20.65	21.94
140	5700	21.24	22.16	21.48	22.67	20.62	20.69	20.57	21.98
144 (U-NII-2C Band)	5720	15.97	16.41	15.95	16.63	15.21	15.18	15.33	15.90

Note: For U-NII-2A, U-NII-2C Band output power limitation is determined based on 26dBc bandwidth.

Power Limit = 11dBm + 10logB <U-NII-2A, U-NII-2C>

Channel Number	Freq.(MHz)	Min. B(MHz)	Determined Conducted Limit (dBm)
52	5260	20.47	24.11 > 24
60	5300	20.62	24.14 > 24
64	5320	20.61	24.14 > 24
100	5500	20.60	24.13 > 24
116	5580	20.65	24.14 > 24
140	5700	20.57	24.13 > 24
144 (U-NII-2C Band)	5720	15.18	22.81 < 24

802.11ac (VHT20)

POWER OUTPUT

Chan.	Freq. (MHz)	Maximum Conducted Power (dBm)								Total Power (mW)	Total Power (dBm)	Limit (dBm)	Pass / Fail
		Chain 0	Chain 1	Chain 2	Chain 3	Chain 4	Chain 5	Chain 6	Chain 7				
52	5260	11.04	11.21	11.25	11.48	10.98	11.11	10.99	11.22	104.562	20.19	20.66	Pass
60	5300	11.03	11.07	11.17	11.43	11.19	11.21	11.31	11.1	105.23	20.22	20.66	Pass
64	5320	11.24	11.21	11.25	11.19	11.37	11.02	10.94	11.13	104.749	20.20	20.66	Pass
100	5500	11.55	11.58	11.97	11.94	11.67	11.58	11.73	11.83	119.26	20.76	21.12	Pass
116	5580	11.38	11.53	12.19	12.27	11.86	11.58	11.48	11.75	120.144	20.80	21.12	Pass
140	5700	11.58	11.43	11.88	12.05	11.6	11.52	11.78	11.59	117.869	20.71	21.12	Pass
*144 (U-NII-2C Band)	5720	7.05	7.26	7.25	7.15	7.12	6.91	7.29	6.85	43.124	16.35	19.96	Pass
*144 (U-NII-3 Band)	5720	1.42	1.67	1.11	1.11	1.43	1.2	1.32	0.82	11.223	10.50	26.80	Pass

Note: * Test was performed in accordance with Measurement follow FCC KDB 789033 UNII test procedure Method SA-2 and use spectrum analyzer test.

1. For U-NII-2A: The directional gain is 9.34dBi > 6dBi, so the power limit shall be reduced to "Determined Conducted Limit -(9.34-6)".
2. For U-NII-2C: The directional gain is 8.88dBi > 6dBi, so the power limit shall be reduced to "Determined Conducted Limit -(8.88-6)".
3. For U-NII-3: The directional gain is 9.2dBi > 6dBi, so the power limit shall be reduced to 30-(9.2-6) = 26.8dBm.

The Total Power for the straddle channel:

Chan.	Chan. Freq. (MHz)	Average Power (mW)	Average Power (dBm)
144	5720	54.347	17.35

Note: The total power was calculated through formula and record the value for reference only.

26dB OCCUPIED BANDWIDTH

Channel	Frequency (MHz)	26dBc Bandwidth (MHz)							
		Chain 0	Chain 1	Chain 2	Chain 3	Chain 4	Chain 5	Chain 6	Chain 7
52	5260	20.84	20.83	20.78	20.78	20.97	20.41	20.80	20.79
60	5300	20.52	21.04	20.74	20.95	20.39	20.68	20.78	20.83
64	5320	20.67	21.13	20.65	20.87	20.89	20.64	20.82	21.17
100	5500	20.67	20.83	20.75	20.76	20.56	20.66	20.67	21.08
116	5580	20.79	20.63	20.93	20.58	21.04	20.75	20.70	20.91
140	5700	20.60	20.74	20.74	20.78	20.78	20.84	20.83	20.88
144 (U-NII-2C Band)	5720	15.35	15.50	15.35	15.43	15.47	15.38	15.41	15.30

Note: For U-NII-2A, U-NII-2C Band output power limitation is determined based on 26dBc bandwidth.

Power Limit = 11dBm + 10logB <U-NII-2A, U-NII-2C>

Channel Number	Freq.(MHz)	Min. B(MHz)	Determined Conducted Limit (dBm)
52	5260	20.41	24.09 > 24
60	5300	20.39	24.09 > 24
64	5320	20.64	24.14 > 24
100	5500	20.56	24.13 > 24
116	5580	20.58	24.13 > 24
140	5700	20.60	24.13 > 24
144 (U-NII-2C Band)	5720	15.30	22.84 < 24

802.11ac (VHT40)

POWER OUTPUT

Chan.	Freq. (MHz)	Maximum Conducted Power (dBm)								Total Power (mW)	Total Power (dBm)	Limit (dBm)	Pass / Fail
		Chain 0	Chain 1	Chain 2	Chain 3	Chain 4	Chain 5	Chain 6	Chain 7				
54	5270	11.00	11.01	11.37	11.10	11.33	11.15	10.97	11.25	104.251	20.18	20.66	Pass
62	5310	11.00	11.20	11.01	11.17	11.11	11.07	11.2	11.1	103.253	20.14	20.66	Pass
102	5510	11.50	11.79	11.46	12.08	12.05	11.98	11.46	11.48	119.231	20.76	21.12	Pass
110	5550	11.50	11.79	11.46	12.10	12.21	11.49	11.56	11.72	119.348	20.77	21.12	Pass
134	5670	11.50	11.68	11.61	11.92	11.98	11.92	11.79	11.42	119.2	20.76	21.12	Pass
*142 (U-NII-2C Band)	5710	7.42	7.90	7.56	8.23	7.84	7.91	7.78	7.9	50.942	17.07	21.12	Pass
*142 (U-NII-3 Band)	5710	-3.99	-3.41	-3.35	-2.79	-2.9	-2.38	-3.42	-3.3	4.0542	6.08	26.80	Pass

Note: * Test was performed in accordance with Measurement follow FCC KDB 789033 UNII test procedure Method SA-2 and use spectrum analyzer test.

1. For U-NII-2A: The directional gain is 9.34dBi > 6dBi, so the power limit shall be reduced to "Determined Conducted Limit -(9.34-6)".
2. For U-NII-2C: The directional gain is 8.88dBi > 6dBi, so the power limit shall be reduced to "Determined Conducted Limit -(8.88-6)".
3. For U-NII-3: The directional gain is 9.2dBi > 6dBi, so the power limit shall be reduced to 30-(9.2-6) = 26.8dBm.

The Total Power for the straddle channel:

Chan.	Chan. Freq. (MHz)	Average Power (mW)	Average Power (dBm)
142	5710	54.9962	17.4

Note: The total power was calculated through formula and record the value for reference only.

26dB OCCUPIED BANDWIDTH

Channel	Frequency (MHz)	26dBc Bandwidth (MHz)							
		Chain 0	Chain 1	Chain 2	Chain 3	Chain 4	Chain 5	Chain 6	Chain 7
54	5270	41.79	41.81	42.06	41.81	41.98	41.57	41.72	41.74
62	5310	41.92	41.73	41.96	41.95	41.77	41.63	42.15	41.62
102	5510	41.56	42.05	42.35	42.08	42.04	41.77	42.00	41.64
110	5550	41.36	41.96	41.77	42.10	41.48	41.60	41.67	41.36
134	5670	41.54	41.74	42.01	41.65	42.13	41.99	42.17	41.74
142 (U-NII-2C Band)	5710	35.95	35.74	36.22	35.90	35.97	36.02	35.89	35.95

Note: For U-NII-2A, U-NII-2C Band output power limitation is determined based on 26dBc bandwidth.

Power Limit = 11dBm + 10logB <U-NII-2A, U-NII-2C>

Channel Number	Freq.(MHz)	Min. B(MHz)	Determined Conducted Limit (dBm)
54	5270	41.57	27.18 > 24
62	5310	41.62	27.19 > 24
102	5510	41.56	27.18 > 24
110	5550	41.36	27.16 > 24
134	5670	41.54	27.18 > 24
142 (U-NII-2C Band)	5710	35.74	26.53 > 24

802.11ac (VHT80)

POWER OUTPUT

Chan.	Freq. (MHz)	Maximum Conducted Power (dBm)								Total Power (mW)	Total Power (dBm)	Limit (dBm)	Pass / Fail
		Chain 0	Chain 1	Chain 2	Chain 3	Chain 4	Chain 5	Chain 6	Chain 7				
58	5290	11.00	10.87	11.31	11.45	11.31	11.39	10.97	11.13	105.059	20.21	20.66	Pass
106	5530	11.79	11.46	12.05	12.12	11.53	11.61	11.73	11.69	119.784	20.78	21.12	Pass
122	5610	11.68	11.59	11.89	11.91	11.89	11.79	11.36	11.88	119.768	20.78	21.12	Pass
*138 (U-NII-2C Band)	5690	7.89	8.17	7.67	8.44	7.92	8.03	7.82	8.02	52.7	17.22	21.12	Pass
*138 (U-NII-3 Band)	5690	-6.88	-6.29	-7.17	-7.11	-7.01	-6.21	-6.44	-7.89	1.7271	2.37	26.80	Pass

Note: * Test was performed in accordance with Measurement follow FCC KDB 789033 UNII test procedure Method SA-2 and use spectrum analyzer test.

1. For U-NII-2A: The directional gain is 9.34dBi > 6dBi, so the power limit shall be reduced to "Determined Conducted Limit -(9.34-6)".
2. For U-NII-2C: The directional gain is 8.88dBi > 6dBi, so the power limit shall be reduced to "Determined Conducted Limit -(8.88-6)".
3. For U-NII-3: The directional gain is 9.2dBi > 6dBi, so the power limit shall be reduced to 30-(9.2-6) = 26.8dBm.

The Total Power for the straddle channel:

Chan.	Chan. Freq. (MHz)	Average Power (mW)	Average Power (dBm)
138	5690	54.4271	17.36

Note: The total power was calculated through formula and record the value for reference only.

26dB OCCUPIED BANDWIDTH

Channel	Frequency (MHz)	26dBc Bandwidth (MHz)							
		Chain 0	Chain 1	Chain 2	Chain 3	Chain 4	Chain 5	Chain 6	Chain 7
58	5290	82.18	82.35	82.35	82.60	83.18	82.28	83.10	82.65
106	5530	82.26	82.12	82.75	82.92	82.38	82.55	82.23	82.59
122	5610	82.05	82.72	82.44	83.06	82.56	82.76	82.85	83.19
138 (U-NII-2C Band)	5690	76.37	75.99	76.20	76.24	76.16	75.76	76.10	76.36

Note: For U-NII-2A, U-NII-2C Band output power limitation is determined based on 26dBc bandwidth.

Power Limit = 11dBm + 10logB <U-NII-2A, U-NII-2C>			
Channel Number	Freq.(MHz)	Min. B(MHz)	Determined Conducted Limit (dBm)
58	5290	82.18	30.14 > 24
106	5530	82.12	30.14 > 24
122	5610	82.05	30.14 > 24
138 (U-NII-2C Band)	5690	75.76	29.79 > 24

802.11ax (HE20)

POWER OUTPUT

Chan.	Freq. (MHz)	Maximum Conducted Power (dBm)								Total Power (mW)	Total Power (dBm)	Limit (dBm)	Pass / Fail
		Chain 0	Chain 1	Chain 2	Chain 3	Chain 4	Chain 5	Chain 6	Chain 7				
52	5260	11.25	11.44	11.50	11.71	11.19	11.34	11.2	11.45	110.13	20.42	20.66	Pass
60	5300	11.26	11.32	11.48	11.69	11.44	11.42	11.53	11.33	111.341	20.47	20.66	Pass
64	5320	11.50	11.45	11.47	11.40	11.6	11.23	11.16	11.36	110.388	20.43	20.66	Pass
100	5500	11.89	11.84	12.33	12.19	11.88	11.84	11.96	12.05	126.815	21.03	21.12	Pass
116	5580	11.63	11.76	12.45	12.63	12.07	11.79	11.71	12	127.335	21.05	21.12	Pass
140	5700	11.89	11.74	12.24	12.26	11.86	11.77	12.02	11.91	125.78	21.00	21.12	Pass
*144 (U-NII-2C Band)	5720	6.99	7.16	6.97	7.83	7.67	6.86	7.27	7.32	44.696	16.50	20.02	Pass
*144 (U-NII-3 Band)	5720	1.47	1.71	1.77	2.15	2.07	1.49	1.57	2.05	12.66	11.02	26.80	Pass

Note: * Test was performed in accordance with Measurement follow FCC KDB 789033 UNII test procedure Method SA-2 and use spectrum analyzer test.

1. For U-NII-2A: The directional gain is 9.34dBi > 6dBi, so the power limit shall be reduced to "Determined Conducted Limit -(9.34-6)".
2. For U-NII-2C: The directional gain is 8.88dBi > 6dBi, so the power limit shall be reduced to "Determined Conducted Limit -(8.88-6)".
3. For U-NII-3: The directional gain is 9.2dBi > 6dBi, so the power limit shall be reduced to 30-(9.2-6) = 26.8dBm.

The Total Power for the straddle channel:

Chan.	Chan. Freq. (MHz)	Average Power (mW)	Average Power (dBm)
144	5720	57.356	17.59

Note: The total power was calculated through formula and record the value for reference only.

26dB OCCUPIED BANDWIDTH

Channel	Frequency (MHz)	26dBc Bandwidth (MHz)							
		Chain 0	Chain 1	Chain 2	Chain 3	Chain 4	Chain 5	Chain 6	Chain 7
52	5260	21.34	21.37	21.59	21.33	21.36	21.42	21.79	21.37
60	5300	21.38	21.28	21.55	21.38	21.28	21.17	21.25	21.23
64	5320	21.28	21.15	21.54	21.48	21.54	21.26	21.24	21.77
100	5500	21.21	21.32	21.33	21.33	21.43	21.35	21.29	21.24
116	5580	21.81	21.20	21.64	21.33	21.18	21.21	21.52	21.29
140	5700	21.65	21.22	21.37	21.30	21.42	21.19	21.75	21.31
144 (U-NII-2C Band)	5720	15.72	15.65	15.84	15.52	15.69	15.69	15.59	15.69

Note: For U-NII-2A, U-NII-2C Band output power limitation is determined based on 26dBc bandwidth.

Power Limit = 11dBm + 10logB <U-NII-2A, U-NII-2C>

Channel Number	Freq.(MHz)	Min. B(MHz)	Determined Conducted Limit (dBm)
52	5260	21.33	24.28 > 24
60	5300	21.17	24.25 > 24
64	5320	21.15	24.25 > 24
100	5500	21.21	24.26 > 24
116	5580	21.18	24.25 > 24
140	5700	21.19	24.26 > 24
144 (U-NII-2C Band)	5720	15.52	22.9 < 24

802.11ax (HE40)

POWER OUTPUT

Chan.	Freq. (MHz)	Maximum Conducted Power (dBm)								Total Power (mW)	Total Power (dBm)	Limit (dBm)	Pass / Fail
		Chain 0	Chain 1	Chain 2	Chain 3	Chain 4	Chain 5	Chain 6	Chain 7				
54	5270	11.23	11.63	11.41	11.56	11.37	11.2	11.48	11.55	111.227	20.46	20.66	Pass
62	5310	11.41	11.23	11.38	11.36	11.32	11.45	11.33	11.29	109.085	20.38	20.66	Pass
102	5510	12.08	11.70	12.34	12.29	12.23	11.72	11.7	11.87	126.761	21.03	21.12	Pass
110	5550	12.02	11.74	12.50	12.43	11.77	11.85	11.97	11.94	127.845	21.07	21.12	Pass
134	5670	11.90	11.82	12.15	12.22	12.15	12	11.68	12.18	127.27	21.05	21.12	Pass
*142 (U-NII-2C Band)	5710	7.59	8.39	7.57	8.69	8.48	8.16	7.71	8.22	53.839	17.31	21.12	Pass
*142 (U-NII-3 Band)	5710	-3.04	-1.31	-2.42	-1.41	-1.1	-1.59	-2.77	-1.95	5.3625	7.29	26.80	Pass

Note: * Test was performed in accordance with Measurement follow FCC KDB 789033 UNII test procedure Method SA-2 and use spectrum analyzer test.

1. For U-NII-2A: The directional gain is 9.34dBi > 6dBi, so the power limit shall be reduced to "Determined Conducted Limit -(9.34-6)".
2. For U-NII-2C: The directional gain is 8.88dBi > 6dBi, so the power limit shall be reduced to "Determined Conducted Limit -(8.88-6)".
3. For U-NII-3: The directional gain is 9.2dBi > 6dBi, so the power limit shall be reduced to 30-(9.2-6) = 26.8dBm.

The Total Power for the straddle channel:

Chan.	Chan. Freq. (MHz)	Average Power (mW)	Average Power (dBm)
142	5710	59.2015	17.72

Note: The total power was calculated through formula and record the value for reference only.

26dB OCCUPIED BANDWIDTH

Channel	Frequency (MHz)	26dBc Bandwidth (MHz)							
		Chain 0	Chain 1	Chain 2	Chain 3	Chain 4	Chain 5	Chain 6	Chain 7
54	5270	42.32	42.54	42.81	42.32	42.27	42.56	42.17	42.32
62	5310	42.40	42.39	42.17	42.56	42.28	42.33	42.52	42.41
102	5510	42.45	42.08	42.15	42.89	42.62	42.28	42.37	42.47
110	5550	42.28	42.51	42.34	43.01	42.36	42.33	42.29	42.45
134	5670	42.22	42.32	42.16	42.27	42.25	42.16	42.37	42.57
142 (U-NII-2C Band)	5710	36.19	36.29	36.15	36.43	36.40	36.65	36.34	36.16

Note: For U-NII-2A, U-NII-2C Band output power limitation is determined based on 26dBc bandwidth.

Power Limit = 11dBm + 10logB <U-NII-2A, U-NII-2C>

Channel Number	Freq.(MHz)	Min. B(MHz)	Determined Conducted Limit (dBm)
54	5270	42.17	27.25 > 24
62	5310	42.17	27.25 > 24
102	5510	42.08	27.24 > 24
110	5550	42.28	27.26 > 24
134	5670	42.16	27.24 > 24
142 (U-NII-2C Band)	5710	36.15	26.58 > 24

802.11ax (HE80)

POWER OUTPUT

Chan.	Freq. (MHz)	Maximum Conducted Power (dBm)								Total Power (mW)	Total Power (dBm)	Limit (dBm)	Pass / Fail
		Chain 0	Chain 1	Chain 2	Chain 3	Chain 4	Chain 5	Chain 6	Chain 7				
58	5290	11.08	11.65	11.67	11.52	11.65	11.2	11.44	11.62	112.582	20.51	20.66	Pass
106	5530	11.88	12.06	12.28	12.54	11.84	11.93	11.67	11.82	127.104	21.04	21.12	Pass
122	5610	12.06	11.67	12.57	12.41	11.84	11.71	11.94	11.93	127.576	21.06	21.12	Pass
*138 (U-NII-2C Band)	5690	8.37	8.25	8.40	8.83	8.45	8.09	8.49	7.95	57.218	17.58	21.12	Pass
*138 (U-NII-3 Band)	5690	-5.64	-5.26	-5.50	-4.57	-5.88	-5.1	-5.23	-5.73	2.437	3.87	26.80	Pass

Note: * Test was performed in accordance with Measurement follow FCC KDB 789033 UNII test procedure Method SA-2 and use spectrum analyzer test.

1. For U-NII-2A: The directional gain is 9.34dBi > 6dBi, so the power limit shall be reduced to "Determined Conducted Limit -(9.34-6)".
2. For U-NII-2C: The directional gain is 8.88dBi > 6dBi, so the power limit shall be reduced to "Determined Conducted Limit -(8.88-6)".
3. For U-NII-3: The directional gain is 9.2dBi > 6dBi, so the power limit shall be reduced to 30-(9.2-6) = 26.8dBm.

The Total Power for the straddle channel:

Chan.	Chan. Freq. (MHz)	Average Power (mW)	Average Power (dBm)
138	5690	59.655	17.76

Note: The total power was calculated through formula and record the value for reference only.

26dB OCCUPIED BANDWIDTH

Channel	Frequency (MHz)	26dBc Bandwidth (MHz)							
		Chain 0	Chain 1	Chain 2	Chain 3	Chain 4	Chain 5	Chain 6	Chain 7
58	5290	83.04	82.87	83.19	83.16	82.79	83.34	82.34	82.69
106	5530	82.70	83.01	83.03	82.63	82.65	82.78	82.48	82.80
122	5610	83.05	82.60	83.19	82.99	82.70	83.10	83.07	83.46
138 (U-NII-2C Band)	5690	76.24	76.46	76.32	76.62	76.34	76.31	76.67	76.63

Note: For U-NII-2A, U-NII-2C Band output power limitation is determined based on 26dBc bandwidth.

Power Limit = 11dBm + 10logB <U-NII-2A, U-NII-2C>			
Channel Number	Freq.(MHz)	Min. B(MHz)	Determined Conducted Limit (dBm)
58	5290	82.34	30.15 > 24
106	5530	82.48	30.16 > 24
122	5610	82.60	30.16 > 24
138 (U-NII-2C Band)	5690	76.24	29.82 > 24

Beamforming Mode

802.11ac (VHT20)

POWER OUTPUT

Chan.	Freq. (MHz)	Maximum Conducted Power (dBm)								Total Power (mW)	Total Power (dBm)	Limit (dBm)	Pass / Fail
		Chain 0	Chain 1	Chain 2	Chain 3	Chain 4	Chain 5	Chain 6	Chain 7				
52	5260	11.04	11.21	11.25	11.48	10.98	11.11	10.99	11.22	104.562	20.19	20.66	Pass
60	5300	11.03	11.07	11.17	11.43	11.19	11.21	11.31	11.1	105.23	20.22	20.66	Pass
64	5320	11.24	11.21	11.25	11.19	11.37	11.02	10.94	11.13	104.749	20.20	20.66	Pass
100	5500	11.55	11.58	11.97	11.94	11.67	11.58	11.73	11.83	119.26	20.76	21.12	Pass
116	5580	11.38	11.53	12.19	12.27	11.86	11.58	11.48	11.75	120.144	20.80	21.12	Pass
140	5700	11.58	11.43	11.88	12.05	11.6	11.52	11.78	11.59	117.869	20.71	21.12	Pass
*144 (U-NII-2C Band)	5720	7.05	7.26	7.25	7.15	7.12	6.91	7.29	6.85	43.124	16.35	19.96	Pass
*144 (U-NII-3 Band)	5720	1.42	1.67	1.11	1.11	1.43	1.2	1.32	0.82	11.223	10.50	26.80	Pass

Note: * Test was performed in accordance with Measurement follow FCC KDB 789033 UNII test procedure Method SA-2 and use spectrum analyzer test.

1. For U-NII-2A: The directional gain is 9.34dBi > 6dBi, so the power limit shall be reduced to "Determined Conducted Limit -(9.34-6)".
2. For U-NII-2C: The directional gain is 8.88dBi > 6dBi, so the power limit shall be reduced to "Determined Conducted Limit -(8.88-6)".
3. For U-NII-3: The directional gain is 9.2dBi > 6dBi, so the power limit shall be reduced to 30-(9.2-6) = 26.8dBm.

The Total Power for the straddle channel:

Chan.	Chan. Freq. (MHz)	Average Power (mW)	Average Power (dBm)
144	5720	54.347	17.35

Note: The total power was calculated through formula and record the value for reference only.

26dB OCCUPIED BANDWIDTH

Channel	Frequency (MHz)	26dBc Bandwidth (MHz)							
		Chain 0	Chain 1	Chain 2	Chain 3	Chain 4	Chain 5	Chain 6	Chain 7
52	5260	20.84	20.83	20.78	20.78	20.97	20.41	20.80	20.79
60	5300	20.52	21.04	20.74	20.95	20.39	20.68	20.78	20.83
64	5320	20.67	21.13	20.65	20.87	20.89	20.64	20.82	21.17
100	5500	20.67	20.83	20.75	20.76	20.56	20.66	20.67	21.08
116	5580	20.79	20.63	20.93	20.58	21.04	20.75	20.70	20.91
140	5700	20.60	20.74	20.74	20.78	20.78	20.84	20.83	20.88
144 (U-NII-2C Band)	5720	15.35	15.50	15.35	15.43	15.47	15.38	15.41	15.30

Note: For U-NII-2A, U-NII-2C Band output power limitation is determined based on 26dBc bandwidth.

Power Limit = 11dBm + 10logB <U-NII-2A, U-NII-2C>

Channel Number	Freq.(MHz)	Min. B(MHz)	Determined Conducted Limit (dBm)
52	5260	20.41	24.09 > 24
60	5300	20.39	24.09 > 24
64	5320	20.64	24.14 > 24
100	5500	20.56	24.13 > 24
116	5580	20.58	24.13 > 24
140	5700	20.60	24.13 > 24
144 (U-NII-2C Band)	5720	15.30	22.84 < 24

802.11ac (VHT40)

POWER OUTPUT

Chan.	Freq. (MHz)	Maximum Conducted Power (dBm)								Total Power (mW)	Total Power (dBm)	Limit (dBm)	Pass / Fail
		Chain 0	Chain 1	Chain 2	Chain 3	Chain 4	Chain 5	Chain 6	Chain 7				
54	5270	11.00	11.01	11.37	11.10	11.33	11.15	10.97	11.25	104.251	20.18	20.66	Pass
62	5310	11.00	11.20	11.01	11.17	11.11	11.07	11.2	11.1	103.253	20.14	20.66	Pass
102	5510	11.50	11.79	11.46	12.08	12.05	11.98	11.46	11.48	119.231	20.76	21.12	Pass
110	5550	11.50	11.79	11.46	12.10	12.21	11.49	11.56	11.72	119.348	20.77	21.12	Pass
134	5670	11.50	11.68	11.61	11.92	11.98	11.92	11.79	11.42	119.2	20.76	21.12	Pass
*142 (U-NII-2C Band)	5710	7.42	7.90	7.56	8.23	7.84	7.91	7.78	7.9	50.942	17.07	21.12	Pass
*142 (U-NII-3 Band)	5710	-3.99	-3.41	-3.35	-2.79	-2.9	-2.38	-3.42	-3.3	4.0542	6.08	26.80	Pass

Note: * Test was performed in accordance with Measurement follow FCC KDB 789033 UNII test procedure Method SA-2 and use spectrum analyzer test.

1. For U-NII-2A: The directional gain is 9.34dBi > 6dBi, so the power limit shall be reduced to "Determined Conducted Limit -(9.34-6)".
2. For U-NII-2C: The directional gain is 8.88dBi > 6dBi, so the power limit shall be reduced to "Determined Conducted Limit -(8.88-6)".
3. For U-NII-3: The directional gain is 9.2dBi > 6dBi, so the power limit shall be reduced to 30-(9.2-6) = 26.8dBm.

The Total Power for the straddle channel:

Chan.	Chan. Freq. (MHz)	Average Power (mW)	Average Power (dBm)
142	5710	54.9962	17.4

Note: The total power was calculated through formula and record the value for reference only.

26dB OCCUPIED BANDWIDTH

Channel	Frequency (MHz)	26dBc Bandwidth (MHz)							
		Chain 0	Chain 1	Chain 2	Chain 3	Chain 4	Chain 5	Chain 6	Chain 7
54	5270	41.79	41.81	42.06	41.81	41.98	41.57	41.72	41.74
62	5310	41.92	41.73	41.96	41.95	41.77	41.63	42.15	41.62
102	5510	41.56	42.05	42.35	42.08	42.04	41.77	42.00	41.64
110	5550	41.36	41.96	41.77	42.10	41.48	41.60	41.67	41.36
134	5670	41.54	41.74	42.01	41.65	42.13	41.99	42.17	41.74
142 (U-NII-2C Band)	5710	35.95	35.74	36.22	35.90	35.97	36.02	35.89	35.95

Note: For U-NII-2A, U-NII-2C Band output power limitation is determined based on 26dBc bandwidth.

Power Limit = 11dBm + 10logB <U-NII-2A, U-NII-2C>

Channel Number	Freq.(MHz)	Min. B(MHz)	Determined Conducted Limit (dBm)
54	5270	41.57	27.18 > 24
62	5310	41.62	27.19 > 24
102	5510	41.56	27.18 > 24
110	5550	41.36	27.16 > 24
134	5670	41.54	27.18 > 24
142 (U-NII-2C Band)	5710	35.74	26.53 > 24

802.11ac (VHT80)

POWER OUTPUT

Chan.	Freq. (MHz)	Maximum Conducted Power (dBm)								Total Power (mW)	Total Power (dBm)	Limit (dBm)	Pass / Fail
		Chain 0	Chain 1	Chain 2	Chain 3	Chain 4	Chain 5	Chain 6	Chain 7				
58	5290	11.00	10.87	11.31	11.45	11.31	11.39	10.97	11.13	105.059	20.21	20.66	Pass
106	5530	11.79	11.46	12.05	12.12	11.53	11.61	11.73	11.69	119.784	20.78	21.12	Pass
122	5610	11.68	11.59	11.89	11.91	11.89	11.79	11.36	11.88	119.768	20.78	21.12	Pass
*138 (U-NII-2C Band)	5690	7.89	8.17	7.67	8.44	7.92	8.03	7.82	8.02	52.7	17.22	21.12	Pass
*138 (U-NII-3 Band)	5690	-6.88	-6.29	-7.17	-7.11	-7.01	-6.21	-6.44	-7.89	1.7271	2.37	26.80	Pass

Note: * Test was performed in accordance with Measurement follow FCC KDB 789033 UNII test procedure Method SA-2 and use spectrum analyzer test.

1. For U-NII-2A: The directional gain is 9.34dBi > 6dBi, so the power limit shall be reduced to "Determined Conducted Limit -(9.34-6)".
2. For U-NII-2C: The directional gain is 8.88dBi > 6dBi, so the power limit shall be reduced to "Determined Conducted Limit -(8.88-6)".
3. For U-NII-3: The directional gain is 9.2dBi > 6dBi, so the power limit shall be reduced to 30-(9.2-6) = 26.8dBm.

The Total Power for the straddle channel:

Chan.	Chan. Freq. (MHz)	Average Power (mW)	Average Power (dBm)
138	5690	54.4271	17.36

Note: The total power was calculated through formula and record the value for reference only.

26dB OCCUPIED BANDWIDTH

Channel	Frequency (MHz)	26dBc Bandwidth (MHz)							
		Chain 0	Chain 1	Chain 2	Chain 3	Chain 4	Chain 5	Chain 6	Chain 7
58	5290	82.18	82.35	82.35	82.60	83.18	82.28	83.10	82.65
106	5530	82.26	82.12	82.75	82.92	82.38	82.55	82.23	82.59
122	5610	82.05	82.72	82.44	83.06	82.56	82.76	82.85	83.19
138 (U-NII-2C Band)	5690	76.37	75.99	76.20	76.24	76.16	75.76	76.10	76.36

Note: For U-NII-2A, U-NII-2C Band output power limitation is determined based on 26dBc bandwidth.

Power Limit = 11dBm + 10logB <U-NII-2A, U-NII-2C>			
Channel Number	Freq.(MHz)	Min. B(MHz)	Determined Conducted Limit (dBm)
58	5290	82.18	30.14 > 24
106	5530	82.12	30.14 > 24
122	5610	82.05	30.14 > 24
138 (U-NII-2C Band)	5690	75.76	29.79 > 24

802.11ax (HE20)

POWER OUTPUT

Chan.	Freq. (MHz)	Maximum Conducted Power (dBm)								Total Power (mW)	Total Power (dBm)	Limit (dBm)	Pass / Fail
		Chain 0	Chain 1	Chain 2	Chain 3	Chain 4	Chain 5	Chain 6	Chain 7				
52	5260	11.25	11.44	11.50	11.71	11.19	11.34	11.2	11.45	110.13	20.42	20.66	Pass
60	5300	11.26	11.32	11.48	11.69	11.44	11.42	11.53	11.33	111.341	20.47	20.66	Pass
64	5320	11.50	11.45	11.47	11.40	11.6	11.23	11.16	11.36	110.388	20.43	20.66	Pass
100	5500	11.89	11.84	12.33	12.19	11.88	11.84	11.96	12.05	126.815	21.03	21.12	Pass
116	5580	11.63	11.76	12.45	12.63	12.07	11.79	11.71	12	127.335	21.05	21.12	Pass
140	5700	11.89	11.74	12.24	12.26	11.86	11.77	12.02	11.91	125.78	21.00	21.12	Pass
*144 (U-NII-2C Band)	5720	6.99	7.16	6.97	7.83	7.67	6.86	7.27	7.32	44.696	16.50	20.02	Pass
*144 (U-NII-3 Band)	5720	1.47	1.71	1.77	2.15	2.07	1.49	1.57	2.05	12.66	11.02	26.80	Pass

Note: * Test was performed in accordance with Measurement follow FCC KDB 789033 UNII test procedure Method SA-2 and use spectrum analyzer test.

1. For U-NII-2A: The directional gain is 9.34dBi > 6dBi, so the power limit shall be reduced to "Determined Conducted Limit -(9.34-6)".
2. For U-NII-2C: The directional gain is 8.88dBi > 6dBi, so the power limit shall be reduced to "Determined Conducted Limit -(8.88-6)".
3. For U-NII-3: The directional gain is 9.2dBi > 6dBi, so the power limit shall be reduced to 30-(9.2-6) = 26.8dBm.

The Total Power for the straddle channel:

Chan.	Chan. Freq. (MHz)	Average Power (mW)	Average Power (dBm)
144	5720	57.356	17.59

Note: The total power was calculated through formula and record the value for reference only.

26dB OCCUPIED BANDWIDTH

Channel	Frequency (MHz)	26dBc Bandwidth (MHz)							
		Chain 0	Chain 1	Chain 2	Chain 3	Chain 4	Chain 5	Chain 6	Chain 7
52	5260	21.34	21.37	21.59	21.33	21.36	21.42	21.79	21.37
60	5300	21.38	21.28	21.55	21.38	21.28	21.17	21.25	21.23
64	5320	21.28	21.15	21.54	21.48	21.54	21.26	21.24	21.77
100	5500	21.21	21.32	21.33	21.33	21.43	21.35	21.29	21.24
116	5580	21.81	21.20	21.64	21.33	21.18	21.21	21.52	21.29
140	5700	21.65	21.22	21.37	21.30	21.42	21.19	21.75	21.31
144 (U-NII-2C Band)	5720	15.72	15.65	15.84	15.52	15.69	15.69	15.59	15.69

Note: For U-NII-2A, U-NII-2C Band output power limitation is determined based on 26dBc bandwidth.

Power Limit = 11dBm + 10logB <U-NII-2A, U-NII-2C>

Channel Number	Freq.(MHz)	Min. B(MHz)	Determined Conducted Limit (dBm)
52	5260	21.33	24.28 > 24
60	5300	21.17	24.25 > 24
64	5320	21.15	24.25 > 24
100	5500	21.21	24.26 > 24
116	5580	21.18	24.25 > 24
140	5700	21.19	24.26 > 24
144 (U-NII-2C Band)	5720	15.52	22.9 < 24

802.11ax (HE40)

POWER OUTPUT

Chan.	Freq. (MHz)	Maximum Conducted Power (dBm)								Total Power (mW)	Total Power (dBm)	Limit (dBm)	Pass / Fail
		Chain 0	Chain 1	Chain 2	Chain 3	Chain 4	Chain 5	Chain 6	Chain 7				
54	5270	11.23	11.63	11.41	11.56	11.37	11.2	11.48	11.55	111.227	20.46	20.66	Pass
62	5310	11.41	11.23	11.38	11.36	11.32	11.45	11.33	11.29	109.085	20.38	20.66	Pass
102	5510	12.08	11.70	12.34	12.29	12.23	11.72	11.7	11.87	126.761	21.03	21.12	Pass
110	5550	12.02	11.74	12.50	12.43	11.77	11.85	11.97	11.94	127.845	21.07	21.12	Pass
134	5670	11.90	11.82	12.15	12.22	12.15	12	11.68	12.18	127.27	21.05	21.12	Pass
*142 (U-NII-2C Band)	5710	7.59	8.39	7.57	8.69	8.48	8.16	7.71	8.22	53.839	17.31	21.12	Pass
*142 (U-NII-3 Band)	5710	-3.04	-1.31	-2.42	-1.41	-1.1	-1.59	-2.77	-1.95	5.3625	7.29	26.80	Pass

Note: * Test was performed in accordance with Measurement follow FCC KDB 789033 UNII test procedure Method SA-2 and use spectrum analyzer test.

1. For U-NII-2A: The directional gain is 9.34dBi > 6dBi, so the power limit shall be reduced to "Determined Conducted Limit -(9.34-6)".
2. For U-NII-2C: The directional gain is 8.88dBi > 6dBi, so the power limit shall be reduced to "Determined Conducted Limit -(8.88-6)".
3. For U-NII-3: The directional gain is 9.2dBi > 6dBi, so the power limit shall be reduced to 30-(9.2-6) = 26.8dBm.

The Total Power for the straddle channel:

Chan.	Chan. Freq. (MHz)	Average Power (mW)	Average Power (dBm)
142	5710	59.2015	17.72

Note: The total power was calculated through formula and record the value for reference only.

26dB OCCUPIED BANDWIDTH

Channel	Frequency (MHz)	26dBc Bandwidth (MHz)							
		Chain 0	Chain 1	Chain 2	Chain 3	Chain 4	Chain 5	Chain 6	Chain 7
54	5270	42.32	42.54	42.81	42.32	42.27	42.56	42.17	42.32
62	5310	42.40	42.39	42.17	42.56	42.28	42.33	42.52	42.41
102	5510	42.45	42.08	42.15	42.89	42.62	42.28	42.37	42.47
110	5550	42.28	42.51	42.34	43.01	42.36	42.33	42.29	42.45
134	5670	42.22	42.32	42.16	42.27	42.25	42.16	42.37	42.57
142 (U-NII-2C Band)	5710	36.19	36.29	36.15	36.43	36.40	36.65	36.34	36.16

Note: For U-NII-2A, U-NII-2C Band output power limitation is determined based on 26dBc bandwidth.

Power Limit = 11dBm + 10logB <U-NII-2A, U-NII-2C>

Channel Number	Freq.(MHz)	Min. B(MHz)	Determined Conducted Limit (dBm)
54	5270	42.17	27.25 > 24
62	5310	42.17	27.25 > 24
102	5510	42.08	27.24 > 24
110	5550	42.28	27.26 > 24
134	5670	42.16	27.24 > 24
142 (U-NII-2C Band)	5710	36.15	26.58 > 24

802.11ax (HE80)

POWER OUTPUT

Chan.	Freq. (MHz)	Maximum Conducted Power (dBm)								Total Power (mW)	Total Power (dBm)	Limit (dBm)	Pass / Fail
		Chain 0	Chain 1	Chain 2	Chain 3	Chain 4	Chain 5	Chain 6	Chain 7				
58	5290	11.08	11.65	11.67	11.52	11.65	11.2	11.44	11.62	112.582	20.51	20.66	Pass
106	5530	11.88	12.06	12.28	12.54	11.84	11.93	11.67	11.82	127.104	21.04	21.12	Pass
122	5610	12.06	11.67	12.57	12.41	11.84	11.71	11.94	11.93	127.576	21.06	21.12	Pass
*138 (U-NII-2C Band)	5690	8.37	8.25	8.40	8.83	8.45	8.09	8.49	7.95	57.218	17.58	21.12	Pass
*138 (U-NII-3 Band)	5690	-5.64	-5.26	-5.50	-4.57	-5.88	-5.1	-5.23	-5.73	2.437	3.87	26.80	Pass

Note: * Test was performed in accordance with Measurement follow FCC KDB 789033 UNII test procedure Method SA-2 and use spectrum analyzer test.

1. For U-NII-2A: The directional gain is 9.34dBi > 6dBi, so the power limit shall be reduced to "Determined Conducted Limit -(9.34-6)".
2. For U-NII-2C: The directional gain is 8.88dBi > 6dBi, so the power limit shall be reduced to "Determined Conducted Limit -(8.88-6)".
3. For U-NII-3: The directional gain is 9.2dBi > 6dBi, so the power limit shall be reduced to 30-(9.2-6) = 26.8dBm.

The Total Power for the straddle channel:

Chan.	Chan. Freq. (MHz)	Average Power (mW)	Average Power (dBm)
138	5690	59.655	17.76

Note: The total power was calculated through formula and record the value for reference only.

26dB OCCUPIED BANDWIDTH

Channel	Frequency (MHz)	26dBc Bandwidth (MHz)							
		Chain 0	Chain 1	Chain 2	Chain 3	Chain 4	Chain 5	Chain 6	Chain 7
58	5290	83.04	82.87	83.19	83.16	82.79	83.34	82.34	82.69
106	5530	82.70	83.01	83.03	82.63	82.65	82.78	82.48	82.80
122	5610	83.05	82.60	83.19	82.99	82.70	83.10	83.07	83.46
138 (U-NII-2C Band)	5690	76.24	76.46	76.32	76.62	76.34	76.31	76.67	76.63

Note: For U-NII-2A, U-NII-2C Band output power limitation is determined based on 26dBc bandwidth.

Power Limit = 11dBm + 10logB <U-NII-2A, U-NII-2C>			
Channel Number	Freq.(MHz)	Min. B(MHz)	Determined Conducted Limit (dBm)
58	5290	82.34	30.15 > 24
106	5530	82.48	30.16 > 24
122	5610	82.60	30.16 > 24
138 (U-NII-2C Band)	5690	76.24	29.82 > 24

Spectrum Plot of Worst Value

802.11a_Chain 5 / CH144 (U-NII-2C Band)

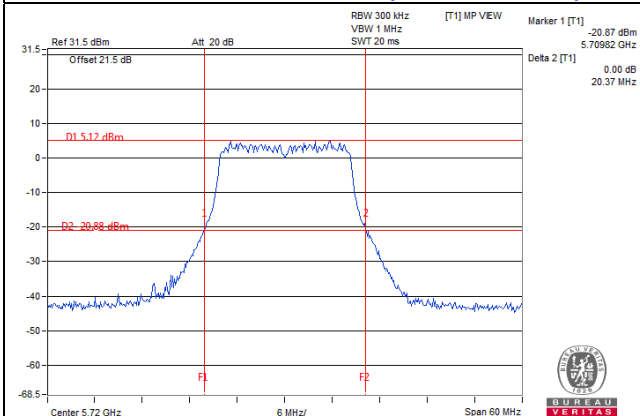

802.11ac (VHT20)_Chain 7 / CH144 (U-NII-2C Band)

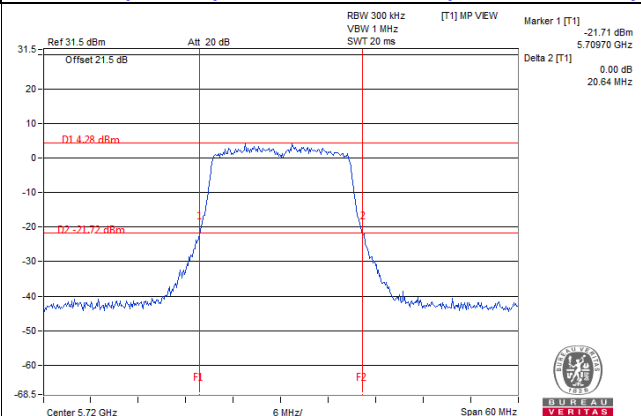

802.11ac (VHT40)_Chain 1 / CH142 (U-NII-2C Band)

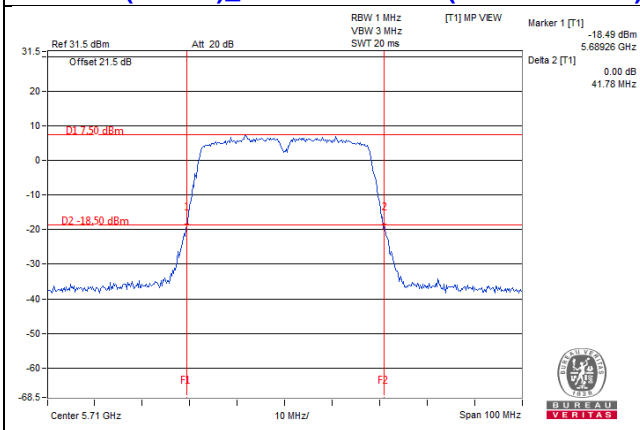

802.11ac (VHT80)_Chain 5 / CH138 (U-NII-2C Band)

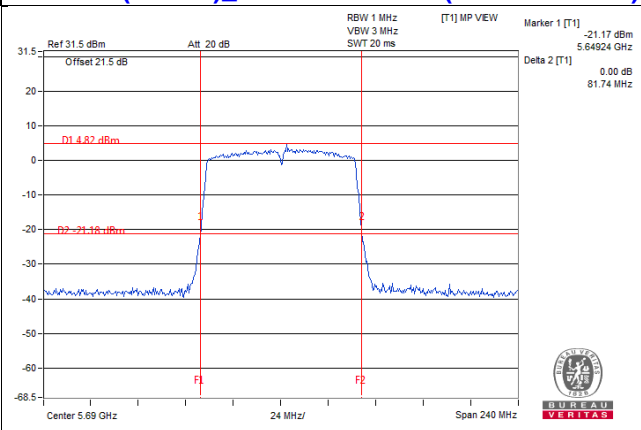

Note:

- For CH144 (U-NII-2C) = 5725MHz - Marker 1
- For CH142 (U-NII-2C) = 5725MHz - Marker 1
- For CH138 (U-NII-2C) = 5725MHz - Marker 1

Spectrum Plot of Worst Value

802.11ax (HE20)_Chain 3 / CH144 (U-NII-2C Band)

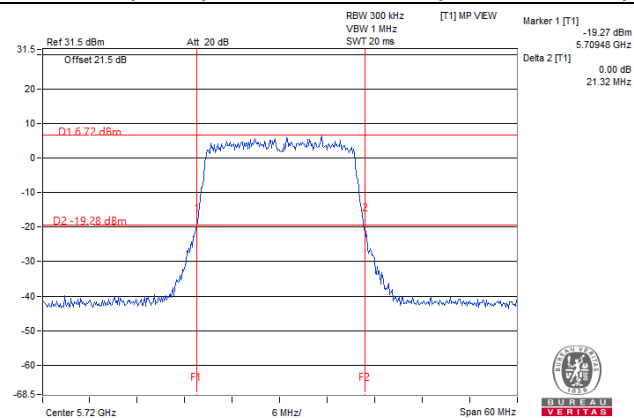

802.11ax (HE40)_Chain 2 / CH142 (U-NII-2C Band)

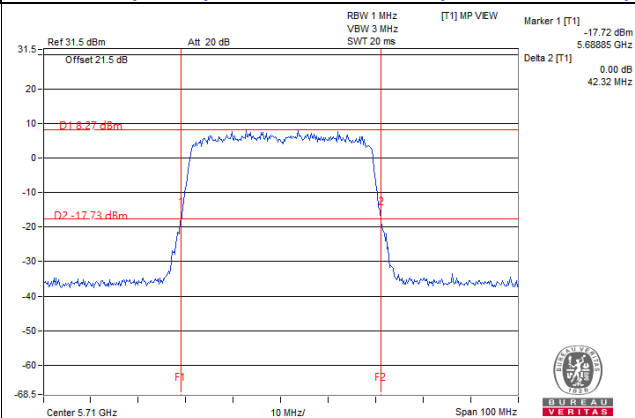

802.11ax (HE80)_Chain 0 / CH138 (U-NII-2C Band)

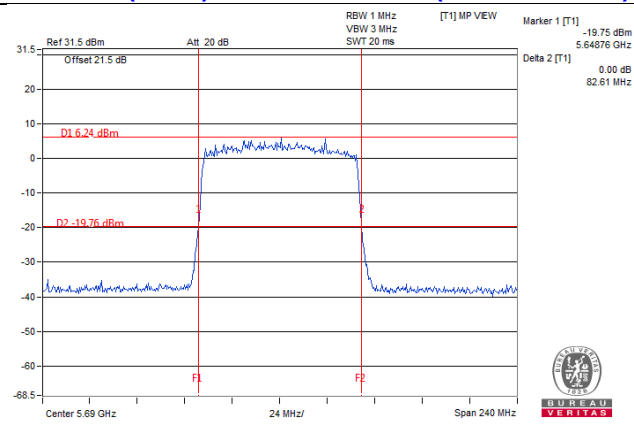

Note:

- For CH144 (U-NII-2C) = 5725MHz - Marker 1
- For CH142 (U-NII-2C) = 5725MHz - Marker 1
- For CH138 (U-NII-2C) = 5725MHz - Marker 1

4.3.8 Test Results (Mode 2)

Non-Beamforming Mode

802.11a

POWER OUTPUT

Chan.	Chan. Freq. (MHz)	Maximum Conducted Power (dBm)				Total Power (mW)	Total Power (dBm)	Limit (dBm)	Pass / Fail
		Chain 4	Chain 5	Chain 6	Chain 7				
52	5260	12.85	12.76	12.87	12.91	77.062	18.87	24.00	Pass
60	5300	12.91	12.98	12.91	13.02	78.992	18.98	24.00	Pass
64	5320	12.73	12.96	13.05	12.95	78.428	18.94	24.00	Pass
100	5500	13.51	13.40	13.36	13.45	88.125	19.45	24.00	Pass
116	5580	13.32	13.68	13.32	13.65	89.465	19.52	24.00	Pass
140	5700	13.48	13.42	13.64	13.42	89.363	19.51	24.00	Pass
*144 (U-NII-2C Band)	5720	8.18	8.21	8.18	8.31	28.87	14.60	22.99	Pass
*144 (U-NII-3 Band)	5720	2.49	2.48	2.72	2.31	7.738	8.89	30.00	Pass

Note: * Test was performed in accordance with Measurement follow FCC KDB 789033 UNII test procedure Method SA-2 and use spectrum analyzer test.

1. For U-NII-2A: The max. gain is 5.81dBi < 6dBi, so the power limit shall not be reduced.
2. For U-NII-2C: The max. gain is 5.8dBi < 6dBi, so the power limit shall not be reduced.
3. For U-NII-3: The max. gain is 5.7dBi < 6dBi, so the power limit shall not be reduced.

The Total Power for the straddle channel:

Chan.	Chan. Freq. (MHz)	Average Power (mW)	Average Power (dBm)
144	5720	36.608	15.64

Note: The total power was calculated through formula and record the value for reference only.

26dB OCCUPIED BANDWIDTH

Channel	Frequency (MHz)	26dBc Bandwidth (MHz)			
		Chain 4	Chain 5	Chain 6	Chain 7
52	5260	22.53	21.42	21.57	21.17
60	5300	22.51	21.35	21.37	21.08
64	5320	22.72	21.17	21.21	21.18
100	5500	21.96	21.56	21.39	21.21
116	5580	22.31	21.32	21.50	20.95
140	5700	22.36	21.33	21.49	21.46
144 (U-NII-2C Band)	5720	16.56	15.83	15.98	15.94

Note: For U-NII-2A, U-NII-2C Band output power limitation is determined based on 26dBc bandwidth

Power Limit = 11dBm + 10logB <U-NII-2A, U-NII-2C>

Channel Number	Freq.(MHz)	Min. B(MHz)	Determined Conducted Limit (dBm)
52	5260	21.17	24.25 > 24
60	5300	21.08	24.23 > 24
64	5320	21.17	24.25 > 24
100	5500	21.21	24.26 > 24
116	5580	20.95	24.21 > 24
140	5700	21.33	24.28 > 24
144 (U-NII-2C Band)	5720	15.83	22.99 < 24

802.11ac (VHT20)

POWER OUTPUT

Chan.	Chan. Freq. (MHz)	Maximum Conducted Power (dBm)				Total Power (mW)	Total Power (dBm)	Limit (dBm)	Pass / Fail
		Chain 4	Chain 5	Chain 6	Chain 7				
52	5260	12.49	12.59	12.46	12.75	72.353	18.59	24.00	Pass
60	5300	12.73	12.69	12.82	12.59	74.626	18.73	24.00	Pass
64	5320	12.90	12.48	12.41	12.63	72.94	18.63	24.00	Pass
100	5500	13.18	13.13	13.26	13.39	84.367	19.26	24.00	Pass
116	5580	13.34	13.17	13.03	13.28	83.698	19.23	24.00	Pass
140	5700	13.19	13.10	13.28	13.24	83.629	19.22	24.00	Pass
*144 (U-NII-2C Band)	5720	8.76	8.45	8.03	8.64	29.53	14.70	22.82	Pass
*144 (U-NII-3 Band)	5720	2.64	2.76	2.15	2.56	7.513	8.76	30.00	Pass

Note: * Test was performed in accordance with Measurement follow FCC KDB 789033 UNII test procedure Method SA-2 and use spectrum analyzer test.

1. For U-NII-2A: The max. gain is 5.81dBi < 6dBi, so the power limit shall not be reduced.
2. For U-NII-2C: The max. gain is 5.8dBi < 6dBi, so the power limit shall not be reduced.
3. For U-NII-3: The max. gain is 5.7dBi < 6dBi, so the power limit shall not be reduced.

The Total Power for the straddle channel:

Chan.	Chan. Freq. (MHz)	Average Power (mW)	Average Power (dBm)
144	5720	37.043	15.69

Note: The total power was calculated through formula and record the value for reference only.

26dB OCCUPIED BANDWIDTH

Channel	Frequency (MHz)	26dBc Bandwidth (MHz)			
		Chain 4	Chain 5	Chain 6	Chain 7
52	5260	20.88	20.93	20.85	20.80
60	5300	20.75	20.69	20.63	20.88
64	5320	20.81	20.67	20.65	20.81
100	5500	20.57	20.66	20.74	20.56
116	5580	20.89	20.81	20.57	20.79
140	5700	20.83	20.70	20.70	20.93
144 (U-NII-2C Band)	5720	15.50	15.27	15.23	15.46

Note: For U-NII-2A, U-NII-2C Band output power limitation is determined based on 26dBc bandwidth

Power Limit = 11dBm + 10logB <U-NII-2A, U-NII-2C>

Channel Number	Freq.(MHz)	Min. B(MHz)	Determined Conducted Limit (dBm)
52	5260	20.80	24.18 > 24
60	5300	20.63	24.14 > 24
64	5320	20.65	24.14 > 24
100	5500	20.56	24.13 > 24
116	5580	20.57	24.13 > 24
140	5700	20.70	24.15 > 24
144 (U-NII-2C Band)	5720	15.23	22.82 < 24

802.11ac (VHT40)

POWER OUTPUT

Chan.	Chan. Freq. (MHz)	Maximum Conducted Power (dBm)				Total Power (mW)	Total Power (dBm)	Limit (dBm)	Pass / Fail
		Chain 4	Chain 5	Chain 6	Chain 7				
54	5270	15.72	15.48	15.74	15.77	147.897	21.70	24.00	Pass
62	5310	15.69	15.69	15.56	15.64	146.755	21.67	24.00	Pass
102	5510	16.49	16.02	16.01	16.14	165.577	22.19	24.00	Pass
110	5550	16.03	16.14	16.24	16.23	165.251	22.18	24.00	Pass
134	5670	16.28	16.29	15.97	16.45	168.716	22.27	24.00	Pass
*142 (U-NII-2C Band)	5710	11.99	12.27	11.83	12.37	68.506	18.36	24.00	Pass
*142 (U-NII-3 Band)	5710	0.54	0.70	0.73	1.77	5.248	7.20	30.00	Pass

Note: * Test was performed in accordance with Measurement follow FCC KDB 789033 UNII test procedure Method SA-2 and use spectrum analyzer test.

1. For U-NII-2A: The max. gain is 5.81dBi < 6dBi, so the power limit shall not be reduced.
2. For U-NII-2C: The max. gain is 5.8dBi < 6dBi, so the power limit shall not be reduced.
3. For U-NII-3: The max. gain is 5.7dBi < 6dBi, so the power limit shall not be reduced.

The Total Power for the straddle channel:

Chan.	Chan. Freq. (MHz)	Average Power (mW)	Average Power (dBm)
142	5710	73.754	18.68

Note: The total power was calculated through formula and record the value for reference only.

26dB OCCUPIED BANDWIDTH

Channel	Frequency (MHz)	26dBc Bandwidth (MHz)			
		Chain 4	Chain 5	Chain 6	Chain 7
54	5270	41.73	41.85	41.75	42.01
62	5310	41.76	42.08	42.19	41.80
102	5510	41.82	41.84	41.65	42.00
110	5550	41.74	42.00	41.71	41.92
134	5670	41.78	42.09	41.61	42.25
142 (U-NII-2C Band)	5710	36.04	36.04	35.97	35.97

Note: For U-NII-2A, U-NII-2C Band output power limitation is determined based on 26dBc bandwidth

Power Limit = 11dBm + 10logB <U-NII-2A, U-NII-2C>			
Channel Number	Freq.(MHz)	Min. B(MHz)	Determined Conducted Limit (dBm)
54	5270	41.73	27.2 > 24
62	5310	41.76	27.2 > 24
102	5510	41.65	27.19 > 24
110	5550	41.71	27.2 > 24
134	5670	41.61	27.19 > 24
142 (U-NII-2C Band)	5710	35.97	26.55 > 24

802.11ac (VHT80)

POWER OUTPUT

Chan.	Chan. Freq. (MHz)	Maximum Conducted Power (dBm)				Total Power (mW)	Total Power (dBm)	Limit (dBm)	Pass / Fail
		Chain 4	Chain 5	Chain 6	Chain 7				
58	5290	14.93	14.45	14.69	14.90	119.325	20.77	24.00	Pass
106	5530	14.62	14.69	14.44	14.59	114.988	20.61	24.00	Pass
122	5610	17.69	17.38	17.48	17.48	225.403	23.53	24.00	Pass
*138 (U-NII-2C Band)	5690	13.93	13.66	13.52	13.57	97.279	19.88	24.00	Pass
*138 (U-NII-3 Band)	5690	-0.60	-0.06	-0.37	-0.68	3.7902	5.79	30.00	Pass

Note: * Test was performed in accordance with Measurement follow FCC KDB 789033 UNII test procedure Method SA-2 and use spectrum analyzer test.

1. For U-NII-2A: The max. gain is 5.81dBi < 6dBi, so the power limit shall not be reduced.
2. For U-NII-2C: The max. gain is 5.8dBi < 6dBi, so the power limit shall not be reduced.
3. For U-NII-3: The max. gain is 5.7dBi < 6dBi, so the power limit shall not be reduced.

The Total Power for the straddle channel:

Chan.	Chan. Freq. (MHz)	Average Power (mW)	Average Power (dBm)
138	5690	101.0692	20.05

Note: The total power was calculated through formula and record the value for reference only.

26dB OCCUPIED BANDWIDTH

Channel	Frequency (MHz)	26dBc Bandwidth (MHz)			
		Chain 4	Chain 5	Chain 6	Chain 7
58	5290	82.30	82.35	82.46	82.50
106	5530	82.20	82.30	82.77	82.45
122	5610	82.88	82.71	83.15	82.49
138 (U-NII-2C Band)	5690	76.18	76.18	76.18	76.30

Note: For U-NII-2A, U-NII-2C Band output power limitation is determined based on 26dBc bandwidth

Power Limit = 11dBm + 10logB <U-NII-2A, U-NII-2C>			
Channel Number	Freq.(MHz)	Min. B(MHz)	Determined Conducted Limit (dBm)
58	5290	82.30	30.15 > 24
106	5530	82.20	30.14 > 24
122	5610	82.49	30.16 > 24
138 (U-NII-2C Band)	5690	76.18	29.81 > 24

802.11ax (HE20)

POWER OUTPUT

Chan.	Chan. Freq. (MHz)	Maximum Conducted Power (dBm)				Total Power (mW)	Total Power (dBm)	Limit (dBm)	Pass / Fail
		Chain 4	Chain 5	Chain 6	Chain 7				
52	5260	12.70	12.82	12.69	12.97	76.157	18.82	24.00	Pass
60	5300	12.95	12.91	13.04	12.81	78.503	18.95	24.00	Pass
64	5320	13.12	12.72	12.65	12.87	76.991	18.86	24.00	Pass
100	5500	13.41	13.36	13.49	13.62	88.955	19.49	24.00	Pass
116	5580	13.59	13.42	13.26	13.52	88.51	19.47	24.00	Pass
140	5700	13.41	13.32	13.51	13.46	88.027	19.45	24.00	Pass
*144 (U-NII-2C Band)	5720	8.65	8.97	8.56	8.73	31.273	14.95	22.90	Pass
*144 (U-NII-3 Band)	5720	3.19	4.24	3.27	3.22	9.385	9.72	30.00	Pass

Note: * Test was performed in accordance with Measurement follow FCC KDB 789033 UNII test procedure Method SA-2 and use spectrum analyzer test.

1. For U-NII-2A: The max. gain is 5.81dBi < 6dBi, so the power limit shall not be reduced.
2. For U-NII-2C: The max. gain is 5.8dBi < 6dBi, so the power limit shall not be reduced.
3. For U-NII-3: The max. gain is 5.7dBi < 6dBi, so the power limit shall not be reduced.

The Total Power for the straddle channel:

Chan.	Chan. Freq. (MHz)	Average Power (mW)	Average Power (dBm)
144	5720	40.658	16.09

Note: The total power was calculated through formula and record the value for reference only.

26dB OCCUPIED BANDWIDTH

Channel	Frequency (MHz)	26dBc Bandwidth (MHz)			
		Chain 4	Chain 5	Chain 6	Chain 7
52	5260	21.31	21.36	21.37	21.32
60	5300	21.32	21.15	21.29	21.36
64	5320	21.53	21.14	21.40	21.09
100	5500	21.39	21.27	21.12	21.18
116	5580	21.41	21.36	21.48	21.21
140	5700	21.34	21.34	21.21	21.36
144 (U-NII-2C Band)	5720	15.62	15.65	15.51	15.60

Note: For U-NII-2A, U-NII-2C Band output power limitation is determined based on 26dBc bandwidth

Power Limit = 11dBm + 10logB <U-NII-2A, U-NII-2C>

Channel Number	Freq.(MHz)	Min. B(MHz)	Determined Conducted Limit (dBm)
52	5260	21.31	24.28 > 24
60	5300	21.15	24.25 > 24
64	5320	21.09	24.24 > 24
100	5500	21.12	24.24 > 24
116	5580	21.21	24.26 > 24
140	5700	21.21	24.26 > 24
144 (U-NII-2C Band)	5720	15.51	22.9 < 24

802.11ax (HE40)

POWER OUTPUT

Chan.	Chan. Freq. (MHz)	Maximum Conducted Power (dBm)				Total Power (mW)	Total Power (dBm)	Limit (dBm)	Pass / Fail
		Chain 4	Chain 5	Chain 6	Chain 7				
54	5270	15.94	15.72	15.99	16.03	156.395	21.94	24.00	Pass
62	5310	15.93	15.96	15.81	15.86	155.275	21.91	24.00	Pass
102	5510	16.72	16.26	16.23	16.38	174.683	22.42	24.00	Pass
110	5550	16.26	16.38	16.48	16.46	174.44	22.42	24.00	Pass
134	5670	16.65	16.51	16.21	16.69	179.458	22.54	24.00	Pass
*142 (U-NII-2C Band)	5710	12.62	12.65	12.19	12.45	73.49	18.66	24.00	Pass
*142 (U-NII-3 Band)	5710	2.40	1.66	2.24	2.06	6.73	8.28	30.00	Pass

Note: * Test was performed in accordance with Measurement follow FCC KDB 789033 UNII test procedure Method SA-2 and use spectrum analyzer test.

1. For U-NII-2A: The max. gain is 5.81dBi < 6dBi, so the power limit shall not be reduced.
2. For U-NII-2C: The max. gain is 5.8dBi < 6dBi, so the power limit shall not be reduced.
3. For U-NII-3: The max. gain is 5.7dBi < 6dBi, so the power limit shall not be reduced.

The Total Power for the straddle channel:

Chan.	Chan. Freq. (MHz)	Average Power (mW)	Average Power (dBm)
142	5710	80.22	19.04

Note: The total power was calculated through formula and record the value for reference only.

26dB OCCUPIED BANDWIDTH

Channel	Frequency (MHz)	26dBc Bandwidth (MHz)			
		Chain 4	Chain 5	Chain 6	Chain 7
54	5270	42.38	42.29	42.44	42.43
62	5310	42.15	42.62	42.41	42.08
102	5510	42.39	42.73	42.75	42.39
110	5550	42.17	42.31	42.40	42.32
134	5670	42.53	42.34	42.54	42.57
142 (U-NII-2C Band)	5710	35.98	36.09	36.02	36.25

Note: For U-NII-2A, U-NII-2C Band output power limitation is determined based on 26dBc bandwidth

Power Limit = 11dBm + 10logB <U-NII-2A, U-NII-2C>

Channel Number	Freq.(MHz)	Min. B(MHz)	Determined Conducted Limit (dBm)
54	5270	42.29	27.26 > 24
62	5310	42.08	27.24 > 24
102	5510	42.39	27.27 > 24
110	5550	42.17	27.25 > 24
134	5670	42.34	27.26 > 24
142 (U-NII-2C Band)	5710	35.98	26.56 > 24

802.11ax (HE80)

POWER OUTPUT

Chan.	Chan. Freq. (MHz)	Maximum Conducted Power (dBm)				Total Power (mW)	Total Power (dBm)	Limit (dBm)	Pass / Fail
		Chain 4	Chain 5	Chain 6	Chain 7				
58	5290	15.15	14.70	14.94	15.12	125.944	21.00	24.00	Pass
106	5530	14.84	14.93	14.67	14.82	121.244	20.84	24.00	Pass
122	5610	17.93	17.61	17.74	17.73	238.486	23.77	24.00	Pass
*138 (U-NII-2C Band)	5690	14.59	14.21	13.83	14.29	110.724	20.44	24.00	Pass
*138 (U-NII-3 Band)	5690	0.37	1.35	-0.71	0.36	4.5785	6.61	30.00	Pass

Note: * Test was performed in accordance with Measurement follow FCC KDB 789033 UNII test procedure Method SA-2 and use spectrum analyzer test.

1. For U-NII-2A: The max. gain is 5.81dBi < 6dBi, so the power limit shall not be reduced.
2. For U-NII-2C: The max. gain is 5.8dBi < 6dBi, so the power limit shall not be reduced.
3. For U-NII-3: The max. gain is 5.7dBi < 6dBi, so the power limit shall not be reduced.

The Total Power for the straddle channel:

Chan.	Chan. Freq. (MHz)	Average Power (mW)	Average Power (dBm)
138	5690	115.3025	20.62

Note: The total power was calculated through formula and record the value for reference only.

26dB OCCUPIED BANDWIDTH

Channel	Frequency (MHz)	26dBc Bandwidth (MHz)			
		Chain 4	Chain 5	Chain 6	Chain 7
58	5290	83.09	82.78	82.69	82.83
106	5530	82.98	82.70	82.87	82.49
122	5610	83.37	82.50	83.16	83.08
138 (U-NII-2C Band)	5690	76.71	76.34	76.21	76.29

Note: For U-NII-2A, U-NII-2C Band output power limitation is determined based on 26dBc bandwidth

Power Limit = 11dBm + 10logB <U-NII-2A, U-NII-2C>			
Channel Number	Freq.(MHz)	Min. B(MHz)	Determined Conducted Limit (dBm)
58	5290	82.69	30.17 > 24
106	5530	82.49	30.16 > 24
122	5610	82.50	30.16 > 24
138 (U-NII-2C Band)	5690	76.21	29.82 > 24

Beamforming Mode

802.11ac (VHT20)

POWER OUTPUT

Chan.	Chan. Freq. (MHz)	Maximum Conducted Power (dBm)				Total Power (mW)	Total Power (dBm)	Limit (dBm)	Pass / Fail
		Chain 4	Chain 5	Chain 6	Chain 7				
52	5260	12.49	12.59	12.46	12.75	72.353	18.59	19.29	Pass
60	5300	12.73	12.69	12.82	12.59	74.626	18.73	19.29	Pass
64	5320	12.90	12.48	12.41	12.63	72.94	18.63	19.29	Pass
100	5500	13.18	13.13	13.26	13.39	84.367	19.26	19.67	Pass
116	5580	13.34	13.17	13.03	13.28	83.698	19.23	19.67	Pass
140	5700	13.19	13.10	13.28	13.24	83.629	19.22	19.67	Pass
*144 (U-NII-2C Band)	5720	8.76	8.45	8.03	8.64	29.53	14.70	18.49	Pass
*144 (U-NII-3 Band)	5720	2.64	2.76	2.15	2.56	7.513	8.76	25.32	Pass

Note: * Test was performed in accordance with Measurement follow FCC KDB 789033 UNII test procedure Method SA-2 and use spectrum analyzer test.

1. For U-NII-2A: The directional gain is 10.71dBi > 6dBi, so the power limit shall be reduced to "Determined Conducted Limit-(10.71-6)".
2. For U-NII-2C: The directional gain is 10.33dBi > 6dBi, so the power limit shall be reduced to "Determined Conducted Limit- (10.33-6)".
3. For U-NII-3: The directional gain is 10.68dBi > 6dBi, so the power limit shall be reduced to $30-(10.68-6) = 25.32\text{dBm}$.

The Total Power for the straddle channel:

Chan.	Chan. Freq. (MHz)	Average Power (mW)	Average Power (dBm)
144	5720	37.043	15.69

Note: The total power was calculated through formula and record the value for reference only.

26dB OCCUPIED BANDWIDTH

Channel	Frequency (MHz)	26dBc Bandwidth (MHz)			
		Chain 4	Chain 5	Chain 6	Chain 7
52	5260	20.88	20.93	20.85	20.80
60	5300	20.75	20.69	20.63	20.88
64	5320	20.81	20.67	20.65	20.81
100	5500	20.57	20.66	20.74	20.56
116	5580	20.89	20.81	20.57	20.79
140	5700	20.83	20.70	20.70	20.93
144 (U-NII-2C Band)	5720	15.50	15.27	15.23	15.46

Note: For U-NII-2A, U-NII-2C Band output power limitation is determined based on 26dBc bandwidth

Power Limit = 11dBm + 10logB <U-NII-2A, U-NII-2C>

Channel Number	Freq.(MHz)	Min. B(MHz)	Determined Conducted Limit (dBm)
52	5260	20.80	24.18 > 24
60	5300	20.63	24.14 > 24
64	5320	20.65	24.14 > 24
100	5500	20.56	24.13 > 24
116	5580	20.57	24.13 > 24
140	5700	20.70	24.15 > 24
144 (U-NII-2C Band)	5720	15.23	22.82 < 24

802.11ac (VHT40)

POWER OUTPUT

Chan.	Chan. Freq. (MHz)	Maximum Conducted Power (dBm)				Total Power (mW)	Total Power (dBm)	Limit (dBm)	Pass / Fail
		Chain 4	Chain 5	Chain 6	Chain 7				
54	5270	12.71	12.46	12.64	12.73	73.399	18.66	19.29	Pass
62	5310	12.64	12.71	12.54	12.61	73.215	18.65	19.29	Pass
102	5510	13.46	13.03	12.98	13.11	82.598	19.17	19.67	Pass
110	5550	13.02	13.12	13.22	13.21	82.487	19.16	19.67	Pass
134	5670	13.38	13.25	12.96	13.35	84.309	19.26	19.67	Pass
*142 (U-NII-2C Band)	5710	9.43	9.32	6.82	9.23	32.062	15.06	19.67	Pass
*142 (U-NII-3 Band)	5710	-0.53	-0.35	-1.61	-1.39	3.3887	5.30	25.32	Pass

Note: * Test was performed in accordance with Measurement follow FCC KDB 789033 UNII test procedure Method SA-2 and use spectrum analyzer test.

1. For U-NII-2A: The directional gain is 10.71dBi > 6dBi, so the power limit shall be reduced to "Determined Conducted Limit-(10.71-6)".
2. For U-NII-2C: The directional gain is 10.33dBi > 6dBi, so the power limit shall be reduced to "Determined Conducted Limit- (10.33-6)".
3. For U-NII-3: The directional gain is 10.68dBi > 6dBi, so the power limit shall be reduced to $30-(10.68-6) = 25.32\text{dBm}$.

The Total Power for the straddle channel:

Chan.	Chan. Freq. (MHz)	Average Power (mW)	Average Power (dBm)
142	5710	39.1997	15.93

Note: The total power was calculated through formula and record the value for reference only.

26dB OCCUPIED BANDWIDTH

Channel	Frequency (MHz)	26dBc Bandwidth (MHz)			
		Chain 4	Chain 5	Chain 6	Chain 7
54	5270	41.73	41.85	41.75	42.01
62	5310	41.76	42.08	42.19	41.80
102	5510	41.82	41.84	41.65	42.00
110	5550	41.74	42.00	41.71	41.92
134	5670	41.78	42.09	41.61	42.25
142 (U-NII-2C Band)	5710	36.04	36.04	35.97	35.97

Note: For U-NII-2A, U-NII-2C Band output power limitation is determined based on 26dBc bandwidth

Power Limit = 11dBm + 10logB <U-NII-2A, U-NII-2C>

Channel Number	Freq.(MHz)	Min. B(MHz)	Determined Conducted Limit (dBm)
54	5270	41.73	27.2 > 24
62	5310	41.76	27.2 > 24
102	5510	41.65	27.19 > 24
110	5550	41.71	27.2 > 24
134	5670	41.61	27.19 > 24
142 (U-NII-2C Band)	5710	35.97	26.55 > 24

802.11ac (VHT80)

POWER OUTPUT

Chan.	Chan. Freq. (MHz)	Maximum Conducted Power (dBm)				Total Power (mW)	Total Power (dBm)	Limit (dBm)	Pass / Fail
		Chain 4	Chain 5	Chain 6	Chain 7				
58	5290	12.87	12.56	12.71	12.87	75.422	18.77	19.29	Pass
106	5530	13.09	13.18	12.91	13.06	80.94	19.08	19.67	Pass
122	5610	13.18	12.84	12.93	12.97	79.477	19.00	19.67	Pass
*138 (U-NII-2C Band)	5690	9.93	9.79	9.24	9.59	38.481	15.85	19.67	Pass
*138 (U-NII-3 Band)	5690	-5.78	-4.29	-5.71	-5.64	1.2297	0.90	25.32	Pass

Note: * Test was performed in accordance with Measurement follow FCC KDB 789033 UNII test procedure Method SA-2 and use spectrum analyzer test.

1. For U-NII-2A: The directional gain is 10.71dBi > 6dBi, so the power limit shall be reduced to "Determined Conducted Limit-(10.71-6)".
2. For U-NII-2C: The directional gain is 10.33dBi > 6dBi, so the power limit shall be reduced to "Determined Conducted Limit- (10.33-6)".
3. For U-NII-3: The directional gain is 10.68dBi > 6dBi, so the power limit shall be reduced to 30-(10.68-6) = 25.32dBm.

The Total Power for the straddle channel:

Chan.	Chan. Freq. (MHz)	Average Power (mW)	Average Power (dBm)
138	5690	39.7107	15.99

Note: The total power was calculated through formula and record the value for reference only.

26dB OCCUPIED BANDWIDTH

Channel	Frequency (MHz)	26dBc Bandwidth (MHz)			
		Chain 4	Chain 5	Chain 6	Chain 7
58	5290	82.30	82.35	82.46	82.50
106	5530	82.20	82.30	82.77	82.45
122	5610	82.88	82.71	83.15	82.49
138 (U-NII-2C Band)	5690	76.18	76.18	76.18	76.30

Note: For U-NII-2A, U-NII-2C Band output power limitation is determined based on 26dBc bandwidth

Power Limit = 11dBm + 10logB <U-NII-2A, U-NII-2C>			
Channel Number	Freq.(MHz)	Min. B(MHz)	Determined Conducted Limit (dBm)
58	5290	82.30	30.15 > 24
106	5530	82.20	30.14 > 24
122	5610	82.49	30.16 > 24
138 (U-NII-2C Band)	5690	76.18	29.81 > 24

802.11ax (HE20)

Chan.	Chan. Freq. (MHz)	Maximum Conducted Power (dBm)				Total Power (mW)	Total Power (dBm)	Limit (dBm)	Pass / Fail
		Chain 4	Chain 5	Chain 6	Chain 7				
52	5260	12.70	12.82	12.69	12.97	76.157	18.82	19.29	Pass
60	5300	12.95	12.91	13.04	12.81	78.503	18.95	19.29	Pass
64	5320	13.12	12.72	12.65	12.87	76.991	18.86	19.29	Pass
100	5500	13.41	13.36	13.49	13.62	88.955	19.49	19.67	Pass
116	5580	13.59	13.42	13.26	13.52	88.51	19.47	19.67	Pass
140	5700	13.41	13.32	13.51	13.46	88.027	19.45	19.67	Pass
*144 (U-NII-2C Band)	5720	8.65	8.97	8.56	8.73	31.273	14.95	18.57	Pass
*144 (U-NII-3 Band)	5720	3.19	4.24	3.27	3.22	9.385	9.72	25.32	Pass

Note: * Test was performed in accordance with Measurement follow FCC KDB 789033 UNII test procedure Method SA-2 and use spectrum analyzer test.

1. For U-NII-2A: The directional gain is 10.71dBi > 6dBi, so the power limit shall be reduced to "Determined Conducted Limit-(10.71-6)".
2. For U-NII-2C: The directional gain is 10.33dBi > 6dBi, so the power limit shall be reduced to "Determined Conducted Limit- (10.33-6)".
3. For U-NII-3: The directional gain is 10.68dBi > 6dBi, so the power limit shall be reduced to $30-(10.68-6) = 25.32\text{dBm}$.

The Total Power for the straddle channel:

Chan.	Chan. Freq. (MHz)	Average Power (mW)	Average Power (dBm)
144	5720	40.658	16.09

Note: The total power was calculated through formula and record the value for reference only.

26dB OCCUPIED BANDWIDTH

Channel	Frequency (MHz)	26dBc Bandwidth (MHz)			
		Chain 4	Chain 5	Chain 6	Chain 7
52	5260	21.31	21.36	21.37	21.32
60	5300	21.32	21.15	21.29	21.36
64	5320	21.53	21.14	21.40	21.09
100	5500	21.39	21.27	21.12	21.18
116	5580	21.41	21.36	21.48	21.21
140	5700	21.34	21.34	21.21	21.36
144 (U-NII-2C Band)	5720	15.62	15.65	15.51	15.60

Note: For U-NII-2A, U-NII-2C Band output power limitation is determined based on 26dBc bandwidth

Power Limit = 11dBm + 10logB <U-NII-2A, U-NII-2C>			
Channel Number	Freq.(MHz)	Min. B(MHz)	Determined Conducted Limit (dBm)
52	5260	21.31	24.28 > 24
60	5300	21.15	24.25 > 24
64	5320	21.09	24.24 > 24
100	5500	21.12	24.24 > 24
116	5580	21.21	24.26 > 24
140	5700	21.21	24.26 > 24
144 (U-NII-2C Band)	5720	15.51	22.9 < 24

802.11ax (HE40)

POWER OUTPUT

Chan.	Chan. Freq. (MHz)	Maximum Conducted Power (dBm)				Total Power (mW)	Total Power (dBm)	Limit (dBm)	Pass / Fail
		Chain 4	Chain 5	Chain 6	Chain 7				
54	5270	12.93	12.69	12.87	12.96	77.346	18.88	19.29	Pass
62	5310	12.89	12.94	12.79	12.84	77.375	18.89	19.29	Pass
102	5510	13.69	13.25	13.21	13.34	87.041	19.40	19.67	Pass
110	5550	13.24	13.34	13.44	13.45	86.874	19.39	19.67	Pass
134	5670	13.64	13.49	13.19	13.64	89.423	19.51	19.67	Pass
*142 (U-NII-2C Band)	5710	9.54	9.42	9.16	9.33	35.856	15.55	19.67	Pass
*142 (U-NII-3 Band)	5710	-0.64	-0.31	-0.60	-0.76	3.6364	5.61	25.32	Pass

Note: * Test was performed in accordance with Measurement follow FCC KDB 789033 UNII test procedure Method SA-2 and use spectrum analyzer test.

1. For U-NII-2A: The directional gain is 10.71dBi > 6dBi, so the power limit shall be reduced to "Determined Conducted Limit-(10.71-6)".
2. For U-NII-2C: The directional gain is 10.33dBi > 6dBi, so the power limit shall be reduced to "Determined Conducted Limit- (10.33-6)".
3. For U-NII-3: The directional gain is 10.68dBi > 6dBi, so the power limit shall be reduced to $30-(10.68-6) = 25.32\text{dBm}$.

The Total Power for the straddle channel:

Chan.	Chan. Freq. (MHz)	Average Power (mW)	Average Power (dBm)
142	5710	39.4924	15.97

Note: The total power was calculated through formula and record the value for reference only.

26dB OCCUPIED BANDWIDTH

Channel	Frequency (MHz)	26dBc Bandwidth (MHz)			
		Chain 4	Chain 5	Chain 6	Chain 7
54	5270	42.38	42.29	42.44	42.43
62	5310	42.15	42.62	42.41	42.08
102	5510	42.39	42.73	42.75	42.39
110	5550	42.17	42.31	42.40	42.32
134	5670	42.53	42.34	42.54	42.57
142 (U-NII-2C Band)	5710	35.98	36.09	36.02	36.25

Note: For U-NII-2A, U-NII-2C Band output power limitation is determined based on 26dBc bandwidth

Power Limit = 11dBm + 10logB <U-NII-2A, U-NII-2C>			
Channel Number	Freq.(MHz)	Min. B(MHz)	Determined Conducted Limit (dBm)
54	5270	42.29	27.26 > 24
62	5310	42.08	27.24 > 24
102	5510	42.39	27.27 > 24
110	5550	42.17	27.25 > 24
134	5670	42.34	27.26 > 24
142 (U-NII-2C Band)	5710	35.98	26.56 > 24

802.11ax (HE80)

POWER OUTPUT

Chan.	Chan. Freq. (MHz)	Maximum Conducted Power (dBm)				Total Power (mW)	Total Power (dBm)	Limit (dBm)	Pass / Fail
		Chain 4	Chain 5	Chain 6	Chain 7				
58	5290	13.11	12.80	12.93	13.11	79.617	19.01	19.29	Pass
106	5530	13.31	13.41	13.15	13.28	85.292	19.31	19.67	Pass
122	5610	13.41	13.09	13.18	13.25	84.23	19.25	19.67	Pass
*138 (U-NII-2C Band)	5690	10.05	10.10	9.42	9.82	40.362	16.06	19.67	Pass
*138 (U-NII-3 Band)	5690	-3.72	-3.74	-7.12	-3.23	1.5821	1.99	25.32	Pass

Note: * Test was performed in accordance with Measurement follow FCC KDB 789033 UNII test procedure Method SA-2 and use spectrum analyzer test.

1. For U-NII-2A: The directional gain is 10.71dBi > 6dBi, so the power limit shall be reduced to "Determined Conducted Limit-(10.71-6)".
2. For U-NII-2C: The directional gain is 10.33dBi > 6dBi, so the power limit shall be reduced to "Determined Conducted Limit- (10.33-6)".
3. For U-NII-3: The directional gain is 10.68dBi > 6dBi, so the power limit shall be reduced to 30-(10.68-6) = 25.32dBm.

The Total Power for the straddle channel:

Chan.	Chan. Freq. (MHz)	Average Power (mW)	Average Power (dBm)
138	5690	41.9441	16.23

Note: The total power was calculated through formula and record the value for reference only.

26dB OCCUPIED BANDWIDTH

Channel	Frequency (MHz)	26dBc Bandwidth (MHz)			
		Chain 4	Chain 5	Chain 6	Chain 7
58	5290	83.09	82.78	82.69	82.83
106	5530	82.98	82.70	82.87	82.49
122	5610	83.37	82.50	83.16	83.08
138 (U-NII-2C Band)	5690	76.71	76.34	76.21	76.29

Note: For U-NII-2A, U-NII-2C Band output power limitation is determined based on 26dBc bandwidth

Power Limit = 11dBm + 10logB <U-NII-2A, U-NII-2C>			
Channel Number	Freq.(MHz)	Min. B(MHz)	Determined Conducted Limit (dBm)
58	5290	82.69	30.17 > 24
106	5530	82.49	30.16 > 24
122	5610	82.50	30.16 > 24
138 (U-NII-2C Band)	5690	76.21	29.82 > 24

Spectrum Plot of Worst Value

802.11a_Chain 5 / CH144 (U-NII-2C Band)

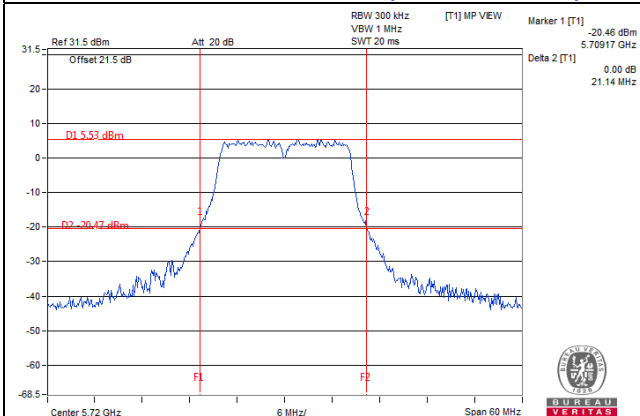

802.11ac (VHT20)_Chain 6 / CH144 (U-NII-2C Band)

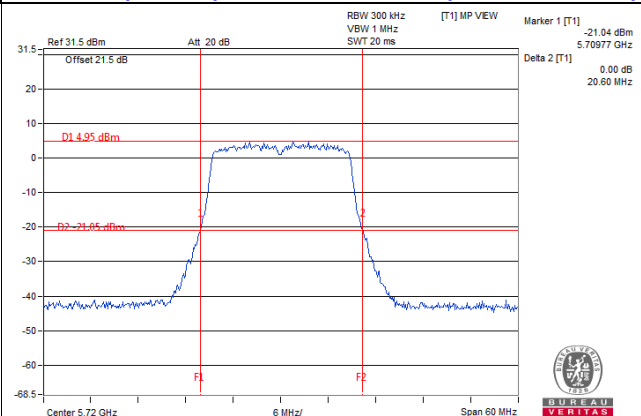

802.11ac (VHT40)_Chain 6 / CH142 (U-NII-2C Band)

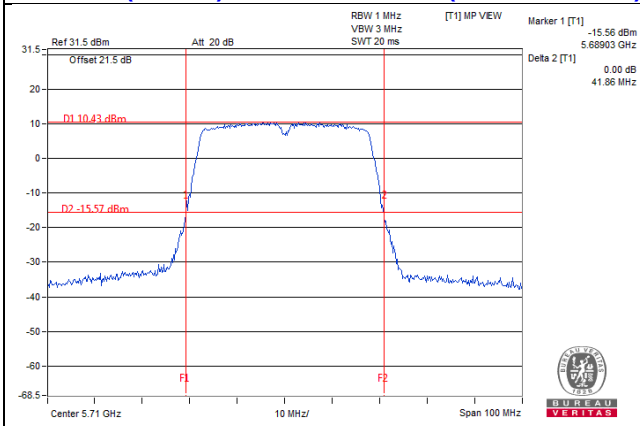

802.11ac (VHT80)_Chain 4 / CH138 (U-NII-2C Band)

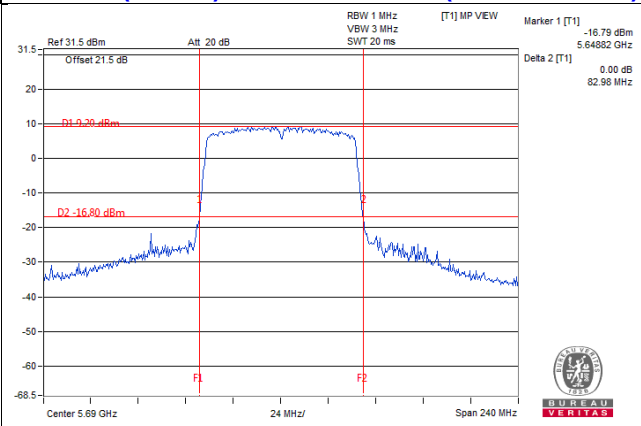

Note:

- For CH144 (U-NII-2C) = 5725MHz - Marker 1
- For CH142 (U-NII-2C) = 5725MHz - Marker 1
- For CH138 (U-NII-2C) = 5725MHz - Marker 1

Spectrum Plot of Worst Value

802.11ax (HE20)_Chain 6 / CH144 (U-NII-2C Band)

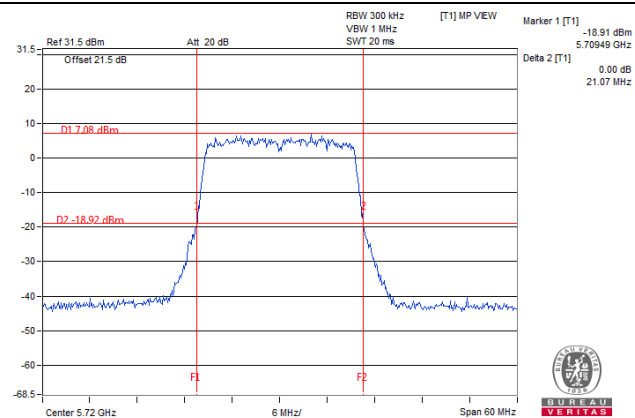

802.11ax (HE40)_Chain 4 / CH142 (U-NII-2C Band)

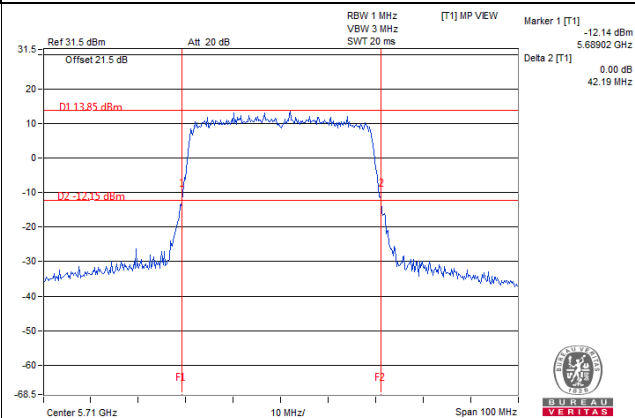

802.11ax (HE80)_Chain 6 / CH138 (U-NII-2C Band)

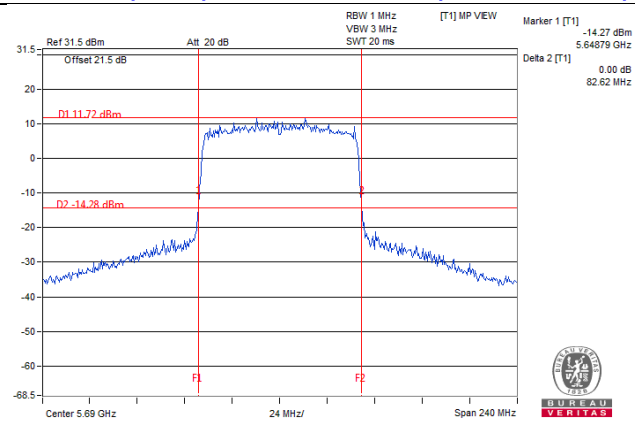

Note:

- For CH144 (U-NII-2C) = 5725MHz - Marker 1
- For CH142 (U-NII-2C) = 5725MHz - Marker 1
- For CH138 (U-NII-2C) = 5725MHz - Marker 1

4.3.9 Test Results (Mode 3)

Non-Beamforming Mode

802.11a

POWER OUTPUT

Chan.	Chan. Freq. (MHz)	Maximum Conducted Power (dBm)		Total Power (mW)	Total Power (dBm)	Limit (dBm)	Pass / Fail
		Chain 1	Chain 2				
52	5260	17.62	17.80	118.066	20.72	23.56	Pass
60	5300	17.66	17.59	115.757	20.64	23.56	Pass
64	5320	17.65	17.75	117.776	20.71	23.56	Pass
100	5500	17.33	17.22	106.798	20.29	24.00	Pass
116	5580	18.25	18.35	135.225	21.31	24.00	Pass
140	5700	17.35	17.25	107.413	20.31	24.00	Pass
*144 (U-NII-2C Band)	5720	12.95	12.74	41.879	16.22	23.93	Pass
*144 (U-NII-3 Band)	5720	7.05	6.71	10.61	10.26	29.61	Pass

Note: * Test was performed in accordance with Measurement follow FCC KDB 789033 UNII test procedure Method SA-2 and use spectrum analyzer test.

1. For U-NII-2A: The max. gain is 6.44dBi > 6dBi, so the power limit shall be reduced to "Determined Conducted Limit-(6.44-6)".
2. For U-NII-2C: The max. gain is 5.69dBi < 6dBi, so the power limit shall not be reduced.
3. For U-NII-3: The max. gain is 6.39dBi > 6dBi, so the power limit shall be reduced to 30-(6.39-6) = 29.61dBm.

The Total Power for the straddle channel:

Chan.	Chan. Freq. (MHz)	Average Power (mW)	Average Power (dBm)
144	5720	52.489	17.2

Note: The total power was calculated through formula and record the value for reference only.

26dB OCCUPIED BANDWIDTH

Channel	Frequency (MHz)	26dBc Bandwidth (MHz)	
		Chain 1	Chain 2
52	5260	27.19	27.65
60	5300	27.26	23.88
64	5320	23.79	23.93
100	5500	23.84	22.90
116	5580	27.59	27.55
140	5700	25.33	24.10
144 (U-NII-2C Band)	5720	19.66	23.73

Note: For U-NII-2A, U-NII-2C Band output power limitation is determined based on 26dBc bandwidth

Power Limit = 11dBm + 10logB <U-NII-2A, U-NII-2C>

Channel Number	Freq.(MHz)	Min. B(MHz)	Determined Conducted Limit (dBm)
52	5260	27.19	25.34 > 24
60	5300	23.88	24.78 > 24
64	5320	23.79	24.76 > 24
100	5500	22.90	24.59 > 24
116	5580	27.55	25.4 > 24
140	5700	24.10	24.82 > 24
144 (U-NII-2C Band)	5720	19.66	23.93 < 24

802.11ac (VHT20)

POWER OUTPUT

Chan.	Chan. Freq. (MHz)	Maximum Conducted Power (dBm)		Total Power (mW)	Total Power (dBm)	Limit (dBm)	Pass / Fail
		Chain 1	Chain 2				
52	5260	17.71	17.77	118.861	20.75	23.56	Pass
60	5300	17.42	17.47	111.055	20.46	23.56	Pass
64	5320	17.51	17.40	111.318	20.47	23.56	Pass
100	5500	17.33	17.42	109.283	20.39	24.00	Pass
116	5580	18.10	18.35	132.956	21.24	24.00	Pass
140	5700	17.39	17.30	108.531	20.36	24.00	Pass
*144 (U-NII-2C Band)	5720	13.23	13.34	44.66	16.50	22.89	Pass
*144 (U-NII-3 Band)	5720	7.53	7.98	12.516	10.97	29.61	Pass

Note: * Test was performed in accordance with Measurement follow FCC KDB 789033 UNII test procedure Method SA-2 and use spectrum analyzer test.

1. For U-NII-2A: The max. gain is 6.44dBi > 6dBi, so the power limit shall be reduced to "Determined Conducted Limit-(6.44-6)".
2. For U-NII-2C: The max. gain is 5.69dBi < 6dBi, so the power limit shall not be reduced.
3. For U-NII-3: The max. gain is 6.39dBi > 6dBi, so the power limit shall be reduced to 30-(6.39-6) = 29.61dBm.

The Total Power for the straddle channel:

Chan.	Chan. Freq. (MHz)	Average Power (mW)	Average Power (dBm)
144	5720	57.176	17.57

Note: The total power was calculated through formula and record the value for reference only.

26dB OCCUPIED BANDWIDTH

Channel	Frequency (MHz)	26dBc Bandwidth (MHz)	
		Chain 1	Chain 2
52	5260	20.93	20.84
60	5300	20.75	20.72
64	5320	20.79	20.78
100	5500	20.65	20.76
116	5580	21.24	21.77
140	5700	21.16	20.61
144 (U-NII-2C Band)	5720	15.57	15.46

Note: For U-NII-2A, U-NII-2C Band output power limitation is determined based on 26dBc bandwidth

Power Limit = 11dBm + 10logB <U-NII-2A, U-NII-2C>			
Channel Number	Freq.(MHz)	Min. B(MHz)	Determined Conducted Limit (dBm)
52	5260	20.84	24.18 > 24
60	5300	20.72	24.16 > 24
64	5320	20.78	24.17 > 24
100	5500	20.65	24.14 > 24
116	5580	21.24	24.27 > 24
140	5700	20.61	24.14 > 24
144 (U-NII-2C Band)	5720	15.46	22.89 < 24

802.11ac (VHT40)

POWER OUTPUT

Chan.	Chan. Freq. (MHz)	Maximum Conducted Power (dBm)		Total Power (mW)	Total Power (dBm)	Limit (dBm)	Pass / Fail
		Chain 1	Chain 2				
54	5270	20.41	20.52	222.621	23.48	23.56	Pass
62	5310	16.42	16.47	88.214	19.46	23.56	Pass
102	5510	15.72	15.81	75.432	18.78	24.00	Pass
110	5550	20.52	20.40	222.368	23.47	24.00	Pass
134	5670	20.41	20.62	225.246	23.53	24.00	Pass
*142 (U-NII-2C Band)	5710	16.36	16.17	88.975	19.49	24.00	Pass
*142 (U-NII-3 Band)	5710	6.15	5.25	7.853	8.95	29.61	Pass

Note: * Test was performed in accordance with Measurement follow FCC KDB 789033 UNII test procedure Method SA-2 and use spectrum analyzer test.

1. For U-NII-2A: The max. gain is 6.44dBi > 6dBi, so the power limit shall be reduced to "Determined Conducted Limit-(6.44-6)".
2. For U-NII-2C: The max. gain is 5.69dBi < 6dBi, so the power limit shall not be reduced.
3. For U-NII-3: The max. gain is 6.39dBi > 6dBi, so the power limit shall be reduced to 30-(6.39-6) = 29.61dBm.

The Total Power for the straddle channel:

Chan.	Chan. Freq. (MHz)	Average Power (mW)	Average Power (dBm)
142	5710	96.828	19.86

Note: The total power was calculated through formula and record the value for reference only.

26dB OCCUPIED BANDWIDTH

Channel	Frequency (MHz)	26dBc Bandwidth (MHz)	
		Chain 1	Chain 2
54	5270	59.05	68.81
62	5310	42.27	42.40
102	5510	41.97	41.85
110	5550	65.62	43.54
134	5670	73.80	78.68
142 (U-NII-2C Band)	5710	43.83	46.82

Note: For U-NII-2A, U-NII-2C Band output power limitation is determined based on 26dBc bandwidth

Power Limit = 11dBm + 10logB <U-NII-2A, U-NII-2C>			
Channel Number	Freq.(MHz)	Min. B(MHz)	Determined Conducted Limit (dBm)
54	5270	59.05	28.71 > 24
62	5310	42.27	27.26 > 24
102	5510	41.85	27.21 > 24
110	5550	43.54	27.38 > 24
134	5670	73.80	29.68 > 24
142 (U-NII-2C Band)	5710	43.83	27.41 > 24

802.11ac (VHT80)

POWER OUTPUT

Chan.	Chan. Freq. (MHz)	Maximum Conducted Power (dBm)		Total Power (mW)	Total Power (dBm)	Limit (dBm)	Pass / Fail
		Chain 1	Chain 2				
58	5290	15.76	15.85	76.129	18.82	23.56	Pass
106	5530	14.92	14.96	62.379	17.95	24.00	Pass
122	5610	20.42	20.49	222.098	23.47	24.00	Pass
*138 (U-NII-2C Band)	5690	16.24	16.61	91.747	19.63	24.00	Pass
*138 (U-NII-3 Band)	5690	1.71	1.26	2.944	4.69	29.61	Pass

Note: * Test was performed in accordance with Measurement follow FCC KDB 789033 UNII test procedure Method SA-2 and use spectrum analyzer test.

1. For U-NII-2A: The max. gain is 6.44dBi > 6dBi, so the power limit shall be reduced to "Determined Conducted Limit-(6.44-6)".
2. For U-NII-2C: The max. gain is 5.69dBi < 6dBi, so the power limit shall not be reduced.
3. For U-NII-3: The max. gain is 6.39dBi > 6dBi, so the power limit shall be reduced to 30-(6.39-6) = 29.61dBm.

The Total Power for the straddle channel:

Chan.	Chan. Freq. (MHz)	Average Power (mW)	Average Power (dBm)
138	5690	94.691	19.76

Note: The total power was calculated through formula and record the value for reference only.

26dB OCCUPIED BANDWIDTH

Channel	Frequency (MHz)	26dBc Bandwidth (MHz)	
		Chain 1	Chain 2
58	5290	82.84	82.72
106	5530	82.45	82.56
122	5610	163.49	141.82
138 (U-NII-2C Band)	5690	98.15	103.70

Note: For U-NII-2A, U-NII-2C Band output power limitation is determined based on 26dBc bandwidth

Power Limit = 11dBm + 10logB <U-NII-2A, U-NII-2C>			
Channel Number	Freq.(MHz)	Min. B(MHz)	Determined Conducted Limit (dBm)
58	5290	82.72	30.17 > 24
106	5530	82.45	30.16 > 24
122	5610	141.82	32.51 > 24
138 (U-NII-2C Band)	5690	98.15	30.91 > 24

802.11ax (HE20)

POWER OUTPUT

Chan.	Chan. Freq. (MHz)	Maximum Conducted Power (dBm)		Total Power (mW)	Total Power (dBm)	Limit (dBm)	Pass / Fail
		Chain 1	Chain 2				
52	5260	17.72	17.80	119.412	20.77	23.56	Pass
60	5300	17.44	17.50	111.697	20.48	23.56	Pass
64	5320	17.52	17.43	111.829	20.49	23.56	Pass
100	5500	17.35	17.45	109.915	20.41	24.00	Pass
116	5580	18.13	18.40	134.196	21.28	24.00	Pass
140	5700	17.42	17.33	109.283	20.39	24.00	Pass
*144 (U-NII-2C Band)	5720	13.12	13.55	45.202	16.55	22.97	Pass
*144 (U-NII-3 Band)	5720	7.88	7.94	12.946	11.12	29.61	Pass

Note: * Test was performed in accordance with Measurement follow FCC KDB 789033 UNII test procedure Method SA-2 and use spectrum analyzer test.

1. For U-NII-2A: The max. gain is 6.44dBi > 6dBi, so the power limit shall be reduced to "Determined Conducted Limit-(6.44-6)".
2. For U-NII-2C: The max. gain is 5.69dBi < 6dBi, so the power limit shall not be reduced.
3. For U-NII-3: The max. gain is 6.39dBi > 6dBi, so the power limit shall be reduced to 30-(6.39-6) = 29.61dBm.

The Total Power for the straddle channel:

Chan.	Chan. Freq. (MHz)	Average Power (mW)	Average Power (dBm)
144	5720	58.148	17.65

Note: The total power was calculated through formula and record the value for reference only.

26dB OCCUPIED BANDWIDTH

Channel	Frequency (MHz)	26dBc Bandwidth (MHz)	
		Chain 1	Chain 2
52	5260	21.76	21.26
60	5300	21.53	21.33
64	5320	21.54	21.17
100	5500	21.29	21.28
116	5580	21.95	21.67
140	5700	21.56	21.28
144 (U-NII-2C Band)	5720	15.74	15.97

Note: For U-NII-2A, U-NII-2C Band output power limitation is determined based on 26dBc bandwidth

Power Limit = 11dBm + 10logB <U-NII-2A, U-NII-2C>			
Channel Number	Freq.(MHz)	Min. B(MHz)	Determined Conducted Limit (dBm)
52	5260	21.26	24.27 > 24
60	5300	21.33	24.28 > 24
64	5320	21.17	24.25 > 24
100	5500	21.28	24.27 > 24
116	5580	21.67	24.35 > 24
140	5700	21.28	24.27 > 24
144 (U-NII-2C Band)	5720	15.74	22.97 < 24

802.11ax (HE40)

POWER OUTPUT

Chan.	Chan. Freq. (MHz)	Maximum Conducted Power (dBm)		Total Power (mW)	Total Power (dBm)	Limit (dBm)	Pass / Fail
		Chain 1	Chain 2				
54	5270	20.45	20.55	224.418	23.51	23.56	Pass
62	5310	16.45	16.50	88.825	19.49	23.56	Pass
102	5510	15.78	15.85	76.303	18.83	24.00	Pass
110	5550	20.55	20.42	223.655	23.50	24.00	Pass
134	5670	20.46	20.65	227.318	23.57	24.00	Pass
*142 (U-NII-2C Band)	5710	16.04	16.35	86.465	19.37	24.00	Pass
*142 (U-NII-3 Band)	5710	5.89	6.10	8.255	9.17	29.61	Pass

Note: * Test was performed in accordance with Measurement follow FCC KDB 789033 UNII test procedure Method SA-2 and use spectrum analyzer test.

1. For U-NII-2A: The max. gain is 6.44dBi > 6dBi, so the power limit shall be reduced to "Determined Conducted Limit-(6.44-6)".
2. For U-NII-2C: The max. gain is 5.69dBi < 6dBi, so the power limit shall not be reduced.
3. For U-NII-3: The max. gain is 6.39dBi > 6dBi, so the power limit shall be reduced to 30-(6.39-6) = 29.61dBm.

The Total Power for the straddle channel:

Chan.	Chan. Freq. (MHz)	Average Power (mW)	Average Power (dBm)
142	5710	94.72	19.76

Note: The total power was calculated through formula and record the value for reference only.

26dB OCCUPIED BANDWIDTH

Channel	Frequency (MHz)	26dBc Bandwidth (MHz)	
		Chain 1	Chain 2
54	5270	73.04	58.62
62	5310	42.53	42.09
102	5510	42.26	43.03
110	5550	66.75	53.37
134	5670	69.75	74.72
142 (U-NII-2C Band)	5710	49.14	43.64

Note: For U-NII-2A, U-NII-2C Band output power limitation is determined based on 26dBc bandwidth

Power Limit = 11dBm + 10logB <U-NII-2A, U-NII-2C>			
Channel Number	Freq.(MHz)	Min. B(MHz)	Determined Conducted Limit (dBm)
54	5270	58.62	28.68 > 24
62	5310	42.09	27.24 > 24
102	5510	42.26	27.25 > 24
110	5550	53.37	28.27 > 24
134	5670	69.75	29.43 > 24
142 (U-NII-2C Band)	5710	43.64	27.39 > 24

802.11ax (HE80)

POWER OUTPUT

Chan.	Chan. Freq. (MHz)	Maximum Conducted Power (dBm)		Total Power (mW)	Total Power (dBm)	Limit (dBm)	Pass / Fail
		Chain 1	Chain 2				
58	5290	15.79	15.89	76.746	18.85	23.56	Pass
106	5530	14.95	14.99	62.811	17.98	24.00	Pass
122	5610	20.44	20.52	223.382	23.49	24.00	Pass
*138 (U-NII-2C Band)	5690	16.43	16.73	94.98	19.78	24.00	Pass
*138 (U-NII-3 Band)	5690	2.22	2.93	3.787	5.78	29.61	Pass

Note: * Test was performed in accordance with Measurement follow FCC KDB 789033 UNII test procedure Method SA-2 and use spectrum analyzer test.

1. For U-NII-2A: The max. gain is 6.44dBi > 6dBi, so the power limit shall be reduced to "Determined Conducted Limit-(6.44-6)".
2. For U-NII-2C: The max. gain is 5.69dBi < 6dBi, so the power limit shall not be reduced.
3. For U-NII-3: The max. gain is 6.39dBi > 6dBi, so the power limit shall be reduced to 30-(6.39-6) = 29.61dBm.

The Total Power for the straddle channel:

Chan.	Chan. Freq. (MHz)	Average Power (mW)	Average Power (dBm)
138	5690	98.767	19.95

Note: The total power was calculated through formula and record the value for reference only.

26dB OCCUPIED BANDWIDTH

Channel	Frequency (MHz)	26dBc Bandwidth (MHz)	
		Chain 1	Chain 2
58	5290	83.14	82.57
106	5530	82.71	82.81
122	5610	170.69	110.16
138 (U-NII-2C Band)	5690	85.80	88.52

Note: For U-NII-2A, U-NII-2C Band output power limitation is determined based on 26dBc bandwidth

Power Limit = 11dBm + 10logB <U-NII-2A, U-NII-2C>			
Channel Number	Freq.(MHz)	Min. B(MHz)	Determined Conducted Limit (dBm)
58	5290	82.57	30.16 > 24
106	5530	82.71	30.17 > 24
122	5610	110.16	31.42 > 24
138 (U-NII-2C Band)	5690	85.80	30.33 > 24

Beamforming Mode

802.11ac (VHT20)

POWER OUTPUT

Chan.	Chan. Freq. (MHz)	Maximum Conducted Power (dBm)		Total Power (mW)	Total Power (dBm)	Limit (dBm)	Pass / Fail
		Chain 1	Chain 2				
52	5260	17.71	17.77	118.861	20.75	21.08	Pass
60	5300	17.42	17.47	111.055	20.46	21.08	Pass
64	5320	17.51	17.40	111.318	20.47	21.08	Pass
100	5500	17.33	17.42	109.283	20.39	21.84	Pass
116	5580	18.10	18.35	132.956	21.24	21.84	Pass
140	5700	17.39	17.30	108.531	20.36	21.84	Pass
*144 (U-NII-2C Band)	5720	13.23	13.34	44.66	16.50	20.73	Pass
*144 (U-NII-3 Band)	5720	7.53	7.98	12.516	10.97	27.41	Pass

Note: * Test was performed in accordance with Measurement follow FCC KDB 789033 UNII test procedure Method SA-2 and use spectrum analyzer test.

1. For U-NII-2A: The directional gain is 8.92dBi > 6dBi, so the power limit shall be reduced to "Determined Conducted Limit-(8.92-6)".
2. For U-NII-2C: The directional gain is 8.16dBi > 6dBi, so the power limit shall be reduced to "Determined Conducted Limit-(8.16-6)".
3. For U-NII-3: The directional gain is 8.59dBi > 6dBi, so the power limit shall be reduced to 30-(8.59-6) = 27.41dBm.

The Total Power for the straddle channel:

Chan.	Chan. Freq. (MHz)	Average Power (mW)	Average Power (dBm)
144	5720	57.176	17.57

Note: The total power was calculated through formula and record the value for reference only.

26dB OCCUPIED BANDWIDTH

Channel	Frequency (MHz)	26dBc Bandwidth (MHz)	
		Chain 1	Chain 2
52	5260	20.93	20.84
60	5300	20.75	20.72
64	5320	20.79	20.78
100	5500	20.65	20.76
116	5580	21.24	21.77
140	5700	21.16	20.61
144 (U-NII-2C Band)	5720	15.57	15.46

Note: For U-NII-2A, U-NII-2C Band output power limitation is determined based on 26dBc bandwidth

Power Limit = 11dBm + 10logB <U-NII-2A, U-NII-2C>			
Channel Number	Freq.(MHz)	Min. B(MHz)	Determined Conducted Limit (dBm)
52	5260	20.84	24.18 > 24
60	5300	20.72	24.16 > 24
64	5320	20.78	24.17 > 24
100	5500	20.65	24.14 > 24
116	5580	21.24	24.27 > 24
140	5700	20.61	24.14 > 24
144 (U-NII-2C Band)	5720	15.46	22.89 < 24

802.11ac (VHT40)

POWER OUTPUT

Chan.	Chan. Freq. (MHz)	Maximum Conducted Power (dBm)		Total Power (mW)	Total Power (dBm)	Limit (dBm)	Pass / Fail
		Chain 1	Chain 2				
54	5270	17.92	18.00	125.04	20.97	21.08	Pass
62	5310	16.42	16.48	88.316	19.46	21.08	Pass
102	5510	15.76	15.82	75.864	18.80	21.84	Pass
110	5550	18.52	18.40	140.304	21.47	21.84	Pass
134	5670	18.42	18.62	142.28	21.53	21.84	Pass
*142 (U-NII-2C Band)	5710	14.32	14.63	58.944	17.70	21.84	Pass
*142 (U-NII-3 Band)	5710	3.88	4.04	5.232	7.19	27.41	Pass

Note: * Test was performed in accordance with Measurement follow FCC KDB 789033 UNII test procedure Method SA-2 and use spectrum analyzer test.

1. For U-NII-2A: The directional gain is 8.92dBi > 6dBi, so the power limit shall be reduced to "Determined Conducted Limit-(8.92-6)".
2. For U-NII-2C: The directional gain is 8.16dBi > 6dBi, so the power limit shall be reduced to "Determined Conducted Limit-(8.16-6)".
3. For U-NII-3: The directional gain is 8.59dBi > 6dBi, so the power limit shall be reduced to 30-(8.59-6) = 27.41dBm.

The Total Power for the straddle channel:

Chan.	Chan. Freq. (MHz)	Average Power (mW)	Average Power (dBm)
142	5710	64.176	18.07

Note: The total power was calculated through formula and record the value for reference only.

26dB OCCUPIED BANDWIDTH

Channel	Frequency (MHz)	26dBc Bandwidth (MHz)	
		Chain 1	Chain 2
54	5270	59.05	68.81
62	5310	42.27	42.40
102	5510	41.97	41.85
110	5550	65.62	43.54
134	5670	73.80	78.68
142 (U-NII-2C Band)	5710	43.83	46.82

Note: For U-NII-2A, U-NII-2C Band output power limitation is determined based on 26dBc bandwidth

Power Limit = 11dBm + 10logB <U-NII-2A, U-NII-2C>			
Channel Number	Freq.(MHz)	Min. B(MHz)	Determined Conducted Limit (dBm)
54	5270	59.05	28.71 > 24
62	5310	42.27	27.26 > 24
102	5510	41.85	27.21 > 24
110	5550	43.54	27.38 > 24
134	5670	73.80	29.68 > 24
142 (U-NII-2C Band)	5710	43.83	27.41 > 24

802.11ac (VHT80)

POWER OUTPUT

Chan.	Chan. Freq. (MHz)	Maximum Conducted Power (dBm)		Total Power (mW)	Total Power (dBm)	Limit (dBm)	Pass / Fail
		Chain 1	Chain 2				
58	5290	15.76	15.85	76.129	18.82	21.08	Pass
106	5530	14.92	14.97	62.451	17.96	21.84	Pass
122	5610	18.42	18.50	140.297	21.47	21.84	Pass
*138 (U-NII-2C Band)	5690	14.72	14.80	62.476	17.96	21.84	Pass
*138 (U-NII-3 Band)	5690	0.97	0.02	2.354	3.72	27.41	Pass

Note: * Test was performed in accordance with Measurement follow FCC KDB 789033 UNII test procedure Method SA-2 and use spectrum analyzer test.

1. For U-NII-2A: The directional gain is 8.92dBi > 6dBi, so the power limit shall be reduced to "Determined Conducted Limit-(8.92-6)".
2. For U-NII-2C: The directional gain is 8.16dBi > 6dBi, so the power limit shall be reduced to "Determined Conducted Limit-(8.16-6)".
3. For U-NII-3: The directional gain is 8.59dBi > 6dBi, so the power limit shall be reduced to 30-(8.59-6) = 27.41dBm.

The Total Power for the straddle channel:

Chan.	Chan. Freq. (MHz)	Average Power (mW)	Average Power (dBm)
138	5690	64.83	18.12

Note: The total power was calculated through formula and record the value for reference only.

26dB OCCUPIED BANDWIDTH

Channel	Frequency (MHz)	26dBc Bandwidth (MHz)	
		Chain 1	Chain 2
58	5290	82.84	82.72
106	5530	82.45	82.56
122	5610	163.49	141.82
138 (U-NII-2C Band)	5690	98.15	103.70

Note: For U-NII-2A, U-NII-2C Band output power limitation is determined based on 26dBc bandwidth

Power Limit = 11dBm + 10logB <U-NII-2A, U-NII-2C>			
Channel Number	Freq.(MHz)	Min. B(MHz)	Determined Conducted Limit (dBm)
58	5290	82.72	30.17 > 24
106	5530	82.45	30.16 > 24
122	5610	141.82	32.51 > 24
138 (U-NII-2C Band)	5690	98.15	30.91 > 24

802.11ax (HE20)

POWER OUTPUT

Chan.	Chan. Freq. (MHz)	Maximum Conducted Power (dBm)		Total Power (mW)	Total Power (dBm)	Limit (dBm)	Pass / Fail
		Chain 1	Chain 2				
52	5260	17.72	17.80	119.412	20.77	21.08	Pass
60	5300	17.44	17.50	111.697	20.48	21.08	Pass
64	5320	17.52	17.43	111.829	20.49	21.08	Pass
100	5500	17.35	17.45	109.915	20.41	21.84	Pass
116	5580	18.13	18.40	134.196	21.28	21.84	Pass
140	5700	17.42	17.33	109.283	20.39	21.84	Pass
*144 (U-NII-2C Band)	5720	13.12	13.55	45.202	16.55	20.81	Pass
*144 (U-NII-3 Band)	5720	7.88	7.94	12.946	11.12	27.41	Pass

Note: * Test was performed in accordance with Measurement follow FCC KDB 789033 UNII test procedure Method SA-2 and use spectrum analyzer test.

1. For U-NII-2A: The directional gain is 8.92dBi > 6dBi, so the power limit shall be reduced to "Determined Conducted Limit-(8.92-6)".
2. For U-NII-2C: The directional gain is 8.16dBi > 6dBi, so the power limit shall be reduced to "Determined Conducted Limit-(8.16-6)".
3. For U-NII-3: The directional gain is 8.59dBi > 6dBi, so the power limit shall be reduced to 30-(8.59-6) = 27.41dBm.

The Total Power for the straddle channel:

Chan.	Chan. Freq. (MHz)	Average Power (mW)	Average Power (dBm)
144	5720	58.148	17.65

Note: The total power was calculated through formula and record the value for reference only.

26dB OCCUPIED BANDWIDTH

Channel	Frequency (MHz)	26dBc Bandwidth (MHz)	
		Chain 1	Chain 2
52	5260	21.76	21.26
60	5300	21.53	21.33
64	5320	21.54	21.17
100	5500	21.29	21.28
116	5580	21.95	21.67
140	5700	21.56	21.28
144 (U-NII-2C Band)	5720	15.74	15.97

Note: For U-NII-2A, U-NII-2C Band output power limitation is determined based on 26dBc bandwidth

Power Limit = 11dBm + 10logB <U-NII-2A, U-NII-2C>			
Channel Number	Freq.(MHz)	Min. B(MHz)	Determined Conducted Limit (dBm)
52	5260	21.26	24.27 > 24
60	5300	21.33	24.28 > 24
64	5320	21.17	24.25 > 24
100	5500	21.28	24.27 > 24
116	5580	21.67	24.35 > 24
140	5700	21.28	24.27 > 24
144 (U-NII-2C Band)	5720	15.74	22.97 < 24

802.11ax (HE40)

POWER OUTPUT

Chan.	Chan. Freq. (MHz)	Maximum Conducted Power (dBm)		Total Power (mW)	Total Power (dBm)	Limit (dBm)	Pass / Fail
		Chain 1	Chain 2				
54	5270	17.95	18.05	126.199	21.01	21.08	Pass
62	5310	16.45	16.50	88.825	19.49	21.08	Pass
102	5510	15.78	15.85	76.303	18.83	21.84	Pass
110	5550	18.55	18.42	141.116	21.50	21.84	Pass
134	5670	18.46	18.65	143.428	21.57	21.84	Pass
*142 (U-NII-2C Band)	5710	14.58	14.74	60.693	17.83	21.84	Pass
*142 (U-NII-3 Band)	5710	4.12	4.39	5.53	7.43	27.41	Pass

Note: * Test was performed in accordance with Measurement follow FCC KDB 789033 UNII test procedure Method SA-2 and use spectrum analyzer test.

1. For U-NII-2A: The directional gain is 8.92dBi > 6dBi, so the power limit shall be reduced to "Determined Conducted Limit-(8.92-6)".
2. For U-NII-2C: The directional gain is 8.16dBi > 6dBi, so the power limit shall be reduced to "Determined Conducted Limit-(8.16-6)".
3. For U-NII-3: The directional gain is 8.59dBi > 6dBi, so the power limit shall be reduced to 30-(8.59-6) = 27.41dBm.

The Total Power for the straddle channel:

Chan.	Chan. Freq. (MHz)	Average Power (mW)	Average Power (dBm)
142	5710	66.223	18.21

Note: The total power was calculated through formula and record the value for reference only.

26dB OCCUPIED BANDWIDTH

Channel	Frequency (MHz)	26dBc Bandwidth (MHz)	
		Chain 1	Chain 2
54	5270	73.04	58.62
62	5310	42.53	42.09
102	5510	42.26	43.03
110	5550	66.75	53.37
134	5670	69.75	74.72
142 (U-NII-2C Band)	5710	49.14	43.64

Note: For U-NII-2A, U-NII-2C Band output power limitation is determined based on 26dBc bandwidth

Power Limit = 11dBm + 10logB <U-NII-2A, U-NII-2C>			
Channel Number	Freq.(MHz)	Min. B(MHz)	Determined Conducted Limit (dBm)
54	5270	58.62	28.68 > 24
62	5310	42.09	27.24 > 24
102	5510	42.26	27.25 > 24
110	5550	53.37	28.27 > 24
134	5670	69.75	29.43 > 24
142 (U-NII-2C Band)	5710	43.64	27.39 > 24

802.11ax (HE80)

POWER OUTPUT

Chan.	Chan. Freq. (MHz)	Maximum Conducted Power (dBm)		Total Power (mW)	Total Power (dBm)	Limit (dBm)	Pass / Fail
		Chain 1	Chain 2				
58	5290	15.79	15.89	76.746	18.85	21.08	Pass
106	5530	14.95	14.99	62.811	17.98	21.84	Pass
122	5610	18.44	18.52	140.944	21.49	21.84	Pass
*138 (U-NII-2C Band)	5690	14.86	15.00	64.928	18.12	21.84	Pass
*138 (U-NII-3 Band)	5690	1.78	1.29	2.976	4.74	27.41	Pass

Note: * Test was performed in accordance with Measurement follow FCC KDB 789033 UNII test procedure Method SA-2 and use spectrum analyzer test.

1. For U-NII-2A: The directional gain is 8.92dBi > 6dBi, so the power limit shall be reduced to "Determined Conducted Limit-(8.92-6)".
2. For U-NII-2C: The directional gain is 8.16dBi > 6dBi, so the power limit shall be reduced to "Determined Conducted Limit-(8.16-6)".
3. For U-NII-3: The directional gain is 8.59dBi > 6dBi, so the power limit shall be reduced to 30-(8.59-6) = 27.41dBm.

The Total Power for the straddle channel:

Chan.	Chan. Freq. (MHz)	Average Power (mW)	Average Power (dBm)
138	5690	67.904	18.32

Note: The total power was calculated through formula and record the value for reference only.

26dB OCCUPIED BANDWIDTH

Channel	Frequency (MHz)	26dBc Bandwidth (MHz)	
		Chain 1	Chain 2
58	5290	83.14	82.57
106	5530	82.71	82.81
122	5610	170.69	110.16
138 (U-NII-2C Band)	5690	85.80	88.52

Note: For U-NII-2A, U-NII-2C Band output power limitation is determined based on 26dBc bandwidth

Power Limit = 11dBm + 10logB <U-NII-2A, U-NII-2C>			
Channel Number	Freq.(MHz)	Min. B(MHz)	Determined Conducted Limit (dBm)
58	5290	82.57	30.16 > 24
106	5530	82.71	30.17 > 24
122	5610	110.16	31.42 > 24
138 (U-NII-2C Band)	5690	85.80	30.33 > 24

Spectrum Plot of Worst Value

802.11a_Chain 1 / CH144 (U-NII-2C Band)

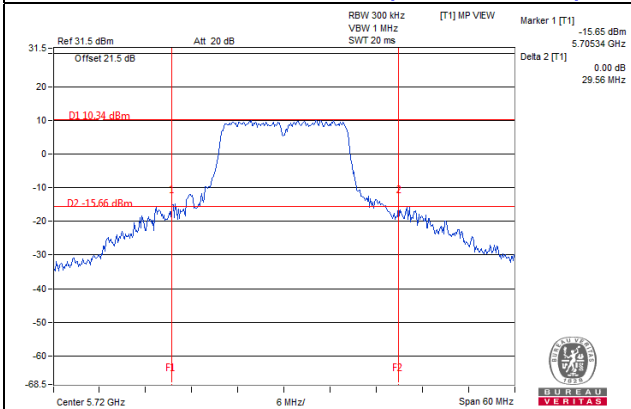

802.11ac (VHT20)_Chain 2 / CH144 (U-NII-2C Band)

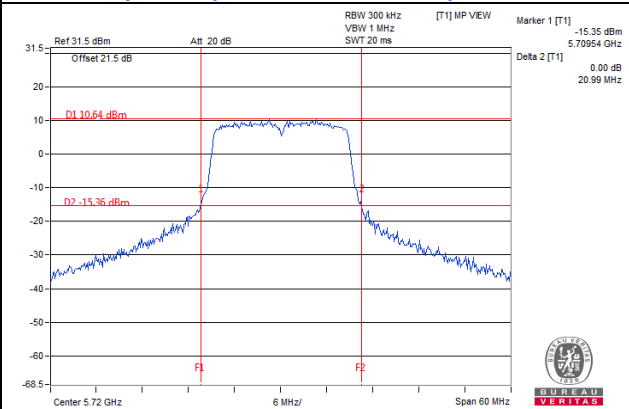

802.11ac (VHT40)_Chain 2 / CH102

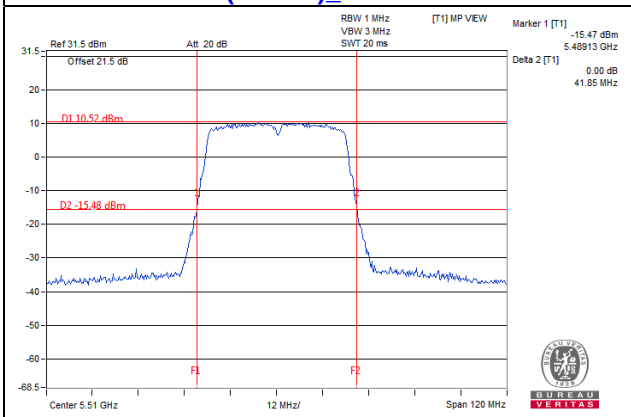

802.11ac (VHT80)_Chain 1 / CH106

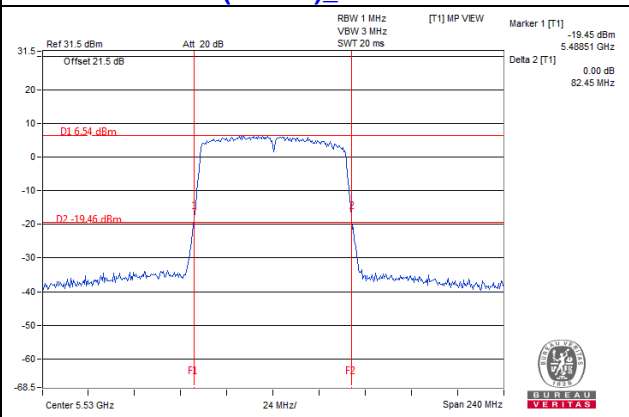

Note:

- For CH144 (U-NII-2C) = 5725MHz - Marker 1
- For CH142 (U-NII-2C) = 5725MHz - Marker 1
- For CH138 (U-NII-2C) = 5725MHz - Marker 1

Spectrum Plot of Worst Value

802.11ax (HE20)_Chain 1 / CH144 (U-NII-2C Band)

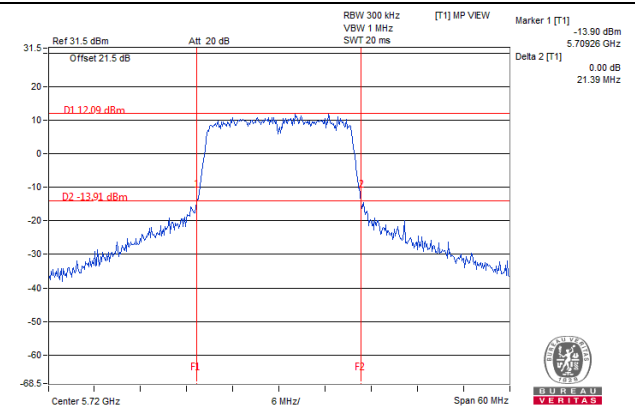

802.11ax (HE40)_Chain 2 / CH62

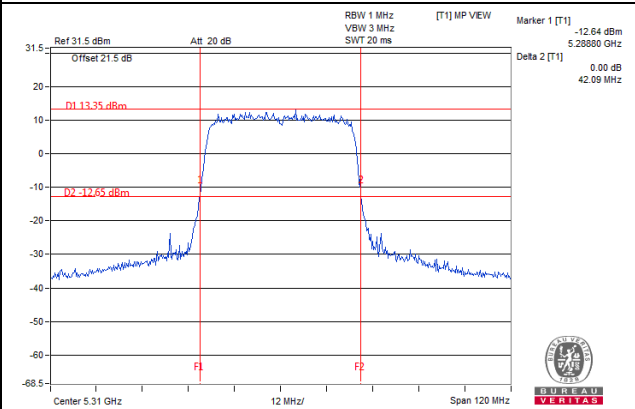

802.11ax (HE80)_Chain 2 / CH58

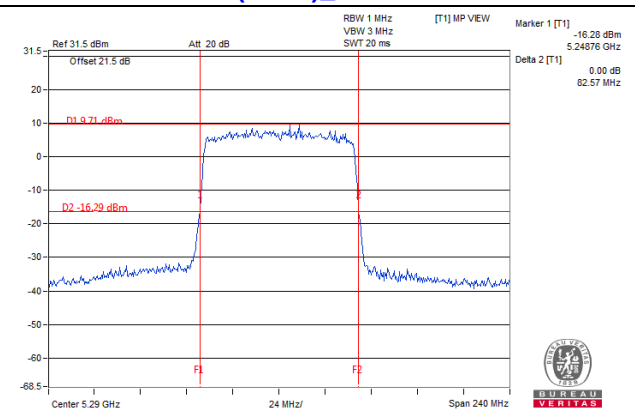

Note:

- For CH144 (U-NII-2C) = 5725MHz - Marker 1
- For CH142 (U-NII-2C) = 5725MHz - Marker 1
- For CH138 (U-NII-2C) = 5725MHz - Marker 1

4.3.10 Test Results (Mode 4)

Non-Beamforming Mode

802.11a

POWER OUTPUT

Chan.	Chan. Freq. (MHz)	Maximum Conducted Power (mW)	Maximum Conducted Power (dBm)	Limit (dBm)	Pass / Fail
52	5260	107.895	20.33	23.56	Pass
60	5300	108.393	20.35	23.56	Pass
64	5320	75.162	18.76	23.56	Pass
100	5500	66.374	18.22	24.00	Pass
116	5580	105.196	20.22	24.00	Pass
140	5700	66.834	18.25	24.00	Pass
*144 (U-NII-2C Band)	5720	32.014	15.05	24.00	Pass
*144 (U-NII-3 Band)	5720	8.248	9.16	30.00	Pass

Note: * Test was performed in accordance with Measurement follow FCC KDB 789033 UNII test procedure Method SA-2 and use spectrum analyzer test.

1. For U-NII-2A: The max. gain is 6.44dBi > 6dBi, so the power limit shall be reduced to "Determined Conducted Limit-(6.44-6)".
2. For U-NII-2C: The max. gain is 5.8dBi < 6dBi, so the power limit shall not be reduced.
3. For U-NII-3: The max. gain is 5.7dBi < 6dBi, so the power limit shall not be reduced.
4. For U-NII-2A: Chain 2 was chosen for test.
For U-NII-2C & U-NII-3: Chain 0 was chosen for test

The Total Power for the straddle channel:

Chan.	Chan. Freq. (MHz)	Average Power (mW)	Average Power (dBm)
144	5720	40.262	16.05

Note: The total power was calculated through formula and record the value for reference only.

26dB OCCUPIED BANDWIDTH

Channel	Frequency (MHz)	26dBc Bandwidth (MHz)
52	5260	39.75
60	5300	37.30
64	5320	32.20
100	5500	27.51
116	5580	38.02
140	5700	36.31
144 (U-NII-2C Band)	5720	23.76

Note: For U-NII-2A, U-NII-2C Band output power limitation is determined based on 26dBc bandwidth

Power Limit = 11dBm + 10logB <U-NII-2A, U-NII-2C>

Channel Number	Freq.(MHz)	Min. B(MHz)	Determined Conducted Limit (dBm)
52	5260	39.75	26.99 > 24
60	5300	37.30	26.71 > 24
64	5320	32.20	26.07 > 24
100	5500	27.51	25.39 > 24
116	5580	38.02	26.8 > 24
140	5700	36.31	26.6 > 24
144 (U-NII-2C Band)	5720	23.76	24.75 > 24

802.11ac (VHT20)

POWER OUTPUT

Chan.	Chan. Freq. (MHz)	Maximum Conducted Power (mW)	Maximum Conducted Power (dBm)	Limit (dBm)	Pass / Fail
52	5260	105.925	20.25	23.56	Pass
60	5300	105.196	20.22	23.56	Pass
64	5320	75.336	18.77	23.56	Pass
100	5500	66.834	18.25	24.00	Pass
116	5580	109.901	20.41	24.00	Pass
140	5700	68.077	18.33	24.00	Pass
*144 (U-NII-2C Band)	5720	34.226	15.34	24.00	Pass
*144 (U-NII-3 Band)	5720	9.065	9.57	30.00	Pass

Note: * Test was performed in accordance with Measurement follow FCC KDB 789033 UNII test procedure Method SA-2 and use spectrum analyzer test.

1. For U-NII-2A: The max. gain is 6.44dBi > 6dBi, so the power limit shall be reduced to "Determined Conducted Limit-(6.44-6)".
2. For U-NII-2C: The max. gain is 5.8dBi < 6dBi, so the power limit shall not be reduced.
3. For U-NII-3: The max. gain is 5.7dBi < 6dBi, so the power limit shall not be reduced.
4. For U-NII-2A: Chain 2 was chosen for test.
For U-NII-2C & U-NII-3: Chain 0 was chosen for test

The Total Power for the straddle channel:

Chan.	Chan. Freq. (MHz)	Average Power (mW)	Average Power (dBm)
144	5720	43.291	16.36

Note: The total power was calculated through formula and record the value for reference only.

26dB OCCUPIED BANDWIDTH

Channel	Frequency (MHz)	26dBc Bandwidth (MHz)
52	5260	32.02
60	5300	32.57
64	5320	21.91
100	5500	20.92
116	5580	34.23
140	5700	22.39
144 (U-NII-2C Band)	5720	24.48

Note: For U-NII-2A, U-NII-2C Band output power limitation is determined based on 26dBc bandwidth

Power Limit = 11dBm + 10logB <U-NII-2A, U-NII-2C>

Channel Number	Freq.(MHz)	Min. B(MHz)	Determined Conducted Limit (dBm)
52	5260	32.02	26.05 > 24
60	5300	32.57	26.12 > 24
64	5320	21.91	24.4 > 24
100	5500	20.92	24.2 > 24
116	5580	34.23	26.34 > 24
140	5700	22.39	24.5 > 24
144 (U-NII-2C Band)	5720	24.48	24.88 > 24

802.11ac (VHT40)

POWER OUTPUT

Chan.	Chan. Freq. (MHz)	Maximum Conducted Power (mW)	Maximum Conducted Power (dBm)	Limit (dBm)	Pass / Fail
54	5270	102.802	20.12	23.56	Pass
62	5310	41.976	16.23	23.56	Pass
102	5510	43.451	16.38	24.00	Pass
110	5550	105.925	20.25	24.00	Pass
134	5670	43.152	16.35	24.00	Pass
*142 (U-NII-2C Band)	5710	42.231	16.26	24.00	Pass
*142 (U-NII-3 Band)	5710	3.554	5.51	30.00	Pass

Note: * Test was performed in accordance with Measurement follow FCC KDB 789033 UNII test procedure Method SA-2 and use spectrum analyzer test.

1. For U-NII-2A: The max. gain is 6.44dBi > 6dBi, so the power limit shall be reduced to "Determined Conducted Limit-(6.44-6)".
2. For U-NII-2C: The max. gain is 5.8dBi < 6dBi, so the power limit shall not be reduced.
3. For U-NII-3: The max. gain is 5.7dBi < 6dBi, so the power limit shall not be reduced.
4. For U-NII-2A: Chain 2 was chosen for test.
For U-NII-2C & U-NII-3: Chain 0 was chosen for test

The Total Power for the straddle channel:

Chan.	Chan. Freq. (MHz)	Average Power (mW)	Average Power (dBm)
142	5710	45.785	16.61

Note: The total power was calculated through formula and record the value for reference only.

26dB OCCUPIED BANDWIDTH

Channel	Frequency (MHz)	26dBc Bandwidth (MHz)
54	5270	80.68
62	5310	44.58
102	5510	42.14
110	5550	67.14
134	5670	42.55
142 (U-NII-2C Band)	5710	56.30

Note: For U-NII-2A, U-NII-2C Band output power limitation is determined based on 26dBc bandwidth

Power Limit = 11dBm + 10logB <U-NII-2A, U-NII-2C>

Channel Number	Freq.(MHz)	Min. B(MHz)	Determined Conducted Limit (dBm)
54	5270	80.68	30.06 > 24
62	5310	44.58	27.49 > 24
102	5510	42.14	27.24 > 24
110	5550	67.14	29.26 > 24
134	5670	42.55	27.28 > 24
142 (U-NII-2C Band)	5710	56.30	28.5 > 24

802.11ac (VHT80)

POWER OUTPUT

Chan.	Chan. Freq. (MHz)	Maximum Conducted Power (mW)	Maximum Conducted Power (dBm)	Limit (dBm)	Pass / Fail
58	5290	36.141	15.58	23.56	Pass
106	5530	42.658	16.30	24.00	Pass
122	5610	103.514	20.15	24.00	Pass
*138 (U-NII-2C Band)	5690	41.463	16.18	24.00	Pass
*138 (U-NII-3 Band)	5690	1.471	1.68	30.00	Pass

Note: * Test was performed in accordance with Measurement follow FCC KDB 789033 UNII test procedure Method SA-2 and use spectrum analyzer test.

1. For U-NII-2A: The max. gain is 6.44dBi > 6dBi, so the power limit shall be reduced to "Determined Conducted Limit-(6.44-6)".
2. For U-NII-2C: The max. gain is 5.8dBi < 6dBi, so the power limit shall not be reduced.
3. For U-NII-3: The max. gain is 5.7dBi < 6dBi, so the power limit shall not be reduced.
4. For U-NII-2A: Chain 2 was chosen for test.
For U-NII-2C & U-NII-3: Chain 0 was chosen for test

The Total Power for the straddle channel:

Chan.	Chan. Freq. (MHz)	Average Power (mW)	Average Power (dBm)
138	5690	42.934	16.33

Note: The total power was calculated through formula and record the value for reference only.

26dB OCCUPIED BANDWIDTH

Channel	Frequency (MHz)	26dBc Bandwidth (MHz)
58	5290	89.44
106	5530	82.43
122	5610	165.57
138 (U-NII-2C Band)	5690	115.26

Note: For U-NII-2A, U-NII-2C Band output power limitation is determined based on 26dBc bandwidth

Power Limit = 11dBm + 10logB <U-NII-2A, U-NII-2C>			
Channel Number	Freq.(MHz)	Min. B(MHz)	Determined Conducted Limit (dBm)
58	5290	89.44	30.51 > 24
106	5530	82.43	30.16 > 24
122	5610	165.57	33.18 > 24
138 (U-NII-2C Band)	5690	115.26	31.61 > 24

802.11ax (HE20)

POWER OUTPUT

Chan.	Chan. Freq. (MHz)	Maximum Conducted Power (mW)	Maximum Conducted Power (dBm)	Limit (dBm)	Pass / Fail
52	5260	110.154	20.42	23.56	Pass
60	5300	110.662	20.44	23.56	Pass
64	5320	77.446	18.89	23.56	Pass
100	5500	68.391	18.35	24.00	Pass
116	5580	110.662	20.44	24.00	Pass
140	5700	69.183	18.40	24.00	Pass
*144 (U-NII-2C Band)	5720	34.443	15.37	23.78	Pass
*144 (U-NII-3 Band)	5720	8.813	9.45	30.00	Pass

Note: * Test was performed in accordance with Measurement follow FCC KDB 789033 UNII test procedure Method SA-2 and use spectrum analyzer test.

1. For U-NII-2A: The max. gain is 6.44dBi > 6dBi, so the power limit shall be reduced to "Determined Conducted Limit-(6.44-6)".
2. For U-NII-2C: The max. gain is 5.8dBi < 6dBi, so the power limit shall not be reduced.
3. For U-NII-3: The max. gain is 5.7dBi < 6dBi, so the power limit shall not be reduced.
4. For U-NII-2A: Chain 2 was chosen for test.
For U-NII-2C & U-NII-3: Chain 0 was chosen for test

The Total Power for the straddle channel:

Chan.	Chan. Freq. (MHz)	Average Power (mW)	Average Power (dBm)
144	5720	43.256	16.36

Note: The total power was calculated through formula and record the value for reference only.

26dB OCCUPIED BANDWIDTH

Channel	Frequency (MHz)	26dBc Bandwidth (MHz)
52	5260	30.94
60	5300	31.70
64	5320	22.04
100	5500	21.21
116	5580	34.98
140	5700	21.40
144 (U-NII-2C Band)	5720	19.01

Note: For U-NII-2A, U-NII-2C Band output power limitation is determined based on 26dBc bandwidth

Power Limit = 11dBm + 10logB <U-NII-2A, U-NII-2C>

Channel Number	Freq.(MHz)	Min. B(MHz)	Determined Conducted Limit (dBm)
52	5260	30.94	25.9 > 24
60	5300	31.70	26.01 > 24
64	5320	22.04	24.43 > 24
100	5500	21.21	24.26 > 24
116	5580	34.98	26.43 > 24
140	5700	21.40	24.3 > 24
144 (U-NII-2C Band)	5720	19.01	23.78 < 24

802.11ax (HE40)

POWER OUTPUT

Chan.	Chan. Freq. (MHz)	Maximum Conducted Power (mW)	Maximum Conducted Power (dBm)	Limit (dBm)	Pass / Fail
54	5270	108.393	20.35	23.56	Pass
62	5310	44.157	16.45	23.56	Pass
102	5510	43.954	16.43	24.00	Pass
110	5550	107.895	20.33	24.00	Pass
134	5670	43.853	16.42	24.00	Pass
*142 (U-NII-2C Band)	5710	42.859	16.32	24.00	Pass
*142 (U-NII-3 Band)	5710	3.785	5.78	30.00	Pass

Note: * Test was performed in accordance with Measurement follow FCC KDB 789033 UNII test procedure Method SA-2 and use spectrum analyzer test.

1. For U-NII-2A: The max. gain is 6.44dBi > 6dBi, so the power limit shall be reduced to "Determined Conducted Limit-(6.44-6)".
2. For U-NII-2C: The max. gain is 5.8dBi < 6dBi, so the power limit shall not be reduced.
3. For U-NII-3: The max. gain is 5.7dBi < 6dBi, so the power limit shall not be reduced.
4. For U-NII-2A: Chain 2 was chosen for test.
For U-NII-2C & U-NII-3: Chain 0 was chosen for test

The Total Power for the straddle channel:

Chan.	Chan. Freq. (MHz)	Average Power (mW)	Average Power (dBm)
142	5710	46.644	16.69

Note: The total power was calculated through formula and record the value for reference only.

26dB OCCUPIED BANDWIDTH

Channel	Frequency (MHz)	26dBc Bandwidth (MHz)
54	5270	63.95
62	5310	42.21
102	5510	42.41
110	5550	62.74
134	5670	42.27
142 (U-NII-2C Band)	5710	53.34

Note: For U-NII-2A, U-NII-2C Band output power limitation is determined based on 26dBc bandwidth

Power Limit = 11dBm + 10logB <U-NII-2A, U-NII-2C>

Channel Number	Freq.(MHz)	Min. B(MHz)	Determined Conducted Limit (dBm)
54	5270	63.95	29.05 > 24
62	5310	42.21	27.25 > 24
102	5510	42.41	27.27 > 24
110	5550	62.74	28.97 > 24
134	5670	42.27	27.26 > 24
142 (U-NII-2C Band)	5710	53.34	28.27 > 24

802.11ax (HE80)

POWER OUTPUT

Chan.	Chan. Freq. (MHz)	Maximum Conducted Power (mW)	Maximum Conducted Power (dBm)	Limit (dBm)	Pass / Fail
58	5290	37.068	15.69	23.56	Pass
106	5530	43.152	16.35	24.00	Pass
122	5610	105.196	20.22	24.00	Pass
*138 (U-NII-2C Band)	5690	39.386	15.95	24.00	Pass
*138 (U-NII-3 Band)	5690	1.735	2.39	30.00	Pass

Note: * Test was performed in accordance with Measurement follow FCC KDB 789033 UNII test procedure Method SA-2 and use spectrum analyzer test.

1. For U-NII-2A: The max. gain is 6.44dBi > 6dBi, so the power limit shall be reduced to "Determined Conducted Limit-(6.44-6)".
2. For U-NII-2C: The max. gain is 5.8dBi < 6dBi, so the power limit shall not be reduced.
3. For U-NII-3: The max. gain is 5.7dBi < 6dBi, so the power limit shall not be reduced.
4. For U-NII-2A: Chain 2 was chosen for test.
For U-NII-2C & U-NII-3: Chain 0 was chosen for test

The Total Power for the straddle channel:

Chan.	Chan. Freq. (MHz)	Average Power (mW)	Average Power (dBm)
138	5690	41.121	16.14

Note: The total power was calculated through formula and record the value for reference only.

26dB OCCUPIED BANDWIDTH

Channel	Frequency (MHz)	26dBc Bandwidth (MHz)
58	5290	83.02
106	5530	82.84
122	5610	157.89
138 (U-NII-2C Band)	5690	92.83

Note: For U-NII-2A, U-NII-2C Band output power limitation is determined based on 26dBc bandwidth

Power Limit = 11dBm + 10logB <U-NII-2A, U-NII-2C>			
Channel Number	Freq.(MHz)	Min. B(MHz)	Determined Conducted Limit (dBm)
58	5290	83.02	30.19 > 24
106	5530	82.84	30.18 > 24
122	5610	157.89	32.98 > 24
138 (U-NII-2C Band)	5690	92.83	30.67 > 24

Spectrum Plot of Worst Value

802.11a_Chain 0 / CH144 (U-NII-2C Band)

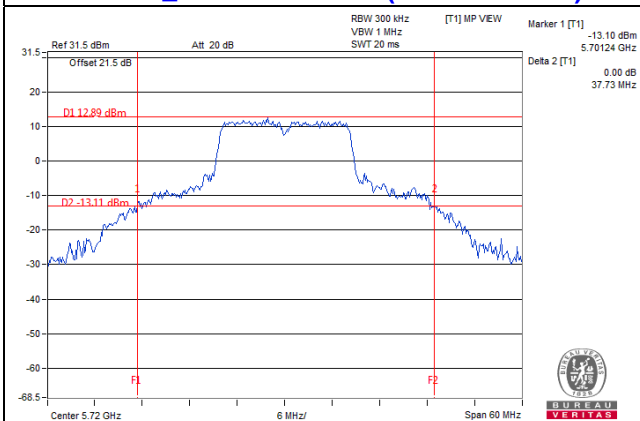

802.11ac (VHT20)_Chain 0 / CH100

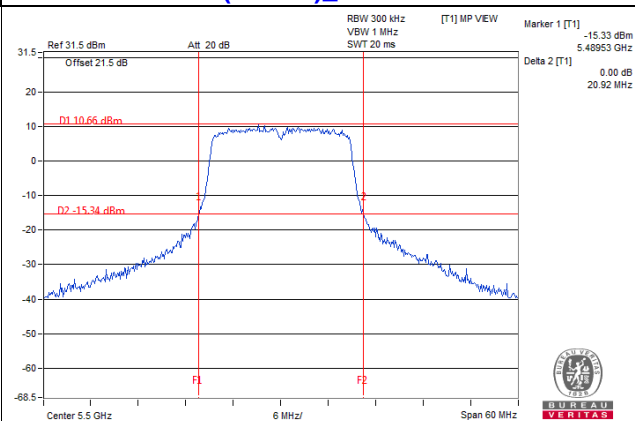

802.11ac (VHT40)_Chain 0 / CH102

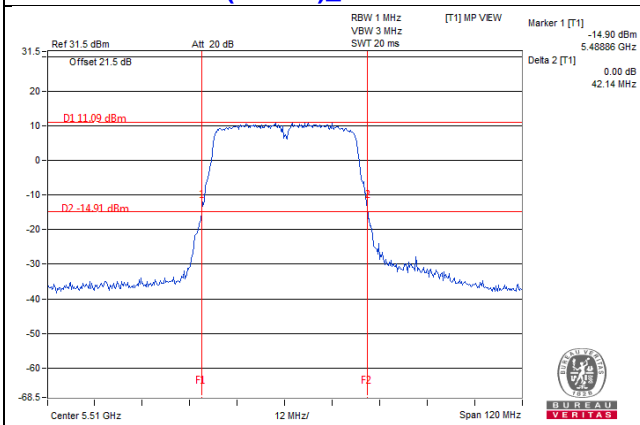

802.11ac (VHT80)_Chain 0 / CH106

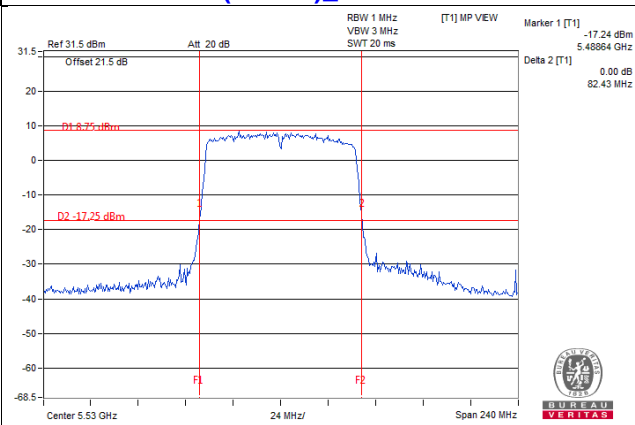

Note:

- For CH144 (U-NII-2C) = 5725MHz - Marker 1
- For CH142 (U-NII-2C) = 5725MHz - Marker 1
- For CH138 (U-NII-2C) = 5725MHz - Marker 1

Spectrum Plot of Worst Value

802.11ax (HE20)_Chain 0 / CH144 (U-NII-2C Band)

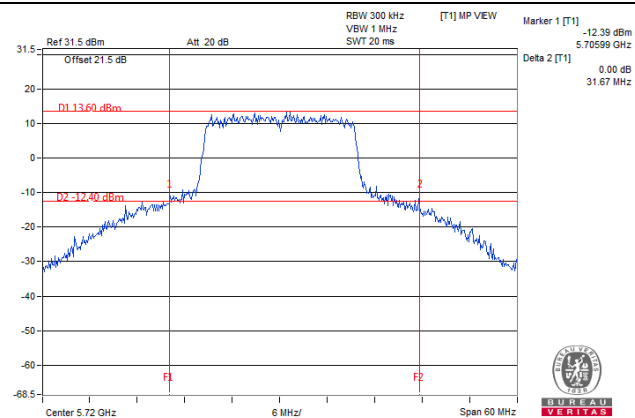

802.11ax (HE40)_Chain 2 / CH62

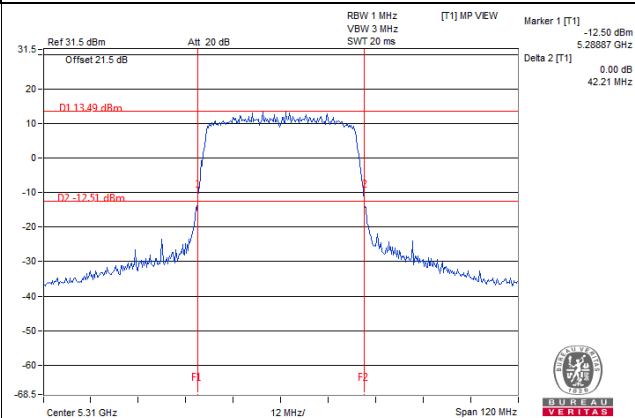

802.11ax (HE80)_Chain 0 / CH106

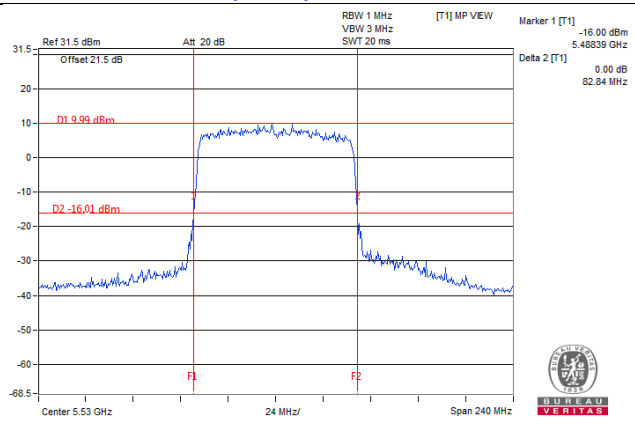

Note:

- For CH144 (U-NII-2C) = 5725MHz - Marker 1
- For CH142 (U-NII-2C) = 5725MHz - Marker 1
- For CH138 (U-NII-2C) = 5725MHz - Marker 1

4.4 Occupied Bandwidth Measurement

4.4.1 Test Setup

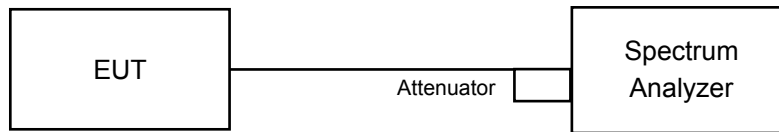

4.4.2 Test Instruments

Refer to section 4.1.2 to get information of above instrument.

4.4.3 Test Procedure

The transmitter output was connected to the spectrum analyzer through an attenuator. The bandwidth of the fundamental frequency was measured by spectrum analyzer with resolution bandwidth in the range of 1% to 5% of the anticipated emission bandwidth, and a video bandwidth at least 3x the resolution bandwidth and set the detector to SAMPLE. The width of a frequency band such that, below the lower and above the upper frequency limits, the mean powers emitted are each equal to a specified percentage 0.5 %of the total mean power of a given emission.

4.4.4 Test Results (Mode 1)

Non-Beamforming Mode

802.11a

Channel	Channel Frequency (MHz)	Occupied Bandwidth (MHz)							
		Chain 0	Chain 1	Chain 2	Chain 3	Chain 4	Chain 5	Chain 6	Chain 7
52	5260	16.80	16.92	16.80	16.92	16.68	16.68	16.68	16.80
60	5300	16.68	16.92	16.68	16.80	16.68	16.68	16.68	16.68
64	5320	16.68	16.80	16.80	16.80	16.68	16.68	16.68	16.80
100	5500	17.72	17.74	17.78	17.72	17.70	17.78	17.78	17.70
116	5580	16.68	16.80	16.80	16.80	16.68	16.68	16.68	16.92
140	5700	16.68	16.80	16.68	16.92	16.68	16.68	16.68	16.80
144 (U-NII-2C Band)	5720	13.52	13.52	13.40	13.52	13.40	13.40	13.40	13.52
144 (U-NII-3 Band)	5720	3.28	3.28	3.28	3.40	3.28	3.28	3.28	3.28

802.11ax (HE20)

Channel	Channel Frequency (MHz)	Occupied Bandwidth (MHz)							
		Chain 0	Chain 1	Chain 2	Chain 3	Chain 4	Chain 5	Chain 6	Chain 7
52	5260	18.84	18.96	18.96	19.08	18.96	18.96	18.96	19.08
60	5300	19.08	19.08	18.96	18.96	18.96	18.96	18.96	18.96
64	5320	19.08	19.08	19.08	19.08	19.08	19.08	18.96	19.08
100	5500	19.08	18.96	18.96	19.08	18.96	19.08	18.96	19.08
116	5580	19.08	18.96	19.08	18.96	18.96	19.08	18.96	18.84
140	5700	19.08	19.08	19.08	19.08	19.08	19.08	19.08	18.96
144 (U-NII-2C Band)	5720	14.60	14.48	14.48	14.60	14.60	14.60	14.60	14.48
144 (U-NII-3 Band)	5720	4.48	4.48	4.48	4.48	4.36	4.36	4.36	4.48

802.11ax (HE40)

Channel	Channel Frequency (MHz)	Occupied Bandwidth (MHz)							
		Chain 0	Chain 1	Chain 2	Chain 3	Chain 4	Chain 5	Chain 6	Chain 7
54	5270	37.92	38.16	37.92	37.92	38.16	38.16	38.16	38.16
62	5310	38.16	38.16	38.16	38.16	38.16	38.16	38.16	38.16
102	5510	38.16	37.92	38.16	38.16	38.16	38.40	38.16	37.92
110	5550	38.16	37.92	38.16	38.16	37.92	38.16	37.92	38.16
134	5670	38.16	38.16	38.16	37.92	38.16	37.92	38.16	38.16
142 (U-NII-2C Band)	5710	34.20	34.20	34.00	34.20	34.20	34.00	34.20	34.00
142 (U-NII-3 Band)	5710	4.00	4.00	4.00	4.00	3.80	4.00	4.00	4.00

802.11ax (HE80)

Channel	Channel Frequency (MHz)	Occupied Bandwidth (MHz)							
		Chain 0	Chain 1	Chain 2	Chain 3	Chain 4	Chain 5	Chain 6	Chain 7
58	5290	77.28	77.28	77.28	77.28	77.28	77.28	77.28	77.28
106	5530	77.28	77.28	77.28	77.76	77.28	77.28	77.28	77.28
122	5610	77.28	77.28	77.28	77.28	77.28	77.28	77.28	77.28
138 (U-NII-2C Band)	5690	73.40	73.88	73.88	73.88	73.88	73.88	73.88	73.88
138 (U-NII-3 Band)	5690	3.40	3.40	3.40	3.40	3.40	3.40	3.40	3.40

Spectrum Plot of Max. Value

802.11a_Chain 6 / CH100

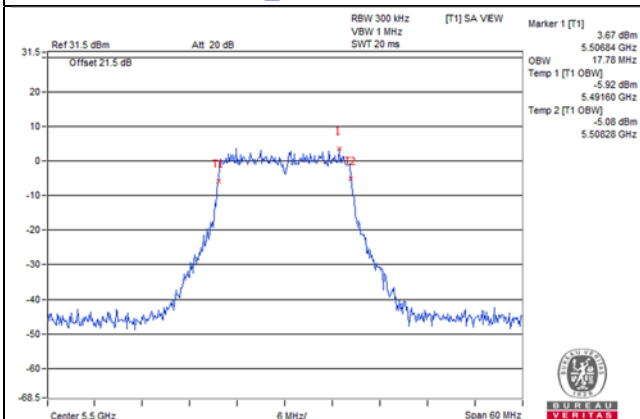

802.11ax (HE20)_Chain 0 / CH60

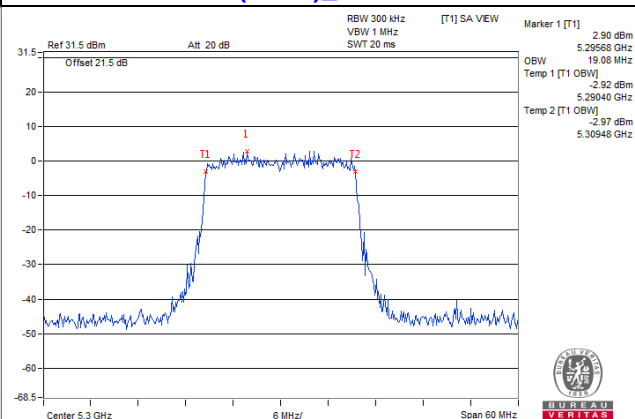

802.11ax (HE40)_Chain 5 / CH102

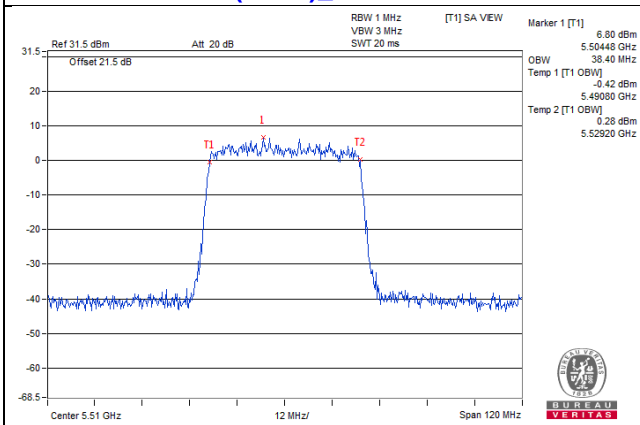

802.11ax (HE80)_Chain 3 / CH106

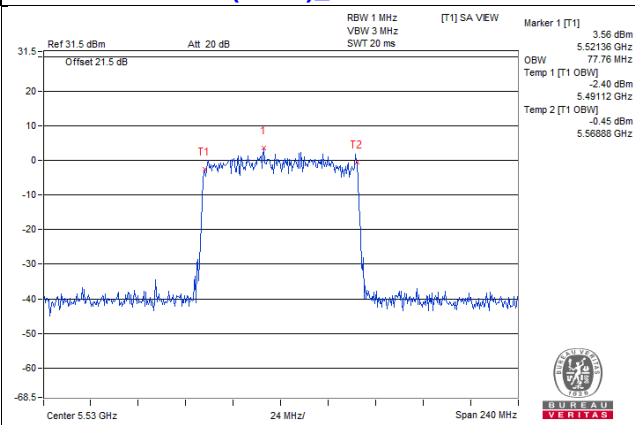

4.4.5 Test Results (Mode 2)

Non-Beamforming Mode

802.11a

Channel	Channel Frequency (MHz)	Occupied Bandwidth (MHz)			
		Chain 4	Chain 5	Chain 6	Chain 7
52	5260	16.80	16.80	16.68	16.80
60	5300	16.68	16.68	16.68	16.92
64	5320	16.80	16.68	16.68	16.56
100	5500	16.92	16.80	16.68	16.68
116	5580	16.92	16.80	16.68	16.68
140	5700	16.68	16.68	16.68	16.68
144 (U-NII-2C Band)	5720	13.40	13.40	13.40	13.40
144 (U-NII-3 Band)	5720	3.40	3.28	3.28	3.28

802.11ax (HE20)

Channel	Channel Frequency (MHz)	Occupied Bandwidth (MHz)			
		Chain 4	Chain 5	Chain 6	Chain 7
52	5260	18.96	18.96	19.08	18.96
60	5300	19.08	18.96	18.84	18.96
64	5320	18.96	18.96	18.96	18.96
100	5500	18.96	18.96	19.08	18.96
116	5580	19.08	18.96	19.08	18.96
140	5700	18.96	18.96	19.08	19.08
144 (U-NII-2C Band)	5720	14.60	14.60	14.60	14.60
144 (U-NII-3 Band)	5720	4.36	4.48	4.48	4.48

802.11ax (HE40)

Channel	Channel Frequency (MHz)	Occupied Bandwidth (MHz)			
		Chain 4	Chain 5	Chain 6	Chain 7
54	5270	38.16	37.92	38.16	38.16
62	5310	38.16	38.16	38.16	38.16
102	5510	38.16	37.92	38.16	37.92
110	5550	37.92	38.16	38.16	37.92
134	5670	37.92	37.92	38.16	38.16
142 (U-NII-2C Band)	5710	34.00	34.20	34.20	34.00
142 (U-NII-3 Band)	5710	4.00	4.00	4.00	4.00

802.11ax (HE80)

Channel	Channel Frequency (MHz)	Occupied Bandwidth (MHz)			
		Chain 4	Chain 5	Chain 6	Chain 7
58	5290	77.28	77.28	77.28	77.28
106	5530	76.80	77.28	77.28	77.28
122	5610	77.76	77.28	77.28	77.28
138 (U-NII-2C Band)	5690	73.88	73.88	73.88	73.88
138 (U-NII-3 Band)	5690	3.40	3.40	3.40	3.40

Spectrum Plot of Max. Value

802.11a_Chain 7 / CH60

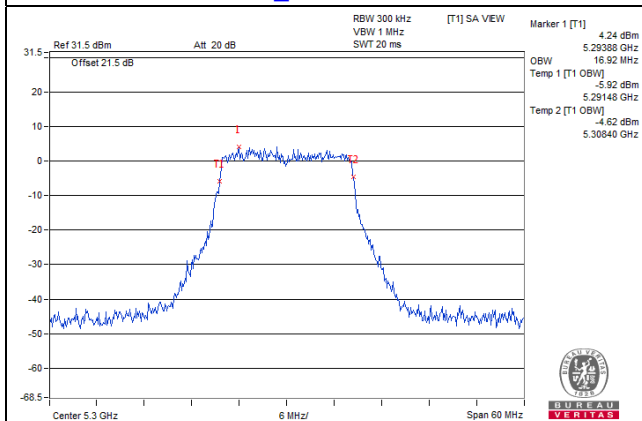

802.11ax (HE20)_Chain 6 / CH52

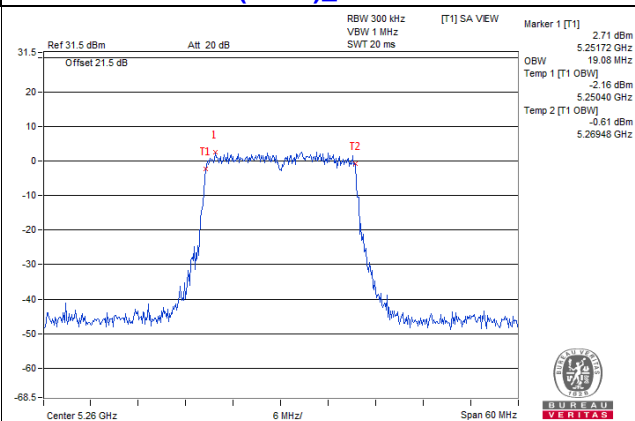

802.11ax (HE40)_Chain 4 / CH54

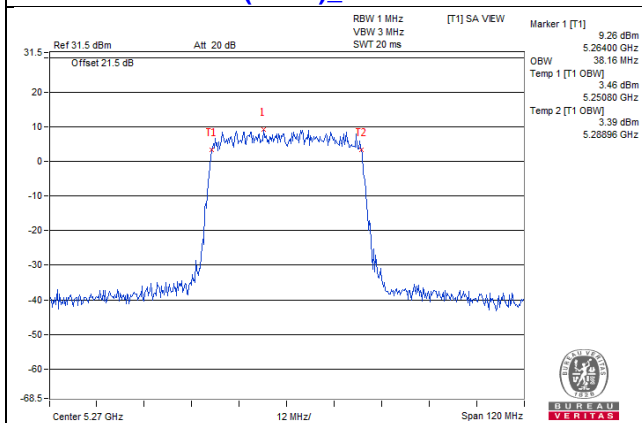

802.11ax (HE80)_Chain 4 / CH122

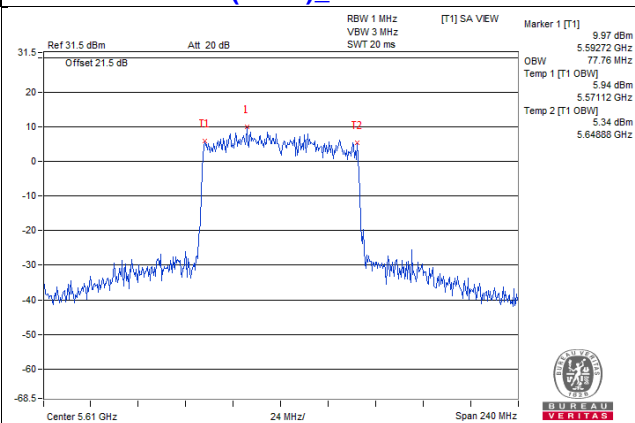

4.4.6 Test Results (Mode 3)

Non-Beamforming Mode

802.11a

Channel	Channel Frequency (MHz)	Occupied Bandwidth (MHz)	
		Chain 1	Chain 2
52	5260	16.68	16.92
60	5300	16.80	16.68
64	5320	16.68	16.68
100	5500	16.80	16.68
116	5580	16.92	16.68
140	5700	16.68	16.80
144 (U-NII-2C Band)	5720	13.52	13.40
144 (U-NII-3 Band)	5720	3.40	3.40

802.11ax (HE20)

Channel	Channel Frequency (MHz)	Occupied Bandwidth (MHz)	
		Chain 1	Chain 2
52	5260	19.08	19.08
60	5300	19.08	18.96
64	5320	18.96	19.08
100	5500	18.96	19.08
116	5580	19.08	19.08
140	5700	18.96	18.96
144 (U-NII-2C Band)	5720	14.60	14.60
144 (U-NII-3 Band)	5720	4.48	4.48

802.11ax (HE40)

Channel	Channel Frequency (MHz)	Occupied Bandwidth (MHz)	
		Chain 1	Chain 2
54	5270	38.40	38.40
62	5310	38.16	38.16
102	5510	38.16	38.16
110	5550	38.40	38.40
134	5670	38.64	38.64
142 (U-NII-2C Band)	5710	34.20	34.40
142 (U-NII-3 Band)	5710	4.00	4.20

802.11ax (HE80)

Channel	Channel Frequency (MHz)	Occupied Bandwidth (MHz)	
		Chain 1	Chain 2
58	5290	77.28	77.28
106	5530	77.28	77.28
122	5610	78.24	78.24
138 (U-NII-2C Band)	5690	73.88	73.88
138 (U-NII-3 Band)	5690	3.88	3.88

Spectrum Plot of Max. Value

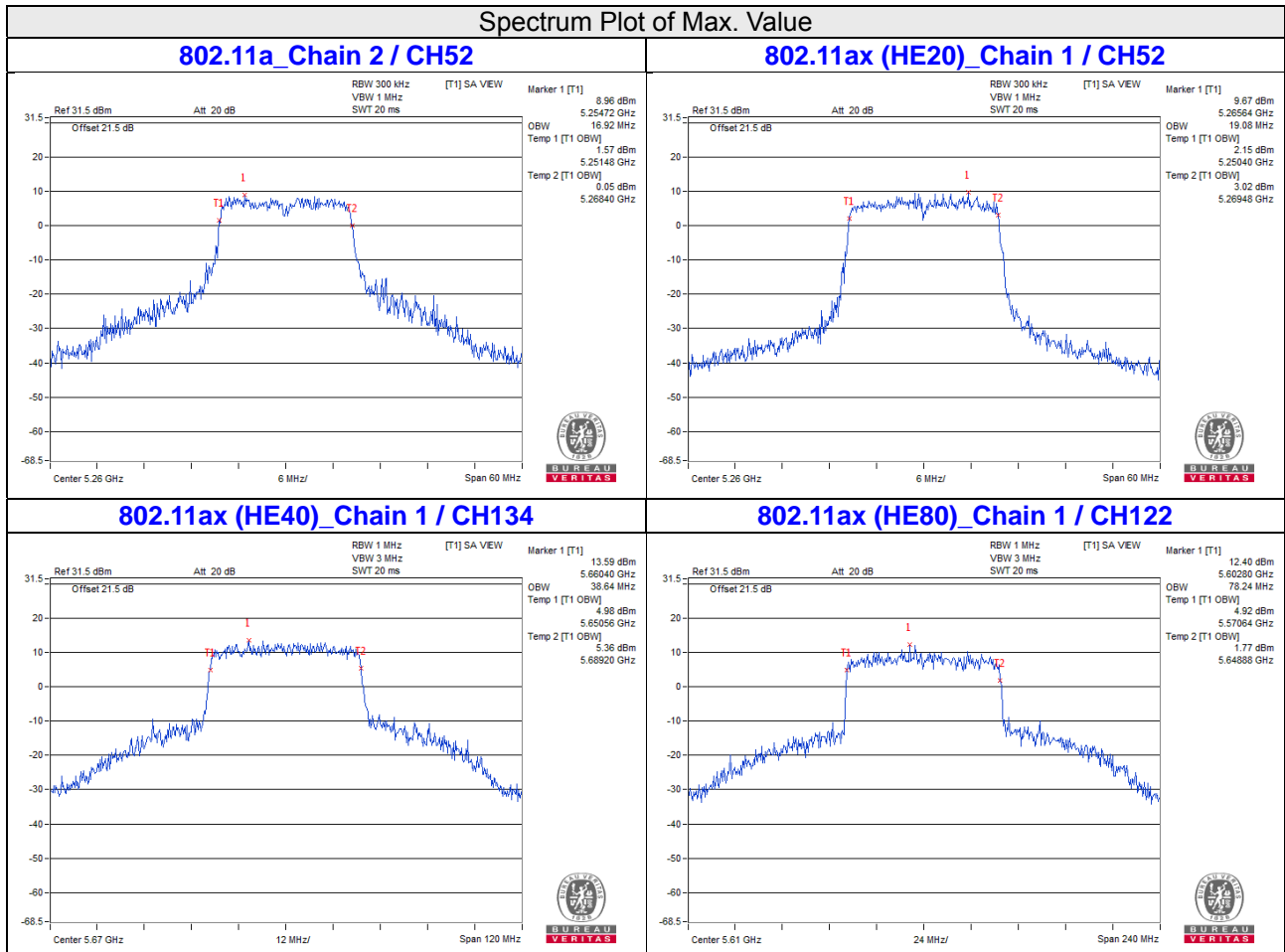

4.4.7 Test Results (Mode 4)

Non-Beamforming Mode

802.11a

Channel	Channel Frequency (MHz)	Occupied Bandwidth (MHz)
52	5260	18.12
60	5300	18.60
64	5320	16.80
100	5500	16.80
116	5580	18.24
140	5700	16.92
144 (U-NII-2C Band)	5720	14.96
144 (U-NII-3 Band)	5720	5.32

Note: 1. For U-NII-2A: Chain 2 was chosen for test.
 For U-NII-2C & U-NII-3: Chain 0 was chosen for test

802.11ax (HE20)

Channel	Channel Frequency (MHz)	Occupied Bandwidth (MHz)
52	5260	19.20
60	5300	19.08
64	5320	19.08
100	5500	18.96
116	5580	19.32
140	5700	19.08
144 (U-NII-2C Band)	5720	14.72
144 (U-NII-3 Band)	5720	4.48

Note: 1. For U-NII-2A: Chain 2 was chosen for test.
 For U-NII-2C & U-NII-3: Chain 0 was chosen for test

802.11ax (HE40)

Channel	Channel Frequency (MHz)	Occupied Bandwidth (MHz)
54	5270	38.40
62	5310	38.16
102	5510	38.16
110	5550	38.64
134	5670	38.40
142 (U-NII-2C Band)	5710	34.60
142 (U-NII-3 Band)	5710	4.20

Note: 1. For U-NII-2A: Chain 2 was chosen for test.
 For U-NII-2C & U-NII-3: Chain 0 was chosen for test

802.11ax (HE80)

Channel	Channel Frequency (MHz)	Occupied Bandwidth (MHz)
58	5290	77.28
106	5530	77.28
122	5610	78.24
138 (U-NII-2C Band)	5690	73.88
138 (U-NII-3 Band)	5690	3.88

Note: 1. For U-NII-2A: Chain 2 was chosen for test.
 For U-NII-2C & U-NII-3: Chain 0 was chosen for test

Spectrum Plot of Max. Value

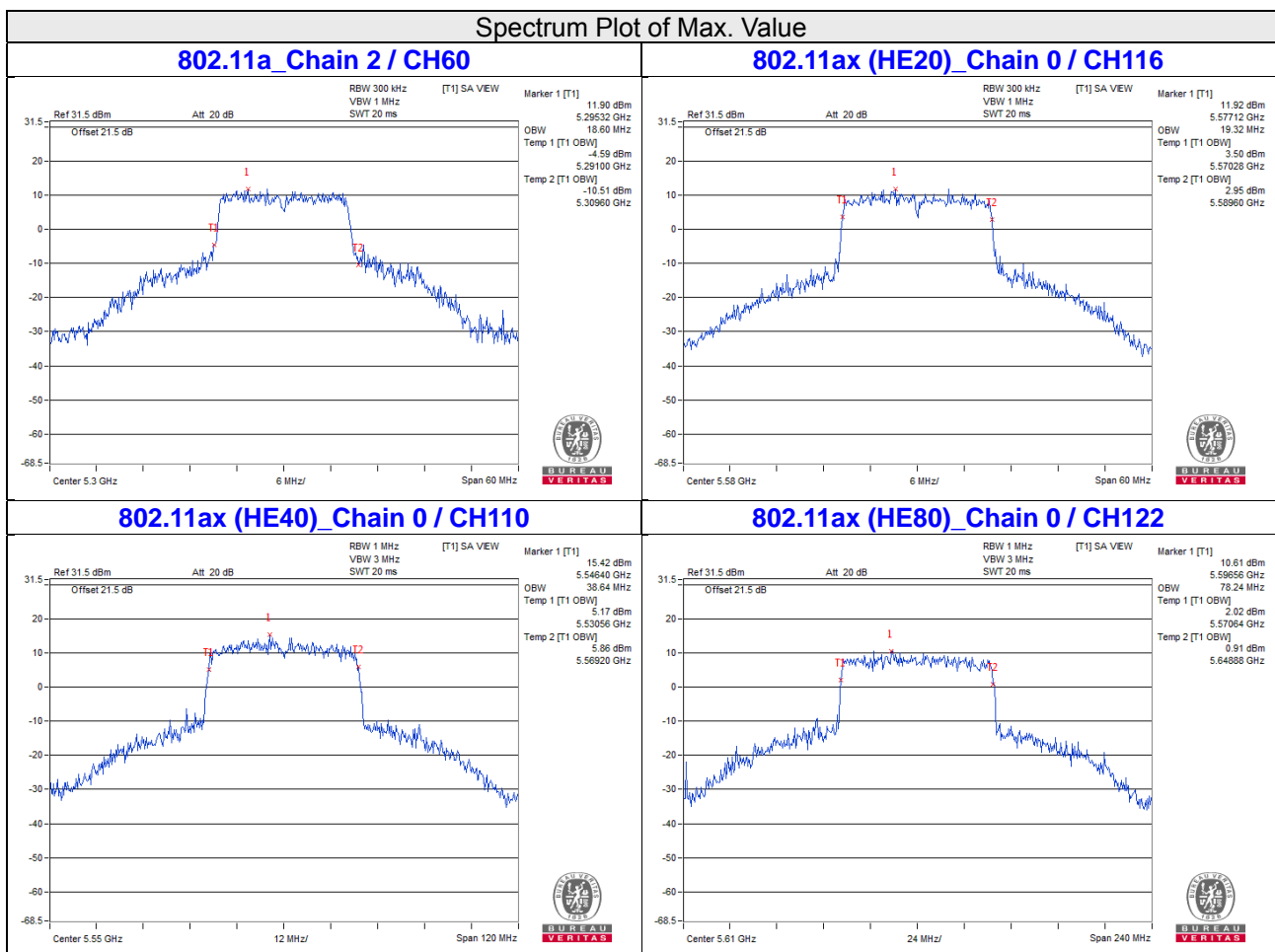

4.5 Peak Power Spectral Density Measurement

4.5.1 Limits of Peak Power Spectral Density Measurement

Operation Band	EUT Category		Limit
U-NII-1		Outdoor Access Point	17dBm/ MHz
		Fixed point-to-point Access Point	
		Indoor Access Point	
		Client device	11dBm/ MHz
U-NII-2A		√	11dBm/ MHz
U-NII-2C		√	11dBm/ MHz
U-NII-3		√	30dBm/ 500kHz

4.5.2 Test Setup

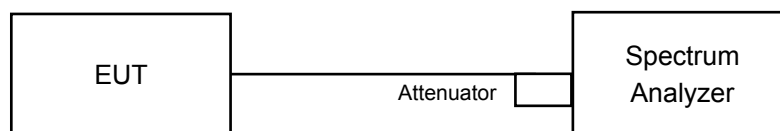

4.5.3 Test Instruments

Refer to section 4.1.2 to get information of above instrument.

4.5.4 Test Procedure

For U-NII-2A, U-NII-2C band:

Using method SA-2

1. Set span to encompass the entire emission bandwidth (EBW) of the signal.
2. Set RBW = 1 MHz, Set VBW ≥ 3 MHz, Detector = RMS
3. Sweep time = auto, trigger set to "free run".
4. Trace average at least 100 traces in power averaging mode.
5. Record the max value and add 10 log (1/duty cycle)

For U-NII-3 band:

1. Set span to encompass the entire emission bandwidth (EBW) of the signal.
2. Set RBW = 300 kHz, Set VBW ≥ 1 MHz, Detector = RMS
3. Use the peak marker function to determine the maximum power level in any 300 kHz band segment within the fundamental EBW.
4. Scale the observed power level to an equivalent value in 500 kHz by adjusting (reducing) the measured power by a bandwidth correction factor (BWCF) where $BWCF = 10\log(500\text{kHz}/300\text{kHz})$
5. Sweep time = auto, trigger set to "free run".
6. Trace average at least 100 traces in power averaging mode.
7. Record the max value and add 10 log (1/duty cycle)

4.5.5 Deviation from Test Standard

No deviation.

4.5.6 EUT Operating Condition

Same as Item 4.3.6.

4.5.7 Test Results (Mode 1)

Non-Beamforming Mode

For U-NII-2A, U-NII-2C:

802.11a

Chan.	Chan. Freq. (MHz)	PSD W/O Duty Factor (dBm/MHz)								Duty Factor (dB)	Total PSD With Duty Factor (dBm/MHz)	Max. Limit (dBm/MHz)	Pass / Fail
		Chain 0	Chain 1	Chain 2	Chain 3	Chain 4	Chain 5	Chain 6	Chain 7				
52	5260	-1.95	-2.44	-2.79	-2.51	-3.08	-3.46	-2.44	-2.21	0.36	6.44	7.66	Pass
60	5300	-3.18	-2.29	-2.97	-3.43	-2.44	-2.27	-3.10	-2.34	0.36	6.30	7.66	Pass
64	5320	-3.03	-3.91	-3.80	-2.63	-3.40	-4.49	-4.80	-3.08	0.36	5.44	7.66	Pass
100	5500	-2.37	-1.65	-1.86	-1.64	-2.50	-2.02	-1.70	-1.62	0.36	7.12	8.12	Pass
116	5580	-2.39	-2.22	-1.96	-2.53	-2.65	-1.86	-1.93	-2.13	0.36	6.83	8.12	Pass
140	5700	-1.67	-1.87	-1.55	-1.46	-1.66	-1.92	-1.75	-2.01	0.36	7.30	8.12	Pass
144 (U-NII-2C Band)	5720	-3.26	-3.22	-2.41	-2.15	-1.93	-3.00	-3.65	-3.62	0.36	6.17	8.12	Pass

- Note: 1. Method a) of power density measurement of KDB 662911 is using for calculating total power density. Total power density is summing entire spectra across corresponding frequency bins on the various outputs by computer.
2. For U-NII-2A: The directional gain = 9.34dBi > 6dBi, so the power density limit shall be reduced to 11-(9.34-6) = 7.66dBm.
3. For U-NII-2C: The directional gain = 8.88dBi > 6dBi, so the power density limit shall be reduced to 11-(8.88-6) = 8.12dBm.
4. Refer to section 3.3 for duty cycle spectrum plot.

802.11ac (VHT20)

Chan.	Chan. Freq. (MHz)	PSD W/O Duty Factor (dBm/MHz)								Duty Factor (dB)	Total PSD With Duty Factor (dBm/MHz)	Max. Limit (dBm/MHz)	Pass / Fail
		Chain 0	Chain 1	Chain 2	Chain 3	Chain 4	Chain 5	Chain 6	Chain 7				
52	5260	-3.28	-2.72	-2.78	-2.47	-3.07	-2.85	-2.87	-2.76	0.20	6.19	7.66	Pass
60	5300	-3.16	-3.26	-3.48	-3.37	-3.69	-3.11	-3.34	-2.82	0.20	5.76	7.66	Pass
64	5320	-3.75	-4.14	-3.77	-4.49	-3.11	-4.12	-3.54	-3.60	0.20	5.23	7.66	Pass
100	5500	-2.95	-3.00	-3.54	-3.24	-2.74	-2.97	-2.63	-2.98	0.20	6.03	8.12	Pass
116	5580	-2.53	-2.63	-2.99	-2.26	-1.92	-2.21	-2.87	-1.97	0.20	6.62	8.12	Pass
140	5700	-3.42	-3.13	-3.04	-2.11	-2.62	-3.16	-3.18	-2.64	0.20	6.14	8.12	Pass
144 (U-NII-2C Band)	5720	-2.85	-2.57	-3.63	-3.27	-2.59	-2.38	-2.74	-3.43	0.20	6.12	8.12	Pass

- Note: 1. Method a) of power density measurement of KDB 662911 is using for calculating total power density. Total power density is summing entire spectra across corresponding frequency bins on the various outputs by computer.
2. For U-NII-2A: The directional gain = 9.34dBi > 6dBi, so the power density limit shall be reduced to 11-(9.34-6) = 7.66dBm.
3. For U-NII-2C: The directional gain = 8.88dBi > 6dBi, so the power density limit shall be reduced to 11-(8.88-6) = 8.12dBm.
4. Refer to section 3.3 for duty cycle spectrum plot.

802.11ac (VHT40)

Chan.	Chan. Freq. (MHz)	PSD W/O Duty Factor (dBm/MHz)								Duty Factor (dB)	Total PSD With Duty Factor (dBm/MHz)	Max. Limit (dBm/MHz)	Pass / Fail
		Chain 0	Chain 1	Chain 2	Chain 3	Chain 4	Chain 5	Chain 6	Chain 7				
54	5270	-6.78	-5.75	-6.84	-6.31	-6.55	-7.30	-5.41	-5.33	0.22	2.80	7.66	Pass
62	5310	-5.53	-5.62	-5.56	-5.70	-5.81	-5.23	-5.44	-5.19	0.22	3.53	7.66	Pass
102	5510	-5.74	-7.01	-5.30	-7.31	-4.46	-5.54	-5.88	-5.59	0.22	3.26	8.12	Pass
110	5550	-5.50	-5.24	-6.12	-5.54	-5.31	-6.16	-6.52	-5.39	0.22	3.33	8.12	Pass
134	5670	-5.62	-6.26	-6.26	-6.27	-6.10	-5.70	-5.94	-5.56	0.22	3.08	8.12	Pass
142 (U-NII-2C Band)	5710	-5.73	-4.92	-5.14	-4.55	-4.81	-5.12	-5.11	-4.81	0.22	4.02	8.12	Pass

- Note: 1. Method a) of power density measurement of KDB 662911 is using for calculating total power density. Total power density is summing entire spectra across corresponding frequency bins on the various outputs by computer.
2. For U-NII-2A: The directional gain = 9.34dBi > 6dBi, so the power density limit shall be reduced to 11-(9.34-6) = 7.66dBm.
3. For U-NII-2C: The directional gain = 8.88dBi > 6dBi, so the power density limit shall be reduced to 11-(8.88-6) = 8.12dBm.
4. Refer to section 3.3 for duty cycle spectrum plot.

802.11ac (VHT80)

Chan.	Chan. Freq. (MHz)	PSD W/O Duty Factor (dBm/MHz)								Duty Factor (dB)	Total PSD With Duty Factor (dBm/MHz)	Max. Limit (dBm/MHz)	Pass / Fail
		Chain 0	Chain 1	Chain 2	Chain 3	Chain 4	Chain 5	Chain 6	Chain 7				
58	5290	-9.09	-8.59	-9.13	-9.00	-8.91	-9.50	-8.34	-8.31	0.19	0.19	7.66	Pass
106	5530	-9.28	-9.13	-8.86	-9.41	-8.38	-8.94	-8.59	-8.17	0.19	0.21	8.12	Pass
122	5610	-8.40	-7.87	-9.65	-10.17	-7.98	-8.75	-9.40	-7.49	0.19	0.41	8.12	Pass
138 (U-NII-2C Band)	5690	-8.16	-7.88	-8.33	-7.61	-8.23	-7.96	-8.30	-8.12	0.19	0.96	8.12	Pass

- Note: 1. Method a) of power density measurement of KDB 662911 is using for calculating total power density. Total power density is summing entire spectra across corresponding frequency bins on the various outputs by computer.
2. For U-NII-2A: The directional gain = 9.34dBi > 6dBi, so the power density limit shall be reduced to 11-(9.34-6) = 7.66dBm.
3. For U-NII-2C: The directional gain = 8.88dBi > 6dBi, so the power density limit shall be reduced to 11-(8.88-6) = 8.12dBm.
4. Refer to section 3.3 for duty cycle spectrum plot.

802.11ax (HE20)

Chan.	Chan. Freq. (MHz)	PSD W/O Duty Factor (dBm/MHz)								Duty Factor (dB)	Total PSD With Duty Factor (dBm/MHz)	Max. Limit (dBm/MHz)	Pass / Fail
		Chain 0	Chain 1	Chain 2	Chain 3	Chain 4	Chain 5	Chain 6	Chain 7				
52	5260	-2.94	-2.58	-2.89	-2.44	-3.03	-2.28	-2.89	-2.47	0.20	6.35	7.66	Pass
60	5300	-3.47	-3.48	-3.08	-3.34	-3.18	-3.20	-3.11	-2.87	0.20	5.82	7.66	Pass
64	5320	-3.35	-3.40	-3.95	-3.89	-3.78	-2.64	-3.00	-3.64	0.20	5.60	7.66	Pass
100	5500	-2.63	-3.53	-3.16	-2.86	-3.32	-2.83	-2.46	-2.74	0.20	6.10	8.12	Pass
116	5580	-2.15	-3.03	-2.95	-3.02	-2.20	-2.62	-3.01	-1.80	0.20	6.46	8.12	Pass
140	5700	-2.77	-2.94	-2.69	-2.53	-2.75	-3.29	-2.67	-3.10	0.20	6.19	8.12	Pass
144 (U-NII-2C Band)	5720	-3.18	-2.83	-3.02	-1.55	-1.51	-2.89	-3.38	-3.56	0.20	6.36	8.12	Pass

- Note: 1. Method a) of power density measurement of KDB 662911 is using for calculating total power density. Total power density is summing entire spectra across corresponding frequency bins on the various outputs by computer.
2. For U-NII-2A: The directional gain = 9.34dBi > 6dBi, so the power density limit shall be reduced to $11-(9.34-6) = 7.66\text{dBm}$.
3. For U-NII-2C: The directional gain = 8.88dBi > 6dBi, so the power density limit shall be reduced to $11-(8.88-6) = 8.12\text{dBm}$.
4. Refer to section 3.3 for duty cycle spectrum plot.

802.11ax (HE40)

Chan.	Chan. Freq. (MHz)	PSD W/O Duty Factor (dBm/MHz)								Duty Factor (dB)	Total PSD With Duty Factor (dBm/MHz)	Max. Limit (dBm/MHz)	Pass / Fail
		Chain 0	Chain 1	Chain 2	Chain 3	Chain 4	Chain 5	Chain 6	Chain 7				
54	5270	-6.19	-5.88	-7.40	-4.69	-6.44	-6.17	-5.92	-6.89	0.16	2.90	7.66	Pass
62	5310	-5.60	-5.57	-6.03	-5.48	-5.26	-5.18	-5.67	-5.34	0.16	3.52	7.66	Pass
102	5510	-6.31	-5.43	-5.51	-5.81	-5.48	-6.20	-5.37	-6.38	0.16	3.24	8.12	Pass
110	5550	-4.92	-5.92	-6.26	-6.13	-5.67	-5.11	-4.49	-4.85	0.16	3.66	8.12	Pass
134	5670	-5.24	-6.47	-5.28	-4.48	-5.57	-6.50	-5.60	-5.77	0.16	3.46	8.12	Pass
142 (U-NII-2C Band)	5710	-5.39	-4.54	-5.44	-4.32	-4.48	-4.89	-5.14	-4.97	0.16	4.15	8.12	Pass

- Note: 1. Method a) of power density measurement of KDB 662911 is using for calculating total power density. Total power density is summing entire spectra across corresponding frequency bins on the various outputs by computer.
2. For U-NII-2A: The directional gain = 9.34dBi > 6dBi, so the power density limit shall be reduced to $11-(9.34-6) = 7.66\text{dBm}$.
3. For U-NII-2C: The directional gain = 8.88dBi > 6dBi, so the power density limit shall be reduced to $11-(8.88-6) = 8.12\text{dBm}$.
4. Refer to section 3.3 for duty cycle spectrum plot.

802.11ax (HE80)

Chan.	Chan. Freq. (MHz)	PSD W/O Duty Factor (dBm/MHz)								Duty Factor (dB)	Total PSD With Duty Factor (dBm/MHz)	Max. Limit (dBm/MHz)	Pass / Fail
		Chain 0	Chain 1	Chain 2	Chain 3	Chain 4	Chain 5	Chain 6	Chain 7				
58	5290	-9.37	-9.50	-9.01	-8.44	-8.66	-9.11	-8.59	-8.20	0.18	0.19	7.66	Pass
106	5530	-8.84	-10.27	-9.03	-8.61	-8.21	-8.81	-7.96	-7.44	0.18	0.45	8.12	Pass
122	5610	-7.42	-8.66	-9.00	-8.28	-8.97	-8.30	-8.93	-8.08	0.18	0.61	8.12	Pass
138 (U-NII-2C Band)	5690	-7.86	-8.14	-8.06	-7.83	-7.79	-8.35	-7.87	-8.42	0.18	1.00	8.12	Pass

- Note: 1. Method a) of power density measurement of KDB 662911 is using for calculating total power density. Total power density is summing entire spectra across corresponding frequency bins on the various outputs by computer.
2. For U-NII-2A: The directional gain = 9.34dBi > 6dBi, so the power density limit shall be reduced to 11-(9.34-6) = 7.66dBm.
3. For U-NII-2C: The directional gain = 8.88dBi > 6dBi, so the power density limit shall be reduced to 11-(8.88-6) = 8.12dBm.
4. Refer to section 3.3 for duty cycle spectrum plot.

Spectrum Plot of Worst Value

802.11a_Chain 3 / CH140

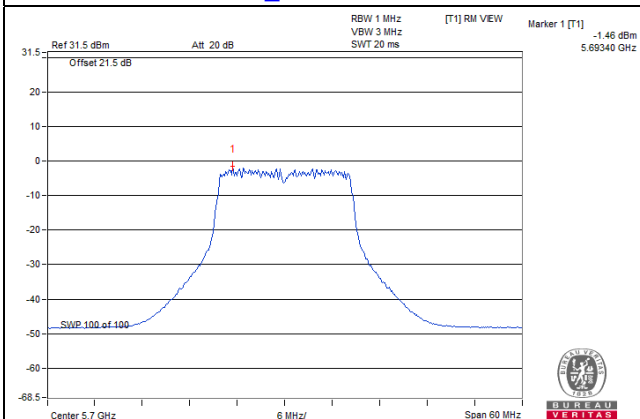

802.11ac (VHT20)_Chain 4 / CH116

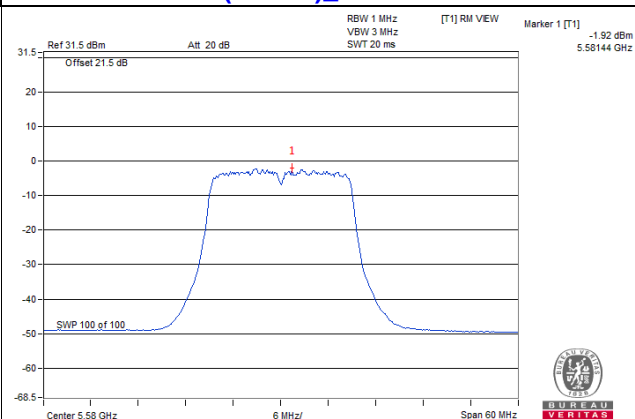

802.11ac (VHT40)_Chain 4 / CH102

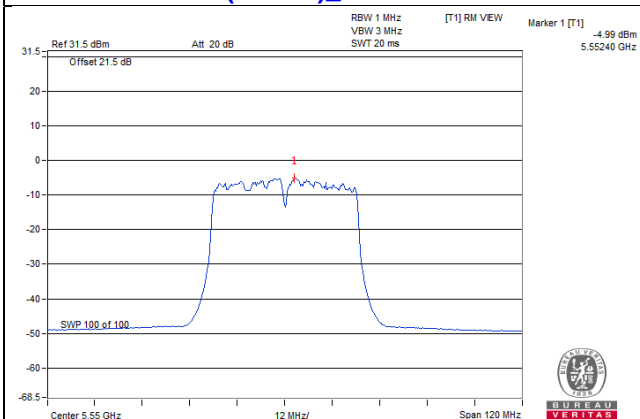

802.11ac (VHT80)_Chain 7 / CH122

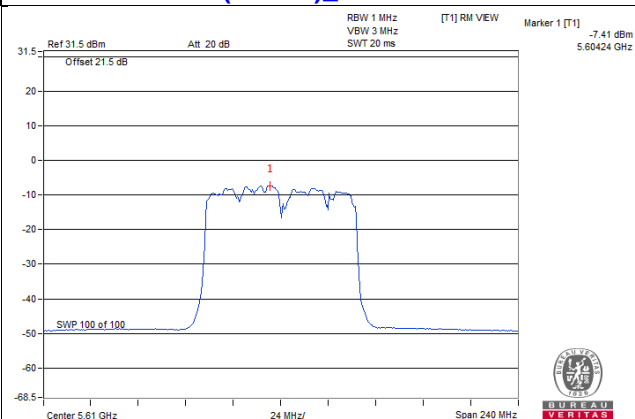

802.11ax (HE20)_Chain 4 / CH144 (U-NII-2C Band)

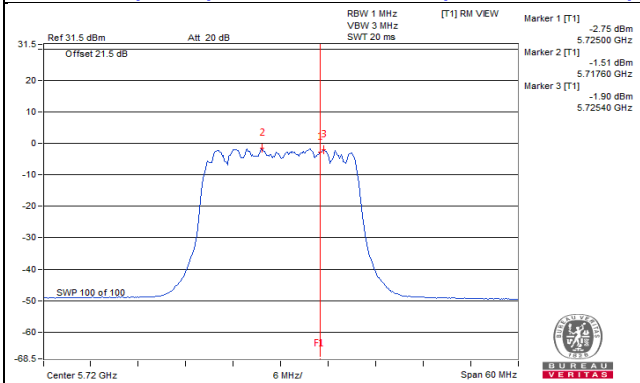

802.11ax (HE40)_Chain 3 / CH142 (U-NII-2C Band)

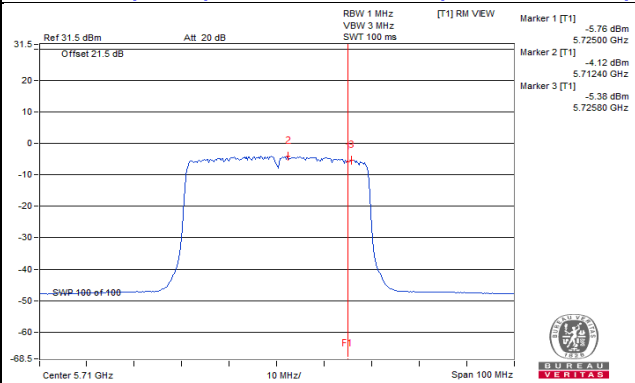

802.11ax (HE80)_Chain 0 / CH122

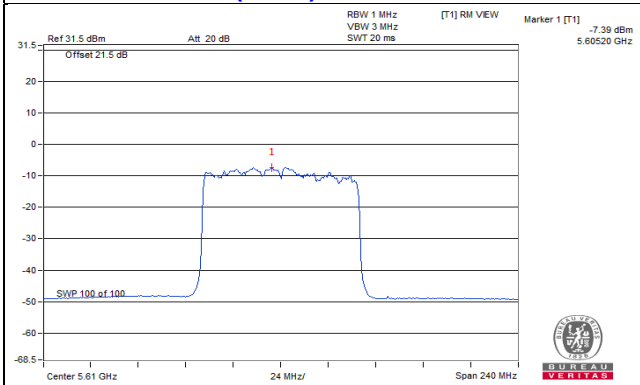

For U-NII-3:

802.11a

Chan.	Freq. (MHz)	PSD W/O Duty Factor (dBm/300kHz)								Duty Factor (dB)	Total PSD With Duty Factor		Total PSD With Duty Factor (dBm/500kHz)	Limit (dBm/500kHz)	Pass /Fail
		Chain 0	Chain 1	Chain 2	Chain 3	Chain 4	Chain 5	Chain 6	Chain 7		mW/300 kHz	dBm/300kHz			
144 (U-NII-3 Band)	5720	-11.90	-13.41	-11.38	-11.96	-12.19	-10.20	-11.05	-11.25	0.36	0.55603	-2.55	-0.33	26.80	Pass

- Note: 1. Method b) Measure and sum spectral maxima across the outputs of KDB 662911 is using for calculating total power density.
 2. The directional gain = 9.2dBi > 6dBi, so the power density limit shall be reduced to 30-(9.2-6) = 26.8dBm.
 3. Refer to section 3.3 for duty cycle spectrum plot.

802.11ac (VHT20)

Chan.	Freq. (MHz)	PSD W/O Duty Factor (dBm/300kHz)								Duty Factor (dB)	Total PSD With Duty Factor		Total PSD With Duty Factor (dBm/500kHz)	Limit (dBm/500kHz)	Pass /Fail
		Chain 0	Chain 1	Chain 2	Chain 3	Chain 4	Chain 5	Chain 6	Chain 7		mW/300 kHz	dBm/300kHz			
144 (U-NII-3 Band)	5720	-11.24	-11.86	-11.42	-11.24	-11.31	-11.37	-10.84	-12.54	0.20	0.57264	-2.42	-0.20	26.80	Pass

- Note: 1. Method b) Measure and sum spectral maxima across the outputs of KDB 662911 is using for calculating total power density.
 2. The directional gain = 9.2dBi > 6dBi, so the power density limit shall be reduced to 30-(9.2-6) = 26.8dBm.
 3. Refer to section 3.3 for duty cycle spectrum plot.

802.11ac (VHT40)

Chan.	Freq. (MHz)	PSD W/O Duty Factor (dBm/300kHz)								Duty Factor (dB)	Total PSD With Duty Factor		Total PSD With Duty Factor (dBm/500kHz)	Limit (dBm/500kHz)	Pass /Fail
		Chain 0	Chain 1	Chain 2	Chain 3	Chain 4	Chain 5	Chain 6	Chain 7		mW/300 kHz	dBm/300kHz			
142 (U-NII-3 Band)	5710	-14.91	-14.75	-14.70	-13.75	-14.60	-14.48	-14.67	-14.86	0.22	0.27893	-5.55	-3.33	26.80	Pass

- Note: 1. Method b) Measure and sum spectral maxima across the outputs of KDB 662911 is using for calculating total power density.
 2. The directional gain = 9.2dBi > 6dBi, so the power density limit shall be reduced to 30-(9.2-6) = 26.8dBm.
 3. Refer to section 3.3 for duty cycle spectrum plot.

802.11ac (VHT80)

Chan.	Freq. (MHz)	PSD W/O Duty Factor (dBm/300kHz)								Duty Factor (dB)	Total PSD With Duty Factor		Total PSD With Duty Factor (dBm/500kHz)	Limit (dBm/500kHz)	Pass /Fail
		Chain 0	Chain 1	Chain 2	Chain 3	Chain 4	Chain 5	Chain 6	Chain 7		mW/300 kHz	dBm/300kHz			
138 (U-NII-3 Band)	5690	-19.72	-18.38	-19.18	-19.09	-20.30	-19.02	-19.41	-19.57	0.19	0.09396	-10.27	-8.05	26.80	Pass

- Note:
- Method b) Measure and sum spectral maxima across the outputs of KDB 662911 is using for calculating total power density.
 - The directional gain = 9.2dBi > 6dBi, so the power density limit shall be reduced to $30-(9.2-6) = 26.8$ dBm.
 - Refer to section 3.3 for duty cycle spectrum plot.

802.11ax (HE20)

Chan.	Freq. (MHz)	PSD W/O Duty Factor (dBm/300kHz)								Duty Factor (dB)	Total PSD With Duty Factor		Total PSD With Duty Factor (dBm/ 500kHz)	Limit (dBm/500kHz)	Pass /Fail
		Chain 0	Chain 1	Chain 2	Chain 3	Chain 4	Chain 5	Chain 6	Chain 7		mW/300 kHz	dBm/300kHz			
144 (U-NII-3 Band)	5720	-15.30	-12.42	-12.70	-11.55	-12.06	-12.96	-11.77	-11.85	0.20	0.45513	-3.42	-1.20	26.80	Pass

- Note:
- Method b) Measure and sum spectral maxima across the outputs of KDB 662911 is using for calculating total power density.
 - The directional gain = 9.2dBi > 6dBi, so the power density limit shall be reduced to $30-(9.2-6) = 26.8$ dBm.
 - Refer to section 3.3 for duty cycle spectrum plot.

802.11ax (HE40)

Chan.	Freq. (MHz)	PSD W/O Duty Factor (dBm/300kHz)								Duty Factor (dB)	Total PSD With Duty Factor		Total PSD With Duty Factor (dBm/ 500kHz)	Limit (dBm/500kHz)	Pass /Fail
		Chain 0	Chain 1	Chain 2	Chain 3	Chain 4	Chain 5	Chain 6	Chain 7		mW/300 kHz	dBm/300kHz			
142 (U-NII-3 Band)	5710	-15.35	-14.75	-14.95	-13.86	-14.78	-14.79	-15.83	-14.57	0.16	0.26327	-5.80	-3.58	26.80	Pass

- Note:
- Method b) Measure and sum spectral maxima across the outputs of KDB 662911 is using for calculating total power density.
 - The directional gain = 9.2dBi > 6dBi, so the power density limit shall be reduced to $30-(9.2-6) = 26.8$ dBm.
 - Refer to section 3.3 for duty cycle spectrum plot.

802.11ax (HE80)

Chan.	Freq. (MHz)	PSD W/O Duty Factor (dBm/300kHz)								Duty Factor (dB)	Total PSD With Duty Factor		Total PSD With Duty Factor (dBm /500kHz)	Limit (dBm/500kHz)	Pass /Fail
		Chain 0	Chain 1	Chain 2	Chain 3	Chain 4	Chain 5	Chain 6	Chain 7		mW/300 kHz	dBm/300kHz			
138 (U-NII-3 Band)	5690	-19.51	-20.27	-18.52	-18.94	-19.39	-19.09	-19.07	-20.32	0.18	0.09293	-10.32	-8.10	26.80	Pass

- Note:
1. Method b) Measure and sum spectral maxima across the outputs of KDB 662911 is using for calculating total power density.
 2. The directional gain = 9.2dBi > 6dBi, so the power density limit shall be reduced to $30 - (9.2 - 6) = 26.8$ dBm.
 3. Refer to section 3.3 for duty cycle spectrum plot.

Spectrum Plot of Worst Value

802.11a_Chain 5 / CH144 (U-NII-3 Band)

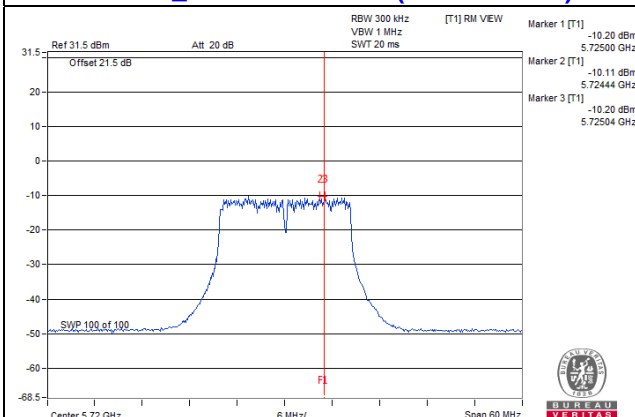

802.11ac (VHT20)_Chain 6 / CH144 (U-NII-3 Band)

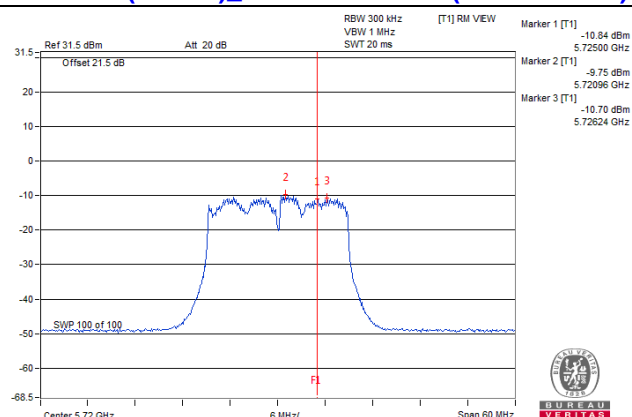

802.11ac (VHT40)_Chain 3 / CH142 (U-NII-3 Band)

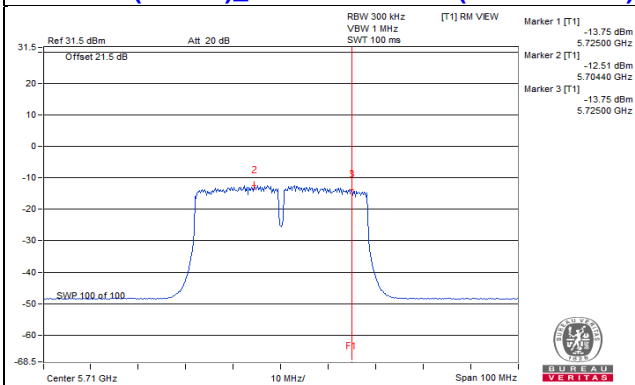

802.11ac (VHT80)_Chain 1 / CH138 (U-NII-3 Band)

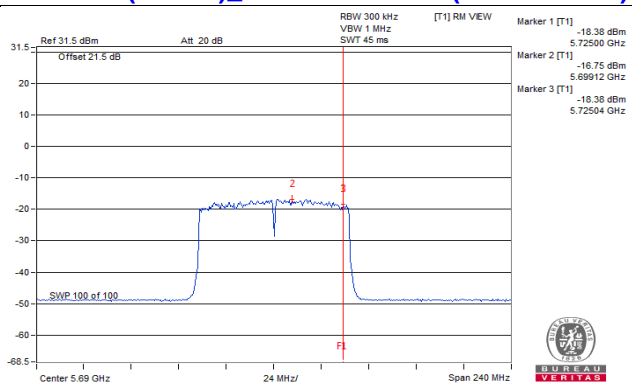

802.11ax (HE20)_Chain 3 / CH144 (U-NII-3 Band)

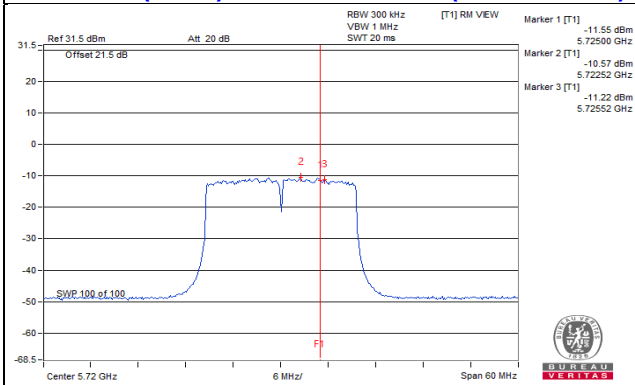

802.11ax (HE40)_Chain 3 / CH142 (U-NII-3 Band)

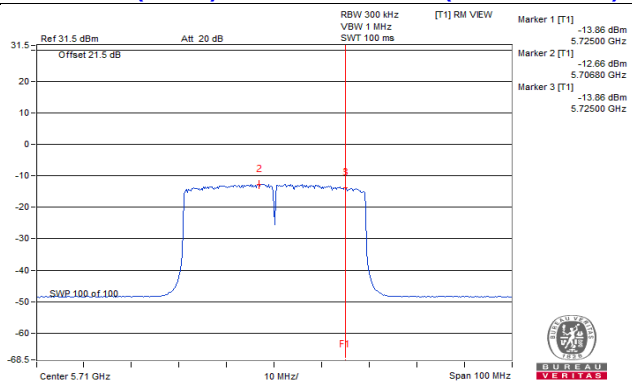

802.11ax (HE80)_Chain 2 / CH138 (U-NII-3 Band)

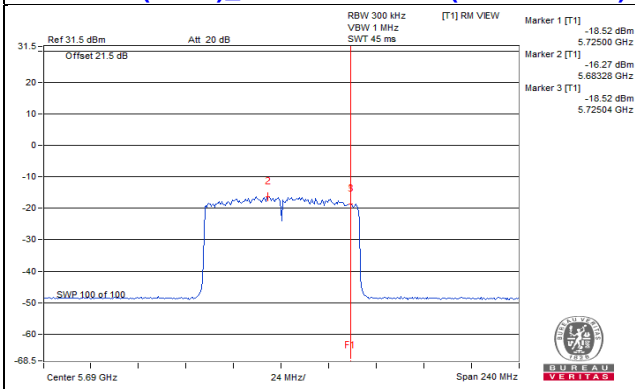

4.5.8 Test Results (Mode 2)

Non-Beamforming Mode

For U-NII-2A, U-NII-2C:

802.11a

Chan.	Chan. Freq. (MHz)	PSD W/O Duty Factor (dBm/MHz)				Duty Factor (dB)	Total PSD With Duty Factor (dBm/MHz)	Max. Limit (dBm/MHz)	Pass / Fail
		Chain 4	Chain 5	Chain 6	Chain 7				
52	5260	-1.39	-1.28	-1.38	-1.01	0.36	5.12	6.29	Pass
60	5300	-0.79	-1.16	-1.00	-0.58	0.36	5.50	6.29	Pass
64	5320	-2.56	-0.80	-2.39	-1.59	0.36	4.60	6.29	Pass
100	5500	-0.30	-0.87	-1.23	-1.08	0.36	5.53	6.67	Pass
116	5580	-0.76	-0.42	-0.82	-0.55	0.36	5.75	6.67	Pass
140	5700	-0.50	-0.72	-0.62	-0.17	0.36	5.88	6.67	Pass
144 (U-NII-2C Band)	5720	-2.53	-1.47	-1.95	-0.22	0.36	4.92	6.67	Pass

- Note: 1. Method a) of power density measurement of KDB 662911 is using for calculating total power density. Total power density is summing entire spectra across corresponding frequency bins on the various outputs by computer.
2. For U-NII-2A: The directional gain = 10.71dBi > 6dBi, so the power density limit shall be reduced to 11-(10.71-6) = 6.29dBm.
3. For U-NII-2C: The directional gain = 10.33dBi > 6dBi, so the power density limit shall be reduced to 11-(10.33-6) = 6.67dBm.
4. Refer to section 3.3 for duty cycle spectrum plot.

802.11ac (VHT20)

Chan.	Chan. Freq. (MHz)	PSD W/O Duty Factor (dBm/MHz)				Duty Factor (dB)	Total PSD With Duty Factor (dBm/MHz)	Max. Limit (dBm/MHz)	Pass / Fail
		Chain 4	Chain 5	Chain 6	Chain 7				
52	5260	-1.38	-1.18	-1.58	-1.11	0.20	4.91	6.29	Pass
60	5300	-1.40	-1.06	-1.77	-1.66	0.20	4.76	6.29	Pass
64	5320	-2.81	-2.11	-1.39	-1.45	0.20	4.32	6.29	Pass
100	5500	-1.76	-0.54	-1.85	-0.96	0.20	4.98	6.67	Pass
116	5580	-1.51	-1.13	-0.76	-0.60	0.20	5.23	6.67	Pass
140	5700	-0.88	-1.47	-1.23	-1.30	0.20	5.01	6.67	Pass
144 (U-NII-2C Band)	5720	-1.24	-1.67	-2.30	-0.77	0.20	4.76	6.67	Pass

- Note: 1. Method a) of power density measurement of KDB 662911 is using for calculating total power density. Total power density is summing entire spectra across corresponding frequency bins on the various outputs by computer.
2. For U-NII-2A: The directional gain = 10.71dBi > 6dBi, so the power density limit shall be reduced to 11-(10.71-6) = 6.29dBm.
3. For U-NII-2C: The directional gain = 10.33dBi > 6dBi, so the power density limit shall be reduced to 11-(10.33-6) = 6.67dBm.
4. Refer to section 3.3 for duty cycle spectrum plot.

802.11ac (VHT40)

Chan.	Chan. Freq. (MHz)	PSD W/O Duty Factor (dBm/MHz)				Duty Factor (dB)	Total PSD With Duty Factor (dBm/MHz)	Max. Limit (dBm/MHz)	Pass / Fail
		Chain 4	Chain 5	Chain 6	Chain 7				
54	5270	-0.79	-2.57	-1.82	-2.13	0.22	4.46	6.29	Pass
62	5310	-1.46	-0.94	-1.10	-1.42	0.22	5.02	6.29	Pass
102	5510	-3.04	-1.03	-1.02	-2.21	0.22	4.50	6.67	Pass
110	5550	-1.20	-0.96	-1.53	-2.38	0.22	4.76	6.67	Pass
134	5670	-1.84	-1.54	-1.05	-2.19	0.22	4.61	6.67	Pass
142 (U-NII-2C Band)	5710	-0.78	-0.36	-0.73	-0.15	0.22	5.74	6.67	Pass

- Note: 1. Method a) of power density measurement of KDB 662911 is using for calculating total power density. Total power density is summing entire spectra across corresponding frequency bins on the various outputs by computer.
2. For U-NII-2A: The directional gain = 10.71dBi > 6dBi, so the power density limit shall be reduced to 11-(10.71-6) = 6.29dBm.
3. For U-NII-2C: The directional gain = 10.33dBi > 6dBi, so the power density limit shall be reduced to 11-(10.33-6) = 6.67dBm.
4. Refer to section 3.3 for duty cycle spectrum plot.

802.11ac (VHT80)

Chan.	Chan. Freq. (MHz)	PSD W/O Duty Factor (dBm/MHz)				Duty Factor (dB)	Total PSD With Duty Factor (dBm/MHz)	Max. Limit (dBm/MHz)	Pass / Fail
		Chain 4	Chain 5	Chain 6	Chain 7				
58	5290	-5.17	-5.87	-5.63	-4.95	0.19	0.82	6.29	Pass
106	5530	-5.50	-7.11	-5.09	-6.61	0.19	0.21	6.67	Pass
122	5610	-2.21	-3.11	-2.80	-3.86	0.19	3.26	6.67	Pass
138 (U-NII-2C Band)	5690	-1.85	-2.35	-2.25	-2.26	0.19	4.04	6.67	Pass

- Note: 1. Method a) of power density measurement of KDB 662911 is using for calculating total power density. Total power density is summing entire spectra across corresponding frequency bins on the various outputs by computer.
2. For U-NII-2A: The directional gain = 10.71dBi > 6dBi, so the power density limit shall be reduced to 11-(10.71-6) = 6.29dBm.
3. For U-NII-2C: The directional gain = 10.33dBi > 6dBi, so the power density limit shall be reduced to 11-(10.33-6) = 6.67dBm.
4. Refer to section 3.3 for duty cycle spectrum plot.

802.11ax (HE20)

Chan.	Chan. Freq. (MHz)	PSD W/O Duty Factor (dBm/MHz)				Duty Factor (dB)	Total PSD With Duty Factor (dBm/MHz)	Max. Limit (dBm/MHz)	Pass / Fail
		Chain 4	Chain 5	Chain 6	Chain 7				
52	5260	-1.29	-2.12	-2.08	-0.92	0.20	4.65	6.29	Pass
60	5300	-2.01	-1.80	-2.01	-2.17	0.20	4.23	6.29	Pass
64	5320	-2.06	-1.70	-1.71	-1.72	0.20	4.43	6.29	Pass
100	5500	-1.02	-1.29	-1.81	-1.55	0.20	4.81	6.67	Pass
116	5580	-0.64	-1.14	-1.16	-0.31	0.20	5.42	6.67	Pass
140	5700	-2.08	-0.33	-1.10	-1.03	0.20	5.13	6.67	Pass
144 (U-NII-2C Band)	5720	-1.03	-1.71	-1.56	-0.44	0.20	5.06	6.67	Pass

- Note: 1. Method a) of power density measurement of KDB 662911 is using for calculating total power density. Total power density is summing entire spectra across corresponding frequency bins on the various outputs by computer.
2. For U-NII-2A: The directional gain = 10.71dBi > 6dBi, so the power density limit shall be reduced to 11-(10.71-6) = 6.29dBm.
3. For U-NII-2C: The directional gain = 10.33dBi > 6dBi, so the power density limit shall be reduced to 11-(10.33-6) = 6.67dBm.
4. Refer to section 3.3 for duty cycle spectrum plot.

802.11ax (HE40)

Chan.	Chan. Freq. (MHz)	PSD W/O Duty Factor (dBm/MHz)				Duty Factor (dB)	Total PSD With Duty Factor (dBm/MHz)	Max. Limit (dBm/MHz)	Pass / Fail
		Chain 4	Chain 5	Chain 6	Chain 7				
54	5270	-2.86	-1.97	-1.06	-1.25	0.16	4.45	6.29	Pass
62	5310	-1.05	-0.70	-1.29	-1.07	0.16	5.16	6.29	Pass
102	5510	-0.47	-1.24	-2.12	-1.43	0.16	4.91	6.67	Pass
110	5550	-0.55	-1.44	-1.64	-0.25	0.16	5.25	6.67	Pass
134	5670	-2.05	-1.46	-1.78	-0.32	0.16	4.83	6.67	Pass
142 (U-NII-2C Band)	5710	-0.45	-0.16	-1.03	-0.42	0.16	5.68	6.67	Pass

- Note: 1. Method a) of power density measurement of KDB 662911 is using for calculating total power density. Total power density is summing entire spectra across corresponding frequency bins on the various outputs by computer.
2. For U-NII-2A: The directional gain = 10.71dBi > 6dBi, so the power density limit shall be reduced to 11-(10.71-6) = 6.29dBm.
3. For U-NII-2C: The directional gain = 10.33dBi > 6dBi, so the power density limit shall be reduced to 11-(10.33-6) = 6.67dBm.
4. Refer to section 3.3 for duty cycle spectrum plot.

802.11ax (HE80)

Chan.	Chan. Freq. (MHz)	PSD W/O Duty Factor (dBm/MHz)				Duty Factor (dB)	Total PSD With Duty Factor (dBm/MHz)	Max. Limit (dBm/MHz)	Pass / Fail
		Chain 4	Chain 5	Chain 6	Chain 7				
58	5290	-5.03	-5.86	-5.52	-5.27	0.18	0.79	6.29	Pass
106	5530	-6.51	-5.16	-5.93	-5.09	0.18	0.57	6.67	Pass
122	5610	-2.53	-4.04	-2.90	-2.55	0.18	3.24	6.67	Pass
138 (U-NII-2C Band)	5690	-1.50	-1.86	-2.41	-1.90	0.18	4.30	6.67	Pass

- Note: 1. Method a) of power density measurement of KDB 662911 is using for calculating total power density. Total power density is summing entire spectra across corresponding frequency bins on the various outputs by computer.
2. For U-NII-2A: The directional gain = 10.71dBi > 6dBi, so the power density limit shall be reduced to $11-(10.71-6) = 6.29\text{dBm}$.
3. For U-NII-2C: The directional gain = 10.33dBi > 6dBi, so the power density limit shall be reduced to $11-(10.33-6) = 6.67\text{dBm}$.
4. Refer to section 3.3 for duty cycle spectrum plot.

Spectrum Plot of Worst Value

802.11a_Chain 7 / CH140

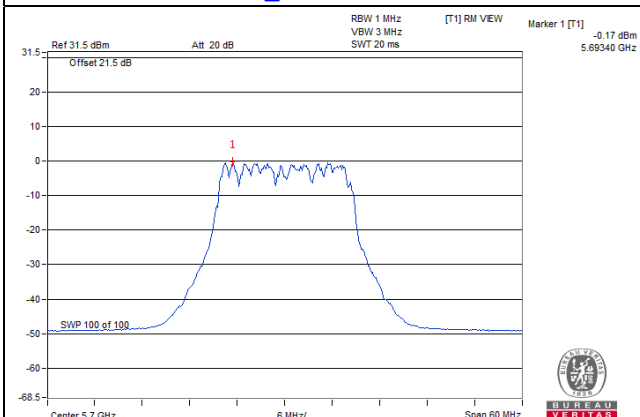

802.11ac (VHT20)_Chain 5 / CH100

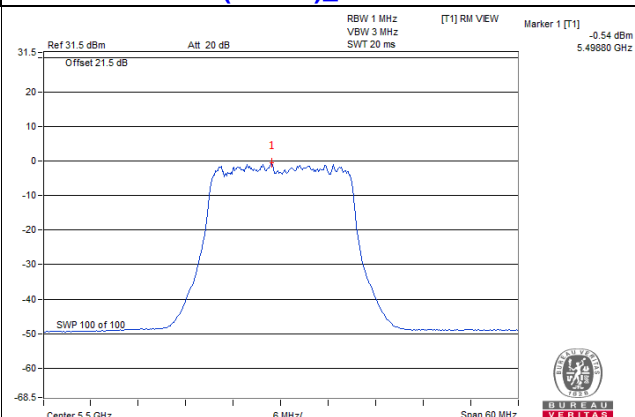

802.11ac (VHT40)_Chain 7 / CH142 (U-NII-2C Band)

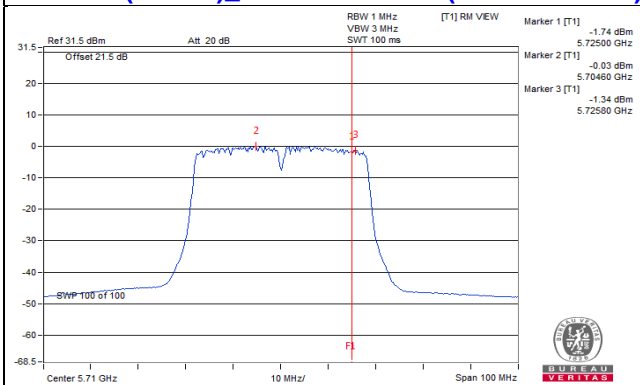

802.11ac (VHT80)_Chain 4 / CH138 (U-NII-2C Band)

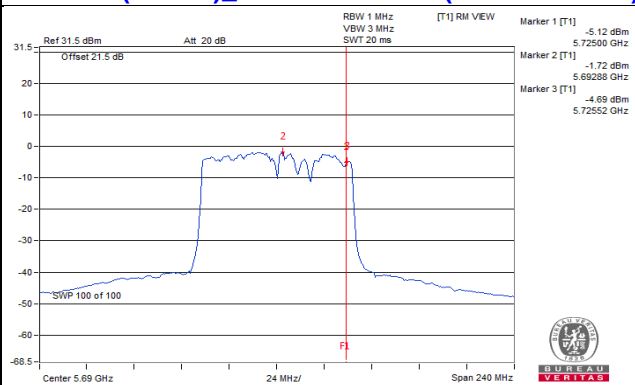

802.11ax (HE20)_Chain 7 / CH116

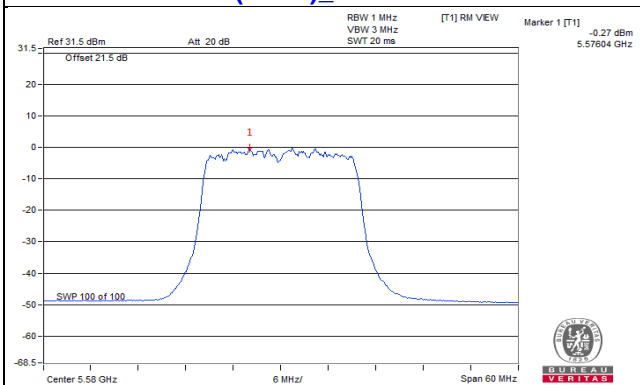

802.11ax (HE40)_Chain 5 / CH142 (U-NII-2C Band)

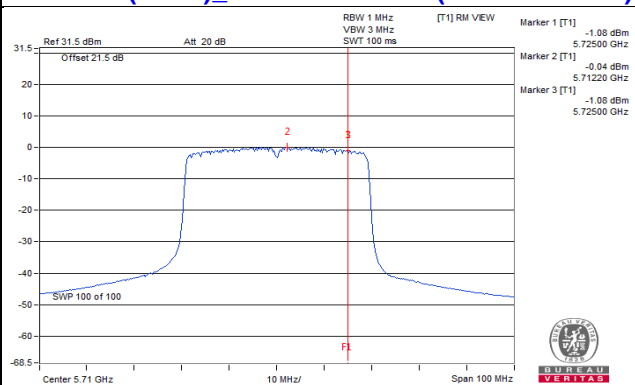

802.11ax (HE80)_Chain 4 / CH138 (U-NII-2C Band)

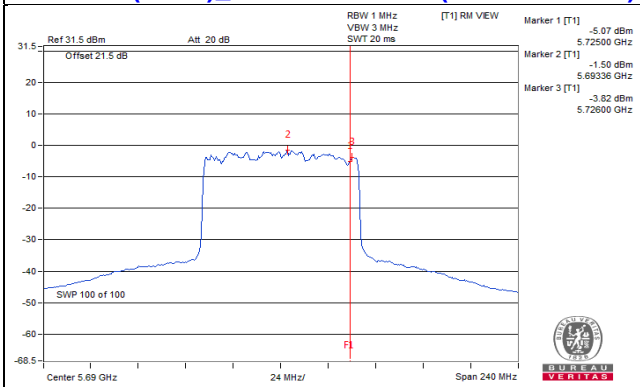

For U-NII-3:

802.11a

Chan.	Freq. (MHz)	PSD (dBm/300kHz)				Duty Factor (dB)	Total PSD		Total PSD With Duty Factor (dBm/500kHz)	Limit (dBm/500kHz)	Pass /Fail
		Chain 4	Chain 5	Chain 6	Chain 7		dBm/300kHz	dBm/300kHz			
144 (U-NII-3 Band)	5720	-8.94	-9.43	-9.44	-9.42	0.36	0.5107	-2.92	-0.70	25.32	Pass

- Note: 1. Method b) Measure and sum spectral maxima across the outputs of KDB 662911 is using for calculating total power density.
 2. The directional gain = 10.68dBi > 6dBi, so the power density limit shall be reduced to 30-(10.68-6) = 25.32dBm.
 3. Refer to section 3.3 for duty cycle spectrum plot.

802.11ac (VHT20)

Chan.	Freq. (MHz)	PSD (dBm/300kHz)				Duty Factor (dB)	Total PSD		Total PSD With Duty Factor (dBm/500kHz)	Limit (dBm/500kHz)	Pass /Fail
		Chain 4	Chain 5	Chain 6	Chain 7		dBm/300kHz	dBm/300kHz			
144 (U-NII-3 Band)	5720	-9.23	-9.34	-10.09	-9.11	0.20	0.47841	-3.20	-0.98	25.32	Pass

- Note: 1. Method b) Measure and sum spectral maxima across the outputs of KDB 662911 is using for calculating total power density.
 2. The directional gain = 10.68dBi > 6dBi, so the power density limit shall be reduced to 30-(10.68-6) = 25.32dBm.
 3. Refer to section 3.3 for duty cycle spectrum plot.

802.11ac (VHT40)

Chan.	Freq. (MHz)	PSD (dBm/300kHz)				Duty Factor (dB)	Total PSD		Total PSD With Duty Factor (dBm/500kHz)	Limit (dBm/500kHz)	Pass /Fail
		Chain 4	Chain 5	Chain 6	Chain 7		dBm/300kHz	dBm/300kHz			
142 (U-NII-3 Band)	5710	-10.57	-9.76	-10.72	-9.78	0.22	0.40288	-3.95	-1.73	25.32	Pass

- Note: 1. Method b) Measure and sum spectral maxima across the outputs of KDB 662911 is using for calculating total power density.
 2. The directional gain = 10.68dBi > 6dBi, so the power density limit shall be reduced to 30-(10.68-6) = 25.32dBm.
 3. Refer to section 3.3 for duty cycle spectrum plot.

802.11ac (VHT80)

Chan.	Freq. (MHz)	PSD (dBm/300kHz)				Duty Factor (dB)	Total PSD		Total PSD With Duty Factor (dBm/500kHz)	Limit (dBm/500kHz)	Pass /Fail
		Chain 4	Chain 5	Chain 6	Chain 7		dBm/300kHz	dBm/300kHz			
138 (U-NII-3 Band)	5690	-12.82	-12.94	-13.56	-14.16	0.19	0.19363	-7.13	-4.91	25.32	Pass

- Note: 1. Method b) Measure and sum spectral maxima across the outputs of KDB 662911 is using for calculating total power density.
 2. The directional gain = 10.68dBi > 6dBi, so the power density limit shall be reduced to $30-(10.68-6) = 25.32$ dBm.
 3. Refer to section 3.3 for duty cycle spectrum plot.

802.11ax (HE20)

Chan.	Freq. (MHz)	PSD (dBm/300kHz)				Duty Factor (dB)	Total PSD		Total PSD With Duty Factor (dBm/500kHz)	Limit (dBm/500kHz)	Pass /Fail
		Chain 4	Chain 5	Chain 6	Chain 7		dBm/300kHz	dBm/300kHz			
144 (U-NII-3 Band)	5720	-10.36	-9.48	-10.52	-9.89	0.20	0.4148	-3.82	-1.60	25.32	Pass

- Note: 1. Method b) Measure and sum spectral maxima across the outputs of KDB 662911 is using for calculating total power density.
 2. The directional gain = 10.68dBi > 6dBi, so the power density limit shall be reduced to $30-(10.68-6) = 25.32$ dBm.
 3. Refer to section 3.3 for duty cycle spectrum plot.

802.11ax (HE40)

Chan.	Freq. (MHz)	PSD (dBm/300kHz)				Duty Factor (dB)	Total PSD		Total PSD With Duty Factor (dBm/500kHz)	Limit (dBm/500kHz)	Pass /Fail
		Chain 4	Chain 5	Chain 6	Chain 7		dBm/300kHz	dBm/300kHz			
142 (U-NII-3 Band)	5710	-10.46	-9.79	-10.70	-10.40	0.16	0.38518	-4.14	-1.92	25.32	Pass

- Note: 1. Method b) Measure and sum spectral maxima across the outputs of KDB 662911 is using for calculating total power density.
 2. The directional gain = 10.68dBi > 6dBi, so the power density limit shall be reduced to $30-(10.68-6) = 25.32$ dBm.
 3. Refer to section 3.3 for duty cycle spectrum plot.

802.11ax (HE80)

Chan.	Freq. (MHz)	PSD (dBm/300kHz)				Duty Factor (dB)	Total PSD		Total PSD With Duty Factor (dBm/500kHz)	Limit (dBm/500kHz)	Pass /Fail
		Chain 4	Chain 5	Chain 6	Chain 7		dBm/300kHz	dBm/300kHz			
138 (U-NII-3 Band)	5690	-12.98	-12.34	-13.35	-13.17	0.18	0.21189	-6.74	-4.52	25.32	Pass

- Note: 1. Method b) Measure and sum spectral maxima across the outputs of KDB 662911 is using for calculating total power density.
2. The directional gain = 10.68dBi > 6dBi, so the power density limit shall be reduced to $30-(10.68-6) = 25.32\text{dBm}$.
3. Refer to section 3.3 for duty cycle spectrum plot.

Spectrum Plot of Worst Value

802.11a_Chain 4 / CH144 (U-NII-3 Band)

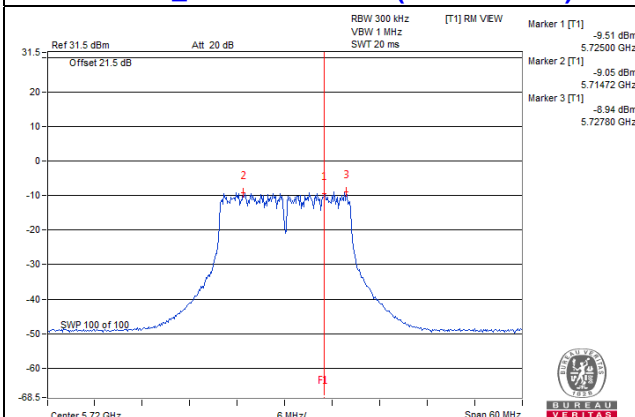

802.11ac (VHT20)_Chain 7 / CH144 (U-NII-3 Band)

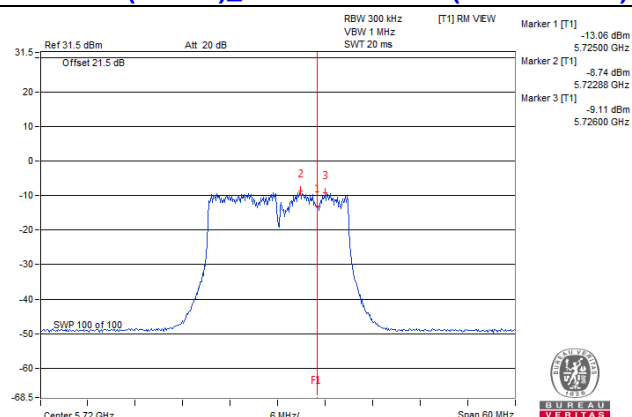

802.11ac (VHT40)_Chain 5 / CH142 (U-NII-3 Band)

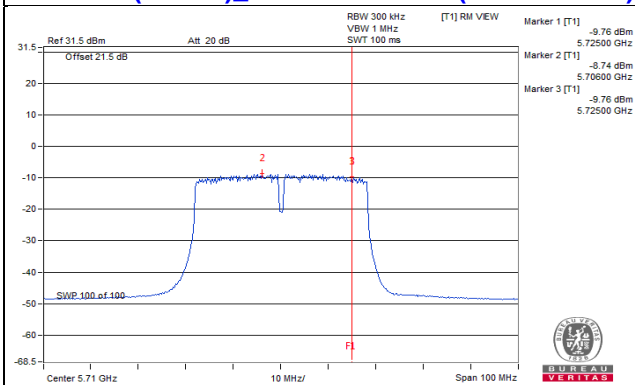

802.11ac (VHT80)_Chain 4 / CH138 (U-NII-3 Band)

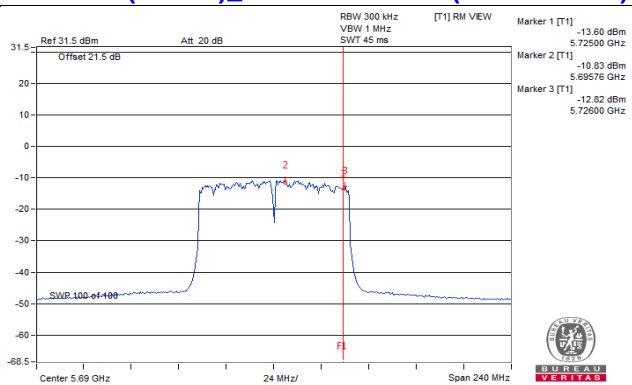

802.11ax (HE20)_Chain 5 / CH144 (U-NII-3 Band)

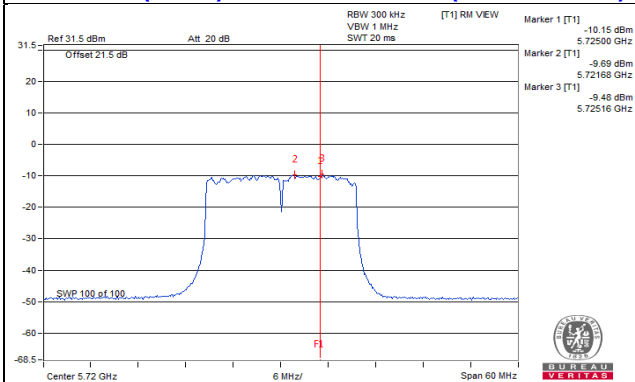

802.11ax (HE40)_Chain 5 / CH142 (U-NII-3 Band)

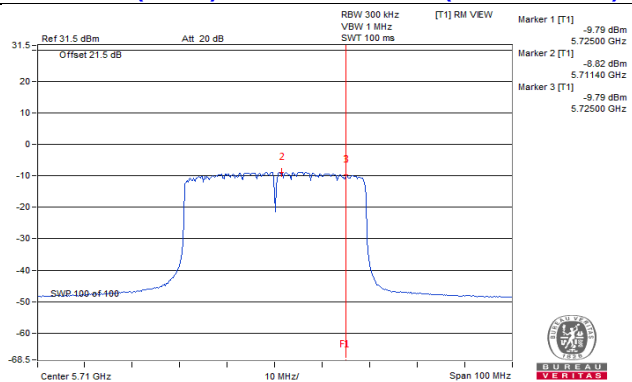

802.11ax (HE80)_Chain 5 / CH138 (U-NII-3 Band)

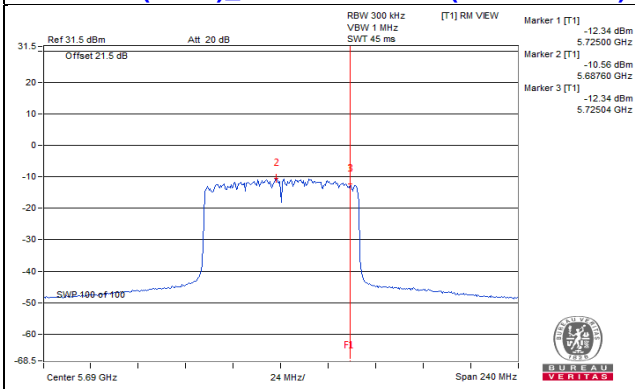

4.5.9 Test Results (Mode 3)

Non-Beamforming Mode

For U-NII-2A, U-NII-2C:

802.11a

Chan.	Chan. Freq. (MHz)	PSD W/O Duty Factor (dBm/MHz)		Duty Factor (dB)	Total PSD With Duty Factor (dBm/MHz)	Max. Limit (dBm/MHz)	Pass / Fail
		Chain 1	Chain 2				
52	5260	3.72	3.77	0.36	7.12	8.08	Pass
60	5300	4.09	3.44	0.36	7.15	8.08	Pass
64	5320	3.40	2.70	0.36	6.43	8.08	Pass
100	5500	3.39	3.57	0.36	6.85	8.84	Pass
116	5580	3.94	4.16	0.36	7.42	8.84	Pass
140	5700	3.83	3.63	0.36	7.10	8.84	Pass
144 (U-NII-2C Band)	5720	4.12	3.35	0.36	7.12	8.84	Pass

- Note: 1. Method a) of power density measurement of KDB 662911 is using for calculating total power density. Total power density is summing entire spectra across corresponding frequency bins on the various outputs by computer.
2. For U-NII-2A: The directional gain = 8.92dBi > 6dBi, so the power density limit shall be reduced to 11-(8.92-6) = 8.08dBm.
3. For U-NII-2C: The directional gain = 8.16dBi > 6dBi, so the power density limit shall be reduced to 11-(8.16-6) = 8.84dBm.
4. Refer to section 3.3 for duty cycle spectrum plot.

802.11ac (VHT20)

Chan.	Chan. Freq. (MHz)	PSD W/O Duty Factor (dBm/MHz)		Duty Factor (dB)	Total PSD With Duty Factor (dBm/MHz)	Max. Limit (dBm/MHz)	Pass / Fail
		Chain 1	Chain 2				
52	5260	4.03	3.94	0.20	7.20	8.08	Pass
60	5300	3.13	3.29	0.20	6.42	8.08	Pass
64	5320	3.11	3.36	0.20	6.45	8.08	Pass
100	5500	3.91	3.16	0.20	6.76	8.84	Pass
116	5580	4.64	4.96	0.20	8.01	8.84	Pass
140	5700	3.76	1.82	0.20	6.11	8.84	Pass
144 (U-NII-2C Band)	5720	4.50	4.61	0.20	7.77	8.84	Pass

- Note: 1. Method a) of power density measurement of KDB 662911 is using for calculating total power density. Total power density is summing entire spectra across corresponding frequency bins on the various outputs by computer.
2. For U-NII-2A: The directional gain = 8.92dBi > 6dBi, so the power density limit shall be reduced to 11-(8.92-6) = 8.08dBm.
3. For U-NII-2C: The directional gain = 8.16dBi > 6dBi, so the power density limit shall be reduced to 11-(8.16-6) = 8.84dBm.
4. Refer to section 3.3 for duty cycle spectrum plot.

802.11ac (VHT40)

Chan.	Chan. Freq. (MHz)	PSD W/O Duty Factor (dBm/MHz)		Duty Factor (dB)	Total PSD With Duty Factor (dBm/MHz)	Max. Limit (dBm/MHz)	Pass / Fail
		Chain 1	Chain 2				
54	5270	2.87	3.77	0.22	6.57	8.08	Pass
62	5310	0.01	-0.34	0.22	3.07	8.08	Pass
102	5510	-1.90	-0.84	0.22	1.89	8.84	Pass
110	5550	3.53	2.84	0.22	6.43	8.84	Pass
134	5670	2.96	3.31	0.22	6.37	8.84	Pass
142 (U-NII-2C Band)	5710	3.72	3.53	0.22	6.86	8.84	Pass

- Note: 1. Method a) of power density measurement of KDB 662911 is using for calculating total power density. Total power density is summing entire spectra across corresponding frequency bins on the various outputs by computer.
2. For U-NII-2A: The directional gain = 8.92dBi > 6dBi, so the power density limit shall be reduced to 11-(8.92-6) = 8.08dBm.
3. For U-NII-2C: The directional gain = 8.16dBi > 6dBi, so the power density limit shall be reduced to 11-(8.16-6) = 8.84dBm.
4. Refer to section 3.3 for duty cycle spectrum plot.

802.11ac (VHT80)

Chan.	Chan. Freq. (MHz)	PSD W/O Duty Factor (dBm/MHz)		Duty Factor (dB)	Total PSD With Duty Factor (dBm/MHz)	Max. Limit (dBm/MHz)	Pass / Fail
		Chain 1	Chain 2				
58	5290	-4.24	-4.10	0.19	-0.97	8.08	Pass
106	5530	-5.21	-5.03	0.19	-1.92	8.84	Pass
122	5610	0.23	0.88	0.19	3.77	8.84	Pass
138 (U-NII-2C Band)	5690	0.01	0.85	0.19	3.65	8.84	Pass

- Note: 1. Method a) of power density measurement of KDB 662911 is using for calculating total power density. Total power density is summing entire spectra across corresponding frequency bins on the various outputs by computer.
2. For U-NII-2A: The directional gain = 8.92dBi > 6dBi, so the power density limit shall be reduced to 11-(8.92-6) = 8.08dBm.
3. For U-NII-2C: The directional gain = 8.16dBi > 6dBi, so the power density limit shall be reduced to 11-(8.16-6) = 8.84dBm.
4. Refer to section 3.3 for duty cycle spectrum plot.

802.11ax (HE20)

Chan.	Chan. Freq. (MHz)	PSD W/O Duty Factor (dBm/MHz)		Duty Factor (dB)	Total PSD With Duty Factor (dBm/MHz)	Max. Limit (dBm/MHz)	Pass / Fail
		Chain 1	Chain 2				
52	5260	3.91	3.62	0.20	6.98	8.08	Pass
60	5300	2.98	2.94	0.20	6.17	8.08	Pass
64	5320	2.78	3.32	0.20	6.27	8.08	Pass
100	5500	3.46	2.45	0.20	6.19	8.84	Pass
116	5580	3.64	4.24	0.20	7.16	8.84	Pass
140	5700	3.70	2.33	0.20	6.28	8.84	Pass
144 (U-NII-2C Band)	5720	3.32	3.75	0.20	6.75	8.84	Pass

- Note: 1. Method a) of power density measurement of KDB 662911 is using for calculating total power density. Total power density is summing entire spectra across corresponding frequency bins on the various outputs by computer.
2. For U-NII-2A: The directional gain = 8.92dBi > 6dBi, so the power density limit shall be reduced to $11-(8.92-6) = 8.08\text{dBm}$.
3. For U-NII-2C: The directional gain = 8.16dBi > 6dBi, so the power density limit shall be reduced to $11-(8.16-6) = 8.84\text{dBm}$.
4. Refer to section 3.3 for duty cycle spectrum plot.

802.11ax (HE40)

Chan.	Chan. Freq. (MHz)	PSD W/O Duty Factor (dBm/MHz)		Duty Factor (dB)	Total PSD With Duty Factor (dBm/MHz)	Max. Limit (dBm/MHz)	Pass / Fail
		Chain 1	Chain 2				
54	5270	3.70	2.88	0.16	6.48	8.08	Pass
62	5310	-0.39	-0.56	0.16	2.70	8.08	Pass
102	5510	-1.43	-1.12	0.16	1.90	8.84	Pass
110	5550	2.61	3.68	0.16	6.35	8.84	Pass
134	5670	3.42	3.87	0.16	6.82	8.84	Pass
142 (U-NII-2C Band)	5710	3.41	3.51	0.16	6.63	8.84	Pass

- Note: 1. Method a) of power density measurement of KDB 662911 is using for calculating total power density. Total power density is summing entire spectra across corresponding frequency bins on the various outputs by computer.
2. For U-NII-2A: The directional gain = 8.92dBi > 6dBi, so the power density limit shall be reduced to $11-(8.92-6) = 8.08\text{dBm}$.
3. For U-NII-2C: The directional gain = 8.16dBi > 6dBi, so the power density limit shall be reduced to $11-(8.16-6) = 8.84\text{dBm}$.
4. Refer to section 3.3 for duty cycle spectrum plot.

802.11ax (HE80)

Chan.	Chan. Freq. (MHz)	PSD W/O Duty Factor (dBm/MHz)		Duty Factor (dB)	Total PSD With Duty Factor (dBm/MHz)	Max. Limit (dBm/MHz)	Pass / Fail
		Chain 1	Chain 2				
58	5290	-3.98	-4.12	0.18	-0.86	8.08	Pass
106	5530	-5.27	-5.33	0.18	-2.11	8.84	Pass
122	5610	0.63	0.69	0.18	3.85	8.84	Pass
138 (U-NII-2C Band)	5690	0.19	0.61	0.18	3.60	8.84	Pass

- Note: 1. Method a) of power density measurement of KDB 662911 is using for calculating total power density. Total power density is summing entire spectra across corresponding frequency bins on the various outputs by computer.
2. For U-NII-2A: The directional gain = 8.92dBi > 6dBi, so the power density limit shall be reduced to $11-(8.92-6) = 8.08\text{dBm}$.
3. For U-NII-2C: The directional gain = 8.16dBi > 6dBi, so the power density limit shall be reduced to $11-(8.16-6) = 8.84\text{dBm}$.
4. Refer to section 3.3 for duty cycle spectrum plot.

Spectrum Plot of Worst Value

802.11a_Chain 2 / CH116

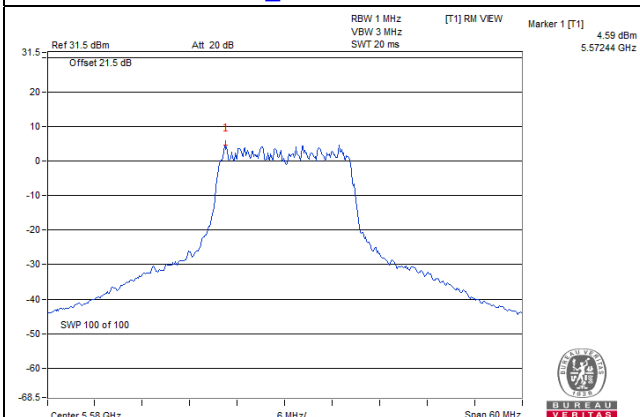

802.11ac (VHT20)_Chain 2 / CH116

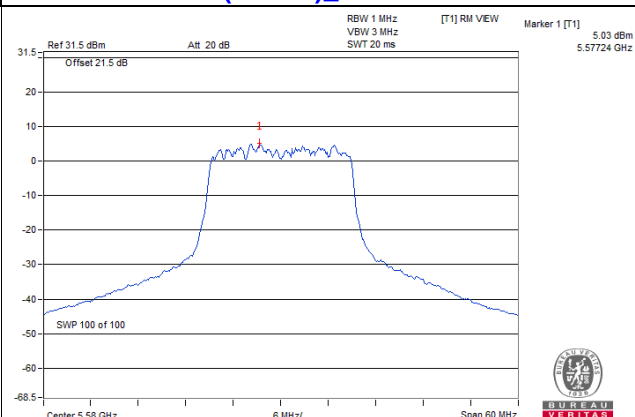

802.11ac (VHT40)_Chain 2 / CH54

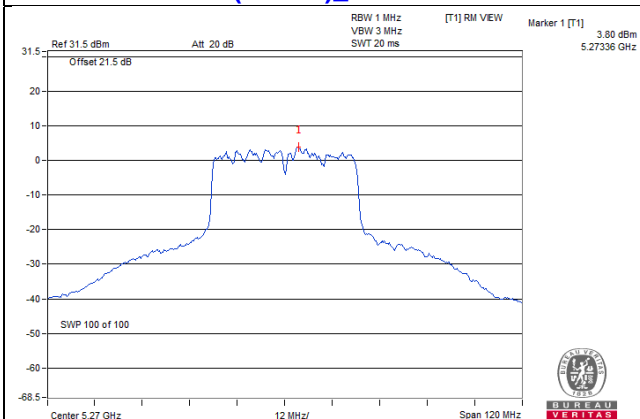

802.11ac (VHT80)_Chain 2 / CH122

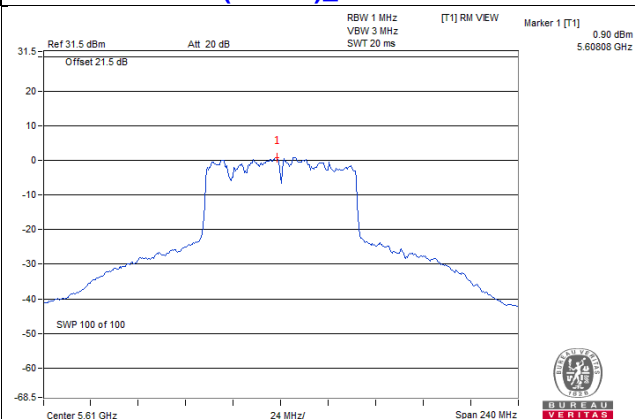

802.11ax (HE20)_Chain 2 / CH116

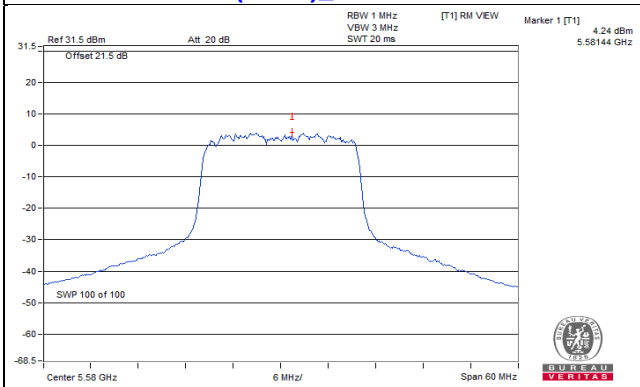

802.11ax (HE40)_Chain 2 / CH134

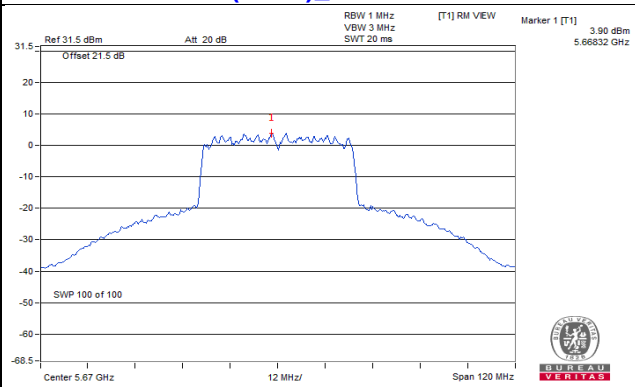

802.11ax (HE80)_Chain 2 / CH122

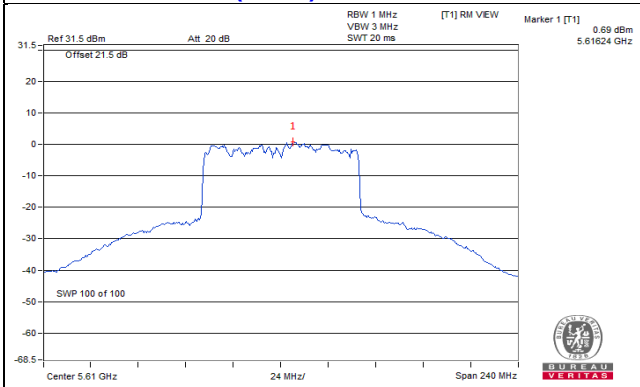

For U-NII-3:

802.11a

Chan.	Freq. (MHz)	PSD W/O Duty Factor (dBm/300kHz)		Duty Factor (dB)	Total PSD With Duty Factor		Total PSD With Duty Factor (dBm/500kHz)	Limit (dBm/500kHz)	Pass /Fail
		Chain 1	Chain 2		mW/300kHz	dBm/300kHz			
144 (U-NII-3 Band)	5720	-4.19	-4.32	0.36	0.8164	-0.88	1.34	27.41	Pass

- Note: 1. Method b) Measure and sum spectral maxima across the outputs of KDB 662911 is using for calculating total power density.
 2. The directional gain = 8.59dBi > 6dBi, so the power density limit shall be reduced to $30-(8.59-6) = 27.41$ dBm.
 3. Refer to section 3.3 for duty cycle spectrum plot.

802.11ac (VHT20)

Chan.	Freq. (MHz)	PSD W/O Duty Factor (dBm/300kHz)		Duty Factor (dB)	Total PSD With Duty Factor		Total PSD With Duty Factor (dBm/500kHz)	Limit (dBm/500kHz)	Pass /Fail
		Chain 1	Chain 2		mW/300kHz	dBm/300kHz			
144 (U-NII-3 Band)	5720	-4.71	-4.79	0.20	0.7021	-1.54	0.68	27.41	Pass

- Note: 1. Method b) Measure and sum spectral maxima across the outputs of KDB 662911 is using for calculating total power density.
 2. The directional gain = 8.59dBi > 6dBi, so the power density limit shall be reduced to $30-(8.59-6) = 27.41$ dBm.
 3. Refer to section 3.3 for duty cycle spectrum plot.

802.11ac (VHT40)

Chan.	Freq. (MHz)	PSD W/O Duty Factor (dBm/300kHz)		Duty Factor (dB)	Total PSD With Duty Factor		Total PSD With Duty Factor (dBm/500kHz)	Limit (dBm/500kHz)	Pass /Fail
		Chain 1	Chain 2		mW/300kHz	dBm/300kHz			
142 (U-NII-3 Band)	5710	-5.77	-5.71	0.22	0.5606	-2.51	-0.29	27.41	Pass

- Note: 1. Method b) Measure and sum spectral maxima across the outputs of KDB 662911 is using for calculating total power density.
 2. The directional gain = 8.59dBi > 6dBi, so the power density limit shall be reduced to $30-(8.59-6) = 27.41$ dBm.
 3. Refer to section 3.3 for duty cycle spectrum plot.

802.11ac (VHT80)

Chan.	Freq. (MHz)	PSD W/O Duty Factor (dBm/300kHz)		Duty Factor (dB)	Total PSD With Duty Factor		Total PSD With Duty Factor (dBm/500kHz)	Limit (dBm/500kHz)	Pass /Fail
		Chain 1	Chain 2		mW/300kHz	dBm/300kHz			
138 (U-NII-3 Band)	5690	-10.61	-10.19	0.19	0.19064	-7.20	-4.98	27.41	Pass

- Note: 1. Method b) Measure and sum spectral maxima across the outputs of KDB 662911 is using for calculating total power density.
 2. The directional gain = 8.59dBi > 6dBi, so the power density limit shall be reduced to $30-(8.59-6) = 27.41$ dBm.
 3. Refer to section 3.3 for duty cycle spectrum plot.

802.11ax (HE20)

Chan.	Freq. (MHz)	PSD W/O Duty Factor (dBm/300kHz)		Duty Factor (dB)	Total PSD With Duty Factor		Total PSD With Duty Factor (dBm/500kHz)	Limit (dBm/500kHz)	Pass /Fail
		Chain 1	Chain 2		mW/300kHz	dBm/300kHz			
144 (U-NII-3 Band)	5720	-5.27	-5.65	0.20	0.5964	-2.24	-0.02	27.41	Pass

- Note: 1. Method b) Measure and sum spectral maxima across the outputs of KDB 662911 is using for calculating total power density.
 2. The directional gain = 8.59dBi > 6dBi, so the power density limit shall be reduced to $30-(8.59-6) = 27.41$ dBm.
 3. Refer to section 3.3 for duty cycle spectrum plot.

802.11ax (HE40)

Chan.	Freq. (MHz)	PSD W/O Duty Factor (dBm/300kHz)		Duty Factor (dB)	Total PSD With Duty Factor		Total PSD With Duty Factor (dBm/500kHz)	Limit (dBm/500kHz)	Pass /Fail
		Chain 1	Chain 2		mW/300kHz	dBm/300kHz			
142 (U-NII-3 Band)	5710	-6.40	-6.61	0.16	0.4642	-3.33	-1.11	27.41	Pass

- Note: 1. Method b) Measure and sum spectral maxima across the outputs of KDB 662911 is using for calculating total power density.
 2. The directional gain = 8.59dBi > 6dBi, so the power density limit shall be reduced to $30-(8.59-6) = 27.41$ dBm.
 3. Refer to section 3.3 for duty cycle spectrum plot.

802.11ax (HE80)

Chan.	Freq. (MHz)	PSD W/O Duty Factor (dBm/300kHz)		Duty Factor (dB)	Total PSD With Duty Factor		Total PSD With Duty Factor (dBm/500kHz)	Limit (dBm/500kHz)	Pass /Fail
		Chain 1	Chain 2		mW/300kHz	dBm/300kHz			
138 (U-NII-3 Band)	5690	-9.83	-10.28	0.18	0.20628	-6.86	-4.64	27.41	Pass

- Note: 1. Method b) Measure and sum spectral maxima across the outputs of KDB 662911 is using for calculating total power density.
 2. The directional gain = 8.59dBi > 6dBi, so the power density limit shall be reduced to $30-(8.59-6) = 27.41$ dBm.
 3. Refer to section 3.3 for duty cycle spectrum plot.

Spectrum Plot of Worst Value

802.11a_Chain 1 / CH144 (U-NII-3 Band)

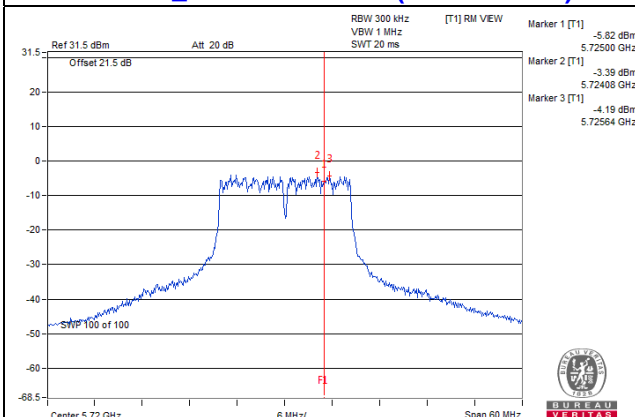

802.11ac (VHT20)_Chain 1 / CH144 (U-NII-3 Band)

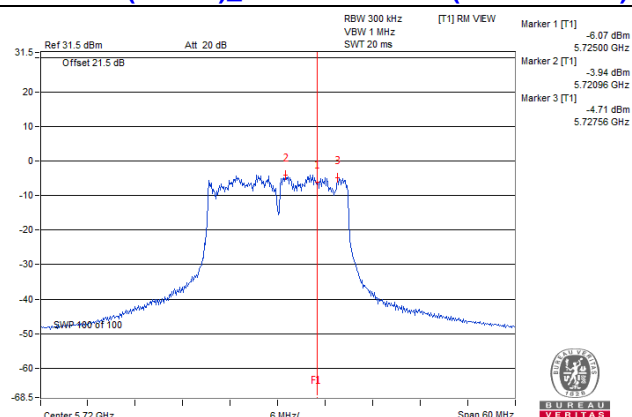

802.11ac (VHT40)_Chain 2 / CH142 (U-NII-3 Band)

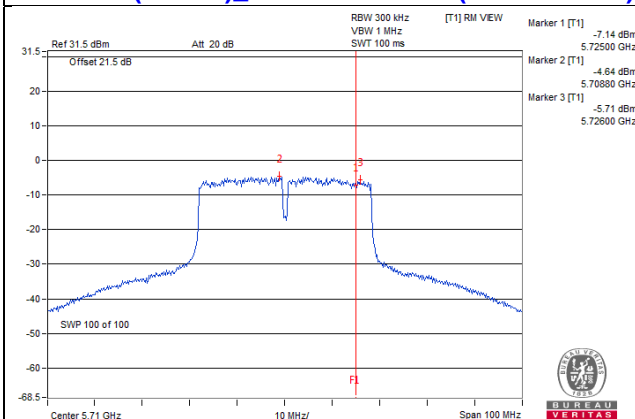

802.11ac (VHT80)_Chain 2 / CH138 (U-NII-3 Band)

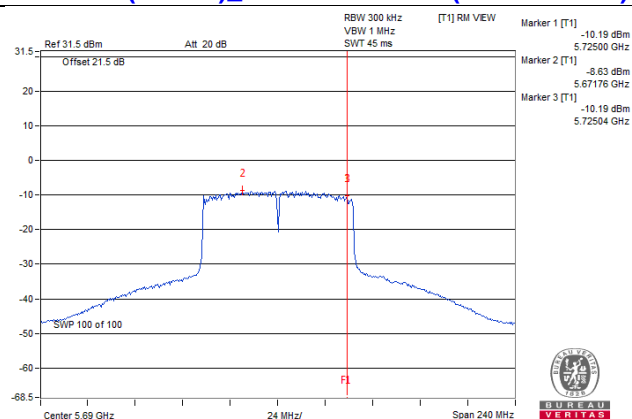

802.11ax (HE20)_Chain 1 / CH144 (U-NII-3 Band)

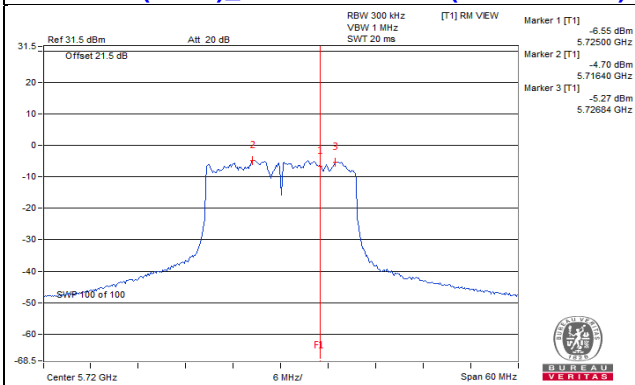

802.11ax (HE40)_Chain 1 / CH142 (U-NII-3 Band)

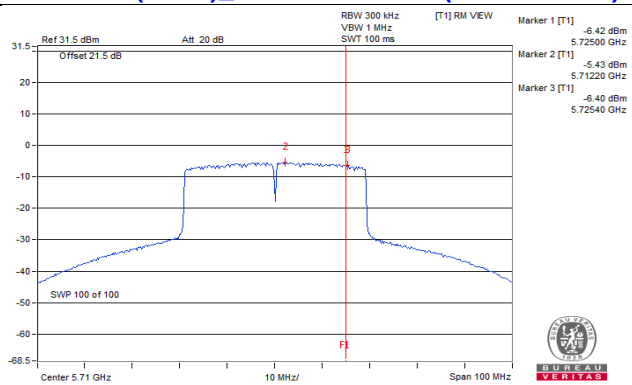

802.11ax (HE80)_Chain 1 / CH138 (U-NII-3 Band)

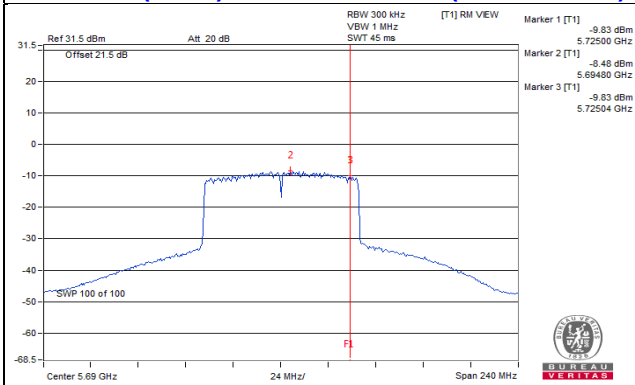

4.5.10 Test Results (Mode 4)

Non-Beamforming Mode

For U-NII-2A, U-NII-2C:

802.11a

Chan.	Chan. Freq. (MHz)	PSD W/O Duty Factor (dBm/MHz)	Duty Factor (dB)	PSD With Duty Factor (dBm/MHz)	Max. Limit (dBm/MHz)	Pass / Fail
52	5260	6.50	0.36	6.86	10.56	Pass
60	5300	7.17	0.36	7.53	10.56	Pass
64	5320	5.00	0.36	5.36	10.56	Pass
100	5500	4.84	0.36	5.20	11.00	Pass
116	5580	6.25	0.36	6.61	11.00	Pass
140	5700	4.16	0.36	4.52	11.00	Pass
144 (U-NII-2C Band)	5720	6.19	0.36	6.55	11.00	Pass

Note: 1. For U-NII-2A: The max. gain is 6.44dBi > 6dBi, so the power density limit shall be reduced to 11-(6.44-6) = 10.56dBm.
 2. For U-NII-2C: The max. gain is 5.8dBi < 6dBi, so the power density limit shall not be reduced.
 3. Refer to section 3.3 for duty cycle spectrum plot.
 4. For U-NII-2A: Chain 2 was chosen for test.
 For U-NII-2C: Chain 0 was chosen for test.

802.11ac (VHT20)

Chan.	Chan. Freq. (MHz)	PSD W/O Duty Factor (dBm/MHz)	Duty Factor (dB)	PSD With Duty Factor (dBm/MHz)	Max. Limit (dBm/MHz)	Pass / Fail
52	5260	6.42	0.20	6.62	10.56	Pass
60	5300	7.13	0.20	7.33	10.56	Pass
64	5320	5.34	0.20	5.54	10.56	Pass
100	5500	4.69	0.20	4.89	11.00	Pass
116	5580	6.29	0.20	6.49	11.00	Pass
140	5700	4.31	0.20	4.51	11.00	Pass
144 (U-NII-2C Band)	5720	5.85	0.20	6.05	11.00	Pass

Note: 1. For U-NII-2A: The max. gain is 6.44dBi > 6dBi, so the power density limit shall be reduced to 11-(6.44-6) = 10.56dBm.
 2. For U-NII-2C: The max. gain is 5.8dBi < 6dBi, so the power density limit shall not be reduced.
 3. Refer to section 3.3 for duty cycle spectrum plot.
 4. For U-NII-2A: Chain 2 was chosen for test.
 For U-NII-2C: Chain 0 was chosen for test.

802.11ac (VHT40)

Chan.	Chan. Freq. (MHz)	PSD W/O Duty Factor (dBm/MHz)	Duty Factor (dB)	PSD With Duty Factor (dBm/MHz)	Max. Limit (dBm/MHz)	Pass / Fail
54	5270	3.17	0.22	3.39	10.56	Pass
62	5310	-0.74	0.22	-0.52	10.56	Pass
102	5510	-0.86	0.22	-0.64	11.00	Pass
110	5550	3.32	0.22	3.54	11.00	Pass
134	5670	-0.53	0.22	-0.31	11.00	Pass
142 (U-NII-2C Band)	5710	3.72	0.22	3.94	11.00	Pass

Note: 1. For U-NII-2A: The max. gain is 6.44dBi > 6dBi, so the power density limit shall be reduced to $11-(6.44-6) = 10.56$ dBm.
 2. For U-NII-2C: The max. gain is 5.8dBi < 6dBi, so the power density limit shall not be reduced.
 3. Refer to section 3.3 for duty cycle spectrum plot.
 4. For U-NII-2A: Chain 2 was chosen for test.
 For U-NII-2C: Chain 0 was chosen for test.

802.11ac (VHT80)

Chan.	Chan. Freq. (MHz)	PSD W/O Duty Factor (dBm/MHz)	Duty Factor (dB)	PSD With Duty Factor (dBm/MHz)	Max. Limit (dBm/MHz)	Pass / Fail
58	5290	-4.39	0.19	-4.20	10.56	Pass
106	5530	-3.79	0.19	-3.60	11.00	Pass
122	5610	0.60	0.19	0.79	11.00	Pass
138 (U-NII-2C Band)	5690	0.32	0.19	0.51	11.00	Pass

Note: 1. For U-NII-2A: The max. gain is 6.44dBi > 6dBi, so the power density limit shall be reduced to $11-(6.44-6) = 10.56$ dBm.
 2. For U-NII-2C: The max. gain is 5.8dBi < 6dBi, so the power density limit shall not be reduced.
 3. Refer to section 3.3 for duty cycle spectrum plot.
 4. For U-NII-2A: Chain 2 was chosen for test.
 For U-NII-2C: Chain 0 was chosen for test.

802.11ax (HE20)

Chan.	Chan. Freq. (MHz)	PSD W/O Duty Factor (dBm/MHz)	Duty Factor (dB)	PSD With Duty Factor (dBm/MHz)	Max. Limit (dBm/MHz)	Pass / Fail
52	5260	6.70	0.20	6.90	10.56	Pass
60	5300	6.60	0.20	6.80	10.56	Pass
64	5320	5.16	0.20	5.36	10.56	Pass
100	5500	3.89	0.20	4.09	11.00	Pass
116	5580	5.97	0.20	6.17	11.00	Pass
140	5700	3.59	0.20	3.79	11.00	Pass
144 (U-NII-2C Band)	5720	5.43	0.20	5.63	11.00	Pass

- Note: 1. For U-NII-2A: The max. gain is 6.44dBi > 6dBi, so the power density limit shall be reduced to $11-(6.44-6) = 10.56$ dBm.
 2. For U-NII-2C: The max. gain is 5.8dBi < 6dBi, so the power density limit shall not be reduced.
 3. Refer to section 3.3 for duty cycle spectrum plot.
 4. For U-NII-2A: Chain 2 was chosen for test.
 For U-NII-2C: Chain 0 was chosen for test.

802.11ax (HE40)

Chan.	Chan. Freq. (MHz)	PSD W/O Duty Factor (dBm/MHz)	Duty Factor (dB)	PSD With Duty Factor (dBm/MHz)	Max. Limit (dBm/MHz)	Pass / Fail
54	5270	3.05	0.16	3.21	10.56	Pass
62	5310	-0.01	0.16	0.15	10.56	Pass
102	5510	-0.24	0.16	-0.08	11.00	Pass
110	5550	3.51	0.16	3.67	11.00	Pass
134	5670	-0.35	0.16	-0.19	11.00	Pass
142 (U-NII-2C Band)	5710	3.60	0.16	3.76	11.00	Pass

- Note: 1. For U-NII-2A: The max. gain is 6.44dBi > 6dBi, so the power density limit shall be reduced to $11-(6.44-6) = 10.56$ dBm.
 2. For U-NII-2C: The max. gain is 5.8dBi < 6dBi, so the power density limit shall not be reduced.
 3. Refer to section 3.3 for duty cycle spectrum plot.
 4. For U-NII-2A: Chain 2 was chosen for test.
 For U-NII-2C: Chain 0 was chosen for test.

802.11ax (HE80)

Chan.	Chan. Freq. (MHz)	PSD W/O Duty Factor (dBm/MHz)	Duty Factor (dB)	PSD With Duty Factor (dBm/MHz)	Max. Limit (dBm/MHz)	Pass / Fail
58	5290	-4.26	0.18	-4.08	10.56	Pass
106	5530	-3.44	0.18	-3.26	11.00	Pass
122	5610	0.59	0.18	0.77	11.00	Pass
138 (U-NII-2C Band)	5690	-0.31	0.18	-0.13	11.00	Pass

- Note:
1. For U-NII-2A: The max. gain is 6.44dBi > 6dBi, so the power density limit shall be reduced to $11-(6.44-6) = 10.56\text{dBm}$.
 2. For U-NII-2C: The max. gain is 5.8dBi < 6dBi, so the power density limit shall not be reduced.
 3. Refer to section 3.3 for duty cycle spectrum plot.
 4. For U-NII-2A: Chain 2 was chosen for test.
For U-NII-2C: Chain 0 was chosen for test.

Spectrum Plot of Worst Value

802.11a_Chain 2 / CH60

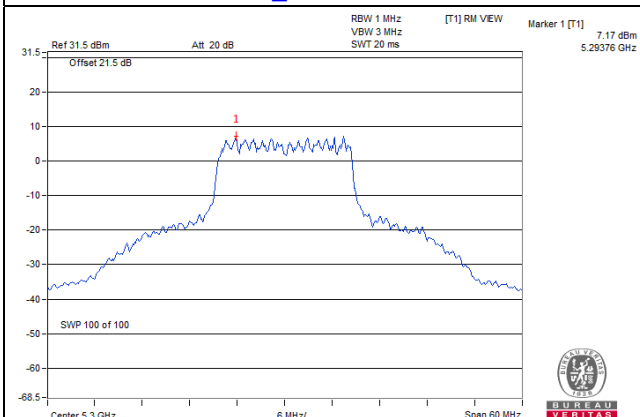

802.11ac (VHT20)_Chain 2 / CH60

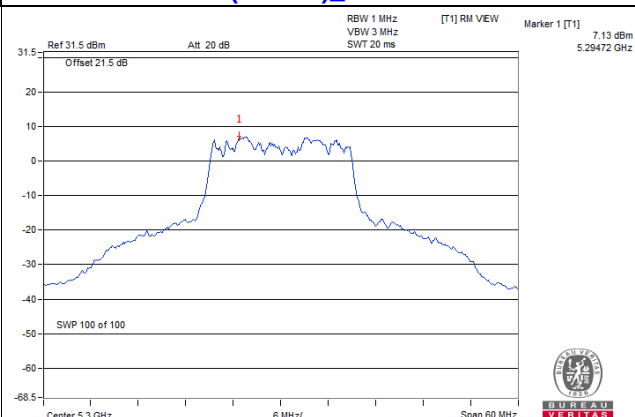

802.11ac (VHT40)_Chain 0 / CH142 (U-NII-2C Band)

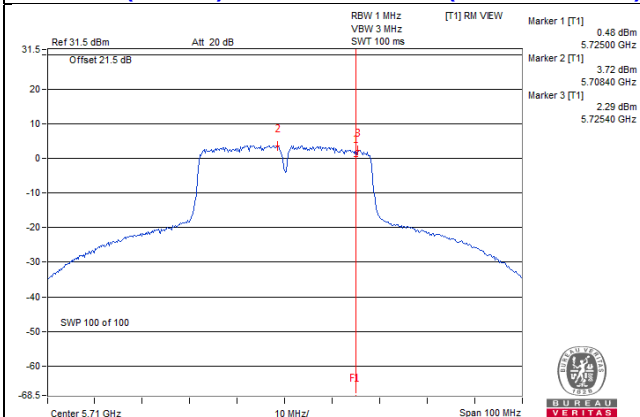

802.11ac (VHT80)_Chain 0 / CH122

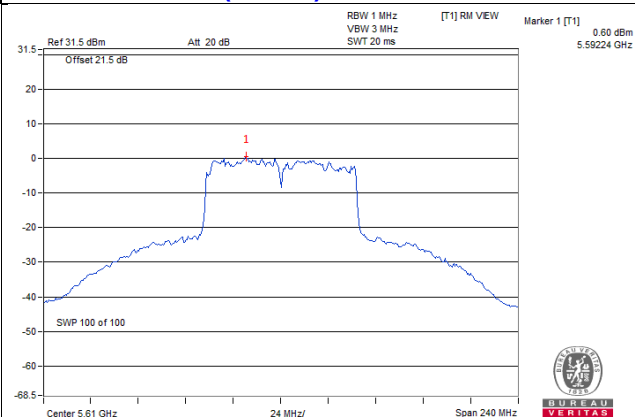

802.11ax (HE20)_Chain 2 / CH52

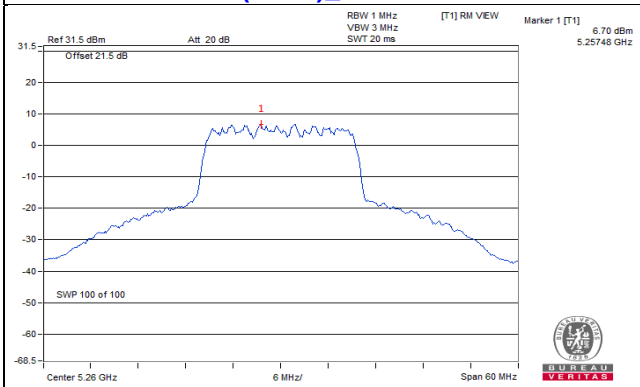

802.11ax (HE40)_Chain 0 / CH142 (U-NII-2C Band)

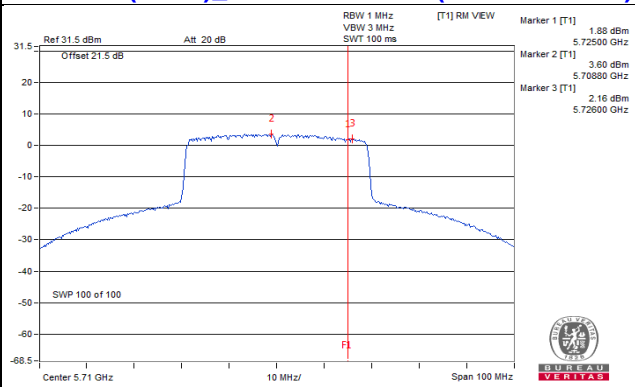

802.11ax (HE80)_Chain 0 / CH122

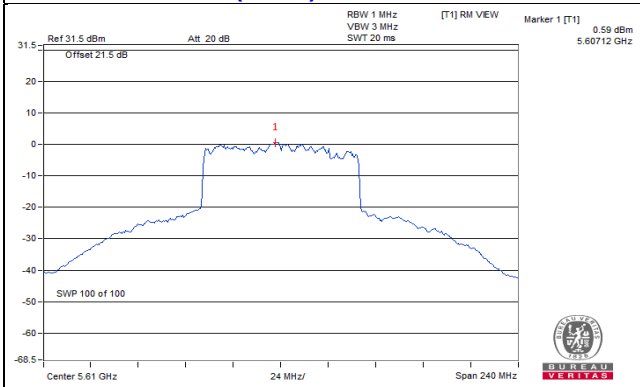

For U-NII-3:
802.11a

Chan.	Chan. Freq. (MHz)	PSD W/O Duty Factor (dBm/300kHz)	Duty Factor (dB)	Total PSD With Duty Factor		Total PSD With Duty Factor (dBm/500kHz)	Limit (dBm/500kHz)	Pass /Fail
				mW/300kHz	dBm/300kHz			
144 (U-NII-3 Band)	5720	-2.38	0.36	0.6286	-2.02	0.20	30.00	Pass

Note: 1. The max. gain is 5.7dBi < 6dBi, so the power density limit shall not be reduced.
 2. Refer to section 3.3 for duty cycle spectrum plot.
 3. Chain 0 was chosen for test.

802.11ac (VHT20)

Chan.	Chan. Freq. (MHz)	PSD W/O Duty Factor (dBm/300kHz)	Duty Factor (dB)	Total PSD With Duty Factor		Total PSD With Duty Factor (dBm/500kHz)	Limit (dBm/500kHz)	Pass /Fail
				mW/300kHz	dBm/300kHz			
144 (U-NII-3 Band)	5720	-2.48	0.20	0.592	-2.28	-0.06	30.00	Pass

Note: 1. The max. gain is 5.7dBi < 6dBi, so the power density limit shall not be reduced.
 2. Refer to section 3.3 for duty cycle spectrum plot.
 3. Chain 0 was chosen for test.

802.11ac (VHT40)

Chan.	Chan. Freq. (MHz)	PSD W/O Duty Factor (dBm/300kHz)	Duty Factor (dB)	Total PSD With Duty Factor		Total PSD With Duty Factor (dBm/500kHz)	Limit (dBm/500kHz)	Pass /Fail
				mW/300kHz	dBm/300kHz			
142 (U-NII-3 Band)	5710	-6.16	0.22	0.2545	-5.94	-3.72	30.00	Pass

Note: 1. The max. gain is 5.7dBi < 6dBi, so the power density limit shall not be reduced.
 2. Refer to section 3.3 for duty cycle spectrum plot.
 3. Chain 0 was chosen for test.

802.11ac (VHT80)

Chan.	Chan. Freq. (MHz)	PSD W/O Duty Factor (dBm/300kHz)	Duty Factor (dB)	Total PSD With Duty Factor		Total PSD With Duty Factor (dBm/500kHz)	Limit (dBm/500kHz)	Pass /Fail
				mW/300kHz	dBm/300kHz			
138 (U-NII-3 Band)	5690	-11.30	0.19	0.07739	-11.11	-8.89	30.00	Pass

Note: 1. The max. gain is 5.7dBi < 6dBi, so the power density limit shall not be reduced.
 2. Refer to section 3.3 for duty cycle spectrum plot.
 3. Chain 0 was chosen for test.

802.11ax (HE20)

Chan.	Chan. Freq. (MHz)	PSD W/O Duty Factor (dBm/300kHz)	Duty Factor (dB)	Total PSD With Duty Factor		Total PSD With Duty Factor (dBm/500kHz)	Limit (dBm/500kHz)	Pass /Fail
				mW/300kHz	dBm/300kHz			
144 (U-NII-3 Band)	5720	-4.44	0.20	0.3768	-4.24	-2.02	30.00	Pass

Note: 1. The max. gain is 5.7dBi < 6dBi, so the power density limit shall not be reduced.
 2. Refer to section 3.3 for duty cycle spectrum plot.
 3. Chain 0 was chosen for test.

802.11ax (HE40)

Chan.	Chan. Freq. (MHz)	PSD W/O Duty Factor (dBm/300kHz)	Duty Factor (dB)	Total PSD With Duty Factor		Total PSD With Duty Factor (dBm/500kHz)	Limit (dBm/500kHz)	Pass /Fail
				mW/300kHz	dBm/300kHz			
142 (U-NII-3 Band)	5710	-6.91	0.16	0.2114	-6.75	-4.53	30.00	Pass

Note: 1. The max. gain is 5.7dBi < 6dBi, so the power density limit shall not be reduced.
 2. Refer to section 3.3 for duty cycle spectrum plot.
 3. Chain 0 was chosen for test.

802.11ax (HE80)

Chan.	Chan. Freq. (MHz)	PSD W/O Duty Factor (dBm/300kHz)	Duty Factor (dB)	Total PSD With Duty Factor		Total PSD With Duty Factor (dBm/500kHz)	Limit (dBm/500kHz)	Pass /Fail
				mW/300kHz	dBm/300kHz			
138 (U-NII-3 Band)	5690	-11.31	0.18	0.07715	-11.13	-8.91	30.00	Pass

Note: 1. The max. gain is 5.7dBi < 6dBi, so the power density limit shall not be reduced.
 2. Refer to section 3.3 for duty cycle spectrum plot.
 3. Chain 0 was chosen for test.

Spectrum Plot of Worst Value

802.11a Chain 0 / CH 144 (U-NII-3 Band)

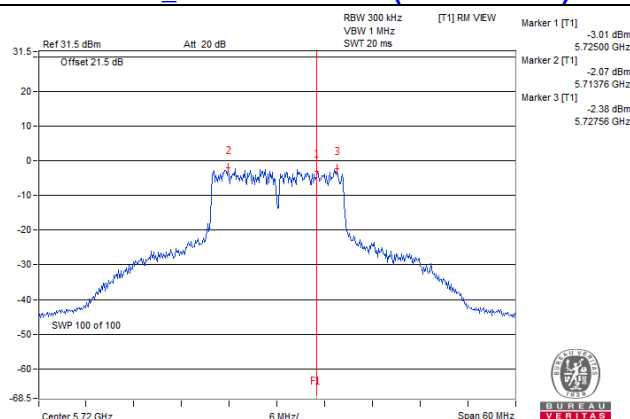

802.11ac (VHT20) Chain 0 / CH 144 (U-NII-3 Band)

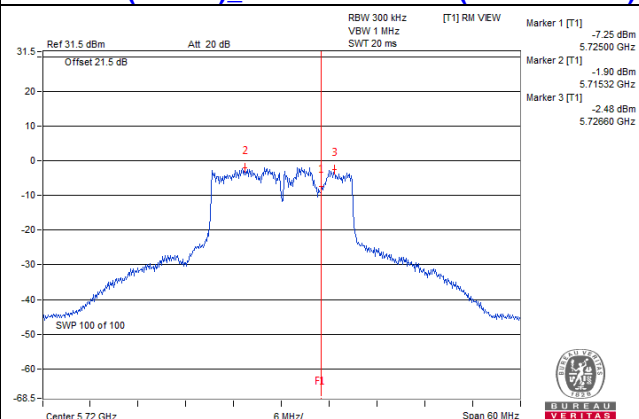

802.11ac (VHT40) Chain 0 / CH 142 (U-NII-3 Band)

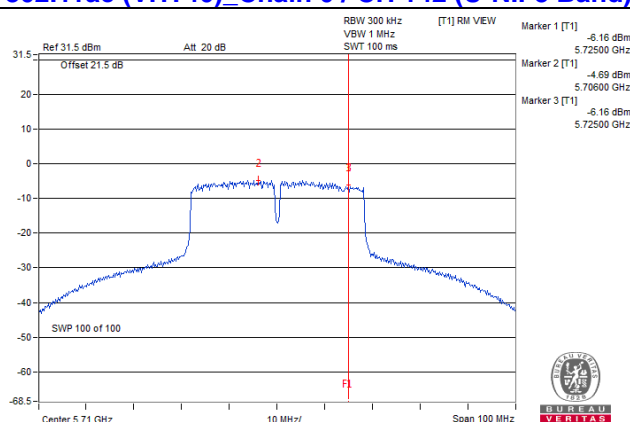

802.11ac (VHT80) Chain 0 / CH 138 (U-NII-3 Band)

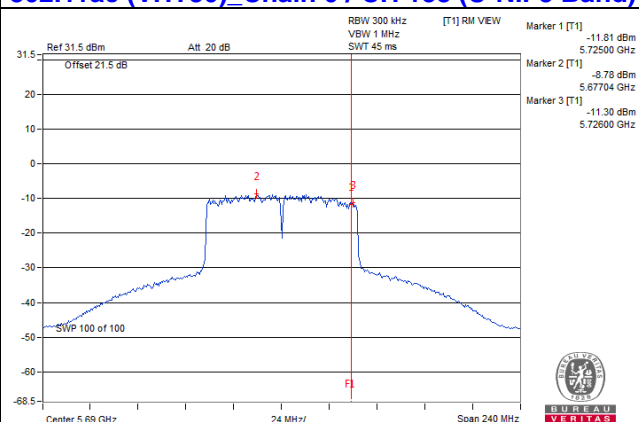

802.11ax (HE20) Chain 0 / CH 144 (U-NII-3 Band)

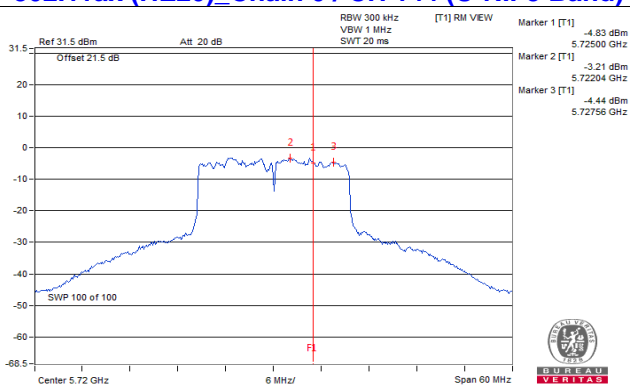

802.11ax (HE40) Chain 0 / CH 142 (U-NII-3 Band)

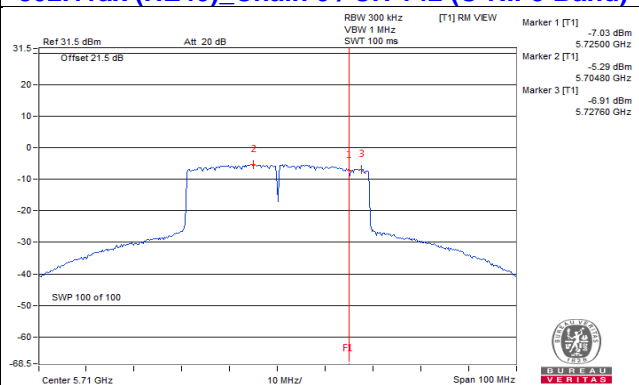

802.11ax (HE80) Chain 0 / CH 138 (U-NII-3 Band)

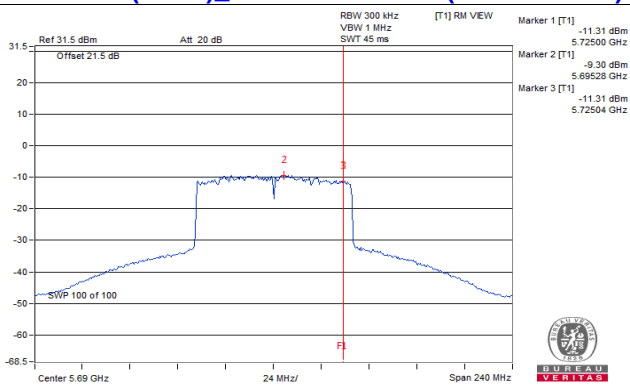

4.6 Frequency Stability Measurement

4.6.1 Limits of Frequency Stability Measurement

The frequency of the carrier signal shall be maintained within band of operation

4.6.2 Test Setup

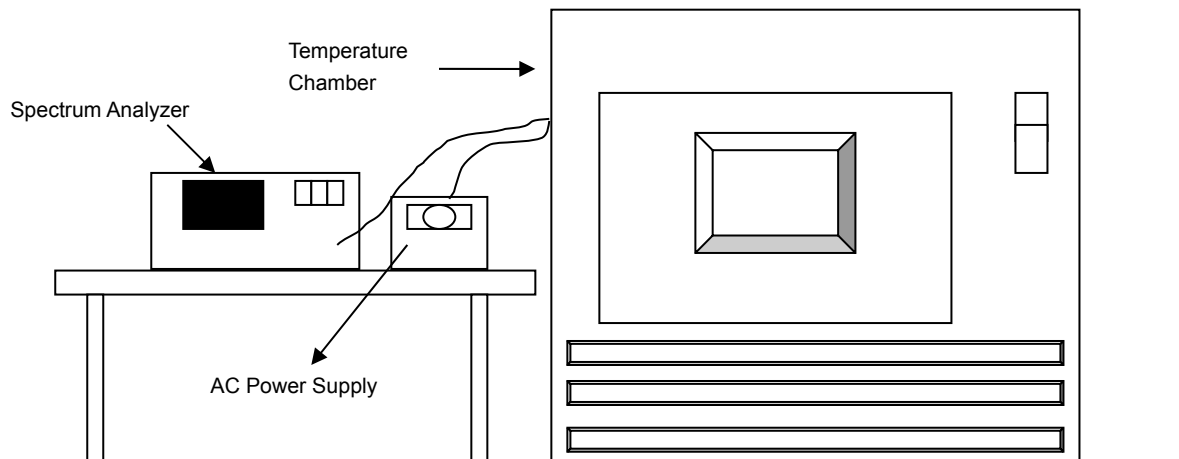

4.6.3 Test Instruments

Refer to section 4.1.2 to get information of above instrument.

4.6.4 Test Procedure

- The EUT was placed inside the environmental test chamber and powered by nominal AC voltage.
- Turn the EUT on and couple its output to a spectrum analyzer.
- Turn the EUT off and set the chamber to the highest temperature specified.
- Allow sufficient time (approximately 30 min) for the temperature of the chamber to stabilize, turn the EUT on and measure the operating frequency after 2, 5, and 10 Minutes.
- Repeat step 2 and 3 with the temperature chamber set to the lowest temperature.
- The test chamber was allowed to stabilize at +20 degree C for a minimum of 30 Minutes. The supply voltage was then adjusted on the EUT from 85% to 115% and the frequency record.

4.6.5 Deviation from Test Standard

No deviation.

4.6.6 EUT Operating Condition

Set the EUT transmit at un-modulation mode to test frequency stability.

4.6.7 Test Results

Frequency Stability Versus Temp.									
Operating Frequency: 5260 MHz									
TEMP. (°C)	Power Supply (Vac)	0 Minute		2 Minutes		5 Minutes		10 Minutes	
		Measured Frequency (MHz)	Pass/Fail	Measured Frequency (MHz)	Pass/Fail	Measured Frequency (MHz)	Pass/Fail	Measured Frequency (MHz)	Pass/Fail
50	120	5259.9968	Pass	5259.998	Pass	5260.0015	Pass	5259.9995	Pass
40	120	5260.0133	Pass	5260.0129	Pass	5260.0128	Pass	5260.0161	Pass
30	120	5260.0069	Pass	5260.0086	Pass	5260.0076	Pass	5260.0045	Pass
20	120	5260.0079	Pass	5260.0098	Pass	5260.0091	Pass	5260.0092	Pass
10	120	5259.981	Pass	5259.981	Pass	5259.9804	Pass	5259.9769	Pass
0	120	5259.98	Pass	5259.9812	Pass	5259.9787	Pass	5259.9777	Pass
-10	120	5260.0156	Pass	5260.0142	Pass	5260.0142	Pass	5260.0124	Pass
-20	120	5260.0188	Pass	5260.0229	Pass	5260.019	Pass	5260.0232	Pass
-30	120	5259.9989	Pass	5259.9965	Pass	5259.9976	Pass	5259.9949	Pass

Frequency Stability Versus Voltage									
Operating Frequency: 5260 MHz									
TEMP. (°C)	Power Supply (Vac)	0 Minute		2 Minutes		5 Minutes		10 Minutes	
		Measured Frequency (MHz)	Pass/Fail	Measured Frequency (MHz)	Pass/Fail	Measured Frequency (MHz)	Pass/Fail	Measured Frequency (MHz)	Pass/Fail
20	138	5260.0076	Pass	5260.0104	Pass	5260.0091	Pass	5260.0088	Pass
	120	5260.0079	Pass	5260.0098	Pass	5260.0091	Pass	5260.0092	Pass
	102	5260.0084	Pass	5260.0103	Pass	5260.0086	Pass	5260.0101	Pass

4.7 6dB Bandwidth Measurement

4.7.1 Limits of 6dB Bandwidth Measurement

The minimum of 6dB Bandwidth Measurement is 0.5MHz.

4.7.2 Test Setup

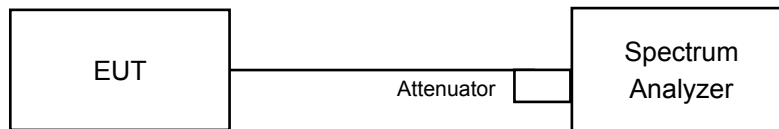

4.7.3 Test Instruments

Refer to section 4.1.2 to get information of above instrument.

4.7.4 Test Procedure

MEASUREMENT PROCEDURE REF

- Set resolution bandwidth (RBW) = 100kHz
- Set the video bandwidth (VBW) $\geq 3 \times$ RBW, Detector = Peak.
- Trace mode = max hold.
- Sweep = auto couple.
- Measure the maximum width of the emission that is constrained by the frequencies associated with the two amplitude points (upper and lower) that are attenuated by 6 dB relative to the maximum level measured in the fundamental emission

4.7.5 Deviation from Test Standard

No deviation.

4.7.6 EUT Operating Condition

The software provided by client to enable the EUT under transmission condition continuously at lowest, middle and highest channel frequencies individually.

4.7.7 Test Results (Mode 1)

Non-Beamforming Mode

802.11a

Channel	Frequency (MHz)	6dB Bandwidth (MHz)								Minimum Limit (MHz)	Pass / Fail
		Chain 0	Chain 1	Chain 2	Chain 3	Chain 4	Chain 5	Chain 6	Chain 7		
144 (U-NII-3 Band)	5720	3.21	3.21	3.22	3.21	3.21	3.22	3.22	3.22	0.5	Pass

Note: The 6dB bandwidth above 5725MHz = Marker 1 + Delta 2 - 5725MHz

802.11ax (HE20)

Channel	Frequency (MHz)	6dB Bandwidth (MHz)								Minimum Limit (MHz)	Pass / Fail
		Chain 0	Chain 1	Chain 2	Chain 3	Chain 4	Chain 5	Chain 6	Chain 7		
144 (U-NII-3 Band)	5720	4.51	4.50	4.31	4.24	4.45	4.42	4.49	4.31	0.5	Pass

Note: The 6dB bandwidth above 5725MHz = Marker 1 + Delta 2 - 5725MHz

802.11ax (HE40)

Channel	Frequency (MHz)	6dB Bandwidth (MHz)								Minimum Limit (MHz)	Pass / Fail
		Chain 0	Chain 1	Chain 2	Chain 3	Chain 4	Chain 5	Chain 6	Chain 7		
142 (U-NII-3 Band)	5710	3.99	3.97	3.94	4.04	4.01	4.03	3.67	3.84	0.5	Pass

Note: The 6dB bandwidth above 5725MHz = Marker 1 + Delta 2 - 5725MHz

802.11ax (HE80)

Channel	Frequency (MHz)	6dB Bandwidth (MHz)								Minimum Limit (MHz)	Pass / Fail
		Chain 0	Chain 1	Chain 2	Chain 3	Chain 4	Chain 5	Chain 6	Chain 7		
138 (U-NII-3 Band)	5690	2.78	3.59	4.02	4.00	3.63	3.26	3.06	3.48	0.5	Pass

Note: The 6dB bandwidth above 5725MHz = Marker 1 + Delta 2 - 5725MHz

Spectrum Plot of Worst Value

802.11a_Chain 0 / CH144 (U-NII-3 Band)

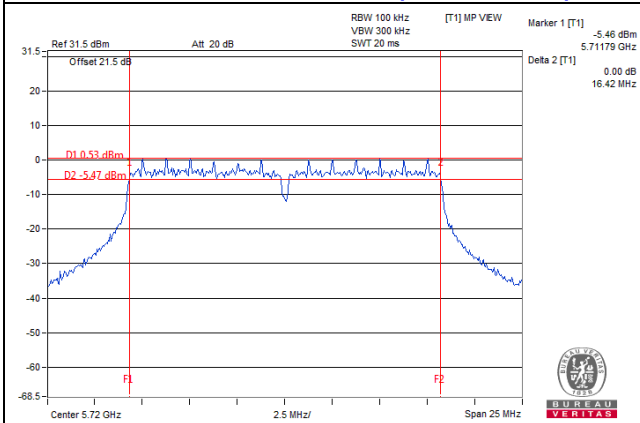

802.11ax (HE20)_Chain 3 / CH144 (U-NII-3 Band)

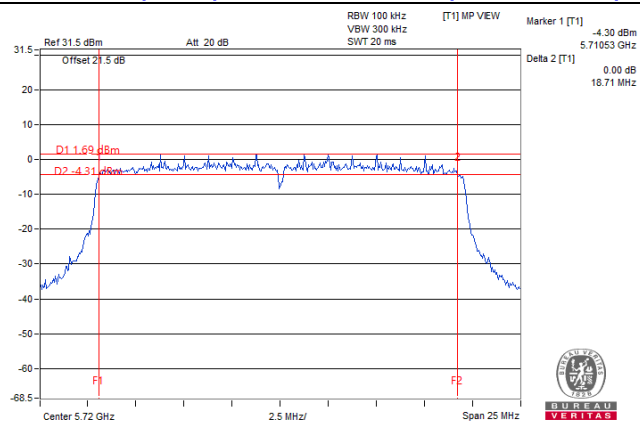

802.11ax (HE40)_Chain 6 / CH142 (U-NII-3 Band)

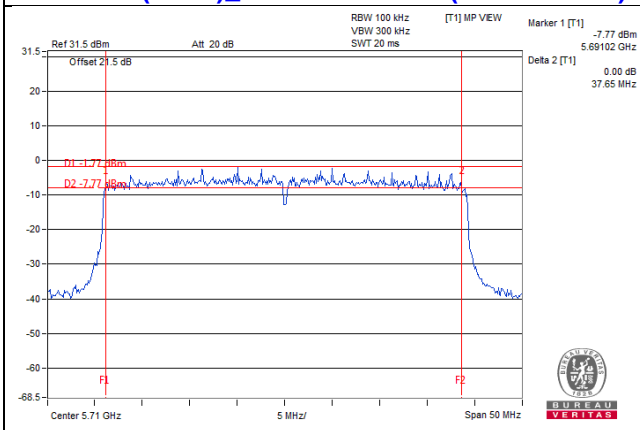

802.11ax (HE80)_Chain 0 / CH138 (U-NII-3 Band)

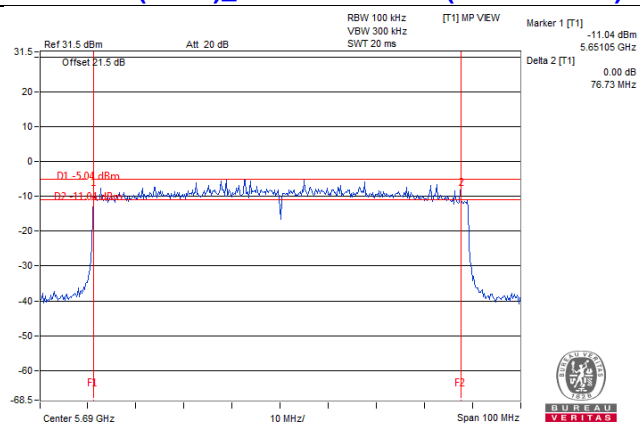

4.7.8 Test Results (Mode 2)

Non-Beamforming Mode

802.11a

Channel	Frequency (MHz)	6dB Bandwidth (MHz)				Minimum Limit (MHz)	Pass / Fail
		Chain 4	Chain 5	Chain 6	Chain 7		
144 (U-NII-3 Band)	5720	3.21	3.22	3.22	3.21	0.5	Pass

Note: The 6dB bandwidth above 5725MHz = Marker 1 + Delta 2 - 5725MHz

802.11ax (HE20)

Channel	Frequency (MHz)	6dB Bandwidth (MHz)				Minimum Limit (MHz)	Pass / Fail
		Chain 4	Chain 5	Chain 6	Chain 7		
144 (U-NII-3 Band)	5720	4.28	4.44	4.29	4.34	0.5	Pass

Note: The 6dB bandwidth above 5725MHz = Marker 1 + Delta 2 - 5725MHz

802.11ax (HE40)

Channel	Frequency (MHz)	6dB Bandwidth (MHz)				Minimum Limit (MHz)	Pass / Fail
		Chain 4	Chain 5	Chain 6	Chain 7		
142 (U-NII-3 Band)	5710	4.00	3.88	3.89	3.75	0.5	Pass

Note: The 6dB bandwidth above 5725MHz = Marker 1 + Delta 2 - 5725MHz

802.11ax (HE80)

Channel	Frequency (MHz)	6dB Bandwidth (MHz)				Minimum Limit (MHz)	Pass / Fail
		Chain 4	Chain 5	Chain 6	Chain 7		
138 (U-NII-3 Band)	5690	2.84	4.00	4.01	3.80	0.5	Pass

Note: The 6dB bandwidth above 5725MHz = Marker 1 + Delta 2 - 5725MHz

Spectrum Plot of Worst Value

802.11a_Chain 4 / CH144 (U-NII-3 Band)

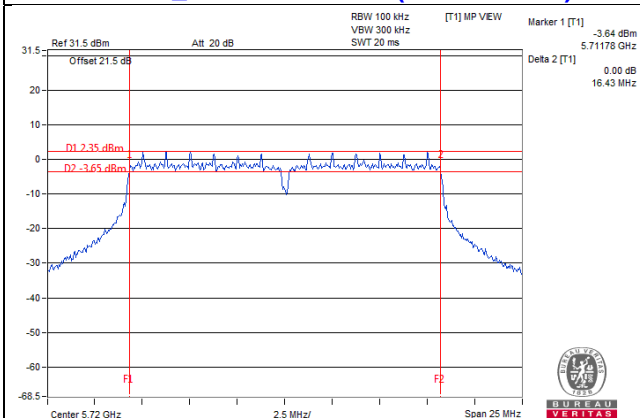

802.11ax (HE20)_Chain 4 / CH144 (U-NII-3 Band)

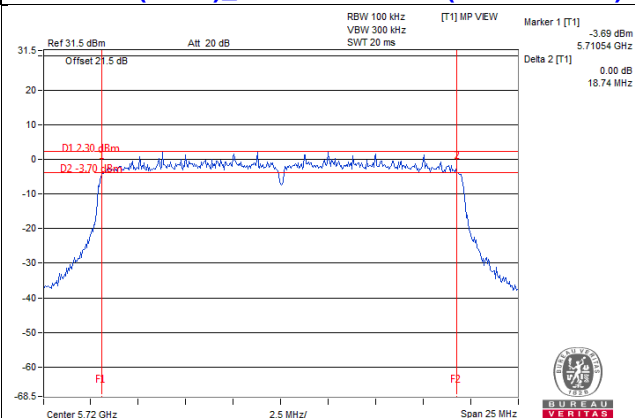

802.11ax (HE40)_Chain 7 / CH142 (U-NII-3 Band)

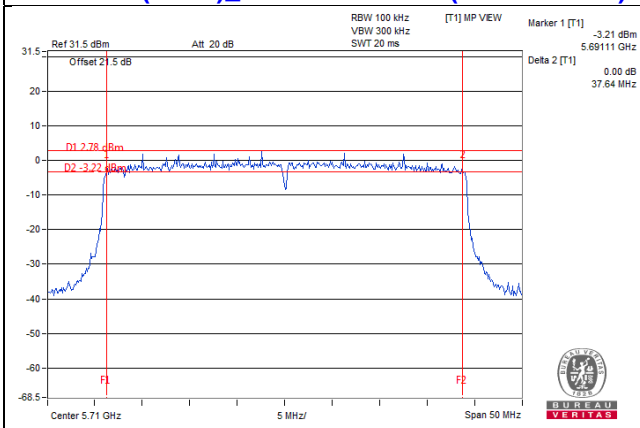

802.11ax (HE80)_Chain 4 / CH138 (U-NII-3 Band)

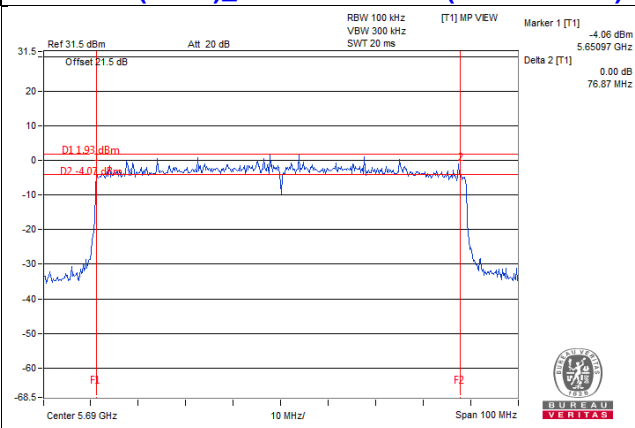

4.7.9 Test Results (Mode 3)

Non-Beamforming Mode

802.11a

Channel	Frequency (MHz)	6dB Bandwidth (MHz)		Minimum Limit (MHz)	Pass / Fail
		Chain 1	Chain 2		
144 (U-NII-3 Band)	5720	3.20	3.21	0.5	Pass

Note: The 6dB bandwidth above 5725MHz = Marker 1 + Delta 2 - 5725MHz

802.11ax (HE20)

Channel	Frequency (MHz)	6dB Bandwidth (MHz)		Minimum Limit (MHz)	Pass / Fail
		Chain 1	Chain 2		
144 (U-NII-3 Band)	5720	4.29	4.31	0.5	Pass

Note: The 6dB bandwidth above 5725MHz = Marker 1 + Delta 2 - 5725MHz

802.11ax (HE40)

Channel	Frequency (MHz)	6dB Bandwidth (MHz)		Minimum Limit (MHz)	Pass / Fail
		Chain 1	Chain 2		
142 (U-NII-3 Band)	5710	3.57	4.04	0.5	Pass

Note: The 6dB bandwidth above 5725MHz = Marker 1 + Delta 2 - 5725MHz

802.11ax (HE80)

Channel	Frequency (MHz)	6dB Bandwidth (MHz)		Minimum Limit (MHz)	Pass / Fail
		Chain 1	Chain 2		
138 (U-NII-3 Band)	5690	3.03	3.47	0.5	Pass

Note: The 6dB bandwidth above 5725MHz = Marker 1 + Delta 2 - 5725MHz

Spectrum Plot of Worst Value

802.11a_Chain 1 / CH144 (U-NII-3 Band)

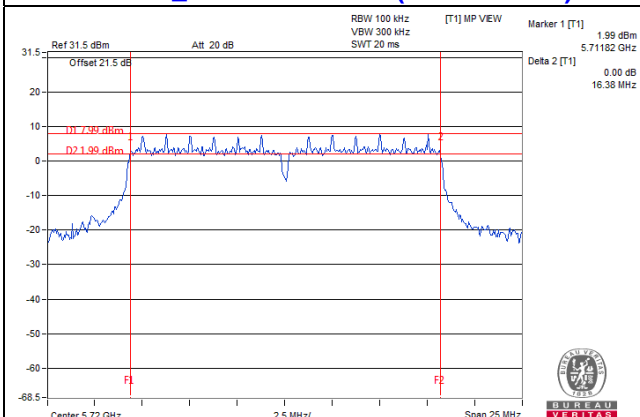

802.11ax (HE20)_Chain 1 / CH144 (U-NII-3 Band)

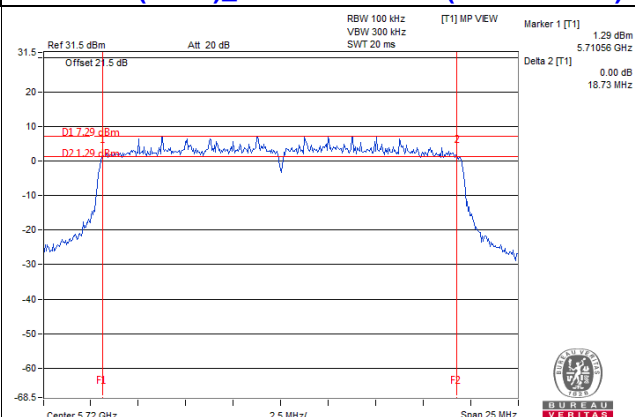

802.11ax (HE40)_Chain 1 / CH142 (U-NII-3 Band)

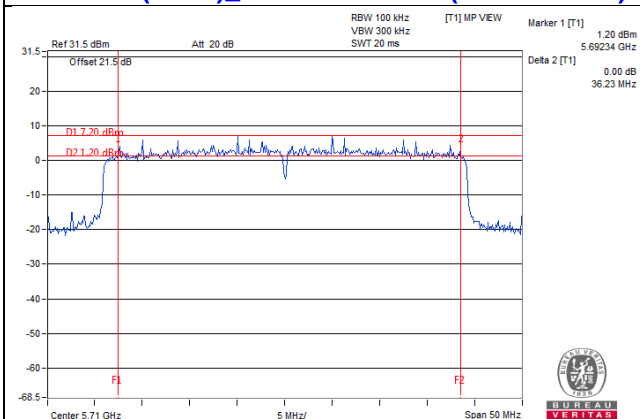

802.11ax (HE80)_Chain 1 / CH138 (U-NII-3 Band)

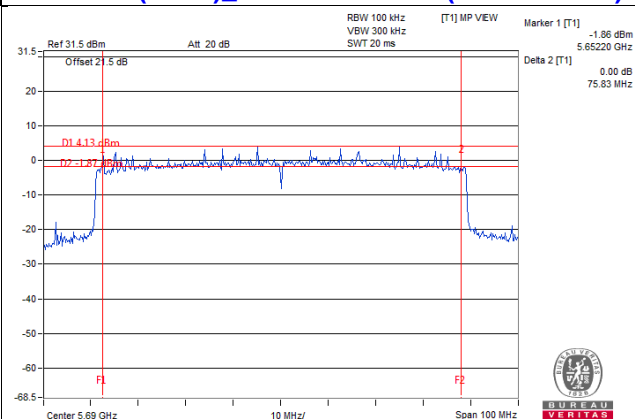

4.7.10 Test Results (Mode 4)

Non-Beamforming Mode

802.11a

Channel	Frequency (MHz)	6dB Bandwidth (MHz)	Minimum Limit (MHz)	Pass / Fail
144 (U-NII-3 Band)	5720	3.20	0.5	Pass

Note: 1. The 6dB bandwidth above 5725MHz = Marker 1 + Delta 2 - 5725MHz
 2. Chain 0 was chosen for test.

802.11ax (HE20)

Channel	Frequency (MHz)	6dB Bandwidth (MHz)	Minimum Limit (MHz)	Pass / Fail
144 (U-NII-3 Band)	5720	4.50	0.5	Pass

Note: 1. The 6dB bandwidth above 5725MHz = Marker 1 + Delta 2 - 5725MHz
 2. Chain 0 was chosen for test.

802.11ax (HE40)

Channel	Frequency (MHz)	6dB Bandwidth (MHz)	Minimum Limit (MHz)	Pass / Fail
142 (U-NII-3 Band)	5710	3.91	0.5	Pass

Note: 1. The 6dB bandwidth above 5725MHz = Marker 1 + Delta 2 - 5725MHz
 2. Chain 0 was chosen for test.

802.11ax (HE80)

Channel	Frequency (MHz)	6dB Bandwidth (MHz)	Minimum Limit (MHz)	Pass / Fail
138 (U-NII-3 Band)	5690	3.02	0.5	Pass

Note: 1. The 6dB bandwidth above 5725MHz = Marker 1 + Delta 2 - 5725MHz
 2. Chain 0 was chosen for test.

Spectrum Plot of Worst Value

802.11a_Chain 0 / CH144 (U-NII-3 Band)

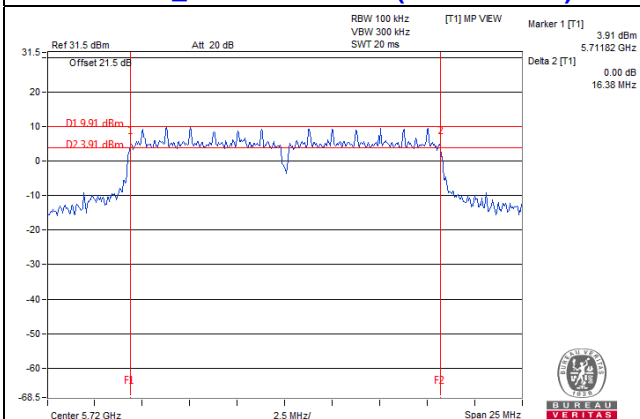

802.11ax (HE20)_Chain 0 / CH144 (U-NII-3 Band)

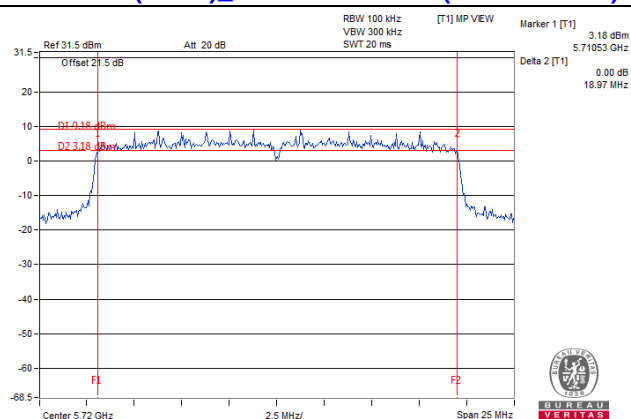

802.11ax (HE40)_Chain 0 / CH142 (U-NII-3 Band)

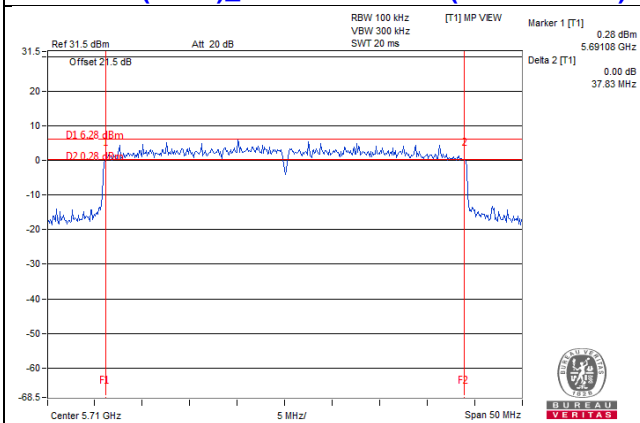

802.11ax (HE80)_Chain 0 / CH138 (U-NII-3 Band)

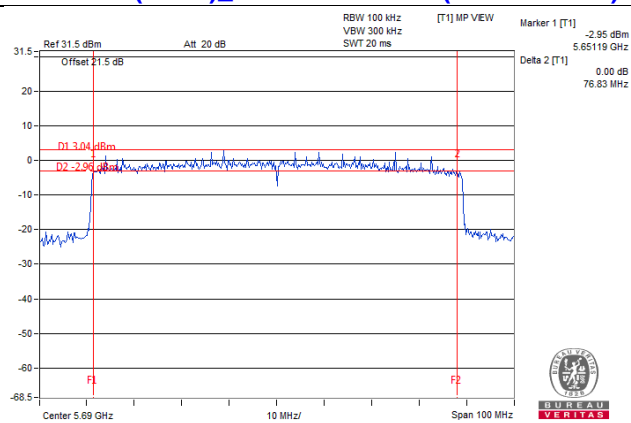

5 Pictures of Test Arrangements

Please refer to the attached file (Test Setup Photo).

Appendix – Information of the Testing Laboratories

We, Bureau Veritas Consumer Products Services (H.K.) Ltd., Taoyuan Branch, were founded in 1988 to provide our best service in EMC, Radio, Telecom and Safety consultation. Our laboratories are FCC recognized accredited test firms and accredited according to ISO/IEC 17025.

If you have any comments, please feel free to contact us at the following:

Linkou EMC/RF Lab

Tel: 886-2-26052180

Fax: 886-2-26051924

Hsin Chu EMC/RF/Telecom Lab

Tel: 886-3-6668565

Fax: 886-3-6668323

Hwa Ya EMC/RF/Safety Lab

Tel: 886-3-3183232

Fax: 886-3-3270892

Email: service.adt@tw.bureauveritas.com

Web Site: www.bureauveritas-adt.com

The address and road map of all our labs can be found in our web site also.

--- END ---