

## FCC Test Report

**Report No.:** RF180704E03-1

**FCC ID:** UDX-60079010

**Test Model:** MR45-HW

**Received Date:** July 04, 2018

**Test Date:** Aug. 29 to Oct. 11, 2018

**Issued Date:** Dec. 24, 2018

**Applicant:** Cisco Systems, Inc.

**Address:** 170 West Tasman Drive, San Jose, CA 95134 USA

**Issued By:** Bureau Veritas Consumer Products Services (H.K.) Ltd., Taoyuan Branch  
Hsin Chu Laboratory

**Lab Address:** E-2, No.1, Li Hsin 1st Road, Hsinchu Science Park, Hsinchu City 300,  
Taiwan R.O.C.

**Test Location :** E-2, No.1, Li Hsin 1st Road, Hsinchu Science Park, Hsinchu City 300,  
Taiwan R.O.C.

**FCC Registration /  
Designation Number:** 723255 / TW2022



This report is for your exclusive use. Any copying or replication of this report to or for any other person or entity, or use of our name or trademark, is permitted only with our prior written permission. This report sets forth our findings solely with respect to the test samples identified herein. The results set forth in this report are not indicative or representative of the quality or characteristics of the lot from which a test sample was taken or any similar or identical product unless specifically and expressly noted. Our report includes all of the tests requested by you and the results thereof based upon the information that you provided to us. You have 60 days from date of issuance of this report to notify us of any material error or omission caused by our negligence, provided, however, that such notice shall be in writing and shall specifically address the issue you wish to raise. A failure to raise such issue within the prescribed time shall constitute your unqualified acceptance of the completeness of this report, the tests conducted and the correctness of the report contents. Unless specific mention, the uncertainty of measurement has been explicitly taken into account to declare the compliance or non-compliance to the specification. The report must not be used by the client to claim product certification, approval, or endorsement by TAF or any government agencies.

## Table of Contents

<b>Release Control Record</b> .....	<b>4</b>
<b>1 Certificate of Conformity</b> .....	<b>5</b>
<b>2 Summary of Test Results</b> .....	<b>6</b>
2.1 Measurement Uncertainty .....	6
2.2 Modification Record .....	6
<b>3 General Information</b> .....	<b>7</b>
3.1 General Description of EUT .....	7
3.2 Description of Test Modes .....	12
3.2.1 Test Mode Applicability and Tested Channel Detail .....	13
3.3 Duty Cycle of Test Signal .....	17
3.4 Description of Support Units .....	19
3.4.1 Configuration of System under Test .....	20
3.5 General Description of Applied Standard .....	22
<b>4 Test Types and Results</b> .....	<b>23</b>
4.1 Radiated Emission and Bandedge Measurement .....	23
4.1.1 Limits of Radiated Emission and Bandedge Measurement .....	23
4.1.2 Test Instruments .....	24
4.1.3 Test Procedure .....	26
4.1.4 Deviation from Test Standard .....	26
4.1.5 Test Setup .....	27
4.1.6 EUT Operating Condition .....	28
4.1.7 Test Results (Mode 1) .....	29
4.1.8 Test Results (Mode 2) .....	50
4.1.9 Test Results (Mode 3) .....	68
4.2 Conducted Emission Measurement .....	86
4.2.1 Limits of Conducted Emission Measurement .....	86
4.2.2 Test Instruments .....	86
4.2.3 Test Procedure .....	87
4.2.4 Deviation from Test Standard .....	87
4.2.5 Test Setup .....	87
4.2.6 EUT Operating Condition .....	87
4.2.7 Test Results (Mode 1) .....	88
4.3 Transmit Power Measurement .....	90
4.3.1 Limits of Transmit Power Measurement .....	90
4.3.2 Test Setup .....	90
4.3.3 Test Instruments .....	90
4.3.4 Test Procedure .....	90
4.3.5 Deviation from Test Standard .....	90
4.3.6 EUT Operating Condition .....	90
4.3.7 Test Result (Mode 1) .....	91
4.3.8 Test Result (Mode 2) .....	97
4.3.9 Test Result (Mode 3) .....	105
4.4 Occupied Bandwidth Measurement .....	107
4.4.1 Test Setup .....	107
4.4.2 Test Instruments .....	107
4.4.3 Test Procedure .....	107
4.4.4 Test Results (Mode 1) .....	108
4.4.5 Test Results (Mode 2) .....	116
4.4.6 Test Results (Mode 3) .....	122
4.5 Peak Power Spectral Density Measurement .....	126
4.5.1 Limits of Peak Power Spectral Density Measurement .....	126
4.5.2 Test Setup .....	126
4.5.3 Test Instruments .....	126

4.5.4	Test Procedure .....	126
4.5.5	Deviation from Test Standard .....	126
4.5.6	EUT Operating Condition .....	126
4.5.7	Test Results (Mode 1).....	127
4.5.8	Test Results (Mode 2).....	139
4.5.9	Test Results (Mode 3).....	149
4.6	Frequency Stability Measurement.....	157
4.6.1	Limits of Frequency Stability Measurement .....	157
4.6.2	Test Setup.....	157
4.6.3	Test Instruments .....	157
4.6.4	Test Procedure .....	157
4.6.5	Deviation from Test Standard .....	157
4.6.6	EUT Operating Condition .....	157
4.6.7	Test Results (Mode 1).....	158
4.7	6dB Bandwidth Measurement.....	159
4.7.1	Limits of 6dB Bandwidth Measurement.....	159
4.7.2	Test Setup.....	159
4.7.3	Test Instruments .....	159
4.7.4	Test Procedure .....	159
4.7.5	Deviation from Test Standard .....	159
4.7.6	EUT Operating Condition .....	159
4.7.7	Test Results (Mode 1).....	160
4.7.8	Test Results (Mode 2).....	162
4.7.9	Test Results (Mode 3).....	164
<b>5</b>	<b>Pictures of Test Arrangements.....</b>	<b>166</b>
	<b>Annex A- Radiated Out of Band Emission (OOBE) Measurement (For U-NII-3 band).....</b>	<b>167</b>
	<b>Appendix – Information on the Testing Laboratories .....</b>	<b>177</b>

### Release Control Record

Issue No.	Description	Date Issued
RF180704E03-1	Original release.	Dec. 24, 2018

## 1 Certificate of Conformity

**Product:** 4x4 802.11a/b/g/n/ac/ax Access Point

**Brand:** Cisco

**Test Model:** MR45-HW

**Sample Status:** ENGINEERING SAMPLE

**Applicant:** Cisco Systems, Inc.

**Test Date:** Aug. 29 to Oct. 11, 2018

**Standard:** 47 CFR FCC Part 15, Subpart E (Section 15.407)  
ANSI C63.10: 2013

The above equipment has been tested by **Bureau Veritas Consumer Products Services (H.K.) Ltd., Taoyuan Branch**, and found compliance with the requirement of the above standards. The test record, data evaluation & Equipment Under Test (EUT) configurations represented herein are true and accurate accounts of the measurements of the sample's EMC characteristics under the conditions specified in this report.

**Prepared by :** Mary Ko , **Date:** Dec. 24, 2018  
Mary Ko / Specialist

**Approved by :** May Chen , **Date:** Dec. 24, 2018  
May Chen / Manager

## 2 Summary of Test Results

47 CFR FCC Part 15, Subpart E (Section 15.407)			
FCC Clause	Test Item	Result	Remarks
15.407(b)(6)	AC Power Conducted Emissions	Pass	Meet the requirement of limit. Minimum passing margin is -4.89dB at 0.37656MHz.
15.407(b) (1/2/3/4(i/ii)/6)	Radiated Emissions & Band Edge Measurement*	Pass	Meet the requirement of limit. Minimum passing margin is -0.1dB at 5139.00MHz, 5150.00MHz.
15.407(a)(1/2/3)	Max Average Transmit Power	Pass	Meet the requirement of limit.
---	Occupied Bandwidth Measurement	-	Reference only.
15.407(a)(1/2/3)	Peak Power Spectral Density	Pass	Meet the requirement of limit.
15.407(e)	6dB bandwidth	Pass	Meet the requirement of limit. (U-NII-3 Band only)
15.407(g)	Frequency Stability	Pass	Meet the requirement of limit.
15.203	Antenna Requirement	Pass	Antenna connector is i-pex(MHF) not a standard connector.

\*For U-NII-3 band compliance with rule part 15.407(b)(4)(i), the OOB test plots were recorded in Annex A.

### 2.1 Measurement Uncertainty

Where relevant, the following measurement uncertainty levels have been estimated for tests performed on the EUT as specified in CISPR 16-4-2:

Measurement	Frequency	Expanded Uncertainty (k=2) (±)
Conducted Emissions at mains ports	150kHz ~ 30MHz	1.84 dB
Radiated Emissions up to 1 GHz	30MHz ~ 1GHz	5.53 dB
Radiated Emissions above 1 GHz	1GHz ~ 6GHz	5.08 dB
	6GHz ~ 18GHz	4.98 dB
	18GHz ~ 40GHz	5.19 dB

### 2.2 Modification Record

There were no modifications required for compliance.

### 3 General Information

#### 3.1 General Description of EUT

Product	4x4 802.11a/b/g/n/ac/ax Access Point
Brand	Cisco
Test Model	MR45-HW
Status of EUT	ENGINEERING SAMPLE
Power Supply Rating	12Vdc from power adapter or 55Vdc from PoE
Modulation Type	CCK, DQPSK, DBPSK for DSSS 64QAM, 16QAM, QPSK, BPSK for OFDM 256QAM for OFDM in 11ac mode and VHT (20/40) mode in 2.4GHz 1024QAM for OFDMA in 11ax HE mode
Modulation Technology	DSSS, OFDM, OFDMA
Transfer Rate	802.11b: up to 11Mbps 802.11a/g: up to 54Mbps 802.11n: up to 600Mbps 802.11ac: up to 1733.3Mbps 802.11ax: up to 2401.9Mbps
Operating Frequency	<b>2.4GHz:</b> 2.412 ~ 2.462GHz <b>5GHz:</b> 5.18GHz ~ 5.24GHz, 5.745GHz ~ 5.825GHz
Number of Channel	<b>2.4GHz:</b> 802.11b, 802.11g, 802.11n (HT20), VHT20, 802.11ax (HE20): 11 802.11n (HT40), VHT40, 802.11ax (HE40): 7 <b>5GHz:</b> 802.11a, 802.11n (HT20), 802.11ac (VHT20), 802.11ax (HE20): 9 802.11n (HT40), 802.11ac (VHT40), 802.11ax (HE40): 4 802.11ac (VHT80), 802.11ax (HE80): 2 802.11ac (VHT80+80), 802.11ax (HE80+80): 1 set
Output Power	<b>2.4GHz:</b> <b>Non-Beamforming Mode:</b> <b>4TX:</b> 872.013mW <b>2TX:</b> 503.965mW <b>1TX:</b> 258.226mW <b>Beamforming Mode:</b> <b>4TX:</b> 591.63mW <b>2TX:</b> 374.567mW <b>5.18 ~ 5.24GHz:</b> <b>Non-Beamforming Mode:</b> <b>4TX:</b> 572.519mW <b>2TX:</b> 309.064mW <b>1TX:</b> 214.783mW <b>Beamforming Mode:</b> <b>4TX:</b> 572.519mW <b>2TX:</b> 302.029mW <b>5.745 ~ 5.825GHz:</b> <b>Non-Beamforming Mode:</b> <b>4TX:</b> 996.654mW <b>2TX:</b> 614.522mW <b>1TX:</b> 266.686mW <b>Beamforming Mode:</b> <b>4TX:</b> 605.112mW <b>2TX:</b> 614.522mW
Antenna Type	Refer to Note
Antenna Connector	Refer to Note
Accessory Device	Adapter x 1 (option)

Data Cable Supplied	NA
---------------------	----

Note:

1. The EUT has below radios as following table:

Radio 1	Radio 2	Radio 3	Radio 4
WLAN (2.4GHz)	WLAN (5GHz)	2.4GHz / 5GHz Scanning (only RX)	Bluetooth

2. Simultaneously transmission condition.

Condition	Technology		
1	WLAN (2.4GHz)	WLAN (5GHz)	Bluetooth

Note: The emission of the simultaneous operation has been evaluated and no non-compliance was found.

3. The EUT must be supplied with a power adapter or POE as following table:

Adapter (Option)

No.	Brand	Model No.	Spec.
1	UMEC	MA-PWR-30W-US	Input: 100-240Vac, 0.8A, 50/60Hz Output: 12Vdc, 2.5A DC Output cable: Unshielded, 1.4m
2	Ktec	KSAS0361200250HU	Input: 100-240Vac, 1.0A, 50/60Hz Output: 12Vdc, 2.5A DC Output cable: Unshielded, 1.8m

POE (Only for test not for sale)

No.	Brand	Model No.	Spec.
1	CISCO	MA-INJ-5	Input: 100-240Vac, 1.5A, 50-60Hz Output: 55Vdc, 0.63A
2	CISCO	MA-INJ-4	Input: 100-240Vac, 0.67A, 50/60Hz Output: 55Vdc, 0.6A

Note:

- From the above conditions, the conducted emissions worse case was found in **POE No. 1**.  
Therefore only the test data of the mode was recorded in this report.
- From the above conditions, the radiated emissions worse case was found in **Adapter No. 2**.  
Therefore only the test data of the mode was recorded in this report.



4. The antennas provided to the EUT, please refer to the following table:

<b>WLAN Directional gain table – 4TX</b>				
Frequency range (GHz)	Directional Antenna Gain (dBi)	Antenna Type	Antenna Connector	
2.4 ~ 2.4835	7.74	PIFA	i-pex(MHF)	
5.15 ~ 5.25	8.40			
5.725 ~ 5.85	8.11			
<b>WLAN Directional gain table – 2TX</b>				
Frequency range (GHz)	Antenna Combine Type	Directional Antenna Gain (dBi)	Antenna Type	Antenna Connector
2.4 ~ 2.4835	2.4G Ant. 1+4	6.12	PIFA	i-pex(MHF)
5.15 ~ 5.25	5.15G Ant. 1+3	6.62		
5.725 ~ 5.85	5.85G Ant. 3+4	7.27		
<b>Bluetooth antenna spec.</b>				
Antenna Net Gain (dBi)	Frequency range (GHz)	Antenna Type	Antenna Connector	
4.24	2.4 ~ 2.4835	PIFA	i-pex(MHF)	
Note: More detailed information, please refer to operating description.				

5. The EUT incorporates a MIMO function.

Radio 1 - 2.4GHz Band			
MODULATION MODE	DATA RATE (MCS)	TX & RX CONFIGURATION	
802.11b	1 ~ 11Mbps	4TX	4RX
802.11g	6 ~ 54Mbps	4TX	4RX
802.11n (HT20)	MCS 0~7	4TX	4RX
	MCS 8~15	4TX	4RX
	MCS 16~23	4TX	4RX
	MCS 24~31	4TX	4RX
802.11n (HT40)	MCS 0~7	4TX	4RX
	MCS 8~15	4TX	4RX
	MCS 16~23	4TX	4RX
	MCS 24~31	4TX	4RX
VHT20	MCS 0~8, Nss=1	4TX	4RX
	MCS 0~8, Nss=2	4TX	4RX
	MCS 0~9, Nss=3	4TX	4RX
	MCS 0~8, Nss=4	4TX	4RX
VHT40	MCS 0~9, Nss=1	4TX	4RX
	MCS 0~9, Nss=2	4TX	4RX
	MCS 0~9, Nss=3	4TX	4RX
	MCS 0~9, Nss=4	4TX	4RX
802.11ax (HE20)	MCS 0~11, Nss=1	4TX	4RX
	MCS 0~11, Nss=2	4TX	4RX
	MCS 0~11, Nss=3	4TX	4RX
	MCS 0~11, Nss=4	4TX	4RX
802.11ax (HE40)	MCS 0~11, Nss=1	4TX	4RX
	MCS 0~11, Nss=2	4TX	4RX
	MCS 0~11, Nss=3	4TX	4RX
	MCS 0~11, Nss=4	4TX	4RX
Radio 2 - 5GHz Band			
MODULATION MODE	DATA RATE (MCS)	TX & RX CONFIGURATION	
802.11a	6 ~ 54Mbps	4TX	4RX
802.11n (HT20)	MCS 0~7	4TX	4RX
	MCS 8~15	4TX	4RX
	MCS 16~23	4TX	4RX
	MCS 24~31	4TX	4RX
802.11n (HT40)	MCS 0~7	4TX	4RX
	MCS 8~15	4TX	4RX
	MCS 16~23	4TX	4RX
	MCS 24~31	4TX	4RX
802.11ac (VHT20)	MCS 0~8, Nss=1	4TX	4RX
	MCS 0~8, Nss=2	4TX	4RX
	MCS 0~9, Nss=3	4TX	4RX
	MCS 0~8, Nss=4	4TX	4RX
802.11ac (VHT40)	MCS 0~9, Nss=1	4TX	4RX
	MCS 0~9, Nss=2	4TX	4RX
	MCS 0~9, Nss=3	4TX	4RX
	MCS 0~9, Nss=4	4TX	4RX
802.11ac (VHT80)	MCS 0~9, Nss=1	4TX	4RX
	MCS 0~9, Nss=2	4TX	4RX
	MCS 0~9, Nss=3	4TX	4RX
	MCS 0~9, Nss=4	4TX	4RX

<b>802.11ac (VHT80+VHT80)</b>	MCS 0~9, Nss=1	2TX+2TX	2RX+2RX
	MCS 0~9, Nss=2	2TX+2TX	2RX+2RX
<b>802.11ax (HE20)</b>	MCS 0~11, Nss=1	4TX	4RX
	MCS 0~11, Nss=2	4TX	4RX
	MCS 0~11, Nss=3	4TX	4RX
	MCS 0~11, Nss=4	4TX	4RX
<b>802.11ax (HE40)</b>	MCS 0~11, Nss=1	4TX	4RX
	MCS 0~11, Nss=2	4TX	4RX
	MCS 0~11, Nss=3	4TX	4RX
	MCS 0~11, Nss=4	4TX	4RX
<b>802.11ax (HE80)</b>	MCS 0~11, Nss=1	4TX	4RX
	MCS 0~11, Nss=2	4TX	4RX
	MCS 0~11, Nss=3	4TX	4RX
	MCS 0~11, Nss=4	4TX	4RX
<b>802.11ax (HE80+HE80)</b>	MCS 0~11, Nss=1	2TX+2TX	2RX+2RX
	MCS 0~11, Nss=2	2TX+2TX	2RX+2RX

Note:

1. All of modulation mode support beamforming function except 802.11a/b/g modulation mode.
2. The EUT support Beamforming and non-beamforming mode, therefore both mode were investigated and the worst case scenario was identified. The worst case data were presented in test report.
3. The modulation and bandwidth are similar for 802.11n mode for 20MHz (40MHz) and 802.11ac/ax mode for 20MHz (40MHz/80MHz), therefore investigated worst case to representative mode in test report.

#### Radio 3 - Scanning (only RX)

##### 2.4GHz

MODULATION MODE	RX CONFIGURATION
802.11b	1RX
802.11g	1RX
802.11n (HT20)	1RX
802.11n (HT40)	1RX
VHT20	1RX
VHT40	1RX

##### 5GHz

MODULATION MODE	RX CONFIGURATION
802.11a	1RX
802.11n (HT20)	1RX
802.11n (HT40)	1RX
802.11ac (VHT20)	1RX
802.11ac (VHT40)	1RX
802.11ac (VHT80)	1RX

6. The above EUT information is declared by manufacturer and for more detailed features description, please refers to the manufacturer's specifications or user's manual.

### 3.2 Description of Test Modes

#### FOR 5180 ~ 5240MHz

4 channels are provided for 802.11a, 802.11n (HT20), 802.11ac (VHT20), 802.11ax (HE20):

Channel	Frequency	Channel	Frequency
36	5180 MHz	44	5220 MHz
40	5200 MHz	48	5240 MHz

2 channels are provided for 802.11n (HT40), 802.11ac (VHT40), 802.11ax (HE40):

Channel	Frequency	Channel	Frequency
38	5190 MHz	46	5230 MHz

1 channel is provided for 802.11ac (VHT80), 802.11ax (HE80):

Channel	Frequency
42	5210 MHz

#### FOR 5745 ~ 5825MHz:

5 channels are provided for 802.11a, 802.11n (HT20), 802.11ac (VHT20), 802.11ax (HE20):

Channel	Frequency	Channel	Frequency
149	5745 MHz	161	5805 MHz
153	5765 MHz	165	5825 MHz
157	5785 MHz		

2 channels are provided for 802.11n (HT40), 802.11ac (VHT40), 802.11ax (HE40):

Channel	Frequency	Channel	Frequency
151	5755 MHz	159	5795 MHz

1 channel is provided for 802.11ac (VHT80), 802.11ax (HE80):

Channel	Frequency
155	5775 MHz

#### For simultaneous transmission:

1 set is provided for 802.11ac (VHT80+80), 802.11ax (HE80+80):

Channel	Frequency
42+155	5210 MHz + 5775 MHz

Note: The transmission is for noncontiguous transmission using two nonadjacent 80MHz channels.

### 3.2.1 Test Mode Applicability and Tested Channel Detail

EUT Configure Mode	Applicable To				Description
	RE $\geq$ 1G	RE $<$ 1G	PLC	APCM	
1	√	√	√	√	4TX (PLC: POE mode; RE: adapter mode)
2	√	-	-	√	2TX (RE: adapter mode)
3	√	-	-	√	1TX (RE: adapter mode)

Where **RE $\geq$ 1G**: Radiated Emission above 1GHz      **RE $<$ 1G**: Radiated Emission below 1GHz  
**PLC**: Power Line Conducted Emission      **APCM**: Antenna Port Conducted Measurement

**NOTE**: 1. The EUT had been pre-tested on the positioned of each 3 axis. The worst case was found when positioned on X-plane.  
 2. "-" means no effect.

#### Radiated Emission Test (Above 1GHz):

- Pre-Scan has been conducted to determine the worst-case mode from all possible combinations between available modulations, data rates and antenna ports (if EUT with antenna diversity architecture).
- Following channel(s) was (were) selected for the final test as listed below.

Non-Beamforming Mode						
Mode	FREQ. Band (MHz)	Available Channel	Tested Channel	Modulation Technology	Modulation Type	Data Rate Parameter
802.11a	5180-5240	36 to 48	36, 40, 48	OFDM	BPSK	6Mb/s
802.11ax (HE20)		36 to 48	36, 40, 48	OFDMA	BPSK	MCS0
802.11ax (HE40)		38 to 46	38, 46	OFDMA	BPSK	MCS0
802.11ax (HE80)		42	42	OFDMA	BPSK	MCS0
802.11a	5745-5825	149 to 165	149, 157, 165	OFDM	BPSK	6Mb/s
802.11ax (HE20)		149 to 165	149, 157, 165	OFDMA	BPSK	MCS0
802.11ax (HE40)		151 to 159	151, 159	OFDMA	BPSK	MCS0
802.11ax (HE80)		155	155	OFDMA	BPSK	MCS0
802.11ax (HE80+80) Only for 4TX	5180-5240 5745-5825	42 + 155	42 + 155	OFDMA	BPSK	MCS0

#### Radiated Emission Test (Below 1GHz):

- Pre-Scan has been conducted to determine the worst-case mode from all possible combinations between available modulations, data rates and antenna ports (if EUT with antenna diversity architecture).
- Following channel(s) was (were) selected for the final test as listed below.

Non-Beamforming Mode						
Mode	FREQ. Band (MHz)	Available Channel	Tested Channel	Modulation Technology	Modulation Type	Data Rate Parameter
802.11ax (HE20)	5180-5240 5745-5825	36 to 48 149 to 165	149	OFDMA	BPSK	MCS0

**Power Line Conducted Emission Test:**

- Pre-Scan has been conducted to determine the worst-case mode from all possible combinations between available modulations, data rates and antenna ports (if EUT with antenna diversity architecture).
- Following channel(s) was (were) selected for the final test as listed below.

<b>Non-Beamforming Mode</b>						
Mode	FREQ. Band (MHz)	Available Channel	Tested Channel	Modulation Technology	Modulation Type	Data Rate Parameter
802.11ax (HE20)	5180-5240 5745-5825	36 to 48 149 to 165	149	OFDMA	BPSK	MCS0

### Antenna Port Conducted Measurement:

- This item includes all test value of each mode, but only includes spectrum plot of worst value of each mode.
- Pre-Scan has been conducted to determine the worst-case mode from all possible combinations between available modulations, data rates and antenna ports (if EUT with antenna diversity architecture).
- Following channel(s) was (were) selected for the final test as listed below.

<b>Non-Beamforming Mode</b>						
Mode	FREQ. Band (MHz)	Available Channel	Tested Channel	Modulation Technology	Modulation Type	Data Rate Parameter
802.11a	5180-5240	36 to 48	36, 40, 48	OFDM	BPSK	6Mb/s
802.11ac (VHT20)		36 to 48	36, 40, 48	OFDM	BPSK	MCS0
802.11ac (VHT40)		38 to 46	38, 46	OFDM	BPSK	MCS0
802.11ac (VHT80)		42	42	OFDM	BPSK	MCS0
802.11ax (HE20)		36 to 48	36, 40, 48	OFDMA	BPSK	MCS0
802.11ax (HE40)		38 to 46	38, 46	OFDMA	BPSK	MCS0
802.11ax (HE80)		42	42	OFDMA	BPSK	MCS0
802.11a	5745-5825	149 to 165	149, 157, 165	OFDM	BPSK	6Mb/s
802.11ac (VHT20)		149 to 165	149, 157, 165	OFDM	BPSK	MCS0
802.11ac (VHT40)		151 to 159	151, 159	OFDM	BPSK	MCS0
802.11ac (VHT80)		155	155	OFDM	BPSK	MCS0
802.11ax (HE20)		149 to 165	149, 157, 165	OFDMA	BPSK	MCS0
802.11ax (HE40)		151 to 159	151, 159	OFDMA	BPSK	MCS0
802.11ax (HE80)		155	155	OFDMA	BPSK	MCS0
802.11ac (VHT80+80) Only for 4TX	5180-5240 5745-5825	42 + 155	42 + 155	OFDM	BPSK	MCS0
802.11ax (HE80+80) Only for 4TX	5180-5240 5745-5825	42 + 155	42 + 155	OFDMA	BPSK	MCS0
<b>Non-Beamforming Mode (Output power only)</b>						
Mode	FREQ. Band (MHz)	Available Channel	Tested Channel	Modulation Technology	Modulation Type	Data Rate Parameter
802.11ac (VHT20)	5180-5240	36 to 48	36, 40, 48	OFDM	BPSK	MCS0
802.11ac (VHT40)		38 to 46	38, 46	OFDM	BPSK	MCS0
802.11ac (VHT80)		42	42	OFDM	BPSK	MCS0
802.11ax (HE20)		36 to 48	36, 40, 48	OFDMA	BPSK	MCS0
802.11ax (HE40)		38 to 46	38, 46	OFDMA	BPSK	MCS0
802.11ax (HE80)		42	42	OFDMA	BPSK	MCS0
802.11ac (VHT20)	5745-5825	149 to 165	149, 157, 165	OFDM	BPSK	MCS0
802.11ac (VHT40)		151 to 159	151, 159	OFDM	BPSK	MCS0
802.11ac (VHT80)		155	155	OFDM	BPSK	MCS0
802.11ax (HE20)		149 to 165	149, 157, 165	OFDMA	BPSK	MCS0
802.11ax (HE40)		151 to 159	151, 159	OFDMA	BPSK	MCS0
802.11ax (HE80)		155	155	OFDMA	BPSK	MCS0
802.11ac (VHT80+80) Only for 4TX	5180-5240 5745-5825	42 + 155	42 + 155	OFDM	BPSK	MCS0
802.11ax (HE80+80) Only for 4TX	5180-5240 5745-5825	42 + 155	42 + 155	OFDMA	BPSK	MCS0

**Test Condition:**

Applicable To	Environmental Conditions	Input Power (system)	Tested By
RE $\geq$ 1G	23deg. C, 67%RH	120Vac, 60Hz	Weiwei Lo
RE<1G	22deg. C, 68%RH	120Vac, 60Hz	Frank Chuang
PLC	25deg. C, 75%RH	120Vac, 60Hz	Frank Chuang
APCM	25deg. C, 60%RH	120Vac, 60Hz	Jyunchun Lin



### 3.3 Duty Cycle of Test Signal

If duty cycle of test signal is < 98%, duty factor shall be considered.

**802.11a:** Duty cycle = 1.428 ms/1.536 ms = 0.93, Duty factor =  $10 * \log(1/0.93) = 0.32$

**802.11ac (VHT20):** Duty cycle = 5.423 ms/5.638 ms = 0.962, Duty factor =  $10 * \log(1/0.962) = 0.17$

**802.11ac (VHT40):** Duty cycle = 5.423 ms/5.635 ms = 0.962, Duty factor =  $10 * \log(1/0.962) = 0.17$

**802.11ac (VHT80):** Duty cycle = 5.423 ms/5.65 ms = 0.96, Duty factor =  $10 * \log(1/0.96) = 0.18$

**802.11ac (VHT80+80):** Duty cycle = 5.425/5.635 = 0.963, Duty factor =  $10 * \log(1/0.963) = 0.16$

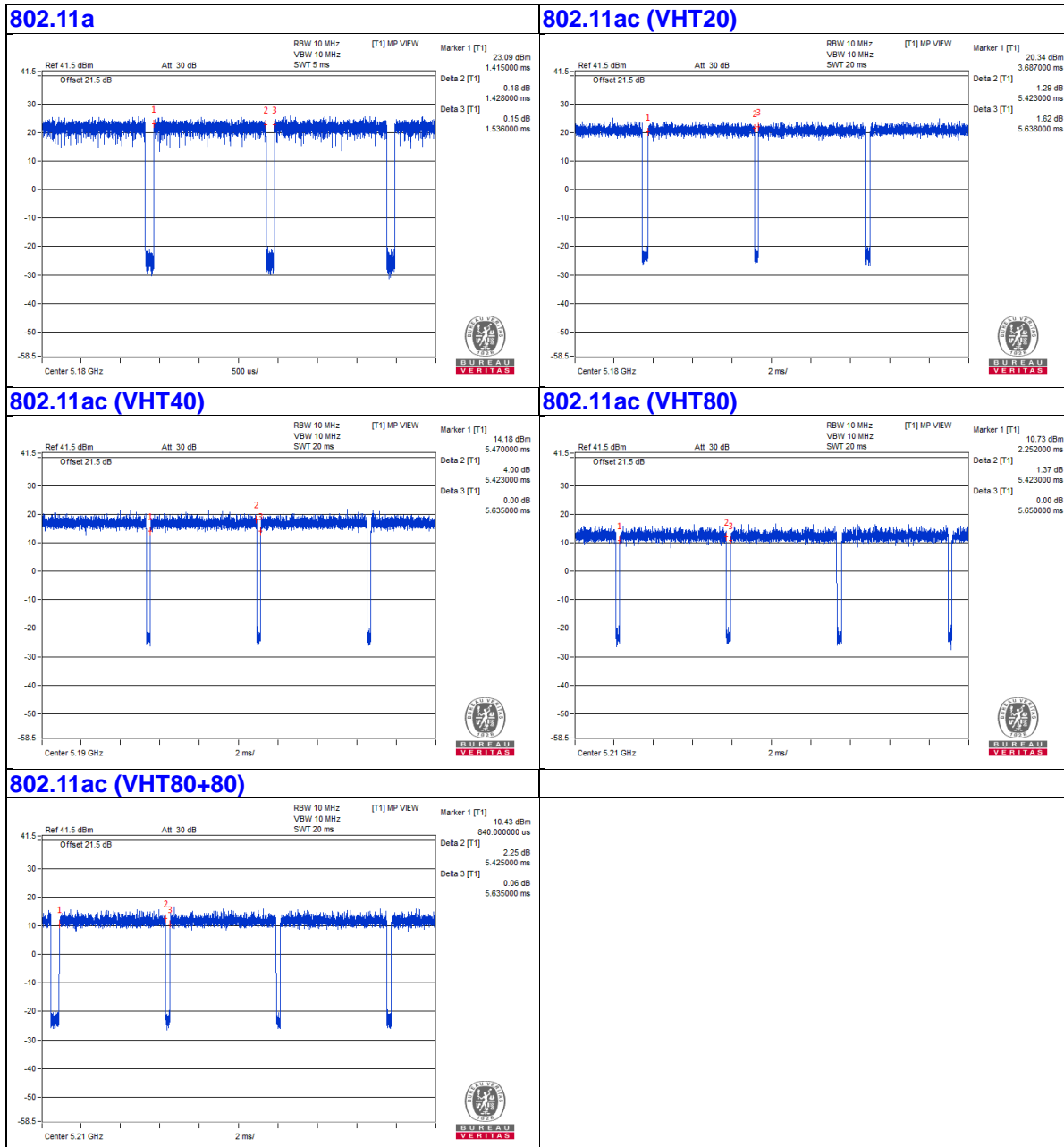

**802.11ax (HE20):** Duty cycle = 5.45 ms/5.708 ms = 0.955, Duty factor =  $10 * \log(1/0.955) = 0.2$   
**802.11ax (HE40):** Duty cycle = 5.443 ms/5.66 ms = 0.962, Duty factor =  $10 * \log(1/0.962) = 0.17$   
**802.11ax (HE80):** Duty cycle = 5.448 ms/5.668 ms = 0.961, Duty factor =  $10 * \log(1/0.961) = 0.17$   
**802.11ax (HE80+80):** Duty cycle = 5.447/5.687 = 0.958, Duty factor =  $10 * \log(1/0.958) = 0.19$

### 802.11ax (HE20)

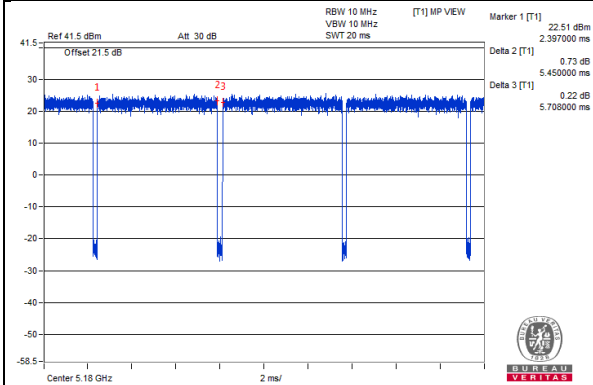

### 802.11ax (HE40)

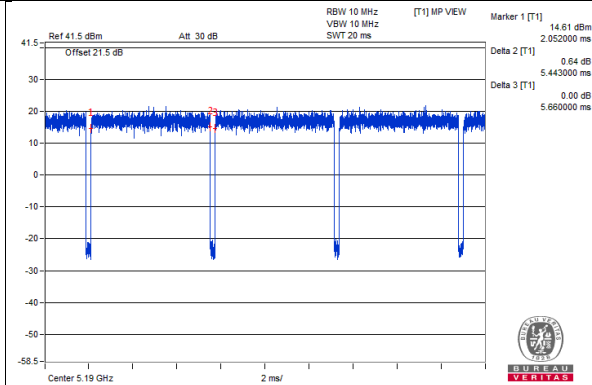

### 802.11ax (HE80)

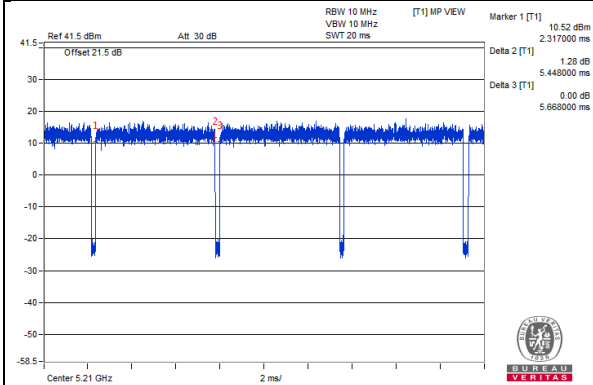

### 802.11ax (HE80+80)

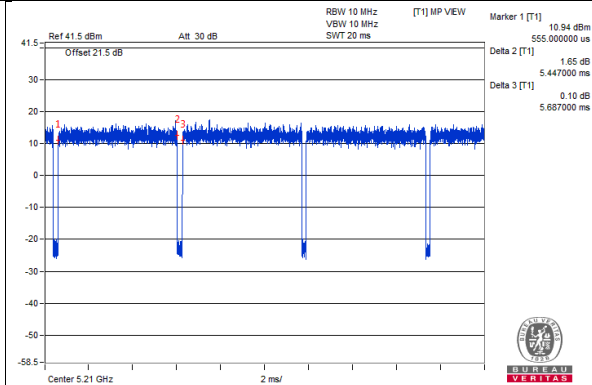

### 3.4 Description of Support Units

The EUT has been tested as an independent unit together with other necessary accessories or support units. The following support units or accessories were used to form a representative test configuration during the tests.

ID	Product	Brand	Model No.	Serial No.	FCC ID	Remarks
A.	Laptop	DELL	E6420	B92T3R1	FCC DoC	Provided by Lab
B.	POE Adapter	CISCO	MA-INJ-5	NA	NA	Supplied by client

Note:

1. All power cords of the above support units are non-shielded (1.8m).

ID	Descriptions	Qty.	Length (m)	Shielding (Yes/No)	Cores (Qty.)	Remarks
1.	RJ-45 Cable	1	10	No	0	Provided by Lab
2.	DC Cable	1	1.8	No	0	Supplied by client
3.	RJ-45 Cable	1	0.5	No	0	Provided by Lab

### 3.4.1 Configuration of System under Test

#### POE mode:

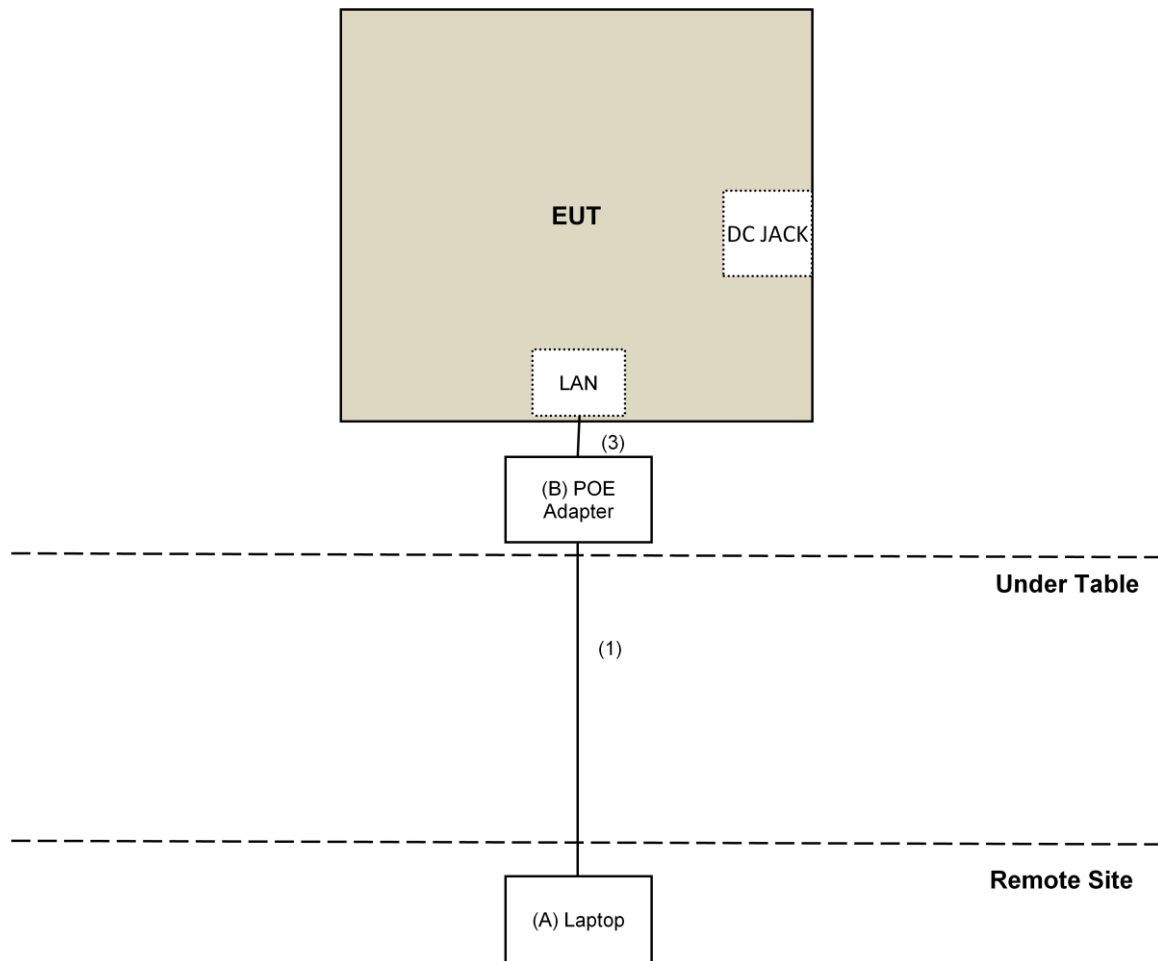

**Adapter mode:**

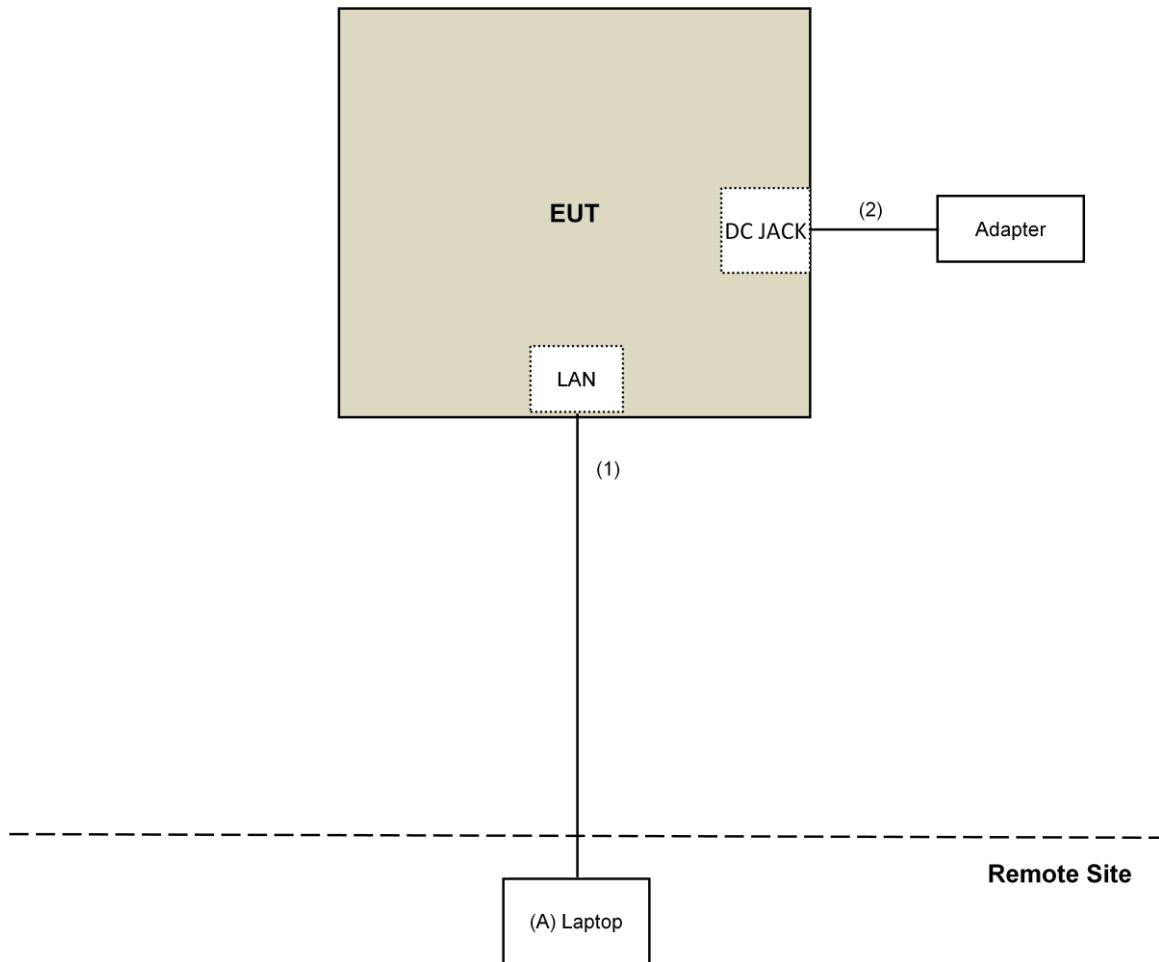

### 3.5 General Description of Applied Standard

The EUT is a RF Product. According to the specifications of the manufacturer, it must comply with the requirements of the following standards:

**FCC Part 15, Subpart E (15.407)**  
**KDB 789033 D02 General UNII Test Procedure New Rules v02r01**  
**KDB 662911 D01 Multiple Transmitter Output v02r01**  
**ANSI C63.10-2013**

All test items have been performed and recorded as per the above standards.

## 4 Test Types and Results

### 4.1 Radiated Emission and Bandedge Measurement

#### 4.1.1 Limits of Radiated Emission and Bandedge Measurement

Radiated emissions which fall in the restricted bands must comply with the radiated emission limits specified as below table.

Frequencies (MHz)	Field Strength (microvolts/meter)	Measurement Distance (meters)
0.009 ~ 0.490	2400/F(kHz)	300
0.490 ~ 1.705	24000/F(kHz)	30
1.705 ~ 30.0	30	30
30 ~ 88	100	3
88 ~ 216	150	3
216 ~ 960	200	3
Above 960	500	3

#### NOTE:

- The lower limit shall apply at the transition frequencies.
- Emission level (dBuV/m) = 20 log Emission level (uV/m).
- For frequencies above 1000MHz, the field strength limits are based on average detector, however, the peak field strength of any emission shall not exceed the maximum permitted average limits, specified above by more than 20dB under any condition of modulation.

Limits of unwanted emission out of the restricted bands

Applicable To		Limit	
789033 D02 General UNII Test Procedure New Rules v02r01		Field Strength at 3m	
		PK:74 (dBuV/m)	AV:54 (dBuV/m)
Frequency Band	Applicable To	EIRP Limit	Equivalent Field Strength at 3m
5150~5250 MHz	15.407(b)(1)	PK:-27 (dBm/MHz)	PK:68.2(dBuV/m)
5250~5350 MHz	15.407(b)(2)		
5470~5725 MHz	15.407(b)(3)		
5725~5850 MHz	<input checked="" type="checkbox"/> 15.407(b)(4)(i)	PK:-27 (dBm/MHz) <sup>*1</sup> PK:10 (dBm/MHz) <sup>*2</sup> PK:15.6 (dBm/MHz) <sup>*3</sup> PK:27 (dBm/MHz) <sup>*4</sup>	PK: 68.2(dBuV/m) <sup>*1</sup> PK:105.2 (dBuV/m) <sup>*2</sup> PK: 110.8(dBuV/m) <sup>*3</sup> PK:122.2 (dBuV/m) <sup>*4</sup>
	<input type="checkbox"/> 15.407(b)(4)(ii)	Emission limits in section 15.247(d)	
<sup>*1</sup> beyond 75 MHz or more above of the band edge.		<sup>*2</sup> below the band edge increasing linearly to 10 dBm/MHz at 25 MHz above.	
<sup>*3</sup> below the band edge increasing linearly to a level of 15.6 dBm/MHz at 5 MHz above.		<sup>*4</sup> from 5 MHz above or below the band edge increasing linearly to a level of 27 dBm/MHz at the band edge.	

#### Note:

The following formula is used to convert the equipment isotropic radiated power (eirp) to field strength:

$$E = \frac{1000000\sqrt{30P}}{3} \mu\text{V/m, where } P \text{ is the eirp (Watts).}$$

## 4.1.2 Test Instruments

**For other test:**

DESCRIPTION & MANUFACTURER	MODEL NO.	SERIAL NO.	CALIBRATED DATE	CALIBRATED UNTIL
Test Receiver Agilent	N9038A	MY50010156	July 12, 2018	July 11, 2019
Pre-Amplifier EMCi	EMC001340	980142	Feb. 09, 2018	Feb. 08, 2019
Loop Antenna(*) Electro-Metrics	EM-6879	264	Dec. 16, 2016	Dec. 15, 2018
RF Cable	NA	LOOPCAB-001	Jan. 15, 2018	Jan. 14, 2019
RF Cable	NA	LOOPCAB-002	Jan. 15, 2018	Jan. 14, 2019
Pre-Amplifier Mini-Circuits	ZFL-1000VH2B	AMP-ZFL-05	May 05, 2018	May 04, 2019
Trilog Broadband Antenna SCHWARZBECK	VULB 9168	9168-361	Nov. 29, 2017	Nov. 28, 2018
RF Cable	8D	966-3-1	Mar. 20, 2018	Mar. 19, 2019
RF Cable	8D	966-3-2	Mar. 20, 2018	Mar. 19, 2019
RF Cable	8D	966-3-3	Mar. 20, 2018	Mar. 19, 2019
Fixed attenuator Mini-Circuits	UNAT-5+	PAD-3m-3-01	Oct. 03, 2017	Oct. 02, 2018
Horn_Antenna SCHWARZBECK	BBHA9120-D	9120D-406	Dec. 12, 2017	Dec. 11, 2018
Pre-Amplifier EMCI	EMC12630SE	980384	Jan. 29, 2018	Jan. 28, 2019
RF Cable	EMC104-SM-SM-1200	160922	Jan. 29, 2018	Jan. 28, 2019
RF Cable	EMC104-SM-SM-2000	150317	Jan. 29, 2018	Jan. 28, 2019
RF Cable	EMC104-SM-SM-5000	150322	Jan. 29, 2018	Jan. 28, 2019
Spectrum Analyzer Keysight	N9030A	MY54490679	July 23, 2018	July 22, 2019
Pre-Amplifier EMCI	EMC184045SE	980386	Jan. 29, 2018	Jan. 28, 2019
Horn_Antenna SCHWARZBECK	BBHA 9170	BBHA9170608	Dec. 14, 2017	Dec. 13, 2018
RF Cable	EMC102-KM-KM-1200	160924	Jan. 29, 2018	Jan. 28, 2019
Attenuator STI	STI02-3310-10	013	Feb. 12, 2018	Feb. 11, 2019
Software	ADT_Radiated_V8.7.08	NA	NA	NA
Antenna Tower & Turn Table Max-Full	MF-7802	MF780208406	NA	NA
Boresight Antenna Fixture	FBA-01	FBA-SIP01	NA	NA

**Note:**

1. The calibration interval of the above test instruments is 12 months and the calibrations are traceable to NML/ROC and NIST/USA.
2. \*The calibration interval of the above test instruments is 24 months and the calibrations are traceable to NML/ROC and NIST/USA.
3. The test was performed in 966 Chamber No. 3.
4. The CANADA Site Registration No. is 20331-1
5. Loop antenna was used for all emissions below 30 MHz.
6. Tested Date: Aug. 29, 2018



**For output power test:**

DESCRIPTION & MANUFACTURER	MODEL NO.	SERIAL NO.	CALIBRATED DATE	CALIBRATED UNTIL
Spectrum Analyzer R&S	FSV40	100964	June 20, 2018	June 19, 2019
Power meter Anritsu	ML2495A	1014008	May 09, 2018	May 08, 2019
Power sensor Anritsu	MA2411B	0917122	May 09, 2018	May 08, 2019
Attenuator STI	STI02-3310-10	013	Feb. 12, 2018	Feb. 11, 2019
AC Power Source Extech Electronics	6205	1440452	NA	NA
Temperature & Humidity Chamber Giant Force	GTH-150-40-SP-AR	MAA0812-008	Jan. 10, 2018	Jan. 09, 2019

**Note:**

1. The test was performed in Oven room 2.
2. The calibration interval of the above test instruments is 12 months and the calibrations are traceable to NML/ROC and NIST/USA.
3. Tested Date: Oct. 11, 2018

#### 4.1.3 Test Procedure

##### **For Radiated emission below 30MHz**

- a. The EUT was placed on the top of a rotating table 0.8 meters above the ground at a 3 meter chamber room. The table was rotated 360 degrees to determine the position of the highest radiation.
- b. The EUT was set 3 meters away from the interference-receiving antenna, which was mounted on the top of a variable-height antenna tower.
- c. Parallel, perpendicular, and ground-parallel orientations of the antenna are set to make the measurement.
- d. For each suspected emission, the EUT was arranged to its worst case and the rotatable table was turned from 0 degrees to 360 degrees to find the maximum reading.
- e. The test-receiver system was set to Quasi-Peak Detect Function and Specified Bandwidth with Maximum Hold Mode.

##### **NOTE:**

1. The resolution bandwidth and video bandwidth of test receiver/spectrum analyzer is 9kHz at frequency below 30MHz.

##### **For Radiated emission above 30MHz**

- a. The EUT was placed on the top of a rotating table 0.8 meters (for 30MHz ~ 1GHz) / 1.5 meters (for above 1GHz) above the ground at 3 meter chamber room for test. The table was rotated 360 degrees to determine the position of the highest radiation.
- b. The EUT was set 3 meters away from the interference-receiving antenna, which was mounted on the top of a variable-height antenna tower.
- c. The height of antenna is varied from one meter to four meters above the ground to determine the maximum value of the field strength. Both horizontal and vertical polarizations of the antenna are set to make the measurement.
- d. For each suspected emission, the EUT was arranged to its worst case and then the antenna was tuned to heights from 1 meter to 4 meters and the rotatable table was turned from 0 degrees to 360 degrees to find the maximum reading.
- e. The test-receiver system was set to quasi-peak detect function and specified bandwidth with maximum hold mode when the test frequency is below 1 GHz.
- f. The test-receiver system was set to peak and average detects function and specified bandwidth with maximum hold mode when the test frequency is above 1 GHz. If the peak reading value also meets average limit, measurement with the average detector is unnecessary.

##### **Note:**

1. The resolution bandwidth and video bandwidth of test receiver/spectrum analyzer is 120kHz for Quasi-peak detection (QP) at frequency below 1GHz.
2. The resolution bandwidth of test receiver/spectrum analyzer is 1 MHz and the video bandwidth is 3 MHz for Peak detection (PK) at frequency above 1GHz.
3. The resolution bandwidth of test receiver/spectrum analyzer is 1MHz and the video bandwidth is  $\geq 1/T$  (Duty cycle  $< 98\%$ ) or 10Hz (Duty cycle  $\geq 98\%$ ) for Average detection (AV) at frequency above 1GHz.
4. All modes of operation were investigated and the worst-case emissions are reported.

#### 4.1.4 Deviation from Test Standard

No deviation.

#### 4.1.5 Test Setup

##### For Radiated emission below 30MHz

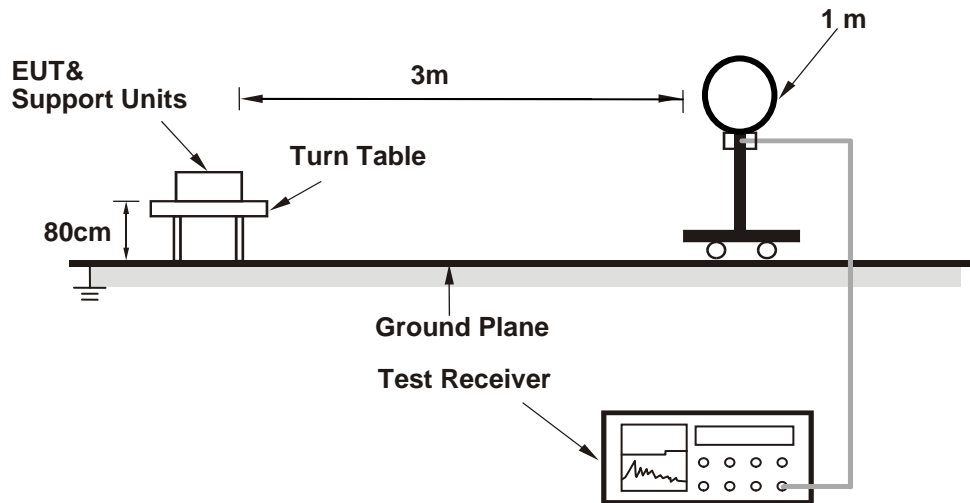

##### For Radiated emission 30MHz to 1GHz

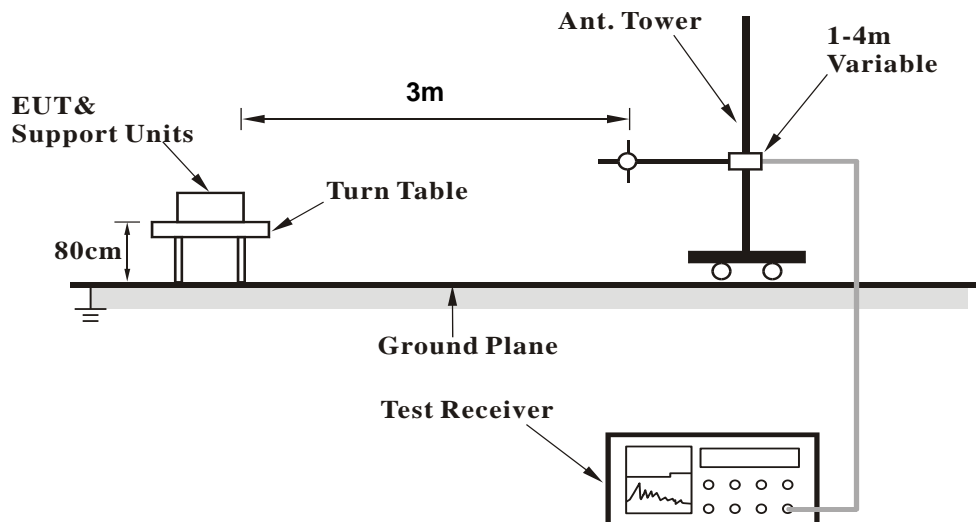

### For Radiated emission above 1GHz

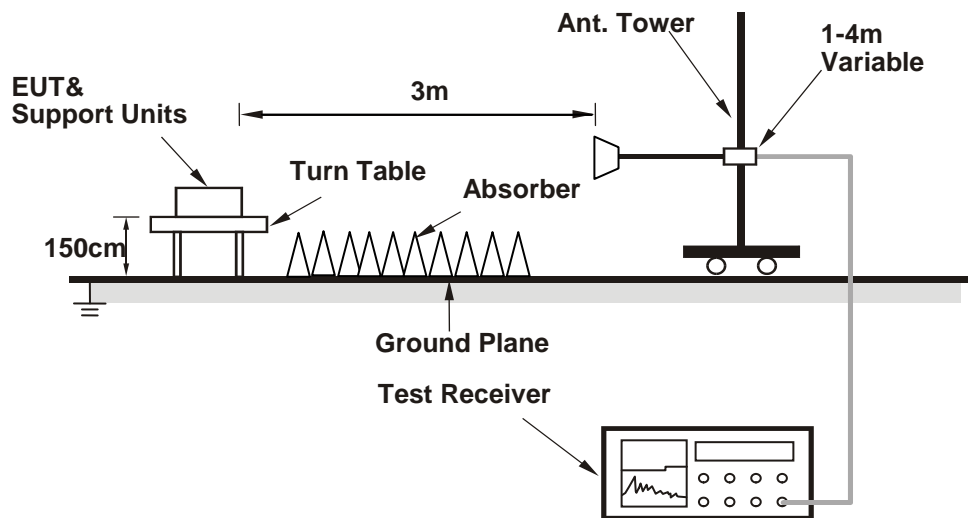

For the actual test configuration, please refer to the attached file (Test Setup Photo).

#### 4.1.6 EUT Operating Condition

- a. Connected the EUT with the Laptop which is placed on remote site.
- b. Controlling software (QSPR (5.0-00161)) has been activated to set the EUT on specific status.

4.1.7 Test Results (Mode 1)

Above 1GHz Data:

802.11a

<b>CHANNEL</b>	TX Channel 36	<b>DETECTOR FUNCTION</b>	Peak (PK)
<b>FREQUENCY RANGE</b>	1GHz ~ 40GHz		Average (AV)

ANTENNA POLARITY & TEST DISTANCE: HORIZONTAL AT 3 M								
NO.	FREQ. (MHz)	EMISSION LEVEL (dBuV/m)	LIMIT (dBuV/m)	MARGIN (dB)	ANTENNA HEIGHT (m)	TABLE ANGLE (Degree)	RAW VALUE (dBuV)	CORRECTION FACTOR (dB/m)
1	5139.00	60.7 PK	74.0	-13.3	1.14 H	16	58.1	2.6
2	5139.00	47.8 AV	54.0	-6.2	1.14 H	16	45.2	2.6
3	5150.00	56.3 PK	74.0	-17.7	1.14 H	16	53.7	2.6
4	5150.00	44.8 AV	54.0	-9.2	1.14 H	16	42.2	2.6
5	*5180.00	110.0 PK			1.14 H	16	107.5	2.5
6	*5180.00	100.7 AV			1.14 H	16	98.2	2.5
7	#10360.00	49.4 PK	68.2	-18.8	2.79 H	319	37.5	11.9
8	15540.00	52.9 PK	74.0	-21.1	1.94 H	31	40.5	12.4
9	15540.00	40.5 AV	54.0	-13.5	1.94 H	31	28.1	12.4

ANTENNA POLARITY & TEST DISTANCE: VERTICAL AT 3 M								
NO.	FREQ. (MHz)	EMISSION LEVEL (dBuV/m)	LIMIT (dBuV/m)	MARGIN (dB)	ANTENNA HEIGHT (m)	TABLE ANGLE (Degree)	RAW VALUE (dBuV)	CORRECTION FACTOR (dB/m)
1	5139.00	69.9 PK	74.0	-4.1	2.60 V	246	67.3	2.6
2	<b>5139.00</b>	<b>53.9 AV</b>	<b>54.0</b>	<b>-0.1</b>	<b>2.60 V</b>	<b>246</b>	<b>51.3</b>	<b>2.6</b>
3	5150.00	62.3 PK	74.0	-11.7	2.60 V	246	59.7	2.6
4	5150.00	50.3 AV	54.0	-3.7	2.60 V	246	47.7	2.6
5	*5180.00	119.1 PK			2.60 V	246	116.6	2.5
6	*5180.00	109.9 AV			2.60 V	246	107.4	2.5
7	#10360.00	51.4 PK	68.2	-16.8	1.92 V	301	39.5	11.9
8	15540.00	59.3 PK	74.0	-14.7	2.91 V	200	46.9	12.4
9	15540.00	48.5 AV	54.0	-5.5	2.91 V	200	36.1	12.4

REMARKS:

1. Emission Level(dBuV/m) = Raw Value(dBuV) + Correction Factor(dB/m)
2. Correction Factor(dB/m) = Antenna Factor(dB/m) + Cable Factor(dB) – Pre-Amplifier Factor(dB)
3. The other emission levels were very low against the limit.
4. Margin value = Emission Level – Limit value
5. " \* ": Fundamental frequency.
6. " # ": The radiated frequency is out of the restricted band.

<b>CHANNEL</b>	TX Channel 40	<b>DETECTOR FUNCTION</b>	Peak (PK)
<b>FREQUENCY RANGE</b>	1GHz ~ 40GHz		Average (AV)

**ANTENNA POLARITY & TEST DISTANCE: HORIZONTAL AT 3 M**

NO.	FREQ. (MHz)	EMISSION LEVEL (dBuV/m)	LIMIT (dBuV/m)	MARGIN (dB)	ANTENNA HEIGHT (m)	TABLE ANGLE (Degree)	RAW VALUE (dBuV)	CORRECTION FACTOR (dB/m)
1	5150.00	60.3 PK	74.0	-13.7	1.09 H	30	57.7	2.6
2	5150.00	47.5 AV	54.0	-6.5	1.09 H	30	44.9	2.6
3	*5200.00	111.5 PK			1.09 H	30	109.1	2.4
4	*5200.00	101.4 AV			1.09 H	30	99.0	2.4
5	5350.00	47.7 PK	74.0	-26.3	1.09 H	30	45.4	2.3
6	5350.00	40.1 AV	54.0	-13.9	1.09 H	30	37.8	2.3
7	5397.00	51.5 PK	74.0	-22.5	1.09 H	30	49.0	2.5
8	5397.00	41.8 AV	54.0	-12.2	1.09 H	30	39.3	2.5
9	#10400.00	49.9 PK	68.2	-18.3	2.76 H	296	37.7	12.2
10	15600.00	53.6 PK	74.0	-20.4	2.00 H	24	40.7	12.9
11	15600.00	41.0 AV	54.0	-13.0	2.00 H	24	28.1	12.9

**ANTENNA POLARITY & TEST DISTANCE: VERTICAL AT 3 M**

NO.	FREQ. (MHz)	EMISSION LEVEL (dBuV/m)	LIMIT (dBuV/m)	MARGIN (dB)	ANTENNA HEIGHT (m)	TABLE ANGLE (Degree)	RAW VALUE (dBuV)	CORRECTION FACTOR (dB/m)
1	5150.00	64.7 PK	74.0	-9.3	2.68 V	237	62.1	2.6
2	5150.00	53.1 AV	54.0	-0.9	2.68 V	237	50.5	2.6
3	*5200.00	120.7 PK			2.68 V	237	118.3	2.4
4	*5200.00	110.6 AV			2.68 V	237	108.2	2.4
5	5350.00	47.8 PK	74.0	-26.2	2.68 V	237	45.5	2.3
6	5350.00	40.2 AV	54.0	-13.8	2.68 V	237	37.9	2.3
7	5397.00	52.8 PK	74.0	-21.2	2.68 V	237	50.3	2.5
8	5397.00	42.7 AV	54.0	-11.3	2.68 V	237	40.2	2.5
9	#10400.00	52.1 PK	68.2	-16.1	1.89 V	311	39.9	12.2
10	15600.00	59.8 PK	74.0	-14.2	3.00 V	216	46.9	12.9
11	15600.00	49.2 AV	54.0	-4.8	3.00 V	216	36.3	12.9

**REMARKS:**

1. Emission Level(dBuV/m) = Raw Value(dBuV) + Correction Factor(dB/m)
2. Correction Factor(dB/m) = Antenna Factor(dB/m) + Cable Factor(dB) – Pre-Amplifier Factor(dB)
3. The other emission levels were very low against the limit.
4. Margin value = Emission Level – Limit value
5. " \* ": Fundamental frequency.
6. " # ": The radiated frequency is out of the restricted band.

<b>CHANNEL</b>	TX Channel 48	<b>DETECTOR FUNCTION</b>	Peak (PK)
<b>FREQUENCY RANGE</b>	1GHz ~ 40GHz		Average (AV)

**ANTENNA POLARITY & TEST DISTANCE: HORIZONTAL AT 3 M**

NO.	FREQ. (MHz)	EMISSION LEVEL (dBuV/m)	LIMIT (dBuV/m)	MARGIN (dB)	ANTENNA HEIGHT (m)	TABLE ANGLE (Degree)	RAW VALUE (dBuV)	CORRECTION FACTOR (dB/m)
1	5150.00	52.5 PK	74.0	-21.5	1.09 H	7	49.9	2.6
2	5150.00	42.7 AV	54.0	-11.3	1.09 H	7	40.1	2.6
3	*5240.00	110.6 PK			1.09 H	7	108.4	2.2
4	*5240.00	102.0 AV			1.09 H	7	99.8	2.2
5	5350.00	48.8 PK	74.0	-25.2	1.09 H	7	46.5	2.3
6	5350.00	40.1 AV	54.0	-13.9	1.09 H	7	37.8	2.3
7	5375.00	53.3 PK	74.0	-20.7	1.09 H	7	50.9	2.4
8	5375.00	42.5 AV	54.0	-11.5	1.09 H	7	40.1	2.4
9	#10480.00	50.1 PK	68.2	-18.1	2.77 H	310	37.7	12.4
10	15720.00	53.8 PK	74.0	-20.2	1.96 H	25	41.8	12.0
11	15720.00	41.2 AV	54.0	-12.8	1.96 H	25	29.2	12.0

**ANTENNA POLARITY & TEST DISTANCE: VERTICAL AT 3 M**

NO.	FREQ. (MHz)	EMISSION LEVEL (dBuV/m)	LIMIT (dBuV/m)	MARGIN (dB)	ANTENNA HEIGHT (m)	TABLE ANGLE (Degree)	RAW VALUE (dBuV)	CORRECTION FACTOR (dB/m)
1	5150.00	53.2 PK	74.0	-20.8	2.61 V	257	50.6	2.6
2	5150.00	43.8 AV	54.0	-10.2	2.61 V	257	41.2	2.6
3	*5240.00	119.7 PK			2.61 V	257	117.5	2.2
4	*5240.00	111.1 AV			2.61 V	257	108.9	2.2
5	5350.00	49.4 PK	74.0	-24.6	2.61 V	257	47.1	2.3
6	5350.00	40.2 AV	54.0	-13.8	2.61 V	257	37.9	2.3
7	5375.00	54.0 PK	74.0	-20.0	2.61 V	257	51.6	2.4
8	5375.00	43.4 AV	54.0	-10.6	2.61 V	257	41.0	2.4
9	#10480.00	51.8 PK	68.2	-16.4	1.94 V	305	39.4	12.4
10	15720.00	59.7 PK	74.0	-14.3	2.95 V	212	47.7	12.0
11	15720.00	49.0 AV	54.0	-5.0	2.95 V	212	37.0	12.0

**REMARKS:**

1. Emission Level(dBuV/m) = Raw Value(dBuV) + Correction Factor(dB/m)
2. Correction Factor(dB/m) = Antenna Factor(dB/m) + Cable Factor(dB) – Pre-Amplifier Factor(dB)
3. The other emission levels were very low against the limit.
4. Margin value = Emission Level – Limit value
5. " \* ": Fundamental frequency.
6. " # ": The radiated frequency is out of the restricted band.

<b>CHANNEL</b>	TX Channel 149	<b>DETECTOR FUNCTION</b>	Peak (PK)
<b>FREQUENCY RANGE</b>	1GHz ~ 40GHz		Average (AV)

**ANTENNA POLARITY & TEST DISTANCE: HORIZONTAL AT 3 M**

NO.	FREQ. (MHz)	EMISSION LEVEL (dBuV/m)	LIMIT (dBuV/m)	MARGIN (dB)	ANTENNA HEIGHT (m)	TABLE ANGLE (Degree)	RAW VALUE (dBuV)	CORRECTION FACTOR (dB/m)
1	*5745.00	113.6 PK			1.84 H	43	110.7	2.9
2	*5745.00	104.7 AV			1.84 H	43	101.8	2.9
3	11490.00	48.6 PK	74.0	-25.4	1.66 H	213	36.3	12.3
4	11490.00	42.3 AV	54.0	-11.7	1.66 H	213	30.0	12.3
5	#17235.00	52.3 PK	68.2	-15.9	2.26 H	124	37.0	15.3

**ANTENNA POLARITY & TEST DISTANCE: VERTICAL AT 3 M**

NO.	FREQ. (MHz)	EMISSION LEVEL (dBuV/m)	LIMIT (dBuV/m)	MARGIN (dB)	ANTENNA HEIGHT (m)	TABLE ANGLE (Degree)	RAW VALUE (dBuV)	CORRECTION FACTOR (dB/m)
1	*5745.00	120.4 PK			2.80 V	268	117.5	2.9
2	*5745.00	112.4 AV			2.80 V	268	109.5	2.9
3	11490.00	50.2 PK	74.0	-23.8	1.37 V	220	37.9	12.3
4	11490.00	45.7 AV	54.0	-8.3	1.37 V	220	33.4	12.3
5	#17235.00	55.6 PK	68.2	-12.6	1.77 V	284	40.3	15.3

**REMARKS:**

1. Emission Level(dBuV/m) = Raw Value(dBuV) + Correction Factor(dB/m)
2. Correction Factor(dB/m) = Antenna Factor(dB/m) + Cable Factor(dB) – Pre-Amplifier Factor(dB)
3. The other emission levels were very low against the limit.
4. Margin value = Emission Level – Limit value
5. " \* ": Fundamental frequency.
6. " # ": The radiated frequency is out of the restricted band.



<b>CHANNEL</b>	TX Channel 157	<b>DETECTOR FUNCTION</b>	Peak (PK)
<b>FREQUENCY RANGE</b>	1GHz ~ 40GHz		Average (AV)

**ANTENNA POLARITY & TEST DISTANCE: HORIZONTAL AT 3 M**

NO.	FREQ. (MHz)	EMISSION LEVEL (dBuV/m)	LIMIT (dBuV/m)	MARGIN (dB)	ANTENNA HEIGHT (m)	TABLE ANGLE (Degree)	RAW VALUE (dBuV)	CORRECTION FACTOR (dB/m)
1	*5785.00	112.8 PK			1.48 H	46	109.7	3.1
2	*5785.00	104.8 AV			1.48 H	46	101.7	3.1
3	11570.00	50.8 PK	74.0	-23.2	1.61 H	212	38.4	12.4
4	11570.00	42.6 AV	54.0	-11.4	1.61 H	212	30.2	12.4
5	#17355.00	52.1 PK	68.2	-16.1	2.22 H	114	36.1	16.0

**ANTENNA POLARITY & TEST DISTANCE: VERTICAL AT 3 M**

NO.	FREQ. (MHz)	EMISSION LEVEL (dBuV/m)	LIMIT (dBuV/m)	MARGIN (dB)	ANTENNA HEIGHT (m)	TABLE ANGLE (Degree)	RAW VALUE (dBuV)	CORRECTION FACTOR (dB/m)
1	*5785.00	121.4 PK			2.80 V	268	118.3	3.1
2	*5785.00	112.5 AV			2.80 V	268	109.4	3.1
3	11570.00	55.6 PK	74.0	-18.4	1.34 V	234	43.2	12.4
4	11570.00	45.8 AV	54.0	-8.2	1.34 V	234	33.4	12.4
5	#17355.00	55.3 PK	68.2	-12.9	1.80 V	272	39.3	16.0

**REMARKS:**

1. Emission Level(dBuV/m) = Raw Value(dBuV) + Correction Factor(dB/m)
2. Correction Factor(dB/m) = Antenna Factor(dB/m) + Cable Factor(dB) – Pre-Amplifier Factor(dB)
3. The other emission levels were very low against the limit.
4. Margin value = Emission Level – Limit value
5. " \* ": Fundamental frequency.
6. " # ": The radiated frequency is out of the restricted band.

<b>CHANNEL</b>	TX Channel 165	<b>DETECTOR FUNCTION</b>	Peak (PK)
<b>FREQUENCY RANGE</b>	1GHz ~ 40GHz		Average (AV)

**ANTENNA POLARITY & TEST DISTANCE: HORIZONTAL AT 3 M**

NO.	FREQ. (MHz)	EMISSION LEVEL (dBuV/m)	LIMIT (dBuV/m)	MARGIN (dB)	ANTENNA HEIGHT (m)	TABLE ANGLE (Degree)	RAW VALUE (dBuV)	CORRECTION FACTOR (dB/m)
1	*5825.00	113.8 PK			1.19 H	18	110.6	3.2
2	*5825.00	104.9 AV			1.19 H	18	101.7	3.2
3	11650.00	50.9 PK	74.0	-23.1	1.71 H	208	38.5	12.4
4	11650.00	42.7 AV	54.0	-11.3	1.71 H	208	30.3	12.4
5	#17475.00	52.5 PK	68.2	-15.7	2.31 H	125	35.1	17.4

**ANTENNA POLARITY & TEST DISTANCE: VERTICAL AT 3 M**

NO.	FREQ. (MHz)	EMISSION LEVEL (dBuV/m)	LIMIT (dBuV/m)	MARGIN (dB)	ANTENNA HEIGHT (m)	TABLE ANGLE (Degree)	RAW VALUE (dBuV)	CORRECTION FACTOR (dB/m)
1	*5825.00	121.2 PK			2.70 V	299	118.0	3.2
2	*5825.00	112.1 AV			2.70 V	299	108.9	3.2
3	11650.00	54.8 PK	74.0	-19.2	1.34 V	216	42.4	12.4
4	11650.00	45.2 AV	54.0	-8.8	1.34 V	216	32.8	12.4
5	#17475.00	55.7 PK	68.2	-12.5	1.83 V	292	38.3	17.4

**REMARKS:**

1. Emission Level(dBuV/m) = Raw Value(dBuV) + Correction Factor(dB/m)
2. Correction Factor(dB/m) = Antenna Factor(dB/m) + Cable Factor(dB) – Pre-Amplifier Factor(dB)
3. The other emission levels were very low against the limit.
4. Margin value = Emission Level – Limit value
5. " \* ": Fundamental frequency.
6. " # ": The radiated frequency is out of the restricted band.

**802.11ax (HE20)**

<b>CHANNEL</b>	TX Channel 36	<b>DETECTOR FUNCTION</b>	Peak (PK)
<b>FREQUENCY RANGE</b>	1GHz ~ 40GHz		Average (AV)

**ANTENNA POLARITY & TEST DISTANCE: HORIZONTAL AT 3 M**

NO.	FREQ. (MHz)	EMISSION LEVEL (dBuV/m)	LIMIT (dBuV/m)	MARGIN (dB)	ANTENNA HEIGHT (m)	TABLE ANGLE (Degree)	RAW VALUE (dBuV)	CORRECTION FACTOR (dB/m)
1	5150.00	60.8 PK	74.0	-13.2	1.14 H	22	58.2	2.6
2	5150.00	47.9 AV	54.0	-6.1	1.14 H	22	45.3	2.6
3	*5180.00	111.2 PK			1.14 H	22	108.7	2.5
4	*5180.00	99.2 AV			1.14 H	22	96.7	2.5
5	#10360.00	50.0 PK	68.2	-18.2	2.71 H	286	38.1	11.9
6	15540.00	53.2 PK	74.0	-20.8	1.98 H	18	40.8	12.4
7	15540.00	40.4 AV	54.0	-13.6	1.98 H	18	28.0	12.4

**ANTENNA POLARITY & TEST DISTANCE: VERTICAL AT 3 M**

NO.	FREQ. (MHz)	EMISSION LEVEL (dBuV/m)	LIMIT (dBuV/m)	MARGIN (dB)	ANTENNA HEIGHT (m)	TABLE ANGLE (Degree)	RAW VALUE (dBuV)	CORRECTION FACTOR (dB/m)
1	5150.00	68.9 PK	74.0	-5.1	2.43 V	176	66.3	2.6
2	<b>5150.00</b>	<b>53.9 AV</b>	<b>54.0</b>	<b>-0.1</b>	<b>2.43 V</b>	<b>176</b>	<b>51.3</b>	<b>2.6</b>
3	*5180.00	120.4 PK			2.43 V	176	117.9	2.5
4	*5180.00	108.3 AV			2.43 V	176	105.8	2.5
5	#10360.00	50.8 PK	68.2	-17.4	1.88 V	292	38.9	11.9
6	15540.00	60.4 PK	74.0	-13.6	2.98 V	235	48.0	12.4
7	15540.00	49.2 AV	54.0	-4.8	2.98 V	235	36.8	12.4

**REMARKS:**

- Emission Level(dBuV/m) = Raw Value(dBuV) + Correction Factor(dB/m)
- Correction Factor(dB/m) = Antenna Factor(dB/m) + Cable Factor(dB) – Pre-Amplifier Factor(dB)
- The other emission levels were very low against the limit.
- Margin value = Emission Level – Limit value
- " \* ": Fundamental frequency.
- " # ": The radiated frequency is out of the restricted band.

<b>CHANNEL</b>	TX Channel 40	<b>DETECTOR FUNCTION</b>	Peak (PK)
<b>FREQUENCY RANGE</b>	1GHz ~ 40GHz		Average (AV)

**ANTENNA POLARITY & TEST DISTANCE: HORIZONTAL AT 3 M**

NO.	FREQ. (MHz)	EMISSION LEVEL (dBuV/m)	LIMIT (dBuV/m)	MARGIN (dB)	ANTENNA HEIGHT (m)	TABLE ANGLE (Degree)	RAW VALUE (dBuV)	CORRECTION FACTOR (dB/m)
1	5150.00	60.7 PK	74.0	-13.3	1.08 H	23	58.1	2.6
2	5150.00	47.5 AV	54.0	-6.5	1.08 H	23	44.9	2.6
3	*5200.00	114.5 PK			1.08 H	23	112.1	2.4
4	*5200.00	102.3 AV			1.08 H	23	99.9	2.4
5	5350.00	48.3 PK	74.0	-25.7	1.08 H	23	46.0	2.3
6	5350.00	40.2 AV	54.0	-13.8	1.08 H	23	37.9	2.3
7	5387.00	54.7 PK	74.0	-19.3	1.08 H	23	52.2	2.5
8	5387.00	41.8 AV	54.0	-12.2	1.08 H	23	39.3	2.5
9	#10400.00	50.8 PK	68.2	-17.4	2.71 H	298	38.6	12.2
10	15600.00	53.8 PK	74.0	-20.2	1.98 H	38	40.9	12.9
11	15600.00	41.3 AV	54.0	-12.7	1.98 H	38	28.4	12.9

**ANTENNA POLARITY & TEST DISTANCE: VERTICAL AT 3 M**

NO.	FREQ. (MHz)	EMISSION LEVEL (dBuV/m)	LIMIT (dBuV/m)	MARGIN (dB)	ANTENNA HEIGHT (m)	TABLE ANGLE (Degree)	RAW VALUE (dBuV)	CORRECTION FACTOR (dB/m)
1	5150.00	69.9 PK	74.0	-4.1	2.84 V	254	67.3	2.6
2	5150.00	53.9 AV	54.0	-0.1	2.84 V	254	51.3	2.6
3	*5200.00	123.2 PK			2.84 V	254	120.8	2.4
4	*5200.00	111.0 AV			2.84 V	254	108.6	2.4
5	5350.00	48.1 PK	74.0	-25.9	2.84 V	254	45.8	2.3
6	5350.00	40.0 AV	54.0	-14.0	2.84 V	254	37.7	2.3
7	5387.00	55.5 PK	74.0	-18.5	2.84 V	254	53.0	2.5
8	5387.00	42.6 AV	54.0	-11.4	2.84 V	254	40.1	2.5
9	#10400.00	51.6 PK	68.2	-16.6	1.88 V	285	39.4	12.2
10	15600.00	60.0 PK	74.0	-14.0	2.93 V	214	47.1	12.9
11	15600.00	49.0 AV	54.0	-5.0	2.93 V	214	36.1	12.9

**REMARKS:**

- Emission Level(dBuV/m) = Raw Value(dBuV) + Correction Factor(dB/m)
- Correction Factor(dB/m) = Antenna Factor(dB/m) + Cable Factor(dB) – Pre-Amplifier Factor(dB)
- The other emission levels were very low against the limit.
- Margin value = Emission Level – Limit value
- " \* ": Fundamental frequency.
- " # ": The radiated frequency is out of the restricted band.

<b>CHANNEL</b>	TX Channel 48	<b>DETECTOR FUNCTION</b>	Peak (PK)
<b>FREQUENCY RANGE</b>	1GHz ~ 40GHz		Average (AV)

**ANTENNA POLARITY & TEST DISTANCE: HORIZONTAL AT 3 M**

NO.	FREQ. (MHz)	EMISSION LEVEL (dBuV/m)	LIMIT (dBuV/m)	MARGIN (dB)	ANTENNA HEIGHT (m)	TABLE ANGLE (Degree)	RAW VALUE (dBuV)	CORRECTION FACTOR (dB/m)
1	5150.00	53.7 PK	74.0	-20.3	1.11 H	28	51.1	2.6
2	5150.00	42.9 AV	54.0	-11.1	1.11 H	28	40.3	2.6
3	*5240.00	114.3 PK			1.11 H	28	112.1	2.2
4	*5240.00	102.1 AV			1.11 H	28	99.9	2.2
5	5350.00	47.2 PK	74.0	-26.8	1.11 H	28	44.9	2.3
6	5350.00	40.8 AV	54.0	-13.2	1.11 H	28	38.5	2.3
7	5375.00	53.2 PK	74.0	-20.8	1.11 H	28	50.8	2.4
8	5375.00	42.2 AV	54.0	-11.8	1.11 H	28	39.8	2.4
9	#10480.00	50.3 PK	68.2	-17.9	2.76 H	295	37.9	12.4
10	15720.00	53.8 PK	74.0	-20.2	1.98 H	23	41.8	12.0
11	15720.00	41.0 AV	54.0	-13.0	1.98 H	23	29.0	12.0

**ANTENNA POLARITY & TEST DISTANCE: VERTICAL AT 3 M**

NO.	FREQ. (MHz)	EMISSION LEVEL (dBuV/m)	LIMIT (dBuV/m)	MARGIN (dB)	ANTENNA HEIGHT (m)	TABLE ANGLE (Degree)	RAW VALUE (dBuV)	CORRECTION FACTOR (dB/m)
1	5150.00	54.0 PK	74.0	-20.0	2.62 V	252	51.4	2.6
2	5150.00	43.1 AV	54.0	-10.9	2.62 V	252	40.5	2.6
3	*5240.00	123.0 PK			2.62 V	252	120.8	2.2
4	*5240.00	111.0 AV			2.62 V	252	108.8	2.2
5	5350.00	47.5 PK	74.0	-26.5	2.62 V	252	45.2	2.3
6	5350.00	41.1 AV	54.0	-12.9	2.62 V	252	38.8	2.3
7	5375.00	53.8 PK	74.0	-20.2	2.62 V	252	51.4	2.4
8	5375.00	42.8 AV	54.0	-11.2	2.62 V	252	40.4	2.4
9	#10480.00	51.3 PK	68.2	-16.9	1.91 V	291	38.9	12.4
10	15720.00	60.1 PK	74.0	-13.9	2.98 V	223	48.1	12.0
11	15720.00	49.3 AV	54.0	-4.7	2.98 V	223	37.3	12.0

**REMARKS:**

1. Emission Level(dBuV/m) = Raw Value(dBuV) + Correction Factor(dB/m)
2. Correction Factor(dB/m) = Antenna Factor(dB/m) + Cable Factor(dB) – Pre-Amplifier Factor(dB)
3. The other emission levels were very low against the limit.
4. Margin value = Emission Level – Limit value
5. " \* ": Fundamental frequency.
6. " # ": The radiated frequency is out of the restricted band.

<b>CHANNEL</b>	TX Channel 149	<b>DETECTOR FUNCTION</b>	Peak (PK)
<b>FREQUENCY RANGE</b>	1GHz ~ 40GHz		Average (AV)

**ANTENNA POLARITY & TEST DISTANCE: HORIZONTAL AT 3 M**

NO.	FREQ. (MHz)	EMISSION LEVEL (dBuV/m)	LIMIT (dBuV/m)	MARGIN (dB)	ANTENNA HEIGHT (m)	TABLE ANGLE (Degree)	RAW VALUE (dBuV)	CORRECTION FACTOR (dB/m)
1	*5745.00	117.2 PK			2.27 H	304	114.3	2.9
2	*5745.00	104.9 AV			2.27 H	304	102.0	2.9
3	11490.00	48.8 PK	74.0	-25.2	1.71 H	211	36.5	12.3
4	11490.00	42.7 AV	54.0	-11.3	1.71 H	211	30.4	12.3
5	#17235.00	52.6 PK	68.2	-15.6	2.27 H	130	37.3	15.3

**ANTENNA POLARITY & TEST DISTANCE: VERTICAL AT 3 M**

NO.	FREQ. (MHz)	EMISSION LEVEL (dBuV/m)	LIMIT (dBuV/m)	MARGIN (dB)	ANTENNA HEIGHT (m)	TABLE ANGLE (Degree)	RAW VALUE (dBuV)	CORRECTION FACTOR (dB/m)
1	*5745.00	121.8 PK			2.22 V	109	118.9	2.9
2	*5745.00	109.6 AV			2.22 V	109	106.7	2.9
3	11490.00	50.0 PK	74.0	-24.0	1.39 V	204	37.7	12.3
4	11490.00	45.5 AV	54.0	-8.5	1.39 V	204	33.2	12.3
5	#17235.00	55.9 PK	68.2	-12.3	1.75 V	286	40.6	15.3

**REMARKS:**

1. Emission Level(dBuV/m) = Raw Value(dBuV) + Correction Factor(dB/m)
2. Correction Factor(dB/m) = Antenna Factor(dB/m) + Cable Factor(dB) – Pre-Amplifier Factor(dB)
3. The other emission levels were very low against the limit.
4. Margin value = Emission Level – Limit value
5. " \* ": Fundamental frequency.
6. " # ": The radiated frequency is out of the restricted band.

<b>CHANNEL</b>	TX Channel 157	<b>DETECTOR FUNCTION</b>	Peak (PK)
<b>FREQUENCY RANGE</b>	1GHz ~ 40GHz		Average (AV)

**ANTENNA POLARITY & TEST DISTANCE: HORIZONTAL AT 3 M**

NO.	FREQ. (MHz)	EMISSION LEVEL (dBuV/m)	LIMIT (dBuV/m)	MARGIN (dB)	ANTENNA HEIGHT (m)	TABLE ANGLE (Degree)	RAW VALUE (dBuV)	CORRECTION FACTOR (dB/m)
1	*5785.00	115.5 PK			2.42 H	315	112.4	3.1
2	*5785.00	103.8 AV			2.42 H	315	100.7	3.1
3	11570.00	48.6 PK	74.0	-25.4	1.72 H	219	36.2	12.4
4	11570.00	42.5 AV	54.0	-11.5	1.72 H	219	30.1	12.4
5	#17355.00	52.9 PK	68.2	-15.3	2.21 H	139	36.9	16.0

**ANTENNA POLARITY & TEST DISTANCE: VERTICAL AT 3 M**

NO.	FREQ. (MHz)	EMISSION LEVEL (dBuV/m)	LIMIT (dBuV/m)	MARGIN (dB)	ANTENNA HEIGHT (m)	TABLE ANGLE (Degree)	RAW VALUE (dBuV)	CORRECTION FACTOR (dB/m)
1	*5785.00	122.7 PK			2.34 V	110	119.6	3.1
2	*5785.00	109.9 AV			2.34 V	110	106.8	3.1
3	11570.00	50.7 PK	74.0	-23.3	1.36 V	209	38.3	12.4
4	11570.00	46.0 AV	54.0	-8.0	1.36 V	209	33.6	12.4
5	#17355.00	56.2 PK	68.2	-12.0	1.80 V	280	40.2	16.0

**REMARKS:**

1. Emission Level(dBuV/m) = Raw Value(dBuV) + Correction Factor(dB/m)
2. Correction Factor(dB/m) = Antenna Factor(dB/m) + Cable Factor(dB) – Pre-Amplifier Factor(dB)
3. The other emission levels were very low against the limit.
4. Margin value = Emission Level – Limit value
5. " \* ": Fundamental frequency.
6. " # ": The radiated frequency is out of the restricted band.

<b>CHANNEL</b>	TX Channel 165	<b>DETECTOR FUNCTION</b>	Peak (PK)
<b>FREQUENCY RANGE</b>	1GHz ~ 40GHz		Average (AV)

**ANTENNA POLARITY & TEST DISTANCE: HORIZONTAL AT 3 M**

NO.	FREQ. (MHz)	EMISSION LEVEL (dBuV/m)	LIMIT (dBuV/m)	MARGIN (dB)	ANTENNA HEIGHT (m)	TABLE ANGLE (Degree)	RAW VALUE (dBuV)	CORRECTION FACTOR (dB/m)
1	*5825.00	113.5 PK			1.71 H	192	110.3	3.2
2	*5825.00	101.7 AV			1.71 H	192	98.5	3.2
3	11650.00	48.5 PK	74.0	-25.5	1.76 H	221	36.1	12.4
4	11650.00	42.2 AV	54.0	-11.8	1.76 H	221	29.8	12.4
5	#17475.00	52.0 PK	68.2	-16.2	2.30 H	127	34.6	17.4

**ANTENNA POLARITY & TEST DISTANCE: VERTICAL AT 3 M**

NO.	FREQ. (MHz)	EMISSION LEVEL (dBuV/m)	LIMIT (dBuV/m)	MARGIN (dB)	ANTENNA HEIGHT (m)	TABLE ANGLE (Degree)	RAW VALUE (dBuV)	CORRECTION FACTOR (dB/m)
1	*5825.00	121.3 PK			2.37 V	191	118.1	3.2
2	*5825.00	109.0 AV			2.37 V	191	105.8	3.2
3	11650.00	50.1 PK	74.0	-23.9	1.41 V	218	37.7	12.4
4	11650.00	45.3 AV	54.0	-8.7	1.41 V	218	32.9	12.4
5	#17475.00	55.2 PK	68.2	-13.0	1.74 V	281	37.8	17.4

**REMARKS:**

1. Emission Level(dBuV/m) = Raw Value(dBuV) + Correction Factor(dB/m)
2. Correction Factor(dB/m) = Antenna Factor(dB/m) + Cable Factor(dB) – Pre-Amplifier Factor(dB)
3. The other emission levels were very low against the limit.
4. Margin value = Emission Level – Limit value
5. " \* ": Fundamental frequency.
6. " # ": The radiated frequency is out of the restricted band.



802.11ax (HE40)

<b>CHANNEL</b>	TX Channel 38	<b>DETECTOR FUNCTION</b>	Peak (PK)
<b>FREQUENCY RANGE</b>	1GHz ~ 40GHz		Average (AV)

**ANTENNA POLARITY & TEST DISTANCE: HORIZONTAL AT 3 M**

NO.	FREQ. (MHz)	EMISSION LEVEL (dBuV/m)	LIMIT (dBuV/m)	MARGIN (dB)	ANTENNA HEIGHT (m)	TABLE ANGLE (Degree)	RAW VALUE (dBuV)	CORRECTION FACTOR (dB/m)
1	5150.00	60.5 PK	74.0	-13.5	1.16 H	30	57.9	2.6
2	5150.00	47.3 AV	54.0	-6.7	1.16 H	30	44.7	2.6
3	*5190.00	107.4 PK			1.16 H	30	104.9	2.5
4	*5190.00	94.7 AV			1.16 H	30	92.2	2.5
5	5350.00	53.7 PK	74.0	-20.3	1.16 H	30	51.4	2.3
6	5350.00	40.5 AV	54.0	-13.5	1.16 H	30	38.2	2.3
7	#10380.00	48.9 PK	68.2	-19.3	2.71 H	295	36.9	12.0
8	15570.00	51.5 PK	74.0	-22.5	2.03 H	27	38.9	12.6
9	15570.00	39.0 AV	54.0	-15.0	2.03 H	27	26.4	12.6

**ANTENNA POLARITY & TEST DISTANCE: VERTICAL AT 3 M**

NO.	FREQ. (MHz)	EMISSION LEVEL (dBuV/m)	LIMIT (dBuV/m)	MARGIN (dB)	ANTENNA HEIGHT (m)	TABLE ANGLE (Degree)	RAW VALUE (dBuV)	CORRECTION FACTOR (dB/m)
1	5150.00	67.9 PK	74.0	-6.1	2.63 V	303	65.3	2.6
2	<b>5150.00</b>	<b>53.9 AV</b>	<b>54.0</b>	<b>-0.1</b>	<b>2.63 V</b>	<b>303</b>	<b>51.3</b>	<b>2.6</b>
3	*5190.00	116.4 PK			2.63 V	303	113.9	2.5
4	*5190.00	103.7 AV			2.63 V	303	101.2	2.5
5	5350.00	54.2 PK	74.0	-19.8	2.63 V	303	51.9	2.3
6	5350.00	40.8 AV	54.0	-13.2	2.63 V	303	38.5	2.3
7	#10380.00	50.1 PK	68.2	-18.1	1.82 V	307	38.1	12.0
8	15570.00	59.0 PK	74.0	-15.0	3.02 V	227	46.4	12.6
9	15570.00	47.7 AV	54.0	-6.3	3.02 V	227	35.1	12.6

**REMARKS:**

1. Emission Level(dBuV/m) = Raw Value(dBuV) + Correction Factor(dB/m)
2. Correction Factor(dB/m) = Antenna Factor(dB/m) + Cable Factor(dB) – Pre-Amplifier Factor(dB)
3. The other emission levels were very low against the limit.
4. Margin value = Emission Level – Limit value
5. " \* ": Fundamental frequency.
6. " # ": The radiated frequency is out of the restricted band.

<b>CHANNEL</b>	TX Channel 46	<b>DETECTOR FUNCTION</b>	Peak (PK)
<b>FREQUENCY RANGE</b>	1GHz ~ 40GHz		Average (AV)

**ANTENNA POLARITY & TEST DISTANCE: HORIZONTAL AT 3 M**

NO.	FREQ. (MHz)	EMISSION LEVEL (dBuV/m)	LIMIT (dBuV/m)	MARGIN (dB)	ANTENNA HEIGHT (m)	TABLE ANGLE (Degree)	RAW VALUE (dBuV)	CORRECTION FACTOR (dB/m)
1	5150.00	60.9 PK	74.0	-13.1	1.00 H	31	58.3	2.6
2	5150.00	47.6 AV	54.0	-6.4	1.00 H	31	45.0	2.6
3	*5230.00	104.7 PK			1.14 H	31	102.5	2.2
4	*5230.00	93.8 AV			1.14 H	31	91.6	2.2
5	5350.00	53.3 PK	74.0	-20.7	1.00 H	31	51.0	2.3
6	5350.00	41.5 AV	54.0	-12.5	1.00 H	31	39.2	2.3
7	#10460.00	50.1 PK	68.2	-18.1	2.66 H	297	37.7	12.4
8	15690.00	52.7 PK	74.0	-21.3	2.02 H	5	40.5	12.2
9	15690.00	40.2 AV	54.0	-13.8	2.02 H	5	28.0	12.2

**ANTENNA POLARITY & TEST DISTANCE: VERTICAL AT 3 M**

NO.	FREQ. (MHz)	EMISSION LEVEL (dBuV/m)	LIMIT (dBuV/m)	MARGIN (dB)	ANTENNA HEIGHT (m)	TABLE ANGLE (Degree)	RAW VALUE (dBuV)	CORRECTION FACTOR (dB/m)
1	5150.00	67.5 PK	74.0	-6.5	2.44 V	351	64.9	2.6
2	5150.00	53.6 AV	54.0	-0.4	2.44 V	351	51.0	2.6
3	*5230.00	113.6 PK			2.44 V	351	111.4	2.2
4	*5230.00	102.7 AV			2.44 V	351	100.5	2.2
5	5350.00	55.6 PK	74.0	-18.4	2.44 V	351	53.3	2.3
6	5350.00	43.9 AV	54.0	-10.1	2.44 V	351	41.6	2.3
7	#10460.00	51.2 PK	68.2	-17.0	1.89 V	280	38.8	12.4
8	15690.00	60.2 PK	74.0	-13.8	3.01 V	230	48.0	12.2
9	15690.00	49.0 AV	54.0	-5.0	3.01 V	230	36.8	12.2

**REMARKS:**

1. Emission Level(dBuV/m) = Raw Value(dBuV) + Correction Factor(dB/m)
2. Correction Factor(dB/m) = Antenna Factor(dB/m) + Cable Factor(dB) – Pre-Amplifier Factor(dB)
3. The other emission levels were very low against the limit.
4. Margin value = Emission Level – Limit value
5. " \* ": Fundamental frequency.
6. " # ": The radiated frequency is out of the restricted band.

<b>CHANNEL</b>	TX Channel 151	<b>DETECTOR FUNCTION</b>	Peak (PK)
<b>FREQUENCY RANGE</b>	1GHz ~ 40GHz		Average (AV)

**ANTENNA POLARITY & TEST DISTANCE: HORIZONTAL AT 3 M**

NO.	FREQ. (MHz)	EMISSION LEVEL (dBuV/m)	LIMIT (dBuV/m)	MARGIN (dB)	ANTENNA HEIGHT (m)	TABLE ANGLE (Degree)	RAW VALUE (dBuV)	CORRECTION FACTOR (dB/m)
1	*5755.00	112.2 PK			1.52 H	36	109.2	3.0
2	*5755.00	99.4 AV			1.52 H	36	96.4	3.0
3	11510.00	48.1 PK	74.0	-25.9	1.71 H	212	35.8	12.3
4	11510.00	41.9 AV	54.0	-12.1	1.71 H	212	29.6	12.3
5	#17265.00	52.4 PK	68.2	-15.8	2.26 H	125	37.0	15.4

**ANTENNA POLARITY & TEST DISTANCE: VERTICAL AT 3 M**

NO.	FREQ. (MHz)	EMISSION LEVEL (dBuV/m)	LIMIT (dBuV/m)	MARGIN (dB)	ANTENNA HEIGHT (m)	TABLE ANGLE (Degree)	RAW VALUE (dBuV)	CORRECTION FACTOR (dB/m)
1	*5755.00	120.3 PK			2.27 V	86	117.3	3.0
2	*5755.00	107.9 AV			2.27 V	86	104.9	3.0
3	11510.00	49.7 PK	74.0	-24.3	1.43 V	228	37.4	12.3
4	11510.00	45.4 AV	54.0	-8.6	1.43 V	228	33.1	12.3
5	#17265.00	55.8 PK	68.2	-12.4	1.74 V	285	40.4	15.4

**REMARKS:**

1. Emission Level(dBuV/m) = Raw Value(dBuV) + Correction Factor(dB/m)
2. Correction Factor(dB/m) = Antenna Factor(dB/m) + Cable Factor(dB) – Pre-Amplifier Factor(dB)
3. The other emission levels were very low against the limit.
4. Margin value = Emission Level – Limit value
5. " \* ": Fundamental frequency.
6. " # ": The radiated frequency is out of the restricted band.

<b>CHANNEL</b>	TX Channel 159	<b>DETECTOR FUNCTION</b>	Peak (PK)
<b>FREQUENCY RANGE</b>	1GHz ~ 40GHz		Average (AV)

**ANTENNA POLARITY & TEST DISTANCE: HORIZONTAL AT 3 M**

NO.	FREQ. (MHz)	EMISSION LEVEL (dBuV/m)	LIMIT (dBuV/m)	MARGIN (dB)	ANTENNA HEIGHT (m)	TABLE ANGLE (Degree)	RAW VALUE (dBuV)	CORRECTION FACTOR (dB/m)
1	*5795.00	112.3 PK			1.80 H	245	109.3	3.0
2	*5795.00	100.3 AV			1.80 H	245	97.3	3.0
3	11590.00	48.9 PK	74.0	-25.1	1.73 H	205	36.5	12.4
4	11590.00	42.7 AV	54.0	-11.3	1.73 H	205	30.3	12.4
5	#17385.00	52.8 PK	68.2	-15.4	2.34 H	132	36.6	16.2

**ANTENNA POLARITY & TEST DISTANCE: VERTICAL AT 3 M**

NO.	FREQ. (MHz)	EMISSION LEVEL (dBuV/m)	LIMIT (dBuV/m)	MARGIN (dB)	ANTENNA HEIGHT (m)	TABLE ANGLE (Degree)	RAW VALUE (dBuV)	CORRECTION FACTOR (dB/m)
1	*5795.00	123.3 PK			2.62 V	308	120.3	3.0
2	*5795.00	110.1 AV			2.62 V	308	107.1	3.0
3	11590.00	50.7 PK	74.0	-23.3	1.37 V	213	38.3	12.4
4	11590.00	46.1 AV	54.0	-7.9	1.37 V	213	33.7	12.4
5	#17385.00	55.6 PK	68.2	-12.6	1.79 V	292	39.4	16.2

**REMARKS:**

1. Emission Level(dBuV/m) = Raw Value(dBuV) + Correction Factor(dB/m)
2. Correction Factor(dB/m) = Antenna Factor(dB/m) + Cable Factor(dB) – Pre-Amplifier Factor(dB)
3. The other emission levels were very low against the limit.
4. Margin value = Emission Level – Limit value
5. " \* ": Fundamental frequency.
6. " # ": The radiated frequency is out of the restricted band.

**802.11ax (HE80)**

<b>CHANNEL</b>	TX Channel 42	<b>DETECTOR FUNCTION</b>	Peak (PK)
<b>FREQUENCY RANGE</b>	1GHz ~ 40GHz		Average (AV)

**ANTENNA POLARITY & TEST DISTANCE: HORIZONTAL AT 3 M**

NO.	FREQ. (MHz)	EMISSION LEVEL (dBuV/m)	LIMIT (dBuV/m)	MARGIN (dB)	ANTENNA HEIGHT (m)	TABLE ANGLE (Degree)	RAW VALUE (dBuV)	CORRECTION FACTOR (dB/m)
1	5150.00	61.0 PK	74.0	-13.0	1.15 H	29	58.4	2.6
2	5150.00	47.2 AV	54.0	-6.8	1.15 H	29	44.6	2.6
3	*5210.00	100.9 PK			1.15 H	29	98.5	2.4
4	*5210.00	89.8 AV			1.15 H	29	87.4	2.4
5	5350.00	51.8 PK	74.0	-22.2	1.15 H	29	49.5	2.3
6	5350.00	40.8 AV	54.0	-13.2	1.15 H	29	38.5	2.3
7	#10420.00	49.0 PK	68.2	-19.2	2.65 H	287	36.8	12.2
8	15630.00	52.3 PK	74.0	-21.7	2.02 H	15	39.6	12.7
9	15630.00	39.9 AV	54.0	-14.1	2.02 H	15	27.2	12.7

**ANTENNA POLARITY & TEST DISTANCE: VERTICAL AT 3 M**

NO.	FREQ. (MHz)	EMISSION LEVEL (dBuV/m)	LIMIT (dBuV/m)	MARGIN (dB)	ANTENNA HEIGHT (m)	TABLE ANGLE (Degree)	RAW VALUE (dBuV)	CORRECTION FACTOR (dB/m)
1	5150.00	64.8 PK	74.0	-9.2	1.16 V	153	62.2	2.6
2	5150.00	53.7 AV	54.0	-0.3	1.16 V	153	51.1	2.6
3	*5210.00	109.5 PK			1.16 V	153	107.1	2.4
4	*5210.00	98.1 AV			1.16 V	153	95.7	2.4
5	5350.00	52.2 PK	74.0	-21.8	1.16 V	153	49.9	2.3
6	5350.00	41.5 AV	54.0	-12.5	1.16 V	153	39.2	2.3
7	#10420.00	49.4 PK	68.2	-18.8	1.77 V	293	37.2	12.2
8	15630.00	58.4 PK	74.0	-15.6	2.99 V	240	45.7	12.7
9	15630.00	47.0 AV	54.0	-7.0	2.99 V	240	34.3	12.7

**REMARKS:**

1. Emission Level(dBuV/m) = Raw Value(dBuV) + Correction Factor(dB/m)
2. Correction Factor(dB/m) = Antenna Factor(dB/m) + Cable Factor(dB) – Pre-Amplifier Factor(dB)
3. The other emission levels were very low against the limit.
4. Margin value = Emission Level – Limit value
5. " \* ": Fundamental frequency.
6. " # ": The radiated frequency is out of the restricted band.

<b>CHANNEL</b>	TX Channel 155	<b>DETECTOR FUNCTION</b>	Peak (PK)
<b>FREQUENCY RANGE</b>	1GHz ~ 40GHz		Average (AV)

**ANTENNA POLARITY & TEST DISTANCE: HORIZONTAL AT 3 M**

NO.	FREQ. (MHz)	EMISSION LEVEL (dBuV/m)	LIMIT (dBuV/m)	MARGIN (dB)	ANTENNA HEIGHT (m)	TABLE ANGLE (Degree)	RAW VALUE (dBuV)	CORRECTION FACTOR (dB/m)
1	*5775.00	106.0 PK			1.63 H	40	103.0	3.0
2	*5775.00	94.6 AV			1.63 H	40	91.6	3.0
3	11550.00	48.7 PK	74.0	-25.3	1.79 H	211	36.3	12.4
4	11550.00	42.6 AV	54.0	-11.4	1.79 H	211	30.2	12.4
5	#17325.00	52.0 PK	68.2	-16.2	2.32 H	125	36.3	15.7

**ANTENNA POLARITY & TEST DISTANCE: VERTICAL AT 3 M**

NO.	FREQ. (MHz)	EMISSION LEVEL (dBuV/m)	LIMIT (dBuV/m)	MARGIN (dB)	ANTENNA HEIGHT (m)	TABLE ANGLE (Degree)	RAW VALUE (dBuV)	CORRECTION FACTOR (dB/m)
1	*5775.00	111.9 PK			1.30 V	117	108.9	3.0
2	*5775.00	100.1 AV			1.30 V	117	97.1	3.0
3	11550.00	50.2 PK	74.0	-23.8	1.35 V	214	37.8	12.4
4	11550.00	45.6 AV	54.0	-8.4	1.35 V	214	33.2	12.4
5	#17325.00	55.9 PK	68.2	-12.3	1.82 V	295	40.2	15.7

**REMARKS:**

1. Emission Level(dBuV/m) = Raw Value(dBuV) + Correction Factor(dB/m)
2. Correction Factor(dB/m) = Antenna Factor(dB/m) + Cable Factor(dB) – Pre-Amplifier Factor(dB)
3. The other emission levels were very low against the limit.
4. Margin value = Emission Level – Limit value
5. " \* ": Fundamental frequency.
6. " # ": The radiated frequency is out of the restricted band.

**802.11ax (HE80+80)**

<b>CHANNEL</b>	TX Channel 42+155	<b>DETECTOR FUNCTION</b>	Peak (PK)
<b>FREQUENCY RANGE</b>	1GHz ~ 40GHz		Average (AV)

**ANTENNA POLARITY & TEST DISTANCE: HORIZONTAL AT 3 M**

NO.	FREQ. (MHz)	EMISSION LEVEL (dBuV/m)	LIMIT (dBuV/m)	MARGIN (dB)	ANTENNA HEIGHT (m)	TABLE ANGLE (Degree)	RAW VALUE (dBuV)	CORRECTION FACTOR (dB/m)
1	5150.00	56.7 PK	74.0	-17.3	1.66 H	291	54.1	2.6
2	5150.00	44.7 AV	54.0	-9.3	1.66 H	291	42.1	2.6
3	*5210.00	97.8 PK			1.66 H	291	95.4	2.4
4	*5210.00	85.6 AV			1.66 H	291	83.2	2.4
5	5350.00	51.7 PK	74.0	-22.3	1.66 H	291	49.4	2.3
6	5350.00	39.0 AV	54.0	-15.0	1.66 H	291	36.7	2.3
7	*5775.00	97.6 PK			1.31 H	177	94.6	3.0
8	*5775.00	84.7 AV			1.31 H	177	81.7	3.0
9	#10420.00	48.5 PK	68.2	-19.7	2.69 H	293	36.3	12.2
10	11550.00	48.5 PK	74.0	-25.5	1.76 H	201	36.1	12.4
11	11550.00	42.1 AV	54.0	-11.9	1.76 H	201	29.7	12.4
12	15630.00	52.6 PK	74.0	-21.4	2.07 H	11	39.9	12.7
13	15630.00	40.1 AV	54.0	-13.9	2.07 H	11	27.4	12.7
14	#17325.00	52.2 PK	68.2	-16.0	2.35 H	120	36.5	15.7

**ANTENNA POLARITY & TEST DISTANCE: VERTICAL AT 3 M**

NO.	FREQ. (MHz)	EMISSION LEVEL (dBuV/m)	LIMIT (dBuV/m)	MARGIN (dB)	ANTENNA HEIGHT (m)	TABLE ANGLE (Degree)	RAW VALUE (dBuV)	CORRECTION FACTOR (dB/m)
1	5150.00	64.9 PK	74.0	-9.1	2.56 V	133	62.3	2.6
2	5150.00	53.6 AV	54.0	-0.4	2.56 V	133	51.0	2.6
3	*5210.00	107.4 PK			2.56 V	133	105.0	2.4
4	*5210.00	96.2 AV			2.56 V	133	93.8	2.4
5	5350.00	52.4 PK	74.0	-21.6	2.56 V	133	50.1	2.3
6	5350.00	41.7 AV	54.0	-12.3	2.56 V	133	39.4	2.3
7	*5775.00	106.8 PK			2.22 V	34	103.8	3.0
8	*5775.00	94.1 AV			2.22 V	34	91.1	3.0
9	#10420.00	49.2 PK	68.2	-19.0	1.76 V	283	37.0	12.2
10	11550.00	50.7 PK	74.0	-23.3	1.36 V	221	38.3	12.4
11	11550.00	46.1 AV	54.0	-7.9	1.36 V	221	33.7	12.4
12	15630.00	58.6 PK	74.0	-15.4	3.00 V	253	45.9	12.7
13	15630.00	47.2 AV	54.0	-6.8	3.00 V	253	34.5	12.7
14	#17325.00	55.9 PK	68.2	-12.3	1.87 V	306	40.2	15.7

**REMARKS:**

1. Emission Level(dBuV/m) = Raw Value(dBuV) + Correction Factor(dB/m)
2. Correction Factor(dB/m) = Antenna Factor(dB/m) + Cable Factor(dB) – Pre-Amplifier Factor(dB)
3. The other emission levels were very low against the limit.
4. Margin value = Emission Level – Limit value
5. " \* ": Fundamental frequency.
6. " # ": The radiated frequency is out of the restricted band.

Below 1GHz Data:

802.11ax (HE20)

<b>CHANNEL</b>	TX Channel 149	<b>DETECTOR FUNCTION</b>	Quasi-Peak (QP)
<b>FREQUENCY RANGE</b>	9kHz ~ 1GHz		

**ANTENNA POLARITY & TEST DISTANCE: HORIZONTAL AT 3 M**

NO.	FREQ. (MHz)	EMISSION LEVEL (dBuV/m)	LIMIT (dBuV/m)	MARGIN (dB)	ANTENNA HEIGHT (m)	TABLE ANGLE (Degree)	RAW VALUE (dBuV)	CORRECTION FACTOR (dB/m)
1	109.20	34.9 QP	43.5	-8.6	1.50 H	304	45.6	-10.7
2	197.01	30.3 QP	43.5	-13.2	2.00 H	69	41.2	-10.9
3	230.23	31.2 QP	46.0	-14.8	1.50 H	68	41.4	-10.2
4	300.87	31.0 QP	46.0	-15.0	1.00 H	70	37.9	-6.9
5	374.98	32.1 QP	46.0	-13.9	1.00 H	88	37.1	-5.0
6	657.95	31.0 QP	46.0	-15.0	2.00 H	253	29.8	1.2

**REMARKS:**

1. Emission Level(dBuV/m) = Raw Value(dBuV) + Correction Factor(dB/m)
2. Correction Factor(dB/m) = Antenna Factor(dB/m) + Cable Factor(dB) – Pre-Amplifier Factor(dB)
3. Margin value = Emission Level – Limit value
4. The emission levels were very low against the limit of frequency range 9kHz~30MHz: the amplitude of spurious emissions attenuated more than 20 dB below the permissible value to be report.

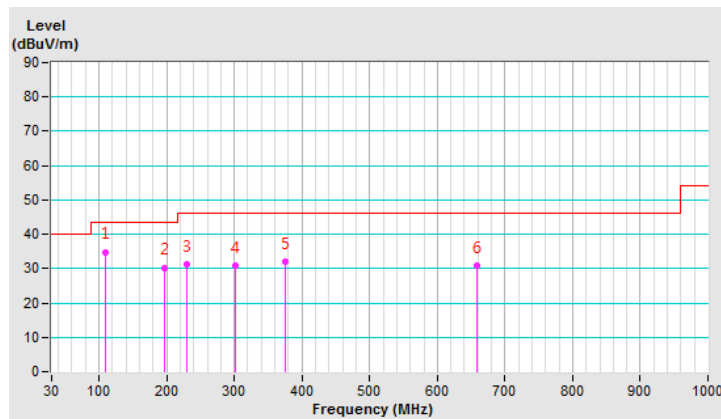



<b>CHANNEL</b>	TX Channel 149	<b>DETECTOR FUNCTION</b>	Quasi-Peak (QP)
<b>FREQUENCY RANGE</b>	9kHz ~ 1GHz		

**ANTENNA POLARITY & TEST DISTANCE: VERTICAL AT 3 M**

NO.	FREQ. (MHz)	EMISSION LEVEL (dBuV/m)	LIMIT (dBuV/m)	MARGIN (dB)	ANTENNA HEIGHT (m)	TABLE ANGLE (Degree)	RAW VALUE (dBuV)	CORRECTION FACTOR (dB/m)
1	132.92	33.0 QP	43.5	-10.5	1.50 V	41	41.8	-8.8
2	166.16	29.9 QP	43.5	-13.6	1.00 V	106	38.0	-8.1
3	230.11	27.9 QP	46.0	-18.1	1.50 V	140	38.1	-10.2
4	294.47	28.1 QP	46.0	-17.9	2.00 V	327	35.2	-7.1
5	457.38	29.5 QP	46.0	-16.5	1.00 V	352	32.3	-2.8
6	644.37	31.4 QP	46.0	-14.6	1.00 V	250	30.2	1.2

**REMARKS:**

1. Emission Level(dBuV/m) = Raw Value(dBuV) + Correction Factor(dB/m)
2. Correction Factor(dB/m) = Antenna Factor(dB/m) + Cable Factor(dB) – Pre-Amplifier Factor(dB)
3. Margin value = Emission Level – Limit value
4. The emission levels were very low against the limit of frequency range 9kHz~30MHz: the amplitude of spurious emissions attenuated more than 20 dB below the permissible value to be report.

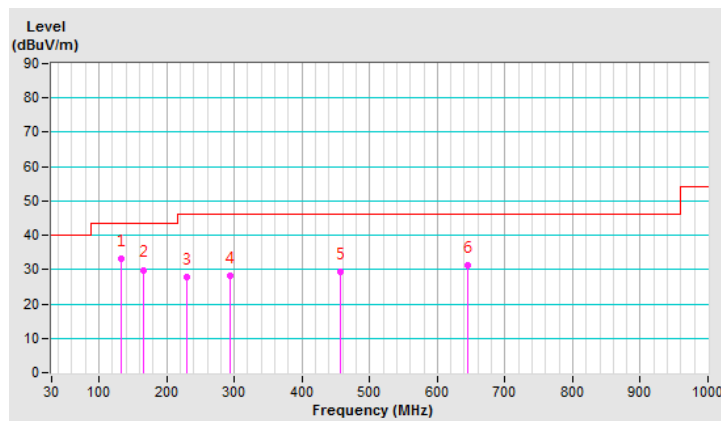

## 4.1.8 Test Results (Mode 2)

## Above 1GHz Data:

## 802.11a

<b>CHANNEL</b>	TX Channel 36	<b>DETECTOR FUNCTION</b>	Peak (PK)
<b>FREQUENCY RANGE</b>	1GHz ~ 40GHz		Average (AV)

**ANTENNA POLARITY & TEST DISTANCE: HORIZONTAL AT 3 M**

NO.	FREQ. (MHz)	EMISSION LEVEL (dBuV/m)	LIMIT (dBuV/m)	MARGIN (dB)	ANTENNA HEIGHT (m)	TABLE ANGLE (Degree)	RAW VALUE (dBuV)	CORRECTION FACTOR (dB/m)
1	5150.00	59.2 PK	74.0	-14.8	2.19 H	248	56.6	2.6
2	5150.00	46.2 AV	54.0	-7.8	2.19 H	248	43.6	2.6
3	*5180.00	105.4 PK			2.19 H	248	102.9	2.5
4	*5180.00	96.5 AV			2.19 H	248	94.0	2.5
5	#10360.00	49.7 PK	68.2	-18.5	2.77 H	297	37.8	11.9
6	15540.00	53.8 PK	74.0	-20.2	2.04 H	34	41.4	12.4
7	15540.00	41.1 AV	54.0	-12.9	2.04 H	34	28.7	12.4

**ANTENNA POLARITY & TEST DISTANCE: VERTICAL AT 3 M**

NO.	FREQ. (MHz)	EMISSION LEVEL (dBuV/m)	LIMIT (dBuV/m)	MARGIN (dB)	ANTENNA HEIGHT (m)	TABLE ANGLE (Degree)	RAW VALUE (dBuV)	CORRECTION FACTOR (dB/m)
1	5150.00	68.6 PK	74.0	-5.4	3.12 V	360	66.0	2.6
2	<b>5150.00</b>	<b>53.9 AV</b>	<b>54.0</b>	<b>-0.1</b>	<b>3.12 V</b>	<b>360</b>	<b>51.3</b>	<b>2.6</b>
3	*5180.00	113.3 PK			3.12 V	360	110.8	2.5
4	*5180.00	104.6 AV			3.12 V	360	102.1	2.5
5	#10360.00	52.2 PK	68.2	-16.0	1.92 V	293	40.3	11.9
6	15540.00	60.0 PK	74.0	-14.0	2.96 V	241	47.6	12.4
7	15540.00	49.1 AV	54.0	-4.9	2.96 V	241	36.7	12.4

**REMARKS:**

1. Emission Level(dBuV/m) = Raw Value(dBuV) + Correction Factor(dB/m)
2. Correction Factor(dB/m) = Antenna Factor(dB/m) + Cable Factor(dB) – Pre-Amplifier Factor(dB)
3. The other emission levels were very low against the limit.
4. Margin value = Emission Level – Limit value
5. " \* ": Fundamental frequency.
6. " # ": The radiated frequency is out of the restricted band.

<b>CHANNEL</b>	TX Channel 40	<b>DETECTOR FUNCTION</b>	Peak (PK)
<b>FREQUENCY RANGE</b>	1GHz ~ 40GHz		Average (AV)

**ANTENNA POLARITY & TEST DISTANCE: HORIZONTAL AT 3 M**

NO.	FREQ. (MHz)	EMISSION LEVEL (dBuV/m)	LIMIT (dBuV/m)	MARGIN (dB)	ANTENNA HEIGHT (m)	TABLE ANGLE (Degree)	RAW VALUE (dBuV)	CORRECTION FACTOR (dB/m)
1	5150.00	59.0 PK	74.0	-15.0	2.13 H	246	56.4	2.6
2	5150.00	46.0 AV	54.0	-8.0	2.13 H	246	43.4	2.6
3	*5200.00	107.5 PK			2.13 H	246	105.1	2.4
4	*5200.00	99.4 AV			2.13 H	246	97.0	2.4
5	5350.00	51.7 PK	74.0	-22.3	2.13 H	246	49.4	2.3
6	5350.00	40.5 AV	54.0	-13.5	2.13 H	246	38.2	2.3
7	#10400.00	50.2 PK	68.2	-18.0	2.75 H	296	38.0	12.2
8	15600.00	54.3 PK	74.0	-19.7	2.08 H	51	41.4	12.9
9	15600.00	41.6 AV	54.0	-12.4	2.08 H	51	28.7	12.9

**ANTENNA POLARITY & TEST DISTANCE: VERTICAL AT 3 M**

NO.	FREQ. (MHz)	EMISSION LEVEL (dBuV/m)	LIMIT (dBuV/m)	MARGIN (dB)	ANTENNA HEIGHT (m)	TABLE ANGLE (Degree)	RAW VALUE (dBuV)	CORRECTION FACTOR (dB/m)
1	5150.00	63.9 PK	74.0	-10.1	2.95 V	360	61.3	2.6
2	5150.00	53.9 AV	54.0	-0.1	2.95 V	360	51.3	2.6
3	*5200.00	115.7 PK			2.95 V	360	113.3	2.4
4	*5200.00	107.2 AV			2.95 V	360	104.8	2.4
5	5350.00	52.3 PK	74.0	-21.7	2.95 V	360	50.0	2.3
6	5350.00	41.3 AV	54.0	-12.7	2.95 V	360	39.0	2.3
7	#10400.00	52.7 PK	68.2	-15.5	1.84 V	295	40.5	12.2
8	15600.00	60.3 PK	74.0	-13.7	3.01 V	223	47.4	12.9
9	15600.00	49.6 AV	54.0	-4.4	3.01 V	223	36.7	12.9

**REMARKS:**

1. Emission Level(dBuV/m) = Raw Value(dBuV) + Correction Factor(dB/m)
2. Correction Factor(dB/m) = Antenna Factor(dB/m) + Cable Factor(dB) – Pre-Amplifier Factor(dB)
3. The other emission levels were very low against the limit.
4. Margin value = Emission Level – Limit value
5. " \* ": Fundamental frequency.
6. " # ": The radiated frequency is out of the restricted band.

<b>CHANNEL</b>	TX Channel 48	<b>DETECTOR FUNCTION</b>	Peak (PK)
<b>FREQUENCY RANGE</b>	1GHz ~ 40GHz		Average (AV)

**ANTENNA POLARITY & TEST DISTANCE: HORIZONTAL AT 3 M**

NO.	FREQ. (MHz)	EMISSION LEVEL (dBuV/m)	LIMIT (dBuV/m)	MARGIN (dB)	ANTENNA HEIGHT (m)	TABLE ANGLE (Degree)	RAW VALUE (dBuV)	CORRECTION FACTOR (dB/m)
1	*5240.00	106.3 PK			2.18 H	257	104.1	2.2
2	*5240.00	98.3 AV			2.18 H	257	96.1	2.2
3	5350.00	50.1 PK	74.0	-23.9	2.18 H	257	47.8	2.3
4	5350.00	40.5 AV	54.0	-13.5	2.18 H	257	38.2	2.3
5	#10480.00	50.1 PK	68.2	-18.1	2.73 H	311	37.7	12.4
6	15720.00	54.1 PK	74.0	-19.9	2.06 H	37	42.1	12.0
7	15720.00	41.4 AV	54.0	-12.6	2.06 H	37	29.4	12.0

**ANTENNA POLARITY & TEST DISTANCE: VERTICAL AT 3 M**

NO.	FREQ. (MHz)	EMISSION LEVEL (dBuV/m)	LIMIT (dBuV/m)	MARGIN (dB)	ANTENNA HEIGHT (m)	TABLE ANGLE (Degree)	RAW VALUE (dBuV)	CORRECTION FACTOR (dB/m)
1	*5240.00	114.7 PK			3.13 V	300	112.5	2.2
2	*5240.00	106.8 AV			3.13 V	300	104.6	2.2
3	5350.00	51.7 PK	74.0	-22.3	3.13 V	300	49.4	2.3
4	5350.00	42.3 AV	54.0	-11.7	3.13 V	300	40.0	2.3
5	#10480.00	52.4 PK	68.2	-15.8	1.88 V	300	40.0	12.4
6	15720.00	60.1 PK	74.0	-13.9	3.01 V	231	48.1	12.0
7	15720.00	49.3 AV	54.0	-4.7	3.01 V	231	37.3	12.0

**REMARKS:**

- Emission Level(dBuV/m) = Raw Value(dBuV) + Correction Factor(dB/m)
- Correction Factor(dB/m) = Antenna Factor(dB/m) + Cable Factor(dB) – Pre-Amplifier Factor(dB)
- The other emission levels were very low against the limit.
- Margin value = Emission Level – Limit value
- " \* ": Fundamental frequency.
- " # ": The radiated frequency is out of the restricted band.

<b>CHANNEL</b>	TX Channel 149	<b>DETECTOR FUNCTION</b>	Peak (PK)
<b>FREQUENCY RANGE</b>	1GHz ~ 40GHz		Average (AV)

**ANTENNA POLARITY & TEST DISTANCE: HORIZONTAL AT 3 M**

NO.	FREQ. (MHz)	EMISSION LEVEL (dBuV/m)	LIMIT (dBuV/m)	MARGIN (dB)	ANTENNA HEIGHT (m)	TABLE ANGLE (Degree)	RAW VALUE (dBuV)	CORRECTION FACTOR (dB/m)
1	*5745.00	109.9 PK			2.37 H	36	107.0	2.9
2	*5745.00	100.9 AV			2.37 H	36	98.0	2.9
3	11490.00	46.8 PK	74.0	-27.2	1.66 H	198	34.5	12.3
4	11490.00	40.5 AV	54.0	-13.5	1.66 H	198	28.2	12.3
5	#17235.00	50.5 PK	68.2	-17.7	2.31 H	122	35.2	15.3

**ANTENNA POLARITY & TEST DISTANCE: VERTICAL AT 3 M**

NO.	FREQ. (MHz)	EMISSION LEVEL (dBuV/m)	LIMIT (dBuV/m)	MARGIN (dB)	ANTENNA HEIGHT (m)	TABLE ANGLE (Degree)	RAW VALUE (dBuV)	CORRECTION FACTOR (dB/m)
1	*5745.00	120.9 PK			2.58 V	170	118.0	2.9
2	*5745.00	111.7 AV			2.58 V	170	108.8	2.9
3	11490.00	48.9 PK	74.0	-25.1	1.37 V	220	36.6	12.3
4	11490.00	43.5 AV	54.0	-10.5	1.37 V	220	31.2	12.3
5	#17235.00	53.6 PK	68.2	-14.6	1.80 V	287	38.3	15.3

**REMARKS:**

1. Emission Level(dBuV/m) = Raw Value(dBuV) + Correction Factor(dB/m)
2. Correction Factor(dB/m) = Antenna Factor(dB/m) + Cable Factor(dB) – Pre-Amplifier Factor(dB)
3. The other emission levels were very low against the limit.
4. Margin value = Emission Level – Limit value
5. " \* ": Fundamental frequency.
6. " # ": The radiated frequency is out of the restricted band.

<b>CHANNEL</b>	TX Channel 157	<b>DETECTOR FUNCTION</b>	Peak (PK)
<b>FREQUENCY RANGE</b>	1GHz ~ 40GHz		Average (AV)

**ANTENNA POLARITY & TEST DISTANCE: HORIZONTAL AT 3 M**

NO.	FREQ. (MHz)	EMISSION LEVEL (dBuV/m)	LIMIT (dBuV/m)	MARGIN (dB)	ANTENNA HEIGHT (m)	TABLE ANGLE (Degree)	RAW VALUE (dBuV)	CORRECTION FACTOR (dB/m)
1	*5785.00	109.7 PK			2.09 H	38	106.6	3.1
2	*5785.00	100.7 AV			2.09 H	38	97.6	3.1
3	11570.00	47.0 PK	74.0	-27.0	1.71 H	215	34.6	12.4
4	11570.00	40.6 AV	54.0	-13.4	1.71 H	215	28.2	12.4
5	#17355.00	50.2 PK	68.2	-18.0	2.34 H	111	34.2	16.0

**ANTENNA POLARITY & TEST DISTANCE: VERTICAL AT 3 M**

NO.	FREQ. (MHz)	EMISSION LEVEL (dBuV/m)	LIMIT (dBuV/m)	MARGIN (dB)	ANTENNA HEIGHT (m)	TABLE ANGLE (Degree)	RAW VALUE (dBuV)	CORRECTION FACTOR (dB/m)
1	*5785.00	120.4 PK			2.72 V	172	117.3	3.1
2	*5785.00	111.5 AV			2.72 V	172	108.4	3.1
3	11570.00	49.2 PK	74.0	-24.8	1.29 V	222	36.8	12.4
4	11570.00	43.6 AV	54.0	-10.4	1.29 V	222	31.2	12.4
5	#17355.00	54.0 PK	68.2	-14.2	1.78 V	302	38.0	16.0

**REMARKS:**

1. Emission Level(dBuV/m) = Raw Value(dBuV) + Correction Factor(dB/m)
2. Correction Factor(dB/m) = Antenna Factor(dB/m) + Cable Factor(dB) – Pre-Amplifier Factor(dB)
3. The other emission levels were very low against the limit.
4. Margin value = Emission Level – Limit value
5. " \* ": Fundamental frequency.
6. " # ": The radiated frequency is out of the restricted band.

<b>CHANNEL</b>	TX Channel 165	<b>DETECTOR FUNCTION</b>	Peak (PK)
<b>FREQUENCY RANGE</b>	1GHz ~ 40GHz		Average (AV)

**ANTENNA POLARITY & TEST DISTANCE: HORIZONTAL AT 3 M**

NO.	FREQ. (MHz)	EMISSION LEVEL (dBuV/m)	LIMIT (dBuV/m)	MARGIN (dB)	ANTENNA HEIGHT (m)	TABLE ANGLE (Degree)	RAW VALUE (dBuV)	CORRECTION FACTOR (dB/m)
1	*5825.00	108.5 PK			2.13 H	79	105.3	3.2
2	*5825.00	100.2 AV			2.13 H	79	97.0	3.2
3	11650.00	47.6 PK	74.0	-26.4	1.75 H	211	35.2	12.4
4	11650.00	41.1 AV	54.0	-12.9	1.75 H	211	28.7	12.4
5	#17475.00	49.7 PK	68.2	-18.5	2.36 H	129	32.3	17.4

**ANTENNA POLARITY & TEST DISTANCE: VERTICAL AT 3 M**

NO.	FREQ. (MHz)	EMISSION LEVEL (dBuV/m)	LIMIT (dBuV/m)	MARGIN (dB)	ANTENNA HEIGHT (m)	TABLE ANGLE (Degree)	RAW VALUE (dBuV)	CORRECTION FACTOR (dB/m)
1	*5825.00	119.2 PK			2.89 V	175	116.0	3.2
2	*5825.00	110.6 AV			2.89 V	175	107.4	3.2
3	11650.00	49.1 PK	74.0	-24.9	1.37 V	210	36.7	12.4
4	11650.00	43.3 AV	54.0	-10.7	1.37 V	210	30.9	12.4
5	#17475.00	53.4 PK	68.2	-14.8	1.83 V	307	36.0	17.4

**REMARKS:**

1. Emission Level(dBuV/m) = Raw Value(dBuV) + Correction Factor(dB/m)
2. Correction Factor(dB/m) = Antenna Factor(dB/m) + Cable Factor(dB) – Pre-Amplifier Factor(dB)
3. The other emission levels were very low against the limit.
4. Margin value = Emission Level – Limit value
5. " \* ": Fundamental frequency.
6. " # ": The radiated frequency is out of the restricted band.

**802.11ax (HE20)**

<b>CHANNEL</b>	TX Channel 36	<b>DETECTOR FUNCTION</b>	Peak (PK)
<b>FREQUENCY RANGE</b>	1GHz ~ 40GHz		Average (AV)

**ANTENNA POLARITY & TEST DISTANCE: HORIZONTAL AT 3 M**

NO.	FREQ. (MHz)	EMISSION LEVEL (dBuV/m)	LIMIT (dBuV/m)	MARGIN (dB)	ANTENNA HEIGHT (m)	TABLE ANGLE (Degree)	RAW VALUE (dBuV)	CORRECTION FACTOR (dB/m)
1	5150.00	58.8 PK	74.0	-15.2	2.19 H	252	56.2	2.6
2	5150.00	45.9 AV	54.0	-8.1	2.19 H	252	43.3	2.6
3	*5180.00	108.9 PK			2.19 H	252	106.4	2.5
4	*5180.00	96.2 AV			2.19 H	252	93.7	2.5
5	#10360.00	50.1 PK	68.2	-18.1	2.80 H	293	38.2	11.9
6	15540.00	54.0 PK	74.0	-20.0	2.02 H	22	41.6	12.4
7	15540.00	41.3 AV	54.0	-12.7	2.02 H	22	28.9	12.4

**ANTENNA POLARITY & TEST DISTANCE: VERTICAL AT 3 M**

NO.	FREQ. (MHz)	EMISSION LEVEL (dBuV/m)	LIMIT (dBuV/m)	MARGIN (dB)	ANTENNA HEIGHT (m)	TABLE ANGLE (Degree)	RAW VALUE (dBuV)	CORRECTION FACTOR (dB/m)
1	5150.00	65.6 PK	74.0	-8.4	3.05 V	303	63.0	2.6
2	5150.00	53.8 AV	54.0	-0.2	3.05 V	303	51.2	2.6
3	*5180.00	117.2 PK			3.05 V	303	114.7	2.5
4	*5180.00	104.1 AV			3.05 V	303	101.6	2.5
5	#10360.00	52.3 PK	68.2	-15.9	1.97 V	307	40.4	11.9
6	15540.00	60.0 PK	74.0	-14.0	2.93 V	238	47.6	12.4
7	15540.00	49.3 AV	54.0	-4.7	2.93 V	238	36.9	12.4

**REMARKS:**

- Emission Level(dBuV/m) = Raw Value(dBuV) + Correction Factor(dB/m)
- Correction Factor(dB/m) = Antenna Factor(dB/m) + Cable Factor(dB) – Pre-Amplifier Factor(dB)
- The other emission levels were very low against the limit.
- Margin value = Emission Level – Limit value
- " \* ": Fundamental frequency.
- " # ": The radiated frequency is out of the restricted band.



<b>CHANNEL</b>	TX Channel 40	<b>DETECTOR FUNCTION</b>	Peak (PK)
<b>FREQUENCY RANGE</b>	1GHz ~ 40GHz		Average (AV)

**ANTENNA POLARITY & TEST DISTANCE: HORIZONTAL AT 3 M**

NO.	FREQ. (MHz)	EMISSION LEVEL (dBuV/m)	LIMIT (dBuV/m)	MARGIN (dB)	ANTENNA HEIGHT (m)	TABLE ANGLE (Degree)	RAW VALUE (dBuV)	CORRECTION FACTOR (dB/m)
1	5150.00	58.6 PK	74.0	-15.4	2.24 H	245	56.0	2.6
2	5150.00	45.7 AV	54.0	-8.3	2.24 H	245	43.1	2.6
3	*5200.00	111.2 PK			2.24 H	245	108.8	2.4
4	*5200.00	99.5 AV			2.24 H	245	97.1	2.4
5	5350.00	50.4 PK	74.0	-23.6	2.24 H	245	48.1	2.3
6	5350.00	38.7 AV	54.0	-15.3	2.24 H	245	36.4	2.3
7	5396.00	52.2 PK	74.0	-21.8	2.24 H	245	49.7	2.5
8	5396.00	40.2 AV	54.0	-13.8	2.24 H	245	37.7	2.5
9	#10400.00	50.4 PK	68.2	-17.8	2.76 H	301	38.2	12.2
10	15600.00	54.3 PK	74.0	-19.7	2.09 H	52	41.4	12.9
11	15600.00	41.4 AV	54.0	-12.6	2.09 H	52	28.5	12.9

**ANTENNA POLARITY & TEST DISTANCE: VERTICAL AT 3 M**

NO.	FREQ. (MHz)	EMISSION LEVEL (dBuV/m)	LIMIT (dBuV/m)	MARGIN (dB)	ANTENNA HEIGHT (m)	TABLE ANGLE (Degree)	RAW VALUE (dBuV)	CORRECTION FACTOR (dB/m)
1	5150.00	66.2 PK	74.0	-7.8	3.15 V	293	63.6	2.6
2	5150.00	53.6 AV	54.0	-0.4	3.15 V	293	51.0	2.6
3	*5200.00	119.5 PK			3.15 V	293	117.1	2.4
4	*5200.00	107.3 AV			3.15 V	293	104.9	2.4
5	5350.00	50.6 PK	74.0	-23.4	3.15 V	293	48.3	2.3
6	5350.00	38.9 AV	54.0	-15.1	3.15 V	293	36.6	2.3
7	5396.00	52.9 PK	74.0	-21.1	3.15 V	293	50.4	2.5
8	5396.00	40.9 AV	54.0	-13.1	3.15 V	293	38.4	2.5
9	#10400.00	53.3 PK	68.2	-14.9	1.86 V	306	41.1	12.2
10	15600.00	60.2 PK	74.0	-13.8	2.96 V	229	47.3	12.9
11	15600.00	49.6 AV	54.0	-4.4	2.96 V	229	36.7	12.9

**REMARKS:**

1. Emission Level(dBuV/m) = Raw Value(dBuV) + Correction Factor(dB/m)
2. Correction Factor(dB/m) = Antenna Factor(dB/m) + Cable Factor(dB) – Pre-Amplifier Factor(dB)
3. The other emission levels were very low against the limit.
4. Margin value = Emission Level – Limit value
5. " \* ": Fundamental frequency.
6. " # ": The radiated frequency is out of the restricted band.

<b>CHANNEL</b>	TX Channel 48	<b>DETECTOR FUNCTION</b>	Peak (PK)
<b>FREQUENCY RANGE</b>	1GHz ~ 40GHz		Average (AV)

**ANTENNA POLARITY & TEST DISTANCE: HORIZONTAL AT 3 M**

NO.	FREQ. (MHz)	EMISSION LEVEL (dBuV/m)	LIMIT (dBuV/m)	MARGIN (dB)	ANTENNA HEIGHT (m)	TABLE ANGLE (Degree)	RAW VALUE (dBuV)	CORRECTION FACTOR (dB/m)
1	5150.00	51.5 PK	74.0	-22.5	2.24 H	259	48.9	2.6
2	5150.00	40.1 AV	54.0	-13.9	2.24 H	259	37.5	2.6
3	*5240.00	111.0 PK			2.24 H	259	108.8	2.2
4	*5240.00	99.2 AV			2.24 H	259	97.0	2.2
5	5350.00	48.3 PK	74.0	-25.7	2.24 H	259	46.0	2.3
6	5350.00	38.7 AV	54.0	-15.3	2.24 H	259	36.4	2.3
7	5435.00	52.1 PK	74.0	-21.9	2.24 H	259	49.6	2.5
8	5435.00	40.5 AV	54.0	-13.5	2.24 H	259	38.0	2.5
9	#10480.00	50.2 PK	68.2	-18.0	2.78 H	323	37.8	12.4
10	15720.00	54.5 PK	74.0	-19.5	2.10 H	22	42.5	12.0
11	15720.00	41.9 AV	54.0	-12.1	2.10 H	22	29.9	12.0

**ANTENNA POLARITY & TEST DISTANCE: VERTICAL AT 3 M**

NO.	FREQ. (MHz)	EMISSION LEVEL (dBuV/m)	LIMIT (dBuV/m)	MARGIN (dB)	ANTENNA HEIGHT (m)	TABLE ANGLE (Degree)	RAW VALUE (dBuV)	CORRECTION FACTOR (dB/m)
1	5150.00	52.2 PK	74.0	-21.8	3.18 V	298	49.6	2.6
2	5150.00	40.9 AV	54.0	-13.1	3.18 V	298	38.3	2.6
3	*5240.00	119.2 PK			3.18 V	298	117.0	2.2
4	*5240.00	107.0 AV			3.18 V	298	104.8	2.2
5	5350.00	48.7 PK	74.0	-25.3	3.18 V	298	46.4	2.3
6	5350.00	39.1 AV	54.0	-14.9	3.18 V	298	36.8	2.3
7	5435.00	52.7 PK	74.0	-21.3	3.18 V	298	50.2	2.5
8	5435.00	41.1 AV	54.0	-12.9	3.18 V	298	38.6	2.5
9	#10480.00	52.3 PK	68.2	-15.9	1.91 V	306	39.9	12.4
10	15720.00	59.5 PK	74.0	-14.5	2.98 V	215	47.5	12.0
11	15720.00	48.9 AV	54.0	-5.1	2.98 V	215	36.9	12.0

**REMARKS:**

1. Emission Level(dBuV/m) = Raw Value(dBuV) + Correction Factor(dB/m)
2. Correction Factor(dB/m) = Antenna Factor(dB/m) + Cable Factor(dB) – Pre-Amplifier Factor(dB)
3. The other emission levels were very low against the limit.
4. Margin value = Emission Level – Limit value
5. " \* ": Fundamental frequency.
6. " # ": The radiated frequency is out of the restricted band.

<b>CHANNEL</b>	TX Channel 149	<b>DETECTOR FUNCTION</b>	Peak (PK)
<b>FREQUENCY RANGE</b>	1GHz ~ 40GHz		Average (AV)

**ANTENNA POLARITY & TEST DISTANCE: HORIZONTAL AT 3 M**

NO.	FREQ. (MHz)	EMISSION LEVEL (dBuV/m)	LIMIT (dBuV/m)	MARGIN (dB)	ANTENNA HEIGHT (m)	TABLE ANGLE (Degree)	RAW VALUE (dBuV)	CORRECTION FACTOR (dB/m)
1	*5745.00	111.7 PK			2.57 H	36	108.8	2.9
2	*5745.00	100.0 AV			2.57 H	36	97.1	2.9
3	11490.00	46.6 PK	74.0	-27.4	1.72 H	219	34.3	12.3
4	11490.00	40.3 AV	54.0	-13.7	1.72 H	219	28.0	12.3
5	#17235.00	49.6 PK	68.2	-18.6	2.37 H	122	34.3	15.3

**ANTENNA POLARITY & TEST DISTANCE: VERTICAL AT 3 M**

NO.	FREQ. (MHz)	EMISSION LEVEL (dBuV/m)	LIMIT (dBuV/m)	MARGIN (dB)	ANTENNA HEIGHT (m)	TABLE ANGLE (Degree)	RAW VALUE (dBuV)	CORRECTION FACTOR (dB/m)
1	*5745.00	122.3 PK			3.01 V	163	119.4	2.9
2	*5745.00	110.4 AV			3.01 V	163	107.5	2.9
3	11490.00	49.2 PK	74.0	-24.8	1.33 V	204	36.9	12.3
4	11490.00	43.6 AV	54.0	-10.4	1.33 V	204	31.3	12.3
5	#17235.00	54.7 PK	68.2	-13.5	1.82 V	304	39.4	15.3

**REMARKS:**

1. Emission Level(dBuV/m) = Raw Value(dBuV) + Correction Factor(dB/m)
2. Correction Factor(dB/m) = Antenna Factor(dB/m) + Cable Factor(dB) – Pre-Amplifier Factor(dB)
3. The other emission levels were very low against the limit.
4. Margin value = Emission Level – Limit value
5. " \* ": Fundamental frequency.
6. " # ": The radiated frequency is out of the restricted band.

<b>CHANNEL</b>	TX Channel 157	<b>DETECTOR FUNCTION</b>	Peak (PK)
<b>FREQUENCY RANGE</b>	1GHz ~ 40GHz		Average (AV)

**ANTENNA POLARITY & TEST DISTANCE: HORIZONTAL AT 3 M**

NO.	FREQ. (MHz)	EMISSION LEVEL (dBuV/m)	LIMIT (dBuV/m)	MARGIN (dB)	ANTENNA HEIGHT (m)	TABLE ANGLE (Degree)	RAW VALUE (dBuV)	CORRECTION FACTOR (dB/m)
1	*5785.00	108.9 PK			1.07 H	287	105.8	3.1
2	*5785.00	97.5 AV			1.07 H	287	94.4	3.1
3	11570.00	46.9 PK	74.0	-27.1	1.70 H	202	34.5	12.4
4	11570.00	40.5 AV	54.0	-13.5	1.70 H	202	28.1	12.4
5	#17355.00	50.0 PK	68.2	-18.2	2.33 H	134	34.0	16.0

**ANTENNA POLARITY & TEST DISTANCE: VERTICAL AT 3 M**

NO.	FREQ. (MHz)	EMISSION LEVEL (dBuV/m)	LIMIT (dBuV/m)	MARGIN (dB)	ANTENNA HEIGHT (m)	TABLE ANGLE (Degree)	RAW VALUE (dBuV)	CORRECTION FACTOR (dB/m)
1	*5785.00	121.4 PK			2.28 V	303	118.3	3.1
2	*5785.00	109.5 AV			2.28 V	303	106.4	3.1
3	11570.00	48.8 PK	74.0	-25.2	1.33 V	216	36.4	12.4
4	11570.00	43.2 AV	54.0	-10.8	1.33 V	216	30.8	12.4
5	#17355.00	53.8 PK	68.2	-14.4	1.83 V	296	37.8	16.0

**REMARKS:**

1. Emission Level(dBuV/m) = Raw Value(dBuV) + Correction Factor(dB/m)
2. Correction Factor(dB/m) = Antenna Factor(dB/m) + Cable Factor(dB) – Pre-Amplifier Factor(dB)
3. The other emission levels were very low against the limit.
4. Margin value = Emission Level – Limit value
5. " \* ": Fundamental frequency.
6. " # ": The radiated frequency is out of the restricted band.

<b>CHANNEL</b>	TX Channel 165	<b>DETECTOR FUNCTION</b>	Peak (PK)
<b>FREQUENCY RANGE</b>	1GHz ~ 40GHz		Average (AV)

**ANTENNA POLARITY & TEST DISTANCE: HORIZONTAL AT 3 M**

NO.	FREQ. (MHz)	EMISSION LEVEL (dBuV/m)	LIMIT (dBuV/m)	MARGIN (dB)	ANTENNA HEIGHT (m)	TABLE ANGLE (Degree)	RAW VALUE (dBuV)	CORRECTION FACTOR (dB/m)
1	*5825.00	112.6 PK			1.02 H	293	109.4	3.2
2	*5825.00	100.2 AV			1.02 H	293	97.0	3.2
3	11650.00	47.6 PK	74.0	-26.4	1.71 H	211	35.2	12.4
4	11650.00	41.0 AV	54.0	-13.0	1.71 H	211	28.6	12.4
5	#17475.00	50.1 PK	68.2	-18.1	2.31 H	135	32.7	17.4

**ANTENNA POLARITY & TEST DISTANCE: VERTICAL AT 3 M**

NO.	FREQ. (MHz)	EMISSION LEVEL (dBuV/m)	LIMIT (dBuV/m)	MARGIN (dB)	ANTENNA HEIGHT (m)	TABLE ANGLE (Degree)	RAW VALUE (dBuV)	CORRECTION FACTOR (dB/m)
1	*5825.00	120.2 PK			2.64 V	303	117.0	3.2
2	*5825.00	108.6 AV			2.64 V	303	105.4	3.2
3	11650.00	49.1 PK	74.0	-24.9	1.37 V	222	36.7	12.4
4	11650.00	43.6 AV	54.0	-10.4	1.37 V	222	31.2	12.4
5	#17475.00	54.4 PK	68.2	-13.8	1.79 V	290	37.0	17.4

**REMARKS:**

1. Emission Level(dBuV/m) = Raw Value(dBuV) + Correction Factor(dB/m)
2. Correction Factor(dB/m) = Antenna Factor(dB/m) + Cable Factor(dB) – Pre-Amplifier Factor(dB)
3. The other emission levels were very low against the limit.
4. Margin value = Emission Level – Limit value
5. " \* ": Fundamental frequency.
6. " # ": The radiated frequency is out of the restricted band.

**802.11ax (HE40)**

<b>CHANNEL</b>	TX Channel 38	<b>DETECTOR FUNCTION</b>	Peak (PK)
<b>FREQUENCY RANGE</b>	1GHz ~ 40GHz		Average (AV)

**ANTENNA POLARITY & TEST DISTANCE: HORIZONTAL AT 3 M**

NO.	FREQ. (MHz)	EMISSION LEVEL (dBuV/m)	LIMIT (dBuV/m)	MARGIN (dB)	ANTENNA HEIGHT (m)	TABLE ANGLE (Degree)	RAW VALUE (dBuV)	CORRECTION FACTOR (dB/m)
1	5150.00	58.9 PK	74.0	-15.1	2.24 H	260	56.3	2.6
2	5150.00	46.0 AV	54.0	-8.0	2.24 H	260	43.4	2.6
3	*5190.00	103.9 PK			2.24 H	260	101.4	2.5
4	*5190.00	91.8 AV			2.24 H	260	89.3	2.5
5	5350.00	51.7 PK	74.0	-22.3	2.24 H	260	49.4	2.3
6	5350.00	39.3 AV	54.0	-14.7	2.24 H	260	37.0	2.3
7	#10380.00	48.4 PK	68.2	-19.8	2.83 H	284	36.4	12.0
8	15570.00	52.7 PK	74.0	-21.3	1.98 H	41	40.1	12.6
9	15570.00	40.2 AV	54.0	-13.8	1.98 H	41	27.6	12.6

**ANTENNA POLARITY & TEST DISTANCE: VERTICAL AT 3 M**

NO.	FREQ. (MHz)	EMISSION LEVEL (dBuV/m)	LIMIT (dBuV/m)	MARGIN (dB)	ANTENNA HEIGHT (m)	TABLE ANGLE (Degree)	RAW VALUE (dBuV)	CORRECTION FACTOR (dB/m)
1	5150.00	65.5 PK	74.0	-8.5	3.14 V	303	62.9	2.6
2	5150.00	53.8 AV	54.0	-0.2	3.14 V	303	51.2	2.6
3	*5190.00	111.6 PK			3.14 V	303	109.1	2.5
4	*5190.00	99.4 AV			3.14 V	303	96.9	2.5
5	5350.00	51.9 PK	74.0	-22.1	3.14 V	303	49.6	2.3
6	5350.00	39.5 AV	54.0	-14.5	3.14 V	303	37.2	2.3
7	#10380.00	51.5 PK	68.2	-16.7	2.01 V	292	39.5	12.0
8	15570.00	58.7 PK	74.0	-15.3	2.89 V	242	46.1	12.6
9	15570.00	47.8 AV	54.0	-6.2	2.89 V	242	35.2	12.6

**REMARKS:**

1. Emission Level(dBuV/m) = Raw Value(dBuV) + Correction Factor(dB/m)
2. Correction Factor(dB/m) = Antenna Factor(dB/m) + Cable Factor(dB) – Pre-Amplifier Factor(dB)
3. The other emission levels were very low against the limit.
4. Margin value = Emission Level – Limit value
5. " \* ": Fundamental frequency.
6. " # ": The radiated frequency is out of the restricted band.

<b>CHANNEL</b>	TX Channel 46	<b>DETECTOR FUNCTION</b>	Peak (PK)
<b>FREQUENCY RANGE</b>	1GHz ~ 40GHz		Average (AV)

**ANTENNA POLARITY & TEST DISTANCE: HORIZONTAL AT 3 M**

NO.	FREQ. (MHz)	EMISSION LEVEL (dBuV/m)	LIMIT (dBuV/m)	MARGIN (dB)	ANTENNA HEIGHT (m)	TABLE ANGLE (Degree)	RAW VALUE (dBuV)	CORRECTION FACTOR (dB/m)
1	5150.00	59.0 PK	74.0	-15.0	2.16 H	240	56.4	2.6
2	5150.00	46.1 AV	54.0	-7.9	2.16 H	240	43.5	2.6
3	*5230.00	107.6 PK			2.16 H	240	105.4	2.2
4	*5230.00	96.2 AV			2.16 H	240	94.0	2.2
5	5350.00	53.2 PK	74.0	-20.8	2.16 H	240	50.9	2.3
6	5350.00	41.2 AV	54.0	-12.8	2.16 H	240	38.9	2.3
7	#10460.00	49.6 PK	68.2	-18.6	2.79 H	296	37.2	12.4
8	15690.00	54.0 PK	74.0	-20.0	1.98 H	43	41.8	12.2
9	15690.00	41.3 AV	54.0	-12.7	1.98 H	43	29.1	12.2

**ANTENNA POLARITY & TEST DISTANCE: VERTICAL AT 3 M**

NO.	FREQ. (MHz)	EMISSION LEVEL (dBuV/m)	LIMIT (dBuV/m)	MARGIN (dB)	ANTENNA HEIGHT (m)	TABLE ANGLE (Degree)	RAW VALUE (dBuV)	CORRECTION FACTOR (dB/m)
1	5150.00	65.7 PK	74.0	-8.3	3.27 V	360	63.1	2.6
2	5150.00	53.9 AV	54.0	-0.1	3.27 V	360	51.3	2.6
3	*5230.00	115.3 PK			3.27 V	360	113.1	2.2
4	*5230.00	103.9 AV			3.27 V	360	101.7	2.2
5	5350.00	54.6 PK	74.0	-19.4	3.27 V	360	52.3	2.3
6	5350.00	42.8 AV	54.0	-11.2	3.27 V	360	40.5	2.3
7	#10460.00	52.7 PK	68.2	-15.5	1.99 V	293	40.3	12.4
8	15690.00	60.0 PK	74.0	-14.0	2.97 V	234	47.8	12.2
9	15690.00	49.1 AV	54.0	-4.9	2.97 V	234	36.9	12.2

**REMARKS:**

1. Emission Level(dBuV/m) = Raw Value(dBuV) + Correction Factor(dB/m)
2. Correction Factor(dB/m) = Antenna Factor(dB/m) + Cable Factor(dB) – Pre-Amplifier Factor(dB)
3. The other emission levels were very low against the limit.
4. Margin value = Emission Level – Limit value
5. " \* ": Fundamental frequency.
6. " # ": The radiated frequency is out of the restricted band.

<b>CHANNEL</b>	TX Channel 151	<b>DETECTOR FUNCTION</b>	Peak (PK)
<b>FREQUENCY RANGE</b>	1GHz ~ 40GHz		Average (AV)

**ANTENNA POLARITY & TEST DISTANCE: HORIZONTAL AT 3 M**

NO.	FREQ. (MHz)	EMISSION LEVEL (dBuV/m)	LIMIT (dBuV/m)	MARGIN (dB)	ANTENNA HEIGHT (m)	TABLE ANGLE (Degree)	RAW VALUE (dBuV)	CORRECTION FACTOR (dB/m)
1	*5755.00	106.1 PK			2.14 H	35	103.1	3.0
2	*5755.00	94.4 AV			2.14 H	35	91.4	3.0
3	11510.00	46.7 PK	74.0	-27.3	1.66 H	219	34.4	12.3
4	11510.00	40.5 AV	54.0	-13.5	1.66 H	219	28.2	12.3
5	#17265.00	50.2 PK	68.2	-18.0	2.26 H	137	34.8	15.4

**ANTENNA POLARITY & TEST DISTANCE: VERTICAL AT 3 M**

NO.	FREQ. (MHz)	EMISSION LEVEL (dBuV/m)	LIMIT (dBuV/m)	MARGIN (dB)	ANTENNA HEIGHT (m)	TABLE ANGLE (Degree)	RAW VALUE (dBuV)	CORRECTION FACTOR (dB/m)
1	*5755.00	117.5 PK			2.45 V	176	114.5	3.0
2	*5755.00	105.5 AV			2.45 V	176	102.5	3.0
3	11510.00	48.5 PK	74.0	-25.5	1.25 V	210	36.2	12.3
4	11510.00	43.1 AV	54.0	-10.9	1.25 V	210	30.8	12.3
5	#17265.00	54.0 PK	68.2	-14.2	1.84 V	288	38.6	15.4

**REMARKS:**

1. Emission Level(dBuV/m) = Raw Value(dBuV) + Correction Factor(dB/m)
2. Correction Factor(dB/m) = Antenna Factor(dB/m) + Cable Factor(dB) – Pre-Amplifier Factor(dB)
3. The other emission levels were very low against the limit.
4. Margin value = Emission Level – Limit value
5. " \* ": Fundamental frequency.
6. " # ": The radiated frequency is out of the restricted band.



<b>CHANNEL</b>	TX Channel 159	<b>DETECTOR FUNCTION</b>	Peak (PK)
<b>FREQUENCY RANGE</b>	1GHz ~ 40GHz		Average (AV)

**ANTENNA POLARITY & TEST DISTANCE: HORIZONTAL AT 3 M**

NO.	FREQ. (MHz)	EMISSION LEVEL (dBuV/m)	LIMIT (dBuV/m)	MARGIN (dB)	ANTENNA HEIGHT (m)	TABLE ANGLE (Degree)	RAW VALUE (dBuV)	CORRECTION FACTOR (dB/m)
1	*5795.00	110.1 PK			2.18 H	39	107.1	3.0
2	*5795.00	97.3 AV			2.18 H	39	94.3	3.0
3	11590.00	46.9 PK	74.0	-27.1	1.67 H	203	34.5	12.4
4	11590.00	40.3 AV	54.0	-13.7	1.67 H	203	27.9	12.4
5	#17385.00	50.5 PK	68.2	-17.7	2.30 H	118	34.3	16.2

**ANTENNA POLARITY & TEST DISTANCE: VERTICAL AT 3 M**

NO.	FREQ. (MHz)	EMISSION LEVEL (dBuV/m)	LIMIT (dBuV/m)	MARGIN (dB)	ANTENNA HEIGHT (m)	TABLE ANGLE (Degree)	RAW VALUE (dBuV)	CORRECTION FACTOR (dB/m)
1	*5795.00	120.2 PK			2.55 V	171	117.2	3.0
2	*5795.00	107.6 AV			2.55 V	171	104.6	3.0
3	11590.00	49.2 PK	74.0	-24.8	1.30 V	219	36.8	12.4
4	11590.00	43.5 AV	54.0	-10.5	1.30 V	219	31.1	12.4
5	#17385.00	54.4 PK	68.2	-13.8	1.84 V	303	38.2	16.2

**REMARKS:**

1. Emission Level(dBuV/m) = Raw Value(dBuV) + Correction Factor(dB/m)
2. Correction Factor(dB/m) = Antenna Factor(dB/m) + Cable Factor(dB) – Pre-Amplifier Factor(dB)
3. The other emission levels were very low against the limit.
4. Margin value = Emission Level – Limit value
5. " \* ": Fundamental frequency.
6. " # ": The radiated frequency is out of the restricted band.

**802.11ax (HE80)**

<b>CHANNEL</b>	TX Channel 42	<b>DETECTOR FUNCTION</b>	Peak (PK)
<b>FREQUENCY RANGE</b>	1GHz ~ 40GHz		Average (AV)

**ANTENNA POLARITY & TEST DISTANCE: HORIZONTAL AT 3 M**

NO.	FREQ. (MHz)	EMISSION LEVEL (dBuV/m)	LIMIT (dBuV/m)	MARGIN (dB)	ANTENNA HEIGHT (m)	TABLE ANGLE (Degree)	RAW VALUE (dBuV)	CORRECTION FACTOR (dB/m)
1	5150.00	58.7 PK	74.0	-15.3	2.19 H	265	56.1	2.6
2	5150.00	45.9 AV	54.0	-8.1	2.19 H	265	43.3	2.6
3	*5210.00	100.8 PK			2.19 H	265	98.4	2.4
4	*5210.00	89.0 AV			2.19 H	265	86.6	2.4
5	5350.00	53.1 PK	74.0	-20.9	2.19 H	265	50.8	2.3
6	5350.00	41.1 AV	54.0	-12.9	2.19 H	265	38.8	2.3
7	#10420.00	47.9 PK	68.2	-20.3	2.85 H	288	35.7	12.2
8	15630.00	52.4 PK	74.0	-21.6	1.93 H	59	39.7	12.7
9	15630.00	39.8 AV	54.0	-14.2	1.93 H	59	27.1	12.7

**ANTENNA POLARITY & TEST DISTANCE: VERTICAL AT 3 M**

NO.	FREQ. (MHz)	EMISSION LEVEL (dBuV/m)	LIMIT (dBuV/m)	MARGIN (dB)	ANTENNA HEIGHT (m)	TABLE ANGLE (Degree)	RAW VALUE (dBuV)	CORRECTION FACTOR (dB/m)
1	5150.00	65.7 PK	74.0	-8.3	3.08 V	119	63.1	2.6
2	5150.00	53.6 AV	54.0	-0.4	3.08 V	119	51.0	2.6
3	*5210.00	108.2 PK			3.08 V	119	105.8	2.4
4	*5210.00	96.4 AV			3.08 V	119	94.0	2.4
5	5350.00	54.2 PK	74.0	-19.8	3.08 V	119	51.9	2.3
6	5350.00	42.2 AV	54.0	-11.8	3.08 V	119	39.9	2.3
7	#10420.00	51.0 PK	68.2	-17.2	1.97 V	303	38.8	12.2
8	15630.00	58.2 PK	74.0	-15.8	2.92 V	235	45.5	12.7
9	15630.00	47.3 AV	54.0	-6.7	2.92 V	235	34.6	12.7

**REMARKS:**

1. Emission Level(dBuV/m) = Raw Value(dBuV) + Correction Factor(dB/m)
2. Correction Factor(dB/m) = Antenna Factor(dB/m) + Cable Factor(dB) – Pre-Amplifier Factor(dB)
3. The other emission levels were very low against the limit.
4. Margin value = Emission Level – Limit value
5. " \* ": Fundamental frequency.
6. " # ": The radiated frequency is out of the restricted band.

<b>CHANNEL</b>	TX Channel 155	<b>DETECTOR FUNCTION</b>	Peak (PK)
<b>FREQUENCY RANGE</b>	1GHz ~ 40GHz		Average (AV)

**ANTENNA POLARITY & TEST DISTANCE: HORIZONTAL AT 3 M**

NO.	FREQ. (MHz)	EMISSION LEVEL (dBuV/m)	LIMIT (dBuV/m)	MARGIN (dB)	ANTENNA HEIGHT (m)	TABLE ANGLE (Degree)	RAW VALUE (dBuV)	CORRECTION FACTOR (dB/m)
1	*5775.00	102.3 PK			1.34 H	250	99.3	3.0
2	*5775.00	90.8 AV			1.34 H	250	87.8	3.0
3	11550.00	46.7 PK	74.0	-27.3	1.77 H	201	34.3	12.4
4	11550.00	40.3 AV	54.0	-13.7	1.77 H	201	27.9	12.4
5	#17325.00	50.0 PK	68.2	-18.2	2.31 H	137	34.3	15.7

**ANTENNA POLARITY & TEST DISTANCE: VERTICAL AT 3 M**

NO.	FREQ. (MHz)	EMISSION LEVEL (dBuV/m)	LIMIT (dBuV/m)	MARGIN (dB)	ANTENNA HEIGHT (m)	TABLE ANGLE (Degree)	RAW VALUE (dBuV)	CORRECTION FACTOR (dB/m)
1	*5775.00	112.5 PK			2.43 V	304	109.5	3.0
2	*5775.00	99.7 AV			2.43 V	304	96.7	3.0
3	11550.00	40.2 PK	74.0	-33.8	1.32 V	211	27.8	12.4
4	11550.00	30.6 AV	54.0	-23.4	1.32 V	211	18.2	12.4
5	#17325.00	42.1 PK	68.2	-26.1	1.78 V	319	26.4	15.7

**REMARKS:**

1. Emission Level(dBuV/m) = Raw Value(dBuV) + Correction Factor(dB/m)
2. Correction Factor(dB/m) = Antenna Factor(dB/m) + Cable Factor(dB) – Pre-Amplifier Factor(dB)
3. The other emission levels were very low against the limit.
4. Margin value = Emission Level – Limit value
5. " \* ": Fundamental frequency.
6. " # ": The radiated frequency is out of the restricted band.

4.1.9 Test Results (Mode 3)

Above 1GHz Data:

802.11a

<b>CHANNEL</b>	TX Channel 36	<b>DETECTOR FUNCTION</b>	Peak (PK)
<b>FREQUENCY RANGE</b>	1GHz ~ 40GHz		Average (AV)

ANTENNA POLARITY & TEST DISTANCE: HORIZONTAL AT 3 M								
NO.	FREQ. (MHz)	EMISSION LEVEL (dBuV/m)	LIMIT (dBuV/m)	MARGIN (dB)	ANTENNA HEIGHT (m)	TABLE ANGLE (Degree)	RAW VALUE (dBuV)	CORRECTION FACTOR (dB/m)
1	5150.00	52.7 PK	74.0	-21.3	1.61 H	250	50.1	2.6
2	5150.00	47.6 AV	54.0	-6.4	1.61 H	250	45.0	2.6
3	*5180.00	102.5 PK			1.61 H	250	100.0	2.5
4	*5180.00	94.1 AV			1.61 H	250	91.6	2.5
5	#10360.00	49.5 PK	68.2	-18.7	2.78 H	290	37.6	11.9
6	15540.00	54.0 PK	74.0	-20.0	1.99 H	15	41.6	12.4
7	15540.00	41.4 AV	54.0	-12.6	1.99 H	15	29.0	12.4

ANTENNA POLARITY & TEST DISTANCE: VERTICAL AT 3 M								
NO.	FREQ. (MHz)	EMISSION LEVEL (dBuV/m)	LIMIT (dBuV/m)	MARGIN (dB)	ANTENNA HEIGHT (m)	TABLE ANGLE (Degree)	RAW VALUE (dBuV)	CORRECTION FACTOR (dB/m)
1	5150.00	68.1 PK	74.0	-5.9	3.27 V	290	65.5	2.6
2	<b>5150.00</b>	<b>53.9 AV</b>	<b>54.0</b>	<b>-0.1</b>	<b>3.27 V</b>	<b>290</b>	<b>51.3</b>	<b>2.6</b>
3	*5180.00	109.6 PK			3.27 V	290	107.1	2.5
4	*5180.00	101.2 AV			3.27 V	290	98.7	2.5
5	#10360.00	51.8 PK	68.2	-16.4	1.95 V	308	39.9	11.9
6	15540.00	60.1 PK	74.0	-13.9	2.96 V	248	47.7	12.4
7	15540.00	49.7 AV	54.0	-4.3	2.96 V	248	37.3	12.4

**REMARKS:**

1. Emission Level(dBuV/m) = Raw Value(dBuV) + Correction Factor(dB/m)
2. Correction Factor(dB/m) = Antenna Factor(dB/m) + Cable Factor(dB) – Pre-Amplifier Factor(dB)
3. The other emission levels were very low against the limit.
4. Margin value = Emission Level – Limit value
5. " \* ": Fundamental frequency.
6. " # ": The radiated frequency is out of the restricted band.

<b>CHANNEL</b>	TX Channel 40	<b>DETECTOR FUNCTION</b>	Peak (PK)
<b>FREQUENCY RANGE</b>	1GHz ~ 40GHz		Average (AV)

**ANTENNA POLARITY & TEST DISTANCE: HORIZONTAL AT 3 M**

NO.	FREQ. (MHz)	EMISSION LEVEL (dBuV/m)	LIMIT (dBuV/m)	MARGIN (dB)	ANTENNA HEIGHT (m)	TABLE ANGLE (Degree)	RAW VALUE (dBuV)	CORRECTION FACTOR (dB/m)
1	5150.00	52.6 PK	74.0	-21.4	1.61 H	257	50.0	2.6
2	5150.00	47.3 AV	54.0	-6.7	1.61 H	257	44.7	2.6
3	*5200.00	107.7 PK			1.61 H	257	105.3	2.4
4	*5200.00	98.9 AV			1.61 H	257	96.5	2.4
5	5350.00	49.9 PK	74.0	-24.1	1.61 H	257	47.6	2.3
6	5350.00	39.6 AV	54.0	-14.4	1.61 H	257	37.3	2.3
7	5384.00	51.1 PK	74.0	-22.9	1.61 H	257	48.7	2.4
8	5384.00	41.1 AV	54.0	-12.9	1.61 H	257	38.7	2.4
9	#10400.00	50.1 PK	68.2	-18.1	2.73 H	294	37.9	12.2
10	15600.00	53.7 PK	74.0	-20.3	1.98 H	21	40.8	12.9
11	15600.00	41.3 AV	54.0	-12.7	1.98 H	21	28.4	12.9

**ANTENNA POLARITY & TEST DISTANCE: VERTICAL AT 3 M**

NO.	FREQ. (MHz)	EMISSION LEVEL (dBuV/m)	LIMIT (dBuV/m)	MARGIN (dB)	ANTENNA HEIGHT (m)	TABLE ANGLE (Degree)	RAW VALUE (dBuV)	CORRECTION FACTOR (dB/m)
1	5150.00	67.5 PK	74.0	-6.5	3.07 V	107	64.9	2.6
2	5150.00	53.9 AV	54.0	-0.1	3.07 V	107	51.3	2.6
3	*5200.00	114.2 PK			3.07 V	107	111.8	2.4
4	*5200.00	105.7 AV			3.07 V	107	103.3	2.4
5	5350.00	50.8 PK	74.0	-23.2	3.07 V	107	48.5	2.3
6	5350.00	40.4 AV	54.0	-13.6	3.07 V	107	38.1	2.3
7	5384.00	52.2 PK	74.0	-21.8	3.07 V	107	49.8	2.4
8	5384.00	42.3 AV	54.0	-11.7	3.07 V	107	39.9	2.4
9	#10400.00	52.2 PK	68.2	-16.0	1.94 V	324	40.0	12.2
10	15600.00	60.5 PK	74.0	-13.5	3.01 V	236	47.6	12.9
11	15600.00	49.3 AV	54.0	-4.7	3.01 V	236	36.4	12.9

**REMARKS:**

1. Emission Level(dBuV/m) = Raw Value(dBuV) + Correction Factor(dB/m)
2. Correction Factor(dB/m) = Antenna Factor(dB/m) + Cable Factor(dB) – Pre-Amplifier Factor(dB)
3. The other emission levels were very low against the limit.
4. Margin value = Emission Level – Limit value
5. " \* ": Fundamental frequency.
6. " # ": The radiated frequency is out of the restricted band.

<b>CHANNEL</b>	TX Channel 48	<b>DETECTOR FUNCTION</b>	Peak (PK)
<b>FREQUENCY RANGE</b>	1GHz ~ 40GHz		Average (AV)

**ANTENNA POLARITY & TEST DISTANCE: HORIZONTAL AT 3 M**

NO.	FREQ. (MHz)	EMISSION LEVEL (dBuV/m)	LIMIT (dBuV/m)	MARGIN (dB)	ANTENNA HEIGHT (m)	TABLE ANGLE (Degree)	RAW VALUE (dBuV)	CORRECTION FACTOR (dB/m)
1	*5240.00	104.5 PK			1.61 H	246	102.3	2.2
2	*5240.00	97.2 AV			1.61 H	246	95.0	2.2
3	5350.00	50.5 PK	74.0	-23.5	1.61 H	246	48.2	2.3
4	5350.00	41.2 AV	54.0	-12.8	1.61 H	246	38.9	2.3
5	#10480.00	49.5 PK	68.2	-18.7	2.81 H	302	37.1	12.4
6	15720.00	53.1 PK	74.0	-20.9	1.96 H	23	41.1	12.0
7	15720.00	40.7 AV	54.0	-13.3	1.96 H	23	28.7	12.0

**ANTENNA POLARITY & TEST DISTANCE: VERTICAL AT 3 M**

NO.	FREQ. (MHz)	EMISSION LEVEL (dBuV/m)	LIMIT (dBuV/m)	MARGIN (dB)	ANTENNA HEIGHT (m)	TABLE ANGLE (Degree)	RAW VALUE (dBuV)	CORRECTION FACTOR (dB/m)
1	*5240.00	111.9 PK			3.06 V	295	109.7	2.2
2	*5240.00	103.9 AV			3.06 V	295	101.7	2.2
3	5350.00	52.6 PK	74.0	-21.4	3.06 V	295	50.3	2.3
4	5350.00	42.3 AV	54.0	-11.7	3.06 V	295	40.0	2.3
5	#10480.00	52.5 PK	68.2	-15.7	1.88 V	302	40.1	12.4
6	15720.00	59.4 PK	74.0	-14.6	3.06 V	221	47.4	12.0
7	15720.00	49.0 AV	54.0	-5.0	3.06 V	221	37.0	12.0

**REMARKS:**

1. Emission Level(dBuV/m) = Raw Value(dBuV) + Correction Factor(dB/m)
2. Correction Factor(dB/m) = Antenna Factor(dB/m) + Cable Factor(dB) – Pre-Amplifier Factor(dB)
3. The other emission levels were very low against the limit.
4. Margin value = Emission Level – Limit value
5. " \* ": Fundamental frequency.
6. " # ": The radiated frequency is out of the restricted band.

<b>CHANNEL</b>	TX Channel 149	<b>DETECTOR FUNCTION</b>	Peak (PK)
<b>FREQUENCY RANGE</b>	1GHz ~ 40GHz		Average (AV)

**ANTENNA POLARITY & TEST DISTANCE: HORIZONTAL AT 3 M**

NO.	FREQ. (MHz)	EMISSION LEVEL (dBuV/m)	LIMIT (dBuV/m)	MARGIN (dB)	ANTENNA HEIGHT (m)	TABLE ANGLE (Degree)	RAW VALUE (dBuV)	CORRECTION FACTOR (dB/m)
1	*5745.00	108.9 PK			2.75 H	107	106.0	2.9
2	*5745.00	99.7 AV			2.75 H	107	96.8	2.9
3	11490.00	46.9 PK	74.0	-27.1	1.68 H	195	34.6	12.3
4	11490.00	40.5 AV	54.0	-13.5	1.68 H	195	28.2	12.3
5	#17235.00	50.2 PK	68.2	-18.0	2.28 H	114	34.9	15.3

**ANTENNA POLARITY & TEST DISTANCE: VERTICAL AT 3 M**

NO.	FREQ. (MHz)	EMISSION LEVEL (dBuV/m)	LIMIT (dBuV/m)	MARGIN (dB)	ANTENNA HEIGHT (m)	TABLE ANGLE (Degree)	RAW VALUE (dBuV)	CORRECTION FACTOR (dB/m)
1	*5745.00	114.1 PK			3.10 V	299	111.2	2.9
2	*5745.00	105.1 AV			3.10 V	299	102.2	2.9
3	11490.00	48.9 PK	74.0	-25.1	1.35 V	204	36.6	12.3
4	11490.00	43.2 AV	54.0	-10.8	1.35 V	204	30.9	12.3
5	#17235.00	54.0 PK	68.2	-14.2	1.78 V	282	38.7	15.3

**REMARKS:**

1. Emission Level(dBuV/m) = Raw Value(dBuV) + Correction Factor(dB/m)
2. Correction Factor(dB/m) = Antenna Factor(dB/m) + Cable Factor(dB) – Pre-Amplifier Factor(dB)
3. The other emission levels were very low against the limit.
4. Margin value = Emission Level – Limit value
5. " \* ": Fundamental frequency.
6. " # ": The radiated frequency is out of the restricted band.

<b>CHANNEL</b>	TX Channel 157	<b>DETECTOR FUNCTION</b>	Peak (PK)
<b>FREQUENCY RANGE</b>	1GHz ~ 40GHz		Average (AV)

**ANTENNA POLARITY & TEST DISTANCE: HORIZONTAL AT 3 M**

NO.	FREQ. (MHz)	EMISSION LEVEL (dBuV/m)	LIMIT (dBuV/m)	MARGIN (dB)	ANTENNA HEIGHT (m)	TABLE ANGLE (Degree)	RAW VALUE (dBuV)	CORRECTION FACTOR (dB/m)
1	*5785.00	106.7 PK			2.72 H	148	103.6	3.1
2	*5785.00	96.9 AV			2.72 H	148	93.8	3.1
3	11570.00	46.2 PK	74.0	-27.8	1.71 H	211	33.8	12.4
4	11570.00	40.2 AV	54.0	-13.8	1.71 H	211	27.8	12.4
5	#17355.00	50.3 PK	68.2	-17.9	2.25 H	133	34.3	16.0

**ANTENNA POLARITY & TEST DISTANCE: VERTICAL AT 3 M**

NO.	FREQ. (MHz)	EMISSION LEVEL (dBuV/m)	LIMIT (dBuV/m)	MARGIN (dB)	ANTENNA HEIGHT (m)	TABLE ANGLE (Degree)	RAW VALUE (dBuV)	CORRECTION FACTOR (dB/m)
1	*5785.00	114.1 PK			3.08 V	296	111.0	3.1
2	*5785.00	104.6 AV			3.08 V	296	101.5	3.1
3	11570.00	49.1 PK	74.0	-24.9	1.35 V	192	36.7	12.4
4	11570.00	43.6 AV	54.0	-10.4	1.35 V	192	31.2	12.4
5	#17355.00	53.2 PK	68.2	-15.0	1.77 V	277	37.2	16.0

**REMARKS:**

1. Emission Level(dBuV/m) = Raw Value(dBuV) + Correction Factor(dB/m)
2. Correction Factor(dB/m) = Antenna Factor(dB/m) + Cable Factor(dB) – Pre-Amplifier Factor(dB)
3. The other emission levels were very low against the limit.
4. Margin value = Emission Level – Limit value
5. " \* ": Fundamental frequency.
6. " # ": The radiated frequency is out of the restricted band.



<b>CHANNEL</b>	TX Channel 165	<b>DETECTOR FUNCTION</b>	Peak (PK)
<b>FREQUENCY RANGE</b>	1GHz ~ 40GHz		Average (AV)

**ANTENNA POLARITY & TEST DISTANCE: HORIZONTAL AT 3 M**

NO.	FREQ. (MHz)	EMISSION LEVEL (dBuV/m)	LIMIT (dBuV/m)	MARGIN (dB)	ANTENNA HEIGHT (m)	TABLE ANGLE (Degree)	RAW VALUE (dBuV)	CORRECTION FACTOR (dB/m)
1	*5825.00	106.9 PK			2.74 H	144	103.7	3.2
2	*5825.00	96.5 AV			2.74 H	144	93.3	3.2
3	11650.00	46.5 PK	74.0	-27.5	1.68 H	201	34.1	12.4
4	11650.00	40.2 AV	54.0	-13.8	1.68 H	201	27.8	12.4
5	#17475.00	50.0 PK	68.2	-18.2	2.27 H	112	32.6	17.4

**ANTENNA POLARITY & TEST DISTANCE: VERTICAL AT 3 M**

NO.	FREQ. (MHz)	EMISSION LEVEL (dBuV/m)	LIMIT (dBuV/m)	MARGIN (dB)	ANTENNA HEIGHT (m)	TABLE ANGLE (Degree)	RAW VALUE (dBuV)	CORRECTION FACTOR (dB/m)
1	*5825.00	114.2 PK			2.85 V	259	111.0	3.2
2	*5825.00	104.9 AV			2.85 V	259	101.7	3.2
3	11650.00	48.5 PK	74.0	-25.5	1.36 V	200	36.1	12.4
4	11650.00	43.1 AV	54.0	-10.9	1.36 V	200	30.7	12.4
5	#17475.00	53.8 PK	68.2	-14.4	1.83 V	271	36.4	17.4

**REMARKS:**

1. Emission Level(dBuV/m) = Raw Value(dBuV) + Correction Factor(dB/m)
2. Correction Factor(dB/m) = Antenna Factor(dB/m) + Cable Factor(dB) – Pre-Amplifier Factor(dB)
3. The other emission levels were very low against the limit.
4. Margin value = Emission Level – Limit value
5. " \* ": Fundamental frequency.
6. " # ": The radiated frequency is out of the restricted band.

**802.11ax (HE20)**

<b>CHANNEL</b>	TX Channel 36	<b>DETECTOR FUNCTION</b>	Peak (PK)
<b>FREQUENCY RANGE</b>	1GHz ~ 40GHz		Average (AV)

**ANTENNA POLARITY & TEST DISTANCE: HORIZONTAL AT 3 M**

NO.	FREQ. (MHz)	EMISSION LEVEL (dBuV/m)	LIMIT (dBuV/m)	MARGIN (dB)	ANTENNA HEIGHT (m)	TABLE ANGLE (Degree)	RAW VALUE (dBuV)	CORRECTION FACTOR (dB/m)
1	5150.00	62.3 PK	74.0	-11.7	1.66 H	252	59.7	2.6
2	5150.00	47.0 AV	54.0	-7.0	1.66 H	252	44.4	2.6
3	*5180.00	106.1 PK			1.66 H	252	103.6	2.5
4	*5180.00	93.7 AV			1.66 H	252	91.2	2.5
5	#10360.00	49.9 PK	68.2	-18.3	2.80 H	290	38.0	11.9
6	15540.00	54.5 PK	74.0	-19.5	2.07 H	15	42.1	12.4
7	15540.00	41.7 AV	54.0	-12.3	2.07 H	15	29.3	12.4

**ANTENNA POLARITY & TEST DISTANCE: VERTICAL AT 3 M**

NO.	FREQ. (MHz)	EMISSION LEVEL (dBuV/m)	LIMIT (dBuV/m)	MARGIN (dB)	ANTENNA HEIGHT (m)	TABLE ANGLE (Degree)	RAW VALUE (dBuV)	CORRECTION FACTOR (dB/m)
1	5150.00	65.9 PK	74.0	-8.1	2.67 V	360	63.3	2.6
2	5150.00	53.6 AV	54.0	-0.4	2.67 V	360	51.0	2.6
3	*5180.00	113.7 PK			2.67 V	360	111.2	2.5
4	*5180.00	100.7 AV			2.67 V	360	98.2	2.5
5	#10360.00	52.5 PK	68.2	-15.7	1.98 V	311	40.6	11.9
6	15540.00	60.6 PK	74.0	-13.4	2.99 V	232	48.2	12.4
7	15540.00	49.7 AV	54.0	-4.3	2.99 V	232	37.3	12.4

**REMARKS:**

1. Emission Level(dBuV/m) = Raw Value(dBuV) + Correction Factor(dB/m)
2. Correction Factor(dB/m) = Antenna Factor(dB/m) + Cable Factor(dB) – Pre-Amplifier Factor(dB)
3. The other emission levels were very low against the limit.
4. Margin value = Emission Level – Limit value
5. " \* ": Fundamental frequency.
6. " # ": The radiated frequency is out of the restricted band.

<b>CHANNEL</b>	TX Channel 40	<b>DETECTOR FUNCTION</b>	Peak (PK)
<b>FREQUENCY RANGE</b>	1GHz ~ 40GHz		Average (AV)

**ANTENNA POLARITY & TEST DISTANCE: HORIZONTAL AT 3 M**

NO.	FREQ. (MHz)	EMISSION LEVEL (dBuV/m)	LIMIT (dBuV/m)	MARGIN (dB)	ANTENNA HEIGHT (m)	TABLE ANGLE (Degree)	RAW VALUE (dBuV)	CORRECTION FACTOR (dB/m)
1	5150.00	62.8 PK	74.0	-11.2	1.62 H	251	60.2	2.6
2	5150.00	47.5 AV	54.0	-6.5	1.62 H	251	44.9	2.6
3	*5200.00	107.5 PK			1.62 H	251	105.1	2.4
4	*5200.00	96.4 AV			1.62 H	251	94.0	2.4
5	5350.00	46.5 PK	74.0	-27.5	1.62 H	251	44.2	2.3
6	5350.00	38.7 AV	54.0	-15.3	1.62 H	251	36.4	2.3
7	5398.00	52.0 PK	74.0	-22.0	1.62 H	251	49.5	2.5
8	5398.00	40.2 AV	54.0	-13.8	1.62 H	251	37.7	2.5
9	#10400.00	50.4 PK	68.2	-17.8	2.76 H	284	38.2	12.2
10	15600.00	53.3 PK	74.0	-20.7	1.97 H	24	40.4	12.9
11	15600.00	40.9 AV	54.0	-13.1	1.97 H	24	28.0	12.9

**ANTENNA POLARITY & TEST DISTANCE: VERTICAL AT 3 M**

NO.	FREQ. (MHz)	EMISSION LEVEL (dBuV/m)	LIMIT (dBuV/m)	MARGIN (dB)	ANTENNA HEIGHT (m)	TABLE ANGLE (Degree)	RAW VALUE (dBuV)	CORRECTION FACTOR (dB/m)
1	5150.00	69.6 PK	74.0	-4.4	3.08 V	294	67.0	2.6
2	5150.00	53.9 AV	54.0	-0.1	3.08 V	294	51.3	2.6
3	*5200.00	114.9 PK			3.08 V	294	112.5	2.4
4	*5200.00	103.3 AV			3.08 V	294	100.9	2.4
5	5350.00	46.7 PK	74.0	-27.3	3.08 V	294	44.4	2.3
6	5350.00	38.9 AV	54.0	-15.1	3.08 V	294	36.6	2.3
7	5398.00	52.5 PK	74.0	-21.5	3.08 V	294	50.0	2.5
8	5398.00	40.8 AV	54.0	-13.2	3.08 V	294	38.3	2.5
9	#10400.00	52.3 PK	68.2	-15.9	1.98 V	312	40.1	12.2
10	15600.00	60.5 PK	74.0	-13.5	3.02 V	246	47.6	12.9
11	15600.00	49.3 AV	54.0	-4.7	3.02 V	246	36.4	12.9

**REMARKS:**

1. Emission Level(dBuV/m) = Raw Value(dBuV) + Correction Factor(dB/m)
2. Correction Factor(dB/m) = Antenna Factor(dB/m) + Cable Factor(dB) – Pre-Amplifier Factor(dB)
3. The other emission levels were very low against the limit.
4. Margin value = Emission Level – Limit value
5. " \* ": Fundamental frequency.
6. " # ": The radiated frequency is out of the restricted band.

<b>CHANNEL</b>	TX Channel 48	<b>DETECTOR FUNCTION</b>	Peak (PK)
<b>FREQUENCY RANGE</b>	1GHz ~ 40GHz		Average (AV)

**ANTENNA POLARITY & TEST DISTANCE: HORIZONTAL AT 3 M**

NO.	FREQ. (MHz)	EMISSION LEVEL (dBuV/m)	LIMIT (dBuV/m)	MARGIN (dB)	ANTENNA HEIGHT (m)	TABLE ANGLE (Degree)	RAW VALUE (dBuV)	CORRECTION FACTOR (dB/m)
1	*5240.00	107.0 PK			1.69 H	251	104.8	2.2
2	*5240.00	96.2 AV			1.69 H	251	94.0	2.2
3	5350.00	49.1 PK	74.0	-24.9	1.69 H	251	46.8	2.3
4	5350.00	38.5 AV	54.0	-15.5	1.69 H	251	36.2	2.3
5	5430.00	51.7 PK	74.0	-22.3	1.69 H	251	49.2	2.5
6	5430.00	39.2 AV	54.0	-14.8	1.69 H	251	36.7	2.5
7	#10480.00	49.4 PK	68.2	-18.8	2.71 H	291	37.0	12.4
8	15720.00	53.7 PK	74.0	-20.3	1.99 H	18	41.7	12.0
9	15720.00	41.2 AV	54.0	-12.8	1.99 H	18	29.2	12.0

**ANTENNA POLARITY & TEST DISTANCE: VERTICAL AT 3 M**

NO.	FREQ. (MHz)	EMISSION LEVEL (dBuV/m)	LIMIT (dBuV/m)	MARGIN (dB)	ANTENNA HEIGHT (m)	TABLE ANGLE (Degree)	RAW VALUE (dBuV)	CORRECTION FACTOR (dB/m)
1	*5240.00	114.2 PK			3.20 V	298	112.0	2.2
2	*5240.00	103.1 AV			3.20 V	298	100.9	2.2
3	5350.00	49.7 PK	74.0	-24.3	3.20 V	298	47.4	2.3
4	5350.00	39.1 AV	54.0	-14.9	3.20 V	298	36.8	2.3
5	5430.00	53.2 PK	74.0	-20.8	3.20 V	298	50.7	2.5
6	5430.00	40.9 AV	54.0	-13.1	3.20 V	298	38.4	2.5
7	#10480.00	52.0 PK	68.2	-16.2	1.90 V	310	39.6	12.4
8	15720.00	59.7 PK	74.0	-14.3	3.00 V	225	47.7	12.0
9	15720.00	49.4 AV	54.0	-4.6	3.00 V	225	37.4	12.0

**REMARKS:**

1. Emission Level(dBuV/m) = Raw Value(dBuV) + Correction Factor(dB/m)
2. Correction Factor(dB/m) = Antenna Factor(dB/m) + Cable Factor(dB) – Pre-Amplifier Factor(dB)
3. The other emission levels were very low against the limit.
4. Margin value = Emission Level – Limit value
5. " \* ": Fundamental frequency.
6. " # ": The radiated frequency is out of the restricted band.

<b>CHANNEL</b>	TX Channel 149	<b>DETECTOR FUNCTION</b>	Peak (PK)
<b>FREQUENCY RANGE</b>	1GHz ~ 40GHz		Average (AV)

**ANTENNA POLARITY & TEST DISTANCE: HORIZONTAL AT 3 M**

NO.	FREQ. (MHz)	EMISSION LEVEL (dBuV/m)	LIMIT (dBuV/m)	MARGIN (dB)	ANTENNA HEIGHT (m)	TABLE ANGLE (Degree)	RAW VALUE (dBuV)	CORRECTION FACTOR (dB/m)
1	*5745.00	107.5 PK			2.70 H	150	104.6	2.9
2	*5745.00	95.6 AV			2.70 H	150	92.7	2.9
3	11490.00	47.3 PK	74.0	-26.7	1.71 H	197	35.0	12.3
4	11490.00	40.7 AV	54.0	-13.3	1.71 H	197	28.4	12.3
5	#17235.00	50.5 PK	68.2	-17.7	2.30 H	139	35.2	15.3

**ANTENNA POLARITY & TEST DISTANCE: VERTICAL AT 3 M**

NO.	FREQ. (MHz)	EMISSION LEVEL (dBuV/m)	LIMIT (dBuV/m)	MARGIN (dB)	ANTENNA HEIGHT (m)	TABLE ANGLE (Degree)	RAW VALUE (dBuV)	CORRECTION FACTOR (dB/m)
1	*5745.00	118.9 PK			3.22 V	165	116.0	2.9
2	*5745.00	106.8 AV			3.22 V	165	103.9	2.9
3	11490.00	48.8 PK	74.0	-25.2	1.33 V	204	36.5	12.3
4	11490.00	43.1 AV	54.0	-10.9	1.33 V	204	30.8	12.3
5	#17235.00	54.0 PK	68.2	-14.2	1.75 V	288	38.7	15.3

**REMARKS:**

1. Emission Level(dBuV/m) = Raw Value(dBuV) + Correction Factor(dB/m)
2. Correction Factor(dB/m) = Antenna Factor(dB/m) + Cable Factor(dB) – Pre-Amplifier Factor(dB)
3. The other emission levels were very low against the limit.
4. Margin value = Emission Level – Limit value
5. " \* ": Fundamental frequency.
6. " # ": The radiated frequency is out of the restricted band.

<b>CHANNEL</b>	TX Channel 157	<b>DETECTOR FUNCTION</b>	Peak (PK)
<b>FREQUENCY RANGE</b>	1GHz ~ 40GHz		Average (AV)

**ANTENNA POLARITY & TEST DISTANCE: HORIZONTAL AT 3 M**

NO.	FREQ. (MHz)	EMISSION LEVEL (dBuV/m)	LIMIT (dBuV/m)	MARGIN (dB)	ANTENNA HEIGHT (m)	TABLE ANGLE (Degree)	RAW VALUE (dBuV)	CORRECTION FACTOR (dB/m)
1	*5785.00	106.5 PK			2.71 H	178	103.4	3.1
2	*5785.00	95.0 AV			2.71 H	178	91.9	3.1
3	11570.00	46.8 PK	74.0	-27.2	1.76 H	213	34.4	12.4
4	11570.00	40.3 AV	54.0	-13.7	1.76 H	213	27.9	12.4
5	#17355.00	50.7 PK	68.2	-17.5	2.27 H	118	34.7	16.0

**ANTENNA POLARITY & TEST DISTANCE: VERTICAL AT 3 M**

NO.	FREQ. (MHz)	EMISSION LEVEL (dBuV/m)	LIMIT (dBuV/m)	MARGIN (dB)	ANTENNA HEIGHT (m)	TABLE ANGLE (Degree)	RAW VALUE (dBuV)	CORRECTION FACTOR (dB/m)
1	*5785.00	117.7 PK			3.19 V	173	114.6	3.1
2	*5785.00	105.2 AV			3.19 V	173	102.1	3.1
3	11570.00	48.9 PK	74.0	-25.1	1.36 V	193	36.5	12.4
4	11570.00	43.7 AV	54.0	-10.3	1.36 V	193	31.3	12.4
5	#17355.00	53.9 PK	68.2	-14.3	1.74 V	291	37.9	16.0

**REMARKS:**

1. Emission Level(dBuV/m) = Raw Value(dBuV) + Correction Factor(dB/m)
2. Correction Factor(dB/m) = Antenna Factor(dB/m) + Cable Factor(dB) – Pre-Amplifier Factor(dB)
3. The other emission levels were very low against the limit.
4. Margin value = Emission Level – Limit value
5. " \* ": Fundamental frequency.
6. " # ": The radiated frequency is out of the restricted band.

<b>CHANNEL</b>	TX Channel 165	<b>DETECTOR FUNCTION</b>	Peak (PK)
<b>FREQUENCY RANGE</b>	1GHz ~ 40GHz		Average (AV)

**ANTENNA POLARITY & TEST DISTANCE: HORIZONTAL AT 3 M**

NO.	FREQ. (MHz)	EMISSION LEVEL (dBuV/m)	LIMIT (dBuV/m)	MARGIN (dB)	ANTENNA HEIGHT (m)	TABLE ANGLE (Degree)	RAW VALUE (dBuV)	CORRECTION FACTOR (dB/m)
1	*5825.00	108.2 PK			2.78 H	179	105.0	3.2
2	*5825.00	95.1 AV			2.78 H	179	91.9	3.2
3	11650.00	46.9 PK	74.0	-27.1	1.69 H	206	34.5	12.4
4	11650.00	40.6 AV	54.0	-13.4	1.69 H	206	28.2	12.4
5	#17475.00	50.1 PK	68.2	-18.1	2.28 H	132	32.7	17.4

**ANTENNA POLARITY & TEST DISTANCE: VERTICAL AT 3 M**

NO.	FREQ. (MHz)	EMISSION LEVEL (dBuV/m)	LIMIT (dBuV/m)	MARGIN (dB)	ANTENNA HEIGHT (m)	TABLE ANGLE (Degree)	RAW VALUE (dBuV)	CORRECTION FACTOR (dB/m)
1	*5825.00	117.3 PK			3.30 V	177	114.1	3.2
2	*5825.00	104.3 AV			3.30 V	177	101.1	3.2
3	11650.00	48.5 PK	74.0	-25.5	1.34 V	211	36.1	12.4
4	11650.00	43.3 AV	54.0	-10.7	1.34 V	211	30.9	12.4
5	#17475.00	53.7 PK	68.2	-14.5	1.83 V	274	36.3	17.4

**REMARKS:**

1. Emission Level(dBuV/m) = Raw Value(dBuV) + Correction Factor(dB/m)
2. Correction Factor(dB/m) = Antenna Factor(dB/m) + Cable Factor(dB) – Pre-Amplifier Factor(dB)
3. The other emission levels were very low against the limit.
4. Margin value = Emission Level – Limit value
5. " \* ": Fundamental frequency.
6. " # ": The radiated frequency is out of the restricted band.

**802.11ax (HE40)**

<b>CHANNEL</b>	TX Channel 38	<b>DETECTOR FUNCTION</b>	Peak (PK)
<b>FREQUENCY RANGE</b>	1GHz ~ 40GHz		Average (AV)

**ANTENNA POLARITY & TEST DISTANCE: HORIZONTAL AT 3 M**

NO.	FREQ. (MHz)	EMISSION LEVEL (dBuV/m)	LIMIT (dBuV/m)	MARGIN (dB)	ANTENNA HEIGHT (m)	TABLE ANGLE (Degree)	RAW VALUE (dBuV)	CORRECTION FACTOR (dB/m)
1	5150.00	62.1 PK	74.0	-11.9	1.70 H	251	59.5	2.6
2	5150.00	46.9 AV	54.0	-7.1	1.70 H	251	44.3	2.6
3	*5190.00	100.3 PK			1.70 H	251	97.8	2.5
4	*5190.00	88.2 AV			1.70 H	251	85.7	2.5
5	5350.00	51.1 PK	74.0	-22.9	1.70 H	251	48.8	2.3
6	5350.00	39.1 AV	54.0	-14.9	1.70 H	251	36.8	2.3
7	#10380.00	49.0 PK	68.2	-19.2	2.84 H	306	37.0	12.0
8	15570.00	53.5 PK	74.0	-20.5	2.12 H	7	40.9	12.6
9	15570.00	40.6 AV	54.0	-13.4	2.12 H	7	28.0	12.6

**ANTENNA POLARITY & TEST DISTANCE: VERTICAL AT 3 M**

NO.	FREQ. (MHz)	EMISSION LEVEL (dBuV/m)	LIMIT (dBuV/m)	MARGIN (dB)	ANTENNA HEIGHT (m)	TABLE ANGLE (Degree)	RAW VALUE (dBuV)	CORRECTION FACTOR (dB/m)
1	5150.00	65.3 PK	74.0	-8.7	3.07 V	297	62.7	2.6
2	<b>5150.00</b>	<b>53.9 AV</b>	<b>54.0</b>	<b>-0.1</b>	<b>3.07 V</b>	<b>297</b>	<b>51.3</b>	<b>2.6</b>
3	*5190.00	107.5 PK			3.07 V	297	105.0	2.5
4	*5190.00	95.4 AV			3.07 V	297	92.9	2.5
5	5350.00	52.7 PK	74.0	-21.3	3.07 V	297	50.4	2.3
6	5350.00	40.7 AV	54.0	-13.3	3.07 V	297	38.4	2.3
7	#10380.00	50.9 PK	68.2	-17.3	2.05 V	308	38.9	12.0
8	15570.00	59.3 PK	74.0	-14.7	2.93 V	226	46.7	12.6
9	15570.00	48.2 AV	54.0	-5.8	2.93 V	226	35.6	12.6

**REMARKS:**

- Emission Level(dBuV/m) = Raw Value(dBuV) + Correction Factor(dB/m)
- Correction Factor(dB/m) = Antenna Factor(dB/m) + Cable Factor(dB) – Pre-Amplifier Factor(dB)
- The other emission levels were very low against the limit.
- Margin value = Emission Level – Limit value
- " \* ": Fundamental frequency.
- " # ": The radiated frequency is out of the restricted band.



<b>CHANNEL</b>	TX Channel 46	<b>DETECTOR FUNCTION</b>	Peak (PK)
<b>FREQUENCY RANGE</b>	1GHz ~ 40GHz		Average (AV)

**ANTENNA POLARITY & TEST DISTANCE: HORIZONTAL AT 3 M**

NO.	FREQ. (MHz)	EMISSION LEVEL (dBuV/m)	LIMIT (dBuV/m)	MARGIN (dB)	ANTENNA HEIGHT (m)	TABLE ANGLE (Degree)	RAW VALUE (dBuV)	CORRECTION FACTOR (dB/m)
1	5150.00	60.2 PK	74.0	-13.8	1.69 H	268	57.6	2.6
2	5150.00	44.6 AV	54.0	-9.4	1.69 H	268	42.0	2.6
3	*5230.00	102.7 PK			1.69 H	268	100.5	2.2
4	*5230.00	90.5 AV			1.69 H	268	88.3	2.2
5	5350.00	52.7 PK	74.0	-21.3	1.69 H	268	50.4	2.3
6	5350.00	39.3 AV	54.0	-14.7	1.69 H	268	37.0	2.3
7	#10460.00	50.2 PK	68.2	-18.0	2.77 H	295	37.8	12.4
8	15690.00	54.7 PK	74.0	-19.3	2.10 H	18	42.5	12.2
9	15690.00	41.7 AV	54.0	-12.3	2.10 H	18	29.5	12.2

**ANTENNA POLARITY & TEST DISTANCE: VERTICAL AT 3 M**

NO.	FREQ. (MHz)	EMISSION LEVEL (dBuV/m)	LIMIT (dBuV/m)	MARGIN (dB)	ANTENNA HEIGHT (m)	TABLE ANGLE (Degree)	RAW VALUE (dBuV)	CORRECTION FACTOR (dB/m)
1	5150.00	63.2 PK	74.0	-10.8	3.18 V	360	60.6	2.6
2	5150.00	51.5 AV	54.0	-2.5	3.18 V	360	48.9	2.6
3	*5230.00	109.5 PK			3.18 V	360	107.3	2.2
4	*5230.00	97.4 AV			3.18 V	360	95.2	2.2
5	5350.00	53.5 PK	74.0	-20.5	3.18 V	360	51.2	2.3
6	5350.00	40.5 AV	54.0	-13.5	3.18 V	360	38.2	2.3
7	#10460.00	52.1 PK	68.2	-16.1	2.00 V	313	39.7	12.4
8	15690.00	60.5 PK	74.0	-13.5	2.97 V	234	48.3	12.2
9	15690.00	49.4 AV	54.0	-4.6	2.97 V	234	37.2	12.2

**REMARKS:**

1. Emission Level(dBuV/m) = Raw Value(dBuV) + Correction Factor(dB/m)
2. Correction Factor(dB/m) = Antenna Factor(dB/m) + Cable Factor(dB) – Pre-Amplifier Factor(dB)
3. The other emission levels were very low against the limit.
4. Margin value = Emission Level – Limit value
5. " \* ": Fundamental frequency.
6. " # ": The radiated frequency is out of the restricted band.

<b>CHANNEL</b>	TX Channel 151	<b>DETECTOR FUNCTION</b>	Peak (PK)
<b>FREQUENCY RANGE</b>	1GHz ~ 40GHz		Average (AV)

**ANTENNA POLARITY & TEST DISTANCE: HORIZONTAL AT 3 M**

NO.	FREQ. (MHz)	EMISSION LEVEL (dBuV/m)	LIMIT (dBuV/m)	MARGIN (dB)	ANTENNA HEIGHT (m)	TABLE ANGLE (Degree)	RAW VALUE (dBuV)	CORRECTION FACTOR (dB/m)
1	*5755.00	107.2 PK			2.65 H	99	104.2	3.0
2	*5755.00	94.3 AV			2.65 H	99	91.3	3.0
3	11510.00	47.2 PK	74.0	-26.8	1.72 H	216	34.9	12.3
4	11510.00	40.6 AV	54.0	-13.4	1.72 H	216	28.3	12.3
5	#17265.00	50.8 PK	68.2	-17.4	2.34 H	140	35.4	15.4

**ANTENNA POLARITY & TEST DISTANCE: VERTICAL AT 3 M**

NO.	FREQ. (MHz)	EMISSION LEVEL (dBuV/m)	LIMIT (dBuV/m)	MARGIN (dB)	ANTENNA HEIGHT (m)	TABLE ANGLE (Degree)	RAW VALUE (dBuV)	CORRECTION FACTOR (dB/m)
1	*5755.00	114.8 PK			3.04 V	162	111.8	3.0
2	*5755.00	102.5 AV			3.04 V	162	99.5	3.0
3	11510.00	48.9 PK	74.0	-25.1	1.33 V	191	36.6	12.3
4	11510.00	43.6 AV	54.0	-10.4	1.33 V	191	31.3	12.3
5	#17265.00	53.8 PK	68.2	-14.4	1.83 V	287	38.4	15.4

**REMARKS:**

1. Emission Level(dBuV/m) = Raw Value(dBuV) + Correction Factor(dB/m)
2. Correction Factor(dB/m) = Antenna Factor(dB/m) + Cable Factor(dB) – Pre-Amplifier Factor(dB)
3. The other emission levels were very low against the limit.
4. Margin value = Emission Level – Limit value
5. " \* ": Fundamental frequency.
6. " # ": The radiated frequency is out of the restricted band.

<b>CHANNEL</b>	TX Channel 159	<b>DETECTOR FUNCTION</b>	Peak (PK)
<b>FREQUENCY RANGE</b>	1GHz ~ 40GHz		Average (AV)

**ANTENNA POLARITY & TEST DISTANCE: HORIZONTAL AT 3 M**

NO.	FREQ. (MHz)	EMISSION LEVEL (dBuV/m)	LIMIT (dBuV/m)	MARGIN (dB)	ANTENNA HEIGHT (m)	TABLE ANGLE (Degree)	RAW VALUE (dBuV)	CORRECTION FACTOR (dB/m)
1	*5795.00	105.5 PK			2.72 H	144	102.5	3.0
2	*5795.00	93.6 AV			2.72 H	144	90.6	3.0
3	11590.00	46.7 PK	74.0	-27.3	1.68 H	221	34.3	12.4
4	11590.00	40.4 AV	54.0	-13.6	1.68 H	221	28.0	12.4
5	#17385.00	50.6 PK	68.2	-17.6	2.31 H	130	34.4	16.2

**ANTENNA POLARITY & TEST DISTANCE: VERTICAL AT 3 M**

NO.	FREQ. (MHz)	EMISSION LEVEL (dBuV/m)	LIMIT (dBuV/m)	MARGIN (dB)	ANTENNA HEIGHT (m)	TABLE ANGLE (Degree)	RAW VALUE (dBuV)	CORRECTION FACTOR (dB/m)
1	*5795.00	114.4 PK			2.74 V	169	111.4	3.0
2	*5795.00	103.2 AV			2.74 V	169	100.2	3.0
3	11590.00	48.6 PK	74.0	-25.4	1.40 V	213	36.2	12.4
4	11590.00	43.0 AV	54.0	-11.0	1.40 V	213	30.6	12.4
5	#17385.00	53.0 PK	68.2	-15.2	1.81 V	292	36.8	16.2

**REMARKS:**

1. Emission Level(dBuV/m) = Raw Value(dBuV) + Correction Factor(dB/m)
2. Correction Factor(dB/m) = Antenna Factor(dB/m) + Cable Factor(dB) – Pre-Amplifier Factor(dB)
3. The other emission levels were very low against the limit.
4. Margin value = Emission Level – Limit value
5. " \* ": Fundamental frequency.
6. " # ": The radiated frequency is out of the restricted band.

**802.11ax (HE80)**

<b>CHANNEL</b>	TX Channel 42	<b>DETECTOR FUNCTION</b>	Peak (PK)
<b>FREQUENCY RANGE</b>	1GHz ~ 40GHz		Average (AV)

**ANTENNA POLARITY & TEST DISTANCE: HORIZONTAL AT 3 M**

NO.	FREQ. (MHz)	EMISSION LEVEL (dBuV/m)	LIMIT (dBuV/m)	MARGIN (dB)	ANTENNA HEIGHT (m)	TABLE ANGLE (Degree)	RAW VALUE (dBuV)	CORRECTION FACTOR (dB/m)
1	5150.00	62.8 PK	74.0	-11.2	1.71 H	263	60.2	2.6
2	5150.00	47.2 AV	54.0	-6.8	1.71 H	263	44.6	2.6
3	*5210.00	96.9 PK			1.71 H	263	94.5	2.4
4	*5210.00	84.8 AV			1.71 H	263	82.4	2.4
5	5350.00	51.7 PK	74.0	-22.3	1.71 H	263	49.4	2.3
6	5350.00	39.2 AV	54.0	-14.8	1.71 H	263	36.9	2.3
7	#10420.00	49.2 PK	68.2	-19.0	2.89 H	308	37.0	12.2
8	15630.00	52.7 PK	74.0	-21.3	2.07 H	21	40.0	12.7
9	15630.00	39.9 AV	54.0	-14.1	2.07 H	21	27.2	12.7

**ANTENNA POLARITY & TEST DISTANCE: VERTICAL AT 3 M**

NO.	FREQ. (MHz)	EMISSION LEVEL (dBuV/m)	LIMIT (dBuV/m)	MARGIN (dB)	ANTENNA HEIGHT (m)	TABLE ANGLE (Degree)	RAW VALUE (dBuV)	CORRECTION FACTOR (dB/m)
1	5150.00	64.2 PK	74.0	-9.8	3.08 V	297	61.6	2.6
2	5150.00	53.7 AV	54.0	-0.3	3.08 V	297	51.1	2.6
3	*5210.00	103.5 PK			3.08 V	297	101.1	2.4
4	*5210.00	91.6 AV			3.08 V	297	89.2	2.4
5	5350.00	52.9 PK	74.0	-21.1	3.08 V	297	50.6	2.3
6	5350.00	40.5 AV	54.0	-13.5	3.08 V	297	38.2	2.3
7	#10420.00	50.2 PK	68.2	-18.0	2.10 V	307	38.0	12.2
8	15630.00	59.3 PK	74.0	-14.7	2.91 V	216	46.6	12.7
9	15630.00	48.0 AV	54.0	-6.0	2.91 V	216	35.3	12.7

**REMARKS:**

- Emission Level(dBuV/m) = Raw Value(dBuV) + Correction Factor(dB/m)
- Correction Factor(dB/m) = Antenna Factor(dB/m) + Cable Factor(dB) – Pre-Amplifier Factor(dB)
- The other emission levels were very low against the limit.
- Margin value = Emission Level – Limit value
- " \* ": Fundamental frequency.
- " # ": The radiated frequency is out of the restricted band.

<b>CHANNEL</b>	TX Channel 155	<b>DETECTOR FUNCTION</b>	Peak (PK)
<b>FREQUENCY RANGE</b>	1GHz ~ 40GHz		Average (AV)

**ANTENNA POLARITY & TEST DISTANCE: HORIZONTAL AT 3 M**

NO.	FREQ. (MHz)	EMISSION LEVEL (dBuV/m)	LIMIT (dBuV/m)	MARGIN (dB)	ANTENNA HEIGHT (m)	TABLE ANGLE (Degree)	RAW VALUE (dBuV)	CORRECTION FACTOR (dB/m)
1	*5775.00	103.1 PK			2.44 H	100	100.1	3.0
2	*5775.00	90.4 AV			2.44 H	100	87.4	3.0
3	11550.00	47.4 PK	74.0	-26.6	1.71 H	221	35.0	12.4
4	11550.00	40.9 AV	54.0	-13.1	1.71 H	221	28.5	12.4
5	#17325.00	50.3 PK	68.2	-17.9	2.35 H	117	34.6	15.7

**ANTENNA POLARITY & TEST DISTANCE: VERTICAL AT 3 M**

NO.	FREQ. (MHz)	EMISSION LEVEL (dBuV/m)	LIMIT (dBuV/m)	MARGIN (dB)	ANTENNA HEIGHT (m)	TABLE ANGLE (Degree)	RAW VALUE (dBuV)	CORRECTION FACTOR (dB/m)
1	*5775.00	109.9 PK			3.16 V	302	106.9	3.0
2	*5775.00	97.3 AV			3.16 V	302	94.3	3.0
3	11550.00	49.5 PK	74.0	-24.5	1.31 V	197	37.1	12.4
4	11550.00	43.9 AV	54.0	-10.1	1.31 V	197	31.5	12.4
5	#17325.00	53.5 PK	68.2	-14.7	1.80 V	297	37.8	15.7

**REMARKS:**

1. Emission Level(dBuV/m) = Raw Value(dBuV) + Correction Factor(dB/m)
2. Correction Factor(dB/m) = Antenna Factor(dB/m) + Cable Factor(dB) – Pre-Amplifier Factor(dB)
3. The other emission levels were very low against the limit.
4. Margin value = Emission Level – Limit value
5. " \* ": Fundamental frequency.
6. " # ": The radiated frequency is out of the restricted band.

## 4.2 Conducted Emission Measurement

### 4.2.1 Limits of Conducted Emission Measurement

Frequency (MHz)	Conducted Limit (dBuV)	
	Quasi-peak	Average
0.15 - 0.5	66 - 56	56 - 46
0.50 - 5.0	56	46
5.0 - 30.0	60	50

Note: 1. The lower limit shall apply at the transition frequencies.

2. The limit decreases in line with the logarithm of the frequency in the range of 0.15 to 0.50MHz.

### 4.2.2 Test Instruments

DESCRIPTION & MANUFACTURER	MODEL NO.	SERIAL NO.	CALIBRATED DATE	CALIBRATED UNTIL
Test Receiver R&S	ESCS 30	847124/029	Nov. 01, 2017	Oct. 31, 2018
Line-Impedance Stabilization Network (for EUT) R&S	ESH3-Z5	848773/004	Nov. 15, 2017	Nov. 14, 2018
Line-Impedance Stabilization Network (for Peripheral) R&S	ENV216	100072	June 04, 2018	June 03, 2019
50 ohms Terminator	N/A	EMC-04	Nov. 01, 2017	Oct. 31, 2018
RF Cable	5D-FB	COCCAB-001	Sep. 29, 2017	Sep. 28, 2018
Fixed attenuator EMCI	STI02-2200-10	003	Mar. 16, 2018	Mar. 15, 2019
Software BVADT	BVADT_Cond_ V7.3.7.4	NA	NA	NA

**Note:**

1. The calibration interval of the above test instruments are 12 months and the calibrations are traceable to NML/ROC and NIST/USA.
2. The test was performed in Conduction 1.
3. Tested Date: Aug. 29, 2018

#### 4.2.3 Test Procedure

- The EUT was placed 0.4 meters from the conducting wall of the shielded room with EUT being connected to the power mains through a line impedance stabilization network (LISN). Other support units were connected to the power mains through another LISN. The two LISNs provide 50 ohm/ 50uH of coupling impedance for the measuring instrument.
- Both lines of the power mains connected to the EUT were checked for maximum conducted interference.
- The frequency range from 150kHz to 30MHz was searched. Emission levels under (Limit - 20dB) was not recorded.

**NOTE:** All modes of operation were investigated and the worst-case emissions are reported.

#### 4.2.4 Deviation from Test Standard

No deviation.

#### 4.2.5 Test Setup

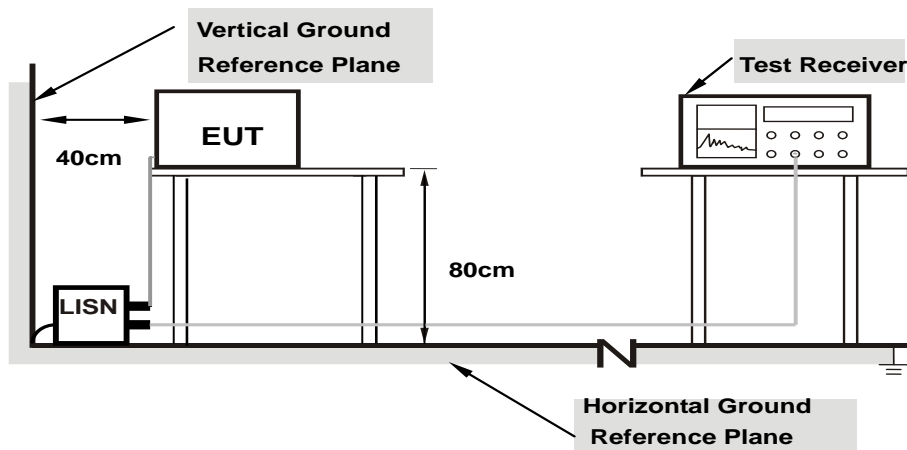

**Note: 1.Support units were connected to second LISN.**

For the actual test configuration, please refer to the attached file (Test Setup Photo).

#### 4.2.6 EUT Operating Condition

Same as 4.1.6.

## 4.2.7 Test Results (Mode 1)

Phase	Line (L)	Detector Function	Quasi-Peak (QP) / Average (AV)
-------	----------	-------------------	--------------------------------

No	Freq.	Corr.	Reading Value		Emission Level		Limit		Margin	
	[MHz]	Factor	[dB (uV)]		[dB (uV)]		[dB (uV)]		(dB)	
		(dB)	Q.P.	AV.	Q.P.	AV.	Q.P.	AV.	Q.P.	AV.
1	0.16562	10.04	26.11	20.22	36.15	30.26	65.18	55.18	-29.03	-24.92
2	0.18516	10.05	36.79	32.52	46.84	42.57	64.25	54.25	-17.41	-11.68
<b>3</b>	<b>0.37656</b>	<b>10.10</b>	<b>34.22</b>	<b>33.36</b>	<b>44.32</b>	<b>43.46</b>	<b>58.35</b>	<b>48.35</b>	<b>-14.03</b>	<b>-4.89</b>
4	1.07422	10.15	26.34	11.63	36.49	21.78	56.00	46.00	-19.51	-24.22
5	16.58594	10.92	28.77	22.71	39.69	33.63	60.00	50.00	-20.31	-16.37
6	25.46094	11.15	29.59	28.63	40.74	39.78	60.00	50.00	-19.26	-10.22

## REMARKS:

1. Q.P. and AV. are abbreviations of quasi-peak and average individually.
2. The emission levels of other frequencies were very low against the limit.
3. Margin value = Emission level - Limit value
4. Correction factor = Insertion loss + Cable loss
5. Emission Level = Correction Factor + Reading Value.

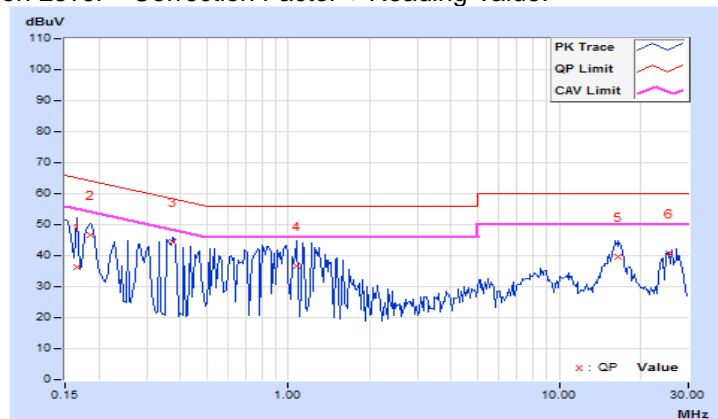



Phase	Neutral (N)	Detector Function	Quasi-Peak (QP) / Average (AV)
-------	-------------	-------------------	--------------------------------

No	Freq. [MHz]	Corr.	Reading Value		Emission Level		Limit		Margin	
		Factor	[dB (uV)]		[dB (uV)]		[dB (uV)]		(dB)	
	(dB)	Q.P.	AV.	Q.P.	AV.	Q.P.	AV.	Q.P.	AV.	
1	0.30625	9.98	30.13	26.80	40.11	36.78	60.07	50.07	-19.96	-13.29
2	0.44688	10.00	25.06	13.13	35.06	23.13	56.93	46.93	-21.87	-23.80
3	1.22266	10.04	28.35	22.83	38.39	32.87	56.00	46.00	-17.61	-13.13
4	1.50781	10.05	28.32	23.21	38.37	33.26	56.00	46.00	-17.63	-12.74
5	16.76953	10.74	29.01	22.28	39.75	33.02	60.00	50.00	-20.25	-16.98
6	26.98438	10.95	29.86	29.20	40.81	40.15	60.00	50.00	-19.19	-9.85

#### REMARKS:

1. Q.P. and AV. are abbreviations of quasi-peak and average individually.
2. The emission levels of other frequencies were very low against the limit.
3. Margin value = Emission level - Limit value
4. Correction factor = Insertion loss + Cable loss
5. Emission Level = Correction Factor + Reading Value.

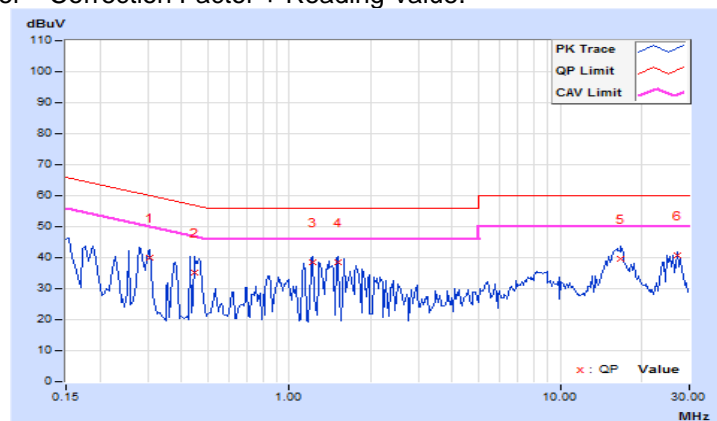

### 4.3 Transmit Power Measurement

#### 4.3.1 Limits of Transmit Power Measurement

Operation Band	EUT Category		Limit
U-NII-1		Outdoor Access Point	1 Watt (30 dBm) (Max. e.i.r.p $\leq$ 125mW(21 dBm) at any elevation angle above 30 degrees as measured from the horizon)
		Fixed point-to-point Access Point	1 Watt (30 dBm)
	√	Indoor Access Point	1 Watt (30 dBm)
		Client device	250mW (24 dBm)
U-NII-2A	---		250mW (24 dBm) or 11 dBm+10 log B*
U-NII-2C	---		250mW (24 dBm) or 11 dBm+10 log B*
U-NII-3	√		1 Watt (30 dBm)

\*B is the 26 dB emission bandwidth in megahertz

Per KDB 662911 Method of conducted output power measurement on IEEE 802.11 devices,

Array Gain = 0 dB (i.e., no array gain) for  $N_{ANT} \leq 4$ ;

Array Gain = 0 dB (i.e., no array gain) for channel widths  $\geq 40$  MHz for any  $N_{ANT}$ ;

Array Gain =  $5 \log(N_{ANT}/N_{SS})$  dB or 3 dB, whichever is less for 20-MHz channel widths with  $N_{ANT} \geq 5$ .

For power measurements on all other devices: Array Gain =  $10 \log(N_{ANT}/N_{SS})$  dB.

#### 4.3.2 Test Setup

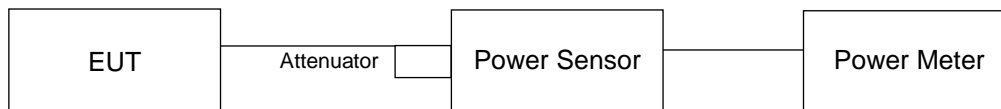

#### 4.3.3 Test Instruments

Refer to section 4.1.2 to get information of above instrument.

#### 4.3.4 Test Procedure

Method PM is used to perform output power measurement, trigger and gating function of wide band power meter is enabled to measure max output power of TX on burst. Duty factor is not added to measured value.

#### 4.3.5 Deviation from Test Standard

No deviation.

#### 4.3.6 EUT Operating Condition

The software provided by client to enable the EUT under transmission condition continuously at lowest, middle and highest channel frequencies individually.

## 4.3.7 Test Result (Mode 1)

**Non-Beamforming Mode**
**802.11a**

Chan.	Chan. Freq. (MHz)	Maximum Conducted Power (dBm)				Total Power (mW)	Total Power (dBm)	Limit (dBm)	Pass / Fail
		Chain 0	Chain 1	Chain 2	Chain 3				
36	5180	20.55	20.32	20.23	20.03	427.28	26.31	30.00	Pass
40	5200	21.21	21.31	21.55	21.04	537.283	27.30	30.00	Pass
48	5240	20.81	20.98	21.24	21.58	522.743	27.18	30.00	Pass
149	5745	23.93	23.13	24.20	24.43	993.12	29.97	30.00	Pass
157	5785	23.73	23.59	23.86	24.26	974.514	29.89	30.00	Pass
165	5825	23.42	23.15	23.57	24.09	910.282	29.59	30.00	Pass

**802.11ac (VHT20)**

Chan.	Chan. Freq. (MHz)	Maximum Conducted Power (dBm)				Total Power (mW)	Total Power (dBm)	Limit (dBm)	Pass / Fail
		Chain 0	Chain 1	Chain 2	Chain 3				
36	5180	20.42	19.89	19.90	20.24	411.059	26.14	30.00	Pass
40	5200	21.38	20.89	21.24	21.47	533.474	27.27	30.00	Pass
48	5240	21.17	20.67	21.02	21.35	510.531	27.08	30.00	Pass
149	5745	23.50	23.33	23.64	24.27	937.657	29.72	30.00	Pass
157	5785	23.42	23.31	23.47	23.68	889.752	29.49	30.00	Pass
165	5825	23.19	22.87	23.32	23.91	862.911	29.36	30.00	Pass

**802.11ac (VHT40)**

Chan.	Chan. Freq. (MHz)	Maximum Conducted Power (dBm)				Total Power (mW)	Total Power (dBm)	Limit (dBm)	Pass / Fail
		Chain 0	Chain 1	Chain 2	Chain 3				
38	5190	16.13	16.02	15.98	16.91	169.733	22.30	30.00	Pass
46	5230	21.02	20.23	20.49	20.14	447.133	26.50	30.00	Pass
151	5755	21.02	19.98	21.43	21.30	499.906	26.99	30.00	Pass
159	5795	23.43	23.41	23.50	23.73	899.493	29.54	30.00	Pass

**802.11ac (VHT80)**

Chan.	Chan. Freq. (MHz)	Maximum Conducted Power (dBm)				Total Power (mW)	Total Power (dBm)	Limit (dBm)	Pass / Fail
		Chain 0	Chain 1	Chain 2	Chain 3				
42	5210	14.12	15.11	14.28	15.12	117.558	20.70	30.00	Pass
155	5775	19.41	18.97	19.36	19.20	335.657	25.26	30.00	Pass

**802.11ac (VHT80+80)**

Chan.	Chan. Freq. (MHz)	Maximum Conducted Power (dBm)				Total Power (mW)	Total Power (dBm)	Limit (dBm)	Pass / Fail
		Chain 0	Chain 1	Chain 2	Chain 3				
42+155	5210	15.64	14.97	-	-	68.049	18.33	30.00	Pass
	5775	-	-	14.87	15.12	63.199	18.01	30.00	Pass

**802.11ax (HE20)**

Chan.	Chan. Freq. (MHz)	Maximum Conducted Power (dBm)				Total Power (mW)	Total Power (dBm)	Limit (dBm)	Pass / Fail
		Chain 0	Chain 1	Chain 2	Chain 3				
36	5180	20.74	20.05	20.21	20.53	437.669	26.41	30.00	Pass
40	5200	21.64	21.08	21.58	21.89	572.519	27.58	30.00	Pass
48	5240	21.39	20.80	21.26	21.61	536.484	27.30	30.00	Pass
149	5745	23.76	23.56	23.89	24.58	996.654	29.99	30.00	Pass
157	5785	23.68	23.65	23.80	24.04	958.481	29.82	30.00	Pass
165	5825	23.45	23.12	23.58	24.14	913.877	29.61	30.00	Pass

**802.11ax (HE40)**

Chan.	Chan. Freq. (MHz)	Maximum Conducted Power (dBm)				Total Power (mW)	Total Power (dBm)	Limit (dBm)	Pass / Fail
		Chain 0	Chain 1	Chain 2	Chain 3				
38	5190	16.36	16.33	16.32	17.17	181.179	22.58	30.00	Pass
46	5230	21.28	20.48	20.80	20.40	475.836	26.77	30.00	Pass
151	5755	21.33	20.15	21.74	21.62	533.835	27.27	30.00	Pass
159	5795	23.68	23.64	23.80	24.07	959.705	29.82	30.00	Pass

**802.11ax (HE80)**

Chan.	Chan. Freq. (MHz)	Maximum Conducted Power (dBm)				Total Power (mW)	Total Power (dBm)	Limit (dBm)	Pass / Fail
		Chain 0	Chain 1	Chain 2	Chain 3				
42	5210	14.37	15.45	14.59	15.38	125.716	20.99	30.00	Pass
155	5775	19.66	19.19	19.67	19.41	355.435	25.51	30.00	Pass

**802.11ax (HE80+80)**

Chan.	Chan. Freq. (MHz)	Maximum Conducted Power (dBm)				Total Power (mW)	Total Power (dBm)	Limit (dBm)	Pass / Fail
		Chain 0	Chain 1	Chain 2	Chain 3				
42+155	5210	15.98	15.09	-	-	71.913	18.57	30.00	Pass
	5775	-	-	15.02	15.48	67.087	18.27	30.00	Pass

## Beamforming Mode

### 802.11ac (VHT20)

Chan.	Chan. Freq. (MHz)	Maximum Conducted Power (dBm)				Total Power (mW)	Total Power (dBm)	Limit (dBm)	Pass / Fail
		Chain 0	Chain 1	Chain 2	Chain 3				
36	5180	20.42	19.89	19.90	20.24	411.059	26.14	27.60	Pass
40	5200	21.38	20.89	21.24	21.47	533.474	27.27	27.60	Pass
48	5240	21.17	20.67	21.02	21.35	510.531	27.08	27.60	Pass
149	5745	21.34	21.15	21.49	21.92	562.987	27.50	27.89	Pass
157	5785	21.16	21.25	21.26	21.45	537.266	27.30	27.89	Pass
165	5825	21.02	20.79	21.22	21.87	532.673	27.26	27.89	Pass

**Note:** 1. For UNII-1: Directional gain is 8.40dBi > 6dBi, so the power limit shall be reduced to  $30-(8.40-6) = 27.60$ dBm.

2. For UNII-3: Directional gain is 8.11dB > 6dBi, so the power limit shall be reduced to  $30-(8.11-6) = 27.89$ dBm.

### 802.11ac (VHT40)

Chan.	Chan. Freq. (MHz)	Maximum Conducted Power (dBm)				Total Power (mW)	Total Power (dBm)	Limit (dBm)	Pass / Fail
		Chain 0	Chain 1	Chain 2	Chain 3				
38	5190	16.13	16.02	15.98	16.91	169.733	22.30	27.60	Pass
46	5230	21.02	20.23	20.49	20.14	447.133	26.50	27.60	Pass
151	5755	21.02	19.98	21.43	21.30	499.906	26.99	27.89	Pass
159	5795	21.38	21.45	21.62	21.59	566.464	27.53	27.89	Pass

**Note:** 1. For UNII-1: Directional gain is 8.40dBi > 6dBi, so the power limit shall be reduced to  $30-(8.40-6) = 27.60$ dBm.

2. For UNII-3: Directional gain is 8.11dB > 6dBi, so the power limit shall be reduced to  $30-(8.11-6) = 27.89$ dBm.

### 802.11ac (VHT80)

Chan.	Chan. Freq. (MHz)	Maximum Conducted Power (dBm)				Total Power (mW)	Total Power (dBm)	Limit (dBm)	Pass / Fail
		Chain 0	Chain 1	Chain 2	Chain 3				
42	5210	14.12	15.11	14.28	15.12	117.558	20.70	27.60	Pass
155	5775	19.41	18.97	19.36	19.20	335.657	25.26	27.89	Pass

**Note:** 1. For UNII-1: Directional gain is 8.40dBi > 6dBi, so the power limit shall be reduced to  $30-(8.40-6) = 27.60$ dBm.

2. For UNII-3: Directional gain is 8.11dB > 6dBi, so the power limit shall be reduced to  $30-(8.11-6) = 27.89$ dBm.

### 802.11ac (VHT80+80)

Chan.	Chan. Freq. (MHz)	Maximum Conducted Power (dBm)				Total Power (mW)	Total Power (dBm)	Limit (dBm)	Pass / Fail
		Chain 0	Chain 1	Chain 2	Chain 3				
42+155	5210	15.64	14.97	-	-	68.049	18.33	27.60	Pass
	5775	-	-	14.87	15.12	63.199	18.01	27.89	Pass

- Note:** 1. For UNII-1: Directional gain is 8.40dBi > 6dBi, so the power limit shall be reduced to  $30-(8.40-6) = 27.60$ dBm.  
 2. For UNII-3: Directional gain is 8.11dB > 6dBi, so the power limit shall be reduced to  $30-(8.11-6) = 27.89$ dBm.

### 802.11ax (HE20)

Chan.	Chan. Freq. (MHz)	Maximum Conducted Power (dBm)				Total Power (mW)	Total Power (dBm)	Limit (dBm)	Pass / Fail
		Chain 0	Chain 1	Chain 2	Chain 3				
36	5180	20.74	20.05	20.21	20.53	437.669	26.41	27.60	Pass
40	5200	21.64	21.08	21.58	21.89	572.519	27.58	27.60	Pass
48	5240	21.39	20.80	21.26	21.61	536.484	27.30	27.60	Pass
149	5745	21.65	21.48	21.67	22.34	605.112	27.82	27.89	Pass
157	5785	21.56	21.46	21.74	21.89	586.982	27.69	27.89	Pass
165	5825	21.38	21.02	21.38	21.96	558.318	27.47	27.89	Pass

- Note:** 1. For UNII-1: Directional gain is 8.40dBi > 6dBi, so the power limit shall be reduced to  $30-(8.40-6) = 27.60$ dBm.  
 2. For UNII-3: Directional gain is 8.11dB > 6dBi, so the power limit shall be reduced to  $30-(8.11-6) = 27.89$ dBm.

### 802.11ax (HE40)

Chan.	Chan. Freq. (MHz)	Maximum Conducted Power (dBm)				Total Power (mW)	Total Power (dBm)	Limit (dBm)	Pass / Fail
		Chain 0	Chain 1	Chain 2	Chain 3				
38	5190	16.36	16.33	16.32	17.17	181.179	22.58	27.60	Pass
46	5230	21.28	20.48	20.80	20.40	475.836	26.77	27.60	Pass
151	5755	21.33	20.15	21.74	21.62	533.835	27.27	27.89	Pass
159	5795	21.56	21.53	21.75	21.94	591.391	27.72	27.89	Pass

- Note:** 1. For UNII-1: Directional gain is 8.40dBi > 6dBi, so the power limit shall be reduced to  $30-(8.40-6) = 27.60$ dBm.  
 2. For UNII-3: Directional gain is 8.11dB > 6dBi, so the power limit shall be reduced to  $30-(8.11-6) = 27.89$ dBm.

### 802.11ax (HE80)

Chan.	Chan. Freq. (MHz)	Maximum Conducted Power (dBm)				Total Power (mW)	Total Power (dBm)	Limit (dBm)	Pass / Fail
		Chain 0	Chain 1	Chain 2	Chain 3				
42	5210	14.37	15.45	14.59	15.38	125.716	20.99	27.60	Pass
155	5775	19.66	19.19	19.67	19.41	355.435	25.51	27.89	Pass

- Note:** 1. For UNII-1: Directional gain is 8.40dBi > 6dBi, so the power limit shall be reduced to  $30-(8.40-6) = 27.60$ dBm.  
 2. For UNII-3: Directional gain is 8.11dB > 6dBi, so the power limit shall be reduced to  $30-(8.11-6) = 27.89$ dBm.

### 802.11ax (HE80+80)

Chan.	Chan. Freq. (MHz)	Maximum Conducted Power (dBm)				Total Power (mW)	Total Power (dBm)	Limit (dBm)	Pass / Fail
		Chain 0	Chain 1	Chain 2	Chain 3				
42+155	5210	15.98	15.09	-	-	71.913	18.57	27.60	Pass
	5775	-	-	15.02	15.48	67.087	18.27	27.89	Pass

- Note:** 1. For UNII-1: Directional gain is 8.40dBi > 6dBi, so the power limit shall be reduced to  $30-(8.40-6) = 27.60$ dBm.  
 2. For UNII-3: Directional gain is 8.11dB > 6dBi, so the power limit shall be reduced to  $30-(8.11-6) = 27.89$ dBm.



## 4.3.8 Test Result (Mode 2)

**Non-Beamforming Mode**
**For U-NII-1:**
**802.11a**

Chan.	Chan. Freq. (MHz)	Maximum Conducted Power (dBm)		Total Power (mW)	Total Power (dBm)	Limit (dBm)	Pass / Fail
		Chain 1	Chain 2				
36	5180	20.39	20.68	226.346	23.55	30.00	Pass
40	5200	21.85	21.93	309.064	24.90	30.00	Pass
48	5240	21.38	21.98	295.165	24.70	30.00	Pass

**802.11ac (VHT20)**

Chan.	Chan. Freq. (MHz)	Maximum Conducted Power (dBm)		Total Power (mW)	Total Power (dBm)	Limit (dBm)	Pass / Fail
		Chain 1	Chain 2				
36	5180	20.09	20.23	207.533	23.17	30.00	Pass
40	5200	21.44	21.51	280.895	24.49	30.00	Pass
48	5240	20.96	21.67	271.631	24.34	30.00	Pass

**802.11ac (VHT40)**

Chan.	Chan. Freq. (MHz)	Maximum Conducted Power (dBm)		Total Power (mW)	Total Power (dBm)	Limit (dBm)	Pass / Fail
		Chain 1	Chain 2				
38	5190	16.38	16.99	93.454	19.71	30.00	Pass
46	5230	20.47	21.07	239.367	23.79	30.00	Pass

**802.11ac (VHT80)**

Chan.	Chan. Freq. (MHz)	Maximum Conducted Power (dBm)		Total Power (mW)	Total Power (dBm)	Limit (dBm)	Pass / Fail
		Chain 1	Chain 2				
42	5210	14.98	15.67	68.375	18.35	30.00	Pass

**802.11ax (HE20)**

Chan.	Chan. Freq. (MHz)	Maximum Conducted Power (dBm)		Total Power (mW)	Total Power (dBm)	Limit (dBm)	Pass / Fail
		Chain 1	Chain 2				
36	5180	20.34	20.48	219.829	23.42	30.00	Pass
40	5200	21.75	21.83	302.029	24.80	30.00	Pass
48	5240	21.25	21.91	288.591	24.60	30.00	Pass

**802.11ax (HE40)**

Chan.	Chan. Freq. (MHz)	Maximum Conducted Power (dBm)		Total Power (mW)	Total Power (dBm)	Limit (dBm)	Pass / Fail
		Chain 1	Chain 2				
38	5190	16.72	17.25	100.077	20.00	30.00	Pass
46	5230	20.79	21.36	256.723	24.09	30.00	Pass

**802.11ax (HE80)**

Chan.	Chan. Freq. (MHz)	Maximum Conducted Power (dBm)		Total Power (mW)	Total Power (dBm)	Limit (dBm)	Pass / Fail
		Chain 1	Chain 2				
42	5210	15.12	15.86	71.057	18.52	30.00	Pass

**For U-NII-3:**
**802.11a**

Chan.	Chan. Freq. (MHz)	Maximum Conducted Power (dBm)		Total Power (mW)	Total Power (dBm)	Limit (dBm)	Pass / Fail
		Chain 0	Chain 1				
149	5745	24.42	24.59	564.434	27.52	30.00	Pass
157	5785	24.37	24.44	551.498	27.42	30.00	Pass
165	5825	24.19	24.21	526.055	27.21	30.00	Pass

**802.11ac (VHT20)**

Chan.	Chan. Freq. (MHz)	Maximum Conducted Power (dBm)		Total Power (mW)	Total Power (dBm)	Limit (dBm)	Pass / Fail
		Chain 0	Chain 1				
149	5745	24.17	24.19	523.638	27.19	30.00	Pass
157	5785	24.08	24.11	513.491	27.11	30.00	Pass
165	5825	24.11	24.16	518.247	27.15	30.00	Pass

**802.11ac (VHT40)**

Chan.	Chan. Freq. (MHz)	Maximum Conducted Power (dBm)		Total Power (mW)	Total Power (dBm)	Limit (dBm)	Pass / Fail
		Chain 0	Chain 1				
151	5755	21.05	21.13	257.068	24.10	30.00	Pass
159	5795	23.83	23.86	484.766	26.86	30.00	Pass

**802.11ac (VHT80)**

Chan.	Chan. Freq. (MHz)	Maximum Conducted Power (dBm)		Total Power (mW)	Total Power (dBm)	Limit (dBm)	Pass / Fail
		Chain 0	Chain 1				
155	5775	20.85	20.87	243.799	23.87	30.00	Pass

**802.11ax (HE20)**

Chan.	Chan. Freq. (MHz)	Maximum Conducted Power (dBm)		Total Power (mW)	Total Power (dBm)	Limit (dBm)	Pass / Fail
		Chain 0	Chain 1				
149	5745	24.33	24.46	550.273	27.41	30.00	Pass
157	5785	24.28	24.35	540.187	27.33	30.00	Pass
165	5825	24.85	24.90	614.522	27.89	30.00	Pass

**802.11ax (HE40)**

Chan.	Chan. Freq. (MHz)	Maximum Conducted Power (dBm)		Total Power (mW)	Total Power (dBm)	Limit (dBm)	Pass / Fail
		Chain 0	Chain 1				
151	5755	21.35	21.47	276.739	24.42	30.00	Pass
159	5795	24.06	24.12	512.909	27.10	30.00	Pass

**802.11ax (HE80)**

Chan.	Chan. Freq. (MHz)	Maximum Conducted Power (dBm)		Total Power (mW)	Total Power (dBm)	Limit (dBm)	Pass / Fail
		Chain 0	Chain 1				
155	5775	21.14	21.18	261.237	24.17	30.00	Pass

## Beamforming Mode

For U-NII-1:

### 802.11ac (VHT20)

Chan.	Chan. Freq. (MHz)	Maximum Conducted Power (dBm)		Total Power (mW)	Total Power (dBm)	Limit (dBm)	Pass / Fail
		Chain 1	Chain 2				
36	5180	20.09	20.23	207.533	23.17	29.38	Pass
40	5200	21.44	21.51	280.895	24.49	29.38	Pass
48	5240	20.96	21.67	271.631	24.34	29.38	Pass

**Note:** 1. Directional gain is 6.62dBi > 6dBi, so the power limit shall be reduced to  $30-(6.62-6) = 29.38$ dBm.

### 802.11ac (VHT40)

Chan.	Chan. Freq. (MHz)	Maximum Conducted Power (dBm)		Total Power (mW)	Total Power (dBm)	Limit (dBm)	Pass / Fail
		Chain 1	Chain 2				
38	5190	16.38	16.99	93.454	19.71	29.38	Pass
46	5230	20.47	21.07	239.367	23.79	29.38	Pass

**Note:** 1. Directional gain is 6.62dBi > 6dBi, so the power limit shall be reduced to  $30-(6.62-6) = 29.38$ dBm.

### 802.11ac (VHT80)

Chan.	Chan. Freq. (MHz)	Maximum Conducted Power (dBm)		Total Power (mW)	Total Power (dBm)	Limit (dBm)	Pass / Fail
		Chain 1	Chain 2				
42	5210	14.98	15.67	68.375	18.35	29.38	Pass

**Note:** 1. Directional gain is 6.62dBi > 6dBi, so the power limit shall be reduced to  $30-(6.62-6) = 29.38$ dBm.

**802.11ax (HE20)**

Chan.	Chan. Freq. (MHz)	Maximum Conducted Power (dBm)		Total Power (mW)	Total Power (dBm)	Limit (dBm)	Pass / Fail
		Chain 1	Chain 2				
36	5180	20.34	20.48	219.829	23.42	29.38	Pass
40	5200	21.75	21.83	302.029	24.80	29.38	Pass
48	5240	21.25	21.91	288.591	24.60	29.38	Pass

**Note:** 1. Directional gain is 6.62dBi > 6dBi, so the power limit shall be reduced to  $30-(6.62-6) = 29.38$ dBm.

**802.11ax (HE40)**

Chan.	Chan. Freq. (MHz)	Maximum Conducted Power (dBm)		Total Power (mW)	Total Power (dBm)	Limit (dBm)	Pass / Fail
		Chain 1	Chain 2				
38	5190	16.72	17.25	100.077	20.00	29.38	Pass
46	5230	20.79	21.36	256.723	24.09	29.38	Pass

**Note:** 1. Directional gain is 6.62dBi > 6dBi, so the power limit shall be reduced to  $30-(6.62-6) = 29.38$ dBm.

**802.11ax (HE80)**

Chan.	Chan. Freq. (MHz)	Maximum Conducted Power (dBm)		Total Power (mW)	Total Power (dBm)	Limit (dBm)	Pass / Fail
		Chain 1	Chain 2				
42	5210	15.12	15.86	71.057	18.52	29.38	Pass

**Note:** 1. Directional gain is 6.62dBi > 6dBi, so the power limit shall be reduced to  $30-(6.62-6) = 29.38$ dBm.

**For U-NII-3:**

**802.11ac (VHT20)**

Chan.	Chan. Freq. (MHz)	Maximum Conducted Power (dBm)		Total Power (mW)	Total Power (dBm)	Limit (dBm)	Pass / Fail
		Chain 0	Chain 1				
149	5745	24.17	24.19	523.638	27.19	28.73	Pass
157	5785	24.08	24.11	513.491	27.11	28.73	Pass
165	5825	24.11	24.16	518.247	27.15	28.73	Pass

**Note:** 1. Directional gain is 7.27dB > 6dBi, so the power limit shall be reduced to  $30-(7.27-6) = 28.73$ dBm.

**802.11ac (VHT40)**

Chan.	Chan. Freq. (MHz)	Maximum Conducted Power (dBm)		Total Power (mW)	Total Power (dBm)	Limit (dBm)	Pass / Fail
		Chain 0	Chain 1				
151	5755	21.05	21.13	257.068	24.10	28.73	Pass
159	5795	23.83	23.86	484.766	26.86	28.73	Pass

**Note:** 1. Directional gain is 7.27dB > 6dBi, so the power limit shall be reduced to  $30-(7.27-6) = 28.73$ dBm.

**802.11ac (VHT80)**

Chan.	Chan. Freq. (MHz)	Maximum Conducted Power (dBm)		Total Power (mW)	Total Power (dBm)	Limit (dBm)	Pass / Fail
		Chain 0	Chain 1				
155	5775	20.85	20.87	243.799	23.87	28.73	Pass

**Note:** 1. Directional gain is 7.27dB > 6dBi, so the power limit shall be reduced to  $30-(7.27-6) = 28.73$ dBm.

### 802.11ax (HE20)

Chan.	Chan. Freq. (MHz)	Maximum Conducted Power (dBm)		Total Power (mW)	Total Power (dBm)	Limit (dBm)	Pass / Fail
		Chain 0	Chain 1				
149	5745	24.33	24.46	550.273	27.41	28.73	Pass
157	5785	24.28	24.35	540.187	27.33	28.73	Pass
165	5825	24.85	24.90	614.522	27.89	28.73	Pass

**Note:** 1. Directional gain is 7.27dB > 6dBi, so the power limit shall be reduced to  $30-(7.27-6) = 28.73$ dBm.

### 802.11ax (HE40)

Chan.	Chan. Freq. (MHz)	Maximum Conducted Power (dBm)		Total Power (mW)	Total Power (dBm)	Limit (dBm)	Pass / Fail
		Chain 0	Chain 1				
151	5755	21.35	21.47	276.739	24.42	28.73	Pass
159	5795	24.06	24.12	512.909	27.10	28.73	Pass

**Note:** 1. Directional gain is 7.27dB > 6dBi, so the power limit shall be reduced to  $30-(7.27-6) = 28.73$ dBm.

### 802.11ax (HE80)

Chan.	Chan. Freq. (MHz)	Maximum Conducted Power (dBm)		Total Power (mW)	Total Power (dBm)	Limit (dBm)	Pass / Fail
		Chain 0	Chain 1				
155	5775	21.14	21.18	261.237	24.17	28.73	Pass

**Note:** 1. Directional gain is 7.27dB > 6dBi, so the power limit shall be reduced to  $30-(7.27-6) = 28.73$ dBm.



#### 4.3.9 Test Result (Mode 3)

##### Non-Beamforming Mode

##### 802.11a

Channel	Channel Frequency (MHz)	Maximum Conducted Power (mW)	Maximum Conducted Power (dBm)	Power Limit (dBm)	Pass/Fail
36	5180	133.352	21.25	30.00	Pass
40	5200	214.783	23.32	30.00	Pass
48	5240	174.582	22.42	30.00	Pass
149	5745	260.615	24.16	30.00	Pass
157	5785	266.686	24.26	30.00	Pass
165	5825	261.818	24.18	30.00	Pass

##### 802.11ac (VHT20)

Channel	Channel Frequency (MHz)	Maximum Conducted Power (mW)	Maximum Conducted Power (dBm)	Power Limit (dBm)	Pass/Fail
36	5180	110.408	20.43	30.00	Pass
40	5200	174.181	22.41	30.00	Pass
48	5240	137.404	21.38	30.00	Pass
149	5745	233.884	23.69	30.00	Pass
157	5785	225.944	23.54	30.00	Pass
165	5825	209.894	23.22	30.00	Pass

##### 802.11ac (VHT40)

Channel	Channel Frequency (MHz)	Maximum Conducted Power (mW)	Maximum Conducted Power (dBm)	Power Limit (dBm)	Pass/Fail
38	5190	52.24	17.18	30.00	Pass
46	5230	138.676	21.42	30.00	Pass
151	5755	145.546	21.63	30.00	Pass
159	5795	219.786	23.42	30.00	Pass

##### 802.11ac (VHT80)

Channel	Channel Frequency (MHz)	Maximum Conducted Power (mW)	Maximum Conducted Power (dBm)	Power Limit (dBm)	Pass/Fail
42	5210	34.041	15.32	30.00	Pass
155	5775	128.233	21.08	30.00	Pass

**802.11ax (HE20)**

Channel	Channel Frequency (MHz)	Maximum Conducted Power (mW)	Maximum Conducted Power (dBm)	Power Limit (dBm)	Pass/Fail
36	5180	113.763	20.56	30.00	Pass
40	5200	179.887	22.55	30.00	Pass
48	5240	142.561	21.54	30.00	Pass
149	5745	242.103	23.84	30.00	Pass
157	5785	237.684	23.76	30.00	Pass
165	5825	219.786	23.42	30.00	Pass

**802.11ax (HE40)**

Channel	Channel Frequency (MHz)	Maximum Conducted Power (mW)	Maximum Conducted Power (dBm)	Power Limit (dBm)	Pass/Fail
38	5190	53.58	17.29	30.00	Pass
46	5230	141.906	21.52	30.00	Pass
151	5755	148.252	21.71	30.00	Pass
159	5795	226.986	23.56	30.00	Pass

**802.11ax (HE80)**

Channel	Channel Frequency (MHz)	Maximum Conducted Power (mW)	Maximum Conducted Power (dBm)	Power Limit (dBm)	Pass/Fail
42	5210	35.075	15.45	30.00	Pass
155	5775	132.739	21.23	30.00	Pass

## 4.4 Occupied Bandwidth Measurement

### 4.4.1 Test Setup



### 4.4.2 Test Instruments

Refer to section 4.1.2 to get information of above instrument.

### 4.4.3 Test Procedure

The transmitter output was connected to the spectrum analyzer through an attenuator. The bandwidth of the fundamental frequency was measured by spectrum analyzer with resolution bandwidth in the range of 1% to 5% of the anticipated emission bandwidth, and a video bandwidth at least 3x the resolution bandwidth and set the detector to SAMPLE. The width of a frequency band such that, below the lower and above the upper frequency limits, the mean powers emitted are each equal to a specified percentage 0.5 %of the total mean power of a given emission.

## 4.4.4 Test Results (Mode 1)

## 802.11a

Channel	Channel Frequency (MHz)	Occupied Bandwidth (MHz)			
		Chain 0	Chain 1	Chain 2	Chain 3
36	5180	19.08	17.52	17.16	17.04
40	5200	20.64	22.08	19.32	18.36
48	5240	17.28	18.12	17.16	17.28
149	5745	34.20	33.48	33.12	35.88
157	5785	34.08	33.36	34.92	35.76
165	5825	34.32	35.28	34.08	35.88

## 802.11ax (HE20)

Channel	Channel Frequency (MHz)	Occupied Bandwidth (MHz)			
		Chain 0	Chain 1	Chain 2	Chain 3
36	5180	19.32	19.08	19.32	19.08
40	5200	19.56	19.32	19.20	19.32
48	5240	19.20	19.20	19.20	19.08
149	5745	35.52	33.36	33.72	34.92
157	5785	34.92	36.84	34.44	37.44
165	5825	34.56	34.92	35.28	37.08

## 802.11ax (HE40)

Channel	Channel Frequency (MHz)	Occupied Bandwidth (MHz)			
		Chain 0	Chain 1	Chain 2	Chain 3
38	5190	38.16	38.16	38.16	38.16
46	5230	38.64	38.16	38.16	37.92
151	5755	43.20	38.88	39.60	49.44
159	5795	68.88	71.28	70.32	67.68

## 802.11ax (HE80)

Channel	Channel Frequency (MHz)	Occupied Bandwidth (MHz)			
		Chain 0	Chain 1	Chain 2	Chain 3
42	5210	77.28	77.28	76.80	77.28
155	5775	78.24	77.76	78.24	78.24

## 802.11ax (HE80+80)

Channel	Channel Frequency (MHz)	Occupied Bandwidth (MHz)			
		Chain 0	Chain 1	Chain 2	Chain 3
42+155	5210	77.28	77.28	-	-
	5775	-	-	77.28	77.28

### Spectrum Plot of Max Value

**802.11a / Chain 3 : CH165**

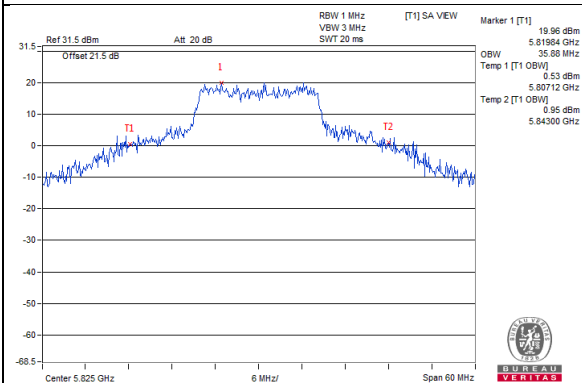

**802.11ax (HE20) / Chain 3: CH157**

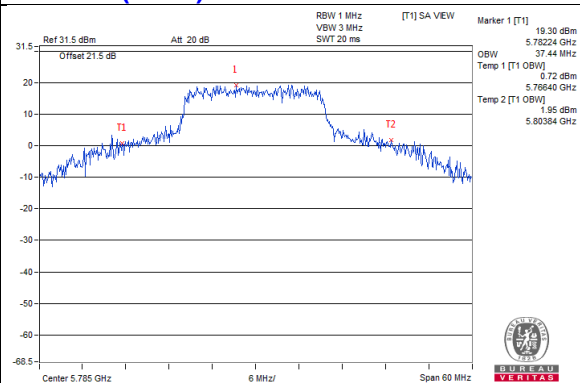

**802.11ax (HE40) / Chain 1: CH159**

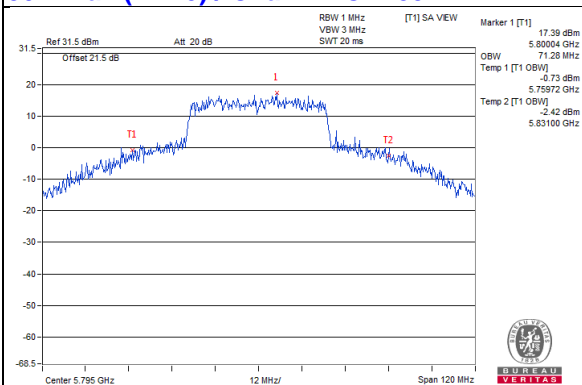

**802.11ax (HE80) / Chain 0 : CH155**

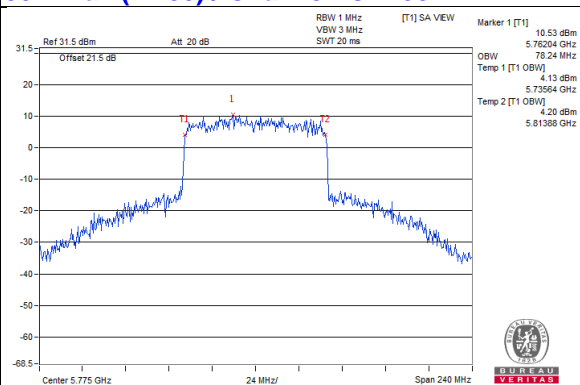

**802.11ax (HE80+80) / Chain 0 : CH42**

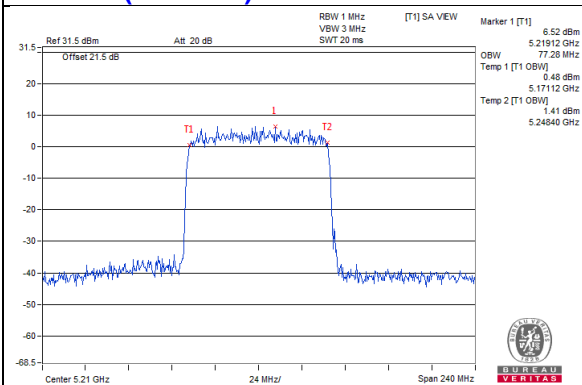

**Spectrum Plot for near by DFS band  
(DFS is required, if 99% OCP straddle into U-NII-2A band)**

**802.11a\_Chain 0 / CH48**

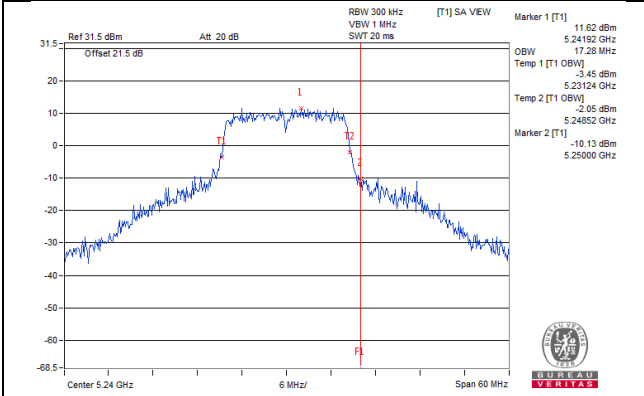

**802.11a\_Chain 1 / CH48**

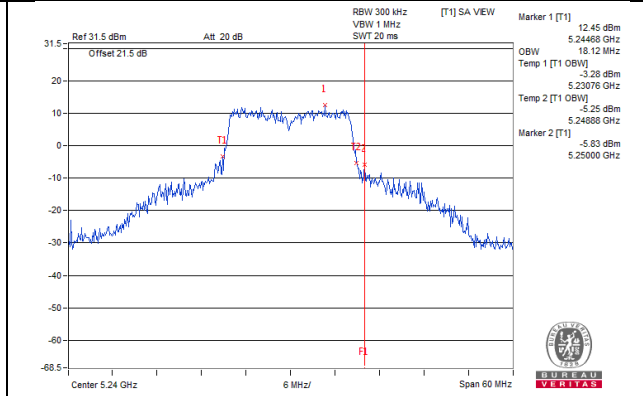

**802.11a\_Chain 2 / CH48**

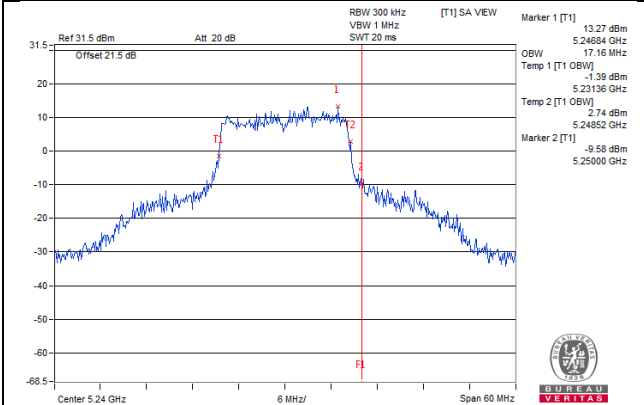

**802.11a\_Chain 3 / CH48**

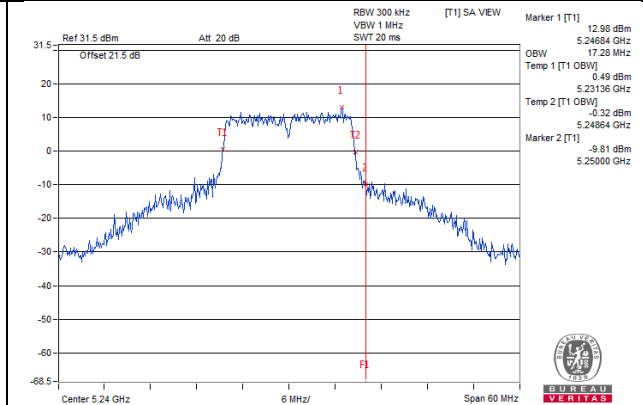

**802.11ax (HE20)\_Chain 0 / CH48**

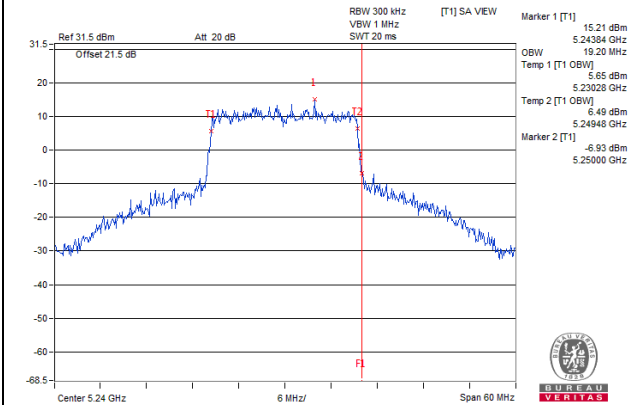

**802.11ax (HE20)\_Chain 1 / CH48**

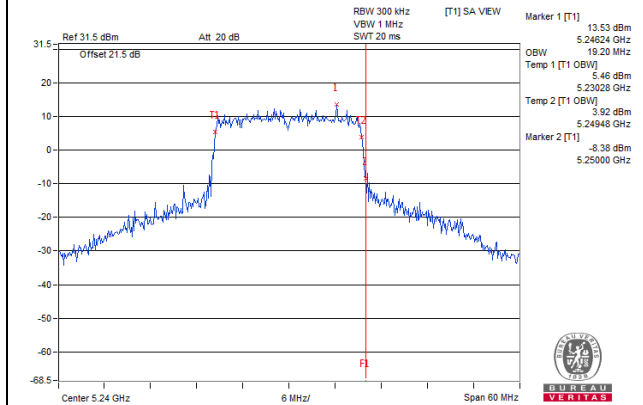

**802.11ax (HE20)\_Chain 2 / CH48**

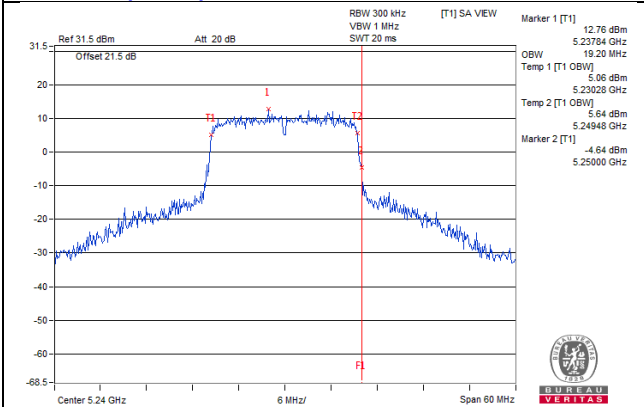

**802.11ax (HE20)\_Chain 3 / CH48**

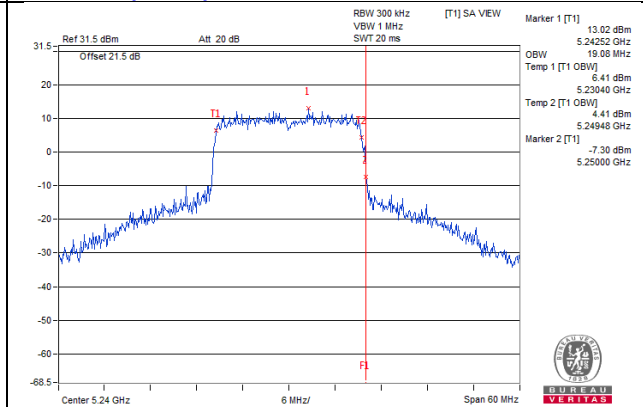

Spectrum Plot for near by DFS band  
(DFS is required, if 99% OCP straddle into U-NII-2A band)

802.11ax (HE40) Chain 0 / CH46

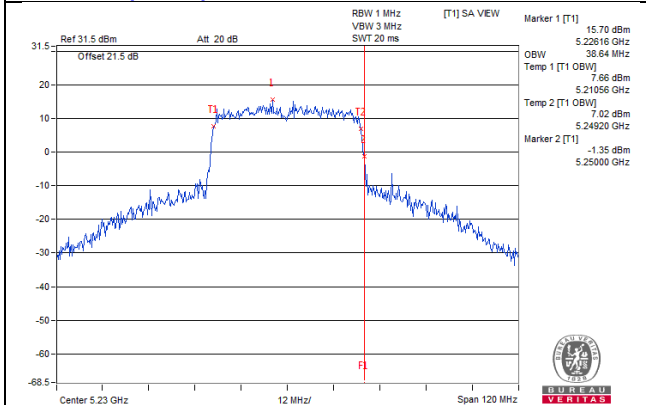

802.11ax (HE40) Chain 1 / CH46

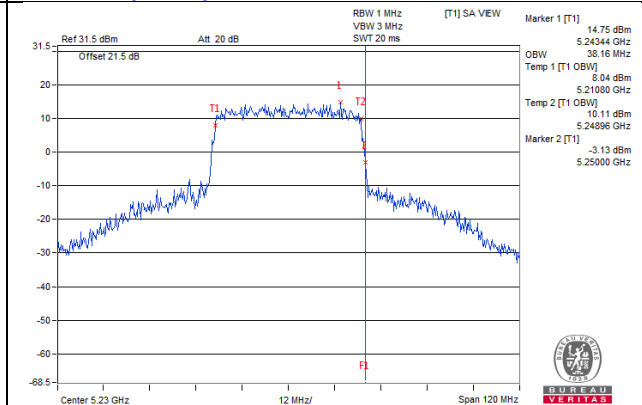

802.11ax (HE40) Chain 2 / CH46

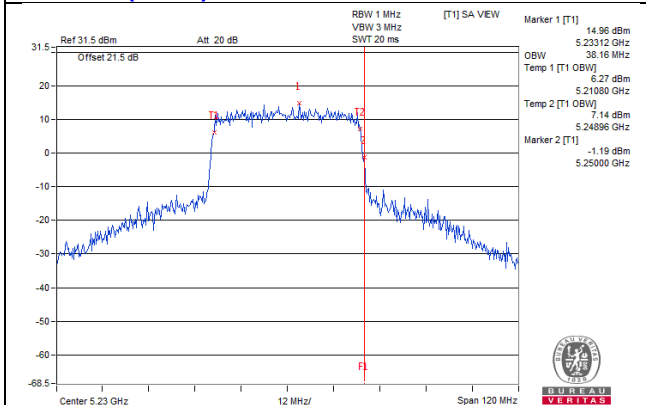

802.11ax (HE40) Chain 3 / CH46

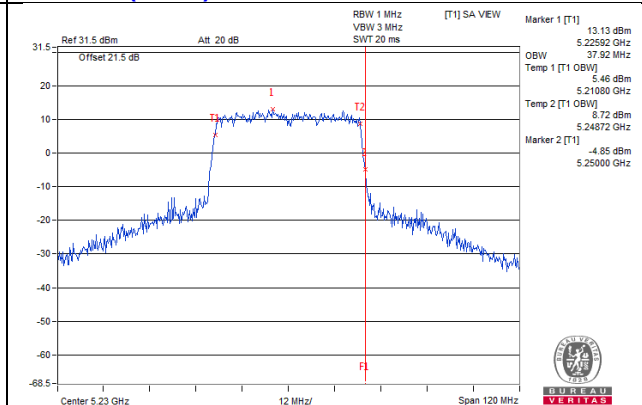

802.11ax (HE80) Chain 0 / CH42

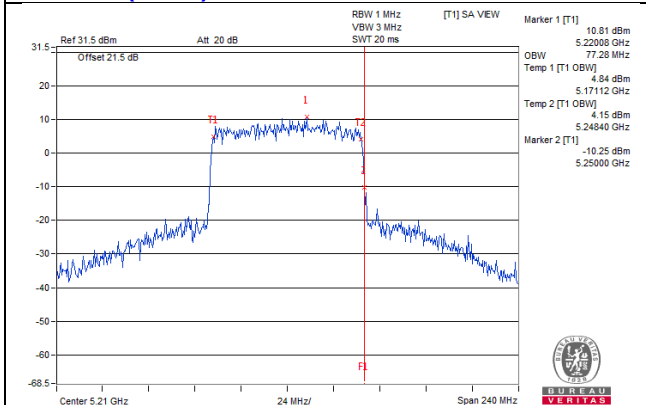

802.11ax (HE80) Chain 1 / CH42

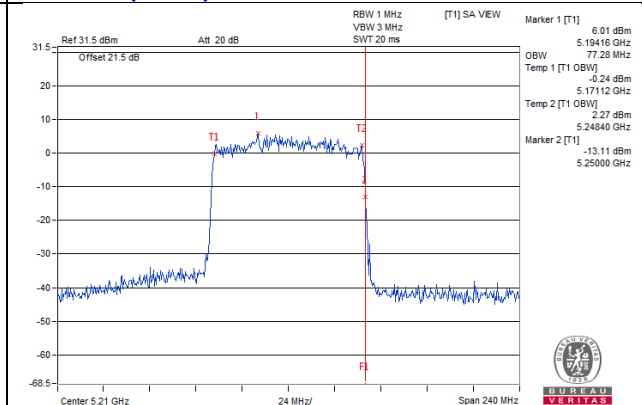

802.11ax (HE80) Chain 2 / CH42

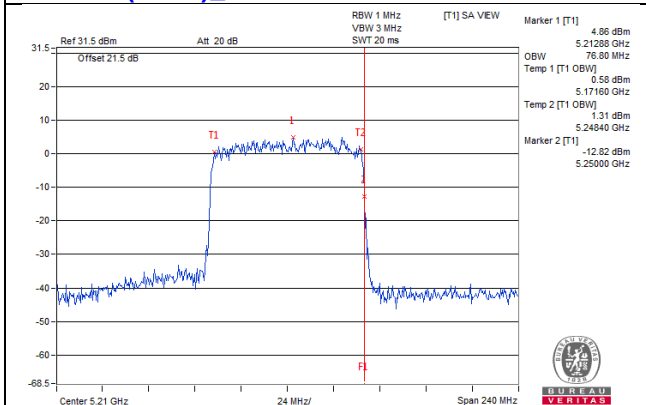

802.11ax (HE80) Chain 3 / CH42

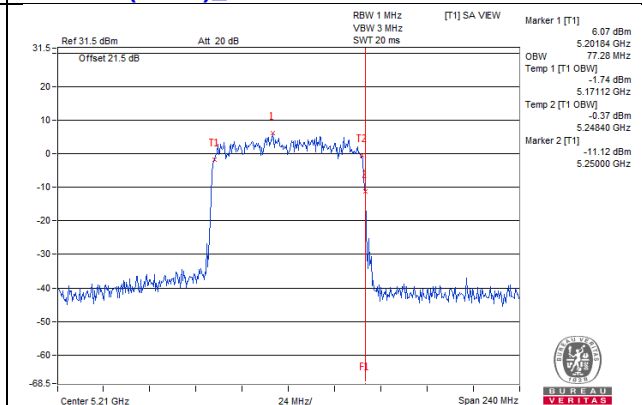

**Spectrum Plot for near by DFS band  
(DFS is required, if 99% OCP straddle into U-NII-2A band)**

**802.11ax (HE80+80)/ Chain 0 : CH42**

**802.11ax (HE80+80)/ Chain 1 : CH42**

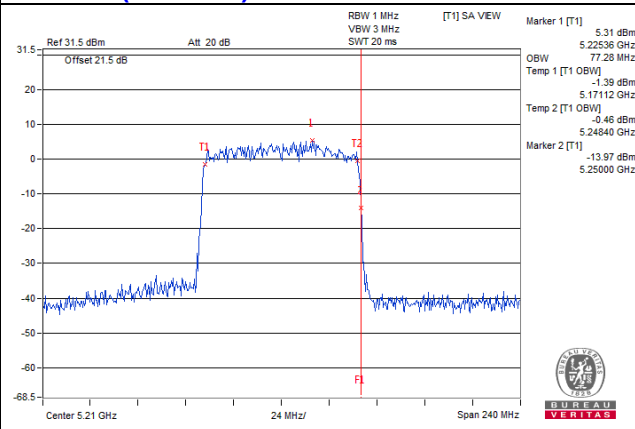
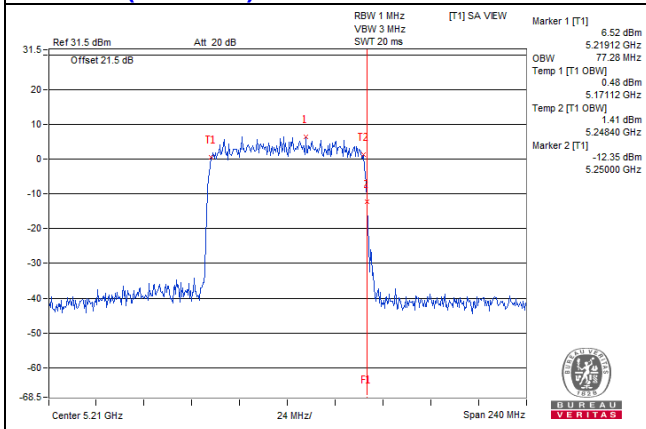



**Spectrum Plot for near by DFS band**  
(DFS is required, if 99% OCP straddle into U-NII-2C band)

**802.11a\_Chain 0 / CH149**

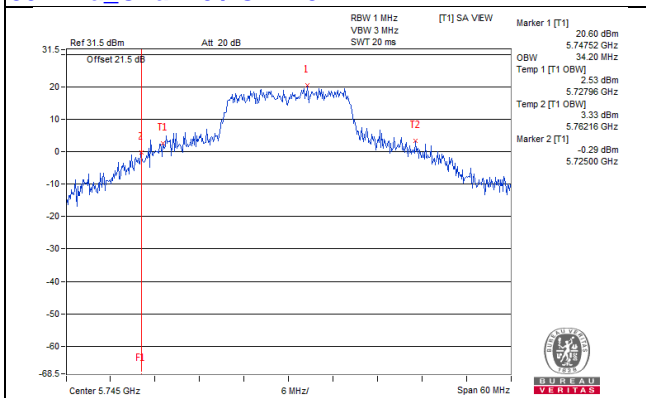

**802.11a\_Chain 1 / CH149**

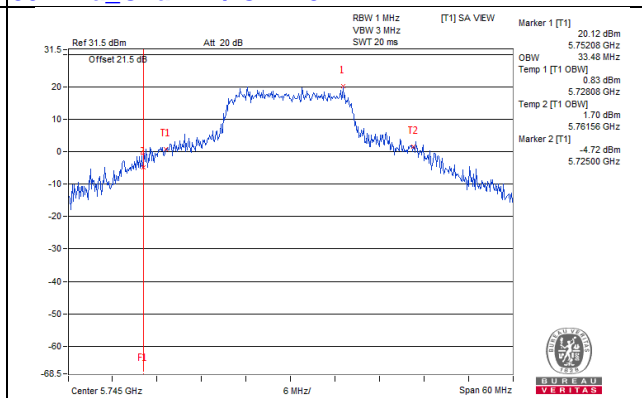

**802.11a\_Chain 2 / CH149**

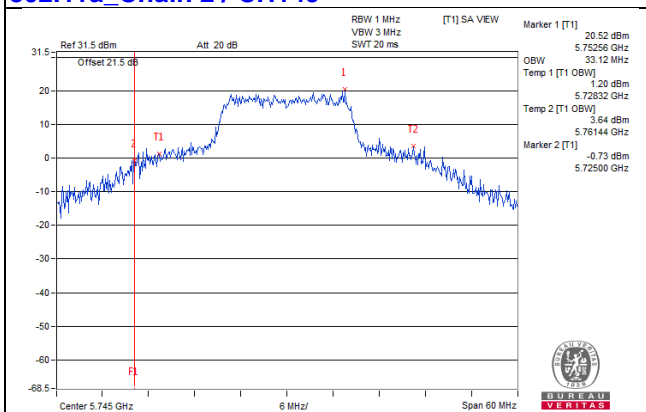

**802.11a\_Chain 3 / CH149**

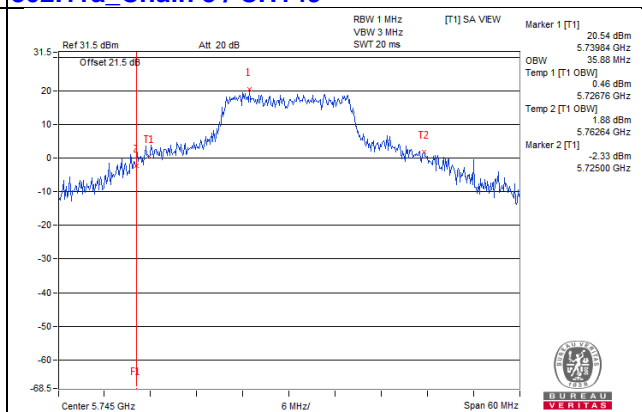

**802.11ax (HE20)\_Chain 0 / CH149**

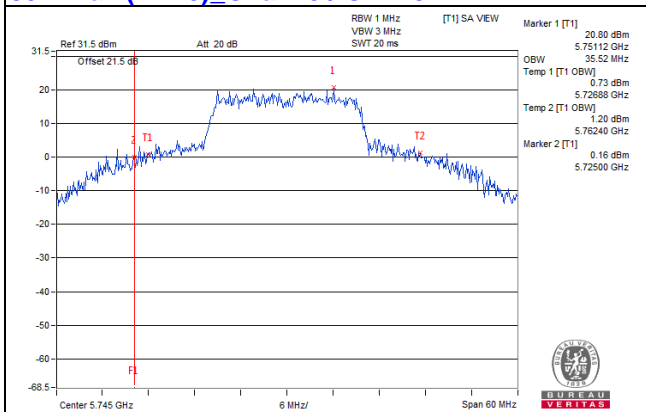

**802.11ax (HE20)\_Chain 1 / CH149**

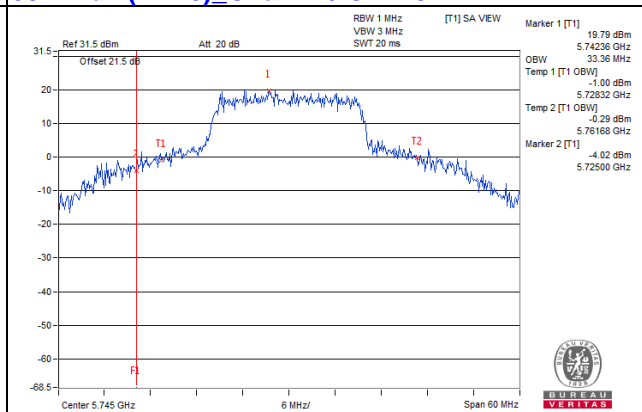

**802.11ax (HE20)\_Chain 2 / CH149**

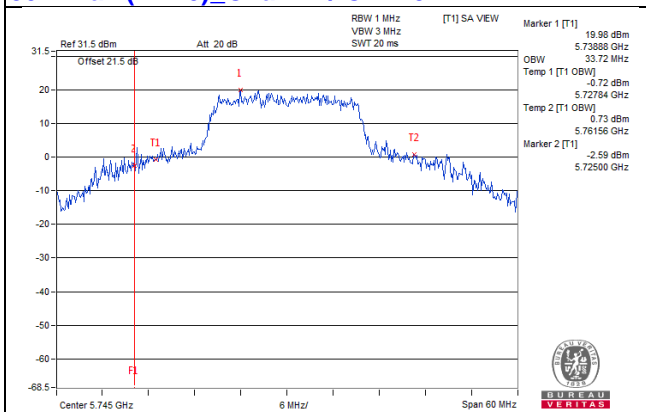

**802.11ax (HE20)\_Chain 3 / CH149**

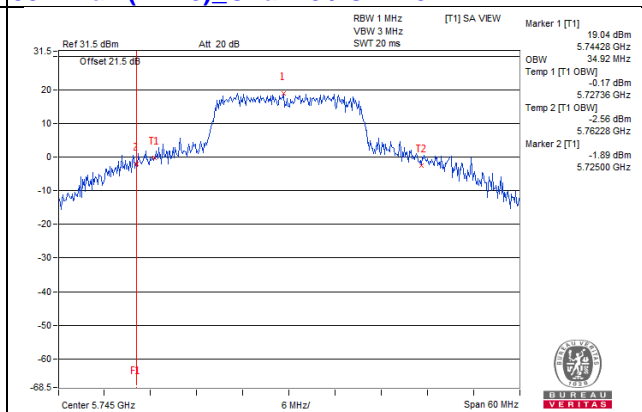

**Spectrum Plot for near by DFS band  
(DFS is required, if 99% OCP straddle into U-NII-2C band)**

**802.11ax (HE40)\_Chain 0 / CH151**

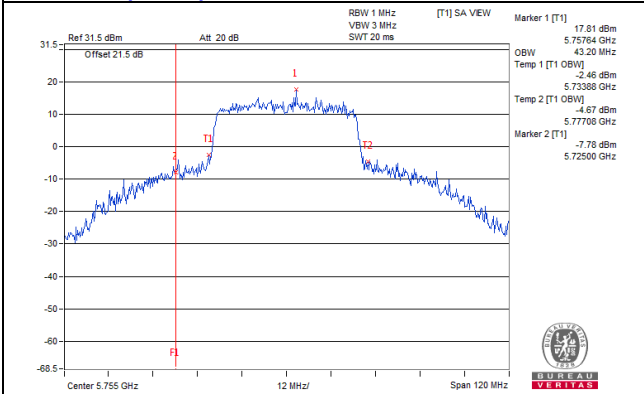

**802.11ax (HE40)\_Chain 1 / CH151**

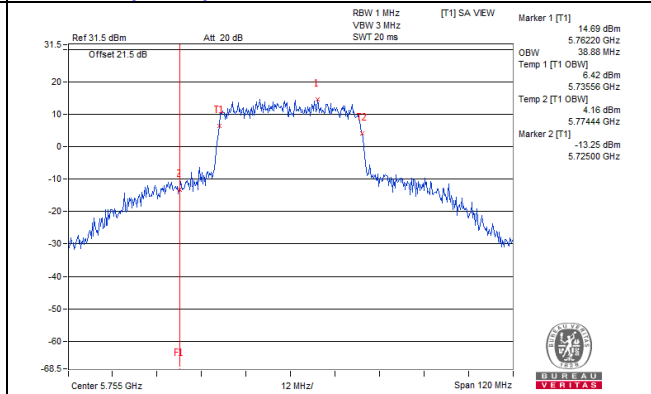

**802.11ax (HE40)\_Chain 2 / CH151**

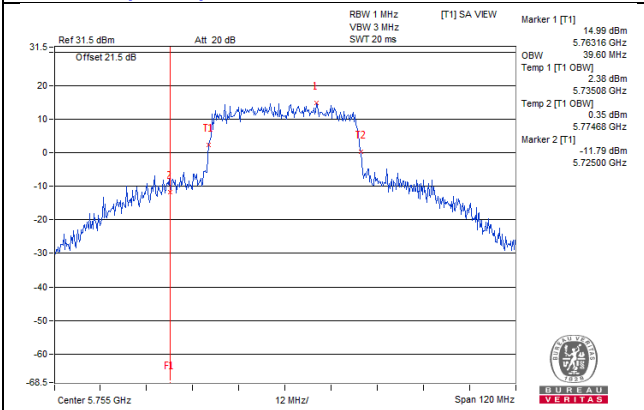

**802.11ax (HE40)\_Chain 3 / CH151**

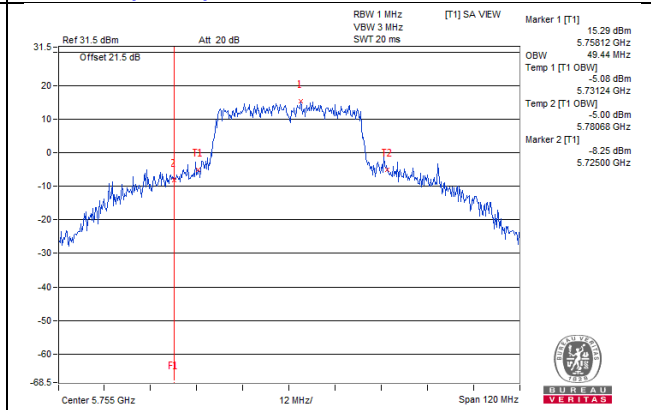

**802.11ax (HE80)\_Chain 0 / CH155**

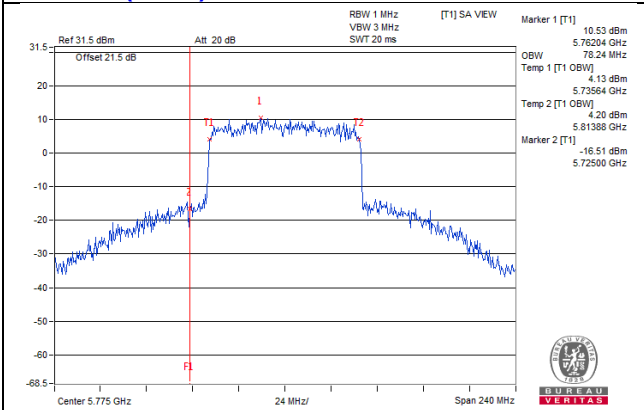

**802.11ax (HE80)\_Chain 1 / CH155**

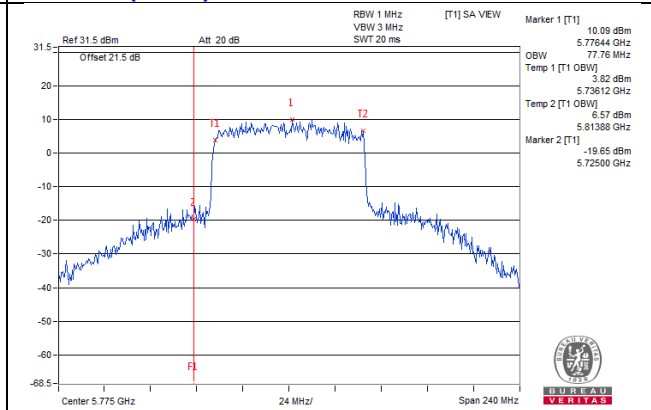

**802.11ax (HE80)\_Chain 2 / CH155**

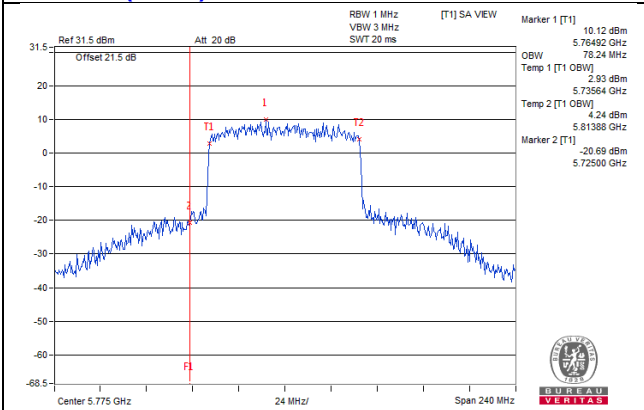

**802.11ax (HE80)\_Chain 3 / CH155**

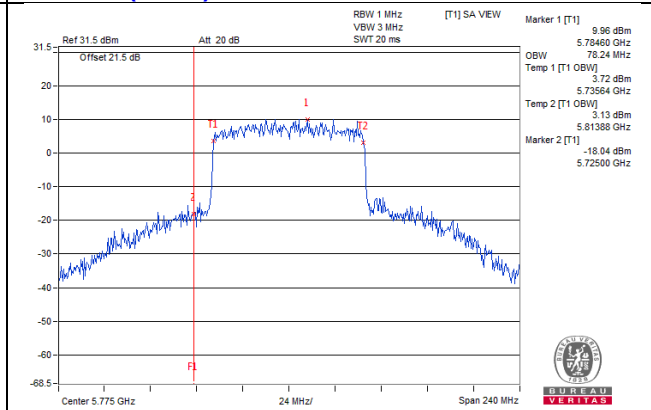

Spectrum Plot for near by DFS band  
(DFS is required, if 99% OCP straddle into U-NII-2C band)

802.11ax (HE80+80)/ Chain 2 : CH155

802.11ax (HE80+80)/ Chain 3 : CH155

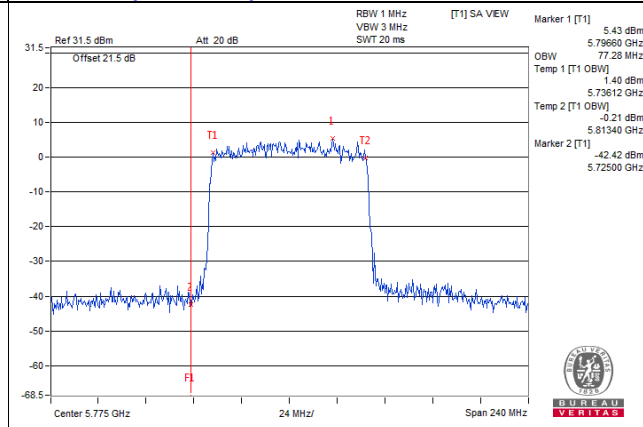
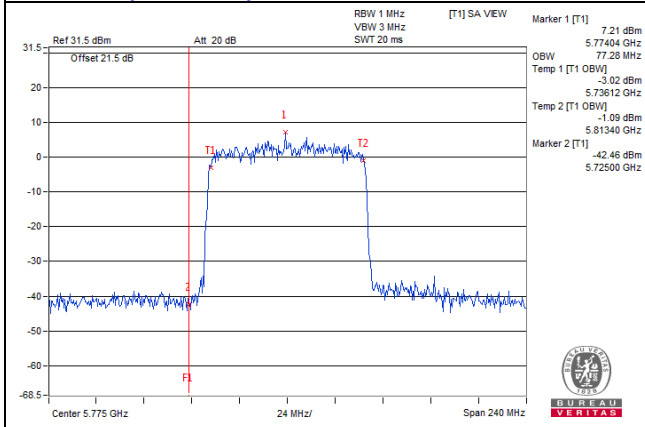

#### 4.4.5 Test Results (Mode 2)

##### For U-NII-1:

##### 802.11a

Channel	Channel Frequency (MHz)	Occupied Bandwidth (MHz)	
		Chain 1	Chain 2
36	5180	17.40	17.88
40	5200	20.16	21.36
48	5240	18.00	19.68

##### 802.11ax (HE20)

Channel	Channel Frequency (MHz)	Occupied Bandwidth (MHz)	
		Chain 1	Chain 2
36	5180	19.08	19.20
40	5200	19.32	19.44
48	5240	19.08	19.20

##### 802.11ax (HE40)

Channel	Channel Frequency (MHz)	Occupied Bandwidth (MHz)	
		Chain 1	Chain 2
38	5190	38.16	38.16
46	5230	38.40	38.16

##### 802.11ax (HE80)

Channel	Channel Frequency (MHz)	Occupied Bandwidth (MHz)	
		Chain 1	Chain 2
42	5210	77.28	77.28

### Spectrum Plot of Max Value

**802.11a / Chain 2 : CH40**

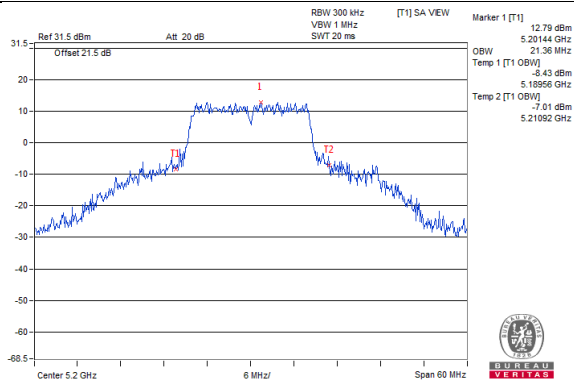

**802.11ax (HE20) / Chain 2: CH40**

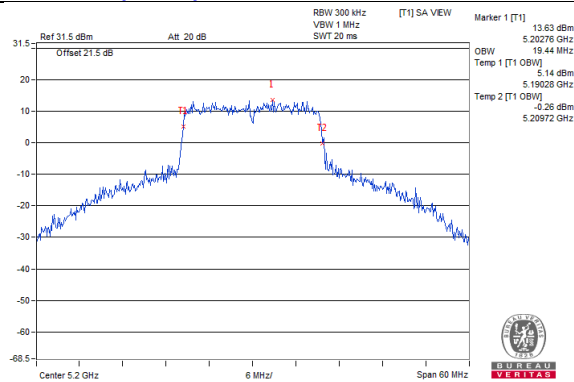

**802.11ax (HE40) / Chain 1: CH46**

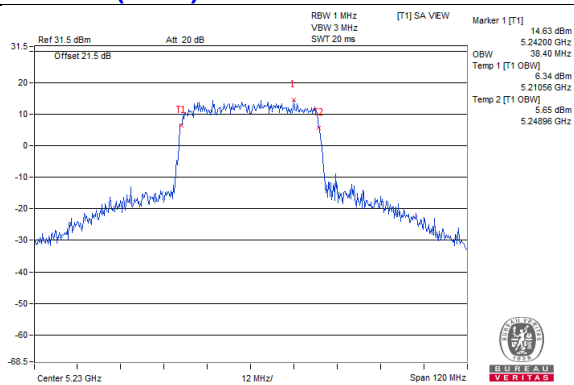

**802.11ax (HE80) / Chain 1 : CH42**

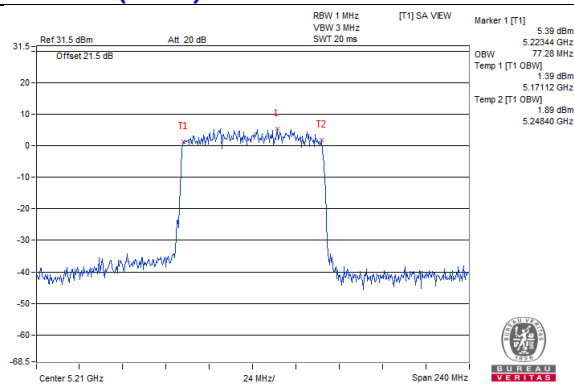

Spectrum Plot for near by DFS band  
(DFS is required, if 99% OCP straddle into U-NII-2A band)

802.11a\_Chain 1 / CH48

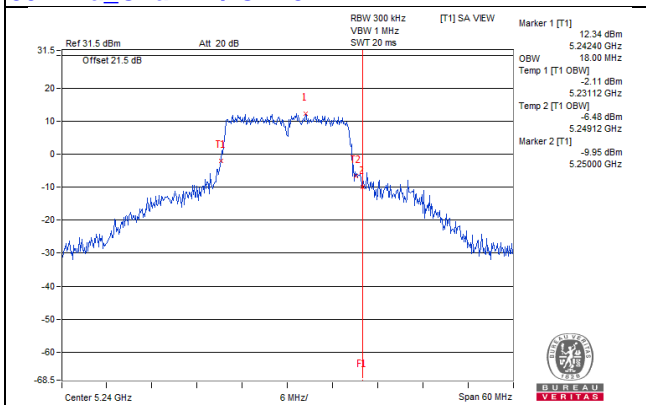

802.11a\_Chain 2 / CH48

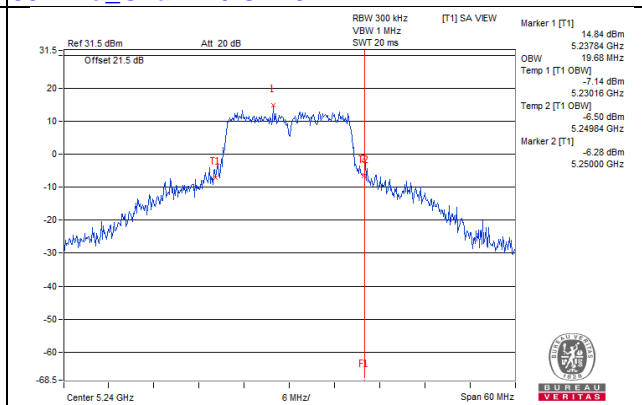

802.11ax (HE20)\_Chain 1 / CH48

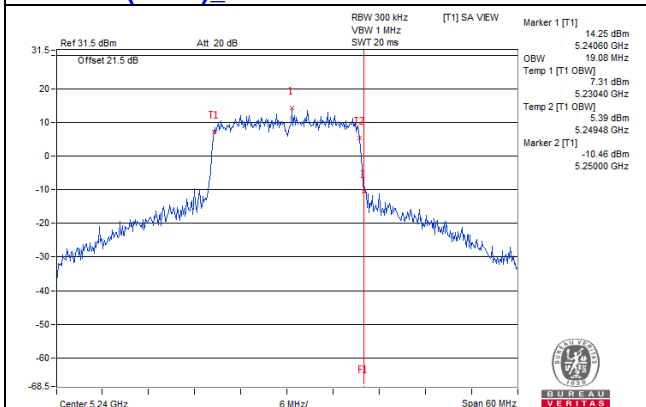

802.11ax (HE20)\_Chain 2 / CH48

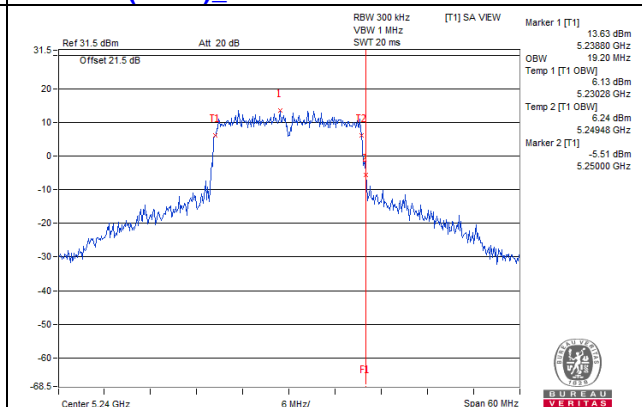

802.11ax (HE40)\_Chain 1 / CH46

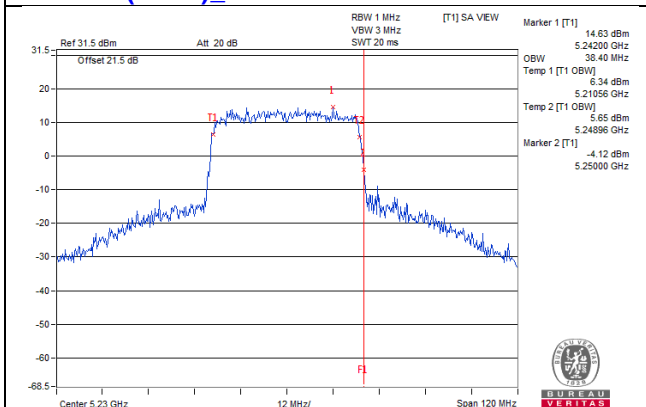

802.11ax (HE40)\_Chain 2 / CH46

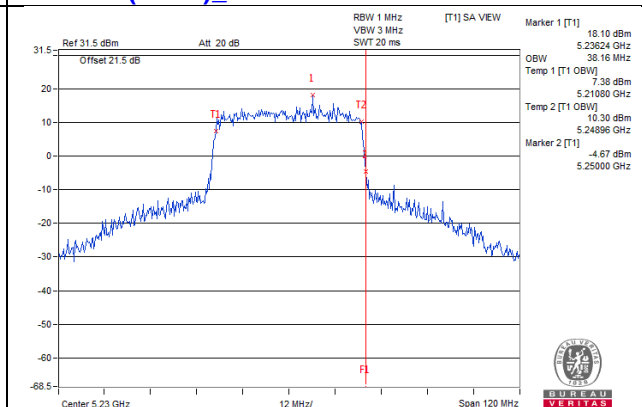

802.11ax (HE80)\_Chain 1 / CH42

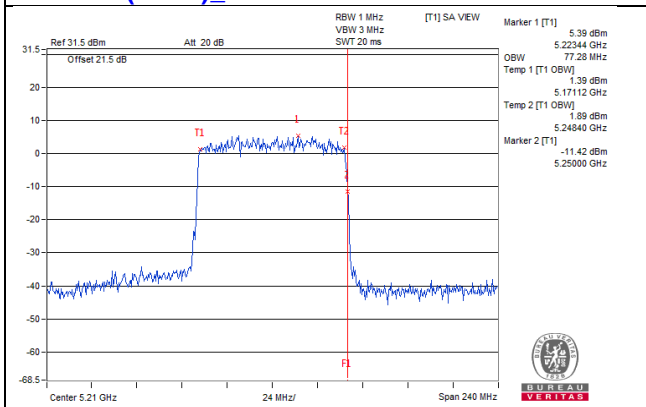

802.11ax (HE80)\_Chain 2 / CH42

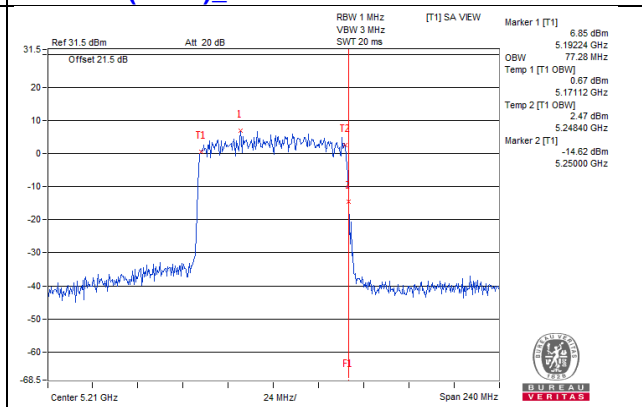

**For U-NII-3:**

**802.11a**

Channel	Channel Frequency (MHz)	Occupied Bandwidth (MHz)	
		Chain 0	Chain 1
149	5745	33.48	33.12
157	5785	33.36	34.92
165	5825	35.28	34.08

**802.11ax (HE20)**

Channel	Channel Frequency (MHz)	Occupied Bandwidth (MHz)	
		Chain 0	Chain 1
149	5745	33.36	33.72
157	5785	36.84	34.44
165	5825	34.92	35.28

**802.11ax (HE40)**

Channel	Channel Frequency (MHz)	Occupied Bandwidth (MHz)	
		Chain 0	Chain 1
151	5755	38.88	39.60
159	5795	71.28	70.32

**802.11ax (HE80)**

Channel	Channel Frequency (MHz)	Occupied Bandwidth (MHz)	
		Chain 0	Chain 1
155	5775	82.08	78.72

### Spectrum Plot of Max Value

**802.11a / Chain 0 : CH165**

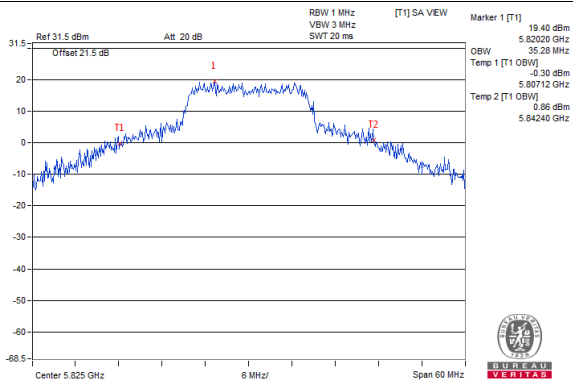

**802.11ax (HE20) / Chain 0: CH157**

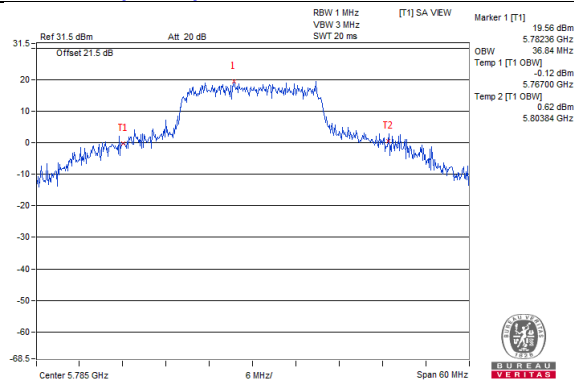

**802.11ax (HE40) / Chain 0: CH159**

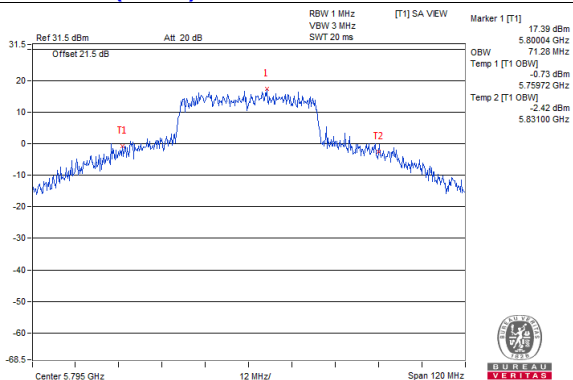

**802.11ax (HE80) / Chain 0 : CH155**

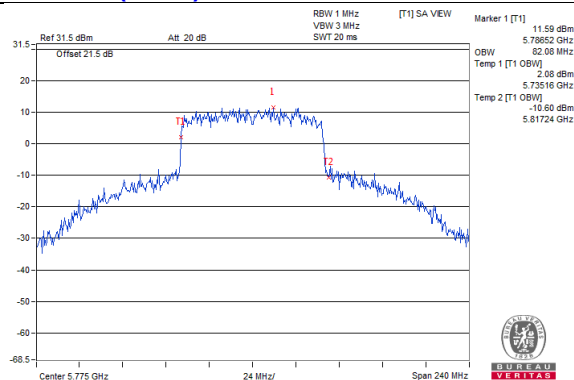



Spectrum Plot for near by DFS band  
(DFS is required, if 99% OCP straddle into U-NII-2C band)

802.11a\_Chain 0 / CH149

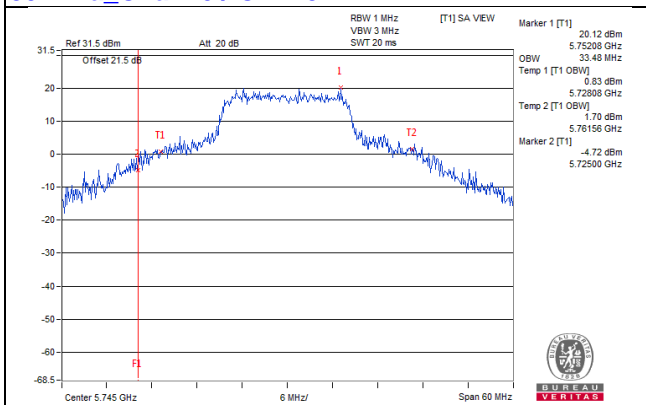

802.11a\_Chain 1 / CH149

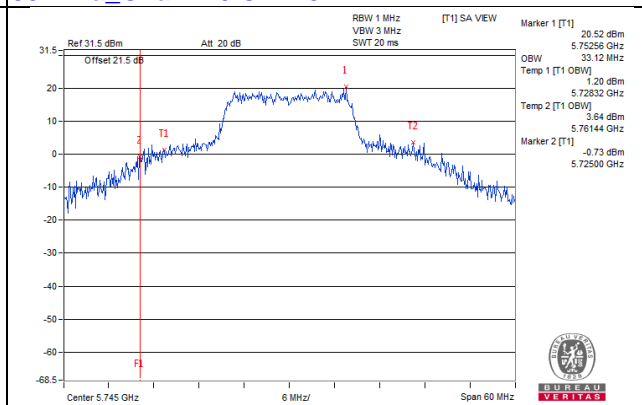

802.11ax (HE20)\_Chain 0 / CH149

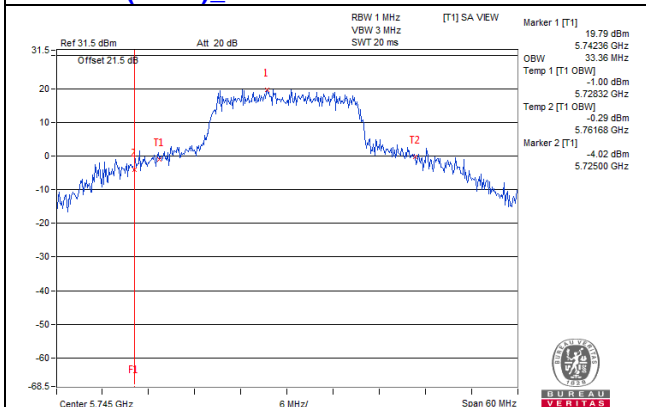

802.11ax (HE20)\_Chain 1 / CH149

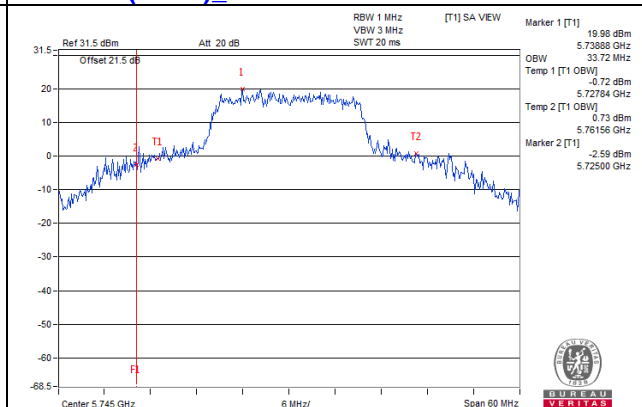

802.11ax (HE40)\_Chain 0 / CH151

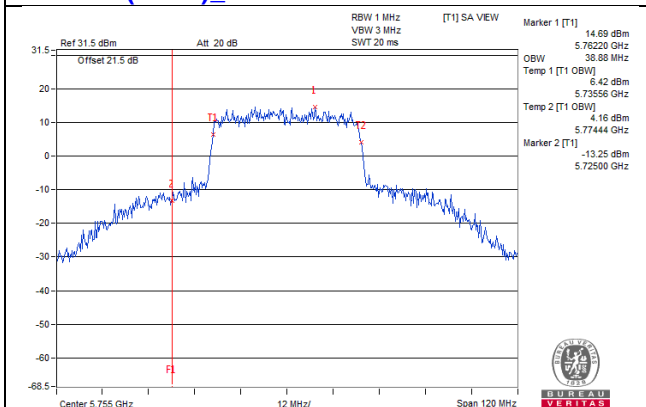

802.11ax (HE40)\_Chain 1 / CH151

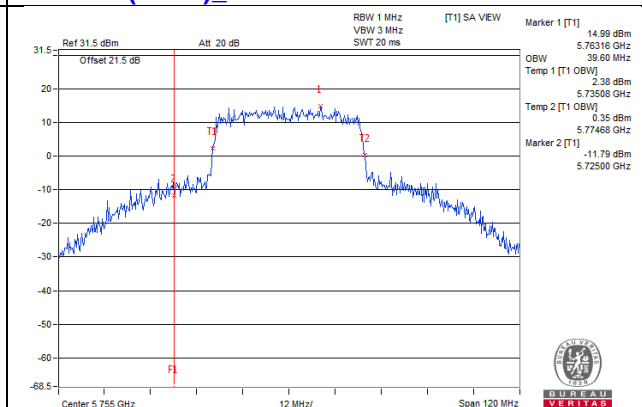

802.11ax (HE80)\_Chain 0 / CH155

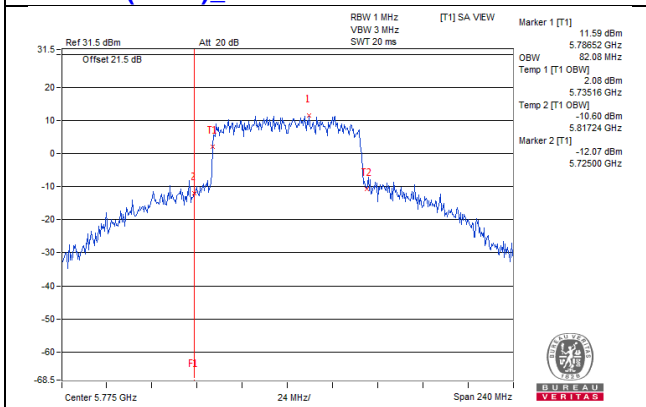

802.11ax (HE80)\_Chain 1 / CH155

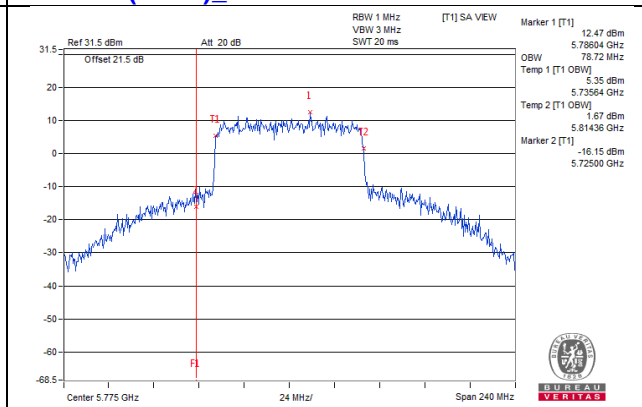

## 4.4.6 Test Results (Mode 3)

## 802.11a

Channel	Channel Frequency (MHz)	Occupied Bandwidth (MHz)
36	5180	18.36
40	5200	24.84
48	5240	18.00
149	5745	33.96
157	5785	35.40
165	5825	34.92

## 802.11ax (HE20)

Channel	Channel Frequency (MHz)	Occupied Bandwidth (MHz)
36	5180	19.08
40	5200	20.88
48	5240	19.08
149	5745	33.84
157	5785	33.36
165	5825	36.12

## 802.11ax (HE40)

Channel	Channel Frequency (MHz)	Occupied Bandwidth (MHz)
38	5190	38.16
46	5230	38.64
151	5755	45.12
159	5795	71.04

## 802.11ax (HE80)

Channel	Channel Frequency (MHz)	Occupied Bandwidth (MHz)
42	5210	77.28
155	5775	78.72

### Spectrum Plot of Max Value

#### 802.11a / CH157

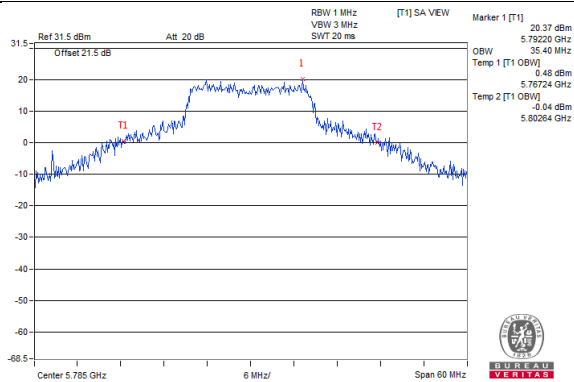

#### 802.11ax (HE20) / CH165

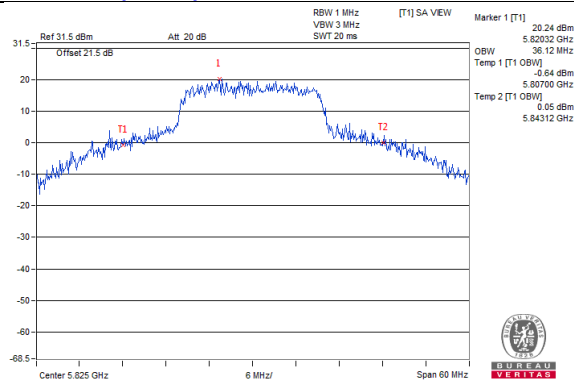

#### 802.11ax (HE40) / CH159

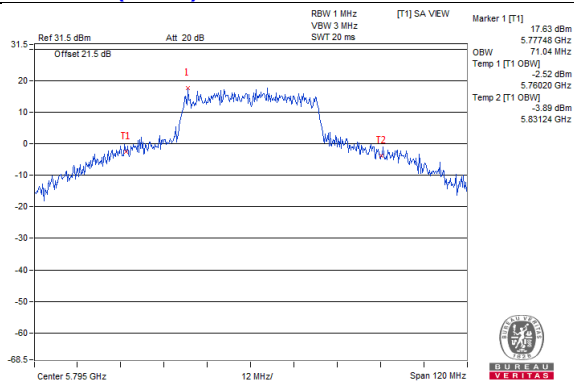

#### 802.11ax (HE80) / CH155

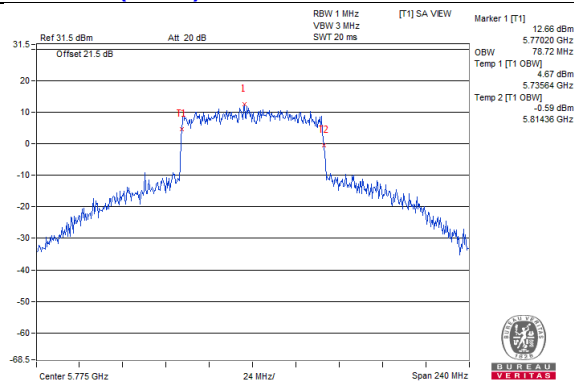

**Spectrum Plot for near by DFS band  
(DFS is required, if 99% OCP straddle into U-NII-2A band)**

**802.11a / CH48**

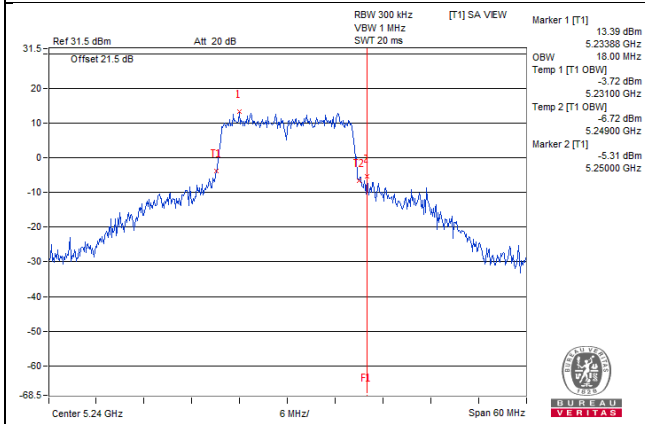

**802.11ax (HE20) / CH48**

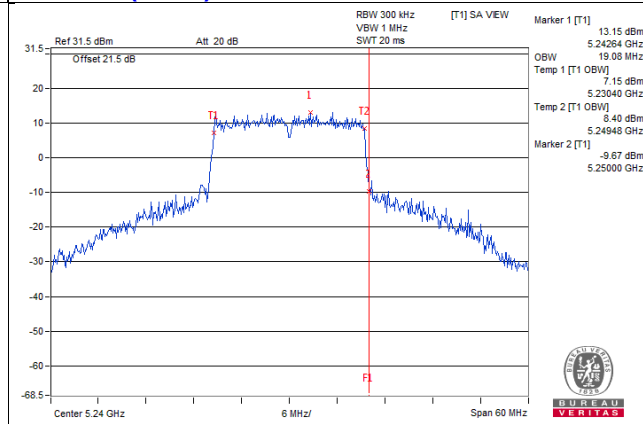

**802.11ax (HE40) / CH46**

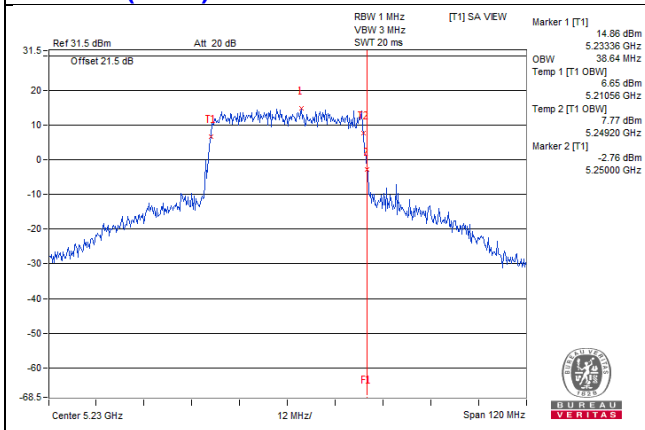

**802.11ax (HE80) / CH42**

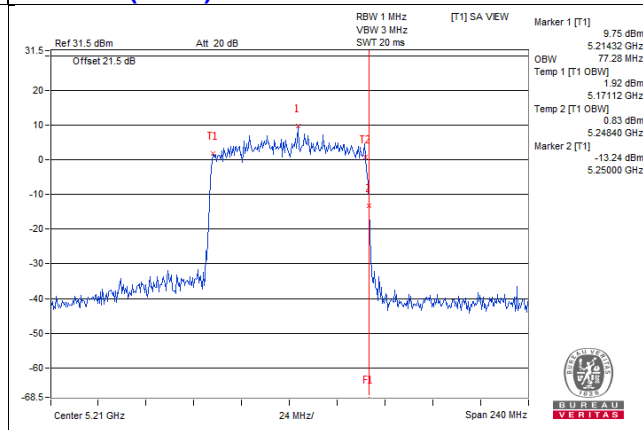

**Spectrum Plot for near by DFS band  
(DFS is required, if 99% OCP straddle into U-NII-2C band)**

**802.11a / CH149**

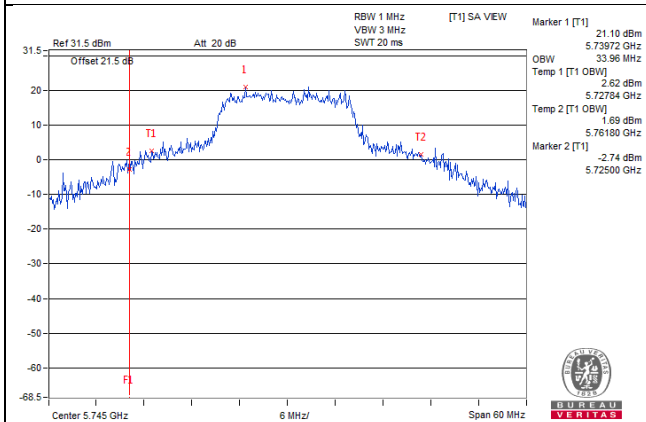

**802.11ax (HE20) / CH149**

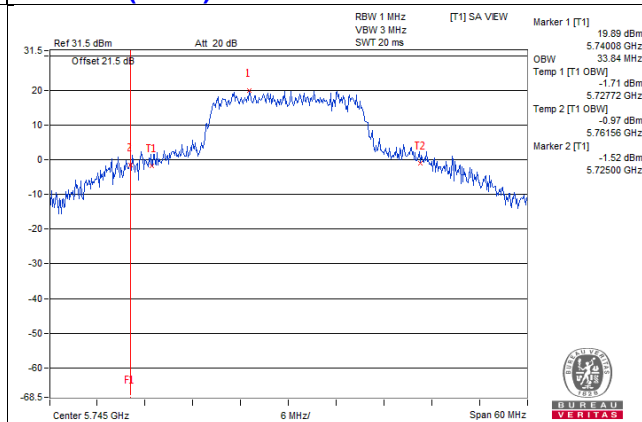

**802.11ax (HE40) / CH151**

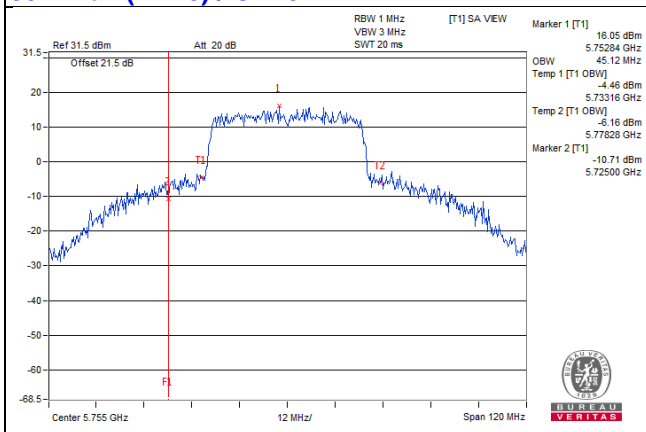

**802.11ax (HE80) / CH155**

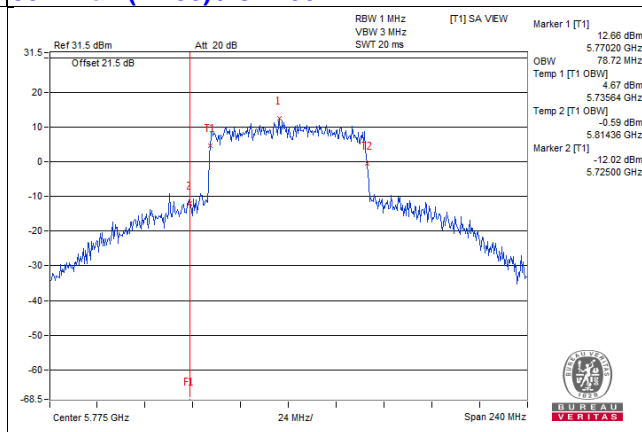

## 4.5 Peak Power Spectral Density Measurement

### 4.5.1 Limits of Peak Power Spectral Density Measurement

Operation Band	EUT Category		Limit
U-NII-1		Outdoor Access Point	17dBm/ MHz
		Fixed point-to-point Access Point	
	√	Indoor Access Point	
		Client device	11dBm/ MHz
U-NII-2A	---		11dBm/ MHz
U-NII-2C	---		11dBm/ MHz
U-NII-3	√		30dBm/ 500kHz

### 4.5.2 Test Setup



### 4.5.3 Test Instruments

Refer to section 4.1.2 to get information of above instrument.

### 4.5.4 Test Procedure

#### For U-NII-1:

Using method SA-2

1. Set span to encompass the entire emission bandwidth (EBW) of the signal.
2. Set RBW = 1 MHz, Set VBW ≥ 3 MHz, Detector = RMS
3. Sweep time = auto, trigger set to "free run".
4. Trace average at least 100 traces in power averaging mode.
5. Record the max value and add 10 log (1/duty cycle)

#### For U-NII-3:

1. Set span to encompass the entire emission bandwidth (EBW) of the signal.
2. Set RBW = 300 kHz, Set VBW ≥ 1 MHz, Detector = RMS
3. Use the peak marker function to determine the maximum power level in any 300 kHz band segment within the fundamental EBW.
4. Scale the observed power level to an equivalent value in 500 kHz by adjusting (reducing) the measured power by a bandwidth correction factor (BWCF) where  $BWCF = 10\log(500\text{ kHz}/300\text{kHz})$
5. Sweep time = auto, trigger set to "free run".
6. Trace average at least 100 traces in power averaging mode.
7. Record the max value and add 10 log (1/duty cycle)

### 4.5.5 Deviation from Test Standard

No deviation.

### 4.5.6 EUT Operating Condition

Same as Item 4.3.6.

#### 4.5.7 Test Results (Mode 1)

##### For U-NII-1:

##### 802.11a

Chan.	Chan. Freq. (MHz)	PSD W/O Duty Factor (dBm)				Duty Factor (dB)	Total PSD With Duty Factor (dBm)	MAX. Limit (dBm/MHz)	Pass / Fail
		Chain 0	Chain 1	Chain 2	Chain 3				
36	5180	6.80	5.68	5.65	5.39	0.32	12.26	14.60	Pass
40	5200	6.59	5.86	7.50	6.20	0.32	12.92	14.60	Pass
48	5240	6.32	6.40	6.21	6.54	0.32	12.71	14.60	Pass

- Note:**
- Method a) of power density measurement of KDB 662911 is using for calculating total power density. Total power density is summing entire spectra across corresponding frequency bins on the various outputs by computer.
  - Directional gain = 8.40dBi > 6dBi, so the power density limit shall be reduced to  $17-(8.40-6) = 14.60\text{dBm}$ .
  - Refer to section 3.3 for duty cycle spectrum plot.

##### 802.11ac (VHT20)

Chan.	Chan. Freq. (MHz)	PSD W/O Duty Factor (dBm)				Duty Factor (dB)	Total PSD With Duty Factor (dBm)	MAX. Limit (dBm/MHz)	Pass / Fail
		Chain 0	Chain 1	Chain 2	Chain 3				
36	5180	5.35	5.14	4.95	5.18	0.17	11.35	14.60	Pass
40	5200	7.50	7.12	5.09	6.26	0.17	12.78	14.60	Pass
48	5240	7.19	6.35	7.17	7.34	0.17	13.22	14.60	Pass

- Note:**
- Method a) of power density measurement of KDB 662911 is using for calculating total power density. Total power density is summing entire spectra across corresponding frequency bins on the various outputs by computer.
  - Directional gain = 8.40dBi > 6dBi, so the power density limit shall be reduced to  $17-(8.40-6) = 14.60\text{dBm}$ .
  - Refer to section 3.3 for duty cycle spectrum plot.

##### 802.11ac (VHT40)

Chan.	Chan. Freq. (MHz)	PSD W/O Duty Factor (dBm)				Duty Factor (dB)	Total PSD With Duty Factor (dBm)	MAX. Limit (dBm/MHz)	Pass / Fail
		Chain 0	Chain 1	Chain 2	Chain 3				
38	5190	-1.20	-0.98	-2.87	-0.29	0.17	4.95	14.60	Pass
46	5230	3.66	3.53	3.26	2.80	0.17	9.52	14.60	Pass

- Note:**
- Method a) of power density measurement of KDB 662911 is using for calculating total power density. Total power density is summing entire spectra across corresponding frequency bins on the various outputs by computer.
  - Directional gain = 8.40dBi > 6dBi, so the power density limit shall be reduced to  $17-(8.40-6) = 14.60\text{dBm}$ .
  - Refer to section 3.3 for duty cycle spectrum plot.

### 802.11ac (VHT80)

Chan.	Chan. Freq. (MHz)	PSD W/O Duty Factor (dBm)				Duty Factor (dB)	Total PSD With Duty Factor (dBm)	MAX. Limit (dBm/MHz)	Pass / Fail
		Chain 0	Chain 1	Chain 2	Chain 3				
42	5210	-5.37	-5.64	-6.37	-4.56	0.18	0.76	14.60	Pass

- Note:**
- Method a) of power density measurement of KDB 662911 is using for calculating total power density. Total power density is summing entire spectra across corresponding frequency bins on the various outputs by computer.
  - Directional gain = 8.40dBi > 6dBi, so the power density limit shall be reduced to  $17-(8.40-6) = 14.60\text{dBm}$ .
  - Refer to section 3.3 for duty cycle spectrum plot.

### 802.11ac (VHT80+80)

Chan.	Chan. Freq. (MHz)	PSD W/O Duty Factor (dBm)				Duty Factor (dB)	Total Power Density (dBm/MHz)	MAX. Limit (dBm/MHz)	Pass / Fail
		Chain 0	Chain 1	Chain 2	Chain 3				
42+155	5210	-5.58	-5.12	-	-	0.16	-2.17	14.60	Pass
	5775	Test results refer to U_NII-3 data							

- Note:**
- Method a) of power density measurement of KDB 662911 is using for calculating total power density. Total power density is summing entire spectra across corresponding frequency bins on the various outputs by computer.
  - Directional gain = 8.40dBi > 6dBi, so the power density limit shall be reduced to  $17-(8.40-6) = 14.60\text{dBm}$ .
  - Refer to section 3.3 for duty cycle spectrum plot.



### 802.11ax (HE20)

Chan.	Chan. Freq. (MHz)	PSD W/O Duty Factor (dBm)				Duty Factor (dB)	Total PSD With Duty Factor (dBm)	MAX. Limit (dBm/MHz)	Pass / Fail
		Chain 0	Chain 1	Chain 2	Chain 3				
36	5180	6.12	4.63	5.76	5.89	0.20	11.86	14.60	Pass
40	5200	5.21	6.69	7.14	6.87	0.20	12.76	14.60	Pass
48	5240	6.92	6.50	6.44	6.74	0.20	12.87	14.60	Pass

- Note:**
- Method a) of power density measurement of KDB 662911 is using for calculating total power density. Total power density is summing entire spectra across corresponding frequency bins on the various outputs by computer.
  - Directional gain = 8.40dBi > 6dBi, so the power density limit shall be reduced to  $17-(8.40-6) = 14.60\text{dBm}$ .
  - Refer to section 3.3 for duty cycle spectrum plot.

### 802.11ax (HE40)

Chan.	Chan. Freq. (MHz)	PSD W/O Duty Factor (dBm)				Duty Factor (dB)	Total PSD With Duty Factor (dBm)	MAX. Limit (dBm/MHz)	Pass / Fail
		Chain 0	Chain 1	Chain 2	Chain 3				
38	5190	-1.40	-0.74	-2.95	0.03	0.17	5.06	14.60	Pass
46	5230	3.89	3.72	3.19	2.45	0.17	9.54	14.60	Pass

- Note:**
- Method a) of power density measurement of KDB 662911 is using for calculating total power density. Total power density is summing entire spectra across corresponding frequency bins on the various outputs by computer.
  - Directional gain = 8.40dBi > 6dBi, so the power density limit shall be reduced to  $17-(8.40-6) = 14.60\text{dBm}$ .
  - Refer to section 3.3 for duty cycle spectrum plot.

### 802.11ax (HE80)

Chan.	Chan. Freq. (MHz)	PSD W/O Duty Factor (dBm)				Duty Factor (dB)	Total PSD With Duty Factor (dBm)	MAX. Limit (dBm/MHz)	Pass / Fail
		Chain 0	Chain 1	Chain 2	Chain 3				
42	5210	-0.58	-5.08	-5.29	-5.53	0.17	2.63	14.60	Pass

- Note:**
- Method a) of power density measurement of KDB 662911 is using for calculating total power density. Total power density is summing entire spectra across corresponding frequency bins on the various outputs by computer.
  - Directional gain = 8.40dBi > 6dBi, so the power density limit shall be reduced to  $17-(8.40-6) = 14.60\text{dBm}$ .
  - Refer to section 3.3 for duty cycle spectrum plot.

**802.11ax (HE80+80)**

Chan.	Chan. Freq. (MHz)	PSD W/O Duty Factor (dBm)				Duty Factor (dB)	Total Power Density (dBm/MHz)	MAX. Limit (dBm/MHz)	Pass / Fail
		Chain 0	Chain 1	Chain 2	Chain 3				
42+155	5210	-4.67	-4.92	-	-	0.19	-1.60	14.60	Pass
	5775	Test results refer to U_NII-3 data							

- Note:**
1. Method a) of power density measurement of KDB 662911 is using for calculating total power density. Total power density is summing entire spectra across corresponding frequency bins on the various outputs by computer.
  2. Directional gain = 8.40dBi > 6dBi, so the power density limit shall be reduced to  $17-(8.40-6) = 14.60\text{dBm}$ .
  3. Refer to section 3.3 for duty cycle spectrum plot.

### Spectrum Plot of Worst Value

**802.11a\_Chain 2 / CH40**

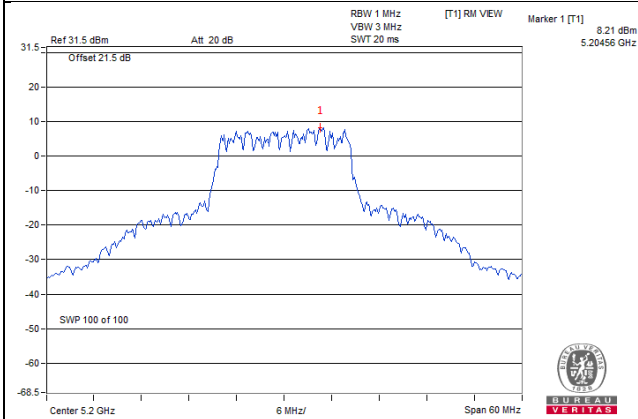

**802.11ac (VHT20)\_Chain 0 / CH40**

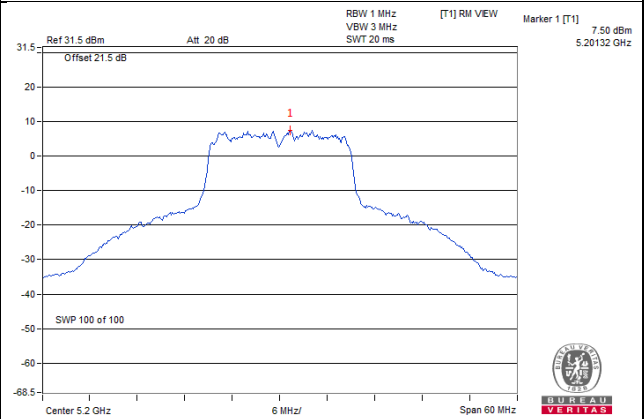

**802.11ac (VHT40)\_Chain 0 / CH46**

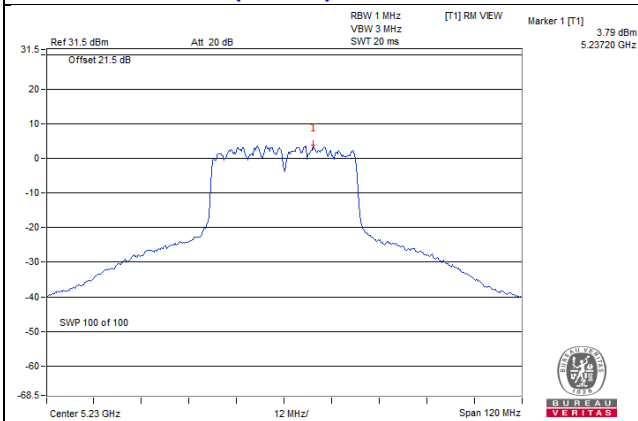

**802.11ac (VHT80)\_Chain 3 / CH42**

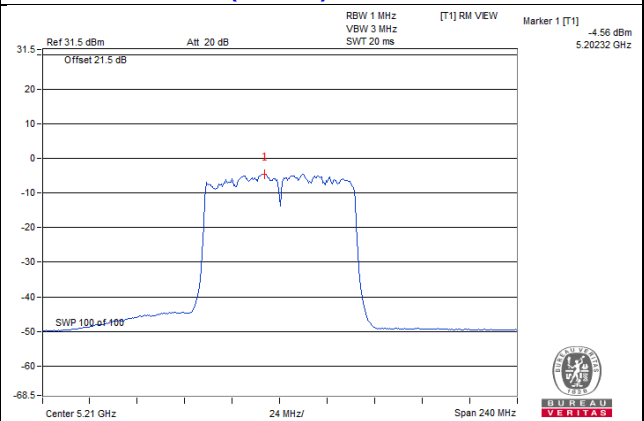

**802.11ac (VHT80+80)\_Chain 1 / CH42**

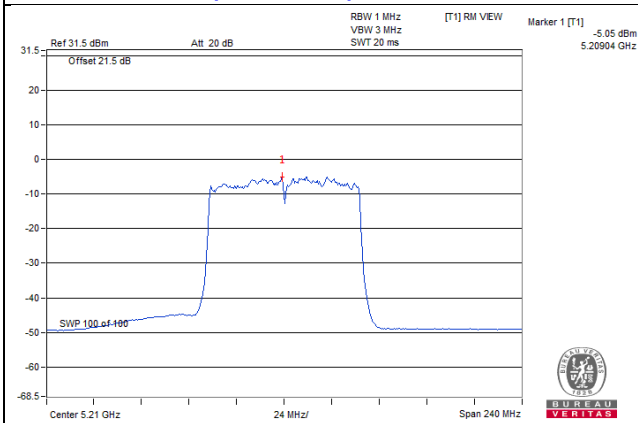

### Spectrum Plot of Worst Value

**802.11ax (HE20)\_Chain 2 / CH40**

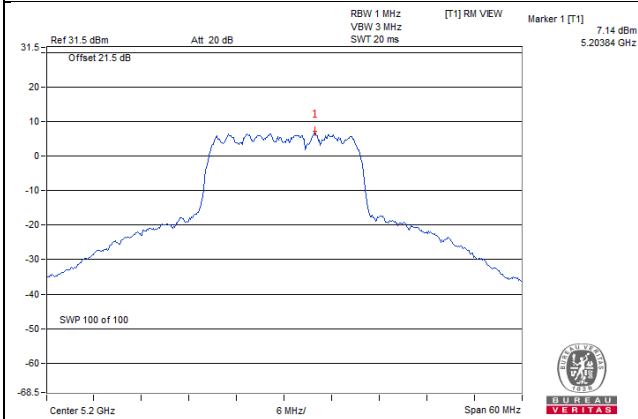

**802.11ax (HE40)\_Chain 0 / CH46**

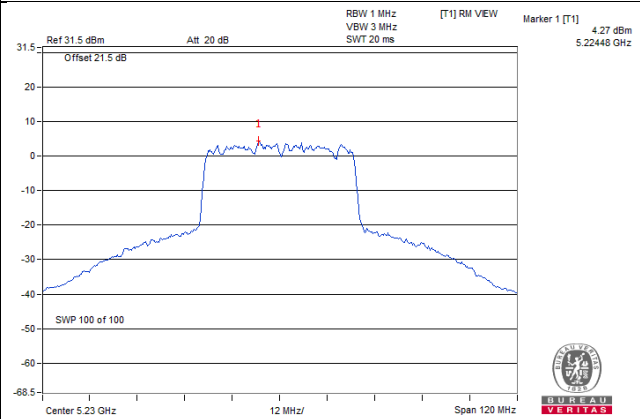

**802.11ax (HE80)\_Chain 0 / CH42**

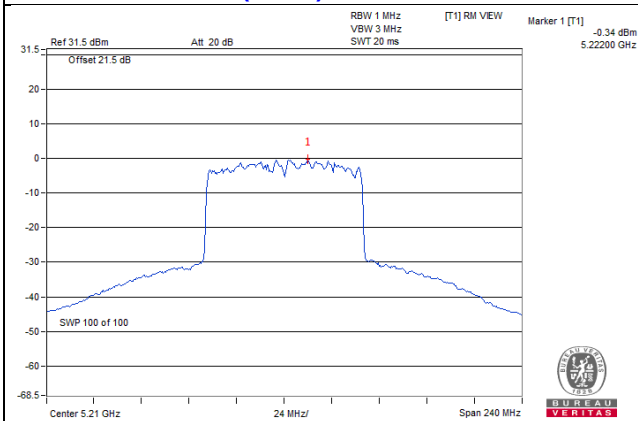

**802.11ax (HE80+80)\_Chain 0 / CH42**

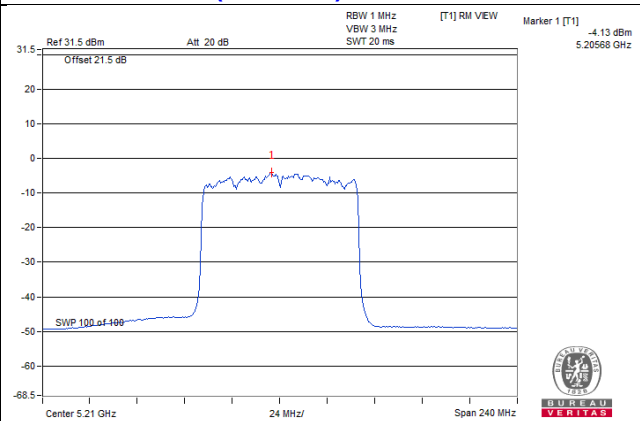

### For U-NII-3:

#### 802.11a

Chan.	Freq. (MHz)	PSD W/O Duty Factor (dBm/300kHz)				Duty Factor (dB)	Total PSD With Duty Factor		Total PSD With Duty Factor (dBm/500kHz)	Limit (dBm/500kHz)	Pass /Fail
		Chain 0	Chain 1	Chain 2	Chain 3		mW/300kHz	dBm/300kHz			
149	5745	1.09	0.94	1.00	1.44	0.32	5.5707	7.46	9.68	27.89	Pass
157	5785	1.35	0.85	0.91	1.96	0.32	5.7914	7.63	9.85	27.89	Pass
165	5825	1.09	0.69	0.73	1.75	0.32	5.5253	7.42	9.64	27.89	Pass

Note: 1. Method b) Measure and sum spectral maxima across the outputs of KDB 662911 is using for calculating total power density.

2. Directional gain = 8.11dBi > 6dBi, so the power density limit shall be reduced to 30-(8.11-6) = 27.89dBm.

3. Refer to section 3.3 for duty cycle spectrum plot.

#### 802.11ac (VHT20)

Chan.	Freq. (MHz)	PSD W/O Duty Factor (dBm/300kHz)				Duty Factor (dB)	Total PSD With Duty Factor		Total PSD With Duty Factor (dBm/500kHz)	Limit (dBm/500kHz)	Pass /Fail
		Chain 0	Chain 1	Chain 2	Chain 3		mW/300kHz	dBm/300kHz			
149	5745	1.47	1.28	0.64	1.71	0.17	5.6004	7.48	9.70	27.89	Pass
157	5785	0.89	1.07	0.94	1.14	0.17	5.2488	7.20	9.42	27.89	Pass
165	5825	1.47	1.28	0.64	1.71	0.17	5.2998	7.24	9.46	27.89	Pass

Note: 1. Method b) Measure and sum spectral maxima across the outputs of KDB 662911 is using for calculating total power density.

2. Directional gain = 8.11dBi > 6dBi, so the power density limit shall be reduced to 30-(8.11-6) = 27.89dBm.

3. Refer to section 3.3 for duty cycle spectrum plot.

#### 802.11ac (VHT40)

Chan.	Freq. (MHz)	PSD W/O Duty Factor (dBm/300kHz)				Duty Factor (dB)	Total PSD With Duty Factor		Total PSD With Duty Factor (dBm/500kHz)	Limit (dBm/500kHz)	Pass /Fail
		Chain 0	Chain 1	Chain 2	Chain 3		mW/300kHz	dBm/300kHz			
151	5755	-4.16	-4.48	-5.23	-3.63	0.17	1.5312	1.85	4.07	27.89	Pass
159	5795	-2.42	-2.43	-1.51	-2.35	0.17	2.5278	4.03	6.25	27.89	Pass

Note: 1. Method b) Measure and sum spectral maxima across the outputs of KDB 662911 is using for calculating total power density.

2. Directional gain = 8.11dBi > 6dBi, so the power density limit shall be reduced to 30-(8.11-6) = 27.89dBm.

3. Refer to section 3.3 for duty cycle spectrum plot.

### 802.11ac (VHT80)

Chan.	Freq. (MHz)	PSD W/O Duty Factor (dBm/300kHz)				Duty Factor (dB)	Total PSD With Duty Factor		Total PSD With Duty Factor (dBm/500kHz)	Limit (dBm/500kHz)	Pass /Fail
		Chain 0	Chain 1	Chain 2	Chain 3		mW/300kHz	dBm/300kHz			
155	5775	-8.91	-8.84	-9.47	-8.89	0.18	0.5222	-2.82	-0.60	27.89	Pass

- Note: 1. Method b) Measure and sum spectral maxima across the outputs of KDB 662911 is using for calculating total power density.
2. Directional gain = 8.11dBi > 6dBi, so the power density limit shall be reduced to  $30-(8.11-6) = 27.89$ dBm.
3. Refer to section 3.3 for duty cycle spectrum plot.

### 802.11ac (VHT80+80)

Chan.	Freq. (MHz)	PSD W/O Duty Factor (dBm/300kHz)				Duty Factor (dB)	Total PSD With Duty Factor		Total PSD With Duty Factor (dBm/500kHz)	Limit (dBm/500kHz)	Pass /Fail
		Chain 0	Chain 1	Chain 2	Chain 3		mW/300kHz	dBm/300kHz			
42+155	5210	Pass Test results refer to U_NII-1 data									
	5775	-	-	-13.92	-14.04	0.16	0.08309	-10.80	-8.58	27.89	Pass

- Note: 1. Method b) Measure and sum spectral maxima across the outputs of KDB 662911 is using for calculating total power density.
2. Directional gain = 8.11dBi > 6dBi, so the power density limit shall be reduced to  $30-(8.11-6) = 27.89$ dBm.
3. Refer to section 3.3 for duty cycle spectrum plot.

### 802.11ax (HE20)

Chan.	Freq. (MHz)	PSD W/O Duty Factor (dBm/300kHz)				Duty Factor (dB)	Total PSD With Duty Factor		Total PSD With Duty Factor (dBm/500kHz)	Limit (dBm/500kHz)	Pass /Fail
		Chain 0	Chain 1	Chain 2	Chain 3		mW/300kHz	dBm/300kHz			
149	5745	0.29	0.74	0.25	0.36	0.20	4.6088	6.64	8.86	27.89	Pass
157	5785	0.22	0.23	0.07	0.43	0.20	4.4268	6.46	8.68	27.89	Pass
165	5825	0.38	0.27	0.09	0.53	0.20	4.5102	6.54	8.76	27.89	Pass

- Note: 1. Method b) Measure and sum spectral maxima across the outputs of KDB 662911 is using for calculating total power density.  
 2. Directional gain = 8.11dBi > 6dBi, so the power density limit shall be reduced to  $30 - (8.11 - 6) = 27.89$ dBm.  
 3. Refer to section 3.3 for duty cycle spectrum plot.

### 802.11ax (HE40)

Chan.	Freq. (MHz)	PSD W/O Duty Factor (dBm/300kHz)				Duty Factor (dB)	Total PSD With Duty Factor		Total PSD With Duty Factor (dBm/500kHz)	Limit (dBm/500kHz)	Pass /Fail
		Chain 0	Chain 1	Chain 2	Chain 3		mW/300kHz	dBm/300kHz			
151	5755	-3.71	-4.80	-4.43	-3.59	0.17	1.6168	2.09	4.31	27.89	Pass
159	5795	-2.29	-2.20	-2.25	-2.95	0.17	2.3869	3.78	6.00	27.89	Pass

- Note: 1. Method b) Measure and sum spectral maxima across the outputs of KDB 662911 is using for calculating total power density.  
 2. Directional gain = 8.11dBi > 6dBi, so the power density limit shall be reduced to  $30 - (8.11 - 6) = 27.89$ dBm.  
 3. Refer to section 3.3 for duty cycle spectrum plot.

### 802.11ax (HE80)

Chan.	Freq. (MHz)	PSD W/O Duty Factor (dBm/300kHz)				Duty Factor (dB)	Total PSD With Duty Factor		Total PSD With Duty Factor (dBm/500kHz)	Limit (dBm/500kHz)	Pass /Fail
		Chain 0	Chain 1	Chain 2	Chain 3		mW/300kHz	dBm/300kHz			
155	5775	-8.42	-8.99	-9.32	-8.85	0.17	0.5382	-2.69	-0.47	27.89	Pass

- Note: 1. Method b) Measure and sum spectral maxima across the outputs of KDB 662911 is using for calculating total power density.  
 2. Directional gain = 8.11dBi > 6dBi, so the power density limit shall be reduced to  $30 - (8.11 - 6) = 27.89$ dBm.  
 3. Refer to section 3.3 for duty cycle spectrum plot.

### 802.11ax (HE80+80)

Chan.	Freq. (MHz)	PSD W/O Duty Factor (dBm/300kHz)				Duty Factor (dB)	Total PSD With Duty Factor		Total PSD With Duty Factor (dBm/500kHz)	Limit (dBm/ 500kHz)	Pass /Fail
		Chain 0	Chain 1	Chain 2	Chain 3		mW/ 300kHz	dBm/ 300kHz			
42+155	5210	Test results refer to U_NII-1 data									
	5775	-	-	-13.94	-13.82	0.19	0.08547	-10.68	-8.46	27.89	Pass

- Note:
- Method b) Measure and sum spectral maxima across the outputs of KDB 662911 is using for calculating total power density.
  - Directional gain = 8.11dBi > 6dBi, so the power density limit shall be reduced to  $30 - (8.11 - 6) = 27.89$ dBm.
  - Refer to section 3.3 for duty cycle spectrum plot.



### Spectrum Plot of Worst Value

**802.11a / Chain 3 : CH157**

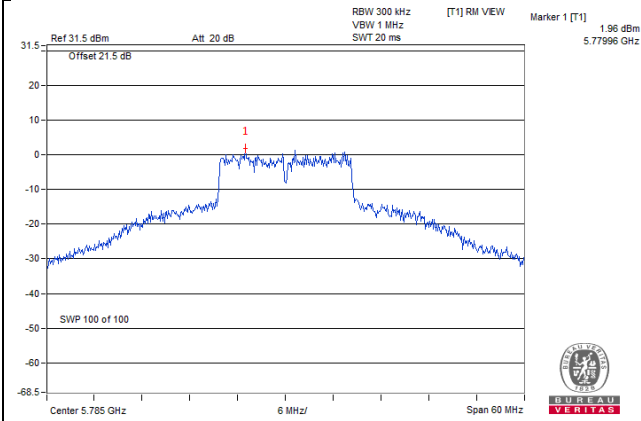

**802.11ac (VHT20) / Chain 3 : CH149**

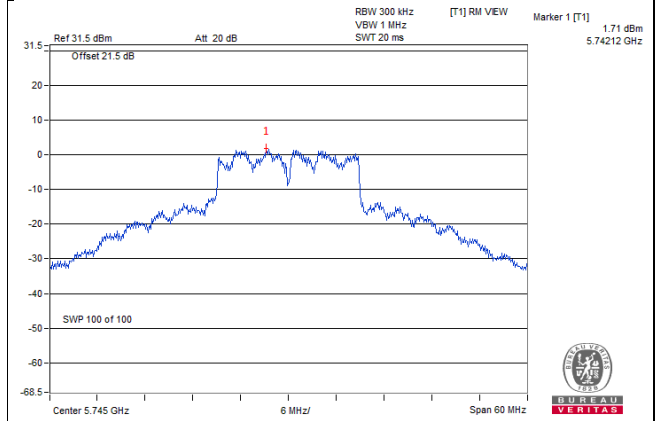

**802.11ac (VHT40) / Chain 2 : CH159**

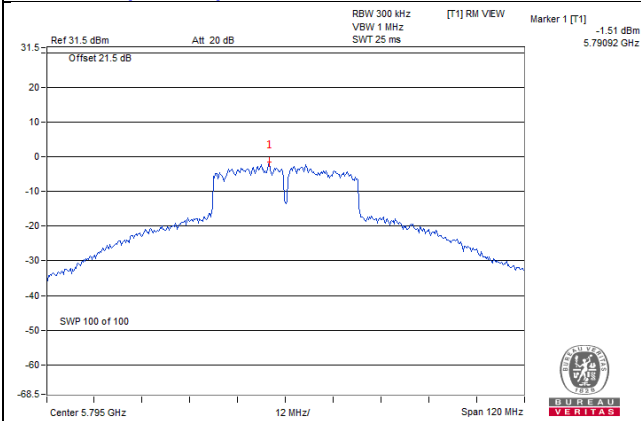

**802.11ac (VHT80) / Chain 1 : CH155**

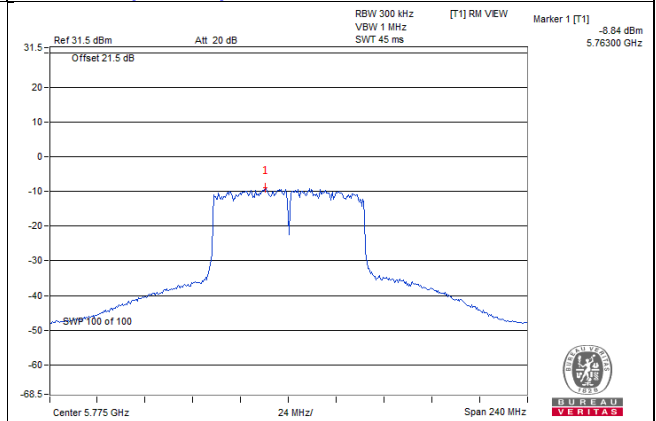

**802.11ac (VHT80+80) / Chain 2 : CH155**

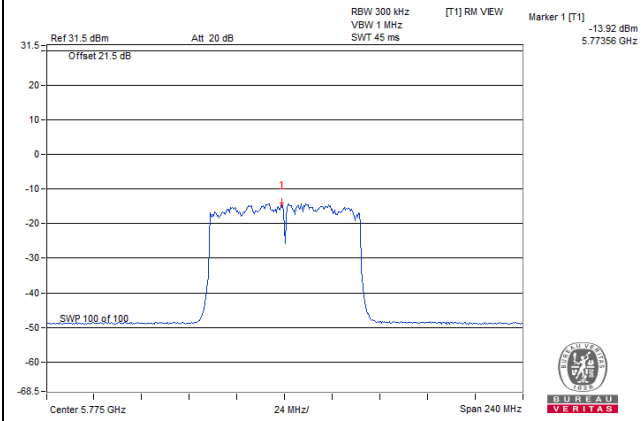

### Spectrum Plot of Worst Value

**802.11ax (HE20) / Chain 1 : CH149**

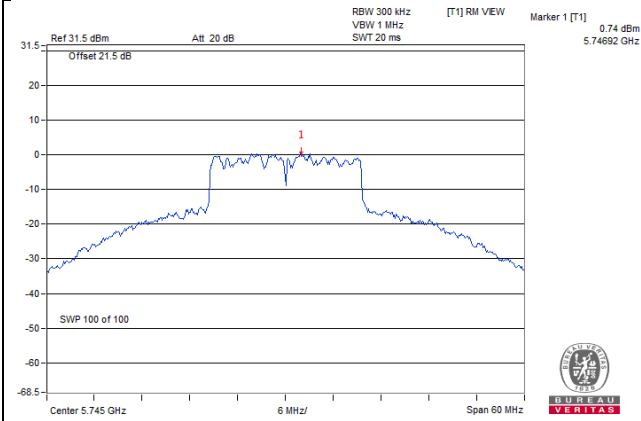

**802.11ax (HE40) / Chain 1 : CH159**

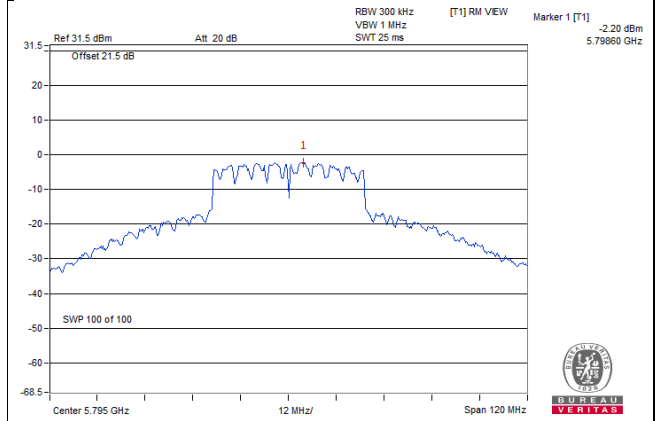

**802.11ax (HE80) / Chain 0 : CH155**

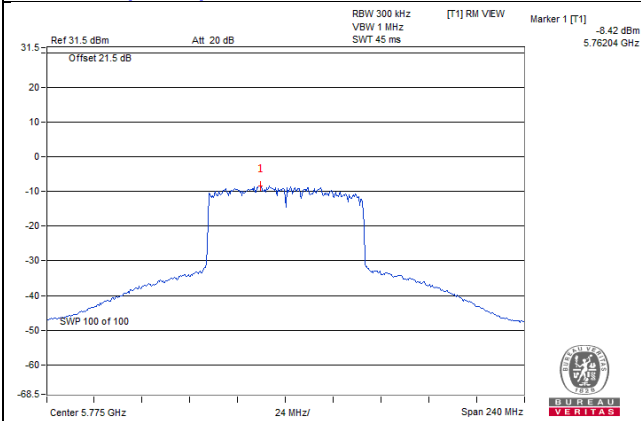

**802.11ax (HE80+80) / Chain 3 : CH155**

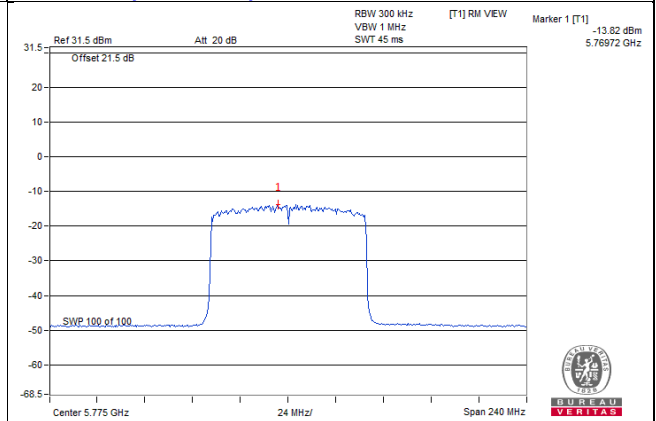

#### 4.5.8 Test Results (Mode 2)

##### For U-NII-1:

##### 802.11a

Chan.	Chan. Freq. (MHz)	PSD W/O Duty Factor (dBm)		Duty Factor (dB)	Total PSD With Duty Factor (dBm)	MAX. Limit (dBm/MHz)	Pass / Fail
		Chain 1	Chain 2				
36	5180	6.44	6.92	0.32	10.02	16.38	Pass
40	5200	7.92	7.43	0.32	11.01	16.38	Pass
48	5240	8.01	8.14	0.32	11.41	16.38	Pass

- Note:**
- Method a) of power density measurement of KDB 662911 is using for calculating total power density. Total power density is summing entire spectra across corresponding frequency bins on the various outputs by computer.
  - Directional gain = 6.62dBi > 6dBi, so the power density limit shall be reduced to  $17-(6.62-6) = 16.38\text{dBm}$ .
  - Refer to section 3.3 for duty cycle spectrum plot.

##### 802.11ac (VHT20)

Chan.	Chan. Freq. (MHz)	PSD W/O Duty Factor (dBm)		Duty Factor (dB)	Total PSD With Duty Factor (dBm)	MAX. Limit (dBm/MHz)	Pass / Fail
		Chain 1	Chain 2				
36	5180	4.40	6.83	0.17	8.96	16.38	Pass
40	5200	7.78	6.71	0.17	10.46	16.38	Pass
48	5240	7.40	7.91	0.17	10.84	16.38	Pass

- Note:**
- Method a) of power density measurement of KDB 662911 is using for calculating total power density. Total power density is summing entire spectra across corresponding frequency bins on the various outputs by computer.
  - Directional gain = 6.62dBi > 6dBi, so the power density limit shall be reduced to  $17-(6.62-6) = 16.38\text{dBm}$ .
  - Refer to section 3.3 for duty cycle spectrum plot.

##### 802.11ac (VHT40)

Chan.	Chan. Freq. (MHz)	PSD W/O Duty Factor (dBm)		Duty Factor (dB)	Total PSD With Duty Factor (dBm)	MAX. Limit (dBm/MHz)	Pass / Fail
		Chain 1	Chain 2				
38	5190	-0.75	-0.25	0.17	2.69	16.38	Pass
46	5230	3.85	4.32	0.17	7.27	16.38	Pass

- Note:**
- Method a) of power density measurement of KDB 662911 is using for calculating total power density. Total power density is summing entire spectra across corresponding frequency bins on the various outputs by computer.
  - Directional gain = 6.62dBi > 6dBi, so the power density limit shall be reduced to  $17-(6.62-6) = 16.38\text{dBm}$ .
  - Refer to section 3.3 for duty cycle spectrum plot.

### 802.11ac (VHT80)

Chan.	Chan. Freq. (MHz)	PSD W/O Duty Factor (dBm)		Duty Factor (dB)	Total PSD With Duty Factor (dBm)	MAX. Limit (dBm/MHz)	Pass / Fail
		Chain 1	Chain 2				
42	5210	-4.68	-3.85	0.18	-1.05	16.38	Pass

- Note:**
1. Method a) of power density measurement of KDB 662911 is using for calculating total power density. Total power density is summing entire spectra across corresponding frequency bins on the various outputs by computer.
  2. Directional gain = 6.62dBi > 6dBi, so the power density limit shall be reduced to  $17 - (6.62 - 6) = 16.38\text{dBm}$ .
  3. Refer to section 3.3 for duty cycle spectrum plot.

### 802.11ax (HE20)

Chan.	Chan. Freq. (MHz)	PSD W/O Duty Factor (dBm)		Duty Factor (dB)	Total PSD With Duty Factor (dBm)	MAX. Limit (dBm/MHz)	Pass / Fail
		Chain 1	Chain 2				
36	5180	4.83	7.00	0.20	9.26	16.38	Pass
40	5200	8.16	7.21	0.20	10.92	16.38	Pass
48	5240	7.08	7.41	0.20	10.46	16.38	Pass

- Note:**
- Method a) of power density measurement of KDB 662911 is using for calculating total power density. Total power density is summing entire spectra across corresponding frequency bins on the various outputs by computer.
  - Directional gain = 6.62dBi > 6dBi, so the power density limit shall be reduced to  $17-(6.62-6) = 16.38\text{dBm}$ .
  - Refer to section 3.3 for duty cycle spectrum plot.

### 802.11ax (HE40)

Chan.	Chan. Freq. (MHz)	PSD W/O Duty Factor (dBm)		Duty Factor (dB)	Total PSD With Duty Factor (dBm)	MAX. Limit (dBm/MHz)	Pass / Fail
		Chain 1	Chain 2				
38	5190	0.38	0.00	0.17	3.37	16.38	Pass
46	5230	4.04	3.97	0.17	7.19	16.38	Pass

- Note:**
- Method a) of power density measurement of KDB 662911 is using for calculating total power density. Total power density is summing entire spectra across corresponding frequency bins on the various outputs by computer.
  - Directional gain = 6.62dBi > 6dBi, so the power density limit shall be reduced to  $17-(6.62-6) = 16.38\text{dBm}$ .
  - Refer to section 3.3 for duty cycle spectrum plot.

### 802.11ax (HE80)

Chan.	Chan. Freq. (MHz)	PSD W/O Duty Factor (dBm)		Duty Factor (dB)	Total PSD With Duty Factor (dBm)	MAX. Limit (dBm/MHz)	Pass / Fail
		Chain 1	Chain 2				
42	5210	-5.09	-4.70	0.17	-1.71	16.38	Pass

- Note:**
- Method a) of power density measurement of KDB 662911 is using for calculating total power density. Total power density is summing entire spectra across corresponding frequency bins on the various outputs by computer.
  - Directional gain = 6.62dBi > 6dBi, so the power density limit shall be reduced to  $17-(6.62-6) = 16.38\text{dBm}$ .
  - Refer to section 3.3 for duty cycle spectrum plot.

### Spectrum Plot of Worst Value

#### 802.11a\_Chain 2 / CH48

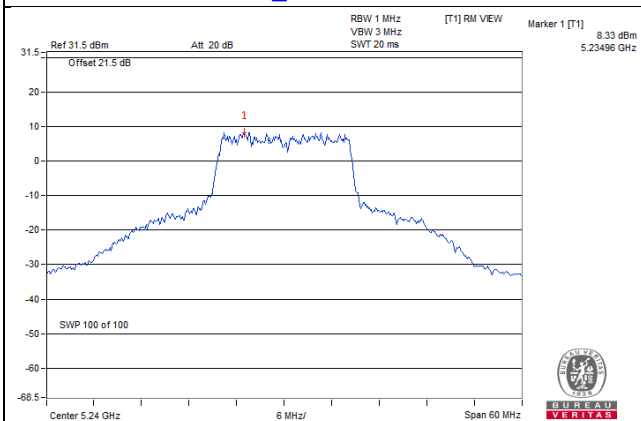

#### 802.11ac (VHT20)\_Chain 2 / CH48

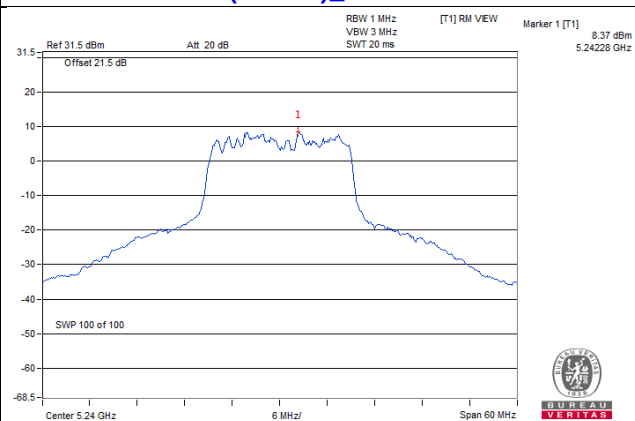

#### 802.11ac (VHT40)\_Chain 2 / CH46

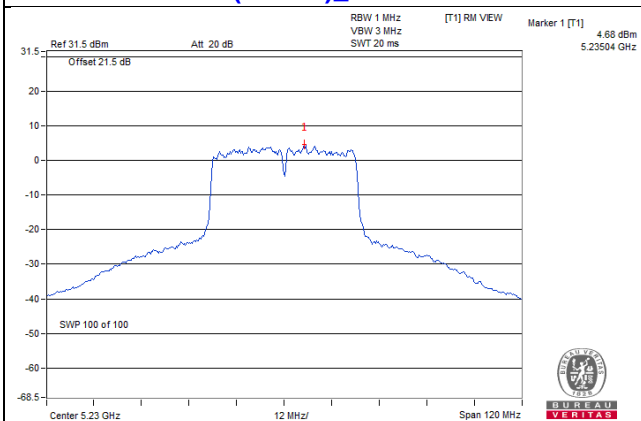

#### 802.11ac (VHT80)\_Chain 2 / CH42

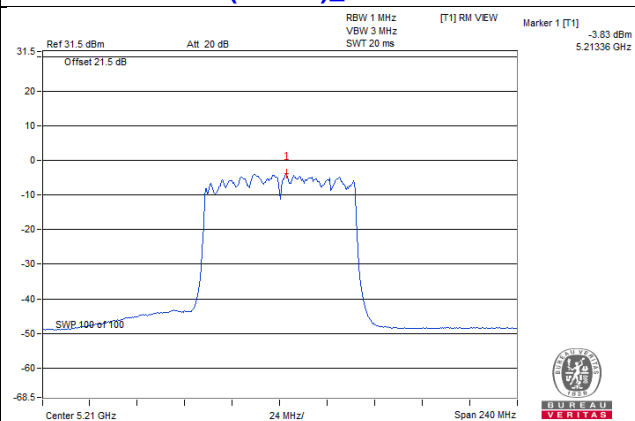

### Spectrum Plot of Worst Value

**802.11ax (HE20)\_Chain 1 / CH40**

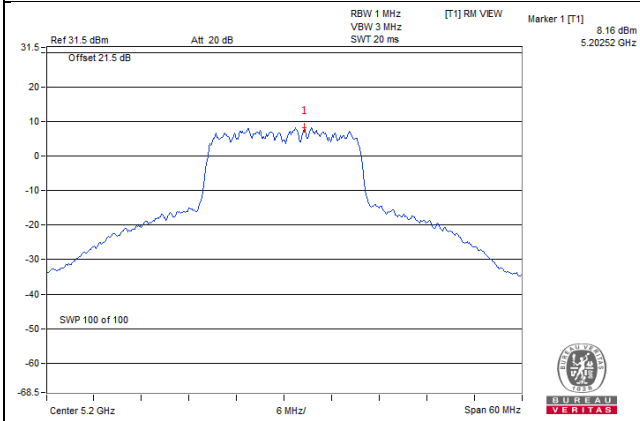

**802.11ax (HE40)\_Chain 1 / CH46**

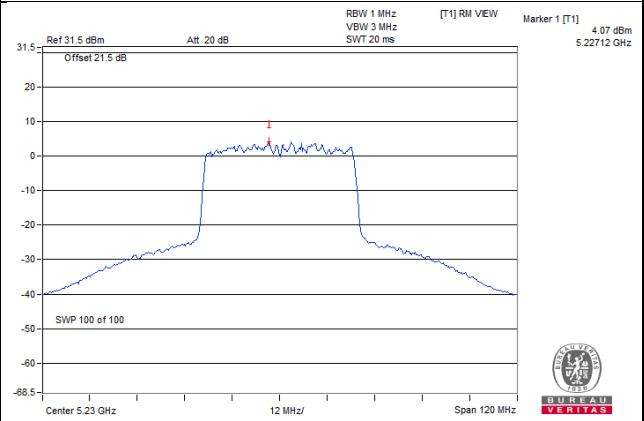

**802.11ax (HE80)\_Chain 2 / CH42**

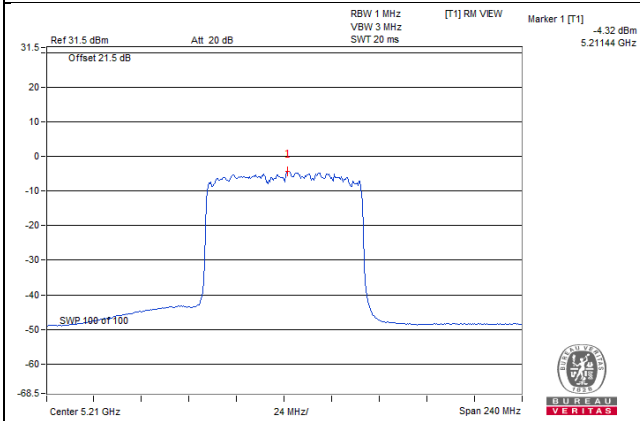

**For U-NII-3:**
**802.11a**

Chan.	Freq. (MHz)	PSD W/O Duty Factor (dBm/300kHz)		Duty Factor (dB)	Total PSD With Duty Factor		Total PSD With Duty Factor (dBm/500kHz)	Limit (dBm/500kHz)	Pass /Fail
		Chain 0	Chain 1		mW/300kHz	dBm/300kHz			
149	5745	0.94	1.00	0.32	2.6897	4.30	6.52	28.73	Pass
157	5785	0.85	0.91	0.32	2.6345	4.21	6.43	28.73	Pass
165	5825	0.69	0.73	0.32	2.5334	4.04	6.26	28.73	Pass

- Note: 1. Method b) Measure and sum spectral maxima across the outputs of KDB 662911 is using for calculating total power density.
2. Directional gain = 7.27dBi > 6dBi, so the power density limit shall be reduced to  $30 - (7.27 - 6) = 28.73\text{dBm}$ .
3. Refer to section 3.3 for duty cycle spectrum plot.

**802.11ac (VHT20)**

Chan.	Freq. (MHz)	PSD W/O Duty Factor (dBm/300kHz)		Duty Factor (dB)	Total PSD With Duty Factor		Total PSD With Duty Factor (dBm/500kHz)	Limit (dBm/500kHz)	Pass /Fail
		Chain 0	Chain 1		mW/300kHz	dBm/300kHz			
149	5745	1.28	0.64	0.17	2.6007	4.15	6.37	28.73	Pass
157	5785	1.07	0.94	0.17	2.621	4.18	6.40	28.73	Pass
165	5825	1.39	1.19	0.17	2.7992	4.47	6.69	28.73	Pass

- Note: 1. Method b) Measure and sum spectral maxima across the outputs of KDB 662911 is using for calculating total power density.
2. Directional gain = 7.27dBi > 6dBi, so the power density limit shall be reduced to  $30 - (7.27 - 6) = 28.73\text{dBm}$ .
3. Refer to section 3.3 for duty cycle spectrum plot.



### 802.11ac (VHT40)

Chan.	Freq. (MHz)	PSD W/O Duty Factor (dBm/300kHz)		Duty Factor (dB)	Total PSD With Duty Factor		Total PSD With Duty Factor (dBm/500kHz)	Limit (dBm/500kHz)	Pass /Fail
		Chain 0	Chain 1		mW/300kHz	dBm/300kHz			
151	5755	-4.48	-5.23	0.17	0.682	-1.66	0.56	28.73	Pass
159	5795	-2.43	-1.51	0.17	1.3277	1.23	3.45	28.73	Pass

- Note: 1. Method b) Measure and sum spectral maxima across the outputs of KDB 662911 is using for calculating total power density.
2. Directional gain = 7.27dBi > 6dBi, so the power density limit shall be reduced to  $30 - (7.27 - 6) = 28.73$ dBm.
3. Refer to section 3.3 for duty cycle spectrum plot.

### 802.11ac (VHT80)

Chan.	Freq. (MHz)	PSD W/O Duty Factor (dBm/300kHz)		Duty Factor (dB)	Total PSD With Duty Factor		Total PSD With Duty Factor (dBm/500kHz)	Limit (dBm/500kHz)	Pass /Fail
		Chain 0	Chain 1		mW/300kHz	dBm/300kHz			
155	5775	-6.92	-7.41	0.18	0.4009	-3.97	-1.75	28.73	Pass

- Note: 1. Method b) Measure and sum spectral maxima across the outputs of KDB 662911 is using for calculating total power density.
2. Directional gain = 7.27dBi > 6dBi, so the power density limit shall be reduced to  $30 - (7.27 - 6) = 28.73$ dBm.
3. Refer to section 3.3 for duty cycle spectrum plot.

### 802.11ax (HE20)

Chan.	Freq. (MHz)	PSD W/O Duty Factor (dBm/300kHz)		Duty Factor (dB)	Total PSD With Duty Factor		Total PSD With Duty Factor (dBm/500kHz)	Limit (dBm/500kHz)	Pass /Fail
		Chain 0	Chain 1		mW/300kHz	dBm/300kHz			
149	5745	0.74	0.25	0.20	2.3513	3.71	5.93	28.73	Pass
157	5785	0.23	0.07	0.20	2.1687	3.36	5.58	28.73	Pass
165	5825	0.27	0.09	0.20	2.1838	3.39	5.61	28.73	Pass

- Note: 1. Method b) Measure and sum spectral maxima across the outputs of KDB 662911 is using for calculating total power density.  
 2. Directional gain = 7.27dBi > 6dBi, so the power density limit shall be reduced to  $30-(7.27-6) = 28.73$ dBm.  
 3. Refer to section 3.3 for duty cycle spectrum plot.

### 802.11ax (HE40)

Chan.	Freq. (MHz)	PSD W/O Duty Factor (dBm/300kHz)		Duty Factor (dB)	Total PSD With Duty Factor		Total PSD With Duty Factor (dBm/500kHz)	Limit (dBm/500kHz)	Pass /Fail
		Chain 0	Chain 1		mW/300kHz	dBm/300kHz			
151	5755	-4.80	-4.43	0.17	0.7193	-1.43	0.79	28.73	Pass
159	5795	-2.20	-2.25	0.17	1.246	0.96	3.18	28.73	Pass

- Note: 1. Method b) Measure and sum spectral maxima across the outputs of KDB 662911 is using for calculating total power density.  
 2. Directional gain = 7.27dBi > 6dBi, so the power density limit shall be reduced to  $30-(7.27-6) = 28.73$ dBm.  
 3. Refer to section 3.3 for duty cycle spectrum plot.

### 802.11ax (HE80)

Chan.	Freq. (MHz)	PSD W/O Duty Factor (dBm/300kHz)		Duty Factor (dB)	Total PSD With Duty Factor		Total PSD With Duty Factor (dBm/500kHz)	Limit (dBm/500kHz)	Pass /Fail
		Chain 0	Chain 1		mW/300kHz	dBm/300kHz			
155	5775	-7.34	-7.68	0.17	0.3694	-4.33	-2.11	28.73	Pass

- Note: 1. Method b) Measure and sum spectral maxima across the outputs of KDB 662911 is using for calculating total power density.  
 2. Directional gain = 7.27dBi > 6dBi, so the power density limit shall be reduced to  $30-(7.27-6) = 28.73$ dBm.  
 3. Refer to section 3.3 for duty cycle spectrum plot.

### Spectrum Plot of Worst Value

**802.11a / Chain 1 : CH149**

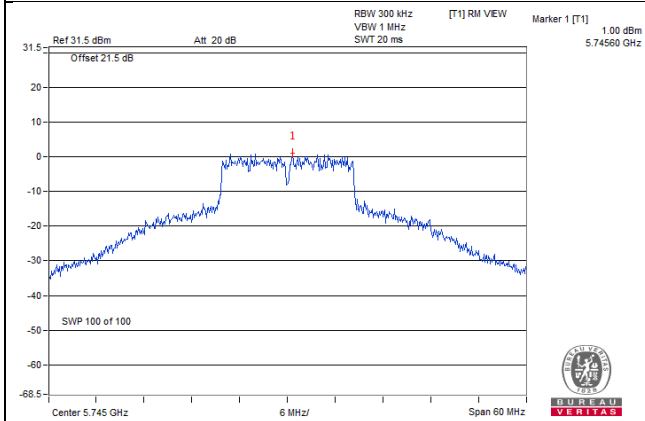

**802.11ac (VHT20) / Chain 0 : CH165**

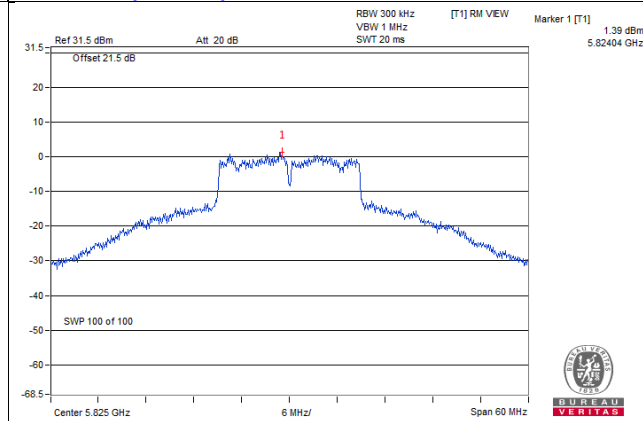

**802.11ac (VHT40) / Chain 1 : CH159**

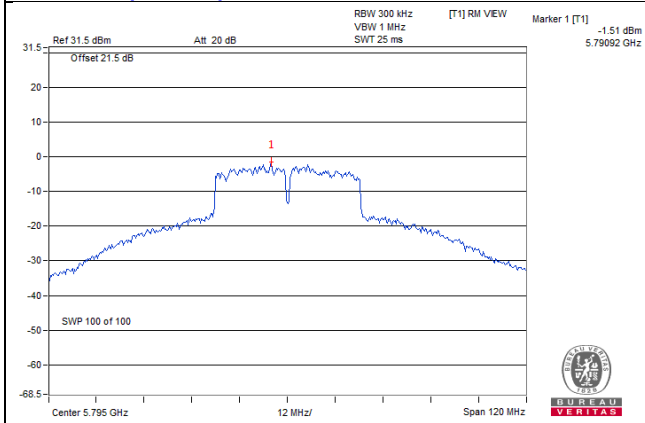

**802.11ac (VHT80) / Chain 0 : CH155**

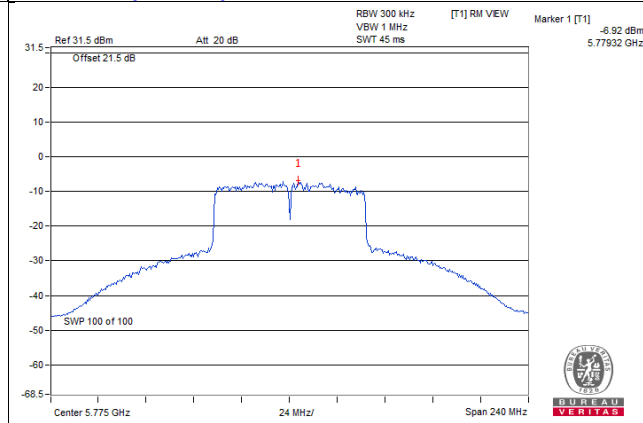

### Spectrum Plot of Worst Value

**802.11ax (HE20) / Chain 0 : CH149**

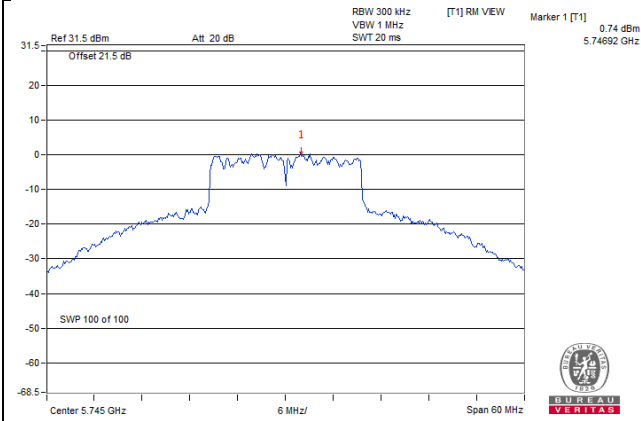

**802.11ax (HE40) / Chain 0 : CH159**

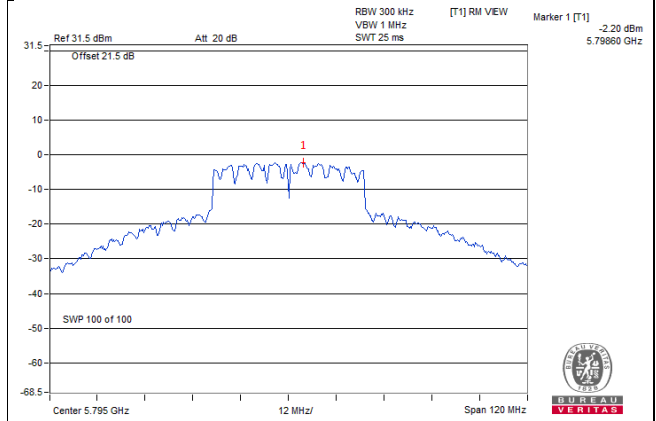

**802.11ax (HE80) / Chain 0 : CH155**

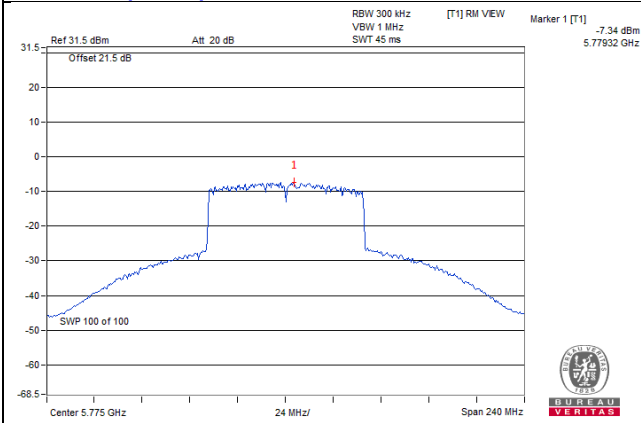

#### 4.5.9 Test Results (Mode 3)

##### For U-NII-1:

##### 802.11a

Chan.	Chan. Freq. (MHz)	PSD W/O Duty Factor (dBm/MHz)	Duty Factor (dB)	PSD With Duty Factor (dBm/MHz)	MAX. Limit (dBm/MHz)	Pass / Fail
36	5180	7.26	0.32	7.58	17.00	Pass
40	5200	8.81	0.32	9.13	17.00	Pass
48	5240	7.50	0.32	7.82	17.00	Pass

Note: 1. Refer to section 3.3 for duty cycle spectrum plot.

##### 802.11ac (VHT20)

Chan.	Chan. Freq. (MHz)	PSD W/O Duty Factor (dBm/MHz)	Duty Factor (dB)	PSD With Duty Factor (dBm/MHz)	MAX. Limit (dBm/MHz)	Pass / Fail
36	5180	6.86	0.17	7.03	17.00	Pass
40	5200	8.43	0.17	8.60	17.00	Pass
48	5240	7.91	0.17	8.08	17.00	Pass

Note: 1. Refer to section 3.3 for duty cycle spectrum plot.

##### 802.11ac (VHT40)

Chan.	Chan. Freq. (MHz)	PSD W/O Duty Factor (dBm/MHz)	Duty Factor (dB)	PSD With Duty Factor (dBm/MHz)	MAX. Limit (dBm/MHz)	Pass / Fail
38	5190	0.78	0.17	0.95	17.00	Pass
46	5230	4.50	0.17	4.67	17.00	Pass

Note: 1. Refer to section 3.3 for duty cycle spectrum plot.

##### 802.11ac (VHT80)

Chan.	Chan. Freq. (MHz)	PSD W/O Duty Factor (dBm/MHz)	Duty Factor (dB)	PSD With Duty Factor (dBm/MHz)	MAX. Limit (dBm/MHz)	Pass / Fail
42	5210	-4.24	0.18	-4.06	17.00	Pass

Note: 1. Refer to section 3.3 for duty cycle spectrum plot.

### 802.11ax (HE20)

Chan.	Chan. Freq. (MHz)	PSD W/O Duty Factor (dBm/MHz)	Duty Factor (dB)	PSD With Duty Factor (dBm/MHz)	MAX. Limit (dBm/MHz)	Pass / Fail
36	5180	6.20	0.20	6.40	17.00	Pass
40	5200	8.54	0.20	8.74	17.00	Pass
48	5240	7.79	0.20	7.99	17.00	Pass

Note: 1. Refer to section 3.3 for duty cycle spectrum plot.

### 802.11ax (HE40)

Chan.	Chan. Freq. (MHz)	PSD W/O Duty Factor (dBm/MHz)	Duty Factor (dB)	PSD With Duty Factor (dBm/MHz)	MAX. Limit (dBm/MHz)	Pass / Fail
38	5190	-0.05	0.17	0.12	17.00	Pass
46	5230	4.49	0.17	4.66	17.00	Pass

Note: 1. Refer to section 3.3 for duty cycle spectrum plot.

### 802.11ax (HE80)

Chan.	Chan. Freq. (MHz)	PSD W/O Duty Factor (dBm/MHz)	Duty Factor (dB)	PSD With Duty Factor (dBm/MHz)	MAX. Limit (dBm/MHz)	Pass / Fail
42	5210	-3.92	0.17	-3.75	17.00	Pass

Note: 1. Refer to section 3.3 for duty cycle spectrum plot.

### Spectrum Plot of Worst Value

**802.11a / CH40**

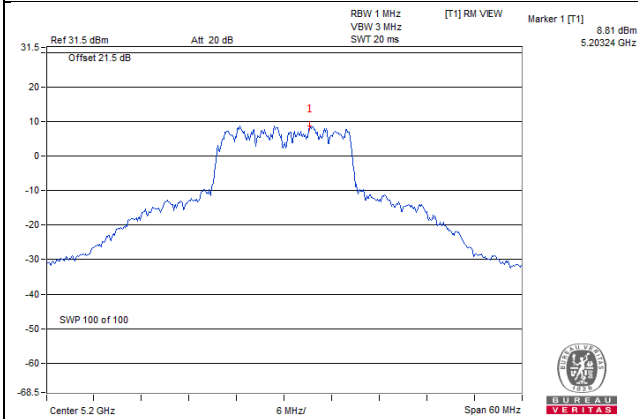

**802.11ac (VHT20) / CH40**

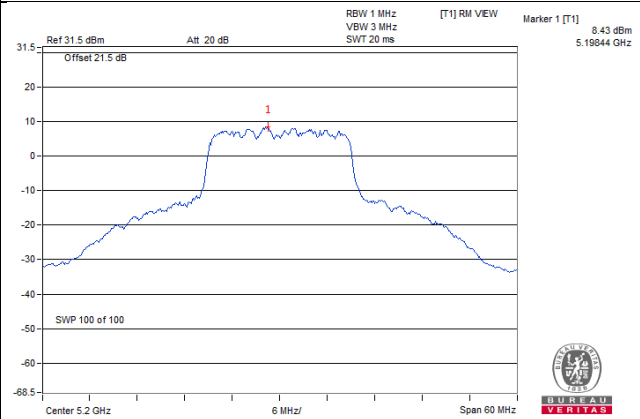

**802.11ac (VHT40) / CH46**

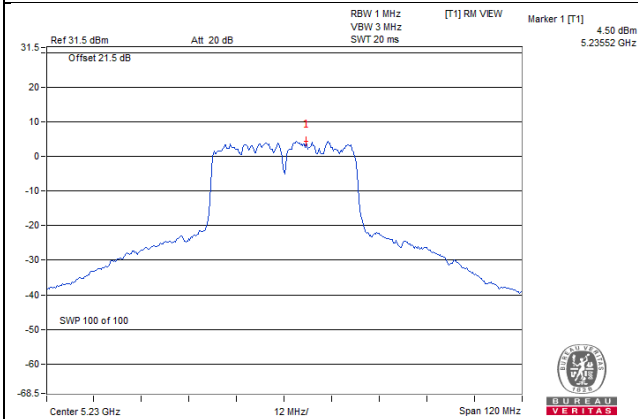

**802.11ac (VHT80) / CH42**

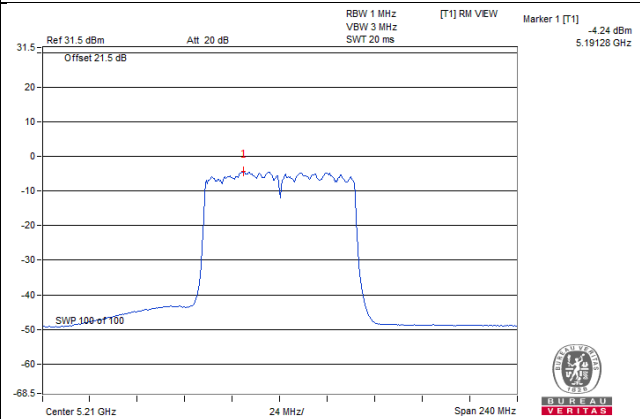

### Spectrum Plot of Worst Value

#### 802.11ax (HE20) / CH40

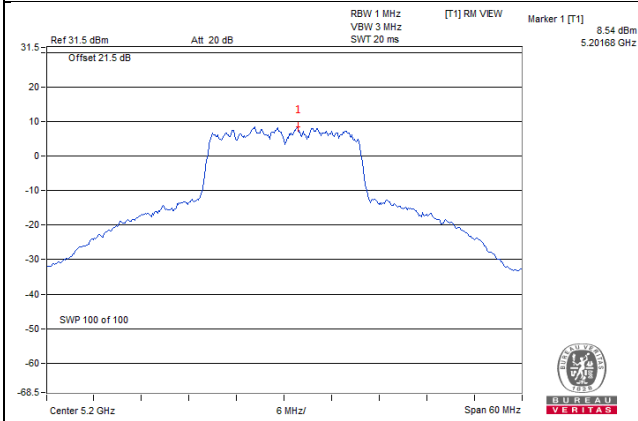

#### 802.11ax (HE40) / CH46

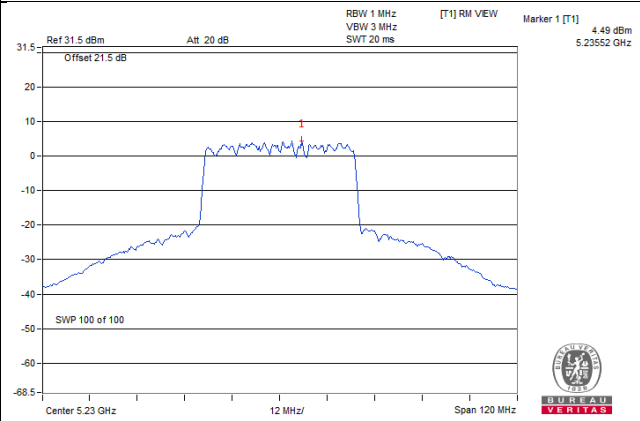

#### 802.11ax (HE80) / CH42

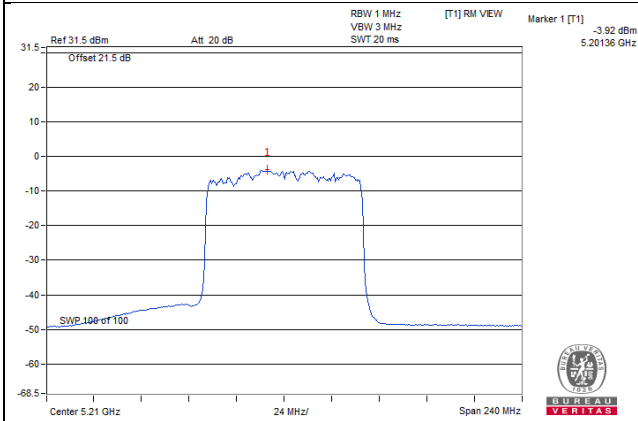



**For U-NII-3:**
**802.11a**

Chan.	Chan. Freq. (MHz)	PSD W/O Duty Factor		Duty Factor (dB)	Total PSD With Duty Factor (dBm/500kHz)	Limit (dBm/500kHz)	Pass /Fail
		(dBm/300kHz)	(dBm/500kHz)				
149	5745	1.46	3.68	0.32	4.00	30.00	Pass
157	5785	1.58	3.80	0.32	4.12	30.00	Pass
165	5825	1.23	3.45	0.32	3.77	30.00	Pass

Note: 1. Refer to section 3.3 for duty cycle spectrum plot.

**802.11ac (VHT20)**

Chan.	Chan. Freq. (MHz)	PSD W/O Duty Factor		Duty Factor (dB)	Total PSD With Duty Factor (dBm/500kHz)	Limit (dBm/500kHz)	Pass /Fail
		(dBm/300kHz)	(dBm/500kHz)				
149	5745	0.87	3.09	0.17	3.26	30.00	Pass
157	5785	1.53	3.75	0.17	3.92	30.00	Pass
165	5825	1.72	3.94	0.17	4.11	30.00	Pass

Note: 1. Refer to section 3.3 for duty cycle spectrum plot.

**802.11ac (VHT40)**

Chan.	Chan. Freq. (MHz)	PSD W/O Duty Factor		Duty Factor (dB)	Total PSD With Duty Factor (dBm/500kHz)	Limit (dBm/500kHz)	Pass /Fail
		(dBm/300kHz)	(dBm/500kHz)				
151	5755	-3.15	-0.93	0.17	-0.76	30.00	Pass
159	5795	-2.17	0.05	0.17	0.22	30.00	Pass

Note: 1. Refer to section 3.3 for duty cycle spectrum plot.

**802.11ac (VHT80)**

Chan.	Chan. Freq. (MHz)	PSD W/O Duty Factor		Duty Factor (dB)	Total PSD With Duty Factor (dBm/500kHz)	Limit (dBm/500kHz)	Pass /Fail
		(dBm/300kHz)	(dBm/500kHz)				
155	5775	-7.68	-5.46	0.18	-5.28	30.00	Pass

Note: 1. Refer to section 3.3 for duty cycle spectrum plot.

### 802.11ax (HE20)

Chan.	Chan. Freq. (MHz)	PSD W/O Duty Factor		Duty Factor (dB)	Total PSD With Duty Factor (dBm/500kHz)	Limit (dBm/500kHz)	Pass /Fail
		(dBm/300kHz)	(dBm/500kHz)				
149	5745	-0.16	2.06	0.20	2.26	30.00	Pass
157	5785	0.18	2.40	0.20	2.60	30.00	Pass
165	5825	0.01	2.23	0.20	2.43	30.00	Pass

Note: 1. Refer to section 3.3 for duty cycle spectrum plot.

### 802.11ax (HE40)

Chan.	Chan. Freq. (MHz)	PSD W/O Duty Factor		Duty Factor (dB)	Total PSD With Duty Factor (dBm/500kHz)	Limit (dBm/500kHz)	Pass /Fail
		(dBm/300kHz)	(dBm/500kHz)				
151	5755	-3.63	-1.41	0.17	-1.24	30.00	Pass
159	5795	-2.68	-0.46	0.17	-0.29	30.00	Pass

Note: 1. Refer to section 3.3 for duty cycle spectrum plot.

### 802.11ax (HE80)

Chan.	Chan. Freq. (MHz)	PSD W/O Duty Factor		Duty Factor (dB)	Total PSD With Duty Factor (dBm/500kHz)	Limit (dBm/500kHz)	Pass /Fail
		(dBm/300kHz)	(dBm/500kHz)				
155	5775	-7.48	-5.26	0.17	-5.09	30.00	Pass

Note: 1. Refer to section 3.3 for duty cycle spectrum plot.

Spectrum Plot of Worst Value

802.11a / CH157

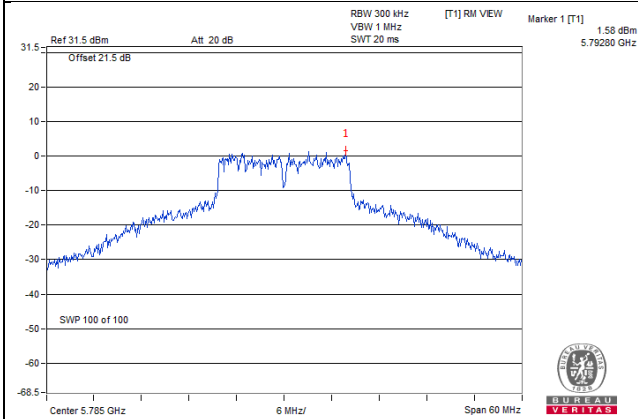

802.11ac (VHT20) / CH165

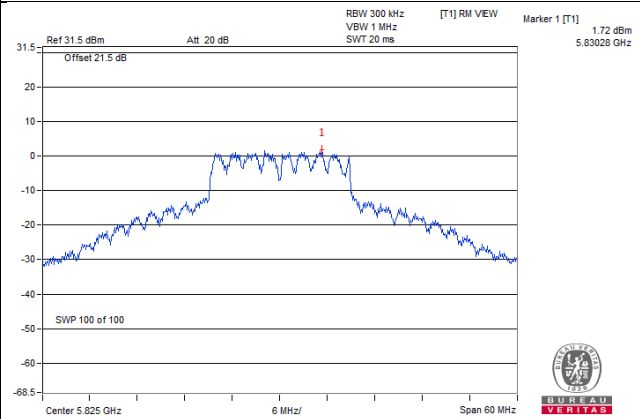

802.11ac (VHT40) / CH159

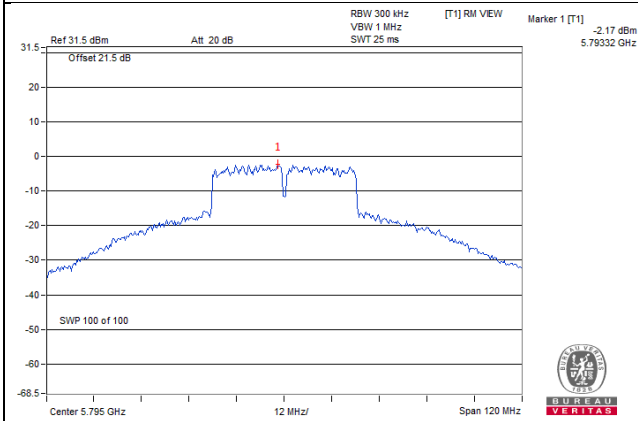

802.11ac (VHT80) / CH155

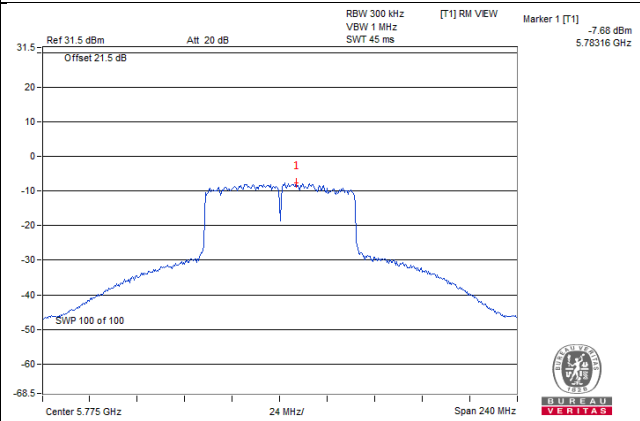

### Spectrum Plot of Worst Value

#### 802.11ax (HE20) / CH157

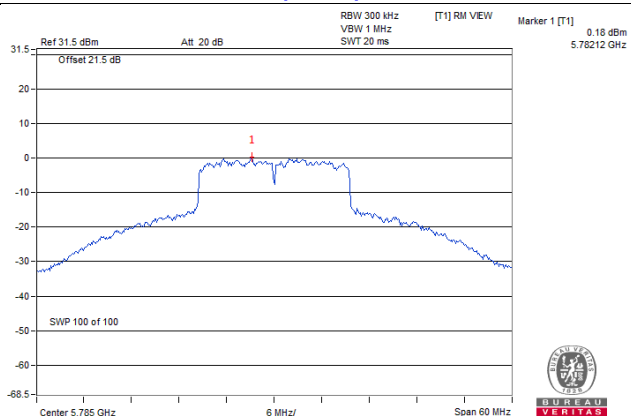

#### 802.11ax (HE40) / CH159

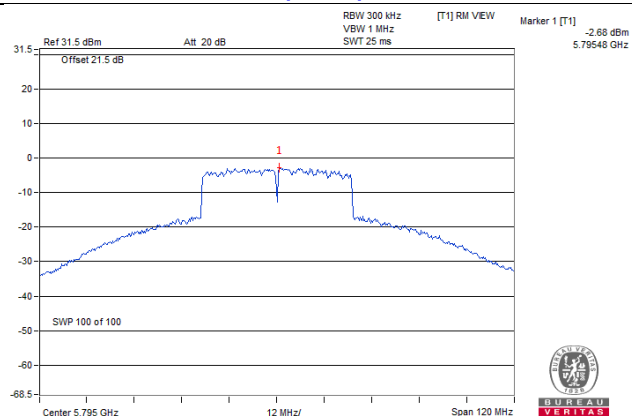

#### 802.11ax (HE80) / CH155

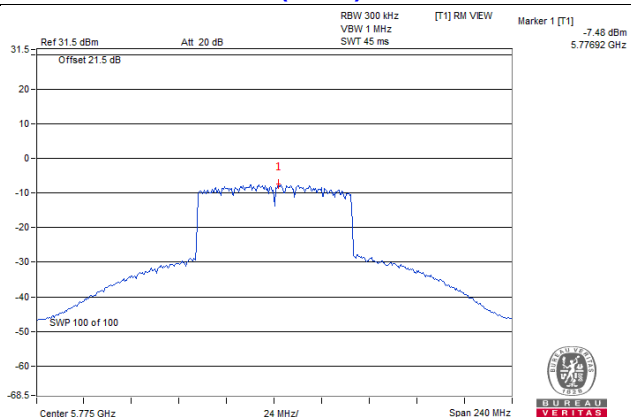

## 4.6 Frequency Stability Measurement

### 4.6.1 Limits of Frequency Stability Measurement

The frequency of the carrier signal shall be maintained within band of operation

### 4.6.2 Test Setup

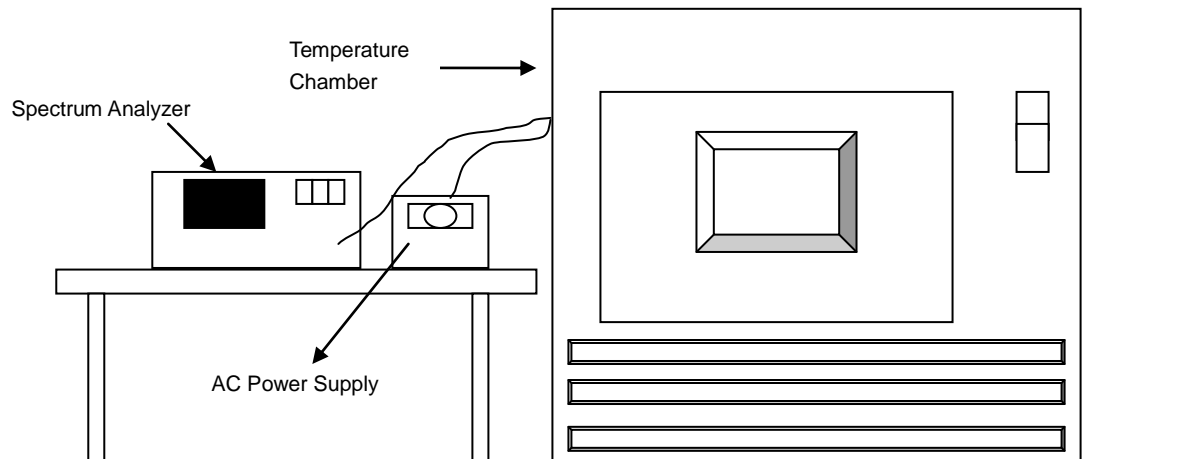

### 4.6.3 Test Instruments

Refer to section 4.1.2 to get information of above instrument.

### 4.6.4 Test Procedure

- The EUT was placed inside the environmental test chamber and powered by nominal AC voltage.
- Turn the EUT on and couple its output to a spectrum analyzer.
- Turn the EUT off and set the chamber to the highest temperature specified.
- Allow sufficient time (approximately 30 min) for the temperature of the chamber to stabilize, turn the EUT on and measure the operating frequency after 2, 5, and 10 Minutes.
- Repeat step 2 and 3 with the temperature chamber set to the lowest temperature.
- The test chamber was allowed to stabilize at +20 degree C for a minimum of 30 Minutes. The supply voltage was then adjusted on the EUT from 85% to 115% and the frequency record.

### 4.6.5 Deviation from Test Standard

No deviation.

### 4.6.6 EUT Operating Condition

Set the EUT transmit at un-modulation mode to test frequency stability.

## 4.6.7 Test Results (Mode 1)

Frequency Stability Versus Temp.									
Operating Frequency: 5180 MHz									
TEMP. (°C)	Power Supply (Vac)	0 Minute		2 Minutes		5 Minutes		10 Minutes	
		Measured Frequency (MHz)	Pass/Fail	Measured Frequency (MHz)	Pass/Fail	Measured Frequency (MHz)	Pass/Fail	Measured Frequency (MHz)	Pass/Fail
50	120	5180.0046	Pass	5180.0043	Pass	5180.0028	Pass	5180.0026	Pass
40	120	5179.987	Pass	5179.9918	Pass	5179.9888	Pass	5179.9888	Pass
30	120	5180.0187	Pass	5180.0168	Pass	5180.0196	Pass	5180.0205	Pass
20	120	5179.9914	Pass	5179.9904	Pass	5179.9928	Pass	5179.9895	Pass
10	120	5179.9917	Pass	5179.9925	Pass	5179.9905	Pass	5179.9935	Pass
0	120	5180.0092	Pass	5180.0097	Pass	5180.0115	Pass	5180.0117	Pass
-10	120	5180.0041	Pass	5180.0076	Pass	5180.0069	Pass	5180.0066	Pass
-20	120	5180.0094	Pass	5180.0117	Pass	5180.013	Pass	5180.013	Pass
-30	120	5179.9895	Pass	5179.9879	Pass	5179.9879	Pass	5179.9856	Pass

Frequency Stability Versus Voltage									
Operating Frequency: 5180 MHz									
TEMP. (°C)	Power Supply (Vac)	0 Minute		2 Minutes		5 Minutes		10 Minutes	
		Measured Frequency (MHz)	Pass/Fail	Measured Frequency (MHz)	Pass/Fail	Measured Frequency (MHz)	Pass/Fail	Measured Frequency (MHz)	Pass/Fail
20	138	5179.9923	Pass	5179.9907	Pass	5179.9924	Pass	5179.9904	Pass
	120	5179.9914	Pass	5179.9904	Pass	5179.9928	Pass	5179.9895	Pass
	102	5179.9919	Pass	5179.9904	Pass	5179.9934	Pass	5179.9896	Pass

## 4.7 6dB Bandwidth Measurement

### 4.7.1 Limits of 6dB Bandwidth Measurement

The minimum of 6dB Bandwidth Measurement is 0.5MHz.

### 4.7.2 Test Setup

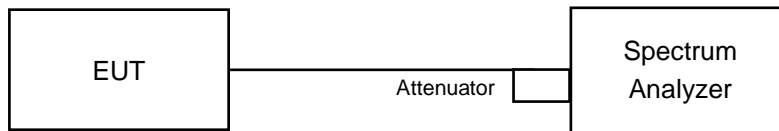

### 4.7.3 Test Instruments

Refer to section 4.1.2 to get information of above instrument.

### 4.7.4 Test Procedure

#### MEASUREMENT PROCEDURE REF

- a. Set resolution bandwidth (RBW) = 100kHz
- b. Set the video bandwidth (VBW)  $\geq 3 \times$  RBW, Detector = Peak.
- c. Trace mode = max hold.
- d. Sweep = auto couple.
- e. Measure the maximum width of the emission that is constrained by the frequencies associated with the two amplitude points (upper and lower) that are attenuated by 6 dB relative to the maximum level measured in the fundamental emission

### 4.7.5 Deviation from Test Standard

No deviation.

### 4.7.6 EUT Operating Condition

The software provided by client to enable the EUT under transmission condition continuously at lowest, middle and highest channel frequencies individually.

## 4.7.7 Test Results (Mode 1)

## 802.11a

Channel	Frequency (MHz)	6dB Bandwidth (MHz)				Minimum Limit (MHz)	Pass / Fail
		Chain 0	Chain 1	Chain 2	Chain 3		
149	5745	16.39	16.37	16.37	16.43	0.5	Pass
157	5785	16.38	16.40	16.37	16.42	0.5	Pass
165	5825	16.39	16.38	16.39	16.40	0.5	Pass

## 802.11ax (HE20)

Channel	Frequency (MHz)	6dB Bandwidth (MHz)				Minimum Limit (MHz)	Pass / Fail
		Chain 0	Chain 1	Chain 2	Chain 3		
149	5745	18.91	18.51	18.18	17.87	0.5	Pass
157	5785	18.81	18.69	18.77	19.11	0.5	Pass
165	5825	18.80	18.81	17.95	18.87	0.5	Pass

## 802.11ax (HE40)

Channel	Frequency (MHz)	6dB Bandwidth (MHz)				Minimum Limit (MHz)	Pass / Fail
		Chain 0	Chain 1	Chain 2	Chain 3		
151	5755	38.03	37.98	37.72	38.13	0.5	Pass
159	5795	37.47	37.55	37.62	38.04	0.5	Pass

## 802.11ax (HE80)

Channel	Frequency (MHz)	6dB Bandwidth (MHz)				Minimum Limit (MHz)	Pass / Fail
		Chain 0	Chain 1	Chain 2	Chain 3		
155	5775	77.26	75.43	75.59	73.56	0.5	Pass

## 802.11ax (HE80+80)

Channel	Frequency (MHz)	6dB Bandwidth (MHz)				Minimum Limit (MHz)	Pass / Fail
		Chain 0	Chain 1	Chain 2	Chain 3		
42+155	5210	-					
	5775	-	-	74.40	76.51	0.5	Pass



### Spectrum Plot of Worst Value

#### 802.11a\_Chain 1 / CH149

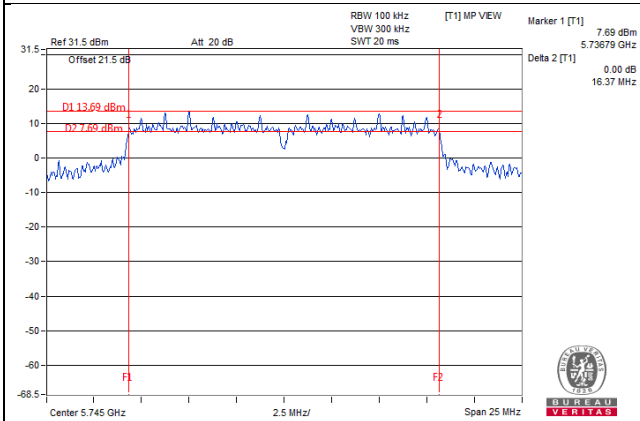

#### 802.11ax (HE20)\_Chain 3 / CH149

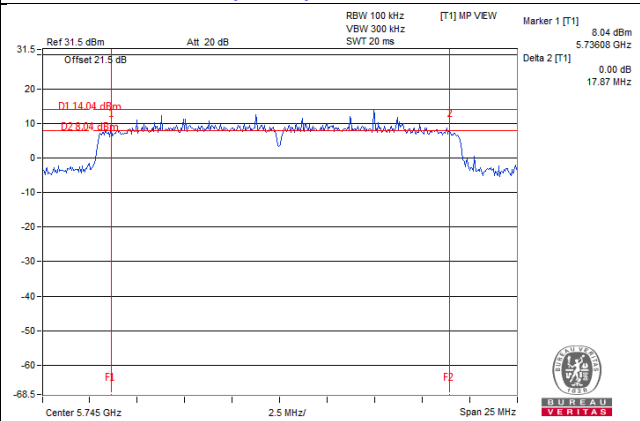

#### 802.11ax (HE40)\_Chain 0 / CH159

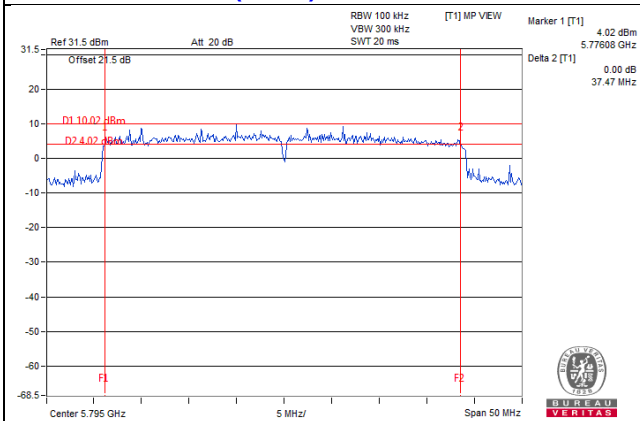

#### 802.11ax (HE80)\_Chain 3 / CH155

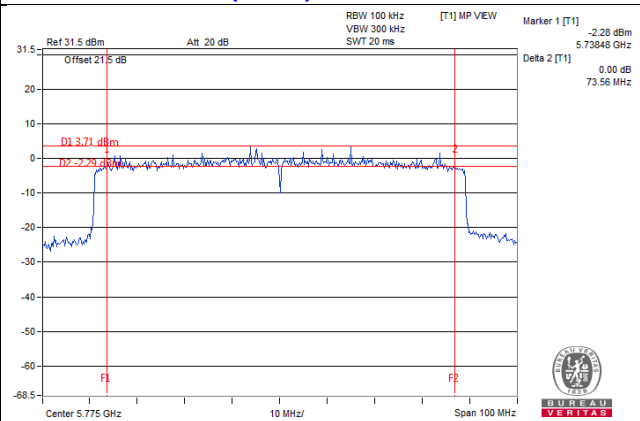

#### 802.11ax (HE80+80)\_Chain 2 / CH155

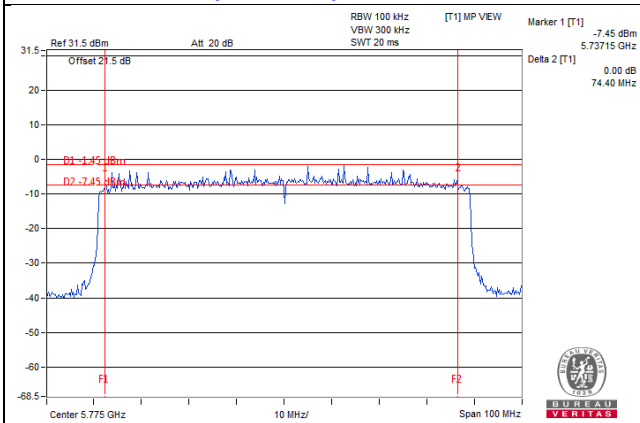

## 4.7.8 Test Results (Mode 2)

## 802.11a

Channel	Frequency (MHz)	6dB Bandwidth (MHz)		Minimum Limit (MHz)	Pass / Fail
		Chain 0	Chain 1		
149	5745	16.37	16.37	0.5	Pass
157	5785	16.40	16.37	0.5	Pass
165	5825	16.38	16.39	0.5	Pass

## 802.11ax (HE20)

Channel	Frequency (MHz)	6dB Bandwidth (MHz)		Minimum Limit (MHz)	Pass / Fail
		Chain 0	Chain 1		
149	5745	18.51	18.18	0.5	Pass
157	5785	18.69	18.77	0.5	Pass
165	5825	18.81	17.95	0.5	Pass

## 802.11ax (HE40)

Channel	Frequency (MHz)	6dB Bandwidth (MHz)		Minimum Limit (MHz)	Pass / Fail
		Chain 0	Chain 1		
151	5755	37.98	37.72	0.5	Pass
159	5795	37.55	37.62	0.5	Pass

## 802.11ax (HE80)

Channel	Frequency (MHz)	6dB Bandwidth (MHz)		Minimum Limit (MHz)	Pass / Fail
		Chain 0	Chain 1		
155	5775	76.54	76.92	0.5	Pass

### Spectrum Plot of Worst Value

#### 802.11a\_Chain 0 / CH149

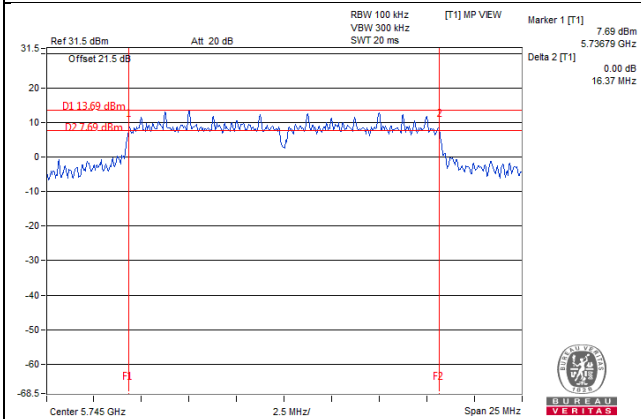

#### 802.11ax (HE20)\_Chain 1 / CH165

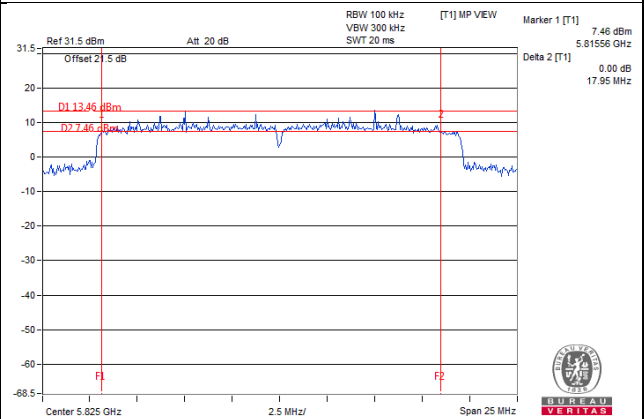

#### 802.11ax (HE40)\_Chain 0 / CH159

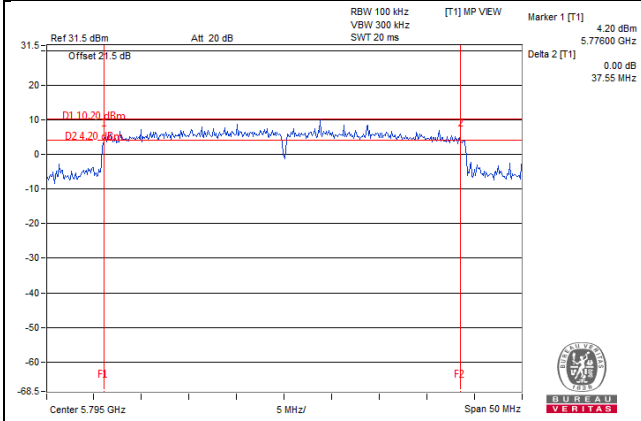

#### 802.11ax (HE80)\_Chain 0 / CH155

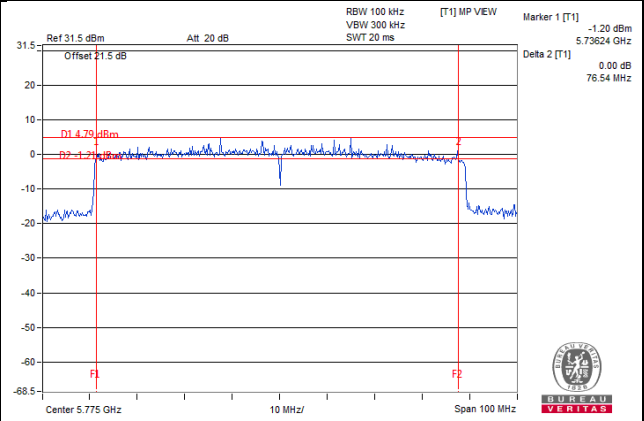

#### 4.7.9 Test Results (Mode 3)

##### 802.11a

Channel	Frequency (MHz)	6dB Bandwidth (MHz)	Minimum Limit (MHz)	Pass / Fail
149	5745	16.07	0.5	PASS
157	5785	16.42	0.5	PASS
165	5825	16.41	0.5	PASS

##### 802.11ax (HE20)

Channel	Frequency (MHz)	6dB Bandwidth (MHz)	Minimum Limit (MHz)	Pass / Fail
149	5745	18.63	0.5	PASS
157	5785	18.37	0.5	PASS
165	5825	18.06	0.5	PASS

##### 802.11ax (HE40)

Channel	Frequency (MHz)	6dB Bandwidth (MHz)	Minimum Limit (MHz)	Pass / Fail
151	5755	38.11	0.5	PASS
159	5795	37.80	0.5	PASS

##### 802.11ax (HE80)

Channel	Frequency (MHz)	6dB Bandwidth (MHz)	Minimum Limit (MHz)	Pass / Fail
155	5775	77.61	0.5	PASS

### Spectrum Plot of Worst Value

#### 802.11a / CH149

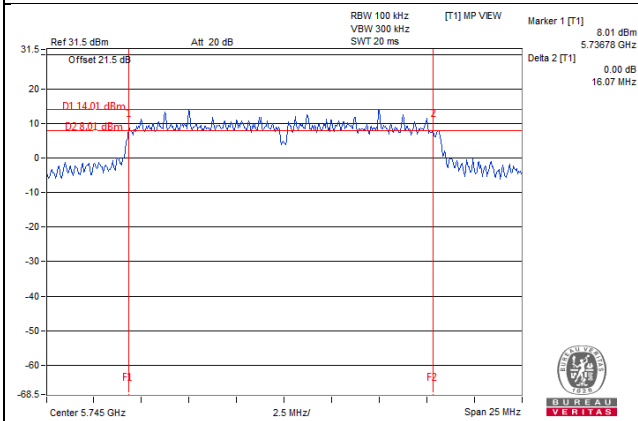

#### 802.11ax (HE20) / CH165

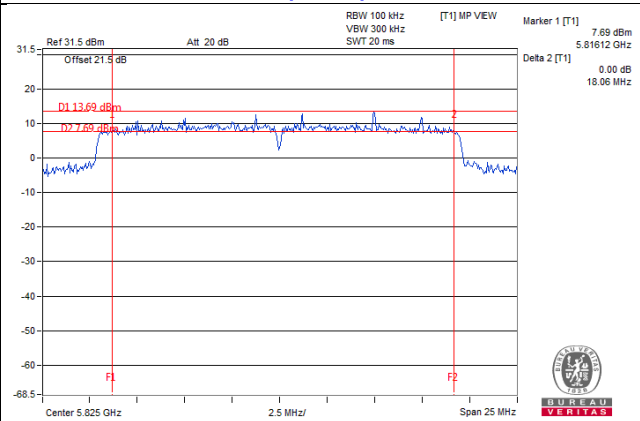

#### 802.11ax (HE40) / CH159

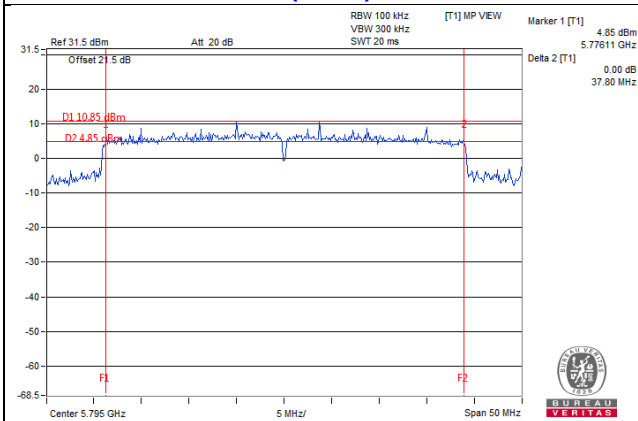

#### 802.11ax (HE80) / CH155

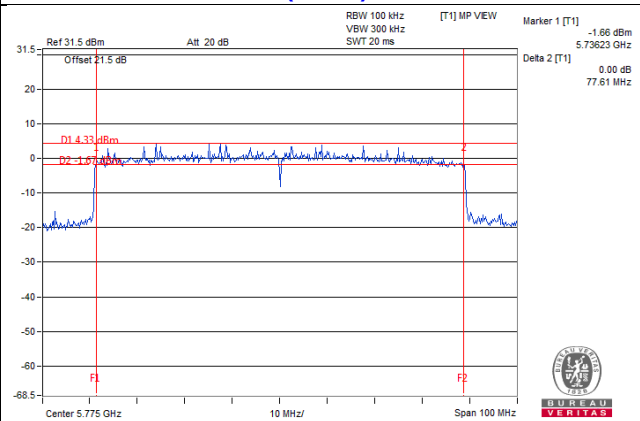

## 5 Pictures of Test Arrangements

Please refer to the attached file (Test Setup Photo).

### Annex A- Radiated Out of Band Emission (OOBE) Measurement (For U-NII-3 band)

4TX:  
802.11a

**CH 149 5745 MHz**

**Horizontal**

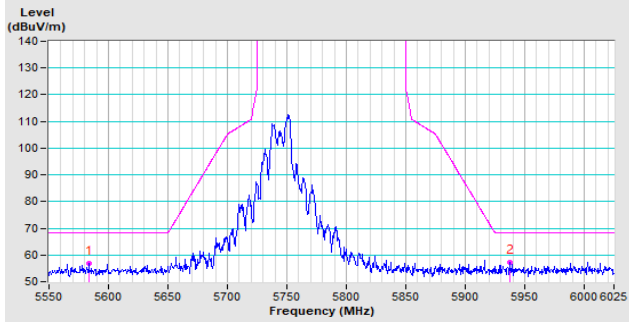

**Vertical**

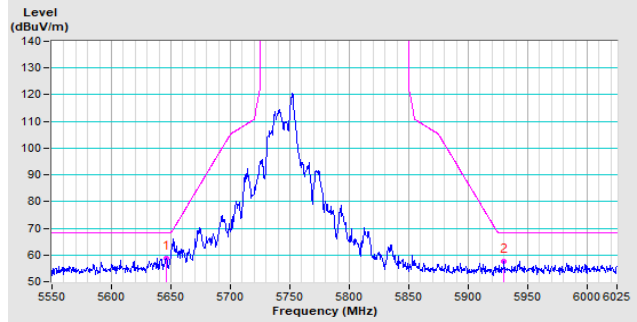

**CH 157 5785 MHz**

**Horizontal**

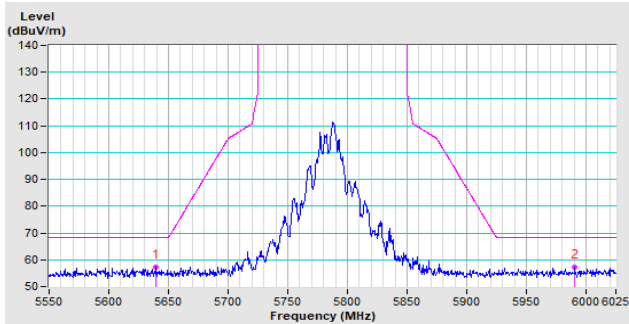

**Vertical**

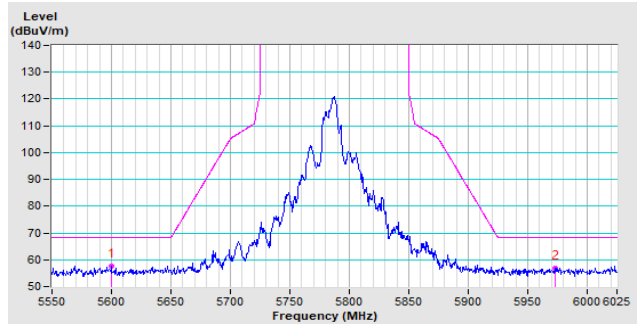

**CH 165 5825 MHz**

**Horizontal**

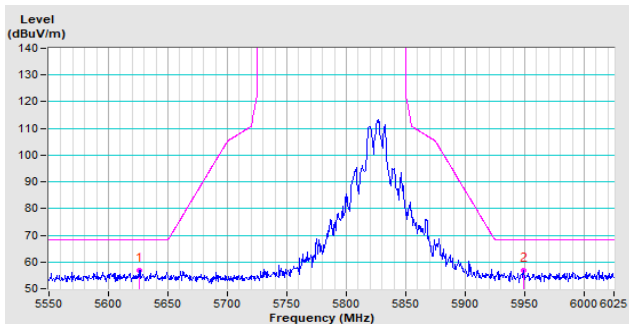

**Vertical**

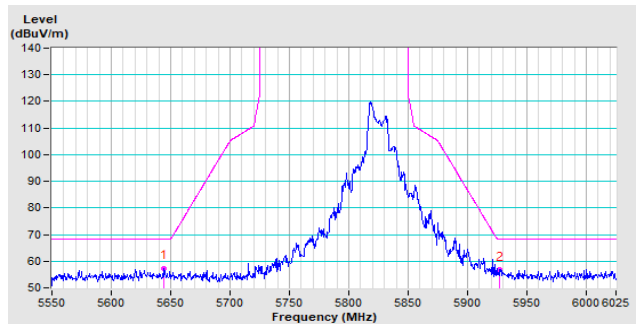

802.11ac (VHT20)

CH 149 5745 MHz

Horizontal

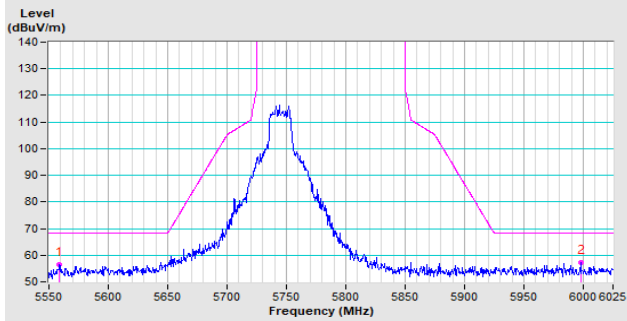

Vertical

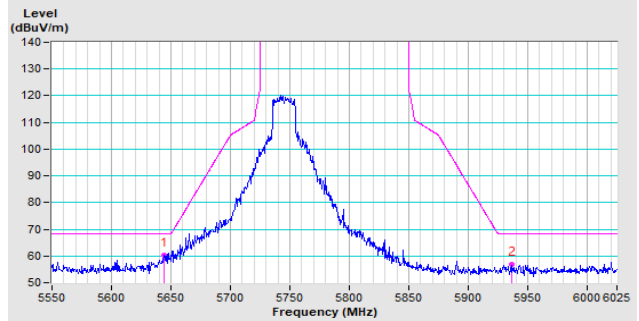

CH 157 5785 MHz

Horizontal

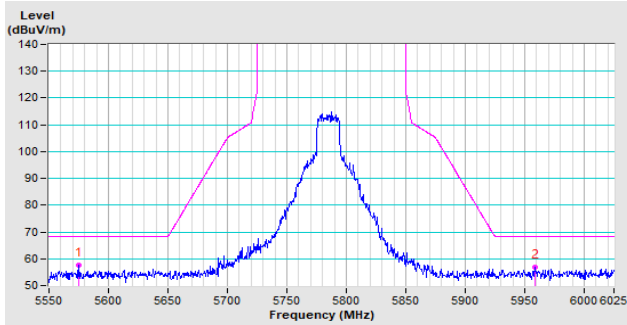

Vertical

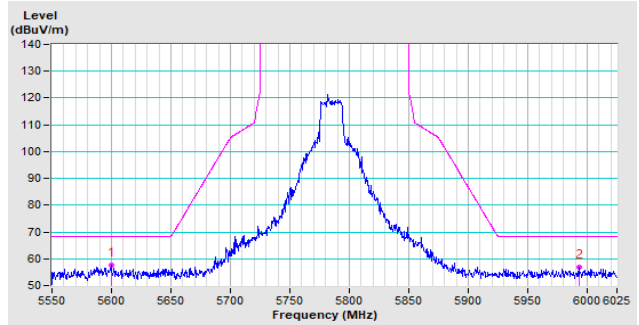

CH 165 5825 MHz

Horizontal

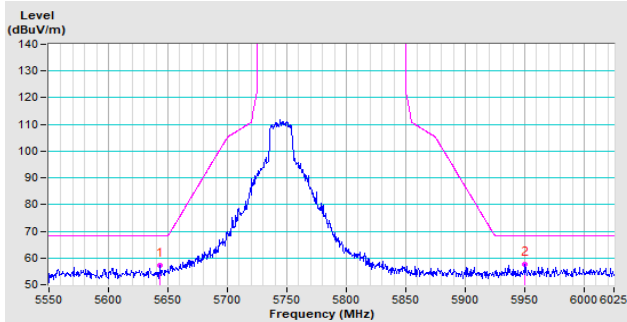

Vertical

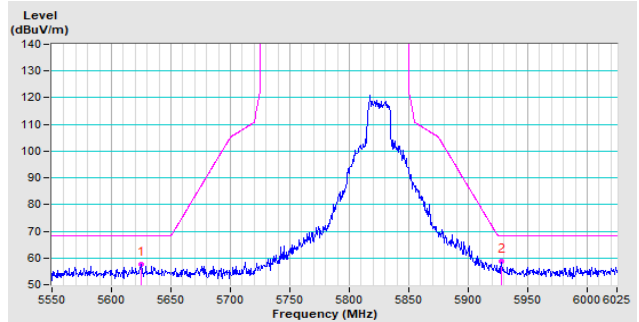



### 802.11ac (VHT40)

**CH 151 5755 MHz**

**Horizontal**

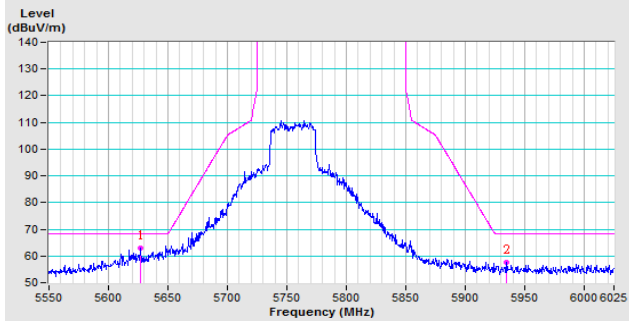

**Vertical**

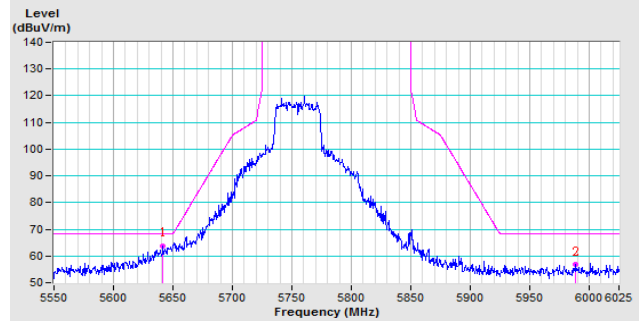

**CH 159 5795 MHz**

**Horizontal**

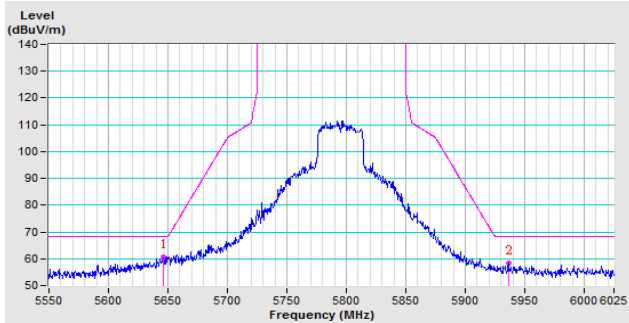

**Vertical**

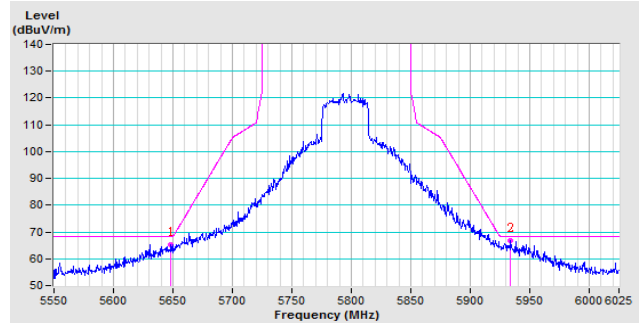

### 802.11ac (VHT80)

**CH 155 5775 MHz**

**Horizontal**

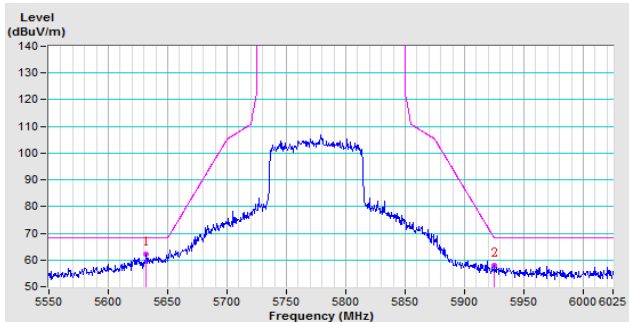

**Vertical**

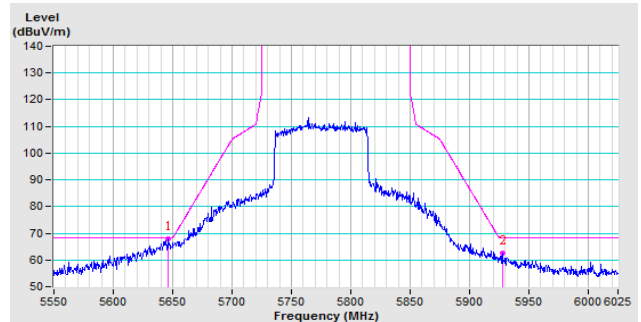

802.11ac (VHT80+80)

CH 42+155 5210+5775 MHz

Horizontal

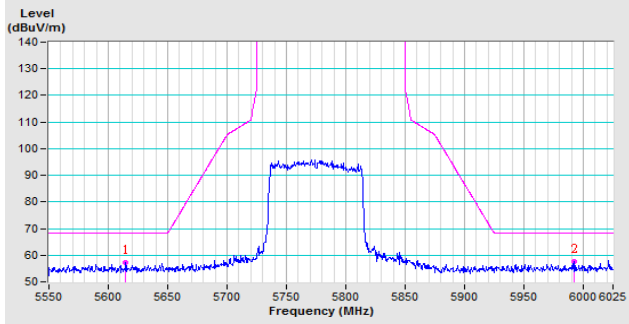

Vertical

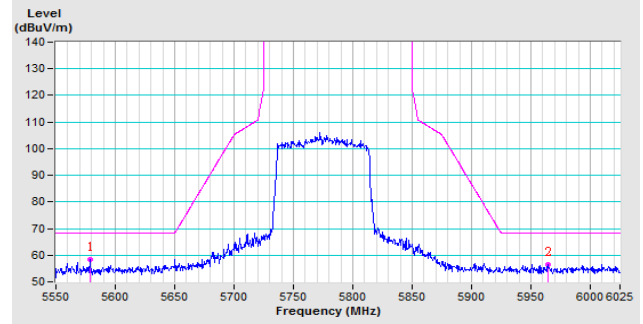

2TX:

802.11a

CH 149 5745 MHz

Horizontal

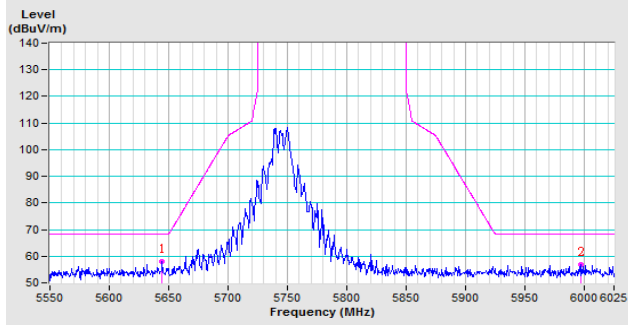

Vertical

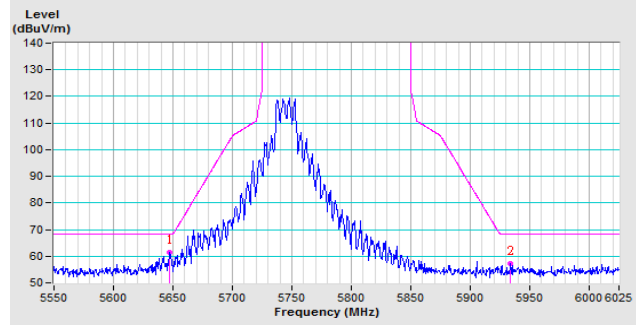

CH 157 5785 MHz

Horizontal

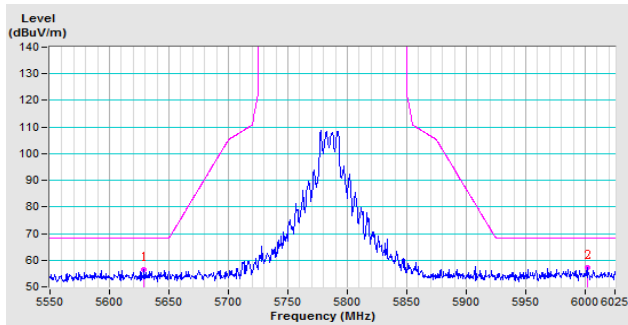

Vertical

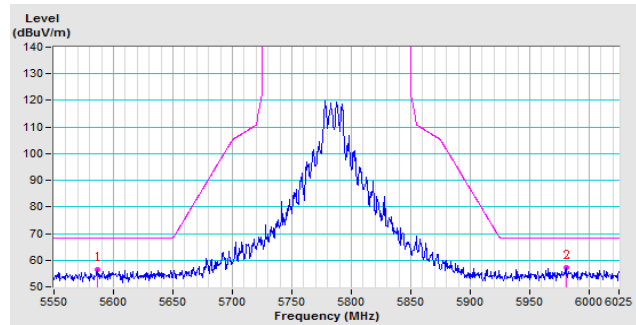

CH 165 5825 MHz

Horizontal

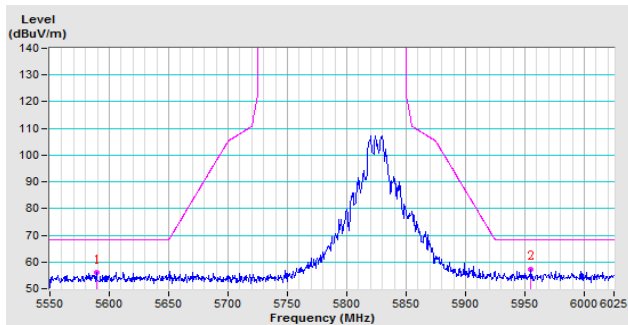

Vertical

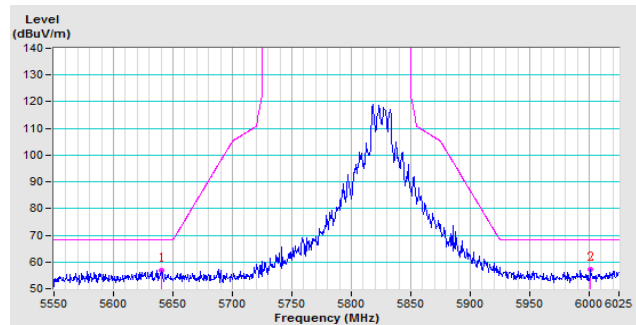

802.11ac (VHT20)

CH 149 5745 MHz

Horizontal

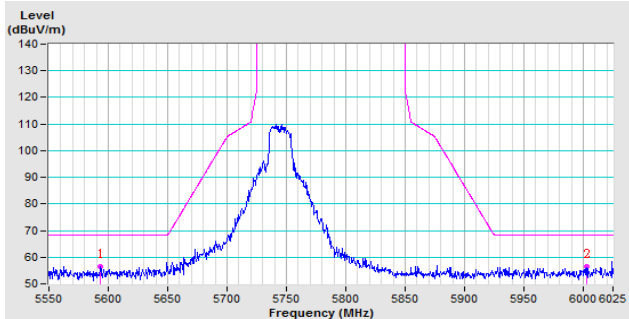

Vertical

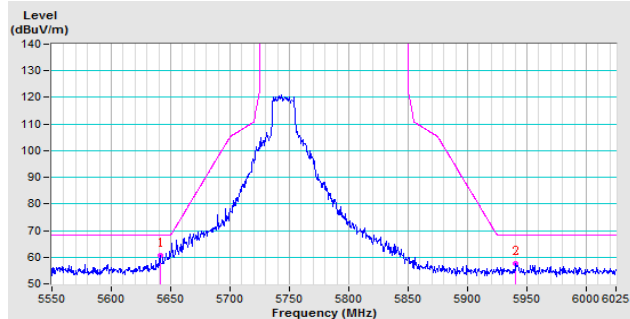

CH 157 5785 MHz

Horizontal

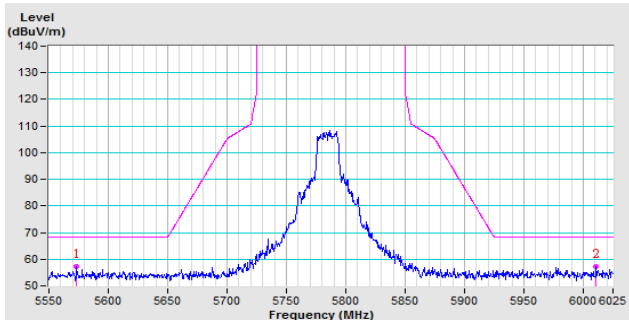

Vertical

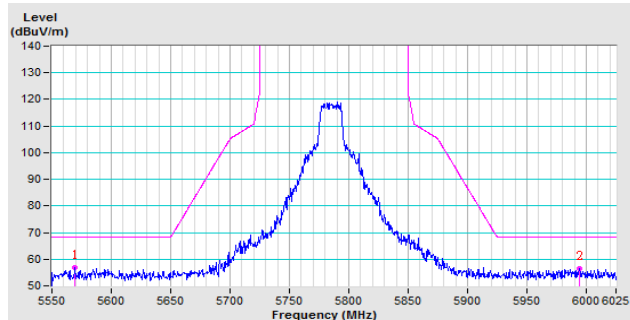

CH 165 5825 MHz

Horizontal

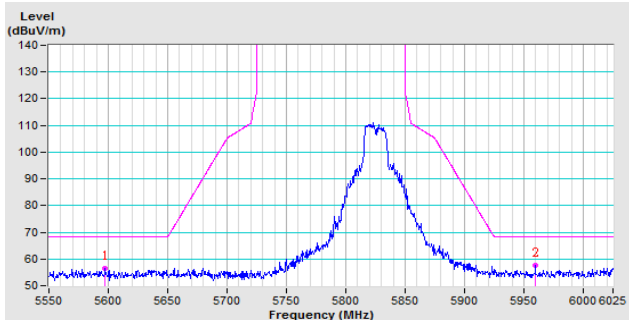

Vertical

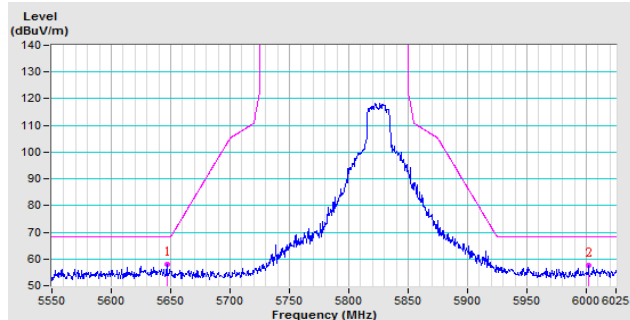

### 802.11ac (VHT40)

**CH 151 5755 MHz**

**Horizontal**

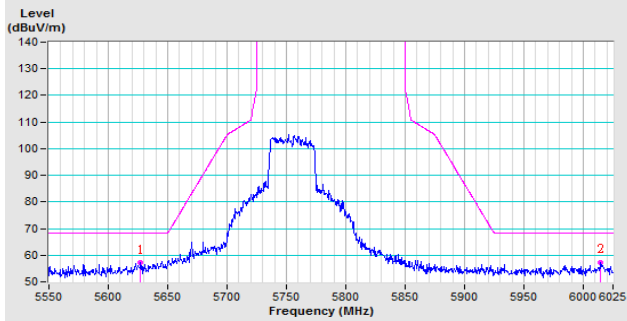

**Vertical**

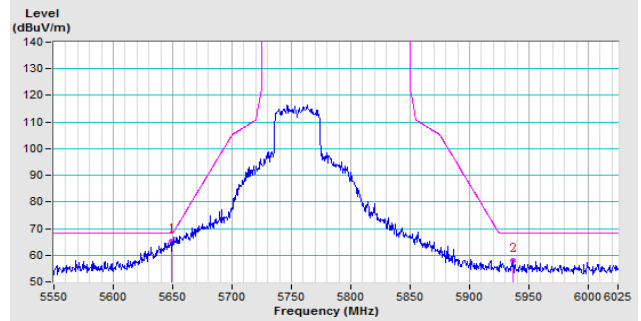

**CH 159 5795 MHz**

**Horizontal**

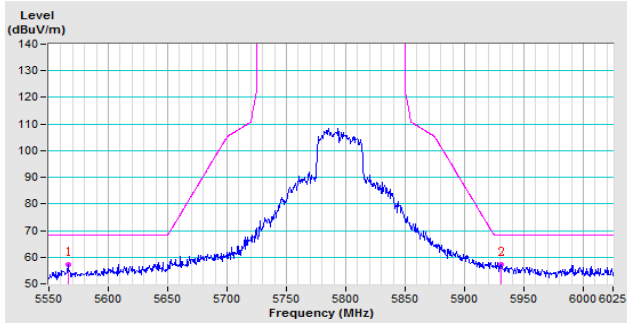

**Vertical**

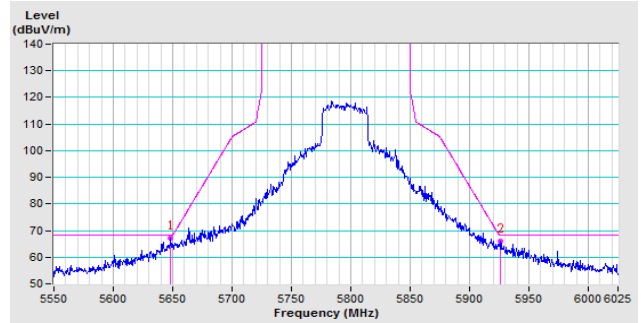

### 802.11ac (VHT80)

**CH 155 5775 MHz**

**Horizontal**

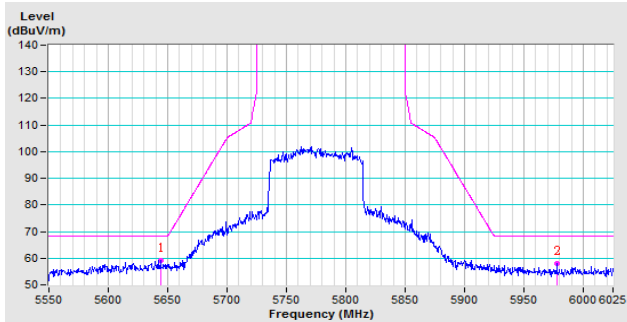

**Vertical**

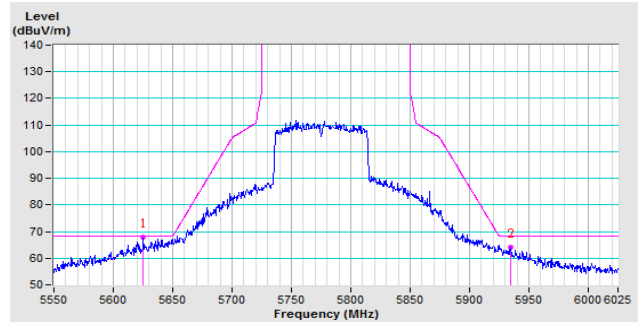

1TX:

802.11a

CH 149 5745 MHz

Horizontal

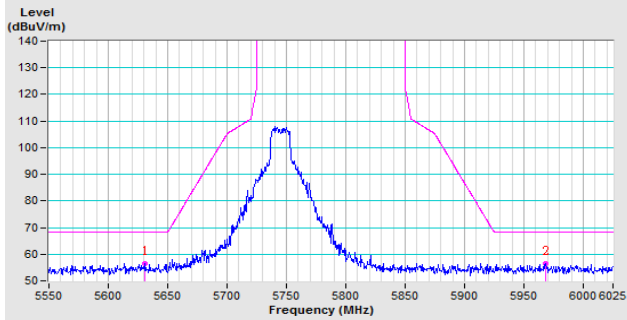

Vertical

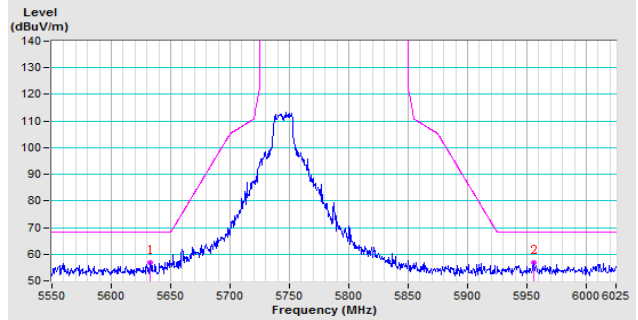

CH 157 5785 MHz

Horizontal

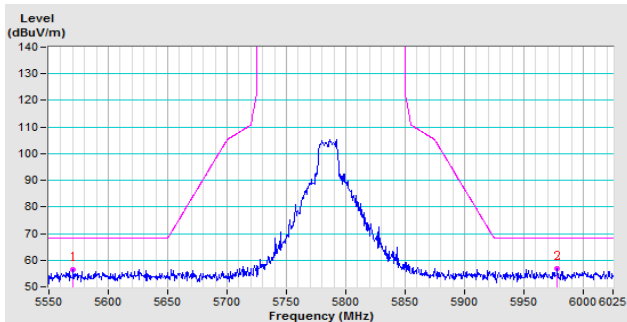

Vertical

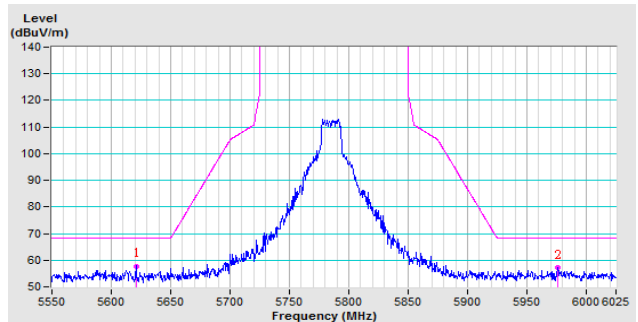

CH 165 5825 MHz

Horizontal

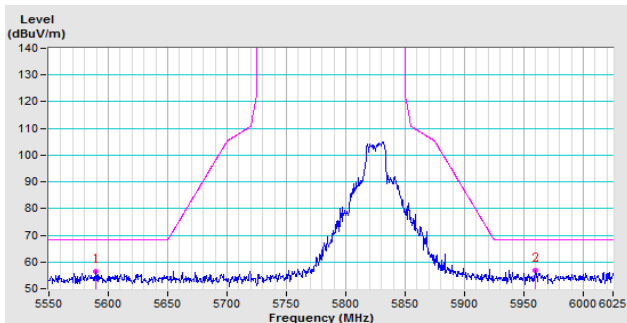

Vertical

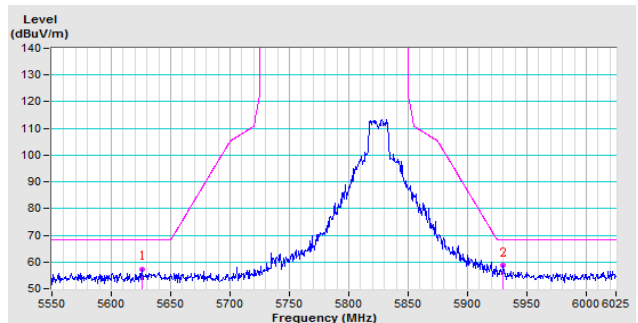

802.11ac (VHT20)

CH 149 5745 MHz

Horizontal

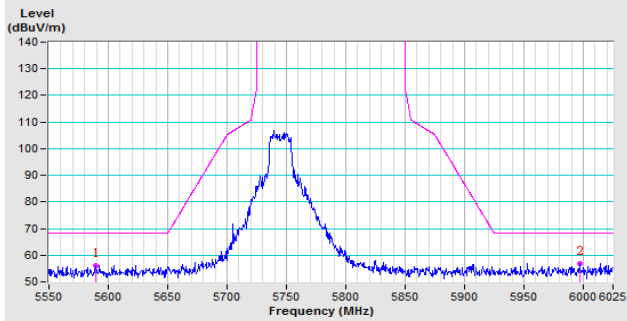

Vertical

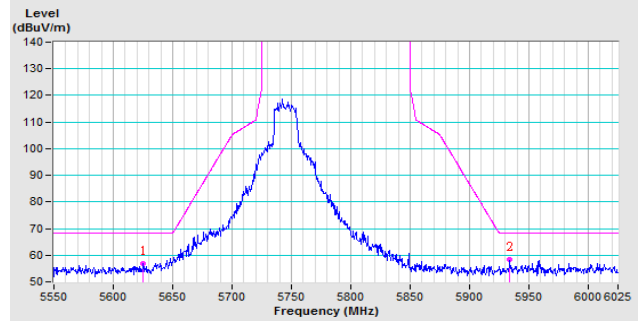

CH 157 5785 MHz

Horizontal

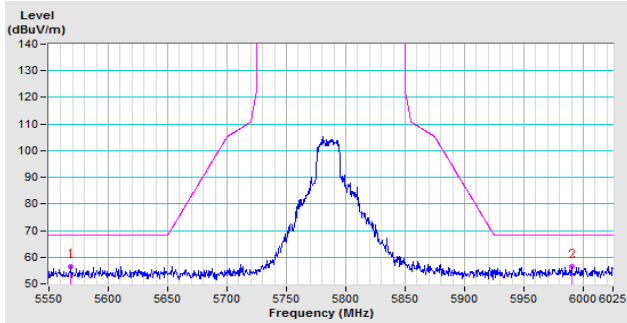

Vertical

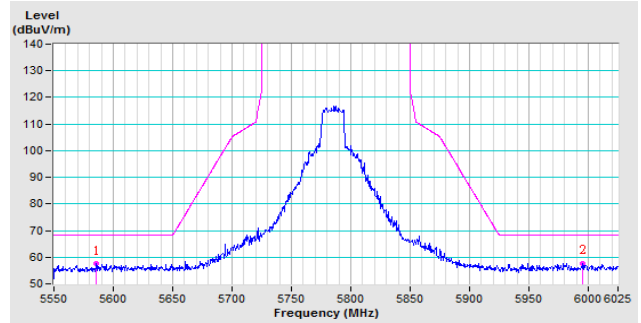

CH 165 5825 MHz

Horizontal

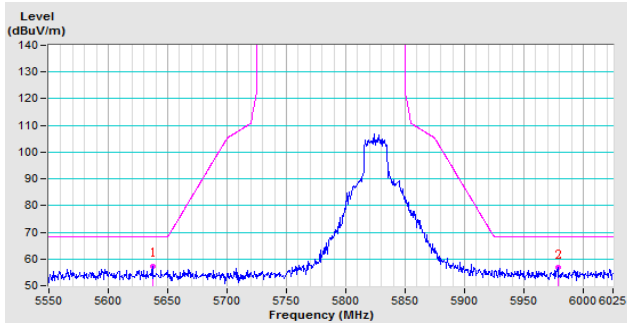

Vertical

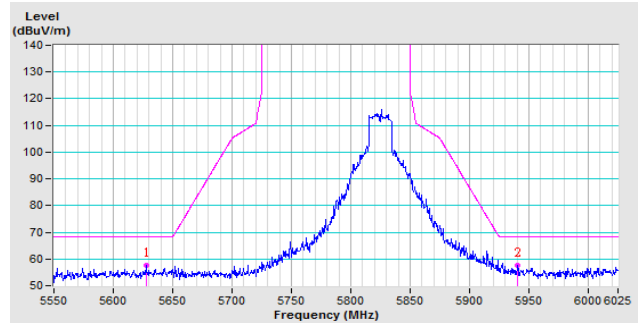

### 802.11ac (VHT40)

**CH 151 5755 MHz**

**Horizontal**

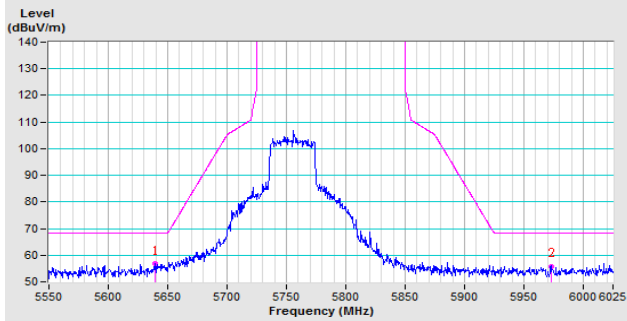

**Vertical**

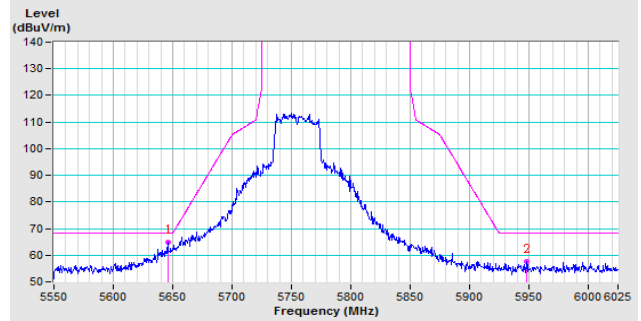

**CH 159 5795 MHz**

**Horizontal**

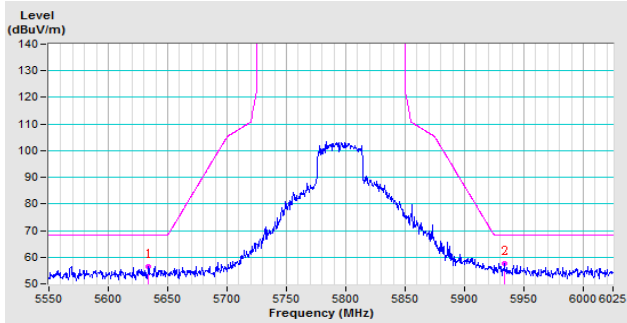

**Vertical**

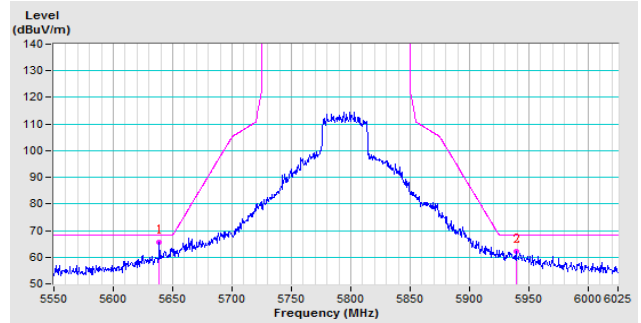

### 802.11ac (VHT80)

**CH 155 5775 MHz**

**Horizontal**

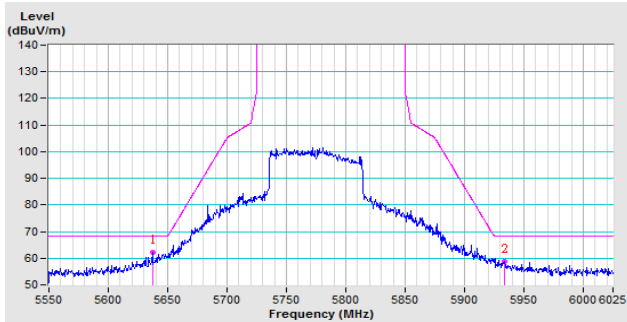

**Vertical**

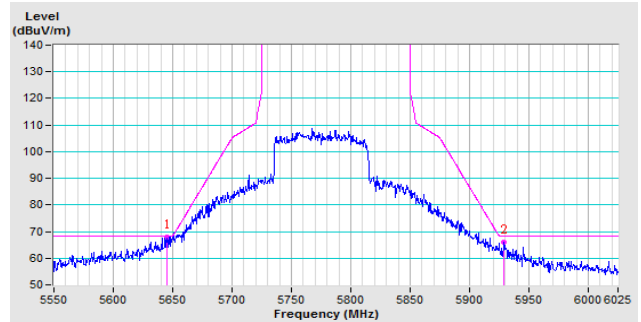



## Appendix – Information on the Testing Laboratories

We, Bureau Veritas Consumer Products Services (H.K.) Ltd., Taoyuan Branch, were founded in 1988 to provide our best service in EMC, Radio, Telecom and Safety consultation. Our laboratories are FCC recognized accredited test firms and accredited according to ISO/IEC 17025.

If you have any comments, please feel free to contact us at the following:

**Linkou EMC/RF Lab**

Tel: 886-2-26052180

Fax: 886-2-26051924

**Hsin Chu EMC/RF/Telecom Lab**

Tel: 886-3-6668565

Fax: 886-3-6668323

**Hwa Ya EMC/RF/Safety Lab**

Tel: 886-3-3183232

Fax: 886-3-3270892

**Email:** [service.adt@tw.bureauveritas.com](mailto:service.adt@tw.bureauveritas.com)

**Web Site:** [www.bureauveritas-adt.com](http://www.bureauveritas-adt.com)

The address and road map of all our labs can be found in our web site also.

--- END ---