

FCC Test Report

Report No.: RF180704E03D-1

FCC ID: UDX-60079010

Test Model: MR45-HW

Received Date: July 04, 2018

Test Date: Aug. 29 to Nov. 21, 2018

Issued Date: Mar. 12, 2019

Applicant: Cisco Systems, Inc.

Address: 170 West Tasman Drive, San Jose, CA 95134 USA

Issued By: Bureau Veritas Consumer Products Services (H.K.) Ltd., Taoyuan Branch
Hsin Chu Laboratory

Lab Address: E-2, No.1, Li Hsin 1st Road, Hsinchu Science Park, Hsinchu City 300,
Taiwan R.O.C.

Test Location : E-2, No.1, Li Hsin 1st Road, Hsinchu Science Park, Hsinchu City 300,
Taiwan R.O.C.

**FCC Registration /
Designation Number:** 723255 / TW2022



This report is for your exclusive use. Any copying or replication of this report to or for any other person or entity, or use of our name or trademark, is permitted only with our prior written permission. This report sets forth our findings solely with respect to the test samples identified herein. The results set forth in this report are not indicative or representative of the quality or characteristics of the lot from which a test sample was taken or any similar or identical product specifically and expressly noted. Our report includes all of the tests requested by you and the results thereof based upon the information that you provided to us. You have 60 days from date of issuance of this report to notify us of any material error or omission caused by our negligence, provided, however, that such notice shall be in writing and shall specifically address the issue you wish to raise. A failure to raise such issue within the prescribed time shall constitute your unqualified acceptance of the completeness of this report, the tests conducted and the correctness of the report contents. Unless specific mention, the uncertainty of measurement has been explicitly taken into account to declare the compliance or non-compliance to the specification. The report must not be used by the client to claim product certification, approval, or endorsement by TAF or any government agencies.

Table of Contents

Release Control Record	4
1 Certificate of Conformity	5
2 Summary of Test Results	6
2.1 Measurement Uncertainty	6
2.2 Modification Record	6
3 General Information	7
3.1 General Description of EUT (DFS Band)	7
3.2 Description of Test Modes	11
3.2.1 Test Mode Applicability and Tested Channel Detail	12
3.3 Duty Cycle of Test Signal	16
3.4 Description of Support Units	18
3.4.1 Configuration of System under Test	19
3.5 General Description of Applied Standard	21
4 Test Types and Results	22
4.1 Radiated Emission and Bandedge Measurement	22
4.1.1 Limits of Radiated Emission and Bandedge Measurement	22
4.1.2 Test Instruments	23
4.1.3 Test Procedure	25
4.1.4 Deviation from Test Standard	25
4.1.5 Test Setup	26
4.1.6 EUT Operating Condition	27
4.1.7 Test Results (Mode 1)	28
4.1.8 Test Results (Mode 2)	54
4.1.9 Test Results (Mode 3)	78
4.2 Conducted Emission Measurement	102
4.2.1 Limits of Conducted Emission Measurement	102
4.2.2 Test Instruments	102
4.2.3 Test Procedure	103
4.2.4 Deviation from Test Standard	103
4.2.5 Test Setup	103
4.2.6 EUT Operating Condition	103
4.2.7 Test Results (Mode 1)	104
4.3 Transmit Power Measurement	106
4.3.1 Limits of Transmit Power Measurement	106
4.3.2 Test Setup	107
4.3.3 Test Instruments	107
4.3.4 Test Procedure	108
4.3.5 Deviation from Test Standard	108
4.3.6 EUT Operating Condition	108
4.3.7 Test Result (Mode 1)	109
4.3.8 Test Result (Mode 2)	137
4.3.9 Test Result (Mode 3)	175
4.4 Occupied Bandwidth Measurement	189
4.4.1 Test Setup	189
4.4.2 Test Instruments	189
4.4.3 Test Procedure	189
4.4.4 Test Results (Mode 1)	190
4.4.5 Test Results (Mode 2)	193
4.4.6 Test Results (Mode 3)	197
4.5 Peak Power Spectral Density Measurement	199
4.5.1 Limits of Peak Power Spectral Density Measurement	199
4.5.2 Test Setup	199
4.5.3 Test Instruments	199

4.5.4	Test Procedure	199
4.5.5	Deviation from Test Standard	199
4.5.6	EUT Operating Condition	199
4.5.7	Test Results (Mode 1).....	200
4.5.8	Test Results (Mode 2).....	212
4.5.9	Test Results (Mode 3).....	228
4.6	Frequency Stability Measurement	238
4.6.1	Limits of Frequency Stability Measurement	238
4.6.2	Test Setup.....	238
4.6.3	Test Instruments	238
4.6.4	Test Procedure	238
4.6.5	Deviation from Test Standard	238
4.6.6	EUT Operating Condition	238
4.6.7	Test Results (Mode 1).....	239
4.7	6dB Bandwidth Measurement.....	240
4.7.1	Limits of 6dB Bandwidth Measurement.....	240
4.7.2	Test Setup.....	240
4.7.3	Test Instruments	240
4.7.4	Test Procedure	240
4.7.5	Deviation from Test Standard	240
4.7.6	EUT Operating Condition	240
4.7.7	Test Results (Mode 1).....	241
4.7.8	Test Results (Mode 2).....	243
4.7.9	Test Results (Mode 3).....	245
5	Pictures of Test Arrangements.....	247
	Appendix – Information on the Testing Laboratories	248

Release Control Record

Issue No.	Description	Date Issued
RF180704E03D-1	Original release.	Mar. 12, 2019

1 Certificate of Conformity

Product: 4x4 802.11a/b/g/n/ac/ax Access Point

Brand: Cisco

Test Model: MR45-HW

Sample Status: ENGINEERING SAMPLE

Applicant: Cisco Systems, Inc.

Test Date: Aug. 29 to Nov. 21, 2018

Standard: 47 CFR FCC Part 15, Subpart E (Section 15.407)
ANSI C63.10: 2013

The above equipment has been tested by **Bureau Veritas Consumer Products Services (H.K.) Ltd., Taoyuan Branch**, and found compliance with the requirement of the above standards. The test record, data evaluation & Equipment Under Test (EUT) configurations represented herein are true and accurate accounts of the measurements of the sample's EMC characteristics under the conditions specified in this report.

Prepared by : Mary Ko , **Date:** Mar. 12, 2019
Mary Ko / Specialist

Approved by : May Chen , **Date:** Mar. 12, 2019
May Chen / Manager

2 Summary of Test Results

47 CFR FCC Part 15, Subpart E (Section 15.407)			
FCC Clause	Test Item	Result	Remarks
15.407(b)(6)	AC Power Conducted Emissions	Pass	Meet the requirement of limit. Minimum passing margin is -4.23dB at 0.38047MHz.
15.407(b) (1/2/3/4(i/ii)/6)	Radiated Emissions & Band Edge Measurement	Pass	Meet the requirement of limit. Minimum passing margin is -0.1dB at 5350.00MHz, 5470.00MHz, 5725.00MHz, 5733.65MHz.
15.407(a)(1/2/3)	Max Average Transmit Power	Pass	Meet the requirement of limit.
---	Occupied Bandwidth Measurement	-	Reference only.
15.407(a)(1/2/3)	Peak Power Spectral Density	Pass	Meet the requirement of limit.
15.407(g)	Frequency Stability	Pass	Meet the requirement of limit.
15.203	Antenna Requirement	Pass	Antenna connector is i-pex(MHF) not a standard connector.

2.1 Measurement Uncertainty

Where relevant, the following measurement uncertainty levels have been estimated for tests performed on the EUT as specified in CISPR 16-4-2:

Measurement	Frequency	Expanded Uncertainty (k=2) (\pm)
Conducted Emissions at mains ports	150kHz ~ 30MHz	1.84 dB
Radiated Emissions up to 1 GHz	30MHz ~ 1GHz	5.53 dB
Radiated Emissions above 1 GHz	1GHz ~ 6GHz	5.08 dB
	6GHz ~ 18GHz	4.98 dB
	18GHz ~ 40GHz	5.19 dB

2.2 Modification Record

There were no modifications required for compliance.

3 General Information

3.1 General Description of EUT (DFS Band)

Product	4x4 802.11a/b/g/n/ac/ax Access Point
Brand	Cisco
Test Model	MR45-HW
Status of EUT	ENGINEERING SAMPLE
Power Supply Rating	12Vdc from power adapter or 55Vdc from PoE
Modulation Type	64QAM, 16QAM, QPSK, BPSK for OFDM 256QAM for OFDM in 11ac mode and VHT (20/40) mode in 2.4GHz 1024QAM for OFDMA in 11ax HE mode
Modulation Technology	OFDM, OFDMA
Transfer Rate	802.11a: up to 54Mbps 802.11n: up to 600Mbps 802.11ac: up to 1733.3Mbps 802.11ax: up to 2401.9Mbps
Operating Frequency	5.26 ~ 5.32GHz, 5.50 ~ 5.72GHz
Number of Channel	802.11a, 802.11n (HT20), 802.11ac (VHT20), 802.11ax (HE20): 16 802.11n (HT40), 802.11ac (VHT40), 802.11ax (HE40): 8 802.11ac (VHT80), 802.11ax (HE80): 4
Output Power	5.26GHz ~ 5.32GHz: Non-Beamforming Mode: 4TX: 248.689mW 2TX: 244.988mW 1TX: 125.314mW Beamforming Mode: 4TX: 123.548mW 2TX: 173.439mW 5.50 ~ 5.72GHz: Non-Beamforming Mode: 4TX: 237.322mW 2TX: 237.497mW 1TX: 121.619mW Beamforming Mode: 4TX: 140.747mW 2TX: 168.134mW
Antenna Type	Refer to Note
Antenna Connector	Refer to Note
Accessory Device	Adapter x 1 (option)
Data Cable Supplied	NA

Note:

- This report is prepared for FCC class III change. The difference compared with the Report No.: RF180704E03-1 as the following information:
 - ◆ Add DFS band <5.26~ 5.32GHz, 5.50 ~ 5.72GHz>.
- According to above condition, all test items need to be performed. And all data were verified to meet the requirements.

3. The EUT has below radios as following table:

Radio 1	Radio 2	Radio 3	Radio 4
WLAN (2.4GHz)	WLAN (5GHz)	2.4GHz / 5GHz Scanning (only RX)	Bluetooth

4. Simultaneously transmission condition.

Condition	Technology		
1	WLAN (2.4GHz)	WLAN (5GHz)	Bluetooth

Note: The emission of the simultaneous operation has been evaluated and no non-compliance was found.

5. The EUT must be supplied with a power adapter or POE as following table:

Adapter (Option)

No.	Brand	Model No.	Spec.
1	UMEC	MA-PWR-30W-US	Input: 100-240Vac, 0.8A, 50/60Hz Output: 12Vdc, 2.5A DC Output cable: Unshielded, 1.4m
2	Ktec	KSAS0361200250HU	Input: 100-240Vac, 1.0A, 50/60Hz Output: 12Vdc, 2.5A DC Output cable: Unshielded, 1.8m

POE (Only for test not for sale)

No.	Brand	Model No.	Spec.
1	CISCO	MA-INJ-5	Input: 100-240Vac, 1.5A, 50-60Hz Output: 55Vdc, 0.63A
2	CISCO	MA-INJ-4	Input: 100-240Vac, 0.67A, 50/60Hz Output: 55Vdc, 0.6A

Note:

- From the above conditions, the conducted emissions worse case was found in **POE No. 1**. Therefore only the test data of the mode was recorded in this report.
- From the above conditions, the radiated emissions worse case was found in **Adapter No. 2**. Therefore only the test data of the mode was recorded in this report.

6. The antennas provided to the EUT, please refer to the following table:

WLAN Directional gain table – 4TX			
Frequency range (GHz)	Directional Antenna Gain (dBi)	Antenna Type	Antenna Connector
2.4 ~ 2.4835	7.74	PIFA	i-pex(MHF)
5.15 ~ 5.25	8.40		
5.25 ~ 5.35	8.93		
5.47 ~ 5.725	8.51		
5.725 ~ 5.85	8.11		

WLAN Directional gain table – 2TX				
Frequency range (GHz)	Antenna Combine Type	Directional Antenna Gain (dBi)	Antenna Type	Antenna Connector
2.4 ~ 2.4835	2.4G Ant. 1+4	6.12	PIFA	i-pex(MHF)
5.15 ~ 5.25	5.15G Ant. 1+3	6.62		
5.25 ~ 5.35	5.35G Ant. 1+2	7.50		
5.47 ~ 5.725	5.55G Ant. 3+4	7.71		
5.725 ~ 5.85	5.85G Ant. 3+4	7.27		

Bluetooth antenna spec.			
Antenna Net Gain (dBi)	Frequency range (GHz)	Antenna Type	Antenna Connector
4.24	2.4 ~ 2.4835	PIFA	i-pex(MHF)

Note: More detailed information, please refer to operating description.

7. The EUT incorporates a MIMO function.

Radio 1 - 2.4GHz Band			
MODULATION MODE	DATA RATE (MCS)	TX & RX CONFIGURATION	
802.11b	1 ~ 11Mbps	4TX	4RX
802.11g	6 ~ 54Mbps	4TX	4RX
802.11n (HT20)	MCS 0~7	4TX	4RX
	MCS 8~15	4TX	4RX
	MCS 16~23	4TX	4RX
	MCS 24~31	4TX	4RX
802.11n (HT40)	MCS 0~7	4TX	4RX
	MCS 8~15	4TX	4RX
	MCS 16~23	4TX	4RX
	MCS 24~31	4TX	4RX
VHT20	MCS 0~8, Nss=1	4TX	4RX
	MCS 0~8, Nss=2	4TX	4RX
	MCS 0~9, Nss=3	4TX	4RX
	MCS 0~8, Nss=4	4TX	4RX
VHT40	MCS 0~9, Nss=1	4TX	4RX
	MCS 0~9, Nss=2	4TX	4RX
	MCS 0~9, Nss=3	4TX	4RX
	MCS 0~9, Nss=4	4TX	4RX
802.11ax (HE20)	MCS 0~11, Nss=1	4TX	4RX
	MCS 0~11, Nss=2	4TX	4RX
	MCS 0~11, Nss=3	4TX	4RX
	MCS 0~11, Nss=4	4TX	4RX
802.11ax (HE40)	MCS 0~11, Nss=1	4TX	4RX
	MCS 0~11, Nss=2	4TX	4RX
	MCS 0~11, Nss=3	4TX	4RX
	MCS 0~11, Nss=4	4TX	4RX
Radio 2 - 5GHz Band			
MODULATION MODE	DATA RATE (MCS)	TX & RX CONFIGURATION	
802.11a	6 ~ 54Mbps	4TX	4RX
802.11n (HT20)	MCS 0~7	4TX	4RX
	MCS 8~15	4TX	4RX
	MCS 16~23	4TX	4RX
	MCS 24~31	4TX	4RX
802.11n (HT40)	MCS 0~7	4TX	4RX
	MCS 8~15	4TX	4RX
	MCS 16~23	4TX	4RX
	MCS 24~31	4TX	4RX
802.11ac (VHT20)	MCS 0~8, Nss=1	4TX	4RX
	MCS 0~8, Nss=2	4TX	4RX
	MCS 0~9, Nss=3	4TX	4RX
	MCS 0~8, Nss=4	4TX	4RX
802.11ac (VHT40)	MCS 0~9, Nss=1	4TX	4RX
	MCS 0~9, Nss=2	4TX	4RX
	MCS 0~9, Nss=3	4TX	4RX
	MCS 0~9, Nss=4	4TX	4RX
802.11ac (VHT80)	MCS 0~9, Nss=1	4TX	4RX
	MCS 0~9, Nss=2	4TX	4RX
	MCS 0~9, Nss=3	4TX	4RX
	MCS 0~9, Nss=4	4TX	4RX

802.11ac (VHT80+VHT80) (for U-NII-1 & U-NII-3)	MCS 0~9, Nss=1	2TX+2TX	2RX+2RX
	MCS 0~9, Nss=2	2TX+2TX	2RX+2RX
802.11ax (HE20)	MCS 0~11, Nss=1	4TX	4RX
	MCS 0~11, Nss=2	4TX	4RX
	MCS 0~11, Nss=3	4TX	4RX
	MCS 0~11, Nss=4	4TX	4RX
802.11ax (HE40)	MCS 0~11, Nss=1	4TX	4RX
	MCS 0~11, Nss=2	4TX	4RX
	MCS 0~11, Nss=3	4TX	4RX
	MCS 0~11, Nss=4	4TX	4RX
802.11ax (HE80)	MCS 0~11, Nss=1	4TX	4RX
	MCS 0~11, Nss=2	4TX	4RX
	MCS 0~11, Nss=3	4TX	4RX
	MCS 0~11, Nss=4	4TX	4RX
802.11ax (HE80+HE80) (for U-NII-1 & U-NII-3)	MCS 0~11, Nss=1	2TX+2TX	2RX+2RX
	MCS 0~11, Nss=2	2TX+2TX	2RX+2RX

Note:

1. All of modulation mode support beamforming function except 802.11a/b/g modulation mode.
2. The EUT support Beamforming and non-beamforming mode, therefore both mode were investigated and the worst case scenario was identified. The worst case data were presented in test report.
3. The modulation and bandwidth are similar for 802.11n mode for 20MHz (40MHz) and 802.11ac/ax mode for 20MHz (40MHz/80MHz), therefore investigated worst case to representative mode in test report.

Radio 3 - Scanning (only RX)

2.4GHz

MODULATION MODE	RX CONFIGURATION
802.11b	1RX
802.11g	1RX
802.11n (HT20)	1RX
802.11n (HT40)	1RX
VHT20	1RX
VHT40	1RX
5GHz	
MODULATION MODE	RX CONFIGURATION
802.11a	1RX
802.11n (HT20)	1RX
802.11n (HT40)	1RX
802.11ac (VHT20)	1RX
802.11ac (VHT40)	1RX
802.11ac (VHT80)	1RX

8. The above EUT information is declared by manufacturer and for more detailed features description, please refers to the manufacturer's specifications or user's manual.

3.2 Description of Test Modes

FOR 5260 ~ 5320MHz

4 channels are provided for 802.11a, 802.11n (HT20), 802.11ac (VHT20), 802.11ax (HE20):

Channel	Frequency	Channel	Frequency
52	5260 MHz	60	5300 MHz
56	5280 MHz	64	5320 MHz

2 channels are provided for 802.11n (HT40), 802.11ac (VHT40), 802.11ax (HE40):

Channel	Frequency	Channel	Frequency
54	5270 MHz	62	5310 MHz

1 channel is provided for 802.11ac (VHT80, 802.11ax (HE80):

Channel	Frequency
58	5290MHz

FOR 5500 ~ 5720MHz

12 channels are provided for 802.11a, 802.11n (HT20), 802.11ac (VHT20), 802.11ax (HE20):

Channel	Frequency	Channel	Frequency
100	5500 MHz	124	5620 MHz
104	5520 MHz	128	5640 MHz
108	5540 MHz	132	5660 MHz
112	5560 MHz	136	5680 MHz
116	5580 MHz	140	5700 MHz
120	5600 MHz	144	5720 MHz

6 channels are provided for 802.11n (HT40), 802.11ac (VHT40), 802.11ax (HE40):

Channel	Frequency	Channel	Frequency
102	5510 MHz	126	5630 MHz
110	5550 MHz	134	5670 MHz
118	5590 MHz	142	5710 MHz

3 channels are provided for 802.11ac (VHT80), 802.11ax (HE80):

Channel	Frequency	Channel	Frequency
106	5530 MHz	138	5690 MHz
122	5610 MHz		

3.2.1 Test Mode Applicability and Tested Channel Detail

EUT Configure Mode	Applicable To				Description
	RE \geq 1G	RE $<$ 1G	PLC	APCM	
1	√	√	√	√	4TX (PLC: POE mode; RE: adapter mode)
2	√	-	-	√	2TX (RE: adapter mode)
3	√	-	-	√	1TX (RE: adapter mode)

Where **RE \geq 1G**: Radiated Emission above 1GHz **RE $<$ 1G**: Radiated Emission below 1GHz
PLC: Power Line Conducted Emission **APCM**: Antenna Port Conducted Measurement

NOTE: 1. The EUT had been pre-tested on the positioned of each 3 axis. The worst case was found when positioned on X-plane.
 2. "-" means no effect.

Radiated Emission Test (Above 1GHz):

- Pre-Scan has been conducted to determine the worst-case mode from all possible combinations between available modulations, data rates and antenna ports (if EUT with antenna diversity architecture).
- Following channel(s) was (were) selected for the final test as listed below.

Non-Beamforming Mode						
Mode	FREQ. Band (MHz)	Available Channel	Tested Channel	Modulation Technology	Modulation Type	Data Rate Parameter
802.11a	5260-5320	52 to 64	52, 60, 64	OFDM	BPSK	6Mb/s
802.11ax (HE20)		52 to 64	52, 60, 64	OFDMA	BPSK	MCS0
802.11ax (HE40)		54 to 62	54, 62	OFDMA	BPSK	MCS0
802.11ax (HE80)		58	58	OFDMA	BPSK	MCS0
802.11a	5500-5720	100 to 144	100, 116, 140, 144	OFDM	BPSK	6Mb/s
802.11ax (HE20)		100 to 144	100, 116, 140, 144	OFDMA	BPSK	MCS0
802.11ax (HE40)		102 to 142	102, 110, 134, 142	OFDMA	BPSK	MCS0
802.11ax (HE80)		106 to 138	106, 122, 138	OFDMA	BPSK	MCS0

Radiated Emission Test (Below 1GHz):

- Pre-Scan has been conducted to determine the worst-case mode from all possible combinations between available modulations, data rates and antenna ports (if EUT with antenna diversity architecture).
- Following channel(s) was (were) selected for the final test as listed below.

Non-Beamforming Mode						
Mode	FREQ. Band (MHz)	Available Channel	Tested Channel	Modulation Technology	Modulation Type	Data Rate Parameter
802.11ax (HE40)	5260-5320 5500-5720	54 to 62 102 to 142	54	OFDMA	BPSK	MCS0

Power Line Conducted Emission Test:

- Pre-Scan has been conducted to determine the worst-case mode from all possible combinations between available modulations, data rates and antenna ports (if EUT with antenna diversity architecture).
- Following channel(s) was (were) selected for the final test as listed below.

Non-Beamforming Mode						
Mode	FREQ. Band (MHz)	Available Channel	Tested Channel	Modulation Technology	Modulation Type	Data Rate Parameter
802.11ax (HE40)	5260-5320 5500-5720	54 to 62 102 to 142	54	OFDMA	BPSK	MCS0

Antenna Port Conducted Measurement:

- This item includes all test value of each mode, but only includes spectrum plot of worst value of each mode.
- Pre-Scan has been conducted to determine the worst-case mode from all possible combinations between available modulations, data rates and antenna ports (if EUT with antenna diversity architecture).
- Following channel(s) was (were) selected for the final test as listed below.

Non-Beamforming Mode						
Mode	FREQ. Band (MHz)	Available Channel	Tested Channel	Modulation Technology	Modulation Type	Data Rate Parameter
802.11a	5260-5320	52 to 64	52, 60, 64	OFDM	BPSK	6Mb/s
802.11ac (VHT20)		52 to 64	52, 60, 64	OFDM	BPSK	MCS0
802.11ac (VHT40)		54 to 62	54, 62	OFDM	BPSK	MCS0
802.11ac (VHT80)		58	58	OFDM	BPSK	MCS0
802.11ax (HE20)		52 to 64	52, 60, 64	OFDMA	BPSK	MCS0
802.11ax (HE40)		54 to 62	54, 62	OFDMA	BPSK	MCS0
802.11ax (HE80)		58	58	OFDMA	BPSK	MCS0
802.11a	5500-5720	100 to 144	100, 116, 140, 144	OFDM	BPSK	6Mb/s
802.11ac (VHT20)		100 to 144	100, 116, 140, 144	OFDM	BPSK	MCS0
802.11ac (VHT40)		102 to 142	102, 110, 134, 142	OFDM	BPSK	MCS0
802.11ac (VHT80)		106 to 138	106, 122, 138	OFDM	BPSK	MCS0
802.11ax (HE20)		100 to 144	100, 116, 140, 144	OFDMA	BPSK	MCS0
802.11ax (HE40)		102 to 142	102, 110, 134, 142	OFDMA	BPSK	MCS0
802.11ax (HE80)		106 to 138	106, 122, 138	OFDMA	BPSK	MCS0

Beamforming Mode (Output power only)						
Mode	FREQ. Band (MHz)	Available Channel	Tested Channel	Modulation Technology	Modulation Type	Data Rate Parameter
802.11ac (VHT20)	5260-5320	52 to 64	52, 60, 64	OFDM	BPSK	MCS0
802.11ac (VHT40)		54 to 62	54, 62	OFDM	BPSK	MCS0
802.11ac (VHT80)		58	58	OFDM	BPSK	MCS0
802.11ax (HE20)		52 to 64	52, 60, 64	OFDMA	BPSK	MCS0
802.11ax (HE40)		54 to 62	54, 62	OFDMA	BPSK	MCS0
802.11ax (HE80)		58	58	OFDMA	BPSK	MCS0
802.11ac (VHT20)	5500-5720	100 to 144	100, 116, 140, 144	OFDM	BPSK	MCS0
802.11ac (VHT40)		102 to 142	102, 110, 134, 142	OFDM	BPSK	MCS0
802.11ac (VHT80)		106 to 138	106, 122, 138	OFDM	BPSK	MCS0
802.11ax (HE20)		100 to 144	100, 116, 140, 144	OFDMA	BPSK	MCS0
802.11ax (HE40)		102 to 142	102, 110, 134, 142	OFDMA	BPSK	MCS0
802.11ax (HE80)		106 to 138	106, 122, 138	OFDMA	BPSK	MCS0

Test Condition:

Applicable To	Environmental Conditions	Input Power (system)	Tested By
RE \geq 1G	22deg. C, 68%RH 22deg. C, 63%RH	120Vac, 60Hz	Weiwei Lo
RE $<$ 1G	22deg. C, 68%RH	120Vac, 60Hz	Frank Chuang
PLC	25deg. C, 75%RH	120Vac, 60Hz	Frank Chuang
APCM	25deg. C, 60%RH	120Vac, 60Hz	Jyunchun Lin

3.3 Duty Cycle of Test Signal

If duty cycle of test signal is < 98%, duty factor shall be considered.

802.11a: Duty cycle = 1.428 ms/1.536 ms = 0.93, Duty factor = $10 * \log(1/0.93) = 0.32$

802.11ac (VHT20): Duty cycle = 5.423 ms/5.638 ms = 0.962, Duty factor = $10 * \log(1/0.962) = 0.17$

802.11ac (VHT40): Duty cycle = 5.423 ms/5.635 ms = 0.962, Duty factor = $10 * \log(1/0.962) = 0.17$

802.11ac (VHT80): Duty cycle = 5.423 ms/5.65 ms = 0.96, Duty factor = $10 * \log(1/0.96) = 0.18$

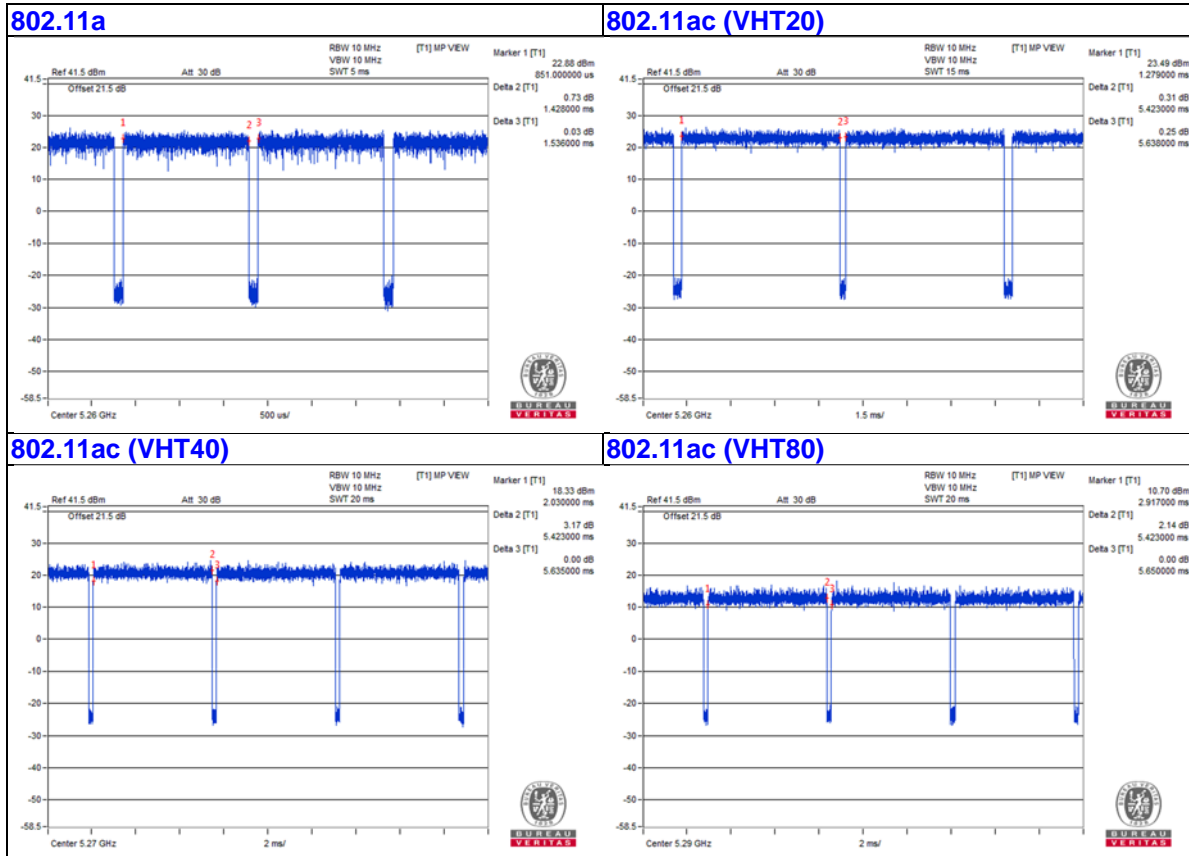

802.11ax (HE20): Duty cycle = 5.45 ms/5.708 ms = 0.955, Duty factor = $10 * \log(1/0.955) = 0.2$
 802.11ax (HE40): Duty cycle = 5.443 ms/5.66 ms = 0.962, Duty factor = $10 * \log(1/0.962) = 0.17$
 802.11ax (HE80): Duty cycle = 5.448 ms/5.668 ms = 0.961, Duty factor = $10 * \log(1/0.961) = 0.17$

802.11ax (HE20)

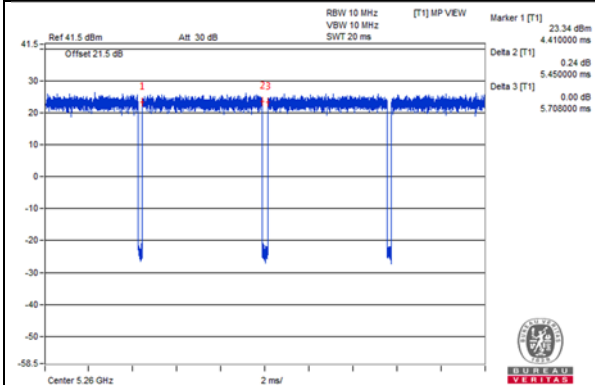

802.11ax (HE40)

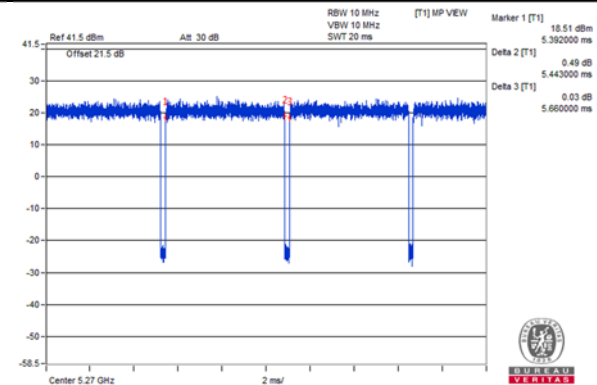

802.11ax (HE80)

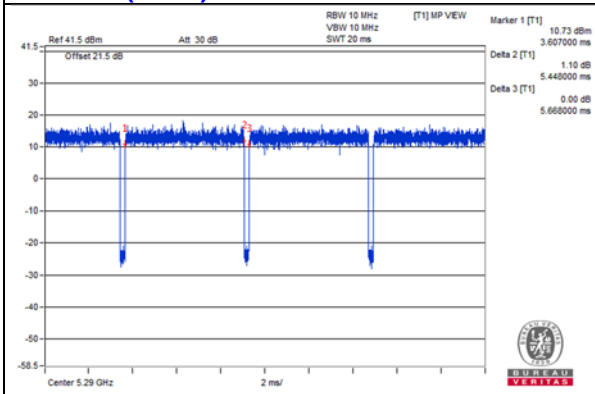

3.4 Description of Support Units

The EUT has been tested as an independent unit together with other necessary accessories or support units. The following support units or accessories were used to form a representative test configuration during the tests.

ID	Product	Brand	Model No.	Serial No.	FCC ID	Remarks
A.	Laptop	DELL	E6420	B92T3R1	FCC DoC	Provided by Lab
B.	POE Adapter	CISCO	MA-INJ-5	NA	NA	Supplied by client

Note:

1. All power cords of the above support units are non-shielded (1.8m).

ID	Descriptions	Qty.	Length (m)	Shielding (Yes/No)	Cores (Qty.)	Remarks
1.	RJ-45 Cable	1	10	No	0	Provided by Lab
2.	DC Cable	1	1.8	No	0	Supplied by client
3.	RJ-45 Cable	1	0.5	No	0	Provided by Lab

3.4.1 Configuration of System under Test

POE mode:

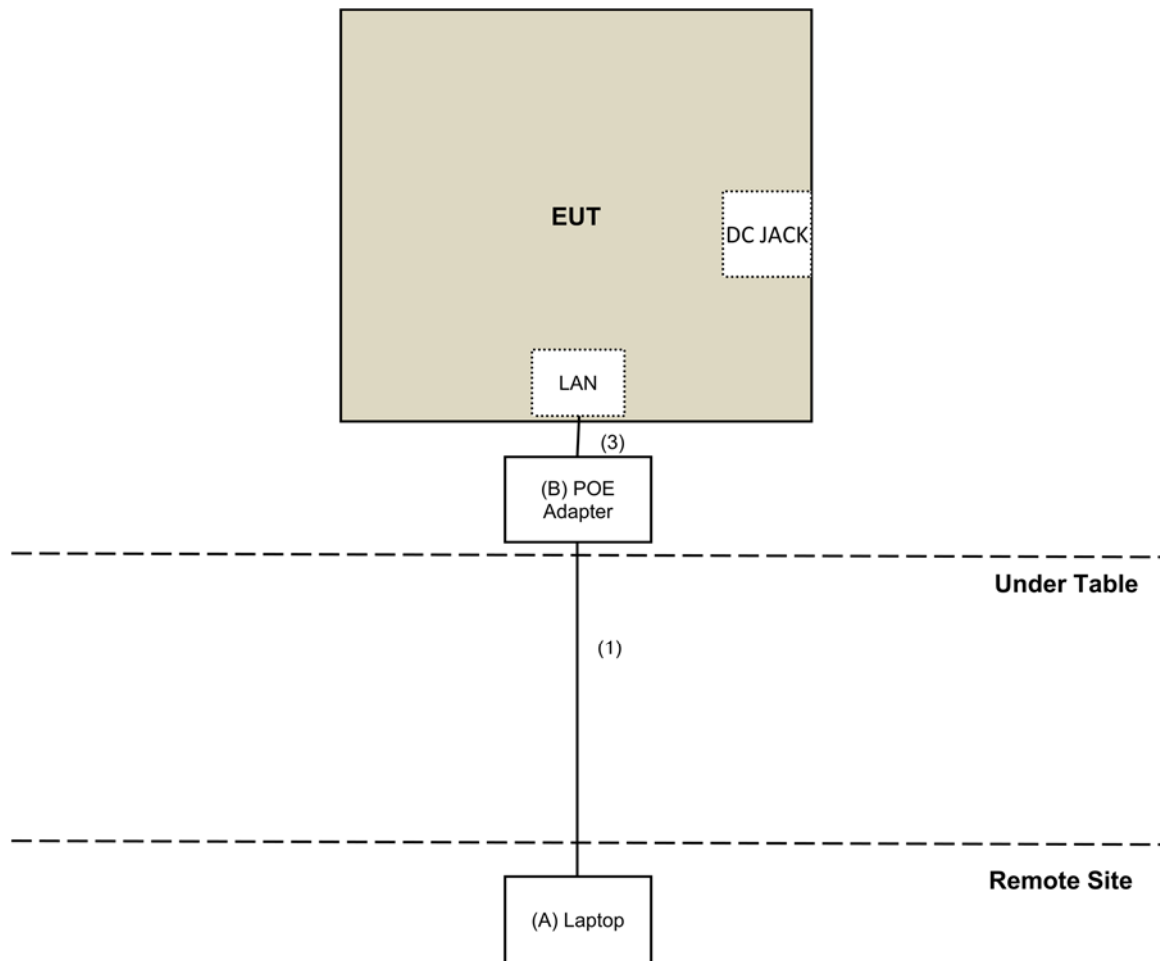

Adapter mode:

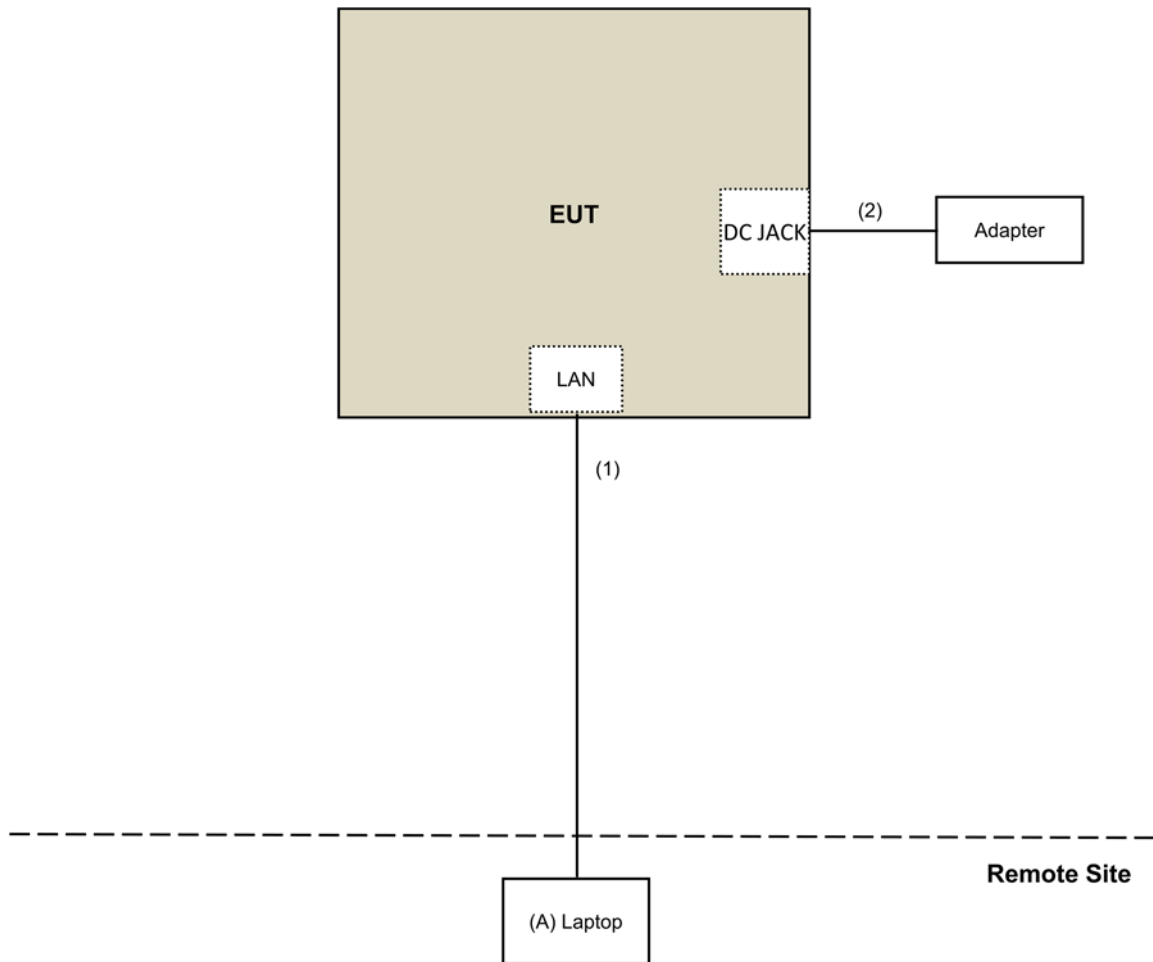

3.5 General Description of Applied Standard

The EUT is a RF Product. According to the specifications of the manufacturer, it must comply with the requirements of the following standards:

FCC Part 15, Subpart E (15.407)
KDB 789033 D02 General UNII Test Procedure New Rules v02r01
KDB 662911 D01 Multiple Transmitter Output v02r01
ANSI C63.10-2013

All test items have been performed and recorded as per the above standards.

4 Test Types and Results

4.1 Radiated Emission and Bandedge Measurement

4.1.1 Limits of Radiated Emission and Bandedge Measurement

Radiated emissions which fall in the restricted bands must comply with the radiated emission limits specified as below table.

Frequencies (MHz)	Field Strength (microvolts/meter)	Measurement Distance (meters)
0.009 ~ 0.490	2400/F(kHz)	300
0.490 ~ 1.705	24000/F(kHz)	30
1.705 ~ 30.0	30	30
30 ~ 88	100	3
88 ~ 216	150	3
216 ~ 960	200	3
Above 960	500	3

NOTE:

1. The lower limit shall apply at the transition frequencies.
2. Emission level (dBuV/m) = 20 log Emission level (uV/m).
3. For frequencies above 1000MHz, the field strength limits are based on average detector, however, the peak field strength of any emission shall not exceed the maximum permitted average limits, specified above by more than 20dB under any condition of modulation.

Limits of unwanted emission out of the restricted bands

Applicable To		Limit	
789033 D02 General UNII Test Procedure New Rules v02r01		Field Strength at 3m	
		PK:74 (dBuV/m)	AV:54 (dBuV/m)
Frequency Band	Applicable To	EIRP Limit	Equivalent Field Strength at 3m
5150~5250 MHz	15.407(b)(1)	PK:-27 (dBm/MHz)	PK:68.2(dBuV/m)
5250~5350 MHz	15.407(b)(2)		
5470~5725 MHz	15.407(b)(3)		
5725~5850 MHz	<input checked="" type="checkbox"/> 15.407(b)(4)(i)	PK:-27 (dBm/MHz) ^{*1} PK:10 (dBm/MHz) ^{*2} PK:15.6 (dBm/MHz) ^{*3} PK:27 (dBm/MHz) ^{*4}	PK: 68.2(dBuV/m) ^{*1} PK:105.2 (dBuV/m) ^{*2} PK: 110.8(dBuV/m) ^{*3} PK:122.2 (dBuV/m) ^{*4}
	<input type="checkbox"/> 15.407(b)(4)(ii)	Emission limits in section 15.247(d)	
^{*1} beyond 75 MHz or more above of the band edge. ^{*3} below the band edge increasing linearly to a level of 15.6 dBm/MHz at 5 MHz above.		^{*2} below the band edge increasing linearly to 10 dBm/MHz at 25 MHz above. ^{*4} from 5 MHz above or below the band edge increasing linearly to a level of 27 dBm/MHz at the band edge.	

Note:

The following formula is used to convert the equipment isotropic radiated power (eirp) to field strength:

$$E = \frac{1000000 \sqrt{30P}}{3} \mu\text{V/m, where P is the eirp (Watts).}$$

4.1.2 Test Instruments

For radiated emission test (below 1GHz test):

DESCRIPTION & MANUFACTURER	MODEL NO.	SERIAL NO.	CALIBRATED DATE	CALIBRATED UNTIL
Test Receiver Agilent	N9038A	MY50010156	July 12, 2018	July 11, 2019
Pre-Amplifier EMCI	EMC001340	980142	Feb. 09, 2018	Feb. 08, 2019
Loop Antenna(*) Electro-Metrics	EM-6879	264	Dec. 16, 2016	Dec. 15, 2018
RF Cable	NA	LOOPCAB-001	Jan. 15, 2018	Jan. 14, 2019
RF Cable	NA	LOOPCAB-002	Jan. 15, 2018	Jan. 14, 2019
Pre-Amplifier Mini-Circuits	ZFL-1000VH2B	AMP-ZFL-05	May 05, 2018	May 04, 2019
Trilog Broadband Antenna SCHWARZBECK	VULB 9168	9168-361	Nov. 29, 2017	Nov. 28, 2018
RF Cable	8D	966-3-1	Mar. 20, 2018	Mar. 19, 2019
RF Cable	8D	966-3-2	Mar. 20, 2018	Mar. 19, 2019
RF Cable	8D	966-3-3	Mar. 20, 2018	Mar. 19, 2019
Fixed attenuator Mini-Circuits	UNAT-5+	PAD-3m-3-01	Oct. 03, 2017	Oct. 02, 2018
Software	ADT_Radiated_V8.7.08	NA	NA	NA
Antenna Tower & Turn Table Max-Full	MF-7802	MF780208406	NA	NA
Boresight Antenna Fixture	FBA-01	FBA-SIP01	NA	NA

Note:

1. The calibration interval of the above test instruments is 12 months and the calibrations are traceable to NML/ROC and NIST/USA.
2. *The calibration interval of the above test instruments is 24 months and the calibrations are traceable to NML/ROC and NIST/USA.
3. The test was performed in 966 Chamber No. 3.
4. The CANADA Site Registration No. is 20331-1
5. Loop antenna was used for all emissions below 30 MHz.
6. Tested Date: Aug. 29, 2018

For other test:

DESCRIPTION & MANUFACTURER	MODEL NO.	SERIAL NO.	CALIBRATED DATE	CALIBRATED UNTIL
Test Receiver Agilent	N9038A	MY50010156	July 12, 2018	July 11, 2019
Horn_Antenna SCHWARZBECK	BBHA9120-D	9120D-406	Dec. 12, 2017	Dec. 11, 2018
Pre-Amplifier EMCI	EMC12630SE	980384	Jan. 29, 2018	Jan. 28, 2019
RF Cable	EMC104-SM-SM-1200	160922	Jan. 29, 2018	Jan. 28, 2019
RF Cable	EMC104-SM-SM-2000	150317	Jan. 29, 2018	Jan. 28, 2019
RF Cable	EMC104-SM-SM-5000	150322	Jan. 29, 2018	Jan. 28, 2019
Spectrum Analyzer Keysight	N9030A	MY54490679	July 23, 2018	July 22, 2019
Pre-Amplifier EMCI	EMC184045SE	980386	Jan. 29, 2018	Jan. 28, 2019
Horn_Antenna SCHWARZBECK	BBHA 9170	BBHA9170608	Dec. 14, 2017	Dec. 13, 2018
RF Cable	EMC102-KM-KM-1200	160924	Jan. 29, 2018	Jan. 28, 2019
Attenuator STI	STI02-3310-10	013	Feb. 12, 2018	Feb. 11, 2019
Software	ADT_Radiated_V8.7.08	NA	NA	NA
Antenna Tower & Turn Table Max-Full	MF-7802	MF780208406	NA	NA
Boresight Antenna Fixture	FBA-01	FBA-SIP01	NA	NA
Spectrum Analyzer R&S	FSV40	100964	June 20, 2018	June 19, 2019
Power meter Anritsu	ML2495A	1014008	May 09, 2018	May 08, 2019
Power sensor Anritsu	MA2411B	0917122	May 09, 2018	May 08, 2019
AC Power Source Extech Electronics	6205	1440452	NA	NA
Temperature & Humidity Chamber Giant Force	GTH-150-40-SP-AR	MAA0812-008	Jan. 10, 2018	Jan. 09, 2019
True RMS Clamp Meter FLUKE	325	31130711WS	May 22, 2018	May 21, 2019

Note:

1. The calibration interval of the above test instruments is 12 months and the calibrations are traceable to NML/ROC and NIST/USA.
2. *The calibration interval of the above test instruments is 24 months and the calibrations are traceable to NML/ROC and NIST/USA.
3. The test was performed in 966 Chamber No. 3.
4. The CANADA Site Registration No. is 20331-1
5. Loop antenna was used for all emissions below 30 MHz.
6. Tested Date: Nov. 05 to 21, 2018

4.1.3 Test Procedure

For Radiated emission below 30MHz

- a. The EUT was placed on the top of a rotating table 0.8 meters above the ground at a 3 meter chamber room. The table was rotated 360 degrees to determine the position of the highest radiation.
- b. The EUT was set 3 meters away from the interference-receiving antenna, which was mounted on the top of a variable-height antenna tower.
- c. Parallel, perpendicular, and ground-parallel orientations of the antenna are set to make the measurement.
- d. For each suspected emission, the EUT was arranged to its worst case and the rotatable table was turned from 0 degrees to 360 degrees to find the maximum reading.
- e. The test-receiver system was set to Quasi-Peak Detect Function and Specified Bandwidth with Maximum Hold Mode.

NOTE:

1. The resolution bandwidth and video bandwidth of test receiver/spectrum analyzer is 9kHz at frequency below 30MHz.

For Radiated emission above 30MHz

- a. The EUT was placed on the top of a rotating table 0.8 meters (for 30MHz ~ 1GHz) / 1.5 meters (for above 1GHz) above the ground at 3 meter chamber room for test. The table was rotated 360 degrees to determine the position of the highest radiation.
- b. The EUT was set 3 meters away from the interference-receiving antenna, which was mounted on the top of a variable-height antenna tower.
- c. The height of antenna is varied from one meter to four meters above the ground to determine the maximum value of the field strength. Both horizontal and vertical polarizations of the antenna are set to make the measurement.
- d. For each suspected emission, the EUT was arranged to its worst case and then the antenna was tuned to heights from 1 meter to 4 meters and the rotatable table was turned from 0 degrees to 360 degrees to find the maximum reading.
- e. The test-receiver system was set to quasi-peak detect function and specified bandwidth with maximum hold mode when the test frequency is below 1 GHz.
- f. The test-receiver system was set to peak and average detects function and specified bandwidth with maximum hold mode when the test frequency is above 1 GHz. If the peak reading value also meets average limit, measurement with the average detector is unnecessary.

Note:

1. The resolution bandwidth and video bandwidth of test receiver/spectrum analyzer is 120kHz for Quasi-peak detection (QP) at frequency below 1GHz.
2. The resolution bandwidth of test receiver/spectrum analyzer is 1 MHz and the video bandwidth is 3 MHz for Peak detection (PK) at frequency above 1GHz.
3. The resolution bandwidth of test receiver/spectrum analyzer is 1MHz and the video bandwidth is $\geq 1/T$ (Duty cycle < 98%) or 10Hz (Duty cycle $\geq 98\%$) for Average detection (AV) at frequency above 1GHz.
4. All modes of operation were investigated and the worst-case emissions are reported.

4.1.4 Deviation from Test Standard

No deviation.

4.1.5 Test Setup

For Radiated emission below 30MHz

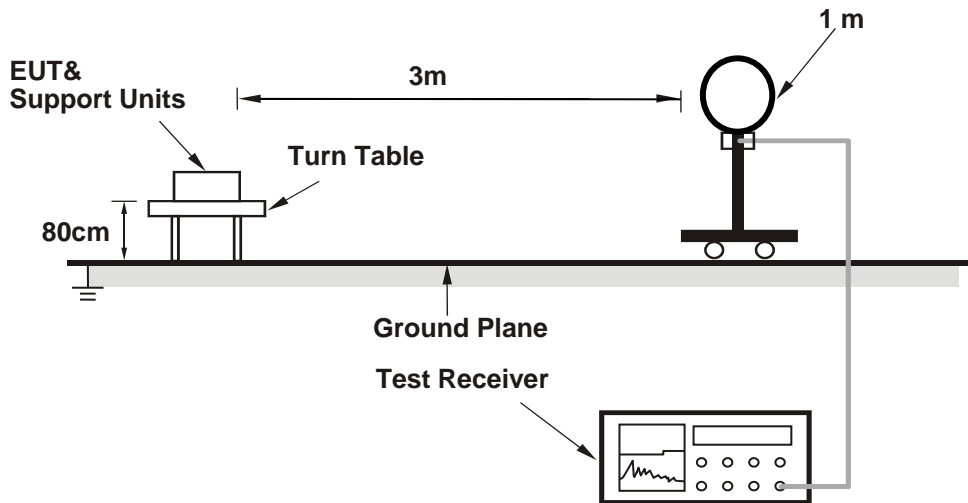

For Radiated emission 30MHz to 1GHz

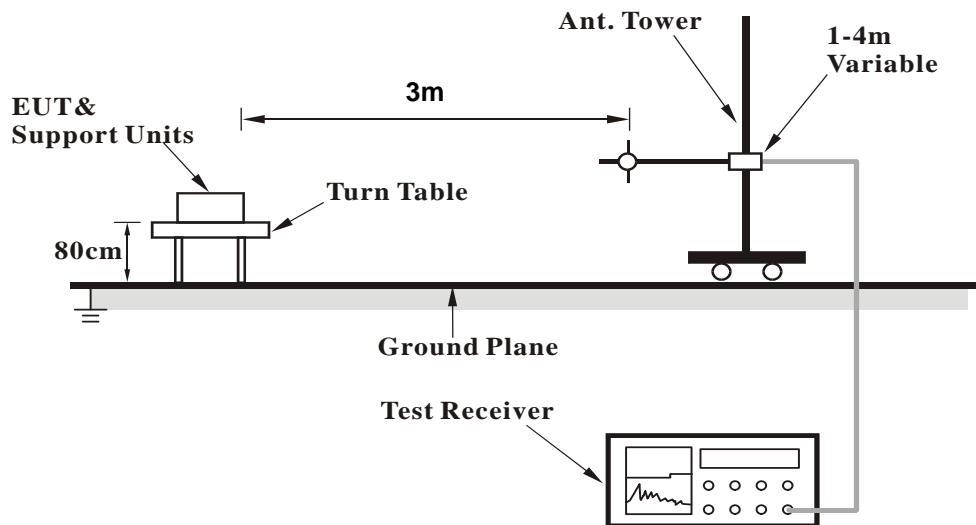

For Radiated emission above 1GHz

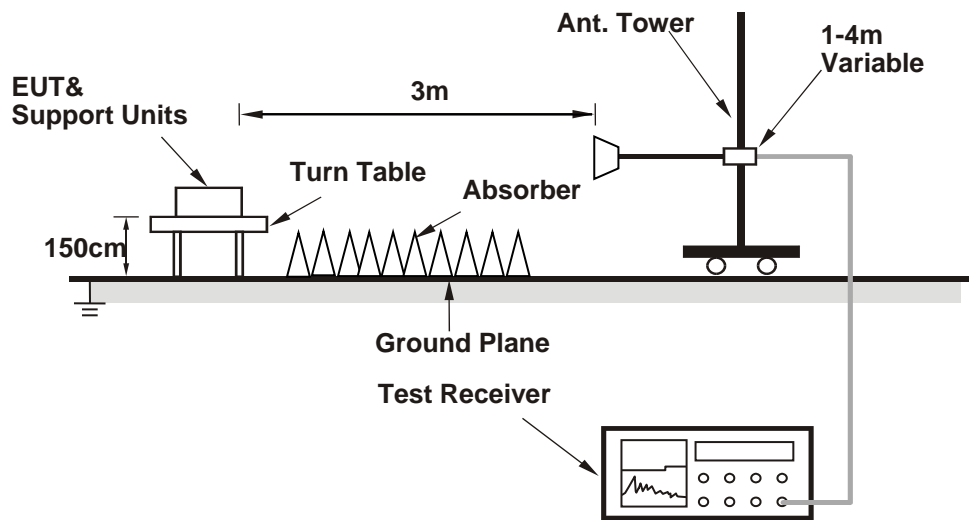

For the actual test configuration, please refer to the attached file (Test Setup Photo).

4.1.6 EUT Operating Condition

- a. Connected the EUT with the Laptop which is placed on remote site.
- b. Controlling software (QSPR (5.0-00161)) has been activated to set the EUT on specific status.

4.1.7 Test Results (Mode 1)

Above 1GHz Data:

802.11a

CHANNEL	TX Channel 52	DETECTOR FUNCTION	Peak (PK)
FREQUENCY RANGE	1GHz ~ 40GHz		Average (AV)

ANTENNA POLARITY & TEST DISTANCE: HORIZONTAL AT 3 M

NO.	FREQ. (MHz)	EMISSION LEVEL (dBuV/m)	LIMIT (dBuV/m)	MARGIN (dB)	ANTENNA HEIGHT (m)	TABLE ANGLE (Degree)	RAW VALUE (dBuV)	CORRECTION FACTOR (dB/m)
1	5150.00	49.4 PK	74.0	-24.6	1.45 H	100	46.8	2.6
2	5150.00	39.2 AV	54.0	-14.8	1.45 H	100	36.6	2.6
3	*5260.00	105.1 PK			1.45 H	100	103.0	2.1
4	*5260.00	94.8 AV			1.45 H	100	92.7	2.1
5	#10520.00	49.4 PK	68.2	-18.8	2.98 H	93	37.0	12.4
6	15780.00	53.0 PK	74.0	-21.0	2.46 H	335	41.5	11.5
7	15780.00	41.1 AV	54.0	-12.9	2.46 H	335	29.6	11.5

ANTENNA POLARITY & TEST DISTANCE: VERTICAL AT 3 M

NO.	FREQ. (MHz)	EMISSION LEVEL (dBuV/m)	LIMIT (dBuV/m)	MARGIN (dB)	ANTENNA HEIGHT (m)	TABLE ANGLE (Degree)	RAW VALUE (dBuV)	CORRECTION FACTOR (dB/m)
1	5150.00	53.0 PK	74.0	-21.0	3.32 V	96	50.4	2.6
2	5150.00	42.3 AV	54.0	-11.7	3.32 V	96	39.7	2.6
3	*5260.00	113.4 PK			3.32 V	96	111.3	2.1
4	*5260.00	103.4 AV			3.32 V	96	101.3	2.1
5	#10520.00	50.3 PK	68.2	-17.9	1.98 V	295	37.9	12.4
6	15780.00	60.2 PK	74.0	-13.8	2.80 V	195	48.7	11.5
7	15780.00	48.7 AV	54.0	-5.3	2.80 V	195	37.2	11.5

REMARKS:

1. Emission Level(dBuV/m) = Raw Value(dBuV) + Correction Factor(dB/m)
2. Correction Factor(dB/m) = Antenna Factor(dB/m) + Cable Factor(dB) – Pre-Amplifier Factor(dB)
3. The other emission levels were very low against the limit.
4. Margin value = Emission Level – Limit value
5. " * ": Fundamental frequency.
6. " # ": The radiated frequency is out of the restricted band.

CHANNEL	TX Channel 60	DETECTOR FUNCTION	Peak (PK)
FREQUENCY RANGE	1GHz ~ 40GHz		Average (AV)

ANTENNA POLARITY & TEST DISTANCE: HORIZONTAL AT 3 M

NO.	FREQ. (MHz)	EMISSION LEVEL (dBuV/m)	LIMIT (dBuV/m)	MARGIN (dB)	ANTENNA HEIGHT (m)	TABLE ANGLE (Degree)	RAW VALUE (dBuV)	CORRECTION FACTOR (dB/m)
1	*5300.00	105.2 PK			1.43 H	99	103.0	2.2
2	*5300.00	94.7 AV			1.43 H	99	92.5	2.2
3	10600.00	49.7 PK	74.0	-24.3	2.99 H	109	38.0	11.7
4	10600.00	39.2 AV	54.0	-14.8	2.99 H	109	27.5	11.7
5	15900.00	52.7 PK	74.0	-21.3	2.43 H	324	41.5	11.2
6	15900.00	40.9 AV	54.0	-13.1	2.43 H	324	29.7	11.2

ANTENNA POLARITY & TEST DISTANCE: VERTICAL AT 3 M

NO.	FREQ. (MHz)	EMISSION LEVEL (dBuV/m)	LIMIT (dBuV/m)	MARGIN (dB)	ANTENNA HEIGHT (m)	TABLE ANGLE (Degree)	RAW VALUE (dBuV)	CORRECTION FACTOR (dB/m)
1	*5300.00	113.8 PK			3.33 V	105	111.6	2.2
2	*5300.00	103.7 AV			3.33 V	105	101.5	2.2
3	10600.00	49.8 PK	74.0	-24.2	1.92 V	306	38.1	11.7
4	10600.00	39.6 AV	54.0	-14.4	1.92 V	306	27.9	11.7
5	15900.00	60.0 PK	74.0	-14.0	2.84 V	208	48.8	11.2
6	15900.00	48.7 AV	54.0	-5.3	2.84 V	208	37.5	11.2

REMARKS:

1. Emission Level(dBuV/m) = Raw Value(dBuV) + Correction Factor(dB/m)
2. Correction Factor(dB/m) = Antenna Factor(dB/m) + Cable Factor(dB) – Pre-Amplifier Factor(dB)
3. The other emission levels were very low against the limit.
4. Margin value = Emission Level – Limit value
5. " * ": Fundamental frequency.

CHANNEL	TX Channel 64	DETECTOR FUNCTION	Peak (PK)
FREQUENCY RANGE	1GHz ~ 40GHz		Average (AV)

ANTENNA POLARITY & TEST DISTANCE: HORIZONTAL AT 3 M

NO.	FREQ. (MHz)	EMISSION LEVEL (dBuV/m)	LIMIT (dBuV/m)	MARGIN (dB)	ANTENNA HEIGHT (m)	TABLE ANGLE (Degree)	RAW VALUE (dBuV)	CORRECTION FACTOR (dB/m)
1	*5320.00	104.6 PK			1.51 H	91	102.3	2.3
2	*5320.00	94.6 AV			1.51 H	91	92.3	2.3
3	5350.00	65.7 PK	74.0	-8.3	1.51 H	91	63.4	2.3
4	5350.00	45.2 AV	54.0	-8.8	1.51 H	91	42.9	2.3
5	10640.00	49.6 PK	74.0	-24.4	3.00 H	98	37.9	11.7
6	10640.00	39.0 AV	54.0	-15.0	3.00 H	98	27.3	11.7
7	15960.00	52.8 PK	74.0	-21.2	2.39 H	320	41.4	11.4
8	15960.00	41.0 AV	54.0	-13.0	2.39 H	320	29.6	11.4

ANTENNA POLARITY & TEST DISTANCE: VERTICAL AT 3 M

NO.	FREQ. (MHz)	EMISSION LEVEL (dBuV/m)	LIMIT (dBuV/m)	MARGIN (dB)	ANTENNA HEIGHT (m)	TABLE ANGLE (Degree)	RAW VALUE (dBuV)	CORRECTION FACTOR (dB/m)
1	*5320.00	112.7 PK			3.33 V	91	110.4	2.3
2	*5320.00	102.9 AV			3.33 V	91	100.6	2.3
3	5350.00	73.2 PK	74.0	-0.8	3.22 V	96	70.9	2.3
4	5350.00	53.0 AV	54.0	-1.0	3.22 V	96	50.7	2.3
5	10640.00	50.2 PK	74.0	-23.8	1.87 V	294	38.5	11.7
6	10640.00	39.7 AV	54.0	-14.3	1.87 V	294	28.0	11.7
7	15960.00	60.0 PK	74.0	-14.0	2.82 V	207	48.6	11.4
8	15960.00	48.6 AV	54.0	-5.4	2.82 V	207	37.2	11.4

REMARKS:

1. Emission Level(dBuV/m) = Raw Value(dBuV) + Correction Factor(dB/m)
2. Correction Factor(dB/m) = Antenna Factor(dB/m) + Cable Factor(dB) – Pre-Amplifier Factor(dB)
3. The other emission levels were very low against the limit.
4. Margin value = Emission Level – Limit value
5. " * ": Fundamental frequency.

CHANNEL	TX Channel 100	DETECTOR FUNCTION	Peak (PK)
FREQUENCY RANGE	1GHz ~ 40GHz		Average (AV)

ANTENNA POLARITY & TEST DISTANCE: HORIZONTAL AT 3 M

NO.	FREQ. (MHz)	EMISSION LEVEL (dBuV/m)	LIMIT (dBuV/m)	MARGIN (dB)	ANTENNA HEIGHT (m)	TABLE ANGLE (Degree)	RAW VALUE (dBuV)	CORRECTION FACTOR (dB/m)
1	5460.00	50.1 PK	74.0	-23.9	1.39 H	87	47.5	2.6
2	5460.00	39.2 AV	54.0	-14.8	1.39 H	87	36.6	2.6
3	#5470.00	62.4 PK	68.2	-5.8	1.39 H	87	59.8	2.6
4	*5500.00	105.6 PK			1.39 H	87	103.1	2.5
5	*5500.00	95.2 AV			1.39 H	87	92.7	2.5
6	11000.00	49.8 PK	74.0	-24.2	3.01 H	97	37.6	12.2
7	11000.00	39.3 AV	54.0	-14.7	3.01 H	97	27.1	12.2
8	#16500.00	52.9 PK	68.2	-15.3	2.49 H	306	39.2	13.7

ANTENNA POLARITY & TEST DISTANCE: VERTICAL AT 3 M

NO.	FREQ. (MHz)	EMISSION LEVEL (dBuV/m)	LIMIT (dBuV/m)	MARGIN (dB)	ANTENNA HEIGHT (m)	TABLE ANGLE (Degree)	RAW VALUE (dBuV)	CORRECTION FACTOR (dB/m)
1	5460.00	57.9 PK	74.0	-16.1	2.79 V	270	55.3	2.6
2	5460.00	43.9 AV	54.0	-10.1	2.79 V	270	41.3	2.6
3	#5470.00	68.1 PK	68.2	-0.1	2.79 V	270	65.5	2.6
4	*5500.00	113.1 PK			3.33 V	97	110.6	2.5
5	*5500.00	103.0 AV			3.33 V	97	100.5	2.5
6	11000.00	50.2 PK	74.0	-23.8	1.95 V	321	38.0	12.2
7	11000.00	39.9 AV	54.0	-14.1	1.95 V	321	27.7	12.2
8	#16500.00	60.3 PK	68.2	-7.9	2.80 V	209	46.6	13.7

REMARKS:

1. Emission Level(dBuV/m) = Raw Value(dBuV) + Correction Factor(dB/m)
2. Correction Factor(dB/m) = Antenna Factor(dB/m) + Cable Factor(dB) – Pre-Amplifier Factor(dB)
3. The other emission levels were very low against the limit.
4. Margin value = Emission Level – Limit value
5. " * ": Fundamental frequency.
6. " # ": The radiated frequency is out of the restricted band.

CHANNEL	TX Channel 116	DETECTOR FUNCTION	Peak (PK)
FREQUENCY RANGE	1GHz ~ 40GHz		Average (AV)

ANTENNA POLARITY & TEST DISTANCE: HORIZONTAL AT 3 M

NO.	FREQ. (MHz)	EMISSION LEVEL (dBuV/m)	LIMIT (dBuV/m)	MARGIN (dB)	ANTENNA HEIGHT (m)	TABLE ANGLE (Degree)	RAW VALUE (dBuV)	CORRECTION FACTOR (dB/m)
1	*5580.00	104.7 PK			1.39 H	99	101.9	2.8
2	*5580.00	94.6 AV			1.39 H	99	91.8	2.8
3	11160.00	49.3 PK	74.0	-24.7	2.98 H	100	37.3	12.0
4	11160.00	38.8 AV	54.0	-15.2	2.98 H	100	26.8	12.0
5	#16740.00	53.1 PK	68.2	-15.1	2.42 H	312	38.9	14.2

ANTENNA POLARITY & TEST DISTANCE: VERTICAL AT 3 M

NO.	FREQ. (MHz)	EMISSION LEVEL (dBuV/m)	LIMIT (dBuV/m)	MARGIN (dB)	ANTENNA HEIGHT (m)	TABLE ANGLE (Degree)	RAW VALUE (dBuV)	CORRECTION FACTOR (dB/m)
1	*5580.00	113.8 PK			3.37 V	91	111.0	2.8
2	*5580.00	103.9 AV			3.37 V	91	101.1	2.8
3	11160.00	50.0 PK	74.0	-24.0	1.98 V	308	38.0	12.0
4	11160.00	39.5 AV	54.0	-14.5	1.98 V	308	27.5	12.0
5	#16740.00	60.1 PK	68.2	-8.1	2.82 V	221	45.9	14.2

REMARKS:

1. Emission Level(dBuV/m) = Raw Value(dBuV) + Correction Factor(dB/m)
2. Correction Factor(dB/m) = Antenna Factor(dB/m) + Cable Factor(dB) – Pre-Amplifier Factor(dB)
3. The other emission levels were very low against the limit.
4. Margin value = Emission Level – Limit value
5. " * ": Fundamental frequency.
6. " # ": The radiated frequency is out of the restricted band.

CHANNEL	TX Channel 140	DETECTOR FUNCTION	Peak (PK)
FREQUENCY RANGE	1GHz ~ 40GHz		Average (AV)

ANTENNA POLARITY & TEST DISTANCE: HORIZONTAL AT 3 M

NO.	FREQ. (MHz)	EMISSION LEVEL (dBuV/m)	LIMIT (dBuV/m)	MARGIN (dB)	ANTENNA HEIGHT (m)	TABLE ANGLE (Degree)	RAW VALUE (dBuV)	CORRECTION FACTOR (dB/m)
1	*5700.00	106.1 PK			1.38 H	96	103.2	2.9
2	*5700.00	95.6 AV			1.38 H	96	92.7	2.9
3	#5725.00	51.4 PK	68.2	-16.8	1.38 H	96	48.5	2.9
4	#5733.65	62.8 PK	68.2	-5.4	1.38 H	96	59.9	2.9
5	11400.00	48.8 PK	74.0	-25.2	3.01 H	116	35.8	13.0
6	11400.00	38.4 AV	54.0	-15.6	3.01 H	116	25.4	13.0
7	#17100.00	52.7 PK	68.2	-15.5	2.50 H	332	36.6	16.1

ANTENNA POLARITY & TEST DISTANCE: VERTICAL AT 3 M

NO.	FREQ. (MHz)	EMISSION LEVEL (dBuV/m)	LIMIT (dBuV/m)	MARGIN (dB)	ANTENNA HEIGHT (m)	TABLE ANGLE (Degree)	RAW VALUE (dBuV)	CORRECTION FACTOR (dB/m)
1	*5700.00	113.8 PK			3.34 V	95	110.9	2.9
2	*5700.00	103.7 AV			3.34 V	95	100.8	2.9
3	#5725.00	58.6 PK	68.2	-9.6	3.09 V	267	55.7	2.9
4	#5733.65	68.1 PK	68.2	-0.1	3.09 V	267	65.2	2.9
5	11400.00	49.7 PK	74.0	-24.3	1.87 V	296	36.7	13.0
6	11400.00	39.8 AV	54.0	-14.2	1.87 V	296	26.8	13.0
7	#17100.00	59.9 PK	68.2	-8.3	2.83 V	195	43.8	16.1

REMARKS:

1. Emission Level(dBuV/m) = Raw Value(dBuV) + Correction Factor(dB/m)
2. Correction Factor(dB/m) = Antenna Factor(dB/m) + Cable Factor(dB) – Pre-Amplifier Factor(dB)
3. The other emission levels were very low against the limit.
4. Margin value = Emission Level – Limit value
5. " * ": Fundamental frequency.
6. " # ": The radiated frequency is out of the restricted band.

CHANNEL	TX Channel 144	DETECTOR FUNCTION	Peak (PK)
FREQUENCY RANGE	1GHz ~ 40GHz		Average (AV)

ANTENNA POLARITY & TEST DISTANCE: HORIZONTAL AT 3 M

NO.	FREQ. (MHz)	EMISSION LEVEL (dBuV/m)	LIMIT (dBuV/m)	MARGIN (dB)	ANTENNA HEIGHT (m)	TABLE ANGLE (Degree)	RAW VALUE (dBuV)	CORRECTION FACTOR (dB/m)
1	#5470.00	49.5 PK	68.2	-18.7	1.40 H	101	46.9	2.6
2	*5720.00	105.6 PK			1.40 H	101	102.7	2.9
3	*5720.00	95.1 AV			1.40 H	101	92.2	2.9
4	#5850.00	49.7 PK	68.2	-18.5	1.40 H	101	46.4	3.3
5	11440.00	49.5 PK	74.0	-24.5	3.06 H	115	36.8	12.7
6	11440.00	39.2 AV	54.0	-14.8	3.06 H	115	26.5	12.7
7	#17160.00	52.9 PK	68.2	-15.3	2.44 H	321	37.3	15.6

ANTENNA POLARITY & TEST DISTANCE: VERTICAL AT 3 M

NO.	FREQ. (MHz)	EMISSION LEVEL (dBuV/m)	LIMIT (dBuV/m)	MARGIN (dB)	ANTENNA HEIGHT (m)	TABLE ANGLE (Degree)	RAW VALUE (dBuV)	CORRECTION FACTOR (dB/m)
1	#5470.00	56.2 PK	68.2	-12.0	2.94 V	266	53.6	2.6
2	*5720.00	113.6 PK			3.33 V	90	110.7	2.9
3	*5720.00	103.4 AV			3.33 V	90	100.5	2.9
4	#5850.00	53.3 PK	68.2	-14.9	2.94 V	266	50.0	3.3
5	11440.00	50.2 PK	74.0	-23.8	1.90 V	313	37.5	12.7
6	11440.00	39.8 AV	54.0	-14.2	1.90 V	313	27.1	12.7
7	#17160.00	60.3 PK	68.2	-7.9	2.79 V	199	44.7	15.6

REMARKS:

- Emission Level(dBuV/m) = Raw Value(dBuV) + Correction Factor(dB/m)
- Correction Factor(dB/m) = Antenna Factor(dB/m) + Cable Factor(dB) – Pre-Amplifier Factor(dB)
- The other emission levels were very low against the limit.
- Margin value = Emission Level – Limit value
- " * ": Fundamental frequency.
- " # ": The radiated frequency is out of the restricted band.

802.11ax(HE20)

CHANNEL	TX Channel 52	DETECTOR FUNCTION	Peak (PK)
FREQUENCY RANGE	1GHz ~ 40GHz		Average (AV)

ANTENNA POLARITY & TEST DISTANCE: HORIZONTAL AT 3 M

NO.	FREQ. (MHz)	EMISSION LEVEL (dBuV/m)	LIMIT (dBuV/m)	MARGIN (dB)	ANTENNA HEIGHT (m)	TABLE ANGLE (Degree)	RAW VALUE (dBuV)	CORRECTION FACTOR (dB/m)
1	5150.00	50.0 PK	74.0	-24.0	1.41 H	75	47.4	2.6
2	5150.00	39.5 AV	54.0	-14.5	1.41 H	75	36.9	2.6
3	*5260.00	106.1 PK			1.41 H	75	104.0	2.1
4	*5260.00	95.7 AV			1.41 H	75	93.6	2.1
5	5350.00	49.6 PK	74.0	-24.4	1.41 H	75	47.3	2.3
6	5350.00	39.6 AV	54.0	-14.4	1.41 H	75	37.3	2.3
7	#10520.00	49.7 PK	68.2	-18.5	3.01 H	102	37.3	12.4
8	15780.00	53.1 PK	74.0	-20.9	2.43 H	336	41.6	11.5
9	15780.00	41.5 AV	54.0	-12.5	2.43 H	336	30.0	11.5

ANTENNA POLARITY & TEST DISTANCE: VERTICAL AT 3 M

NO.	FREQ. (MHz)	EMISSION LEVEL (dBuV/m)	LIMIT (dBuV/m)	MARGIN (dB)	ANTENNA HEIGHT (m)	TABLE ANGLE (Degree)	RAW VALUE (dBuV)	CORRECTION FACTOR (dB/m)
1	5150.00	52.8 PK	74.0	-21.2	2.81 V	274	50.2	2.6
2	5150.00	41.4 AV	54.0	-12.6	2.81 V	274	38.8	2.6
3	*5260.00	113.0 PK			3.29 V	112	110.9	2.1
4	*5260.00	103.3 AV			3.29 V	112	101.2	2.1
5	5350.00	55.2 PK	74.0	-18.8	2.81 V	274	52.9	2.3
6	5350.00	42.6 AV	54.0	-11.4	2.81 V	274	40.3	2.3
7	#10520.00	49.1 PK	68.2	-19.1	1.93 V	300	36.7	12.4
8	15780.00	59.9 PK	74.0	-14.1	2.90 V	205	48.4	11.5
9	15780.00	48.5 AV	54.0	-5.5	2.90 V	205	37.0	11.5

REMARKS:

1. Emission Level(dBuV/m) = Raw Value(dBuV) + Correction Factor(dB/m)
2. Correction Factor(dB/m) = Antenna Factor(dB/m) + Cable Factor(dB) – Pre-Amplifier Factor(dB)
3. The other emission levels were very low against the limit.
4. Margin value = Emission Level – Limit value
5. " * ": Fundamental frequency.
6. " # ": The radiated frequency is out of the restricted band.

CHANNEL	TX Channel 60	DETECTOR FUNCTION	Peak (PK)
FREQUENCY RANGE	1GHz ~ 40GHz		Average (AV)

ANTENNA POLARITY & TEST DISTANCE: HORIZONTAL AT 3 M

NO.	FREQ. (MHz)	EMISSION LEVEL (dBuV/m)	LIMIT (dBuV/m)	MARGIN (dB)	ANTENNA HEIGHT (m)	TABLE ANGLE (Degree)	RAW VALUE (dBuV)	CORRECTION FACTOR (dB/m)
1	*5300.00	105.3 PK			1.35 H	82	103.1	2.2
2	*5300.00	94.7 AV			1.35 H	82	92.5	2.2
3	10600.00	49.1 PK	74.0	-24.9	3.03 H	102	37.4	11.7
4	10600.00	38.4 AV	54.0	-15.6	3.03 H	102	26.7	11.7
5	15900.00	53.1 PK	74.0	-20.9	2.45 H	326	41.9	11.2
6	15900.00	41.3 AV	54.0	-12.7	2.45 H	326	30.1	11.2

ANTENNA POLARITY & TEST DISTANCE: VERTICAL AT 3 M

NO.	FREQ. (MHz)	EMISSION LEVEL (dBuV/m)	LIMIT (dBuV/m)	MARGIN (dB)	ANTENNA HEIGHT (m)	TABLE ANGLE (Degree)	RAW VALUE (dBuV)	CORRECTION FACTOR (dB/m)
1	*5300.00	113.2 PK			3.38 V	91	111.0	2.2
2	*5300.00	102.9 AV			3.38 V	91	100.7	2.2
3	10600.00	49.7 PK	74.0	-24.3	1.94 V	291	38.0	11.7
4	10600.00	39.7 AV	54.0	-14.3	1.94 V	291	28.0	11.7
5	15900.00	59.8 PK	74.0	-14.2	2.87 V	211	48.6	11.2
6	15900.00	48.3 AV	54.0	-5.7	2.87 V	211	37.1	11.2

REMARKS:

1. Emission Level(dBuV/m) = Raw Value(dBuV) + Correction Factor(dB/m)
2. Correction Factor(dB/m) = Antenna Factor(dB/m) + Cable Factor(dB) – Pre-Amplifier Factor(dB)
3. The other emission levels were very low against the limit.
4. Margin value = Emission Level – Limit value
5. " * ": Fundamental frequency.

CHANNEL	TX Channel 64	DETECTOR FUNCTION	Peak (PK)
FREQUENCY RANGE	1GHz ~ 40GHz		Average (AV)

ANTENNA POLARITY & TEST DISTANCE: HORIZONTAL AT 3 M

NO.	FREQ. (MHz)	EMISSION LEVEL (dBuV/m)	LIMIT (dBuV/m)	MARGIN (dB)	ANTENNA HEIGHT (m)	TABLE ANGLE (Degree)	RAW VALUE (dBuV)	CORRECTION FACTOR (dB/m)
1	*5320.00	105.7 PK			1.37 H	75	103.4	2.3
2	*5320.00	95.1 AV			1.37 H	75	92.8	2.3
3	5350.00	55.9 PK	74.0	-18.1	1.37 H	75	53.6	2.3
4	5350.00	45.4 AV	54.0	-8.6	1.37 H	75	43.1	2.3
5	10640.00	49.2 PK	74.0	-24.8	3.05 H	107	37.5	11.7
6	10640.00	38.9 AV	54.0	-15.1	3.05 H	107	27.2	11.7
7	15960.00	52.9 PK	74.0	-21.1	2.44 H	336	41.5	11.4
8	15960.00	41.2 AV	54.0	-12.8	2.44 H	336	29.8	11.4

ANTENNA POLARITY & TEST DISTANCE: VERTICAL AT 3 M

NO.	FREQ. (MHz)	EMISSION LEVEL (dBuV/m)	LIMIT (dBuV/m)	MARGIN (dB)	ANTENNA HEIGHT (m)	TABLE ANGLE (Degree)	RAW VALUE (dBuV)	CORRECTION FACTOR (dB/m)
1	*5320.00	113.3 PK			3.26 V	108	111.0	2.3
2	*5320.00	103.4 AV			3.26 V	108	101.1	2.3
3	5350.00	67.2 PK	74.0	-6.8	2.53 V	287	64.9	2.3
4	5350.00	53.9 AV	54.0	-0.1	2.53 V	287	51.6	2.3
5	10640.00	49.7 PK	74.0	-24.3	1.95 V	293	38.0	11.7
6	10640.00	39.5 AV	54.0	-14.5	1.95 V	293	27.8	11.7
7	15960.00	59.9 PK	74.0	-14.1	2.88 V	219	48.5	11.4
8	15960.00	48.9 AV	54.0	-5.1	2.88 V	219	37.5	11.4

REMARKS:

1. Emission Level(dBuV/m) = Raw Value(dBuV) + Correction Factor(dB/m)
2. Correction Factor(dB/m) = Antenna Factor(dB/m) + Cable Factor(dB) – Pre-Amplifier Factor(dB)
3. The other emission levels were very low against the limit.
4. Margin value = Emission Level – Limit value
5. " * ": Fundamental frequency.

CHANNEL	TX Channel 100	DETECTOR FUNCTION	Peak (PK)
FREQUENCY RANGE	1GHz ~ 40GHz		Average (AV)

ANTENNA POLARITY & TEST DISTANCE: HORIZONTAL AT 3 M

NO.	FREQ. (MHz)	EMISSION LEVEL (dBuV/m)	LIMIT (dBuV/m)	MARGIN (dB)	ANTENNA HEIGHT (m)	TABLE ANGLE (Degree)	RAW VALUE (dBuV)	CORRECTION FACTOR (dB/m)
1	5460.00	50.4 PK	74.0	-23.6	1.36 H	100	47.8	2.6
2	5460.00	39.4 AV	54.0	-14.6	1.36 H	100	36.8	2.6
3	#5470.00	62.3 PK	68.2	-5.9	1.36 H	100	59.7	2.6
4	*5500.00	105.1 PK			1.36 H	100	102.6	2.5
5	*5500.00	94.8 AV			1.36 H	100	92.3	2.5
6	11000.00	49.4 PK	74.0	-24.6	3.00 H	100	37.2	12.2
7	11000.00	38.9 AV	54.0	-15.1	3.00 H	100	26.7	12.2
8	#16500.00	52.5 PK	68.2	-15.7	2.51 H	319	38.8	13.7

ANTENNA POLARITY & TEST DISTANCE: VERTICAL AT 3 M

NO.	FREQ. (MHz)	EMISSION LEVEL (dBuV/m)	LIMIT (dBuV/m)	MARGIN (dB)	ANTENNA HEIGHT (m)	TABLE ANGLE (Degree)	RAW VALUE (dBuV)	CORRECTION FACTOR (dB/m)
1	5460.00	56.2 PK	74.0	-17.8	1.81 V	185	53.6	2.6
2	5460.00	44.1 AV	54.0	-9.9	1.81 V	185	41.5	2.6
3	#5470.00	68.0 PK	68.2	-0.2	1.81 V	185	65.4	2.6
4	*5500.00	113.0 PK			3.38 V	100	110.5	2.5
5	*5500.00	103.2 AV			3.38 V	100	100.7	2.5
6	11000.00	49.9 PK	74.0	-24.1	1.91 V	307	37.7	12.2
7	11000.00	39.5 AV	54.0	-14.5	1.91 V	307	27.3	12.2
8	#16500.00	59.6 PK	68.2	-8.6	2.82 V	204	45.9	13.7

REMARKS:

1. Emission Level(dBuV/m) = Raw Value(dBuV) + Correction Factor(dB/m)
2. Correction Factor(dB/m) = Antenna Factor(dB/m) + Cable Factor(dB) – Pre-Amplifier Factor(dB)
3. The other emission levels were very low against the limit.
4. Margin value = Emission Level – Limit value
5. " * ": Fundamental frequency.
6. " # ": The radiated frequency is out of the restricted band.

CHANNEL	TX Channel 116	DETECTOR FUNCTION	Peak (PK)
FREQUENCY RANGE	1GHz ~ 40GHz		Average (AV)

ANTENNA POLARITY & TEST DISTANCE: HORIZONTAL AT 3 M

NO.	FREQ. (MHz)	EMISSION LEVEL (dBuV/m)	LIMIT (dBuV/m)	MARGIN (dB)	ANTENNA HEIGHT (m)	TABLE ANGLE (Degree)	RAW VALUE (dBuV)	CORRECTION FACTOR (dB/m)
1	*5580.00	105.3 PK			1.35 H	99	102.5	2.8
2	*5580.00	95.1 AV			1.35 H	99	92.3	2.8
3	11160.00	48.9 PK	74.0	-25.1	3.00 H	109	36.9	12.0
4	11160.00	38.6 AV	54.0	-15.4	3.00 H	109	26.6	12.0
5	#16740.00	53.1 PK	68.2	-15.1	2.45 H	324	38.9	14.2

ANTENNA POLARITY & TEST DISTANCE: VERTICAL AT 3 M

NO.	FREQ. (MHz)	EMISSION LEVEL (dBuV/m)	LIMIT (dBuV/m)	MARGIN (dB)	ANTENNA HEIGHT (m)	TABLE ANGLE (Degree)	RAW VALUE (dBuV)	CORRECTION FACTOR (dB/m)
1	*5580.00	113.3 PK			3.31 V	111	110.5	2.8
2	*5580.00	103.4 AV			3.31 V	111	100.6	2.8
3	11160.00	49.6 PK	74.0	-24.4	1.87 V	298	37.6	12.0
4	11160.00	39.6 AV	54.0	-14.4	1.87 V	298	27.6	12.0
5	#16740.00	60.0 PK	68.2	-8.2	2.82 V	218	45.8	14.2

REMARKS:

1. Emission Level(dBuV/m) = Raw Value(dBuV) + Correction Factor(dB/m)
2. Correction Factor(dB/m) = Antenna Factor(dB/m) + Cable Factor(dB) – Pre-Amplifier Factor(dB)
3. The other emission levels were very low against the limit.
4. Margin value = Emission Level – Limit value
5. " * ": Fundamental frequency.
6. " # ": The radiated frequency is out of the restricted band.

CHANNEL	TX Channel 140	DETECTOR FUNCTION	Peak (PK)
FREQUENCY RANGE	1GHz ~ 40GHz		Average (AV)

ANTENNA POLARITY & TEST DISTANCE: HORIZONTAL AT 3 M

NO.	FREQ. (MHz)	EMISSION LEVEL (dBuV/m)	LIMIT (dBuV/m)	MARGIN (dB)	ANTENNA HEIGHT (m)	TABLE ANGLE (Degree)	RAW VALUE (dBuV)	CORRECTION FACTOR (dB/m)
1	*5700.00	105.2 PK			1.42 H	96	102.3	2.9
2	*5700.00	94.9 AV			1.42 H	96	92.0	2.9
3	#5725.00	62.0 PK	68.2	-6.2	1.42 H	96	59.1	2.9
4	11400.00	49.1 PK	74.0	-24.9	3.03 H	99	36.1	13.0
5	11400.00	38.6 AV	54.0	-15.4	3.03 H	99	25.6	13.0
6	#17100.00	53.0 PK	68.2	-15.2	2.47 H	331	36.9	16.1

ANTENNA POLARITY & TEST DISTANCE: VERTICAL AT 3 M

NO.	FREQ. (MHz)	EMISSION LEVEL (dBuV/m)	LIMIT (dBuV/m)	MARGIN (dB)	ANTENNA HEIGHT (m)	TABLE ANGLE (Degree)	RAW VALUE (dBuV)	CORRECTION FACTOR (dB/m)
1	*5700.00	113.7 PK			3.27 V	90	110.8	2.9
2	*5700.00	103.6 AV			3.27 V	90	100.7	2.9
3	#5725.00	68.0 PK	68.2	-0.2	1.56 V	181	65.1	2.9
4	11400.00	50.0 PK	74.0	-24.0	1.89 V	311	37.0	13.0
5	11400.00	40.0 AV	54.0	-14.0	1.89 V	311	27.0	13.0
6	#17100.00	59.6 PK	68.2	-8.6	2.78 V	222	43.5	16.1

REMARKS:

1. Emission Level(dBuV/m) = Raw Value(dBuV) + Correction Factor(dB/m)
2. Correction Factor(dB/m) = Antenna Factor(dB/m) + Cable Factor(dB) – Pre-Amplifier Factor(dB)
3. The other emission levels were very low against the limit.
4. Margin value = Emission Level – Limit value
5. " * ": Fundamental frequency.
6. " # ": The radiated frequency is out of the restricted band.

CHANNEL	TX Channel 144	DETECTOR FUNCTION	Peak (PK)
FREQUENCY RANGE	1GHz ~ 40GHz		Average (AV)

ANTENNA POLARITY & TEST DISTANCE: HORIZONTAL AT 3 M

NO.	FREQ. (MHz)	EMISSION LEVEL (dBuV/m)	LIMIT (dBuV/m)	MARGIN (dB)	ANTENNA HEIGHT (m)	TABLE ANGLE (Degree)	RAW VALUE (dBuV)	CORRECTION FACTOR (dB/m)
1	#5470.00	49.6 PK	68.2	-18.6	1.34 H	74	47.0	2.6
2	*5720.00	105.5 PK			1.34 H	74	102.6	2.9
3	*5720.00	95.1 AV			1.34 H	74	92.2	2.9
4	#5850.00	49.0 PK	68.2	-19.2	1.34 H	74	45.7	3.3
5	11440.00	49.3 PK	74.0	-24.7	2.98 H	122	36.6	12.7
6	11440.00	38.7 AV	54.0	-15.3	2.98 H	122	26.0	12.7
7	#17160.00	53.0 PK	68.2	-15.2	2.46 H	319	37.4	15.6

ANTENNA POLARITY & TEST DISTANCE: VERTICAL AT 3 M

NO.	FREQ. (MHz)	EMISSION LEVEL (dBuV/m)	LIMIT (dBuV/m)	MARGIN (dB)	ANTENNA HEIGHT (m)	TABLE ANGLE (Degree)	RAW VALUE (dBuV)	CORRECTION FACTOR (dB/m)
1	#5470.00	55.1 PK	68.2	-13.1	2.02 V	200	52.5	2.6
2	*5720.00	113.0 PK			3.38 V	108	110.1	2.9
3	*5720.00	102.9 AV			3.38 V	108	100.0	2.9
4	#5850.00	55.9 PK	68.2	-12.3	2.02 V	200	52.6	3.3
5	11440.00	49.7 PK	74.0	-24.3	1.96 V	299	37.0	12.7
6	11440.00	39.5 AV	54.0	-14.5	1.96 V	299	26.8	12.7
7	#17160.00	60.0 PK	68.2	-8.2	2.83 V	212	44.4	15.6

REMARKS:

1. Emission Level(dBuV/m) = Raw Value(dBuV) + Correction Factor(dB/m)
2. Correction Factor(dB/m) = Antenna Factor(dB/m) + Cable Factor(dB) – Pre-Amplifier Factor(dB)
3. The other emission levels were very low against the limit.
4. Margin value = Emission Level – Limit value
5. " * ": Fundamental frequency.
6. " # ": The radiated frequency is out of the restricted band.

802.11ax (HE40)

CHANNEL	TX Channel 54	DETECTOR FUNCTION	Peak (PK)
FREQUENCY RANGE	1GHz ~ 40GHz		Average (AV)

ANTENNA POLARITY & TEST DISTANCE: HORIZONTAL AT 3 M

NO.	FREQ. (MHz)	EMISSION LEVEL (dBuV/m)	LIMIT (dBuV/m)	MARGIN (dB)	ANTENNA HEIGHT (m)	TABLE ANGLE (Degree)	RAW VALUE (dBuV)	CORRECTION FACTOR (dB/m)
1	5150.00	49.9 PK	74.0	-24.1	1.33 H	82	47.3	2.6
2	5150.00	39.8 AV	54.0	-14.2	1.33 H	82	37.2	2.6
3	*5270.00	107.8 PK			1.33 H	82	105.7	2.1
4	*5270.00	97.2 AV			1.33 H	82	95.1	2.1
5	5350.00	50.5 PK	74.0	-23.5	1.33 H	82	48.2	2.3
6	5350.00	39.5 AV	54.0	-14.5	1.33 H	82	37.2	2.3
7	#10540.00	49.3 PK	68.2	-18.9	2.96 H	116	37.1	12.2
8	15810.00	52.4 PK	74.0	-21.6	2.49 H	324	41.1	11.3
9	15810.00	40.9 AV	54.0	-13.1	2.49 H	324	29.6	11.3

ANTENNA POLARITY & TEST DISTANCE: VERTICAL AT 3 M

NO.	FREQ. (MHz)	EMISSION LEVEL (dBuV/m)	LIMIT (dBuV/m)	MARGIN (dB)	ANTENNA HEIGHT (m)	TABLE ANGLE (Degree)	RAW VALUE (dBuV)	CORRECTION FACTOR (dB/m)
1	5150.00	54.5 PK	74.0	-19.5	2.37 V	10	51.9	2.6
2	5150.00	42.4 AV	54.0	-11.6	2.37 V	10	39.8	2.6
3	*5270.00	114.8 PK			3.38 V	81	112.7	2.1
4	*5270.00	104.6 AV			3.38 V	81	102.5	2.1
5	5350.00	59.0 PK	74.0	-15.0	2.37 V	10	56.7	2.3
6	5350.00	45.6 AV	54.0	-8.4	2.37 V	10	43.3	2.3
7	#10540.00	50.1 PK	68.2	-18.1	1.93 V	305	37.9	12.2
8	15810.00	60.2 PK	74.0	-13.8	2.81 V	193	48.9	11.3
9	15810.00	48.9 AV	54.0	-5.1	2.81 V	193	37.6	11.3

REMARKS:

- Emission Level(dBuV/m) = Raw Value(dBuV) + Correction Factor(dB/m)
- Correction Factor(dB/m) = Antenna Factor(dB/m) + Cable Factor(dB) – Pre-Amplifier Factor(dB)
- The other emission levels were very low against the limit.
- Margin value = Emission Level – Limit value
- " * ": Fundamental frequency.
- " # ": The radiated frequency is out of the restricted band.

CHANNEL	TX Channel 62	DETECTOR FUNCTION	Peak (PK)
FREQUENCY RANGE	1GHz ~ 40GHz		Average (AV)

ANTENNA POLARITY & TEST DISTANCE: HORIZONTAL AT 3 M

NO.	FREQ. (MHz)	EMISSION LEVEL (dBuV/m)	LIMIT (dBuV/m)	MARGIN (dB)	ANTENNA HEIGHT (m)	TABLE ANGLE (Degree)	RAW VALUE (dBuV)	CORRECTION FACTOR (dB/m)
1	*5310.00	106.1 PK			1.33 H	63	103.9	2.2
2	*5310.00	95.5 AV			1.33 H	63	93.3	2.2
3	5350.00	55.8 PK	74.0	-18.2	1.33 H	63	53.5	2.3
4	5350.00	45.0 AV	54.0	-9.0	1.33 H	63	42.7	2.3
5	10620.00	50.0 PK	74.0	-24.0	3.01 H	105	38.3	11.7
6	10620.00	39.4 AV	54.0	-14.6	3.01 H	105	27.7	11.7
7	15930.00	52.4 PK	74.0	-21.6	2.42 H	329	41.2	11.2
8	15930.00	40.7 AV	54.0	-13.3	2.42 H	329	29.5	11.2

ANTENNA POLARITY & TEST DISTANCE: VERTICAL AT 3 M

NO.	FREQ. (MHz)	EMISSION LEVEL (dBuV/m)	LIMIT (dBuV/m)	MARGIN (dB)	ANTENNA HEIGHT (m)	TABLE ANGLE (Degree)	RAW VALUE (dBuV)	CORRECTION FACTOR (dB/m)
1	*5310.00	115.2 PK			2.58 V	360	113.0	2.2
2	*5310.00	102.9 AV			2.58 V	360	100.7	2.2
3	5350.00	69.2 PK	74.0	-4.8	2.58 V	360	66.9	2.3
4	5350.00	53.9 AV	54.0	-0.1	2.58 V	360	51.6	2.3
5	10620.00	50.1 PK	74.0	-23.9	1.92 V	297	38.4	11.7
6	10620.00	39.8 AV	54.0	-14.2	1.92 V	297	28.1	11.7
7	15930.00	59.7 PK	74.0	-14.3	2.80 V	212	48.5	11.2
8	15930.00	48.2 AV	54.0	-5.8	2.80 V	212	37.0	11.2

REMARKS:

1. Emission Level(dBuV/m) = Raw Value(dBuV) + Correction Factor(dB/m)
2. Correction Factor(dB/m) = Antenna Factor(dB/m) + Cable Factor(dB) – Pre-Amplifier Factor(dB)
3. The other emission levels were very low against the limit.
4. Margin value = Emission Level – Limit value
5. " * ": Fundamental frequency.

CHANNEL	TX Channel 102	DETECTOR FUNCTION	Peak (PK)
FREQUENCY RANGE	1GHz ~ 40GHz		Average (AV)

ANTENNA POLARITY & TEST DISTANCE: HORIZONTAL AT 3 M

NO.	FREQ. (MHz)	EMISSION LEVEL (dBuV/m)	LIMIT (dBuV/m)	MARGIN (dB)	ANTENNA HEIGHT (m)	TABLE ANGLE (Degree)	RAW VALUE (dBuV)	CORRECTION FACTOR (dB/m)
1	5460.00	50.4 PK	74.0	-23.6	1.28 H	68	47.8	2.6
2	5460.00	39.6 AV	54.0	-14.4	1.28 H	68	37.0	2.6
3	#5470.00	62.0 PK	68.2	-6.2	1.28 H	68	59.4	2.6
4	*5510.00	105.5 PK			1.28 H	68	103.0	2.5
5	*5510.00	95.3 AV			1.28 H	68	92.8	2.5
6	11020.00	48.6 PK	74.0	-25.4	3.06 H	107	36.3	12.3
7	11020.00	38.4 AV	54.0	-15.6	3.06 H	107	26.1	12.3
8	#16530.00	52.9 PK	68.2	-15.3	2.46 H	318	39.0	13.9

ANTENNA POLARITY & TEST DISTANCE: VERTICAL AT 3 M

NO.	FREQ. (MHz)	EMISSION LEVEL (dBuV/m)	LIMIT (dBuV/m)	MARGIN (dB)	ANTENNA HEIGHT (m)	TABLE ANGLE (Degree)	RAW VALUE (dBuV)	CORRECTION FACTOR (dB/m)
1	5460.00	63.8 PK	74.0	-10.2	2.43 V	163	61.2	2.6
2	5460.00	48.9 AV	54.0	-5.1	2.43 V	163	46.3	2.6
3	#5470.00	68.1 PK	68.2	-0.1	2.43 V	163	65.5	2.6
4	*5510.00	116.5 PK			2.43 V	163	114.0	2.5
5	*5510.00	103.2 AV			2.43 V	163	100.7	2.5
6	11020.00	49.3 PK	74.0	-24.7	1.94 V	315	37.0	12.3
7	11020.00	39.3 AV	54.0	-14.7	1.94 V	315	27.0	12.3
8	#16530.00	60.1 PK	68.2	-8.1	2.88 V	203	46.2	13.9

REMARKS:

1. Emission Level(dBuV/m) = Raw Value(dBuV) + Correction Factor(dB/m)
2. Correction Factor(dB/m) = Antenna Factor(dB/m) + Cable Factor(dB) – Pre-Amplifier Factor(dB)
3. The other emission levels were very low against the limit.
4. Margin value = Emission Level – Limit value
5. " * ": Fundamental frequency.
6. " # ": The radiated frequency is out of the restricted band.

CHANNEL	TX Channel 110	DETECTOR FUNCTION	Peak (PK)
FREQUENCY RANGE	1GHz ~ 40GHz		Average (AV)

ANTENNA POLARITY & TEST DISTANCE: HORIZONTAL AT 3 M

NO.	FREQ. (MHz)	EMISSION LEVEL (dBuV/m)	LIMIT (dBuV/m)	MARGIN (dB)	ANTENNA HEIGHT (m)	TABLE ANGLE (Degree)	RAW VALUE (dBuV)	CORRECTION FACTOR (dB/m)
1	*5550.00	105.5 PK			1.40 H	79	102.8	2.7
2	*5550.00	94.9 AV			1.40 H	79	92.2	2.7
3	11100.00	49.8 PK	74.0	-24.2	3.03 H	105	37.7	12.1
4	11100.00	39.2 AV	54.0	-14.8	3.03 H	105	27.1	12.1
5	#16650.00	52.6 PK	68.2	-15.6	2.44 H	316	38.4	14.2

ANTENNA POLARITY & TEST DISTANCE: VERTICAL AT 3 M

NO.	FREQ. (MHz)	EMISSION LEVEL (dBuV/m)	LIMIT (dBuV/m)	MARGIN (dB)	ANTENNA HEIGHT (m)	TABLE ANGLE (Degree)	RAW VALUE (dBuV)	CORRECTION FACTOR (dB/m)
1	*5550.00	115.2 PK			2.41 V	18	112.5	2.7
2	*5550.00	103.0 AV			2.41 V	18	100.3	2.7
3	11100.00	50.2 PK	74.0	-23.8	1.90 V	303	38.1	12.1
4	11100.00	40.0 AV	54.0	-14.0	1.90 V	303	27.9	12.1
5	#16650.00	60.2 PK	68.2	-8.0	2.78 V	197	46.0	14.2

REMARKS:

1. Emission Level(dBuV/m) = Raw Value(dBuV) + Correction Factor(dB/m)
2. Correction Factor(dB/m) = Antenna Factor(dB/m) + Cable Factor(dB) – Pre-Amplifier Factor(dB)
3. The other emission levels were very low against the limit.
4. Margin value = Emission Level – Limit value
5. " * ": Fundamental frequency.
6. " # ": The radiated frequency is out of the restricted band.

CHANNEL	TX Channel 134	DETECTOR FUNCTION	Peak (PK)
FREQUENCY RANGE	1GHz ~ 40GHz		Average (AV)

ANTENNA POLARITY & TEST DISTANCE: HORIZONTAL AT 3 M

NO.	FREQ. (MHz)	EMISSION LEVEL (dBuV/m)	LIMIT (dBuV/m)	MARGIN (dB)	ANTENNA HEIGHT (m)	TABLE ANGLE (Degree)	RAW VALUE (dBuV)	CORRECTION FACTOR (dB/m)
1	*5670.00	105.9 PK			1.29 H	61	103.0	2.9
2	*5670.00	95.6 AV			1.29 H	61	92.7	2.9
3	#5725.00	62.6 PK	68.2	-5.6	1.29 H	61	59.7	2.9
4	11340.00	49.3 PK	74.0	-24.7	3.00 H	107	36.4	12.9
5	11340.00	39.1 AV	54.0	-14.9	3.00 H	107	26.2	12.9
6	#17010.00	52.5 PK	68.2	-15.7	2.44 H	313	36.7	15.8

ANTENNA POLARITY & TEST DISTANCE: VERTICAL AT 3 M

NO.	FREQ. (MHz)	EMISSION LEVEL (dBuV/m)	LIMIT (dBuV/m)	MARGIN (dB)	ANTENNA HEIGHT (m)	TABLE ANGLE (Degree)	RAW VALUE (dBuV)	CORRECTION FACTOR (dB/m)
1	*5670.00	115.7 PK			2.11 V	170	112.8	2.9
2	*5670.00	103.1 AV			2.11 V	170	100.2	2.9
3	#5725.00	67.9 PK	68.2	-0.3	2.11 V	170	65.0	2.9
4	11340.00	49.8 PK	74.0	-24.2	1.98 V	312	36.9	12.9
5	11340.00	39.5 AV	54.0	-14.5	1.98 V	312	26.6	12.9
6	#17010.00	60.0 PK	68.2	-8.2	2.87 V	197	44.2	15.8

REMARKS:

1. Emission Level(dBuV/m) = Raw Value(dBuV) + Correction Factor(dB/m)
2. Correction Factor(dB/m) = Antenna Factor(dB/m) + Cable Factor(dB) – Pre-Amplifier Factor(dB)
3. The other emission levels were very low against the limit.
4. Margin value = Emission Level – Limit value
5. " * ": Fundamental frequency.
6. " # ": The radiated frequency is out of the restricted band.

CHANNEL	TX Channel 142	DETECTOR FUNCTION	Peak (PK)
FREQUENCY RANGE	1GHz ~ 40GHz		Average (AV)

ANTENNA POLARITY & TEST DISTANCE: HORIZONTAL AT 3 M

NO.	FREQ. (MHz)	EMISSION LEVEL (dBuV/m)	LIMIT (dBuV/m)	MARGIN (dB)	ANTENNA HEIGHT (m)	TABLE ANGLE (Degree)	RAW VALUE (dBuV)	CORRECTION FACTOR (dB/m)
1	#5470.00	51.5 PK	68.2	-16.7	1.30 H	68	48.9	2.6
2	*5710.00	105.8 PK			1.30 H	68	102.8	3.0
3	*5710.00	95.5 AV			1.30 H	68	92.5	3.0
4	#5850.00	49.9 PK	68.2	-18.3	1.30 H	68	46.6	3.3
5	11420.00	49.7 PK	74.0	-24.3	3.05 H	120	36.8	12.9
6	11420.00	39.0 AV	54.0	-15.0	3.05 H	120	26.1	12.9
7	#17130.00	52.9 PK	68.2	-15.3	2.43 H	319	37.1	15.8

ANTENNA POLARITY & TEST DISTANCE: VERTICAL AT 3 M

NO.	FREQ. (MHz)	EMISSION LEVEL (dBuV/m)	LIMIT (dBuV/m)	MARGIN (dB)	ANTENNA HEIGHT (m)	TABLE ANGLE (Degree)	RAW VALUE (dBuV)	CORRECTION FACTOR (dB/m)
1	#5470.00	59.6 PK	68.2	-8.6	1.56 V	181	57.0	2.6
2	*5710.00	115.9 PK			1.56 V	181	112.9	3.0
3	*5710.00	103.4 AV			1.56 V	181	100.4	3.0
4	#5850.00	54.6 PK	68.2	-13.6	1.56 V	181	51.3	3.3
5	11420.00	50.3 PK	74.0	-23.7	1.91 V	321	37.4	12.9
6	11420.00	39.9 AV	54.0	-14.1	1.91 V	321	27.0	12.9
7	#17130.00	60.2 PK	68.2	-8.0	2.87 V	209	44.4	15.8

REMARKS:

1. Emission Level(dBuV/m) = Raw Value(dBuV) + Correction Factor(dB/m)
2. Correction Factor(dB/m) = Antenna Factor(dB/m) + Cable Factor(dB) – Pre-Amplifier Factor(dB)
3. The other emission levels were very low against the limit.
4. Margin value = Emission Level – Limit value
5. " * ": Fundamental frequency.
6. " # ": The radiated frequency is out of the restricted band.

802.11ax (HE80)

CHANNEL	TX Channel 58	DETECTOR FUNCTION	Peak (PK)
FREQUENCY RANGE	1GHz ~ 40GHz		Average (AV)

ANTENNA POLARITY & TEST DISTANCE: HORIZONTAL AT 3 M

NO.	FREQ. (MHz)	EMISSION LEVEL (dBuV/m)	LIMIT (dBuV/m)	MARGIN (dB)	ANTENNA HEIGHT (m)	TABLE ANGLE (Degree)	RAW VALUE (dBuV)	CORRECTION FACTOR (dB/m)
1	5150.00	49.7 PK	74.0	-24.3	1.38 H	69	47.1	2.6
2	5150.00	39.8 AV	54.0	-14.2	1.38 H	69	37.2	2.6
3	*5290.00	99.6 PK			1.38 H	69	97.5	2.1
4	*5290.00	87.8 AV			1.38 H	69	85.7	2.1
5	5350.00	55.9 PK	74.0	-18.1	1.38 H	69	53.6	2.3
6	5350.00	45.5 AV	54.0	-8.5	1.38 H	69	43.2	2.3
7	#10580.00	49.3 PK	68.2	-18.9	3.05 H	114	37.5	11.8
8	15870.00	52.8 PK	74.0	-21.2	2.49 H	317	41.6	11.2
9	15870.00	41.2 AV	54.0	-12.8	2.49 H	317	30.0	11.2

ANTENNA POLARITY & TEST DISTANCE: VERTICAL AT 3 M

NO.	FREQ. (MHz)	EMISSION LEVEL (dBuV/m)	LIMIT (dBuV/m)	MARGIN (dB)	ANTENNA HEIGHT (m)	TABLE ANGLE (Degree)	RAW VALUE (dBuV)	CORRECTION FACTOR (dB/m)
1	5150.00	52.6 PK	74.0	-21.4	2.23 V	352	50.0	2.6
2	5150.00	40.8 AV	54.0	-13.2	2.23 V	352	38.2	2.6
3	*5290.00	107.7 PK			2.23 V	352	105.6	2.1
4	*5290.00	95.5 AV			2.23 V	352	93.4	2.1
5	5350.00	67.6 PK	74.0	-6.4	2.23 V	352	65.3	2.3
6	5350.00	53.6 AV	54.0	-0.4	2.23 V	352	51.3	2.3
7	#10580.00	50.1 PK	68.2	-18.1	1.91 V	304	38.3	11.8
8	15870.00	60.3 PK	74.0	-13.7	2.89 V	194	49.1	11.2
9	15870.00	49.1 AV	54.0	-4.9	2.89 V	194	37.9	11.2

REMARKS:

- Emission Level(dBuV/m) = Raw Value(dBuV) + Correction Factor(dB/m)
- Correction Factor(dB/m) = Antenna Factor(dB/m) + Cable Factor(dB) – Pre-Amplifier Factor(dB)
- The other emission levels were very low against the limit.
- Margin value = Emission Level – Limit value
- " * ": Fundamental frequency.
- " # ": The radiated frequency is out of the restricted band.

CHANNEL	TX Channel 106	DETECTOR FUNCTION	Peak (PK)
FREQUENCY RANGE	1GHz ~ 40GHz		Average (AV)

ANTENNA POLARITY & TEST DISTANCE: HORIZONTAL AT 3 M

NO.	FREQ. (MHz)	EMISSION LEVEL (dBuV/m)	LIMIT (dBuV/m)	MARGIN (dB)	ANTENNA HEIGHT (m)	TABLE ANGLE (Degree)	RAW VALUE (dBuV)	CORRECTION FACTOR (dB/m)
1	5460.00	54.6 PK	74.0	-19.4	1.35 H	74	52.0	2.6
2	5460.00	42.3 AV	54.0	-11.7	1.35 H	74	39.7	2.6
3	#5470.00	62.0 PK	68.2	-6.2	1.35 H	74	59.4	2.6
4	*5530.00	98.2 PK			1.35 H	74	95.6	2.6
5	*5530.00	86.6 AV			1.35 H	74	84.0	2.6
6	#5725.00	49.4 PK	68.2	-18.8	1.35 H	74	46.5	2.9
7	11060.00	50.0 PK	74.0	-24.0	2.98 H	118	37.9	12.1
8	11060.00	39.3 AV	54.0	-14.7	2.98 H	118	27.2	12.1
9	#16590.00	52.8 PK	68.2	-15.4	2.45 H	329	38.6	14.2

ANTENNA POLARITY & TEST DISTANCE: VERTICAL AT 3 M

NO.	FREQ. (MHz)	EMISSION LEVEL (dBuV/m)	LIMIT (dBuV/m)	MARGIN (dB)	ANTENNA HEIGHT (m)	TABLE ANGLE (Degree)	RAW VALUE (dBuV)	CORRECTION FACTOR (dB/m)
1	5460.00	63.2 PK	74.0	-10.8	1.47 V	313	60.6	2.6
2	5460.00	50.0 AV	54.0	-4.0	1.47 V	313	47.4	2.6
3	#5470.00	67.8 PK	68.2	-0.4	1.47 V	313	65.2	2.6
4	*5530.00	106.2 PK			1.47 V	313	103.6	2.6
5	*5530.00	94.2 AV			1.47 V	313	91.6	2.6
6	#5725.00	52.2 PK	68.2	-16.0	1.47 V	313	49.3	2.9
7	11060.00	49.7 PK	74.0	-24.3	1.95 V	308	37.6	12.1
8	11060.00	39.5 AV	54.0	-14.5	1.95 V	308	27.4	12.1
9	#16590.00	60.7 PK	68.2	-7.5	2.88 V	216	46.5	14.2

REMARKS:

1. Emission Level(dBuV/m) = Raw Value(dBuV) + Correction Factor(dB/m)
2. Correction Factor(dB/m) = Antenna Factor(dB/m) + Cable Factor(dB) – Pre-Amplifier Factor(dB)
3. The other emission levels were very low against the limit.
4. Margin value = Emission Level – Limit value
5. " * ": Fundamental frequency.
6. " # ": The radiated frequency is out of the restricted band.

CHANNEL	TX Channel 122	DETECTOR FUNCTION	Peak (PK)
FREQUENCY RANGE	1GHz ~ 40GHz		Average (AV)

ANTENNA POLARITY & TEST DISTANCE: HORIZONTAL AT 3 M

NO.	FREQ. (MHz)	EMISSION LEVEL (dBuV/m)	LIMIT (dBuV/m)	MARGIN (dB)	ANTENNA HEIGHT (m)	TABLE ANGLE (Degree)	RAW VALUE (dBuV)	CORRECTION FACTOR (dB/m)
1	*5610.00	105.1 PK			1.28 H	61	102.3	2.8
2	*5610.00	93.8 AV			1.28 H	61	91.0	2.8
3	#5725.00	62.6 PK	68.2	-5.6	1.28 H	61	59.7	2.9
4	11220.00	49.8 PK	74.0	-24.2	3.01 H	114	37.5	12.3
5	11220.00	39.4 AV	54.0	-14.6	3.01 H	114	27.1	12.3
6	#16830.00	52.9 PK	68.2	-15.3	2.50 H	324	38.3	14.6

ANTENNA POLARITY & TEST DISTANCE: VERTICAL AT 3 M

NO.	FREQ. (MHz)	EMISSION LEVEL (dBuV/m)	LIMIT (dBuV/m)	MARGIN (dB)	ANTENNA HEIGHT (m)	TABLE ANGLE (Degree)	RAW VALUE (dBuV)	CORRECTION FACTOR (dB/m)
1	*5610.00	112.9 PK			2.19 V	200	110.1	2.8
2	*5610.00	101.5 AV			2.19 V	200	98.7	2.8
3	#5725.00	67.9 PK	68.2	-0.3	2.19 V	200	65.0	2.9
4	11220.00	49.7 PK	74.0	-24.3	1.90 V	317	37.4	12.3
5	11220.00	39.2 AV	54.0	-14.8	1.90 V	317	26.9	12.3
6	#16830.00	59.4 PK	68.2	-8.8	2.82 V	207	44.8	14.6

REMARKS:

1. Emission Level(dBuV/m) = Raw Value(dBuV) + Correction Factor(dB/m)
2. Correction Factor(dB/m) = Antenna Factor(dB/m) + Cable Factor(dB) – Pre-Amplifier Factor(dB)
3. The other emission levels were very low against the limit.
4. Margin value = Emission Level – Limit value
5. " * ": Fundamental frequency.
6. " # ": The radiated frequency is out of the restricted band.

CHANNEL	TX Channel 138	DETECTOR FUNCTION	Peak (PK)
FREQUENCY RANGE	1GHz ~ 40GHz		Average (AV)

ANTENNA POLARITY & TEST DISTANCE: HORIZONTAL AT 3 M

NO.	FREQ. (MHz)	EMISSION LEVEL (dBuV/m)	LIMIT (dBuV/m)	MARGIN (dB)	ANTENNA HEIGHT (m)	TABLE ANGLE (Degree)	RAW VALUE (dBuV)	CORRECTION FACTOR (dB/m)
1	#5470.00	52.1 PK	68.2	-16.1	1.30 H	61	49.5	2.6
2	*5690.00	105.1 PK			1.30 H	61	102.2	2.9
3	*5690.00	93.9 AV			1.30 H	61	91.0	2.9
4	#5850.00	61.8 PK	68.2	-6.4	1.30 H	61	58.5	3.3
5	11380.00	48.9 PK	74.0	-25.1	2.97 H	115	36.0	12.9
6	11380.00	38.5 AV	54.0	-15.5	2.97 H	115	25.6	12.9
7	#17070.00	53.3 PK	68.2	-14.9	2.43 H	318	37.2	16.1

ANTENNA POLARITY & TEST DISTANCE: VERTICAL AT 3 M

NO.	FREQ. (MHz)	EMISSION LEVEL (dBuV/m)	LIMIT (dBuV/m)	MARGIN (dB)	ANTENNA HEIGHT (m)	TABLE ANGLE (Degree)	RAW VALUE (dBuV)	CORRECTION FACTOR (dB/m)
1	#5470.00	59.6 PK	68.2	-8.6	2.58 V	167	57.0	2.6
2	*5690.00	112.9 PK			2.58 V	167	110.0	2.9
3	*5690.00	101.6 AV			2.58 V	167	98.7	2.9
4	#5850.00	67.2 PK	68.2	-1.0	2.58 V	167	63.9	3.3
5	11380.00	49.9 PK	74.0	-24.1	1.88 V	304	37.0	12.9
6	11380.00	39.4 AV	54.0	-14.6	1.88 V	304	26.5	12.9
7	#17070.00	59.6 PK	68.2	-8.6	2.80 V	196	43.5	16.1

REMARKS:

1. Emission Level(dBuV/m) = Raw Value(dBuV) + Correction Factor(dB/m)
2. Correction Factor(dB/m) = Antenna Factor(dB/m) + Cable Factor(dB) – Pre-Amplifier Factor(dB)
3. The other emission levels were very low against the limit.
4. Margin value = Emission Level – Limit value
5. " * ": Fundamental frequency.
6. " # ": The radiated frequency is out of the restricted band.

Below 1GHz Data:

802.11ax (HE40)

CHANNEL	TX Channel 54	DETECTOR FUNCTION	Quasi-Peak (QP)
FREQUENCY RANGE	9kHz ~ 1GHz		

ANTENNA POLARITY & TEST DISTANCE: HORIZONTAL AT 3 M

NO.	FREQ. (MHz)	EMISSION LEVEL (dBuV/m)	LIMIT (dBuV/m)	MARGIN (dB)	ANTENNA HEIGHT (m)	TABLE ANGLE (Degree)	RAW VALUE (dBuV)	CORRECTION FACTOR (dB/m)
1	109.20	34.6 QP	43.5	-8.9	2.00 H	304	45.3	-10.7
2	150.79	30.0 QP	43.5	-13.5	1.00 H	73	37.5	-7.5
3	230.23	30.3 QP	46.0	-15.7	1.50 H	113	40.5	-10.2
4	295.66	32.2 QP	46.0	-13.8	1.00 H	66	39.3	-7.1
5	375.03	30.7 QP	46.0	-15.3	1.00 H	76	35.7	-5.0
6	657.54	30.5 QP	46.0	-15.5	1.00 H	360	29.3	1.2

REMARKS:

1. Emission Level(dBuV/m) = Raw Value(dBuV) + Correction Factor(dB/m)
2. Correction Factor(dB/m) = Antenna Factor(dB/m) + Cable Factor(dB) – Pre-Amplifier Factor(dB)
3. Margin value = Emission Level – Limit value
4. The emission levels were very low against the limit of frequency range 9kHz~30MHz: the amplitude of spurious emissions attenuated more than 20 dB below the permissible value to be report.

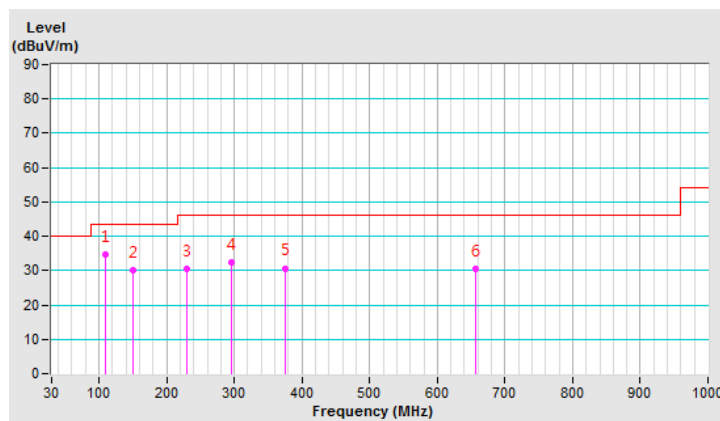

CHANNEL	TX Channel 54	DETECTOR FUNCTION	Quasi-Peak (QP)
FREQUENCY RANGE	9kHz ~ 1GHz		

ANTENNA POLARITY & TEST DISTANCE: VERTICAL AT 3 M

NO.	FREQ. (MHz)	EMISSION LEVEL (dBuV/m)	LIMIT (dBuV/m)	MARGIN (dB)	ANTENNA HEIGHT (m)	TABLE ANGLE (Degree)	RAW VALUE (dBuV)	CORRECTION FACTOR (dB/m)
1	132.92	34.7 QP	43.5	-8.8	1.00 V	360	43.5	-8.8
2	195.82	29.1 QP	43.5	-14.4	1.00 V	100	39.9	-10.8
3	294.81	27.3 QP	46.0	-18.7	1.50 V	0	34.4	-7.1
4	456.46	29.1 QP	46.0	-16.9	1.00 V	360	32.0	-2.9
5	644.35	31.8 QP	46.0	-14.2	2.00 V	188	30.6	1.2
6	801.49	33.0 QP	46.0	-13.0	1.50 V	269	29.3	3.7

REMARKS:

1. Emission Level(dBuV/m) = Raw Value(dBuV) + Correction Factor(dB/m)
2. Correction Factor(dB/m) = Antenna Factor(dB/m) + Cable Factor(dB) – Pre-Amplifier Factor(dB)
3. Margin value = Emission Level – Limit value
4. The emission levels were very low against the limit of frequency range 9kHz~30MHz: the amplitude of spurious emissions attenuated more than 20 dB below the permissible value to be report.

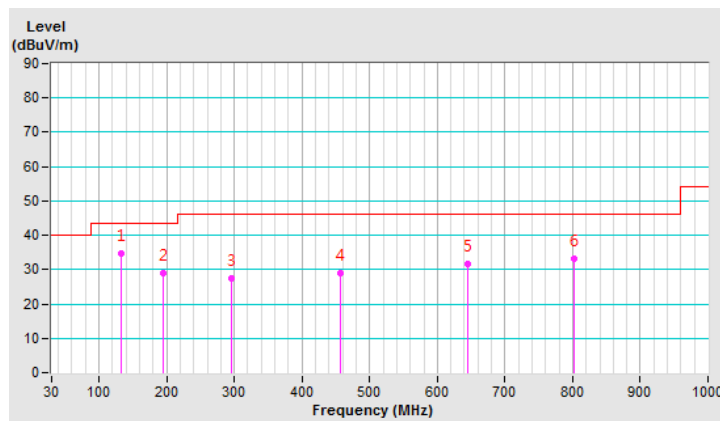

4.1.8 Test Results (Mode 2)

Above 1GHz Data:

802.11a

CHANNEL	TX Channel 52	DETECTOR FUNCTION	Peak (PK)
FREQUENCY RANGE	1GHz ~ 40GHz		Average (AV)

ANTENNA POLARITY & TEST DISTANCE: HORIZONTAL AT 3 M								
NO.	FREQ. (MHz)	EMISSION LEVEL (dBuV/m)	LIMIT (dBuV/m)	MARGIN (dB)	ANTENNA HEIGHT (m)	TABLE ANGLE (Degree)	RAW VALUE (dBuV)	CORRECTION FACTOR (dB/m)
1	5150.00	49.7 PK	74.0	-24.3	1.73 H	280	47.1	2.6
2	5150.00	39.5 AV	54.0	-14.5	1.73 H	280	36.9	2.6
3	*5260.00	109.2 PK			1.73 H	280	107.1	2.1
4	*5260.00	98.9 AV			1.73 H	280	96.8	2.1
5	#10520.00	49.3 PK	68.2	-18.9	3.06 H	100	36.9	12.4
6	15780.00	53.9 PK	74.0	-20.1	2.42 H	331	42.4	11.5
7	15780.00	42.2 AV	54.0	-11.8	2.42 H	331	30.7	11.5

ANTENNA POLARITY & TEST DISTANCE: VERTICAL AT 3 M								
NO.	FREQ. (MHz)	EMISSION LEVEL (dBuV/m)	LIMIT (dBuV/m)	MARGIN (dB)	ANTENNA HEIGHT (m)	TABLE ANGLE (Degree)	RAW VALUE (dBuV)	CORRECTION FACTOR (dB/m)
1	5150.00	53.0 PK	74.0	-21.0	2.60 V	230	50.4	2.6
2	5150.00	42.3 AV	54.0	-11.7	2.60 V	230	39.7	2.6
3	*5260.00	114.9 PK			2.60 V	230	112.8	2.1
4	*5260.00	104.1 AV			2.60 V	230	102.0	2.1
5	#10520.00	50.2 PK	68.2	-18.0	1.92 V	316	37.8	12.4
6	15780.00	54.1 PK	74.0	-19.9	2.94 V	284	42.6	11.5
7	15780.00	41.9 AV	54.0	-12.1	2.94 V	284	30.4	11.5

REMARKS:

1. Emission Level(dBuV/m) = Raw Value(dBuV) + Correction Factor(dB/m)
2. Correction Factor(dB/m) = Antenna Factor(dB/m) + Cable Factor(dB) – Pre-Amplifier Factor(dB)
3. The other emission levels were very low against the limit.
4. Margin value = Emission Level – Limit value
5. " * ": Fundamental frequency.
6. " # ": The radiated frequency is out of the restricted band.

CHANNEL	TX Channel 60	DETECTOR FUNCTION	Peak (PK)
FREQUENCY RANGE	1GHz ~ 40GHz		Average (AV)

ANTENNA POLARITY & TEST DISTANCE: HORIZONTAL AT 3 M

NO.	FREQ. (MHz)	EMISSION LEVEL (dBuV/m)	LIMIT (dBuV/m)	MARGIN (dB)	ANTENNA HEIGHT (m)	TABLE ANGLE (Degree)	RAW VALUE (dBuV)	CORRECTION FACTOR (dB/m)
1	*5300.00	108.7 PK			1.78 H	294	106.5	2.2
2	*5300.00	98.6 AV			1.78 H	294	96.4	2.2
3	10600.00	49.5 PK	74.0	-24.5	3.06 H	81	37.8	11.7
4	10600.00	39.0 AV	54.0	-15.0	3.06 H	81	27.3	11.7
5	15900.00	52.8 PK	74.0	-21.2	2.48 H	332	41.6	11.2
6	15900.00	41.5 AV	54.0	-12.5	2.48 H	332	30.3	11.2

ANTENNA POLARITY & TEST DISTANCE: VERTICAL AT 3 M

NO.	FREQ. (MHz)	EMISSION LEVEL (dBuV/m)	LIMIT (dBuV/m)	MARGIN (dB)	ANTENNA HEIGHT (m)	TABLE ANGLE (Degree)	RAW VALUE (dBuV)	CORRECTION FACTOR (dB/m)
1	*5300.00	114.3 PK			2.58 V	220	112.1	2.2
2	*5300.00	103.6 AV			2.58 V	220	101.4	2.2
3	10600.00	49.8 PK	74.0	-24.2	1.91 V	294	38.1	11.7
4	10600.00	39.2 AV	54.0	-14.8	1.91 V	294	27.5	11.7
5	15900.00	53.7 PK	74.0	-20.3	2.95 V	286	42.5	11.2
6	15900.00	41.6 AV	54.0	-12.4	2.95 V	286	30.4	11.2

REMARKS:

1. Emission Level(dBuV/m) = Raw Value(dBuV) + Correction Factor(dB/m)
2. Correction Factor(dB/m) = Antenna Factor(dB/m) + Cable Factor(dB) – Pre-Amplifier Factor(dB)
3. The other emission levels were very low against the limit.
4. Margin value = Emission Level – Limit value
5. " * ": Fundamental frequency.

CHANNEL	TX Channel 64	DETECTOR FUNCTION	Peak (PK)
FREQUENCY RANGE	1GHz ~ 40GHz		Average (AV)

ANTENNA POLARITY & TEST DISTANCE: HORIZONTAL AT 3 M

NO.	FREQ. (MHz)	EMISSION LEVEL (dBuV/m)	LIMIT (dBuV/m)	MARGIN (dB)	ANTENNA HEIGHT (m)	TABLE ANGLE (Degree)	RAW VALUE (dBuV)	CORRECTION FACTOR (dB/m)
1	*5320.00	109.2 PK			1.68 H	289	106.9	2.3
2	*5320.00	99.1 AV			1.68 H	289	96.8	2.3
3	5350.00	62.7 PK	74.0	-11.3	1.68 H	289	60.4	2.3
4	5350.00	48.7 AV	54.0	-5.3	1.68 H	289	46.4	2.3
5	10640.00	49.9 PK	74.0	-24.1	3.04 H	70	38.2	11.7
6	10640.00	39.4 AV	54.0	-14.6	3.04 H	70	27.7	11.7
7	15960.00	53.2 PK	74.0	-20.8	2.38 H	335	41.8	11.4
8	15960.00	41.4 AV	54.0	-12.6	2.38 H	335	30.0	11.4

ANTENNA POLARITY & TEST DISTANCE: VERTICAL AT 3 M

NO.	FREQ. (MHz)	EMISSION LEVEL (dBuV/m)	LIMIT (dBuV/m)	MARGIN (dB)	ANTENNA HEIGHT (m)	TABLE ANGLE (Degree)	RAW VALUE (dBuV)	CORRECTION FACTOR (dB/m)
1	*5320.00	115.2 PK			2.55 V	227	112.9	2.3
2	*5320.00	104.2 AV			2.55 V	227	101.9	2.3
3	5350.00	67.2 PK	74.0	-6.8	2.55 V	227	64.9	2.3
4	5350.00	53.1 AV	54.0	-0.9	2.55 V	227	50.8	2.3
5	10640.00	49.7 PK	74.0	-24.3	1.94 V	311	38.0	11.7
6	10640.00	39.2 AV	54.0	-14.8	1.94 V	311	27.5	11.7
7	15960.00	54.4 PK	74.0	-19.6	2.95 V	274	43.0	11.4
8	15960.00	41.8 AV	54.0	-12.2	2.95 V	274	30.4	11.4

REMARKS:

1. Emission Level(dBuV/m) = Raw Value(dBuV) + Correction Factor(dB/m)
2. Correction Factor(dB/m) = Antenna Factor(dB/m) + Cable Factor(dB) – Pre-Amplifier Factor(dB)
3. The other emission levels were very low against the limit.
4. Margin value = Emission Level – Limit value
5. " * ": Fundamental frequency.

CHANNEL	TX Channel 100	DETECTOR FUNCTION	Peak (PK)
FREQUENCY RANGE	1GHz ~ 40GHz		Average (AV)

ANTENNA POLARITY & TEST DISTANCE: HORIZONTAL AT 3 M

NO.	FREQ. (MHz)	EMISSION LEVEL (dBuV/m)	LIMIT (dBuV/m)	MARGIN (dB)	ANTENNA HEIGHT (m)	TABLE ANGLE (Degree)	RAW VALUE (dBuV)	CORRECTION FACTOR (dB/m)
1	5460.00	49.3 PK	74.0	-24.7	2.41 H	25	46.7	2.6
2	5460.00	39.5 AV	54.0	-14.5	2.41 H	25	36.9	2.6
3	#5470.00	63.0 PK	68.2	-5.2	2.41 H	25	60.4	2.6
4	*5500.00	107.8 PK			2.41 H	25	105.3	2.5
5	*5500.00	95.1 AV			2.41 H	25	92.6	2.5
6	11000.00	49.5 PK	74.0	-24.5	3.03 H	85	37.3	12.2
7	11000.00	38.9 AV	54.0	-15.1	3.03 H	85	26.7	12.2
8	#16500.00	54.0 PK	68.2	-14.2	2.46 H	316	40.3	13.7

ANTENNA POLARITY & TEST DISTANCE: VERTICAL AT 3 M

NO.	FREQ. (MHz)	EMISSION LEVEL (dBuV/m)	LIMIT (dBuV/m)	MARGIN (dB)	ANTENNA HEIGHT (m)	TABLE ANGLE (Degree)	RAW VALUE (dBuV)	CORRECTION FACTOR (dB/m)
1	5460.00	55.8 PK	74.0	-18.2	2.64 V	220	53.2	2.6
2	5460.00	45.6 AV	54.0	-8.4	2.64 V	220	43.0	2.6
3	#5470.00	67.9 PK	68.2	-0.3	2.64 V	220	65.3	2.6
4	*5500.00	112.9 PK			2.64 V	220	110.4	2.5
5	*5500.00	100.1 AV			2.64 V	220	97.6	2.5
6	11000.00	49.6 PK	74.0	-24.4	1.87 V	290	37.4	12.2
7	11000.00	39.1 AV	54.0	-14.9	1.87 V	290	26.9	12.2
8	#16500.00	54.2 PK	68.2	-14.0	2.93 V	265	40.5	13.7

REMARKS:

1. Emission Level(dBuV/m) = Raw Value(dBuV) + Correction Factor(dB/m)
2. Correction Factor(dB/m) = Antenna Factor(dB/m) + Cable Factor(dB) – Pre-Amplifier Factor(dB)
3. The other emission levels were very low against the limit.
4. Margin value = Emission Level – Limit value
5. " * ": Fundamental frequency.
6. " # ": The radiated frequency is out of the restricted band.

CHANNEL	TX Channel 116	DETECTOR FUNCTION	Peak (PK)
FREQUENCY RANGE	1GHz ~ 40GHz		Average (AV)

ANTENNA POLARITY & TEST DISTANCE: HORIZONTAL AT 3 M

NO.	FREQ. (MHz)	EMISSION LEVEL (dBuV/m)	LIMIT (dBuV/m)	MARGIN (dB)	ANTENNA HEIGHT (m)	TABLE ANGLE (Degree)	RAW VALUE (dBuV)	CORRECTION FACTOR (dB/m)
1	*5580.00	108.3 PK			2.39 H	33	105.5	2.8
2	*5580.00	95.3 AV			2.39 H	33	92.5	2.8
3	11160.00	50.1 PK	74.0	-23.9	2.97 H	87	38.1	12.0
4	11160.00	39.2 AV	54.0	-14.8	2.97 H	87	27.2	12.0
5	#16740.00	53.4 PK	68.2	-14.8	2.40 H	304	39.2	14.2

ANTENNA POLARITY & TEST DISTANCE: VERTICAL AT 3 M

NO.	FREQ. (MHz)	EMISSION LEVEL (dBuV/m)	LIMIT (dBuV/m)	MARGIN (dB)	ANTENNA HEIGHT (m)	TABLE ANGLE (Degree)	RAW VALUE (dBuV)	CORRECTION FACTOR (dB/m)
1	*5580.00	113.3 PK			2.57 V	238	110.5	2.8
2	*5580.00	100.6 AV			2.57 V	238	97.8	2.8
3	11160.00	49.9 PK	74.0	-24.1	1.90 V	310	37.9	12.0
4	11160.00	38.9 AV	54.0	-15.1	1.90 V	310	26.9	12.0
5	#16740.00	53.9 PK	68.2	-14.3	2.96 V	281	39.7	14.2

REMARKS:

1. Emission Level(dBuV/m) = Raw Value(dBuV) + Correction Factor(dB/m)
2. Correction Factor(dB/m) = Antenna Factor(dB/m) + Cable Factor(dB) – Pre-Amplifier Factor(dB)
3. The other emission levels were very low against the limit.
4. Margin value = Emission Level – Limit value
5. " * ": Fundamental frequency.
6. " # ": The radiated frequency is out of the restricted band.

CHANNEL	TX Channel 140	DETECTOR FUNCTION	Peak (PK)
FREQUENCY RANGE	1GHz ~ 40GHz		Average (AV)

ANTENNA POLARITY & TEST DISTANCE: HORIZONTAL AT 3 M

NO.	FREQ. (MHz)	EMISSION LEVEL (dBuV/m)	LIMIT (dBuV/m)	MARGIN (dB)	ANTENNA HEIGHT (m)	TABLE ANGLE (Degree)	RAW VALUE (dBuV)	CORRECTION FACTOR (dB/m)
1	*5700.00	107.4 PK			2.38 H	21	104.5	2.9
2	*5700.00	94.9 AV			2.38 H	21	92.0	2.9
3	#5725.00	62.2 PK	68.2	-6.0	2.38 H	21	59.3	2.9
4	11400.00	49.8 PK	74.0	-24.2	2.98 H	98	36.8	13.0
5	11400.00	39.1 AV	54.0	-14.9	2.98 H	98	26.1	13.0
6	#17100.00	53.2 PK	68.2	-15.0	2.47 H	311	37.1	16.1

ANTENNA POLARITY & TEST DISTANCE: VERTICAL AT 3 M

NO.	FREQ. (MHz)	EMISSION LEVEL (dBuV/m)	LIMIT (dBuV/m)	MARGIN (dB)	ANTENNA HEIGHT (m)	TABLE ANGLE (Degree)	RAW VALUE (dBuV)	CORRECTION FACTOR (dB/m)
1	*5700.00	112.8 PK			2.61 V	231	109.9	2.9
2	*5700.00	100.2 AV			2.61 V	231	97.3	2.9
3	#5725.00	67.1 PK	68.2	-1.1	2.61 V	231	64.2	2.9
4	11400.00	50.3 PK	74.0	-23.7	1.91 V	311	37.3	13.0
5	11400.00	39.6 AV	54.0	-14.4	1.91 V	311	26.6	13.0
6	#17100.00	53.2 PK	68.2	-15.0	3.02 V	264	37.1	16.1

REMARKS:

1. Emission Level(dBuV/m) = Raw Value(dBuV) + Correction Factor(dB/m)
2. Correction Factor(dB/m) = Antenna Factor(dB/m) + Cable Factor(dB) – Pre-Amplifier Factor(dB)
3. The other emission levels were very low against the limit.
4. Margin value = Emission Level – Limit value
5. " * ": Fundamental frequency.
6. " # ": The radiated frequency is out of the restricted band.

CHANNEL	TX Channel 144	DETECTOR FUNCTION	Peak (PK)
FREQUENCY RANGE	1GHz ~ 40GHz		Average (AV)

ANTENNA POLARITY & TEST DISTANCE: HORIZONTAL AT 3 M

NO.	FREQ. (MHz)	EMISSION LEVEL (dBuV/m)	LIMIT (dBuV/m)	MARGIN (dB)	ANTENNA HEIGHT (m)	TABLE ANGLE (Degree)	RAW VALUE (dBuV)	CORRECTION FACTOR (dB/m)
1	#5470.00	49.3 PK	68.2	-18.9	2.36 H	41	46.7	2.6
2	*5720.00	108.2 PK			2.36 H	41	105.3	2.9
3	*5720.00	95.4 AV			2.36 H	41	92.5	2.9
4	#5850.00	49.7 PK	68.2	-18.5	2.36 H	41	46.4	3.3
5	11440.00	49.7 PK	74.0	-24.3	3.00 H	99	37.0	12.7
6	11440.00	39.3 AV	54.0	-14.7	3.00 H	99	26.6	12.7
7	#17160.00	53.2 PK	68.2	-15.0	2.48 H	306	37.6	15.6

ANTENNA POLARITY & TEST DISTANCE: VERTICAL AT 3 M

NO.	FREQ. (MHz)	EMISSION LEVEL (dBuV/m)	LIMIT (dBuV/m)	MARGIN (dB)	ANTENNA HEIGHT (m)	TABLE ANGLE (Degree)	RAW VALUE (dBuV)	CORRECTION FACTOR (dB/m)
1	#5470.00	55.8 PK	68.2	-12.4	2.65 V	225	53.2	2.6
2	*5720.00	113.1 PK			2.65 V	225	110.2	2.9
3	*5720.00	100.3 AV			2.65 V	225	97.4	2.9
4	#5850.00	56.0 PK	68.2	-12.2	2.65 V	225	52.7	3.3
5	11440.00	50.5 PK	74.0	-23.5	1.88 V	310	37.8	12.7
6	11440.00	39.7 AV	54.0	-14.3	1.88 V	310	27.0	12.7
7	#17160.00	54.0 PK	68.2	-14.2	2.94 V	287	38.4	15.6

REMARKS:

- Emission Level(dBuV/m) = Raw Value(dBuV) + Correction Factor(dB/m)
- Correction Factor(dB/m) = Antenna Factor(dB/m) + Cable Factor(dB) – Pre-Amplifier Factor(dB)
- The other emission levels were very low against the limit.
- Margin value = Emission Level – Limit value
- " * ": Fundamental frequency.
- " # ": The radiated frequency is out of the restricted band.

802.11ax (HE20)

CHANNEL	TX Channel 52	DETECTOR FUNCTION	Peak (PK)
FREQUENCY RANGE	1GHz ~ 40GHz		Average (AV)

ANTENNA POLARITY & TEST DISTANCE: HORIZONTAL AT 3 M

NO.	FREQ. (MHz)	EMISSION LEVEL (dBuV/m)	LIMIT (dBuV/m)	MARGIN (dB)	ANTENNA HEIGHT (m)	TABLE ANGLE (Degree)	RAW VALUE (dBuV)	CORRECTION FACTOR (dB/m)
1	5150.00	50.3 PK	74.0	-23.7	1.75 H	285	47.7	2.6
2	5150.00	39.9 AV	54.0	-14.1	1.75 H	285	37.3	2.6
3	*5260.00	109.4 PK			1.75 H	285	107.3	2.1
4	*5260.00	99.0 AV			1.75 H	285	96.9	2.1
5	5350.00	49.8 PK	74.0	-24.2	1.75 H	285	47.5	2.3
6	5350.00	39.5 AV	54.0	-14.5	1.75 H	285	37.2	2.3
7	#10520.00	49.5 PK	68.2	-18.7	3.06 H	86	37.1	12.4
8	15780.00	54.1 PK	74.0	-19.9	2.40 H	305	42.6	11.5
9	15780.00	42.3 AV	54.0	-11.7	2.40 H	305	30.8	11.5

ANTENNA POLARITY & TEST DISTANCE: VERTICAL AT 3 M

NO.	FREQ. (MHz)	EMISSION LEVEL (dBuV/m)	LIMIT (dBuV/m)	MARGIN (dB)	ANTENNA HEIGHT (m)	TABLE ANGLE (Degree)	RAW VALUE (dBuV)	CORRECTION FACTOR (dB/m)
1	5150.00	52.0 PK	74.0	-22.0	1.83 V	93	49.4	2.6
2	5150.00	39.5 AV	54.0	-14.5	1.83 V	93	36.9	2.6
3	*5260.00	116.8 PK			1.83 V	93	114.7	2.1
4	*5260.00	103.5 AV			1.83 V	93	101.4	2.1
5	5350.00	52.2 PK	74.0	-21.8	1.83 V	93	49.9	2.3
6	5350.00	39.9 AV	54.0	-14.1	1.83 V	93	37.6	2.3
7	#10520.00	50.2 PK	68.2	-18.0	1.91 V	300	37.8	12.4
8	15780.00	53.8 PK	74.0	-20.2	3.01 V	282	42.3	11.5
9	15780.00	41.5 AV	54.0	-12.5	3.01 V	282	30.0	11.5

REMARKS:

- Emission Level(dBuV/m) = Raw Value(dBuV) + Correction Factor(dB/m)
- Correction Factor(dB/m) = Antenna Factor(dB/m) + Cable Factor(dB) – Pre-Amplifier Factor(dB)
- The other emission levels were very low against the limit.
- Margin value = Emission Level – Limit value
- " * ": Fundamental frequency.
- " # ": The radiated frequency is out of the restricted band.

CHANNEL	TX Channel 60	DETECTOR FUNCTION	Peak (PK)
FREQUENCY RANGE	1GHz ~ 40GHz		Average (AV)

ANTENNA POLARITY & TEST DISTANCE: HORIZONTAL AT 3 M

NO.	FREQ. (MHz)	EMISSION LEVEL (dBuV/m)	LIMIT (dBuV/m)	MARGIN (dB)	ANTENNA HEIGHT (m)	TABLE ANGLE (Degree)	RAW VALUE (dBuV)	CORRECTION FACTOR (dB/m)
1	*5300.00	109.4 PK			1.75 H	277	107.2	2.2
2	*5300.00	99.0 AV			1.75 H	277	96.8	2.2
3	10600.00	49.6 PK	74.0	-24.4	3.05 H	74	37.9	11.7
4	10600.00	39.3 AV	54.0	-14.7	3.05 H	74	27.6	11.7
5	15900.00	53.5 PK	74.0	-20.5	2.42 H	332	42.3	11.2
6	15900.00	42.1 AV	54.0	-11.9	2.42 H	332	30.9	11.2

ANTENNA POLARITY & TEST DISTANCE: VERTICAL AT 3 M

NO.	FREQ. (MHz)	EMISSION LEVEL (dBuV/m)	LIMIT (dBuV/m)	MARGIN (dB)	ANTENNA HEIGHT (m)	TABLE ANGLE (Degree)	RAW VALUE (dBuV)	CORRECTION FACTOR (dB/m)
1	*5300.00	116.5 PK			1.61 V	95	114.3	2.2
2	*5300.00	104.3 AV			1.61 V	95	102.1	2.2
3	10600.00	49.8 PK	74.0	-24.2	1.89 V	308	38.1	11.7
4	10600.00	38.9 AV	54.0	-15.1	1.89 V	308	27.2	11.7
5	15900.00	53.9 PK	74.0	-20.1	3.04 V	271	42.7	11.2
6	15900.00	41.6 AV	54.0	-12.4	3.04 V	271	30.4	11.2

REMARKS:

1. Emission Level(dBuV/m) = Raw Value(dBuV) + Correction Factor(dB/m)
2. Correction Factor(dB/m) = Antenna Factor(dB/m) + Cable Factor(dB) – Pre-Amplifier Factor(dB)
3. The other emission levels were very low against the limit.
4. Margin value = Emission Level – Limit value
5. " * ": Fundamental frequency.

CHANNEL	TX Channel 64	DETECTOR FUNCTION	Peak (PK)
FREQUENCY RANGE	1GHz ~ 40GHz		Average (AV)

ANTENNA POLARITY & TEST DISTANCE: HORIZONTAL AT 3 M

NO.	FREQ. (MHz)	EMISSION LEVEL (dBuV/m)	LIMIT (dBuV/m)	MARGIN (dB)	ANTENNA HEIGHT (m)	TABLE ANGLE (Degree)	RAW VALUE (dBuV)	CORRECTION FACTOR (dB/m)
1	*5320.00	109.4 PK			1.71 H	285	107.1	2.3
2	*5320.00	99.0 AV			1.71 H	285	96.7	2.3
3	5350.00	62.9 PK	74.0	-11.1	1.71 H	285	60.6	2.3
4	5350.00	48.8 AV	54.0	-5.2	1.71 H	285	46.5	2.3
5	10640.00	49.2 PK	74.0	-24.8	3.03 H	86	37.5	11.7
6	10640.00	38.8 AV	54.0	-15.2	3.03 H	86	27.1	11.7
7	15960.00	52.9 PK	74.0	-21.1	2.48 H	313	41.5	11.4
8	15960.00	41.5 AV	54.0	-12.5	2.48 H	313	30.1	11.4

ANTENNA POLARITY & TEST DISTANCE: VERTICAL AT 3 M

NO.	FREQ. (MHz)	EMISSION LEVEL (dBuV/m)	LIMIT (dBuV/m)	MARGIN (dB)	ANTENNA HEIGHT (m)	TABLE ANGLE (Degree)	RAW VALUE (dBuV)	CORRECTION FACTOR (dB/m)
1	*5320.00	115.9 PK			2.78 V	167	113.6	2.3
2	*5320.00	103.4 AV			2.78 V	167	101.1	2.3
3	5350.00	66.7 PK	74.0	-7.3	2.78 V	167	64.4	2.3
4	5350.00	53.1 AV	54.0	-0.9	2.78 V	167	50.8	2.3
5	10640.00	49.4 PK	74.0	-24.6	1.88 V	298	37.7	11.7
6	10640.00	38.8 AV	54.0	-15.2	1.88 V	298	27.1	11.7
7	15960.00	53.6 PK	74.0	-20.4	3.04 V	277	42.2	11.4
8	15960.00	41.4 AV	54.0	-12.6	3.04 V	277	30.0	11.4

REMARKS:

1. Emission Level(dBuV/m) = Raw Value(dBuV) + Correction Factor(dB/m)
2. Correction Factor(dB/m) = Antenna Factor(dB/m) + Cable Factor(dB) – Pre-Amplifier Factor(dB)
3. The other emission levels were very low against the limit.
4. Margin value = Emission Level – Limit value
5. " * ": Fundamental frequency.

CHANNEL	TX Channel 100	DETECTOR FUNCTION	Peak (PK)
FREQUENCY RANGE	1GHz ~ 40GHz		Average (AV)

ANTENNA POLARITY & TEST DISTANCE: HORIZONTAL AT 3 M

NO.	FREQ. (MHz)	EMISSION LEVEL (dBuV/m)	LIMIT (dBuV/m)	MARGIN (dB)	ANTENNA HEIGHT (m)	TABLE ANGLE (Degree)	RAW VALUE (dBuV)	CORRECTION FACTOR (dB/m)
1	5460.00	49.8 PK	74.0	-24.2	2.33 H	20	47.2	2.6
2	5460.00	39.6 AV	54.0	-14.4	2.33 H	20	37.0	2.6
3	#5470.00	63.3 PK	68.2	-4.9	2.33 H	20	60.7	2.6
4	*5500.00	107.7 PK			2.33 H	20	105.2	2.5
5	*5500.00	94.8 AV			2.33 H	20	92.3	2.5
6	11000.00	49.8 PK	74.0	-24.2	2.99 H	99	37.6	12.2
7	11000.00	39.4 AV	54.0	-14.6	2.99 H	99	27.2	12.2
8	#16500.00	53.4 PK	68.2	-14.8	2.46 H	312	39.7	13.7

ANTENNA POLARITY & TEST DISTANCE: VERTICAL AT 3 M

NO.	FREQ. (MHz)	EMISSION LEVEL (dBuV/m)	LIMIT (dBuV/m)	MARGIN (dB)	ANTENNA HEIGHT (m)	TABLE ANGLE (Degree)	RAW VALUE (dBuV)	CORRECTION FACTOR (dB/m)
1	5460.00	56.2 PK	74.0	-17.8	1.79 V	269	53.6	2.6
2	5460.00	44.4 AV	54.0	-9.6	1.79 V	269	41.8	2.6
3	#5470.00	68.1 PK	68.2	-0.1	1.79 V	269	65.5	2.6
4	*5500.00	112.9 PK			1.79 V	269	110.4	2.5
5	*5500.00	100.1 AV			1.79 V	269	97.6	2.5
6	11000.00	50.1 PK	74.0	-23.9	1.97 V	320	37.9	12.2
7	11000.00	39.2 AV	54.0	-14.8	1.97 V	320	27.0	12.2
8	#16500.00	54.4 PK	68.2	-13.8	2.97 V	285	40.7	13.7

REMARKS:

1. Emission Level(dBuV/m) = Raw Value(dBuV) + Correction Factor(dB/m)
2. Correction Factor(dB/m) = Antenna Factor(dB/m) + Cable Factor(dB) – Pre-Amplifier Factor(dB)
3. The other emission levels were very low against the limit.
4. Margin value = Emission Level – Limit value
5. " * ": Fundamental frequency.
6. " # ": The radiated frequency is out of the restricted band.

CHANNEL	TX Channel 116	DETECTOR FUNCTION	Peak (PK)
FREQUENCY RANGE	1GHz ~ 40GHz		Average (AV)

ANTENNA POLARITY & TEST DISTANCE: HORIZONTAL AT 3 M

NO.	FREQ. (MHz)	EMISSION LEVEL (dBuV/m)	LIMIT (dBuV/m)	MARGIN (dB)	ANTENNA HEIGHT (m)	TABLE ANGLE (Degree)	RAW VALUE (dBuV)	CORRECTION FACTOR (dB/m)
1	*5580.00	110.1 PK			2.40 H	41	107.3	2.8
2	*5580.00	97.9 AV			2.40 H	41	95.1	2.8
3	11160.00	50.2 PK	74.0	-23.8	3.07 H	75	38.2	12.0
4	11160.00	39.6 AV	54.0	-14.4	3.07 H	75	27.6	12.0
5	#16740.00	53.1 PK	68.2	-15.1	2.47 H	326	38.9	14.2

ANTENNA POLARITY & TEST DISTANCE: VERTICAL AT 3 M

NO.	FREQ. (MHz)	EMISSION LEVEL (dBuV/m)	LIMIT (dBuV/m)	MARGIN (dB)	ANTENNA HEIGHT (m)	TABLE ANGLE (Degree)	RAW VALUE (dBuV)	CORRECTION FACTOR (dB/m)
1	*5580.00	115.4 PK			1.80 V	264	112.6	2.8
2	*5580.00	103.1 AV			1.80 V	264	100.3	2.8
3	11160.00	49.5 PK	74.0	-24.5	1.97 V	313	37.5	12.0
4	11160.00	38.8 AV	54.0	-15.2	1.97 V	313	26.8	12.0
5	#16740.00	53.5 PK	68.2	-14.7	2.96 V	279	39.3	14.2

REMARKS:

1. Emission Level(dBuV/m) = Raw Value(dBuV) + Correction Factor(dB/m)
2. Correction Factor(dB/m) = Antenna Factor(dB/m) + Cable Factor(dB) – Pre-Amplifier Factor(dB)
3. The other emission levels were very low against the limit.
4. Margin value = Emission Level – Limit value
5. " * ": Fundamental frequency.
6. " # ": The radiated frequency is out of the restricted band.

CHANNEL	TX Channel 140	DETECTOR FUNCTION	Peak (PK)
FREQUENCY RANGE	1GHz ~ 40GHz		Average (AV)

ANTENNA POLARITY & TEST DISTANCE: HORIZONTAL AT 3 M

NO.	FREQ. (MHz)	EMISSION LEVEL (dBuV/m)	LIMIT (dBuV/m)	MARGIN (dB)	ANTENNA HEIGHT (m)	TABLE ANGLE (Degree)	RAW VALUE (dBuV)	CORRECTION FACTOR (dB/m)
1	*5700.00	107.2 PK			2.38 H	35	104.3	2.9
2	*5700.00	94.5 AV			2.38 H	35	91.6	2.9
3	#5725.00	61.8 PK	68.2	-6.4	2.38 H	35	58.9	2.9
4	11400.00	49.6 PK	74.0	-24.4	2.97 H	90	36.6	13.0
5	11400.00	39.0 AV	54.0	-15.0	2.97 H	90	26.0	13.0
6	#17100.00	53.1 PK	68.2	-15.1	2.43 H	332	37.0	16.1

ANTENNA POLARITY & TEST DISTANCE: VERTICAL AT 3 M

NO.	FREQ. (MHz)	EMISSION LEVEL (dBuV/m)	LIMIT (dBuV/m)	MARGIN (dB)	ANTENNA HEIGHT (m)	TABLE ANGLE (Degree)	RAW VALUE (dBuV)	CORRECTION FACTOR (dB/m)
1	*5700.00	112.8 PK			1.77 V	275	109.9	2.9
2	*5700.00	100.2 AV			1.77 V	275	97.3	2.9
3	#5725.00	66.9 PK	68.2	-1.3	1.77 V	275	64.0	2.9
4	11400.00	49.8 PK	74.0	-24.2	1.94 V	297	36.8	13.0
5	11400.00	38.8 AV	54.0	-15.2	1.94 V	297	25.8	13.0
6	#17100.00	54.1 PK	68.2	-14.1	2.97 V	272	38.0	16.1

REMARKS:

1. Emission Level(dBuV/m) = Raw Value(dBuV) + Correction Factor(dB/m)
2. Correction Factor(dB/m) = Antenna Factor(dB/m) + Cable Factor(dB) – Pre-Amplifier Factor(dB)
3. The other emission levels were very low against the limit.
4. Margin value = Emission Level – Limit value
5. " * ": Fundamental frequency.
6. " # ": The radiated frequency is out of the restricted band.

CHANNEL	TX Channel 144	DETECTOR FUNCTION	Peak (PK)
FREQUENCY RANGE	1GHz ~ 40GHz		Average (AV)

ANTENNA POLARITY & TEST DISTANCE: HORIZONTAL AT 3 M

NO.	FREQ. (MHz)	EMISSION LEVEL (dBuV/m)	LIMIT (dBuV/m)	MARGIN (dB)	ANTENNA HEIGHT (m)	TABLE ANGLE (Degree)	RAW VALUE (dBuV)	CORRECTION FACTOR (dB/m)
1	#5470.00	49.5 PK	68.2	-18.7	2.34 H	42	46.9	2.6
2	*5720.00	110.3 PK			2.34 H	42	107.4	2.9
3	*5720.00	97.9 AV			2.34 H	42	95.0	2.9
4	#5850.00	49.6 PK	68.2	-18.6	2.34 H	42	46.3	3.3
5	11440.00	49.2 PK	74.0	-24.8	3.06 H	71	36.5	12.7
6	11440.00	38.8 AV	54.0	-15.2	3.06 H	71	26.1	12.7
7	#17160.00	54.0 PK	68.2	-14.2	2.39 H	312	38.4	15.6

ANTENNA POLARITY & TEST DISTANCE: VERTICAL AT 3 M

NO.	FREQ. (MHz)	EMISSION LEVEL (dBuV/m)	LIMIT (dBuV/m)	MARGIN (dB)	ANTENNA HEIGHT (m)	TABLE ANGLE (Degree)	RAW VALUE (dBuV)	CORRECTION FACTOR (dB/m)
1	#5470.00	55.3 PK	68.2	-12.9	1.81 V	256	52.7	2.6
2	*5720.00	116.2 PK			1.81 V	256	113.3	2.9
3	*5720.00	103.4 AV			1.81 V	256	100.5	2.9
4	#5850.00	56.1 PK	68.2	-12.1	1.81 V	256	52.8	3.3
5	11440.00	50.2 PK	74.0	-23.8	1.91 V	306	37.5	12.7
6	11440.00	39.4 AV	54.0	-14.6	1.91 V	306	26.7	12.7
7	#17160.00	54.2 PK	68.2	-14.0	2.98 V	288	38.6	15.6

REMARKS:

- Emission Level(dBuV/m) = Raw Value(dBuV) + Correction Factor(dB/m)
- Correction Factor(dB/m) = Antenna Factor(dB/m) + Cable Factor(dB) – Pre-Amplifier Factor(dB)
- The other emission levels were very low against the limit.
- Margin value = Emission Level – Limit value
- " * ": Fundamental frequency.
- " # ": The radiated frequency is out of the restricted band.

802.11ax (HE40)

CHANNEL	TX Channel 54	DETECTOR FUNCTION	Peak (PK)
FREQUENCY RANGE	1GHz ~ 40GHz		Average (AV)

ANTENNA POLARITY & TEST DISTANCE: HORIZONTAL AT 3 M

NO.	FREQ. (MHz)	EMISSION LEVEL (dBuV/m)	LIMIT (dBuV/m)	MARGIN (dB)	ANTENNA HEIGHT (m)	TABLE ANGLE (Degree)	RAW VALUE (dBuV)	CORRECTION FACTOR (dB/m)
1	5150.00	49.7 PK	74.0	-24.3	1.76 H	268	47.1	2.6
2	5150.00	39.5 AV	54.0	-14.5	1.76 H	268	36.9	2.6
3	*5270.00	109.4 PK			1.76 H	268	107.3	2.1
4	*5270.00	98.9 AV			1.76 H	268	96.8	2.1
5	#10540.00	49.7 PK	68.2	-18.5	3.05 H	72	37.5	12.2
6	15810.00	54.0 PK	74.0	-20.0	2.39 H	320	42.7	11.3
7	15810.00	42.2 AV	54.0	-11.8	2.39 H	320	30.9	11.3

ANTENNA POLARITY & TEST DISTANCE: VERTICAL AT 3 M

NO.	FREQ. (MHz)	EMISSION LEVEL (dBuV/m)	LIMIT (dBuV/m)	MARGIN (dB)	ANTENNA HEIGHT (m)	TABLE ANGLE (Degree)	RAW VALUE (dBuV)	CORRECTION FACTOR (dB/m)
1	5150.00	52.3 PK	74.0	-21.7	1.57 V	96	49.7	2.6
2	5150.00	41.9 AV	54.0	-12.1	1.57 V	96	39.3	2.6
3	*5270.00	112.4 PK			1.57 V	96	110.3	2.1
4	*5270.00	100.5 AV			1.57 V	96	98.4	2.1
5	#10540.00	50.4 PK	68.2	-17.8	1.95 V	304	38.2	12.2
6	15810.00	53.3 PK	74.0	-20.7	3.04 V	272	42.0	11.3
7	15810.00	41.2 AV	54.0	-12.8	3.04 V	272	29.9	11.3

REMARKS:

1. Emission Level(dBuV/m) = Raw Value(dBuV) + Correction Factor(dB/m)
2. Correction Factor(dB/m) = Antenna Factor(dB/m) + Cable Factor(dB) – Pre-Amplifier Factor(dB)
3. The other emission levels were very low against the limit.
4. Margin value = Emission Level – Limit value
5. " * ": Fundamental frequency.
6. " # ": The radiated frequency is out of the restricted band.

CHANNEL	TX Channel 62	DETECTOR FUNCTION	Peak (PK)
FREQUENCY RANGE	1GHz ~ 40GHz		Average (AV)

ANTENNA POLARITY & TEST DISTANCE: HORIZONTAL AT 3 M

NO.	FREQ. (MHz)	EMISSION LEVEL (dBuV/m)	LIMIT (dBuV/m)	MARGIN (dB)	ANTENNA HEIGHT (m)	TABLE ANGLE (Degree)	RAW VALUE (dBuV)	CORRECTION FACTOR (dB/m)
1	*5310.00	109.4 PK			1.68 H	282	107.2	2.2
2	*5310.00	99.3 AV			1.68 H	282	97.1	2.2
3	5350.00	63.3 PK	74.0	-10.7	1.68 H	282	61.0	2.3
4	5350.00	49.3 AV	54.0	-4.7	1.68 H	282	47.0	2.3
5	10620.00	49.6 PK	74.0	-24.4	3.01 H	89	37.9	11.7
6	10620.00	38.8 AV	54.0	-15.2	3.01 H	89	27.1	11.7
7	15930.00	54.1 PK	74.0	-19.9	2.43 H	335	42.9	11.2
8	15930.00	42.3 AV	54.0	-11.7	2.43 H	335	31.1	11.2

ANTENNA POLARITY & TEST DISTANCE: VERTICAL AT 3 M

NO.	FREQ. (MHz)	EMISSION LEVEL (dBuV/m)	LIMIT (dBuV/m)	MARGIN (dB)	ANTENNA HEIGHT (m)	TABLE ANGLE (Degree)	RAW VALUE (dBuV)	CORRECTION FACTOR (dB/m)
1	*5310.00	110.0 PK			2.62 V	360	107.8	2.2
2	*5310.00	98.5 AV			2.62 V	360	96.3	2.2
3	5350.00	69.1 PK	74.0	-4.9	2.62 V	360	66.8	2.3
4	5350.00	53.9 AV	54.0	-0.1	2.62 V	360	51.6	2.3
5	10620.00	50.4 PK	74.0	-23.6	1.92 V	304	38.7	11.7
6	10620.00	39.5 AV	54.0	-14.5	1.92 V	304	27.8	11.7
7	15930.00	53.6 PK	74.0	-20.4	2.93 V	269	42.4	11.2
8	15930.00	41.2 AV	54.0	-12.8	2.93 V	269	30.0	11.2

REMARKS:

1. Emission Level(dBuV/m) = Raw Value(dBuV) + Correction Factor(dB/m)
2. Correction Factor(dB/m) = Antenna Factor(dB/m) + Cable Factor(dB) – Pre-Amplifier Factor(dB)
3. The other emission levels were very low against the limit.
4. Margin value = Emission Level – Limit value
5. " * ": Fundamental frequency.

CHANNEL	TX Channel 102	DETECTOR FUNCTION	Peak (PK)
FREQUENCY RANGE	1GHz ~ 40GHz		Average (AV)

ANTENNA POLARITY & TEST DISTANCE: HORIZONTAL AT 3 M

NO.	FREQ. (MHz)	EMISSION LEVEL (dBuV/m)	LIMIT (dBuV/m)	MARGIN (dB)	ANTENNA HEIGHT (m)	TABLE ANGLE (Degree)	RAW VALUE (dBuV)	CORRECTION FACTOR (dB/m)
1	5460.00	58.2 PK	74.0	-15.8	2.33 H	47	55.6	2.6
2	5460.00	44.2 AV	54.0	-9.8	2.33 H	47	41.6	2.6
3	#5470.00	62.8 PK	68.2	-5.4	2.33 H	47	60.2	2.6
4	*5510.00	106.8 PK			2.33 H	47	104.3	2.5
5	*5510.00	94.1 AV			2.33 H	47	91.6	2.5
6	11020.00	49.6 PK	74.0	-24.4	3.06 H	75	37.3	12.3
7	11020.00	39.0 AV	54.0	-15.0	3.06 H	75	26.7	12.3
8	#16530.00	53.6 PK	68.2	-14.6	2.40 H	305	39.7	13.9

ANTENNA POLARITY & TEST DISTANCE: VERTICAL AT 3 M

NO.	FREQ. (MHz)	EMISSION LEVEL (dBuV/m)	LIMIT (dBuV/m)	MARGIN (dB)	ANTENNA HEIGHT (m)	TABLE ANGLE (Degree)	RAW VALUE (dBuV)	CORRECTION FACTOR (dB/m)
1	5460.00	63.3 PK	74.0	-10.7	2.37 V	201	60.7	2.6
2	5460.00	49.2 AV	54.0	-4.8	2.37 V	201	46.6	2.6
3	#5470.00	68.0 PK	68.2	-0.2	2.37 V	201	65.4	2.6
4	*5510.00	111.8 PK			2.37 V	201	109.3	2.5
5	*5510.00	98.8 AV			2.37 V	201	96.3	2.5
6	11020.00	50.1 PK	74.0	-23.9	1.90 V	293	37.8	12.3
7	11020.00	39.1 AV	54.0	-14.9	1.90 V	293	26.8	12.3
8	#16530.00	54.2 PK	68.2	-14.0	3.00 V	279	40.3	13.9

REMARKS:

1. Emission Level(dBuV/m) = Raw Value(dBuV) + Correction Factor(dB/m)
2. Correction Factor(dB/m) = Antenna Factor(dB/m) + Cable Factor(dB) – Pre-Amplifier Factor(dB)
3. The other emission levels were very low against the limit.
4. Margin value = Emission Level – Limit value
5. " * ": Fundamental frequency.
6. " # ": The radiated frequency is out of the restricted band.

CHANNEL	TX Channel 110	DETECTOR FUNCTION	Peak (PK)
FREQUENCY RANGE	1GHz ~ 40GHz		Average (AV)

ANTENNA POLARITY & TEST DISTANCE: HORIZONTAL AT 3 M

NO.	FREQ. (MHz)	EMISSION LEVEL (dBuV/m)	LIMIT (dBuV/m)	MARGIN (dB)	ANTENNA HEIGHT (m)	TABLE ANGLE (Degree)	RAW VALUE (dBuV)	CORRECTION FACTOR (dB/m)
1	*5550.00	108.1 PK			2.33 H	28	105.4	2.7
2	*5550.00	96.8 AV			2.33 H	28	94.1	2.7
3	11100.00	49.6 PK	74.0	-24.4	3.00 H	82	37.5	12.1
4	11100.00	39.2 AV	54.0	-14.8	3.00 H	82	27.1	12.1
5	#16650.00	53.7 PK	68.2	-14.5	2.49 H	329	39.5	14.2

ANTENNA POLARITY & TEST DISTANCE: VERTICAL AT 3 M

NO.	FREQ. (MHz)	EMISSION LEVEL (dBuV/m)	LIMIT (dBuV/m)	MARGIN (dB)	ANTENNA HEIGHT (m)	TABLE ANGLE (Degree)	RAW VALUE (dBuV)	CORRECTION FACTOR (dB/m)
1	*5550.00	113.5 PK			2.40 V	191	110.8	2.7
2	*5550.00	101.8 AV			2.40 V	191	99.1	2.7
3	11100.00	49.5 PK	74.0	-24.5	1.89 V	302	37.4	12.1
4	11100.00	39.0 AV	54.0	-15.0	1.89 V	302	26.9	12.1
5	#16650.00	54.0 PK	68.2	-14.2	2.99 V	263	39.8	14.2

REMARKS:

1. Emission Level(dBuV/m) = Raw Value(dBuV) + Correction Factor(dB/m)
2. Correction Factor(dB/m) = Antenna Factor(dB/m) + Cable Factor(dB) – Pre-Amplifier Factor(dB)
3. The other emission levels were very low against the limit.
4. Margin value = Emission Level – Limit value
5. " * ": Fundamental frequency.
6. " # ": The radiated frequency is out of the restricted band.

CHANNEL	TX Channel 134	DETECTOR FUNCTION	Peak (PK)
FREQUENCY RANGE	1GHz ~ 40GHz		Average (AV)

ANTENNA POLARITY & TEST DISTANCE: HORIZONTAL AT 3 M

NO.	FREQ. (MHz)	EMISSION LEVEL (dBuV/m)	LIMIT (dBuV/m)	MARGIN (dB)	ANTENNA HEIGHT (m)	TABLE ANGLE (Degree)	RAW VALUE (dBuV)	CORRECTION FACTOR (dB/m)
1	*5670.00	107.8 PK			2.40 H	48	104.9	2.9
2	*5670.00	95.2 AV			2.40 H	48	92.3	2.9
3	#5725.00	63.4 PK	68.2	-4.8	2.40 H	48	60.5	2.9
4	11340.00	49.0 PK	74.0	-25.0	3.07 H	84	36.1	12.9
5	11340.00	38.7 AV	54.0	-15.3	3.07 H	84	25.8	12.9
6	#17010.00	53.4 PK	68.2	-14.8	2.47 H	327	37.6	15.8

ANTENNA POLARITY & TEST DISTANCE: VERTICAL AT 3 M

NO.	FREQ. (MHz)	EMISSION LEVEL (dBuV/m)	LIMIT (dBuV/m)	MARGIN (dB)	ANTENNA HEIGHT (m)	TABLE ANGLE (Degree)	RAW VALUE (dBuV)	CORRECTION FACTOR (dB/m)
1	*5670.00	112.6 PK			2.35 V	194	109.7	2.9
2	*5670.00	100.1 AV			2.35 V	194	97.2	2.9
3	#5725.00	68.0 PK	68.2	-0.2	2.35 V	194	65.1	2.9
4	11340.00	50.1 PK	74.0	-23.9	1.92 V	318	37.2	12.9
5	11340.00	39.2 AV	54.0	-14.8	1.92 V	318	26.3	12.9
6	#17010.00	54.4 PK	68.2	-13.8	3.00 V	267	38.6	15.8

REMARKS:

1. Emission Level(dBuV/m) = Raw Value(dBuV) + Correction Factor(dB/m)
2. Correction Factor(dB/m) = Antenna Factor(dB/m) + Cable Factor(dB) – Pre-Amplifier Factor(dB)
3. The other emission levels were very low against the limit.
4. Margin value = Emission Level – Limit value
5. " * ": Fundamental frequency.
6. " # ": The radiated frequency is out of the restricted band.

CHANNEL	TX Channel 142	DETECTOR FUNCTION	Peak (PK)
FREQUENCY RANGE	1GHz ~ 40GHz		Average (AV)

ANTENNA POLARITY & TEST DISTANCE: HORIZONTAL AT 3 M

NO.	FREQ. (MHz)	EMISSION LEVEL (dBuV/m)	LIMIT (dBuV/m)	MARGIN (dB)	ANTENNA HEIGHT (m)	TABLE ANGLE (Degree)	RAW VALUE (dBuV)	CORRECTION FACTOR (dB/m)
1	#5470.00	49.3 PK	68.2	-18.9	2.32 H	51	46.7	2.6
2	*5710.00	108.2 PK			2.32 H	51	105.2	3.0
3	*5710.00	96.1 AV			2.32 H	51	93.1	3.0
4	#5850.00	49.5 PK	68.2	-18.7	2.32 H	51	46.2	3.3
5	11420.00	50.0 PK	74.0	-24.0	2.98 H	89	37.1	12.9
6	11420.00	39.3 AV	54.0	-14.7	2.98 H	89	26.4	12.9
7	#17130.00	53.9 PK	68.2	-14.3	2.45 H	310	38.1	15.8

ANTENNA POLARITY & TEST DISTANCE: VERTICAL AT 3 M

NO.	FREQ. (MHz)	EMISSION LEVEL (dBuV/m)	LIMIT (dBuV/m)	MARGIN (dB)	ANTENNA HEIGHT (m)	TABLE ANGLE (Degree)	RAW VALUE (dBuV)	CORRECTION FACTOR (dB/m)
1	#5470.00	59.2 PK	68.2	-9.0	2.33 V	186	56.6	2.6
2	*5710.00	113.1 PK			2.33 V	186	110.1	3.0
3	*5710.00	100.9 AV			2.33 V	186	97.9	3.0
4	#5850.00	54.4 PK	68.2	-13.8	2.33 V	186	51.1	3.3
5	11420.00	50.3 PK	74.0	-23.7	1.92 V	300	37.4	12.9
6	11420.00	39.6 AV	54.0	-14.4	1.92 V	300	26.7	12.9
7	#17130.00	54.3 PK	68.2	-13.9	2.93 V	287	38.5	15.8

REMARKS:

1. Emission Level(dBuV/m) = Raw Value(dBuV) + Correction Factor(dB/m)
2. Correction Factor(dB/m) = Antenna Factor(dB/m) + Cable Factor(dB) – Pre-Amplifier Factor(dB)
3. The other emission levels were very low against the limit.
4. Margin value = Emission Level – Limit value
5. " * ": Fundamental frequency.
6. " # ": The radiated frequency is out of the restricted band.

802.11ax (HE80)

CHANNEL	TX Channel 58	DETECTOR FUNCTION	Peak (PK)
FREQUENCY RANGE	1GHz ~ 40GHz		Average (AV)

ANTENNA POLARITY & TEST DISTANCE: HORIZONTAL AT 3 M

NO.	FREQ. (MHz)	EMISSION LEVEL (dBuV/m)	LIMIT (dBuV/m)	MARGIN (dB)	ANTENNA HEIGHT (m)	TABLE ANGLE (Degree)	RAW VALUE (dBuV)	CORRECTION FACTOR (dB/m)
1	5150.00	49.9 PK	74.0	-24.1	1.75 H	295	47.3	2.6
2	5150.00	39.7 AV	54.0	-14.3	1.75 H	295	37.1	2.6
3	*5290.00	109.2 PK			1.75 H	295	107.1	2.1
4	*5290.00	98.8 AV			1.75 H	295	96.7	2.1
5	5350.00	62.7 PK	74.0	-11.3	1.75 H	295	60.4	2.3
6	5350.00	49.0 AV	54.0	-5.0	1.75 H	295	46.7	2.3
7	#10580.00	49.4 PK	68.2	-18.8	3.06 H	93	37.6	11.8
8	15870.00	53.1 PK	74.0	-20.9	2.45 H	316	41.9	11.2
9	15870.00	41.8 AV	54.0	-12.2	2.45 H	316	30.6	11.2

ANTENNA POLARITY & TEST DISTANCE: VERTICAL AT 3 M

NO.	FREQ. (MHz)	EMISSION LEVEL (dBuV/m)	LIMIT (dBuV/m)	MARGIN (dB)	ANTENNA HEIGHT (m)	TABLE ANGLE (Degree)	RAW VALUE (dBuV)	CORRECTION FACTOR (dB/m)
1	5150.00	52.6 PK	74.0	-21.4	2.27 V	355	50.0	2.6
2	5150.00	40.9 AV	54.0	-13.1	2.27 V	355	38.3	2.6
3	*5290.00	106.5 PK			2.27 V	355	104.4	2.1
4	*5290.00	93.7 AV			2.27 V	355	91.6	2.1
5	5350.00	66.8 PK	74.0	-7.2	2.27 V	355	64.5	2.3
6	5350.00	53.9 AV	54.0	-0.1	2.27 V	355	51.6	2.3
7	#10580.00	49.4 PK	68.2	-18.8	1.87 V	298	37.6	11.8
8	15870.00	53.6 PK	74.0	-20.4	2.94 V	282	42.4	11.2
9	15870.00	41.3 AV	54.0	-12.7	2.94 V	282	30.1	11.2

REMARKS:

- Emission Level(dBuV/m) = Raw Value(dBuV) + Correction Factor(dB/m)
- Correction Factor(dB/m) = Antenna Factor(dB/m) + Cable Factor(dB) – Pre-Amplifier Factor(dB)
- The other emission levels were very low against the limit.
- Margin value = Emission Level – Limit value
- " * ": Fundamental frequency.
- " # ": The radiated frequency is out of the restricted band.

CHANNEL	TX Channel 106	DETECTOR FUNCTION	Peak (PK)
FREQUENCY RANGE	1GHz ~ 40GHz		Average (AV)

ANTENNA POLARITY & TEST DISTANCE: HORIZONTAL AT 3 M

NO.	FREQ. (MHz)	EMISSION LEVEL (dBuV/m)	LIMIT (dBuV/m)	MARGIN (dB)	ANTENNA HEIGHT (m)	TABLE ANGLE (Degree)	RAW VALUE (dBuV)	CORRECTION FACTOR (dB/m)
1	5460.00	58.1 PK	74.0	-15.9	2.36 H	21	55.5	2.6
2	5460.00	43.5 AV	54.0	-10.5	2.36 H	21	40.9	2.6
3	#5470.00	63.3 PK	68.2	-4.9	2.36 H	21	60.7	2.6
4	*5530.00	96.8 PK			2.36 H	21	94.2	2.6
5	*5530.00	87.7 AV			2.36 H	21	85.1	2.6
6	#5725.00	49.3 PK	68.2	-18.9	2.36 H	21	46.4	2.9
7	11060.00	49.8 PK	74.0	-24.2	3.01 H	86	37.7	12.1
8	11060.00	39.0 AV	54.0	-15.0	3.01 H	86	26.9	12.1
9	#16590.00	53.6 PK	68.2	-14.6	2.39 H	316	39.4	14.2

ANTENNA POLARITY & TEST DISTANCE: VERTICAL AT 3 M

NO.	FREQ. (MHz)	EMISSION LEVEL (dBuV/m)	LIMIT (dBuV/m)	MARGIN (dB)	ANTENNA HEIGHT (m)	TABLE ANGLE (Degree)	RAW VALUE (dBuV)	CORRECTION FACTOR (dB/m)
1	5460.00	62.9 PK	74.0	-11.1	1.31 V	114	60.3	2.6
2	5460.00	50.0 AV	54.0	-4.0	1.31 V	114	47.4	2.6
3	#5470.00	67.6 PK	68.2	-0.6	1.31 V	114	65.0	2.6
4	*5530.00	104.8 PK			1.31 V	114	102.2	2.6
5	*5530.00	92.6 AV			1.31 V	114	90.0	2.6
6	#5725.00	51.8 PK	68.2	-16.4	1.31 V	114	48.9	2.9
7	11060.00	49.7 PK	74.0	-24.3	1.92 V	313	37.6	12.1
8	11060.00	38.9 AV	54.0	-15.1	1.92 V	313	26.8	12.1
9	#16590.00	54.1 PK	68.2	-14.1	2.99 V	285	39.9	14.2

REMARKS:

1. Emission Level(dBuV/m) = Raw Value(dBuV) + Correction Factor(dB/m)
2. Correction Factor(dB/m) = Antenna Factor(dB/m) + Cable Factor(dB) – Pre-Amplifier Factor(dB)
3. The other emission levels were very low against the limit.
4. Margin value = Emission Level – Limit value
5. " * ": Fundamental frequency.
6. " # ": The radiated frequency is out of the restricted band.

CHANNEL	TX Channel 122	DETECTOR FUNCTION	Peak (PK)
FREQUENCY RANGE	1GHz ~ 40GHz		Average (AV)

ANTENNA POLARITY & TEST DISTANCE: HORIZONTAL AT 3 M

NO.	FREQ. (MHz)	EMISSION LEVEL (dBuV/m)	LIMIT (dBuV/m)	MARGIN (dB)	ANTENNA HEIGHT (m)	TABLE ANGLE (Degree)	RAW VALUE (dBuV)	CORRECTION FACTOR (dB/m)
1	*5610.00	107.4 PK			2.43 H	48	104.6	2.8
2	*5610.00	96.1 AV			2.43 H	48	93.3	2.8
3	#5725.00	63.1 PK	68.2	-5.1	2.43 H	48	60.2	2.9
4	11220.00	50.1 PK	74.0	-23.9	3.03 H	90	37.8	12.3
5	11220.00	39.4 AV	54.0	-14.6	3.03 H	90	27.1	12.3
6	#16830.00	53.7 PK	68.2	-14.5	2.48 H	304	39.1	14.6

ANTENNA POLARITY & TEST DISTANCE: VERTICAL AT 3 M

NO.	FREQ. (MHz)	EMISSION LEVEL (dBuV/m)	LIMIT (dBuV/m)	MARGIN (dB)	ANTENNA HEIGHT (m)	TABLE ANGLE (Degree)	RAW VALUE (dBuV)	CORRECTION FACTOR (dB/m)
1	*5610.00	112.8 PK			1.27 V	114	110.0	2.8
2	*5610.00	100.9 AV			1.27 V	114	98.1	2.8
3	#5725.00	66.1 PK	68.2	-2.1	1.27 V	114	63.2	2.9
4	11220.00	49.8 PK	74.0	-24.2	1.86 V	300	37.5	12.3
5	11220.00	39.1 AV	54.0	-14.9	1.86 V	300	26.8	12.3
6	#16830.00	54.2 PK	68.2	-14.0	2.96 V	271	39.6	14.6

REMARKS:

1. Emission Level(dBuV/m) = Raw Value(dBuV) + Correction Factor(dB/m)
2. Correction Factor(dB/m) = Antenna Factor(dB/m) + Cable Factor(dB) – Pre-Amplifier Factor(dB)
3. The other emission levels were very low against the limit.
4. Margin value = Emission Level – Limit value
5. " * ": Fundamental frequency.
6. " # ": The radiated frequency is out of the restricted band.

CHANNEL	TX Channel 138	DETECTOR FUNCTION	Peak (PK)
FREQUENCY RANGE	1GHz ~ 40GHz		Average (AV)

ANTENNA POLARITY & TEST DISTANCE: HORIZONTAL AT 3 M

NO.	FREQ. (MHz)	EMISSION LEVEL (dBuV/m)	LIMIT (dBuV/m)	MARGIN (dB)	ANTENNA HEIGHT (m)	TABLE ANGLE (Degree)	RAW VALUE (dBuV)	CORRECTION FACTOR (dB/m)
1	#5470.00	54.2 PK	68.2	-14.0	2.37 H	38	51.6	2.6
2	*5690.00	108.2 PK			2.37 H	38	105.3	2.9
3	*5690.00	96.7 AV			2.37 H	38	93.8	2.9
4	#5850.00	62.9 PK	68.2	-5.3	2.37 H	38	59.6	3.3
5	11380.00	49.5 PK	74.0	-24.5	3.00 H	97	36.6	12.9
6	11380.00	38.9 AV	54.0	-15.1	3.00 H	97	26.0	12.9
7	#17070.00	54.1 PK	68.2	-14.1	2.40 H	319	38.0	16.1

ANTENNA POLARITY & TEST DISTANCE: VERTICAL AT 3 M

NO.	FREQ. (MHz)	EMISSION LEVEL (dBuV/m)	LIMIT (dBuV/m)	MARGIN (dB)	ANTENNA HEIGHT (m)	TABLE ANGLE (Degree)	RAW VALUE (dBuV)	CORRECTION FACTOR (dB/m)
1	#5470.00	59.8 PK	68.2	-8.4	1.30 V	124	57.2	2.6
2	*5690.00	113.9 PK			1.30 V	124	111.0	2.9
3	*5690.00	101.7 AV			1.30 V	124	98.8	2.9
4	#5850.00	66.0 PK	68.2	-2.2	1.30 V	124	62.7	3.3
5	11380.00	49.5 PK	74.0	-24.5	1.92 V	319	36.6	12.9
6	11380.00	39.0 AV	54.0	-15.0	1.92 V	319	26.1	12.9
7	#17070.00	54.7 PK	68.2	-13.5	2.93 V	293	38.6	16.1

REMARKS:

1. Emission Level(dBuV/m) = Raw Value(dBuV) + Correction Factor(dB/m)
2. Correction Factor(dB/m) = Antenna Factor(dB/m) + Cable Factor(dB) – Pre-Amplifier Factor(dB)
3. The other emission levels were very low against the limit.
4. Margin value = Emission Level – Limit value
5. " * ": Fundamental frequency.
6. " # ": The radiated frequency is out of the restricted band.

4.1.9 Test Results (Mode 3)

Above 1GHz Data:

802.11a

CHANNEL	TX Channel 52	DETECTOR FUNCTION	Peak (PK)
FREQUENCY RANGE	1GHz ~ 40GHz		Average (AV)

ANTENNA POLARITY & TEST DISTANCE: HORIZONTAL AT 3 M								
NO.	FREQ. (MHz)	EMISSION LEVEL (dBuV/m)	LIMIT (dBuV/m)	MARGIN (dB)	ANTENNA HEIGHT (m)	TABLE ANGLE (Degree)	RAW VALUE (dBuV)	CORRECTION FACTOR (dB/m)
1	5150.00	49.8 PK	74.0	-24.2	1.74 H	302	47.2	2.6
2	5150.00	39.6 AV	54.0	-14.4	1.74 H	302	37.0	2.6
3	*5260.00	107.8 PK			1.74 H	302	105.7	2.1
4	*5260.00	98.5 AV			1.74 H	302	96.4	2.1
5	#10520.00	49.4 PK	68.2	-18.8	3.01 H	108	37.0	12.4
6	15780.00	52.9 PK	74.0	-21.1	2.45 H	322	41.4	11.5
7	15780.00	41.1 AV	54.0	-12.9	2.45 H	322	29.6	11.5

ANTENNA POLARITY & TEST DISTANCE: VERTICAL AT 3 M								
NO.	FREQ. (MHz)	EMISSION LEVEL (dBuV/m)	LIMIT (dBuV/m)	MARGIN (dB)	ANTENNA HEIGHT (m)	TABLE ANGLE (Degree)	RAW VALUE (dBuV)	CORRECTION FACTOR (dB/m)
1	5150.00	52.8 PK	74.0	-21.2	2.14 V	190	50.2	2.6
2	5150.00	42.0 AV	54.0	-12.0	2.14 V	190	39.4	2.6
3	*5260.00	112.5 PK			2.14 V	190	110.4	2.1
4	*5260.00	103.8 AV			2.14 V	190	101.7	2.1
5	#10520.00	51.9 PK	68.2	-16.3	1.92 V	351	39.5	12.4
6	15780.00	59.8 PK	74.0	-14.2	3.00 V	241	48.3	11.5
7	15780.00	48.7 AV	54.0	-5.3	3.00 V	241	37.2	11.5

REMARKS:

1. Emission Level(dBuV/m) = Raw Value(dBuV) + Correction Factor(dB/m)
2. Correction Factor(dB/m) = Antenna Factor(dB/m) + Cable Factor(dB) – Pre-Amplifier Factor(dB)
3. The other emission levels were very low against the limit.
4. Margin value = Emission Level – Limit value
5. " * ": Fundamental frequency.
6. " # ": The radiated frequency is out of the restricted band.

CHANNEL	TX Channel 60	DETECTOR FUNCTION	Peak (PK)
FREQUENCY RANGE	1GHz ~ 40GHz		Average (AV)

ANTENNA POLARITY & TEST DISTANCE: HORIZONTAL AT 3 M

NO.	FREQ. (MHz)	EMISSION LEVEL (dBuV/m)	LIMIT (dBuV/m)	MARGIN (dB)	ANTENNA HEIGHT (m)	TABLE ANGLE (Degree)	RAW VALUE (dBuV)	CORRECTION FACTOR (dB/m)
1	*5300.00	107.6 PK			1.78 H	294	105.4	2.2
2	*5300.00	98.3 AV			1.78 H	294	96.1	2.2
3	10600.00	49.5 PK	74.0	-24.5	2.99 H	90	37.8	11.7
4	10600.00	39.1 AV	54.0	-14.9	2.99 H	90	27.4	11.7
5	15900.00	53.3 PK	74.0	-20.7	2.42 H	306	42.1	11.2
6	15900.00	41.2 AV	54.0	-12.8	2.42 H	306	30.0	11.2

ANTENNA POLARITY & TEST DISTANCE: VERTICAL AT 3 M

NO.	FREQ. (MHz)	EMISSION LEVEL (dBuV/m)	LIMIT (dBuV/m)	MARGIN (dB)	ANTENNA HEIGHT (m)	TABLE ANGLE (Degree)	RAW VALUE (dBuV)	CORRECTION FACTOR (dB/m)
1	*5300.00	112.5 PK			2.20 V	211	110.3	2.2
2	*5300.00	103.7 AV			2.20 V	211	101.5	2.2
3	10600.00	53.1 PK	74.0	-20.9	1.96 V	348	41.4	11.7
4	10600.00	42.5 AV	54.0	-11.5	1.96 V	348	30.8	11.7
5	15900.00	59.2 PK	74.0	-14.8	2.97 V	248	48.0	11.2
6	15900.00	48.3 AV	54.0	-5.7	2.97 V	248	37.1	11.2

REMARKS:

1. Emission Level(dBuV/m) = Raw Value(dBuV) + Correction Factor(dB/m)
2. Correction Factor(dB/m) = Antenna Factor(dB/m) + Cable Factor(dB) – Pre-Amplifier Factor(dB)
3. The other emission levels were very low against the limit.
4. Margin value = Emission Level – Limit value
5. " * ": Fundamental frequency.

CHANNEL	TX Channel 64	DETECTOR FUNCTION	Peak (PK)
FREQUENCY RANGE	1GHz ~ 40GHz		Average (AV)

ANTENNA POLARITY & TEST DISTANCE: HORIZONTAL AT 3 M

NO.	FREQ. (MHz)	EMISSION LEVEL (dBuV/m)	LIMIT (dBuV/m)	MARGIN (dB)	ANTENNA HEIGHT (m)	TABLE ANGLE (Degree)	RAW VALUE (dBuV)	CORRECTION FACTOR (dB/m)
1	*5320.00	107.3 PK			1.76 H	304	105.0	2.3
2	*5320.00	98.0 AV			1.76 H	304	95.7	2.3
3	5350.00	63.1 PK	74.0	-10.9	1.76 H	304	60.8	2.3
4	5350.00	48.6 AV	54.0	-5.4	1.76 H	304	46.3	2.3
5	10640.00	49.2 PK	74.0	-24.8	3.05 H	111	37.5	11.7
6	10640.00	38.5 AV	54.0	-15.5	3.05 H	111	26.8	11.7
7	15960.00	53.3 PK	74.0	-20.7	2.45 H	310	41.9	11.4
8	15960.00	41.4 AV	54.0	-12.6	2.45 H	310	30.0	11.4

ANTENNA POLARITY & TEST DISTANCE: VERTICAL AT 3 M

NO.	FREQ. (MHz)	EMISSION LEVEL (dBuV/m)	LIMIT (dBuV/m)	MARGIN (dB)	ANTENNA HEIGHT (m)	TABLE ANGLE (Degree)	RAW VALUE (dBuV)	CORRECTION FACTOR (dB/m)
1	*5320.00	110.4 PK			2.24 V	206	108.1	2.3
2	*5320.00	102.3 AV			2.24 V	206	100.0	2.3
3	5350.00	67.9 PK	74.0	-6.1	2.24 V	206	65.6	2.3
4	5350.00	53.8 AV	54.0	-0.2	2.24 V	206	51.5	2.3
5	10640.00	52.1 PK	74.0	-21.9	1.97 V	324	40.4	11.7
6	10640.00	42.1 AV	54.0	-11.9	1.97 V	324	30.4	11.7
7	15960.00	59.5 PK	74.0	-14.5	2.96 V	241	48.1	11.4
8	15960.00	48.4 AV	54.0	-5.6	2.96 V	241	37.0	11.4

REMARKS:

1. Emission Level(dBuV/m) = Raw Value(dBuV) + Correction Factor(dB/m)
2. Correction Factor(dB/m) = Antenna Factor(dB/m) + Cable Factor(dB) – Pre-Amplifier Factor(dB)
3. The other emission levels were very low against the limit.
4. Margin value = Emission Level – Limit value
5. " * ": Fundamental frequency.

CHANNEL	TX Channel 100	DETECTOR FUNCTION	Peak (PK)
FREQUENCY RANGE	1GHz ~ 40GHz		Average (AV)

ANTENNA POLARITY & TEST DISTANCE: HORIZONTAL AT 3 M

NO.	FREQ. (MHz)	EMISSION LEVEL (dBuV/m)	LIMIT (dBuV/m)	MARGIN (dB)	ANTENNA HEIGHT (m)	TABLE ANGLE (Degree)	RAW VALUE (dBuV)	CORRECTION FACTOR (dB/m)
1	5460.00	50.1 PK	74.0	-23.9	1.77 H	273	47.5	2.6
2	5460.00	39.9 AV	54.0	-14.1	1.77 H	273	37.3	2.6
3	#5470.00	62.7 PK	68.2	-5.5	1.77 H	273	60.1	2.6
4	*5500.00	104.2 PK			1.77 H	273	101.7	2.5
5	*5500.00	91.8 AV			1.77 H	273	89.3	2.5
6	11000.00	49.9 PK	74.0	-24.1	2.76 H	300	37.7	12.2
7	11000.00	39.8 AV	54.0	-14.2	2.76 H	300	27.6	12.2
8	#16500.00	53.7 PK	68.2	-14.5	2.05 H	21	40.0	13.7

ANTENNA POLARITY & TEST DISTANCE: VERTICAL AT 3 M

NO.	FREQ. (MHz)	EMISSION LEVEL (dBuV/m)	LIMIT (dBuV/m)	MARGIN (dB)	ANTENNA HEIGHT (m)	TABLE ANGLE (Degree)	RAW VALUE (dBuV)	CORRECTION FACTOR (dB/m)
1	5460.00	55.8 PK	74.0	-18.2	2.98 V	95	53.2	2.6
2	5460.00	45.3 AV	54.0	-8.7	2.98 V	95	42.7	2.6
3	#5470.00	68.1 PK	68.2	-0.1	2.98 V	95	65.5	2.6
4	*5500.00	110.3 PK			2.98 V	95	107.8	2.5
5	*5500.00	97.6 AV			2.98 V	95	95.1	2.5
6	11000.00	52.4 PK	74.0	-21.6	1.95 V	335	40.2	12.2
7	11000.00	42.1 AV	54.0	-11.9	1.95 V	335	29.9	12.2
8	#16500.00	59.6 PK	68.2	-8.6	2.96 V	242	45.9	13.7

REMARKS:

1. Emission Level(dBuV/m) = Raw Value(dBuV) + Correction Factor(dB/m)
2. Correction Factor(dB/m) = Antenna Factor(dB/m) + Cable Factor(dB) – Pre-Amplifier Factor(dB)
3. The other emission levels were very low against the limit.
4. Margin value = Emission Level – Limit value
5. " * ": Fundamental frequency.
6. " # ": The radiated frequency is out of the restricted band.

CHANNEL	TX Channel 116	DETECTOR FUNCTION	Peak (PK)
FREQUENCY RANGE	1GHz ~ 40GHz		Average (AV)

ANTENNA POLARITY & TEST DISTANCE: HORIZONTAL AT 3 M

NO.	FREQ. (MHz)	EMISSION LEVEL (dBuV/m)	LIMIT (dBuV/m)	MARGIN (dB)	ANTENNA HEIGHT (m)	TABLE ANGLE (Degree)	RAW VALUE (dBuV)	CORRECTION FACTOR (dB/m)
1	*5580.00	103.8 PK			1.82 H	272	101.0	2.8
2	*5580.00	91.6 AV			1.82 H	272	88.8	2.8
3	11160.00	50.5 PK	74.0	-23.5	2.74 H	303	38.5	12.0
4	11160.00	40.2 AV	54.0	-13.8	2.74 H	303	28.2	12.0
5	#16740.00	54.0 PK	68.2	-14.2	2.00 H	24	39.8	14.2

ANTENNA POLARITY & TEST DISTANCE: VERTICAL AT 3 M

NO.	FREQ. (MHz)	EMISSION LEVEL (dBuV/m)	LIMIT (dBuV/m)	MARGIN (dB)	ANTENNA HEIGHT (m)	TABLE ANGLE (Degree)	RAW VALUE (dBuV)	CORRECTION FACTOR (dB/m)
1	*5580.00	110.5 PK			2.93 V	106	107.7	2.8
2	*5580.00	97.6 AV			2.93 V	106	94.8	2.8
3	11160.00	52.4 PK	74.0	-21.6	1.95 V	335	40.4	12.0
4	11160.00	42.1 AV	54.0	-11.9	1.95 V	335	30.1	12.0
5	#16740.00	59.6 PK	68.2	-8.6	2.96 V	242	45.4	14.2

REMARKS:

1. Emission Level(dBuV/m) = Raw Value(dBuV) + Correction Factor(dB/m)
2. Correction Factor(dB/m) = Antenna Factor(dB/m) + Cable Factor(dB) – Pre-Amplifier Factor(dB)
3. The other emission levels were very low against the limit.
4. Margin value = Emission Level – Limit value
5. " * ": Fundamental frequency.
6. " # ": The radiated frequency is out of the restricted band.

CHANNEL	TX Channel 140	DETECTOR FUNCTION	Peak (PK)
FREQUENCY RANGE	1GHz ~ 40GHz		Average (AV)

ANTENNA POLARITY & TEST DISTANCE: HORIZONTAL AT 3 M

NO.	FREQ. (MHz)	EMISSION LEVEL (dBuV/m)	LIMIT (dBuV/m)	MARGIN (dB)	ANTENNA HEIGHT (m)	TABLE ANGLE (Degree)	RAW VALUE (dBuV)	CORRECTION FACTOR (dB/m)
1	*5700.00	103.8 PK			1.77 H	288	100.9	2.9
2	*5700.00	91.5 AV			1.77 H	288	88.6	2.9
3	#5725.00	62.4 PK	68.2	-5.8	1.72 H	263	59.5	2.9
4	11400.00	50.7 PK	74.0	-23.3	2.81 H	301	37.7	13.0
5	11400.00	40.3 AV	54.0	-13.7	2.81 H	301	27.3	13.0
6	#17100.00	53.2 PK	68.2	-15.0	2.05 H	22	37.1	16.1

ANTENNA POLARITY & TEST DISTANCE: VERTICAL AT 3 M

NO.	FREQ. (MHz)	EMISSION LEVEL (dBuV/m)	LIMIT (dBuV/m)	MARGIN (dB)	ANTENNA HEIGHT (m)	TABLE ANGLE (Degree)	RAW VALUE (dBuV)	CORRECTION FACTOR (dB/m)
1	*5700.00	110.0 PK			2.97 V	108	107.1	2.9
2	*5700.00	97.9 AV			2.97 V	108	95.0	2.9
3	#5725.00	67.9 PK	68.2	-0.3	2.97 V	108	65.0	2.9
4	11400.00	52.8 PK	74.0	-21.2	1.92 V	332	39.8	13.0
5	11400.00	42.5 AV	54.0	-11.5	1.92 V	332	29.5	13.0
6	#17100.00	59.9 PK	68.2	-8.3	2.96 V	243	43.8	16.1

REMARKS:

1. Emission Level(dBuV/m) = Raw Value(dBuV) + Correction Factor(dB/m)
2. Correction Factor(dB/m) = Antenna Factor(dB/m) + Cable Factor(dB) – Pre-Amplifier Factor(dB)
3. The other emission levels were very low against the limit.
4. Margin value = Emission Level – Limit value
5. " * ": Fundamental frequency.
6. " # ": The radiated frequency is out of the restricted band.

CHANNEL	TX Channel 144	DETECTOR FUNCTION	Peak (PK)
FREQUENCY RANGE	1GHz ~ 40GHz		Average (AV)

ANTENNA POLARITY & TEST DISTANCE: HORIZONTAL AT 3 M

NO.	FREQ. (MHz)	EMISSION LEVEL (dBuV/m)	LIMIT (dBuV/m)	MARGIN (dB)	ANTENNA HEIGHT (m)	TABLE ANGLE (Degree)	RAW VALUE (dBuV)	CORRECTION FACTOR (dB/m)
1	*5720.00	104.5 PK			1.80 H	280	101.6	2.9
2	*5720.00	92.1 AV			1.80 H	280	89.2	2.9
3	#5850.00	49.9 PK	68.2	-18.3	1.67 H	255	46.6	3.3
4	11440.00	50.3 PK	74.0	-23.7	2.78 H	293	37.6	12.7
5	11440.00	40.0 AV	54.0	-14.0	2.78 H	293	27.3	12.7
6	#17160.00	53.6 PK	68.2	-14.6	2.04 H	31	38.0	15.6

ANTENNA POLARITY & TEST DISTANCE: VERTICAL AT 3 M

NO.	FREQ. (MHz)	EMISSION LEVEL (dBuV/m)	LIMIT (dBuV/m)	MARGIN (dB)	ANTENNA HEIGHT (m)	TABLE ANGLE (Degree)	RAW VALUE (dBuV)	CORRECTION FACTOR (dB/m)
1	*5720.00	110.0 PK			2.96 V	105	107.1	2.9
2	*5720.00	97.9 AV			2.96 V	105	95.0	2.9
3	#5850.00	55.6 PK	68.2	-12.6	2.96 V	105	52.3	3.3
4	11440.00	52.4 PK	74.0	-21.6	1.93 V	328	39.7	12.7
5	11440.00	41.9 AV	54.0	-12.1	1.93 V	328	29.2	12.7
6	#17160.00	59.5 PK	68.2	-8.7	2.96 V	233	43.9	15.6

REMARKS:

1. Emission Level(dBuV/m) = Raw Value(dBuV) + Correction Factor(dB/m)
2. Correction Factor(dB/m) = Antenna Factor(dB/m) + Cable Factor(dB) – Pre-Amplifier Factor(dB)
3. The other emission levels were very low against the limit.
4. Margin value = Emission Level – Limit value
5. " * ": Fundamental frequency.
6. " # ": The radiated frequency is out of the restricted band.

802.11ax (HE20)

CHANNEL	TX Channel 52	DETECTOR FUNCTION	Peak (PK)
FREQUENCY RANGE	1GHz ~ 40GHz		Average (AV)

ANTENNA POLARITY & TEST DISTANCE: HORIZONTAL AT 3 M

NO.	FREQ. (MHz)	EMISSION LEVEL (dBuV/m)	LIMIT (dBuV/m)	MARGIN (dB)	ANTENNA HEIGHT (m)	TABLE ANGLE (Degree)	RAW VALUE (dBuV)	CORRECTION FACTOR (dB/m)
1	5150.00	49.3 PK	74.0	-24.7	1.75 H	293	46.7	2.6
2	5150.00	39.2 AV	54.0	-14.8	1.75 H	293	36.6	2.6
3	*5260.00	108.1 PK			1.75 H	293	106.0	2.1
4	*5260.00	98.9 AV			1.75 H	293	96.8	2.1
5	5350.00	49.7 PK	74.0	-24.3	1.75 H	293	47.4	2.3
6	5350.00	39.6 AV	54.0	-14.4	1.75 H	293	37.3	2.3
7	#10520.00	49.6 PK	68.2	-18.6	3.00 H	105	37.2	12.4
8	15780.00	53.2 PK	74.0	-20.8	2.47 H	321	41.7	11.5
9	15780.00	41.1 AV	54.0	-12.9	2.47 H	321	29.6	11.5

ANTENNA POLARITY & TEST DISTANCE: VERTICAL AT 3 M

NO.	FREQ. (MHz)	EMISSION LEVEL (dBuV/m)	LIMIT (dBuV/m)	MARGIN (dB)	ANTENNA HEIGHT (m)	TABLE ANGLE (Degree)	RAW VALUE (dBuV)	CORRECTION FACTOR (dB/m)
1	5150.00	52.4 PK	74.0	-21.6	2.17 V	198	49.8	2.6
2	5150.00	39.5 AV	54.0	-14.5	2.17 V	198	36.9	2.6
3	*5260.00	112.4 PK			2.17 V	198	110.3	2.1
4	*5260.00	103.5 AV			2.17 V	198	101.4	2.1
5	5350.00	52.9 PK	74.0	-21.1	2.17 V	198	50.6	2.3
6	5350.00	40.2 AV	54.0	-13.8	2.17 V	198	37.9	2.3
7	#10520.00	52.4 PK	68.2	-15.8	1.93 V	329	40.0	12.4
8	15780.00	59.7 PK	74.0	-14.3	2.93 V	247	48.2	11.5
9	15780.00	48.5 AV	54.0	-5.5	2.93 V	247	37.0	11.5

REMARKS:

1. Emission Level(dBuV/m) = Raw Value(dBuV) + Correction Factor(dB/m)
2. Correction Factor(dB/m) = Antenna Factor(dB/m) + Cable Factor(dB) – Pre-Amplifier Factor(dB)
3. The other emission levels were very low against the limit.
4. Margin value = Emission Level – Limit value
5. " * ": Fundamental frequency.
6. " # ": The radiated frequency is out of the restricted band.

CHANNEL	TX Channel 60	DETECTOR FUNCTION	Peak (PK)
FREQUENCY RANGE	1GHz ~ 40GHz		Average (AV)

ANTENNA POLARITY & TEST DISTANCE: HORIZONTAL AT 3 M

NO.	FREQ. (MHz)	EMISSION LEVEL (dBuV/m)	LIMIT (dBuV/m)	MARGIN (dB)	ANTENNA HEIGHT (m)	TABLE ANGLE (Degree)	RAW VALUE (dBuV)	CORRECTION FACTOR (dB/m)
1	*5300.00	107.4 PK			1.78 H	286	105.2	2.2
2	*5300.00	98.1 AV			1.78 H	286	95.9	2.2
3	10600.00	49.7 PK	74.0	-24.3	2.97 H	94	38.0	11.7
4	10600.00	39.3 AV	54.0	-14.7	2.97 H	94	27.6	11.7
5	15900.00	53.8 PK	74.0	-20.2	2.43 H	323	42.6	11.2
6	15900.00	41.7 AV	54.0	-12.3	2.43 H	323	30.5	11.2

ANTENNA POLARITY & TEST DISTANCE: VERTICAL AT 3 M

NO.	FREQ. (MHz)	EMISSION LEVEL (dBuV/m)	LIMIT (dBuV/m)	MARGIN (dB)	ANTENNA HEIGHT (m)	TABLE ANGLE (Degree)	RAW VALUE (dBuV)	CORRECTION FACTOR (dB/m)
1	*5300.00	112.0 PK			2.26 V	189	109.8	2.2
2	*5300.00	103.3 AV			2.26 V	189	101.1	2.2
3	10600.00	52.1 PK	74.0	-21.9	1.93 V	349	40.4	11.7
4	10600.00	42.1 AV	54.0	-11.9	1.93 V	349	30.4	11.7
5	15900.00	59.1 PK	74.0	-14.9	2.93 V	233	47.9	11.2
6	15900.00	48.4 AV	54.0	-5.6	2.93 V	233	37.2	11.2

REMARKS:

1. Emission Level(dBuV/m) = Raw Value(dBuV) + Correction Factor(dB/m)
2. Correction Factor(dB/m) = Antenna Factor(dB/m) + Cable Factor(dB) – Pre-Amplifier Factor(dB)
3. The other emission levels were very low against the limit.
4. Margin value = Emission Level – Limit value
5. " * ": Fundamental frequency.

CHANNEL	TX Channel 64	DETECTOR FUNCTION	Peak (PK)
FREQUENCY RANGE	1GHz ~ 40GHz		Average (AV)

ANTENNA POLARITY & TEST DISTANCE: HORIZONTAL AT 3 M

NO.	FREQ. (MHz)	EMISSION LEVEL (dBuV/m)	LIMIT (dBuV/m)	MARGIN (dB)	ANTENNA HEIGHT (m)	TABLE ANGLE (Degree)	RAW VALUE (dBuV)	CORRECTION FACTOR (dB/m)
1	*5320.00	107.6 PK			1.70 H	306	105.3	2.3
2	*5320.00	98.4 AV			1.70 H	306	96.1	2.3
3	5350.00	63.1 PK	74.0	-10.9	1.70 H	306	60.8	2.3
4	5350.00	48.5 AV	54.0	-5.5	1.70 H	306	46.2	2.3
5	10640.00	49.5 PK	74.0	-24.5	3.04 H	111	37.8	11.7
6	10640.00	38.8 AV	54.0	-15.2	3.04 H	111	27.1	11.7
7	15960.00	53.2 PK	74.0	-20.8	2.47 H	311	41.8	11.4
8	15960.00	41.5 AV	54.0	-12.5	2.47 H	311	30.1	11.4

ANTENNA POLARITY & TEST DISTANCE: VERTICAL AT 3 M

NO.	FREQ. (MHz)	EMISSION LEVEL (dBuV/m)	LIMIT (dBuV/m)	MARGIN (dB)	ANTENNA HEIGHT (m)	TABLE ANGLE (Degree)	RAW VALUE (dBuV)	CORRECTION FACTOR (dB/m)
1	*5320.00	112.4 PK			2.24 V	189	110.1	2.3
2	*5320.00	103.6 AV			2.24 V	189	101.3	2.3
3	5350.00	67.4 PK	74.0	-6.6	2.24 V	189	65.1	2.3
4	5350.00	53.8 AV	54.0	-0.2	2.24 V	189	51.5	2.3
5	10640.00	52.2 PK	74.0	-21.8	1.99 V	335	40.5	11.7
6	10640.00	41.8 AV	54.0	-12.2	1.99 V	335	30.1	11.7
7	15960.00	59.1 PK	74.0	-14.9	2.93 V	255	47.7	11.4
8	15960.00	48.2 AV	54.0	-5.8	2.93 V	255	36.8	11.4

REMARKS:

1. Emission Level(dBuV/m) = Raw Value(dBuV) + Correction Factor(dB/m)
2. Correction Factor(dB/m) = Antenna Factor(dB/m) + Cable Factor(dB) – Pre-Amplifier Factor(dB)
3. The other emission levels were very low against the limit.
4. Margin value = Emission Level – Limit value
5. " * ": Fundamental frequency.

CHANNEL	TX Channel 100	DETECTOR FUNCTION	Peak (PK)
FREQUENCY RANGE	1GHz ~ 40GHz		Average (AV)

ANTENNA POLARITY & TEST DISTANCE: HORIZONTAL AT 3 M

NO.	FREQ. (MHz)	EMISSION LEVEL (dBuV/m)	LIMIT (dBuV/m)	MARGIN (dB)	ANTENNA HEIGHT (m)	TABLE ANGLE (Degree)	RAW VALUE (dBuV)	CORRECTION FACTOR (dB/m)
1	5460.00	50.8 PK	74.0	-23.2	1.83 H	275	48.2	2.6
2	5460.00	49.7 AV	54.0	-4.3	1.83 H	275	47.1	2.6
3	#5470.00	62.6 PK	68.2	-5.6	1.83 H	275	60.0	2.6
4	*5500.00	104.4 PK			1.73 H	267	101.9	2.5
5	*5500.00	91.7 AV			1.73 H	267	89.2	2.5
6	11000.00	49.5 PK	74.0	-24.5	2.75 H	301	37.3	12.2
7	11000.00	39.4 AV	54.0	-14.6	2.75 H	301	27.2	12.2
8	#16500.00	53.9 PK	68.2	-14.3	2.05 H	30	40.2	13.7

ANTENNA POLARITY & TEST DISTANCE: VERTICAL AT 3 M

NO.	FREQ. (MHz)	EMISSION LEVEL (dBuV/m)	LIMIT (dBuV/m)	MARGIN (dB)	ANTENNA HEIGHT (m)	TABLE ANGLE (Degree)	RAW VALUE (dBuV)	CORRECTION FACTOR (dB/m)
1	5460.00	56.0 PK	74.0	-18.0	3.01 V	82	53.4	2.6
2	5460.00	44.2 AV	54.0	-9.8	3.01 V	82	41.6	2.6
3	#5470.00	68.0 PK	68.2	-0.2	3.01 V	82	65.4	2.6
4	*5500.00	109.7 PK			3.01 V	82	107.2	2.5
5	*5500.00	97.2 AV			3.01 V	82	94.7	2.5
6	11000.00	51.9 PK	74.0	-22.1	1.89 V	350	39.7	12.2
7	11000.00	41.9 AV	54.0	-12.1	1.89 V	350	29.7	12.2
8	#16500.00	60.1 PK	68.2	-8.1	2.92 V	257	46.4	13.7

REMARKS:

1. Emission Level(dBuV/m) = Raw Value(dBuV) + Correction Factor(dB/m)
2. Correction Factor(dB/m) = Antenna Factor(dB/m) + Cable Factor(dB) – Pre-Amplifier Factor(dB)
3. The other emission levels were very low against the limit.
4. Margin value = Emission Level – Limit value
5. " * ": Fundamental frequency.
6. " # ": The radiated frequency is out of the restricted band.

CHANNEL	TX Channel 116	DETECTOR FUNCTION	Peak (PK)
FREQUENCY RANGE	1GHz ~ 40GHz		Average (AV)

ANTENNA POLARITY & TEST DISTANCE: HORIZONTAL AT 3 M

NO.	FREQ. (MHz)	EMISSION LEVEL (dBuV/m)	LIMIT (dBuV/m)	MARGIN (dB)	ANTENNA HEIGHT (m)	TABLE ANGLE (Degree)	RAW VALUE (dBuV)	CORRECTION FACTOR (dB/m)
1	*5580.00	104.7 PK			1.76 H	280	101.9	2.8
2	*5580.00	92.2 AV			1.76 H	280	89.4	2.8
3	11160.00	49.8 PK	74.0	-24.2	2.78 H	298	37.8	12.0
4	11160.00	39.7 AV	54.0	-14.3	2.78 H	298	27.7	12.0
5	#16740.00	53.3 PK	68.2	-14.9	2.02 H	14	39.1	14.2

ANTENNA POLARITY & TEST DISTANCE: VERTICAL AT 3 M

NO.	FREQ. (MHz)	EMISSION LEVEL (dBuV/m)	LIMIT (dBuV/m)	MARGIN (dB)	ANTENNA HEIGHT (m)	TABLE ANGLE (Degree)	RAW VALUE (dBuV)	CORRECTION FACTOR (dB/m)
1	*5580.00	109.8 PK			2.96 V	96	107.0	2.8
2	*5580.00	97.0 AV			2.96 V	96	94.2	2.8
3	11160.00	52.7 PK	74.0	-21.3	1.93 V	323	40.7	12.0
4	11160.00	42.5 AV	54.0	-11.5	1.93 V	323	30.5	12.0
5	#16740.00	60.0 PK	68.2	-8.2	3.01 V	228	45.8	14.2

REMARKS:

1. Emission Level(dBuV/m) = Raw Value(dBuV) + Correction Factor(dB/m)
2. Correction Factor(dB/m) = Antenna Factor(dB/m) + Cable Factor(dB) – Pre-Amplifier Factor(dB)
3. The other emission levels were very low against the limit.
4. Margin value = Emission Level – Limit value
5. " * ": Fundamental frequency.
6. " # ": The radiated frequency is out of the restricted band.

CHANNEL	TX Channel 140	DETECTOR FUNCTION	Peak (PK)
FREQUENCY RANGE	1GHz ~ 40GHz		Average (AV)

ANTENNA POLARITY & TEST DISTANCE: HORIZONTAL AT 3 M

NO.	FREQ. (MHz)	EMISSION LEVEL (dBuV/m)	LIMIT (dBuV/m)	MARGIN (dB)	ANTENNA HEIGHT (m)	TABLE ANGLE (Degree)	RAW VALUE (dBuV)	CORRECTION FACTOR (dB/m)
1	*5700.00	104.9 PK			1.81 H	264	102.0	2.9
2	*5700.00	92.3 AV			1.81 H	264	89.4	2.9
3	#5725.00	62.2 PK	68.2	-6.0	1.83 H	272	59.3	2.9
4	11400.00	49.7 PK	74.0	-24.3	2.76 H	303	36.7	13.0
5	11400.00	39.5 AV	54.0	-14.5	2.76 H	303	26.5	13.0
6	#17100.00	54.0 PK	68.2	-14.2	2.06 H	18	37.9	16.1

ANTENNA POLARITY & TEST DISTANCE: VERTICAL AT 3 M

NO.	FREQ. (MHz)	EMISSION LEVEL (dBuV/m)	LIMIT (dBuV/m)	MARGIN (dB)	ANTENNA HEIGHT (m)	TABLE ANGLE (Degree)	RAW VALUE (dBuV)	CORRECTION FACTOR (dB/m)
1	*5700.00	110.8 PK			2.95 V	104	107.9	2.9
2	*5700.00	98.1 AV			2.95 V	104	95.2	2.9
3	#5725.00	67.9 PK	68.2	-0.3	2.95 V	104	65.0	2.9
4	11400.00	52.5 PK	74.0	-21.5	1.98 V	321	39.5	13.0
5	11400.00	42.3 AV	54.0	-11.7	1.98 V	321	29.3	13.0
6	#17100.00	60.4 PK	68.2	-7.8	2.91 V	247	44.3	16.1

REMARKS:

1. Emission Level(dBuV/m) = Raw Value(dBuV) + Correction Factor(dB/m)
2. Correction Factor(dB/m) = Antenna Factor(dB/m) + Cable Factor(dB) – Pre-Amplifier Factor(dB)
3. The other emission levels were very low against the limit.
4. Margin value = Emission Level – Limit value
5. " * ": Fundamental frequency.
6. " # ": The radiated frequency is out of the restricted band.

CHANNEL	TX Channel 144	DETECTOR FUNCTION	Peak (PK)
FREQUENCY RANGE	1GHz ~ 40GHz		Average (AV)

ANTENNA POLARITY & TEST DISTANCE: HORIZONTAL AT 3 M

NO.	FREQ. (MHz)	EMISSION LEVEL (dBuV/m)	LIMIT (dBuV/m)	MARGIN (dB)	ANTENNA HEIGHT (m)	TABLE ANGLE (Degree)	RAW VALUE (dBuV)	CORRECTION FACTOR (dB/m)
1	#5470.00	49.3 PK	68.2	-18.9	1.73 H	260	46.7	2.6
2	*5720.00	104.6 PK			1.73 H	260	101.7	2.9
3	*5720.00	92.1 AV			1.73 H	260	89.2	2.9
4	#5850.00	50.1 PK	68.2	-18.1	1.74 H	258	46.8	3.3
5	11440.00	49.8 PK	74.0	-24.2	2.72 H	300	37.1	12.7
6	11440.00	39.5 AV	54.0	-14.5	2.72 H	300	26.8	12.7
7	#17160.00	53.9 PK	68.2	-14.3	2.08 H	30	38.3	15.6

ANTENNA POLARITY & TEST DISTANCE: VERTICAL AT 3 M

NO.	FREQ. (MHz)	EMISSION LEVEL (dBuV/m)	LIMIT (dBuV/m)	MARGIN (dB)	ANTENNA HEIGHT (m)	TABLE ANGLE (Degree)	RAW VALUE (dBuV)	CORRECTION FACTOR (dB/m)
1	#5470.00	54.9 PK	68.2	-13.3	3.00 V	100	52.3	2.6
2	*5720.00	110.0 PK			3.00 V	100	107.1	2.9
3	*5720.00	97.3 AV			3.00 V	100	94.4	2.9
4	#5850.00	56.6 PK	68.2	-11.6	3.00 V	100	53.3	3.3
5	11440.00	52.9 PK	74.0	-21.1	1.97 V	319	40.2	12.7
6	11440.00	42.5 AV	54.0	-11.5	1.97 V	319	29.8	12.7
7	#17160.00	59.9 PK	68.2	-8.3	2.98 V	254	44.3	15.6

REMARKS:

1. Emission Level(dBuV/m) = Raw Value(dBuV) + Correction Factor(dB/m)
2. Correction Factor(dB/m) = Antenna Factor(dB/m) + Cable Factor(dB) – Pre-Amplifier Factor(dB)
3. The other emission levels were very low against the limit.
4. Margin value = Emission Level – Limit value
5. " * ": Fundamental frequency.
6. " # ": The radiated frequency is out of the restricted band.

802.11ax (HE40)

CHANNEL	TX Channel 54	DETECTOR FUNCTION	Peak (PK)
FREQUENCY RANGE	1GHz ~ 40GHz		Average (AV)

ANTENNA POLARITY & TEST DISTANCE: HORIZONTAL AT 3 M								
NO.	FREQ. (MHz)	EMISSION LEVEL (dBuV/m)	LIMIT (dBuV/m)	MARGIN (dB)	ANTENNA HEIGHT (m)	TABLE ANGLE (Degree)	RAW VALUE (dBuV)	CORRECTION FACTOR (dB/m)
1	5150.00	49.4 PK	74.0	-24.6	1.78 H	294	46.8	2.6
2	5150.00	39.4 AV	54.0	-14.6	1.78 H	294	36.8	2.6
3	*5270.00	106.4 PK			1.78 H	294	104.3	2.1
4	*5270.00	95.1 AV			1.78 H	294	93.0	2.1
5	#10540.00	50.3 PK	68.2	-17.9	3.02 H	109	38.1	12.2
6	15810.00	53.3 PK	74.0	-20.7	2.44 H	315	42.0	11.3
7	15810.00	41.2 AV	54.0	-12.8	2.44 H	315	29.9	11.3

ANTENNA POLARITY & TEST DISTANCE: VERTICAL AT 3 M								
NO.	FREQ. (MHz)	EMISSION LEVEL (dBuV/m)	LIMIT (dBuV/m)	MARGIN (dB)	ANTENNA HEIGHT (m)	TABLE ANGLE (Degree)	RAW VALUE (dBuV)	CORRECTION FACTOR (dB/m)
1	5150.00	52.4 PK	74.0	-21.6	1.67 V	302	49.8	2.6
2	5150.00	41.7 AV	54.0	-12.3	1.67 V	302	39.1	2.6
3	*5270.00	109.8 PK			1.67 V	302	107.7	2.1
4	*5270.00	100.4 AV			1.67 V	302	98.3	2.1
5	#10540.00	50.3 PK	68.2	-17.9	1.89 V	307	38.1	12.2
6	15810.00	52.7 PK	74.0	-21.3	3.04 V	279	41.4	11.3
7	15810.00	40.8 AV	54.0	-13.2	3.04 V	279	29.5	11.3

REMARKS:

1. Emission Level(dBuV/m) = Raw Value(dBuV) + Correction Factor(dB/m)
2. Correction Factor(dB/m) = Antenna Factor(dB/m) + Cable Factor(dB) – Pre-Amplifier Factor(dB)
3. The other emission levels were very low against the limit.
4. Margin value = Emission Level – Limit value
5. " * ": Fundamental frequency.
6. " # ": The radiated frequency is out of the restricted band.

CHANNEL	TX Channel 62	DETECTOR FUNCTION	Peak (PK)
FREQUENCY RANGE	1GHz ~ 40GHz		Average (AV)

ANTENNA POLARITY & TEST DISTANCE: HORIZONTAL AT 3 M

NO.	FREQ. (MHz)	EMISSION LEVEL (dBuV/m)	LIMIT (dBuV/m)	MARGIN (dB)	ANTENNA HEIGHT (m)	TABLE ANGLE (Degree)	RAW VALUE (dBuV)	CORRECTION FACTOR (dB/m)
1	*5310.00	101.8 PK			1.76 H	310	99.6	2.2
2	*5310.00	91.9 AV			1.76 H	310	89.7	2.2
3	5350.00	63.1 PK	74.0	-10.9	1.76 H	310	60.8	2.3
4	5350.00	48.7 AV	54.0	-5.3	1.76 H	310	46.4	2.3
5	10620.00	49.7 PK	74.0	-24.3	3.02 H	86	38.0	11.7
6	10620.00	39.1 AV	54.0	-14.9	3.02 H	86	27.4	11.7
7	15930.00	53.5 PK	74.0	-20.5	2.43 H	319	42.3	11.2
8	15930.00	41.9 AV	54.0	-12.1	2.43 H	319	30.7	11.2

ANTENNA POLARITY & TEST DISTANCE: VERTICAL AT 3 M

NO.	FREQ. (MHz)	EMISSION LEVEL (dBuV/m)	LIMIT (dBuV/m)	MARGIN (dB)	ANTENNA HEIGHT (m)	TABLE ANGLE (Degree)	RAW VALUE (dBuV)	CORRECTION FACTOR (dB/m)
1	*5310.00	107.4 PK			1.69 V	298	105.2	2.2
2	*5310.00	97.7 AV			1.69 V	298	95.5	2.2
3	5350.00	69.4 PK	74.0	-4.6	1.69 V	298	67.1	2.3
4	5350.00	53.9 AV	54.0	-0.1	1.69 V	298	51.6	2.3
5	10620.00	49.9 PK	74.0	-24.1	1.91 V	304	38.2	11.7
6	10620.00	39.2 AV	54.0	-14.8	1.91 V	304	27.5	11.7
7	15930.00	53.9 PK	74.0	-20.1	2.99 V	278	42.7	11.2
8	15930.00	41.6 AV	54.0	-12.4	2.99 V	278	30.4	11.2

REMARKS:

1. Emission Level(dBuV/m) = Raw Value(dBuV) + Correction Factor(dB/m)
2. Correction Factor(dB/m) = Antenna Factor(dB/m) + Cable Factor(dB) – Pre-Amplifier Factor(dB)
3. The other emission levels were very low against the limit.
4. Margin value = Emission Level – Limit value
5. " * ": Fundamental frequency.

CHANNEL	TX Channel 102	DETECTOR FUNCTION	Peak (PK)
FREQUENCY RANGE	1GHz ~ 40GHz		Average (AV)

ANTENNA POLARITY & TEST DISTANCE: HORIZONTAL AT 3 M

NO.	FREQ. (MHz)	EMISSION LEVEL (dBuV/m)	LIMIT (dBuV/m)	MARGIN (dB)	ANTENNA HEIGHT (m)	TABLE ANGLE (Degree)	RAW VALUE (dBuV)	CORRECTION FACTOR (dB/m)
1	5460.00	57.8 PK	74.0	-16.2	1.70 H	263	55.2	2.6
2	5460.00	43.7 AV	54.0	-10.3	1.70 H	263	41.1	2.6
3	#5470.00	63.4 PK	68.2	-4.8	1.70 H	263	60.8	2.6
4	*5510.00	100.6 PK			1.70 H	263	98.1	2.5
5	*5510.00	87.5 AV			1.70 H	263	85.0	2.5
6	11020.00	49.8 PK	74.0	-24.2	2.70 H	285	37.5	12.3
7	11020.00	39.7 AV	54.0	-14.3	2.70 H	285	27.4	12.3
8	#16530.00	54.2 PK	68.2	-14.0	2.07 H	45	40.3	13.9

ANTENNA POLARITY & TEST DISTANCE: VERTICAL AT 3 M

NO.	FREQ. (MHz)	EMISSION LEVEL (dBuV/m)	LIMIT (dBuV/m)	MARGIN (dB)	ANTENNA HEIGHT (m)	TABLE ANGLE (Degree)	RAW VALUE (dBuV)	CORRECTION FACTOR (dB/m)
1	5460.00	63.0 PK	74.0	-11.0	3.02 V	97	60.4	2.6
2	5460.00	49.1 AV	54.0	-4.9	3.02 V	97	46.5	2.6
3	#5470.00	68.0 PK	68.2	-0.2	3.02 V	97	65.4	2.6
4	*5510.00	106.2 PK			3.02 V	97	103.7	2.5
5	*5510.00	93.6 AV			3.02 V	97	91.1	2.5
6	11020.00	49.8 PK	74.0	-24.2	1.91 V	317	37.5	12.3
7	11020.00	39.3 AV	54.0	-14.7	1.91 V	317	27.0	12.3
8	#16530.00	53.2 PK	68.2	-15.0	3.01 V	265	39.3	13.9

REMARKS:

1. Emission Level(dBuV/m) = Raw Value(dBuV) + Correction Factor(dB/m)
2. Correction Factor(dB/m) = Antenna Factor(dB/m) + Cable Factor(dB) – Pre-Amplifier Factor(dB)
3. The other emission levels were very low against the limit.
4. Margin value = Emission Level – Limit value
5. " * ": Fundamental frequency.
6. " # ": The radiated frequency is out of the restricted band.

CHANNEL	TX Channel 110	DETECTOR FUNCTION	Peak (PK)
FREQUENCY RANGE	1GHz ~ 40GHz		Average (AV)

ANTENNA POLARITY & TEST DISTANCE: HORIZONTAL AT 3 M

NO.	FREQ. (MHz)	EMISSION LEVEL (dBuV/m)	LIMIT (dBuV/m)	MARGIN (dB)	ANTENNA HEIGHT (m)	TABLE ANGLE (Degree)	RAW VALUE (dBuV)	CORRECTION FACTOR (dB/m)
1	*5550.00	101.4 PK			1.69 H	252	98.7	2.7
2	*5550.00	88.7 AV			1.69 H	252	86.0	2.7
3	11100.00	50.3 PK	74.0	-23.7	2.66 H	298	38.2	12.1
4	11100.00	39.9 AV	54.0	-14.1	2.66 H	298	27.8	12.1
5	#16650.00	53.8 PK	68.2	-14.4	2.06 H	30	39.6	14.2

ANTENNA POLARITY & TEST DISTANCE: VERTICAL AT 3 M

NO.	FREQ. (MHz)	EMISSION LEVEL (dBuV/m)	LIMIT (dBuV/m)	MARGIN (dB)	ANTENNA HEIGHT (m)	TABLE ANGLE (Degree)	RAW VALUE (dBuV)	CORRECTION FACTOR (dB/m)
1	*5550.00	107.5 PK			2.96 V	92	104.8	2.7
2	*5550.00	94.8 AV			2.96 V	92	92.1	2.7
3	11100.00	50.2 PK	74.0	-23.8	1.88 V	308	38.1	12.1
4	11100.00	39.8 AV	54.0	-14.2	1.88 V	308	27.7	12.1
5	#16650.00	53.0 PK	68.2	-15.2	2.99 V	266	38.8	14.2

REMARKS:

1. Emission Level(dBuV/m) = Raw Value(dBuV) + Correction Factor(dB/m)
2. Correction Factor(dB/m) = Antenna Factor(dB/m) + Cable Factor(dB) – Pre-Amplifier Factor(dB)
3. The other emission levels were very low against the limit.
4. Margin value = Emission Level – Limit value
5. " * ": Fundamental frequency.
6. " # ": The radiated frequency is out of the restricted band.

CHANNEL	TX Channel 134	DETECTOR FUNCTION	Peak (PK)
FREQUENCY RANGE	1GHz ~ 40GHz		Average (AV)

ANTENNA POLARITY & TEST DISTANCE: HORIZONTAL AT 3 M

NO.	FREQ. (MHz)	EMISSION LEVEL (dBuV/m)	LIMIT (dBuV/m)	MARGIN (dB)	ANTENNA HEIGHT (m)	TABLE ANGLE (Degree)	RAW VALUE (dBuV)	CORRECTION FACTOR (dB/m)
1	*5670.00	101.7 PK			1.72 H	267	98.8	2.9
2	*5670.00	88.9 AV			1.72 H	267	86.0	2.9
3	#5725.00	63.0 PK	68.2	-5.2	1.72 H	267	60.1	2.9
4	11340.00	50.0 PK	74.0	-24.0	2.74 H	300	37.1	12.9
5	11340.00	39.7 AV	54.0	-14.3	2.74 H	300	26.8	12.9
6	#17010.00	54.2 PK	68.2	-14.0	2.03 H	38	38.4	15.8

ANTENNA POLARITY & TEST DISTANCE: VERTICAL AT 3 M

NO.	FREQ. (MHz)	EMISSION LEVEL (dBuV/m)	LIMIT (dBuV/m)	MARGIN (dB)	ANTENNA HEIGHT (m)	TABLE ANGLE (Degree)	RAW VALUE (dBuV)	CORRECTION FACTOR (dB/m)
1	*5670.00	107.4 PK			3.02 V	100	104.5	2.9
2	*5670.00	94.9 AV			3.02 V	100	92.0	2.9
3	#5725.00	68.1 PK	68.2	-0.1	3.02 V	100	65.2	2.9
4	11340.00	49.2 PK	74.0	-24.8	1.97 V	308	36.3	12.9
5	11340.00	38.8 AV	54.0	-15.2	1.97 V	308	25.9	12.9
6	#17010.00	53.8 PK	68.2	-14.4	2.99 V	278	38.0	15.8

REMARKS:

1. Emission Level(dBuV/m) = Raw Value(dBuV) + Correction Factor(dB/m)
2. Correction Factor(dB/m) = Antenna Factor(dB/m) + Cable Factor(dB) – Pre-Amplifier Factor(dB)
3. The other emission levels were very low against the limit.
4. Margin value = Emission Level – Limit value
5. " * ": Fundamental frequency.
6. " # ": The radiated frequency is out of the restricted band.

CHANNEL	TX Channel 142	DETECTOR FUNCTION	Peak (PK)
FREQUENCY RANGE	1GHz ~ 40GHz		Average (AV)

ANTENNA POLARITY & TEST DISTANCE: HORIZONTAL AT 3 M

NO.	FREQ. (MHz)	EMISSION LEVEL (dBuV/m)	LIMIT (dBuV/m)	MARGIN (dB)	ANTENNA HEIGHT (m)	TABLE ANGLE (Degree)	RAW VALUE (dBuV)	CORRECTION FACTOR (dB/m)
1	#5470.00	53.2 PK	68.2	-15.0	1.71 H	256	50.6	2.6
2	*5710.00	101.2 PK			1.71 H	256	98.2	3.0
3	*5710.00	88.6 AV			1.71 H	256	85.6	3.0
4	#5850.00	49.6 PK	68.2	-18.6	1.71 H	256	46.3	3.3
5	11420.00	49.6 PK	74.0	-24.4	2.69 H	304	36.7	12.9
6	11420.00	39.4 AV	54.0	-14.6	2.69 H	304	26.5	12.9
7	#17130.00	54.1 PK	68.2	-14.1	2.11 H	16	38.3	15.8

ANTENNA POLARITY & TEST DISTANCE: VERTICAL AT 3 M

NO.	FREQ. (MHz)	EMISSION LEVEL (dBuV/m)	LIMIT (dBuV/m)	MARGIN (dB)	ANTENNA HEIGHT (m)	TABLE ANGLE (Degree)	RAW VALUE (dBuV)	CORRECTION FACTOR (dB/m)
1	#5470.00	59.4 PK	68.2	-8.8	2.89 V	80	56.8	2.6
2	*5710.00	107.4 PK			2.89 V	80	104.4	3.0
3	*5710.00	94.6 AV			2.89 V	80	91.6	3.0
4	#5850.00	54.5 PK	68.2	-13.7	2.89 V	80	51.2	3.3
5	11420.00	49.9 PK	74.0	-24.1	1.88 V	315	37.0	12.9
6	11420.00	39.3 AV	54.0	-14.7	1.88 V	315	26.4	12.9
7	#17130.00	53.0 PK	68.2	-15.2	3.02 V	268	37.2	15.8

REMARKS:

1. Emission Level(dBuV/m) = Raw Value(dBuV) + Correction Factor(dB/m)
2. Correction Factor(dB/m) = Antenna Factor(dB/m) + Cable Factor(dB) – Pre-Amplifier Factor(dB)
3. The other emission levels were very low against the limit.
4. Margin value = Emission Level – Limit value
5. " * ": Fundamental frequency.
6. " # ": The radiated frequency is out of the restricted band.

802.11ax (HE80)

CHANNEL	TX Channel 58	DETECTOR FUNCTION	Peak (PK)
FREQUENCY RANGE	1GHz ~ 40GHz		Average (AV)

ANTENNA POLARITY & TEST DISTANCE: HORIZONTAL AT 3 M

NO.	FREQ. (MHz)	EMISSION LEVEL (dBuV/m)	LIMIT (dBuV/m)	MARGIN (dB)	ANTENNA HEIGHT (m)	TABLE ANGLE (Degree)	RAW VALUE (dBuV)	CORRECTION FACTOR (dB/m)
1	5150.00	50.3 PK	74.0	-23.7	1.74 H	290	47.7	2.6
2	5150.00	40.0 AV	54.0	-14.0	1.74 H	290	37.4	2.6
3	*5290.00	96.6 PK			1.74 H	290	94.5	2.1
4	*5290.00	87.6 AV			1.74 H	290	85.5	2.1
5	5350.00	63.7 PK	74.0	-10.3	1.74 H	290	61.4	2.3
6	5350.00	49.0 AV	54.0	-5.0	1.74 H	290	46.7	2.3
7	#10580.00	49.5 PK	68.2	-18.7	3.02 H	100	37.7	11.8
8	15870.00	53.4 PK	74.0	-20.6	2.44 H	311	42.2	11.2
9	15870.00	41.5 AV	54.0	-12.5	2.44 H	311	30.3	11.2

ANTENNA POLARITY & TEST DISTANCE: VERTICAL AT 3 M

NO.	FREQ. (MHz)	EMISSION LEVEL (dBuV/m)	LIMIT (dBuV/m)	MARGIN (dB)	ANTENNA HEIGHT (m)	TABLE ANGLE (Degree)	RAW VALUE (dBuV)	CORRECTION FACTOR (dB/m)
1	5150.00	52.5 PK	74.0	-21.5	2.20 V	198	49.9	2.6
2	5150.00	40.5 AV	54.0	-13.5	2.20 V	198	37.9	2.6
3	*5290.00	102.4 PK			2.20 V	198	100.3	2.1
4	*5290.00	93.5 AV			2.20 V	198	91.4	2.1
5	5350.00	67.0 PK	74.0	-7.0	2.20 V	198	64.7	2.3
6	5350.00	53.8 AV	54.0	-0.2	2.20 V	198	51.5	2.3
7	#10580.00	49.9 PK	68.2	-18.3	1.91 V	313	38.1	11.8
8	15870.00	53.4 PK	74.0	-20.6	3.07 V	280	42.2	11.2
9	15870.00	41.2 AV	54.0	-12.8	3.07 V	280	30.0	11.2

REMARKS:

- Emission Level(dBuV/m) = Raw Value(dBuV) + Correction Factor(dB/m)
- Correction Factor(dB/m) = Antenna Factor(dB/m) + Cable Factor(dB) – Pre-Amplifier Factor(dB)
- The other emission levels were very low against the limit.
- Margin value = Emission Level – Limit value
- " * ": Fundamental frequency.
- " # ": The radiated frequency is out of the restricted band.

CHANNEL	TX Channel 106	DETECTOR FUNCTION	Peak (PK)
FREQUENCY RANGE	1GHz ~ 40GHz		Average (AV)

ANTENNA POLARITY & TEST DISTANCE: HORIZONTAL AT 3 M

NO.	FREQ. (MHz)	EMISSION LEVEL (dBuV/m)	LIMIT (dBuV/m)	MARGIN (dB)	ANTENNA HEIGHT (m)	TABLE ANGLE (Degree)	RAW VALUE (dBuV)	CORRECTION FACTOR (dB/m)
1	5460.00	57.2 PK	74.0	-16.8	1.71 H	256	54.6	2.6
2	5460.00	44.7 AV	54.0	-9.3	1.71 H	256	42.1	2.6
3	#5470.00	63.2 PK	68.2	-5.0	1.71 H	256	60.6	2.6
4	*5530.00	96.7 PK			1.71 H	256	94.1	2.6
5	*5530.00	84.9 AV			1.71 H	256	82.3	2.6
6	11060.00	49.5 PK	74.0	-24.5	2.71 H	289	37.4	12.1
7	11060.00	39.4 AV	54.0	-14.6	2.71 H	289	27.3	12.1
8	#16590.00	54.1 PK	68.2	-14.1	2.14 H	45	39.9	14.2

ANTENNA POLARITY & TEST DISTANCE: VERTICAL AT 3 M

NO.	FREQ. (MHz)	EMISSION LEVEL (dBuV/m)	LIMIT (dBuV/m)	MARGIN (dB)	ANTENNA HEIGHT (m)	TABLE ANGLE (Degree)	RAW VALUE (dBuV)	CORRECTION FACTOR (dB/m)
1	5460.00	62.9 PK	74.0	-11.1	2.92 V	103	60.3	2.6
2	5460.00	50.0 AV	54.0	-4.0	2.92 V	103	47.4	2.6
3	#5470.00	68.1 PK	68.2	-0.1	2.92 V	103	65.5	2.6
4	*5530.00	102.4 PK			2.92 V	103	99.8	2.6
5	*5530.00	90.4 AV			2.92 V	103	87.8	2.6
6	11060.00	50.2 PK	74.0	-23.8	1.90 V	314	38.1	12.1
7	11060.00	39.7 AV	54.0	-14.3	1.90 V	314	27.6	12.1
8	#16590.00	53.6 PK	68.2	-14.6	3.03 V	273	39.4	14.2

REMARKS:

1. Emission Level(dBuV/m) = Raw Value(dBuV) + Correction Factor(dB/m)
2. Correction Factor(dB/m) = Antenna Factor(dB/m) + Cable Factor(dB) – Pre-Amplifier Factor(dB)
3. The other emission levels were very low against the limit.
4. Margin value = Emission Level – Limit value
5. " * ": Fundamental frequency.
6. " # ": The radiated frequency is out of the restricted band.

CHANNEL	TX Channel 122	DETECTOR FUNCTION	Peak (PK)
FREQUENCY RANGE	1GHz ~ 40GHz		Average (AV)

ANTENNA POLARITY & TEST DISTANCE: HORIZONTAL AT 3 M

NO.	FREQ. (MHz)	EMISSION LEVEL (dBuV/m)	LIMIT (dBuV/m)	MARGIN (dB)	ANTENNA HEIGHT (m)	TABLE ANGLE (Degree)	RAW VALUE (dBuV)	CORRECTION FACTOR (dB/m)
1	*5610.00	98.4 PK			1.69 H	248	95.6	2.8
2	*5610.00	86.1 AV			1.69 H	248	83.3	2.8
3	#5725.00	61.2 PK	68.2	-7.0	1.69 H	248	58.3	2.9
4	11220.00	49.2 PK	74.0	-24.8	2.74 H	300	36.9	12.3
5	11220.00	39.2 AV	54.0	-14.8	2.74 H	300	26.9	12.3
6	#16830.00	53.6 PK	68.2	-14.6	2.13 H	42	39.0	14.6

ANTENNA POLARITY & TEST DISTANCE: VERTICAL AT 3 M

NO.	FREQ. (MHz)	EMISSION LEVEL (dBuV/m)	LIMIT (dBuV/m)	MARGIN (dB)	ANTENNA HEIGHT (m)	TABLE ANGLE (Degree)	RAW VALUE (dBuV)	CORRECTION FACTOR (dB/m)
1	*5610.00	104.2 PK			3.02 V	99	101.4	2.8
2	*5610.00	91.8 AV			3.02 V	99	89.0	2.8
3	#5725.00	66.6 PK	68.2	-1.6	3.02 V	99	63.7	2.9
4	11220.00	50.0 PK	74.0	-24.0	1.95 V	301	37.7	12.3
5	11220.00	39.6 AV	54.0	-14.4	1.95 V	301	27.3	12.3
6	#16830.00	53.1 PK	68.2	-15.1	2.95 V	261	38.5	14.6

REMARKS:

1. Emission Level(dBuV/m) = Raw Value(dBuV) + Correction Factor(dB/m)
2. Correction Factor(dB/m) = Antenna Factor(dB/m) + Cable Factor(dB) – Pre-Amplifier Factor(dB)
3. The other emission levels were very low against the limit.
4. Margin value = Emission Level – Limit value
5. " * ": Fundamental frequency.
6. " # ": The radiated frequency is out of the restricted band.

CHANNEL	TX Channel 138	DETECTOR FUNCTION	Peak (PK)
FREQUENCY RANGE	1GHz ~ 40GHz		Average (AV)

ANTENNA POLARITY & TEST DISTANCE: HORIZONTAL AT 3 M

NO.	FREQ. (MHz)	EMISSION LEVEL (dBuV/m)	LIMIT (dBuV/m)	MARGIN (dB)	ANTENNA HEIGHT (m)	TABLE ANGLE (Degree)	RAW VALUE (dBuV)	CORRECTION FACTOR (dB/m)
1	#5470.00	51.8 PK	68.2	-16.4	1.66 H	248	49.2	2.6
2	*5690.00	98.5 PK			1.66 H	248	95.6	2.9
3	*5690.00	86.0 AV			1.66 H	248	83.1	2.9
4	#5850.00	59.4 PK	68.2	-8.8	1.66 H	248	56.1	3.3
5	11380.00	50.0 PK	74.0	-24.0	2.73 H	301	37.1	12.9
6	11380.00	39.6 AV	54.0	-14.4	2.73 H	301	26.7	12.9
7	#17070.00	54.0 PK	68.2	-14.2	2.02 H	40	37.9	16.1

ANTENNA POLARITY & TEST DISTANCE: VERTICAL AT 3 M

NO.	FREQ. (MHz)	EMISSION LEVEL (dBuV/m)	LIMIT (dBuV/m)	MARGIN (dB)	ANTENNA HEIGHT (m)	TABLE ANGLE (Degree)	RAW VALUE (dBuV)	CORRECTION FACTOR (dB/m)
1	#5470.00	59.8 PK	68.2	-8.4	2.88 V	100	57.2	2.6
2	*5690.00	103.5 PK			2.88 V	100	100.6	2.9
3	*5690.00	91.3 AV			2.88 V	100	88.4	2.9
4	#5850.00	65.6 PK	68.2	-2.6	2.88 V	100	62.3	3.3
5	11380.00	49.9 PK	74.0	-24.1	1.89 V	304	37.0	12.9
6	11380.00	39.5 AV	54.0	-14.5	1.89 V	304	26.6	12.9
7	#17070.00	53.3 PK	68.2	-14.9	3.00 V	261	37.2	16.1

REMARKS:

1. Emission Level(dBuV/m) = Raw Value(dBuV) + Correction Factor(dB/m)
2. Correction Factor(dB/m) = Antenna Factor(dB/m) + Cable Factor(dB) – Pre-Amplifier Factor(dB)
3. The other emission levels were very low against the limit.
4. Margin value = Emission Level – Limit value
5. " * ": Fundamental frequency.
6. " # ": The radiated frequency is out of the restricted band.

4.2 Conducted Emission Measurement

4.2.1 Limits of Conducted Emission Measurement

Frequency (MHz)	Conducted Limit (dBuV)	
	Quasi-peak	Average
0.15 - 0.5	66 - 56	56 - 46
0.50 - 5.0	56	46
5.0 - 30.0	60	50

Note: 1. The lower limit shall apply at the transition frequencies.

2. The limit decreases in line with the logarithm of the frequency in the range of 0.15 to 0.50MHz.

4.2.2 Test Instruments

DESCRIPTION & MANUFACTURER	MODEL NO.	SERIAL NO.	CALIBRATED DATE	CALIBRATED UNTIL
Test Receiver R&S	ESCS 30	847124/029	Nov. 01, 2017	Oct. 31, 2018
Line-Impedance Stabilization Network (for EUT) R&S	ESH3-Z5	848773/004	Nov. 15, 2017	Nov. 14, 2018
Line-Impedance Stabilization Network (for Peripheral) R&S	ENV216	100072	June 04, 2018	June 03, 2019
50 ohms Terminator	N/A	EMC-04	Nov. 01, 2017	Oct. 31, 2018
RF Cable	5D-FB	COCCAB-001	Sep. 29, 2017	Sep. 28, 2018
Fixed attenuator EMCI	STI02-2200-10	003	Mar. 16, 2018	Mar. 15, 2019
Software BVADT	BVADT_Cond_ V7.3.7.4	NA	NA	NA

Note:

1. The calibration interval of the above test instruments are 12 months and the calibrations are traceable to NML/ROC and NIST/USA.
2. The test was performed in Conduction 1.
3. Tested Date: Aug. 29, 2018

4.2.3 Test Procedure

- The EUT was placed 0.4 meters from the conducting wall of the shielded room with EUT being connected to the power mains through a line impedance stabilization network (LISN). Other support units were connected to the power mains through another LISN. The two LISNs provide 50 ohm/ 50uH of coupling impedance for the measuring instrument.
- Both lines of the power mains connected to the EUT were checked for maximum conducted interference.
- The frequency range from 150kHz to 30MHz was searched. Emission levels under (Limit - 20dB) was not recorded.

NOTE: All modes of operation were investigated and the worst-case emissions are reported.

4.2.4 Deviation from Test Standard

No deviation.

4.2.5 Test Setup

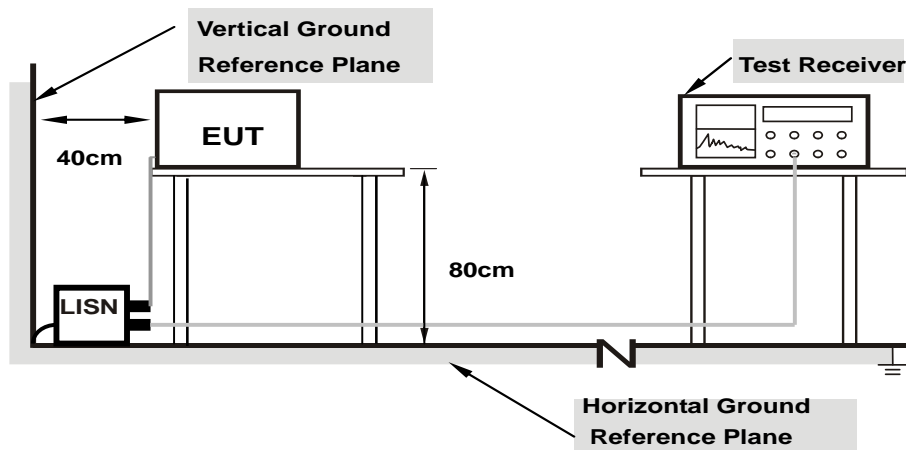

Note: 1.Support units were connected to second LISN.

For the actual test configuration, please refer to the attached file (Test Setup Photo).

4.2.6 EUT Operating Condition

Same as 4.1.6.

4.2.7 Test Results (Mode 1)

Phase	Line (L)	Detector Function	Quasi-Peak (QP) / Average (AV)
-------	----------	-------------------	--------------------------------

No	Freq. [MHz]	Corr.	Reading Value		Emission Level		Limit		Margin	
		Factor	[dB (uV)]		[dB (uV)]		[dB (uV)]		(dB)	
	(dB)	Q.P.	AV.	Q.P.	AV.	Q.P.	AV.	Q.P.	AV.	
1	0.17734	10.03	35.11	22.40	45.14	32.43	64.61	54.61	-19.47	-22.18
2	0.38047	10.07	34.93	33.97	45.00	44.04	58.27	48.27	-13.27	-4.23
3	1.12500	10.12	33.12	22.68	43.24	32.80	56.00	46.00	-12.76	-13.20
4	1.31641	10.13	32.21	26.75	42.34	36.88	56.00	46.00	-13.66	-9.12
5	16.54688	10.88	28.75	22.57	39.63	33.45	60.00	50.00	-20.37	-16.55
6	25.45313	11.15	30.38	29.83	41.53	40.98	60.00	50.00	-18.47	-9.02

REMARKS:

1. Q.P. and AV. are abbreviations of quasi-peak and average individually.
2. The emission levels of other frequencies were very low against the limit.
3. Margin value = Emission level - Limit value
4. Correction factor = Insertion loss + Cable loss
5. Emission Level = Correction Factor + Reading Value.

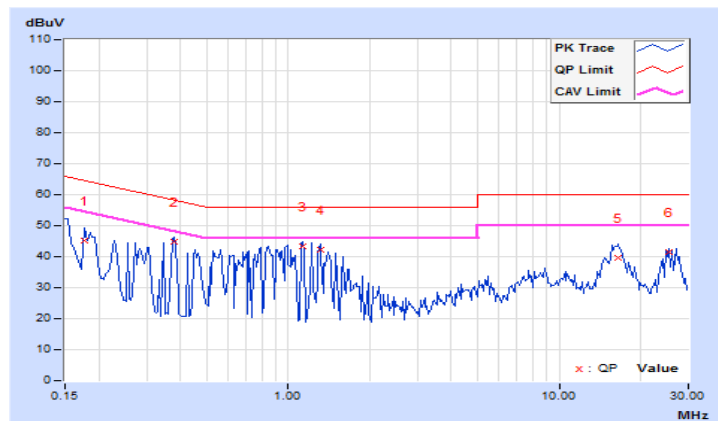

Phase	Neutral (N)	Detector Function	Quasi-Peak (QP) / Average (AV)
-------	-------------	-------------------	--------------------------------

No	Freq. [MHz]	Corr. Factor	Reading Value [dB (uV)]		Emission Level [dB (uV)]		Limit [dB (uV)]		Margin (dB)	
		(dB)	Q.P.	AV.	Q.P.	AV.	Q.P.	AV.	Q.P.	AV.
	1	0.25938	9.95	27.36	7.57	37.31	17.52	61.45	51.45	-24.14
2	0.46250	9.96	25.35	21.80	35.31	31.76	56.65	46.65	-21.34	-14.89
3	1.21875	10.00	29.16	26.56	39.16	36.56	56.00	46.00	-16.84	-9.44
4	1.51172	10.02	28.32	24.15	38.34	34.17	56.00	46.00	-17.66	-11.83
5	16.70703	10.71	27.77	21.85	38.48	32.56	60.00	50.00	-21.52	-17.44
6	25.45313	10.93	29.51	28.06	40.44	38.99	60.00	50.00	-19.56	-11.01

REMARKS:

1. Q.P. and AV. are abbreviations of quasi-peak and average individually.
2. The emission levels of other frequencies were very low against the limit.
3. Margin value = Emission level - Limit value
4. Correction factor = Insertion loss + Cable loss
5. Emission Level = Correction Factor + Reading Value.

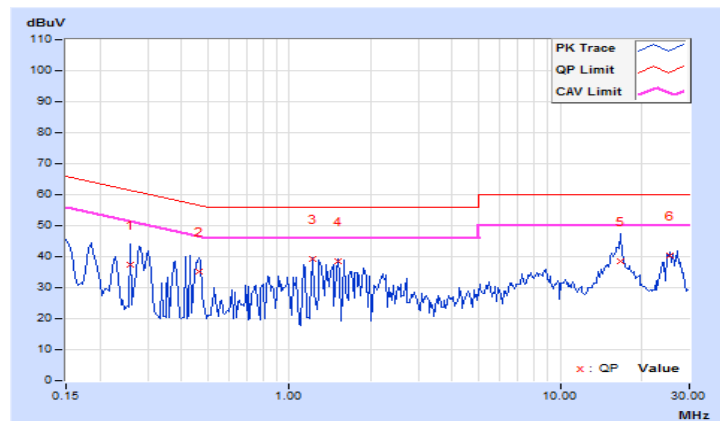

4.3 Transmit Power Measurement

4.3.1 Limits of Transmit Power Measurement

Operation Band	EUT Category		Limit
U-NII-1		Outdoor Access Point	1 Watt (30 dBm) (Max. e.i.r.p \leq 125mW(21 dBm) at any elevation angle above 30 degrees as measured from the horizon)
		Fixed point-to-point Access Point	1 Watt (30 dBm)
		Indoor Access Point	1 Watt (30 dBm)
		Client device	250mW (24 dBm)
U-NII-2A		√	250mW (24 dBm) or 11 dBm+10 log B*
U-NII-2C		√	250mW (24 dBm) or 11 dBm+10 log B*
U-NII-3		√	1 Watt (30 dBm)

*B is the 26 dB emission bandwidth in megahertz

Per KDB 662911 Method of conducted output power measurement on IEEE 802.11 devices,

Array Gain = 0 dB (i.e., no array gain) for $N_{ANT} \leq 4$;

Array Gain = 0 dB (i.e., no array gain) for channel widths ≥ 40 MHz for any N_{ANT} ;

Array Gain = $5 \log(N_{ANT}/N_{SS})$ dB or 3 dB, whichever is less for 20-MHz channel widths with $N_{ANT} \geq 5$.

For power measurements on all other devices: Array Gain = $10 \log(N_{ANT}/N_{SS})$ dB.

4.3.2 Test Setup

FOR POWER OUTPUT MEASUREMENT

For channel straddling 5725MHz:

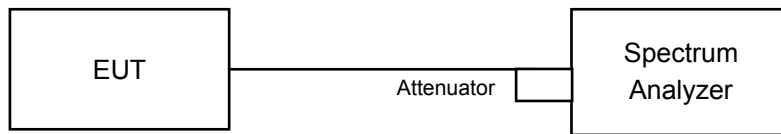

For other channels:

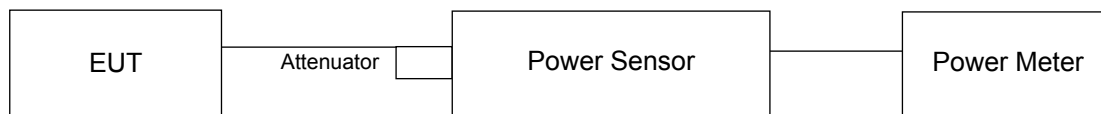

FOR 26dB OCCUPIED BANDWIDTH

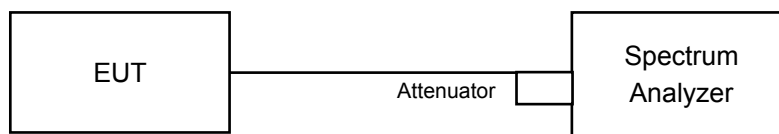

4.3.3 Test Instruments

Refer to section 4.1.2 to get information of above instrument.

4.3.4 Test Procedure

For Average Power Measurement

For channel straddling 5725MHz:

Method SA-2

1. Set span to encompass the emission bandwidth (EBW) of the signal.
2. Set RBW =1MHz.
3. Set the VBW $\geq 3 \times$ RBW.
4. Number of points in sweep ≥ 2 Span / RBW.
5. Sweep time = auto.
6. Detector = RMS.
7. Trace average at least 100 traces in power averaging mode
8. Compute power by integrating the spectrum across the 26 dB EBW of the signal.
9. Duty factor need added to measured value (duty cycle < 98 percent).

For other channels:

Method PM is used to perform output power measurement, trigger and gating function of wide band power meter is enabled to measure max output power of TX on burst. Duty factor is not added to measured value.

FOR 26dB OCCUPIED BANDWIDTH

1. Set RBW = approximately 1% of the emission bandwidth.
2. Set the VBW > RBW.
3. Detector = Peak.
4. Trace mode = max hold.
5. Measure the maximum width of the emission that is 26 dB down from the peak of the emission. Compare this with the RBW setting of the analyzer. Readjust RBW and repeat measurement as needed until the RBW/EBW ratio is approximately 1%.

4.3.5 Deviation from Test Standard

No deviation.

4.3.6 EUT Operating Condition

The software provided by client to enable the EUT under transmission condition continuously at lowest, middle and highest channel frequencies individually.

4.3.7 Test Result (Mode 1)

Non-Beamforming Mode

802.11a

Power Output:

Chan.	Chan. Freq. (MHz)	Maximum Conducted Power (dBm)				Total Power (mW)	Total Power (dBm)	Limit (dBm)	Pass / Fail
		Chain 0	Chain 1	Chain 2	Chain 3				
52	5260	14.76	14.78	14.69	14.86	120.048	20.79	24.00	Pass
60	5300	14.85	14.89	14.72	14.91	122.003	20.86	24.00	Pass
64	5320	14.93	14.77	14.73	14.78	120.887	20.82	24.00	Pass
100	5500	15.26	15.89	15.22	15.31	139.618	21.45	24.00	Pass
116	5580	15.38	15.68	15.18	15.32	138.499	21.41	24.00	Pass
140	5700	15.44	15.73	15.26	15.38	140.494	21.48	24.00	Pass
*144 (UNII-2C Band)	5720	9.64	10.08	10.10	9.79	42.112	16.24	22.92	Pass
*144 (UNII-3 Band)	5720	4.63	3.03	2.39	4.34	10.071	10.03	30.00	Pass

Note: * Test was performed in accordance with Measurement follow FCC KDB 789033 UNII test procedure Method SA-2 and use spectrum analyzer test.

The Average Power for the straddle channel:

Chan.	Chan. Freq. (MHz)	Average Power (mW)	Average Power (dBm)
144	5720	52.183	17.18

Note: The total power was calculated through formula and record the value for reference only.

26dB OCCUPIED BANDWIDTH

Channel	Frequency (MHz)	26dBc Bandwidth (MHz)			
		Chain 0	Chain 1	Chain 2	Chain 3
52	5260	21.46	20.84	21.87	20.80
60	5300	21.10	21.32	22.03	21.08
64	5320	21.11	20.75	21.88	20.98
100	5500	21.69	20.60	22.15	20.63
116	5580	21.48	21.03	22.50	20.81
140	5700	20.77	20.96	21.45	20.43
144 (UNII-2C Band)	5720	15.63	15.58	15.92	15.63

Note: For U-NII-2A, U-NII-2C Band output power limitation is determined based on 26dBc bandwidth

Power Limit = 11dBm + 10logB < U-NII-2A, U-NII-2C >			
Channel Number	Freq.(MHz)	Min. B(MHz)	Determined Conducted Limit (dBm)
52	5260	20.80	24.18 > 24
60	5300	21.08	24.23 > 24
64	5320	20.75	24.17 > 24
100	5500	20.60	24.13 > 24
116	5580	20.81	24.18 > 24
140	5700	20.43	24.1 > 24
144 (UNII-2C Band)	5720	15.58	22.92 < 24

802.11ac (VHT20)

Power Output:

Chan.	Chan. Freq. (MHz)	Maximum Conducted Power (dBm)				Total Power (mW)	Total Power (dBm)	Limit (dBm)	Pass / Fail
		Chain 0	Chain 1	Chain 2	Chain 3				
52	5260	14.58	14.64	14.47	14.72	115.453	20.62	24.00	Pass
60	5300	14.72	14.62	14.58	14.71	116.909	20.68	24.00	Pass
64	5320	14.52	14.42	14.57	14.67	113.934	20.57	24.00	Pass
100	5500	15.10	15.67	14.80	14.92	130.503	21.16	24.00	Pass
116	5580	15.23	15.54	14.89	14.98	131.462	21.19	24.00	Pass
140	5700	15.22	15.47	14.95	15.23	133.107	21.24	24.00	Pass
*144 (UNII-2C Band)	5720	10.41	10.02	10.08	10.28	43.549	16.39	22.84	Pass
*144 (UNII-3 Band)	5720	4.65	3.72	4.17	4.50	11.126	10.46	30.00	Pass

Note: * Test was performed in accordance with Measurement follow FCC KDB 789033 UNII test procedure Method SA-2 and use spectrum analyzer test.

The Average Power for the straddle channel:

Chan.	Chan. Freq. (MHz)	Average Power (mW)	Average Power (dBm)
144	5720	54.675	17.38

Note: The total power was calculated through formula and record the value for reference only.

26dB OCCUPIED BANDWIDTH

Channel	Frequency (MHz)	26dBc Bandwidth (MHz)			
		Chain 0	Chain 1	Chain 2	Chain 3
52	5260	20.68	20.48	20.92	20.36
60	5300	20.72	20.45	21.06	20.90
64	5320	20.69	20.69	20.86	20.36
100	5500	20.67	20.65	21.23	20.70
116	5580	20.57	20.93	20.97	20.80
140	5700	20.45	20.77	20.86	20.71
144 (UNII-2C Band)	5720	15.31	15.49	15.43	15.38

Note: For U-NII-2A, U-NII-2C Band output power limitation is determined based on 26dBc bandwidth

Power Limit = 11dBm + 10logB < U-NII-2A, U-NII-2C >			
Channel Number	Freq.(MHz)	Min. B(MHz)	Determined Conducted Limit (dBm)
52	5260	20.36	24.08 > 24
60	5300	20.45	24.1 > 24
64	5320	20.36	24.08 > 24
100	5500	20.65	24.14 > 24
116	5580	20.57	24.13 > 24
140	5700	20.45	24.1 > 24
144 (UNII-2C Band)	5720	15.31	22.84 < 24

802.11ac (VHT40)

Power Output:

Chan.	Chan. Freq. (MHz)	Maximum Conducted Power (dBm)				Total Power (mW)	Total Power (dBm)	Limit (dBm)	Pass / Fail
		Chain 0	Chain 1	Chain 2	Chain 3				
54	5270	17.76	17.65	17.73	17.53	233.831	23.69	24.00	Pass
62	5310	16.31	16.30	16.10	15.99	165.871	22.20	24.00	Pass
102	5510	15.95	15.86	15.98	15.93	156.705	21.95	24.00	Pass
110	5550	17.73	17.16	17.08	17.33	216.418	23.35	24.00	Pass
134	5670	17.58	17.34	17.70	17.38	225.066	23.52	24.00	Pass
*142 (UNII-2C Band)	5710	13.03	13.36	13.40	13.12	87.448	19.42	24.00	Pass
*142 (UNII-3 Band)	5710	1.58	1.88	2.29	2.57	6.735	8.28	30.00	Pass

Note: * Test was performed in accordance with Measurement follow FCC KDB 789033 UNII test procedure Method SA-2 and use spectrum analyzer test.

The Average Power for the straddle channel:

Chan.	Chan. Freq. (MHz)	Average Power (mW)	Average Power (dBm)
142	5710	94.183	19.74

Note: The total power was calculated through formula and record the value for reference only.

26dB OCCUPIED BANDWIDTH

Channel	Frequency (MHz)	26dBc Bandwidth (MHz)			
		Chain 0	Chain 1	Chain 2	Chain 3
54	5270	41.94	41.90	41.62	41.81
62	5310	41.93	41.67	41.76	42.01
102	5510	41.56	41.97	41.81	41.70
110	5550	41.62	41.65	41.90	41.85
134	5670	42.06	42.35	41.67	41.76
142 (UNII-2C Band)	5710	35.91	36.02	35.92	35.93

Note: For U-NII-2A, U-NII-2C Band output power limitation is determined based on 26dBc bandwidth

Power Limit = 11dBm + 10logB < U-NII-2A, U-NII-2C >			
Channel Number	Freq.(MHz)	Min. B(MHz)	Determined Conducted Limit (dBm)
54	5270	41.62	27.19 > 24
62	5310	41.67	27.19 > 24
102	5510	41.56	27.18 > 24
110	5550	41.62	27.19 > 24
134	5670	41.67	27.19 > 24
142 (UNII-2C Band)	5710	35.91	26.55 > 24

802.11ac (VHT80)

Power Output:

Chan.	Chan. Freq. (MHz)	Maximum Conducted Power (dBm)				Total Power (mW)	Total Power (dBm)	Limit (dBm)	Pass / Fail
		Chain 0	Chain 1	Chain 2	Chain 3				
58	5290	14.58	13.94	14.25	14.61	108.996	20.37	24.00	Pass
106	5530	14.87	15.02	15.06	14.62	123.495	20.92	24.00	Pass
122	5610	17.47	17.61	17.40	17.22	221.201	23.45	24.00	Pass
*138 (UNII-2C Band)	5690	13.78	13.28	13.69	13.28	93.588	19.71	24.00	Pass
*138 (UNII-3 Band)	5690	-1.02	-1.75	-1.48	-1.87	2.9384	4.68	30.00	Pass

Note: * Test was performed in accordance with Measurement follow FCC KDB 789033 UNII test procedure Method SA-2 and use spectrum analyzer test.

The Average Power for the straddle channel:

Chan.	Chan. Freq. (MHz)	Average Power (mW)	Average Power (dBm)
138	5690	96.5264	19.85

Note: The total power was calculated through formula and record the value for reference only.

26dB OCCUPIED BANDWIDTH

Channel	Frequency (MHz)	26dBc Bandwidth (MHz)			
		Chain 0	Chain 1	Chain 2	Chain 3
58	5290	82.76	82.49	82.89	82.38
106	5530	82.07	82.41	82.38	82.88
122	5610	82.28	82.73	82.31	82.43
138 (UNII-2C Band)	5690	76.17	76.17	76.25	76.15

Note: For U-NII-2A, U-NII-2C Band output power limitation is determined based on 26dBc bandwidth

Power Limit = 11dBm + 10logB < U-NII-2A, U-NII-2C >			
Channel Number	Freq.(MHz)	Min. B(MHz)	Determined Conducted Limit (dBm)
58	5290	82.38	30.15 > 24
106	5530	82.07	30.14 > 24
122	5610	82.28	30.15 > 24
138 (UNII-2C Band)	5690	76.15	29.81 > 24

802.11ax (HE20)

Power Output:

Chan.	Chan. Freq. (MHz)	Maximum Conducted Power (dBm)				Total Power (mW)	Total Power (dBm)	Limit (dBm)	Pass / Fail
		Chain 0	Chain 1	Chain 2	Chain 3				
52	5260	14.88	14.86	14.72	14.98	122.506	20.88	24.00	Pass
60	5300	14.96	14.87	14.84	14.92	123.548	20.92	24.00	Pass
64	5320	14.78	14.65	14.86	14.89	120.687	20.82	24.00	Pass
100	5500	15.34	15.98	15.12	15.23	139.678	21.45	24.00	Pass
116	5580	15.45	15.77	15.21	15.24	139.441	21.44	24.00	Pass
140	5700	15.48	15.69	15.18	15.49	140.747	21.48	24.00	Pass
*144 (UNII-2C Band)	5720	10.43	10.74	10.47	10.37	47.058	16.73	22.91	Pass
*144 (UNII-3 Band)	5720	4.83	5.28	5.03	4.82	13.23	11.22	30.00	Pass

Note: * Test was performed in accordance with Measurement follow FCC KDB 789033 UNII test procedure Method SA-2 and use spectrum analyzer test.

The Average Power for the straddle channel:

Chan.	Chan. Freq. (MHz)	Average Power (mW)	Average Power (dBm)
144	5720	60.288	17.8

Note: The total power was calculated through formula and record the value for reference only.

26dB OCCUPIED BANDWIDTH

Channel	Frequency (MHz)	26dBc Bandwidth (MHz)			
		Chain 0	Chain 1	Chain 2	Chain 3
52	5260	21.30	21.46	21.20	21.54
60	5300	21.23	21.30	21.57	21.44
64	5320	21.23	21.33	21.54	21.43
100	5500	21.26	21.13	21.21	21.52
116	5580	21.18	21.40	21.06	21.51
140	5700	21.26	21.23	21.22	21.30
144 (UNII-2C Band)	5720	15.83	15.66	15.54	15.59

Note: For U-NII-2A, U-NII-2C Band output power limitation is determined based on 26dBc bandwidth

Power Limit = $11\text{dBm} + 10\log B < \text{U-NII-2A, U-NII-2C} >$

Channel Number	Freq.(MHz)	Min. B(MHz)	Determined Conducted Limit (dBm)
52	5260	21.20	24.26 > 24
60	5300	21.23	24.26 > 24
64	5320	21.23	24.26 > 24
100	5500	21.13	24.24 > 24
116	5580	21.06	24.23 > 24
140	5700	21.22	24.26 > 24
144 (UNII-2C Band)	5720	15.54	22.91 < 24

802.11ax (HE40)

Power Output:

Chan.	Chan. Freq. (MHz)	Maximum Conducted Power (dBm)				Total Power (mW)	Total Power (dBm)	Limit (dBm)	Pass / Fail
		Chain 0	Chain 1	Chain 2	Chain 3				
54	5270	18.02	17.96	17.98	17.78	248.689	23.96	24.00	Pass
62	5310	16.54	16.48	16.36	16.25	174.966	22.43	24.00	Pass
102	5510	16.19	16.18	16.30	16.19	167.335	22.24	24.00	Pass
110	5550	17.98	17.42	17.39	17.58	230.122	23.62	24.00	Pass
134	5670	17.80	17.56	17.95	17.61	237.322	23.75	24.00	Pass
*142 (UNII-2C Band)	5710	13.53	13.53	13.57	13.74	95.142	19.78	24.00	Pass
*142 (UNII-3 Band)	5710	2.74	3.24	3.56	3.40	8.783	9.44	30.00	Pass

Note: * Test was performed in accordance with Measurement follow FCC KDB 789033 UNII test procedure Method SA-2 and use spectrum analyzer test.

The Average Power for the straddle channel:

Chan.	Chan. Freq. (MHz)	Average Power (mW)	Average Power (dBm)
142	5710	103.925	20.17

Note: The total power was calculated through formula and record the value for reference only.

26dB OCCUPIED BANDWIDTH

Channel	Frequency (MHz)	26dBc Bandwidth (MHz)			
		Chain 0	Chain 1	Chain 2	Chain 3
54	5270	42.64	42.54	42.39	42.59
62	5310	42.21	42.10	42.73	42.51
102	5510	42.33	42.39	42.29	43.04
110	5550	42.86	42.23	42.58	42.62
134	5670	42.73	42.84	42.53	42.53
142 (UNII-2C Band)	5710	36.12	36.49	36.18	36.24

Note: For U-NII-2A, U-NII-2C Band output power limitation is determined based on 26dBc bandwidth

Power Limit = 11dBm + 10logB < U-NII-2A, U-NII-2C >			
Channel Number	Freq.(MHz)	Min. B(MHz)	Determined Conducted Limit (dBm)
54	5270	42.39	27.27 > 24
62	5310	42.10	27.24 > 24
102	5510	42.29	27.26 > 24
110	5550	42.23	27.25 > 24
134	5670	42.53	27.28 > 24
142 (UNII-2C Band)	5710	36.12	26.57 > 24

802.11ax (HE80)

Power Output:

Chan.	Chan. Freq. (MHz)	Maximum Conducted Power (dBm)				Total Power (mW)	Total Power (dBm)	Limit (dBm)	Pass / Fail
		Chain 0	Chain 1	Chain 2	Chain 3				
58	5290	14.88	14.19	14.56	14.87	116.269	20.65	24.00	Pass
106	5530	15.13	15.23	15.38	14.87	131.131	21.18	24.00	Pass
122	5610	17.76	17.85	17.64	17.45	234.324	23.70	24.00	Pass
*138 (UNII-2C Band)	5690	13.83	13.97	13.93	13.88	102.22	20.10	24.00	Pass
*138 (UNII-3 Band)	5690	-0.47	0.56	0.69	0.53	4.5121	6.54	30.00	Pass

Note: * Test was performed in accordance with Measurement follow FCC KDB 789033 UNII test procedure Method SA-2 and use spectrum analyzer test.

The Average Power for the straddle channel:

Chan.	Chan. Freq. (MHz)	Average Power (mW)	Average Power (dBm)
138	5690	106.7321	20.28

Note: The total power was calculated through formula and record the value for reference only.

26dB OCCUPIED BANDWIDTH

Channel	Frequency (MHz)	26dBc Bandwidth (MHz)			
		Chain 0	Chain 1	Chain 2	Chain 3
58	5290	83.03	82.72	82.82	82.51
106	5530	82.29	82.80	82.95	82.95
122	5610	82.87	83.36	82.74	83.31
138 (UNII-2C Band)	5690	76.61	76.51	76.33	76.23

Note: For U-NII-2A, U-NII-2C Band output power limitation is determined based on 26dBc bandwidth

Power Limit = 11dBm + 10logB < U-NII-2A, U-NII-2C >			
Channel Number	Freq.(MHz)	Min. B(MHz)	Determined Conducted Limit (dBm)
58	5290	82.51	30.16 > 24
106	5530	82.29	30.15 > 24
122	5610	82.74	30.17 > 24
138 (UNII-2C Band)	5690	76.23	29.82 > 24

Spectrum Plot of Worst Value

802.11a / Chain 1 : CH144 (UNII-2C Band)

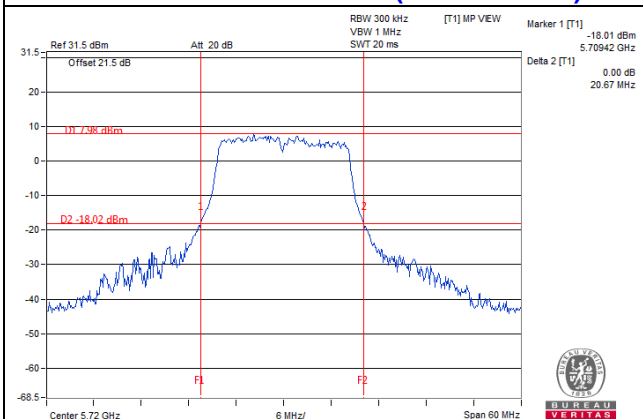

802.11ac (VHT20) / Chain 0 : CH144 (UNII-2C Band)

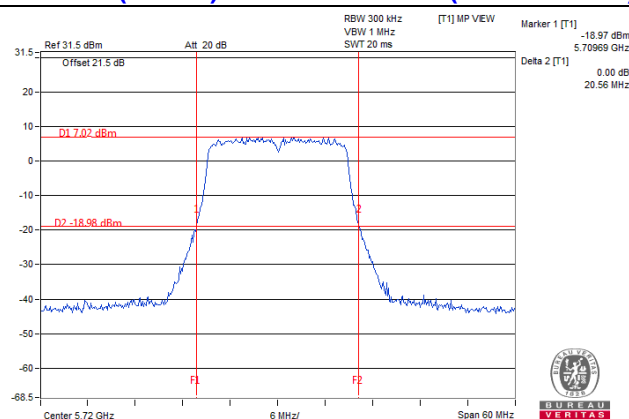

802.11ac (VHT40) / Chain 0 : CH142 (UNII-2C Band)

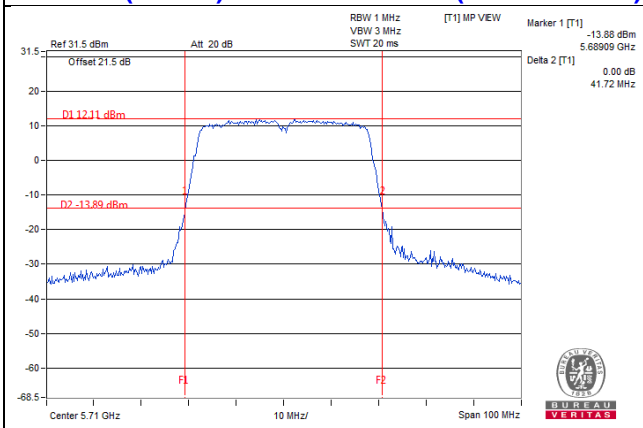

802.11ac (VHT80) / Chain 3 : CH138 (UNII-2C Band)

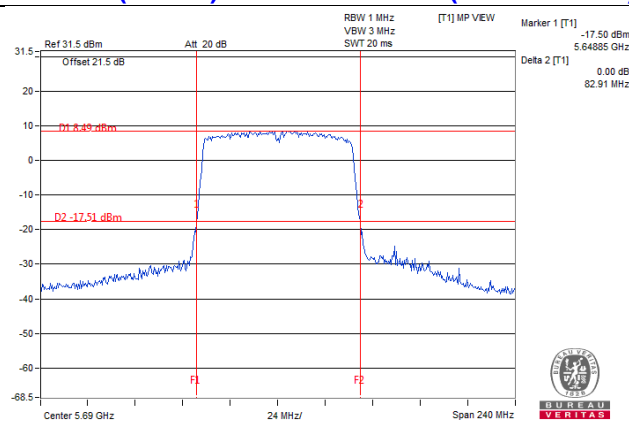

NOTE:

- For CH144 (UNII-2C Band) = 5725MHz - Marker 1
- For CH142 (UNII-2C Band) = 5725MHz - Marker 1
- For CH138 (UNII-2C Band) = 5725MHz - Marker 1

Spectrum Plot of Worst Value

802.11ax (HE20) / Chain 2 : CH144 (UNII-2C Band)

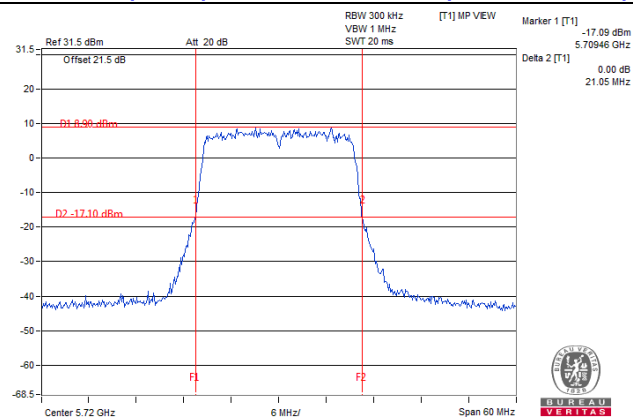

802.11ax (HE40) / Chain 0 : CH142 (UNII-2C Band)

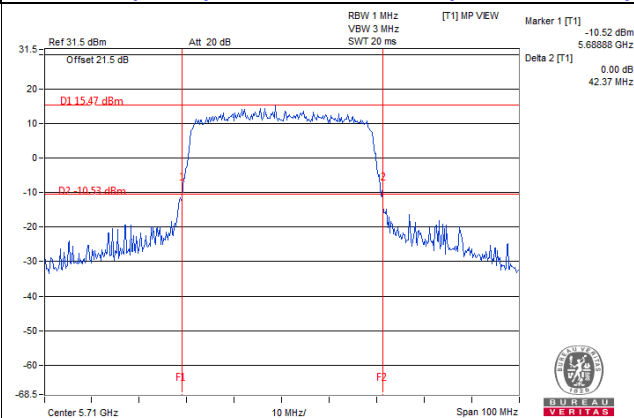

802.11ax (HE80) / Chain 3 : CH138 (UNII-2C Band)

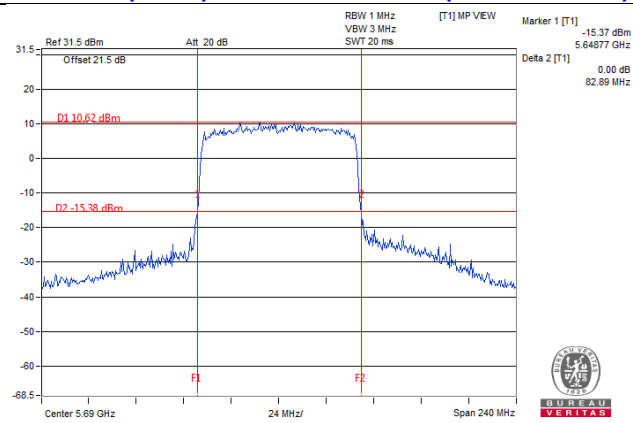

NOTE:

- For CH144 (UNII-2C Band) = 5725MHz - Marker 1
- For CH142 (UNII-2C Band) = 5725MHz - Marker 1
- For CH138 (UNII-2C Band) = 5725MHz - Marker 1

Beamforming Mode

802.11ac (VHT20)

Power Output:

Chan.	Chan. Freq. (MHz)	Maximum Conducted Power (dBm)				Total Power (mW)	Total Power (dBm)	Limit (dBm)	Pass / Fail
		Chain 0	Chain 1	Chain 2	Chain 3				
52	5260	14.58	14.64	14.47	14.72	115.453	20.62	21.07	Pass
60	5300	14.72	14.62	14.58	14.71	116.909	20.68	21.07	Pass
64	5320	14.52	14.42	14.57	14.67	113.934	20.57	21.07	Pass
100	5500	15.10	15.67	14.80	14.92	130.503	21.16	21.49	Pass
116	5580	15.23	15.54	14.89	14.98	131.462	21.19	21.49	Pass
140	5700	15.22	15.47	14.95	15.23	133.107	21.24	21.49	Pass
*144 (UNII-2C Band)	5720	10.41	10.02	10.08	10.28	43.549	16.39	20.33	Pass
*144 (UNII-3 Band)	5720	4.65	3.72	4.17	4.50	11.126	10.46	27.89	Pass

Note: * Test was performed in accordance with Measurement follow FCC KDB 789033 UNII test procedure Method SA-2 and use spectrum analyzer test.

1. For UNII-2A Band: the directional gain = 8.93dBi > 6dBi, so the power limit shall be reduced to "Determined Conducted Limit-(8.93-6)".
2. For UNII-2C Band: the directional gain = 8.51dBi > 6dBi, so the power limit shall be reduced to "Determined Conducted Limit-(8.51-6)".
3. For UNII-3 Band: the directional gain = 8.11dBi > 6dBi, so the power limit shall be reduced to 30-(8.11-6) = 27.89dBm.

The Average Power for the straddle channel:

Chan.	Chan. Freq. (MHz)	Average Power (mW)	Average Power (dBm)
144	5720	54.675	17.38

Note: The total power was calculated through formula and record the value for reference only.

26dB OCCUPIED BANDWIDTH

Channel	Frequency (MHz)	26dBc Bandwidth (MHz)			
		Chain 0	Chain 1	Chain 2	Chain 3
52	5260	20.68	20.48	20.92	20.36
60	5300	20.72	20.45	21.06	20.90
64	5320	20.69	20.69	20.86	20.36
100	5500	20.67	20.65	21.23	20.70
116	5580	20.57	20.93	20.97	20.80
140	5700	20.45	20.77	20.86	20.71
144 (UNII-2C Band)	5720	15.31	15.49	15.43	15.38

Note: For U-NII-2A, U-NII-2C Band output power limitation is determined based on 26dBc bandwidth

Power Limit = 11dBm + 10logB < U-NII-2A, U-NII-2C >			
Channel Number	Freq.(MHz)	Min. B(MHz)	Determined Conducted Limit (dBm)
52	5260	20.36	24.08 > 24
60	5300	20.45	24.1 > 24
64	5320	20.36	24.08 > 24
100	5500	20.65	24.14 > 24
116	5580	20.57	24.13 > 24
140	5700	20.45	24.1 > 24
144 (UNII-2C Band)	5720	15.31	22.84 < 24

802.11ac (VHT40)

Power Output:

Chan.	Chan. Freq. (MHz)	Maximum Conducted Power (dBm)				Total Power (mW)	Total Power (dBm)	Limit (dBm)	Pass / Fail
		Chain 0	Chain 1	Chain 2	Chain 3				
54	5270	14.80	14.82	14.78	14.80	120.8	20.82	21.07	Pass
62	5310	14.78	14.75	14.72	14.88	120.324	20.80	21.07	Pass
102	5510	15.12	15.17	15.28	15.12	131.632	21.19	21.49	Pass
110	5550	12.20	15.15	15.36	15.56	119.661	20.78	21.49	Pass
134	5670	15.20	15.17	15.42	15.60	137.14	21.37	21.49	Pass
*142 (UNII-2C Band)	5710	10.66	11.24	11.17	11.67	54.788	17.39	21.49	Pass
*142 (UNII-3 Band)	5710	-0.22	0.16	0.00	0.69	4.3229	6.36	27.89	Pass

Note: * Test was performed in accordance with Measurement follow FCC KDB 789033 UNII test procedure Method SA-2 and use spectrum analyzer test.

1. For UNII-2A Band: the directional gain = 8.93dBi > 6dBi, so the power limit shall be reduced to "Determined Conducted Limit-(8.93-6)".
2. For UNII-2C Band: the directional gain = 8.51dBi > 6dBi, so the power limit shall be reduced to "Determined Conducted Limit-(8.51-6)".
3. For UNII-3 Band: the directional gain = 8.11dBi > 6dBi, so the power limit shall be reduced to $30-(8.11-6) = 27.89$ dBm.

The Average Power for the straddle channel:

Chan.	Chan. Freq. (MHz)	Average Power (mW)	Average Power (dBm)
142	5710	59.1109	17.72

Note: The total power was calculated through formula and record the value for reference only.

26dB OCCUPIED BANDWIDTH

Channel	Frequency (MHz)	26dBc Bandwidth (MHz)			
		Chain 0	Chain 1	Chain 2	Chain 3
54	5270	41.94	41.90	41.62	41.81
62	5310	41.93	41.67	41.76	42.01
102	5510	41.56	41.97	41.81	41.70
110	5550	41.62	41.65	41.90	41.85
134	5670	42.06	42.35	41.67	41.76
142 (UNII-2C Band)	5710	35.91	36.02	35.92	35.93

Note: For U-NII-2A, U-NII-2C Band output power limitation is determined based on 26dBc bandwidth

Power Limit = 11dBm + 10logB < U-NII-2A, U-NII-2C >			
Channel Number	Freq.(MHz)	Min. B(MHz)	Determined Conducted Limit (dBm)
54	5270	41.62	27.19 > 24
62	5310	41.67	27.19 > 24
102	5510	41.56	27.18 > 24
110	5550	41.62	27.19 > 24
134	5670	41.67	27.19 > 24
142 (UNII-2C Band)	5710	35.91	26.55 > 24

802.11ac (VHT80)

Power Output:

Chan.	Chan. Freq. (MHz)	Maximum Conducted Power (dBm)				Total Power (mW)	Total Power (dBm)	Limit (dBm)	Pass / Fail
		Chain 0	Chain 1	Chain 2	Chain 3				
58	5290	14.58	13.94	14.25	14.61	108.996	20.37	21.07	Pass
106	5530	14.87	15.02	15.06	14.62	123.495	20.92	21.49	Pass
122	5610	15.24	15.33	15.12	15.32	134.089	21.27	21.49	Pass
*138 (UNII-2C Band)	5690	11.62	11.42	11.20	11.65	58.546	17.67	21.49	Pass
*138 (UNII-3 Band)	5690	-2.46	-3.67	-2.48	-3.50	2.0927	3.21	27.89	Pass

Note: * Test was performed in accordance with Measurement follow FCC KDB 789033 UNII test procedure Method SA-2 and use spectrum analyzer test.

1. For UNII-2A Band: the directional gain = 8.93dBi > 6dBi, so the power limit shall be reduced to "Determined Conducted Limit-(8.93-6)".
2. For UNII-2C Band: the directional gain = 8.51dBi > 6dBi, so the power limit shall be reduced to "Determined Conducted Limit-(8.51-6)".
3. For UNII-3 Band: the directional gain = 8.11dBi > 6dBi, so the power limit shall be reduced to 30-(8.11-6) = 27.89dBm.

The Average Power for the straddle channel:

Chan.	Chan. Freq. (MHz)	Average Power (mW)	Average Power (dBm)
138	5690	60.6387	17.83

Note: The total power was calculated through formula and record the value for reference only.

26dB OCCUPIED BANDWIDTH

Channel	Frequency (MHz)	26dBc Bandwidth (MHz)			
		Chain 0	Chain 1	Chain 2	Chain 3
58	5290	82.76	82.49	82.89	82.38
106	5530	82.07	82.41	82.38	82.88
122	5610	82.28	82.73	82.31	82.43
138 (UNII-2C Band)	5690	76.17	76.17	76.25	76.15

Note: For U-NII-2A, U-NII-2C Band output power limitation is determined based on 26dBc bandwidth

Power Limit = 11dBm + 10logB < U-NII-2A, U-NII-2C >			
Channel Number	Freq.(MHz)	Min. B(MHz)	Determined Conducted Limit (dBm)
58	5290	82.38	30.15 > 24
106	5530	82.07	30.14 > 24
122	5610	82.28	30.15 > 24
138 (UNII-2C Band)	5690	76.15	29.81 > 24

802.11ax (HE20)

Power Output:

Chan.	Chan. Freq. (MHz)	Maximum Conducted Power (dBm)				Total Power (mW)	Total Power (dBm)	Limit (dBm)	Pass / Fail
		Chain 0	Chain 1	Chain 2	Chain 3				
52	5260	14.88	14.86	14.72	14.98	122.506	20.88	21.07	Pass
60	5300	14.96	14.87	14.84	14.92	123.548	20.92	21.07	Pass
64	5320	14.78	14.65	14.86	14.89	120.687	20.82	21.07	Pass
100	5500	15.34	15.98	15.12	15.23	139.678	21.45	21.49	Pass
116	5580	15.45	15.77	15.21	15.24	139.441	21.44	21.49	Pass
140	5700	15.48	15.69	15.18	15.49	140.747	21.48	21.49	Pass
*144 (UNII-2C Band)	5720	10.43	10.74	10.47	10.37	47.058	16.73	20.40	Pass
*144 (UNII-3 Band)	5720	4.83	5.28	5.03	4.82	13.23	11.22	27.89	Pass

Note: * Test was performed in accordance with Measurement follow FCC KDB 789033 UNII test procedure Method SA-2 and use spectrum analyzer test.

1. For UNII-2A Band: the directional gain = 8.93dBi > 6dBi, so the power limit shall be reduced to "Determined Conducted Limit-(8.93-6)".
2. For UNII-2C Band: the directional gain = 8.51dBi > 6dBi, so the power limit shall be reduced to "Determined Conducted Limit-(8.51-6)".
3. For UNII-3 Band: the directional gain = 8.11dBi > 6dBi, so the power limit shall be reduced to $30-(8.11-6) = 27.89\text{dBm}$.

The Average Power for the straddle channel:

Chan.	Chan. Freq. (MHz)	Average Power (mW)	Average Power (dBm)
144	5720	60.288	17.8

Note: The total power was calculated through formula and record the value for reference only.

26dB OCCUPIED BANDWIDTH

Channel	Frequency (MHz)	26dBc Bandwidth (MHz)			
		Chain 0	Chain 1	Chain 2	Chain 3
52	5260	21.30	21.46	21.20	21.54
60	5300	21.23	21.30	21.57	21.44
64	5320	21.23	21.33	21.54	21.43
100	5500	21.26	21.13	21.21	21.52
116	5580	21.18	21.40	21.06	21.51
140	5700	21.26	21.23	21.22	21.30
144 (UNII-2C Band)	5720	15.83	15.66	15.54	15.59

Note: For U-NII-2A, U-NII-2C Band output power limitation is determined based on 26dBc bandwidth

Power Limit = 11dBm + 10logB < U-NII-2A, U-NII-2C >			
Channel Number	Freq.(MHz)	Min. B(MHz)	Determined Conducted Limit (dBm)
52	5260	21.20	24.26 > 24
60	5300	21.23	24.26 > 24
64	5320	21.23	24.26 > 24
100	5500	21.13	24.24 > 24
116	5580	21.06	24.23 > 24
140	5700	21.22	24.26 > 24
144 (UNII-2C Band)	5720	15.54	22.91 < 24

802.11ax (HE40)

Power Output:

Chan.	Chan. Freq. (MHz)	Maximum Conducted Power (dBm)				Total Power (mW)	Total Power (dBm)	Limit (dBm)	Pass / Fail
		Chain 0	Chain 1	Chain 2	Chain 3				
54	5270	14.82	14.85	14.79	14.92	122.064	20.87	21.07	Pass
62	5310	14.80	14.79	14.75	14.90	121.087	20.83	21.07	Pass
102	5510	15.19	15.18	15.30	15.19	132.919	21.24	21.49	Pass
110	5550	15.22	15.16	15.39	15.58	136.811	21.36	21.49	Pass
134	5670	15.21	15.19	15.46	15.61	137.774	21.39	21.49	Pass
*142 (UNII-2C Band)	5710	10.79	10.98	11.73	11.47	55.579	17.45	21.49	Pass
*142 (UNII-3 Band)	5710	0.75	0.77	0.86	0.87	5.016	7.00	27.89	Pass

Note: * Test was performed in accordance with Measurement follow FCC KDB 789033 UNII test procedure Method SA-2 and use spectrum analyzer test.

1. For UNII-2A Band: the directional gain = 8.93dBi > 6dBi, so the power limit shall be reduced to "Determined Conducted Limit-(8.93-6)".
2. For UNII-2C Band: the directional gain = 8.51dBi > 6dBi, so the power limit shall be reduced to "Determined Conducted Limit-(8.51-6)".
3. For UNII-3 Band: the directional gain = 8.11dBi > 6dBi, so the power limit shall be reduced to $30-(8.11-6) = 27.89$ dBm.

The Average Power for the straddle channel:

Chan.	Chan. Freq. (MHz)	Average Power (mW)	Average Power (dBm)
142	5710	60.595	17.82

Note: The total power was calculated through formula and record the value for reference only.

26dB OCCUPIED BANDWIDTH

Channel	Frequency (MHz)	26dBc Bandwidth (MHz)			
		Chain 0	Chain 1	Chain 2	Chain 3
54	5270	42.64	42.54	42.39	42.59
62	5310	42.21	42.10	42.73	42.51
102	5510	42.33	42.39	42.29	43.04
110	5550	42.86	42.23	42.58	42.62
134	5670	42.73	42.84	42.53	42.53
142 (UNII-2C Band)	5710	36.12	36.49	36.18	36.24

Note: For U-NII-2A, U-NII-2C Band output power limitation is determined based on 26dBc bandwidth

Power Limit = 11dBm + 10logB < U-NII-2A, U-NII-2C >			
Channel Number	Freq.(MHz)	Min. B(MHz)	Determined Conducted Limit (dBm)
54	5270	42.39	27.27 > 24
62	5310	42.10	27.24 > 24
102	5510	42.29	27.26 > 24
110	5550	42.23	27.25 > 24
134	5670	42.53	27.28 > 24
142 (UNII-2C Band)	5710	36.12	26.57 > 24

802.11ax (HE80)

Power Output:

Chan.	Chan. Freq. (MHz)	Maximum Conducted Power (dBm)				Total Power (mW)	Total Power (dBm)	Limit (dBm)	Pass / Fail
		Chain 0	Chain 1	Chain 2	Chain 3				
58	5290	14.88	14.19	14.56	14.87	116.269	20.65	21.07	Pass
106	5530	15.13	15.23	15.38	14.87	131.131	21.18	21.49	Pass
122	5610	15.26	15.35	15.14	15.32	134.551	21.29	21.49	Pass
*138 (UNII-2C Band)	5690	11.65	11.53	11.75	11.57	60.511	17.82	21.49	Pass
*138 (UNII-3 Band)	5690	-2.95	-2.29	-3.16	-3.62	2.0962	3.21	27.89	Pass

Note: * Test was performed in accordance with Measurement follow FCC KDB 789033 UNII test procedure Method SA-2 and use spectrum analyzer test.

1. For UNII-2A Band: the directional gain = 8.93dBi > 6dBi, so the power limit shall be reduced to "Determined Conducted Limit-(8.93-6)".
2. For UNII-2C Band: the directional gain = 8.51dBi > 6dBi, so the power limit shall be reduced to "Determined Conducted Limit-(8.51-6)".
3. For UNII-3 Band: the directional gain = 8.11dBi > 6dBi, so the power limit shall be reduced to 30-(8.11-6) = 27.89dBm.

The Average Power for the straddle channel:

Chan.	Chan. Freq. (MHz)	Average Power (mW)	Average Power (dBm)
138	5690	62.6072	17.97

Note: The total power was calculated through formula and record the value for reference only.

26dB OCCUPIED BANDWIDTH

Channel	Frequency (MHz)	26dBc Bandwidth (MHz)			
		Chain 0	Chain 1	Chain 2	Chain 3
58	5290	83.03	82.72	82.82	82.51
106	5530	82.29	82.80	82.95	82.95
122	5610	82.87	83.36	82.74	83.31
138 (UNII-2C Band)	5690	76.61	76.51	76.33	76.23

Note: For U-NII-2A, U-NII-2C Band output power limitation is determined based on 26dBc bandwidth

Power Limit = 11dBm + 10logB < U-NII-2A, U-NII-2C >			
Channel Number	Freq.(MHz)	Min. B(MHz)	Determined Conducted Limit (dBm)
58	5290	82.51	30.16 > 24
106	5530	82.29	30.15 > 24
122	5610	82.74	30.17 > 24
138 (UNII-2C Band)	5690	76.23	29.82 > 24

Spectrum Plot of Worst Value

802.11ac (VHT20) / Chain 0 : CH144 (UNII-2C Band) 802.11ac (VHT40) / Chain 0 : CH142 (UNII-2C Band)

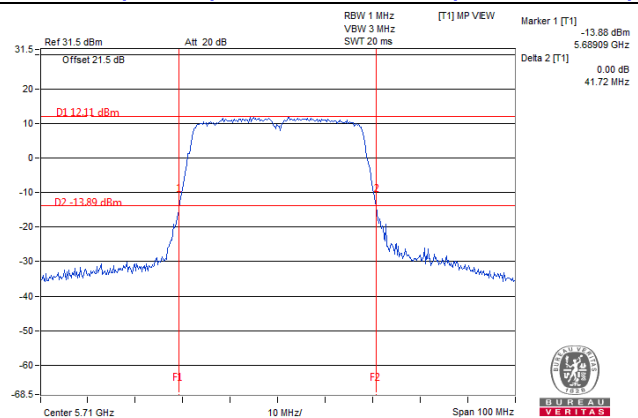
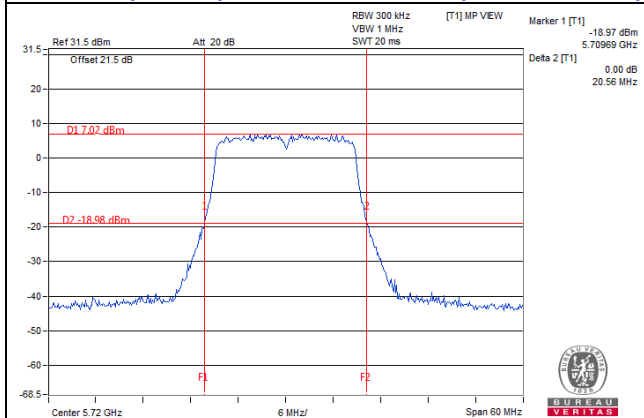

802.11ac (VHT80) / Chain 3 : CH138 (UNII-2C Band)

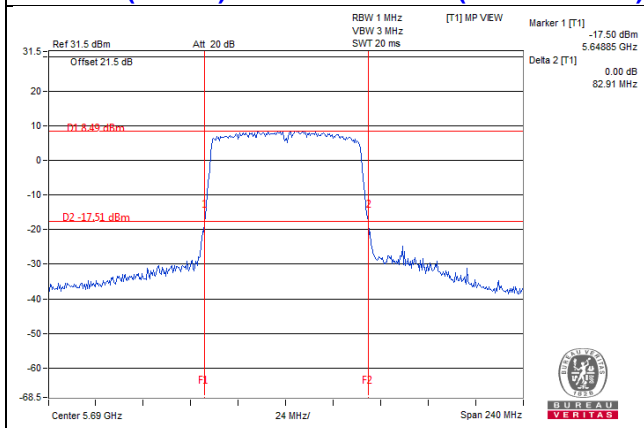

NOTE:

- For CH144 (UNII-2C Band) = 5725MHz - Marker 1
- For CH142 (UNII-2C Band) = 5725MHz - Marker 1
- For CH138 (UNII-2C Band) = 5725MHz - Marker 1

Spectrum Plot of Worst Value

802.11ax (HE20) / Chain 2 : CH144 (UNII-2C Band)

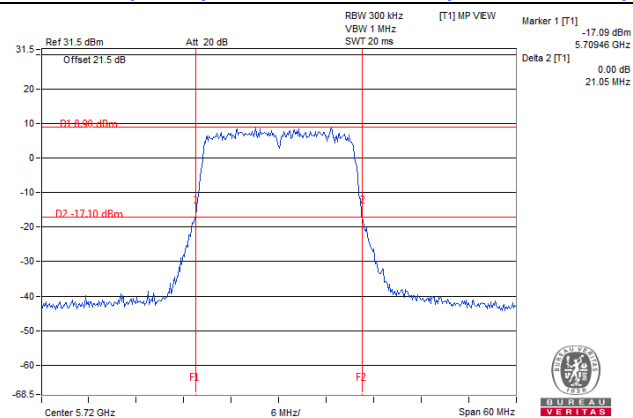

802.11ax (HE40) / Chain 0 : CH142 (UNII-2C Band)

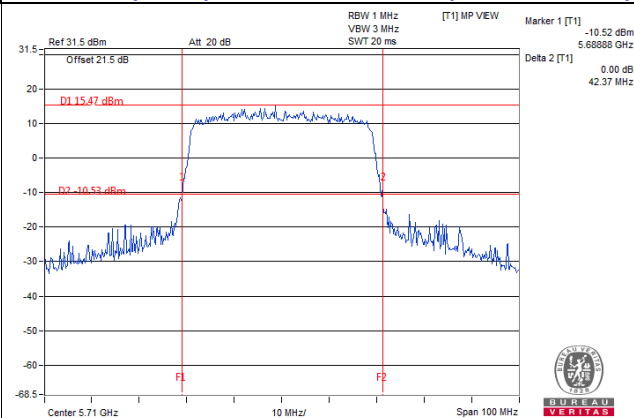

802.11ax (HE80) / Chain 3 : CH138 (UNII-2C Band)

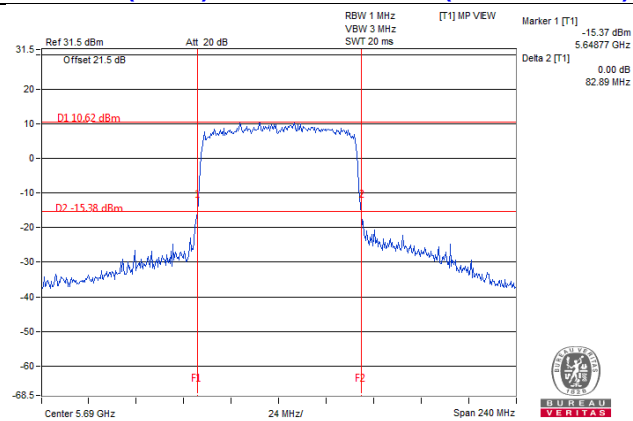

NOTE:

- For CH144 (UNII-2C Band) = 5725MHz - Marker 1
- For CH142 (UNII-2C Band) = 5725MHz - Marker 1
- For CH138 (UNII-2C Band) = 5725MHz - Marker 1

4.3.8 Test Result (Mode 2)

For U-NII-2A:

Non-Beamforming Mode

802.11a

Power Output:

Chan.	Chan. Freq. (MHz)	Maximum Conducted Power (dBm)		Total Power (mW)	Total Power (dBm)	Limit (dBm)	Pass / Fail
		Chain 2	Chain 3				
52	5260	19.19	19.36	169.283	22.29	24.00	Pass
60	5300	19.22	19.41	170.857	22.33	24.00	Pass
64	5320	19.23	19.28	168.476	22.27	24.00	Pass

Note: * Test was performed in accordance with Measurement follow FCC KDB 789033 UNII test procedure Method SA-2 and use spectrum analyzer test.

26dB OCCUPIED BANDWIDTH

Channel	Frequency (MHz)	26dBc Bandwidth (MHz)	
		Chain 2	Chain 3
52	5260	27.19	32.71
60	5300	24.08	27.54
64	5320	27.05	27.73

Note: For U-NII-2A Band output power limitation is determined based on 26dBc bandwidth.

Power Limit = 11dBm + 10logB < U-NII-2A >			
Channel Number	Freq.(MHz)	Min. B(MHz)	Determined Conducted Limit (dBm)
52	5260	27.19	25.34 > 24
60	5300	24.08	24.81 > 24
64	5320	27.05	25.32 > 24

802.11ac (VHT20)

Power Output:

Chan.	Chan. Freq. (MHz)	Maximum Conducted Power (dBm)		Total Power (mW)	Total Power (dBm)	Limit (dBm)	Pass / Fail
		Chain 2	Chain 3				
52	5260	19.18	19.45	170.899	22.33	24.00	Pass
60	5300	19.28	19.40	171.819	22.35	24.00	Pass
64	5320	19.35	19.35	172.198	22.36	24.00	Pass

Note: * Test was performed in accordance with Measurement follow FCC KDB 789033 UNII test procedure Method SA-2 and use spectrum analyzer test.

26dB OCCUPIED BANDWIDTH

Channel	Frequency (MHz)	26dBc Bandwidth (MHz)	
		Chain 2	Chain 3
52	5260	20.90	21.11
60	5300	20.85	20.95
64	5320	20.77	21.14

Note: For U-NII-2A Band output power limitation is determined based on 26dBc bandwidth.

Power Limit = 11dBm + 10logB < U-NII-2A>			
Channel Number	Freq.(MHz)	Min. B(MHz)	Determined Conducted Limit (dBm)
52	5260	20.90	24.2 > 24
60	5300	20.85	24.19 > 24
64	5320	20.77	24.17 > 24

802.11ac (VHT40)

Power Output:

Chan.	Chan. Freq. (MHz)	Maximum Conducted Power (dBm)		Total Power (mW)	Total Power (dBm)	Limit (dBm)	Pass / Fail
		Chain 2	Chain 3				
54	5270	20.95	20.76	243.575	23.87	24.00	Pass
62	5310	17.32	17.22	106.674	20.28	24.00	Pass

Note: * Test was performed in accordance with Measurement follow FCC KDB 789033 UNII test procedure Method SA-2 and use spectrum analyzer test.

26dB OCCUPIED BANDWIDTH

Channel	Frequency (MHz)	26dBc Bandwidth (MHz)	
		Chain 2	Chain 3
54	5270	55.33	52.39
62	5310	41.64	41.65

Note: For U-NII-2A Band output power limitation is determined based on 26dBc bandwidth.

Power Limit = $11\text{dBm} + 10\log B < \text{U-NII-2A}>$			
Channel Number	Freq.(MHz)	Min. B(MHz)	Determined Conducted Limit (dBm)
54	5270	52.39	28.19 > 24
62	5310	41.64	27.19 > 24

802.11ac (VHT80)

Power Output:

Chan.	Chan. Freq. (MHz)	Maximum Conducted Power (dBm)		Total Power (mW)	Total Power (dBm)	Limit (dBm)	Pass / Fail
		Chain 2	Chain 3				
58	5290	15.52	15.83	73.927	18.69	24.00	Pass

Note: * Test was performed in accordance with Measurement follow FCC KDB 789033 UNII test procedure Method SA-2 and use spectrum analyzer test.

26dB OCCUPIED BANDWIDTH

Channel	Frequency (MHz)	26dBc Bandwidth (MHz)	
		Chain 2	Chain 3
58	5290	82.50	82.50

Note: For U-NII-2A Band output power limitation is determined based on 26dBc bandwidth.

Power Limit = 11dBm + 10logB < U-NII-2A >			
Channel Number	Freq.(MHz)	Min. B(MHz)	Determined Conducted Limit (dBm)
58	5290	82.50	30.16 > 24

802.11ax (HE20)

Power Output:

Chan.	Chan. Freq. (MHz)	Maximum Conducted Power (dBm)		Total Power (mW)	Total Power (dBm)	Limit (dBm)	Pass / Fail
		Chain 2	Chain 3				
52	5260	19.22	19.48	172.276	22.36	24.00	Pass
60	5300	19.31	19.42	172.808	22.38	24.00	Pass
64	5320	19.36	19.39	173.194	22.39	24.00	Pass

Note: * Test was performed in accordance with Measurement follow FCC KDB 789033 UNII test procedure Method SA-2 and use spectrum analyzer test.

26dB OCCUPIED BANDWIDTH

Channel	Frequency (MHz)	26dBc Bandwidth (MHz)	
		Chain 2	Chain 3
52	5260	21.49	21.58
60	5300	21.38	21.51
64	5320	21.46	21.70

Note: For U-NII-2A Band output power limitation is determined based on 26dBc bandwidth.

Power Limit = 11dBm + 10logB < U-NII-2A >			
Channel Number	Freq.(MHz)	Min. B(MHz)	Determined Conducted Limit (dBm)
52	5260	21.49	24.32 > 24
60	5300	21.38	24.3 > 24
64	5320	21.46	24.31 > 24

802.11ax (HE40)

Power Output:

Chan.	Chan. Freq. (MHz)	Maximum Conducted Power (dBm)		Total Power (mW)	Total Power (dBm)	Limit (dBm)	Pass / Fail
		Chain 2	Chain 3				
54	5270	20.98	20.78	244.988	23.89	24.00	Pass
62	5310	17.36	17.25	107.538	20.32	24.00	Pass

Note: * Test was performed in accordance with Measurement follow FCC KDB 789033 UNII test procedure Method SA-2 and use spectrum analyzer test.

26dB OCCUPIED BANDWIDTH

Channel	Frequency (MHz)	26dBc Bandwidth (MHz)	
		Chain 2	Chain 3
54	5270	55.52	42.76
62	5310	42.74	42.29

Note: For U-NII-2A Band output power limitation is determined based on 26dBc bandwidth.

Power Limit = 11dBm + 10logB < U-NII-2A >			
Channel Number	Freq.(MHz)	Min. B(MHz)	Determined Conducted Limit (dBm)
54	5270	42.76	27.31 > 24
62	5310	42.29	27.26 > 24

802.11ax (HE80)

Power Output:

Chan.	Chan. Freq. (MHz)	Maximum Conducted Power (dBm)		Total Power (mW)	Total Power (dBm)	Limit (dBm)	Pass / Fail
		Chain 2	Chain 3				
58	5290	15.56	15.87	74.612	18.73	24.00	Pass

Note: * Test was performed in accordance with Measurement follow FCC KDB 789033 UNII test procedure Method SA-2 and use spectrum analyzer test.

26dB OCCUPIED BANDWIDTH

Channel	Frequency (MHz)	26dBc Bandwidth (MHz)	
		Chain 2	Chain 3
58	5290	83.28	83.15

Note: For U-NII-2A Band output power limitation is determined based on 26dBc bandwidth.

Power Limit = 11dBm + 10logB < U-NII-2A >			
Channel Number	Freq.(MHz)	Min. B(MHz)	Determined Conducted Limit (dBm)
58	5290	83.15	30.19 > 24

Spectrum Plot of Worst Value

802.11a / Chain 2 : CH60

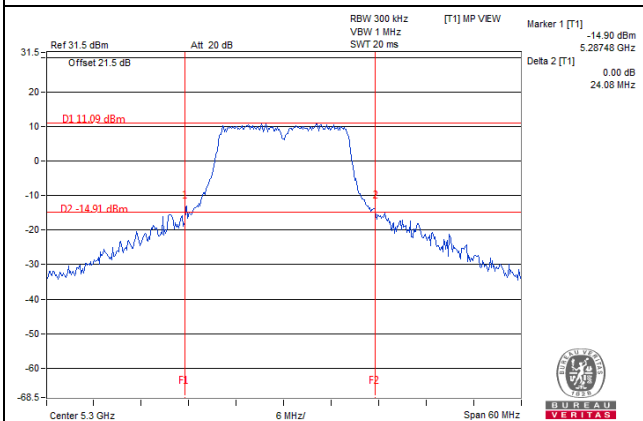

802.11ac (VHT20) / Chain 2 : CH64

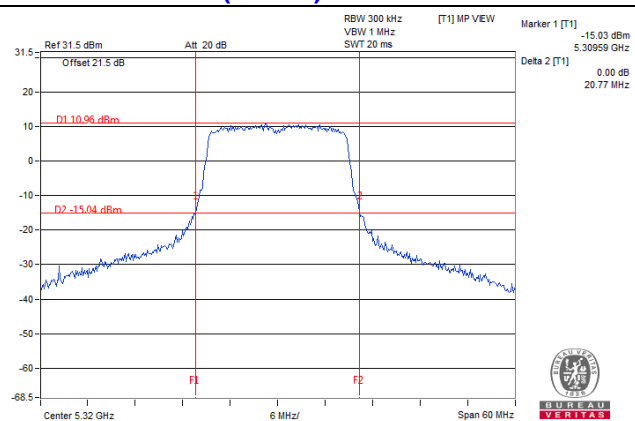

802.11ac (VHT40) / Chain 2 : CH62

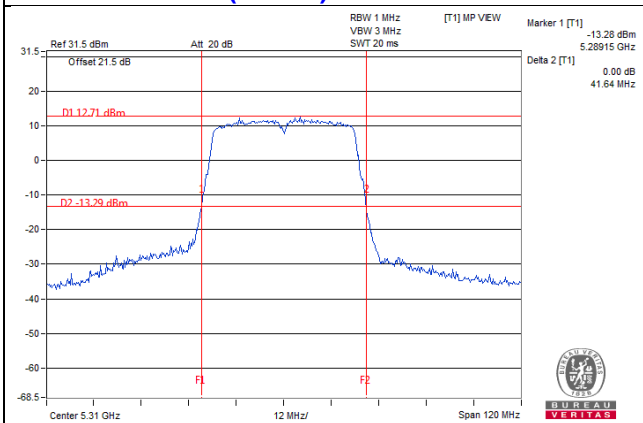

802.11ac (VHT80) / Chain 2 : CH58

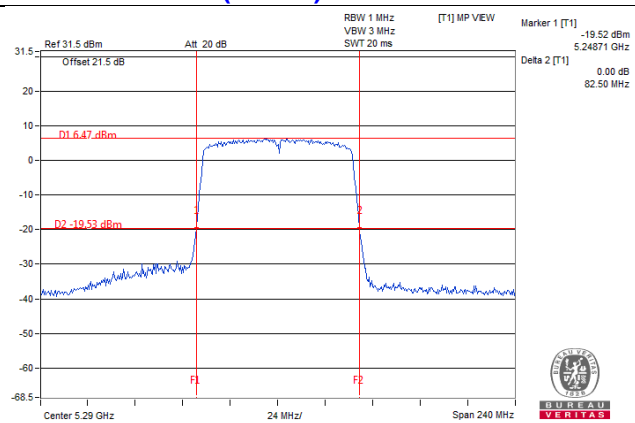

Spectrum Plot of Worst Value

802.11ax (HE20) / Chain 2 : CH60

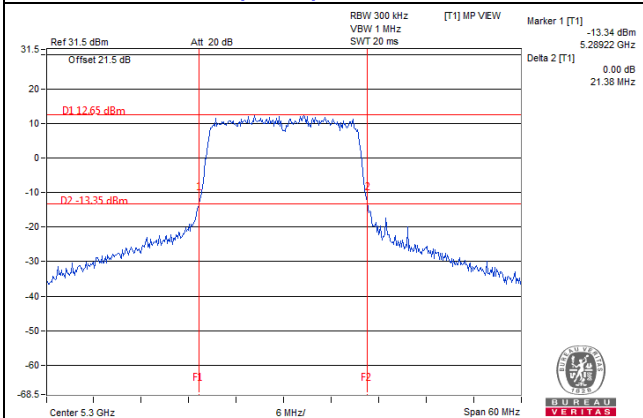

802.11ax (HE40) / Chain 3 : CH62

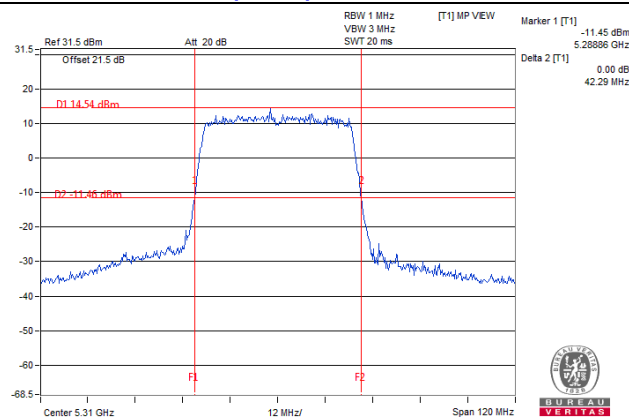

802.11ax (HE80) / Chain 3 : CH58

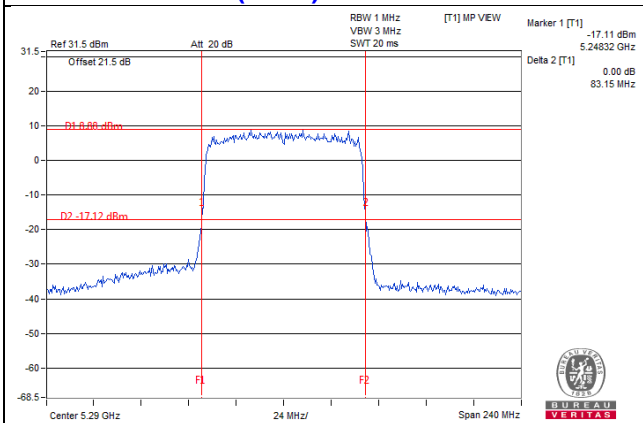

Beamforming Mode

802.11ac (VHT20)

Power Output:

Chan.	Chan. Freq. (MHz)	Maximum Conducted Power (dBm)		Total Power (mW)	Total Power (dBm)	Limit (dBm)	Pass / Fail
		Chain 2	Chain 3				
52	5260	19.18	19.45	170.899	22.33	22.50	Pass
60	5300	19.28	19.40	171.819	22.35	22.50	Pass
64	5320	19.35	19.35	172.198	22.36	22.50	Pass

Note: * Test was performed in accordance with Measurement follow FCC KDB 789033 UNII test procedure Method SA-2 and use spectrum analyzer test.

1. Directional gain = 7.5dBi > 6dBi, so the power limit shall be reduced to "Determined Conducted Limit-(7.5-6)".

26dB OCCUPIED BANDWIDTH

Channel	Frequency (MHz)	26dBc Bandwidth (MHz)	
		Chain 2	Chain 3
52	5260	20.90	21.11
60	5300	20.85	20.95
64	5320	20.77	21.14

Note: For U-NII-2A Band output power limitation is determined based on 26dBc bandwidth.

Power Limit = 11dBm + 10logB < U-NII-2A >			
Channel Number	Freq.(MHz)	Min. B(MHz)	Determined Conducted Limit (dBm)
52	5260	20.90	24.2 > 24
60	5300	20.85	24.19 > 24
64	5320	20.77	24.17 > 24

802.11ac (VHT40)

Power Output:

Chan.	Chan. Freq. (MHz)	Maximum Conducted Power (dBm)		Total Power (mW)	Total Power (dBm)	Limit (dBm)	Pass / Fail
		Chain 2	Chain 3				
54	5270	19.45	19.26	172.438	22.37	22.50	Pass
62	5310	17.32	17.22	106.674	20.28	22.50	Pass

Note: * Test was performed in accordance with Measurement follow FCC KDB 789033 UNII test procedure Method SA-2 and use spectrum analyzer test.

1. Directional gain = 7.5dBi > 6dBi, so the power limit shall be reduced to "Determined Conducted Limit-(7.5-6)".

26dB OCCUPIED BANDWIDTH

Channel	Frequency (MHz)	26dBc Bandwidth (MHz)	
		Chain 2	Chain 3
54	5270	55.33	52.39
62	5310	41.64	41.65

Note: For U-NII-2A Band output power limitation is determined based on 26dBc bandwidth.

Power Limit = 11dBm + 10logB < U-NII-2A >			
Channel Number	Freq.(MHz)	Min. B(MHz)	Determined Conducted Limit (dBm)
54	5270	52.39	28.19 > 24
62	5310	41.64	27.19 > 24

802.11ac (VHT80)

Power Output:

Chan.	Chan. Freq. (MHz)	Maximum Conducted Power (dBm)		Total Power (mW)	Total Power (dBm)	Limit (dBm)	Pass / Fail
		Chain 2	Chain 3				
58	5290	15.52	15.83	73.927	18.69	22.50	Pass

Note: * Test was performed in accordance with Measurement follow FCC KDB 789033 UNII test procedure Method SA-2 and use spectrum analyzer test.

1. Directional gain = 7.5dBi > 6dBi, so the power limit shall be reduced to "Determined Conducted Limit-(7.5-6)".

26dB OCCUPIED BANDWIDTH

Channel	Frequency (MHz)	26dBc Bandwidth (MHz)	
		Chain 2	Chain 3
58	5290	82.50	82.50

Note: For U-NII-2A Band output power limitation is determined based on 26dBc bandwidth.

Power Limit = 11dBm + 10logB < U-NII-2A >			
Channel Number	Freq.(MHz)	Min. B(MHz)	Determined Conducted Limit (dBm)
58	5290	82.50	30.16 > 24

802.11ax (HE20)

Power Output:

Chan.	Chan. Freq. (MHz)	Maximum Conducted Power (dBm)		Total Power (mW)	Total Power (dBm)	Limit (dBm)	Pass / Fail
		Chain 2	Chain 3				
52	5260	19.22	19.48	172.276	22.36	22.50	Pass
60	5300	19.31	19.42	172.808	22.38	22.50	Pass
64	5320	19.36	19.39	173.194	22.39	22.50	Pass

Note: * Test was performed in accordance with Measurement follow FCC KDB 789033 UNII test procedure Method SA-2 and use spectrum analyzer test.

1. Directional gain = 7.5dBi > 6dBi, so the power limit shall be reduced to "Determined Conducted Limit-(7.5-6)".

26dB OCCUPIED BANDWIDTH

Channel	Frequency (MHz)	26dBc Bandwidth (MHz)	
		Chain 2	Chain 3
52	5260	21.49	21.58
60	5300	21.38	21.51
64	5320	21.46	21.70

Note: For U-NII-2A Band output power limitation is determined based on 26dBc bandwidth.

Power Limit = 11dBm + 10logB < U-NII-2A >			
Channel Number	Freq.(MHz)	Min. B(MHz)	Determined Conducted Limit (dBm)
52	5260	21.49	24.32 > 24
60	5300	21.38	24.3 > 24
64	5320	21.46	24.31 > 24

802.11ax (HE40)

Power Output:

Chan.	Chan. Freq. (MHz)	Maximum Conducted Power (dBm)		Total Power (mW)	Total Power (dBm)	Limit (dBm)	Pass / Fail
		Chain 2	Chain 3				
54	5270	19.48	19.28	173.439	22.39	22.50	Pass
62	5310	17.36	17.25	107.538	20.32	22.50	Pass

Note: * Test was performed in accordance with Measurement follow FCC KDB 789033 UNII test procedure Method SA-2 and use spectrum analyzer test.

1. Directional gain = 7.5dBi > 6dBi, so the power limit shall be reduced to "Determined Conducted Limit-(7.5-6)".

26dB OCCUPIED BANDWIDTH

Channel	Frequency (MHz)	26dBc Bandwidth (MHz)	
		Chain 2	Chain 3
54	5270	55.52	42.76
62	5310	42.74	42.29

Note: For U-NII-2A Band output power limitation is determined based on 26dBc bandwidth.

Power Limit = 11dBm + 10logB < U-NII-2A >			
Channel Number	Freq.(MHz)	Min. B(MHz)	Determined Conducted Limit (dBm)
54	5270	42.76	27.31 > 24
62	5310	42.29	27.26 > 24

802.11ax (HE80)

Power Output:

Chan.	Chan. Freq. (MHz)	Maximum Conducted Power (dBm)		Total Power (mW)	Total Power (dBm)	Limit (dBm)	Pass / Fail
		Chain 2	Chain 3				
58	5290	15.56	15.87	74.612	18.73	22.50	Pass

Note: * Test was performed in accordance with Measurement follow FCC KDB 789033 UNII test procedure Method SA-2 and use spectrum analyzer test.

1. Directional gain = 7.5dBi > 6dBi, so the power limit shall be reduced to "Determined Conducted Limit-(7.5-6)".

26dB OCCUPIED BANDWIDTH

Channel	Frequency (MHz)	26dBc Bandwidth (MHz)	
		Chain 2	Chain 3
58	5290	83.28	83.15

Note: For U-NII-2A Band output power limitation is determined based on 26dBc bandwidth.

Power Limit = 11dBm + 10logB < U-NII-2A >			
Channel Number	Freq.(MHz)	Min. B(MHz)	Determined Conducted Limit (dBm)
58	5290	83.15	30.19 > 24

Spectrum Plot of Worst Value

802.11ac (VHT20) / Chain 2 : CH64

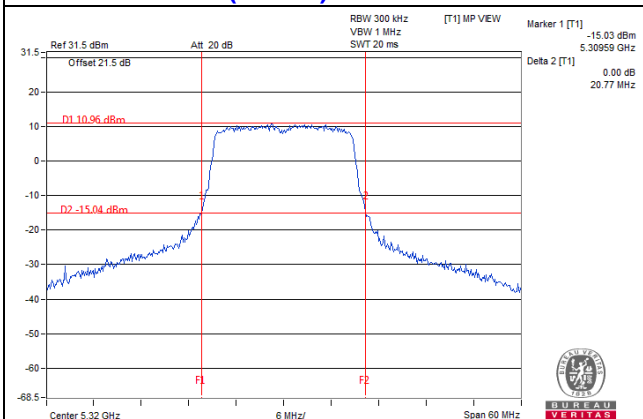

802.11ac (VHT40) / Chain 2 : CH62

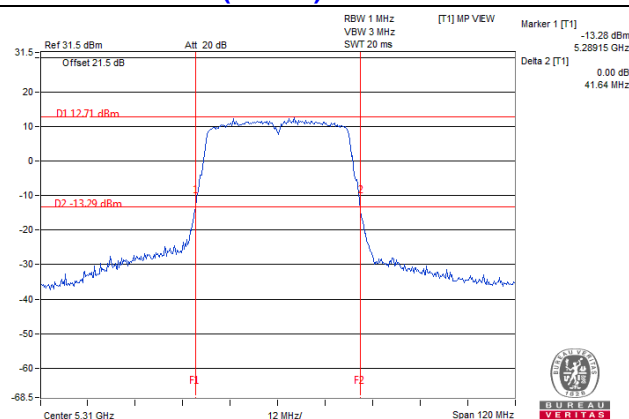

802.11ac (VHT80) / Chain 2 : CH58

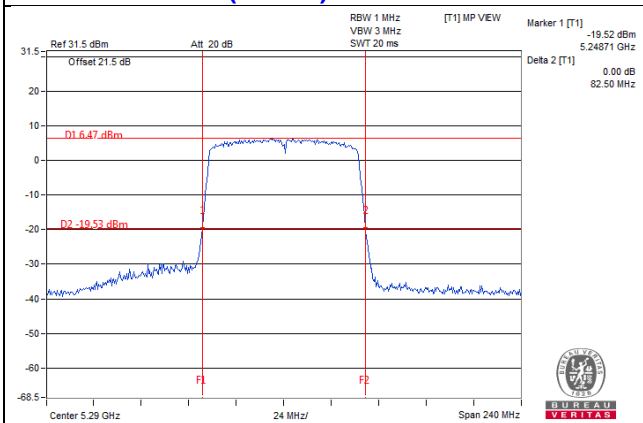

Spectrum Plot of Worst Value

802.11ax (HE20) / Chain 2 : CH60

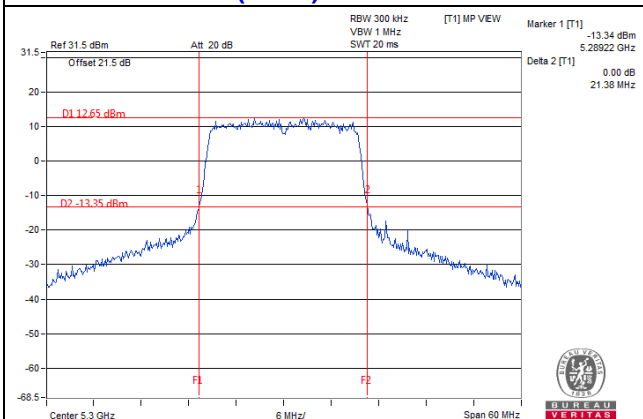

802.11ax (HE40) / Chain 3 : CH62

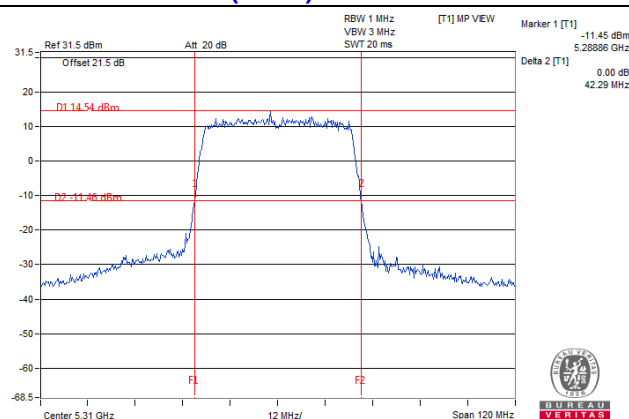

802.11ax (HE80) / Chain 3 : CH58

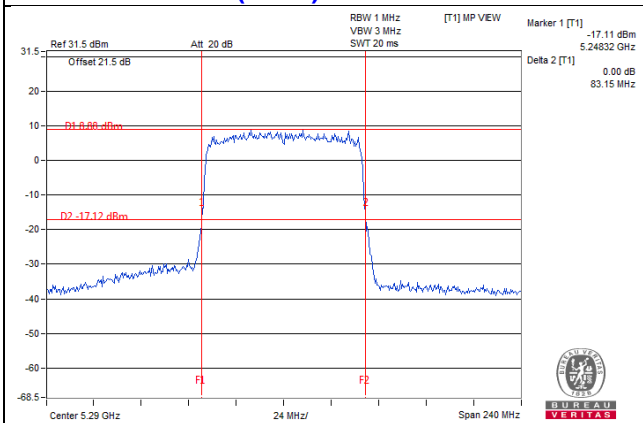

For UNII-2C, UNII-3:

Non-Beamforming Mode

802.11a

Power Output:

Chan.	Chan. Freq. (MHz)	Maximum Conducted Power (dBm)		Total Power (mW)	Total Power (dBm)	Limit (dBm)	Pass / Fail
		Chain 0	Chain 1				
100	5500	19.39	18.72	161.369	22.08	24.00	Pass
116	5580	19.35	18.89	163.545	22.14	24.00	Pass
140	5700	19.36	18.82	162.506	22.11	24.00	Pass
*144 (UNII-2C Band)	5720	14.18	13.60	52.804	17.23	22.95	Pass
*144 (UNII-3 Band)	5720	7.40	7.83	12.436	10.95	30.00	Pass

Note: * Test was performed in accordance with Measurement follow FCC KDB 789033 UNII test procedure Method SA-2 and use spectrum analyzer test.

The Average Power for the straddle channel:

Chan.	Chan. Freq. (MHz)	Average Power (mW)	Average Power (dBm)
144	5720	65.24	18.15

Note: The total power was calculated through formula and record the value for reference only.

26dB OCCUPIED BANDWIDTH

Channel	Frequency (MHz)	26dBc Bandwidth (MHz)	
		Chain 0	Chain 1
100	5500	30.24	20.97
116	5580	32.20	21.51
140	5700	30.21	21.69
144 (UNII-2C Band)	5720	21.57	15.67

Note: For U-NII-2C Band output power limitation is determined based on 26dBc bandwidth.

Power Limit = 11dBm + 10logB < U-NII-2C >			
Channel Number	Freq.(MHz)	Min. B(MHz)	Determined Conducted Limit (dBm)
100	5500	20.97	24.21 > 24
116	5580	21.51	24.32 > 24
140	5700	21.69	24.36 > 24
144 (UNII-2C Band)	5720	15.67	22.95 < 24

802.11ac (VHT20)

Power Output:

Chan.	Chan. Freq. (MHz)	Maximum Conducted Power (dBm)		Total Power (mW)	Total Power (dBm)	Limit (dBm)	Pass / Fail
		Chain 0	Chain 1				
100	5500	19.44	18.60	160.346	22.05	24.00	Pass
116	5580	19.50	18.64	162.239	22.10	24.00	Pass
140	5700	19.40	18.96	165.801	22.20	24.00	Pass
*144 (UNII-2C Band)	5720	14.53	14.09	56.166	17.49	23.06	Pass
*144 (UNII-3 Band)	5720	8.82	8.21	14.808	11.70	30.00	Pass

Note: * Test was performed in accordance with Measurement follow FCC KDB 789033 UNII test procedure Method SA-2 and use spectrum analyzer test.

The Average Power for the straddle channel:

Chan.	Chan. Freq. (MHz)	Average Power (mW)	Average Power (dBm)
144	5720	70.974	18.51

Note: The total power was calculated through formula and record the value for reference only.

26dB OCCUPIED BANDWIDTH

Channel	Frequency (MHz)	26dBc Bandwidth (MHz)	
		Chain 0	Chain 1
100	5500	22.43	21.15
116	5580	24.68	21.29
140	5700	21.58	21.50
144 (UNII-2C Band)	5720	16.25	16.08

Note: For U-NII-2C Band output power limitation is determined based on 26dBc bandwidth.

Power Limit = 11dBm + 10logB < U-NII-2C >			
Channel Number	Freq.(MHz)	Min. B(MHz)	Determined Conducted Limit (dBm)
100	5500	21.15	24.25 > 24
116	5580	21.29	24.28 > 24
140	5700	21.50	24.32 > 24
144 (UNII-2C Band)	5720	16.08	23.06 < 24

802.11ac (VHT40)

Power Output:

Chan.	Chan. Freq. (MHz)	Maximum Conducted Power (dBm)		Total Power (mW)	Total Power (dBm)	Limit (dBm)	Pass / Fail
		Chain 0	Chain 1				
102	5510	17.15	17.28	105.336	20.23	24.00	Pass
110	5550	20.40	20.35	218.041	23.39	24.00	Pass
134	5670	18.52	18.92	149.104	21.73	24.00	Pass
*142 (UNII-2C Band)	5710	16.45	16.56	92.944	19.68	24.00	Pass
*142 (UNII-3 Band)	5710	5.01	6.06	7.488	8.74	30.00	Pass

Note: * Test was performed in accordance with Measurement follow FCC KDB 789033 UNII test procedure Method SA-2 and use spectrum analyzer test.

The Average Power for the straddle channel:

Chan.	Chan. Freq. (MHz)	Average Power (mW)	Average Power (dBm)
142	5710	100.432	20.02

Note: The total power was calculated through formula and record the value for reference only.

26dB OCCUPIED BANDWIDTH

Channel	Frequency (MHz)	26dBc Bandwidth (MHz)	
		Chain 0	Chain 1
102	5510	41.60	41.63
110	5550	64.42	50.39
134	5670	41.90	42.00
142 (UNII-2C Band)	5710	43.65	42.35

Note: For U-NII-2C Band output power limitation is determined based on 26dBc bandwidth.

Power Limit = 11dBm + 10logB < U-NII-2C >			
Channel Number	Freq.(MHz)	Min. B(MHz)	Determined Conducted Limit (dBm)
102	5510	41.60	27.19 > 24
110	5550	50.39	28.02 > 24
134	5670	41.90	27.22 > 24
142 (UNII-2C Band)	5710	42.35	27.26 > 24

802.11ac (VHT80)

Power Output:

Chan.	Chan. Freq. (MHz)	Maximum Conducted Power (dBm)		Total Power (mW)	Total Power (dBm)	Limit (dBm)	Pass / Fail
		Chain 0	Chain 1				
106	5530	16.20	16.35	84.839	19.29	24.00	Pass
122	5610	20.82	20.62	236.126	23.73	24.00	Pass
*138 (UNII-2C Band)	5690	16.60	16.50	94.16	19.74	24.00	Pass
*138 (UNII-3 Band)	5690	2.86	1.66	3.54	5.49	30.00	Pass

Note: * Test was performed in accordance with Measurement follow FCC KDB 789033 UNII test procedure Method SA-2 and use spectrum analyzer test.

The Average Power for the straddle channel:

Chan.	Chan. Freq. (MHz)	Average Power (mW)	Average Power (dBm)
138	5690	97.7	19.9

Note: The total power was calculated through formula and record the value for reference only.

26dB OCCUPIED BANDWIDTH

Channel	Frequency (MHz)	26dBc Bandwidth (MHz)	
		Chain 0	Chain 1
106	5530	82.59	82.57
122	5610	156.66	139.89
138 (UNII-2C Band)	5690	88.41	90.16

Note: For U-NII-2C Band output power limitation is determined based on 26dBc bandwidth.

Power Limit = 11dBm + 10logB < U-NII-2C >			
Channel Number	Freq.(MHz)	Min. B(MHz)	Determined Conducted Limit (dBm)
106	5530	82.57	30.16 > 24
122	5610	139.89	32.45 > 24
138 (UNII-2C Band)	5690	88.41	30.46 > 24

802.11ax (HE20)

Power Output:

Chan.	Chan. Freq. (MHz)	Maximum Conducted Power (dBm)		Total Power (mW)	Total Power (dBm)	Limit (dBm)	Pass / Fail
		Chain 0	Chain 1				
100	5500	19.48	18.62	161.494	22.08	24.00	Pass
116	5580	19.52	18.66	162.987	22.12	24.00	Pass
140	5700	19.42	18.98	166.566	22.22	24.00	Pass
*144 (UNII-2C Band)	5720	14.16	13.89	52.946	17.24	22.97	Pass
*144 (UNII-3 Band)	5720	8.53	8.48	14.847	11.72	30.00	Pass

Note: * Test was performed in accordance with Measurement follow FCC KDB 789033 UNII test procedure Method SA-2 and use spectrum analyzer test.

The Average Power for the straddle channel:

Chan.	Chan. Freq. (MHz)	Average Power (mW)	Average Power (dBm)
144	5720	67.793	18.31

Note: The total power was calculated through formula and record the value for reference only.

26dB OCCUPIED BANDWIDTH

Channel	Frequency (MHz)	26dBc Bandwidth (MHz)	
		Chain 0	Chain 1
100	5500	22.20	21.53
116	5580	23.24	21.57
140	5700	21.77	22.18
144 (UNII-2C Band)	5720	15.74	15.89

Note: For U-NII-2C Band output power limitation is determined based on 26dBc bandwidth.

Power Limit = 11dBm + 10logB < U-NII-2C >			
Channel Number	Freq.(MHz)	Min. B(MHz)	Determined Conducted Limit (dBm)
100	5500	21.53	24.33 > 24
116	5580	21.57	24.33 > 24
140	5700	21.77	24.37 > 24
144 (UNII-2C Band)	5720	15.74	22.97 < 24

802.11ax (HE40)

Power Output:

Chan.	Chan. Freq. (MHz)	Maximum Conducted Power (dBm)		Total Power (mW)	Total Power (dBm)	Limit (dBm)	Pass / Fail
		Chain 0	Chain 1				
102	5510	17.18	17.30	105.943	20.25	24.00	Pass
110	5550	20.42	20.39	219.55	23.42	24.00	Pass
134	5670	18.56	18.95	150.303	21.77	24.00	Pass
*142 (UNII-2C Band)	5710	16.33	16.53	91.438	19.61	24.00	Pass
*142 (UNII-3 Band)	5710	6.50	6.28	9.06	9.57	30.00	Pass

Note: * Test was performed in accordance with Measurement follow FCC KDB 789033 UNII test procedure Method SA-2 and use spectrum analyzer test.

The Average Power for the straddle channel:

Chan.	Chan. Freq. (MHz)	Average Power (mW)	Average Power (dBm)
142	5710	100.498	20.02

Note: The total power was calculated through formula and record the value for reference only.

26dB OCCUPIED BANDWIDTH

Channel	Frequency (MHz)	26dBc Bandwidth (MHz)	
		Chain 0	Chain 1
102	5510	42.34	42.12
110	5550	64.86	45.11
134	5670	42.06	43.28
142 (UNII-2C Band)	5710	42.91	42.67

Note: For U-NII-2C Band output power limitation is determined based on 26dBc bandwidth.

Power Limit = 11dBm + 10logB < U-NII-2C >			
Channel Number	Freq.(MHz)	Min. B(MHz)	Determined Conducted Limit (dBm)
102	5510	42.12	27.24 > 24
110	5550	45.11	27.54 > 24
134	5670	42.06	27.23 > 24
142 (UNII-2C Band)	5710	42.67	27.3 > 24

802.11ax (HE80)

Power Output:

Chan.	Chan. Freq. (MHz)	Maximum Conducted Power (dBm)		Total Power (mW)	Total Power (dBm)	Limit (dBm)	Pass / Fail
		Chain 0	Chain 1				
106	5530	16.23	16.38	85.427	19.32	24.00	Pass
122	5610	20.85	20.64	237.497	23.76	24.00	Pass
*138 (UNII-2C Band)	5690	17.10	16.71	102.131	20.09	24.00	Pass
*138 (UNII-3 Band)	5690	3.37	2.29	4.023	6.05	30.00	Pass

Note: * Test was performed in accordance with Measurement follow FCC KDB 789033 UNII test procedure Method SA-2 and use spectrum analyzer test.

The Average Power for the straddle channel:

Chan.	Chan. Freq. (MHz)	Average Power (mW)	Average Power (dBm)
138	5690	106.154	20.26

Note: The total power was calculated through formula and record the value for reference only.

26dB OCCUPIED BANDWIDTH

Channel	Frequency (MHz)	26dBc Bandwidth (MHz)	
		Chain 0	Chain 1
106	5530	82.90	82.93
122	5610	118.44	119.03
138 (UNII-2C Band)	5690	91.31	82.54

Note: For U-NII-2C Band output power limitation is determined based on 26dBc bandwidth.

Power Limit = 11dBm + 10logB < U-NII-2C >			
Channel Number	Freq.(MHz)	Min. B(MHz)	Determined Conducted Limit (dBm)
106	5530	82.90	30.18 > 24
122	5610	118.44	31.73 > 24
138 (UNII-2C Band)	5690	82.54	30.16 > 24

Spectrum Plot of Worst Value

802.11a / Chain 1 : CH144 (UNII-2C Band)

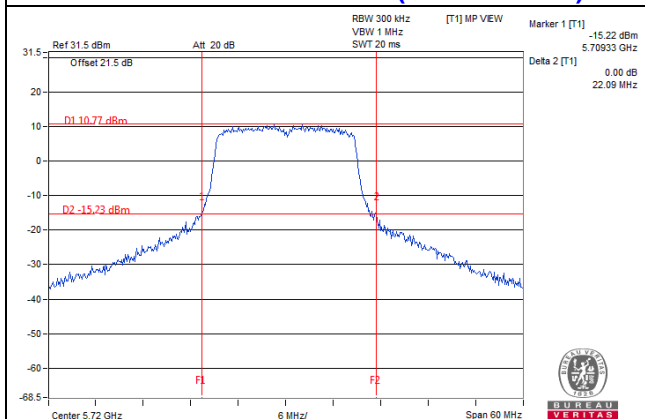

802.11ac (VHT20) / Chain 1 : CH144 (UNII-2C Band)

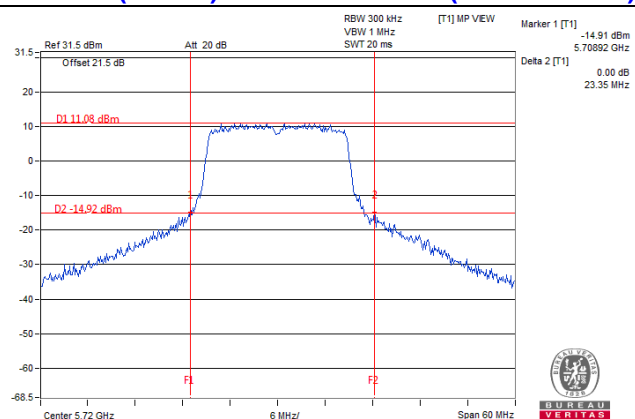

802.11ac (VHT40) / Chain 0 : CH102

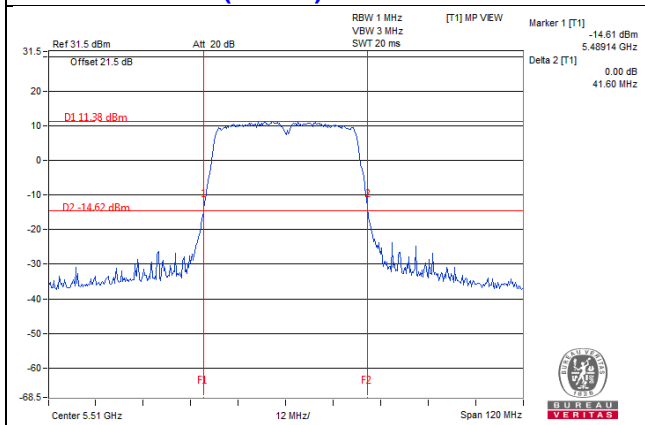

802.11ac (VHT80) / Chain 1 : CH106

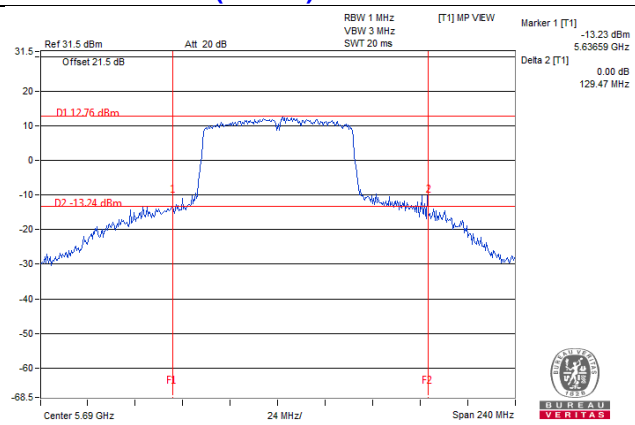

NOTE:

- For CH144 (UNII-2C Band) = 5725MHz - Marker 1
- For CH142 (UNII-2C Band) = 5725MHz - Marker 1
- For CH138 (UNII-2C Band) = 5725MHz - Marker 1

Spectrum Plot of Worst Value

802.11ax (HE20) / Chain 0 : CH144 (UNII-2C Band)

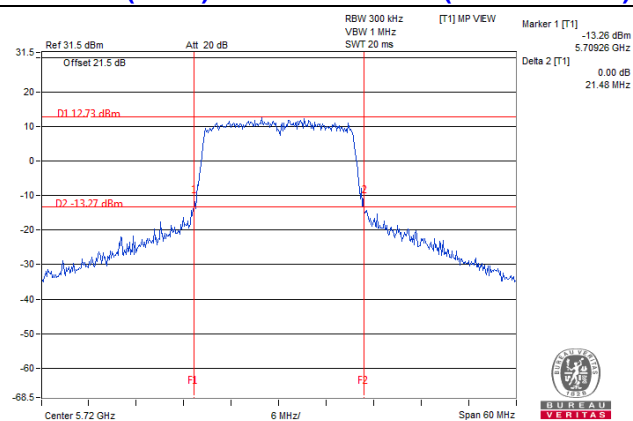

802.11ax (HE40) / Chain 0 : CH134

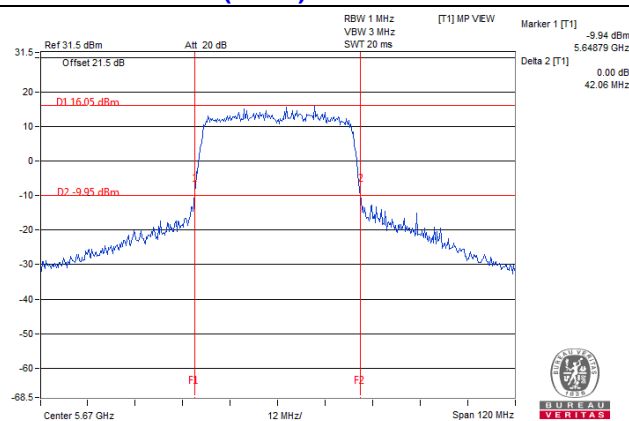

802.11ax (HE80) / Chain 1 : CH138 (UNII-2C Band)

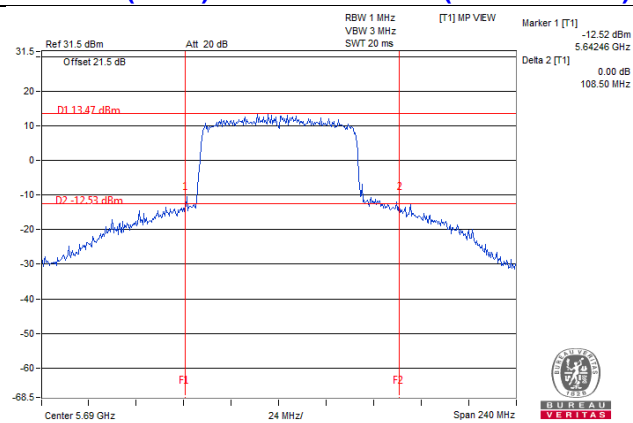

NOTE:

- For CH144 (UNII-2C Band) = 5725MHz - Marker 1
- For CH142 (UNII-2C Band) = 5725MHz - Marker 1
- For CH138 (UNII-2C Band) = 5725MHz - Marker 1

Beamforming Mode

802.11ac (VHT20)

Power Output:

Chan.	Chan. Freq. (MHz)	Maximum Conducted Power (dBm)		Total Power (mW)	Total Power (dBm)	Limit (dBm)	Pass / Fail
		Chain 0	Chain 1				
100	5500	19.44	18.60	160.346	22.05	22.29	Pass
116	5580	19.50	18.64	162.239	22.10	22.29	Pass
140	5700	19.40	18.96	165.801	22.20	22.29	Pass
*144 (UNII-2C Band)	5720	14.53	14.09	56.166	17.49	21.35	Pass
*144 (UNII-3 Band)	5720	8.82	8.21	14.808	11.70	28.73	Pass

Note: * Test was performed in accordance with Measurement follow FCC KDB 789033 UNII test procedure Method SA-2 and use spectrum analyzer test.

1. For UNII-2C Band: the directional gain = 7.71dBi > 6dBi, so the power limit shall be reduced to "Determined Conducted Limit-(7.71-6)".
2. For UNII-3 Band: the directional gain = 7.27dBi > 6dBi, so the power limit shall be reduced to $30-(7.27-6) = 28.73\text{dBm}$.

The Average Power for the straddle channel:

Chan.	Chan. Freq. (MHz)	Average Power (mW)	Average Power (dBm)
144	5720	70.974	18.51

Note: The total power was calculated through formula and record the value for reference only.

26dB OCCUPIED BANDWIDTH

Channel	Frequency (MHz)	26dBc Bandwidth (MHz)	
		Chain 0	Chain 1
100	5500	22.43	21.15
116	5580	24.68	21.29
140	5700	21.58	21.50
144 (UNII-2C Band)	5720	16.25	16.08

Note: For U-NII-2C Band output power limitation is determined based on 26dBc bandwidth.

Power Limit = 11dBm + 10logB < U-NII-2C >			
Channel Number	Freq.(MHz)	Min. B(MHz)	Determined Conducted Limit (dBm)
100	5500	21.15	24.25 > 24
116	5580	21.29	24.28 > 24
140	5700	21.50	24.32 > 24
144 (UNII-2C Band)	5720	16.08	23.06 < 24

802.11ac (VHT40)

Power Output:

Chan.	Chan. Freq. (MHz)	Maximum Conducted Power (dBm)		Total Power (mW)	Total Power (dBm)	Limit (dBm)	Pass / Fail
		Chain 0	Chain 1				
102	5510	17.15	17.28	105.336	20.23	22.29	Pass
110	5550	19.20	18.86	160.089	22.04	22.29	Pass
134	5670	18.52	18.92	149.104	21.73	22.29	Pass
*142 (UNII-2C Band)	5710	15.22	14.84	66.237	18.21	22.29	Pass
*142 (UNII-3 Band)	5710	2.59	4.12	4.57	6.60	28.73	Pass

Note: * Test was performed in accordance with Measurement follow FCC KDB 789033 UNII test procedure Method SA-2 and use spectrum analyzer test.

1. For UNII-2C Band: the directional gain = 7.71dBi > 6dBi, so the power limit shall be reduced to "Determined Conducted Limit-(7.71-6)".
2. For UNII-3 Band: the directional gain = 7.27dBi > 6dBi, so the power limit shall be reduced to 30-(7.27-6) = 28.73dBm.

The Average Power for the straddle channel:

Chan.	Chan. Freq. (MHz)	Average Power (mW)	Average Power (dBm)
142	5710	70.807	18.5

Note: The total power was calculated through formula and record the value for reference only.

26dB OCCUPIED BANDWIDTH

Channel	Frequency (MHz)	26dBc Bandwidth (MHz)	
		Chain 0	Chain 1
102	5510	41.60	41.63
110	5550	64.42	50.39
134	5670	41.90	42.00
142 (UNII-2C Band)	5710	43.65	42.35

Note: For U-NII-2C Band output power limitation is determined based on 26dBc bandwidth.

Power Limit = 11dBm + 10logB < U-NII-2C >			
Channel Number	Freq.(MHz)	Min. B(MHz)	Determined Conducted Limit (dBm)
102	5510	41.60	27.19 > 24
110	5550	50.39	28.02 > 24
134	5670	41.90	27.22 > 24
142 (UNII-2C Band)	5710	42.35	27.26 > 24

802.11ac (VHT80)

Power Output:

Chan.	Chan. Freq. (MHz)	Maximum Conducted Power (dBm)		Total Power (mW)	Total Power (dBm)	Limit (dBm)	Pass / Fail
		Chain 0	Chain 1				
106	5530	16.20	16.35	84.839	19.29	22.29	Pass
122	5610	19.32	19.12	167.165	22.23	22.29	Pass
*138 (UNII-2C Band)	5690	15.29	15.17	69.483	18.42	22.29	Pass
*138 (UNII-3 Band)	5690	0.65	0.71	2.437	3.87	28.73	Pass

Note: * Test was performed in accordance with Measurement follow FCC KDB 789033 UNII test procedure Method SA-2 and use spectrum analyzer test.

1. For UNII-2C Band: the directional gain = 7.71dBi > 6dBi, so the power limit shall be reduced to "Determined Conducted Limit-(7.71-6)".
2. For UNII-3 Band: the directional gain = 7.27dBi > 6dBi, so the power limit shall be reduced to 30-(7.27-6) = 28.73dBm.

The Average Power for the straddle channel:

Chan.	Chan. Freq. (MHz)	Average Power (mW)	Average Power (dBm)
138	5690	71.92	18.57

Note: The total power was calculated through formula and record the value for reference only.

26dB OCCUPIED BANDWIDTH

Channel	Frequency (MHz)	26dBc Bandwidth (MHz)	
		Chain 0	Chain 1
106	5530	82.59	82.57
122	5610	156.66	139.89
138 (UNII-2C Band)	5690	88.41	90.16

Note: For U-NII-2C Band output power limitation is determined based on 26dBc bandwidth.

Power Limit = 11dBm + 10logB < U-NII-2C >			
Channel Number	Freq.(MHz)	Min. B(MHz)	Determined Conducted Limit (dBm)
106	5530	82.57	30.16 > 24
122	5610	139.89	32.45 > 24
138 (UNII-2C Band)	5690	88.41	30.46 > 24

802.11ax (HE20)

Power Output:

Chan.	Chan. Freq. (MHz)	Maximum Conducted Power (dBm)		Total Power (mW)	Total Power (dBm)	Limit (dBm)	Pass / Fail
		Chain 0	Chain 1				
100	5500	19.48	18.62	161.494	22.08	22.29	Pass
116	5580	19.52	18.66	162.987	22.12	22.29	Pass
140	5700	19.42	18.98	166.566	22.22	22.29	Pass
*144 (UNII-2C Band)	5720	14.16	13.89	52.946	17.24	21.26	Pass
*144 (UNII-3 Band)	5720	8.53	8.48	14.847	11.72	28.73	Pass

Note: * Test was performed in accordance with Measurement follow FCC KDB 789033 UNII test procedure Method SA-2 and use spectrum analyzer test.

1. For UNII-2C Band: the directional gain = 7.71dBi > 6dBi, so the power limit shall be reduced to "Determined Conducted Limit-(7.71-6)".
2. For UNII-3 Band: the directional gain = 7.27dBi > 6dBi, so the power limit shall be reduced to 30-(7.27-6) = 28.73dBm.

The Average Power for the straddle channel:

Chan.	Chan. Freq. (MHz)	Average Power (mW)	Average Power (dBm)
144	5720	67.793	18.31

Note: The total power was calculated through formula and record the value for reference only.

26dB OCCUPIED BANDWIDTH

Channel	Frequency (MHz)	26dBc Bandwidth (MHz)	
		Chain 0	Chain 1
100	5500	22.20	21.53
116	5580	23.24	21.57
140	5700	21.77	22.18
144 (UNII-2C Band)	5720	15.74	15.89

Note: For U-NII-2C Band output power limitation is determined based on 26dBc bandwidth.

Power Limit = 11dBm + 10logB < U-NII-2C >			
Channel Number	Freq.(MHz)	Min. B(MHz)	Determined Conducted Limit (dBm)
100	5500	21.53	24.33 > 24
116	5580	21.57	24.33 > 24
140	5700	21.77	24.37 > 24
144 (UNII-2C Band)	5720	15.74	22.97 < 24

802.11ax (HE40)

Power Output:

Chan.	Chan. Freq. (MHz)	Maximum Conducted Power (dBm)		Total Power (mW)	Total Power (dBm)	Limit (dBm)	Pass / Fail
		Chain 0	Chain 1				
102	5510	17.18	17.30	105.943	20.25	22.29	Pass
110	5550	19.22	18.89	161.006	22.07	22.29	Pass
134	5670	18.56	18.95	150.303	21.77	22.29	Pass
*142 (UNII-2C Band)	5710	14.73	14.98	63.634	18.04	22.29	Pass
*142 (UNII-3 Band)	5710	4.03	4.57	5.608	7.49	28.73	Pass

Note: * Test was performed in accordance with Measurement follow FCC KDB 789033 UNII test procedure Method SA-2 and use spectrum analyzer test.

1. For UNII-2C Band: the directional gain = 7.71dBi > 6dBi, so the power limit shall be reduced to "Determined Conducted Limit-(7.71-6)".
2. For UNII-3 Band: the directional gain = 7.27dBi > 6dBi, so the power limit shall be reduced to 30-(7.27-6) = 28.73dBm.

The Average Power for the straddle channel:

Chan.	Chan. Freq. (MHz)	Average Power (mW)	Average Power (dBm)
142	5710	69.242	18.4

Note: The total power was calculated through formula and record the value for reference only.

26dB OCCUPIED BANDWIDTH

Channel	Frequency (MHz)	26dBc Bandwidth (MHz)	
		Chain 0	Chain 1
102	5510	42.34	42.12
110	5550	64.86	45.11
134	5670	42.06	43.28
142 (UNII-2C Band)	5710	42.91	42.67

Note: For U-NII-2C Band output power limitation is determined based on 26dBc bandwidth.

Power Limit = 11dBm + 10logB < U-NII-2C >			
Channel Number	Freq.(MHz)	Min. B(MHz)	Determined Conducted Limit (dBm)
102	5510	42.12	27.24 > 24
110	5550	45.11	27.54 > 24
134	5670	42.06	27.23 > 24
142 (UNII-2C Band)	5710	42.67	27.3 > 24

802.11ax (HE80)

Power Output:

Chan.	Chan. Freq. (MHz)	Maximum Conducted Power (dBm)		Total Power (mW)	Total Power (dBm)	Limit (dBm)	Pass / Fail
		Chain 0	Chain 1				
106	5530	16.23	16.38	85.427	19.32	22.29	Pass
122	5610	19.35	19.14	168.134	22.26	22.29	Pass
*138 (UNII-2C Band)	5690	15.14	15.46	70.553	18.49	22.29	Pass
*138 (UNII-3 Band)	5690	1.84	2.10	3.277	5.15	28.73	Pass

Note: * Test was performed in accordance with Measurement follow FCC KDB 789033 UNII test procedure Method SA-2 and use spectrum analyzer test.

1. For UNII-2C Band: the directional gain = 7.71dBi > 6dBi, so the power limit shall be reduced to "Determined Conducted Limit-(7.71-6)".
2. For UNII-3 Band: the directional gain = 7.27dBi > 6dBi, so the power limit shall be reduced to $30-(7.27-6) = 28.73\text{dBm}$.

The Average Power for the straddle channel:

Chan.	Chan. Freq. (MHz)	Average Power (mW)	Average Power (dBm)
138	5690	73.83	18.68

Note: The total power was calculated through formula and record the value for reference only.

26dB OCCUPIED BANDWIDTH

Channel	Frequency (MHz)	26dBc Bandwidth (MHz)	
		Chain 0	Chain 1
106	5530	82.90	82.93
122	5610	118.44	119.03
138 (UNII-2C Band)	5690	91.31	82.54

Note: For U-NII-2C Band output power limitation is determined based on 26dBc bandwidth.

Power Limit = 11dBm + 10logB < U-NII-2C >			
Channel Number	Freq.(MHz)	Min. B(MHz)	Determined Conducted Limit (dBm)
106	5530	82.90	30.18 > 24
122	5610	118.44	31.73 > 24
138 (UNII-2C Band)	5690	82.54	30.16 > 24

Spectrum Plot of Worst Value

802.11ac (VHT20) / Chain 1 : CH144 (UNII-2C Band)

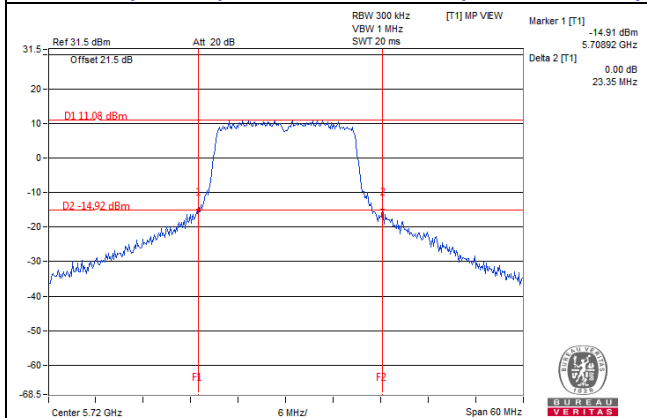

802.11ac (VHT40) / Chain 0 : CH102

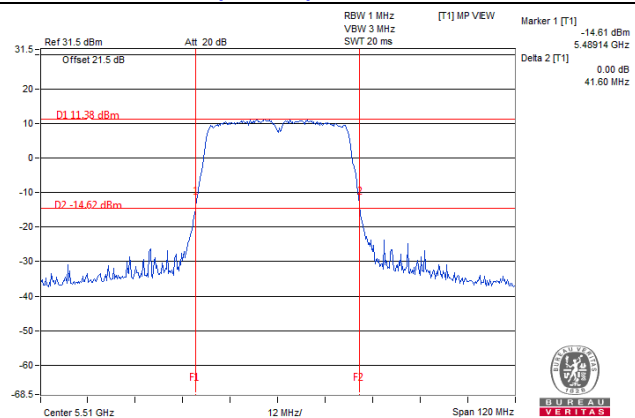

802.11ac (VHT80) / Chain 1 : CH106

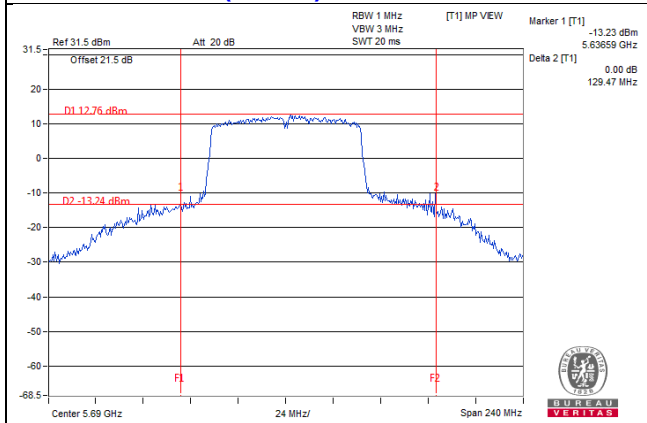

NOTE:

- For CH144 (UNII-2C Band) = 5725MHz - Marker 1
- For CH142 (UNII-2C Band) = 5725MHz - Marker 1
- For CH138 (UNII-2C Band) = 5725MHz - Marker 1

Spectrum Plot of Worst Value

802.11ax (HE20) / Chain 0 : CH144 (UNII-2C Band)

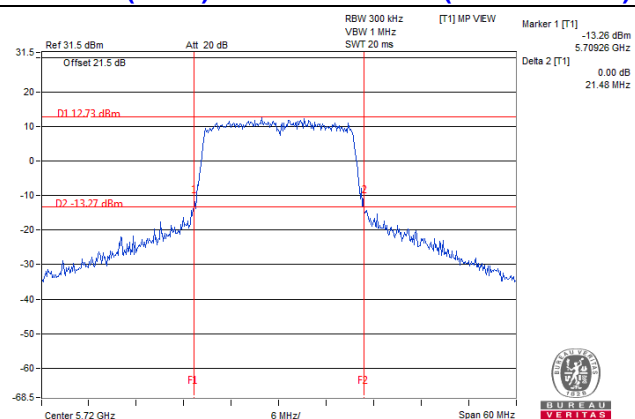

802.11ax (HE40) / Chain 0 : CH134

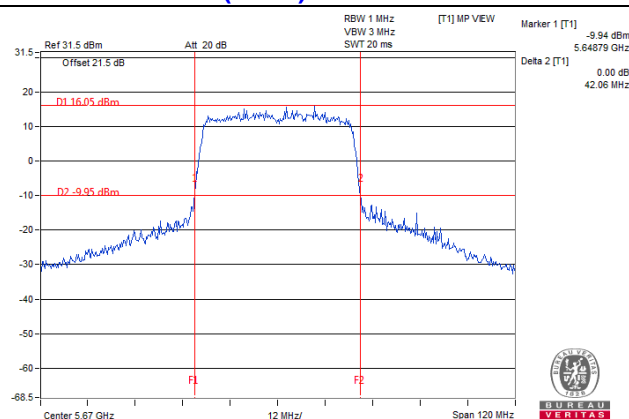

802.11ax (HE80) / Chain 1 : CH138 (UNII-2C Band)

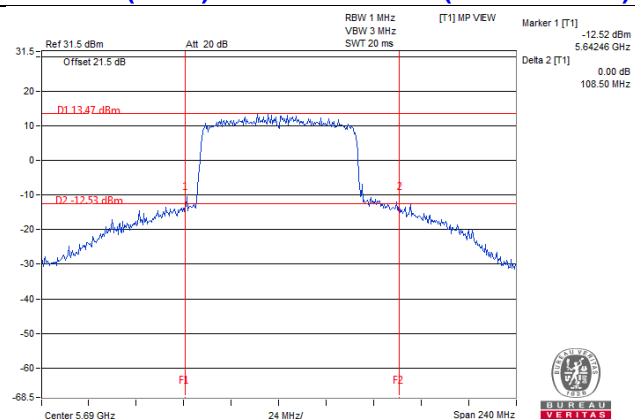

NOTE:

- For CH144 (UNII-2C Band) = 5725MHz - Marker 1
- For CH142 (UNII-2C Band) = 5725MHz - Marker 1
- For CH138 (UNII-2C Band) = 5725MHz - Marker 1

4.3.9 Test Result (Mode 3)

Non-Beamforming Mode

802.11a

Power Output:

Chan.	Chan. Freq. (MHz)	Maximum Conducted Power (mW)	Maximum Conducted Power (dBm)	Limit (dBm)	Pass / Fail
52	5260	117.22	20.69	24.00	Pass
60	5300	118.032	20.72	24.00	Pass
64	5320	118.304	20.73	24.00	Pass
100	5500	109.396	20.39	24.00	Pass
116	5580	116.95	20.68	24.00	Pass
140	5700	118.304	20.73	24.00	Pass
*144 (UNII-2C Band)	5720	35.617	15.52	24.00	Pass
*144 (UNII-3 Band)	5720	8.927	9.51	30.00	Pass

Note: * Test was performed in accordance with Measurement follow FCC KDB 789033 UNII test procedure Method SA-2 and use spectrum analyzer test.

1. For UNII-2A Band: Chain 2 was chosen for test.

For UNII-2C & UNII-3 Band: Chain 1 was chosen for test

The Total Power for the straddle channel:

Chan.	Chan. Freq. (MHz)	Average Power (mW)	Average Power (dBm)
144	5720	44.544	16.49

Note: The total power was calculated through formula and record the value for reference only.

26dB BANDWIDTH:

Channel	Frequency (MHz)	26dBc Bandwidth (MHz)
52	5260	34.92
60	5300	34.11
64	5320	34.23
100	5500	34.90
116	5580	35.09
140	5700	37.13
144 (UNII-2C Band)	5720	21.85

Note: For U_NII-2A, U_NII-2C Band output power limitation is determined based on 26dBc bandwidth!

Power Limit = 11dBm + 10logB < U_NII-2A, U_NII-2C >

Channel Number	Freq.(MHz)	Min. B(MHz)	Determined Conducted Limit (dBm)
52	5260	34.92	26.43 > 24
60	5300	34.11	26.32 > 24
64	5320	34.23	26.34 > 24
100	5500	34.90	26.42 > 24
116	5580	35.09	26.45 > 24
140	5700	37.13	26.69 > 24
144 (UNII-2C Band)	5720	21.85	24.39 > 24

802.11ac (VHT20)

Power Output:

Chan.	Chan. Freq. (MHz)	Maximum Conducted Power (mW)	Maximum Conducted Power (dBm)	Limit (dBm)	Pass / Fail
52	5260	117.22	20.69	24.00	Pass
60	5300	120.781	20.82	24.00	Pass
64	5320	121.06	20.83	24.00	Pass
100	5500	110.917	20.45	24.00	Pass
116	5580	118.032	20.72	24.00	Pass
140	5700	116.145	20.65	24.00	Pass
*144 (UNII-2C Band)	5720	35.146	15.46	23.58	Pass
*144 (UNII-3 Band)	5720	8.951	9.52	30.00	Pass

Note: * Test was performed in accordance with Measurement follow FCC KDB 789033 UNII test procedure Method SA-2 and use spectrum analyzer test.

1. For UNII-2A Band: Chain 2 was chosen for test.

For UNII-2C & UNII-3 Band: Chain 1 was chosen for test

The Total Power for the straddle channel:

Chan.	Chan. Freq. (MHz)	Average Power (mW)	Average Power (dBm)
144	5720	44.097	16.44

Note: The total power was calculated through formula and record the value for reference only.

26dB BANDWIDTH:

Channel	Frequency (MHz)	26dBc Bandwidth (MHz)
52	5260	25.12
60	5300	23.35
64	5320	21.84
100	5500	25.66
116	5580	26.31
140	5700	22.51
144 (UNII-2C Band)	5720	18.13

Note: For U_NII-2A, U_NII-2C Band output power limitation is determined based on 26dBc bandwidth!

Power Limit = 11dBm + 10logB < U_NII-2A, U_NII-2C >

Channel Number	Freq.(MHz)	Min. B(MHz)	Determined Conducted Limit (dBm)
52	5260	25.12	25 > 24
60	5300	23.35	24.68 > 24
64	5320	21.84	24.39 > 24
100	5500	25.66	25.09 > 24
116	5580	26.31	25.2 > 24
140	5700	22.51	24.52 > 24
144 (UNII-2C Band)	5720	18.13	23.58 < 24

802.11ac (VHT40)

Power Output:

Chan.	Chan. Freq. (MHz)	Maximum Conducted Power (mW)	Maximum Conducted Power (dBm)	Limit (dBm)	Pass / Fail
54	5270	124.738	20.96	24.00	Pass
62	5310	67.92	18.32	24.00	Pass
102	5510	65.464	18.16	24.00	Pass
110	5550	109.648	20.40	24.00	Pass
134	5670	89.536	19.52	24.00	Pass
*142 (UNII-2C Band)	5710	47.061	16.73	24.00	Pass
*142 (UNII-3 Band)	5710	4.194	6.23	30.00	Pass

Note: * Test was performed in accordance with Measurement follow FCC KDB 789033 UNII test procedure Method SA-2 and use spectrum analyzer test.

1. For UNII-2A Band: Chain 2 was chosen for test.

For UNII-2C & UNII-3 Band: Chain 1 was chosen for test

The Total Power for the straddle channel:

Chan.	Chan. Freq. (MHz)	Average Power (mW)	Average Power (dBm)
142	5710	51.255	17.1

Note: The total power was calculated through formula and record the value for reference only.

26dB BANDWIDTH:

Channel	Frequency (MHz)	26dBc Bandwidth (MHz)
54	5270	55.33
62	5310	42.20
102	5510	42.17
110	5550	50.39
134	5670	49.84
142 (UNII-2C Band)	5710	42.35

Note: For U_NII-2A, U_NII-2C Band output power limitation is determined based on 26dBc bandwidth

Power Limit = 11dBm + 10logB < U_NII-2A, U_NII-2C >

Channel Number	Freq.(MHz)	Min. B(MHz)	Determined Conducted Limit (dBm)
54	5270	55.33	28.42 > 24
62	5310	42.20	27.25 > 24
102	5510	42.17	27.25 > 24
110	5550	50.39	28.02 > 24
134	5670	49.84	27.97 > 24
142 (UNII-2C Band)	5710	42.35	27.26 > 24

802.11ac (VHT80)

Power Output:

Chan.	Chan. Freq. (MHz)	Maximum Conducted Power (mW)	Maximum Conducted Power (dBm)	Limit (dBm)	Pass / Fail
58	5290	44.875	16.52	24.00	Pass
106	5530	52.481	17.20	24.00	Pass
122	5610	120.781	20.82	24.00	Pass
*138 (UNII-2C Band)	5690	46.538	16.68	24.00	Pass
*138 (UNII-3 Band)	5690	1.527	1.84	30.00	Pass

Note: * Test was performed in accordance with Measurement follow FCC KDB 789033 UNII test procedure Method SA-2 and use spectrum analyzer test.

1. For UNII-2A Band: Chain 2 was chosen for test.

For UNII-2C & UNII-3 Band: Chain 1 was chosen for test

The Total Power for the straddle channel:

Chan.	Chan. Freq. (MHz)	Average Power (mW)	Average Power (dBm)
138	5690	48.065	16.82

Note: The total power was calculated through formula and record the value for reference only.

26dB BANDWIDTH:

Channel	Frequency (MHz)	26dBc Bandwidth (MHz)
58	5290	82.93
106	5530	82.58
122	5610	139.89
138 (UNII-2C Band)	5690	90.16

Note: For U_NII-2A, U_NII-2C Band output power limitation is determined based on 26dBc bandwidth

Power Limit = 11dBm + 10logB < U_NII-2A, U_NII-2C >

Channel Number	Freq.(MHz)	Min. B(MHz)	Determined Conducted Limit (dBm)
58	5290	82.93	30.18 > 24
106	5530	82.58	30.16 > 24
122	5610	139.89	32.45 > 24
138 (UNII-2C Band)	5690	90.16	30.55 > 24

802.11ax (HE20)

Power Output:

Chan.	Chan. Freq. (MHz)	Maximum Conducted Power (mW)	Maximum Conducted Power (dBm)	Limit (dBm)	Pass / Fail
52	5260	118.032	20.72	24.00	Pass
60	5300	121.339	20.84	24.00	Pass
64	5320	121.899	20.86	24.00	Pass
100	5500	111.686	20.48	24.00	Pass
116	5580	119.399	20.77	24.00	Pass
140	5700	117.22	20.69	24.00	Pass
*144 (UNII-2C Band)	5720	39.002	15.91	24.00	Pass
*144 (UNII-3 Band)	5720	11.171	10.48	30.00	Pass

Note: * Test was performed in accordance with Measurement follow FCC KDB 789033 UNII test procedure Method SA-2 and use spectrum analyzer test.

1. For UNII-2A Band: Chain 2 was chosen for test.

For UNII-2C & UNII-3 Band: Chain 1 was chosen for test

The Total Power for the straddle channel:

Chan.	Chan. Freq. (MHz)	Average Power (mW)	Average Power (dBm)
144	5720	50.173	17

Note: The total power was calculated through formula and record the value for reference only.

26dB BANDWIDTH:

Channel	Frequency (MHz)	26dBc Bandwidth (MHz)
52	5260	22.40
60	5300	22.11
64	5320	22.32
100	5500	25.81
116	5580	25.99
140	5700	25.04
144 (UNII-2C Band)	5720	20.07

Note: For U_NII-2A, U_NII-2C Band output power limitation is determined based on 26dBc bandwidth!

Power Limit = 11dBm + 10logB < U_NII-2A, U_NII-2C >

Channel Number	Freq.(MHz)	Min. B(MHz)	Determined Conducted Limit (dBm)
52	5260	22.40	24.5 > 24
60	5300	22.11	24.44 > 24
64	5320	22.32	24.48 > 24
100	5500	25.81	25.11 > 24
116	5580	25.99	25.14 > 24
140	5700	25.04	24.98 > 24
144 (UNII-2C Band)	5720	20.07	24.02 > 24

802.11ax (HE40)

Power Output:

Chan.	Chan. Freq. (MHz)	Maximum Conducted Power (mW)	Maximum Conducted Power (dBm)	Limit (dBm)	Pass / Fail
54	5270	125.314	20.98	24.00	Pass
62	5310	68.549	18.36	24.00	Pass
102	5510	65.766	18.18	24.00	Pass
110	5550	110.154	20.42	24.00	Pass
134	5670	90.365	19.56	24.00	Pass
*142 (UNII-2C Band)	5710	46.771	16.70	24.00	Pass
*142 (UNII-3 Band)	5710	4.415	6.45	30.00	Pass

Note: * Test was performed in accordance with Measurement follow FCC KDB 789033 UNII test procedure Method SA-2 and use spectrum analyzer test.

1. For UNII-2A Band: Chain 2 was chosen for test.

For UNII-2C & UNII-3 Band: Chain 1 was chosen for test

The Total Power for the straddle channel:

Chan.	Chan. Freq. (MHz)	Average Power (mW)	Average Power (dBm)
142	5710	51.186	17.09

Note: The total power was calculated through formula and record the value for reference only.

26dB BANDWIDTH:

Channel	Frequency (MHz)	26dBc Bandwidth (MHz)
54	5270	55.52
62	5310	42.28
102	5510	42.56
110	5550	45.11
134	5670	43.84
142 (UNII-2C Band)	5710	42.67

Note: For U_NII-2A, U_NII-2C Band output power limitation is determined based on 26dBc bandwidth!

Power Limit = 11dBm + 10logB < U_NII-2A, U_NII-2C >

Channel Number	Freq.(MHz)	Min. B(MHz)	Determined Conducted Limit (dBm)
54	5270	55.52	28.44 > 24
62	5310	42.28	27.26 > 24
102	5510	42.56	27.29 > 24
110	5550	45.11	27.54 > 24
134	5670	43.84	27.41 > 24
142 (UNII-2C Band)	5710	42.67	27.3 > 24

802.11ax (HE80)

Power Output:

Chan.	Chan. Freq. (MHz)	Maximum Conducted Power (mW)	Maximum Conducted Power (dBm)	Limit (dBm)	Pass / Fail
58	5290	45.29	16.56	24.00	Pass
106	5530	52.845	17.23	24.00	Pass
122	5610	121.619	20.85	24.00	Pass
*138 (UNII-2C Band)	5690	48.774	16.88	24.00	Pass
*138 (UNII-3 Band)	5690	1.762	2.46	30.00	Pass

Note: * Test was performed in accordance with Measurement follow FCC KDB 789033 UNII test procedure Method SA-2 and use spectrum analyzer test.

1. For UNII-2A Band: Chain 2 was chosen for test.

For UNII-2C & UNII-3 Band: Chain 1 was chosen for test

The Total Power for the straddle channel:

Chan.	Chan. Freq. (MHz)	Average Power (mW)	Average Power (dBm)
138	5690	50.536	17.04

Note: The total power was calculated through formula and record the value for reference only.

26dB BANDWIDTH:

Channel	Frequency (MHz)	26dBc Bandwidth (MHz)
58	5290	83.19
106	5530	82.42
122	5610	119.03
138 (UNII-2C Band)	5690	82.54

Note: For U_NII-2A, U_NII-2C Band output power limitation is determined based on 26dBc bandwidth

Power Limit = 11dBm + 10logB < U_NII-2A, U_NII-2C >			
Channel Number	Freq.(MHz)	Min. B(MHz)	Determined Conducted Limit (dBm)
58	5290	83.19	30.2 > 24
106	5530	82.42	30.16 > 24
122	5610	119.03	31.75 > 24
138 (UNII-2C Band)	5690	82.54	30.16 > 24

Spectrum Plot of Worst Value

802.11a / CH144 (UNII-2C Band)

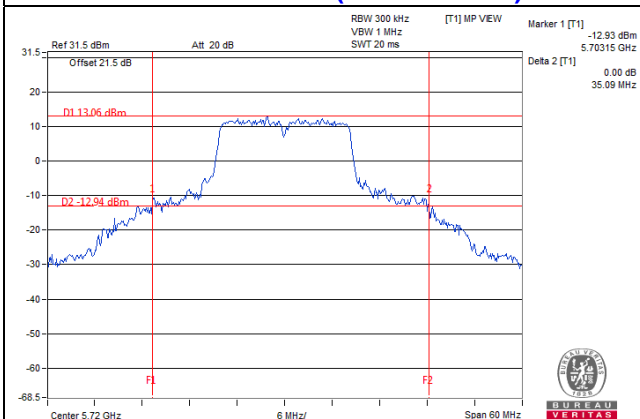

802.11ac (VHT20) / CH144 (UNII-2C Band)

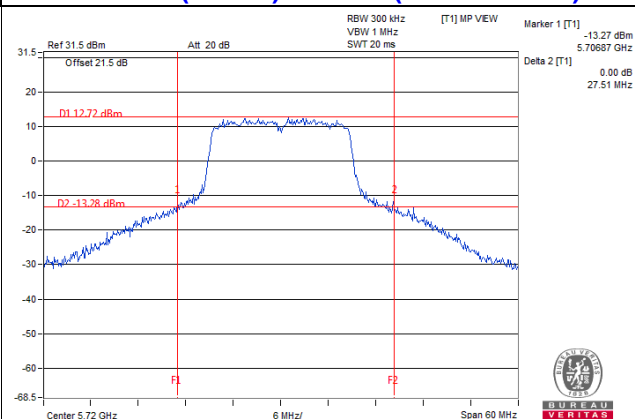

802.11ac (VHT40) / CH102

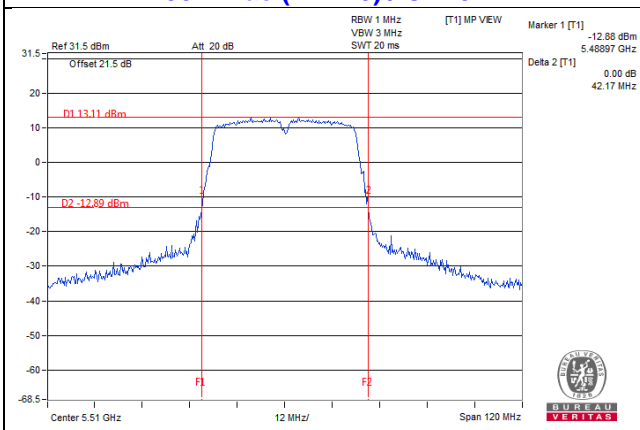

802.11ac (VHT80) / CH106

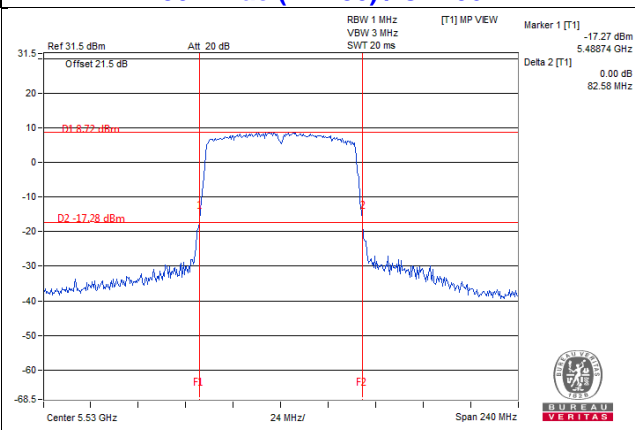

For CH144 (UNII-2C Band) = 5725MHz - Marker 1
 For CH142 (UNII-2C Band) = 5725MHz - Marker 1
 For CH138 (UNII-2C Band) = 5725MHz - Marker 1

Spectrum Plot of Worst Value

802.11ax (HE20) / CH144 (UNII-2C Band)

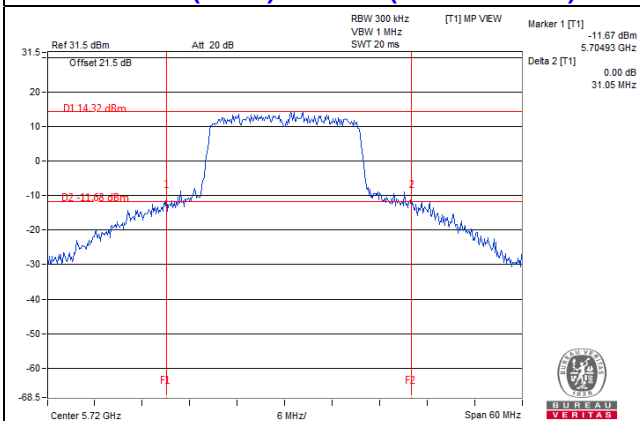

802.11ax (HE40) / CH62

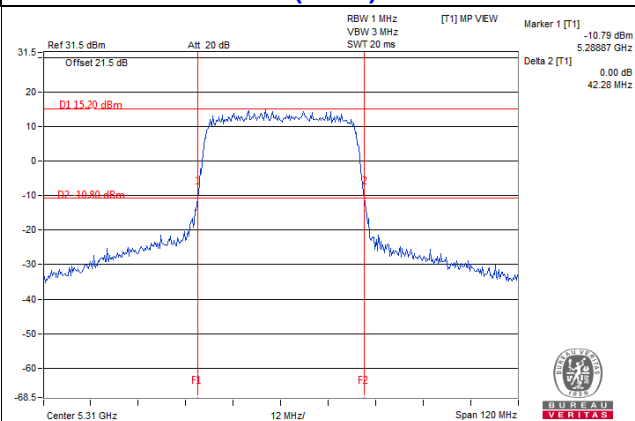

802.11ax (HE80) / CH106

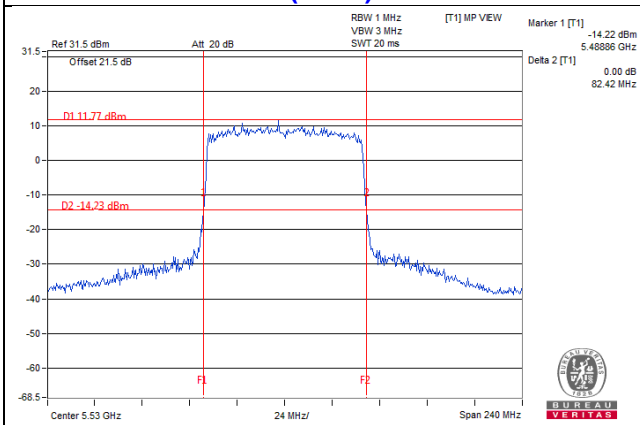

For CH144 (UNII-2C Band) = 5725MHz - Marker 1
 For CH142 (UNII-2C Band) = 5725MHz - Marker 1
 For CH138 (UNII-2C Band) = 5725MHz - Marker 1

4.4 Occupied Bandwidth Measurement

4.4.1 Test Setup



4.4.2 Test Instruments

Refer to section 4.1.2 to get information of above instrument.

4.4.3 Test Procedure

The transmitter output was connected to the spectrum analyzer through an attenuator. The bandwidth of the fundamental frequency was measured by spectrum analyzer with resolution bandwidth in the range of 1% to 5% of the anticipated emission bandwidth, and a video bandwidth at least 3x the resolution bandwidth and set the detector to SAMPLE. The width of a frequency band such that, below the lower and above the upper frequency limits, the mean powers emitted are each equal to a specified percentage 0.5 %of the total mean power of a given emission.

4.4.4 Test Results (Mode 1)

802.11a

Channel	Channel Frequency (MHz)	Occupied Bandwidth (MHz)			
		Chain 0	Chain 1	Chain 2	Chain 3
52	5260	16.80	16.68	16.92	16.68
60	5300	16.80	16.68	16.92	16.80
64	5320	16.80	16.56	16.80	16.80
100	5500	16.92	16.56	17.04	16.80
116	5580	17.04	16.92	16.92	16.80
140	5700	16.68	16.92	16.68	16.56
144 (UNII-2C Band)	5720	13.52	13.40	13.52	13.52
144 (UNII-3 Band)	5720	3.28	3.28	3.16	3.40

802.11ax (HE20)

Channel	Channel Frequency (MHz)	Occupied Bandwidth (MHz)			
		Chain 0	Chain 1	Chain 2	Chain 3
52	5260	18.96	18.96	18.96	18.96
60	5300	19.08	18.96	19.08	18.96
64	5320	18.96	18.96	19.08	18.96
100	5500	18.96	18.96	18.96	19.08
116	5580	18.96	19.08	18.96	19.08
140	5700	18.96	18.96	18.96	18.96
144 (UNII-2C Band)	5720	14.60	14.60	14.60	14.60
144 (UNII-3 Band)	5720	4.36	4.36	4.36	4.36

802.11ax (HE40)

Channel	Channel Frequency (MHz)	Occupied Bandwidth (MHz)			
		Chain 0	Chain 1	Chain 2	Chain 3
54	5270	37.92	37.92	38.16	37.92
62	5310	38.16	37.92	38.16	38.16
102	5510	38.16	38.16	37.92	38.40
110	5550	37.92	38.16	37.92	38.16
134	5670	38.16	38.40	37.92	38.16
142 (UNII-2C Band)	5710	34.20	34.20	34.20	34.20
142 (UNII-3 Band)	5710	3.80	3.80	4.00	3.80

802.11ax (HE80)

Channel	Channel Frequency (MHz)	Occupied Bandwidth (MHz)			
		Chain 0	Chain 1	Chain 2	Chain 3
58	5290	76.80	77.28	77.76	77.28
106	5530	77.28	77.28	77.76	77.28
122	5610	77.28	77.76	77.28	77.28
138 (UNII-2C Band)	5690	73.88	73.88	73.88	73.88
138 (UNII-3 Band)	5690	3.40	3.40	3.40	3.40

Spectrum Plot of Max. Value

802.11a_Chain 0 / CH116

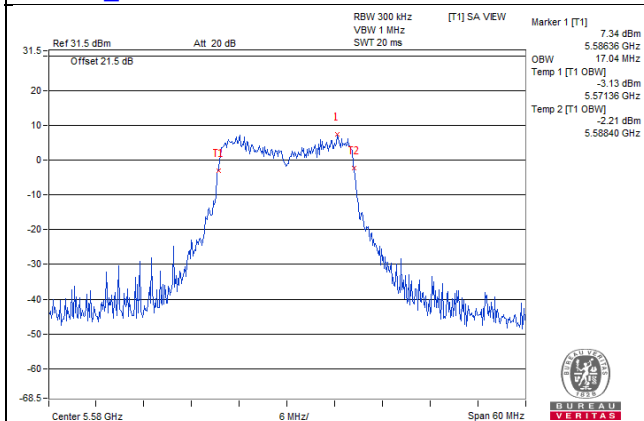

802.11ax (HE20)_Chain 0 / CH60

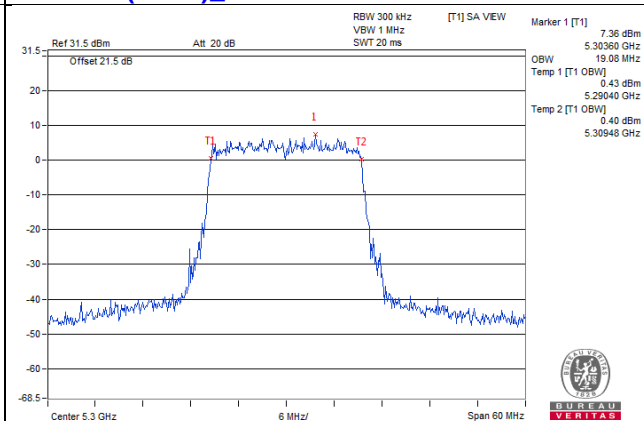

802.11ax (HE40)_Chain 3 / CH102

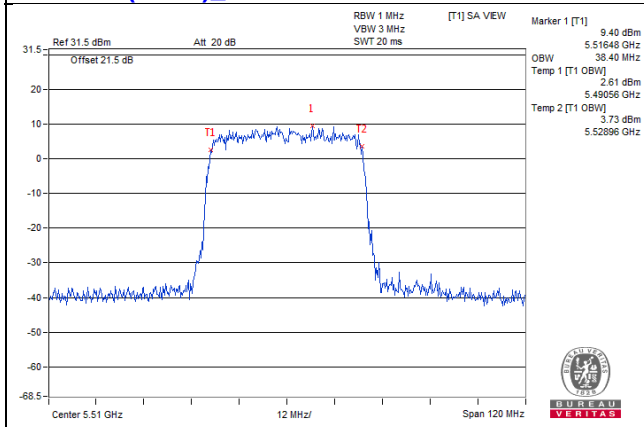

802.11ax (HE80)_Chain 1 / CH122

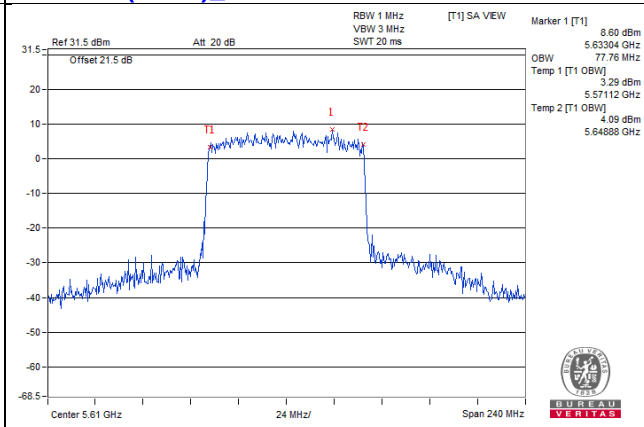

4.4.5 Test Results (Mode 2)

For UNII-2A:

802.11a

Channel	Channel Frequency (MHz)	Occupied Bandwidth (MHz)	
		Chain 2	Chain 3
52	5260	16.92	17.04
60	5300	16.92	16.80
64	5320	16.80	17.04

802.11ax (HE20)

Channel	Channel Frequency (MHz)	Occupied Bandwidth (MHz)	
		Chain 2	Chain 3
52	5260	18.96	19.08
60	5300	19.08	19.08
64	5320	19.08	18.96

802.11ax (HE40)

Channel	Channel Frequency (MHz)	Occupied Bandwidth (MHz)	
		Chain 2	Chain 3
54	5270	38.16	38.16
62	5310	38.16	38.16

802.11ax (HE80)

Channel	Channel Frequency (MHz)	Occupied Bandwidth (MHz)	
		Chain 2	Chain 3
58	5290	77.28	77.28

Spectrum Plot of Max. Value

802.11a_Chain 3 / CH52

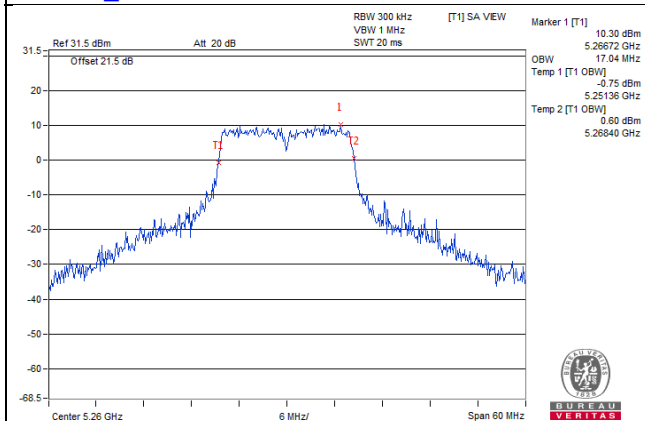

802.11ax (HE20)_Chain 2 / CH60

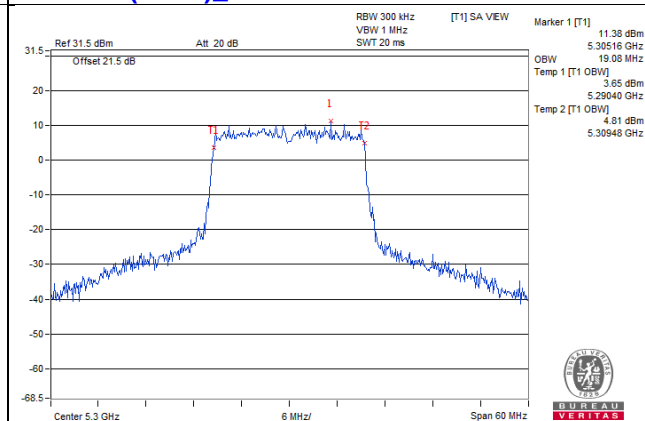

802.11ax (HE40)_Chain 2 / CH54

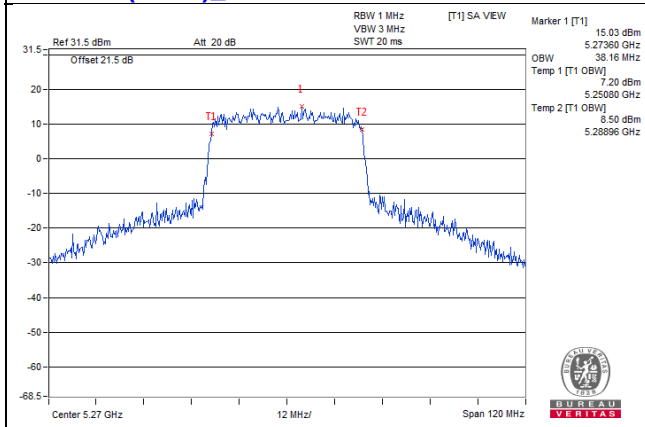

802.11ax (HE80)_Chain 2 / CH58

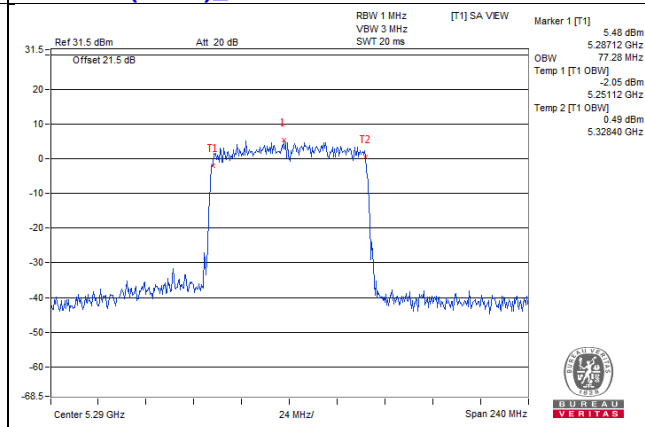

For UNII-2C, UNII-3:
802.11a

Channel	Channel Frequency (MHz)	Occupied Bandwidth (MHz)	
		Chain 0	Chain 1
100	5500	16.92	17.88
116	5580	16.80	17.76
140	5700	16.80	17.64
144 (UNII-2C Band)	5720	13.52	13.88
144 (UNII-3 Band)	5720	3.40	3.76

802.11ax (HE20)

Channel	Channel Frequency (MHz)	Occupied Bandwidth (MHz)	
		Chain 0	Chain 1
100	5500	19.08	19.08
116	5580	19.08	18.96
140	5700	19.08	18.96
144 (UNII-2C Band)	5720	14.60	14.60
144 (UNII-3 Band)	5720	4.36	4.48

802.11ax (HE40)

Channel	Channel Frequency (MHz)	Occupied Bandwidth (MHz)	
		Chain 0	Chain 1
102	5510	38.16	38.16
110	5550	38.40	38.16
134	5670	38.16	38.16
142 (UNII-2C Band)	5710	34.20	34.40
142 (UNII-3 Band)	5710	4.20	4.20

802.11ax (HE80)

Channel	Channel Frequency (MHz)	Occupied Bandwidth (MHz)	
		Chain 0	Chain 1
106	5530	77.28	77.28
122	5610	77.76	77.76
138 (UNII-2C Band)	5690	73.88	73.88
138 (UNII-3 Band)	5690	3.88	3.88

Spectrum Plot of Max. Value

802.11a_Chain 1 / CH100

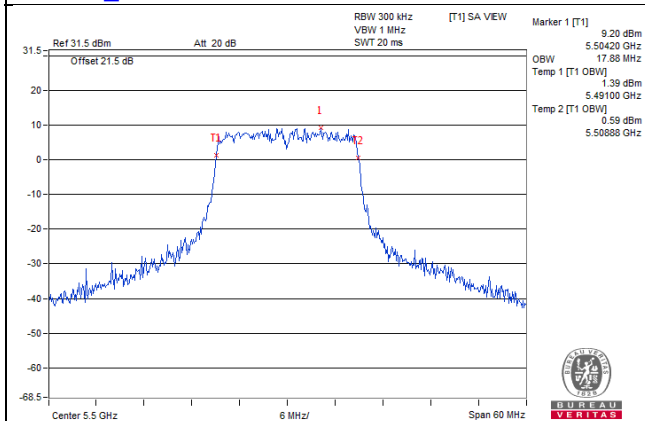

802.11ax (VHT20)_Chain 0 / CH100

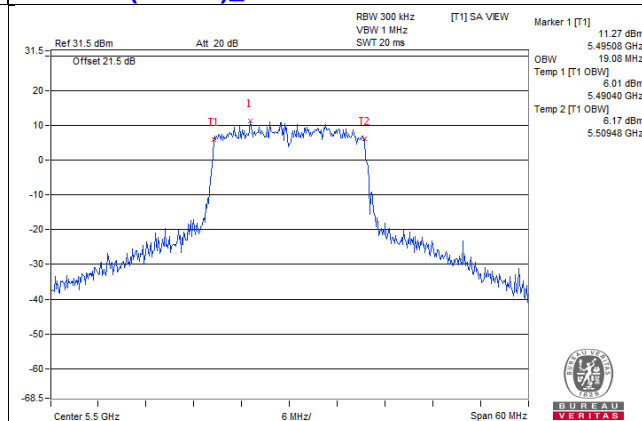

802.11ax (VHT40)_Chain 0 / CH110

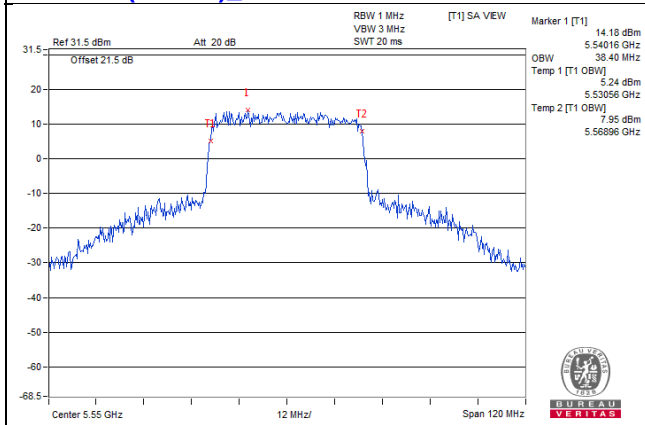

802.11ax (VHT80)_Chain 0 / CH122

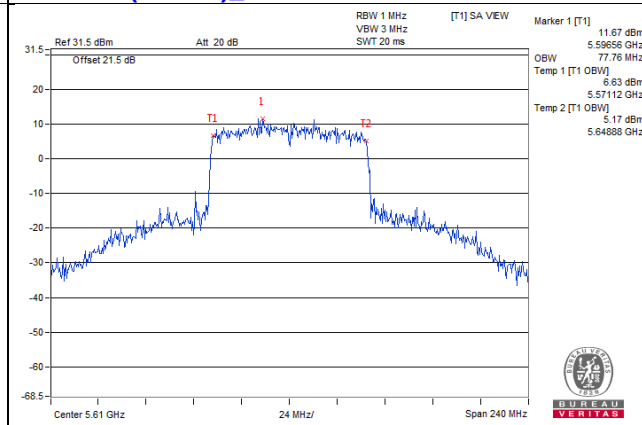

4.4.6 Test Results (Mode 3)

802.11a

Channel	Channel Frequency (MHz)	Occupied Bandwidth (MHz)
52	5260	17.04
60	5300	17.04
64	5320	17.04
100	5500	17.04
116	5580	17.04
140	5700	17.64
144 (UNII-2C Band)	5720	13.64
144 (UNII-3 Band)	5720	3.52

Note: 1. For UNII-2A Band: Chain 2 was chosen for test.
 For UNII-2C & UNII-3 Band: Chain 1 was chosen for test

802.11ax (HE20)

Channel	Channel Frequency (MHz)	Occupied Bandwidth (MHz)
52	5260	19.08
60	5300	19.08
64	5320	19.08
100	5500	19.08
116	5580	19.08
140	5700	19.08
144 (UNII-2C Band)	5720	14.60
144 (UNII-3 Band)	5720	4.48

Note: 1. For UNII-2A Band: Chain 2 was chosen for test.
 For UNII-2C & UNII-3 Band: Chain 1 was chosen for test

802.11ax (HE40)

Channel	Channel Frequency (MHz)	Occupied Bandwidth (MHz)
54	5270	38.16
62	5310	38.16
102	5510	38.16
110	5550	38.16
134	5670	38.16
142 (UNII-2C Band)	5710	34.40
142 (UNII-3 Band)	5710	4.20

Note: 1. For UNII-2A Band: Chain 2 was chosen for test.
 For UNII-2C & UNII-3 Band: Chain 1 was chosen for test

802.11ax (HE80)

Channel	Channel Frequency (MHz)	Occupied Bandwidth (MHz)
58	5290	77.28
106	5530	76.80
122	5610	77.76
138 (UNII-2C Band)	5690	73.88
138 (UNII-3 Band)	5690	3.88

Note: 1. For UNII-2A Band: Chain 2 was chosen for test.

For UNII-2C & UNII-3 Band: Chain 1 was chosen for test

Spectrum Plot of Max. Value

802.11a_Chain 1 / CH140

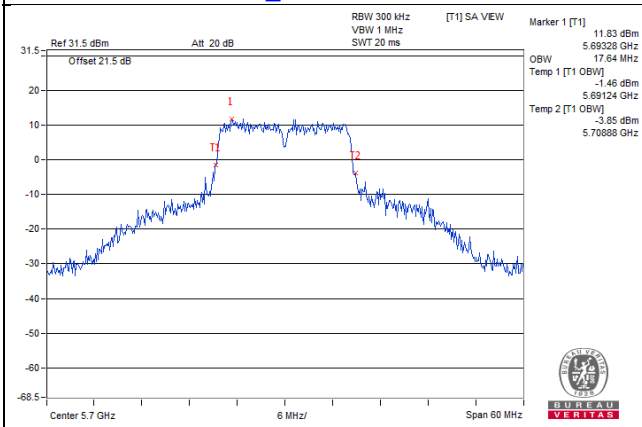

802.11ax (HE20)_Chain 2 / CH52

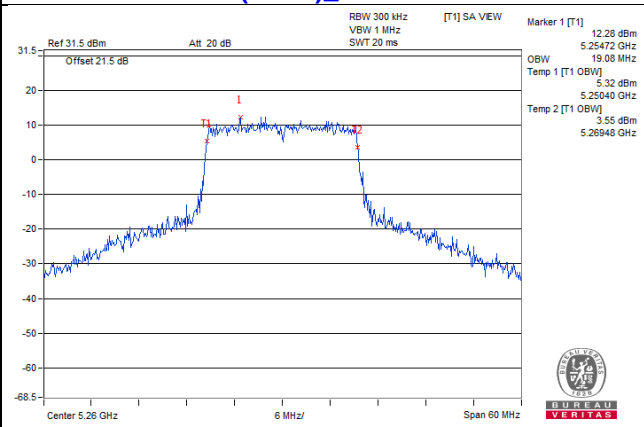

802.11ax (HE40)_Chain 2 / CH54

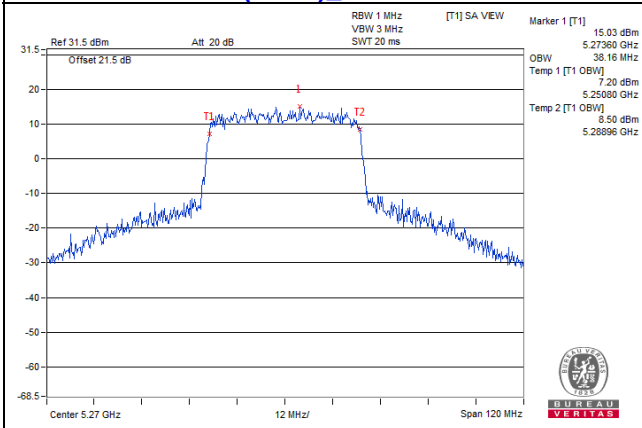

802.11ax (HE80)_Chain 1 / CH122

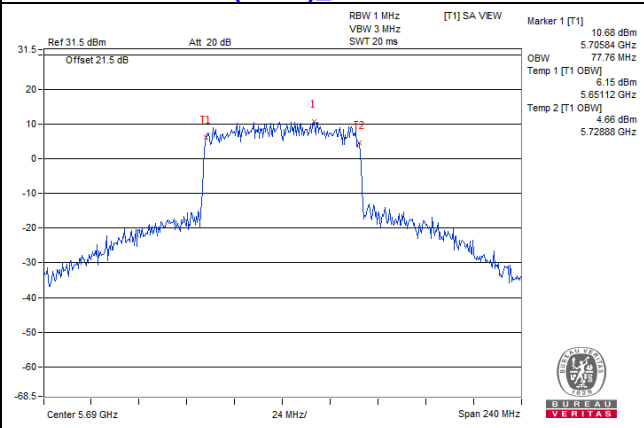

4.5 Peak Power Spectral Density Measurement

4.5.1 Limits of Peak Power Spectral Density Measurement

Operation Band	EUT Category		Limit
U-NII-1		Outdoor Access Point	17dBm/ MHz
		Fixed point-to-point Access Point	
		Indoor Access Point	
		Client device	11dBm/ MHz
U-NII-2A		√	11dBm/ MHz
U-NII-2C		√	11dBm/ MHz
U-NII-3		√	30dBm/ 500kHz

4.5.2 Test Setup

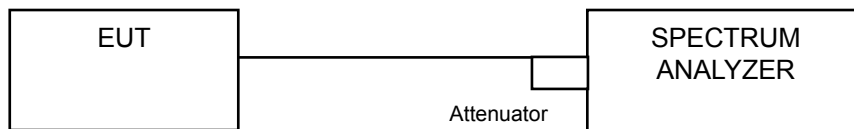

4.5.3 Test Instruments

Refer to section 4.1.2 to get information of above instrument.

4.5.4 Test Procedure

For U-NII-2A, U-NII-2C band:

Using method SA-2

1. Set span to encompass the entire emission bandwidth (EBW) of the signal.
2. Set RBW = 1 MHz, Set VBW ≥ 3 MHz, Detector = RMS
3. Sweep time = auto, trigger set to "free run".
4. Trace average at least 100 traces in power averaging mode.
5. Record the max value and add 10 log (1/duty cycle)

For U-NII-3 band:

1. Set span to encompass the entire emission bandwidth (EBW) of the signal.
2. Set RBW = 300 kHz, Set VBW ≥ 1 MHz, Detector = RMS
3. Use the peak marker function to determine the maximum power level in any 300 kHz band segment within the fundamental EBW.
4. Scale the observed power level to an equivalent value in 500 kHz by adjusting (reducing) the measured power by a bandwidth correction factor (BWCF) where $BWCF = 10\log(500\text{ kHz}/300\text{kHz})$
5. Sweep time = auto, trigger set to "free run".
6. Trace average at least 100 traces in power averaging mode.
7. Record the max value and add 10 log (1/duty cycle)

4.5.5 Deviation from Test Standard

No deviation.

4.5.6 EUT Operating Condition

Same as Item 4.3.6.

4.5.7 Test Results (Mode 1)

Non-Beamforming Mode

For U-NII-2A, UNII-2C:

802.11a

Chan.	Chan. Freq. (MHz)	PSD W/O Duty Factor (dBm/MHz)				Duty Factor (dB)	Total PSD With Duty Factor (dBm/MHz)	MAX. Limit (dBm/MHz)	Pass / Fail
		Chain 0	Chain 1	Chain 2	Chain 3				
52	5260	1.02	0.80	0.05	0.10	0.32	6.85	8.07	Pass
60	5300	0.43	1.80	-1.86	1.06	0.32	6.90	8.07	Pass
64	5320	-0.41	0.24	1.69	-1.19	0.32	6.56	8.07	Pass
100	5500	0.01	1.32	1.41	1.54	0.32	7.45	8.49	Pass
116	5580	1.42	0.75	0.60	0.80	0.32	7.24	8.49	Pass
140	5700	1.63	2.78	-2.37	0.52	0.32	7.36	8.49	Pass
144 (UNII-2C Band)	5720	-1.15	1.90	1.00	0.92	0.32	7.14	8.49	Pass

- Note:**
- Method a) of power density measurement of KDB 662911 is using for calculating total power density. Total power density is summing entire spectra across corresponding frequency bins on the various outputs by computer.
 - UNII-2A: Directional gain = 8.93dBi > 6dBi, so the power density limit shall be reduced to $11-(8.93-6) = 8.07\text{dBm}$.
 - UNII-2C: Directional gain = 8.51dBi > 6dBi, so the power density limit shall be reduced to $11-(8.51-6) = 8.49\text{dBm}$.
 - Refer to section 3.3 for duty cycle spectrum plot.

802.11ac (VHT20)

Chan.	Chan. Freq. (MHz)	PSD W/O Duty Factor (dBm/MHz)				Duty Factor (dB)	Total PSD With Duty Factor (dBm/MHz)	MAX. Limit (dBm/MHz)	Pass / Fail
		Chain 0	Chain 1	Chain 2	Chain 3				
52	5260	0.08	0.45	0.56	0.77	0.17	6.66	8.07	Pass
60	5300	0.23	0.05	0.30	0.02	0.17	6.34	8.07	Pass
64	5320	0.45	-1.41	0.45	-0.84	0.17	5.93	8.07	Pass
100	5500	0.15	1.12	-0.31	-0.05	0.17	6.45	8.49	Pass
116	5580	0.78	1.49	0.95	0.82	0.17	7.21	8.49	Pass
140	5700	0.81	1.05	0.22	0.60	0.17	6.87	8.49	Pass
144 (UNII-2C Band)	5720	0.47	0.69	-0.20	1.01	0.17	6.71	8.49	Pass

- Note:**
- Method a) of power density measurement of KDB 662911 is using for calculating total power density. Total power density is summing entire spectra across corresponding frequency bins on the various outputs by computer.
 - UNII-2A: Directional gain = 8.93dBi > 6dBi, so the power density limit shall be reduced to $11-(8.93-6) = 8.07\text{dBm}$.
 - UNII-2C: Directional gain = 8.51dBi > 6dBi, so the power density limit shall be reduced to $11-(8.51-6) = 8.49\text{dBm}$.
 - Refer to section 3.3 for duty cycle spectrum plot.

802.11ac (VHT40)

Chan.	Chan. Freq. (MHz)	PSD W/O Duty Factor (dBm/MHz)				Duty Factor (dB)	Total PSD With Duty Factor (dBm/MHz)	MAX. Limit (dBm/MHz)	Pass / Fail
		Chain 0	Chain 1	Chain 2	Chain 3				
54	5270	1.21	0.93	0.03	-0.20	0.17	6.72	8.07	Pass
62	5310	-0.60	-0.34	-0.94	-1.07	0.17	5.46	8.07	Pass
102	5510	-0.70	-2.75	-2.01	-1.58	0.17	4.49	8.49	Pass
110	5550	0.13	-0.41	-1.10	-0.08	0.17	5.85	8.49	Pass
134	5670	-0.02	-0.62	0.59	-0.12	0.17	6.17	8.49	Pass
142 (UNII-2C Band)	5710	0.47	0.72	0.53	0.47	0.17	6.74	8.49	Pass

- Note:**
- Method a) of power density measurement of KDB 662911 is using for calculating total power density. Total power density is summing entire spectra across corresponding frequency bins on the various outputs by computer.
 - UNII-2A: Directional gain = 8.93dBi > 6dBi, so the power density limit shall be reduced to $11-(8.93-6) = 8.07\text{dBm}$.
 - UNII-2C: Directional gain = 8.51dBi > 6dBi, so the power density limit shall be reduced to $11-(8.51-6) = 8.49\text{dBm}$.
 - Refer to section 3.3 for duty cycle spectrum plot.

802.11ac (VHT80)

Chan.	Chan. Freq. (MHz)	PSD W/O Duty Factor (dBm/MHz)				Duty Factor (dB)	Total PSD With Duty Factor (dBm/MHz)	MAX. Limit (dBm/MHz)	Pass / Fail
		Chain 0	Chain 1	Chain 2	Chain 3				
58	5290	-5.60	-6.11	-5.67	-5.83	0.18	0.40	8.07	Pass
106	5530	-5.47	-5.21	-6.61	-7.10	0.18	0.17	8.49	Pass
122	5610	-3.48	-2.67	-3.79	-2.45	0.18	3.14	8.49	Pass
138 (UNII-2C Band)	5690	-2.46	-2.52	-2.58	-2.84	0.18	3.60	8.49	Pass

- Note:**
- Method a) of power density measurement of KDB 662911 is using for calculating total power density. Total power density is summing entire spectra across corresponding frequency bins on the various outputs by computer.
 - UNII-2A: Directional gain = 8.93dBi > 6dBi, so the power density limit shall be reduced to $11-(8.93-6) = 8.07\text{dBm}$.
 - UNII-2C: Directional gain = 8.51dBi > 6dBi, so the power density limit shall be reduced to $11-(8.51-6) = 8.49\text{dBm}$.
 - Refer to section 3.3 for duty cycle spectrum plot.

802.11ax (HE20)

Chan.	Chan. Freq. (MHz)	PSD W/O Duty Factor (dBm/MHz)				Duty Factor (dB)	Total PSD With Duty Factor (dBm/MHz)	MAX. Limit (dBm/MHz)	Pass / Fail
		Chain 0	Chain 1	Chain 2	Chain 3				
52	5260	0.82	0.35	0.28	0.71	0.20	6.77	8.07	Pass
60	5300	-0.52	0.67	-0.06	0.17	0.20	6.31	8.07	Pass
64	5320	-0.57	-0.30	0.32	0.68	0.20	6.28	8.07	Pass
100	5500	1.37	1.11	-0.01	1.03	0.20	7.13	8.49	Pass
116	5580	1.46	1.59	0.79	0.68	0.20	7.37	8.49	Pass
140	5700	0.69	1.19	0.19	0.74	0.20	6.94	8.49	Pass
144 (UNII-2C Band)	5720	0.74	1.10	0.81	-0.33	0.20	6.83	8.49	Pass

- Note:**
- Method a) of power density measurement of KDB 662911 is using for calculating total power density. Total power density is summing entire spectra across corresponding frequency bins on the various outputs by computer.
 - UNII-2A: Directional gain = 8.93dBi > 6dBi, so the power density limit shall be reduced to $11-(8.93-6) = 8.07\text{dBm}$.
 - UNII-2C: Directional gain = 8.51dBi > 6dBi, so the power density limit shall be reduced to $11-(8.51-6) = 8.49\text{dBm}$.
 - Refer to section 3.3 for duty cycle spectrum plot.

802.11ax (HE40)

Chan.	Chan. Freq. (MHz)	PSD W/O Duty Factor (dBm/MHz)				Duty Factor (dB)	Total PSD With Duty Factor (dBm/MHz)	MAX. Limit (dBm/MHz)	Pass / Fail
		Chain 0	Chain 1	Chain 2	Chain 3				
54	5270	0.04	-1.70	1.06	0.11	0.17	6.18	8.07	Pass
62	5310	-0.76	-0.47	-0.69	-0.61	0.17	5.56	8.07	Pass
102	5510	-1.68	-2.23	-1.14	-2.01	0.17	4.45	8.49	Pass
110	5550	0.15	-0.81	0.00	0.66	0.17	6.22	8.49	Pass
134	5670	0.66	-0.01	0.27	-0.33	0.17	6.35	8.49	Pass
142 (UNII-2C Band)	5710	0.72	0.67	0.55	0.91	0.17	6.91	8.49	Pass

- Note:**
- Method a) of power density measurement of KDB 662911 is using for calculating total power density. Total power density is summing entire spectra across corresponding frequency bins on the various outputs by computer.
 - UNII-2A: Directional gain = 8.93dBi > 6dBi, so the power density limit shall be reduced to $11-(8.93-6) = 8.07\text{dBm}$.
 - UNII-2C: Directional gain = 8.51dBi > 6dBi, so the power density limit shall be reduced to $11-(8.51-6) = 8.49\text{dBm}$.
 - Refer to section 3.3 for duty cycle spectrum plot.

802.11ax (HE80)

Chan.	Chan. Freq. (MHz)	PSD W/O Duty Factor (dBm/MHz)				Duty Factor (dB)	Total PSD With Duty Factor (dBm/MHz)	MAX. Limit (dBm/MHz)	Pass / Fail
		Chain 0	Chain 1	Chain 2	Chain 3				
58	5290	-5.32	-6.82	-6.20	-5.80	0.17	0.19	8.07	Pass
106	5530	-5.42	-5.04	-5.41	-4.94	0.17	0.99	8.49	Pass
122	5610	-4.00	-2.87	-2.46	-2.79	0.17	3.20	8.49	Pass
138 (UNII-2C Band)	5690	-2.45	-2.05	-2.40	-2.30	0.17	3.89	8.49	Pass

- Note:**
- Method a) of power density measurement of KDB 662911 is using for calculating total power density. Total power density is summing entire spectra across corresponding frequency bins on the various outputs by computer.
 - UNII-2A: Directional gain = 8.93dBi > 6dBi, so the power density limit shall be reduced to $11-(8.93-6) = 8.07\text{dBm}$.
 - UNII-2C: Directional gain = 8.51dBi > 6dBi, so the power density limit shall be reduced to $11-(8.51-6) = 8.49\text{dBm}$.
 - Refer to section 3.3 for duty cycle spectrum plot.

Spectrum Plot of Worst Value

802.11a_Chain 1 / CH140

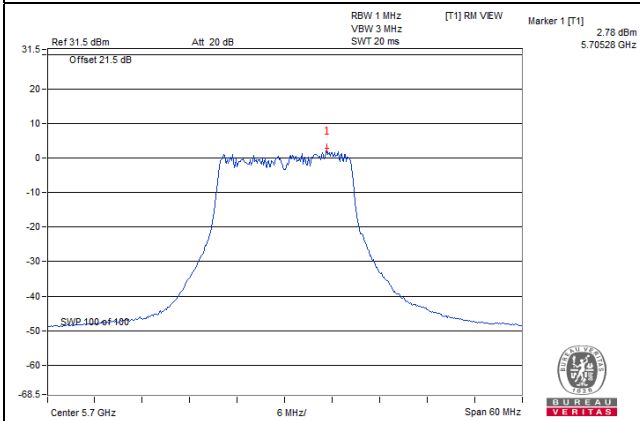

802.11ac (VHT20)_Chain 1 / CH116

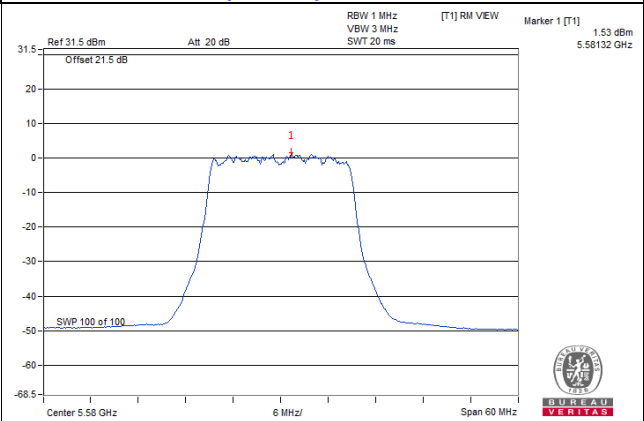

802.11ac (VHT40)_Chain 0 / CH54

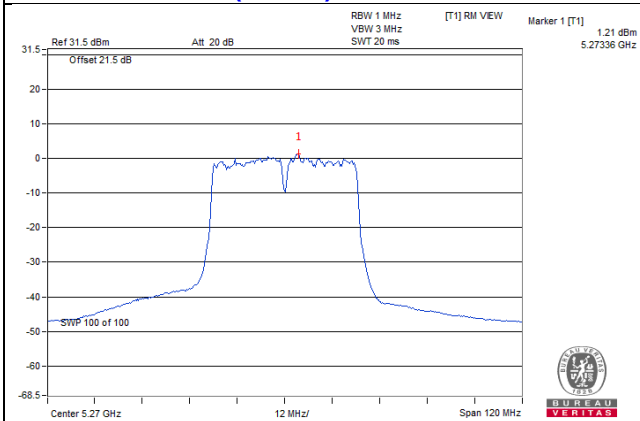

802.11ac (VHT80)_Chain 3 / CH122

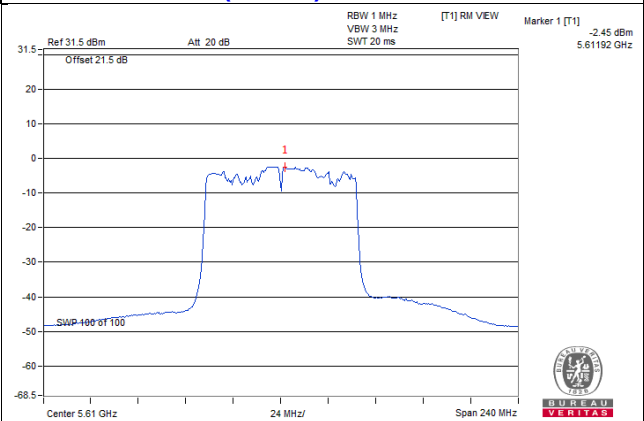

Spectrum Plot of Worst Value

802.11ax (HE20)_Chain 1 / CH116

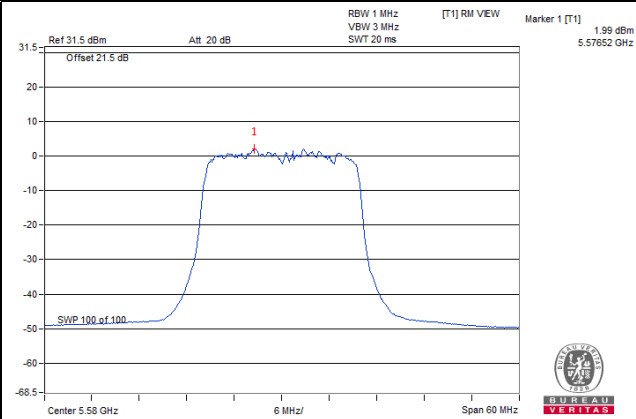

802.11ax (HE40)_Chain 2 / CH54

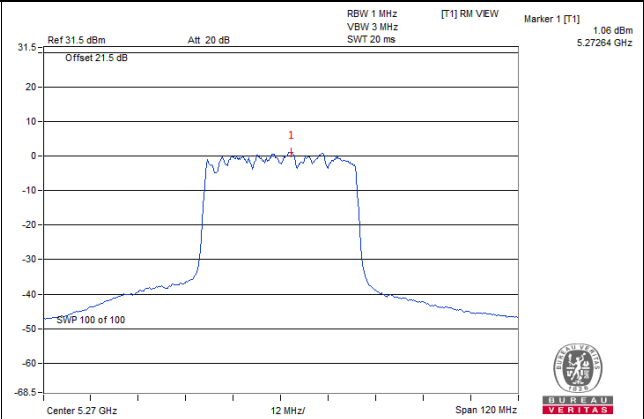

802.11ax (HE80)_Chain 1 / CH138 (UNII-2C Band)

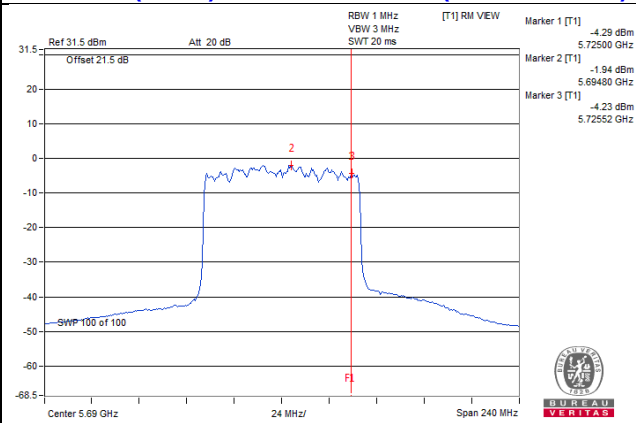

For U-NII-3:
Non-Beamforming Mode
802.11a

Chan.	Freq. (MHz)	PSD W/O Duty Factor (dBm/300kHz)				Duty Factor (dB)	Total PSD With Duty Factor		Total PSD With Duty Factor (dBm/500kHz)	Limit (dBm/500kHz)	Pass /Fail
		Chain 0	Chain 1	Chain 2	Chain 3		mW/300kHz	dBm/300kHz			
144 (UNII-3 Band)	5720	-6.13	-7.57	-7.96	-6.64	0.32	0.8557	-0.68	1.54	27.89	Pass

- Note: 1. Method b) Measure and sum spectral maxima across the outputs of KDB 662911 is using for calculating total power density.
2. Directional gain = 8.11dBi > 6dBi, so the power density limit shall be reduced to 30-(8.11-6) = 27.89dBm.
3. Refer to section 3.3 for duty cycle spectrum plot.

802.11ac (VHT20)

Chan.	Freq. (MHz)	PSD W/O Duty Factor (dBm/300kHz)				Duty Factor (dB)	Total PSD With Duty Factor		Total PSD With Duty Factor (dBm/500kHz)	Limit (dBm/500kHz)	Pass /Fail
		Chain 0	Chain 1	Chain 2	Chain 3		mW/300kHz	dBm/300kHz			
144 (UNII-3 Band)	5720	-6.41	-8.12	-7.10	-7.33	0.17	0.7929	-1.01	1.21	27.89	Pass

- Note: 1. Method b) Measure and sum spectral maxima across the outputs of KDB 662911 is using for calculating total power density.
2. Directional gain = 8.11dBi > 6dBi, so the power density limit shall be reduced to 30-(8.11-6) = 27.89dBm.
3. Refer to section 3.3 for duty cycle spectrum plot.

802.11ac (VHT40)

Chan.	Freq. (MHz)	PSD W/O Duty Factor (dBm/300kHz)				Duty Factor (dB)	Total PSD With Duty Factor		Total PSD With Duty Factor (dBm/500kHz)	Limit (dBm/500kHz)	Pass /Fail
		Chain 0	Chain 1	Chain 2	Chain 3		mW/300kHz	dBm/300kHz			
142 (UNII-3 Band)	5710	-8.89	-9.08	-8.43	-8.39	0.17	0.5623	-2.50	-0.28	27.89	Pass

- Note: 1. Method b) Measure and sum spectral maxima across the outputs of KDB 662911 is using for calculating total power density.
2. Directional gain = 8.11dBi > 6dBi, so the power density limit shall be reduced to 30-(8.11-6) = 27.89dBm.
3. Refer to section 3.3 for duty cycle spectrum plot.

802.11ac (VHT80)

Chan.	Freq. (MHz)	PSD W/O Duty Factor (dBm/300kHz)				Duty Factor (dB)	Total PSD With Duty Factor		Total PSD With Duty Factor (dBm/500kHz)	Limit (dBm/ 500kHz)	Pass /Fail
		Chain 0	Chain 1	Chain 2	Chain 3		mW/ 300kHz	dBm/ 300kHz			
138 (UNII-3 Band)	5690	-13.12	-13.37	-13.27	-14.17	0.18	0.1877	-7.27	-5.05	27.89	Pass

- Note: 1. Method b) Measure and sum spectral maxima across the outputs of KDB 662911 is using for calculating total power density.
2. Directional gain = 8.11dBi > 6dBi, so the power density limit shall be reduced to $30 - (8.11 - 6) = 27.89$ dBm.
3. Refer to section 3.3 for duty cycle spectrum plot.

802.11ax (HE20)

Chan.	Freq. (MHz)	PSD W/O Duty Factor (dBm/300kHz)				Duty Factor (dB)	Total PSD With Duty Factor		Total PSD With Duty Factor (dBm/500kHz)	Limit (dBm/500kHz)	Pass /Fail
		Chain 0	Chain 1	Chain 2	Chain 3		mW/300kHz	dBm/300kHz			
144 (UNII-3 Band)	5720	-8.58	-7.97	-7.70	-8.63	0.20	0.6338	-1.98	0.24	27.89	Pass

- Note: 1. Method b) Measure and sum spectral maxima across the outputs of KDB 662911 is using for calculating total power density.
2. Directional gain = 8.11dBi > 6dBi, so the power density limit shall be reduced to $30-(8.11-6) = 27.89$ dBm.
3. Refer to section 3.3 for duty cycle spectrum plot.

802.11ax (HE40)

Chan.	Freq. (MHz)	PSD W/O Duty Factor (dBm/300kHz)				Duty Factor (dB)	Total PSD With Duty Factor		Total PSD With Duty Factor (dBm/500kHz)	Limit (dBm/500kHz)	Pass /Fail
		Chain 0	Chain 1	Chain 2	Chain 3		mW/300kHz	dBm/300kHz			
142 (UNII-3 Band)	5710	-9.25	-9.08	-9.03	-9.00	0.17	0.513	-2.90	-0.68	27.89	Pass

- Note: 1. Method b) Measure and sum spectral maxima across the outputs of KDB 662911 is using for calculating total power density.
2. Directional gain = 8.11dBi > 6dBi, so the power density limit shall be reduced to $30-(8.11-6) = 27.89$ dBm.
3. Refer to section 3.3 for duty cycle spectrum plot.

802.11ax (HE80)

Chan.	Freq. (MHz)	PSD W/O Duty Factor (dBm/300kHz)				Duty Factor (dB)	Total PSD With Duty Factor		Total PSD With Duty Factor (dBm/500kHz)	Limit (dBm/500kHz)	Pass /Fail
		Chain 0	Chain 1	Chain 2	Chain 3		mW/300kHz	dBm/300kHz			
138 (UNII-3 Band)	5690	-13.10	-12.70	-12.84	-12.60	0.17	0.2181	-6.61	-4.39	27.89	Pass

- Note: 1. Method b) Measure and sum spectral maxima across the outputs of KDB 662911 is using for calculating total power density.
2. Directional gain = 8.11dBi > 6dBi, so the power density limit shall be reduced to $30-(8.11-6) = 27.89$ dBm.
3. Refer to section 3.3 for duty cycle spectrum plot.

Spectrum Plot of Worst Value

802.11a_Chain 0 / CH144 (UNII-3 Band)

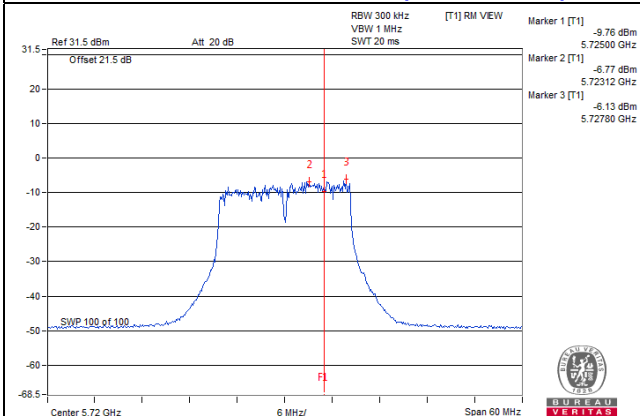

802.11ac (VHT20)_Chain 0 / CH144 (UNII-3 Band)

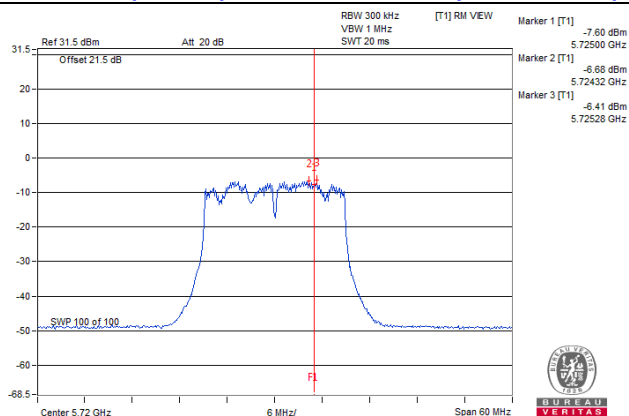

802.11ac (VHT40)_Chain 3 / CH142 (UNII-3 Band)

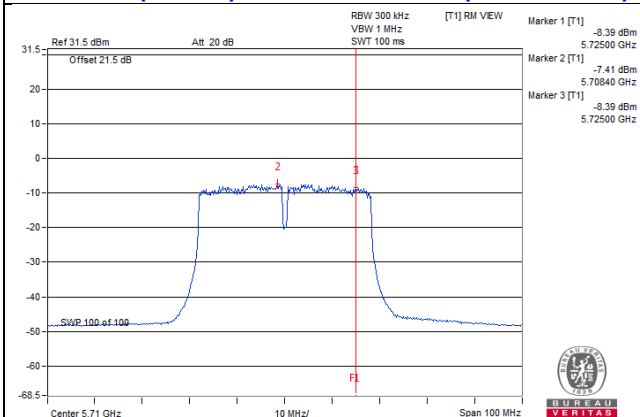

802.11ac (VHT80)_Chain 0 / CH138 (UNII-3 Band)

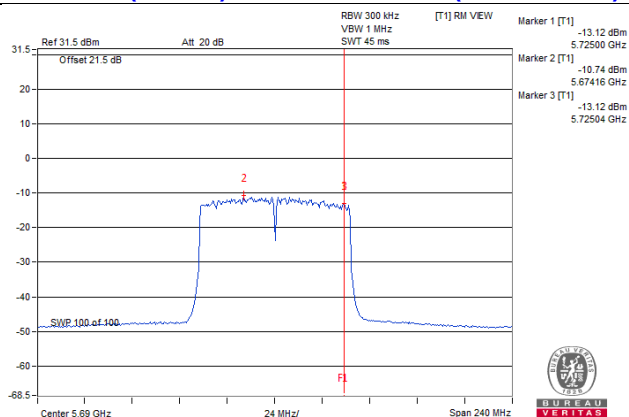

Spectrum Plot of Worst Value

802.11ax (HE20)_Chain 2 / CH144 (UNII-3 Band)

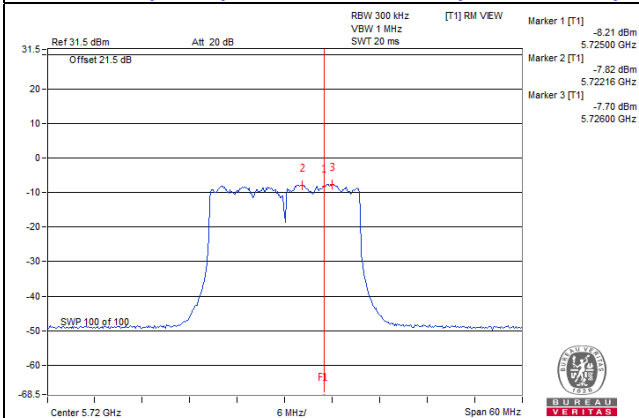

802.11ax (HE40)_Chain 3 / CH142 (UNII-3 Band)

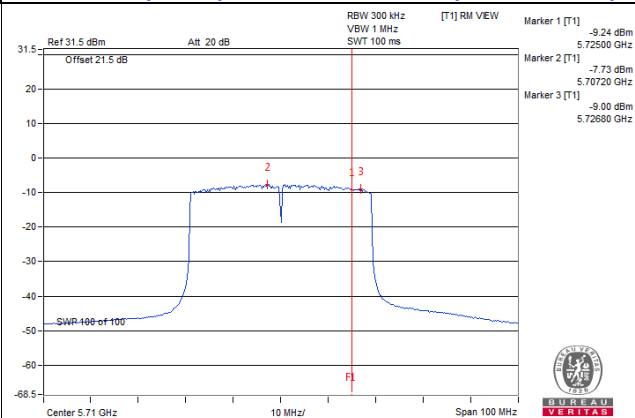

802.11ax (HE80)_Chain 3 / CH138 (UNII-3 Band)

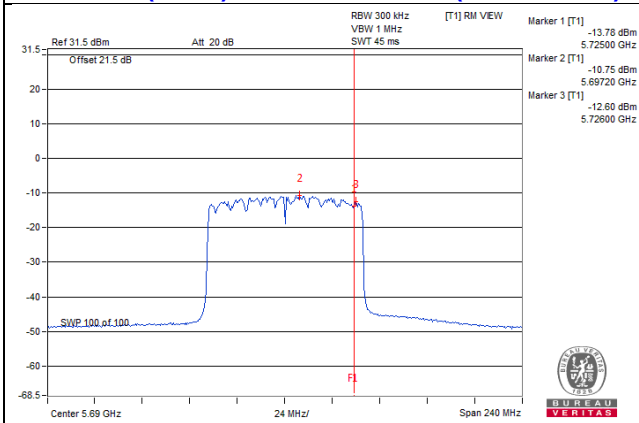

4.5.8 Test Results (Mode 2)

Non-Beamforming Mode

For U-NII-2A:

802.11a

Chan.	Chan. Freq. (MHz)	PSD W/O Duty Factor (dBm/MHz)		Duty Factor (dB)	Total PSD With Duty Factor (dBm/MHz)	MAX. Limit (dBm/MHz)	Pass / Fail
		Chain 2	Chain 3				
52	5260	5.23	4.93	0.32	8.41	9.50	Pass
60	5300	5.01	5.40	0.32	8.54	9.50	Pass
64	5320	5.39	5.23	0.32	8.64	9.50	Pass

- Note:**
- Method a) of power density measurement of KDB 662911 is using for calculating total power density. Total power density is summing entire spectra across corresponding frequency bins on the various outputs by computer.
 - Directional gain = 7.5dBi > 6dBi, so the power density limit shall be reduced to $11-(7.5-6) = 9.5\text{dBm}$.
 - Refer to section 3.3 for duty cycle spectrum plot.

802.11ac (VHT20)

Chan.	Chan. Freq. (MHz)	PSD W/O Duty Factor (dBm/MHz)		Duty Factor (dB)	Total PSD With Duty Factor (dBm/MHz)	MAX. Limit (dBm/MHz)	Pass / Fail
		Chain 2	Chain 3				
52	5260	4.98	5.09	0.17	8.22	9.50	Pass
60	5300	3.57	5.68	0.17	7.93	9.50	Pass
64	5320	4.90	4.69	0.17	7.98	9.50	Pass

- Note:**
- Method a) of power density measurement of KDB 662911 is using for calculating total power density. Total power density is summing entire spectra across corresponding frequency bins on the various outputs by computer.
 - Directional gain = 7.5dBi > 6dBi, so the power density limit shall be reduced to $11-(7.5-6) = 9.5\text{dBm}$.
 - Refer to section 3.3 for duty cycle spectrum plot.

802.11ac (VHT40)

Chan.	Chan. Freq. (MHz)	PSD W/O Duty Factor (dBm/MHz)		Duty Factor (dB)	Total PSD With Duty Factor (dBm/MHz)	MAX. Limit (dBm/MHz)	Pass / Fail
		Chain 2	Chain 3				
54	5270	4.55	2.88	0.17	6.98	9.50	Pass
62	5310	0.58	0.35	0.17	3.65	9.50	Pass

- Note:**
- Method a) of power density measurement of KDB 662911 is using for calculating total power density. Total power density is summing entire spectra across corresponding frequency bins on the various outputs by computer.
 - Directional gain = 7.5dBi > 6dBi, so the power density limit shall be reduced to $11-(7.5-6) = 9.5\text{dBm}$.
 - Refer to section 3.3 for duty cycle spectrum plot.

802.11ac (VHT80)

Chan.	Chan. Freq. (MHz)	PSD W/O Duty Factor (dBm/MHz)		Duty Factor (dB)	Total PSD With Duty Factor (dBm/MHz)	MAX. Limit (dBm/MHz)	Pass / Fail
		Chain 2	Chain 3				
58	5290	-4.51	-4.95	0.18	-1.53	9.50	Pass

- Note:**
- Method a) of power density measurement of KDB 662911 is using for calculating total power density. Total power density is summing entire spectra across corresponding frequency bins on the various outputs by computer.
 - Directional gain = 7.5dBi > 6dBi, so the power density limit shall be reduced to $11-(7.5-6) = 9.5\text{dBm}$.
 - Refer to section 3.3 for duty cycle spectrum plot.

802.11ax (HE20)

Chan.	Chan. Freq. (MHz)	PSD W/O Duty Factor (dBm/MHz)		Duty Factor (dB)	Total PSD With Duty Factor (dBm/MHz)	MAX. Limit (dBm/MHz)	Pass / Fail
		Chain 2	Chain 3				
52	5260	4.60	5.48	0.20	8.27	9.50	Pass
60	5300	4.74	5.59	0.20	8.40	9.50	Pass
64	5320	5.11	4.58	0.20	8.06	9.50	Pass

- Note:** 1. Method a) of power density measurement of KDB 662911 is using for calculating total power density. Total power density is summing entire spectra across corresponding frequency bins on the various outputs by computer.
2. Directional gain = 7.5dBi > 6dBi, so the power density limit shall be reduced to $11-(7.5-6) = 9.5\text{dBm}$.
3. Refer to section 3.3 for duty cycle spectrum plot.

802.11ax (HE40)

Chan.	Chan. Freq. (MHz)	PSD W/O Duty Factor (dBm/MHz)		Duty Factor (dB)	Total PSD With Duty Factor (dBm/MHz)	MAX. Limit (dBm/MHz)	Pass / Fail
		Chain 2	Chain 3				
54	5270	3.18	3.49	0.17	6.52	9.50	Pass
62	5310	0.25	-0.03	0.17	3.29	9.50	Pass

- Note:** 1. Method a) of power density measurement of KDB 662911 is using for calculating total power density. Total power density is summing entire spectra across corresponding frequency bins on the various outputs by computer.
2. Directional gain = 7.5dBi > 6dBi, so the power density limit shall be reduced to $11-(7.5-6) = 9.5\text{dBm}$.
3. Refer to section 3.3 for duty cycle spectrum plot.

802.11ax (HE80)

Chan.	Chan. Freq. (MHz)	PSD W/O Duty Factor (dBm/MHz)		Duty Factor (dB)	Total PSD With Duty Factor (dBm/MHz)	MAX. Limit (dBm/MHz)	Pass / Fail
		Chain 2	Chain 3				
58	5290	-5.12	-4.56	0.17	-1.65	9.50	Pass

- Note:** 1. Method a) of power density measurement of KDB 662911 is using for calculating total power density. Total power density is summing entire spectra across corresponding frequency bins on the various outputs by computer.
2. Directional gain = 7.5dBi > 6dBi, so the power density limit shall be reduced to $11-(7.5-6) = 9.5\text{dBm}$.
3. Refer to section 3.3 for duty cycle spectrum plot.

Spectrum Plot of Worst Value

802.11a_Chain 3 / CH60

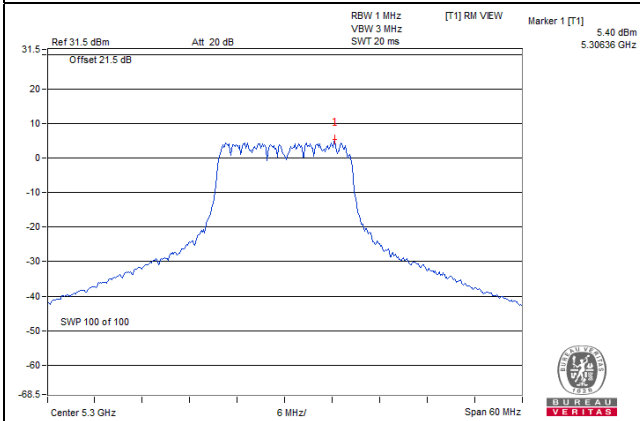

802.11ac (VHT20)_Chain 3 / CH60

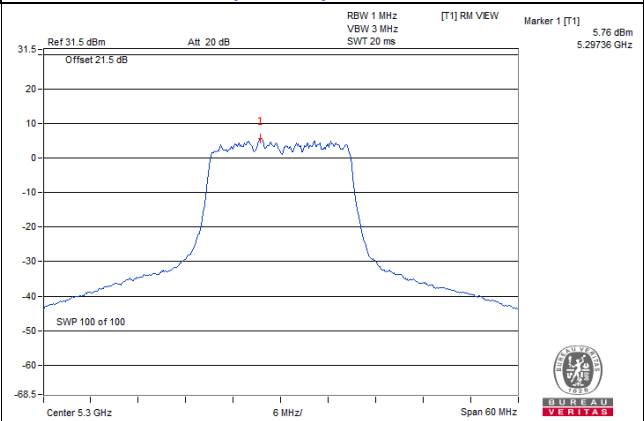

802.11ac (VHT40)_Chain 2 / CH54

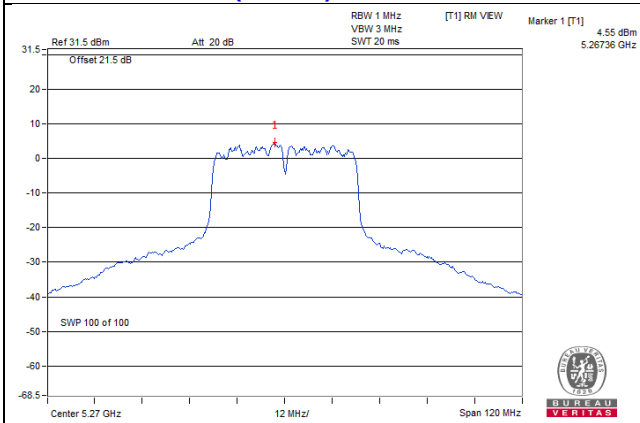

802.11ac (VHT80)_Chain 2 / CH58

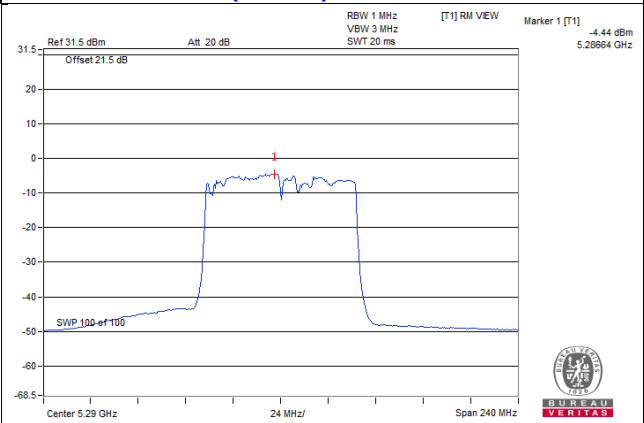

Spectrum Plot of Worst Value

802.11ax (HE20)_Chain 3 / CH60

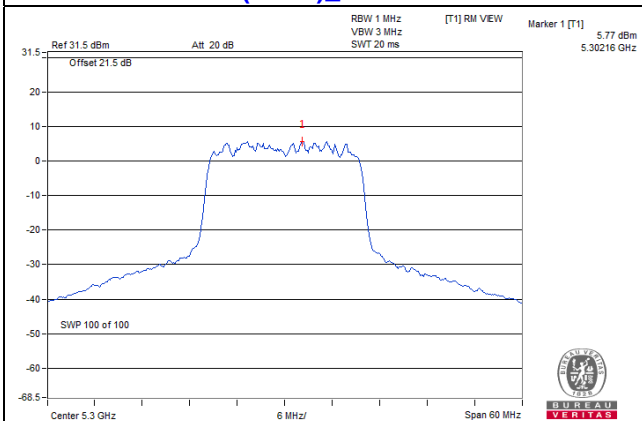

802.11ax (HE40)_Chain 3 / CH54

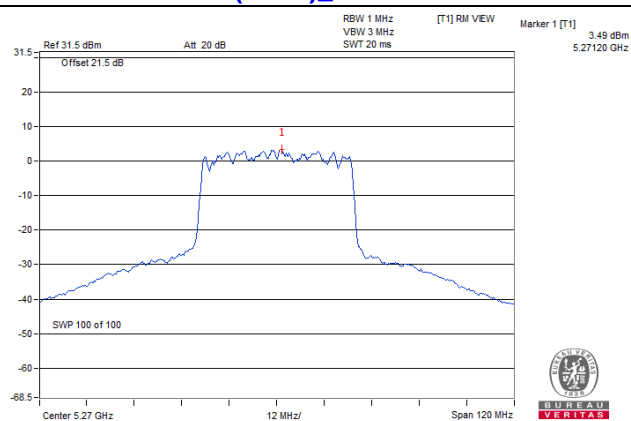

802.11ax (HE80)_Chain 3 / CH58

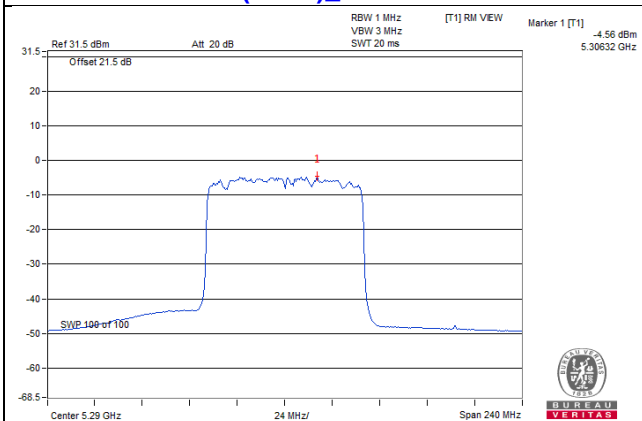

For UNII-2C:
802.11a

Chan.	Chan. Freq. (MHz)	PSD W/O Duty Factor (dBm/MHz)		Duty Factor (dB)	Total PSD With Duty Factor (dBm/MHz)	MAX. Limit (dBm/MHz)	Pass / Fail
		Chain 0	Chain 1				
100	5500	5.57	3.34	0.32	7.93	9.29	Pass
116	5580	5.79	3.19	0.32	8.01	9.29	Pass
140	5700	3.92	5.03	0.32	7.84	9.29	Pass
144 (UNII-2C Band)	5720	5.80	3.63	0.32	8.18	9.29	Pass

- Note:**
- Method a) of power density measurement of KDB 662911 is using for calculating total power density. Total power density is summing entire spectra across corresponding frequency bins on the various outputs by computer.
 - Directional gain = 7.71dBi > 6dBi, so the power density limit shall be reduced to $11-(7.71-6) = 9.29\text{dBm}$.
 - Refer to section 3.3 for duty cycle spectrum plot.

802.11ac (VHT20)

Chan.	Chan. Freq. (MHz)	PSD W/O Duty Factor (dBm/MHz)		Duty Factor (dB)	Total PSD With Duty Factor (dBm/MHz)	MAX. Limit (dBm/MHz)	Pass / Fail
		Chain 0	Chain 1				
100	5500	4.56	4.99	0.17	7.96	9.29	Pass
116	5580	4.64	4.97	0.17	7.99	9.29	Pass
140	5700	5.16	4.25	0.17	7.91	9.29	Pass
144 (UNII-2C Band)	5720	5.91	4.46	0.17	8.43	9.29	Pass

- Note:**
- Method a) of power density measurement of KDB 662911 is using for calculating total power density. Total power density is summing entire spectra across corresponding frequency bins on the various outputs by computer.
 - Directional gain = 7.71dBi > 6dBi, so the power density limit shall be reduced to $11-(7.71-6) = 9.29\text{dBm}$.
 - Refer to section 3.3 for duty cycle spectrum plot.

802.11ac (VHT40)

Chan.	Chan. Freq. (MHz)	PSD W/O Duty Factor (dBm/MHz)		Duty Factor (dB)	Total PSD With Duty Factor (dBm/MHz)	MAX. Limit (dBm/MHz)	Pass / Fail
		Chain 0	Chain 1				
102	5510	-1.02	0.62	0.17	3.06	9.29	Pass
110	5550	3.72	2.84	0.17	6.48	9.29	Pass
134	5670	2.01	0.94	0.17	4.69	9.29	Pass
142 (UNII-2C Band)	5710	3.91	4.04	0.17	7.16	9.29	Pass

- Note:**
- Method a) of power density measurement of KDB 662911 is using for calculating total power density. Total power density is summing entire spectra across corresponding frequency bins on the various outputs by computer.
 - Directional gain = 7.71dBi > 6dBi, so the power density limit shall be reduced to $11-(7.71-6) = 9.29\text{dBm}$.
 - Refer to section 3.3 for duty cycle spectrum plot.

802.11ac (VHT80)

Chan.	Chan. Freq. (MHz)	PSD W/O Duty Factor (dBm/MHz)		Duty Factor (dB)	Total PSD With Duty Factor (dBm/MHz)	MAX. Limit (dBm/MHz)	Pass / Fail
		Chain 0	Chain 1				
106	5530	-4.36	-4.66	0.18	-1.32	9.29	Pass
122	5610	1.21	0.68	0.18	4.14	9.29	Pass
138 (UNII-2C Band)	5690	1.07	0.68	0.18	4.07	9.29	Pass

- Note:**
- Method a) of power density measurement of KDB 662911 is using for calculating total power density. Total power density is summing entire spectra across corresponding frequency bins on the various outputs by computer.
 - Directional gain = 7.71dBi > 6dBi, so the power density limit shall be reduced to $11-(7.71-6) = 9.29\text{dBm}$.
 - Refer to section 3.3 for duty cycle spectrum plot.

802.11ax (HE20)

Chan.	Chan. Freq. (MHz)	PSD W/O Duty Factor (dBm/MHz)		Duty Factor (dB)	Total PSD With Duty Factor (dBm/MHz)	MAX. Limit (dBm/MHz)	Pass / Fail
		Chain 0	Chain 1				
100	5500	4.57	4.18	0.20	7.59	9.29	Pass
116	5580	4.66	4.52	0.20	7.80	9.29	Pass
140	5700	4.91	4.31	0.20	7.83	9.29	Pass
144 (UNII-2C Band)	5720	4.52	4.80	0.20	7.87	9.29	Pass

- Note:**
- Method a) of power density measurement of KDB 662911 is using for calculating total power density. Total power density is summing entire spectra across corresponding frequency bins on the various outputs by computer.
 - Directional gain = 7.71dBi > 6dBi, so the power density limit shall be reduced to $11-(7.71-6) = 9.29\text{dBm}$.
 - Refer to section 3.3 for duty cycle spectrum plot.

802.11ax (HE40)

Chan.	Chan. Freq. (MHz)	PSD W/O Duty Factor (dBm/MHz)		Duty Factor (dB)	Total PSD With Duty Factor (dBm/MHz)	MAX. Limit (dBm/MHz)	Pass / Fail
		Chain 0	Chain 1				
102	5510	-0.43	0.34	0.17	3.15	9.29	Pass
110	5550	3.53	2.87	0.17	6.39	9.29	Pass
134	5670	0.42	1.68	0.17	4.28	9.29	Pass
142 (UNII-2C Band)	5710	3.62	3.82	0.17	6.90	9.29	Pass

- Note:**
- Method a) of power density measurement of KDB 662911 is using for calculating total power density. Total power density is summing entire spectra across corresponding frequency bins on the various outputs by computer.
 - Directional gain = 7.71dBi > 6dBi, so the power density limit shall be reduced to $11-(7.71-6) = 9.29\text{dBm}$.
 - Refer to section 3.3 for duty cycle spectrum plot.

802.11ax (HE80)

Chan.	Chan. Freq. (MHz)	PSD W/O Duty Factor (dBm/MHz)		Duty Factor (dB)	Total PSD With Duty Factor (dBm/MHz)	MAX. Limit (dBm/MHz)	Pass / Fail
		Chain 0	Chain 1				
106	5530	-4.39	-4.15	0.17	-1.09	9.29	Pass
122	5610	0.53	-0.07	0.17	3.42	9.29	Pass
138 (UNII-2C Band)	5690	0.75	0.46	0.17	3.79	9.29	Pass

- Note:**
- Method a) of power density measurement of KDB 662911 is using for calculating total power density. Total power density is summing entire spectra across corresponding frequency bins on the various outputs by computer.
 - Directional gain = 7.71dBi > 6dBi, so the power density limit shall be reduced to $11-(7.71-6) = 9.29\text{dBm}$.
 - Refer to section 3.3 for duty cycle spectrum plot.

Spectrum Plot of Worst Value

802.11a_Chain 0 / CH116

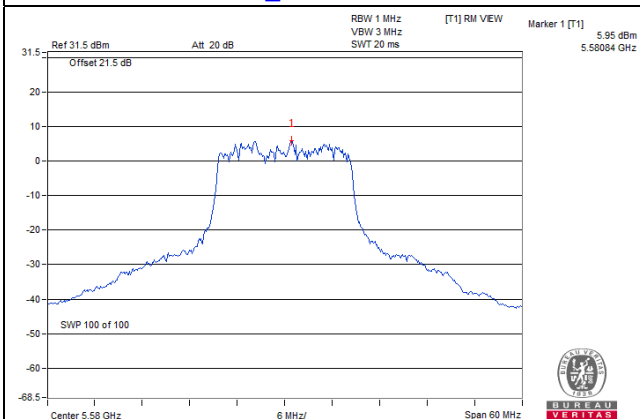

802.11ac (VHT20)_Chain 0 / CH144 (UNII-2C Band)

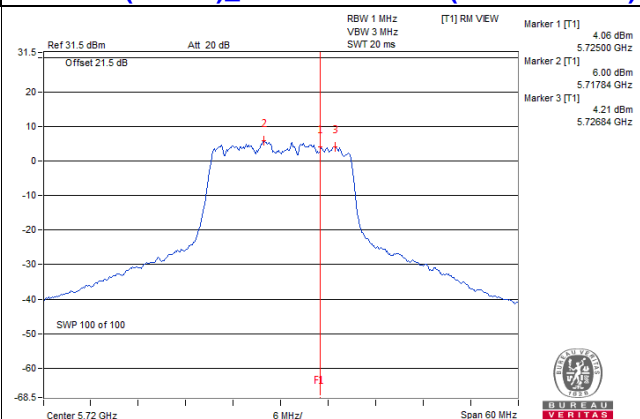

802.11ac (VHT40)_Chain 1 / CH142 (UNII-2C Band)

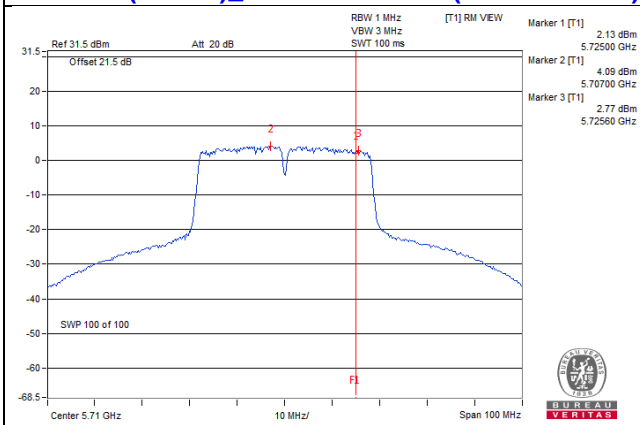

802.11ac (VHT80)_Chain 0 / CH122

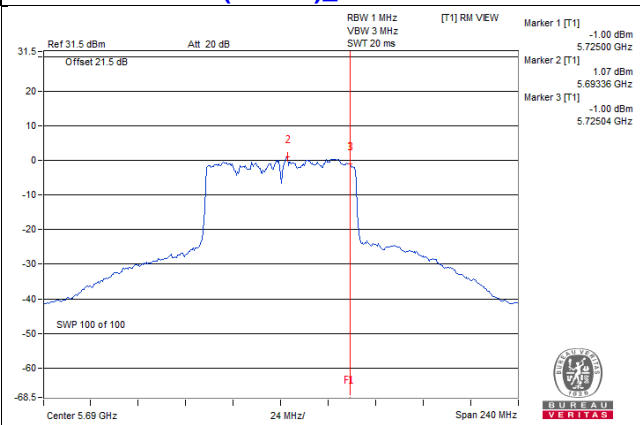

Spectrum Plot of Worst Value

802.11ax (HE20)_Chain 0 / CH140

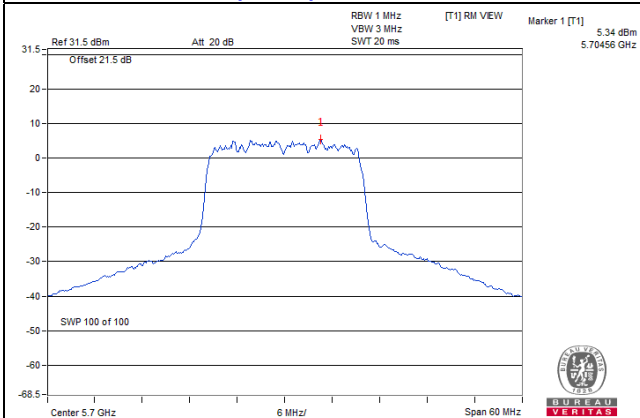

802.11ax (HE40)_Chain 1 / CH142 (UNII-2C Band)

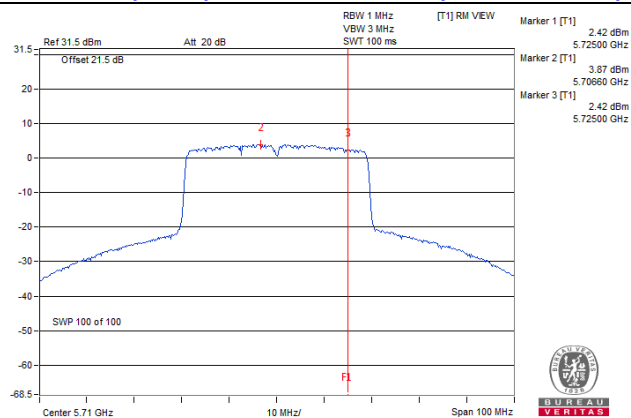

802.11ax (HE80)_Chain 0 / CH138 (UNII-2C Band)

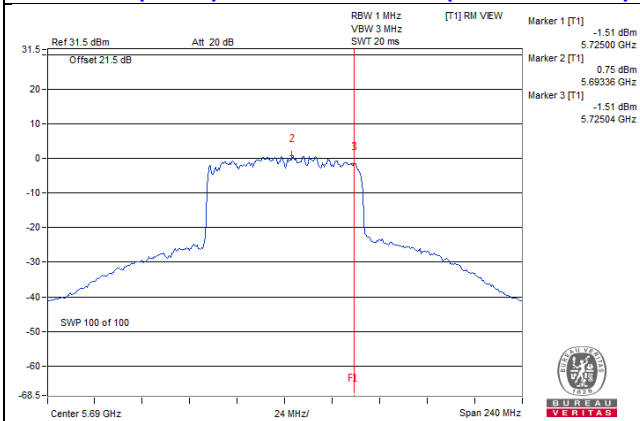

For U-NII-3:

Non-Beamforming Mode

802.11a

Chan.	Freq. (MHz)	PSD W/O Duty Factor (dBm/300kHz)		Duty Factor (dB)	Total PSD With Duty Factor		Total PSD With Duty Factor (dBm/500kHz)	Limit (dBm/500kHz)	Pass /Fail
		Chain 0	Chain 1		mW/300kHz	dBm/300kHz			
144 (UNII-3 Band)	5720	-2.50	-4.01	0.32	1.0321	0.14	2.36	28.73	Pass

- Note: 1. Method b) Measure and sum spectral maxima across the outputs of KDB 662911 is using for calculating total power density.
 2. Directional gain = 7.27dBi > 6dBi, so the power density limit shall be reduced to $30-(7.27-6) = 28.73$ dBm.
 3. Refer to section 3.3 for duty cycle spectrum plot.

802.11ac (VHT20)

Chan.	Freq. (MHz)	PSD W/O Duty Factor (dBm/300kHz)		Duty Factor (dB)	Total PSD With Duty Factor		Total PSD With Duty Factor (dBm/500kHz)	Limit (dBm/500kHz)	Pass /Fail
		Chain 0	Chain 1		mW/300kHz	dBm/300kHz			
144 (UNII-3 Band)	5720	-4.07	-3.12	0.17	0.9141	-0.39	1.83	28.73	Pass

- Note: 1. Method b) Measure and sum spectral maxima across the outputs of KDB 662911 is using for calculating total power density.
 2. Directional gain = 7.27dBi > 6dBi, so the power density limit shall be reduced to $30-(7.27-6) = 28.73$ dBm.
 3. Refer to section 3.3 for duty cycle spectrum plot.

802.11ac (VHT40)

Chan.	Freq. (MHz)	PSD W/O Duty Factor (dBm/300kHz)		Duty Factor (dB)	Total PSD With Duty Factor		Total PSD With Duty Factor (dBm/500kHz)	Limit (dBm/500kHz)	Pass /Fail
		Chain 0	Chain 1		mW/300kHz	dBm/300kHz			
142 (UNII-3 Band)	5710	-5.55	-5.86	0.17	0.5591	-2.53	-0.31	28.73	Pass

- Note: 1. Method b) Measure and sum spectral maxima across the outputs of KDB 662911 is using for calculating total power density.
 2. Directional gain = 7.27dBi > 6dBi, so the power density limit shall be reduced to $30-(7.27-6) = 28.73$ dBm.
 3. Refer to section 3.3 for duty cycle spectrum plot.

802.11ac (VHT80)

Chan.	Freq. (MHz)	PSD W/O Duty Factor (dBm/300kHz)		Duty Factor (dB)	Total PSD With Duty Factor		Total PSD With Duty Factor (dBm/500kHz)	Limit (dBm/500kHz)	Pass /Fail
		Chain 0	Chain 1		mW/300kHz	dBm/300kHz			
138 (UNII-3 Band)	5690	-10.15	-11.02	0.18	0.18303	-7.37	-5.15	28.73	Pass

- Note: 1. Method b) Measure and sum spectral maxima across the outputs of KDB 662911 is using for calculating total power density.
 2. Directional gain = 7.27dBi > 6dBi, so the power density limit shall be reduced to $30 - (7.27 - 6) = 28.73$ dBm.
 3. Refer to section 3.3 for duty cycle spectrum plot.

802.11ax (HE20)

Chan.	Freq. (MHz)	PSD W/O Duty Factor (dBm/300kHz)		Duty Factor (dB)	Total PSD With Duty Factor		Total PSD With Duty Factor (dBm/500kHz)	Limit (dBm/500kHz)	Pass /Fail
		Chain 0	Chain 1		mW/300kHz	dBm/300kHz			
144 (UNII-3 Band)	5720	-4.61	-4.40	0.20	0.7426	-1.29	0.93	28.73	Pass

- Note: 1. Method b) Measure and sum spectral maxima across the outputs of KDB 662911 is using for calculating total power density.
 2. Directional gain = 7.27dBi > 6dBi, so the power density limit shall be reduced to $30 - (7.27 - 6) = 28.73$ dBm.
 3. Refer to section 3.3 for duty cycle spectrum plot.

802.11ax (HE40)

Chan.	Freq. (MHz)	PSD W/O Duty Factor (dBm/300kHz)		Duty Factor (dB)	Total PSD With Duty Factor		Total PSD With Duty Factor (dBm/500kHz)	Limit (dBm/500kHz)	Pass /Fail
		Chain 0	Chain 1		mW/300kHz	dBm/300kHz			
142 (UNII-3 Band)	5710	-5.87	-6.30	0.17	0.5129	-2.90	-0.68	28.73	Pass

- Note: 1. Method b) Measure and sum spectral maxima across the outputs of KDB 662911 is using for calculating total power density.
 2. Directional gain = 7.27dBi > 6dBi, so the power density limit shall be reduced to $30 - (7.27 - 6) = 28.73$ dBm.
 3. Refer to section 3.3 for duty cycle spectrum plot.

802.11ax (HE80)

Chan.	Freq. (MHz)	PSD W/O Duty Factor (dBm/300kHz)		Duty Factor (dB)	Total PSD With Duty Factor		Total PSD With Duty Factor (dBm/500kHz)	Limit (dBm/500kHz)	Pass /Fail
		Chain 0	Chain 1		mW/300kHz	dBm/300kHz			
138 (UNII-3 Band)	5690	-9.39	-10.43	0.17	0.21396	-6.70	-4.48	28.73	Pass

- Note: 1. Method b) Measure and sum spectral maxima across the outputs of KDB 662911 is using for calculating total power density.
2. Directional gain = 7.27dBi > 6dBi, so the power density limit shall be reduced to $30 - (7.27 - 6) = 28.73$ dBm.
3. Refer to section 3.3 for duty cycle spectrum plot.

Spectrum Plot of Worst Value

802.11a_Chain 0 / CH144 (UNII-3 Band)

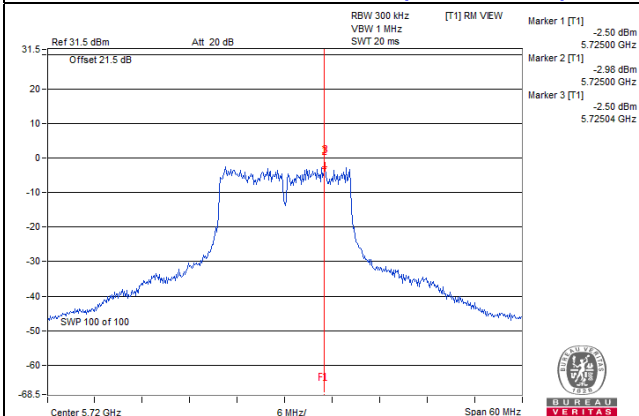

802.11ac (VHT20)_Chain 1 / CH144 (UNII-3 Band)

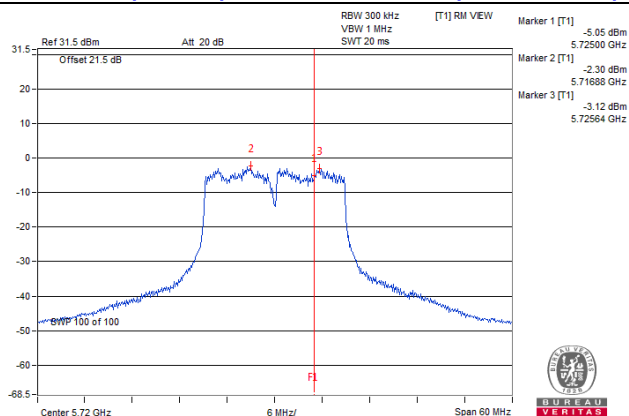

802.11ac (VHT40)_Chain 0 / CH142 (UNII-3 Band)

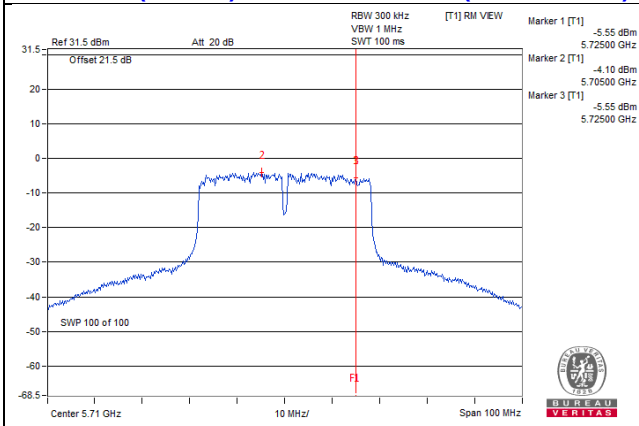

802.11ac (VHT80)_Chain 0 / CH138 (UNII-3 Band)

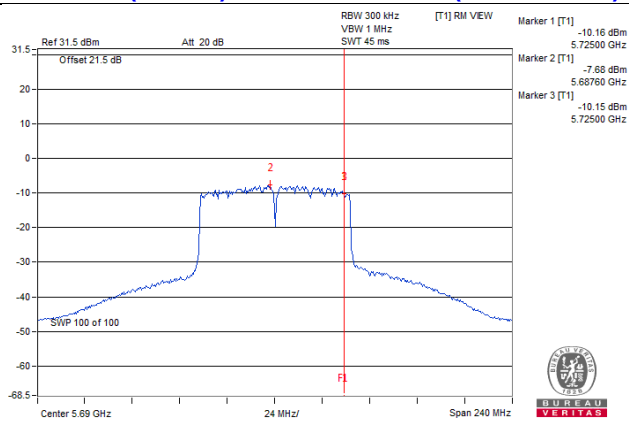

Spectrum Plot of Worst Value

802.11ax (HE20)_Chain 1 / CH144 (UNII-3 Band)

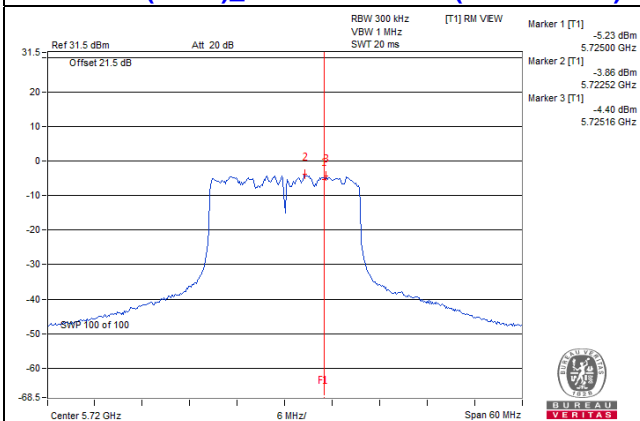

802.11ax (HE40)_Chain 0 / CH142 (UNII-3 Band)

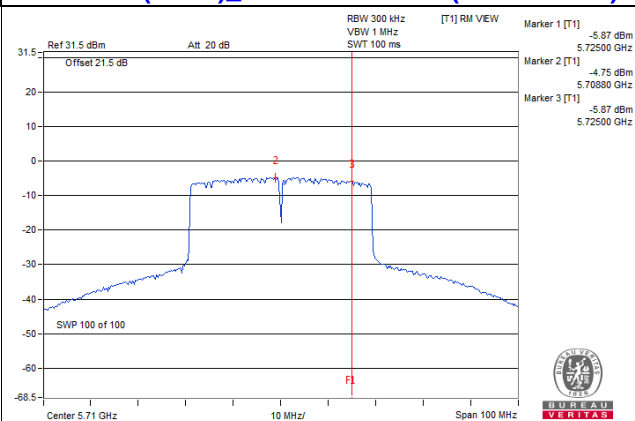

802.11ax (HE80)_Chain 0 / CH138 (UNII-3 Band)

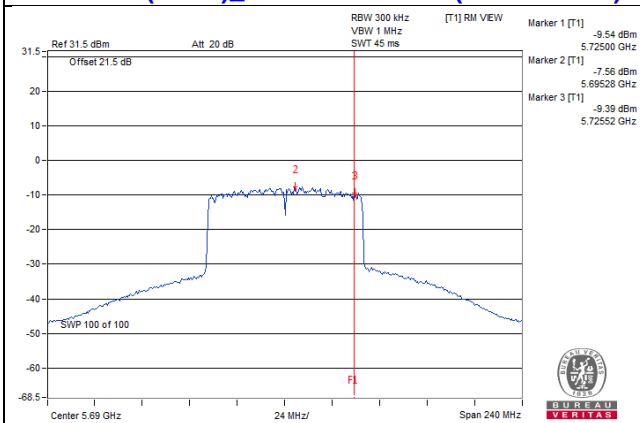

4.5.9 Test Results (Mode 3)

Non-Beamforming Mode

For U-NII-2A, UNII-2C:

802.11a

Chan.	Chan. Freq. (MHz)	PSD W/O Duty Factor (dBm/MHz)	Duty Factor (dB)	PSD With Duty Factor (dBm/MHz)	MAX. Limit (dBm/MHz)	Pass / Fail
52	5260	7.01	0.32	7.33	11.00	Pass
60	5300	7.03	0.32	7.35	11.00	Pass
64	5320	6.63	0.32	6.95	11.00	Pass
100	5500	6.85	0.32	7.17	11.00	Pass
116	5580	6.83	0.32	7.15	11.00	Pass
140	5700	7.10	0.32	7.42	11.00	Pass
144 (UNII-2C Band)	5720	6.44	0.32	6.76	11.00	Pass

- Note:** 1. Refer to section 3.3 for duty cycle spectrum plot.
 2. For UNII-2A Band: Chain 2 was chosen for test.
 For UNII-2C Band: Chain 1 was chosen for test.

802.11ac (VHT20)

Chan.	Chan. Freq. (MHz)	PSD W/O Duty Factor (dBm/MHz)	Duty Factor (dB)	PSD With Duty Factor (dBm/MHz)	MAX. Limit (dBm/MHz)	Pass / Fail
52	5260	6.99	0.17	7.16	11.00	Pass
60	5300	7.00	0.17	7.17	11.00	Pass
64	5320	6.55	0.17	6.72	11.00	Pass
100	5500	6.17	0.17	6.34	11.00	Pass
116	5580	6.63	0.17	6.80	11.00	Pass
140	5700	6.21	0.17	6.38	11.00	Pass
144 (UNII-2C Band)	5720	5.66	0.17	5.83	11.00	Pass

- Note:** 1. Refer to section 3.3 for duty cycle spectrum plot.
 2. For UNII-2A Band: Chain 2 was chosen for test.
 For UNII-2C Band: Chain 1 was chosen for test.

802.11ac (VHT40)

Chan.	Chan. Freq. (MHz)	PSD W/O Duty Factor (dBm/MHz)	Duty Factor (dB)	PSD With Duty Factor (dBm/MHz)	MAX. Limit (dBm/MHz)	Pass / Fail
54	5270	4.55	0.17	4.72	11.00	Pass
62	5310	1.66	0.17	1.83	11.00	Pass
102	5510	1.42	0.17	1.59	11.00	Pass
110	5550	3.42	0.17	3.59	11.00	Pass
134	5670	2.75	0.17	2.92	11.00	Pass
142 (UNII-2C Band)	5710	4.09	0.17	4.26	11.00	Pass

Note: 1. Refer to section 3.3 for duty cycle spectrum plot.
 2. For UNII-2A Band: Chain 2 was chosen for test.
 For UNII-2C Band: Chain 1 was chosen for test.

802.11ac (VHT80)

Chan.	Chan. Freq. (MHz)	PSD W/O Duty Factor (dBm/MHz)	Duty Factor (dB)	PSD With Duty Factor (dBm/MHz)	MAX. Limit (dBm/MHz)	Pass / Fail
58	5290	-3.70	0.18	-3.52	11.00	Pass
106	5530	-2.61	0.18	-2.43	11.00	Pass
122	5610	0.68	0.18	0.86	11.00	Pass
138 (UNII-2C Band)	5690	0.68	0.18	0.86	11.00	Pass

Note: 1. Refer to section 3.3 for duty cycle spectrum plot.
 2. For UNII-2A Band: Chain 2 was chosen for test.
 For UNII-2C Band: Chain 1 was chosen for test.

802.11ax (HE20)

Chan.	Chan. Freq. (MHz)	PSD W/O Duty Factor (dBm/MHz)	Duty Factor (dB)	PSD With Duty Factor (dBm/MHz)	MAX. Limit (dBm/MHz)	Pass / Fail
52	5260	6.33	0.20	6.53	11.00	Pass
60	5300	6.89	0.20	7.09	11.00	Pass
64	5320	6.46	0.20	6.66	11.00	Pass
100	5500	5.73	0.20	5.93	11.00	Pass
116	5580	6.62	0.20	6.82	11.00	Pass
140	5700	6.31	0.20	6.51	11.00	Pass
144 (UNII-2C Band)	5720	6.21	0.20	6.41	11.00	Pass

- Note:** 1. Refer to section 3.3 for duty cycle spectrum plot.
 2. For UNII-2A Band: Chain 2 was chosen for test.
 For UNII-2C Band: Chain 1 was chosen for test.

802.11ax (HE40)

Chan.	Chan. Freq. (MHz)	PSD W/O Duty Factor (dBm/MHz)	Duty Factor (dB)	PSD With Duty Factor (dBm/MHz)	MAX. Limit (dBm/MHz)	Pass / Fail
54	5270	4.20	0.17	4.37	11.00	Pass
62	5310	1.49	0.17	1.66	11.00	Pass
102	5510	0.64	0.17	0.81	11.00	Pass
110	5550	3.75	0.17	3.92	11.00	Pass
134	5670	2.72	0.17	2.89	11.00	Pass
142 (UNII-2C Band)	5710	3.87	0.17	4.04	11.00	Pass

- Note:** 1. Refer to section 3.3 for duty cycle spectrum plot.
 2. For UNII-2A Band: Chain 2 was chosen for test.
 For UNII-2C Band: Chain 1 was chosen for test.

802.11ax (HE80)

Chan.	Chan. Freq. (MHz)	PSD W/O Duty Factor (dBm/MHz)	Duty Factor (dB)	PSD With Duty Factor (dBm/MHz)	MAX. Limit (dBm/MHz)	Pass / Fail
58	5290	-3.50	0.17	-3.33	11.00	Pass
106	5530	-2.25	0.17	-2.08	11.00	Pass
122	5610	0.60	0.17	0.77	11.00	Pass
138 (UNII-2C Band)	5690	0.48	0.17	0.65	11.00	Pass

- Note:**
1. Refer to section 3.3 for duty cycle spectrum plot.
 2. For UNII-2A Band: Chain 2 was chosen for test.
For UNII-2C Band: Chain 1 was chosen for test.

Spectrum Plot of Worst Value

802.11a_Chain 1 / CH140

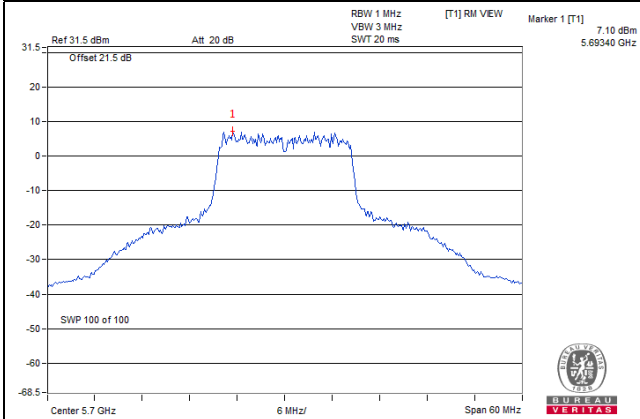

802.11ac (VHT20)_Chain 2 / CH60

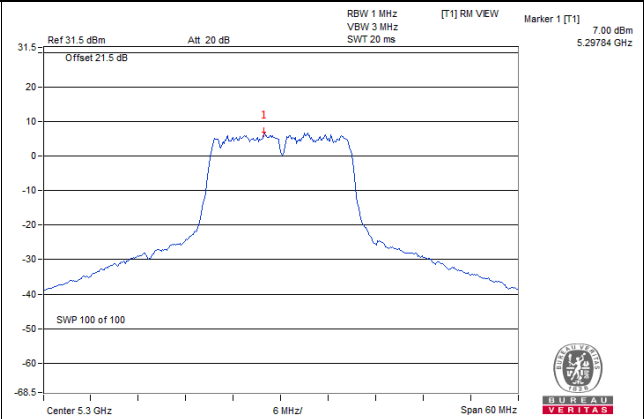

802.11ac (VHT40)_Chain 2 / CH54

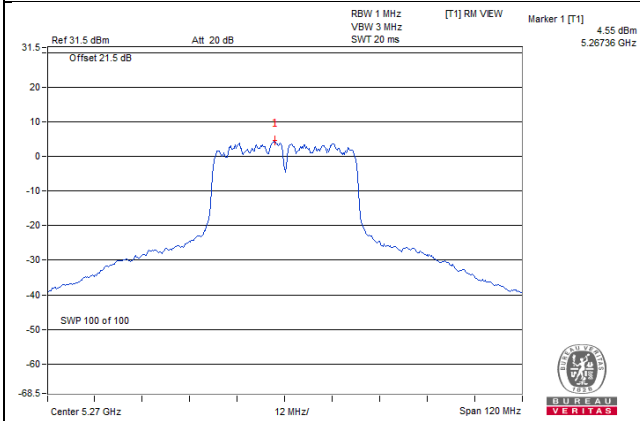

802.11ac (VHT80)_Chain 1 / CH138 (UNII-2C band)

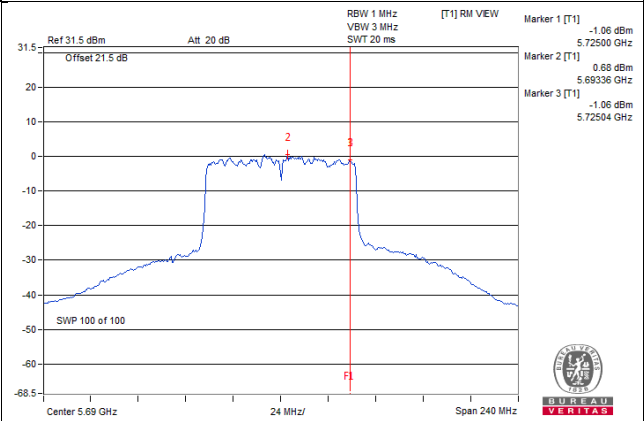

Spectrum Plot of Worst Value

802.11ax (HE20) _Chain 2 / CH60

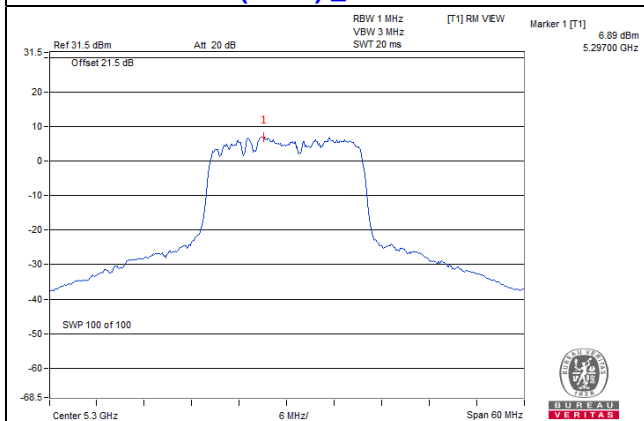

802.11ax (HE40) _Chain 2 / CH54

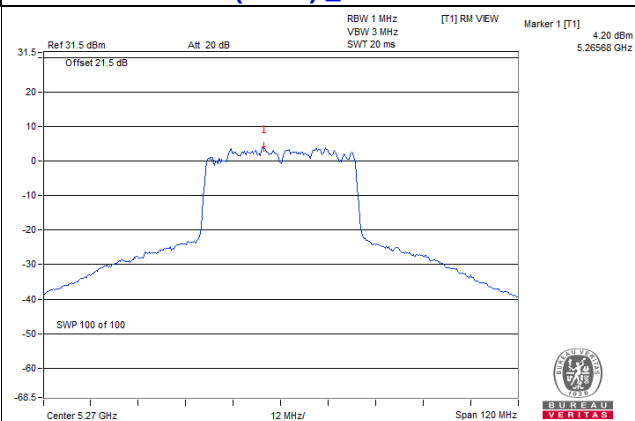

802.11ax (HE80) _Chain 1 / CH122

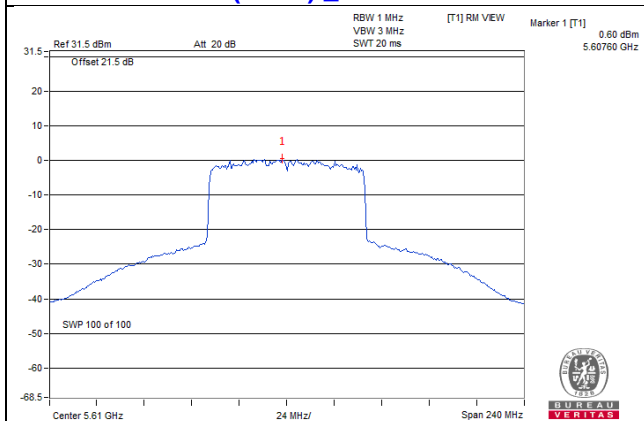

For U-NII-3:
Non-Beamforming Mode
802.11a

Chan.	Chan. Freq. (MHz)	PSD W/O Duty Factor (dBm/300kHz)	Duty Factor (dB)	Total PSD With Duty Factor		Total PSD With Duty Factor (dBm/500kHz)	Limit (dBm/500kHz)	Pass /Fail
				mW/300kHz	dBm/300kHz			
144 (U-NII-3 Band)	5720	-1.62	0.32	0.7407	-1.30	0.92	30.00	Pass

- Note:** 1. Refer to section 3.3 for duty cycle spectrum plot.
 2. Chain 1 was chosen for test.

802.11ac (VHT20)

Chan.	Chan. Freq. (MHz)	PSD W/O Duty Factor (dBm/300kHz)	Duty Factor (dB)	Total PSD With Duty Factor		Total PSD With Duty Factor (dBm/500kHz)	Limit (dBm/500kHz)	Pass /Fail
				mW/300kHz	dBm/300kHz			
144 (U-NII-3 Band)	5720	-1.93	0.17	0.6666	-1.76	0.46	30.00	Pass

- Note:** 1. Refer to section 3.3 for duty cycle spectrum plot.
 2. Chain 1 was chosen for test.

802.11ac (VHT40)

Chan.	Chan. Freq. (MHz)	PSD W/O Duty Factor (dBm/300kHz)	Duty Factor (dB)	Total PSD With Duty Factor		Total PSD With Duty Factor (dBm/500kHz)	Limit (dBm/500kHz)	Pass /Fail
				mW/300kHz	dBm/300kHz			
142 (U-NII-3 Band)	5710	-5.86	0.17	0.2696	-5.69	-3.47	30.00	Pass

- Note:** 1. Refer to section 3.3 for duty cycle spectrum plot.
 2. Chain 1 was chosen for test.

802.11ac (VHT80)

Chan.	Chan. Freq. (MHz)	PSD W/O Duty Factor (dBm/300kHz)	Duty Factor (dB)	Total PSD With Duty Factor		Total PSD With Duty Factor (dBm/500kHz)	Limit (dBm/500kHz)	Pass /Fail
				mW/300kHz	dBm/300kHz			
138 (U-NII-3 Band)	5690	-11.02	0.18	0.08238	-10.84	-8.62	30.00	Pass

- Note:** 1. Refer to section 3.3 for duty cycle spectrum plot.
 2. Chain 1 was chosen for test.

802.11ax (HE20)

Chan.	Chan. Freq. (MHz)	PSD W/O Duty Factor (dBm/300kHz)	Duty Factor (dB)	Total PSD With Duty Factor		Total PSD With Duty Factor (dBm/500kHz)	Limit (dBm/500kHz)	Pass /Fail
				mW/300kHz	dBm/300kHz			
144 (U-NII-3 Band)	5720	-2.77	0.20	0.5535	-2.57	-0.35	30.00	Pass

- Note:** 1. Refer to section 3.3 for duty cycle spectrum plot.
 2. Chain 1 was chosen for test.

802.11ax (HE40)

Chan.	Chan. Freq. (MHz)	PSD W/O Duty Factor (dBm/300kHz)	Duty Factor (dB)	Total PSD With Duty Factor		Total PSD With Duty Factor (dBm/500kHz)	Limit (dBm/500kHz)	Pass /Fail
				mW/300kHz	dBm/300kHz			
142 (U-NII-3 Band)	5710	-6.30	0.17	0.2438	-6.13	-3.91	30.00	Pass

- Note:** 1. Refer to section 3.3 for duty cycle spectrum plot.
 2. Chain 1 was chosen for test.

802.11ax (HE80)

Chan.	Chan. Freq. (MHz)	PSD W/O Duty Factor (dBm/300kHz)	Duty Factor (dB)	Total PSD With Duty Factor		Total PSD With Duty Factor (dBm/500kHz)	Limit (dBm/500kHz)	Pass /Fail
				mW/300kHz	dBm/300kHz			
138 (U-NII-3 Band)	5690	-10.43	0.17	0.09423	-10.26	-8.04	30.00	Pass

- Note:** 1. Refer to section 3.3 for duty cycle spectrum plot.
 2. Chain 1 was chosen for test.

Spectrum Plot of Worst Value

802.11a_Chain 1 / CH 144 (UNII-3)

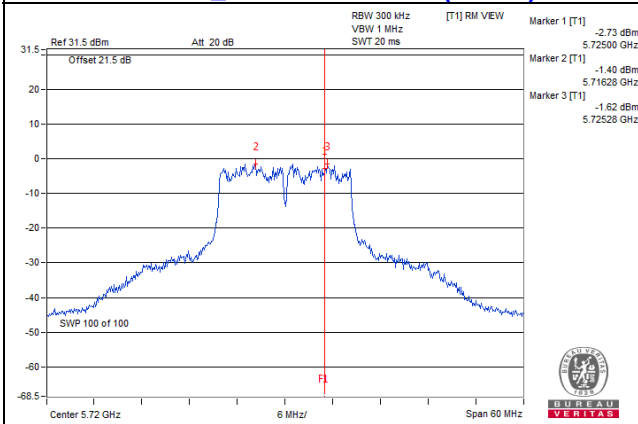

802.11ac (VHT20)_Chain 1 / CH 144 (UNII-3)

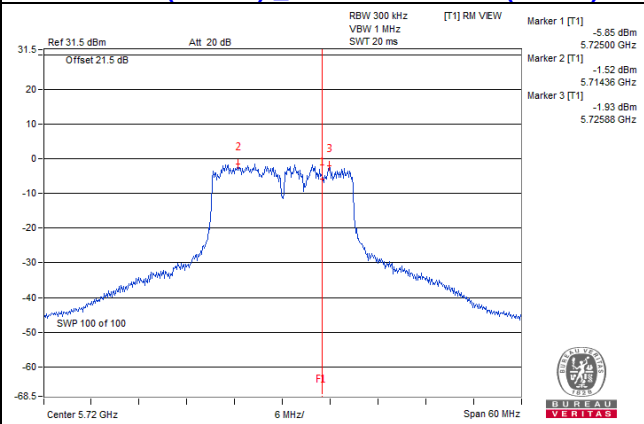

802.11ac (VHT40)_Chain 1 / CH 142 (UNII-3)

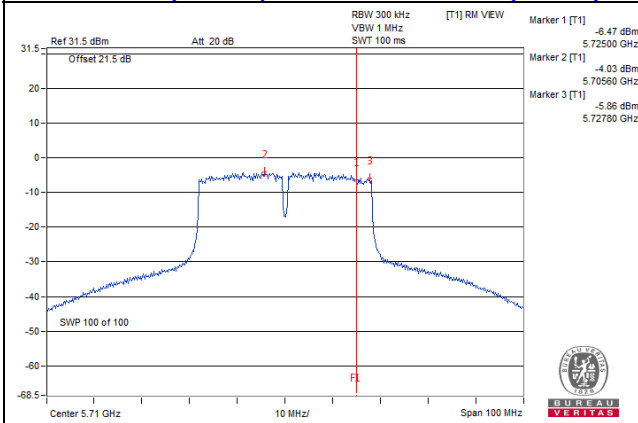

802.11ac (VHT80)_Chain 1 / CH 138 (UNII-3)

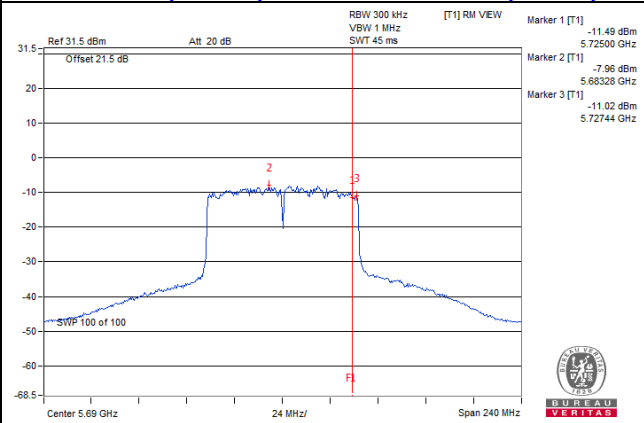

Spectrum Plot of Worst Value

802.11ax (HE20) _Chain 1 / CH 144 (UNII-3)

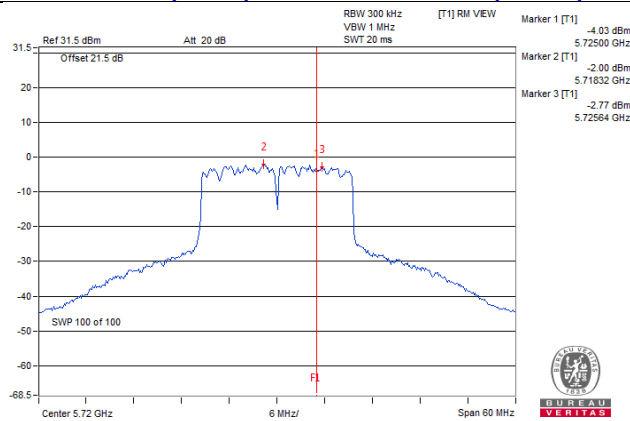

802.11ax (HE40) _Chain 1 / CH 142 (UNII-3)

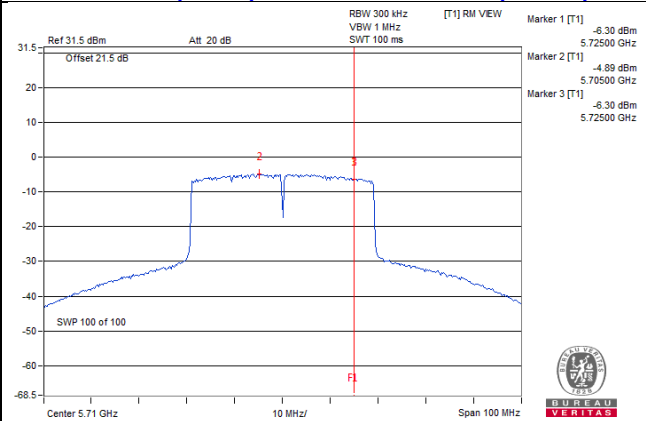

802.11ax (HE80) _Chain 1 / CH 138 (UNII-3)

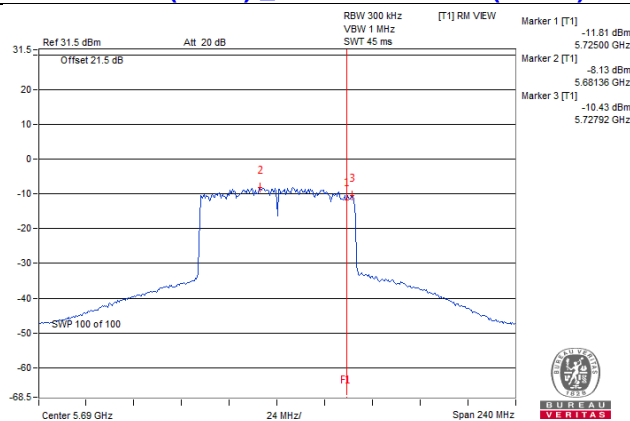

4.6 Frequency Stability Measurement

4.6.1 Limits of Frequency Stability Measurement

The frequency of the carrier signal shall be maintained within band of operation

4.6.2 Test Setup

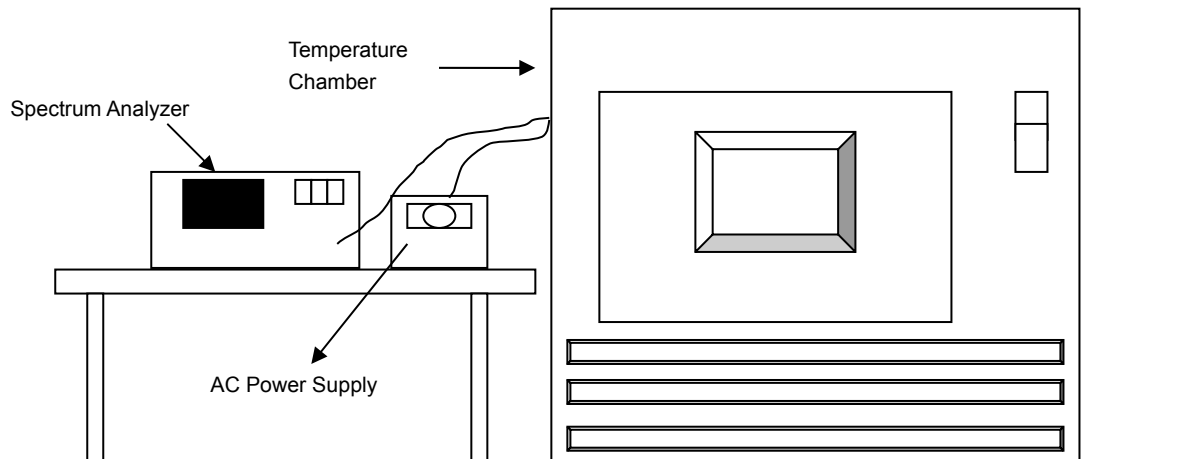

4.6.3 Test Instruments

Refer to section 4.1.2 to get information of above instrument.

4.6.4 Test Procedure

- The EUT was placed inside the environmental test chamber and powered by nominal AC voltage.
- Turn the EUT on and couple its output to a spectrum analyzer.
- Turn the EUT off and set the chamber to the highest temperature specified.
- Allow sufficient time (approximately 30 min) for the temperature of the chamber to stabilize, turn the EUT on and measure the operating frequency after 2, 5, and 10 Minutes.
- Repeat step 2 and 3 with the temperature chamber set to the lowest temperature.
- The test chamber was allowed to stabilize at +20 degree C for a minimum of 30 Minutes. The supply voltage was then adjusted on the EUT from 85% to 115% and the frequency record.

4.6.5 Deviation from Test Standard

No deviation.

4.6.6 EUT Operating Condition

Set the EUT transmit at un-modulation mode to test frequency stability.

4.6.7 Test Results (Mode 1)

Frequency Stability Versus Temp.									
Operating Frequency: 5260 MHz									
TEMP. (°C)	Power Supply (Vac)	0 Minute		2 Minutes		5 Minutes		10 Minutes	
		Measured Frequency (MHz)	Pass/Fail	Measured Frequency (MHz)	Pass/Fail	Measured Frequency (MHz)	Pass/Fail	Measured Frequency (MHz)	Pass/Fail
50	120	5260.0233	Pass	5260.0229	Pass	5260.0255	Pass	5260.0221	Pass
40	120	5260.0105	Pass	5260.0109	Pass	5260.0097	Pass	5260.0132	Pass
30	120	5259.974	Pass	5259.9761	Pass	5259.976	Pass	5259.9741	Pass
20	120	5259.9864	Pass	5259.9847	Pass	5259.9828	Pass	5259.9861	Pass
10	120	5259.9746	Pass	5259.9743	Pass	5259.9742	Pass	5259.9755	Pass
0	120	5259.9759	Pass	5259.9745	Pass	5259.9754	Pass	5259.9719	Pass
-10	120	5260.0222	Pass	5260.0227	Pass	5260.0192	Pass	5260.0206	Pass
-20	120	5259.9772	Pass	5259.9813	Pass	5259.9811	Pass	5259.9791	Pass
-30	120	5260.0112	Pass	5260.0098	Pass	5260.013	Pass	5260.01	Pass

Frequency Stability Versus Voltage									
Operating Frequency: 5260 MHz									
TEMP. (°C)	Power Supply (Vac)	0 Minute		2 Minutes		5 Minutes		10 Minutes	
		Measured Frequency (MHz)	Pass/Fail	Measured Frequency (MHz)	Pass/Fail	Measured Frequency (MHz)	Pass/Fail	Measured Frequency (MHz)	Pass/Fail
20	138	5259.9874	Pass	5259.9854	Pass	5259.9835	Pass	5259.9855	Pass
	120	5259.9864	Pass	5259.9847	Pass	5259.9828	Pass	5259.9861	Pass
	102	5259.9856	Pass	5259.9856	Pass	5259.9834	Pass	5259.9868	Pass

4.7 6dB Bandwidth Measurement

4.7.1 Limits of 6dB Bandwidth Measurement

The minimum of 6dB Bandwidth Measurement is 0.5MHz.

4.7.2 Test Setup

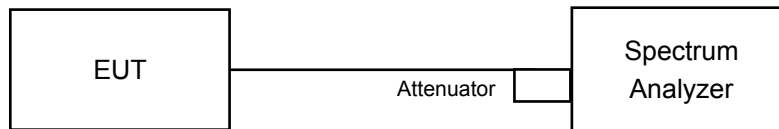

4.7.3 Test Instruments

Refer to section 4.1.2 to get information of above instrument.

4.7.4 Test Procedure

MEASUREMENT PROCEDURE REF

- a. Set resolution bandwidth (RBW) = 100kHz
- b. Set the video bandwidth (VBW) $\geq 3 \times$ RBW, Detector = Peak.
- c. Trace mode = max hold.
- d. Sweep = auto couple.
- e. Measure the maximum width of the emission that is constrained by the frequencies associated with the two amplitude points (upper and lower) that are attenuated by 6 dB relative to the maximum level measured in the fundamental emission

4.7.5 Deviation from Test Standard

No deviation.

4.7.6 EUT Operating Condition

The software provided by client to enable the EUT under transmission condition continuously at lowest, middle and highest channel frequencies individually.

4.7.7 Test Results (Mode 1)

802.11a

Channel	Frequency (MHz)	6dB Bandwidth (MHz)				Minimum Limit (MHz)	Pass / Fail
		Chain 0	Chain 1	Chain 2	Chain 3		
144 (UNII-3 Band)	5720	3.16	3.14	2.52	3.17	0.5	Pass

Note: The 6dB bandwidth above 5725MHz = Marker 1 + Delta 2 - 5725MHz

802.11ax (HE20)

Channel	Frequency (MHz)	6dB Bandwidth (MHz)				Minimum Limit (MHz)	Pass / Fail
		Chain 0	Chain 1	Chain 2	Chain 3		
144 (UNII-3 Band)	5720	4.11	4.45	4.16	4.31	0.5	Pass

Note: The 6dB bandwidth above 5725MHz = Marker 1 + Delta 2 - 5725MHz

802.11ax (HE40)

Channel	Frequency (MHz)	6dB Bandwidth (MHz)				Minimum Limit (MHz)	Pass / Fail
		Chain 0	Chain 1	Chain 2	Chain 3		
142 (UNII-3 Band)	5710	3.36	3.50	3.73	3.83	0.5	Pass

Note: The 6dB bandwidth above 5725MHz = Marker 1 + Delta 2 - 5725MHz

802.11ax (HE80)

Channel	Frequency (MHz)	6dB Bandwidth (MHz)				Minimum Limit (MHz)	Pass / Fail
		Chain 0	Chain 1	Chain 2	Chain 3		
138 (UNII-3 Band)	5690	4.42	3.52	3.45	2.72	0.5	Pass

Note: The 6dB bandwidth above 5725MHz = Marker 1 + Delta 2 - 5725MHz

Spectrum Plot of Worst Value

802.11a / Chain 2 - CH144 (UNII-3 Band)

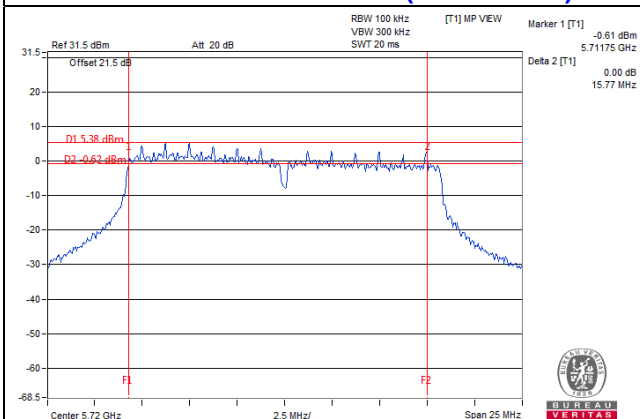

802.11ax (HE20) / Chain 0 - CH144 (UNII-3 Band)

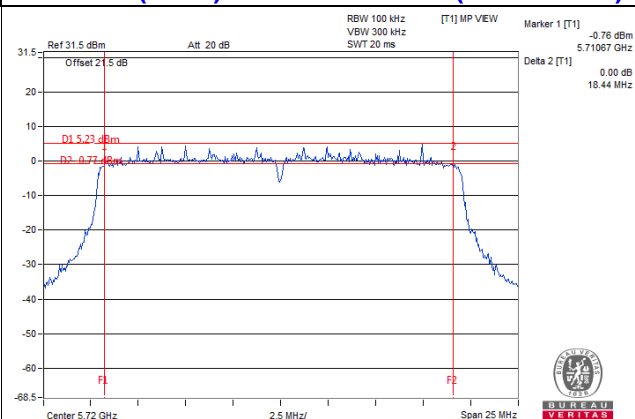

802.11ax (HE40) / Chain 0 - CH142 (UNII-3 Band)

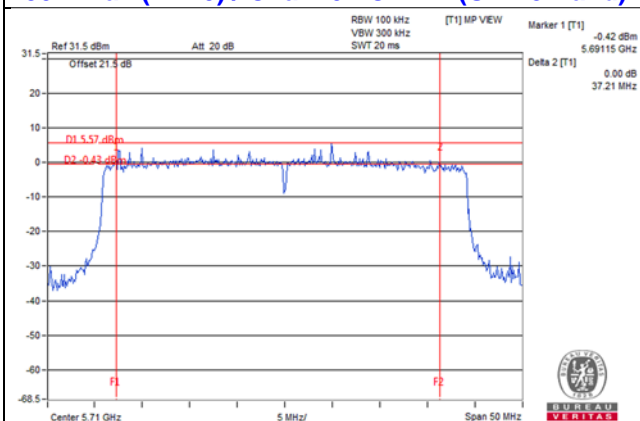

802.11ax (HE80) / Chain 3 - CH138 (UNII-3 Band)

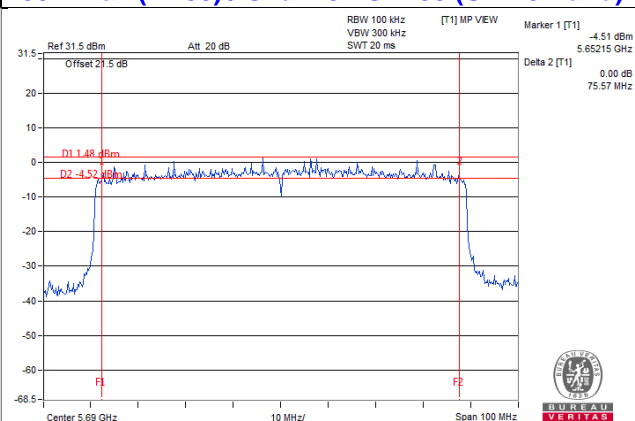

4.7.8 Test Results (Mode 2)

802.11a

Channel	Frequency (MHz)	6dB Bandwidth (MHz)		Minimum Limit (MHz)	Pass / Fail
		Chain 0	Chain 1		
144 (UNII-3 Band)	5720	3.16	3.50	0.5	Pass

Note: The 6dB bandwidth above 5725MHz = Marker 1 + Delta 2 - 5725MHz

802.11ax (HE20)

Channel	Frequency (MHz)	6dB Bandwidth (MHz)		Minimum Limit (MHz)	Pass / Fail
		Chain 0	Chain 1		
144 (UNII-3 Band)	5720	4.20	4.26	0.5	Pass

Note: The 6dB bandwidth above 5725MHz = Marker 1 + Delta 2 - 5725MHz

802.11ax (HE40)

Channel	Frequency (MHz)	6dB Bandwidth (MHz)		Minimum Limit (MHz)	Pass / Fail
		Chain 0	Chain 1		
142 (UNII-3 Band)	5710	3.45	3.94	0.5	Pass

Note: The 6dB bandwidth above 5725MHz = Marker 1 + Delta 2 - 5725MHz

802.11ax (HE80)

Channel	Frequency (MHz)	6dB Bandwidth (MHz)		Minimum Limit (MHz)	Pass / Fail
		Chain 0	Chain 1		
138 (UNII-3 Band)	5690	1.12	2.70	0.5	Pass

Note: The 6dB bandwidth above 5725MHz = Marker 1 + Delta 2 - 5725MHz

Spectrum Plot of Worst Value

802.11a / Chain 0 - CH144 (UNII-3 Band)

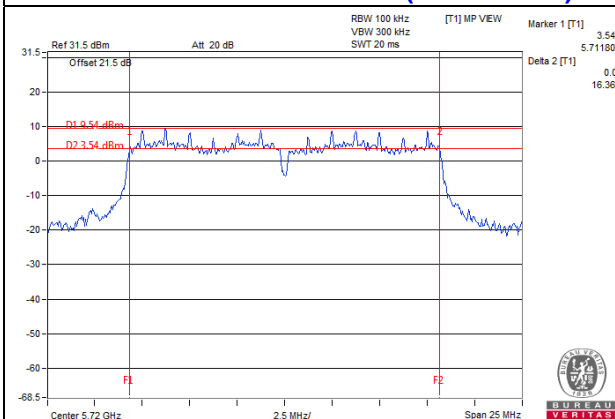

802.11ax (HE20) / Chain 0 - CH144 (UNII-3 Band)

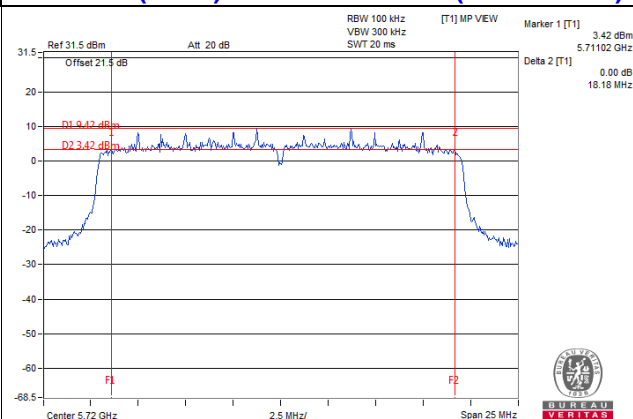

802.11ax (HE40) / Chain 0 - CH142 (UNII-3 Band)

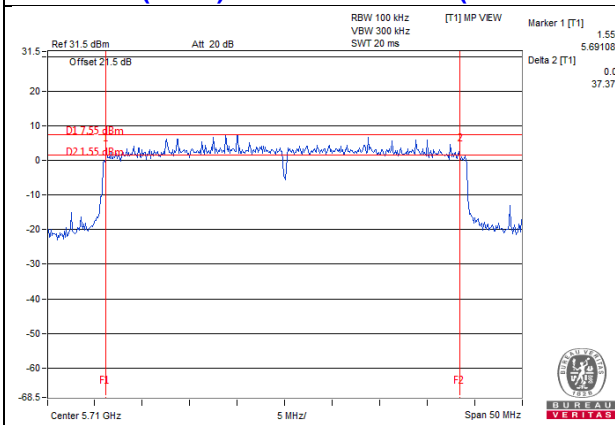

802.11ax (HE80) / Chain 0 - CH138 (UNII-3 Band)

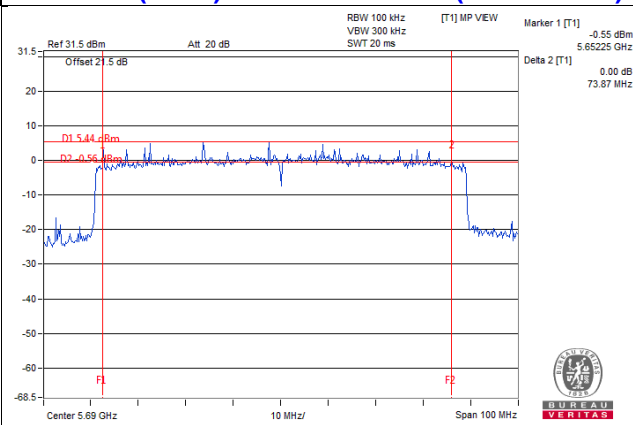

4.7.9 Test Results (Mode 3)

802.11a

Channel	Frequency (MHz)	6dB Bandwidth (MHz)	Minimum Limit (MHz)	Pass / Fail
144 (UNII-3 Band)	5720	3.15	0.5	Pass

Note: 1. The 6dB bandwidth above 5725MHz = Marker 1 + Delta 2 - 5725MHz
 2. Chain 1 was chosen for test.

802.11ax (HE20)

Channel	Frequency (MHz)	6dB Bandwidth (MHz)	Minimum Limit (MHz)	Pass / Fail
144 (UNII-3 Band)	5720	4.26	0.5	Pass

Note: 1. The 6dB bandwidth above 5725MHz = Marker 1 + Delta 2 - 5725MHz
 2. Chain 1 was chosen for test.

802.11ax (HE40)

Channel	Frequency (MHz)	6dB Bandwidth (MHz)	Minimum Limit (MHz)	Pass / Fail
142 (UNII-3 Band)	5710	3.94	0.5	Pass

Note: 1. The 6dB bandwidth above 5725MHz = Marker 1 + Delta 2 - 5725MHz
 2. Chain 1 was chosen for test.

802.11ax (HE80)

Channel	Frequency (MHz)	6dB Bandwidth (MHz)	Minimum Limit (MHz)	Pass / Fail
138 (UNII-3 Band)	5690	2.70	0.5	Pass

Note: 1. The 6dB bandwidth above 5725MHz = Marker 1 + Delta 2 - 5725MHz
 2. Chain 1 was chosen for test.

Spectrum Plot of Worst Value

802.11a_Chain 1 / CH144 (UNII-3 Band)

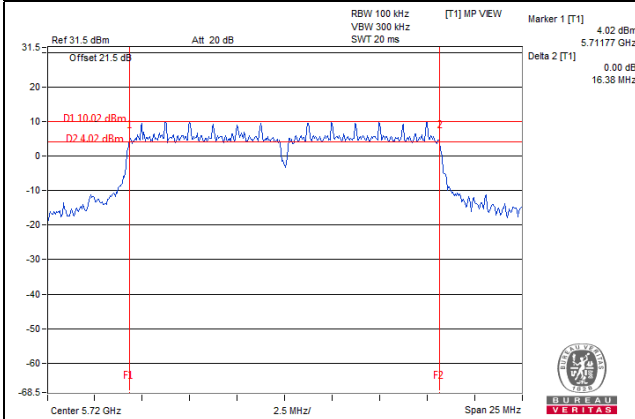

802.11ax (HE20)_Chain 1 / CH144 (UNII-3 Band)

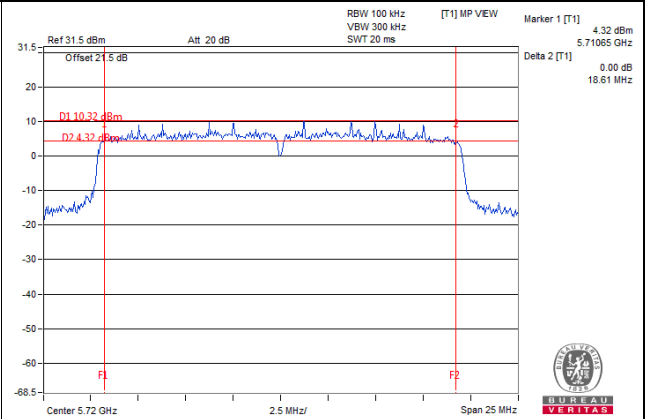

802.11ax (HE40)_Chain 1 / CH142 (UNII-3 Band)

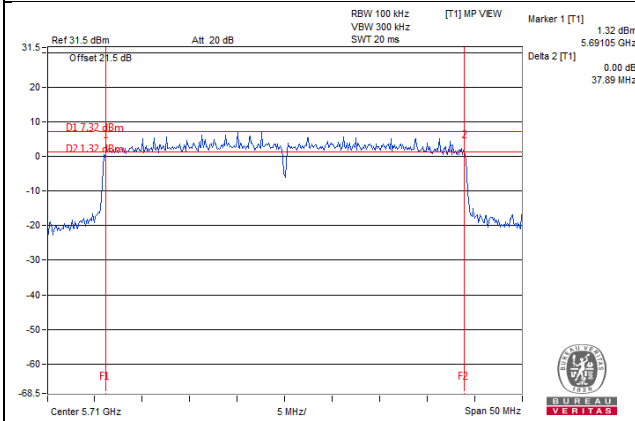

802.11ax (HE80)_Chain 1 / CH138 (UNII-3 Band)

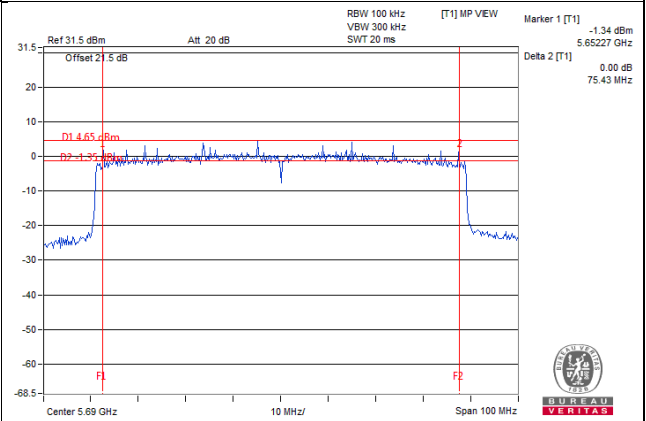

5 Pictures of Test Arrangements

Please refer to the attached file (Test Setup Photo).

Appendix – Information on the Testing Laboratories

We, Bureau Veritas Consumer Products Services (H.K.) Ltd., Taoyuan Branch, were founded in 1988 to provide our best service in EMC, Radio, Telecom and Safety consultation. Our laboratories are FCC recognized accredited test firms and accredited according to ISO/IEC 17025.

If you have any comments, please feel free to contact us at the following:

Linkou EMC/RF Lab

Tel: 886-2-26052180

Fax: 886-2-26051924

Hsin Chu EMC/RF/Telecom Lab

Tel: 886-3-6668565

Fax: 886-3-6668323

Hwa Ya EMC/RF/Safety Lab

Tel: 886-3-3183232

Fax: 886-3-3270892

Email: service.adt@tw.bureauveritas.com

Web Site: www.bureauveritas-adt.com

The address and road map of all our labs can be found in our web site also.

--- END ---