



FCC RADIO TEST REPORT

FCC ID : UDX-60076027
Equipment : LTE & Wi-Fi Router
Brand Name : CISCO
Model Name : MX68CW-HW-NA
Applicant : Cisco Systems, Inc.
170 West Tasman Drive, San Jose, CA 95134
Standard : 47 CFR Part 2, 22(H), 24(E), 27

The product was received on Mar. 16, 2018 and testing was started from Jul. 10, 2018 and completed on Jul. 20, 2018. We, SPORTON INTERNATIONAL INC., would like to declare that the tested sample has been evaluated in accordance with the test procedures given in ANSI / TIA-603-E and has been in compliance with the applicable technical standards.

The report must not be used by the client to claim product certification, approval, or endorsement by TAF or any agency of government.

The test results in this report apply exclusively to the tested model / sample. Without written approval of SPORTON INTERNATIONAL INC. EMC & Wireless Communications Laboratory, the test report shall not be reproduced except in full.

Approved by: Jones Tsai

SPORTON INTERNATIONAL INC. EMC & Wireless Communications Laboratory

No. 52, Huaya 1st Rd., Guishan Dist., Taoyuan City, Taiwan (R.O.C.)



Table of Contents

History of this test report.....	3
Summary of Test Result.....	4
1 General Description	5
1.1 Product Feature of Equipment Under Test.....	5
1.2 Modification of EUT	5
1.3 Testing Location	5
1.4 Applicable Standards.....	6
2 Test Configuration of Equipment Under Test	7
2.1 Test Mode.....	7
2.2 Connection Diagram of Test System.....	9
2.3 Support Unit used in test configuration and system	9
2.4 Measurement Results Explanation Example.....	9
2.5 Frequency List of Low/Middle/High Channels	10
3 Conducted Test Items.....	12
3.1 Measuring Instruments	12
3.2 Conducted Output Power and ERP/EIRP	13
3.3 Peak-to-Average Ratio	14
3.4 Occupied Bandwidth.....	15
3.5 Conducted Band Edge	16
3.6 Conducted Spurious Emission	18
3.7 Frequency Stability	19
4 Radiated Test Items	20
4.1 Measuring Instruments	20
4.2 Radiated Spurious Emission	21
5 List of Measuring Equipment.....	22
6 Uncertainty of Evaluation.....	24
Appendix A. Test Results of Conducted Test	
Appendix B. Test Results of ERP/EIRP and Radiated Test	
Appendix C. Test Setup Photographs	



History of this test report

Report No.	Version	Description	Issued Date
FG831635B	01	Initial issue of report	Sep. 03, 2018



Summary of Test Result

Report Clause	Ref Std. Clause	Test Items	Result (PASS/FAIL)	Remark
3.2	§2.1046	Conducted Output Power	Reporting only	-
	§22.913 (a)(2)	Effective Radiated Power (Band 5)	Pass	
	§27.50 (b)(10) §27.50 (c)(10)	Effective Radiated Power (Band 12) (Band 13)		
	§24.232 (c) §27.50 (h)(2)	Equivalent Isotropic Radiated Power (Band 2)		
	§27.50 (d)(4)	Equivalent Isotropic Radiated Power (Band 4)		
3.3	§24.232 (d) §27.50 (d)(5)	Peak-to-Average Ratio	Pass	-
3.4	§2.1049	Occupied Bandwidth	Reporting only	-
3.5	§2.1051 §22.917 (a) §24.238 (a) §27.53 (c)(2)(4) §27.53 (g) §27.53 (h)	Conducted Band Edge Measurement (Band 2) (Band 4) (Band 5) (Band 12) (Band 13)	Pass	-
3.6	§2.1051 §22.917 (a) §24.238 (a) §27.53 (c)(2) §27.53 (g) §27.53 (h)	Conducted Spurious Emission (Band 2) (Band 4) (Band 5) (Band 12) (Band 13)	Pass	-
3.7	§2.1055 §22.355 §24.235 §27.54	Frequency Stability Temperature & Voltage	Pass	-
4.2	§2.1053 §22.917 (a) §24.238 (a) §27.53 (c)(2) §27.53 (f) §27.53 (g) §27.53 (h)	Radiated Spurious Emission (Band 2) (Band 4) (Band 5) (Band 12) (Band 13)	Pass	Under limit 20.87 dB at 1568.000 MHz

Reviewed by: Joseph Lin

Report Producer: Polly Tsai



1 General Description

1.1 Product Feature of Equipment Under Test

GSM/WCDMA/LTE, Wi-Fi 2.4GHz 802.11b/g/n/ac, and Wi-Fi 5GHz 802.11a/n/ac

Product Specification subjective to this standard	
Antenna Type	WWAN: Dipole Antenna WLAN: Dipole Antenna

1.2 Modification of EUT

No modifications are made to the EUT during all test items.

1.3 Testing Location

Sporton Lab is accredited to ISO 17025 by Taiwan Accreditation Foundation (TAF code : 1190) and the FCC designation No. TW1190 and TW0007 under the FCC 2.948(e) by Mutual Recognition Agreement (MRA) in FCC Test.

Test Site	SPORTON INTERNATIONAL INC.
Test Site Location	No.52, Huaya 1st Rd., Guishan Dist., Taoyuan City, Taiwan (R.O.C.) TEL: +886-3-327-3456 FAX: +886-3-328-4978
Test Site No.	Sporton Site No. TH05-HY

Note: The test site complies with ANSI C63.4 2014 requirement.

Test Site	SPORTON INTERNATIONAL INC.
Test Site Location	No.58, Aly. 75, Ln. 564, Wenhua 3rd, Rd., Guishan Dist., Taoyuan City, Taiwan (R.O.C.) TEL: +886-3-327-0868 FAX: +886-3-327-0855
Test Site No.	Sporton Site No. 03CH13-HY

Note: The test site complies with ANSI C63.4 2014 requirement.



1.4 Applicable Standards

According to the specifications of the manufacturer, the EUT must comply with the requirements of the following standards:

- ♦ ANSI C63.26-2015
- ♦ ANSI / TIA-603-E
- ♦ 47 CFR Part 2, 22(H), 24(E), 27
- ♦ FCC KDB 971168 D01 Power Meas. License Digital Systems v03r01
- ♦ FCC KDB 412172 D01 Determining ERP and EIRP v01r01

Remark:

1. All test items were verified and recorded according to the standards and without any deviation during the test.
2. This EUT has also been tested and complied with the requirements of FCC Part 15, Subpart B, recorded in a separate test report.



2 Test Configuration of Equipment Under Test

2.1 Test Mode

Antenna port conducted and radiated test items listed below are performed according to KDB 971168 D01 Power Meas. License Digital Systems v03r01 with maximum output power.

Test Items	Band	Bandwidth (MHz)						Modulation		RB #			Test Channel		
		1.4	3	5	10	15	20	QPSK	16QAM	1	Half	Full	L	M	H
Max. Output Power	2	v	v	v	v	v	v	v	v	v	v	v	v	v	v
	4	v	v	v	v	v	v	v	v	v	v	v	v	v	v
	5	v	v	v	v	-	-	v	v	v	v	v	v	v	v
	12	v	v	v	v	-	-	v	v	v	v	v	v	v	v
	13	-	-	v	v	-	-	v	v	v	v	v	v	v	v
Peak-to-Average Ratio	2						v	v	v	v		v	v	v	v
	4						v	v	v	v		v	v	v	v
	5				v	-	-	v	v	v		v	v	v	v
	12				v	-	-	v	v	v		v	v	v	v
	13	-	-		v	-	-	v	v	v		v	v	v	v
26dB and 99% Bandwidth	2	v	v	v	v	v	v	v	v			v	v	v	v
	4	v	v	v	v	v	v	v	v			v	v	v	v
	5	v	v	v	v	-	-	v	v			v	v	v	v
	12	v	v	v	v	-	-	v	v			v	v	v	v
	13	-	-	v	v	-	-	v	v			v	v	v	v
Conducted Band Edge	2	v	v	v	v	v	v	v	v	v		v	v		v
	4	v	v	v	v	v	v	v	v	v		v	v		v
	5	v	v	v	v	-	-	v	v	v		v	v		v
	12	v	v	v	v	-	-	v	v	v		v	v		v
	13	-	-	v	v	-	-	v	v	v		v	v		v



Test Items	Band	Bandwidth (MHz)						Modulation		RB #			Test Channel		
		1.4	3	5	10	15	20	QPSK	16QAM	1	Half	Full	L	M	H
Conducted Spurious Emission	2	v	v	v	v	v	v	v	v	v			v	v	v
	4	v	v	v	v	v	v	v	v	v			v	v	v
	5	v	v	v	v	-	-	v	v	v			v	v	v
	12	v	v	v	v	-	-	v	v	v			v	v	v
	13	-	-	v	v	-	-	v	v	v			v	v	v
Frequency Stability	2				v			v				v		v	
	4				v			v				v		v	
	5				v	-	-	v				v		v	
	12				v	-	-	v				v		v	
	13	-	-		v	-	-	v				v		v	
E.R.P / E.I.R.P	2	v	v	v	v	v	v	v	v	v			v	v	v
	4	v	v	v	v	v	v	v	v	v			v	v	v
	5	v	v	v	v	-	-	v	v	v			v	v	v
	12	v	v	v	v	-	-	v	v	v			v	v	v
	13	-	-	v	v	-	-	v	v	v			v	v	v
Radiated Spurious Emission	2	Worst Case										v	v	v	
	4	Worst Case										v	v	v	
	5	Worst Case										v	v	v	
	12	Worst Case										v	v	v	
	13	Worst Case										v	v	v	
Remark	1. The mark "v" means that this configuration is chosen for testing 2. The mark "-" means that this bandwidth is not supported. 3. The device is investigated from 30MHz to 10 times of fundamental signal for radiated spurious emission test under different RB size/offset and modulations in exploratory test. Subsequently, only the worst case emissions are reported.														

2.2 Connection Diagram of Test System

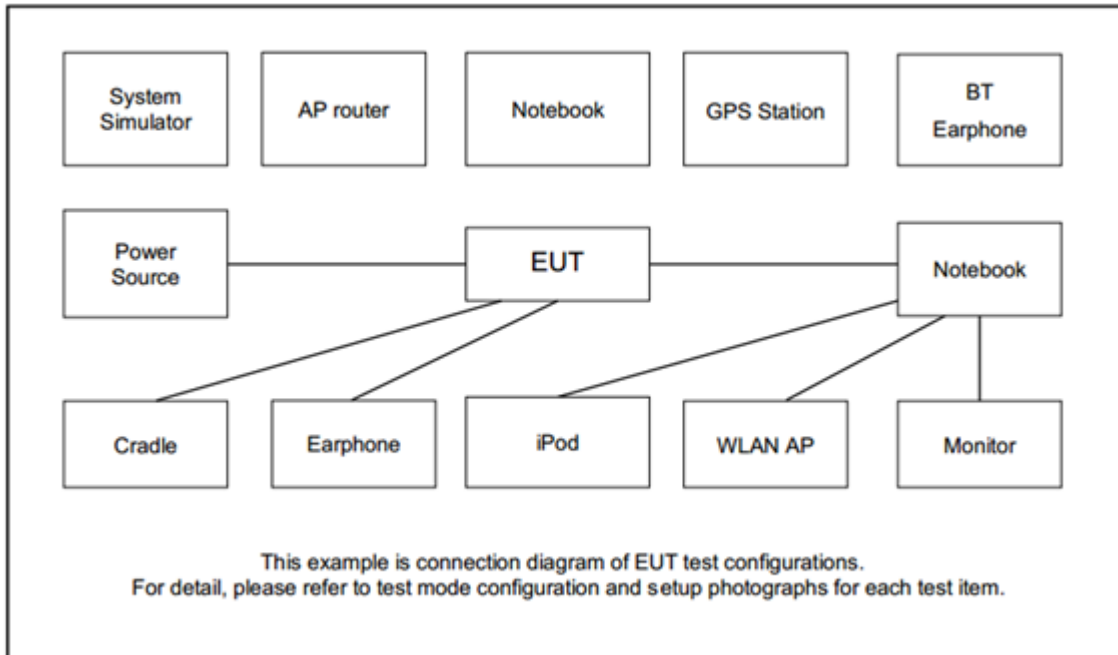

2.3 Support Unit used in test configuration and system

Item	Equipment	Trade Name	Model No.	FCC ID	Data Cable	Power Cord
1.	System Simulator	Anritsu	MT8820C	N/A	N/A	Unshielded, 1.8 m

2.4 Measurement Results Explanation Example

For all conducted test items:

The offset level is set in the spectrum analyzer to compensate the RF cable loss and attenuator factor between EUT conducted output port and spectrum analyzer. With the offset compensation, the spectrum analyzer reading level is exactly the EUT RF output level.

The spectrum analyzer offset is derived from RF cable loss and attenuator factor.

Offset = RF cable loss + attenuator factor.

Following shows an offset computation example with cable loss 4.2 dB and 10dB attenuator.

Example :

Offset(dB) = RF cable loss(dB) + attenuator factor(dB).

$$= 4.2 + 10 = 14.2 \text{ (dB)}$$



2.5 Frequency List of Low/Middle/High Channels

LTE Band 2 Channel and Frequency List				
BW [MHz]	Channel/Frequency(MHz)	Lowest	Middle	Highest
20	Channel	18700	18900	19100
	Frequency	1860	1880	1900
15	Channel	18675	18900	19125
	Frequency	1857.5	1880	1902.5
10	Channel	18650	18900	19150
	Frequency	1855	1880	1905
5	Channel	18625	18900	19175
	Frequency	1852.5	1880	1907.5
3	Channel	18615	18900	19185
	Frequency	1851.5	1880	1908.5
1.4	Channel	18607	18900	19193
	Frequency	1850.7	1880	1909.3

LTE Band 4 Channel and Frequency List				
BW [MHz]	Channel/Frequency(MHz)	Lowest	Middle	Highest
20	Channel	20050	20175	20300
	Frequency	1720	1732.5	1745
15	Channel	20025	20175	20325
	Frequency	1717.5	1732.5	1747.5
10	Channel	20000	20175	20350
	Frequency	1715	1732.5	1750
5	Channel	19975	20175	20375
	Frequency	1712.5	1732.5	1752.5
3	Channel	19965	20175	20385
	Frequency	1711.5	1732.5	1753.5
1.4	Channel	19957	20175	20393
	Frequency	1710.7	1732.5	1754.3



LTE Band 5 Channel and Frequency List				
BW [MHz]	Channel/Frequency(MHz)	Lowest	Middle	Highest
10	Channel	20450	20525	20600
	Frequency	829	836.5	844
5	Channel	20425	20525	20625
	Frequency	826.5	836.5	846.5
3	Channel	20415	20525	20635
	Frequency	825.5	836.5	847.5
1.4	Channel	20407	20525	20643
	Frequency	824.7	836.5	848.3

LTE Band 12 Channel and Frequency List				
BW [MHz]	Channel/Frequency(MHz)	Lowest	Middle	Highest
10	Channel	23060	23095	23130
	Frequency	704	707.5	711
5	Channel	23035	23095	23155
	Frequency	701.5	707.5	713.5
3	Channel	23025	23095	23165
	Frequency	700.5	707.5	714.5
1.4	Channel	23017	23095	23173
	Frequency	699.7	707.5	715.3

LTE Band 13 Channel and Frequency List				
BW [MHz]	Channel/Frequency(MHz)	Lowest	Middle	Highest
10	Channel	-	23230	-
	Frequency	-	782	-
5	Channel	23205	23230	23255
	Frequency	779.5	782	784.5

3 Conducted Test Items

3.1 Measuring Instruments

See list of measuring instruments of this test report.

3.1.1 Test Setup

3.1.2 Conducted Output Power

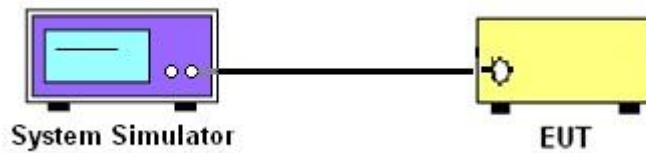

3.1.3 Peak-to-Average Ratio, Occupied Bandwidth ,Conducted Band-Edge and Conducted Spurious Emission

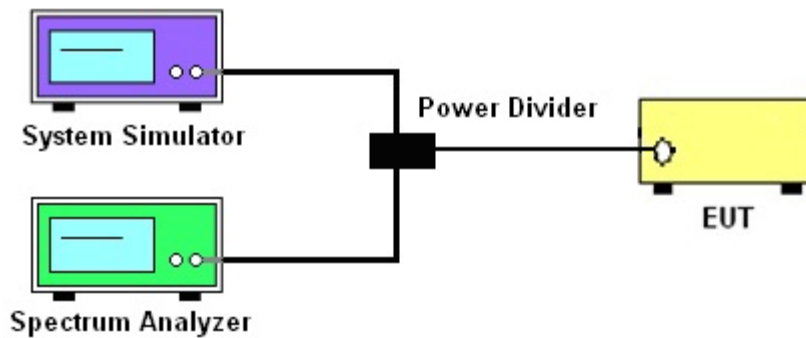

3.1.4 Frequency Stability

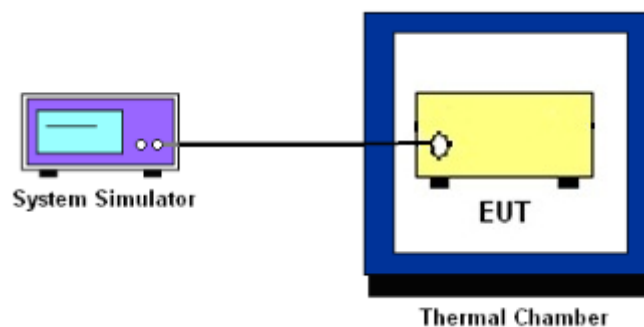

3.1.5 Test Result of Conducted Test

Please refer to Appendix A.



3.2 Conducted Output Power and ERP/EIRP

3.2.1 Description of the Conducted Output Power Measurement and ERP/EIRP Measurement

A system simulator was used to establish communication with the EUT. Its parameters were set to force the EUT transmitting at maximum output power. The measured power in the radio frequency on the transmitter output terminals shall be reported.

The ERP of mobile transmitters must not exceed 7 Watts for LTE Band 5.

The ERP of mobile transmitters must not exceed 3 Watts for LTE Band 12 and Band 13.

The EIRP of mobile transmitters must not exceed 2 Watts for LTE Band 2.

The EIRP of mobile transmitters must not exceed 1 Watts for LTE Band 4.

According to KDB 412172 D01 Power Approach,

$EIRP = P_T + G_T - L_C$, $ERP = EIRP - 2.15$, where

P_T = transmitter output power in dBm

G_T = gain of the transmitting antenna in dBi

L_C = signal attenuation in the connecting cable between the transmitter and antenna in dB

3.2.2 Test Procedures

1. The transmitter output port was connected to the system simulator.
2. Set EUT at maximum power through the system simulator.
3. Select lowest, middle, and highest channels for each band and different modulation.
4. Measure and record the power level from the system simulator.



3.3 Peak-to-Average Ratio

3.3.1 Description of the PAR Measurement

Power Complementary Cumulative Distribution Function (CCDF) curves provide a means for characterizing the power peaks of a digitally modulated signal on a statistical basis. A CCDF curve depicts the probability of the peak signal amplitude exceeding the average power level. Most contemporary measurement instrumentation include the capability to produce CCDF curves for an input signal provided that the instrument's resolution bandwidth can be set wide enough to accommodate the entire input signal bandwidth. In measuring transmissions in this band using an average power technique, the peak-to-average ratio (PAR) of the transmission may not exceed 13 dB.

3.3.2 Test Procedures

The testing follows FCC KDB 971168 D01 v03r01 Section 5.7.1

1. The EUT was connected to spectrum and system simulator via a power divider.
2. Set the CCDF (Complementary Cumulative Distribution Function) option in spectrum analyzer.
3. The highest RF powers were measured and recorded the maximum PAPR level associated with a probability of 0.1 %.
4. Record the deviation as Peak to Average Ratio.



3.4 Occupied Bandwidth

3.4.1 Description of Occupied Bandwidth Measurement

The occupied bandwidth is the width of a frequency band such that, below the lower and above the upper frequency limits, the mean powers emitted are each equal to a specified percentage 0.5% of the total mean transmitted power.

The 26 dB emission bandwidth is defined as the frequency range between two points, one above and one below the carrier frequency, at which the spectral density of the emission is attenuated 26 dB below the maximum in-band spectral density of the modulated signal. Spectral density (power per unit bandwidth) is to be measured with a detector of resolution bandwidth equal to approximately 1.0% of the emission bandwidth.

3.4.2 Test Procedures

The testing follows FCC KDB 971168 D01 v03r01 Section 4.2

1. The EUT was connected to spectrum analyzer and system simulator via a power divider.
2. The spectrum analyzer center frequency is set to the nominal EUT channel center frequency. The span range for the spectrum analyzer shall be between two and five times the anticipated OBW.
3. The nominal resolution bandwidth (RBW) shall be in the range of 1 to 5 % of the anticipated OBW, and the VBW shall be at least 3 times the RBW.
4. Set the detection mode to peak, and the trace mode to max hold.
5. Determine the reference value: Set the EUT to transmit a modulated signal. Allow the trace to stabilize. Set the spectrum analyzer marker to the highest level of the displayed trace.
(this is the reference value)
6. Determine the “-26 dB down amplitude” as equal to (Reference Value – X).
7. Place two markers, one at the lowest and the other at the highest frequency of the envelope of the spectral display such that each marker is at or slightly below the “-X dB down amplitude” determined in step 6. If a marker is below this “-X dB down amplitude” value it shall be placed as close as possible to this value. The OBW is the positive frequency difference between the two markers.
8. Use the 99 % power bandwidth function of the spectrum analyzer and report the measured bandwidth.



3.5 Conducted Band Edge

3.5.1 Description of Conducted Band Edge Measurement

22.917(a)

For operations in the 824 – 849 MHz band, the FCC limit is $43 + 10\log_{10}(P[\text{Watts}])$ dB below the transmitter power $P(\text{Watts})$ in a 100kHz bandwidth. However, in the 1MHz bands immediately outside and adjacent to the licensee's frequency block, a resolution bandwidth of at least one percent of the emission bandwidth of the fundamental emission of the transmitter may be employed.

24.238 (a)

For operations in the 1850-1910 and 1930-1990 MHz band, the FCC limit is $43 + 10\log_{10}(P[\text{Watts}])$ dB below the transmitter power $P(\text{Watts})$ in a 1MHz bandwidth. However, in the 1 MHz bands immediately outside and adjacent to the frequency block a resolution bandwidth of at least one percent of the emission bandwidth of the fundamental emission of the transmitter may be employed.

27.53 (c)

For operations in the 776-788 MHz band, the FCC limit is $43 + 10\log_{10}(P[\text{Watts}])$ dB below the transmitter power $P(\text{Watts})$ in a 100 kHz bandwidth. However, in the 100 kHz bands immediately outside and adjacent to the frequency block, a resolution bandwidth of at least 30 kHz may be employed. In addition, the power of any unwanted emissions in any 6.25 kHz bandwidth for all frequencies between 763-775 MHz and 793-806 MHz shall be attenuated below the transmitter power, P (dBW), by at least $65 + 10 \log_{10} p(\text{watts})$, dB, for mobile and portable equipment.

27.53 (g)

For operations in the 600MHz band and 698 -746 MHz band, the FCC limit is $43 + 10\log_{10}(P[\text{Watts}])$ dB below the transmitter power $P(\text{Watts})$ in a 100 kHz bandwidth. However, in the 100 kilohertz bands immediately outside and adjacent to a licensee's frequency block, a resolution bandwidth of at least 30 kHz may be employed.

27.53 (h)

For operations in the 1710 – 1755 MHz band, the FCC limit is $43 + 10\log_{10}(P[\text{Watts}])$ dB below the transmitter power $P(\text{Watts})$ in a 1 MHz bandwidth. However, in the 1MHz bands immediately outside and adjacent to the licensee's frequency block, a resolution bandwidth of at least one percent of the emission bandwidth of the fundamental emission of the transmitter may be employed.



3.5.2 Test Procedures

The testing follows FCC KDB 971168 D01 v03r01 Section 6.0.

1. The EUT was connected to spectrum analyzer and system simulator via a power divider.
2. The band edges of low and high channels for the highest RF powers were measured.
3. Set RBW \geq 1% EBW in the 1MHz band immediately outside and adjacent to the band edge.
4. Beyond the 1 MHz band from the band edge, RBW=1MHz was used.
5. Set spectrum analyzer with RMS detector.
6. The RF fundamental frequency should be excluded against the limit line in the operating frequency band.
7. Checked that all the results comply with the emission limit line.

The limit line is derived from $43 + 10\log(P)$ dB below the transmitter power P(Watts)



3.6 Conducted Spurious Emission

3.6.1 Description of Conducted Spurious Emission Measurement

The power of any emission outside of the authorized operating frequency ranges must be lower than the transmitter power (P) by a factor of at least $43 + 10 \log (P)$ dB.

It is measured by means of a calibrated spectrum analyzer and scanned from 30 MHz up to a frequency including its 10th harmonic.

3.6.2 Test Procedures

The testing follows FCC KDB 971168 D01 v03r01 Section 6.0.

1. The EUT was connected to spectrum analyzer and system simulator via a power divider.
2. The RF output of EUT was connected to the spectrum analyzer by RF cable and attenuator. The path loss was compensated to the results for each measurement.
3. The middle channel for the highest RF power within the transmitting frequency was measured.
4. The conducted spurious emission for the whole frequency range was taken.
5. Make the measurement with the spectrum analyzer's RBW = 1MHz, VBW = 3MHz.
6. Set spectrum analyzer with RMS detector.
7. Taking the record of maximum spurious emission.
8. The RF fundamental frequency should be excluded against the limit line in the operating frequency band.
9. The limit line is derived from $43 + 10\log(P)$ dB below the transmitter power P(Watts)



3.7 Frequency Stability

3.7.1 Description of Frequency Stability Measurement

22.355

The frequency stability shall be measured by variation of ambient temperature and variation of primary supply voltage to ensure that the fundamental emission stays within the authorized frequency block. The frequency stability of the transmitter shall be maintained within $\pm 0.00025\%$ ($\pm 2.5\text{ppm}$) of the center frequency.

24.235 & 27.54

The frequency stability shall be sufficient to ensure that the fundamental emission stays within the authorized frequency block.

3.7.2 Test Procedures for Temperature Variation

The testing follows FCC KDB 971168 D01 v03r01 Section 9.0.

1. The EUT was set up in the thermal chamber and connected with the system simulator.
2. With power OFF, the temperature was decreased to -30°C and the EUT was stabilized before testing. Power was applied and the maximum change in frequency was recorded within one minute.
3. With power OFF, the temperature was raised in 10°C step up to 50°C . The EUT was stabilized at each step for at least half an hour. Power was applied and the maximum frequency change was recorded within one minute.

3.7.3 Test Procedures for Voltage Variation

The testing follows FCC KDB 971168 D01 v03r01 Section 9.0.

1. The EUT was placed in a temperature chamber at $20\pm 5^{\circ}\text{C}$ and connected with the system simulator.
2. The power supply voltage to the EUT was varied from 85% to 115% of the nominal value measured at the input to the EUT.
3. The variation in frequency was measured for the worst case.

4 Radiated Test Items

4.1 Measuring Instruments

See list of measuring instruments of this test report.

4.1.1 Test Setup

For radiated test from 30MHz to 1GHz

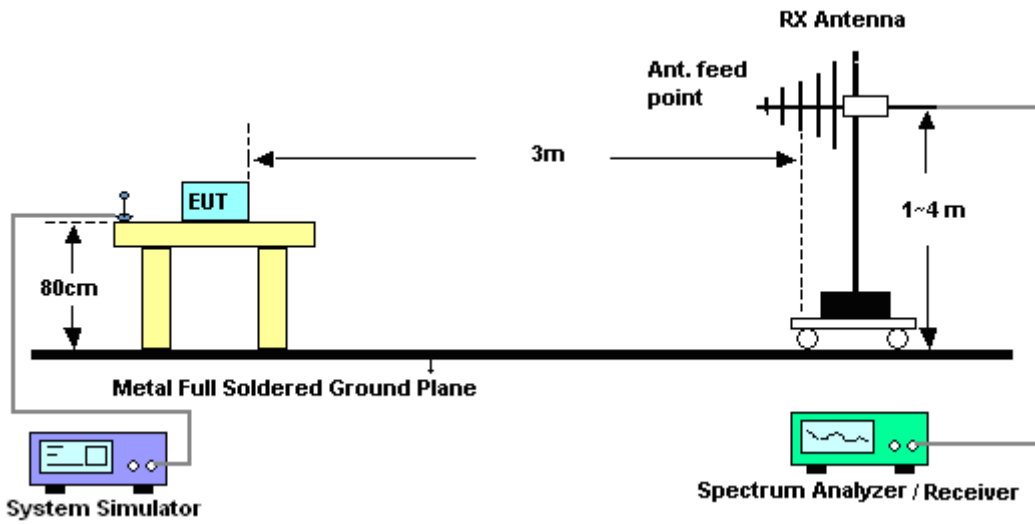

For radiated test above 1GHz

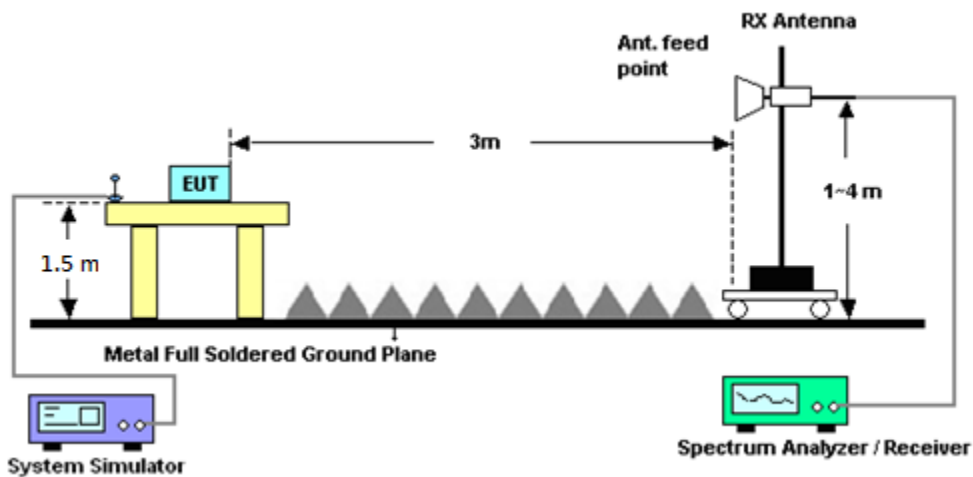

4.1.2 Test Result of Radiated Test

Please refer to Appendix B.



4.2 Radiated Spurious Emission

4.2.1 Description of Radiated Spurious Emission

The radiated spurious emission was measured by substitution method according to ANSI / TIA-603-E. The power of any emission outside of the authorized operating frequency ranges must be attenuated below the transmitter power (P) by a factor of at least $43 + 10 \log (P)$ dB.

For LTE Band 13

For operations in the 746-758 MHz, 775-788 MHz, and 805-806 MHz bands, emissions in the band 1559-1610 MHz shall be limited to -70 dBW/MHz equivalent isotropically radiated power (EIRP) for wideband signals, and -80 dBW EIRP for discrete emissions of less than 700 Hz bandwidth.

The spectrum is scanned from 30 MHz up to a frequency including its 10th harmonic.

4.2.2 Test Procedures

The testing follows FCC KDB 971168 D01 v03r01 Section 5.8 and ANSI / TIA-603-E Section 2.2.12.

1. The EUT was placed on a turntable with 0.8 meter for frequency below 1GHz and 1.5 meter for frequency above 1GHz respectively above ground.
2. The EUT was set 3 meters from the receiving antenna, which was mounted on the antenna tower.
3. The table was rotated 360 degrees to determine the position of the highest spurious emission.
4. The height of the receiving antenna is varied between one meter and four meters to search the maximum spurious emission for both horizontal and vertical polarizations.
5. Make the measurement with the spectrum analyzer's RBW = 1MHz, VBW = 3MHz, taking the record of maximum spurious emission.
6. A horn antenna was substituted in place of the EUT and was driven by a signal generator.
7. Tune the output power of signal generator to the same emission level with EUT maximum spurious emission.
8. Taking the record of output power at antenna port.
9. Repeat step 7 to step 8 for another polarization.
10. The RF fundamental frequency should be excluded against the limit line in the operating frequency band.

The limit line is derived from $43 + 10\log(P)$ dB below the transmitter power P(Watts)



5 List of Measuring Equipment

Instrument	Manufacturer	Model No.	Serial No.	Characteristics	Calibration Date	Test Date	Due Date	Remark
LTE Base Station	Anritsu	MT8820C	6201432821	GSM/GPRS /WCDMA/LTE	Oct. 13, 2017	Jul. 10, 2018 ~ Jul. 16, 2018	Oct. 12, 2018	Conducted (TH05-HY)
Spectrum Analyzer	Rohde & Schwarz	FSV40	101397	10Hz~40GHz	Nov. 07, 2017	Jul. 10, 2018 ~ Jul. 16, 2018	Nov. 06, 2018	Conducted (TH05-HY)
Temperature Chamber	ESPEC	SH-641	92013720	-30°C~70°C	Aug. 28, 2017	Jul. 10, 2018 ~ Jul. 16, 2018	Aug. 27, 2018	Conducted (TH05-HY)
Programmable Power Supply	GW Instek	PSS-2005	EL890001	1V~20V 0.5A~5A	Oct. 06, 2017	Jul. 10, 2018 ~ Jul. 16, 2018	Oct. 05, 2018	Conducted (TH05-HY)
Programmable Power Supply	GW Instek	PSS-2005	EL890089	1V~20V 0.5A~5A	Jan. 12, 2018	Jul. 10, 2018 ~ Jul. 16, 2018	Jan. 11, 2019	Conducted (TH05-HY)
Programmable Power Supply	GW Instek	PSS-2005	EL890094	1V~20V 0.5A~5A	Oct. 16, 2017	Jul. 10, 2018 ~ Jul. 16, 2018	Oct. 15, 2019	Conducted (TH05-HY)
Coupler	Warison	1-18GHz 20dB 25WSMA Directional Coupler	#B	1G~18GHz	Dec. 04, 2017	Jul. 10, 2018 ~ Jul. 16, 2018	Dec. 03, 2018	Conducted (TH04-HY)
Amplifier	Sonoma-Instrument	310 N	187282	9KHz~1GHz	Jan. 19, 2018	Jul. 19, 2018 ~ Jul. 20, 2018	Jan. 18, 2020	Radiation (03CH13-HY)
Bilog Antenna	TESEQ	CBL 6111D&00800 N1D01N-06	40103&07	30MHz to 1GHz	Jan. 10, 2018	Jul. 19, 2018 ~ Jul. 20, 2018	Jan. 09, 2019	Radiation (03CH13-HY)
Horn Antenna	SCHWARZBECK	BBHA 9120 D	9120D-1241	1GHz ~ 18GHz	Jun. 29, 2018	Jul. 19, 2018 ~ Jul. 20, 2018	Jun. 28, 2019	Radiation (03CH13-HY)
Preamplifier	MITEQ	AMF-7D-0010 1800-30-10P	1590074	1GHz~18GHz	May 21, 2018	Jul. 19, 2018 ~ Jul. 20, 2018	May 20, 2019	Radiation (03CH13-HY)
Preamplifier	Keysight	83017A	MY53270147	1GHz~26.5GHz	Feb. 02, 2018	Jul. 19, 2018 ~ Jul. 20, 2018	Feb. 01, 2019	Radiation (03CH13-HY)
Spectrum Analyzer	Keysight	N9010A	MY55370526	10Hz~44GHz	Mar. 15, 2018	Jul. 19, 2018 ~ Jul. 20, 2018	Mar. 14, 2019	Radiation (03CH13-HY)
Filter	Wainwright	WHKX12-270 0-3000-18000-60SS	SN2	3G High Pass	Sep. 18, 2017	Jul. 19, 2018 ~ Jul. 20, 2018	Sep. 17, 2018	Radiation (03CH13-HY)
Antenna Mast	EMEC	AM-BS-4500-B	N/A	1m~4m	N/A	Jul. 19, 2018 ~ Jul. 20, 2018	N/A	Radiation (03CH13-HY)
Turn Table	EMEC	TT2000	N/A	0~360 Degree	N/A	Jul. 19, 2018 ~ Jul. 20, 2018	N/A	Radiation (03CH13-HY)
SHF-EHF Horn Antenna	SCHWARZBECK	BBHA 9170	BBHA9170251	18GHz- 40GHz	Nov. 10, 2017	Jul. 19, 2018 ~ Jul. 20, 2018	Nov. 09, 2018	Radiation (03CH13-HY)
Signal Generator	Anritsu	MG3694C	163401	0.1Hz~40GHz	Jan. 15, 2018	Jul. 19, 2018 ~ Jul. 20, 2018	Jan. 14, 2019	Radiation (03CH13-HY)
SHF-EHF Horn Antenna	SCHWARZBECK	BBHA 9170	BBHA9170584	18GHz- 40GHz	Nov. 27, 2017	Jul. 19, 2018 ~ Jul. 20, 2018	Nov. 26, 2018	Radiation (03CH13-HY)
Horn Antenna	SCHWARZBECK	BBHA 9120 D	9120D-1522	1G~18GHz	May 10, 2018	Jul. 19, 2018 ~ Jul. 20, 2018	May 09, 2019	Radiation (03CH13-HY)
Filter	Wainwright	WHKX12-108 0-1200-15000-60ST	SN2	1.2G High Pass	Sep.18 , 2017	Jul. 19, 2018 ~ Jul. 20, 2018	Sep. 17, 2018	Radiation (03CH13-HY)
Software	AUDIX	E3 6.2009-8-24c	RK-001124	N/A	N/A	Jul. 19, 2018 ~ Jul. 20, 2018	N/A	Radiation (03CH13-HY)



Instrument	Manufacturer	Model No.	Serial No.	Characteristics	Calibration Date	Test Date	Due Date	Remark
RF Cable	HUBER + SUHNER	SUCOFLEX 126E	0030/126E	30M-18G	Jan. 22, 2018	Jul. 19, 2018 ~ Jul. 20, 2018	Jan. 21, 2019	Radiation (03CH13-HY)
RF Cable	HUBER + SUHNER	SUCOFLEX 104	335041/4	30M-18G	Jan. 22, 2018	Jul. 19, 2018 ~ Jul. 20, 2018	Jan. 21, 2019	Radiation (03CH13-HY)
RF Cable	HUBER + SUHNER	SUCOFLEX 104	MY24961/4	30M~18GHz	Jan. 22, 2018	Jul. 19, 2018 ~ Jul. 20, 2018	Jan. 21, 2019	Radiation (03CH13-HY)
RF Cable	HUBER + SUHNER	SUCOFLEX 102	505134/2	30M~40GHz	Oct. 17, 2017	Jul. 19, 2018 ~ Jul. 20, 2018	Oct. 16, 2018	Radiation (03CH13-HY)
RF Cable	HUBER + SUHNER	SUCOFLEX 102	800740/2	30M~40GHz	Oct. 17, 2017	Jul. 19, 2018 ~ Jul. 20, 2018	Oct. 16, 2018	Radiation (03CH13-HY)
Amplifier	MITEQ	TTA1840-35-HG	1871923	18GHz~40GHz, VSWR : 2.5:1 max	Jul. 16, 2018	Jul. 19, 2018 ~ Jul. 20, 2018	Jul. 15, 2019	Radiation (03CH13-HY)



6 Uncertainty of Evaluation

Uncertainty of Radiated Emission Measurement (30 MHz ~ 1000 MHz)

Measuring Uncertainty for a Level of Confidence of 95% ($U = 2Uc(y)$)	3.07
---	------

Uncertainty of Radiated Emission Measurement (1 GHz ~ 18 GHz)

Measuring Uncertainty for a Level of Confidence of 95% ($U = 2Uc(y)$)	3.48
---	------

Uncertainty of Radiated Emission Measurement (18 GHz ~ 40 GHz)

Measuring Uncertainty for a Level of Confidence of 95% ($U = 2Uc(y)$)	3.92
---	------



Appendix A. Test Results of Conducted Test

Conducted Output Power(Average power)

LTE Band 2 Maximum Average Power [dBm]						
BW [MHz]	RB Size	RB Offset	Mod	Lowest	Middle	Highest
20	1	0	QPSK	23.28	23.30	23.88
20	1	49		22.36	22.57	22.93
20	1	99		22.73	23.15	22.62
20	50	0		21.86	21.96	22.41
20	50	24		21.51	21.75	22.12
20	50	50		21.47	21.77	22.03
20	100	0		21.64	21.86	22.20
20	1	0	16-QAM	22.54	22.55	23.00
20	1	49		21.60	21.82	22.13
20	1	99		21.93	22.39	21.90
20	50	0		20.69	20.99	21.32
20	50	24		20.38	20.64	21.01
20	50	50		20.38	20.70	20.97
20	100	0		20.58	20.77	21.18
15	1	0	QPSK	22.91	23.01	23.51
15	1	37		22.27	22.48	22.63
15	1	74		22.46	22.77	22.41
15	36	0		21.50	21.68	21.99
15	36	20		21.29	21.59	21.87
15	36	39		21.28	21.58	21.86
15	75	0		21.34	21.58	21.90
15	1	0	16-QAM	22.10	22.23	22.74
15	1	37		21.44	21.72	21.94
15	1	74		21.64	22.00	21.62
15	36	0		20.46	20.70	20.96
15	36	20		20.26	20.54	20.82
15	36	39		20.27	20.56	20.76
15	75	0		20.34	20.64	20.97



LTE Band 2 Maximum Average Power [dBm]						
BW [MHz]	RB Size	RB Offset	Mod	Lowest	Middle	Highest
10	1	0	QPSK	22.40	22.84	23.13
10	1	25		22.22	22.59	22.90
10	1	49		22.14	22.67	22.33
10	25	0		21.16	21.59	21.86
10	25	12		21.14	21.57	21.72
10	25	25		21.03	21.61	21.73
10	50	0		21.10	21.60	21.76
10	1	0	16-QAM	21.79	22.19	22.45
10	1	25		21.42	21.83	22.05
10	1	49		21.50	22.02	21.67
10	25	0		20.16	20.66	20.86
10	25	12		20.13	20.56	20.67
10	25	25		20.09	20.63	20.71
10	50	0		20.14	20.52	20.72
5	1	0	QPSK	22.18	22.65	22.90
5	1	12		22.01	22.42	22.19
5	1	24		22.01	22.63	22.29
5	12	0		21.08	21.44	21.70
5	12	7		21.04	21.49	21.20
5	12	13		21.02	21.45	21.17
5	25	0		21.03	21.55	21.74
5	1	0	16-QAM	21.46	21.91	22.15
5	1	12		21.38	21.79	21.56
5	1	24		21.30	21.97	21.54
5	12	0		20.08	20.44	20.81
5	12	7		20.03	20.48	20.29
5	12	13		20.04	20.46	20.26
5	25	0		20.03	20.52	20.71



LTE Band 2 Maximum Average Power [dBm]						
BW [MHz]	RB Size	RB Offset	Mod	Lowest	Middle	Highest
3	1	0	QPSK	22.25	22.67	22.35
3	1	8		22.16	22.55	22.38
3	1	14		22.06	22.68	22.24
3	8	0		21.11	21.57	21.25
3	8	4		21.14	21.58	21.35
3	8	7		21.08	21.59	21.27
3	15	0		21.11	21.54	21.27
3	1	0	16-QAM	21.41	21.88	21.56
3	1	8		21.41	21.86	21.60
3	1	14		21.29	21.93	21.51
3	8	0		20.16	20.63	20.31
3	8	4		20.18	20.59	20.34
3	8	7		20.14	20.61	20.36
3	15	0		20.08	20.51	20.28
1.4	1	0	QPSK	22.28	22.60	22.31
1.4	1	3		22.27	22.59	22.23
1.4	1	5		22.21	22.66	22.26
1.4	3	0		22.12	22.44	22.20
1.4	3	1		22.12	22.56	22.25
1.4	3	3		22.00	22.46	22.27
1.4	6	0		21.02	21.46	21.17
1.4	1	0	16-QAM	21.48	22.01	21.61
1.4	1	3		21.48	21.88	21.61
1.4	1	5		21.45	21.99	21.60
1.4	3	0		21.12	21.55	21.26
1.4	3	1		21.15	21.57	21.31
1.4	3	3		21.11	21.55	21.27
1.4	6	0		20.12	20.52	20.30



LTE Band 4 Maximum Average Power [dBm]						
BW [MHz]	RB Size	RB Offset	Mod	Lowest	Middle	Highest
20	1	0	QPSK	23.60	23.82	23.73
20	1	49		22.73	23.01	22.53
20	1	99		23.07	23.06	22.83
20	50	0		22.06	22.37	22.15
20	50	24		21.82	22.04	21.71
20	50	50		21.79	21.97	21.63
20	100	0		21.99	22.10	21.93
20	1	0	16-QAM	22.91	23.00	22.93
20	1	49		22.01	22.29	21.76
20	1	99		22.37	22.34	22.05
20	50	0		21.05	21.29	21.08
20	50	24		20.84	20.98	20.71
20	50	50		20.77	20.96	20.64
20	100	0		21.00	21.10	20.91
15	1	0	QPSK	23.29	23.45	23.39
15	1	37		22.58	22.89	22.56
15	1	74		22.86	22.89	22.72
15	36	0		21.94	22.09	21.94
15	36	20		21.72	21.87	21.68
15	36	39		21.71	21.80	21.69
15	75	0		21.84	21.88	21.83
15	1	0	16-QAM	22.56	22.66	22.61
15	1	37		21.85	22.03	21.78
15	1	74		22.07	22.10	21.88
15	36	0		20.92	21.04	20.92
15	36	20		20.71	20.87	20.66
15	36	39		20.68	20.79	20.66
15	75	0		20.85	20.92	20.82



LTE Band 4 Maximum Average Power [dBm]						
BW [MHz]	RB Size	RB Offset	Mod	Lowest	Middle	Highest
10	1	0	QPSK	23.08	23.16	22.90
10	1	25		22.88	22.95	22.63
10	1	49		22.84	22.76	22.52
10	25	0		21.79	21.79	21.65
10	25	12		21.71	21.76	21.55
10	25	25		21.55	21.72	21.48
10	50	0		21.68	21.83	21.61
10	1	0	16-QAM	22.42	22.47	22.23
10	1	25		22.02	22.06	21.83
10	1	49		22.16	22.06	21.82
10	25	0		20.78	20.81	20.66
10	25	12		20.71	20.74	20.54
10	25	25		20.57	20.69	20.49
10	50	0		20.69	20.81	20.64
5	1	0	QPSK	22.84	22.84	22.58
5	1	12		22.60	22.71	22.42
5	1	24		22.68	22.75	22.35
5	12	0		21.74	21.75	21.39
5	12	7		21.68	21.75	21.35
5	12	13		21.61	21.65	21.33
5	25	0		21.65	21.72	21.33
5	1	0	16-QAM	22.10	22.07	21.84
5	1	12		22.06	22.16	21.77
5	1	24		21.97	21.97	21.63
5	12	0		20.77	20.73	20.46
5	12	7		20.73	20.71	20.36
5	12	13		20.65	20.67	20.35
5	25	0		20.65	20.71	20.35



LTE Band 4 Maximum Average Power [dBm]						
BW [MHz]	RB Size	RB Offset	Mod	Lowest	Middle	Highest
3	1	0	QPSK	22.75	22.80	22.56
3	1	8		22.60	22.77	22.55
3	1	14		22.63	22.70	22.46
3	8	0		21.69	21.63	21.49
3	8	4		21.62	21.72	21.52
3	8	7		21.62	21.71	21.40
3	15	0		21.59	21.69	21.49
3	1	0	16-QAM	21.95	22.02	21.83
3	1	8		21.92	21.97	21.77
3	1	14		21.86	21.95	21.69
3	8	0		20.75	20.72	20.54
3	8	4		20.68	20.77	20.57
3	8	7		20.66	20.78	20.45
3	15	0		20.59	20.67	20.48
1.4	1	0	QPSK	22.74	22.77	22.52
1.4	1	3		22.74	22.82	22.48
1.4	1	5		22.72	22.77	22.43
1.4	3	0		22.60	22.62	22.37
1.4	3	1		22.70	22.73	22.42
1.4	3	3		22.61	22.67	22.39
1.4	6	0		21.56	21.60	21.30
1.4	1	0	16-QAM	22.05	22.08	21.81
1.4	1	3		22.07	22.05	21.69
1.4	1	5		22.06	22.12	21.80
1.4	3	0		21.65	21.71	21.44
1.4	3	1		21.70	21.72	21.41
1.4	3	3		21.69	21.72	21.46
1.4	6	0		20.66	20.68	20.37



LTE Band 5 Maximum Average Power [dBm]						
BW [MHz]	RB Size	RB Offset	Mod	Lowest	Middle	Highest
10	1	0	QPSK	22.90	22.60	22.86
10	1	25		22.71	22.60	22.93
10	1	49		22.59	22.50	22.79
10	25	0		21.72	21.41	21.82
10	25	12		21.62	21.41	21.71
10	25	25		21.60	21.41	21.71
10	50	0		21.74	21.44	21.76
10	1	0	16-QAM	22.24	21.88	22.13
10	1	25		21.89	21.76	22.15
10	1	49		21.90	21.76	22.07
10	25	0		20.66	20.43	20.76
10	25	12		20.60	20.40	20.67
10	25	25		20.59	20.38	20.66
10	50	0		20.66	20.43	20.73
5	1	0	QPSK	22.75	22.49	22.72
5	1	12		22.72	22.48	22.62
5	1	24		22.60	22.42	22.63
5	12	0		21.72	21.37	21.49
5	12	7		21.69	21.40	21.56
5	12	13		21.69	21.39	21.55
5	25	0		21.70	21.37	21.57
5	1	0	16-QAM	22.05	21.74	21.93
5	1	12		22.14	21.85	21.99
5	1	24		21.91	21.68	21.89
5	12	0		20.66	20.37	20.48
5	12	7		20.59	20.40	20.54
5	12	13		20.67	20.39	20.55
5	25	0		20.70	20.35	20.53



LTE Band 5 Maximum Average Power [dBm]						
BW [MHz]	RB Size	RB Offset	Mod	Lowest	Middle	Highest
3	1	0	QPSK	22.70	22.49	22.67
3	1	8		22.77	22.49	22.67
3	1	14		22.75	22.49	22.56
3	8	0		21.72	21.38	21.53
3	8	4		21.71	21.46	21.64
3	8	7		21.68	21.38	21.57
3	15	0		21.65	21.41	21.61
3	1	0	16-QAM	21.91	21.67	21.86
3	1	8		22.02	21.72	21.92
3	1	14		21.95	21.64	21.77
3	8	0		20.77	20.44	20.56
3	8	4		20.73	20.49	20.63
3	8	7		20.70	20.42	20.60
3	15	0		20.62	20.39	20.58
1.4	1	0	QPSK	22.76	22.56	22.67
1.4	1	3		22.76	22.52	22.63
1.4	1	5		22.72	22.47	22.60
1.4	3	0		22.65	22.40	22.55
1.4	3	1		22.69	22.47	22.65
1.4	3	3		22.57	22.39	22.53
1.4	6	0		21.59	21.33	21.50
1.4	1	0	16-QAM	22.05	21.81	21.97
1.4	1	3		22.02	21.81	21.98
1.4	1	5		22.14	21.82	22.03
1.4	3	0		21.76	21.42	21.57
1.4	3	1		21.71	21.43	21.63
1.4	3	3		21.64	21.42	21.58
1.4	6	0		20.67	20.43	20.57



LTE Band 12 Maximum Average Power [dBm]						
BW [MHz]	RB Size	RB Offset	Mod	Lowest	Middle	Highest
10	1	0	QPSK	22.42	22.35	22.36
10	1	25		22.60	22.64	22.86
10	1	49		22.26	22.61	22.53
10	25	0		21.30	21.32	21.34
10	25	12		21.28	21.38	21.38
10	25	25		21.29	21.36	21.44
10	50	0		21.34	21.43	21.46
10	1	0	16-QAM	21.69	21.82	21.73
10	1	25		21.77	21.80	21.87
10	1	49		21.56	21.87	21.91
10	25	0		20.40	20.36	20.35
10	25	12		20.33	20.38	20.39
10	25	25		20.32	20.40	20.49
10	50	0		20.29	20.36	20.49
5	1	0	QPSK	22.52	22.31	22.44
5	1	12		22.44	22.44	22.54
5	1	24		22.32	22.44	22.47
5	12	0		21.30	21.20	21.32
5	12	7		21.32	21.32	21.32
5	12	13		21.33	21.20	21.35
5	25	0		21.29	21.34	21.28
5	1	0	16-QAM	21.74	21.56	21.72
5	1	12		21.86	21.63	21.55
5	1	24		21.72	21.84	21.72
5	12	0		20.46	20.29	20.48
5	12	7		20.42	20.42	20.47
5	12	13		20.46	20.34	20.49
5	25	0		20.41	20.33	20.32



LTE Band 12 Maximum Average Power [dBm]						
BW [MHz]	RB Size	RB Offset	Mod	Lowest	Middle	Highest
3	1	0	QPSK	22.38	22.41	22.43
3	1	8		22.33	22.34	22.28
3	1	14		22.28	22.41	22.31
3	8	0		21.32	21.29	21.19
3	8	4		21.29	21.39	21.29
3	8	7		21.18	21.36	21.21
3	15	0		21.20	21.27	21.23
3	1	0	16-QAM	21.46	21.64	21.59
3	1	8		21.62	21.72	21.61
3	1	14		21.48	21.61	21.64
3	8	0		20.41	20.34	20.33
3	8	4		20.34	20.42	20.41
3	8	7		20.25	20.39	20.31
3	15	0		20.26	20.31	20.31
1.4	1	0	QPSK	22.16	22.17	22.23
1.4	1	3		22.23	22.31	22.33
1.4	1	5		22.11	22.22	22.19
1.4	3	0		22.27	22.19	22.18
1.4	3	1		22.24	22.22	22.22
1.4	3	3		22.29	22.28	22.18
1.4	6	0		21.21	21.10	21.09
1.4	1	0	16-QAM	21.50	21.57	21.47
1.4	1	3		21.46	21.53	21.52
1.4	1	5		21.47	21.58	21.45
1.4	3	0		21.20	21.29	21.20
1.4	3	1		21.35	21.27	21.40
1.4	3	3		21.27	21.29	21.11
1.4	6	0		20.36	20.21	20.28



LTE Band 13 Maximum Average Power [dBm]						
BW [MHz]	RB Size	RB Offset	Mod	Lowest	Middle	Highest
10	1	0	QPSK		21.42	
10	1	25			21.28	
10	1	49			21.32	
10	25	0			20.34	
10	25	12			20.22	
10	25	25			20.30	
10	50	0			20.51	
10	1	0	16-QAM		20.71	
10	1	25			20.48	
10	1	49			20.69	
10	25	0			19.51	
10	25	12			19.35	
10	25	25			19.33	
10	50	0			19.50	
5	1	0	QPSK	21.41	21.35	21.18
5	1	12		21.24	21.29	21.10
5	1	24		21.27	21.37	21.19
5	12	0		20.18	20.21	20.06
5	12	7		20.27	20.32	20.12
5	12	13		20.13	20.27	20.10
5	25	0		20.22	20.26	20.15
5	1	0	16-QAM	20.78	20.59	20.46
5	1	12		20.51	20.54	20.37
5	1	24		20.50	20.59	20.46
5	12	0		19.10	19.29	19.14
5	12	7		19.21	19.40	19.16
5	12	13		19.16	19.33	19.20
5	25	0		19.31	19.29	19.17



LTE Band 2

Peak-to-Average Ratio

Mode	LTE Band 2 / 20MHz				
Mod.	QPSK		16QAM		Limit: 13dB
RB Size	1RB	Full RB	1RB	Full RB	Result
Lowest CH	4.14	4.75	4.72	5.77	PASS
Middle CH	3.74	4.7	4.84	5.71	
Highest CH	3.91	4.49	4.58	5.54	



LTE Band 2 / 20MHz / QPSK

Lowest Channel / 1RB



Date: 10 JUL 2018 06:34:01

Lowest Channel / Full RB

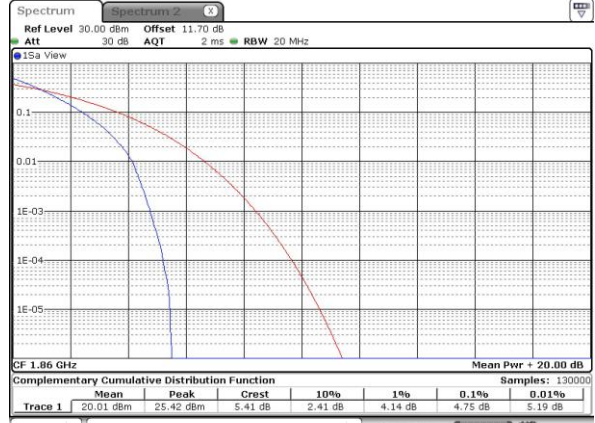

Date: 10 JUL 2018 06:34:11

Middle Channel / 1RB

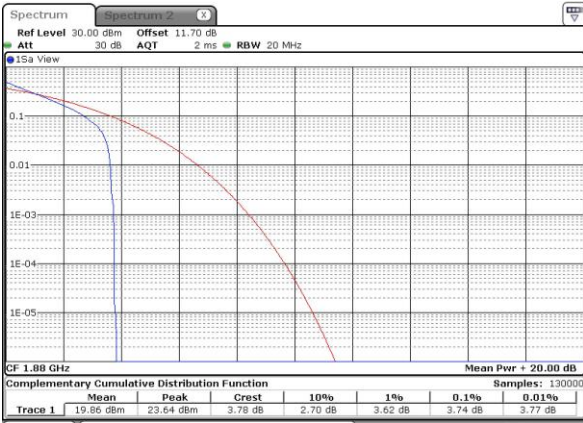

Date: 10 JUL 2018 06:34:29

Middle Channel / Full RB



Date: 10 JUL 2018 06:34:40

Highest Channel / 1RB



Date: 10 JUL 2018 06:34:51

Highest Channel / Full RB

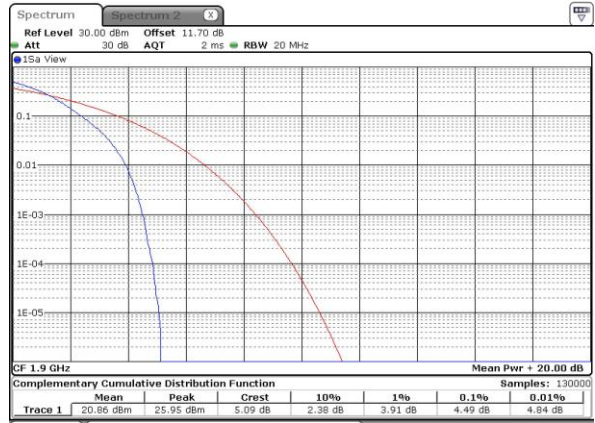

Date: 10 JUL 2018 06:35:02



LTE Band 2 / 20MHz / 16QAM

Lowest Channel / 1RB

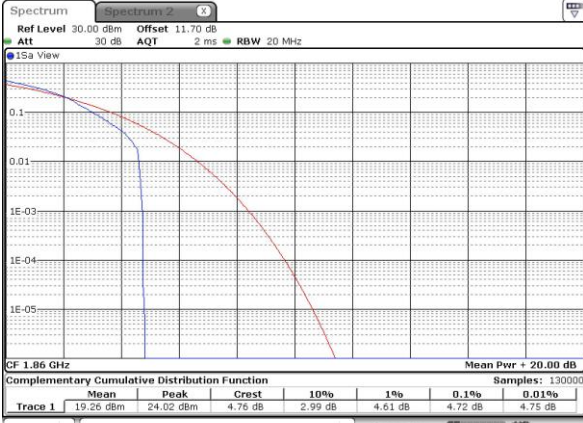

Date: 10 JUL 2018 06:32:48

Lowest Channel / Full RB

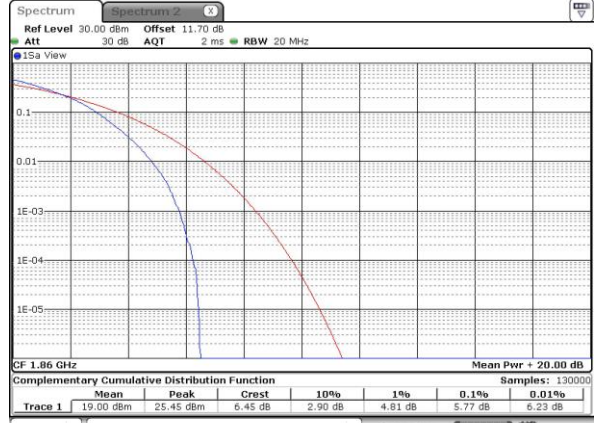

Date: 10 JUL 2018 06:32:58

Middle Channel / 1RB



Date: 10 JUL 2018 06:33:09

Middle Channel / Full RB

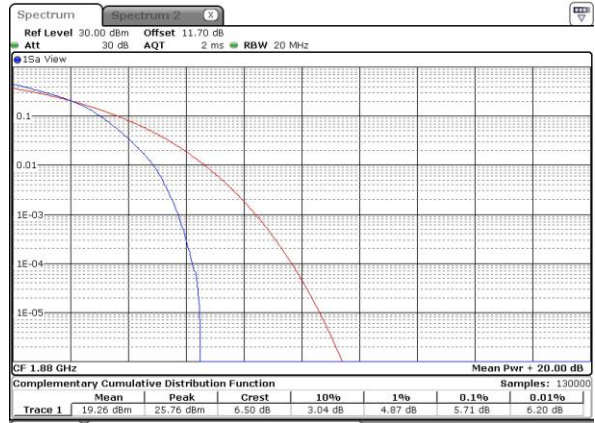

Date: 10 JUL 2018 06:33:24

Highest Channel / 1RB

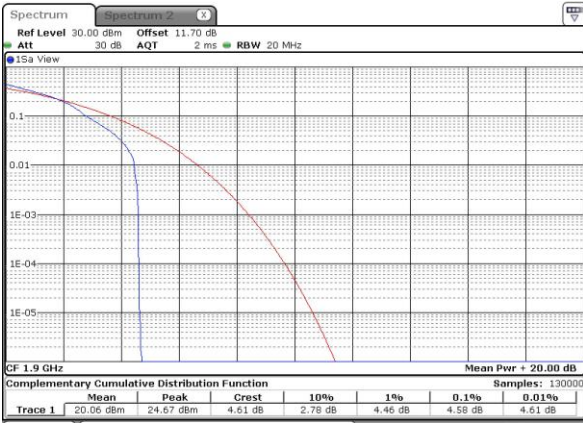

Date: 10 JUL 2018 06:33:38

Highest Channel / Full RB

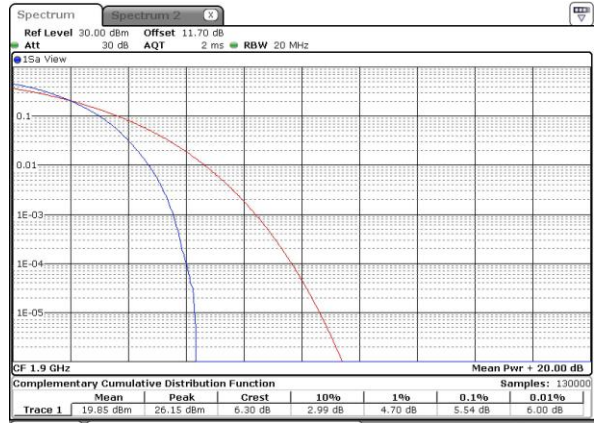

Date: 10 JUL 2018 06:33:49



26dB Bandwidth

Mode	LTE Band 2 : 26dB BW(MHz)											
	1.4MHz		3MHz		5MHz		10MHz		15MHz		20MHz	
BW	QPSK	16QAM	QPSK	16QAM	QPSK	16QAM	QPSK	16QAM	QPSK	16QAM	QPSK	16QAM
Mod.	QPSK	16QAM	QPSK	16QAM	QPSK	16QAM	QPSK	16QAM	QPSK	16QAM	QPSK	16QAM
Lowest CH	1.236	1.228	3.021	3.045	5.015	4.815	9.81	9.73	14.595	14.386	20.06	20.18
Middle CH	1.239	1.228	3.027	3.015	4.955	4.975	9.79	9.85	14.206	14.236	20.22	20.38
Highest CH	1.236	1.231	3.063	3.021	4.925	4.855	9.81	9.75	14.266	14.266	20.26	20.1



LTE Band 2

Lowest Channel / 1.4MHz / QPSK

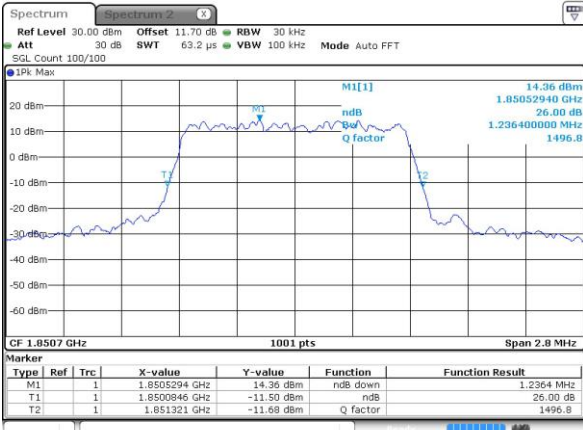

Date: 10 JUL 2018 06:15:35

Lowest Channel / 1.4MHz / 16QAM

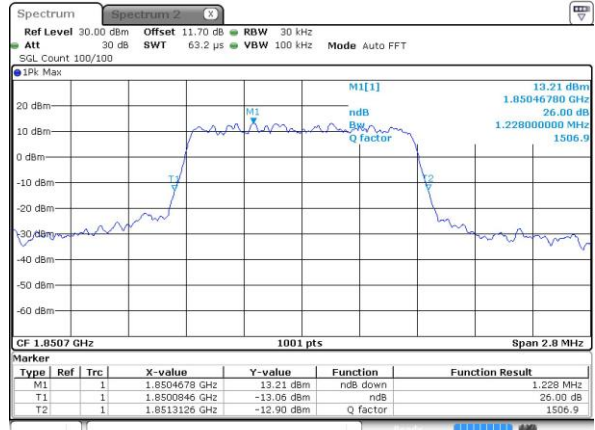

Date: 10 JUL 2018 06:15:46

Middle Channel / 1.4MHz / QPSK



Date: 10 JUL 2018 06:22:53

Middle Channel / 1.4MHz / 16QAM

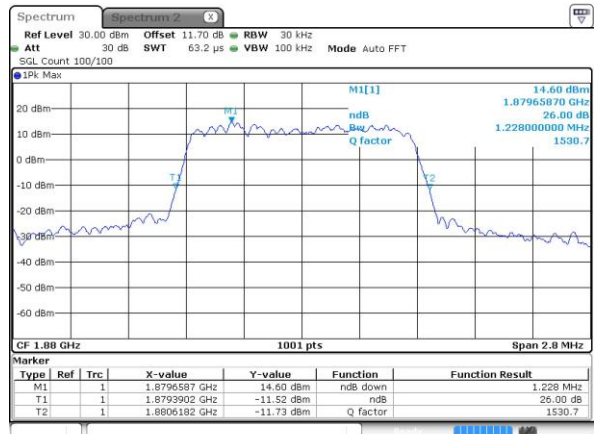

Date: 10 JUL 2018 06:23:05

Highest Channel / 1.4MHz / QPSK



Date: 10 JUL 2018 06:25:31

Highest Channel / 1.4MHz / 16QAM

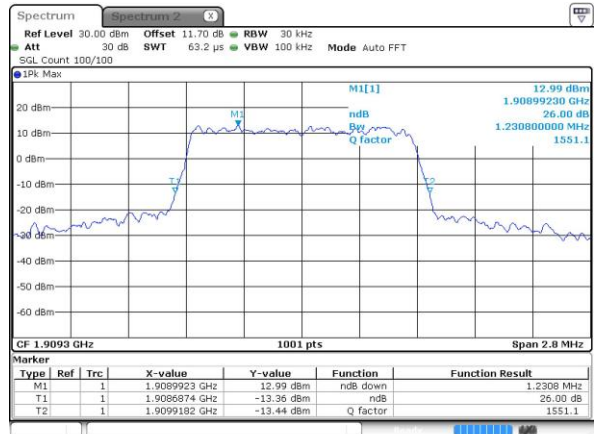

Date: 10 JUL 2018 06:25:42



LTE Band 2

Lowest Channel / 3MHz / QPSK

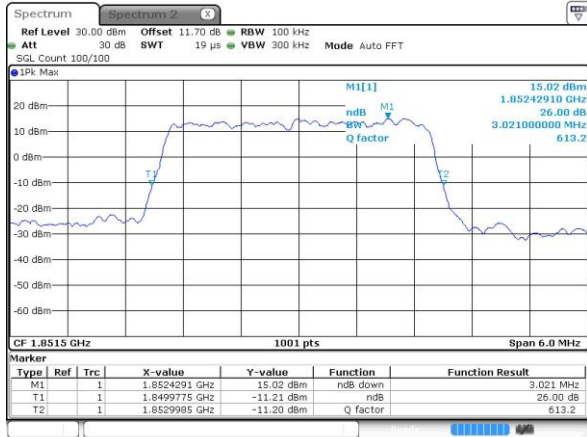

Date: 10_JUL_2018 04:47:07

Lowest Channel / 3MHz / 16QAM

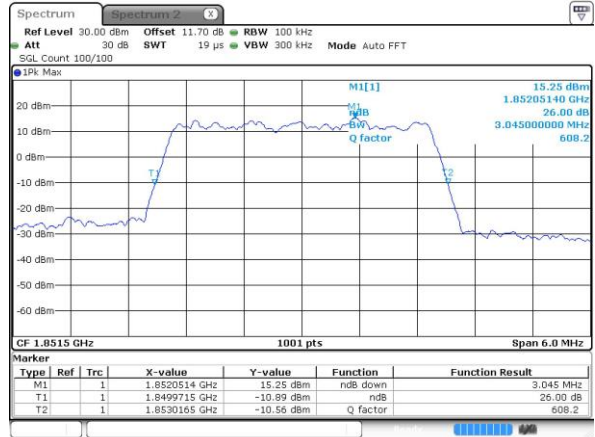

Date: 10_JUL_2018 04:47:19

Middle Channel / 3MHz / QPSK

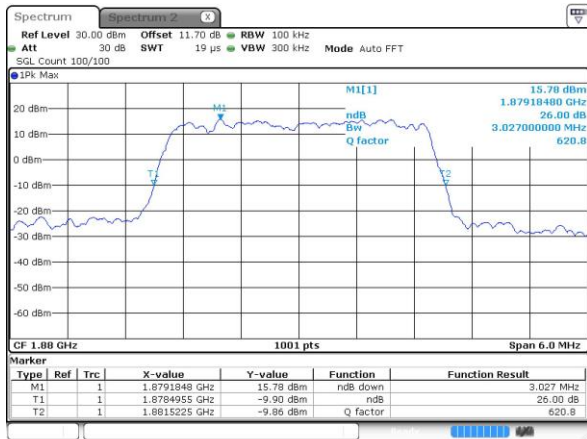

Date: 10_JUL_2018 04:54:26

Middle Channel / 3MHz / 16QAM

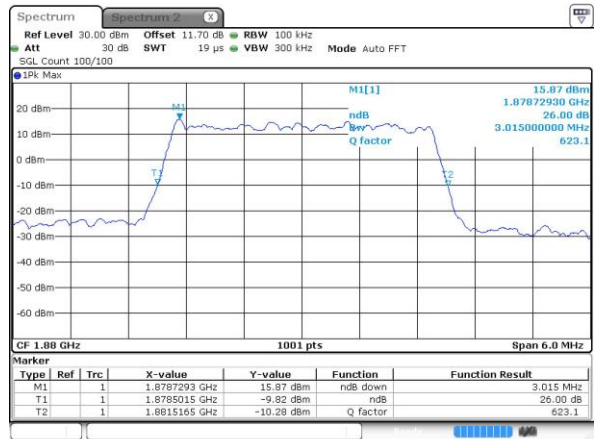

Date: 10_JUL_2018 04:54:37

Highest Channel / 3MHz / QPSK

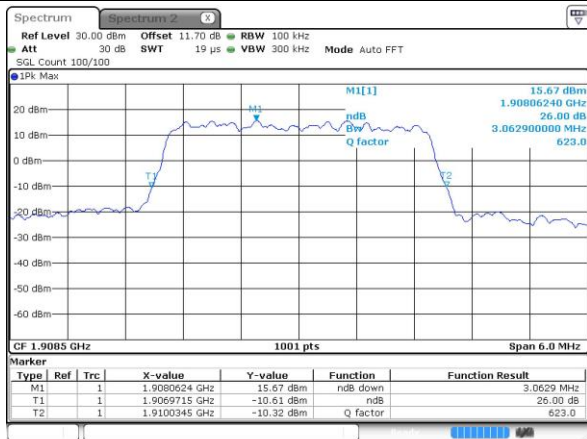

Date: 10_JUL_2018 04:57:03

Highest Channel / 3MHz / 16QAM

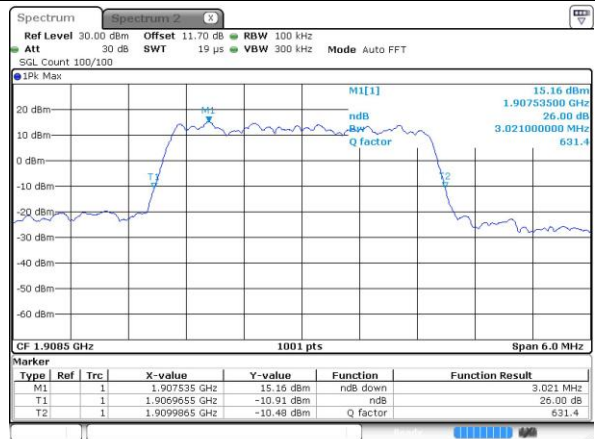

Date: 10_JUL_2018 04:57:14



LTE Band 2

Lowest Channel / 5MHz / QPSK

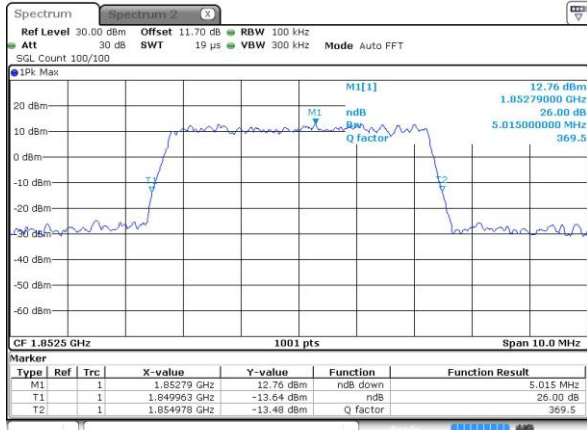

Date: 10 JUL 2018 05:04:21

Lowest Channel / 5MHz / 16QAM

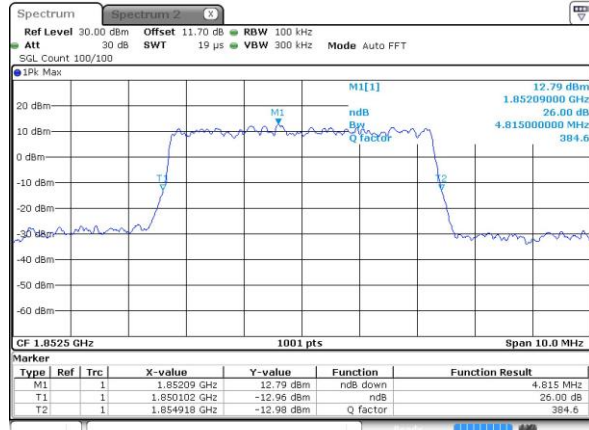

Date: 10 JUL 2018 05:04:33

Middle Channel / 5MHz / QPSK

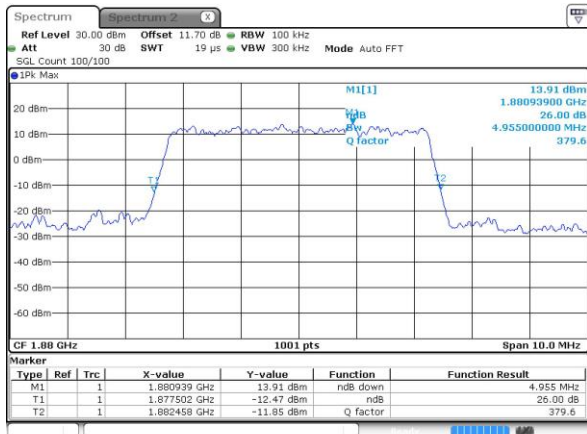

Date: 10 JUL 2018 05:11:40

Middle Channel / 5MHz / 16QAM

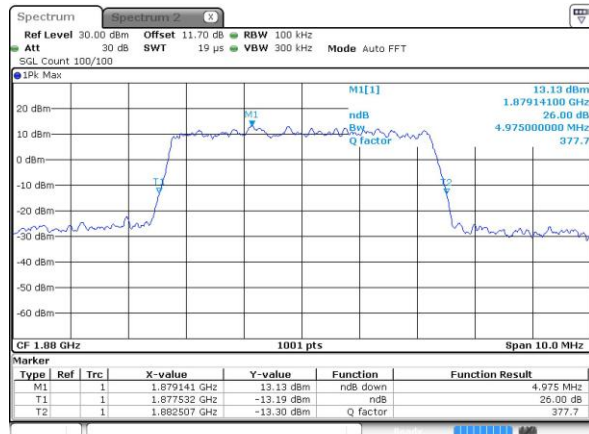

Date: 10 JUL 2018 05:11:51

Highest Channel / 5MHz / QPSK

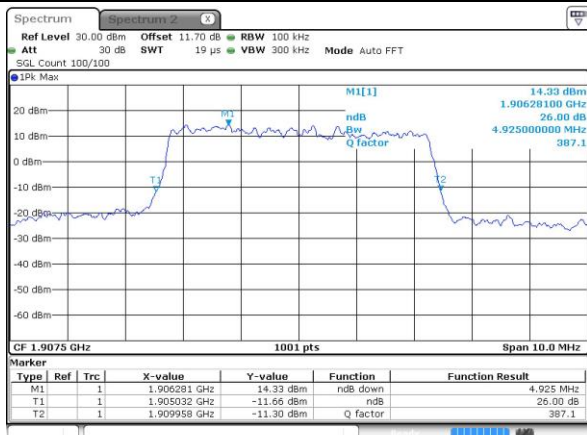

Date: 10 JUL 2018 05:14:17

Highest Channel / 5MHz / 16QAM

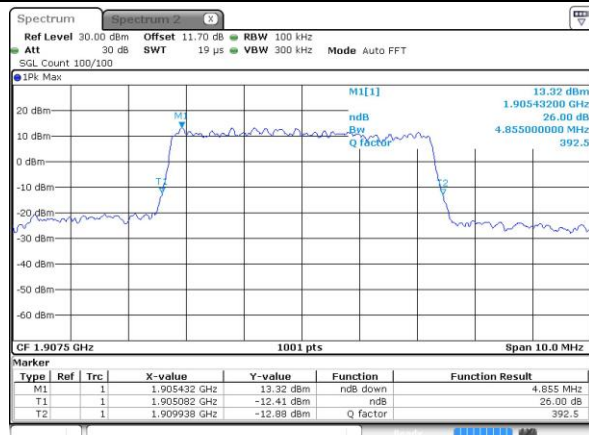

Date: 10 JUL 2018 05:14:29



LTE Band 2

Lowest Channel / 10MHz / QPSK

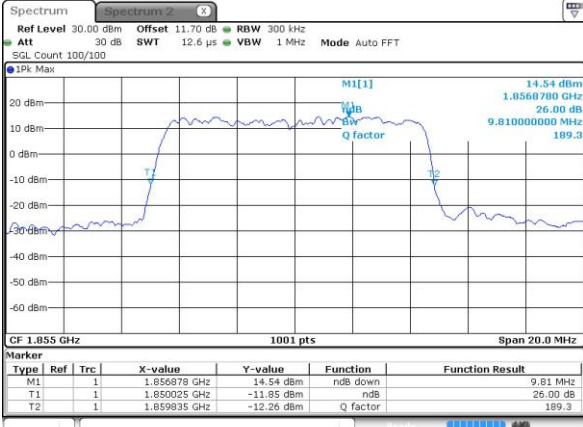

Date: 10 JUL 2018 05:21:36

Lowest Channel / 10MHz / 16QAM

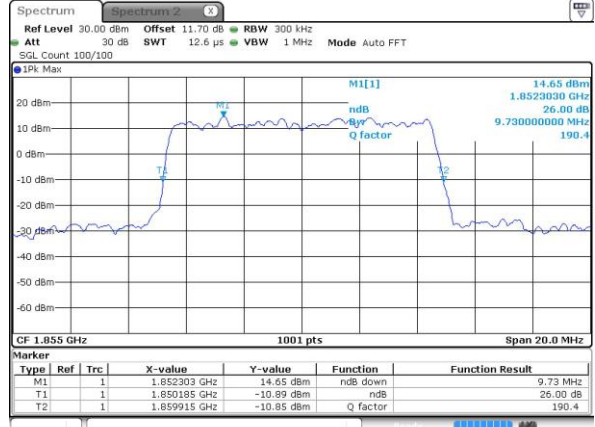

Date: 10 JUL 2018 05:21:48

Middle Channel / 10MHz / QPSK

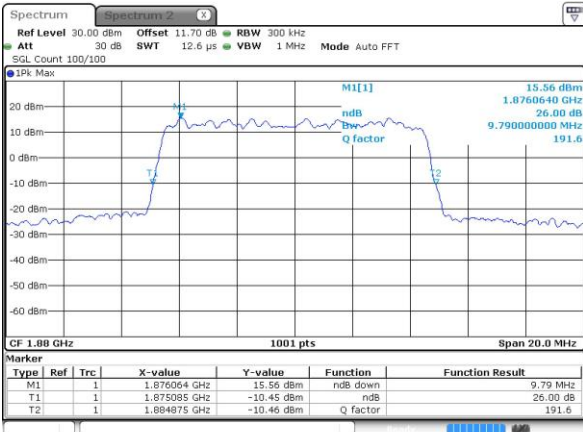

Date: 10 JUL 2018 05:28:55

Middle Channel / 10MHz / 16QAM



Date: 10 JUL 2018 05:29:06

Highest Channel / 10MHz / QPSK

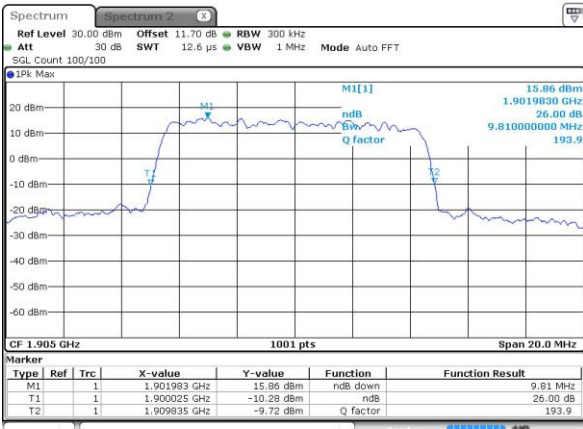

Date: 10 JUL 2018 05:31:32

Highest Channel / 10MHz / 16QAM

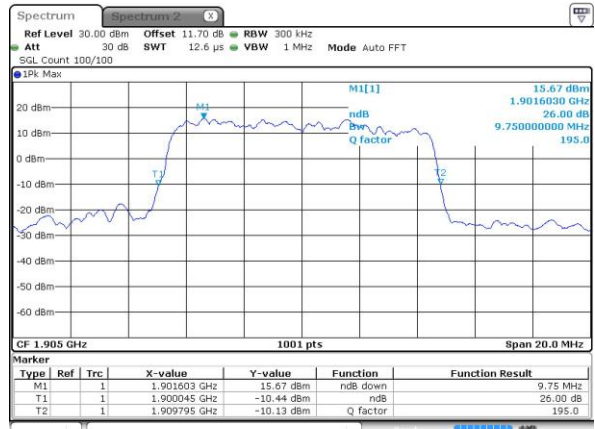

Date: 10 JUL 2018 05:31:44



LTE Band 2

Lowest Channel / 15MHz / QPSK

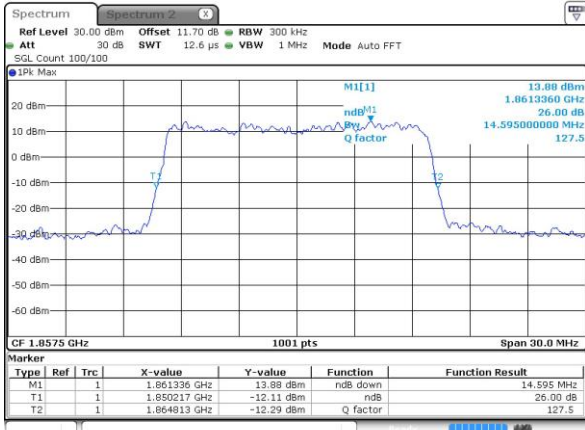

Date: 10 JUL 2018 05:38:51

Lowest Channel / 15MHz / 16QAM

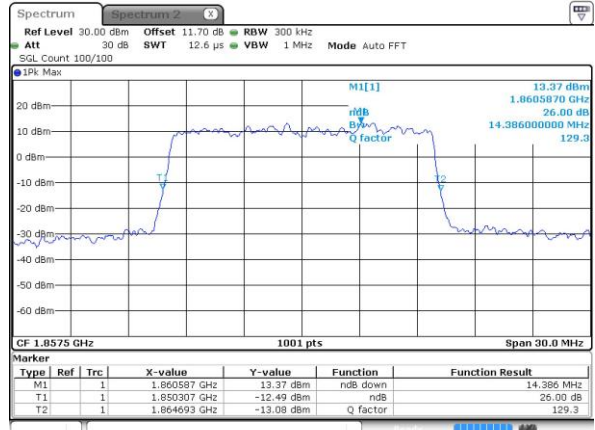

Date: 10 JUL 2018 05:39:02

Middle Channel / 15MHz / QPSK

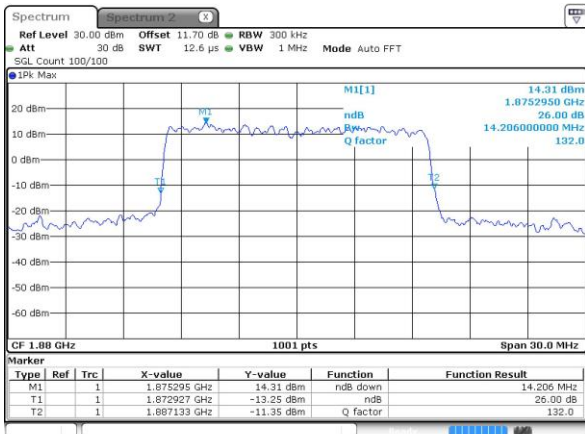

Date: 10 JUL 2018 05:46:09

Middle Channel / 15MHz / 16QAM

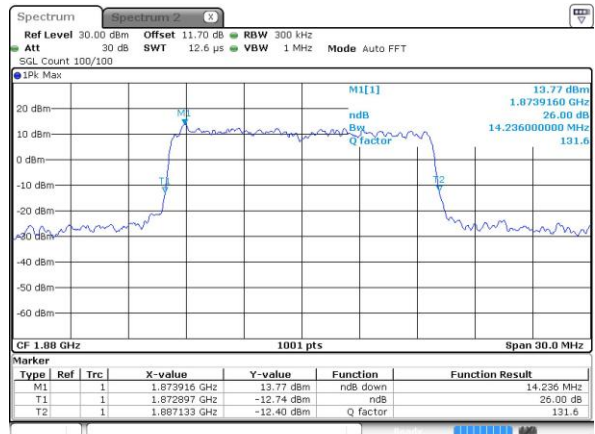

Date: 10 JUL 2018 05:46:21

Highest Channel / 15MHz / QPSK

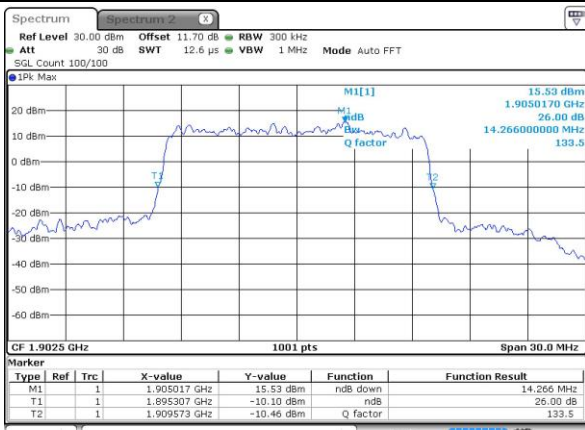

Date: 10 JUL 2018 05:48:47

Highest Channel / 15MHz / 16QAM

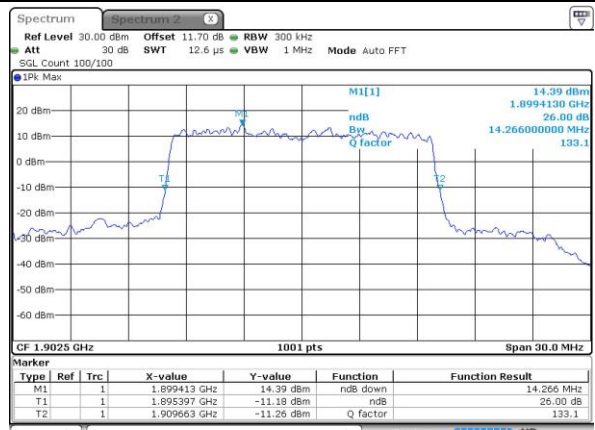

Date: 10 JUL 2018 05:48:58



LTE Band 2

Lowest Channel / 20MHz / QPSK

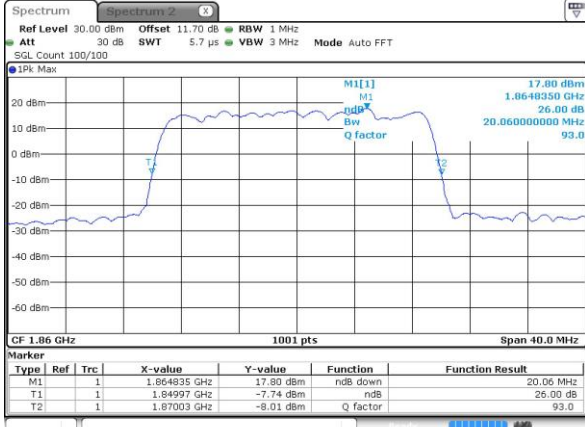

Date: 10 JUL 2018 05:56:05

Lowest Channel / 20MHz / 16QAM

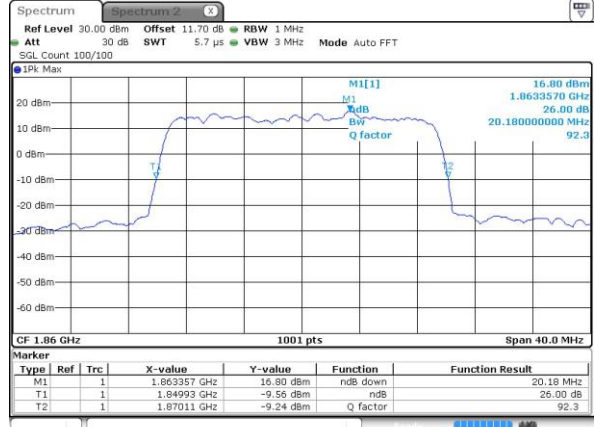

Date: 10 JUL 2018 05:56:17

Middle Channel / 20MHz / QPSK

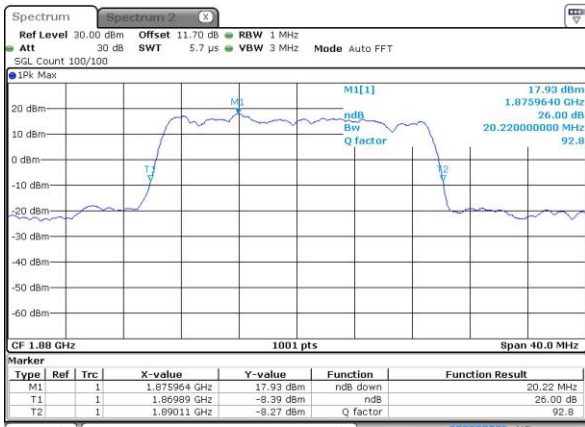

Date: 10 JUL 2018 06:03:24

Middle Channel / 20MHz / 16QAM

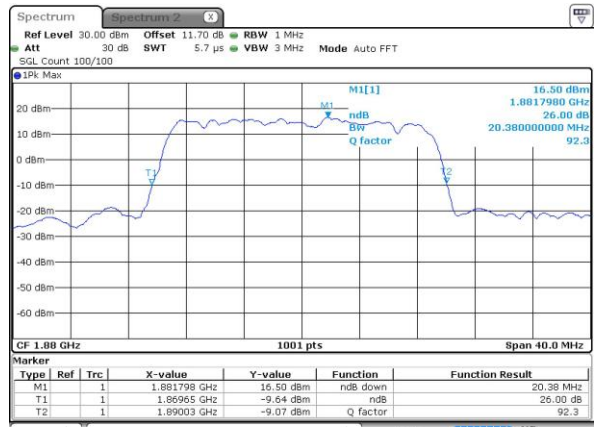

Date: 10 JUL 2018 06:03:36

Highest Channel / 20MHz / QPSK

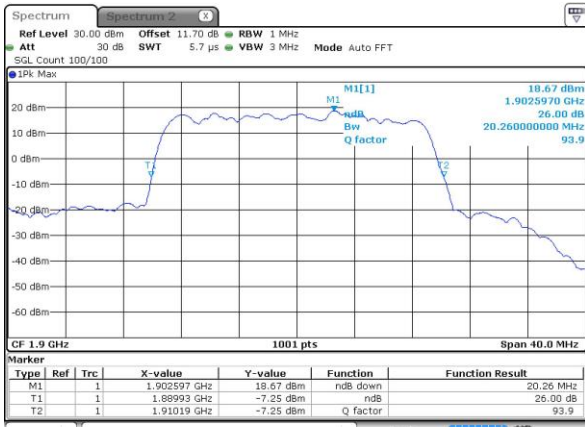

Date: 10 JUL 2018 06:06:01

Highest Channel / 20MHz / 16QAM

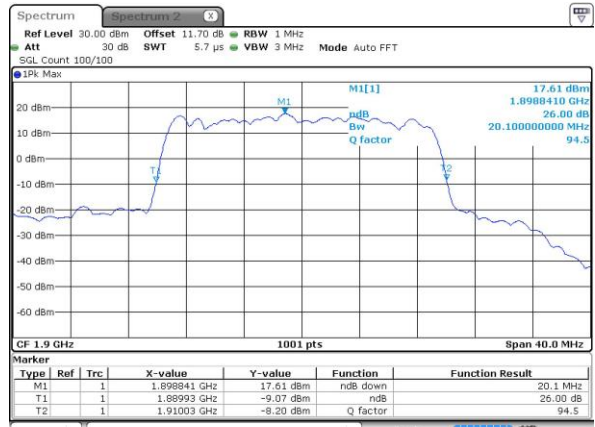

Date: 10 JUL 2018 06:06:13



Occupied Bandwidth

Mode	LTE Band 2 : 99%OBW(MHz)											
	1.4MHz		3MHz		5MHz		10MHz		15MHz		20MHz	
BW	QPSK	16QAM	QPSK	16QAM	QPSK	16QAM	QPSK	16QAM	QPSK	16QAM	QPSK	16QAM
Lowest CH	1.09	1.09	2.73	2.73	4.5	4.49	9.01	9.03	13.4	13.43	18.3	18.26
Middle CH	1.09	1.1	2.72	2.73	4.47	4.49	9.05	9.07	13.4	13.46	18.34	18.5
Highest CH	1.09	1.09	2.72	2.73	4.49	4.48	8.99	8.97	13.34	13.46	18.22	18.26



LTE Band 2

Lowest Channel / 1.4MHz / QPSK

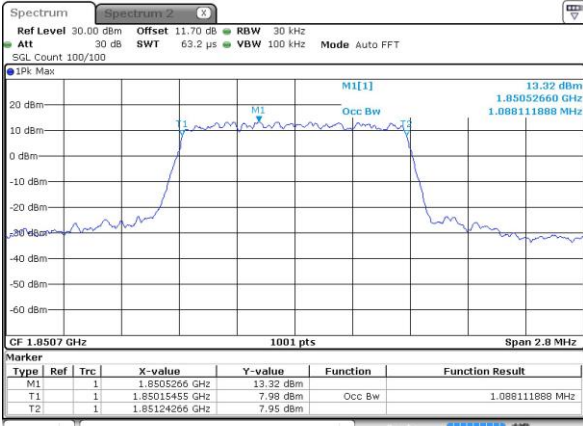

Date: 10 JUL 2018 06:14:33

Lowest Channel / 1.4MHz / 16QAM

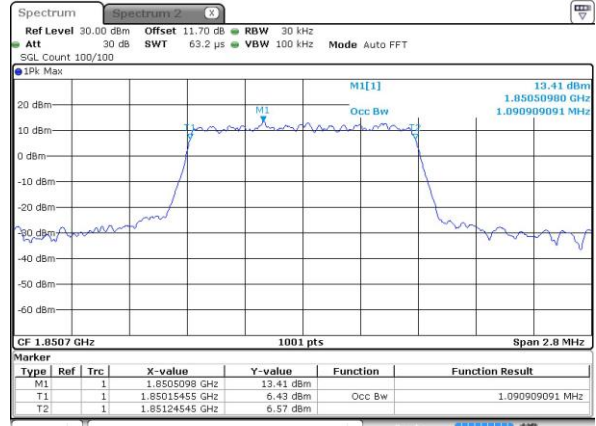

Date: 10 JUL 2018 06:15:23

Middle Channel / 1.4MHz / QPSK

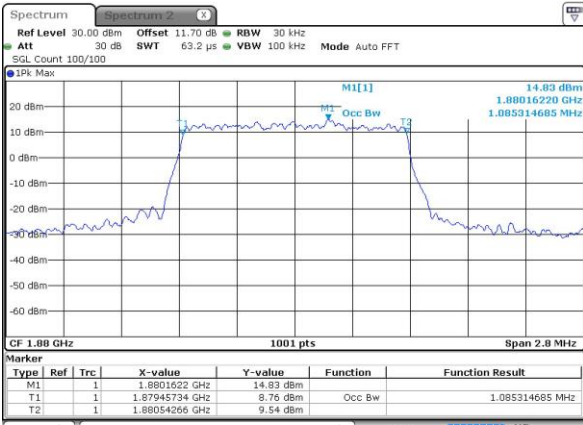

Date: 10 JUL 2018 06:22:30

Middle Channel / 1.4MHz / 16QAM

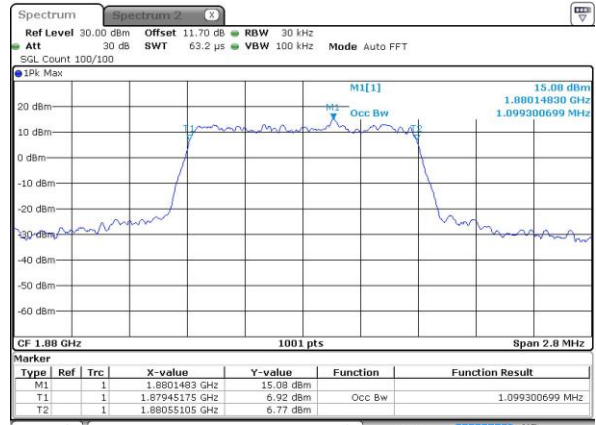

Date: 10 JUL 2018 06:22:42

Highest Channel / 1.4MHz / QPSK

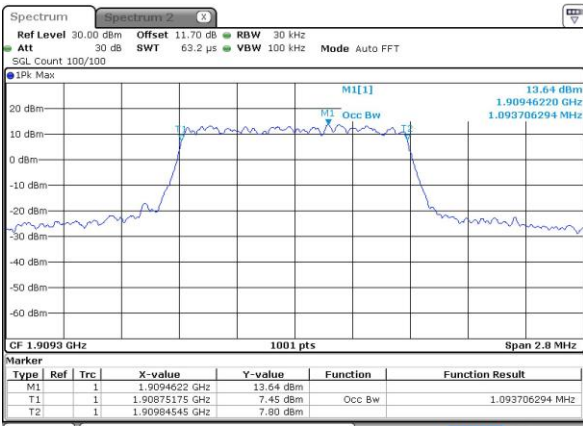

Date: 10 JUL 2018 06:25:08

Highest Channel / 1.4MHz / 16QAM

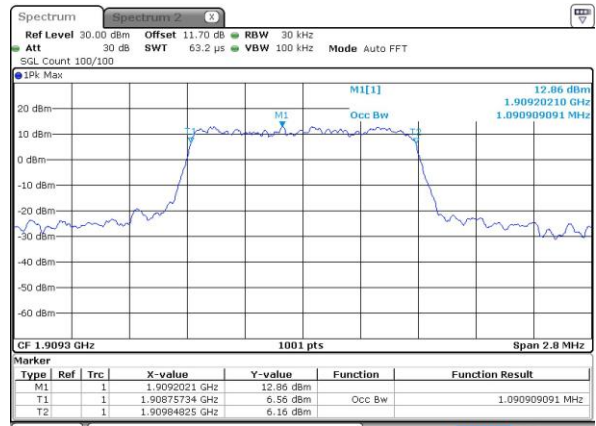

Date: 10 JUL 2018 06:25:19



LTE Band 2

Lowest Channel / 3MHz / QPSK

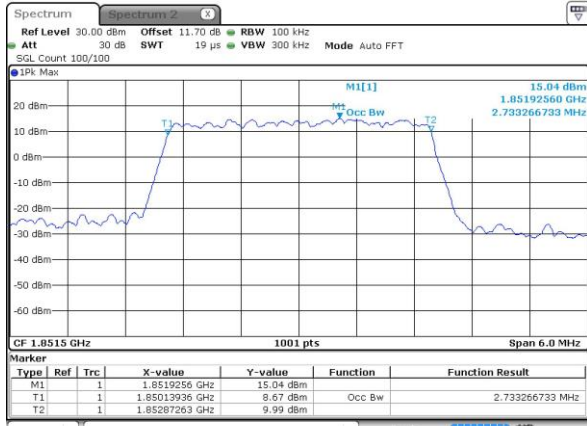

Date: 10 JUL 2018 04:46:44

Lowest Channel / 3MHz / 16QAM

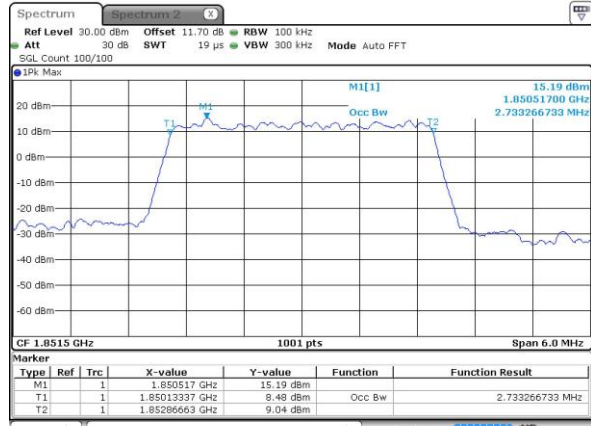

Date: 10 JUL 2018 04:46:56

Middle Channel / 3MHz / QPSK

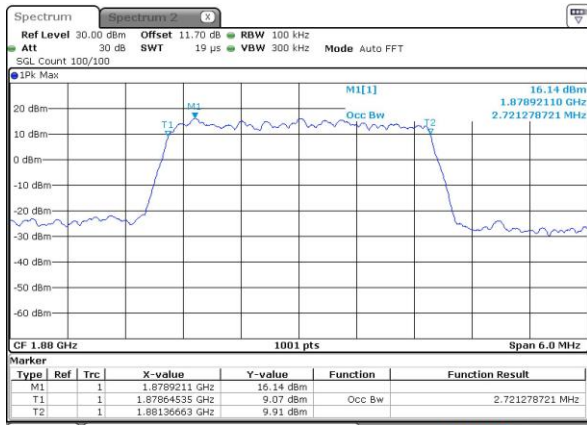

Date: 10 JUL 2018 04:54:02

Middle Channel / 3MHz / 16QAM

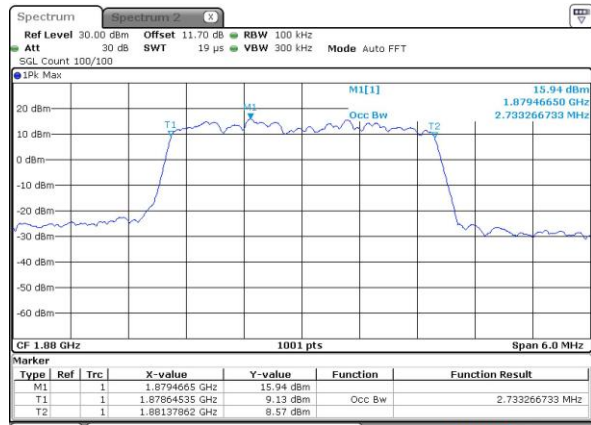

Date: 10 JUL 2018 04:54:14

Highest Channel / 3MHz / QPSK

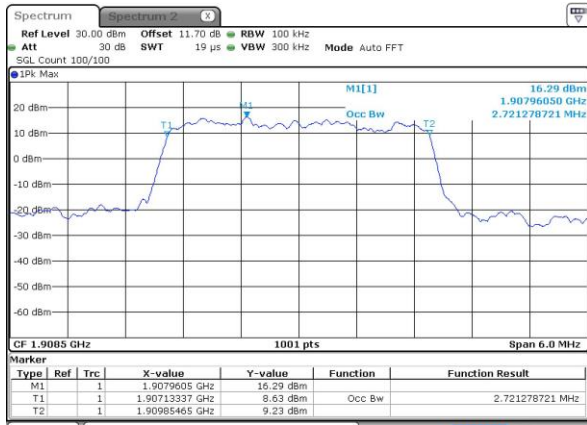

Date: 10 JUL 2018 04:56:40

Highest Channel / 3MHz / 16QAM

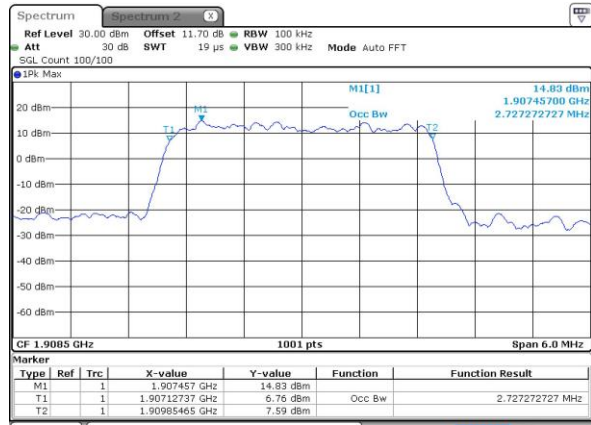

Date: 10 JUL 2018 04:56:51



LTE Band 2

Lowest Channel / 5MHz / QPSK

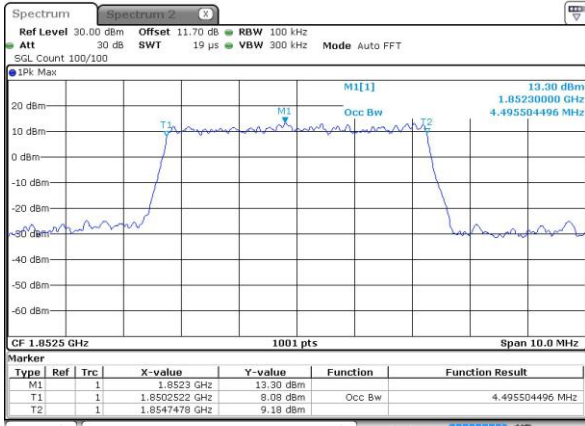

Date: 10 JUL 2018 05:03:58

Lowest Channel / 5MHz / 16QAM

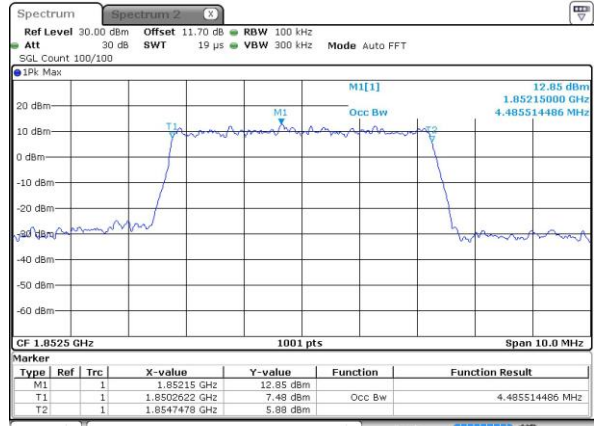

Date: 10 JUL 2018 05:04:10

Middle Channel / 5MHz / QPSK

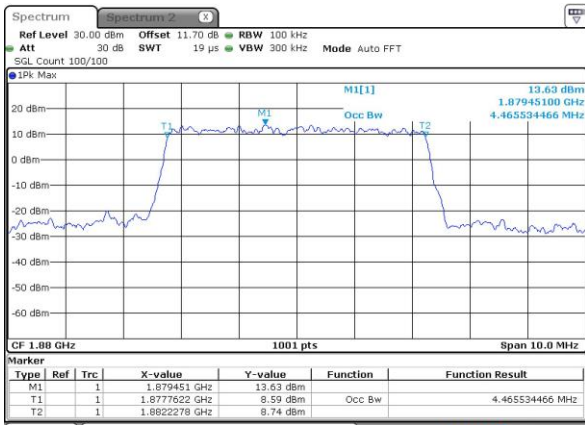

Date: 10 JUL 2018 05:11:17

Middle Channel / 5MHz / 16QAM

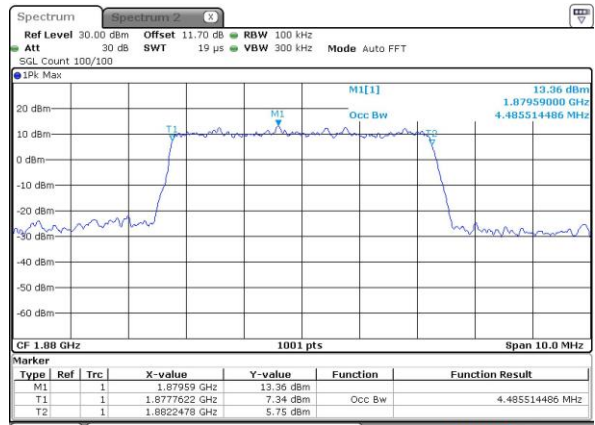

Date: 10 JUL 2018 05:11:28

Highest Channel / 5MHz / QPSK

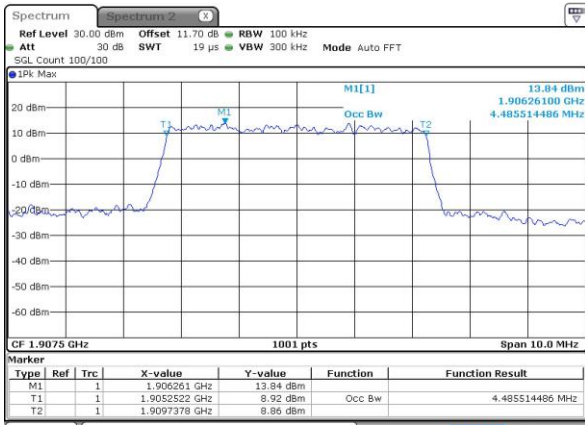

Date: 10 JUL 2018 05:13:54

Highest Channel / 5MHz / 16QAM

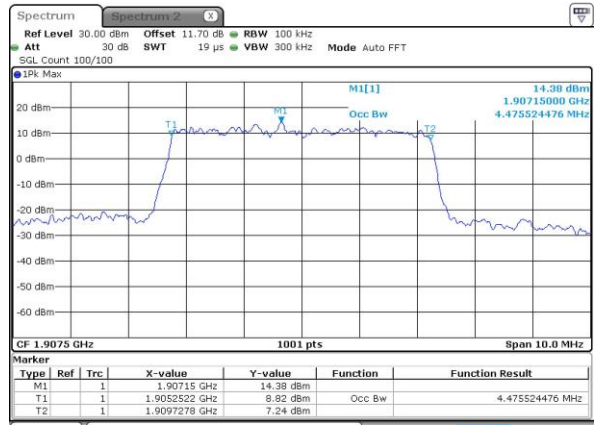

Date: 10 JUL 2018 05:14:06



LTE Band 2

Lowest Channel / 10MHz / QPSK

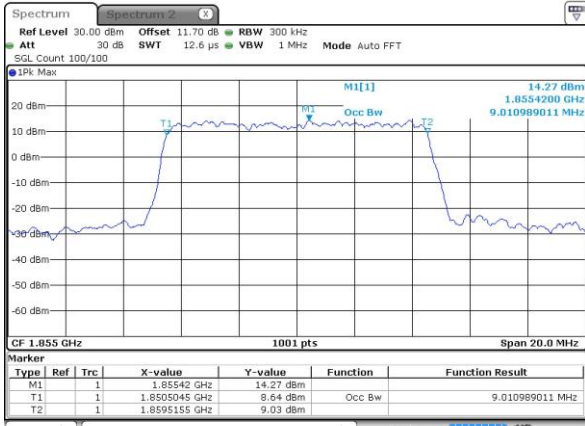

Date: 10 JUL 2018 05:21:13

Lowest Channel / 10MHz / 16QAM

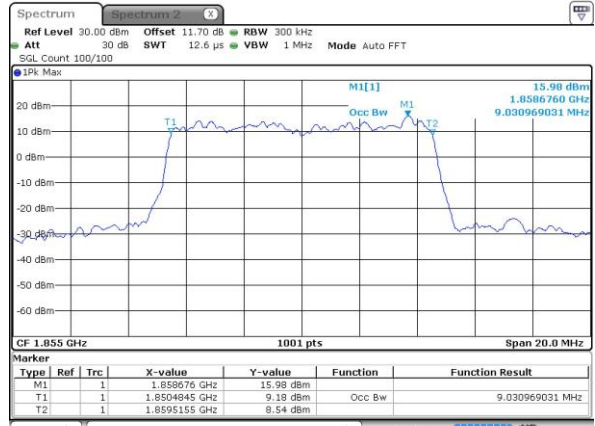

Date: 10 JUL 2018 05:21:24

Middle Channel / 10MHz / QPSK

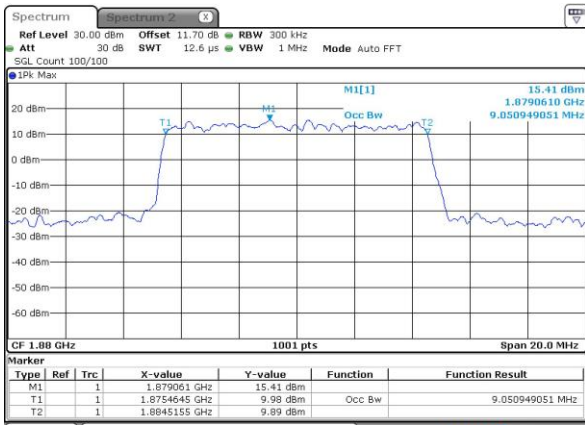

Date: 10 JUL 2018 05:28:31

Middle Channel / 10MHz / 16QAM

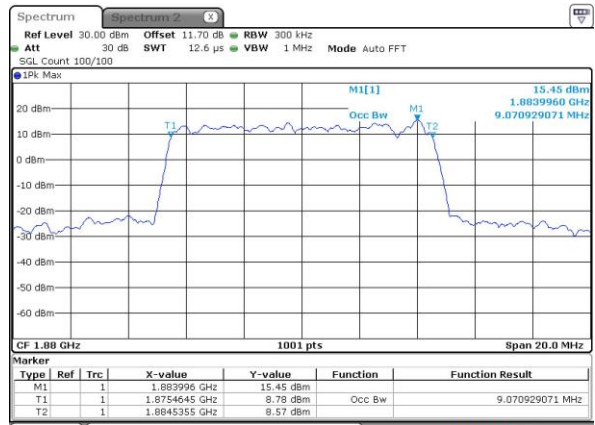

Date: 10 JUL 2018 05:28:43

Highest Channel / 10MHz / QPSK

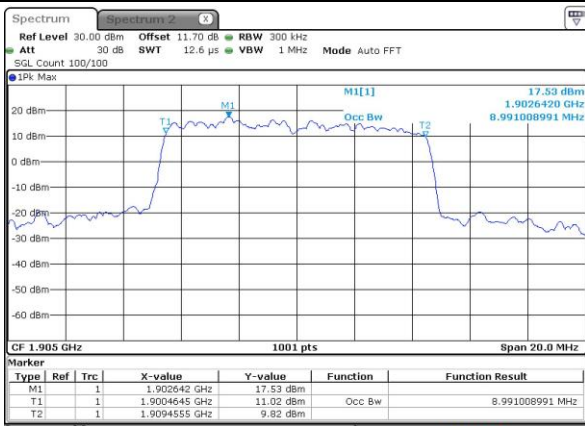

Date: 10 JUL 2018 05:31:09

Highest Channel / 10MHz / 16QAM

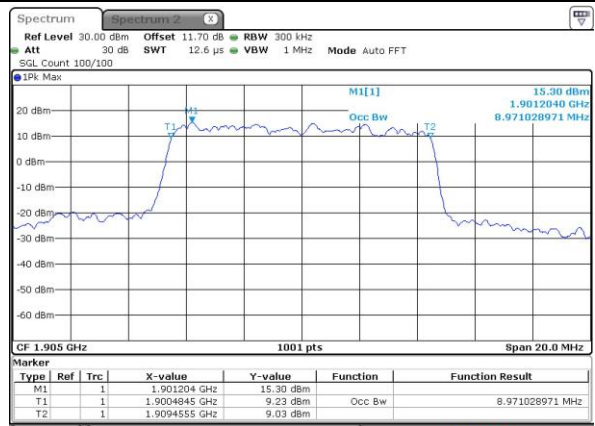

Date: 10 JUL 2018 05:31:21



LTE Band 2

Lowest Channel / 15MHz / QPSK

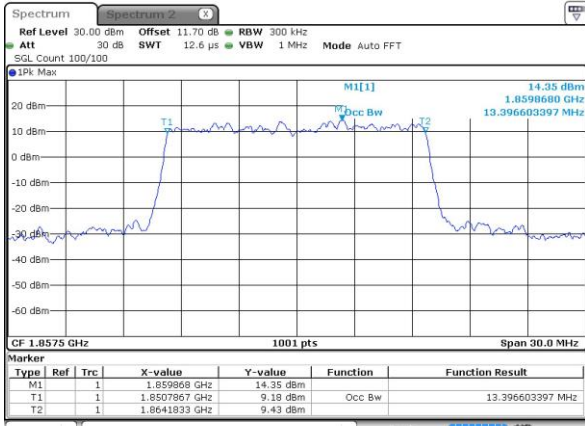

Date: 10 JUL 2018 05:38:28

Lowest Channel / 15MHz / 16QAM

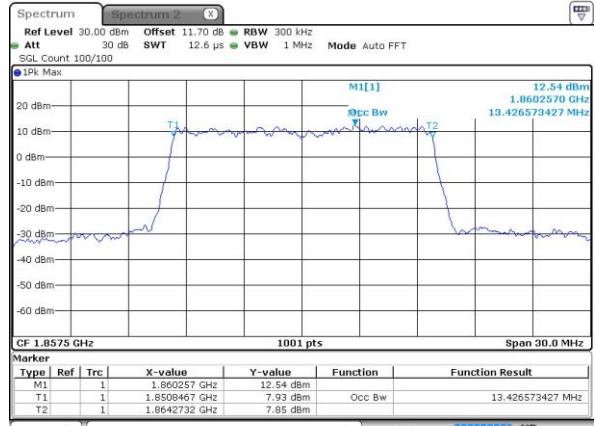

Date: 10 JUL 2018 05:38:39

Middle Channel / 15MHz / QPSK

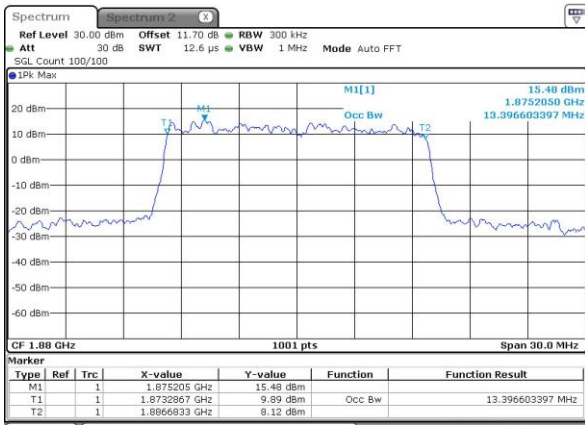

Date: 10 JUL 2018 05:45:46

Middle Channel / 15MHz / 16QAM

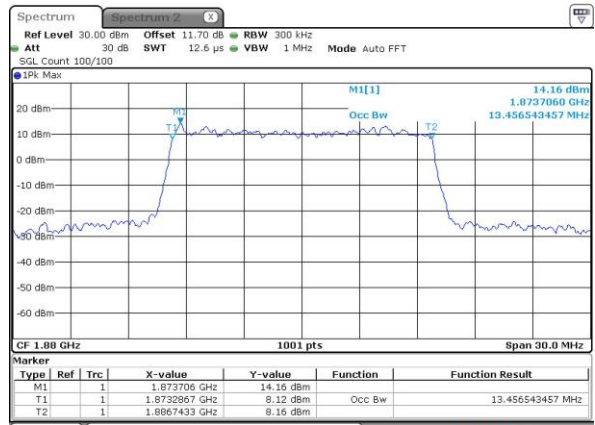

Date: 10 JUL 2018 05:45:56

Highest Channel / 15MHz / QPSK

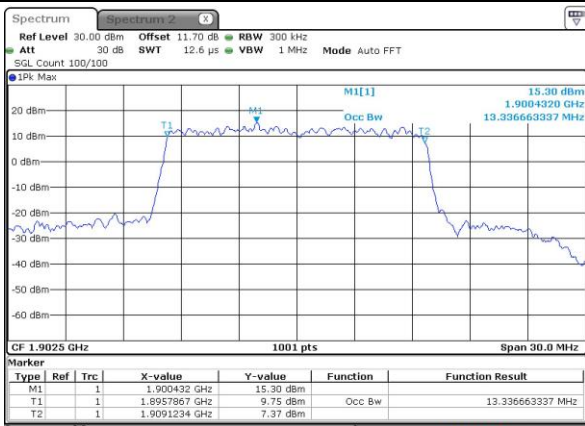

Date: 10 JUL 2018 05:48:23

Highest Channel / 15MHz / 16QAM

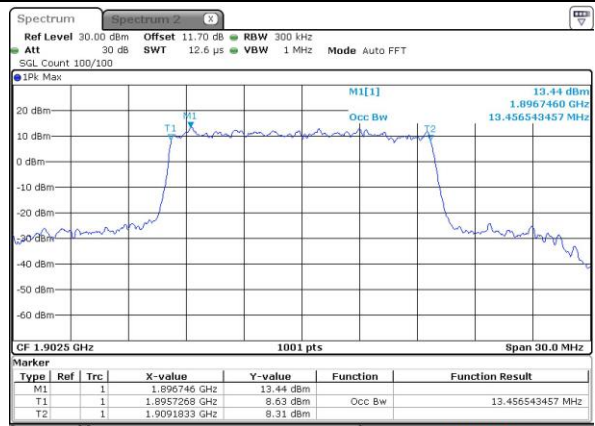

Date: 10 JUL 2018 05:48:35



LTE Band 2

Lowest Channel / 20MHz / QPSK

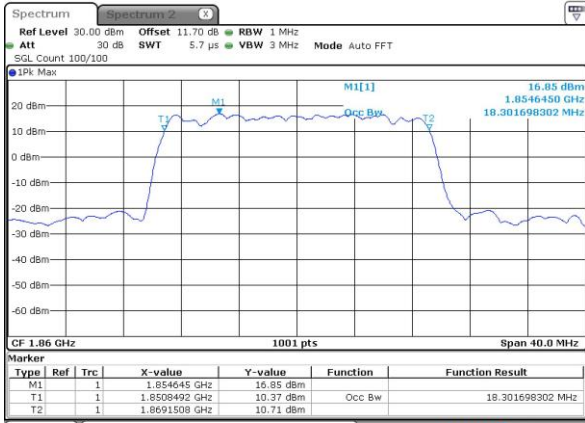

Date: 10 JUL 2018 05:55:42

Lowest Channel / 20MHz / 16QAM

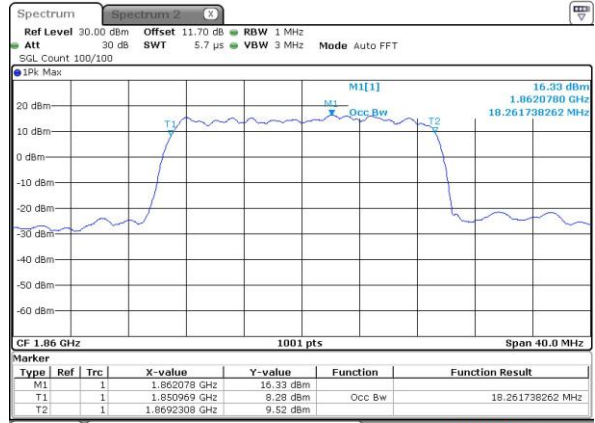

Date: 10 JUL 2018 05:55:54

Middle Channel / 20MHz / QPSK

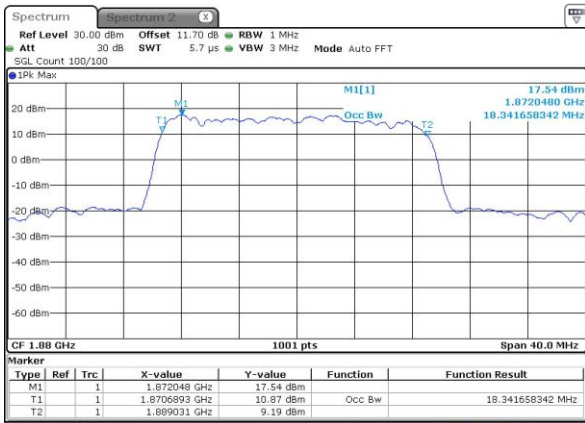

Date: 10 JUL 2018 06:03:01

Middle Channel / 20MHz / 16QAM

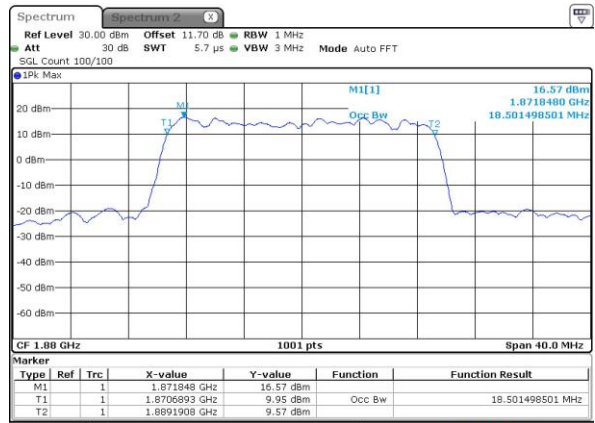

Date: 10 JUL 2018 06:03:12

Highest Channel / 20MHz / QPSK

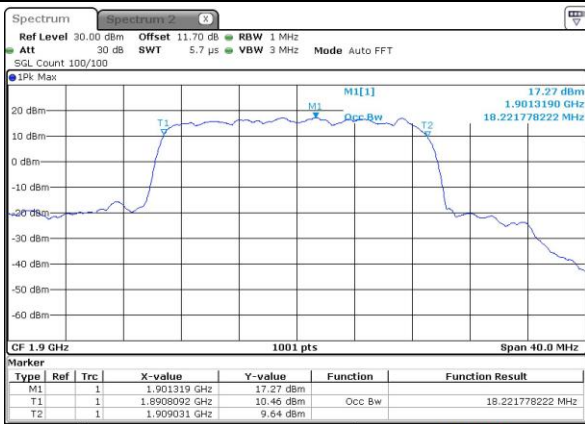

Date: 10 JUL 2018 06:05:38

Highest Channel / 20MHz / 16QAM

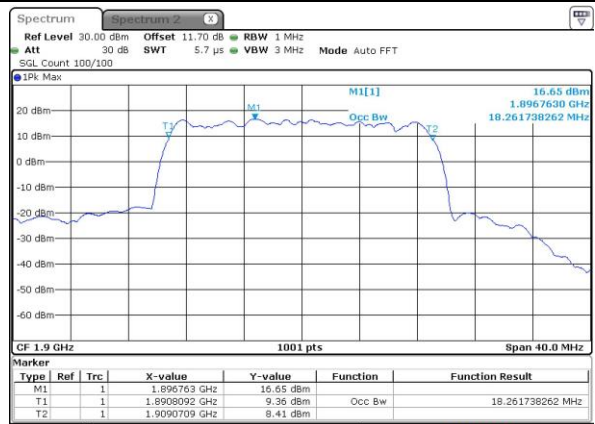

Date: 10 JUL 2018 06:05:50