



FCC RF Test Report

APPLICANT : Cisco Systems, Inc.
EQUIPMENT : LTE Router
BRAND NAME : CISCO
MODEL NAME : MX67C-HW-NA
FCC ID : UDX-60076017
STANDARD : 47 CFR Part 2, 22(H), 24(E), 27
CLASSIFICATION : PCS Licensed Transmitter (PCB)

The product was received on Mar, 14, 2018 and completely tested on Apr. 27, 2018. We, SPORTON INTERNATIONAL Inc., would like to declare that the tested sample has been evaluated in accordance with the test procedures given in ANSI / TIA-603-E and the testing has shown the tested sample to be in compliance with the applicable technical standards.

The test results in this report apply exclusively to the tested model / sample. Without written approval of SPORTON INTERNATIONAL INC., the test report shall not be reproduced except in full.

Reviewed by: Joseph Lin / Supervisor

Approved by: Jones Tsai / Manager



SPORTON INTERNATIONAL INC.

No. 52, Hwa Ya 1st Rd., Hwa Ya Technology Park, Kwei-Shan District, Tao Yuan City, Taiwan, R.O.C.

SPORTON INTERNATIONAL INC.

TEL : 886-3-327-3456

FAX : 886-3-328-4978

FCC ID: UDX-60076017

Page Number : 1 of 24

Report Issued Date : Aug. 03, 2018

Report Version : Rev. 02

Report Template No.: BU5-FGLTE Version 2.0



TABLE OF CONTENTS

REVISION HISTORY..... 3

SUMMARY OF TEST RESULT 4

1 GENERAL DESCRIPTION 5

 1.1 Applicant 5

 1.2 Product Feature of Equipment Under Test..... 5

 1.3 Modification of EUT 5

 1.4 Testing Location 6

 1.5 Applicable Standards 6

2 TEST CONFIGURATION OF EQUIPMENT UNDER TEST 7

 2.1 Test Mode 7

 2.2 Connection Diagram of Test System 9

 2.3 Support Unit used in test configuration and system 9

 2.4 Measurement Results Explanation Example 9

 2.5 Frequency List of Low/Middle/High Channels 10

3 CONDUCTED TEST ITEMS 12

 3.1 Measuring Instruments 12

 3.2 Conducted Output Power and ERP/EIRP 13

 3.3 Peak-to-Average Ratio 14

 3.4 Occupied Bandwidth 15

 3.5 Conducted Band Edge 16

 3.6 Conducted Spurious Emission 18

 3.7 Frequency Stability 19

4 RADIATED TEST ITEMS 20

 4.1 Measuring Instruments 20

 4.2 Test Setup 20

 4.3 Test Result of Radiated Test 20

 4.4 Radiated Spurious Emission 21

5 LIST OF MEASURING EQUIPMENT 22

6 UNCERTAINTY OF EVALUATION 24

APPENDIX A. TEST RESULTS OF CONDUCTED TEST

APPENDIX B. TEST RESULTS OF ERP/EIRP AND RADIATED TEST

APPENDIX C. TEST SETUP PHOTOGRAPHS



SUMMARY OF TEST RESULT

| Report Section | FCC Rule | Description | Limit | Result | Remark |
|----------------|--|--|-------------------------------------|--------|--------------------------------------|
| 3.2 | §2.1046 | Conducted Output Power | Reporting Only | PASS | - |
| | §22.913(a)(2) | Effective Radiated Power (Band 5) | ERP < 7 Watt | | |
| | §27.50(b)(10) §27.50(c)(10) | Effective Radiated Power (Band 12) (Band 13) | ERP < 3 Watt | | |
| | §24.232(c) | Equivalent Isotropic Radiated Power (Band 2) | EIRP < 2Watt | | |
| | §27.50(d)(4) | Equivalent Isotropic Radiated Power (Band 4) | EIRP < 1Watt | | |
| 3.5 | §24.232(d) §27.50(d)(5) | Peak-to-Average Ratio | <13 dB | PASS | - |
| 3.6 | §2.1049 | Occupied Bandwidth | Reporting Only | PASS | - |
| 3.7 | §2.1051 §22.917(a) §24.238(a) §27.53(c)(2)(4) §27.53(g) §27.53(h) | Conducted Band Edge Measurement (Band 2) (Band 4) (Band 5) (Band 12) (Band 13) | < 43+10log ₁₀ (P[Watts]) | PASS | - |
| 3.8 | §2.1051 §22.917(a) §24.238(a) §27.53(c)(2) §27.53(g) §27.53(h) | Conducted Spurious Emission (Band 2) (Band 4) (Band 5) (Band 12) (Band 13) | < 43+10log ₁₀ (P[Watts]) | PASS | - |
| 3.9 | §2.1055 §22.355 | Frequency Stability Temperature & Voltage | < 2.5 ppm for Part 22 | PASS | - |
| | §2.1055 §24.235 §27.54 | | Within Authorized Band | | |
| 4.4 | §2.1053 §22.917(a) §24.238(a) §27.53(c)(2) §27.53(f) §27.53(g) §27.53(h) | Radiated Spurious Emission (Band 2) (Band 4) (Band 5) (Band 12) (Band 13) | < 43+10log ₁₀ (P[Watts]) | PASS | Under limit 21.35 dB at 1560.000 MHz |



1 General Description

1.1 Applicant

Cisco Systems, Inc.
170 West Tasman Drive, San Jose, CA 95134

1.2 Product Feature of Equipment Under Test

GSM/WCDMA/LTE

| Product specification subjective to this standard | |
|---|----------------------|
| Antenna Type | WWAN: Dipole Antenna |

1.3 Modification of EUT

No modifications are made to the EUT during all test items.



1.4 Testing Location

Sporton Lab is accredited to ISO 17025 by Taiwan Accreditation Foundation (TAF code : 1190) and the FCC designation No. TW1190 and TW0007 under the FCC 2.948(e) by Mutual Recognition Agreement (MRA) in FCC Test.

| | |
|---------------------------|--|
| Test Site | SPORTON INTERNATIONAL INC. |
| Test Site Location | No. 52, Hwa Ya 1 st Rd., Hwa Ya Technology Park, Kwei-Shan District, Tao Yuan City, Taiwan, R.O.C. TEL: +886-3-327-3456 FAX: +886-3-328-4978 |
| Test Site No. | Sporton Site No. TH05-HY |

Note: The test site complies with ANSI C63.4 2014 requirement.

| | |
|---------------------------|--|
| Test Site | SPORTON INTERNATIONAL INC. |
| Test Site Location | No.58, Aly. 75, Ln. 564, Wenhua 3rd Rd. Guishan Dist, Taoyuan City, Taiwan (R.O.C.) TEL: +886-3-327-0868 FAX: +886-3-327-0855 |
| Test Site No. | Sporton Site No. 03CH13-HY |

Note: The test site complies with ANSI C63.4 2014 requirement.

1.5 Applicable Standards

According to the specifications of the manufacturer, the EUT must comply with the requirements of the following standards:

- ♦ 47 CFR Part 2, 22(H), 24(E), 27
- ♦ ANSI / TIA-603-E
- ♦ FCC KDB 971168 D01 Power Meas. License Digital Systems v03r01
- ♦ FCC KDB 412172 D01 Determining ERP and EIRP v01r01

Remark:

1. All test items were verified and recorded according to the standards and without any deviation during the test.
2. This EUT has also been tested and complied with the requirements of FCC Part 15, Subpart B, Subpart B, recorded in a separate test report.



2 Test Configuration of Equipment Under Test

2.1 Test Mode

Antenna port conducted and radiated test items listed below are performed according to KDB 971168 D01 Power Meas. License Digital Systems v03r01 with maximum output power.

| Test Items | Band | Bandwidth (MHz) | | | | | | Modulation | | | RB # | | | Test Channel | | |
|------------------------|------|-----------------|---|---|----|----|----|------------|-------|-------|------|------|------|--------------|---|---|
| | | 1.4 | 3 | 5 | 10 | 15 | 20 | QPSK | 16QAM | 64QAM | 1 | Half | Full | L | M | H |
| Max. Output Power | 2 | v | v | v | v | v | v | v | v | | v | v | v | v | v | v |
| | 4 | v | v | v | v | v | v | v | v | | v | v | v | v | v | v |
| | 5 | v | v | v | v | - | - | v | v | | v | v | v | v | v | v |
| | 12 | v | v | v | v | - | - | v | v | | v | v | v | v | v | v |
| | 13 | - | - | v | v | - | - | v | v | | v | v | v | v | v | v |
| Peak-to-Average Ratio | 2 | | | | | | v | v | v | | v | | v | v | v | v |
| | 4 | | | | | | v | v | v | | v | | v | v | v | v |
| | 5 | | | | v | - | - | v | v | | v | | v | v | v | v |
| | 12 | | | | v | - | - | v | v | | v | | v | v | v | v |
| | 13 | - | - | | v | - | - | v | v | | v | | v | v | v | v |
| 26dB and 99% Bandwidth | 2 | v | v | v | v | v | v | v | v | | | | v | v | v | v |
| | 4 | v | v | v | v | v | v | v | v | | | | v | v | v | v |
| | 5 | v | v | v | v | - | - | v | v | | | | v | v | v | v |
| | 12 | v | v | v | v | - | - | v | v | | | | v | v | v | v |
| | 13 | - | - | v | v | - | - | v | v | | | | v | v | v | v |
| Conducted Band Edge | 2 | v | v | v | v | v | v | v | v | | v | | v | v | | v |
| | 4 | v | v | v | v | v | v | v | v | | v | | v | v | | v |
| | 5 | v | v | v | v | - | - | v | v | | v | | v | v | | v |
| | 12 | v | v | v | v | - | - | v | v | | v | | v | v | | v |
| | 13 | - | - | v | v | - | - | v | v | | v | | v | v | | v |



| Test Items | Band | Bandwidth (MHz) | | | | | | Modulation | | | RB # | | | Test Channel | | |
|-----------------------------|--|-----------------|---|---|----|----|----|------------|-------|-------|------|------|------|--------------|---|---|
| | | 1.4 | 3 | 5 | 10 | 15 | 20 | QPSK | 16QAM | 64QAM | 1 | Half | Full | L | M | H |
| Conducted Spurious Emission | 2 | v | v | v | v | v | v | v | v | | v | | | v | v | v |
| | 4 | v | v | v | v | v | v | v | v | | v | | | v | v | v |
| | 5 | v | v | v | v | - | - | v | v | | v | | | v | v | v |
| | 12 | v | v | v | v | - | - | v | v | | v | | | v | v | v |
| | 13 | - | - | v | v | - | - | v | v | | v | | | v | v | v |
| Frequency Stability | 2 | | | | v | | | v | | | | | v | | v | |
| | 4 | | | | v | | | v | | | | | v | | v | |
| | 5 | | | | v | - | - | v | | | | | v | | v | |
| | 12 | | | | v | - | - | v | | | | | v | | v | |
| | 13 | - | - | | v | - | - | v | | | | | v | | v | |
| E.R.P / E.I.R.P | 2 | v | v | v | v | v | v | v | v | | v | | | v | v | v |
| | 4 | v | v | v | v | v | v | v | v | | v | | | v | v | v |
| | 5 | v | v | v | v | - | - | v | v | | v | | | v | v | v |
| | 12 | v | v | v | v | - | - | v | v | | v | | | v | v | v |
| | 13 | - | - | v | v | - | - | v | v | | v | | | v | v | v |
| Radiated Spurious Emission | 2 | Worst Case | | | | | | | | | | | v | v | v | |
| | 4 | Worst Case | | | | | | | | | | | v | v | v | |
| | 5 | Worst Case | | | | | | | | | | | v | v | v | |
| | 12 | Worst Case | | | | | | | | | | | v | v | v | |
| | 13 | Worst Case | | | | | | | | | | | v | v | v | |
| Note | 1. The mark "v" means that this configuration is chosen for testing 2. The mark "-" means that this bandwidth is not supported. 3. The device is investigated from 30MHz to 10 times of fundamental signal for radiated spurious emission test under different RB size/offset and modulations in exploratory test. Subsequently, only the worst case emissions are reported. | | | | | | | | | | | | | | | |

2.2 Connection Diagram of Test System

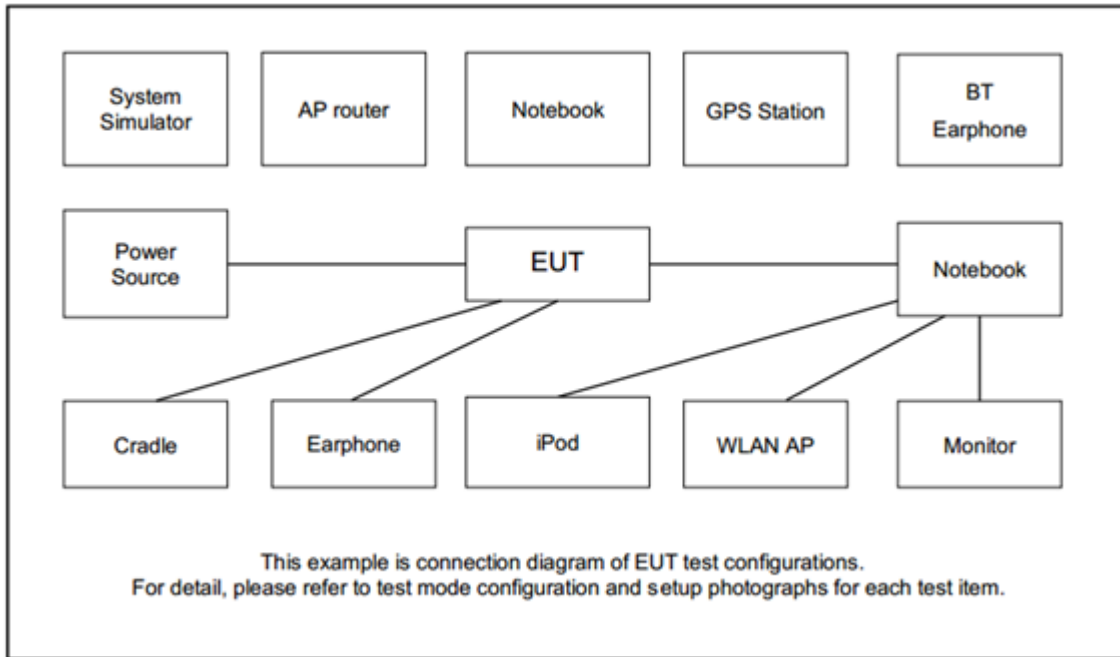

2.3 Support Unit used in test configuration and system

| Item | Equipment | Trade Name | Model No. | FCC ID | Data Cable | Power Cord |
|------|------------------|------------|-----------|--------|------------|-------------------|
| 1. | System Simulator | Anritsu | MT8820C | N/A | N/A | Unshielded, 1.8 m |

2.4 Measurement Results Explanation Example

For all conducted test items:

The offset level is set in the spectrum analyzer to compensate the RF cable loss and attenuator factor between EUT conducted output port and spectrum analyzer. With the offset compensation, the spectrum analyzer reading level is exactly the EUT RF output level.

The spectrum analyzer offset is derived from RF cable loss and attenuator factor.

Offset = RF cable loss + attenuator factor.

Following shows an offset computation example with cable loss 4.2 dB and 10dB attenuator.

Example :

Offset(dB) = RF cable loss(dB) + attenuator factor(dB).

$$= 4.2 + 10 = 14.2 \text{ (dB)}$$



2.5 Frequency List of Low/Middle/High Channels

| LTE Band 2 Channel and Frequency List | | | | |
|---------------------------------------|------------------------|--------|--------|---------|
| BW [MHz] | Channel/Frequency(MHz) | Lowest | Middle | Highest |
| 20 | Channel | 18700 | 18900 | 19100 |
| | Frequency | 1860 | 1880 | 1900 |
| 15 | Channel | 18675 | 18900 | 19125 |
| | Frequency | 1857.5 | 1880 | 1902.5 |
| 10 | Channel | 18650 | 18900 | 19150 |
| | Frequency | 1855 | 1880 | 1905 |
| 5 | Channel | 18625 | 18900 | 19175 |
| | Frequency | 1852.5 | 1880 | 1907.5 |
| 3 | Channel | 18615 | 18900 | 19185 |
| | Frequency | 1851.5 | 1880 | 1908.5 |
| 1.4 | Channel | 18607 | 18900 | 19193 |
| | Frequency | 1850.7 | 1880 | 1909.3 |

| LTE Band 4 Channel and Frequency List | | | | |
|---------------------------------------|------------------------|--------|--------|---------|
| BW [MHz] | Channel/Frequency(MHz) | Lowest | Middle | Highest |
| 20 | Channel | 20050 | 20175 | 20300 |
| | Frequency | 1720 | 1732.5 | 1745 |
| 15 | Channel | 20025 | 20175 | 20325 |
| | Frequency | 1717.5 | 1732.5 | 1747.5 |
| 10 | Channel | 20000 | 20175 | 20350 |
| | Frequency | 1715 | 1732.5 | 1750 |
| 5 | Channel | 19975 | 20175 | 20375 |
| | Frequency | 1712.5 | 1732.5 | 1752.5 |
| 3 | Channel | 19965 | 20175 | 20385 |
| | Frequency | 1711.5 | 1732.5 | 1753.5 |
| 1.4 | Channel | 19957 | 20175 | 20393 |
| | Frequency | 1710.7 | 1732.5 | 1754.3 |



| LTE Band 5 Channel and Frequency List | | | | |
|---------------------------------------|------------------------|--------|--------|---------|
| BW [MHz] | Channel/Frequency(MHz) | Lowest | Middle | Highest |
| 10 | Channel | 20450 | 20525 | 20600 |
| | Frequency | 829 | 836.5 | 844 |
| 5 | Channel | 20425 | 20525 | 20625 |
| | Frequency | 826.5 | 836.5 | 846.5 |
| 3 | Channel | 20415 | 20525 | 20635 |
| | Frequency | 825.5 | 836.5 | 847.5 |
| 1.4 | Channel | 20407 | 20525 | 20643 |
| | Frequency | 824.7 | 836.5 | 848.3 |

| LTE Band 12 Channel and Frequency List | | | | |
|--|------------------------|--------|--------|---------|
| BW [MHz] | Channel/Frequency(MHz) | Lowest | Middle | Highest |
| 10 | Channel | 23060 | 23095 | 23130 |
| | Frequency | 704 | 707.5 | 711 |
| 5 | Channel | 23035 | 23095 | 23155 |
| | Frequency | 701.5 | 707.5 | 713.5 |
| 3 | Channel | 23025 | 23095 | 23165 |
| | Frequency | 700.5 | 707.5 | 714.5 |
| 1.4 | Channel | 23017 | 23095 | 23173 |
| | Frequency | 699.7 | 707.5 | 715.3 |

| LTE Band 13 Channel and Frequency List | | | | |
|--|------------------------|--------|--------|---------|
| BW [MHz] | Channel/Frequency(MHz) | Lowest | Middle | Highest |
| 10 | Channel | - | 23230 | - |
| | Frequency | - | 782 | - |
| 5 | Channel | 23205 | 23230 | 23255 |
| | Frequency | 779.5 | 782 | 784.5 |

3 Conducted Test Items

3.1 Measuring Instruments

See list of measuring instruments of this test report.

3.1.1 Test Setup

3.1.2 Conducted Output Power

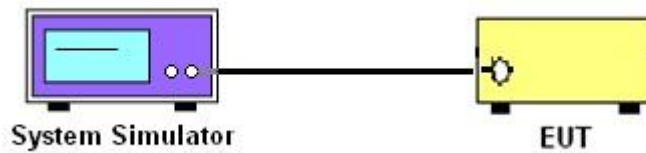

3.1.3 Peak-to-Average Ratio, Occupied Bandwidth ,Conducted Band-Edge and Conducted Spurious Emission

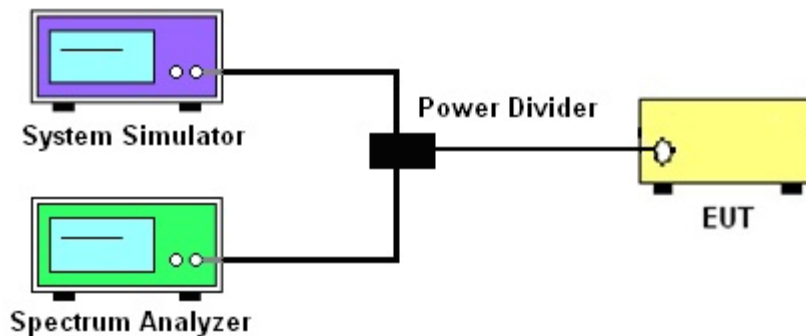

3.1.4 Frequency Stability

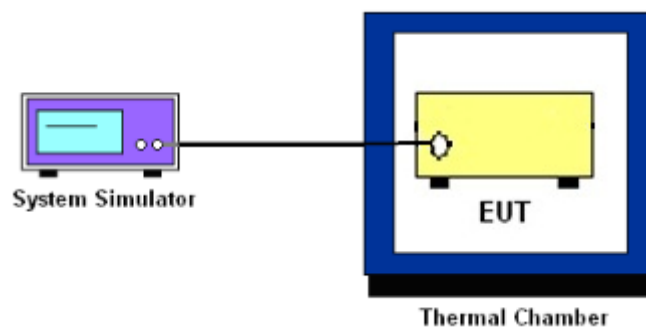

3.1.5 Test Result of Conducted Test

Please refer to Appendix A.



3.2 Conducted Output Power and ERP/EIRP

3.2.1 Description of the Conducted Output Power Measurement and ERP/EIRP Measurement

A system simulator was used to establish communication with the EUT. Its parameters were set to force the EUT transmitting at maximum output power. The measured power in the radio frequency on the transmitter output terminals shall be reported.

The ERP of mobile transmitters must not exceed 7 Watts for LTE Band 5.

The ERP of mobile transmitters must not exceed 3 Watts for LTE Band 12, Band 13.

The EIRP of mobile transmitters must not exceed 2 Watts for LTE Band 2.

The EIRP of mobile transmitters must not exceed 1 Watts for LTE Band 4.

According to KDB 412172 D01 Power Approach,

$EIRP = P_T + G_T - L_C$, $ERP = EIRP - 2.15$, where

P_T = transmitter output power in dBm

G_T = gain of the transmitting antenna in dBi

L_C = signal attenuation in the connecting cable between the transmitter and antenna in dB

3.2.2 Test Procedures

1. The transmitter output port was connected to the system simulator.
2. Set EUT at maximum power through the system simulator.
3. Select lowest, middle, and highest channels for each band and different modulation.
4. Measure and record the power level from the system simulator.



3.3 Peak-to-Average Ratio

3.3.1 Description of the PAR Measurement

Power Complementary Cumulative Distribution Function (CCDF) curves provide a means for characterizing the power peaks of a digitally modulated signal on a statistical basis. A CCDF curve depicts the probability of the peak signal amplitude exceeding the average power level. Most contemporary measurement instrumentation include the capability to produce CCDF curves for an input signal provided that the instrument's resolution bandwidth can be set wide enough to accommodate the entire input signal bandwidth. In measuring transmissions in this band using an average power technique, the peak-to-average ratio (PAR) of the transmission may not exceed 13 dB.

3.3.2 Test Procedures

The testing follows FCC KDB 971168 v03r01 Section 5.7.1

1. The EUT was connected to spectrum and system simulator via a power divider.
2. Set the CCDF (Complementary Cumulative Distribution Function) option in spectrum analyzer.
3. The highest RF powers were measured and recorded the maximum PAPR level associated with a probability of 0.1 %.
4. Record the deviation as Peak to Average Ratio.



3.4 Occupied Bandwidth

3.4.1 Description of Occupied Bandwidth Measurement

The occupied bandwidth is the width of a frequency band such that, below the lower and above the upper frequency limits, the mean powers emitted are each equal to a specified percentage 0.5% of the total mean transmitted power.

The 26 dB emission bandwidth is defined as the frequency range between two points, one above and one below the carrier frequency, at which the spectral density of the emission is attenuated 26 dB below the maximum in-band spectral density of the modulated signal. Spectral density (power per unit bandwidth) is to be measured with a detector of resolution bandwidth equal to approximately 1.0% of the emission bandwidth.

3.4.2 Test Procedures

The testing follows FCC KDB 971168 v03r01 Section 4.2

1. The EUT was connected to spectrum analyzer and system simulator via a power divider.
2. The spectrum analyzer center frequency is set to the nominal EUT channel center frequency. The span range for the spectrum analyzer shall be between two and five times the anticipated OBW.
3. The nominal resolution bandwidth (RBW) shall be in the range of 1 to 5 % of the anticipated OBW, and the VBW shall be at least 3 times the RBW.
4. Set the detection mode to peak, and the trace mode to max hold.
5. Determine the reference value: Set the EUT to transmit a modulated signal. Allow the trace to stabilize. Set the spectrum analyzer marker to the highest level of the displayed trace.
(this is the reference value)
6. Determine the “-26 dB down amplitude” as equal to (Reference Value – X).
7. Place two markers, one at the lowest and the other at the highest frequency of the envelope of the spectral display such that each marker is at or slightly below the “-X dB down amplitude” determined in step 6. If a marker is below this “-X dB down amplitude” value it shall be placed as close as possible to this value. The OBW is the positive frequency difference between the two markers.
8. Use the 99 % power bandwidth function of the spectrum analyzer and report the measured bandwidth.



3.5 Conducted Band Edge

3.5.1 Description of Conducted Band Edge Measurement

22.917(a)

For operations in the 824 – 849 MHz band, the FCC limit is $43 + 10\log_{10}(P[\text{Watts}])$ dB below the transmitter power $P(\text{Watts})$ in a 100kHz bandwidth. However, in the 1MHz bands immediately outside and adjacent to the licensee's frequency block, a resolution bandwidth of at least one percent of the emission bandwidth of the fundamental emission of the transmitter may be employed.

24.238 (a)

For operations in the 1850-1910 and 1930-1990 MHz band, the FCC limit is $43 + 10\log_{10}(P[\text{Watts}])$ dB below the transmitter power $P(\text{Watts})$ in a 1MHz bandwidth. However, in the 1 MHz bands immediately outside and adjacent to the frequency block a resolution bandwidth of at least one percent of the emission bandwidth of the fundamental emission of the transmitter may be employed.

27.53 (c)

For operations in the 776-788 MHz band, the FCC limit is $43 + 10\log_{10}(P[\text{Watts}])$ dB below the transmitter power $P(\text{Watts})$ in a 100 kHz bandwidth. However, in the 100 kHz bands immediately outside and adjacent to the frequency block, a resolution bandwidth of at least 30 kHz may be employed. In addition, the power of any unwanted emissions in any 6.25 kHz bandwidth for all frequencies between 763-775 MHz and 793-806 MHz shall be attenuated below the transmitter power, P (dBW), by at least $65 + 10 \log_{10} p(\text{watts})$, dB, for mobile and portable equipment.

27.53 (g)

For operations in the 698 -746 MHz band, the FCC limit is $43 + 10\log_{10}(P[\text{Watts}])$ dB below the transmitter power $P(\text{Watts})$ in a 100 kHz bandwidth. However, in the 100 kilohertz bands immediately outside and adjacent to a licensee's frequency block, a resolution bandwidth of at least 30 kHz may be employed.

27.53 (h)

For operations in the 1710 – 1755 MHz band, the FCC limit is $43 + 10\log_{10}(P[\text{Watts}])$ dB below the transmitter power $P(\text{Watts})$ in a 1 MHz bandwidth. However, in the 1MHz bands immediately outside and adjacent to the licensee's frequency block, a resolution bandwidth of at least one percent of the emission bandwidth of the fundamental emission of the transmitter may be employed.



3.5.2 Test Procedures

The testing follows FCC KDB 971168 v03r01 Section 6.0.

1. The EUT was connected to spectrum analyzer and system simulator via a power divider.
2. The band edges of low and high channels for the highest RF powers were measured.
3. Set RBW \geq 1% EBW in the 1MHz band immediately outside and adjacent to the band edge.
4. Beyond the 1 MHz band from the band edge, RBW=1MHz was used.
5. Set spectrum analyzer with RMS detector.
6. The RF fundamental frequency should be excluded against the limit line in the operating frequency band.
7. Checked that all the results comply with the emission limit line.

The limit line is derived from $43 + 10\log(P)$ dB below the transmitter power P(Watts)



3.6 Conducted Spurious Emission

3.6.1 Description of Conducted Spurious Emission Measurement

The power of any emission outside of the authorized operating frequency ranges must be lower than the transmitter power (P) by a factor of at least $43 + 10 \log (P)$ dB.

It is measured by means of a calibrated spectrum analyzer and scanned from 30 MHz up to a frequency including its 10th harmonic.

3.6.2 Test Procedures

The testing follows FCC KDB 971168 v03r01 Section 6.0.

1. The EUT was connected to spectrum analyzer and system simulator via a power divider.
2. The RF output of EUT was connected to the spectrum analyzer by RF cable and attenuator.
The path loss was compensated to the results for each measurement.
3. The middle channel for the highest RF power within the transmitting frequency was measured.
4. The conducted spurious emission for the whole frequency range was taken.
5. Make the measurement with the spectrum analyzer's RBW = 1MHz, VBW = 3MHz.
6. Set spectrum analyzer with RMS detector.
7. Taking the record of maximum spurious emission.
8. The RF fundamental frequency should be excluded against the limit line in the operating frequency band.
9. The limit line is derived from $43 + 10\log(P)$ dB below the transmitter power P(Watts)



3.7 Frequency Stability

3.7.1 Description of Frequency Stability Measurement

The frequency stability shall be measured by variation of ambient temperature and variation of primary supply voltage to ensure that the fundamental emission stays within the authorized frequency block. The frequency stability of the transmitter shall be maintained within $\pm 0.00025\%$ ($\pm 2.5\text{ppm}$) of the center frequency.

3.7.2 Test Procedures for Temperature Variation

The testing follows FCC KDB 971168 v03r01 Section 9.0.

1. The EUT was set up in the thermal chamber and connected with the system simulator.
2. With power OFF, the temperature was decreased to -30°C and the EUT was stabilized before testing. Power was applied and the maximum change in frequency was recorded within one minute.
3. With power OFF, the temperature was raised in 10°C step up to 50°C . The EUT was stabilized at each step for at least half an hour. Power was applied and the maximum frequency change was recorded within one minute.

3.7.3 Test Procedures for Voltage Variation

The testing follows FCC KDB 971168 v03r01 Section 9.0.

1. The EUT was placed in a temperature chamber at $20\pm 5^{\circ}\text{C}$ and connected with the system simulator.
2. The power supply voltage to the EUT was varied from 85% to 115% of the nominal value measured at the input to the EUT.
3. The variation in frequency was measured for the worst case.

4 Radiated Test Items

4.1 Measuring Instruments

See list of measuring instruments of this test report.

4.2 Test Setup

4.2.1 For radiated test from 30MHz to 1GHz

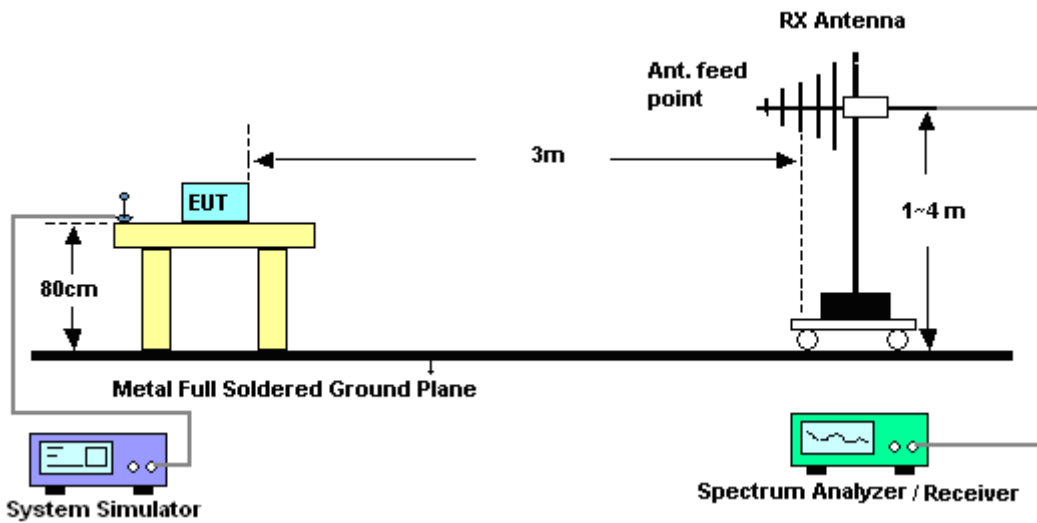

4.2.2 For radiated test above 1GHz

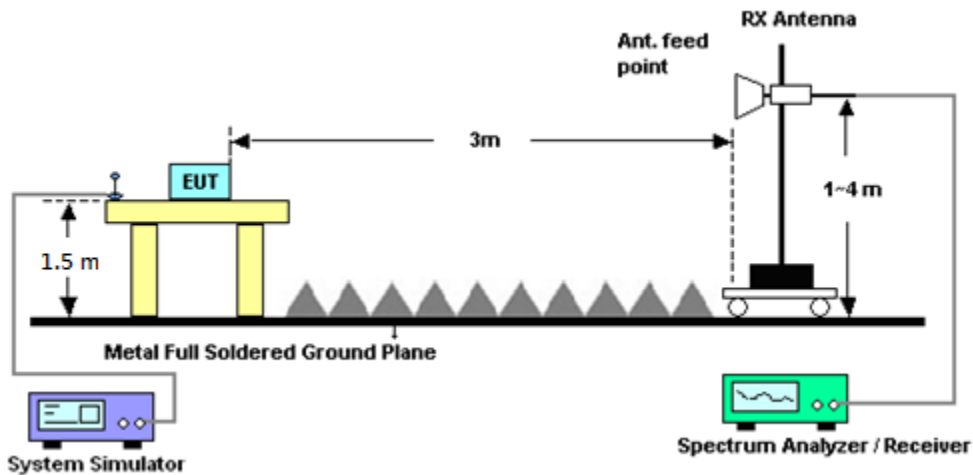

4.3 Test Result of Radiated Test

Please refer to Appendix B.



4.4 Radiated Spurious Emission

4.4.1 Description of Radiated Spurious Emission

The radiated spurious emission was measured by substitution method according to ANSI / TIA-603-E. The power of any emission outside of the authorized operating frequency ranges must be attenuated below the transmitter power (P) by a factor of at least $43 + 10 \log (P)$ dB.

For LTE Band 12,13

For operations in the 746-758 MHz, 775-788 MHz, and 805-806 MHz bands, emissions in the band 1559-1610 MHz shall be limited to -70 dBW/MHz equivalent isotropically radiated power (EIRP) for wideband signals, and -80 dBW EIRP for discrete emissions of less than 700 Hz bandwidth.

The spectrum is scanned from 30 MHz up to a frequency including its 10th harmonic.

4.4.2 Test Procedures

The testing follows FCC KDB 971168 v03r01 Section 5.8 and ANSI / TIA-603-E Section 2.2.12.

1. The EUT was placed on a turntable with 0.8 meter for frequency below 1GHz and 1.5 meter for frequency above 1GHz respectively above ground.
2. The EUT was set 3 meters from the receiving antenna, which was mounted on the antenna tower.
3. The table was rotated 360 degrees to determine the position of the highest spurious emission.
4. The height of the receiving antenna is varied between one meter and four meters to search the maximum spurious emission for both horizontal and vertical polarizations.
5. Make the measurement with the spectrum analyzer's RBW = 1MHz, VBW = 3MHz, taking the record of maximum spurious emission.
6. A horn antenna was substituted in place of the EUT and was driven by a signal generator.
7. Tune the output power of signal generator to the same emission level with EUT maximum spurious emission.
8. Taking the record of output power at antenna port.
9. Repeat step 7 to step 8 for another polarization.
10. The RF fundamental frequency should be excluded against the limit line in the operating frequency band.

The limit line is derived from $43 + 10\log(P)$ dB below the transmitter power P(Watts)



5 List of Measuring Equipment

| Instrument | Manufacturer | Model No. | Serial No. | Characteristics | Calibration Date | Test Date | Due Date | Remark |
|---------------------------|-------------------|---|----------------|-------------------------------------|------------------|----------------------------------|---------------|--------------------------|
| LTE Base Station | Anritsu | MT8820C | 620143282 1 | GSM/GPRS /WCDMA/LTE | Oct. 13, 2017 | Apr. 23, 2018 ~ Apr. 25, 2018 | Oct. 12, 2018 | Conducted (TH05-HY) |
| Spectrum Analyzer | Rohde & Schwarz | FSV40 | 101397 | 10Hz~40GHz | Nov. 07, 2017 | Apr. 23, 2018 ~ Apr. 25, 2018 | Nov. 06, 2018 | Conducted (TH05-HY) |
| Temperature Chamber | ESPEC | SH-641 | 92013720 | -30°C~70°C | Aug. 28, 2017 | Apr. 23, 2018 ~ Apr. 25, 2018 | Aug. 27, 2018 | Conducted (TH05-HY) |
| Programmable Power Supply | GW Instek | PSS-2005 | EL890001 | 1V~20V 0.5A~5A | Oct. 06, 2017 | Apr. 23, 2018 ~ Apr. 25, 2018 | Oct. 05, 2018 | Conducted (TH05-HY) |
| Coupler | Warison | 1-18GHz 20dB 25WSMA Directional Coupler | #B | 1G~18GHz | Dec. 04, 2017 | Apr. 23, 2018 ~ Apr. 25, 2018 | Dec. 03, 2018 | Conducted (TH05-HY) |
| Amplifier | MITEQ | TTA1840-35-HG | 1871923 | 18GHz~40GHz, VSWR : 2.5:1 max | Jul. 18, 2017 | Apr. 26, 2018 ~ Apr. 27, 2018 | Jul. 17, 2018 | Radiation (03CH13-HY) |
| Bilog Antenna | TESEQ | CBL 6111D&N-6-06 | 35414&AT-N0602 | 30MHz~1GHz | Oct. 14, 2017 | Apr. 26, 2018 ~ Apr. 27, 2018 | Oct. 13, 2018 | Radiation (03CH13-HY) |
| Amplifier | Sonoma-Instrument | 310 N | 187282 | 9KHz~1GHz | Dec. 21, 2016 | Apr. 26, 2018 ~ Apr. 27, 2018 | Dec. 20, 2018 | Radiation (03CH13-HY) |
| Horn Antenna | SCHWARZBECK | BBHA 9120 D | 9120D-1241 | 1GHz ~ 18GHz | Jun. 15, 2017 | Apr. 26, 2018 ~ Apr. 27, 2018 | Jun. 14, 2018 | Radiation (03CH13-HY) |
| Preamplifier | MITEQ | AMF-7D-0010 1800-30-10P | 1590074 | 1GHz~18GHz | May 22, 2017 | Apr. 26, 2018 ~ Apr. 27, 2018 | May 21, 2018 | Radiation (03CH13-HY) |
| Spectrum Analyzer | Keysight | N9010A | MY55370526 | 10Hz~44GHz | Mar. 15, 2018 | Apr. 26, 2018 ~ Apr. 27, 2018 | Mar. 14, 2019 | Radiation (03CH13-HY) |
| Antenna Mast | EMEC | AM-BS-4500-B | N/A | 1m~4m | N/A | Apr. 26, 2018 ~ Apr. 27, 2018 | N/A | Radiation (03CH13-HY) |
| Turn Table | EMEC | TT2000 | N/A | 0~360 Degree | N/A | Apr. 26, 2018 ~ Apr. 27, 2018 | N/A | Radiation (03CH13-HY) |
| SHF-EHF Horn Antenna | SCHWARZBECK | BBHA 9170 | BBHA9170251 | 18GHz- 40GHz | Nov. 10, 2017 | Apr. 26, 2018 ~ Apr. 27, 2018 | Nov. 09, 2018 | Radiation (03CH13-HY) |
| SHF-EHF Horn Antenna | SCHWARZBECK | BBHA 9170 | BBHA9170584 | 18GHz- 40GHz | Nov. 27, 2017 | Apr. 26, 2018 ~ Apr. 27, 2018 | Nov. 26, 2018 | Radiation (03CH13-HY) |
| RF Cable | HUBER + SUHNER | SUCOFLEX 126E | 0030/126E | 30M-18G | Jan. 22, 2018 | Apr. 26, 2018 ~ Apr. 27, 2018 | Jan. 21, 2019 | Radiation (03CH13-HY) |
| RF Cable | HUBER + SUHNER | SUCOFLEX 104 | 335041/4 | 30M-18G | Jan. 22, 2018 | Apr. 26, 2018 ~ Apr. 27, 2018 | Jan. 21, 2019 | Radiation (03CH13-HY) |
| RF Cable | HUBER + SUHNER | SUCOFLEX 104 | MY24961/4 | 30M~18GHz | Jan. 22, 2018 | Apr. 26, 2018 ~ Apr. 27, 2018 | Jan. 21, 2019 | Radiation (03CH13-HY) |
| Software | AUDIX | E3 6.2009-8-24c | RK-001124 | N/A | N/A | Apr. 26, 2018 ~ Apr. 27, 2018 | N/A | Radiation (03CH13-HY) |



| Instrument | Manufacturer | Model No. | Serial No. | Characteristics | Calibration Date | Test Date | Due Date | Remark |
|------------------|--------------------|-------------------------------------|----------------|-------------------------|------------------|----------------------------------|---------------|--------------------------|
| Filter | Wainwright | WHKX12-270 0-3000-18000 -60SS | SN2 | 3G High Pass | Sep. 18, 2017 | Apr. 26, 2018 ~ Apr. 27, 2018 | Sep. 17, 2018 | Radiation (03CH13-HY) |
| Filter | Wainwright | WLK4-1000-1 530-8000-40S S | SN12 | 1GHz Low Pass Filter | Sep. 18, 2017 | Apr. 26, 2018 ~ Apr. 27, 2018 | Sep. 17, 2018 | Radiation (03CH13-HY) |
| Horn Antenna | SCHWARZBE CK | BBHA 9120 D | 9120D-132 6 | 1G~18GHz | Oct. 16, 2017 | Apr. 26, 2018 ~ Apr. 27, 2018 | Oct. 15, 2018 | Radiation (03CH13-HY) |
| Signal Generator | Rohde & Schwarz | SMF100A | 101107 | 100kHz~40GHz | May 22, 2017 | Apr. 26, 2018 ~ Apr. 27, 2018 | May 21, 2018 | Radiation (03CH13-HY) |
| Preamplifier | Keysight | 83017A | MY532702 64 | 1GHz ~ 26.5GHz | Dec. 05, 2017 | Apr. 26, 2018 ~ Apr. 27, 2018 | Dec. 04, 2018 | Radiation (03CH13-HY) |



6 Uncertainty of Evaluation

Uncertainty of Radiated Emission Measurement (30 MHz ~ 1000 MHz)

| | |
|---|------|
| Measuring Uncertainty for a Level of Confidence of 95% ($U = 2Uc(y)$) | 3.07 |
|---|------|

Uncertainty of Radiated Emission Measurement (1 GHz ~ 18 GHz)

| | |
|---|------|
| Measuring Uncertainty for a Level of Confidence of 95% ($U = 2Uc(y)$) | 3.48 |
|---|------|

Uncertainty of Radiated Emission Measurement (18 GHz ~ 40 GHz)

| | |
|---|------|
| Measuring Uncertainty for a Level of Confidence of 95% ($U = 2Uc(y)$) | 3.92 |
|---|------|



Appendix A. Test Results of Conducted Test

Conducted Output Power(Average power)

| LTE Band 2 Maximum Average Power [dBm] | | | | | | |
|--|---------|-----------|--------|--------|--------|---------|
| BW [MHz] | RB Size | RB Offset | Mod | Lowest | Middle | Highest |
| 20 | 1 | 0 | QPSK | 24.19 | 24.18 | 24.47 |
| 20 | 1 | 49 | | 23.24 | 23.16 | 23.37 |
| 20 | 1 | 99 | | 23.50 | 23.58 | 23.34 |
| 20 | 50 | 0 | | 22.66 | 22.59 | 22.76 |
| 20 | 50 | 24 | | 22.37 | 22.31 | 22.52 |
| 20 | 50 | 50 | | 22.32 | 22.23 | 22.61 |
| 20 | 100 | 0 | | 22.43 | 22.47 | 22.70 |
| 20 | 1 | 0 | 16-QAM | 23.49 | 23.46 | 23.50 |
| 20 | 1 | 49 | | 22.55 | 22.41 | 22.63 |
| 20 | 1 | 99 | | 22.77 | 22.87 | 22.64 |
| 20 | 50 | 0 | | 21.58 | 21.51 | 21.73 |
| 20 | 50 | 24 | | 21.34 | 21.20 | 21.44 |
| 20 | 50 | 50 | | 21.29 | 21.22 | 21.55 |
| 20 | 100 | 0 | | 21.41 | 21.49 | 21.70 |
| 15 | 1 | 0 | QPSK | 23.92 | 23.82 | 23.82 |
| 15 | 1 | 37 | | 23.21 | 22.95 | 23.21 |
| 15 | 1 | 74 | | 23.28 | 23.30 | 22.99 |
| 15 | 36 | 0 | | 22.42 | 22.34 | 22.45 |
| 15 | 36 | 20 | | 22.23 | 22.19 | 22.29 |
| 15 | 36 | 39 | | 22.17 | 22.18 | 22.30 |
| 15 | 75 | 0 | | 22.25 | 22.23 | 22.32 |
| 15 | 1 | 0 | 16-QAM | 23.08 | 23.10 | 23.06 |
| 15 | 1 | 37 | | 22.41 | 22.31 | 22.46 |
| 15 | 1 | 74 | | 22.55 | 22.52 | 22.25 |
| 15 | 36 | 0 | | 21.37 | 21.30 | 21.45 |
| 15 | 36 | 20 | | 21.21 | 21.14 | 21.29 |
| 15 | 36 | 39 | | 21.16 | 21.15 | 21.25 |
| 15 | 75 | 0 | | 21.27 | 21.25 | 21.41 |



| LTE Band 2 Maximum Average Power [dBm] | | | | | | |
|--|---------|-----------|--------|--------|--------|---------|
| BW [MHz] | RB Size | RB Offset | Mod | Lowest | Middle | Highest |
| 10 | 1 | 0 | QPSK | 23.43 | 23.44 | 23.67 |
| 10 | 1 | 25 | | 23.10 | 23.28 | 23.75 |
| 10 | 1 | 49 | | 22.98 | 23.15 | 23.09 |
| 10 | 25 | 0 | | 22.15 | 22.29 | 22.43 |
| 10 | 25 | 12 | | 21.96 | 22.14 | 22.47 |
| 10 | 25 | 25 | | 21.92 | 22.07 | 22.44 |
| 10 | 50 | 0 | | 22.01 | 22.17 | 22.48 |
| 10 | 1 | 0 | 16-QAM | 22.62 | 22.76 | 22.96 |
| 10 | 1 | 25 | | 22.24 | 22.45 | 22.69 |
| 10 | 1 | 49 | | 22.26 | 22.47 | 22.33 |
| 10 | 25 | 0 | | 21.12 | 21.28 | 21.44 |
| 10 | 25 | 12 | | 20.96 | 21.09 | 21.44 |
| 10 | 25 | 25 | | 20.90 | 21.02 | 21.40 |
| 10 | 50 | 0 | | 20.95 | 21.10 | 21.44 |
| 5 | 1 | 0 | QPSK | 23.16 | 23.29 | 23.54 |
| 5 | 1 | 12 | | 22.99 | 23.15 | 23.06 |
| 5 | 1 | 24 | | 22.98 | 23.04 | 23.08 |
| 5 | 12 | 0 | | 22.01 | 22.12 | 22.39 |
| 5 | 12 | 7 | | 22.02 | 22.12 | 21.97 |
| 5 | 12 | 13 | | 21.92 | 22.02 | 21.88 |
| 5 | 25 | 0 | | 21.98 | 22.07 | 22.53 |
| 5 | 1 | 0 | 16-QAM | 22.39 | 22.56 | 22.84 |
| 5 | 1 | 12 | | 22.42 | 22.53 | 22.40 |
| 5 | 1 | 24 | | 22.28 | 22.42 | 22.37 |
| 5 | 12 | 0 | | 20.96 | 21.07 | 21.48 |
| 5 | 12 | 7 | | 20.98 | 21.10 | 21.00 |
| 5 | 12 | 13 | | 20.89 | 21.05 | 21.00 |
| 5 | 25 | 0 | | 21.00 | 21.04 | 21.47 |



| LTE Band 2 Maximum Average Power [dBm] | | | | | | |
|--|---------|-----------|--------|--------|--------|---------|
| BW [MHz] | RB Size | RB Offset | Mod | Lowest | Middle | Highest |
| 3 | 1 | 0 | QPSK | 23.10 | 23.14 | 22.96 |
| 3 | 1 | 8 | | 23.06 | 23.12 | 22.96 |
| 3 | 1 | 14 | | 23.10 | 23.05 | 22.98 |
| 3 | 8 | 0 | | 22.03 | 22.07 | 21.93 |
| 3 | 8 | 4 | | 22.04 | 22.12 | 22.00 |
| 3 | 8 | 7 | | 22.01 | 21.99 | 21.96 |
| 3 | 15 | 0 | | 22.02 | 22.07 | 21.92 |
| 3 | 1 | 0 | 16-QAM | 22.33 | 22.36 | 22.17 |
| 3 | 1 | 8 | | 22.36 | 22.40 | 22.27 |
| 3 | 1 | 14 | | 22.27 | 22.32 | 22.25 |
| 3 | 8 | 0 | | 20.98 | 21.12 | 20.99 |
| 3 | 8 | 4 | | 21.01 | 21.12 | 21.01 |
| 3 | 8 | 7 | | 20.99 | 21.04 | 21.03 |
| 3 | 15 | 0 | | 20.90 | 21.07 | 20.94 |
| 1.4 | 1 | 0 | QPSK | 22.89 | 22.96 | 22.78 |
| 1.4 | 1 | 3 | | 22.88 | 22.96 | 22.78 |
| 1.4 | 1 | 5 | | 22.87 | 22.89 | 22.74 |
| 1.4 | 3 | 0 | | 22.79 | 22.84 | 22.77 |
| 1.4 | 3 | 1 | | 22.89 | 22.94 | 22.79 |
| 1.4 | 3 | 3 | | 22.82 | 22.81 | 22.80 |
| 1.4 | 6 | 0 | | 21.75 | 21.82 | 21.68 |
| 1.4 | 1 | 0 | 16-QAM | 22.15 | 22.23 | 22.09 |
| 1.4 | 1 | 3 | | 22.23 | 22.26 | 22.10 |
| 1.4 | 1 | 5 | | 22.13 | 22.14 | 22.10 |
| 1.4 | 3 | 0 | | 21.88 | 21.92 | 21.82 |
| 1.4 | 3 | 1 | | 21.88 | 21.94 | 21.79 |
| 1.4 | 3 | 3 | | 21.85 | 21.91 | 21.81 |
| 1.4 | 6 | 0 | | 20.84 | 20.90 | 20.78 |



| LTE Band 4 Maximum Average Power [dBm] | | | | | | |
|--|---------|-----------|--------|--------|--------|---------|
| BW [MHz] | RB Size | RB Offset | Mod | Lowest | Middle | Highest |
| 20 | 1 | 0 | QPSK | 24.32 | 24.50 | 24.44 |
| 20 | 1 | 49 | | 23.37 | 23.46 | 23.31 |
| 20 | 1 | 99 | | 23.67 | 23.82 | 23.70 |
| 20 | 50 | 0 | | 22.74 | 22.86 | 22.84 |
| 20 | 50 | 24 | | 22.38 | 22.60 | 22.53 |
| 20 | 50 | 50 | | 22.36 | 22.53 | 22.44 |
| 20 | 100 | 0 | | 22.58 | 22.69 | 22.64 |
| 20 | 1 | 0 | 16-QAM | 23.50 | 23.46 | 23.44 |
| 20 | 1 | 49 | | 22.63 | 22.74 | 22.61 |
| 20 | 1 | 99 | | 22.94 | 23.04 | 22.92 |
| 20 | 50 | 0 | | 21.69 | 21.76 | 21.72 |
| 20 | 50 | 24 | | 21.37 | 21.51 | 21.47 |
| 20 | 50 | 50 | | 21.36 | 21.44 | 21.48 |
| 20 | 100 | 0 | | 21.56 | 21.72 | 21.57 |
| 15 | 1 | 0 | QPSK | 24.06 | 24.25 | 24.11 |
| 15 | 1 | 37 | | 23.42 | 23.48 | 23.22 |
| 15 | 1 | 74 | | 23.60 | 23.62 | 23.52 |
| 15 | 36 | 0 | | 22.59 | 22.71 | 22.58 |
| 15 | 36 | 20 | | 22.40 | 22.53 | 22.49 |
| 15 | 36 | 39 | | 22.39 | 22.52 | 22.38 |
| 15 | 75 | 0 | | 22.43 | 22.52 | 22.50 |
| 15 | 1 | 0 | 16-QAM | 23.26 | 23.45 | 23.28 |
| 15 | 1 | 37 | | 22.61 | 22.72 | 22.65 |
| 15 | 1 | 74 | | 22.77 | 22.81 | 22.78 |
| 15 | 36 | 0 | | 21.51 | 21.71 | 21.59 |
| 15 | 36 | 20 | | 21.39 | 21.54 | 21.42 |
| 15 | 36 | 39 | | 21.37 | 21.45 | 21.36 |
| 15 | 75 | 0 | | 21.45 | 21.57 | 21.50 |



| LTE Band 4 Maximum Average Power [dBm] | | | | | | |
|--|---------|-----------|--------|--------|--------|---------|
| BW [MHz] | RB Size | RB Offset | Mod | Lowest | Middle | Highest |
| 10 | 1 | 0 | QPSK | 23.46 | 23.62 | 23.66 |
| 10 | 1 | 25 | | 23.28 | 23.24 | 23.28 |
| 10 | 1 | 49 | | 23.17 | 23.18 | 23.23 |
| 10 | 25 | 0 | | 22.23 | 22.35 | 22.43 |
| 10 | 25 | 12 | | 22.20 | 22.22 | 22.27 |
| 10 | 25 | 25 | | 22.10 | 22.12 | 22.24 |
| 10 | 50 | 0 | | 22.20 | 22.21 | 22.30 |
| 10 | 1 | 0 | 16-QAM | 22.78 | 22.93 | 22.97 |
| 10 | 1 | 25 | | 22.45 | 22.42 | 22.49 |
| 10 | 1 | 49 | | 22.52 | 22.55 | 22.59 |
| 10 | 25 | 0 | | 21.24 | 21.38 | 21.38 |
| 10 | 25 | 12 | | 21.17 | 21.27 | 21.25 |
| 10 | 25 | 25 | | 21.10 | 21.06 | 21.24 |
| 10 | 50 | 0 | | 21.18 | 21.19 | 21.24 |
| 5 | 1 | 0 | QPSK | 23.23 | 23.36 | 23.40 |
| 5 | 1 | 12 | | 23.08 | 23.16 | 23.27 |
| 5 | 1 | 24 | | 23.04 | 23.09 | 23.23 |
| 5 | 12 | 0 | | 22.17 | 22.16 | 22.31 |
| 5 | 12 | 7 | | 22.14 | 22.14 | 22.25 |
| 5 | 12 | 13 | | 22.05 | 22.12 | 22.21 |
| 5 | 25 | 0 | | 22.14 | 22.09 | 22.23 |
| 5 | 1 | 0 | 16-QAM | 22.53 | 22.64 | 22.67 |
| 5 | 1 | 12 | | 22.51 | 22.55 | 22.72 |
| 5 | 1 | 24 | | 22.36 | 22.40 | 22.53 |
| 5 | 12 | 0 | | 21.12 | 21.17 | 21.32 |
| 5 | 12 | 7 | | 21.11 | 21.14 | 21.22 |
| 5 | 12 | 13 | | 21.04 | 21.15 | 21.25 |
| 5 | 25 | 0 | | 21.10 | 21.11 | 21.23 |



| LTE Band 4 Maximum Average Power [dBm] | | | | | | |
|--|---------|-----------|--------|--------|--------|---------|
| BW [MHz] | RB Size | RB Offset | Mod | Lowest | Middle | Highest |
| 3 | 1 | 0 | QPSK | 23.16 | 23.30 | 23.33 |
| 3 | 1 | 8 | | 23.09 | 23.13 | 23.30 |
| 3 | 1 | 14 | | 23.04 | 23.09 | 23.23 |
| 3 | 8 | 0 | | 22.13 | 22.23 | 22.26 |
| 3 | 8 | 4 | | 22.12 | 22.13 | 22.31 |
| 3 | 8 | 7 | | 22.02 | 22.07 | 22.20 |
| 3 | 15 | 0 | | 22.10 | 22.09 | 22.29 |
| 3 | 1 | 0 | 16-QAM | 22.39 | 22.50 | 22.57 |
| 3 | 1 | 8 | | 22.39 | 22.42 | 22.57 |
| 3 | 1 | 14 | | 22.31 | 22.31 | 22.47 |
| 3 | 8 | 0 | | 21.21 | 21.31 | 21.34 |
| 3 | 8 | 4 | | 21.12 | 21.19 | 21.34 |
| 3 | 8 | 7 | | 21.07 | 21.14 | 21.25 |
| 3 | 15 | 0 | | 21.11 | 21.13 | 21.31 |
| 1.4 | 1 | 0 | QPSK | 23.22 | 23.23 | 23.43 |
| 1.4 | 1 | 3 | | 23.30 | 23.26 | 23.27 |
| 1.4 | 1 | 5 | | 23.17 | 23.17 | 23.34 |
| 1.4 | 3 | 0 | | 23.06 | 23.11 | 23.22 |
| 1.4 | 3 | 1 | | 23.14 | 23.25 | 23.29 |
| 1.4 | 3 | 3 | | 23.12 | 23.07 | 23.25 |
| 1.4 | 6 | 0 | | 22.01 | 22.04 | 22.13 |
| 1.4 | 1 | 0 | 16-QAM | 22.45 | 22.52 | 22.63 |
| 1.4 | 1 | 3 | | 22.57 | 22.53 | 22.54 |
| 1.4 | 1 | 5 | | 22.42 | 22.46 | 22.59 |
| 1.4 | 3 | 0 | | 22.23 | 22.20 | 22.28 |
| 1.4 | 3 | 1 | | 22.17 | 22.26 | 22.27 |
| 1.4 | 3 | 3 | | 22.26 | 22.16 | 22.36 |
| 1.4 | 6 | 0 | | 21.07 | 21.17 | 21.23 |



| LTE Band 5 Maximum Average Power [dBm] | | | | | | |
|--|---------|-----------|--------|--------|--------|---------|
| BW [MHz] | RB Size | RB Offset | Mod | Lowest | Middle | Highest |
| 10 | 1 | 0 | QPSK | 23.25 | 23.13 | 23.42 |
| 10 | 1 | 25 | | 23.29 | 23.25 | 23.49 |
| 10 | 1 | 49 | | 23.10 | 22.99 | 23.38 |
| 10 | 25 | 0 | | 22.19 | 22.00 | 22.39 |
| 10 | 25 | 12 | | 22.14 | 22.03 | 22.33 |
| 10 | 25 | 25 | | 22.08 | 22.01 | 22.29 |
| 10 | 50 | 0 | | 22.12 | 22.02 | 22.32 |
| 10 | 1 | 0 | 16-QAM | 22.53 | 22.45 | 22.69 |
| 10 | 1 | 25 | | 22.54 | 22.42 | 22.67 |
| 10 | 1 | 49 | | 22.43 | 22.28 | 22.66 |
| 10 | 25 | 0 | | 21.16 | 20.97 | 21.36 |
| 10 | 25 | 12 | | 21.10 | 20.99 | 21.32 |
| 10 | 25 | 25 | | 21.04 | 20.96 | 21.27 |
| 10 | 50 | 0 | | 21.05 | 20.97 | 21.31 |
| 5 | 1 | 0 | QPSK | 23.22 | 23.09 | 23.24 |
| 5 | 1 | 12 | | 23.20 | 23.05 | 23.36 |
| 5 | 1 | 24 | | 23.15 | 23.03 | 23.28 |
| 5 | 12 | 0 | | 22.12 | 21.96 | 22.19 |
| 5 | 12 | 7 | | 22.11 | 22.04 | 22.24 |
| 5 | 12 | 13 | | 22.15 | 21.96 | 22.21 |
| 5 | 25 | 0 | | 22.11 | 22.01 | 22.21 |
| 5 | 1 | 0 | 16-QAM | 22.51 | 22.36 | 22.53 |
| 5 | 1 | 12 | | 22.64 | 22.46 | 22.72 |
| 5 | 1 | 24 | | 22.36 | 22.32 | 22.60 |
| 5 | 12 | 0 | | 21.12 | 20.95 | 21.21 |
| 5 | 12 | 7 | | 21.07 | 21.01 | 21.24 |
| 5 | 12 | 13 | | 21.13 | 20.93 | 21.26 |
| 5 | 25 | 0 | | 21.09 | 20.94 | 21.17 |



| LTE Band 5 Maximum Average Power [dBm] | | | | | | |
|--|---------|-----------|--------|--------|--------|---------|
| BW [MHz] | RB Size | RB Offset | Mod | Lowest | Middle | Highest |
| 3 | 1 | 0 | QPSK | 23.15 | 23.08 | 23.29 |
| 3 | 1 | 8 | | 23.20 | 23.05 | 23.32 |
| 3 | 1 | 14 | | 23.10 | 23.02 | 23.25 |
| 3 | 8 | 0 | | 22.14 | 21.94 | 22.21 |
| 3 | 8 | 4 | | 22.17 | 22.06 | 22.33 |
| 3 | 8 | 7 | | 22.06 | 21.95 | 22.28 |
| 3 | 15 | 0 | | 22.06 | 22.03 | 22.29 |
| 3 | 1 | 0 | 16-QAM | 22.39 | 22.25 | 22.50 |
| 3 | 1 | 8 | | 22.47 | 22.36 | 22.63 |
| 3 | 1 | 14 | | 22.38 | 22.19 | 22.48 |
| 3 | 8 | 0 | | 21.23 | 20.97 | 21.27 |
| 3 | 8 | 4 | | 21.16 | 21.02 | 21.36 |
| 3 | 8 | 7 | | 21.09 | 20.99 | 21.31 |
| 3 | 15 | 0 | | 21.02 | 20.98 | 21.28 |
| 1.4 | 1 | 0 | QPSK | 23.23 | 23.17 | 23.39 |
| 1.4 | 1 | 3 | | 23.14 | 23.09 | 23.38 |
| 1.4 | 1 | 5 | | 23.17 | 23.02 | 23.24 |
| 1.4 | 3 | 0 | | 23.02 | 23.03 | 23.24 |
| 1.4 | 3 | 1 | | 23.25 | 23.11 | 23.26 |
| 1.4 | 3 | 3 | | 23.05 | 23.00 | 23.29 |
| 1.4 | 6 | 0 | | 22.02 | 21.95 | 22.19 |
| 1.4 | 1 | 0 | 16-QAM | 22.57 | 22.47 | 22.67 |
| 1.4 | 1 | 3 | | 22.49 | 22.41 | 22.62 |
| 1.4 | 1 | 5 | | 22.60 | 22.40 | 22.72 |
| 1.4 | 3 | 0 | | 22.12 | 22.11 | 22.34 |
| 1.4 | 3 | 1 | | 22.24 | 22.07 | 22.31 |
| 1.4 | 3 | 3 | | 22.10 | 22.08 | 22.34 |
| 1.4 | 6 | 0 | | 21.10 | 21.00 | 21.26 |



| LTE Band 12 Maximum Average Power [dBm] | | | | | | |
|---|---------|-----------|--------|--------|--------------|---------|
| BW [MHz] | RB Size | RB Offset | Mod | Lowest | Middle | Highest |
| 10 | 1 | 0 | QPSK | 23.02 | 23.13 | 23.04 |
| 10 | 1 | 25 | | 23.30 | 23.43 | 23.30 |
| 10 | 1 | 49 | | 23.02 | 23.05 | 23.09 |
| 10 | 25 | 0 | | 21.86 | 22.07 | 22.01 |
| 10 | 25 | 12 | | 21.95 | 22.06 | 22.01 |
| 10 | 25 | 25 | | 21.89 | 22.05 | 21.97 |
| 10 | 50 | 0 | | 21.96 | 22.02 | 21.99 |
| 10 | 1 | 0 | 16-QAM | 22.39 | 22.45 | 22.38 |
| 10 | 1 | 25 | | 22.45 | 22.52 | 22.51 |
| 10 | 1 | 49 | | 22.27 | 22.37 | 22.44 |
| 10 | 25 | 0 | | 20.95 | 21.18 | 20.98 |
| 10 | 25 | 12 | | 21.03 | 21.11 | 21.04 |
| 10 | 25 | 25 | | 21.01 | 21.10 | 20.98 |
| 10 | 50 | 0 | | 20.98 | 20.99 | 21.06 |
| 5 | 1 | 0 | QPSK | 23.08 | 23.16 | 22.96 |
| 5 | 1 | 12 | | 23.15 | 23.19 | 23.13 |
| 5 | 1 | 24 | | 23.27 | 23.07 | 22.93 |
| 5 | 12 | 0 | | 21.89 | 21.89 | 21.91 |
| 5 | 12 | 7 | | 22.01 | 22.07 | 22.03 |
| 5 | 12 | 13 | | 22.02 | 21.98 | 21.96 |
| 5 | 25 | 0 | | 21.96 | 22.05 | 22.02 |
| 5 | 1 | 0 | 16-QAM | 22.37 | 22.38 | 22.23 |
| 5 | 1 | 12 | | 22.43 | 22.20 | 22.08 |
| 5 | 1 | 24 | | 22.59 | 22.40 | 22.34 |
| 5 | 12 | 0 | | 21.08 | 21.03 | 21.13 |
| 5 | 12 | 7 | | 21.13 | 21.14 | 21.15 |
| 5 | 12 | 13 | | 21.17 | 21.11 | 21.17 |
| 5 | 25 | 0 | | 21.06 | 21.09 | 21.07 |



| LTE Band 12 Maximum Average Power [dBm] | | | | | | |
|---|---------|-----------|--------|--------|--------|---------|
| BW [MHz] | RB Size | RB Offset | Mod | Lowest | Middle | Highest |
| 3 | 1 | 0 | QPSK | 23.07 | 23.13 | 23.07 |
| 3 | 1 | 8 | | 23.01 | 23.13 | 22.97 |
| 3 | 1 | 14 | | 23.12 | 23.15 | 22.90 |
| 3 | 8 | 0 | | 21.83 | 22.02 | 21.86 |
| 3 | 8 | 4 | | 21.94 | 22.14 | 21.93 |
| 3 | 8 | 7 | | 21.90 | 22.05 | 21.93 |
| 3 | 15 | 0 | | 21.88 | 21.99 | 21.88 |
| 3 | 1 | 0 | 16-QAM | 22.23 | 22.27 | 22.17 |
| 3 | 1 | 8 | | 22.30 | 22.50 | 22.31 |
| 3 | 1 | 14 | | 22.46 | 22.47 | 22.24 |
| 3 | 8 | 0 | | 20.90 | 21.11 | 20.95 |
| 3 | 8 | 4 | | 21.00 | 21.15 | 21.02 |
| 3 | 8 | 7 | | 20.99 | 21.10 | 21.02 |
| 3 | 15 | 0 | | 20.93 | 20.99 | 20.86 |
| 1.4 | 1 | 0 | QPSK | 22.81 | 22.92 | 22.81 |
| 1.4 | 1 | 3 | | 22.92 | 23.15 | 22.92 |
| 1.4 | 1 | 5 | | 22.71 | 22.96 | 22.75 |
| 1.4 | 3 | 0 | | 22.82 | 22.98 | 22.82 |
| 1.4 | 3 | 1 | | 22.85 | 23.03 | 22.82 |
| 1.4 | 3 | 3 | | 22.88 | 22.98 | 22.91 |
| 1.4 | 6 | 0 | | 21.80 | 21.81 | 21.76 |
| 1.4 | 1 | 0 | 16-QAM | 22.16 | 22.33 | 21.96 |
| 1.4 | 1 | 3 | | 22.01 | 22.21 | 22.06 |
| 1.4 | 1 | 5 | | 21.99 | 22.14 | 22.14 |
| 1.4 | 3 | 0 | | 21.84 | 21.99 | 21.87 |
| 1.4 | 3 | 1 | | 21.98 | 22.10 | 21.94 |
| 1.4 | 3 | 3 | | 21.83 | 21.99 | 21.94 |
| 1.4 | 6 | 0 | | 20.87 | 20.89 | 20.88 |



| LTE Band 13 Maximum Average Power [dBm] | | | | | | |
|---|---------|-----------|--------|--------|--------------|---------|
| BW [MHz] | RB Size | RB Offset | Mod | Lowest | Middle | Highest |
| 10 | 1 | 0 | QPSK | | 21.86 | |
| 10 | 1 | 25 | | | 21.67 | |
| 10 | 1 | 49 | | | 21.49 | |
| 10 | 25 | 0 | | | 20.74 | |
| 10 | 25 | 12 | | | 20.58 | |
| 10 | 25 | 25 | | | 20.47 | |
| 10 | 50 | 0 | | | 20.69 | |
| 10 | 1 | 0 | 16-QAM | | 21.15 | |
| 10 | 1 | 25 | | | 20.79 | |
| 10 | 1 | 49 | | | 20.75 | |
| 10 | 25 | 0 | | | 19.84 | |
| 10 | 25 | 12 | | | 19.58 | |
| 10 | 25 | 25 | | | 19.50 | |
| 10 | 50 | 0 | | | 19.61 | |
| 5 | 1 | 0 | QPSK | 21.64 | 21.58 | 21.28 |
| 5 | 1 | 12 | | 21.48 | 21.53 | 21.29 |
| 5 | 1 | 24 | | 21.48 | 21.53 | 21.34 |
| 5 | 12 | 0 | | 20.69 | 20.50 | 20.25 |
| 5 | 12 | 7 | | 20.57 | 20.44 | 20.33 |
| 5 | 12 | 13 | | 20.39 | 20.41 | 20.26 |
| 5 | 25 | 0 | | 20.52 | 20.53 | 20.28 |
| 5 | 1 | 0 | 16-QAM | 20.92 | 20.88 | 20.53 |
| 5 | 1 | 12 | | 20.81 | 20.79 | 20.64 |
| 5 | 1 | 24 | | 20.72 | 20.78 | 20.59 |
| 5 | 12 | 0 | | 19.61 | 19.55 | 19.30 |
| 5 | 12 | 7 | | 19.48 | 19.51 | 19.35 |
| 5 | 12 | 13 | | 19.40 | 19.49 | 19.32 |
| 5 | 25 | 0 | | 19.70 | 19.55 | 19.30 |



LTE Band 2

Peak-to-Average Ratio

| Mode | LTE Band 2 / 20MHz | | | | |
|------------|--------------------|---------|-------|---------|-------------|
| Mod. | QPSK | | 16QAM | | Limit: 13dB |
| RB Size | 1RB | Full RB | 1RB | Full RB | Result |
| Lowest CH | 3.62 | 4.58 | 4.26 | 5.65 | PASS |
| Middle CH | 3.94 | 4.67 | 4.99 | 5.68 | |
| Highest CH | 3.74 | 4.49 | 4.17 | 5.59 | |



LTE Band 2 / 20MHz / QPSK

Lowest Channel / 1RB

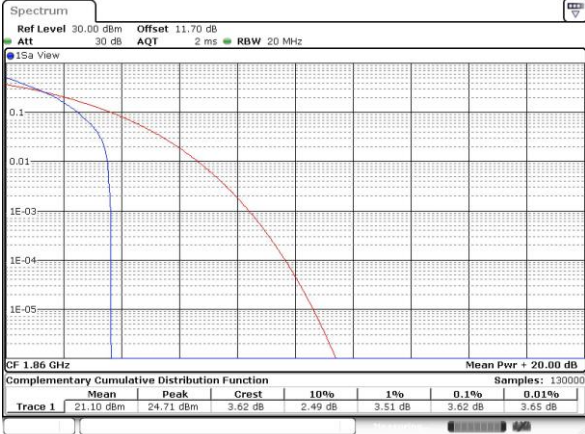

Date: 25 APR 2018 00:03:20

Lowest Channel / Full RB

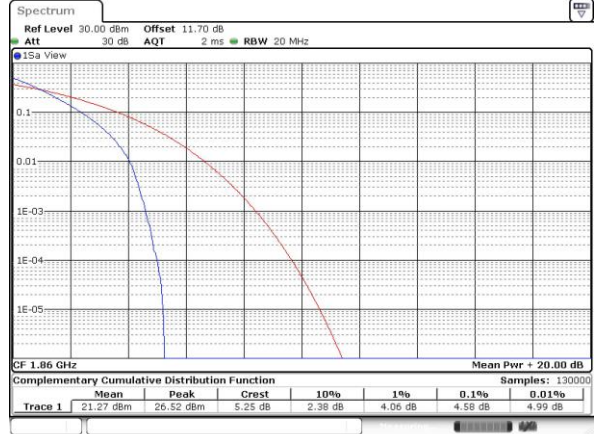

Date: 25 APR 2018 00:03:33

Middle Channel / 1RB



Date: 25 APR 2018 00:03:44

Middle Channel / Full RB

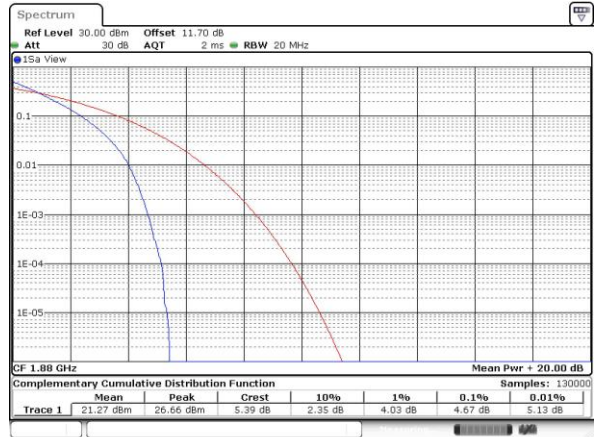

Date: 25 APR 2018 00:03:55

Highest Channel / 1RB

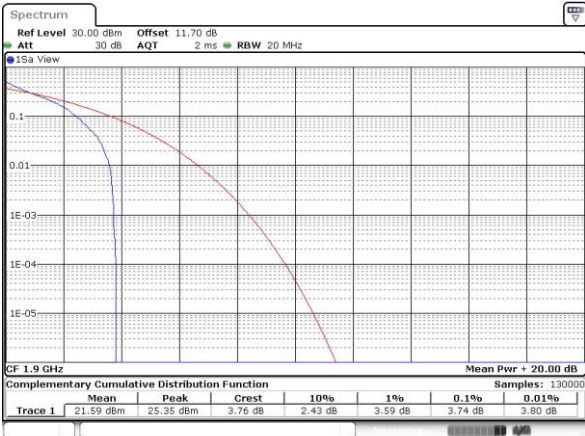

Date: 25 APR 2018 00:04:05

Highest Channel / Full RB

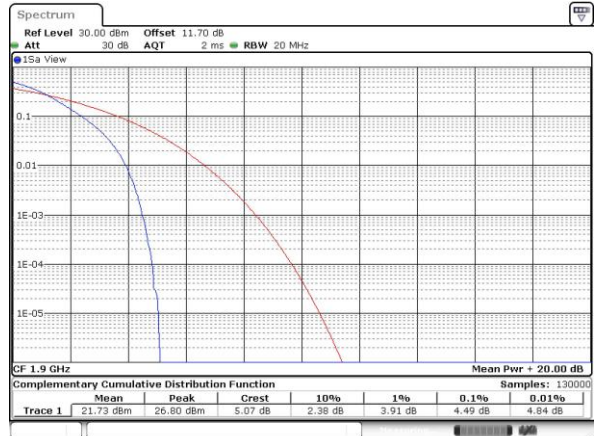

Date: 25 APR 2018 00:04:17



LTE Band 2 / 20MHz / 16QAM

Lowest Channel / 1RB

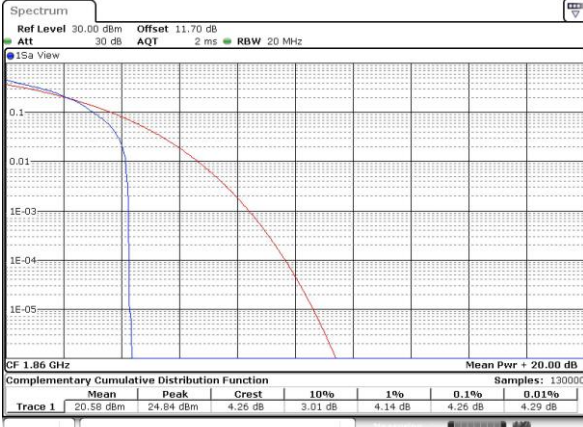

Date: 25 APR 2018 00:02:15

Lowest Channel / Full RB

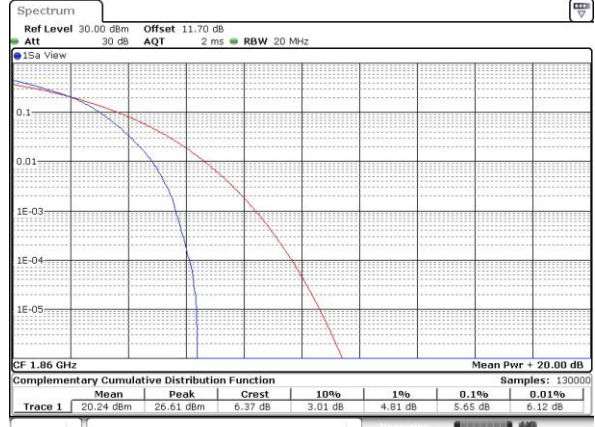

Date: 25 APR 2018 00:02:28

Middle Channel / 1RB

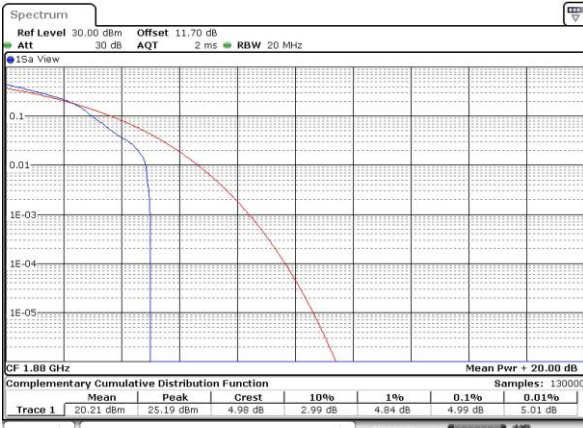

Date: 25 APR 2018 00:02:39

Middle Channel / Full RB

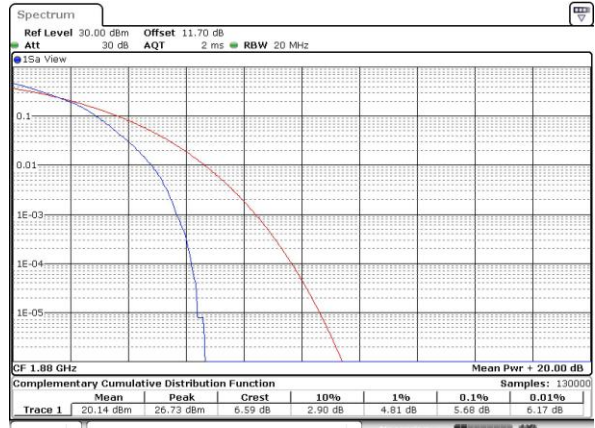

Date: 25 APR 2018 00:02:49

Highest Channel / 1RB

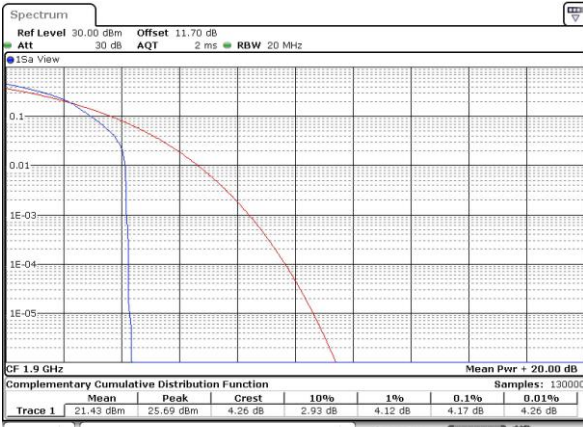

Date: 25 APR 2018 00:03:00

Highest Channel / Full RB

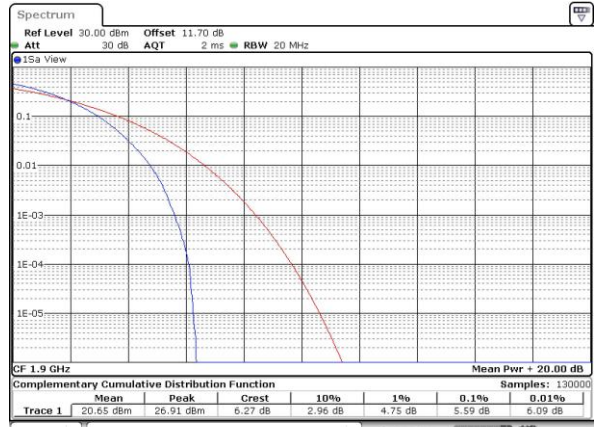

Date: 25 APR 2018 00:03:10



26dB Bandwidth

| Mode | LTE Band 2 : 26dB BW(MHz) | | | | | | | | | | | |
|------------|---------------------------|-------|------|-------|------|-------|-------|-------|-------|-------|-------|-------|
| | 1.4MHz | | 3MHz | | 5MHz | | 10MHz | | 15MHz | | 20MHz | |
| BW | | | | | | | | | | | | |
| Mod. | QPSK | 16QAM | QPSK | 16QAM | QPSK | 16QAM | QPSK | 16QAM | QPSK | 16QAM | QPSK | 16QAM |
| Lowest CH | 1.24 | 1.21 | 2.98 | 3.03 | 4.92 | 4.95 | 9.79 | 9.73 | 14.36 | 14.42 | 20.14 | 20.26 |
| Middle CH | 1.24 | 1.24 | 3.00 | 3.06 | 5.03 | 4.92 | 9.77 | 9.81 | 14.51 | 14.51 | 20.14 | 20.38 |
| Highest CH | 1.23 | 1.25 | 3.01 | 3.02 | 4.95 | 4.91 | 9.63 | 9.89 | 14.42 | 14.48 | 20.14 | 20.34 |



LTE Band 2

Lowest Channel / 1.4MHz / QPSK

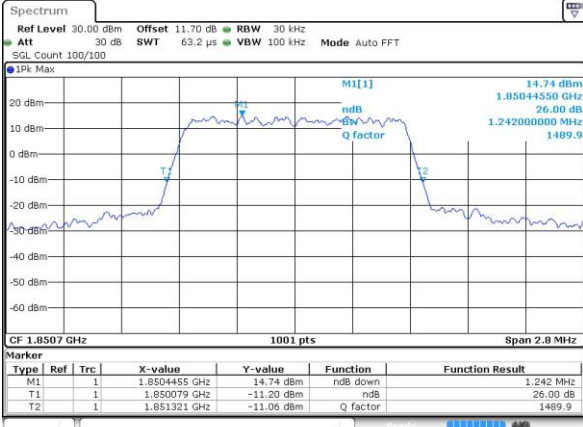

Date: 24 APR 2018 23:45:30

Lowest Channel / 1.4MHz / 16QAM

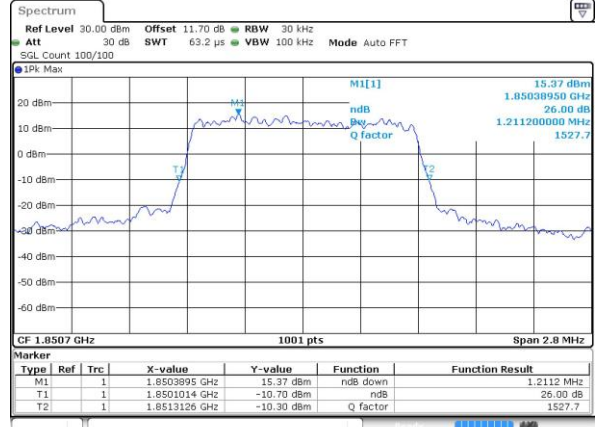

Date: 24 APR 2018 23:45:41

Middle Channel / 1.4MHz / QPSK

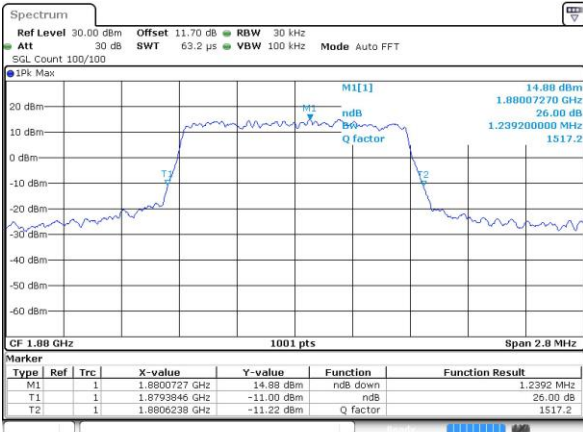

Date: 24 APR 2018 23:52:42

Middle Channel / 1.4MHz / 16QAM

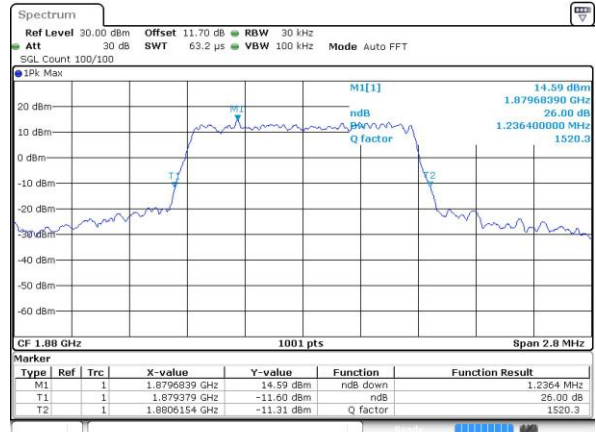

Date: 24 APR 2018 23:52:53

Highest Channel / 1.4MHz / QPSK

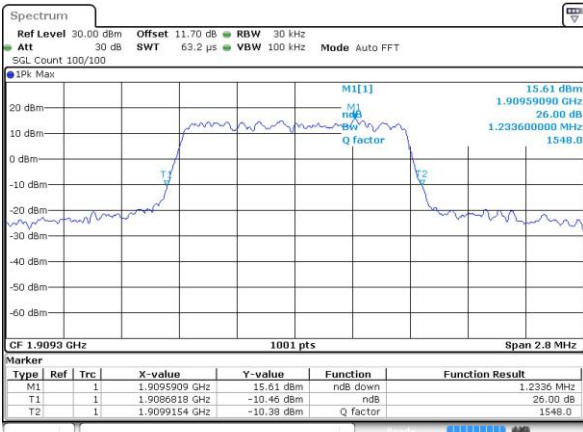

Date: 24 APR 2018 23:55:15

Highest Channel / 1.4MHz / 16QAM

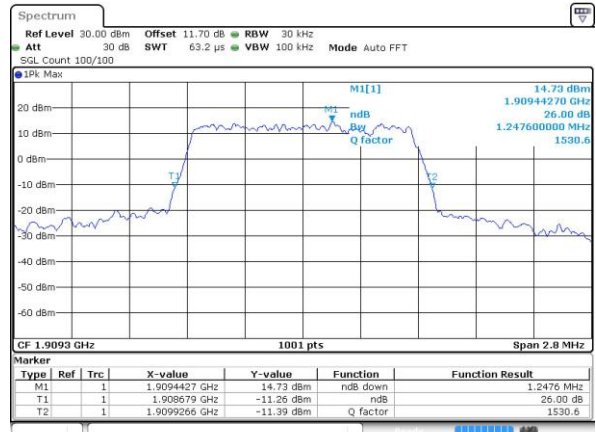

Date: 24 APR 2018 23:55:26



LTE Band 2

Lowest Channel / 3MHz / QPSK

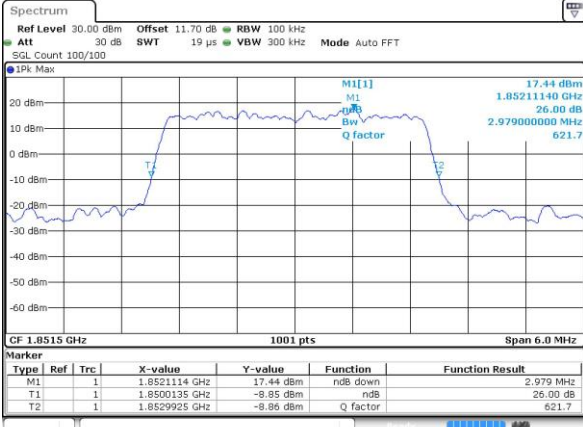

Date: 24 APR 2018 22:11:25

Lowest Channel / 3MHz / 16QAM

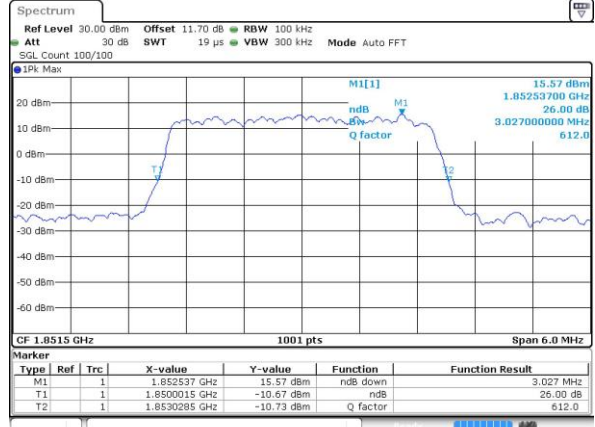

Date: 24 APR 2018 22:11:35

Middle Channel / 3MHz / QPSK

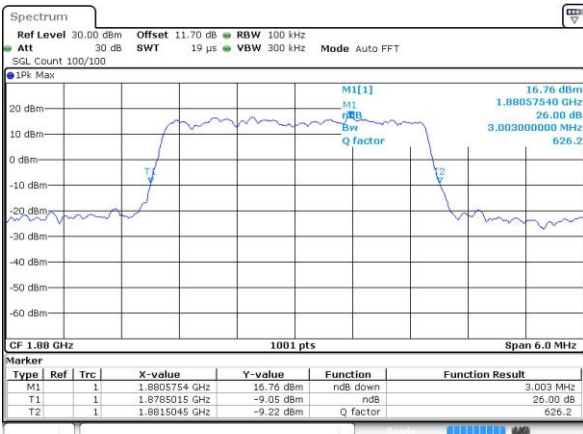

Date: 24 APR 2018 22:18:36

Middle Channel / 3MHz / 16QAM

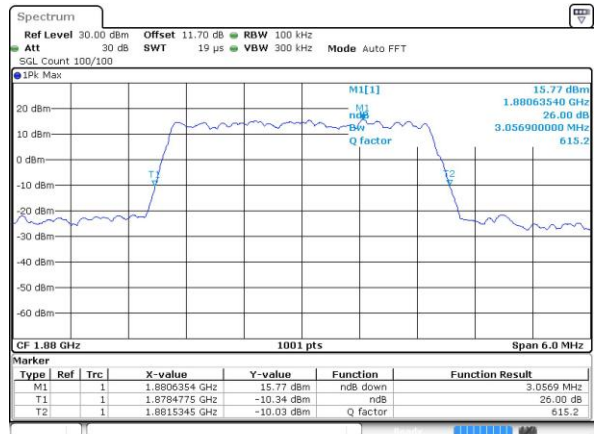

Date: 24 APR 2018 22:18:47

Highest Channel / 3MHz / QPSK

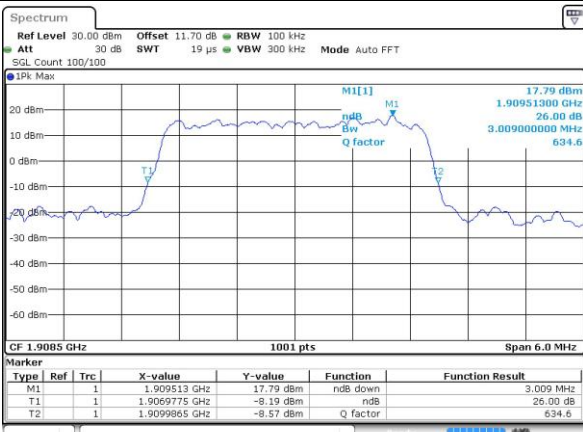

Date: 24 APR 2018 22:21:09

Highest Channel / 3MHz / 16QAM

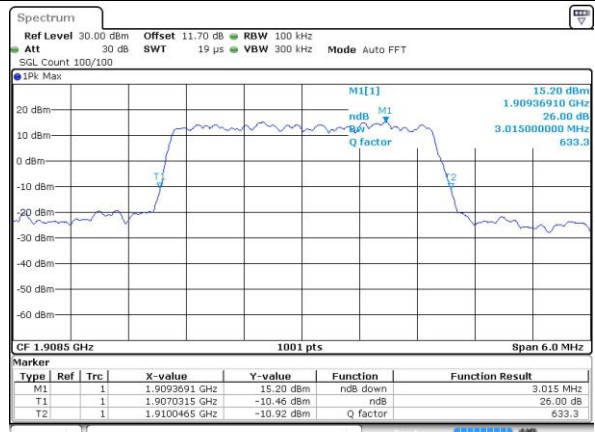

Date: 24 APR 2018 22:21:20



LTE Band 2

Lowest Channel / 5MHz / QPSK



Date: 24 APR 2018 22:28:20

Lowest Channel / 5MHz / 16QAM

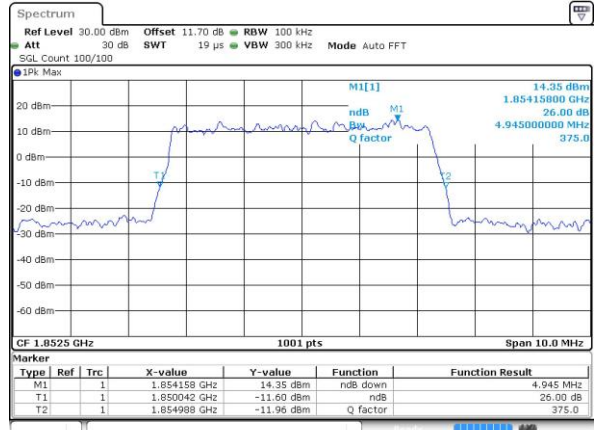

Date: 24 APR 2018 22:28:31

Middle Channel / 5MHz / QPSK

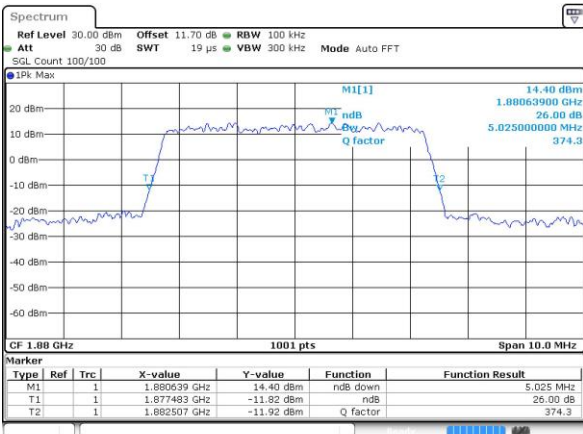

Date: 24 APR 2018 22:35:31

Middle Channel / 5MHz / 16QAM

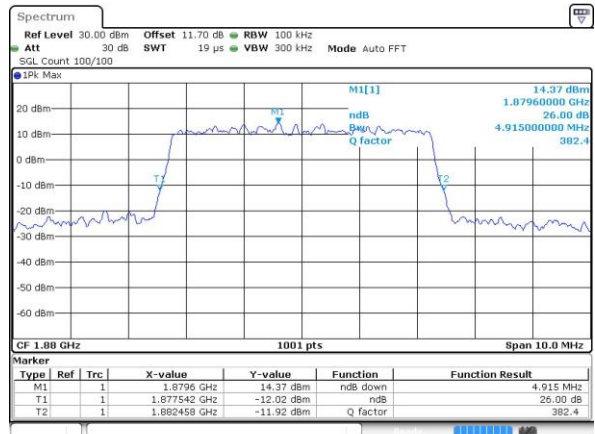

Date: 24 APR 2018 22:35:42

Highest Channel / 5MHz / QPSK

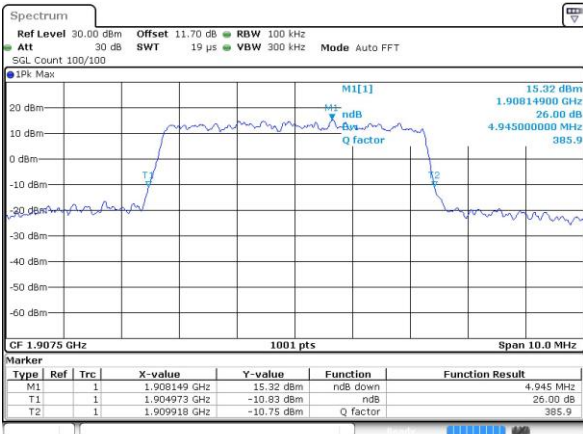

Date: 24 APR 2018 22:38:04

Highest Channel / 5MHz / 16QAM

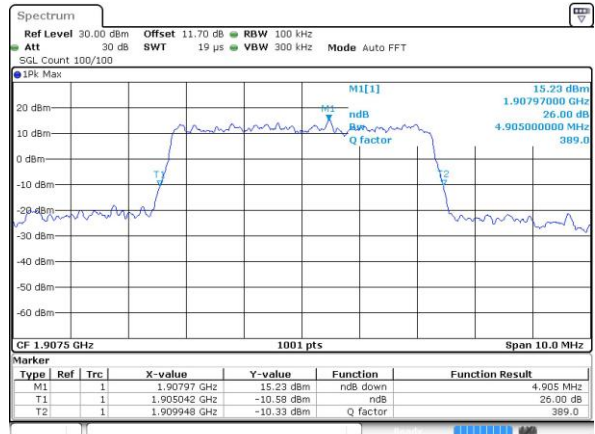

Date: 24 APR 2018 22:38:15



LTE Band 2

Lowest Channel / 10MHz / QPSK

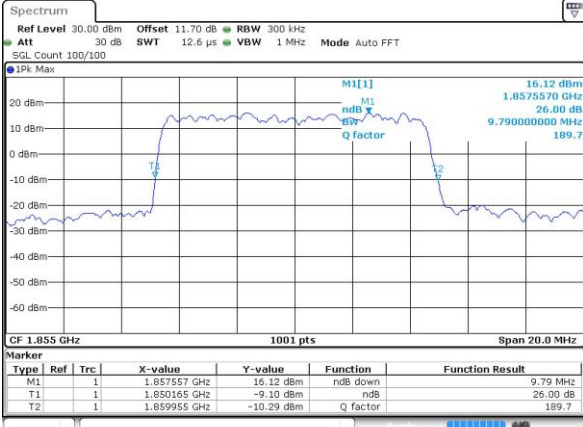

Date: 24 APR 2018 22:45:15

Lowest Channel / 10MHz / 16QAM

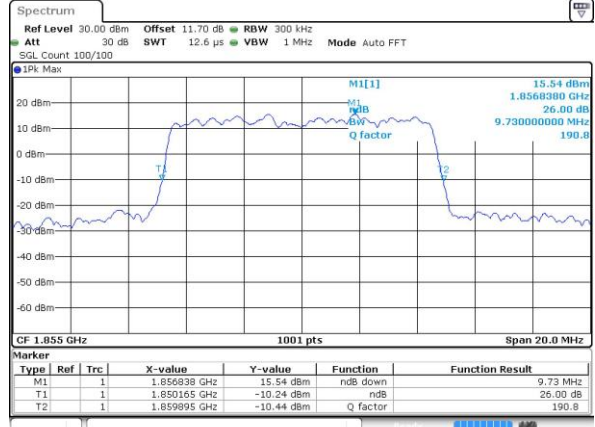

Date: 24 APR 2018 22:45:26

Middle Channel / 10MHz / QPSK

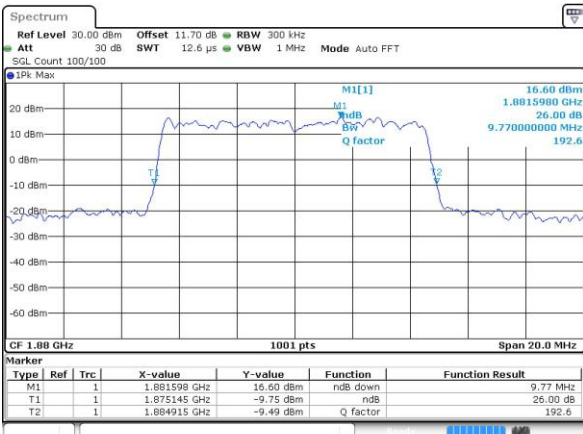

Date: 24 APR 2018 22:52:27

Middle Channel / 10MHz / 16QAM

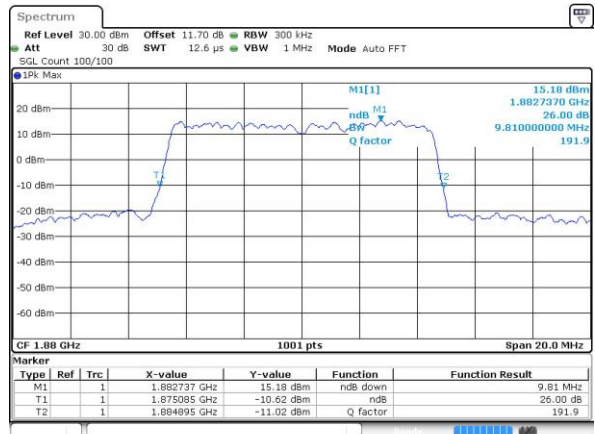

Date: 24 APR 2018 22:52:38

Highest Channel / 10MHz / QPSK

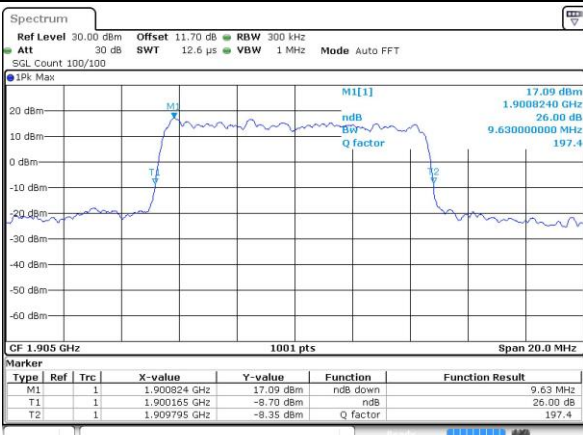

Date: 24 APR 2018 22:55:00

Highest Channel / 10MHz / 16QAM

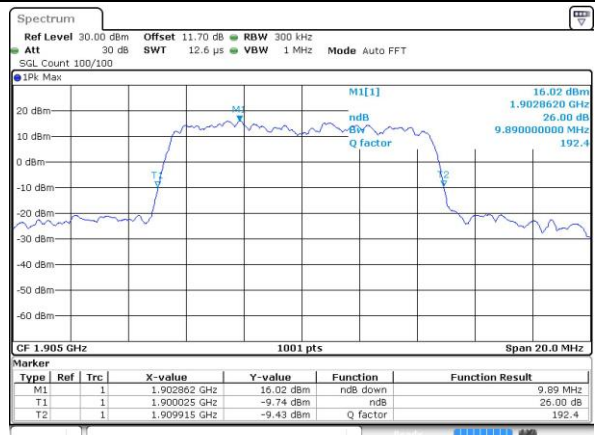

Date: 24 APR 2018 22:55:11



LTE Band 2

Lowest Channel / 15MHz / QPSK



Date: 24 APR 2018 23:02:12

Lowest Channel / 15MHz / 16QAM

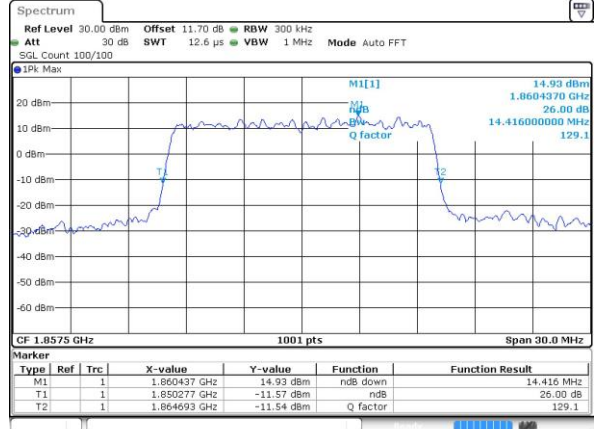

Date: 24 APR 2018 23:02:22

Middle Channel / 15MHz / QPSK

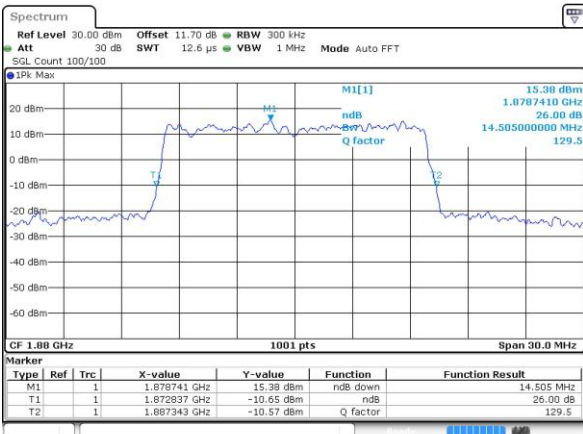

Date: 24 APR 2018 23:09:23

Middle Channel / 15MHz / 16QAM

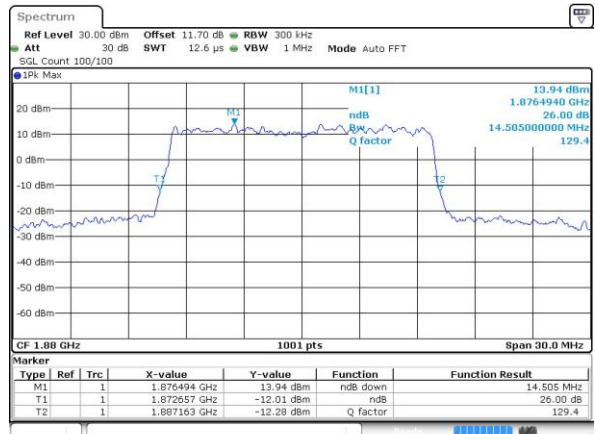

Date: 24 APR 2018 23:09:34

Highest Channel / 15MHz / QPSK

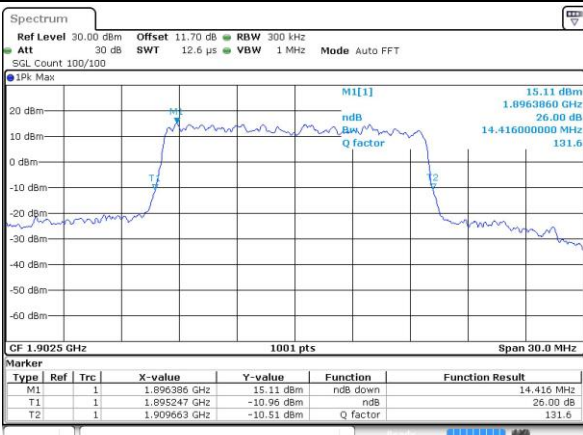

Date: 24 APR 2018 23:11:57

Highest Channel / 15MHz / 16QAM

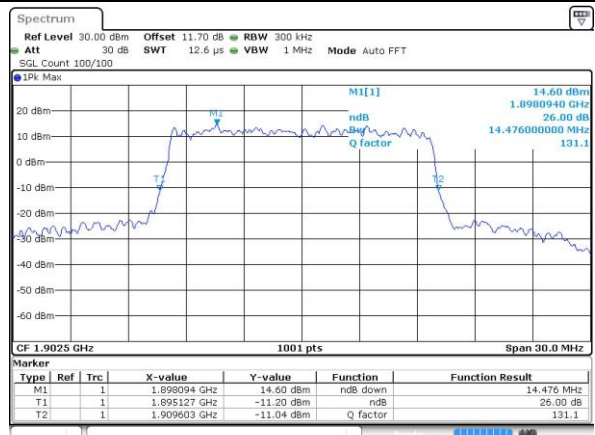

Date: 24 APR 2018 23:12:07



LTE Band 2

Lowest Channel / 20MHz / QPSK

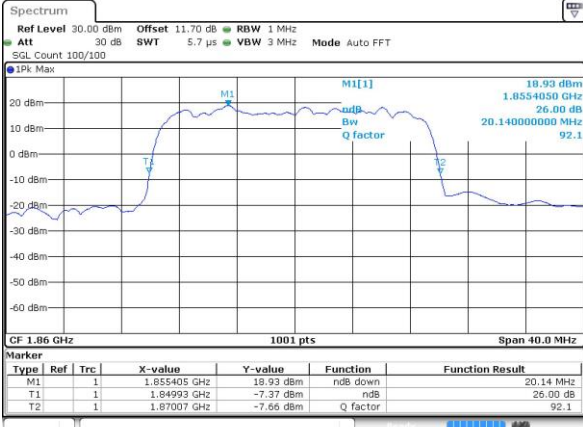

Date: 24 APR 2018 23:19:09

Lowest Channel / 20MHz / 16QAM

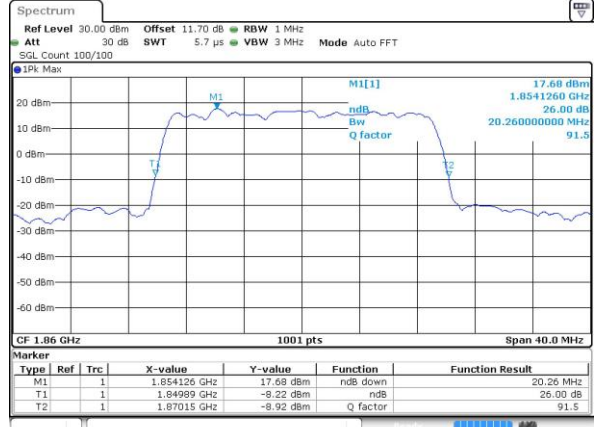

Date: 24 APR 2018 23:19:21

Middle Channel / 20MHz / QPSK

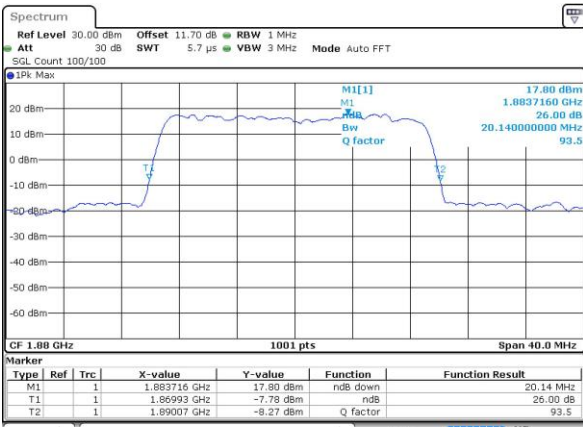

Date: 24 APR 2018 23:26:22

Middle Channel / 20MHz / 16QAM

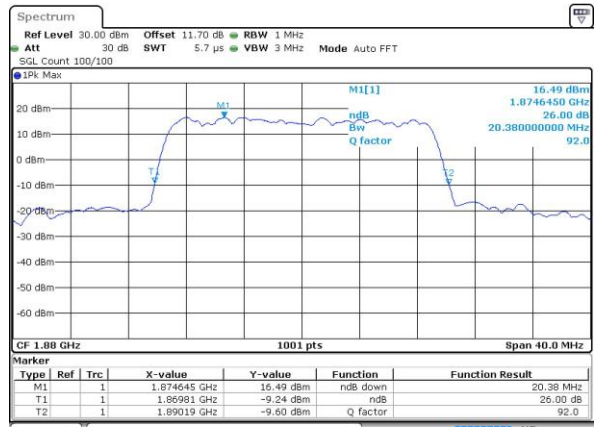

Date: 24 APR 2018 23:26:33

Highest Channel / 20MHz / QPSK

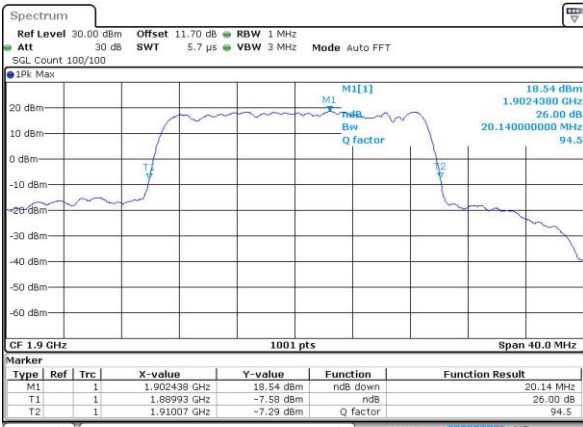

Date: 24 APR 2018 23:28:55

Highest Channel / 20MHz / 16QAM

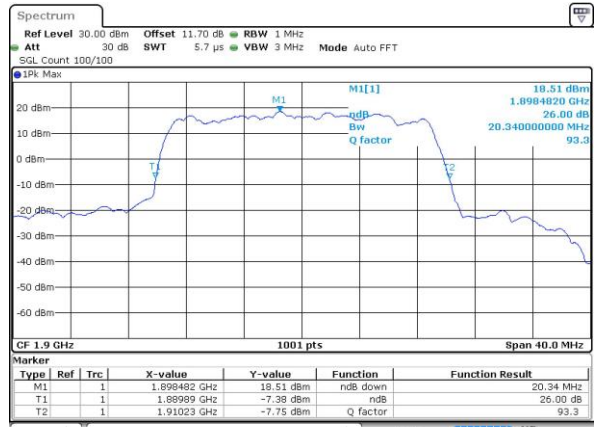

Date: 24 APR 2018 23:29:06



Occupied Bandwidth

| Mode | LTE Band 2 : 99%OBW(MHz) | | | | | | | | | | | |
|------------|--------------------------|-------|------|-------|------|-------|-------|-------|-------|-------|-------|-------|
| | 1.4MHz | | 3MHz | | 5MHz | | 10MHz | | 15MHz | | 20MHz | |
| BW | QPSK | 16QAM | QPSK | 16QAM | QPSK | 16QAM | QPSK | 16QAM | QPSK | 16QAM | QPSK | 16QAM |
| Lowest CH | 1.09 | 1.09 | 2.73 | 2.73 | 4.48 | 4.48 | 9.03 | 9.01 | 13.49 | 13.52 | 18.3 | 18.22 |
| Middle CH | 1.09 | 1.09 | 2.73 | 2.71 | 4.5 | 4.49 | 9.01 | 8.99 | 13.46 | 13.52 | 18.54 | 18.42 |
| Highest CH | 1.09 | 1.09 | 2.72 | 2.73 | 4.5 | 4.48 | 9.01 | 8.97 | 13.43 | 13.46 | 18.3 | 18.22 |



LTE Band 2

Lowest Channel / 1.4MHz / QPSK

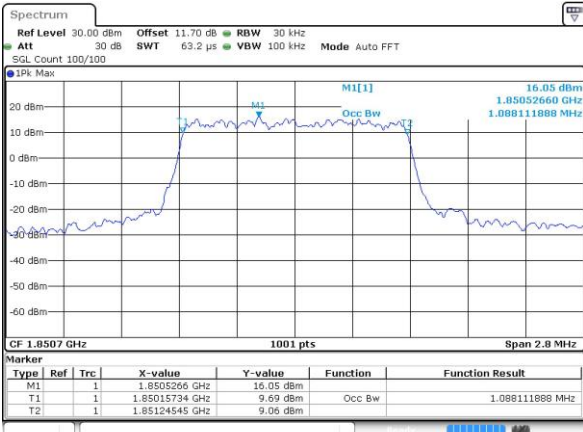

Lowest Channel / 1.4MHz / 16QAM

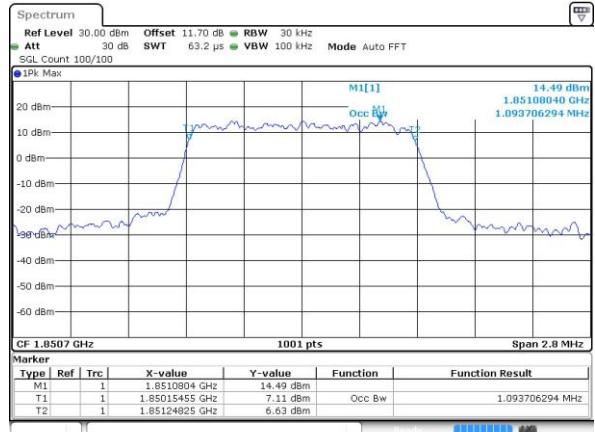

Middle Channel / 1.4MHz / QPSK

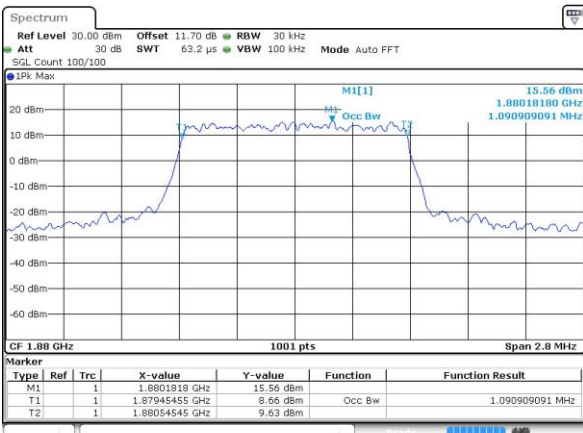

Middle Channel / 1.4MHz / 16QAM

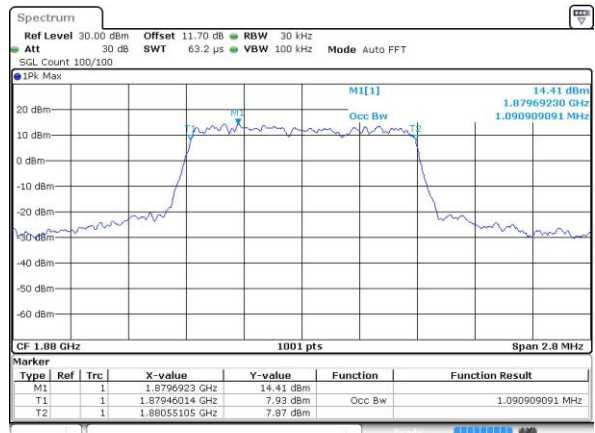

Highest Channel / 1.4MHz / QPSK

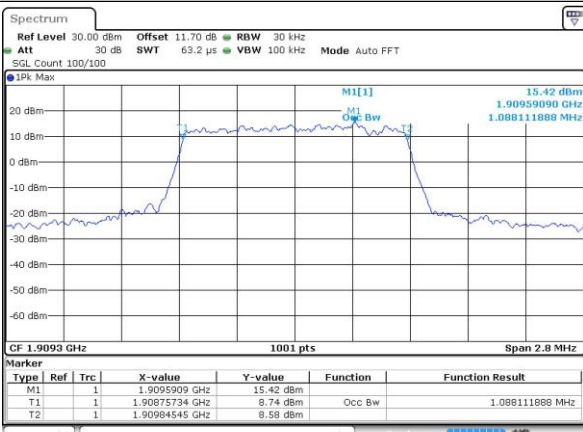

Highest Channel / 1.4MHz / 16QAM

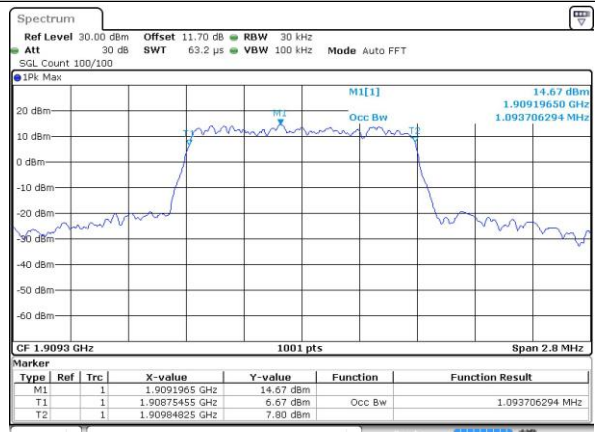



LTE Band 2

Lowest Channel / 3MHz / QPSK

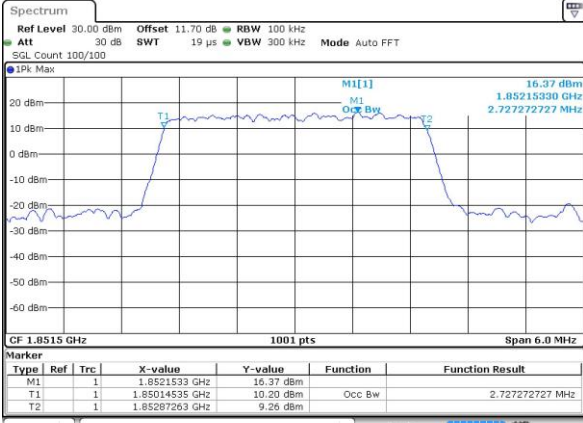

Date: 24 APR 2018 22:11:03

Lowest Channel / 3MHz / 16QAM

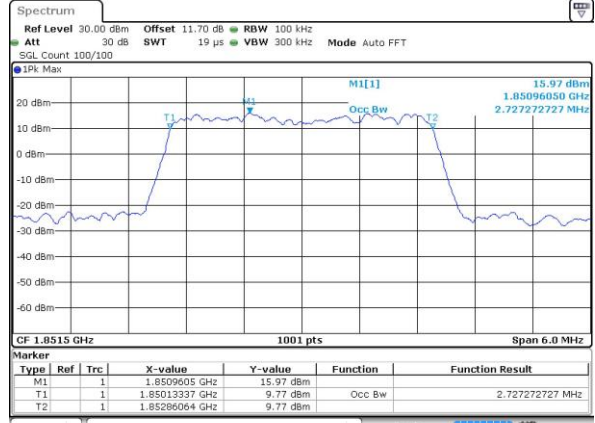

Date: 24 APR 2018 22:11:14

Middle Channel / 3MHz / QPSK

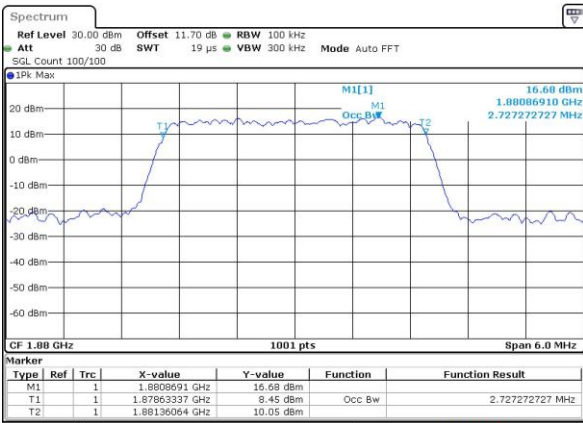

Date: 24 APR 2018 22:18:15

Middle Channel / 3MHz / 16QAM

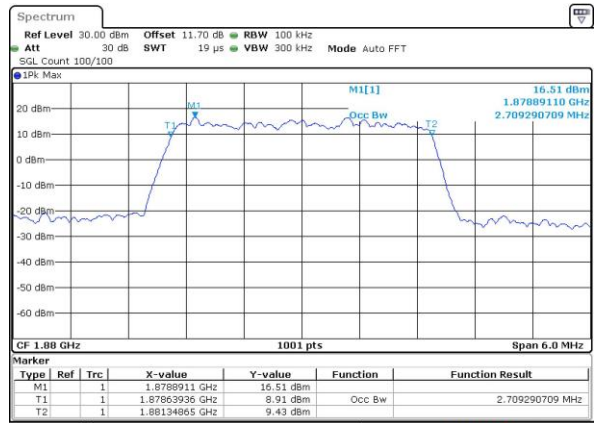

Date: 24 APR 2018 22:18:25

Highest Channel / 3MHz / QPSK

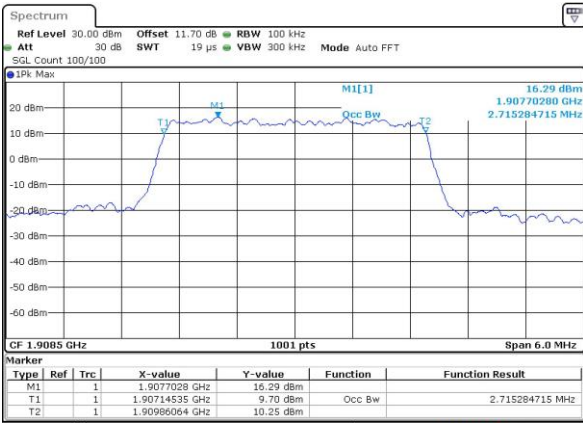

Date: 24 APR 2018 22:20:48

Highest Channel / 3MHz / 16QAM

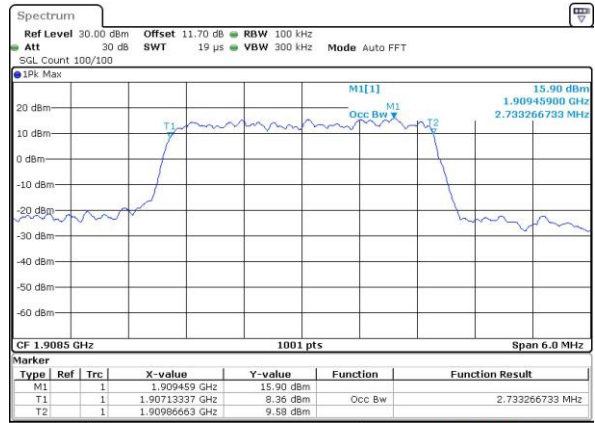

Date: 24 APR 2018 22:20:58



LTE Band 2

Lowest Channel / 5MHz / QPSK

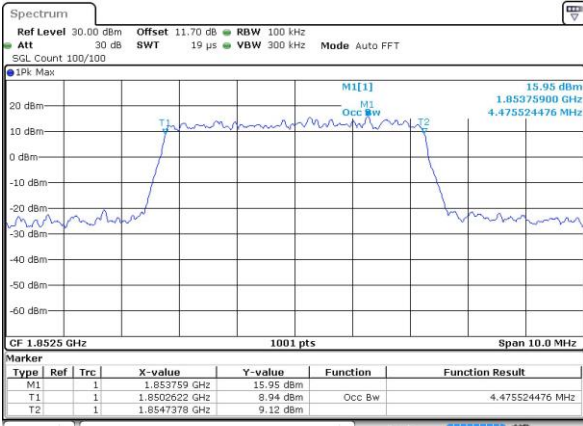

Date: 24 APR 2018 22:27:59

Lowest Channel / 5MHz / 16QAM

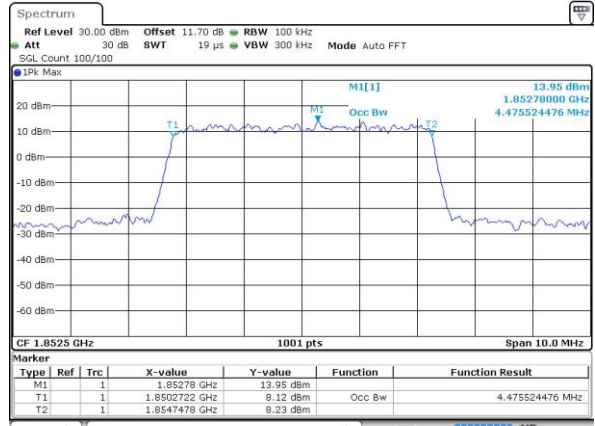

Date: 24 APR 2018 22:28:10

Middle Channel / 5MHz / QPSK

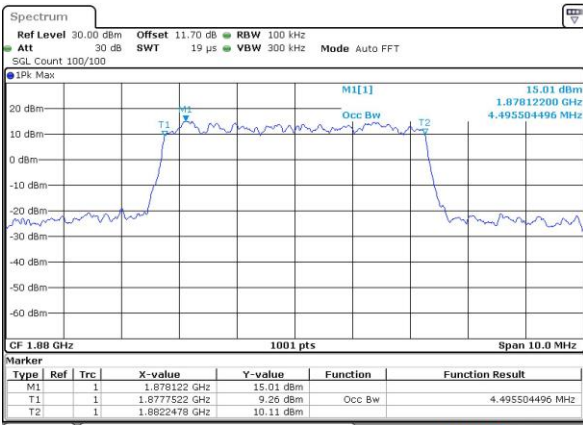

Date: 24 APR 2018 22:35:10

Middle Channel / 5MHz / 16QAM

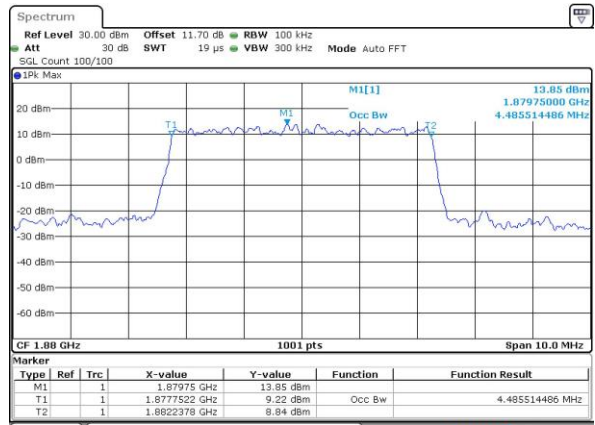

Date: 24 APR 2018 22:35:21

Highest Channel / 5MHz / QPSK

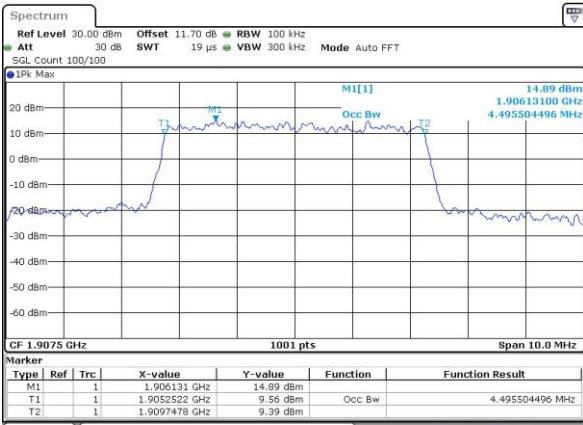

Date: 24 APR 2018 22:37:43

Highest Channel / 5MHz / 16QAM

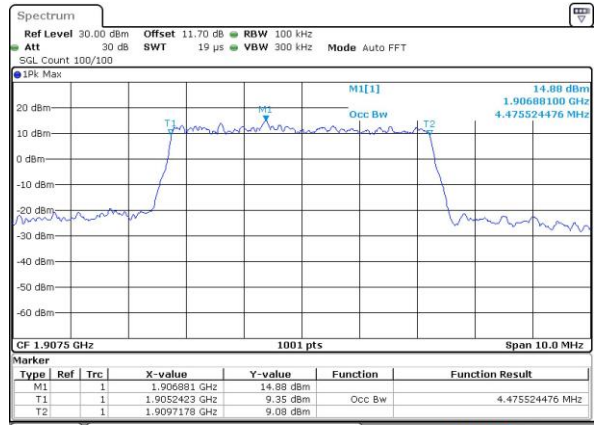

Date: 24 APR 2018 22:37:53



LTE Band 2

Lowest Channel / 10MHz / QPSK

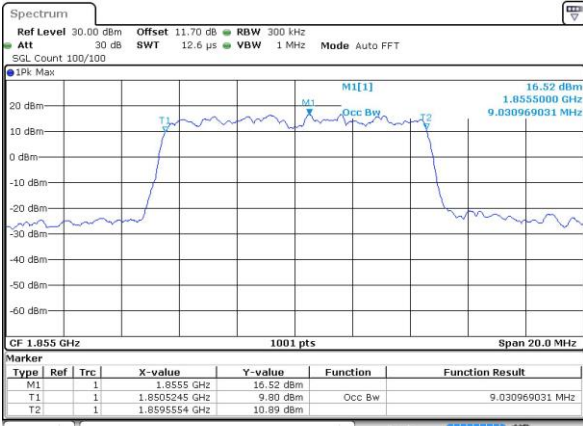

Date: 24 APR 2018 22:44:54

Lowest Channel / 10MHz / 16QAM

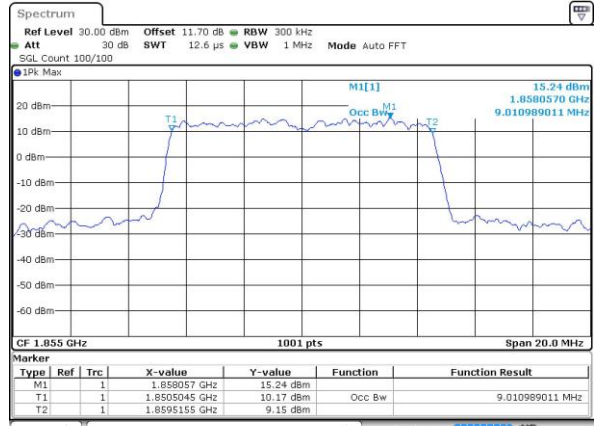

Date: 24 APR 2018 22:45:05

Middle Channel / 10MHz / QPSK

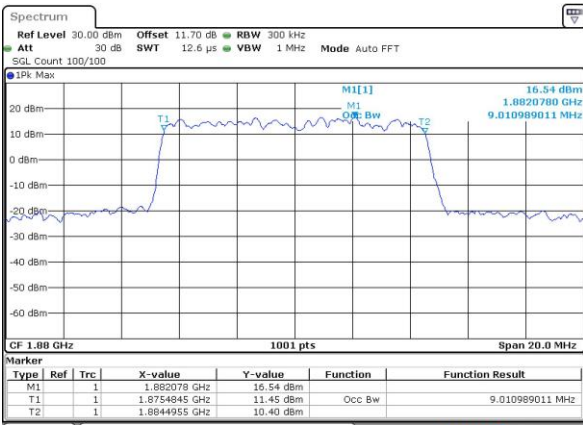

Date: 24 APR 2018 22:52:08

Middle Channel / 10MHz / 16QAM

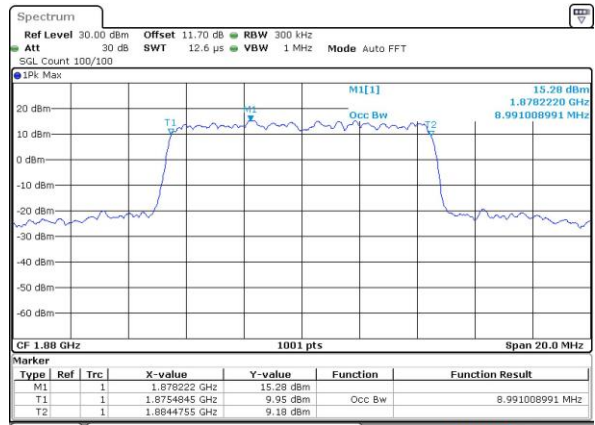

Date: 24 APR 2018 22:52:17

Highest Channel / 10MHz / QPSK

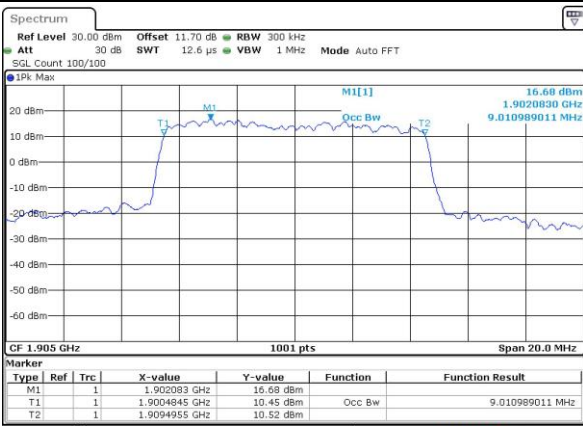

Date: 24 APR 2018 22:54:39

Highest Channel / 10MHz / 16QAM

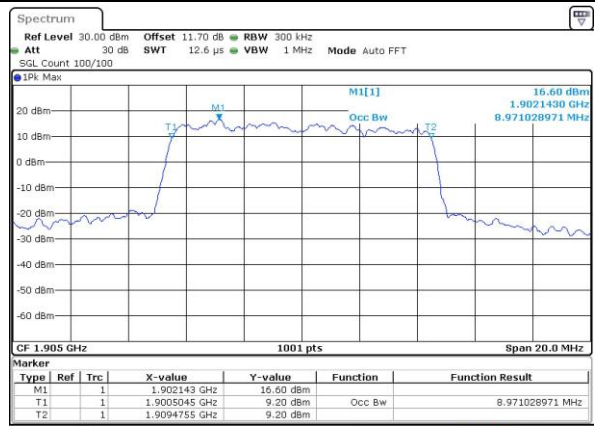

Date: 24 APR 2018 22:54:50



LTE Band 2

Lowest Channel / 15MHz / QPSK

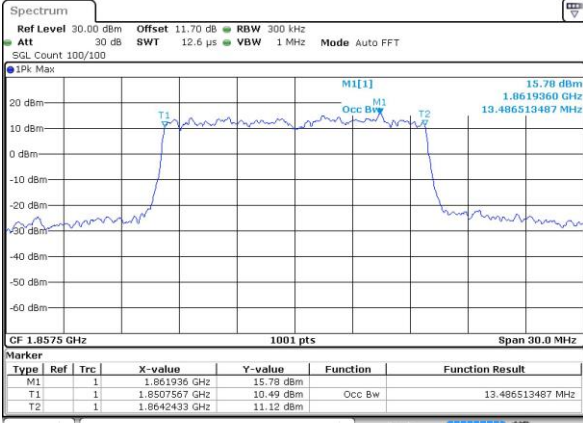

Date: 24 APR 2018 23:01:50

Lowest Channel / 15MHz / 16QAM

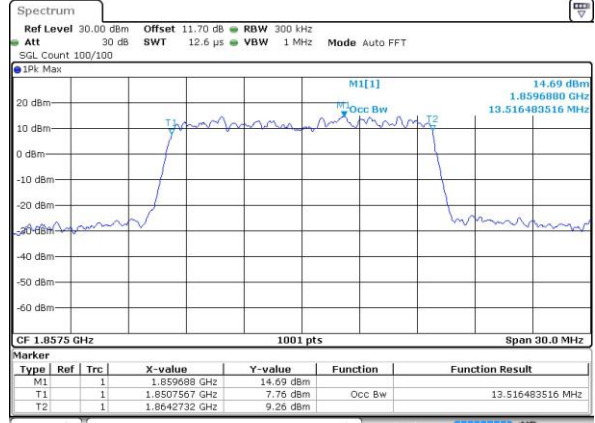

Date: 24 APR 2018 23:02:01

Middle Channel / 15MHz / QPSK

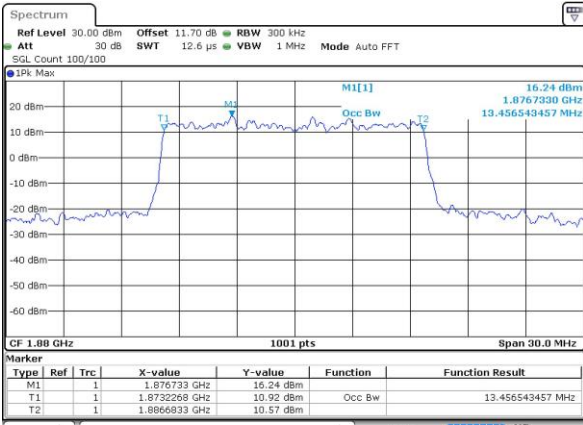

Date: 24 APR 2018 23:09:02

Middle Channel / 15MHz / 16QAM

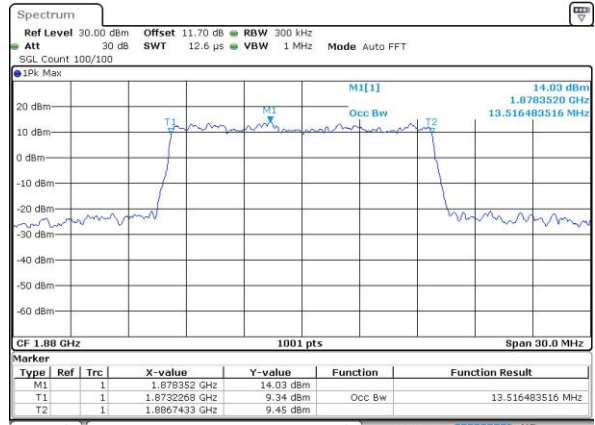

Date: 24 APR 2018 23:09:13

Highest Channel / 15MHz / QPSK

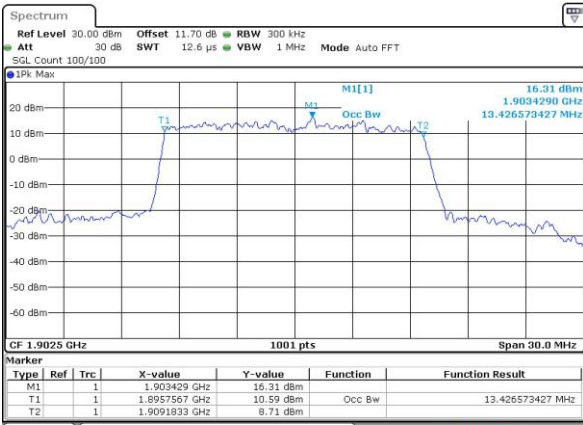

Date: 24 APR 2018 23:11:35

Highest Channel / 15MHz / 16QAM

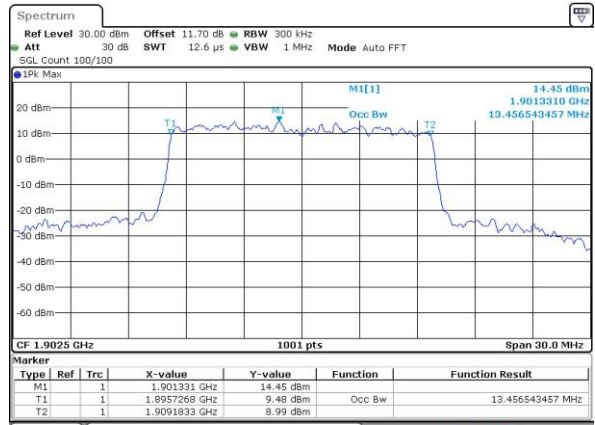

Date: 24 APR 2018 23:11:46