



FCC Test Report

Equipment : 802.11a/b/g/n/ac Wireless Access Point
Brand Name : CISCO
Model No. : MR70-HW
FCC ID : UDX-60067010
Standard : 47 CFR FCC Part 15.407
Operating Band : 5250 MHz – 5350 MHz
 5470 MHz – 5725 MHz
Applicant : Cisco Systems, Inc.
 170 West Tasman Drive, San Jose, CA 95134 USA
Manufacturer : Cisco Systems, Inc.
 170 West Tasman Drive, San Jose, CA 95134 USA
Function : Outdoor; Indoor; Fixed P2P
 Client
TPC Function : With TPC Without TPC

The product sample received on Aug. 22, 2017 and completely tested on Sep. 05, 2017. We, SPORTON, would like to declare that the tested sample has been evaluated in accordance with the procedures given in ANSI C63.10-2013 and shown compliance with the applicable technical standards.

The test results in this report apply exclusively to the tested model / sample. Without written approval of SPORTON INTERNATIONAL INC., the test report shall not be reproduced except in full.

 Cliff Chang
 SPORTON INTERNATIONAL INC.





Table of Contents

- 1 GENERAL DESCRIPTION5**
- 1.1 Information.....5
- 1.2 Testing Applied Standards 12
- 1.3 Testing Location Information..... 12
- 1.4 Measurement Uncertainty 12
- 2 TEST CONFIGURATION OF EUT13**
- 2.1 Test Channel Mode 13
- 2.2 The Worst Case Measurement Configuration..... 15
- 2.3 EUT Operation during Test 16
- 2.4 Accessories 17
- 2.5 Support Equipment..... 17
- 2.6 Test Setup Diagram 19
- 3 TRANSMITTER TEST RESULT23**
- 3.1 AC Power-line Conducted Emissions 23
- 3.2 Emission Bandwidth 26
- 3.3 Maximum Conducted Output Power 46
- 3.4 Peak Power Spectral Density 56
- 3.5 Unwanted Emissions 77
- 3.6 Frequency Stability 248
- 4 TEST EQUIPMENT AND CALIBRATION DATA255**

APPENDIX A. TEST RESULTS OF RADIATED EMISSION CO-LOCATION

APPENDIX B. TEST PHOTOS

PHOTOGRAPHS OF EUT V02



Summary of Test Result

Conformance Test Specifications			
Report Clause	Ref. Std. Clause	Description	Result
1.1.2	15.203	Antenna Requirement	Complied
3.1	15.207	AC Power-line Conducted Emissions	Complied
3.2	15.407(a)	Emission Bandwidth	Complied
3.3	15.407(a)	Maximum Conducted Output Power	Complied
3.4	15.407(a)	Peak Power Spectral Density	Complied
3.5	15.407(b)	Unwanted Emissions	Complied
3.6	15.407(g)	Frequency Stability	Complied



1 General Description

1.1 Information

1.1.1 RF General Information

Frequency Range (MHz)	IEEE Std. 802.11	Ch. Frequency (MHz)	Channel Number
5250-5350	a, n (HT20), ac (VHT20)	5260-5320	52-64 [4]
5470-5725		5500-5720	100-140 [12]
5250-5350	n (HT40), ac (VHT40)	5270-5310	54-62 [2]
5470-5725		5510-5710	102-142 [6]
5250-5350	ac (VHT80)	5290	58 [1]
5470-5725		5530-5690	106-138 [3]

Band	Mode	BWch (MHz)	Nant
5.25-5.35GHz	802.11a	20	2TX
5.25-5.35GHz	802.11n HT20	20	2TX
5.25-5.35GHz	802.11n HT20-BF	20	2TX
5.25-5.35GHz	802.11ac VHT20	20	2TX
5.25-5.35GHz	802.11ac VHT20-BF	20	2TX
5.25-5.35GHz	802.11n HT40	40	2TX
5.25-5.35GHz	802.11n HT40-BF	40	2TX
5.25-5.35GHz	802.11ac VHT40	40	2TX
5.25-5.35GHz	802.11ac VHT40-BF	40	2TX
5.25-5.35GHz	802.11ac VHT80	80	2TX
5.25-5.35GHz	802.11ac VHT80-BF	80	2TX
5.47-5.725GHz	802.11a	20	2TX
5.47-5.725GHz	802.11n HT20	20	2TX
5.47-5.725GHz	802.11n HT20-BF	20	2TX
5.47-5.725GHz	802.11ac VHT20	20	2TX
5.47-5.725GHz	802.11ac VHT20-BF	20	2TX
5.47-5.725GHz	802.11n HT40	40	2TX
5.47-5.725GHz	802.11n HT40-BF	40	2TX
5.47-5.725GHz	802.11ac VHT40	40	2TX
5.47-5.725GHz	802.11ac VHT40-BF	40	2TX
5.47-5.725GHz	802.11ac VHT80	80	2TX
5.47-5.725GHz	802.11ac VHT80-BF	80	2TX



Note:

- ♦ 11a, HT20 and HT40 use a combination of OFDM-BPSK, QPSK, 16QAM, 64QAM modulation.
- ♦ VHT20, VHT40, VHT80 use a combination of OFDM-BPSK, QPSK, 16QAM, 64QAM, 256QAM modulation.
- ♦ BWch is the nominal channel bandwidth.
- ♦ Nss-Min is the minimum number of spatial streams.
- ♦ Nant is the number of outputs. e.g., 2(2,3) means have 2 outputs for port 2 and port 3. 2 means have 2 outputs for port 1 and port 2.

1.1.2 Antenna Information

Ant.	Port	Brand	Model Name	Antenna Type	Connector	Gain (dBi)	
						2.4GHz	5GHz
1	1	WNC	48XKAA1Z.SGA.X02	Dipole Antenna	I-PEX	4.84	4.87
2	2	WNC	48XKAA1Z.SGA.X02	Dipole Antenna	I-PEX	4.37	4.86
2TX Correlated Composite Gain(dBi)						4.96	5.15

Note: The EUT has two antennas.

2.4GHz Functions

For IEEE 802.11b/g/n/ac mode (2TX, 2RX):

Ant. 1 and Ant. 2 could transmit/receive simultaneously.

5GHz Functions

For IEEE 802.11a/n/ac mode (2TX, 2RX):

Ant. 1 and Ant. 2 could transmit/receive simultaneously.



1.1.3 Mode Test Duty Cycle

Mode	DC	DCF(dB)	T(s)	VBW(Hz) ≥ 1/T
802.11a	0.964	0.159	2.033m	1k
802.11ac VHT20	0.984	0.07	n/a (DC>=0.98)	n/a (DC>=0.98)
802.11ac VHT20-BF	0.911	0.405	1.823m	1k
802.11ac VHT40	0.961	0.173	2.403m	1k
802.11ac VHT40-BF	0.913	0.395	1.753m	1k
802.11ac VHT80	0.926	0.334	1.125m	1k
802.11ac VHT80-BF	0.885	0.531	2.015m	1k

Note:

The test procedure refers to ANSI C63.10:2013 clause 11.6 b). The ON and OFF times of the transmitted signal is measured by spectrum analyzer and the setting as follows:

- 1) Set the center frequency of the instrument to the center frequency of the transmission.
- 2) Set RBW ≥ OBW if possible; otherwise, set RBW to the largest available value.
- 3) Set VBW ≥ RBW. Set detector = peak or average.

The measured result and plots are recorded in 1.1.3.

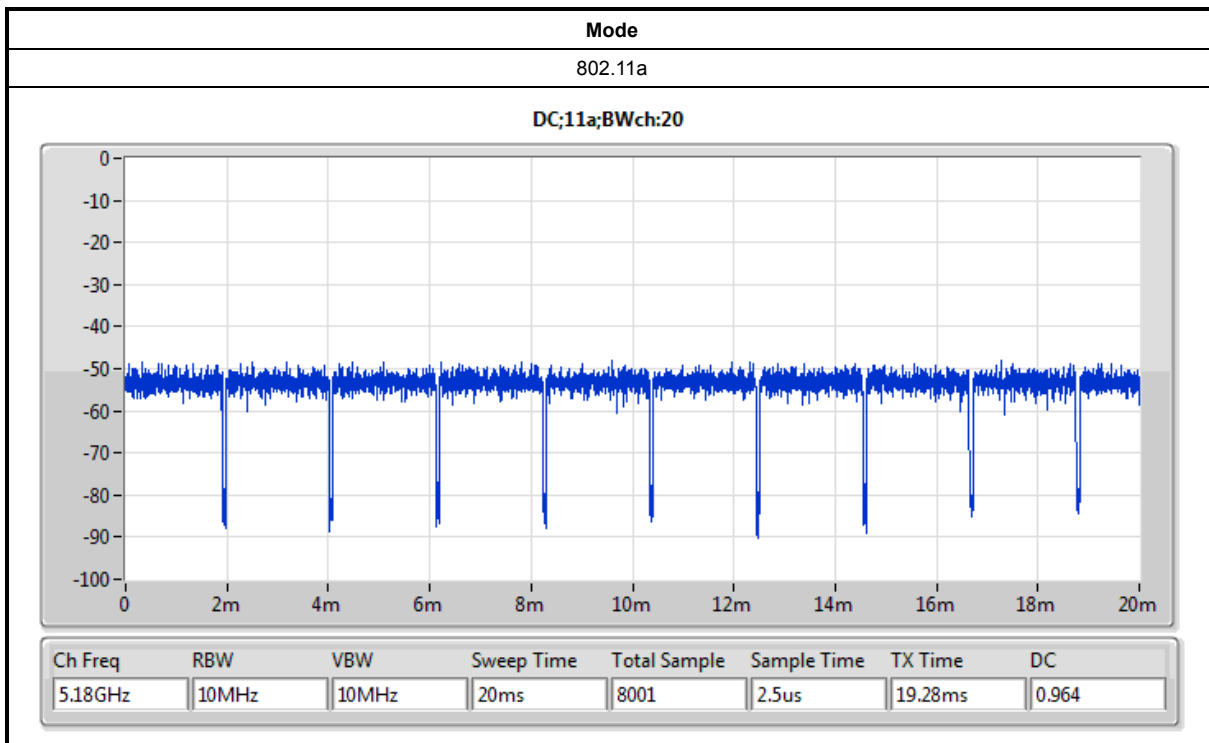

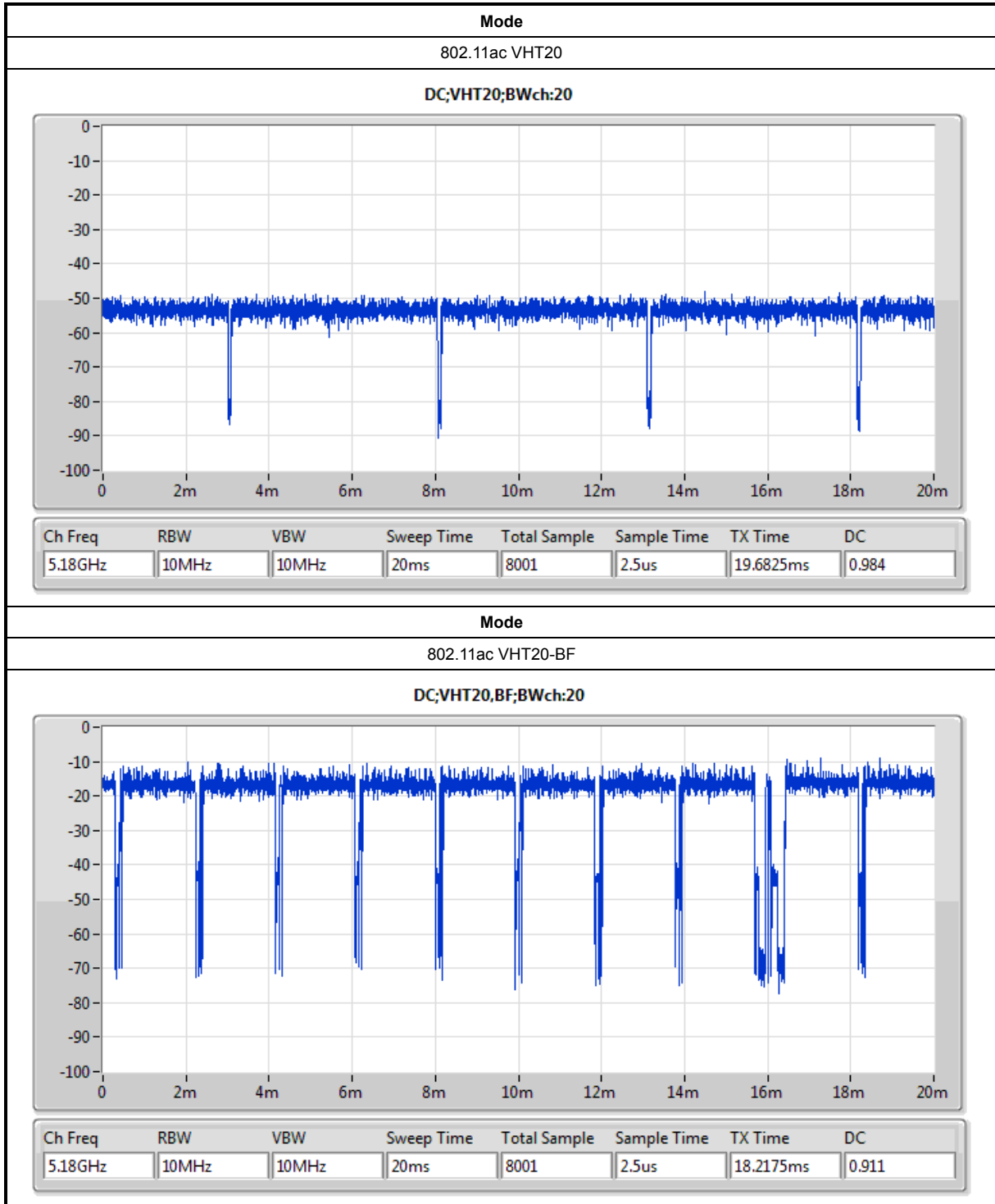

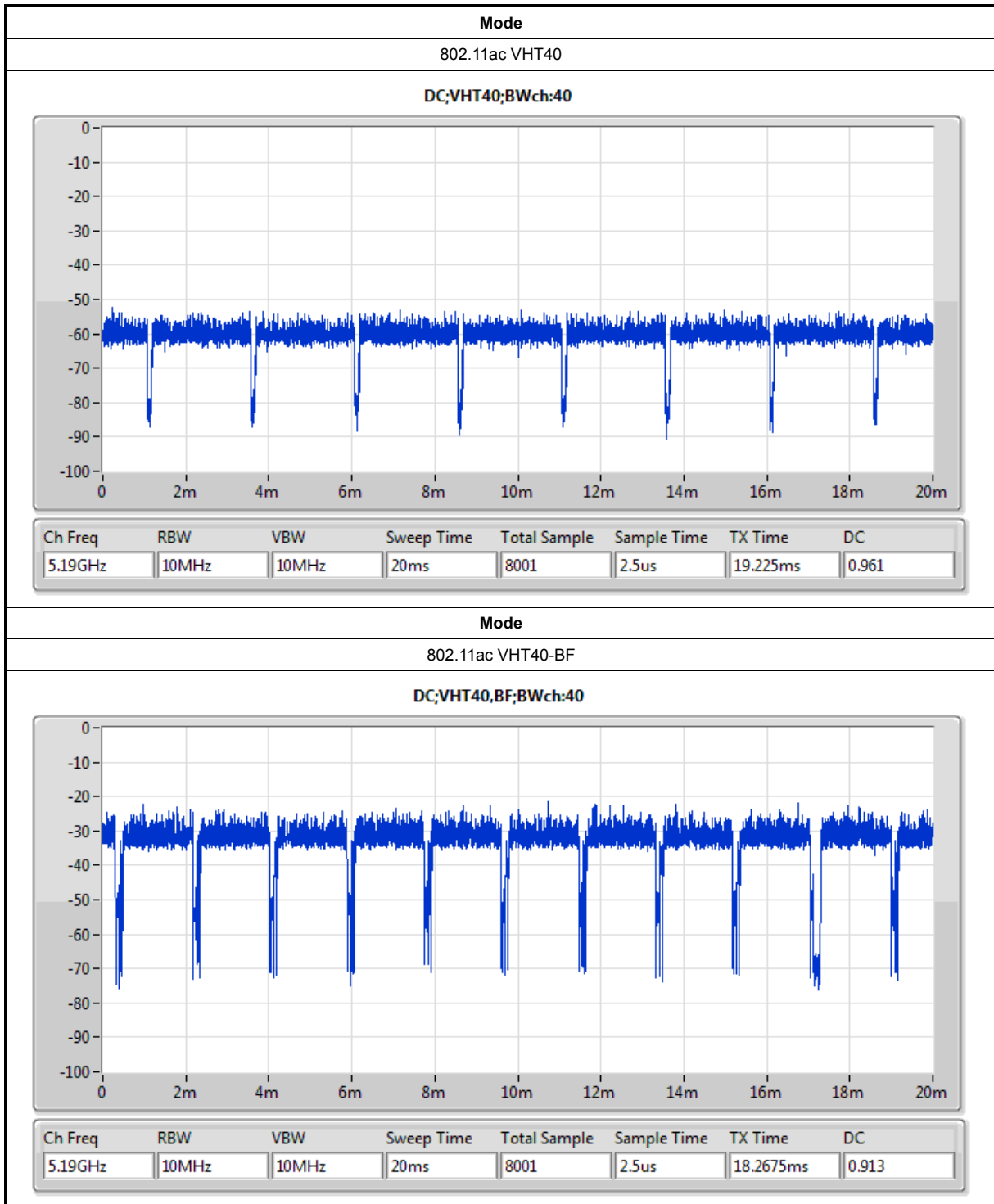

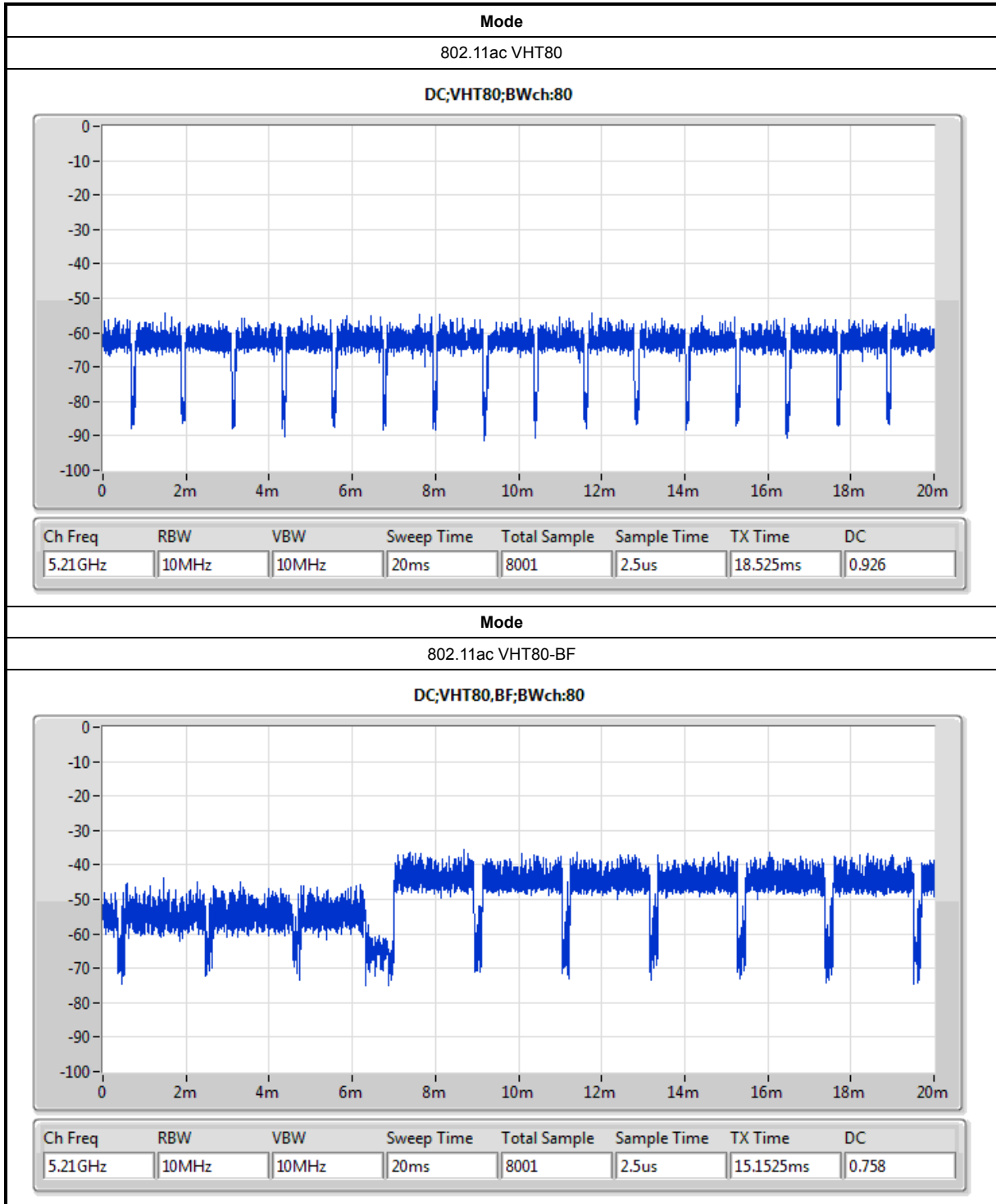



1.1.4 EUT Operational Condition

EUT Power Type	From Power Adapter or PoE		
Beamforming Function	<input checked="" type="checkbox"/>	With beamforming for 802.11n/ac in 2.4GHz/5GHz.	<input type="checkbox"/> Without beamforming
Weather Band	<input checked="" type="checkbox"/>	With 5600~5650MHz	<input type="checkbox"/> Without 5600~5650MHz

1.2 Testing Applied Standards

According to the specifications of the manufacturer, the EUT must comply with the requirements of the following standards:

- ◆ 47 CFR FCC Part 15
- ◆ ANSI C63.10-2013
- ◆ FCC KDB 789033 D02 v02r01
- ◆ FCC KDB 662911 D01 v02r01
- ◆ FCC KDB 412172 D01 v01r01

1.3 Testing Location Information

Testing Location		
<input type="checkbox"/>	HWA YA	ADD : No. 52, Hwa Ya 1st Rd., Kwei-Shan Hsiang, Tao Yuan Hsien, Taiwan, R.O.C. TEL : 886-3-327-3456 FAX : 886-3-318-0055
<input checked="" type="checkbox"/>	JHUBEI	ADD : No.8, Lane 724, Bo-ai St., Jhubei City, HsinChu County 302, Taiwan, R.O.C. TEL : 886-3-656-9065 FAX : 886-3-656-9085

Test Condition	Test Site No.	Test Engineer	Test Environment	Test Date
RF Conducted	TH01-CB	Gary Chu & Ron Huang	26.9°C / 62%	Sep. 04, 2017
Radiated	03CH01-CB	Justin Lin & Paul Chen	22°C / 54%	Aug. 31, 2017 ~ Sep. 05, 2017
AC Conduction	CO01-CB	Deven Huang	23°C / 60%	Sep. 05, 2017

Test site Designation No. TW0006 with FCC

Test site registered number IC 4086D with Industry Canada.

1.4 Measurement Uncertainty

ISO/IEC 17025 requires that an estimate of the measurement uncertainties associated with the emissions test results be included in the report. The measurement uncertainties given below are based on a 95% confidence level (based on a coverage factor (k=2))

Test Items	Uncertainty	Remark
Conducted Emission (150kHz ~ 30MHz)	3.2 dB	Confidence levels of 95%
Radiated Emission (30MHz ~ 1,000MHz)	3.6 dB	Confidence levels of 95%
Radiated Emission (1GHz ~ 18GHz)	3.7 dB	Confidence levels of 95%
Radiated Emission (18GHz ~ 40GHz)	3.5 dB	Confidence levels of 95%
Conducted Emission	1.7 dB	Confidence levels of 95%
Output Power Measurement	1.33 dB	Confidence levels of 95%
Power Density Measurement	1.27 dB	Confidence levels of 95%
Bandwidth Measurement	9.74 x10 ⁻⁸	Confidence levels of 95%
Frequency Stability	6.06 x10 ⁻⁸	Confidence levels of 95%



2 Test Configuration of EUT

2.1 Test Channel Mode

Mode	Power Setting
802.11a_(6Mbps)_2TX	-
5260MHz	21
5300MHz	20.5
5320MHz	20.5
5500MHz	20.5
5580MHz	21
5700MHz	15.5
5720MHz Straddle 5.47-5.725GHz	18
5720MHz Straddle 5.725-5.85GHz	18
802.11ac VHT20_Nss1,(MCS0)_2TX	-
5260MHz	21.5
5300MHz	20.5
5320MHz	18
5500MHz	19
5580MHz	21
5700MHz	16.5
5720MHz Straddle 5.47-5.725GHz	21
5720MHz Straddle 5.725-5.85GHz	21
802.11ac VHT40_Nss1,(MCS0)_2TX	-
5270MHz	20.5
5310MHz	15.5
5510MHz	15.5
5550MHz	20.5
5670MHz	18.5
5710MHz Straddle 5.47-5.725GHz	20.5
5710MHz Straddle 5.725-5.85GHz	20.5
802.11ac VHT80_Nss1,(MCS0)_2TX	-
5290MHz	15
5530MHz	16.5
5610MHz	19.5
5690MHz Straddle 5.47-5.725GHz	20.5
5690MHz Straddle 5.725-5.85GHz	20.5
802.11ac VHT20-BF_Nss1,(MCS0)_2TX	-



Mode	Power Setting
5260MHz	21
5300MHz	21
5320MHz	20
5500MHz	21
5580MHz	21
5700MHz	19
5720MHz Straddle 5.47-5.725GHz	21
5720MHz Straddle 5.725-5.85GHz	21
802.11ac VHT40-BF_Nss1,(MCS0)_2TX	-
5270MHz	21
5310MHz	19
5510MHz	20
5550MHz	21
5670MHz	21
5710MHz Straddle 5.47-5.725GHz	21
5710MHz Straddle 5.725-5.85GHz	21
802.11ac VHT80-BF_Nss1,(MCS0)_2TX	-
5290MHz	19
5530MHz	19
5610MHz	21
5690MHz Straddle 5.47-5.725GHz	21
5690MHz Straddle 5.725-5.85GHz	21

Note:

- ♦ VHT20/VHT40 covers HT20/HT40, due to same modulation. The power setting for 802.11n HT20 and HT40 are the same or lower than 802.11ac VHT20 and VHT40.
- ♦ There are two modes of EUT for 802.11ac in 2.4GHz/5GHz. One is beamforming mode, and the other is non-beamforming mode. Both modes have been tested and recorded in this test report.

2.2 The Worst Case Measurement Configuration

The Worst Case Mode for Following Conformance Tests	
Tests Item	AC power-line conducted emissions
Condition	AC power-line conducted measurement for line and neutral
Operating Mode	Normal Link
1	EUT + Adapter
2	EUT + PoE
For operating mode 2 is the worst case and it was record in this test report.	

The Worst Case Mode for Following Conformance Tests	
Tests Item	Emission Bandwidth Maximum Conducted Output Power Peak Power Spectral Density Frequency Stability
Test Condition	Conducted measurement at transmit chains

The Worst Case Mode for Following Conformance Tests	
Tests Item	Unwanted Emissions
Test Condition	Radiated measurement If EUT consist of multiple antenna assembly (multiple antenna are used in EUT regardless of spatial multiplexing MIMO configuration), the radiated test should be performed with highest antenna gain of each antenna type.
Operating Mode < 1GHz	Normal Link
1	EUT in Y axis + Adapter
2	EUT in Z axis + Adapter
Mode 2 has been evaluated to be the worst case among Mode 1~2, thus measurement for Mode 3 will follow this same test mode.	
3	EUT in Z axis + PoE
For operating mode 2 is the worst case and it was record in this test report.	
Operating Mode > 1GHz	CTX The EUT was performed at Y axis and Z axis position for Radiated emission above 1GHz test, and the worst case was found at Z axis. So the measurement will follow this same test configuration.
1	EUT in Z axis



The Worst Case Mode for Following Conformance Tests	
Tests Item	Simultaneous Transmission Analysis - Radiated Emission Co-location
Test Condition	Radiated measurement
Operating Mode	Normal Link
	The EUT was performed at Y axis and Z axis position for radiated emission below 1GHz test, and the worst case was found at Z axis. So the measurement will follow this same test configuration.
1	WLAN 2.4GHz + WLAN 5GHz
Refer to Appendix A for Radiated Emission Co-location.	

The Worst Case Mode for Following Conformance Tests	
Tests Item	Simultaneous Transmission Analysis - Co-location RF Exposure Evaluation
Operating Mode	
1	WLAN 2.4GHz + WLAN 5GHz
Refer to Sporton Test Report No.: FA782229 for Co-location RF Exposure Evaluation.	

Note1: The PoE was for measurement only, would not be marketed.

The PoE information as below:

Support Unit	Brand	Model Number
PoE	CISCO	MA-INJ-4

2.3 EUT Operation during Test

For CTX Mode:

non-beamforming mode:

The EUT was programmed to be in continuously transmitting mode.

beamforming mode:

For Conducted Mode:

The EUT was programmed to be in continuously transmitting mode.

For Radiated Mode:

During the test, the following programs under WIN 7 were executed.

The program was executed as follows:

1. During the test, the EUT operation to normal function.
2. Executed command fixed test channel under Telnet.
3. Executed "Lantest.exe" to link with the remote workstation to transmit and receive packet by RX Device and transmit duty cycle no less than 98%.

For Normal Link:

During the test, the EUT operation to normal function.



2.4 Accessories

Accessories			
Equipment Name	Brand Name	Model Name	Rating
Adapter	CISCO	KSAS0361200250HU	INPUT: 100-240V ~ 50/60Hz 1.0A OUTPUT: 12V, 2.5A
Other			
Wall-mounted rack*1			

2.5 Support Equipment

For Test Site No: CO01-CB

Support Equipment				
No.	Equipment	Brand Name	Model Name	FCC ID
1	NB	DELL	E6430	DoC
2	NB	DELL	E6430	DoC
3	NB	DELL	E6430	DoC
4	PoE	CISCO	MA-INJ-4	DoC

For Test Site No: 03CH01-CB (below 1GHz)

Support Equipment				
No.	Equipment	Brand Name	Model Name	FCC ID
1	NB	DELL	E4300	DoC
2	NB	Apple	Mac Book	DoC
3	NB	Apple	Mac Book	DoC

For Test Site No: 03CH01-CB (above 1GHz)

<For Non-Beamforming Mode>

Support Equipment				
No.	Equipment	Brand Name	Model Name	FCC ID
1	NB	DELL	E4300	DoC

<For Beamforming Mode>

Support Equipment				
No.	Equipment	Brand Name	Model Name	FCC ID
1	NB	DELL	E4300	DoC
2	NB	DELL	E4300	DoC
3	RX Device	CISCO	GR60-HW	UDX-60067010



For Test Site No: TH01-CB

Support Equipment				
No.	Equipment	Brand Name	Model Name	FCC ID
1	NB	DELL	E4300	DoC

2.6 Test Setup Diagram

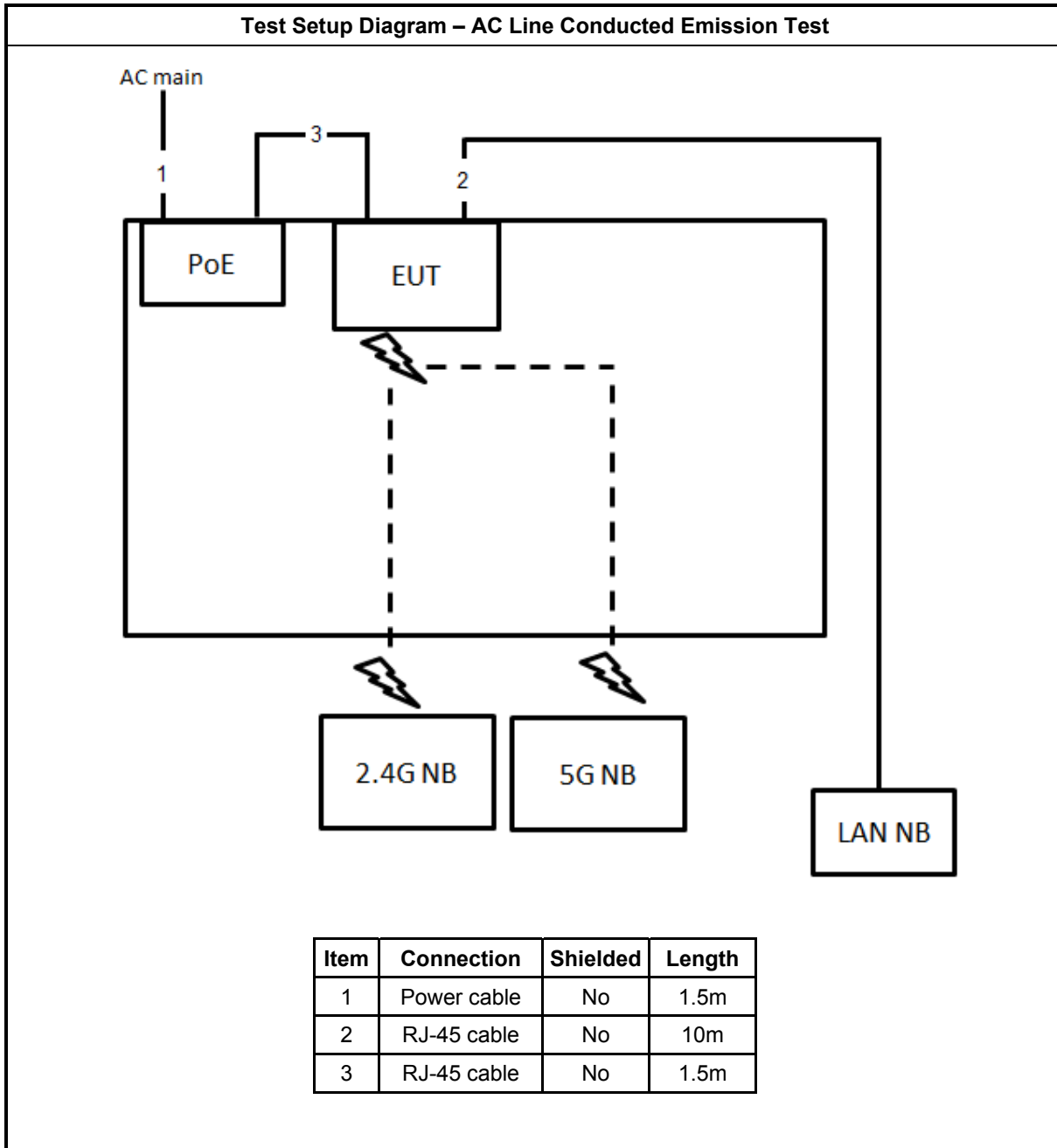

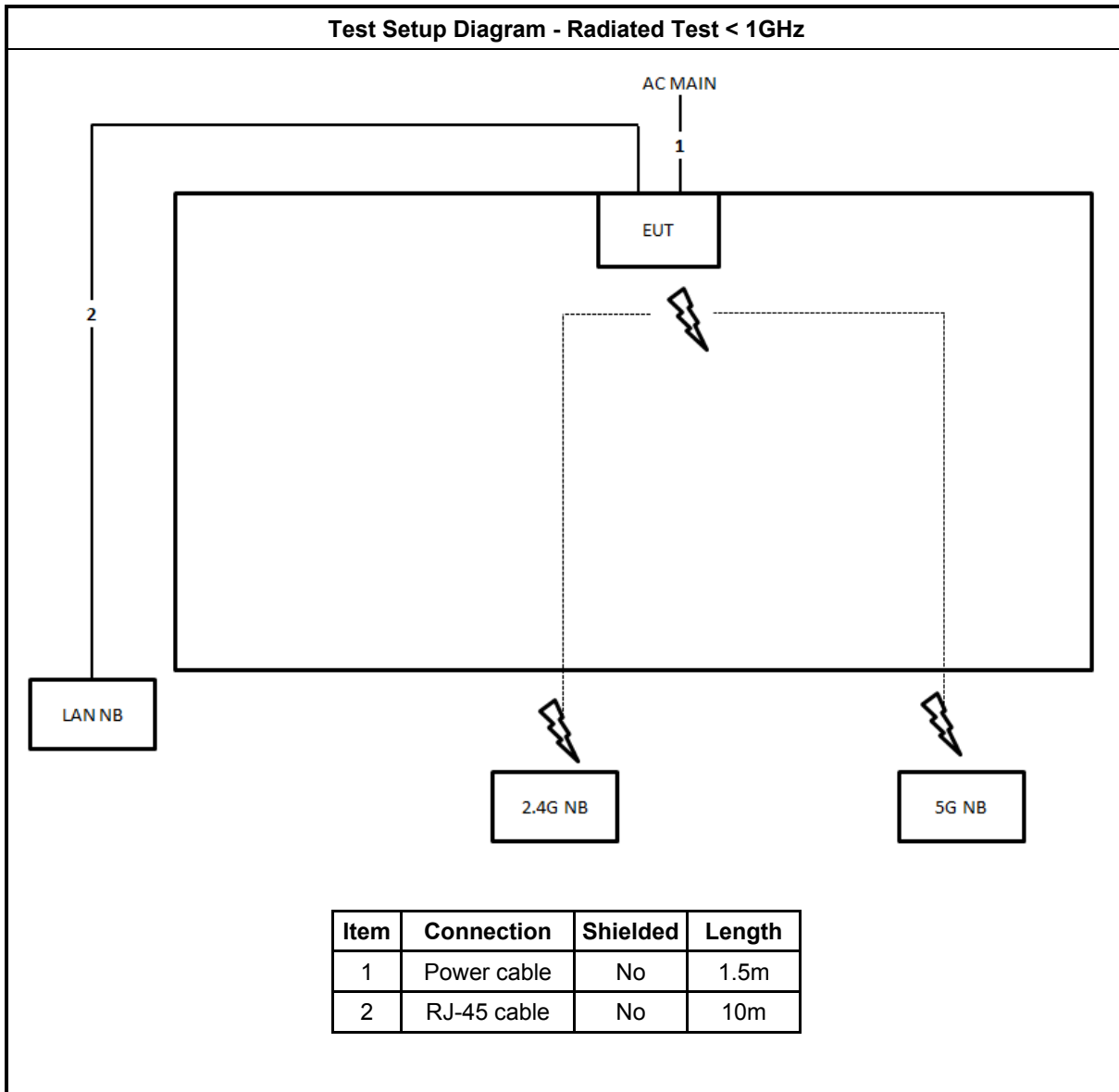

Test Setup Diagram - Radiated Test > 1GHz / For Non-Beamforming Mode

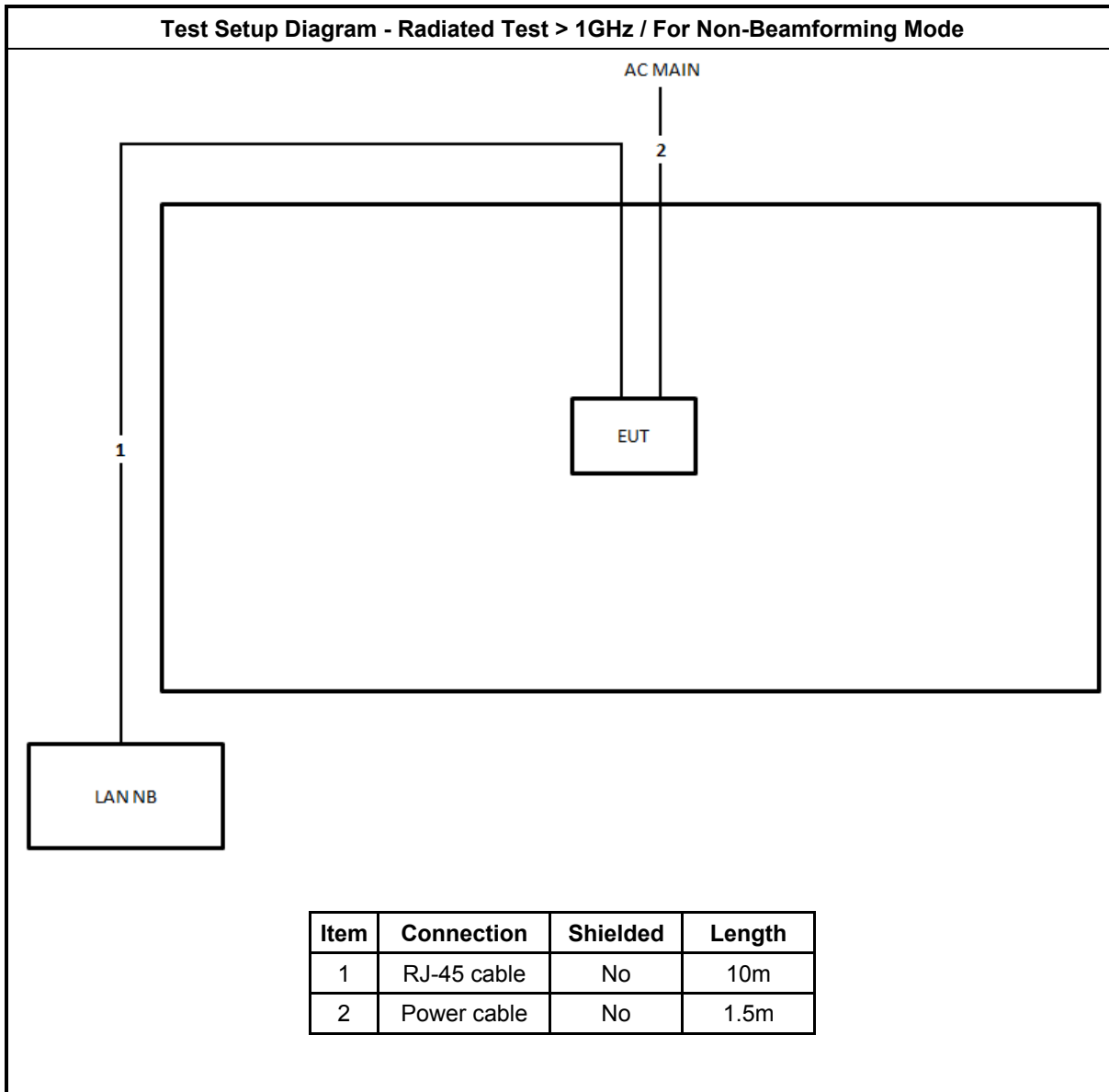

Item	Connection	Shielded	Length
1	RJ-45 cable	No	10m
2	Power cable	No	1.5m

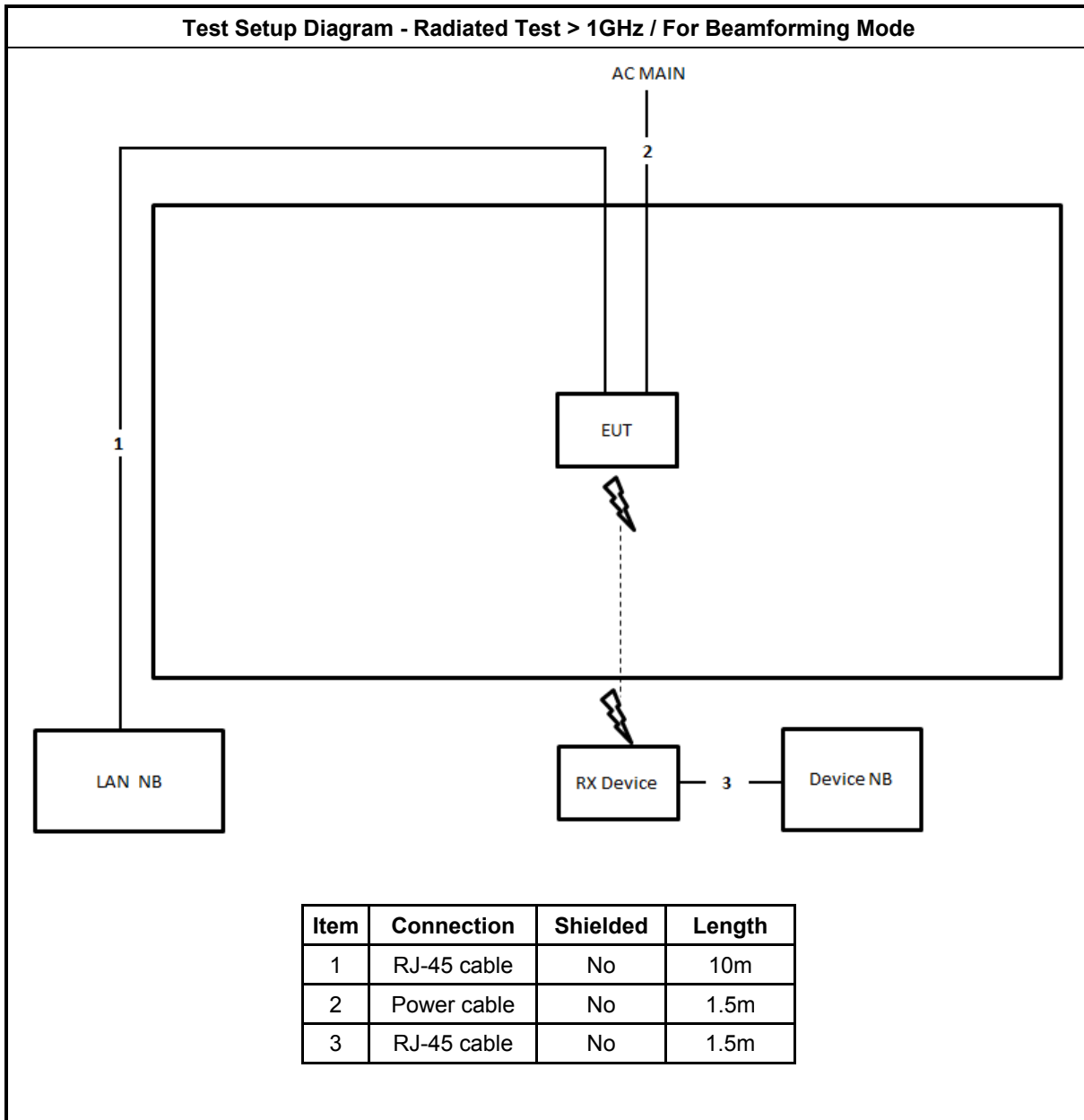

3 Transmitter Test Result

3.1 AC Power-line Conducted Emissions

3.1.1 AC Power-line Conducted Emissions Limit

AC Power-line Conducted Emissions Limit		
Frequency Emission (MHz)	Quasi-Peak	Average
0.15-0.5	66 - 56 *	56 - 46 *
0.5-5	56	46
5-30	60	50

Note 1: * Decreases with the logarithm of the frequency.

3.1.2 Measuring Instruments

Refer a test equipment and calibration data table in this test report.

3.1.3 Test Procedures

Test Method
<input checked="" type="checkbox"/> Refer as ANSI C63.10-2013, clause 6.2 for AC power-line conducted emissions.

3.1.4 Test Setup

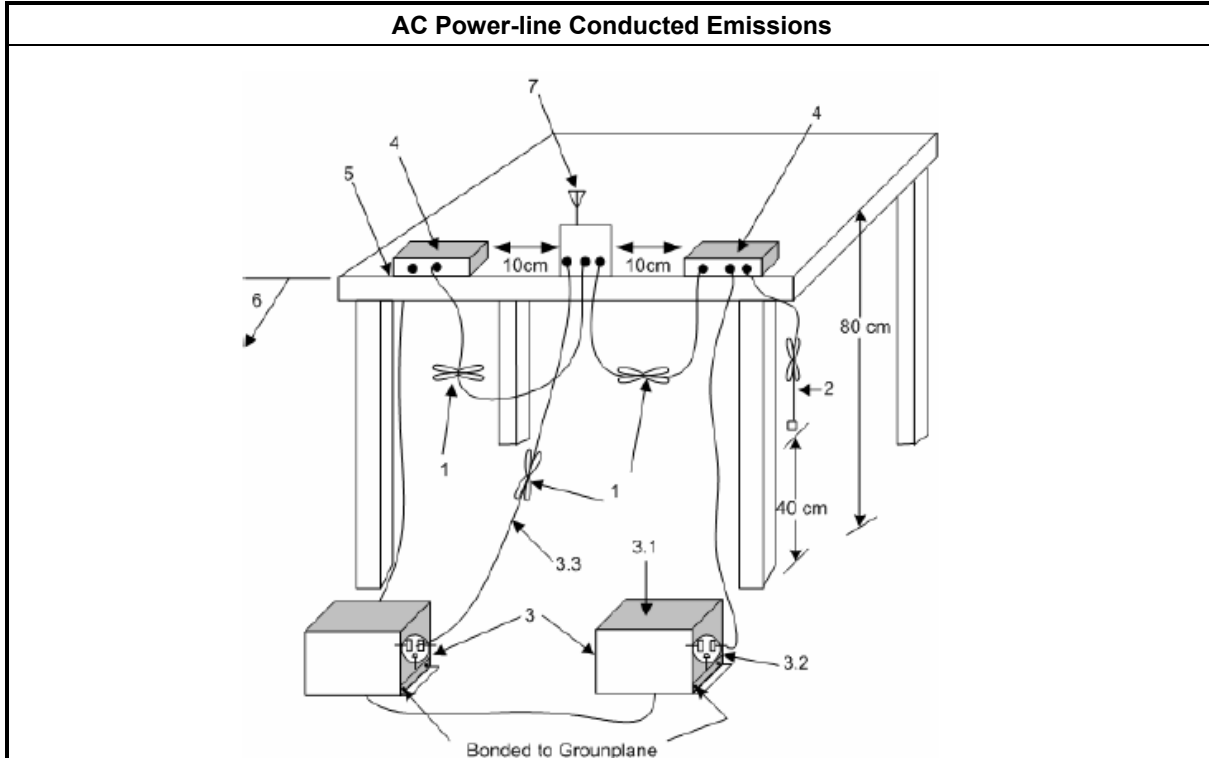



3.1.5 Test Result of AC Power-line Conducted Emissions

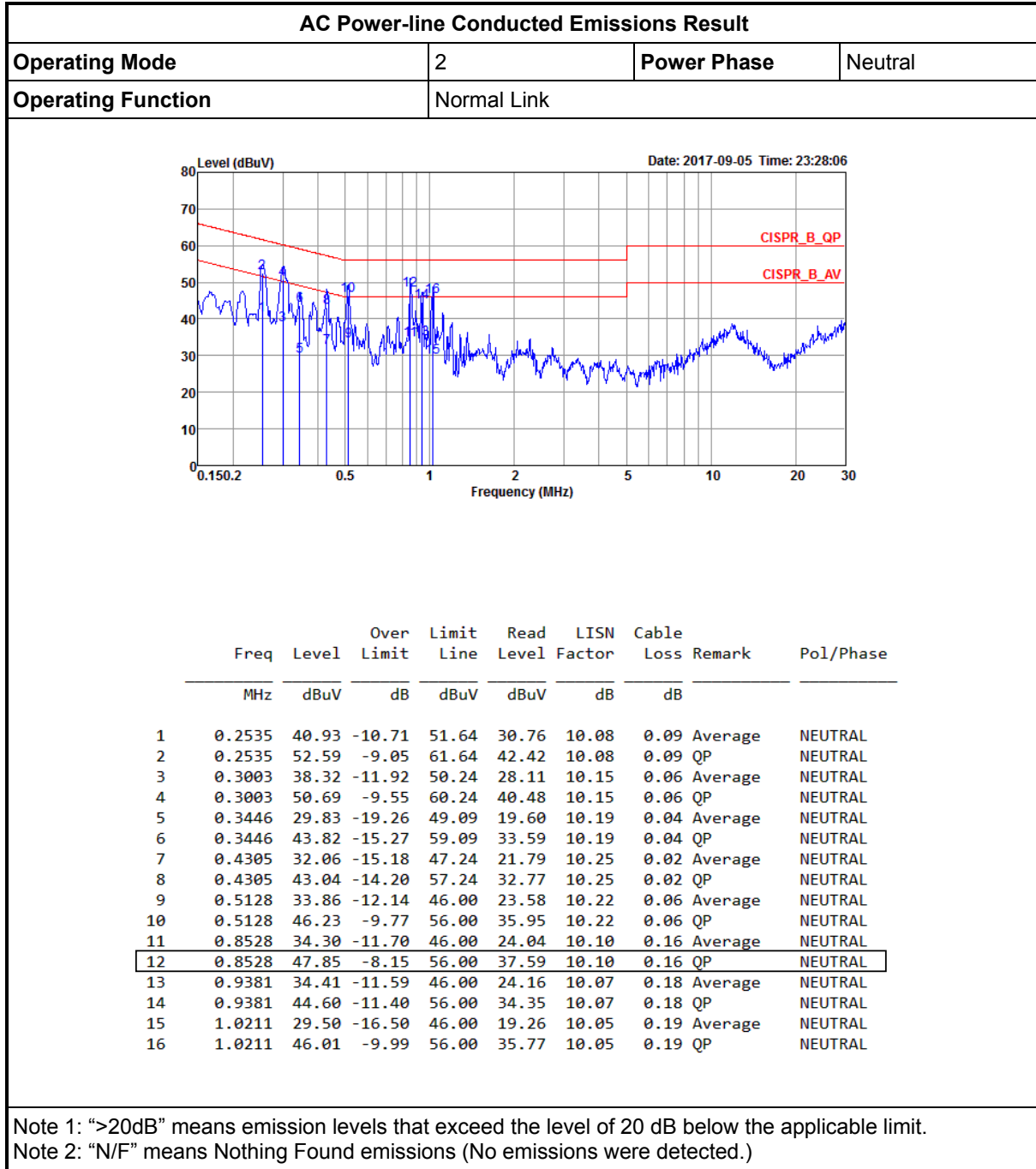



AC Power-line Conducted Emissions Result									
Operating Mode	2		Power Phase	Line					
Operating Function	Normal Link								
<p>The graph displays the AC power-line conducted emissions. The y-axis represents Level in dBuV (0 to 80), and the x-axis represents Frequency in MHz (0.150.2 to 30). Two red lines indicate the CISPR limits: CISPR_B_QP (Quasi-Peak) and CISPR_B_AV (Average). The test results are shown as a blue line with peaks labeled 1 through 16. Most peaks are below the CISPR_B_QP limit, but peak 2 is above it.</p>									
	Freq	Level	Over Limit	Limit Line	Read Level	LISN Factor	Cable Loss	Remark	Pol/Phase
	MHz	dBuV	dB	dBuV	dBuV	dB	dB		
1	0.2562	42.23	-9.33	51.56	32.22	9.92	0.09	Average	LINE
2	0.2562	52.73	-8.83	61.56	42.72	9.92	0.09	QP	LINE
3	0.3003	38.18	-12.06	50.24	28.19	9.93	0.06	Average	LINE
4	0.3003	50.26	-9.98	60.24	40.27	9.93	0.06	QP	LINE
5	0.3446	29.34	-19.75	49.09	19.36	9.94	0.04	Average	LINE
6	0.3446	43.34	-15.75	59.09	33.36	9.94	0.04	QP	LINE
7	0.4260	31.91	-15.42	47.33	21.94	9.95	0.02	Average	LINE
8	0.4260	42.46	-14.87	57.33	32.49	9.95	0.02	QP	LINE
9	0.5128	33.28	-12.72	46.00	23.27	9.95	0.06	Average	LINE
10	0.5128	45.59	-10.41	56.00	35.58	9.95	0.06	QP	LINE
11	0.8528	33.87	-12.13	46.00	23.75	9.96	0.16	Average	LINE
12	0.8528	47.44	-8.56	56.00	37.32	9.96	0.16	QP	LINE
13	0.9381	33.86	-12.14	46.00	23.72	9.96	0.18	Average	LINE
14	0.9381	44.33	-11.67	56.00	34.19	9.96	0.18	QP	LINE
15	1.0211	29.22	-16.78	46.00	19.07	9.96	0.19	Average	LINE
16	1.0211	45.75	-10.25	56.00	35.60	9.96	0.19	QP	LINE
<p>Note 1: ">20dB" means emission levels that exceed the level of 20 dB below the applicable limit. Note 2: "N/F" means Nothing Found emissions (No emissions were detected.)</p>									

3.2 Emission Bandwidth

3.2.1 Emission Bandwidth Limit

Emission Bandwidth Limit	
UNII Devices	
<input type="checkbox"/>	For the 5.15-5.25 GHz band, N/A
<input checked="" type="checkbox"/>	For the 5.25-5.35 GHz band, the maximum conducted output power shall not exceed the lesser of 250 mW or 11 dBm + 10 log B, where B is the 26 dB emission bandwidth in MHz.
<input checked="" type="checkbox"/>	For the 5.47-5.725 GHz band, the maximum conducted output power shall not exceed the lesser of 250 mW or 11 dBm + 10 log B, where B is the 26 dB emission bandwidth in MHz.
<input checked="" type="checkbox"/>	For the 5.725-5.85 GHz band, 6 dB emission bandwidth ≥ 500kHz.
LE-LAN Devices	
<input type="checkbox"/>	For the band 5.15-5.25 GHz, the maximum e.i.r.p. shall not exceed 200 mW or 10 + 10 log B, dBm, whichever power is less. B is the 99% emission bandwidth in MHz.
<input type="checkbox"/>	For the 5.25-5.35 GHz band, the maximum e.i.r.p. shall not exceed 1.0 W or 17 + 10 log B, dBm, whichever power is less. B is the 99% emission bandwidth in MHz
<input type="checkbox"/>	For the 5.47-5.6 GHz band and 5.65-5.725 GHz band, the maximum e.i.r.p. shall not exceed 1.0 W or 17 + 10 log B, dBm, whichever power is less. B is the 99% emission bandwidth in MHz
<input type="checkbox"/>	For the 5.725-5.85 GHz band, 6 dB emission bandwidth ≥ 500kHz.

3.2.2 Measuring Instruments

Refer a test equipment and calibration data table in this test report.

3.2.3 Test Procedures

Test Method							
<ul style="list-style-type: none"> ▪ For the emission bandwidth shall be measured using one of the options below: <table border="1" style="width: 100%; border-collapse: collapse;"> <tr> <td style="width: 20px;"><input checked="" type="checkbox"/></td> <td>Refer as FCC KDB 789033, clause C for EBW and clause D for OBW measurement.</td> </tr> <tr> <td><input type="checkbox"/></td> <td>Refer as ANSI C63.10, clause 6.9.1 for occupied bandwidth testing.</td> </tr> <tr> <td><input checked="" type="checkbox"/></td> <td>Refer as IC RSS-Gen, clause 4.6 for bandwidth testing.</td> </tr> </table> 		<input checked="" type="checkbox"/>	Refer as FCC KDB 789033, clause C for EBW and clause D for OBW measurement.	<input type="checkbox"/>	Refer as ANSI C63.10, clause 6.9.1 for occupied bandwidth testing.	<input checked="" type="checkbox"/>	Refer as IC RSS-Gen, clause 4.6 for bandwidth testing.
<input checked="" type="checkbox"/>	Refer as FCC KDB 789033, clause C for EBW and clause D for OBW measurement.						
<input type="checkbox"/>	Refer as ANSI C63.10, clause 6.9.1 for occupied bandwidth testing.						
<input checked="" type="checkbox"/>	Refer as IC RSS-Gen, clause 4.6 for bandwidth testing.						

3.2.4 Test Setup

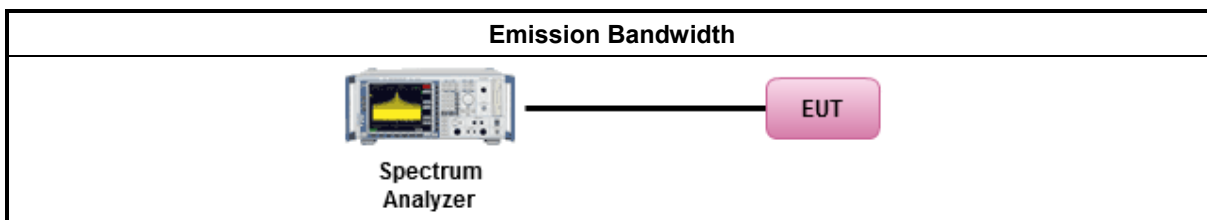



3.2.5 Test Result of Emission Bandwidth

Summary

Mode	Max-N dB (Hz)	Max-OBW (Hz)	ITU-Code	Min-N dB (Hz)	Min-OBW (Hz)
802.11a_(6Mbps)_2TX	-	-	-	-	-
5.25-5.35GHz	41.45M	19.865M	19M9D1D	35.75M	16.592M
5.47-5.725GHz	39.175M	16.992M	17MOD1D	14.91M	13.238M
5.725-5.85GHz	3.14M	3.738M	3M74D1D	3.12M	3.418M
802.11ac VHT20_Nss1,(MCS0)_2TX	-	-	-	-	-
5.25-5.35GHz	43.05M	19.89M	19M9D1D	21.4M	17.641M
5.47-5.725GHz	40.175M	18.066M	18M1D1D	19.975M	13.898M
5.725-5.85GHz	3.76M	13.013M	13MOD1D	3.74M	9.535M
802.11ac VHT40_Nss1,(MCS0)_2TX	-	-	-	-	-
5.25-5.35GHz	89.9M	39.73M	39M7D1D	39.45M	35.882M
5.47-5.725GHz	81.35M	36.432M	36M4D1D	39.55M	33.058M
5.725-5.85GHz	3.22M	26.147M	26M1D1D	3.12M	22.089M
802.11ac VHT80_Nss1,(MCS0)_2TX	-	-	-	-	-
5.25-5.35GHz	83.5M	75.662M	75M7D1D	82.6M	75.562M
5.47-5.725GHz	149.8M	75.862M	75M9D1D	83.7M	72.864M
5.725-5.85GHz	3.12M	36.562M	36M6D1D	3.1M	33.583M
802.11ac VHT20-BF_Nss1,(MCS0)_2TX	-	-	-	-	-
5.25-5.35GHz	23.575M	17.691M	17M7D1D	20.65M	17.641M
5.47-5.725GHz	21.125M	17.641M	17M6D1D	15.03M	13.808M
5.725-5.85GHz	3.76M	4.058M	4M06D1D	3.74M	3.918M
802.11ac VHT40-BF_Nss1,(MCS0)_2TX	-	-	-	-	-
5.25-5.35GHz	68.65M	36.232M	36M2D1D	39.45M	35.982M
5.47-5.725GHz	56.7M	36.182M	36M2D1D	34.895M	32.884M
5.725-5.85GHz	3.12M	13.893M	13M9D1D	3.12M	3.778M
802.11ac VHT80-BF_Nss1,(MCS0)_2TX	-	-	-	-	-
5.25-5.35GHz	83.7M	75.762M	75M8D1D	82.8M	75.662M
5.47-5.725GHz	83.9M	75.762M	75M8D1D	76.725M	72.714M
5.725-5.85GHz	3.12M	24.668M	24M7D1D	3.12M	5.897M

Max-N dB = Maximum 6dB down bandwidth for 5.725-5.85GHz band / Maximum 26dB down bandwidth for other band;

Max-OBW = Maximum 99% occupied bandwidth;

Min-N dB = Minimum 6dB down bandwidth for 5.725-5.85GHz band / Maximum 26dB down bandwidth for other band;

Min-OBW = Minimum 99% occupied bandwidth;



Result

Mode	Result	Limit (Hz)	Port 1-N dB (Hz)	Port 1-OBW (Hz)	Port 2-N dB (Hz)	Port 2-OBW (Hz)
802.11a_(6Mbps)_2TX	-	-	-	-	-	-
5260MHz	Pass	Inf	38.725M	16.717M	38.35M	17.216M
5300MHz	Pass	Inf	36.35M	16.592M	41.225M	18.641M
5320MHz	Pass	Inf	35.75M	16.692M	41.45M	19.865M
5500MHz	Pass	Inf	31.675M	16.517M	36.95M	16.692M
5580MHz	Pass	Inf	39.175M	16.992M	36.175M	16.667M
5700MHz	Pass	Inf	19.275M	16.442M	18.95M	16.417M
5720MHz Straddle 5.47-5.725GHz	Pass	Inf	15.645M	13.238M	14.91M	13.238M
5720MHz Straddle 5.725-5.85GHz	Pass	500k	3.12M	3.738M	3.14M	3.418M
802.11ac VHT20_Nss1,(MCS0)_2TX	-	-	-	-	-	-
5260MHz	Pass	Inf	43.05M	18.541M	42.825M	19.89M
5300MHz	Pass	Inf	37.725M	17.791M	41.25M	18.966M
5320MHz	Pass	Inf	21.4M	17.641M	27.75M	17.716M
5500MHz	Pass	Inf	21.2M	17.616M	26.05M	17.641M
5580MHz	Pass	Inf	40.175M	18.066M	37.275M	17.841M
5700MHz	Pass	Inf	20.5M	17.616M	19.975M	17.616M
5720MHz Straddle 5.47-5.725GHz	Pass	Inf	24.885M	14.363M	20.535M	13.898M
5720MHz Straddle 5.725-5.85GHz	Pass	500k	3.74M	13.013M	3.76M	9.535M
802.11ac VHT40_Nss1,(MCS0)_2TX	-	-	-	-	-	-
5270MHz	Pass	Inf	81.65M	36.532M	89.9M	39.73M
5310MHz	Pass	Inf	39.45M	35.882M	39.5M	35.932M
5510MHz	Pass	Inf	39.55M	35.982M	39.6M	36.032M
5550MHz	Pass	Inf	79.65M	36.332M	81.35M	36.432M
5670MHz	Pass	Inf	70.75M	36.132M	40.15M	36.032M
5710MHz Straddle 5.47-5.725GHz	Pass	Inf	60.06M	34.668M	56.21M	33.058M
5710MHz Straddle 5.725-5.85GHz	Pass	500k	3.22M	26.147M	3.12M	22.089M
802.11ac VHT80_Nss1,(MCS0)_2TX	-	-	-	-	-	-
5290MHz	Pass	Inf	83.5M	75.562M	82.6M	75.662M
5530MHz	Pass	Inf	84.1M	75.562M	83.7M	75.862M
5610MHz	Pass	Inf	149.8M	75.762M	115.9M	75.862M
5690MHz Straddle 5.47-5.725GHz	Pass	Inf	130.875M	73.538M	114.525M	72.864M
5690MHz Straddle 5.725-5.85GHz	Pass	500k	3.1M	36.562M	3.12M	33.583M
802.11ac VHT20-BF_Nss1,(MCS0)_2TX	-	-	-	-	-	-
5260MHz	Pass	Inf	23.1M	17.691M	23.575M	17.666M
5300MHz	Pass	Inf	21.25M	17.666M	22.75M	17.666M
5320MHz	Pass	Inf	20.65M	17.641M	21.175M	17.666M
5500MHz	Pass	Inf	20.475M	17.591M	21.125M	17.616M
5580MHz	Pass	Inf	20.5M	17.641M	20.625M	17.591M
5700MHz	Pass	Inf	19.975M	17.616M	20M	17.616M
5720MHz Straddle 5.47-5.725GHz	Pass	Inf	15.42M	13.823M	15.03M	13.808M
5720MHz Straddle 5.725-5.85GHz	Pass	500k	3.74M	4.058M	3.76M	3.918M
802.11ac VHT40-BF_Nss1,(MCS0)_2TX	-	-	-	-	-	-
5270MHz	Pass	Inf	49.1M	36.032M	68.65M	36.232M



Mode	Result	Limit (Hz)	Port 1-N dB (Hz)	Port 1-OBW (Hz)	Port 2-N dB (Hz)	Port 2-OBW (Hz)
5310MHz	Pass	Inf	39.65M	35.982M	39.45M	35.982M
5510MHz	Pass	Inf	39.65M	36.032M	39.65M	36.032M
5550MHz	Pass	Inf	39.75M	36.082M	39.75M	36.032M
5670MHz	Pass	Inf	56.7M	36.182M	39.65M	36.032M
5710MHz Straddle 5.47-5.725GHz	Pass	Inf	41.72M	32.919M	34.895M	32.884M
5710MHz Straddle 5.725-5.85GHz	Pass	500k	3.12M	13.893M	3.12M	3.778M
802.11ac VHT80-BF_Nss1,(MCS0)_2TX	-	-	-	-	-	-
5290MHz	Pass	Inf	83.7M	75.762M	82.8M	75.662M
5530MHz	Pass	Inf	83.1M	75.562M	83.2M	75.762M
5610MHz	Pass	Inf	83.9M	75.762M	83.3M	75.762M
5690MHz Straddle 5.47-5.725GHz	Pass	Inf	76.95M	72.714M	76.725M	72.714M
5690MHz Straddle 5.725-5.85GHz	Pass	500k	3.12M	24.668M	3.12M	5.897M

Port X-N dB = Port X 6dB down bandwidth for 5.725-5.85GHz band / 26dB down bandwidth for other band

Port X-OBW = Port X 99% occupied bandwidth;

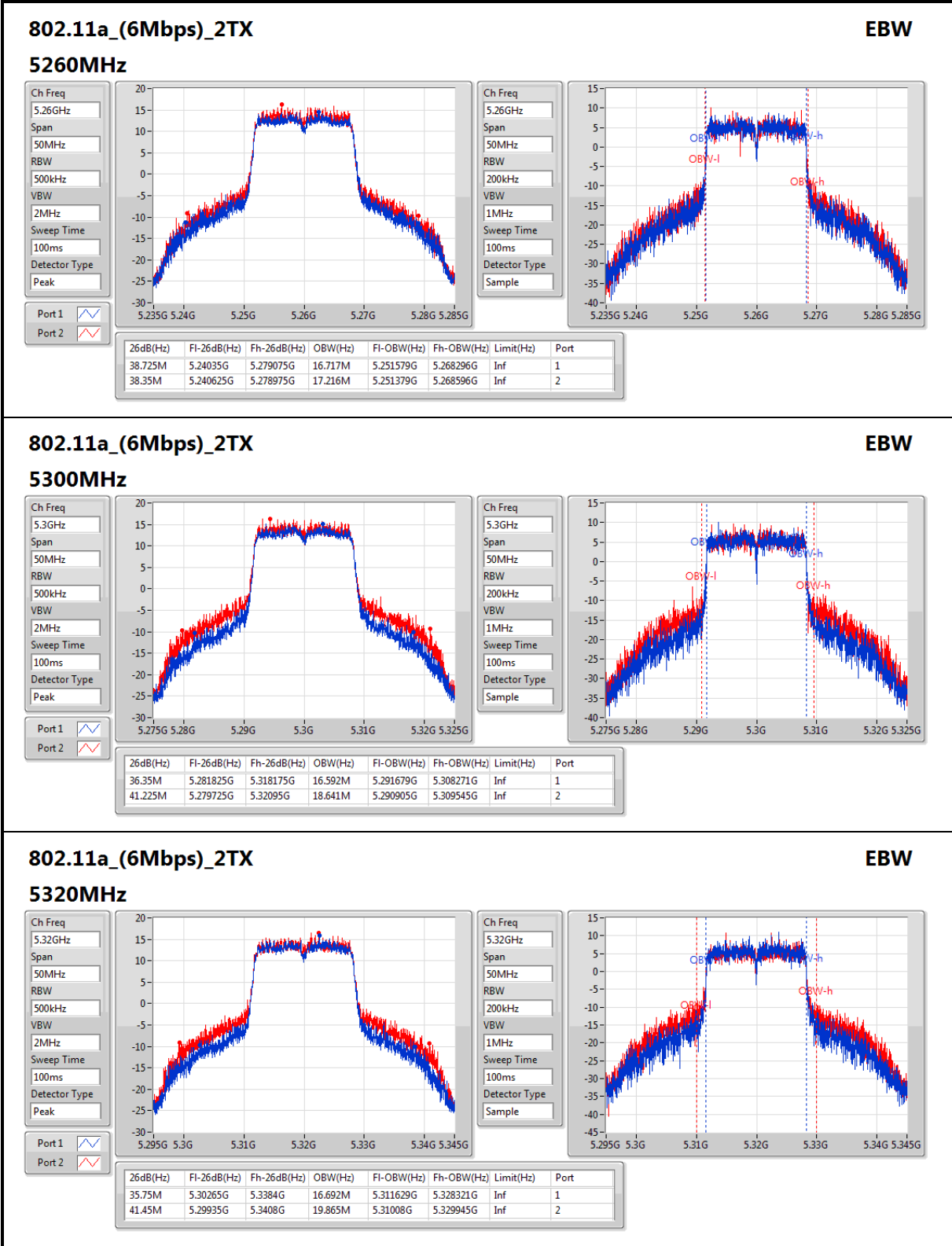

802.11a_(6Mbps)_2TX
EBW

5320MHz

Ch Freq: 5.32GHz
Span: 50MHz
RBW: 500kHz
VBW: 2MHz
Sweep Time: 100ms
Detector Type: Peak

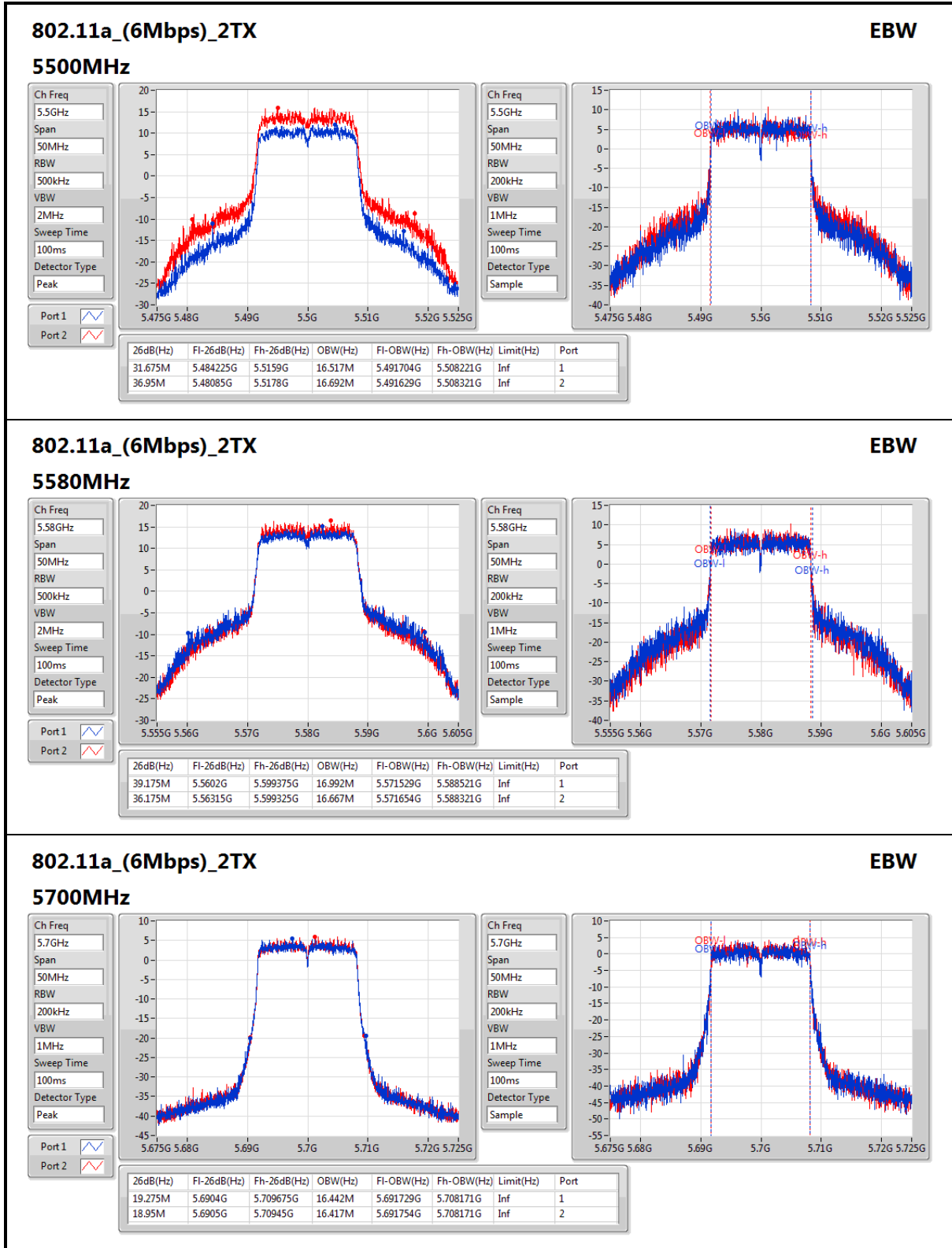
Ch Freq: 5.32GHz
Span: 50MHz
RBW: 200kHz
VBW: 1MHz
Sweep Time: 100ms
Detector Type: Sample

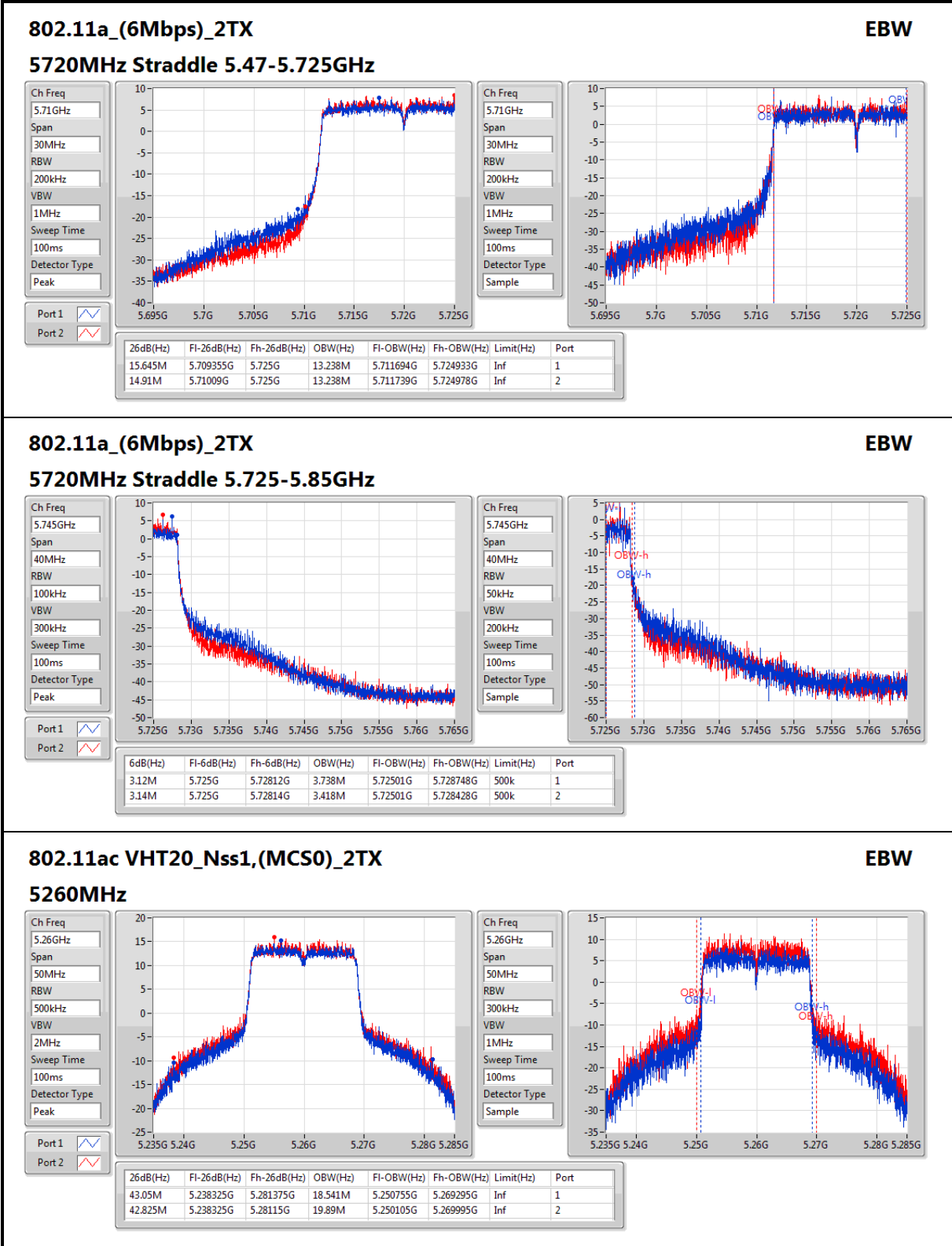



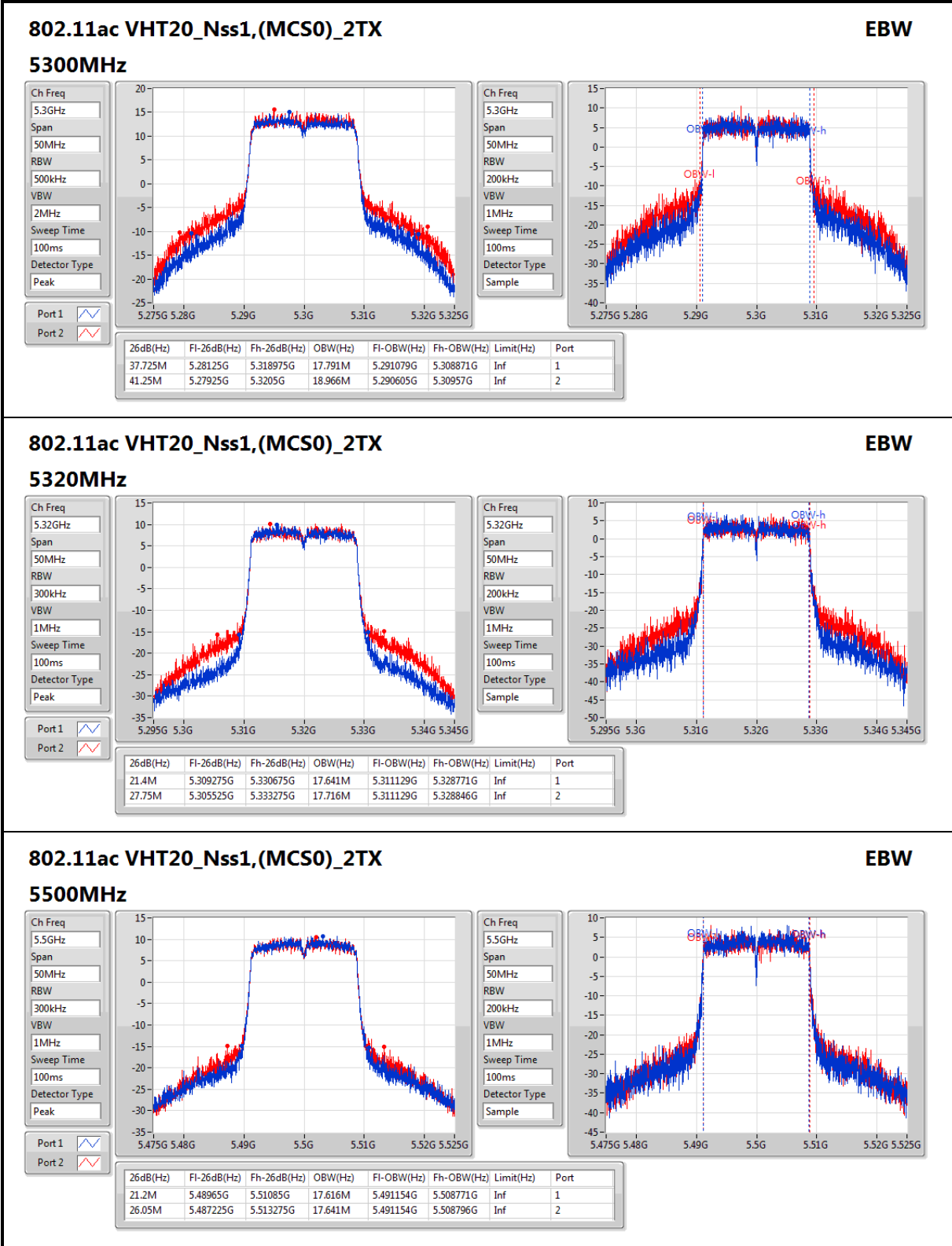

802.11ac VHT20_Nss1,(MCS0)_2TX
EBW
5500MHz

Ch Freq: 5.5GHz
Span: 50MHz
RBW: 300kHz
VBW: 1MHz
Sweep Time: 100ms
Detector Type: Peak

Port 1

Port 2

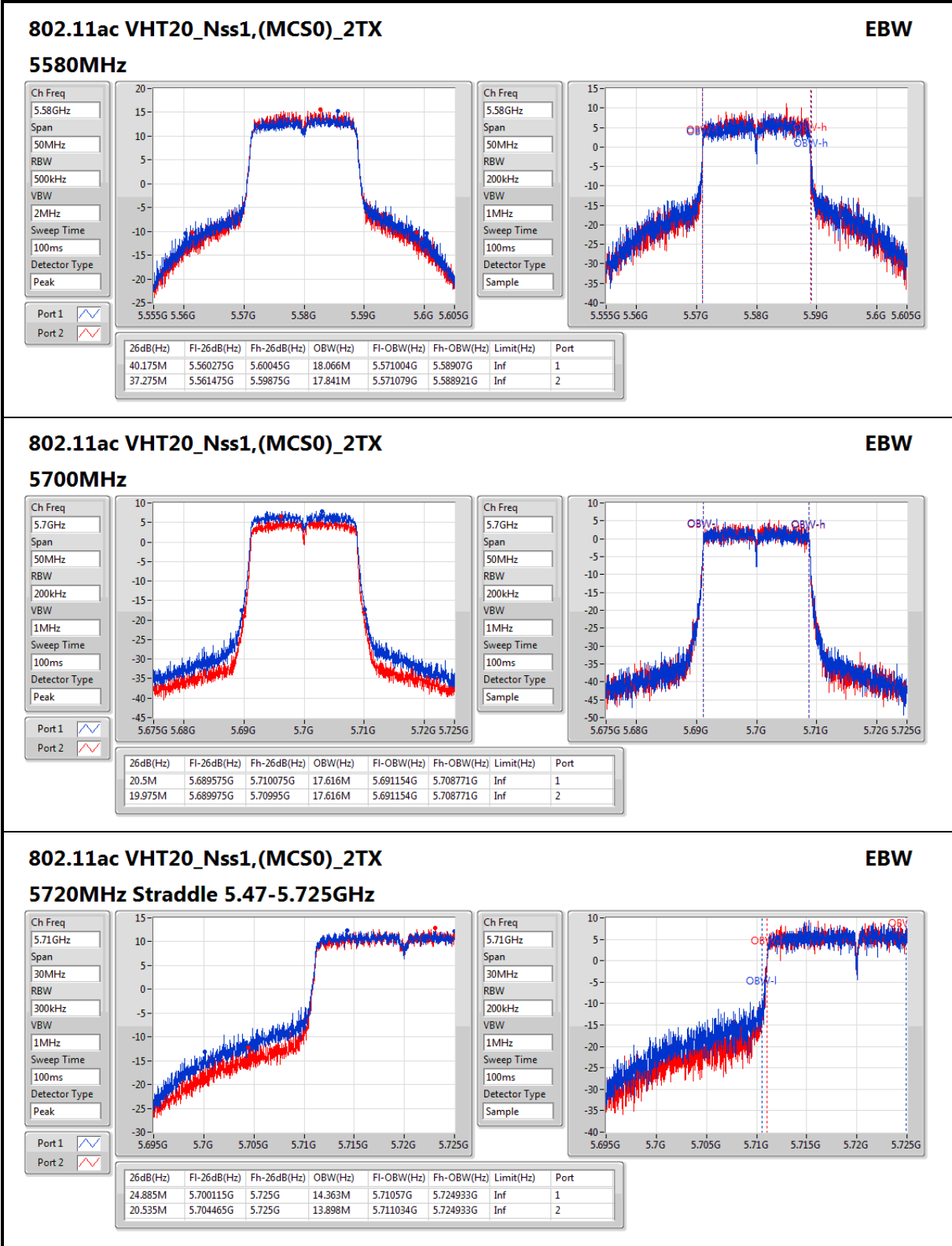
Ch Freq: 5.5GHz
Span: 50MHz
RBW: 200kHz
VBW: 1MHz
Sweep Time: 100ms
Detector Type: Sample

802.11ac VHT20_Nss1,(MCS0)_2TX
EBW

5720MHz Straddle 5.47-5.725GHz

Ch Freq: 5.71GHz
Span: 30MHz
RBW: 300kHz
VBW: 1MHz
Sweep Time: 100ms
Detector Type: Peak

Port 1

Port 2

Ch Freq: 5.71GHz
Span: 30MHz
RBW: 200kHz
VBW: 1MHz
Sweep Time: 100ms
Detector Type: Sample

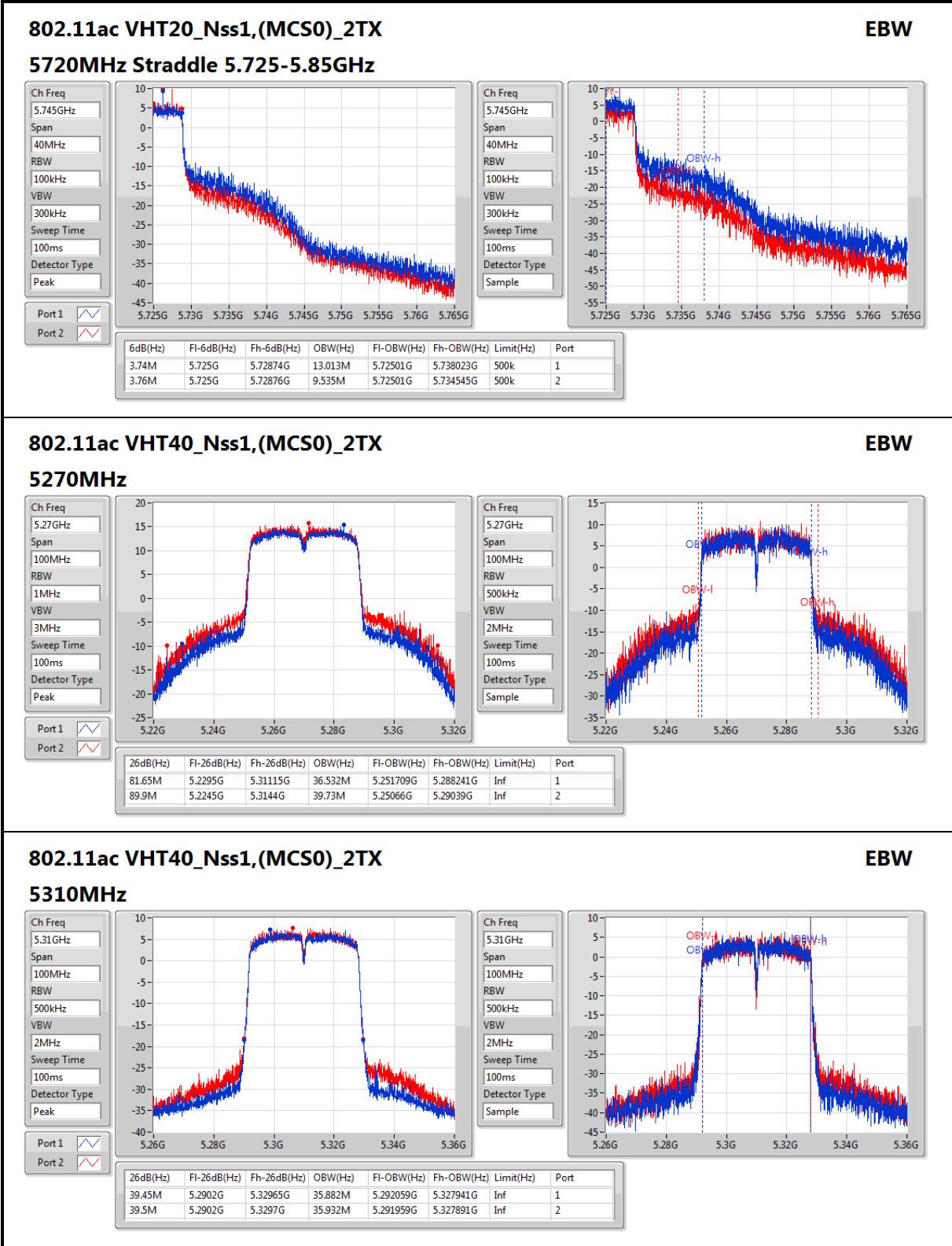

802.11ac VHT40_Nss1,(MCS0)_2TX

5310MHz

EBW

Ch Freq: 5.31GHz
Span: 100MHz
RBW: 500kHz
VBW: 2MHz
Sweep Time: 100ms
Detector Type: Peak

Port 1

Port 2

Ch Freq: 5.31GHz
Span: 100MHz
RBW: 500kHz
VBW: 2MHz
Sweep Time: 100ms
Detector Type: Sample

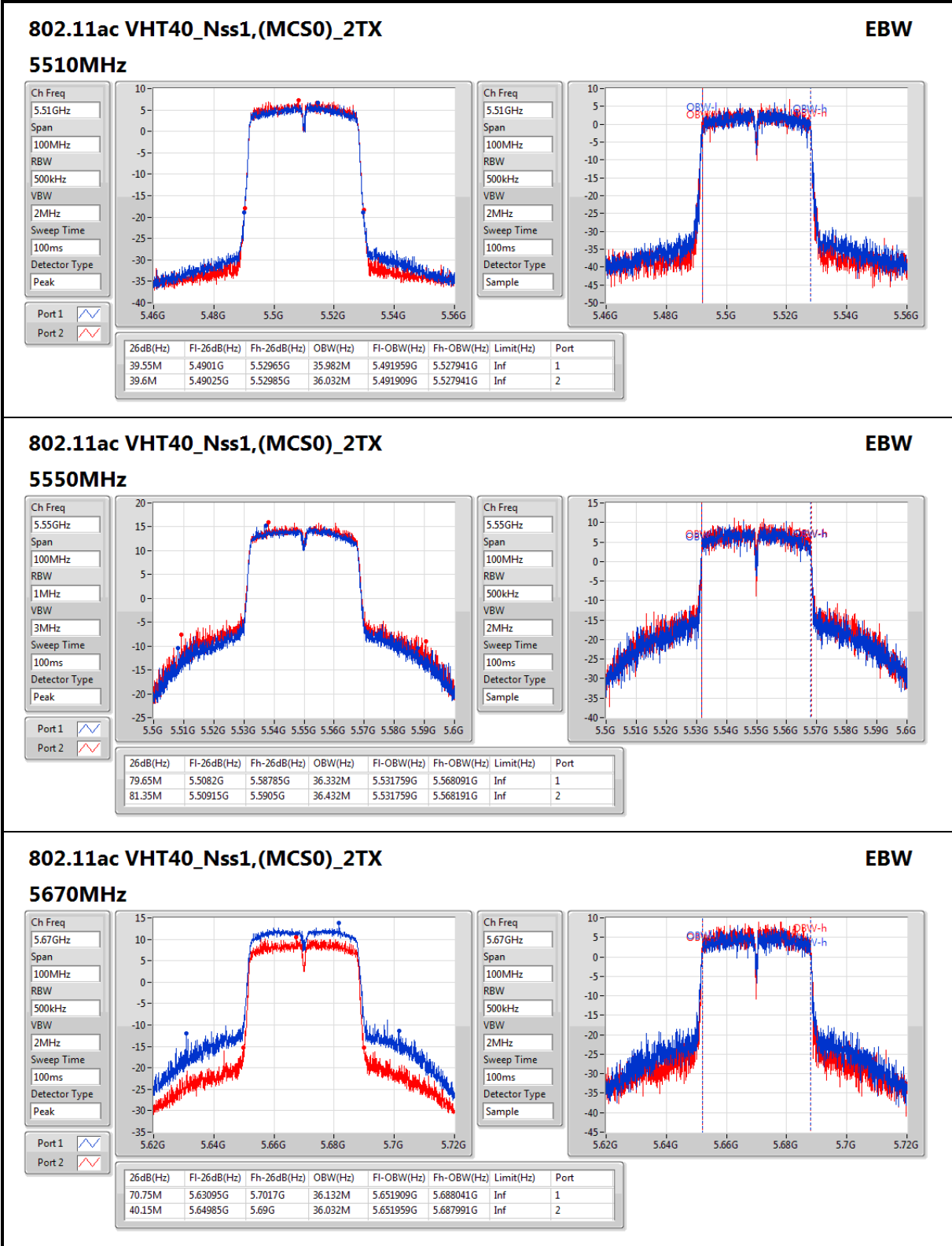

802.11ac VHT40_Nss1,(MCS0)_2TX
EBW

Ch Freq: 5.67GHz
Span: 100MHz
RBW: 500kHz
VBW: 2MHz
Sweep Time: 100ms
Detector Type: Peak

Port 1

Port 2

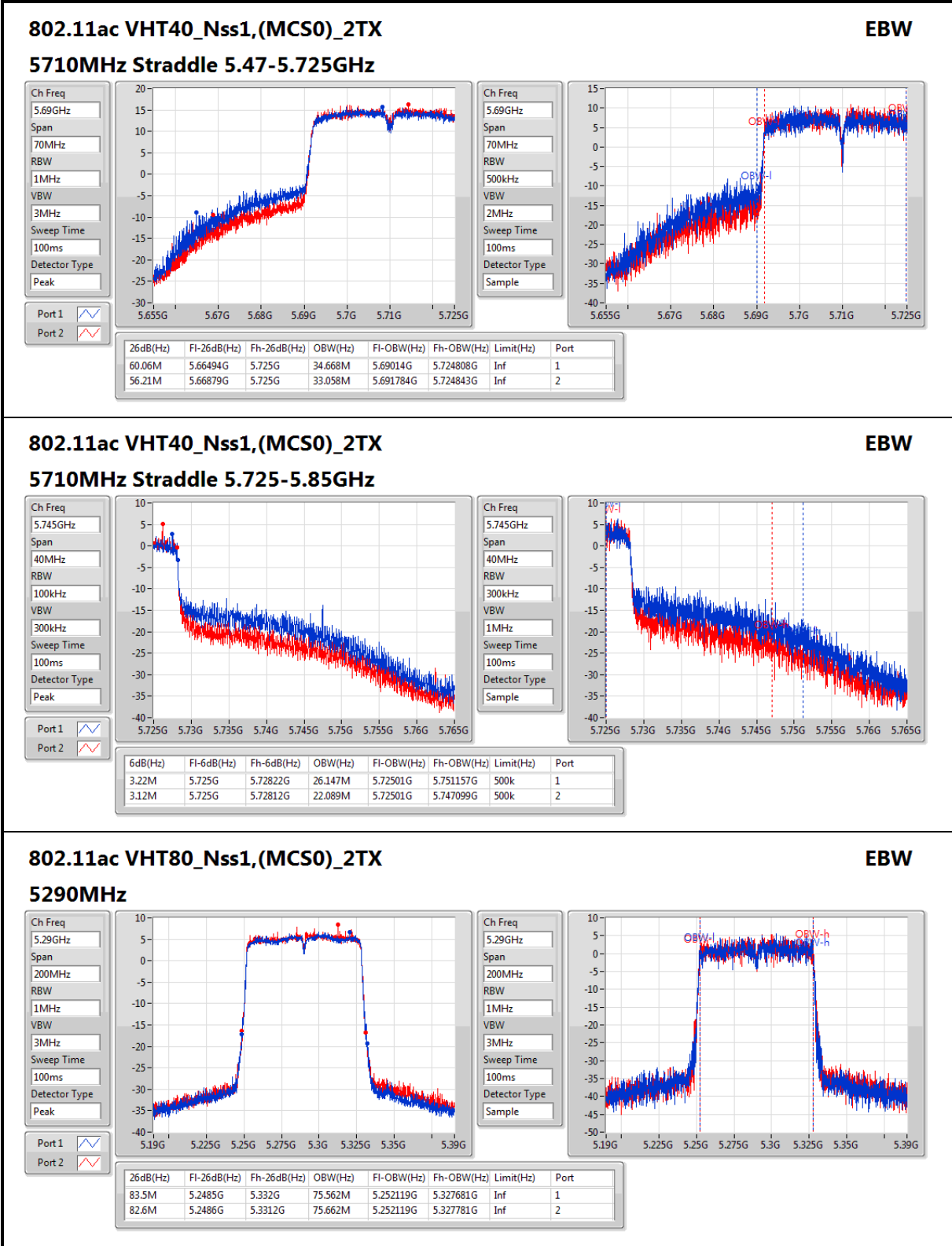
Ch Freq: 5.67GHz
Span: 100MHz
RBW: 500kHz
VBW: 2MHz
Sweep Time: 100ms
Detector Type: Sample



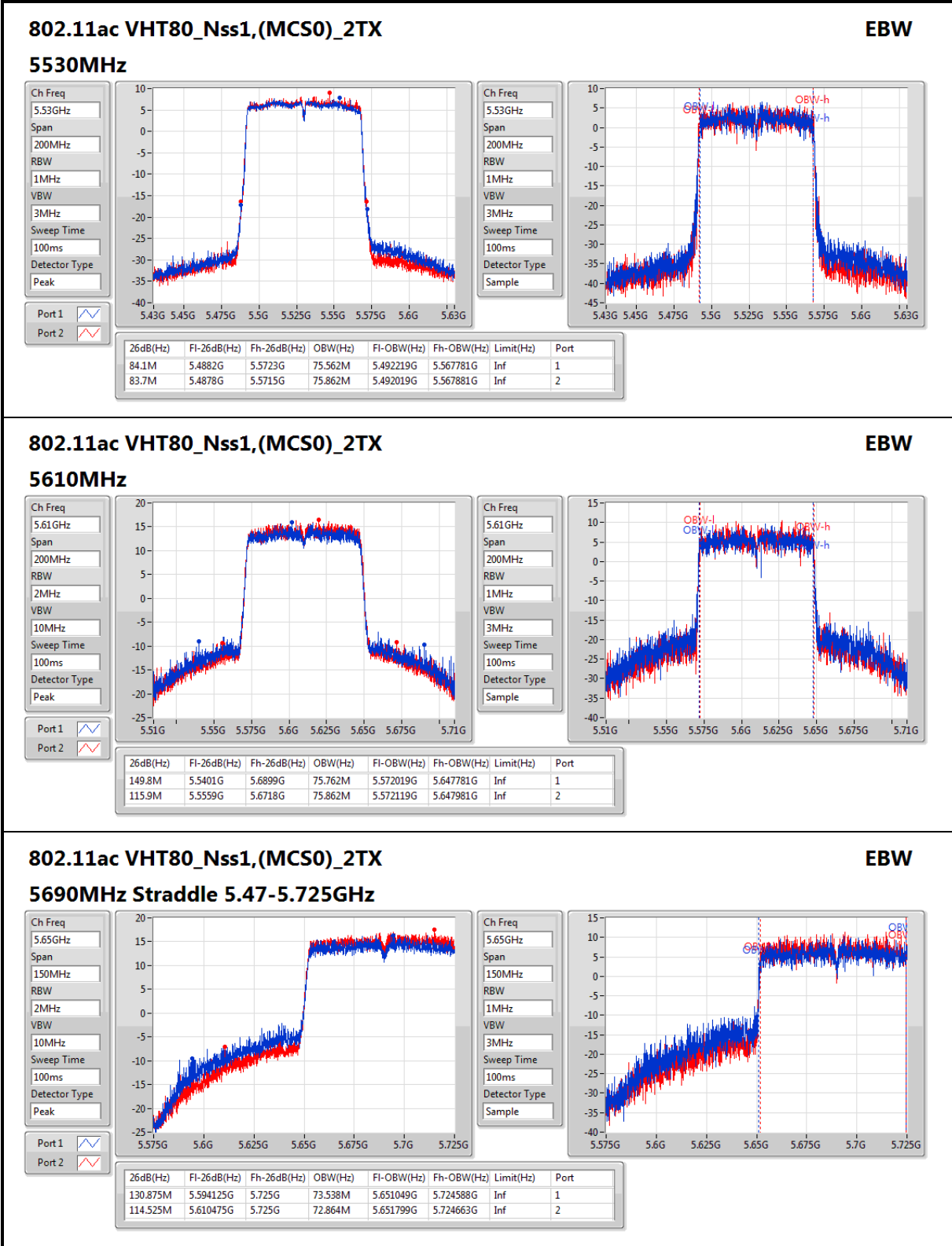

802.11ac VHT80_Nss1,(MCS0)_2TX
EBW

5690MHz Straddle 5.47-5.725GHz

Ch Freq: 5.65GHz
Span: 150MHz
RBW: 2MHz
VBW: 10MHz
Sweep Time: 100ms
Detector Type: Peak

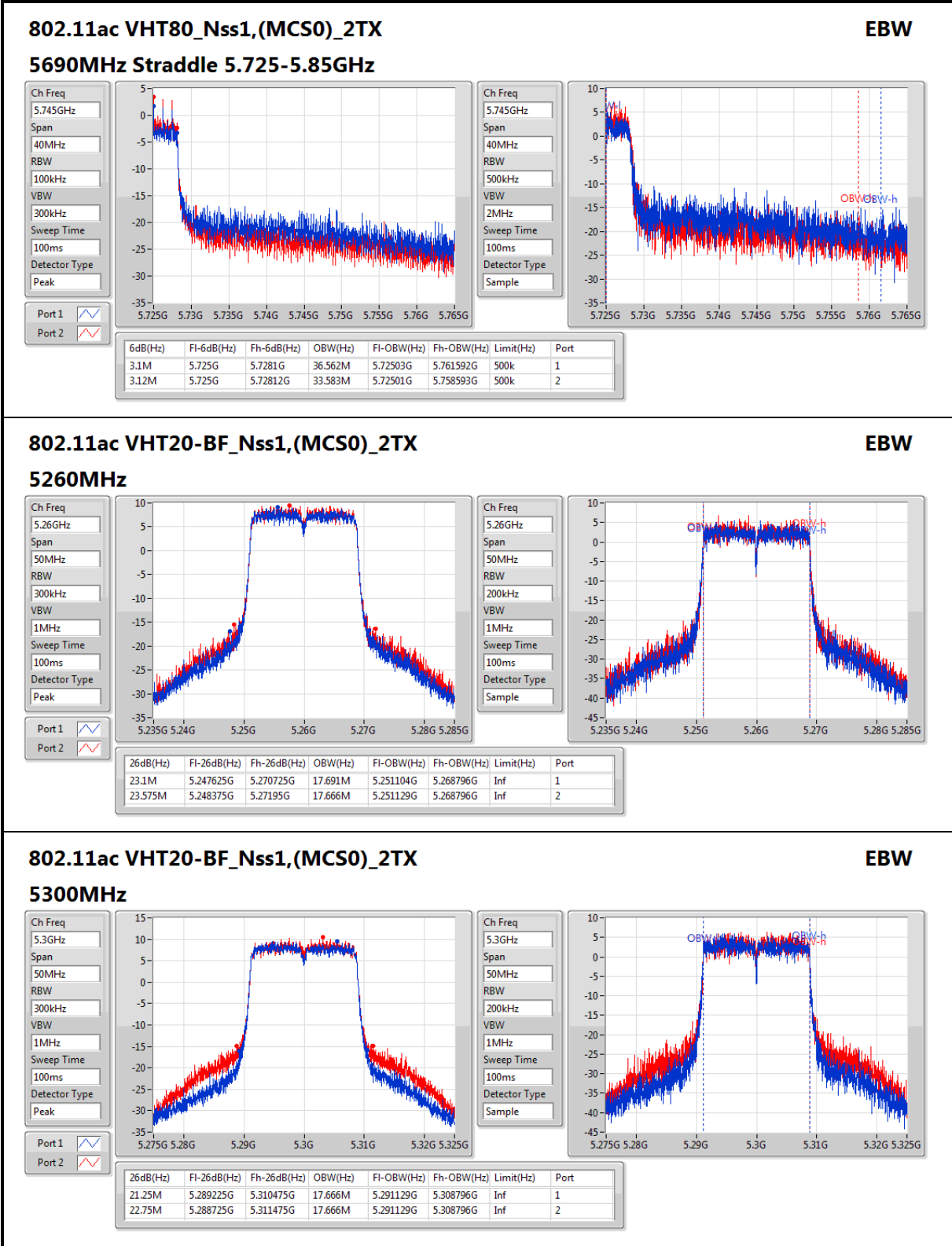
Ch Freq: 5.65GHz
Span: 150MHz
RBW: 1MHz
VBW: 3MHz
Sweep Time: 100ms
Detector Type: Sample

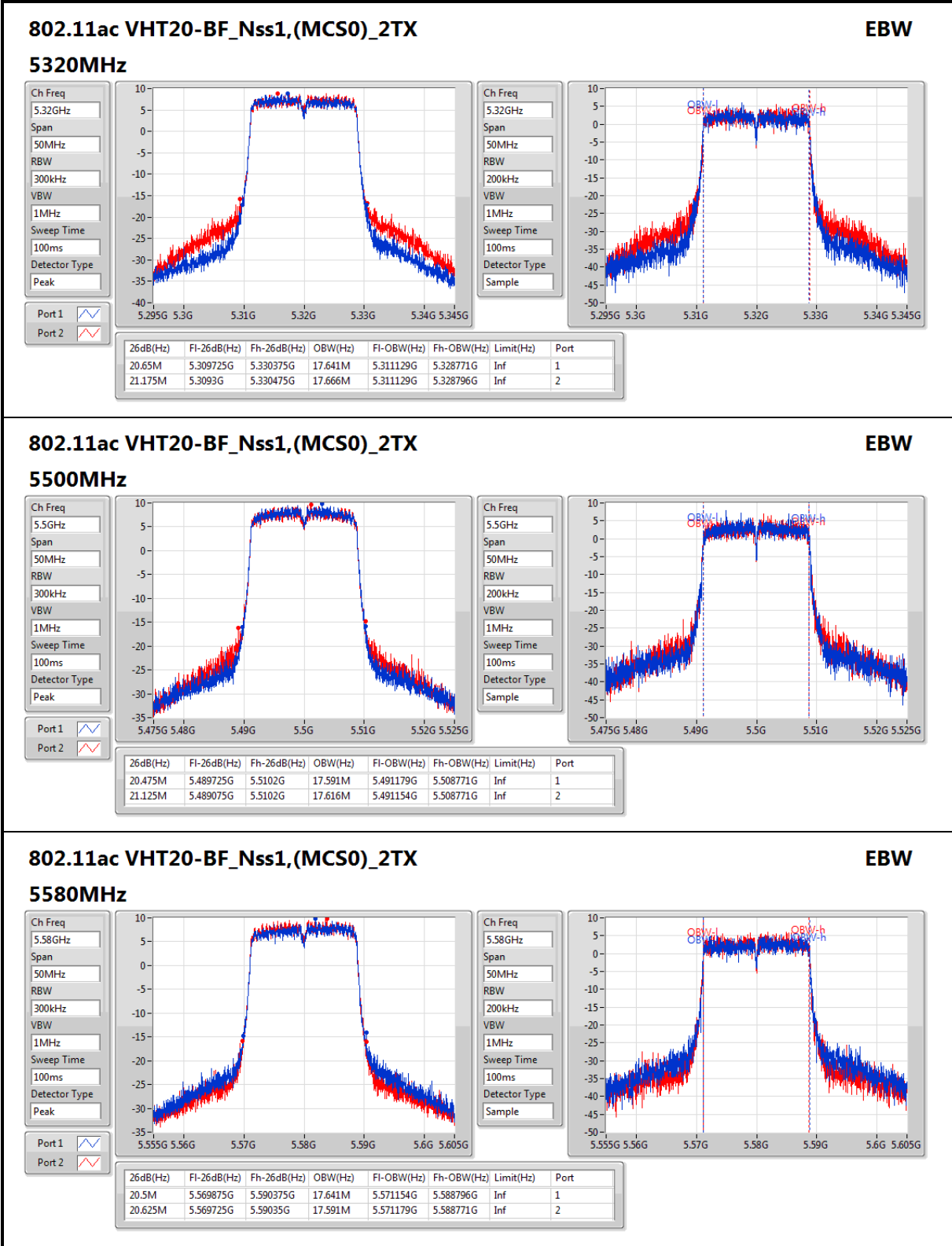

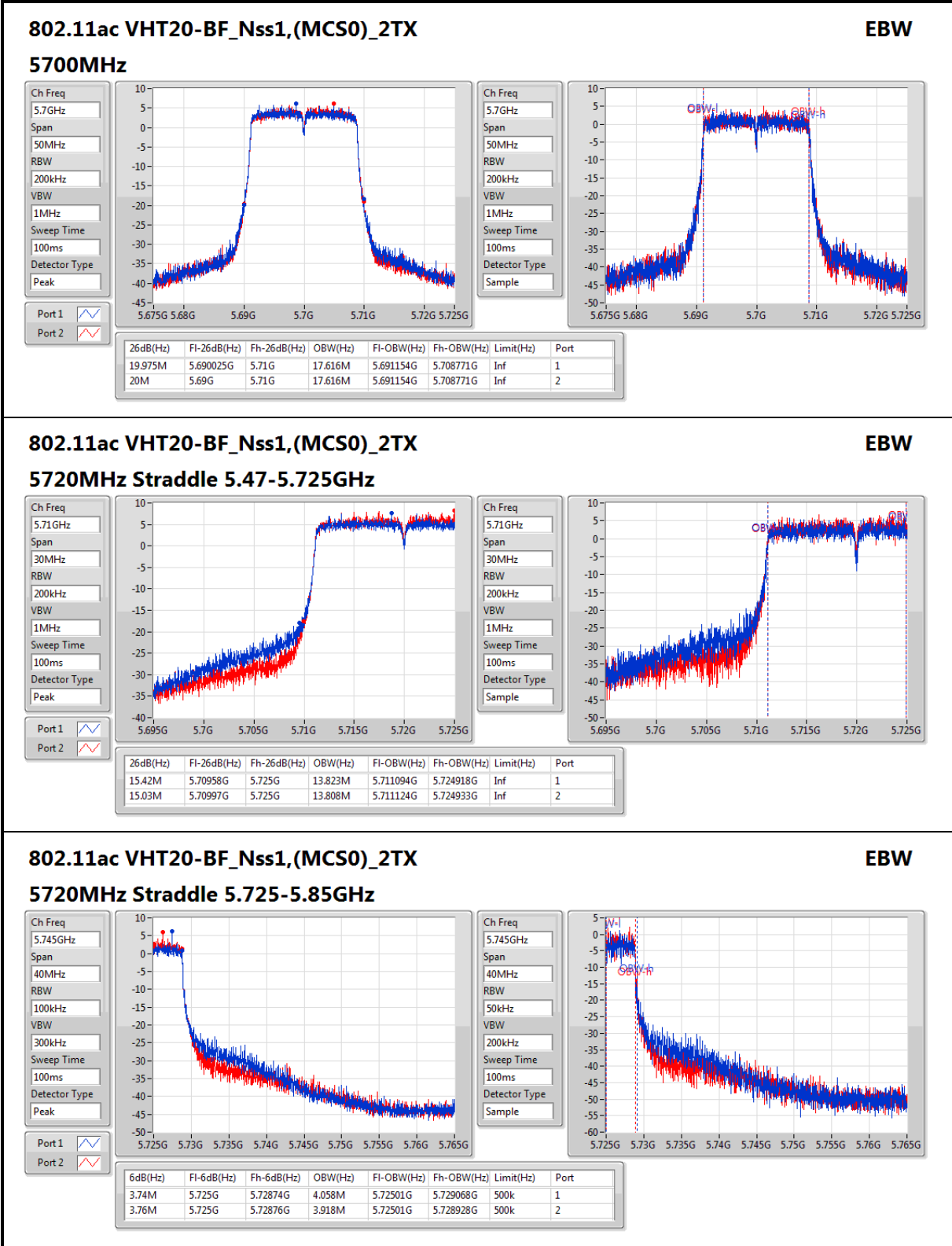

802.11ac VHT20-BF_Nss1,(MCS0)_2TX
EBW

Ch Freq: 5.745GHz
Span: 40MHz
RBW: 100kHz
VBW: 300kHz
Sweep Time: 100ms
Detector Type: Peak

Port 1

Port 2

6dB(Hz)	FI-6dB(Hz)	Fh-6dB(Hz)	OBW(Hz)	FI-OBW(Hz)	Fh-OBW(Hz)	Limit(Hz)	Port
3.74M	5.725G	5.72874G	4.058M	5.72501G	5.729068G	500k	1
3.76M	5.725G	5.72876G	3.918M	5.72501G	5.728928G	500k	2

Ch Freq: 5.745GHz
Span: 40MHz
RBW: 50kHz
VBW: 200kHz
Sweep Time: 100ms
Detector Type: Sample

Port 1

Port 2

6dB(Hz)	FI-6dB(Hz)	Fh-6dB(Hz)	OBW(Hz)	FI-OBW(Hz)	Fh-OBW(Hz)	Limit(Hz)	Port
3.74M	5.725G	5.72874G	4.058M	5.72501G	5.729068G	500k	1
3.76M	5.725G	5.72876G	3.918M	5.72501G	5.728928G	500k	2

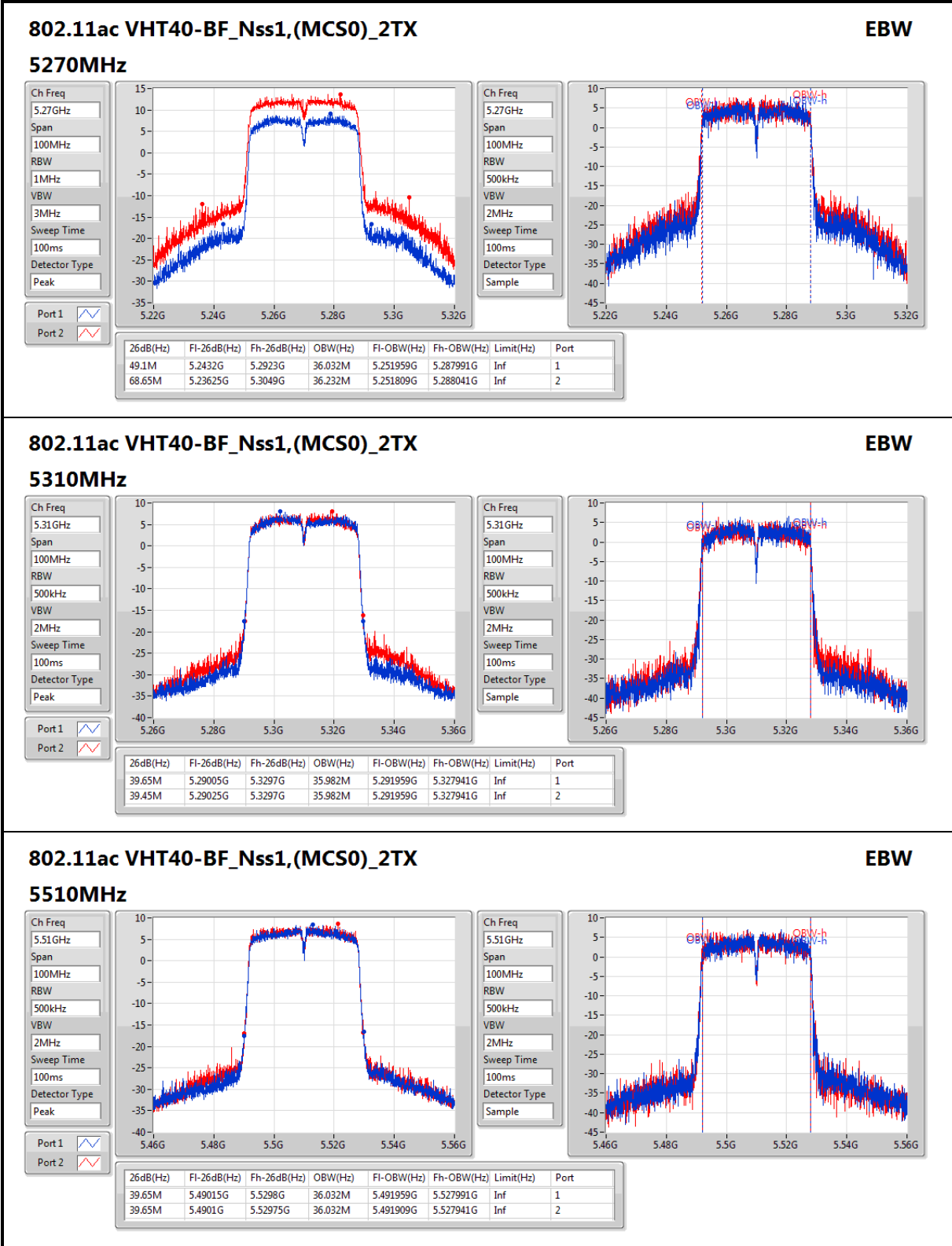
802.11ac VHT40-BF_Nss1,(MCS0)_2TX
EBW

Ch Freq: 5.51GHz
Span: 100MHz
RBW: 500kHz
VBW: 2MHz
Sweep Time: 100ms
Detector Type: Peak



Port 1

Port 2

26dB(Hz)	Fl-26dB(Hz)	Fh-26dB(Hz)	OBW(Hz)	Fl-OBW(Hz)	Fh-OBW(Hz)	Limit(Hz)	Port
39.65M	5.49015G	5.5298G	36.032M	5.491959G	5.527991G	Inf	1
39.65M	5.4901G	5.52975G	36.032M	5.491909G	5.527941G	Inf	2

Ch Freq: 5.51GHz
Span: 100MHz
RBW: 500kHz
VBW: 2MHz
Sweep Time: 100ms
Detector Type: Sample



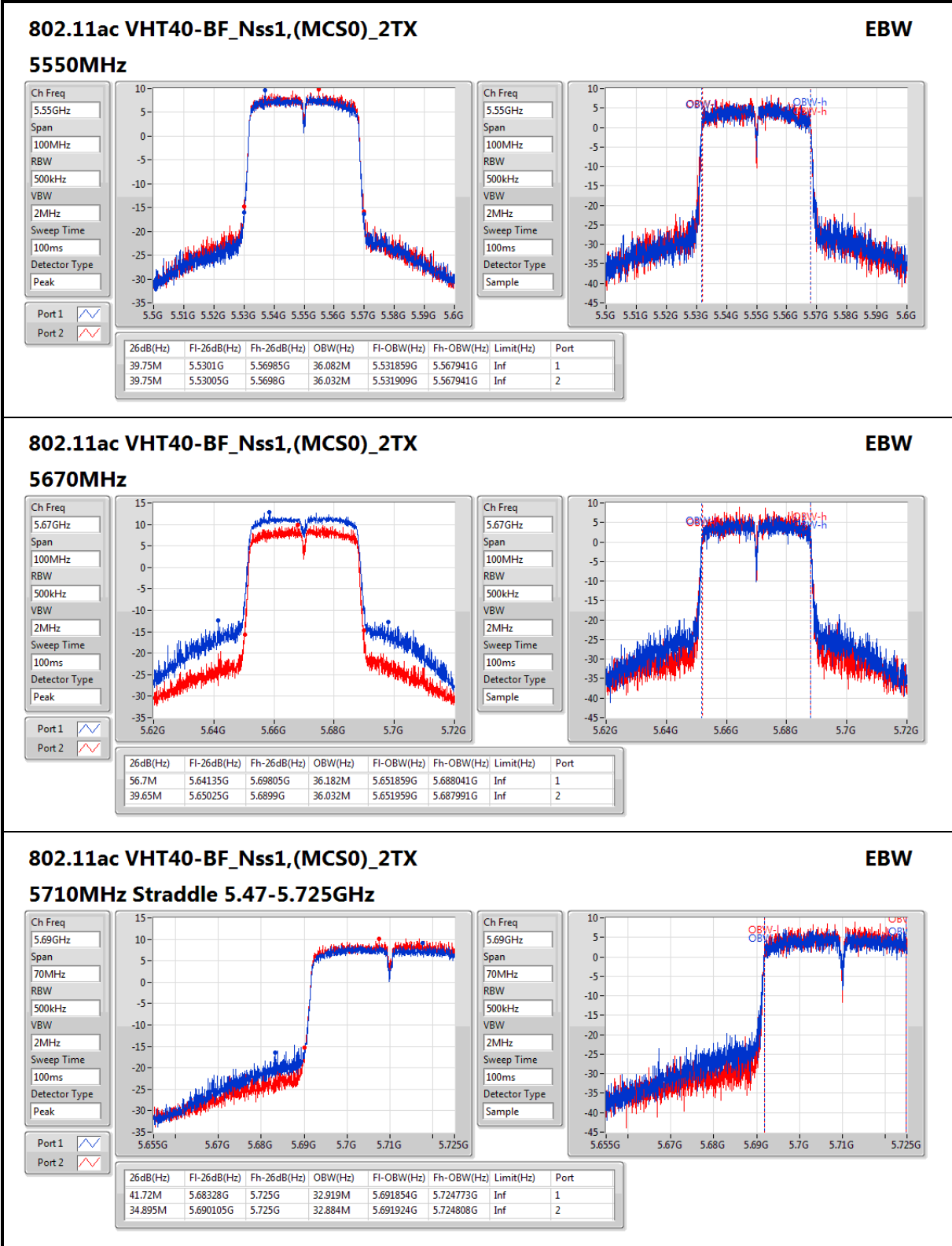

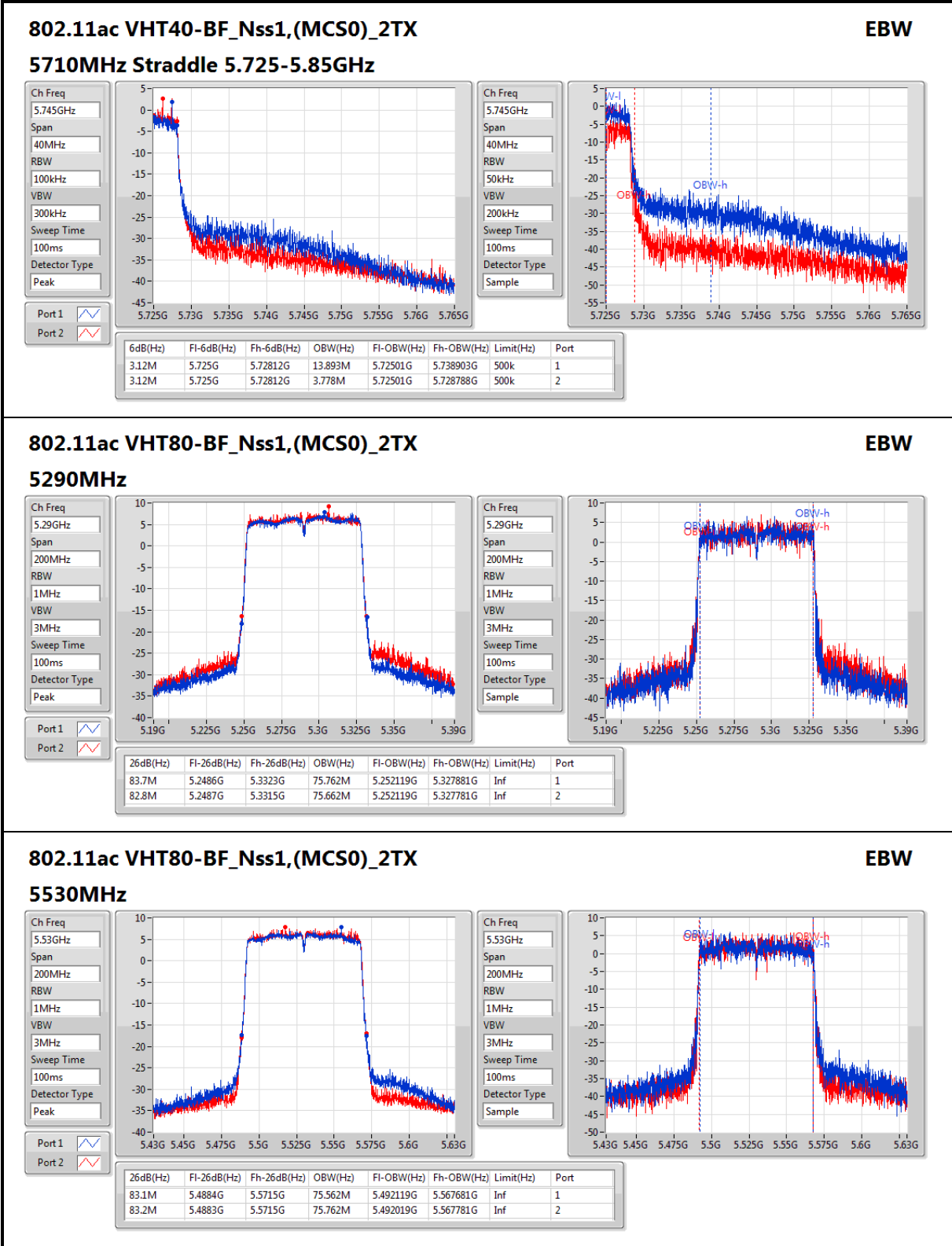

802.11ac VHT80-BF_Nss1,(MCS0)_2TX

5530MHz

EBW

Ch Freq: 5.53GHz
Span: 200MHz
RBW: 1MHz
VBW: 3MHz
Sweep Time: 100ms
Detector Type: Peak

Port 1

Port 2

Ch Freq: 5.53GHz
Span: 200MHz
RBW: 1MHz
VBW: 3MHz
Sweep Time: 100ms
Detector Type: Sample

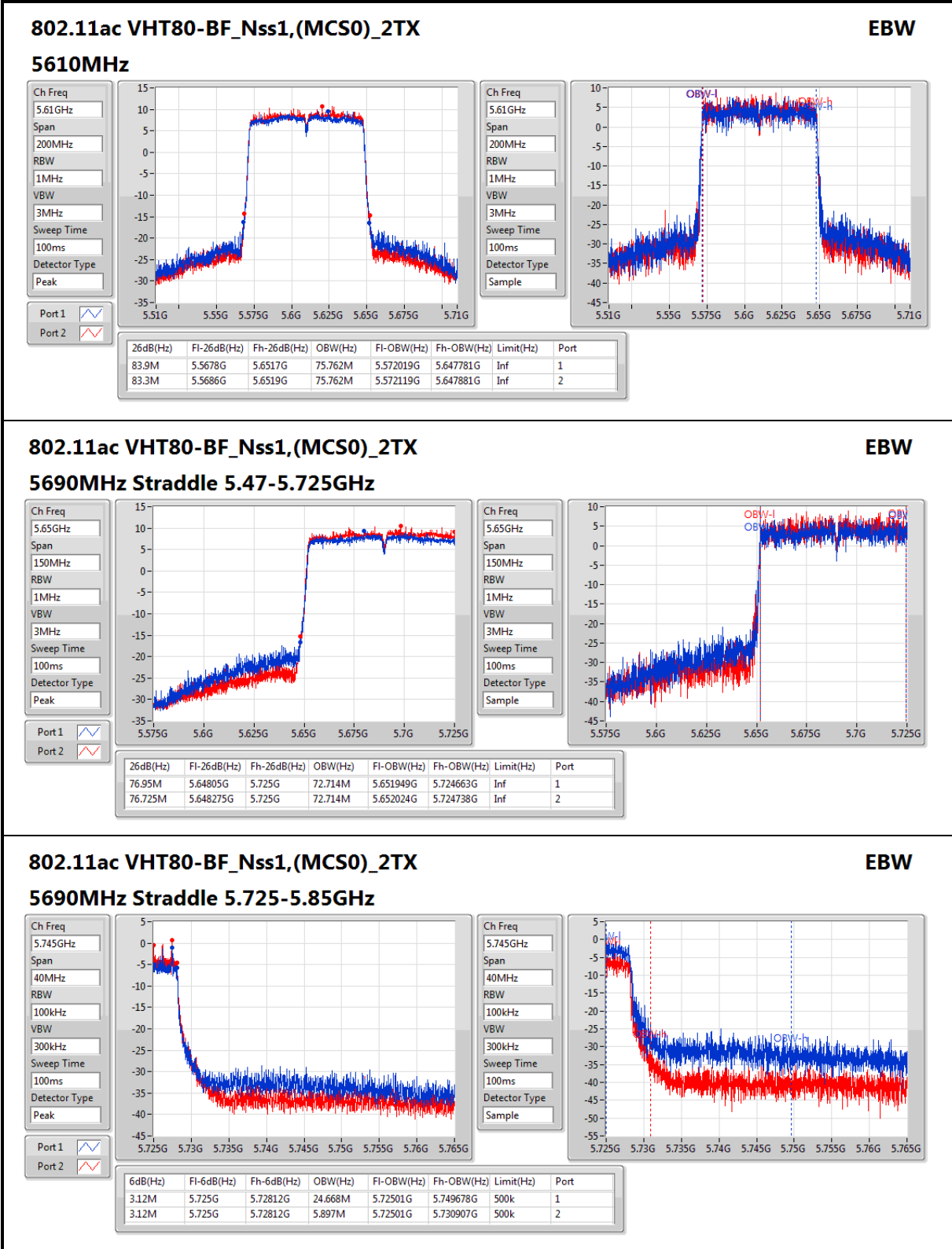



3.3 Maximum Conducted Output Power

3.3.1 Maximum Conducted Output Power Limit

Maximum Conducted Output Power Limit	
UNII Devices	
<input type="checkbox"/> For the 5.15-5.25 GHz band:	
	<ul style="list-style-type: none"> ▪ Outdoor AP: the maximum conducted output power (P_{Out}) shall not exceed the lesser of 1 W. If $G_{TX} > 6$ dBi, then $P_{Out} = 30 - (G_{TX} - 6)$. e.i.r.p. at any elevation angle above 30 degrees $\leq 125mW$ [21dBm]
	<ul style="list-style-type: none"> ▪ Indoor AP: the maximum conducted output power (P_{Out}) shall not exceed the lesser of 1 W. If $G_{TX} > 6$ dBi, then $P_{Out} = 30 - (G_{TX} - 6)$
	<ul style="list-style-type: none"> ▪ Point-to-point AP: the maximum conducted output power (P_{Out}) shall not exceed the lesser of 1 W. If $G_{TX} > 23$ dBi, then $P_{Out} = 30 - (G_{TX} - 23)$.
	<ul style="list-style-type: none"> ▪ Mobile or Portable Client: the maximum conducted output power (P_{Out}) shall not exceed the lesser of 250 mW. If $G_{TX} > 6$ dBi, then $P_{Out} = 24 - (G_{TX} - 6)$.
<input checked="" type="checkbox"/> For the 5.25-5.35 GHz band, the maximum conducted output power (P_{Out}) shall not exceed the lesser of 250 mW or 11 dBm + 10 log B, where B is the 26 dB emission bandwidth in MHz. If $G_{TX} > 6$ dBi, then $P_{Out} = 24 - (G_{TX} - 6)$.	
<input checked="" type="checkbox"/> For the 5.47-5.725 GHz band, the maximum conducted output power (P_{Out}) shall not exceed the lesser of 250 mW or 11 dBm + 10 log B, where B is the 26 dB emission bandwidth in MHz. If $G_{TX} > 6$ dBi, then $P_{Out} = 24 - (G_{TX} - 6)$.	
<input checked="" type="checkbox"/> For the 5.725-5.85 GHz band:	
	<ul style="list-style-type: none"> ▪ Point-to-multipoint systems (P2M): the maximum conducted output power (P_{Out}) shall not exceed the lesser of 1 W. If $G_{TX} > 6$ dBi, then $P_{Out} = 30 - (G_{TX} - 6)$.
	<ul style="list-style-type: none"> ▪ Point-to-point systems (P2P): the maximum conducted output power (P_{Out}) shall not exceed the lesser of 1 W.
LE-LAN Devices	
<input type="checkbox"/> For the 5.15-5.25 GHz band, the maximum e.i.r.p. shall not exceed 200 mW or 10 + 10 log B, dBm, whichever power is less. B is the 99% emission bandwidth in MHz.	
<input type="checkbox"/> For the 5.25-5.35 GHz band, the maximum e.i.r.p. shall not exceed 1.0 W or 17 + 10 log B, dBm, whichever power is less. B is the 99% emission bandwidth in MHz	
<input type="checkbox"/> For the 5.47-5.6 GHz band and 5.65-5.725 GHz band, the maximum e.i.r.p. shall not exceed 1.0 W or 17 + 10 log B, dBm, whichever power is less. B is the 99% emission bandwidth in MHz	
<input type="checkbox"/> For the 5.725-5.85 GHz band:	
	<ul style="list-style-type: none"> ▪ Point-to-multipoint systems (P2M): the maximum conducted output power (P_{Out}) shall not exceed the lesser of 1 W. If $G_{TX} > 6$ dBi, then $P_{Out} = 30 - (G_{TX} - 6)$.
	<ul style="list-style-type: none"> ▪ Point-to-point systems (P2P): the maximum conducted output power (P_{Out}) shall not exceed the lesser of 1 W.
P_{Out} = maximum conducted output power in dBm, G_{TX} = the maximum transmitting antenna directional gain in dBi.	

3.3.2 Measuring Instruments

Refer a test equipment and calibration data table in this test report.

3.3.3 Test Procedures

Test Method	
<ul style="list-style-type: none"> Maximum Conducted Output Power 	
Average over on/off periods with duty factor	
<input checked="" type="checkbox"/>	Refer as FCC KDB 789033, clause E Method SA-2 (spectral trace averaging).
<input type="checkbox"/>	Refer as FCC KDB 789033, clause E Method SA-2 Alt. (RMS detection with slow sweep speed)
Wideband RF power meter and average over on/off periods with duty factor	
<input checked="" type="checkbox"/>	Refer as FCC KDB 789033, clause E Method PM-G (using an RF average power meter).
<ul style="list-style-type: none"> For conducted measurement. 	
<ul style="list-style-type: none"> If the EUT supports multiple transmit chains using options given below: Refer as FCC KDB 662911, In-band power measurements. Using the measure-and-sum approach, measured all transmit ports individually. Sum the power (in linear power units e.g., mW) of all ports for each individual sample and save them. 	
<ul style="list-style-type: none"> If multiple transmit chains, EIRP calculation could be following as methods: $P_{total} = P_1 + P_2 + \dots + P_n$ (calculated in linear unit [mW] and transfer to log unit [dBm]) $EIRP_{total} = P_{total} + DG$ 	

3.3.4 Test Setup

For straddle channel

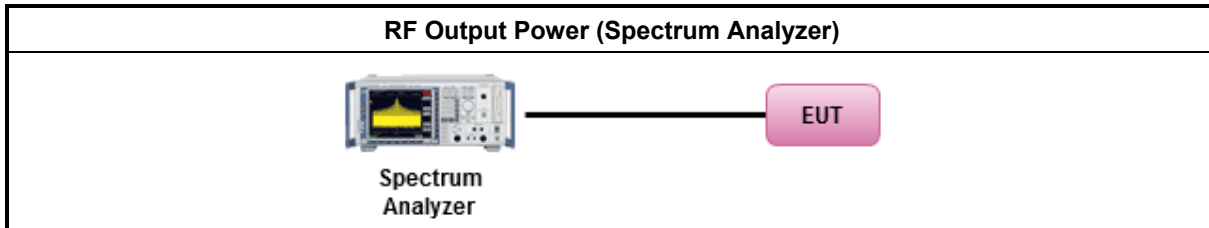

For other channel

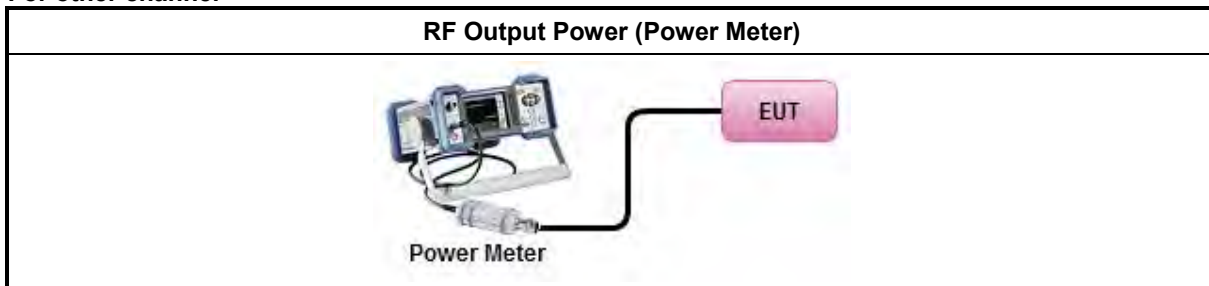



3.3.5 Test Result of Maximum Conducted Output Power

Summary

Mode	Total Power (dBm)	Total Power (W)	EIRP (dBm)	EIRP (W)
802.11a_(6Mbps)_2TX	-	-	-	-
5.25-5.35GHz	23.57	0.22751	28.44	0.69823
5.47-5.725GHz	23.79	0.23933	28.66	0.73451
5.725-5.85GHz	14.17	0.02612	19.04	0.08017
802.11ac VHT20_Nss1,(MCS0)_2TX	-	-	-	-
5.25-5.35GHz	23.97	0.24946	28.84	0.76560
5.47-5.725GHz	23.89	0.24491	28.76	0.75162
5.725-5.85GHz	17.65	0.05821	22.52	0.17865
802.11ac VHT40_Nss1,(MCS0)_2TX	-	-	-	-
5.25-5.35GHz	23.81	0.24044	28.68	0.73790
5.47-5.725GHz	23.87	0.24378	28.74	0.74817
5.725-5.85GHz	12.50	0.01778	17.37	0.05458
802.11ac VHT80_Nss1,(MCS0)_2TX	-	-	-	-
5.25-5.35GHz	18.20	0.06607	23.07	0.20277
5.47-5.725GHz	23.80	0.23988	28.67	0.73621
5.725-5.85GHz	9.71	0.00935	14.58	0.02871
802.11ac VHT20-BF_Nss1,(MCS0)_2TX	-	-	-	-
5.25-5.35GHz	21.17	0.13092	26.32	0.42855
5.47-5.725GHz	21.27	0.13397	26.42	0.43853
5.725-5.85GHz	14.87	0.03069	20.02	0.10046
802.11ac VHT40-BF_Nss1,(MCS0)_2TX	-	-	-	-
5.25-5.35GHz	21.02	0.12647	26.17	0.41400
5.47-5.725GHz	21.47	0.14028	26.62	0.45920
5.725-5.85GHz	10.09	0.01021	15.24	0.03342
802.11ac VHT80-BF_Nss1,(MCS0)_2TX	-	-	-	-
5.25-5.35GHz	18.96	0.07870	24.11	0.25763
5.47-5.725GHz	21.57	0.14355	26.72	0.46989
5.725-5.85GHz	7.63	0.00579	12.78	0.01897



Result

Mode	Result	DG	Port 1	Port 2	Total Power	Power Limit
		(dBi)	(dBm)	(dBm)	(dBm)	(dBm)
802.11a_(6Mbps)_2TX	-	-	-	-	-	-
5260MHz	Pass	4.87	20.51	20.60	23.57	23.98
5300MHz	Pass	4.87	20.32	20.53	23.44	23.98
5320MHz	Pass	4.87	20.24	20.40	23.33	23.98
5500MHz	Pass	4.87	20.56	20.54	23.56	23.98
5580MHz	Pass	4.87	20.59	20.97	23.79	23.98
5700MHz	Pass	4.87	14.92	15.72	18.35	23.78
5720MHz Straddle 5.47-5.725GHz	Pass	4.87	16.99	17.70	20.37	22.73
5720MHz Straddle 5.725-5.85GHz	Pass	4.87	10.74	11.55	14.17	30.00
802.11ac VHT20_Nss1,(MCS0)_2TX	-	-	-	-	-	-
5260MHz	Pass	4.87	20.85	21.06	23.97	23.98
5300MHz	Pass	4.87	20.44	20.56	23.51	23.98
5320MHz	Pass	4.87	18.31	18.24	21.29	23.98
5500MHz	Pass	4.87	19.34	19.17	22.27	23.98
5580MHz	Pass	4.87	20.64	21.10	23.89	23.98
5700MHz	Pass	4.87	16.39	16.69	19.55	23.98
5720MHz Straddle 5.47-5.725GHz	Pass	4.87	20.16	20.19	23.19	23.98
5720MHz Straddle 5.725-5.85GHz	Pass	4.87	14.58	14.70	17.65	30.00
802.11ac VHT40_Nss1,(MCS0)_2TX	-	-	-	-	-	-
5270MHz	Pass	4.87	20.60	21.00	23.81	23.98
5310MHz	Pass	4.87	15.99	16.17	19.09	23.98
5510MHz	Pass	4.87	15.74	16.06	18.91	23.98
5550MHz	Pass	4.87	20.68	21.04	23.87	23.98
5670MHz	Pass	4.87	18.16	18.73	21.46	23.98
5710MHz Straddle 5.47-5.725GHz	Pass	4.87	20.60	20.83	23.73	23.98
5710MHz Straddle 5.725-5.85GHz	Pass	4.87	9.34	9.64	12.50	30.00
802.11ac VHT80_Nss1,(MCS0)_2TX	-	-	-	-	-	-
5290MHz	Pass	4.87	15.17	15.21	18.20	23.98
5530MHz	Pass	4.87	16.55	16.71	19.64	23.98
5610MHz	Pass	4.87	19.44	19.94	22.71	23.98
5690MHz Straddle 5.47-5.725GHz	Pass	4.87	20.35	21.18	23.80	23.98
5690MHz Straddle 5.725-5.85GHz	Pass	4.87	6.12	7.21	9.71	30.00
802.11ac VHT20-BF_Nss1,(MCS0)_2TX	-	-	-	-	-	-
5260MHz	Pass	5.15	17.55	17.85	20.71	23.98
5300MHz	Pass	5.15	18.05	18.27	21.17	23.98
5320MHz	Pass	5.15	17.26	17.18	20.23	23.98
5500MHz	Pass	5.15	18.28	18.24	21.27	23.98
5580MHz	Pass	5.15	17.87	18.16	21.03	23.98
5700MHz	Pass	5.15	16.01	16.16	19.10	23.98
5720MHz Straddle 5.47-5.725GHz	Pass	5.15	17.09	17.83	20.49	22.77
5720MHz Straddle 5.725-5.85GHz	Pass	5.15	11.42	12.26	14.87	30.00
802.11ac VHT40-BF_Nss1,(MCS0)_2TX	-	-	-	-	-	-
5270MHz	Pass	5.15	17.82	18.19	21.02	23.98
5310MHz	Pass	5.15	16.34	16.35	19.36	23.98



Mode	Result	DG	Port 1	Port 2	Total Power	Power Limit
5510MHz	Pass	5.15	17.37	17.41	20.40	23.98
5550MHz	Pass	5.15	18.09	18.26	21.19	23.98
5670MHz	Pass	5.15	18.02	18.22	21.13	23.98
5710MHz Straddle 5.47-5.725GHz	Pass	5.15	18.14	18.76	21.47	23.98
5710MHz Straddle 5.725-5.85GHz	Pass	5.15	6.66	7.46	10.09	30.00
802.11ac VHT80-BF_Nss1,(MCS0)_2TX	-	-	-	-	-	-
5290MHz	Pass	5.15	15.87	16.02	18.96	23.98
5530MHz	Pass	5.15	15.90	16.05	18.99	23.98
5610MHz	Pass	5.15	17.92	18.37	21.16	23.98
5690MHz Straddle 5.47-5.725GHz	Pass	5.15	18.14	18.95	21.57	23.98
5690MHz Straddle 5.725-5.85GHz	Pass	5.15	4.08	5.10	7.63	30.00

DG = Directional Gain; Port X = Port X output power

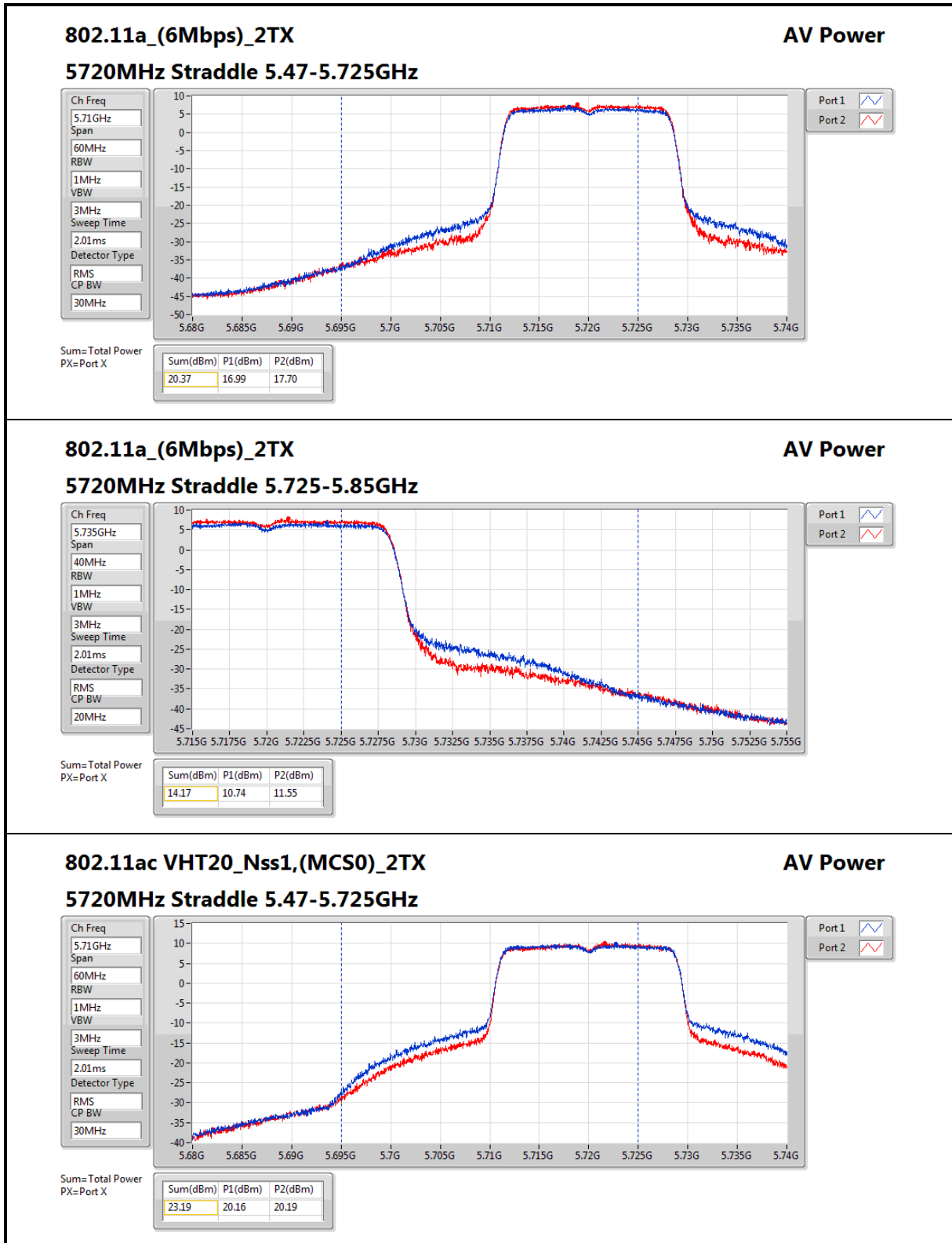

802.11ac VHT20_Nss1,(MCS0)_2TX

5720MHz Straddle 5.47-5.725GHz

AV Power

Ch Freq
5.71GHz

Span
60MHz

RBW
1MHz

VBW
3MHz

Sweep Time
2.01ms

Detector Type
RMS

CP BW
30MHz

Port 1

Port 2

Sum= Total Power
PX=Port X

Sum(dBm)	P1(dBm)	P2(dBm)
23.19	20.16	20.19

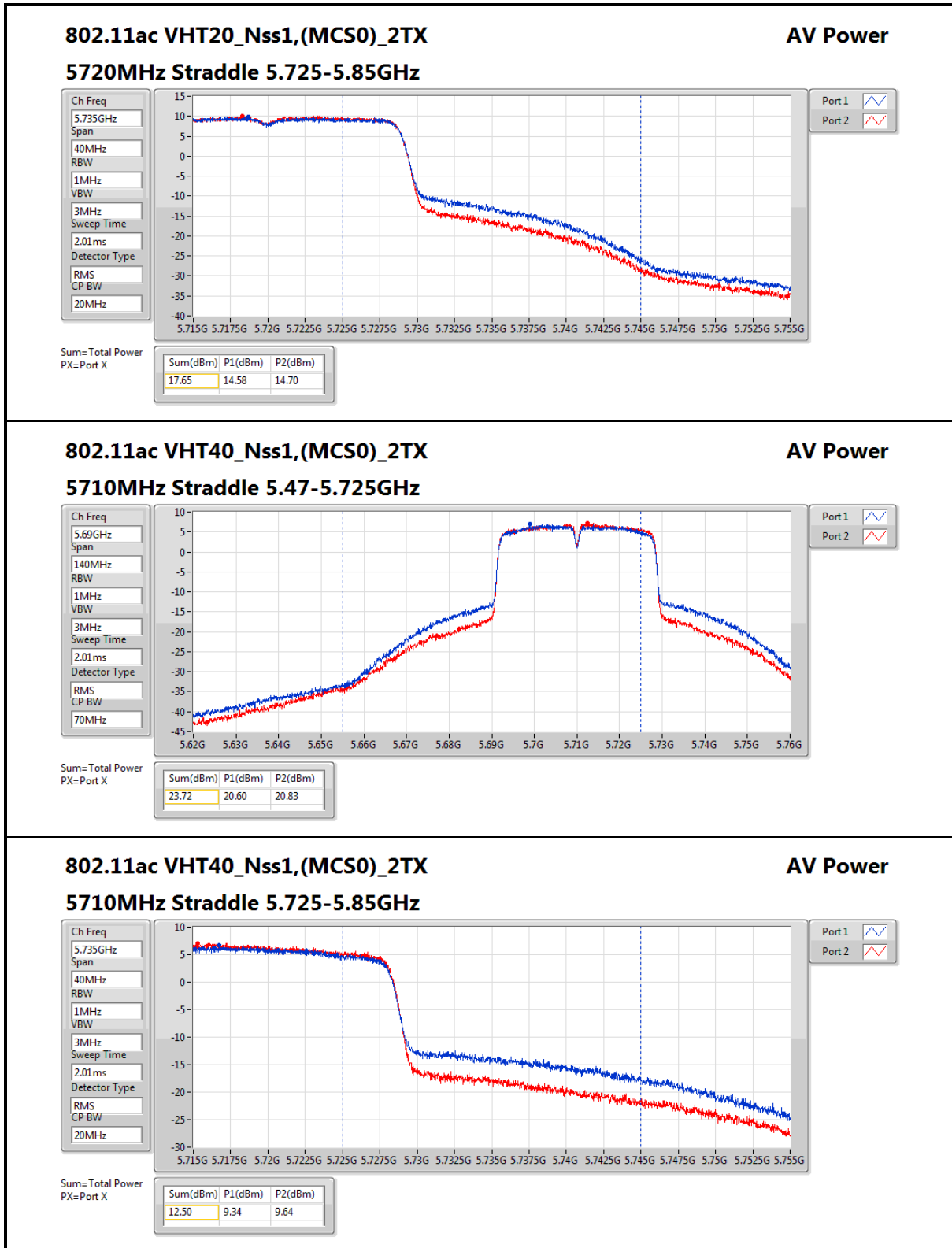

802.11ac VHT40_Nss1,(MCS0)_2TX

5710MHz Straddle 5.725-5.85GHz

AV Power

Ch Freq
5.735GHz

Span
40MHz

RBW
1MHz

VBW
3MHz

Sweep Time
2.01ms

Detector Type
RMS

CP BW
20MHz



Port 1 

Port 2 

Sum= Total Power
PX=Port X

Sum(dBm)	P1(dBm)	P2(dBm)
12.50	9.34	9.64

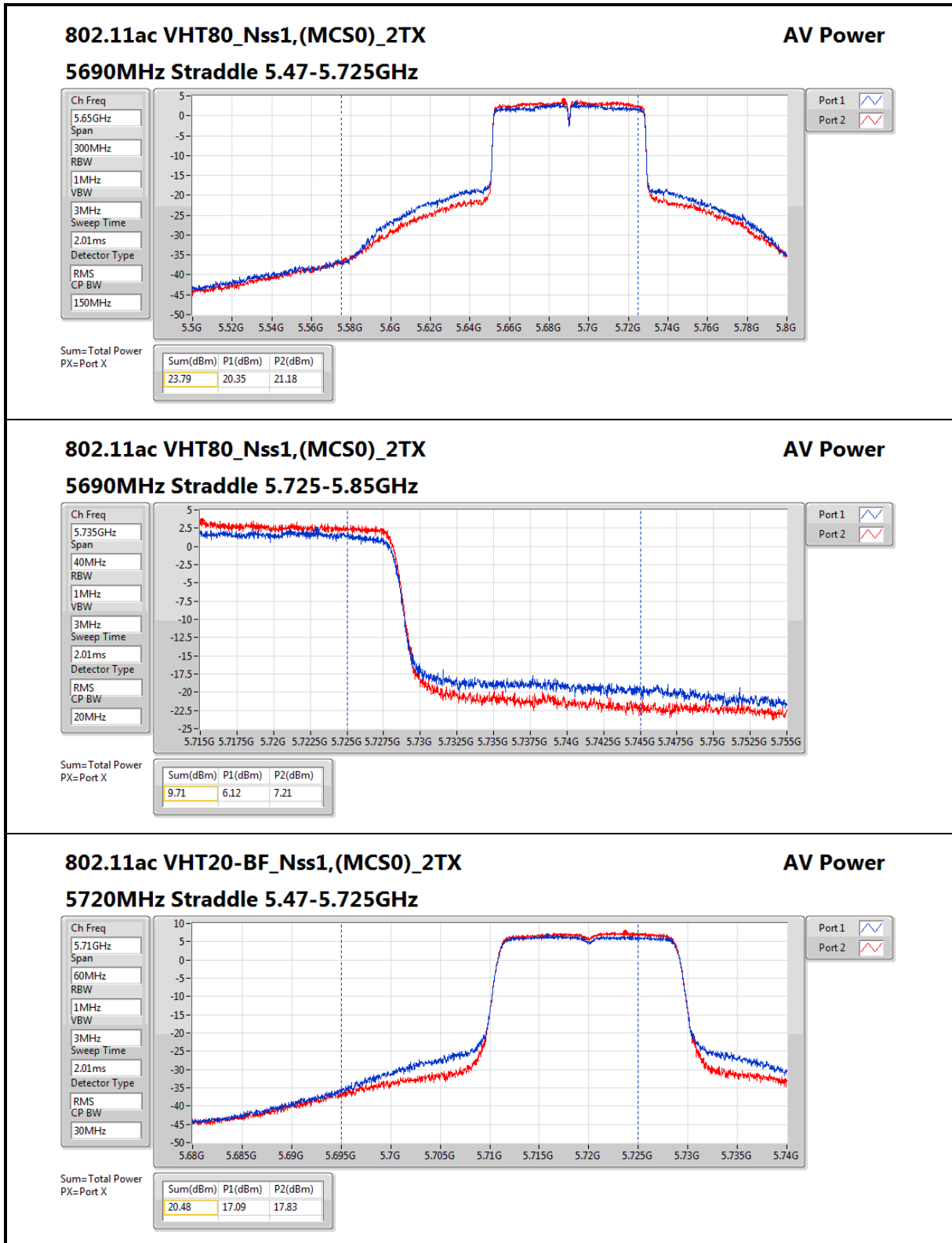

802.11ac VHT20-BF_Nss1,(MCS0)_2TX

5720MHz Straddle 5.47-5.725GHz

AV Power

Ch Freq
5.71GHz

Span
60MHz

RBW
1MHz

VBW
3MHz

Sweep Time
2.01ms

Detector Type
RMS

CP BW
30MHz



Port 1 

Port 2 

Sum= Total Power
PX=Port X

Sum(dBm)	P1(dBm)	P2(dBm)
20.48	17.09	17.83

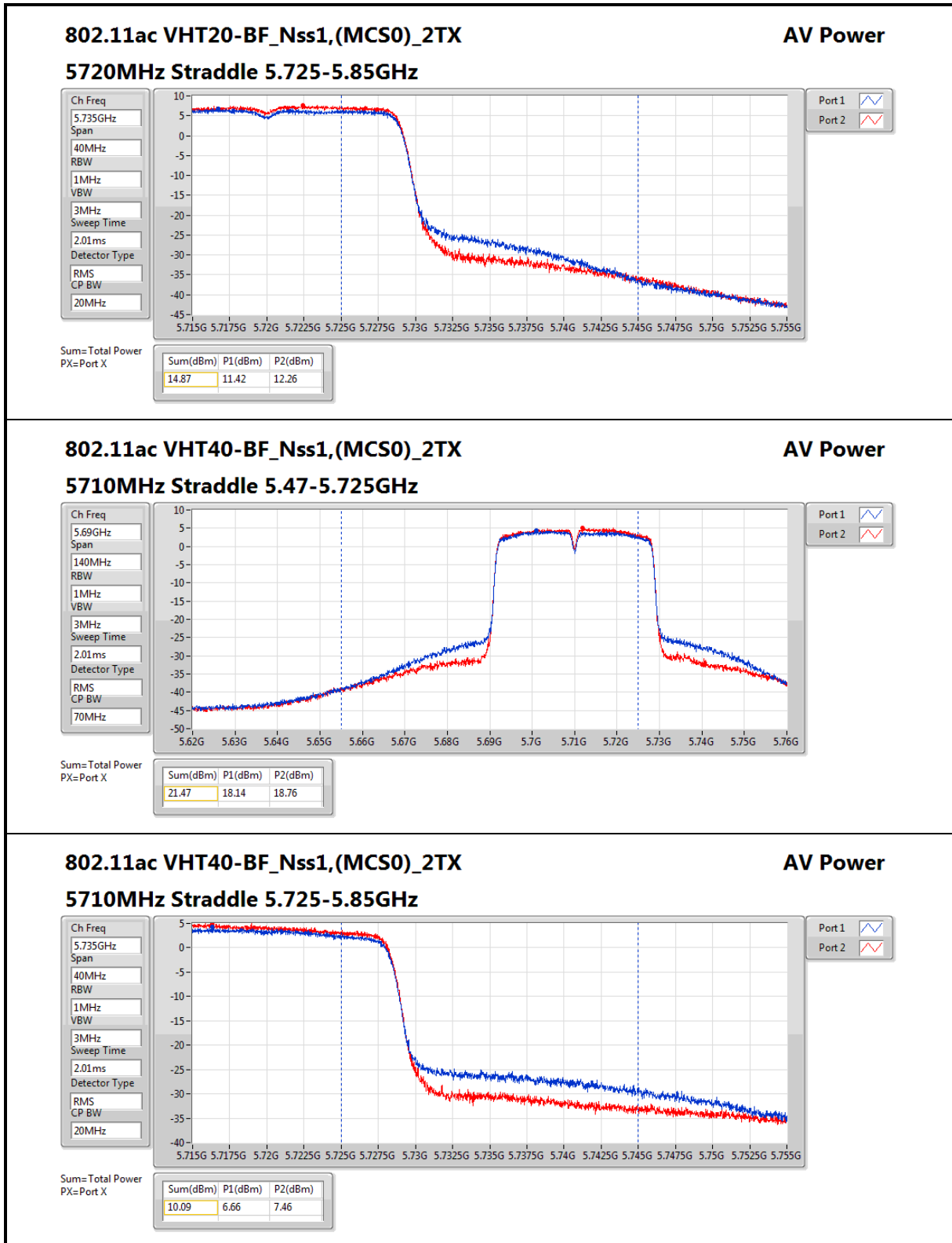

802.11ac VHT40-BF_Nss1,(MCS0)_2TX

5710MHz Straddle 5.725-5.85GHz

AV Power

Ch Freq
5.735GHz

Span
40MHz

RBW
1MHz

VBW
3MHz

Sweep Time
2.01ms

Detector Type
RMS

CP BW
20MHz



Port 1 

Port 2 

Sum= Total Power
PX=Port X

Sum(dBm)	P1(dBm)	P2(dBm)
10.09	6.66	7.46

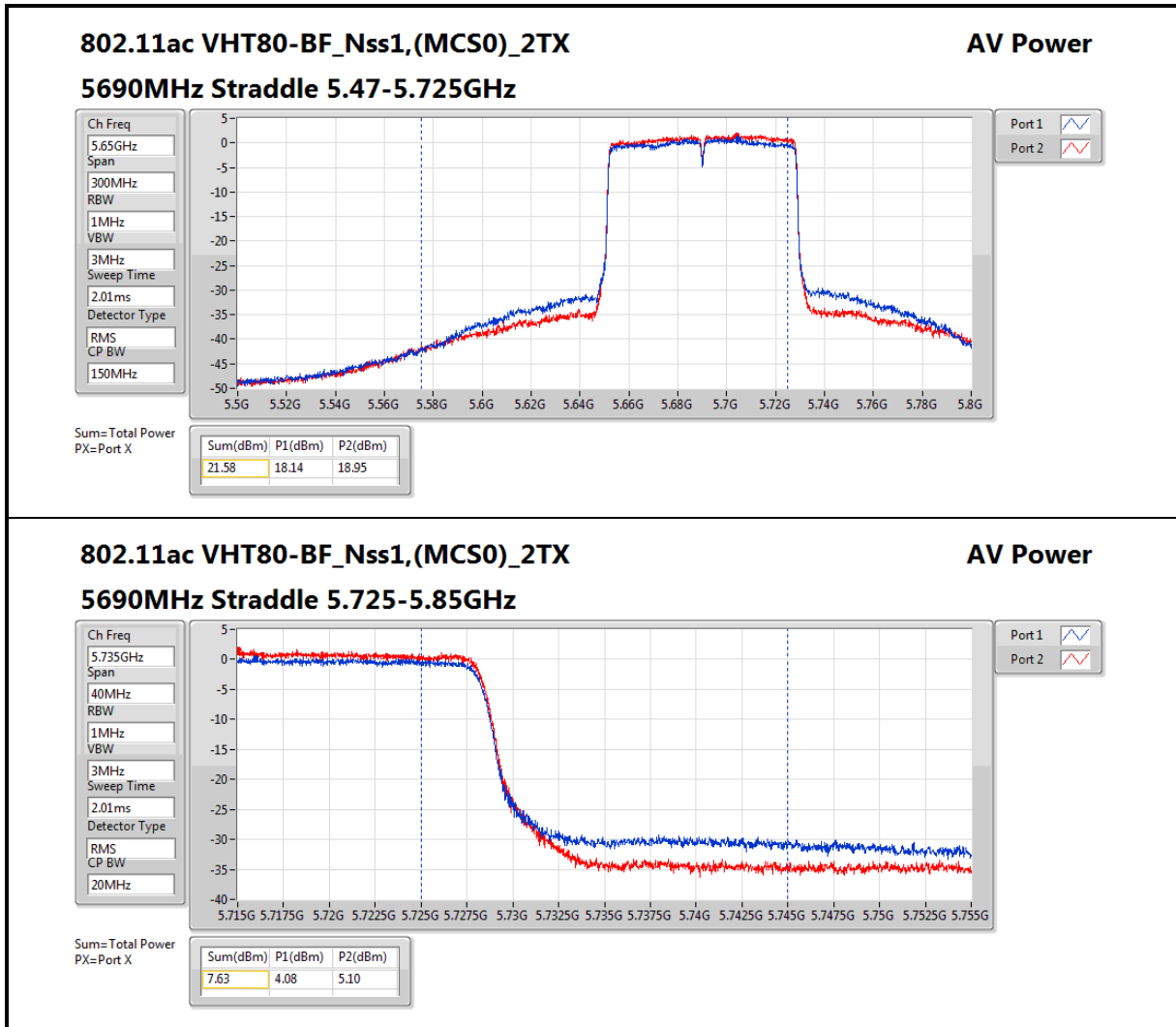

802.11ac VHT80-BF_Nss1,(MCS0)_2TX

5690MHz Straddle 5.725-5.85GHz

AV Power



3.4 Peak Power Spectral Density

3.4.1 Peak Power Spectral Density Limit

Peak Power Spectral Density Limit	
UNII Devices	
<input type="checkbox"/> For the 5.15-5.25 GHz band:	
<input type="checkbox"/>	<ul style="list-style-type: none"> ▪ Outdoor AP: the peak power spectral density (PPSD) shall not exceed the lesser of 17dBm/MHz. If $G_{TX} > 6$ dBi, then $P_{Out} = 17 - (G_{TX} - 6)$. ▪ Indoor AP: the peak power spectral density (PPSD) shall not exceed the lesser of 17dBm/MHz. If $G_{TX} > 6$ dBi, then $P_{Out} = 17 - (G_{TX} - 6)$. ▪ Point-to-point AP: the peak power spectral density (PPSD) shall not exceed the lesser of 17dBm/MHz. If $G_{TX} > 23$ dBi, then $P_{Out} = 17 - (G_{TX} - 23)$. ▪ Mobile or Portable Client: the peak power spectral density (PPSD) ≤ 11 dBm/MHz. If $G_{TX} > 6$ dBi, then $PPSD = 11 - (G_{TX} - 6)$.
<input checked="" type="checkbox"/> For the 5.25-5.35 GHz band, the peak power spectral density (PPSD) ≤ 11 dBm/MHz. If $G_{TX} > 6$ dBi, then $PPSD = 11 - (G_{TX} - 6)$.	
<input checked="" type="checkbox"/> For the 5.47-5.725 GHz band, the peak power spectral density (PPSD) ≤ 11 dBm/MHz. If $G_{TX} > 6$ dBi, then $PPSD = 11 - (G_{TX} - 6)$.	
<input checked="" type="checkbox"/> For the 5.725-5.85 GHz band:	
<input type="checkbox"/>	<ul style="list-style-type: none"> ▪ Point-to-multipoint systems (P2M): the peak power spectral density (PPSD) ≤ 30 dBm/500kHz. If $G_{TX} > 6$ dBi, then $PPSD = 30 - (G_{TX} - 6)$. ▪ Point-to-point systems (P2P): the peak power spectral density (PPSD) ≤ 30 dBm/500kHz.
LE-LAN Devices	
<input type="checkbox"/> For the 5.15-5.25 GHz band, the peak power spectral density (PPSD) ≤ 4 dBm/MHz and the e.i.r.p. peak power spectral density (PPSD) ≤ 10 dBm/MHz.	
<input type="checkbox"/> For the 5.25-5.35 GHz band, the peak power spectral density (PPSD) ≤ 11 dBm/MHz and the e.i.r.p. peak power spectral density (PPSD) ≤ 17 dBm/MHz.	
<input type="checkbox"/>	<ul style="list-style-type: none"> ▪ e.i.r.p. greater than 200 mW shall comply with the following e.i.r.p. at different elevations, where θ is the angle above the local horizontal plane (of the Earth) as shown below: -13 dBW/MHz for $0^\circ \leq \theta < 8^\circ$; -13 - 0.716 (θ-8) dBW/MHz for $8^\circ \leq \theta < 40^\circ$ -35.9 - 1.22 (θ-40) dBW/MHz for $40^\circ \leq \theta \leq 45^\circ$; -42 dBW/MHz for $\theta > 45^\circ$
<input type="checkbox"/> For the 5.47-5.6 GHz band and 5.65-5.725 GHz band, the peak power spectral density (PPSD) ≤ 11 dBm/MHz and the e.i.r.p. peak power spectral density (PPSD) ≤ 17 dBm/MHz.	
<input type="checkbox"/> For the 5.725-5.85 GHz band:	
<input type="checkbox"/>	<ul style="list-style-type: none"> ▪ Point-to-multipoint systems (P2M): the peak power spectral density (PPSD) ≤ 30 dBm/500kHz. If $G_{TX} > 6$ dBi, then $PPSD = 30 - (G_{TX} - 6)$. ▪ Point-to-point systems (P2P): the peak power spectral density (PPSD) ≤ 30 dBm/500kHz.
<p>PPSD = peak power spectral density that he same method as used to determine the conducted output power shall be used to determine the power spectral density. And power spectral density in dBm/MHz</p> <p>G_{TX} = the maximum transmitting antenna directional gain in dBi.</p>	

3.4.2 Measuring Instruments

Refer a test equipment and calibration data table in this test report.

3.4.3 Test Procedures

Test Method	
<ul style="list-style-type: none"> ▪ Peak power spectral density procedures that the same method as used to determine the conducted output power shall be used to determine the peak power spectral density and use the peak search function on the spectrum analyzer to find the peak of the spectrum. For the peak power spectral density shall be measured using below options: 	
<input type="checkbox"/> Refer as FCC KDB 789033, F)5) power spectral density can be measured using resolution bandwidths < 1 MHz provided that the results are integrated over 1 MHz bandwidth [duty cycle ≥ 98% or external video / power trigger]	
<input checked="" type="checkbox"/> Refer as FCC KDB 789033, clause E Method SA-1 (spectral trace averaging).	
<input type="checkbox"/> Refer as FCC KDB 789033, clause E Method SA-1 Alt. (RMS detection with slow sweep speed) duty cycle < 98% and average over on/off periods with duty factor	
<input checked="" type="checkbox"/> Refer as FCC KDB 789033, clause E Method SA-2 (spectral trace averaging).	
<input type="checkbox"/> Refer as FCC KDB 789033, clause E Method SA-2 Alt. (RMS detection with slow sweep speed)	
<ul style="list-style-type: none"> ▪ For conducted measurement. 	
<ul style="list-style-type: none"> ▪ If the EUT supports multiple transmit chains using options given below: 	
<input checked="" type="checkbox"/> Option 1: Measure and sum the spectra across the outputs. Refer as FCC KDB 662911, In-band power spectral density (PSD). Sample all transmit ports simultaneously using a spectrum analyzer for each transmit port. Where the trace bin-by-bin of each transmit port summing can be performed. (i.e., in the first spectral bin of output 1 is summed with that in the first spectral bin of output 2 and that from the first spectral bin of output 3, and so on up to the NTX output to obtain the value for the first frequency bin of the summed spectrum.). Add up the amplitude (power) values for the different transmit chains and use this as the new data trace.	
<input type="checkbox"/> Option 2: Measure and sum spectral maxima across the outputs. With this technique, spectra are measured at each output of the device at the required resolution bandwidth. The maximum value (peak) of each spectrum is determined. These maximum values are then summed mathematically in linear power units across the outputs. These operations shall be performed separately over frequency spans that have different out-of-band or spurious emission limits,	
<input type="checkbox"/> Option 3: Measure and add 10 log(N) dB, where N is the number of transmit chains. Refer as FCC KDB 662911, In-band power spectral density (PSD). Performed at each transmit chains and each transmit chains shall be compared with the limit have been reduced with 10 log(N). Or each transmit chains shall be add 10 log(N) to compared with the limit.	
<ul style="list-style-type: none"> ▪ If multiple transmit chains, EIRP PPSD calculation could be following as methods: $PPSD_{total} = PPSD_1 + PPSD_2 + \dots + PPSD_n$ (calculated in linear unit [mW] and transfer to log unit [dBm]) $EIRP_{total} = PPSD_{total} + DG$ 	

3.4.4 Test Setup

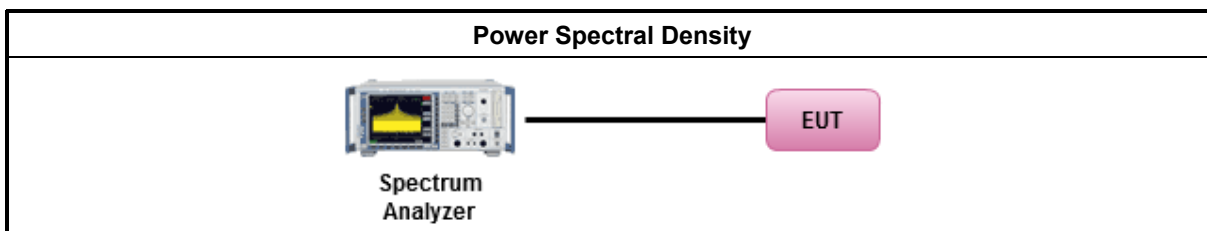



3.4.5 Test Result of Peak Power Spectral Density

Summary

Mode	PD (dBm/RBW)	EIRP PD (dBm/RBW)
802.11a_(6Mbps)_2TX	-	-
5.25-5.35GHz	10.98	16.13
5.47-5.725GHz	10.99	16.14
5.725-5.85GHz	6.73	11.88
802.11ac VHT20_Nss1,(MCS0)_2TX	-	-
5.25-5.35GHz	10.97	16.12
5.47-5.725GHz	10.73	15.88
5.725-5.85GHz	9.19	14.34
802.11ac VHT40_Nss1,(MCS0)_2TX	-	-
5.25-5.35GHz	8.10	13.25
5.47-5.725GHz	8.04	13.19
5.725-5.85GHz	5.15	10.30
802.11ac VHT80_Nss1,(MCS0)_2TX	-	-
5.25-5.35GHz	-0.47	4.68
5.47-5.725GHz	4.65	9.80
5.725-5.85GHz	2.05	7.20
802.11ac VHT20-BF_Nss1,(MCS0)_2TX	-	-
5.25-5.35GHz	8.60	13.75
5.47-5.725GHz	8.44	13.59
5.725-5.85GHz	6.58	11.73
802.11ac VHT40-BF_Nss1,(MCS0)_2TX	-	-
5.25-5.35GHz	5.71	10.86
5.47-5.725GHz	5.77	10.92
5.725-5.85GHz	2.86	8.01
802.11ac VHT80-BF_Nss1,(MCS0)_2TX	-	-
5.25-5.35GHz	0.64	5.79
5.47-5.725GHz	2.36	7.51
5.725-5.85GHz	-0.20	4.95

RBW = 500kHz for 5.725-5.85GHz band / 1MHz for other band;



Result

Mode	Result	DG (dBi)	Port 1 (dBm/RBW)	Port 2 (dBm/RBW)	PD (dBm/RBW)	PD Limit (dBm/RBW)
802.11a_(6Mbps)_2TX	-	-	-	-	-	-
5260MHz	Pass	5.15	8.04	8.00	10.97	11.00
5300MHz	Pass	5.15	8.03	8.04	10.98	11.00
5320MHz	Pass	5.15	8.25	7.87	10.92	11.00
5500MHz	Pass	5.15	7.74	7.67	10.66	11.00
5580MHz	Pass	5.15	7.80	8.21	10.99	11.00
5700MHz	Pass	5.15	3.06	3.39	6.13	11.00
5720MHz Straddle 5.47-5.725GHz	Pass	5.15	5.05	5.92	8.46	11.00
5720MHz Straddle 5.725-5.85GHz	Pass	5.15	3.18	4.25	6.73	30.00
802.11ac VHT20_Nss1,(MCS0)_2TX	-	-	-	-	-	-
5260MHz	Pass	5.15	7.89	8.17	10.97	11.00
5300MHz	Pass	5.15	7.59	7.65	10.53	11.00
5320MHz	Pass	5.15	5.56	5.42	8.34	11.00
5500MHz	Pass	5.15	6.17	6.01	9.09	11.00
5580MHz	Pass	5.15	7.50	8.00	10.73	11.00
5700MHz	Pass	5.15	3.45	4.04	6.71	11.00
5720MHz Straddle 5.47-5.725GHz	Pass	5.15	7.17	8.26	10.69	11.00
5720MHz Straddle 5.725-5.85GHz	Pass	5.15	5.90	6.49	9.19	30.00
802.11ac VHT40_Nss1,(MCS0)_2TX	-	-	-	-	-	-
5270MHz	Pass	5.15	5.00	5.41	8.10	11.00
5310MHz	Pass	5.15	0.68	0.69	3.58	11.00
5510MHz	Pass	5.15	0.18	0.23	3.16	11.00
5550MHz	Pass	5.15	5.00	5.08	7.95	11.00
5670MHz	Pass	5.15	2.53	3.35	5.82	11.00
5710MHz Straddle 5.47-5.725GHz	Pass	5.15	5.04	5.46	8.04	11.00
5710MHz Straddle 5.725-5.85GHz	Pass	5.15	2.00	2.32	5.15	30.00
802.11ac VHT80_Nss1,(MCS0)_2TX	-	-	-	-	-	-
5290MHz	Pass	5.15	-3.39	-3.31	-0.47	11.00
5530MHz	Pass	5.15	-2.38	-2.38	0.56	11.00
5610MHz	Pass	5.15	0.56	1.07	3.69	11.00
5690MHz Straddle 5.47-5.725GHz	Pass	5.15	1.25	1.99	4.65	11.00
5690MHz Straddle 5.725-5.85GHz	Pass	5.15	-1.51	-0.40	2.05	30.00
802.11ac VHT20-BF_Nss1,(MCS0)_2TX	-	-	-	-	-	-
5260MHz	Pass	5.15	4.97	5.32	8.08	11.00
5300MHz	Pass	5.15	5.60	5.84	8.60	11.00
5320MHz	Pass	5.15	4.79	4.72	7.63	11.00
5500MHz	Pass	5.15	5.60	5.34	8.44	11.00
5580MHz	Pass	5.15	5.20	5.53	8.34	11.00
5700MHz	Pass	5.15	3.43	3.75	6.52	11.00
5720MHz Straddle 5.47-5.725GHz	Pass	5.15	4.92	5.81	8.33	11.00
5720MHz Straddle 5.725-5.85GHz	Pass	5.15	3.15	4.10	6.58	30.00
802.11ac VHT40-BF_Nss1,(MCS0)_2TX	-	-	-	-	-	-
5270MHz	Pass	5.15	2.69	2.92	5.71	11.00
5310MHz	Pass	5.15	1.36	1.05	4.15	11.00



Mode	Result	DG (dBi)	Port 1 (dBm/RBW)	Port 2 (dBm/RBW)	PD (dBm/RBW)	PD Limit (dBm/RBW)
5510MHz	Pass	5.15	1.92	1.86	4.88	11.00
5550MHz	Pass	5.15	2.55	2.57	5.57	11.00
5670MHz	Pass	5.15	2.19	3.09	5.54	11.00
5710MHz Straddle 5.47-5.725GHz	Pass	5.15	2.56	3.22	5.77	11.00
5710MHz Straddle 5.725-5.85GHz	Pass	5.15	-0.40	0.16	2.86	30.00
802.11ac VHT80-BF_Nss1,(MCS0)_2TX	-	-	-	-	-	-
5290MHz	Pass	5.15	-2.09	-2.27	0.64	11.00
5530MHz	Pass	5.15	-2.71	-2.79	0.21	11.00
5610MHz	Pass	5.15	-0.76	-0.39	2.36	11.00
5690MHz Straddle 5.47-5.725GHz	Pass	5.15	-0.95	-0.25	2.30	11.00
5690MHz Straddle 5.725-5.85GHz	Pass	5.15	-3.67	-2.69	-0.20	30.00

DG = Directional Gain; RBW = 500kHz for 5.725-5.85GHz band / 1MHz for other band;

PD = trace bin-by-bin of each transmits port summing can be performed maximum power density; Port X = Port X power density;

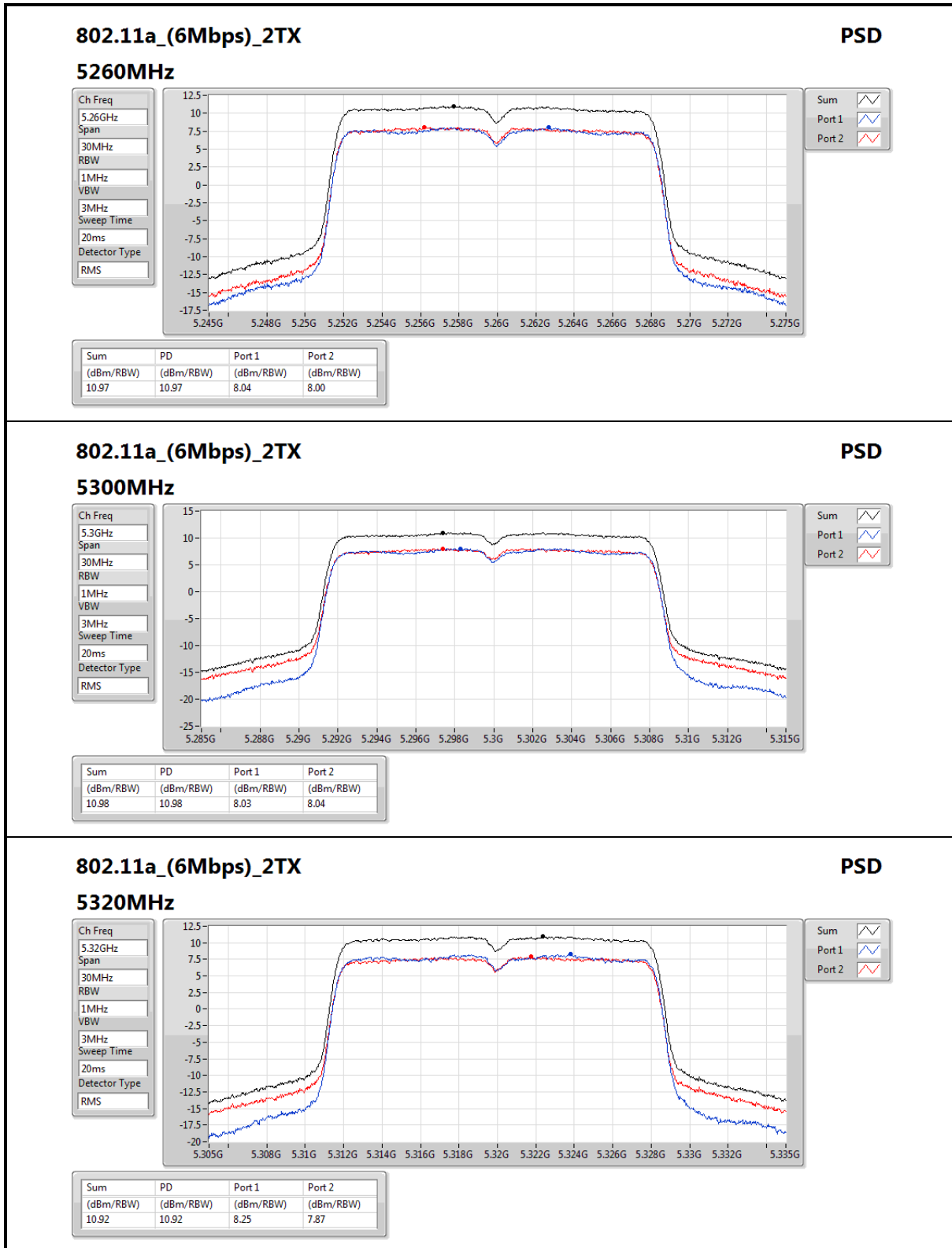
802.11a_(6Mbps)_2TX
PSD

5320MHz

Ch Freq
5.32GHz

Span
30MHz

RBW
1MHz

VBW
3MHz

Sweep Time
20ms

Detector Type
RMS



Sum

Port 1

Port 2

Sum	PD	Port 1	Port 2
(dBm/RBW)	(dBm/RBW)	(dBm/RBW)	(dBm/RBW)
10.92	10.92	8.25	7.87

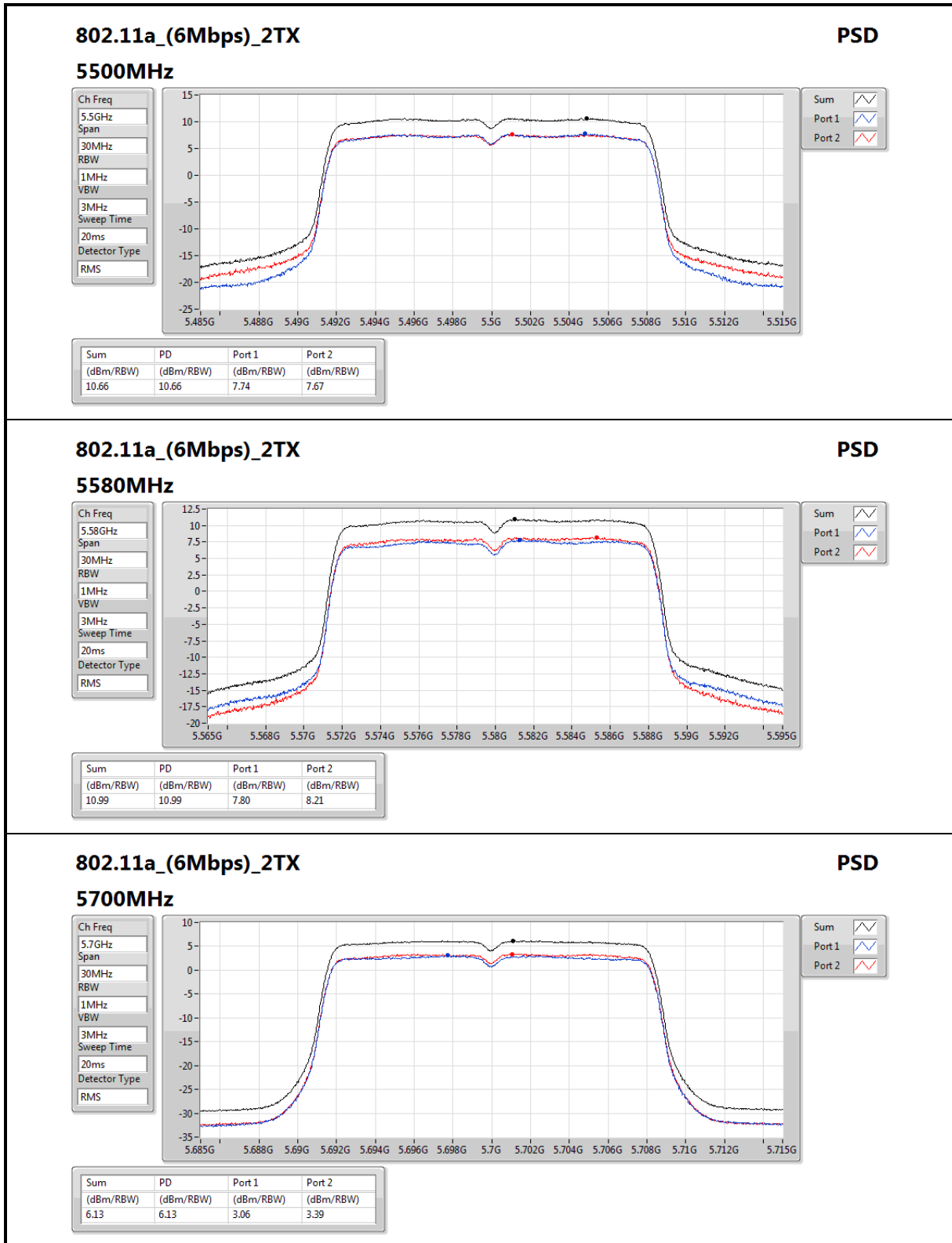

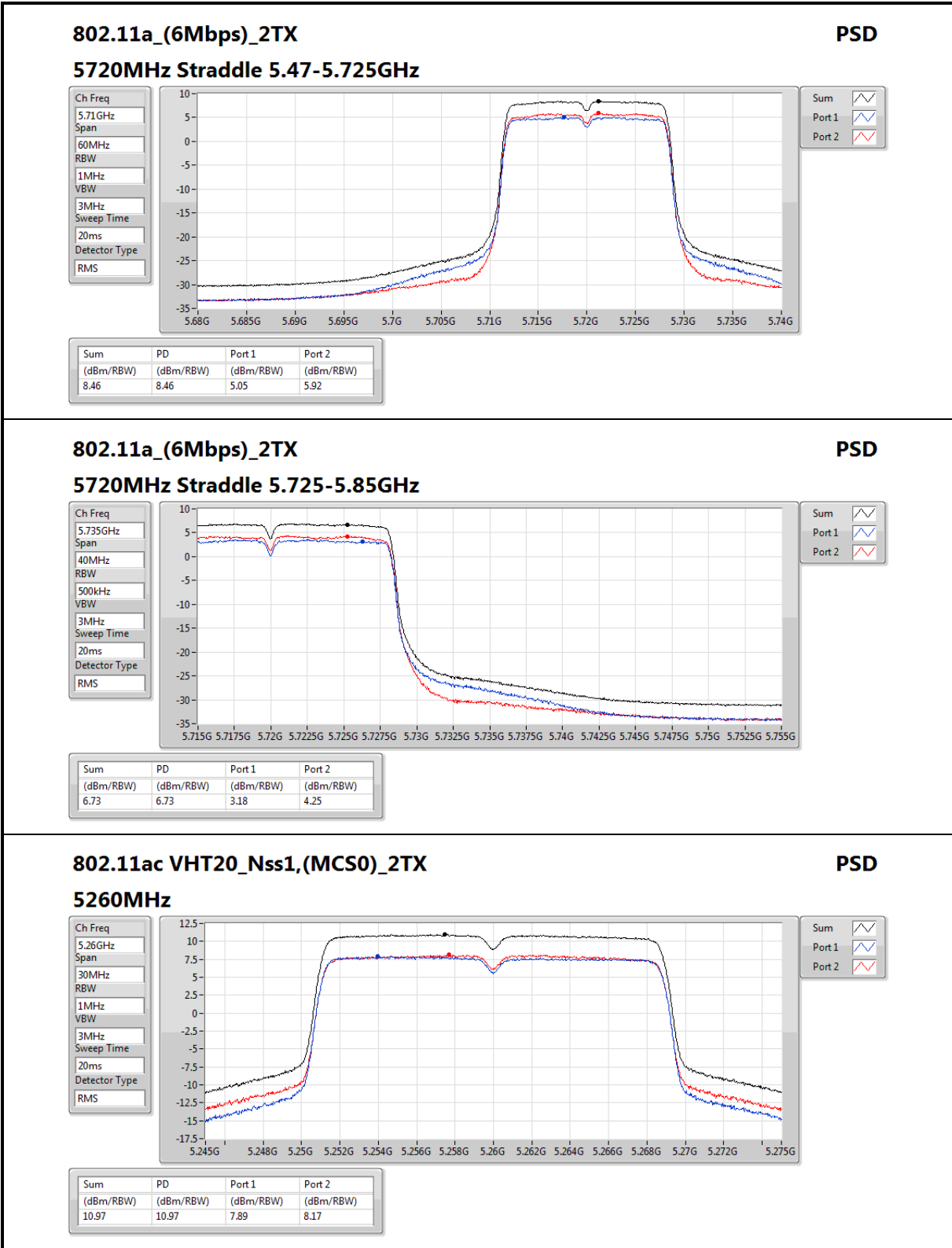

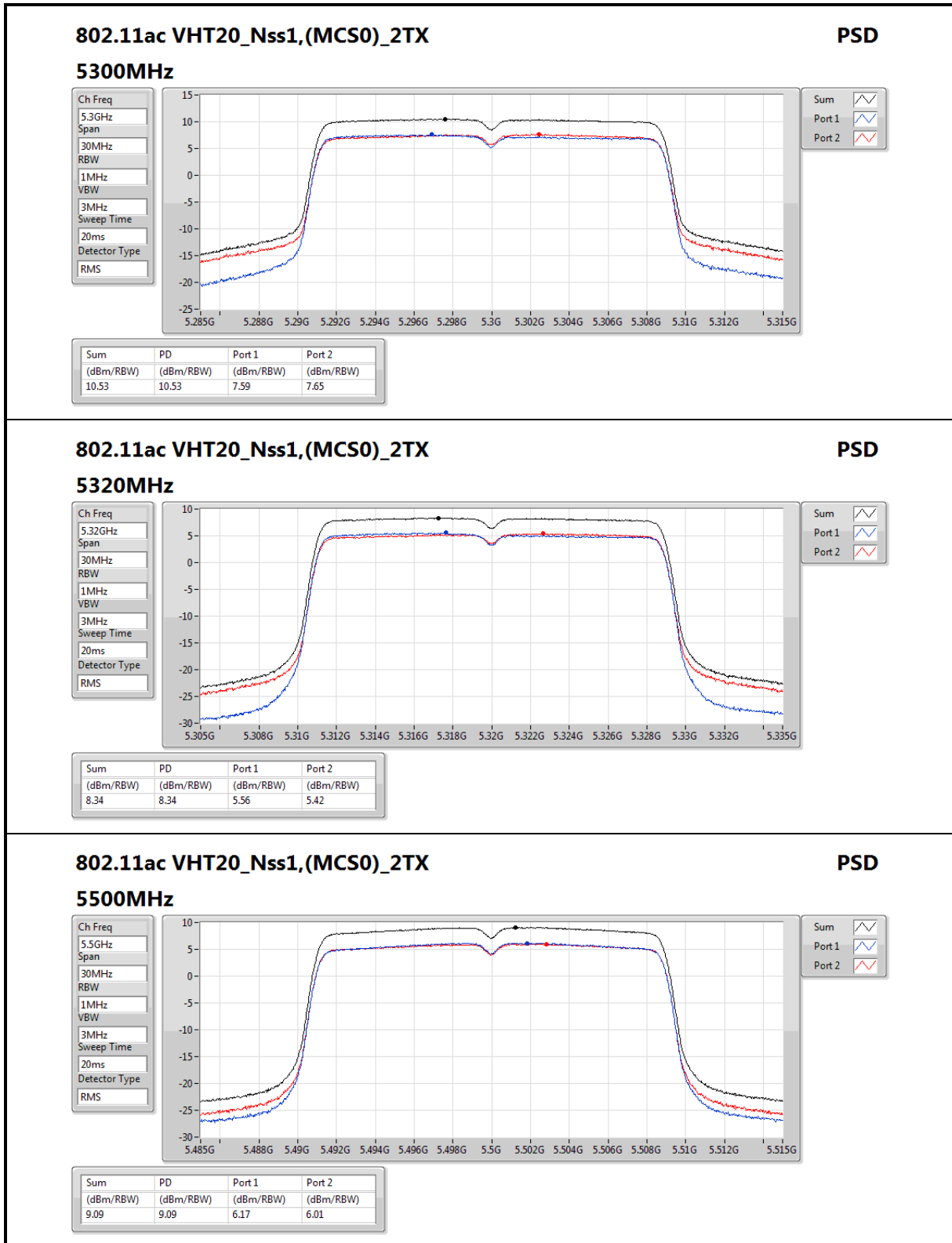

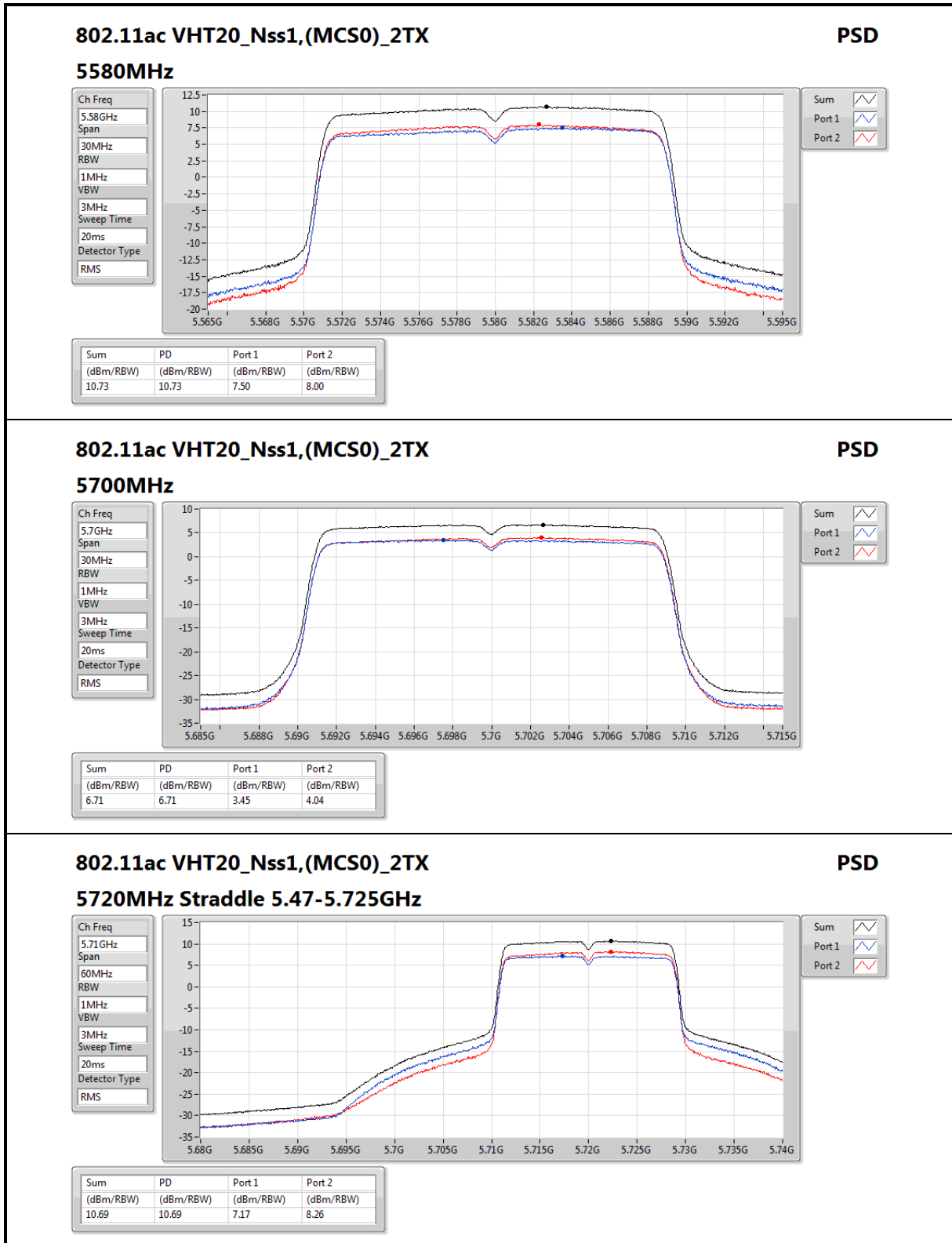

802.11ac VHT20_Nss1,(MCS0)_2TX

5720MHz Straddle 5.47-5.725GHz

PSD

Ch Freq
5.71GHz

Span
60MHz

RBW
1MHz

VBW
3MHz

Sweep Time
20ms

Detector Type
RMS



Sum

Port 1

Port 2

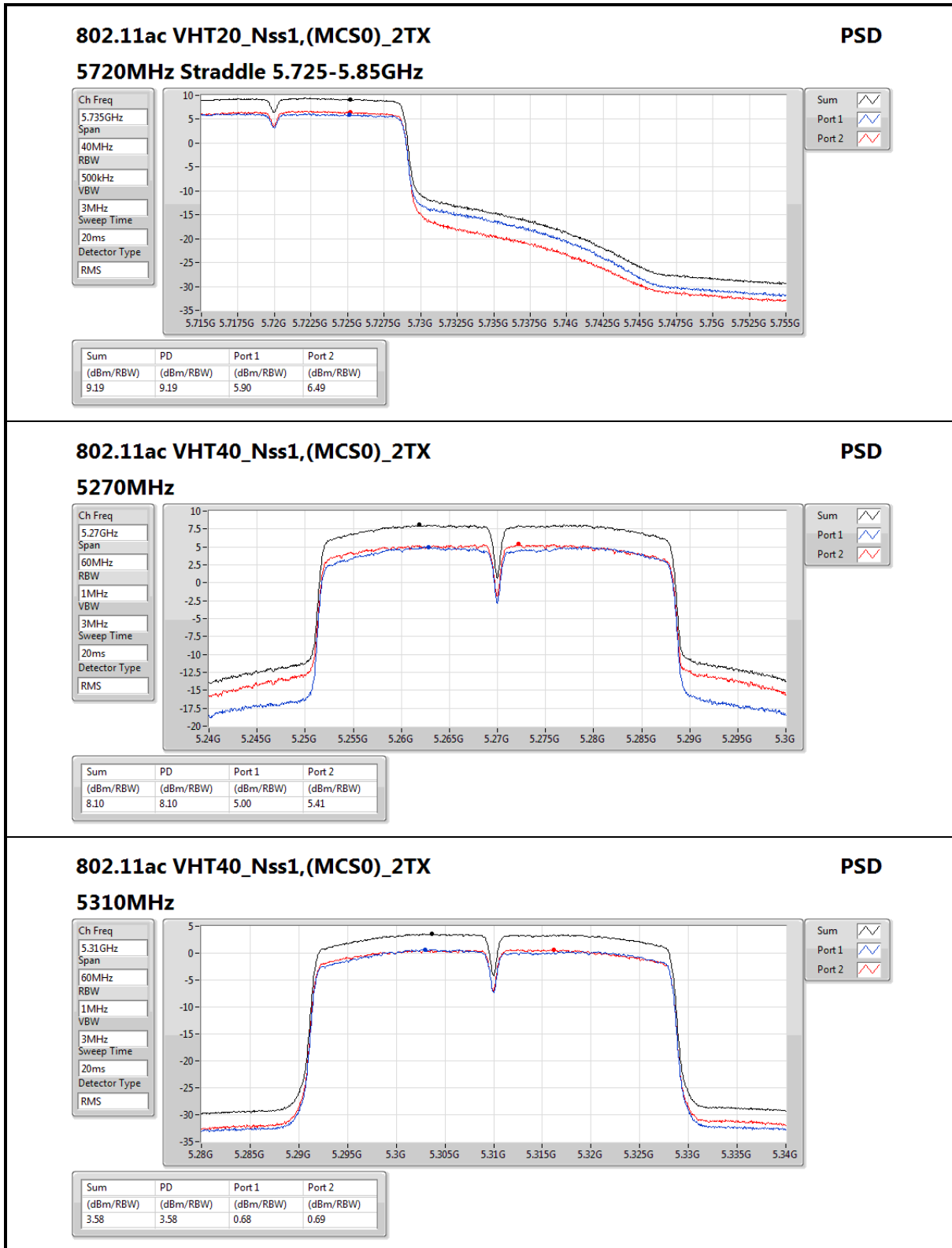

802.11ac VHT40_Nss1,(MCS0)_2TX

5310MHz

PSD

Ch Freq
5.31GHz

Span
60MHz

RBW
1MHz

VBW
3MHz

Sweep Time
20ms

Detector Type
RMS



Sum

Port 1

Port 2

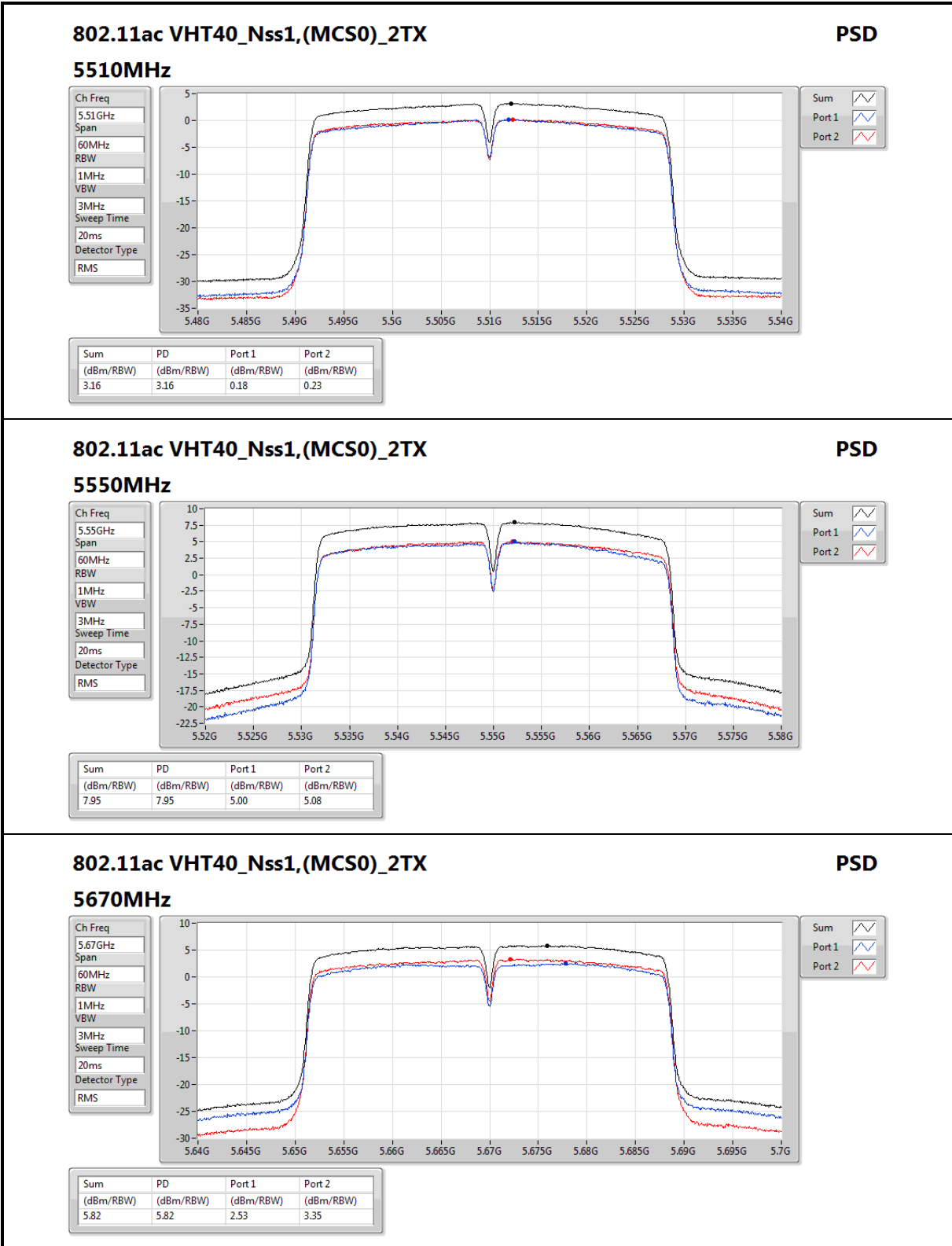

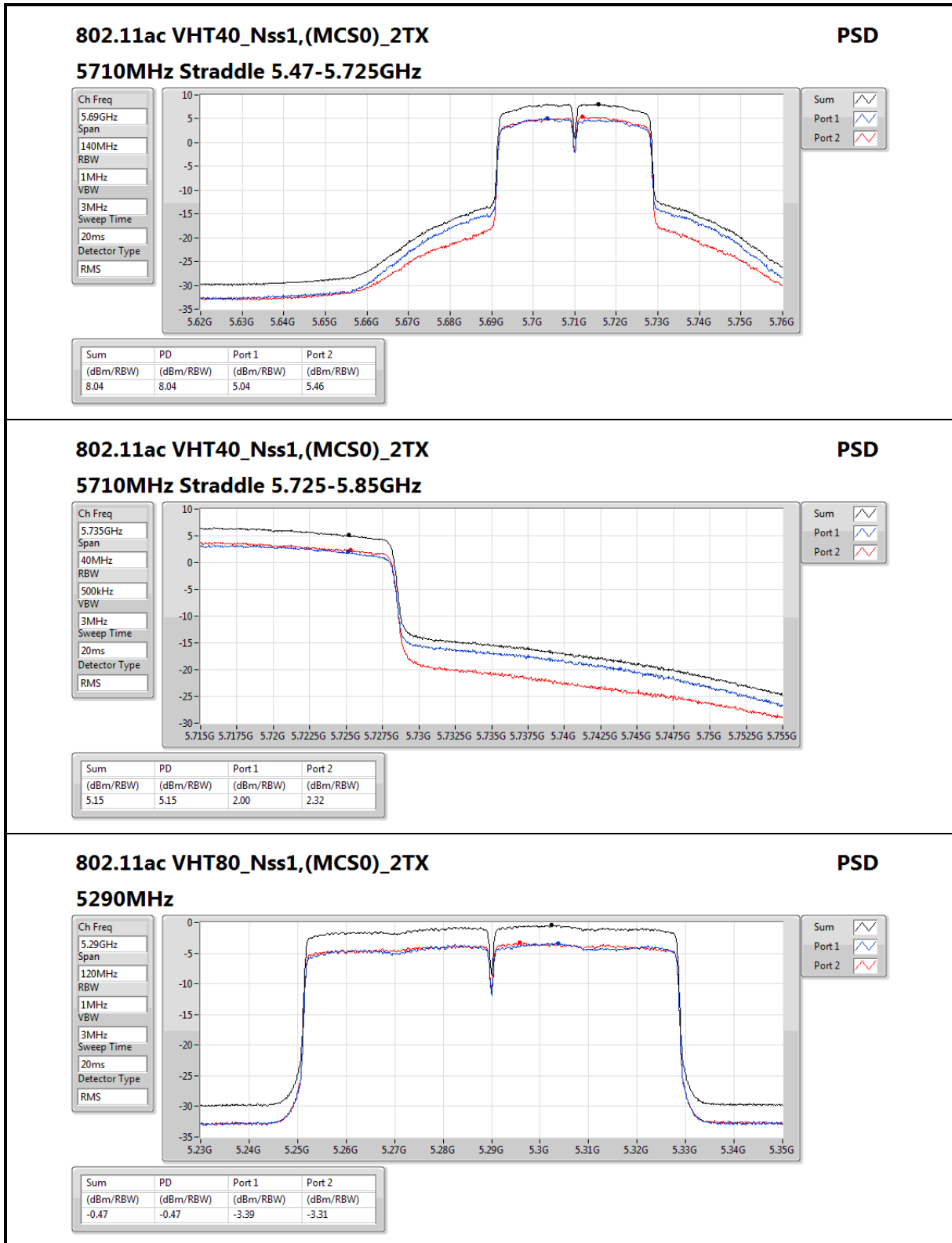

802.11ac VHT80_Nss1,(MCS0)_2TX

5290MHz

PSD

Ch Freq
5.29GHz

Span
120MHz

RBW
1MHz

VBW
3MHz

Sweep Time
20ms

Detector Type
RMS



Sum

Port 1

Port 2

Sum	PD	Port 1	Port 2
(dBm/RBW)	(dBm/RBW)	(dBm/RBW)	(dBm/RBW)
-0.47	-0.47	-3.39	-3.31

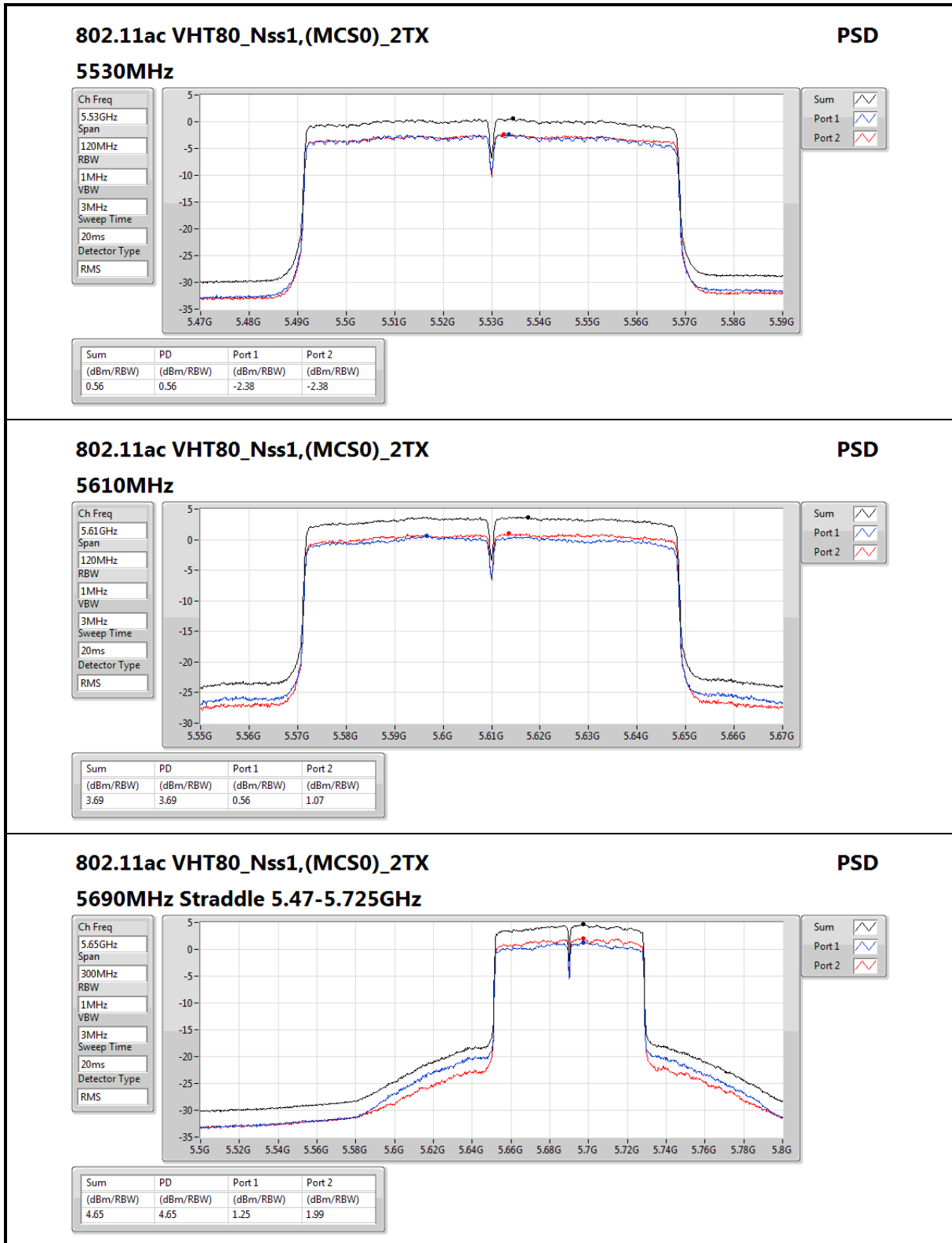

802.11ac VHT80_Nss1,(MCS0)_2TX

5690MHz Straddle 5.47-5.725GHz

PSD

Ch Freq
5.65GHz

Span
300MHz

RBW
1MHz

VBW
3MHz

Sweep Time
20ms

Detector Type
RMS



Sum

Port 1

Port 2

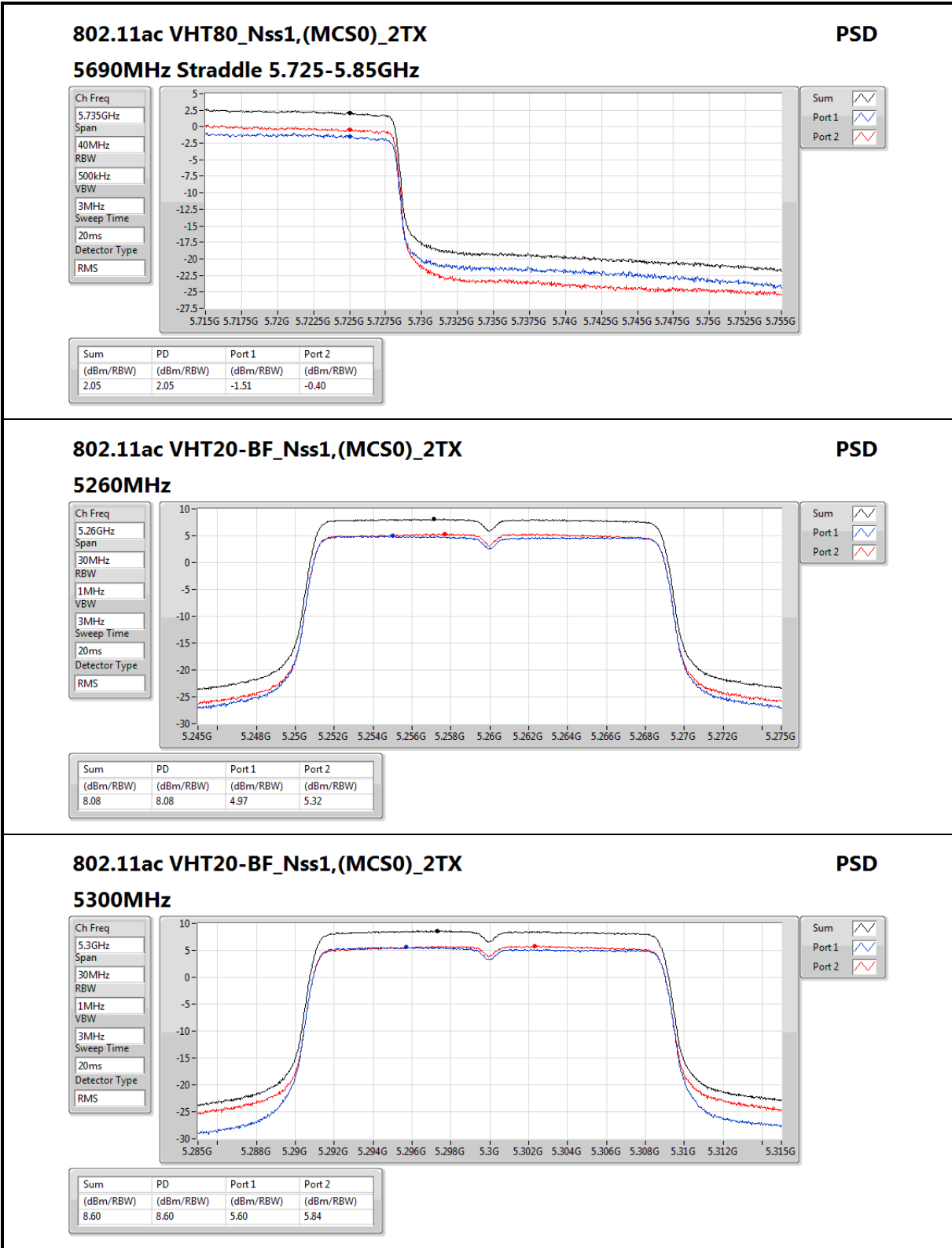

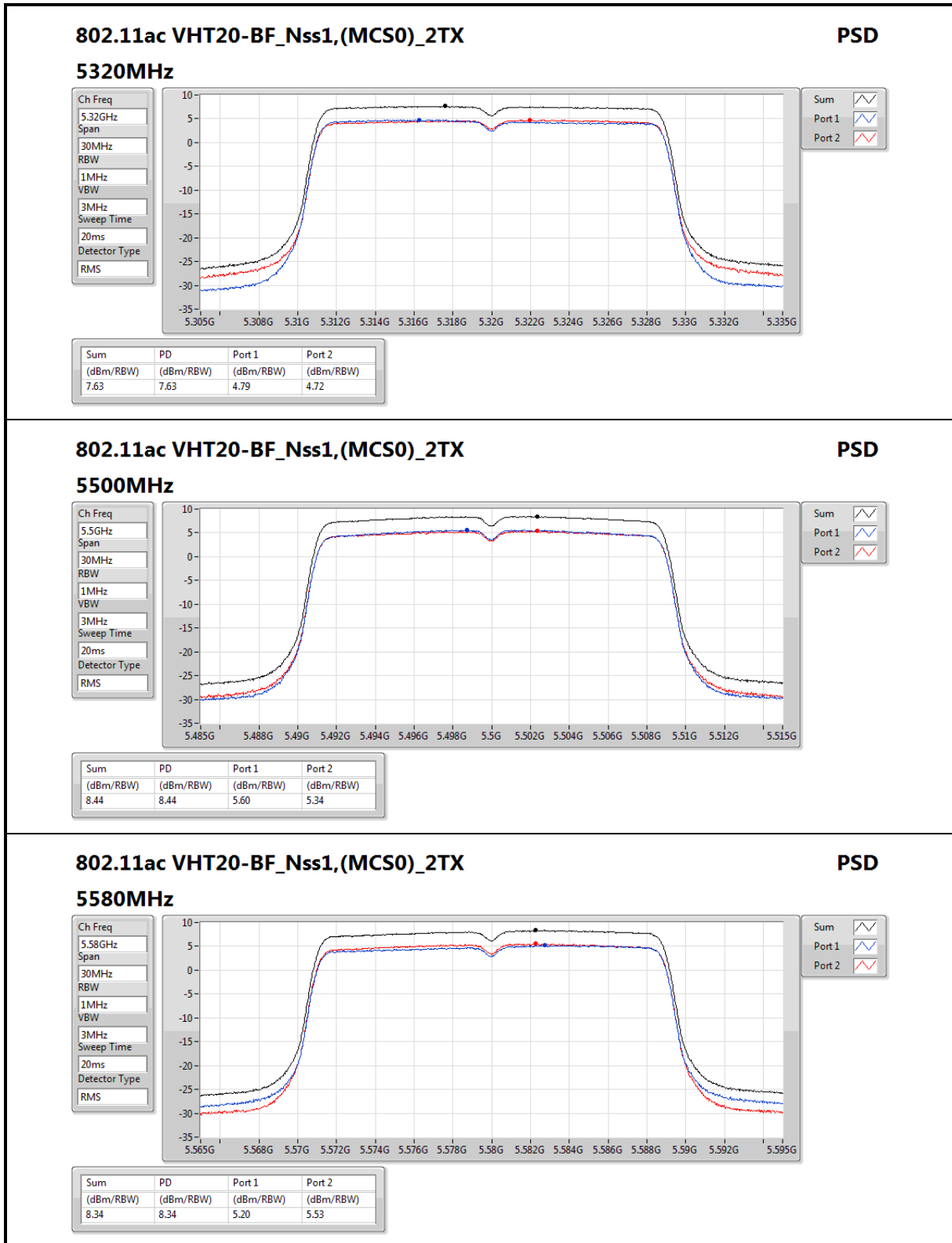

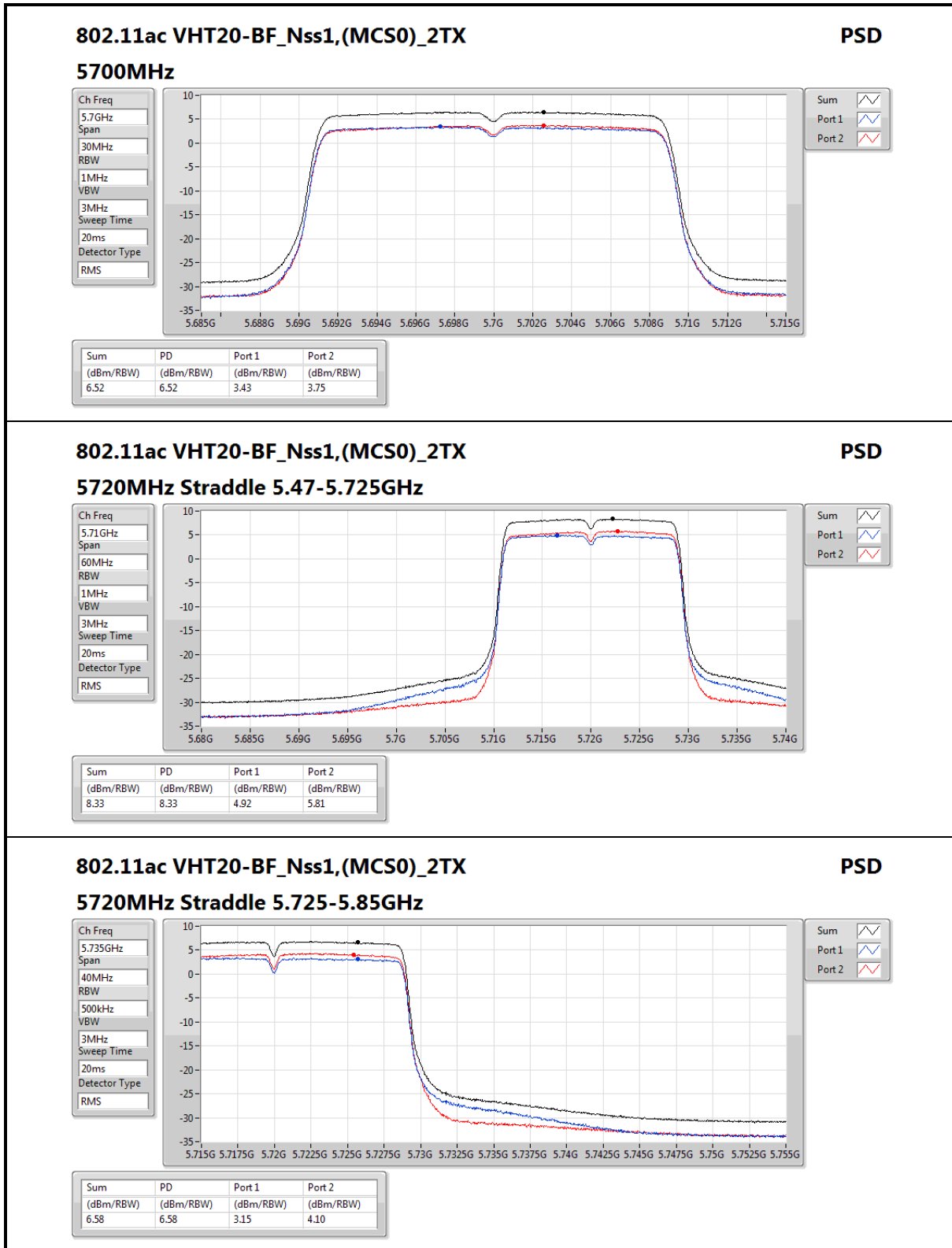

802.11ac VHT20-BF_Nss1,(MCS0)_2TX

5720MHz Straddle 5.725-5.85GHz

PSD

Ch Freq
5.735GHz

Span
40MHz

RBW
500kHz

VBW
3MHz

Sweep Time
20ms

Detector Type
RMS



Sum

Port 1

Port 2

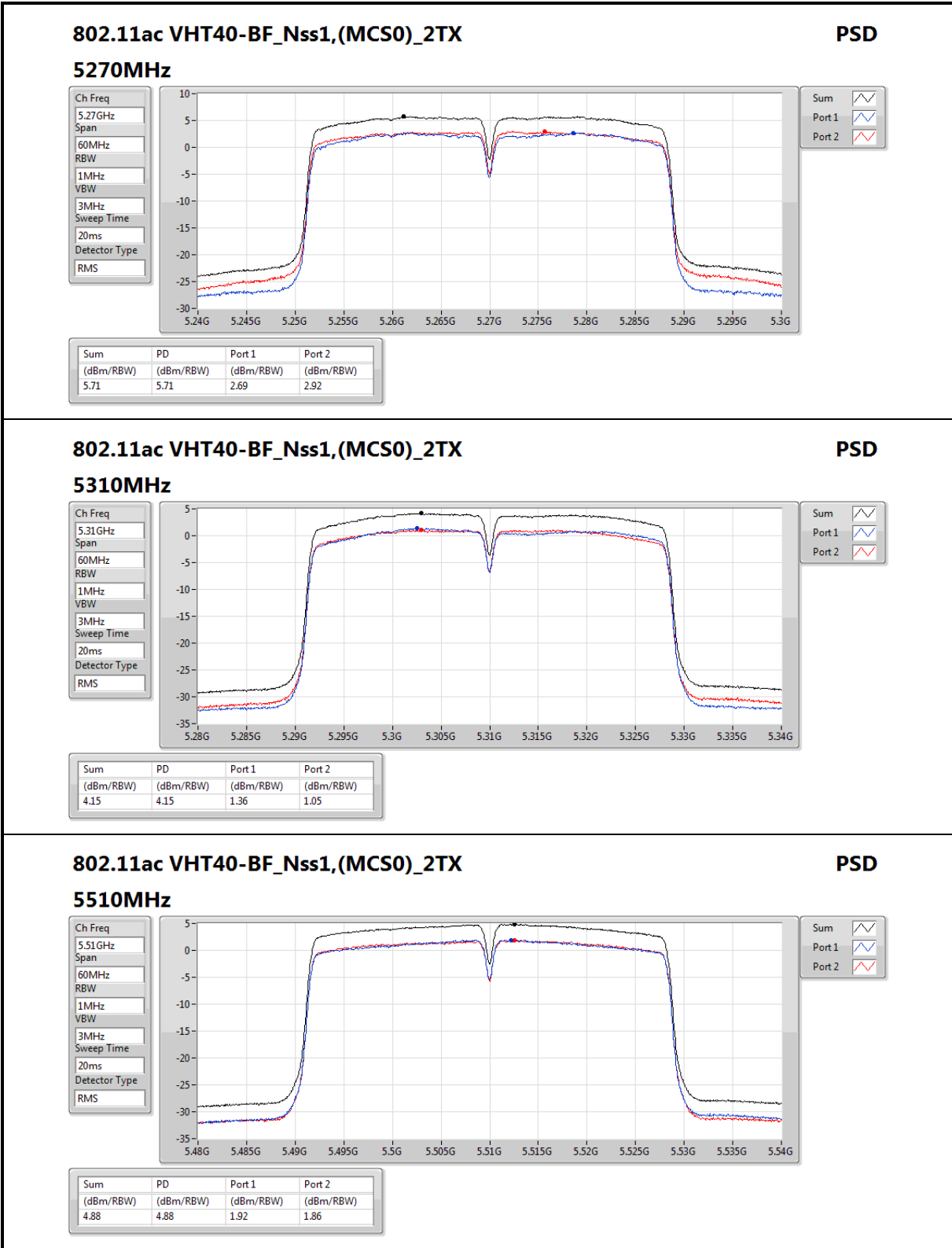

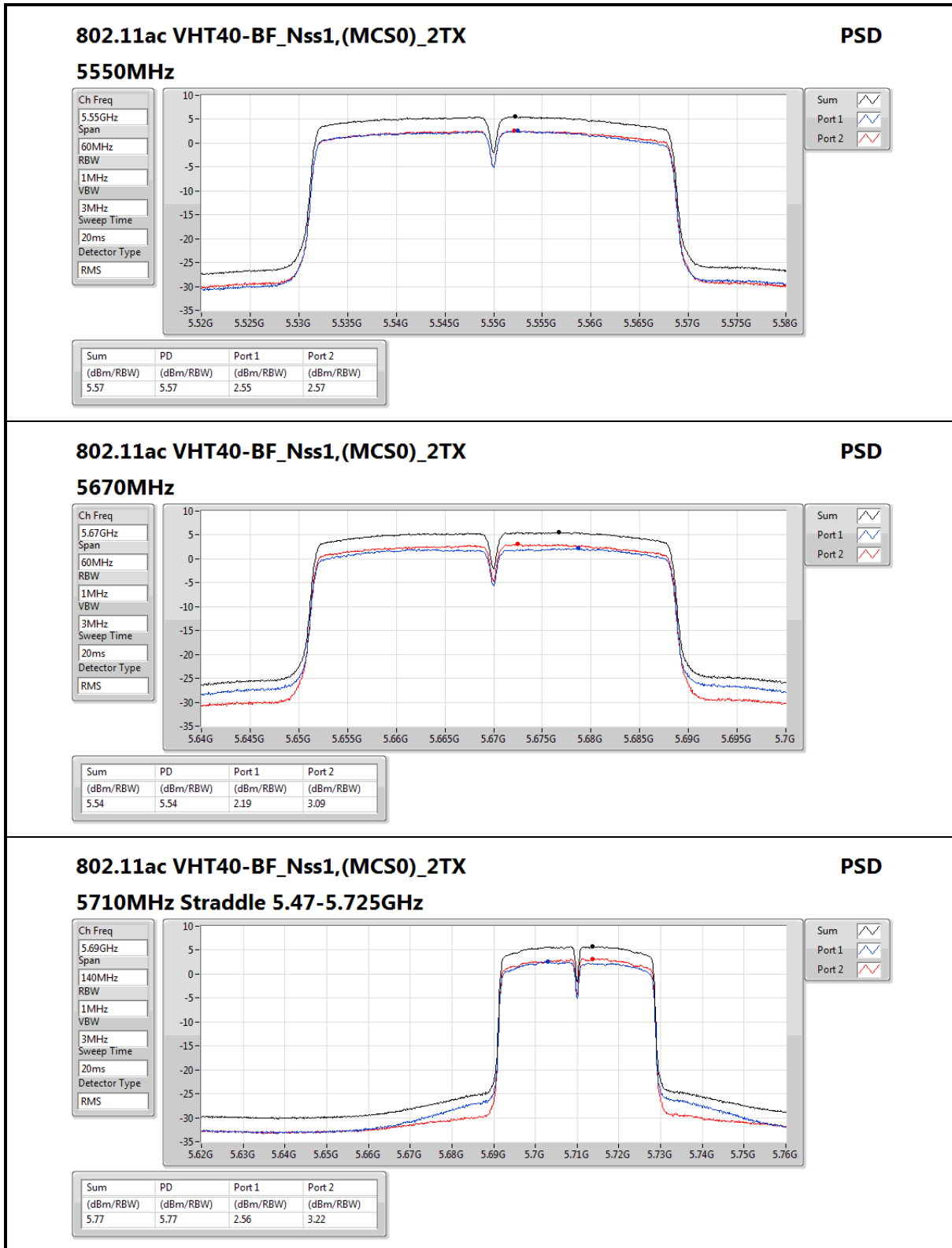

802.11ac VHT40-BF_Nss1,(MCS0)_2TX

5710MHz Straddle 5.47-5.725GHz

PSD

Ch Freq
5.69GHz

Span
140MHz

RBW
1MHz

VBW
3MHz

Sweep Time
20ms

Detector Type
RMS



Sum

Port 1

Port 2

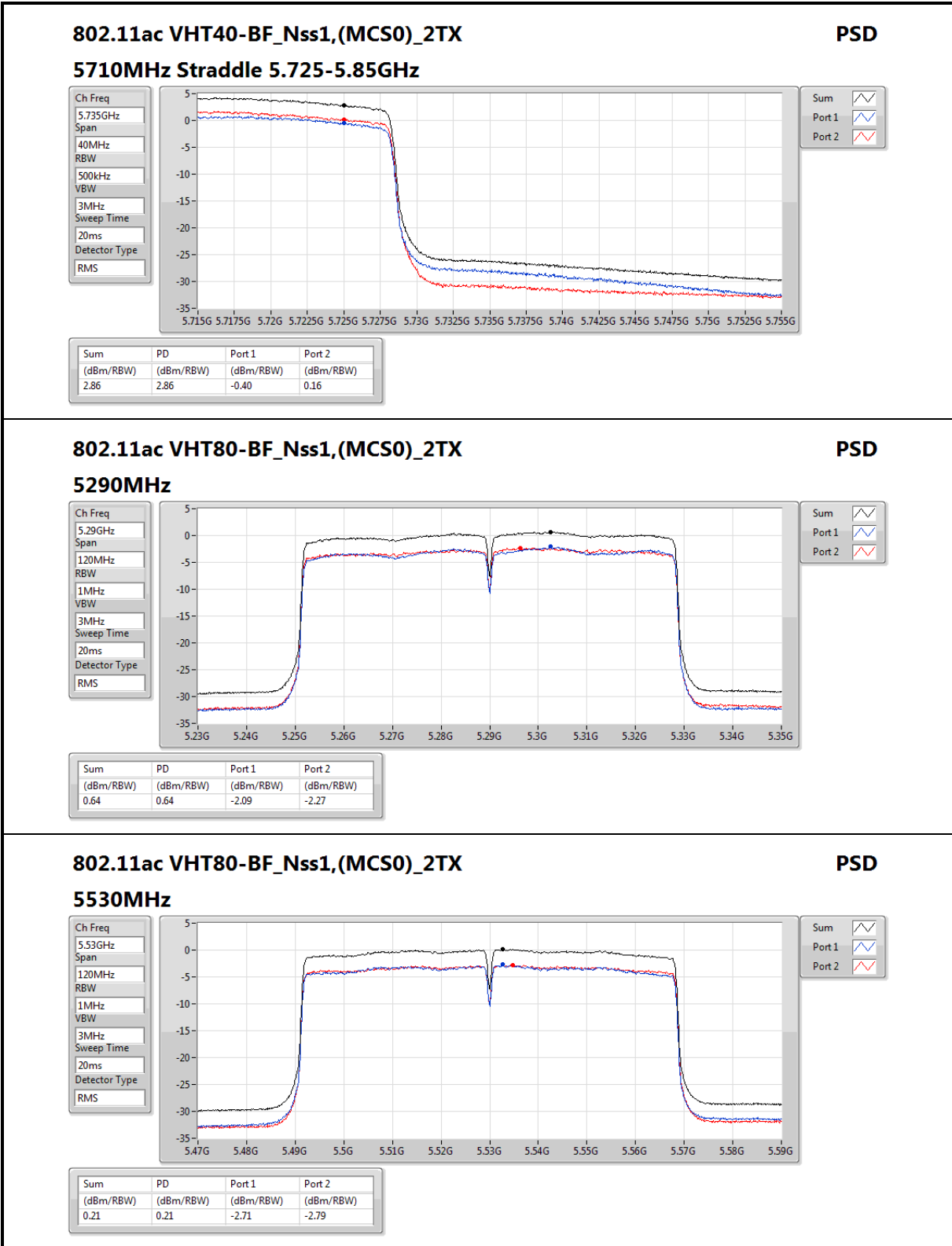

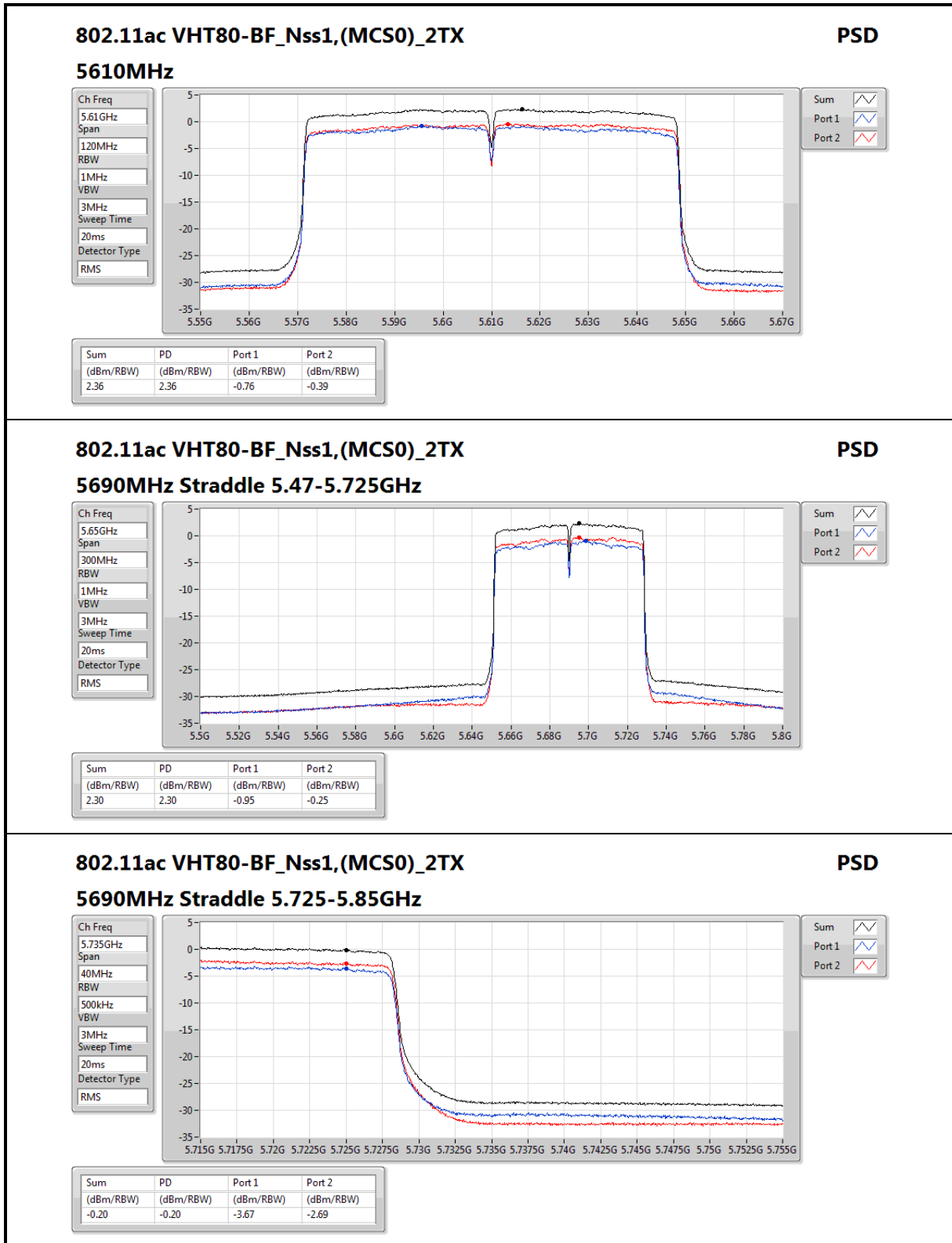

802.11ac VHT80-BF_Nss1,(MCS0)_2TX

5690MHz Straddle 5.725-5.85GHz

PSD

Ch Freq
5.735GHz

Span
40MHz

RBW
500kHz

VBW
3MHz

Sweep Time
20ms

Detector Type
RMS



Sum

Port 1

Port 2

Sum	PD	Port 1	Port 2
(dBm/RBW)	(dBm/RBW)	(dBm/RBW)	(dBm/RBW)
-0.20	-0.20	-3.67	-2.69



3.5 Unwanted Emissions

3.5.1 Transmitter Radiated Unwanted Emissions Limit

Unwanted emissions below 1 GHz and restricted band emissions above 1GHz limit			
Frequency Range (MHz)	Field Strength (uV/m)	Field Strength (dBuV/m)	Measure Distance (m)
0.009~0.490	2400/F(kHz)	48.5 - 13.8	300
0.490~1.705	24000/F(kHz)	33.8 - 23	30
1.705~30.0	30	29	30
30~88	100	40	3
88~216	150	43.5	3
216~960	200	46	3
Above 960	500	54	3

Note 1: Test distance for frequencies at or above 30 MHz, measurements may be performed at a distance other than the limit distance provided they are not performed in the near field and the emissions to be measured can be detected by the measurement equipment. When performing measurements at a distance other than that specified, the results shall be extrapolated to the specified distance using an extrapolation factor of 20 dB/decade (inverse of linear distance for field-strength measurements, inverse of linear distance-squared for power-density measurements).

Note 2: Test distance for frequencies at below 30 MHz, measurements may be performed at a distance closer than the EUT limit distance; however, an attempt should be made to avoid making measurements in the near field. When performing measurements below 30 MHz at a closer distance than the limit distance, the results shall be extrapolated to the specified distance by either making measurements at a minimum of two or more distances on at least one radial to determine the proper extrapolation factor or by using the square of an inverse linear distance extrapolation factor (40 dB/decade). The test report shall specify the extrapolation method used to determine compliance of the EUT.

Un-restricted band emissions above 1GHz Limit	
Operating Band	Limit
5.15 - 5.25 GHz	e.i.r.p. -27 dBm [68.2 dBuV/m@3m]
5.25 - 5.35 GHz	e.i.r.p. -27 dBm [68.2 dBuV/m@3m]
5.47 - 5.725 GHz	e.i.r.p. -27 dBm [68.2 dBuV/m@3m]
5.725 - 5.85 GHz	all emissions shall be limited to a level of -27 dBm/MHz at 75 MHz or more above or below the band edge increasing linearly to 10 dBm/MHz at 25 MHz above or below the band edge, and from 25 MHz above or below the band edge increasing linearly to a level of 15.6 dBm/MHz at 5 MHz above or below the band edge, and from 5 MHz above or below the band edge increasing linearly to a level of 27 dBm/MHz at the band edge.

Note 1: Measurements may be performed at a distance other than the limit distance provided they are not performed in the near field and the emissions to be measured can be detected by the measurement equipment. When performing measurements at a distance other than that specified, the results shall be extrapolated to the specified distance using an extrapolation factor of 20 dB/decade (inverse of linear distance for field-strength measurements, inverse of linear distance-squared for power-density measurements).



3.5.2 Measuring Instruments

Refer a test equipment and calibration data table in this test report.

3.5.3 Test Procedures

Test Method	
<ul style="list-style-type: none"> Measurements may be performed at a distance other than the limit distance provided they are not performed in the near field and the emissions to be measured can be detected by the measurement equipment. Measurements shall not be performed at a distance greater than 30 m for frequencies above 30 MHz, unless it can be further demonstrated that measurements at a distance of 30 m or less are impractical. When performing measurements at a distance other than that specified, the results shall be extrapolated to the specified distance using an extrapolation factor of 20 dB/decade (inverse of linear distance for field-strength measurements, inverse of linear distance-squared for power-density measurements). 	
<ul style="list-style-type: none"> The average emission levels shall be measured in [duty cycle ≥ 98 or duty factor]. 	
<ul style="list-style-type: none"> For the transmitter unwanted emissions shall be measured using following options below: <ul style="list-style-type: none"> Refer as FCC KDB 789033, clause H)2) for unwanted emissions into non-restricted bands. Refer as FCC KDB 789033, clause H)1) for unwanted emissions into restricted bands. <ul style="list-style-type: none"> <input type="checkbox"/> Refer as FCC KDB 789033, H)6) Method AD (Trace Averaging). <input checked="" type="checkbox"/> Refer as FCC KDB 789033, H)6) Method VB (Reduced VBW). <input type="checkbox"/> Refer as ANSI C63.10, clause 4.2.3.2.3 (Reduced VBW). VBW ≥ 1/T, where T is pulse time. <input type="checkbox"/> Refer as ANSI C63.10, clause 4.2.3.2.4 average value of pulsed emissions. <input checked="" type="checkbox"/> Refer as FCC KDB 789033, clause H)5) measurement procedure peak limit. <input type="checkbox"/> Refer as ANSI C63.10, clause 4.2.3.2.2 measurement procedure peak limit. 	
<ul style="list-style-type: none"> For radiated measurement. <ul style="list-style-type: none"> Refer as ANSI C63.10, clause 6.4 for radiated emissions below 30 MHz and test distance is 3m. Refer as ANSI C63.10, clause 6.5 for radiated emissions 30 MHz to 1 GHz and test distance is 3m. Refer as ANSI C63.10, clause 6.6 for radiated emissions above 1GHz. 	
<ul style="list-style-type: none"> The any unwanted emissions level shall not exceed the fundamental emission level. 	
<ul style="list-style-type: none"> All amplitude of spurious emissions that are attenuated by more than 20 dB below the permissible value has no need to be reported. 	

3.5.4 Test Setup

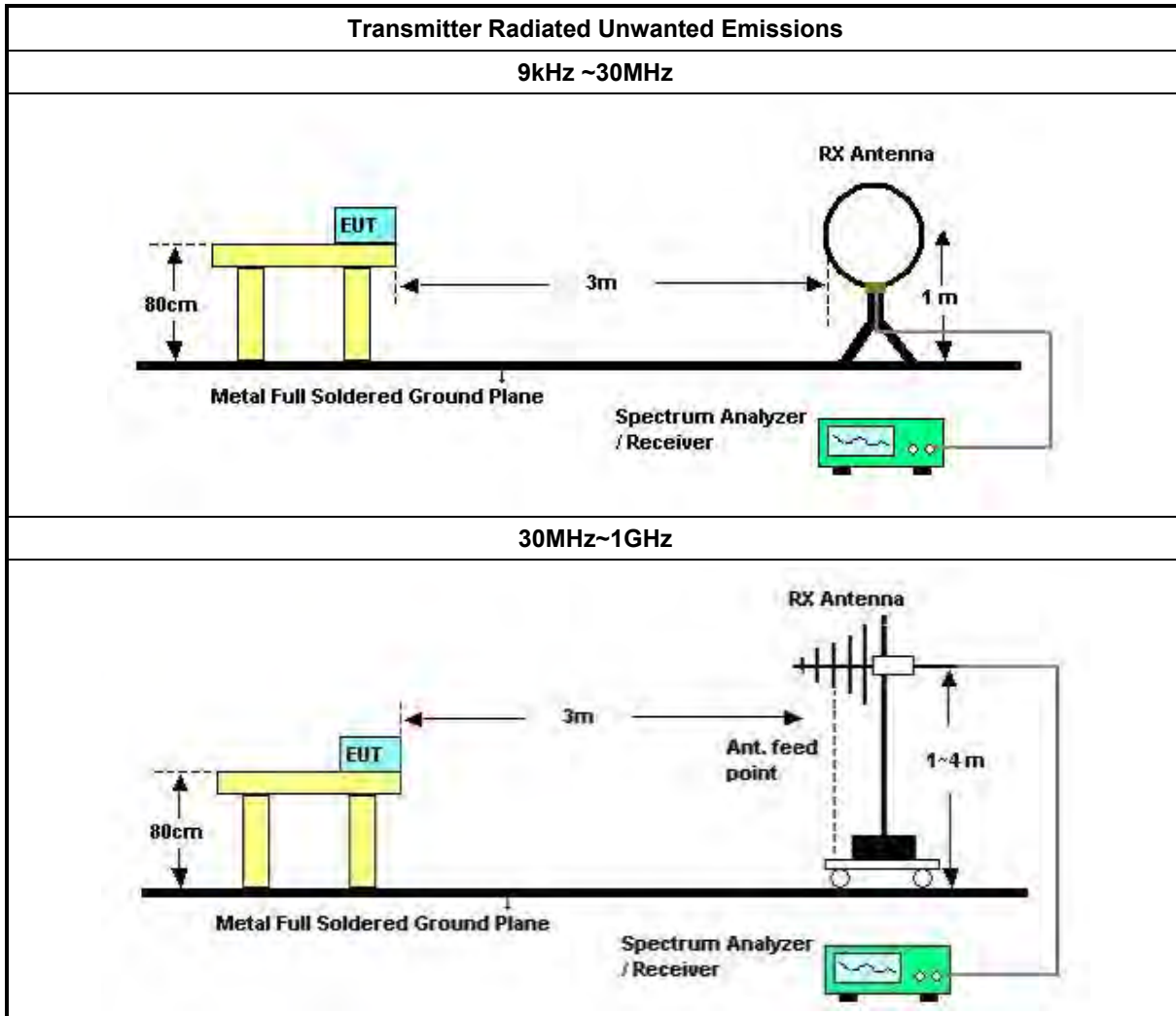

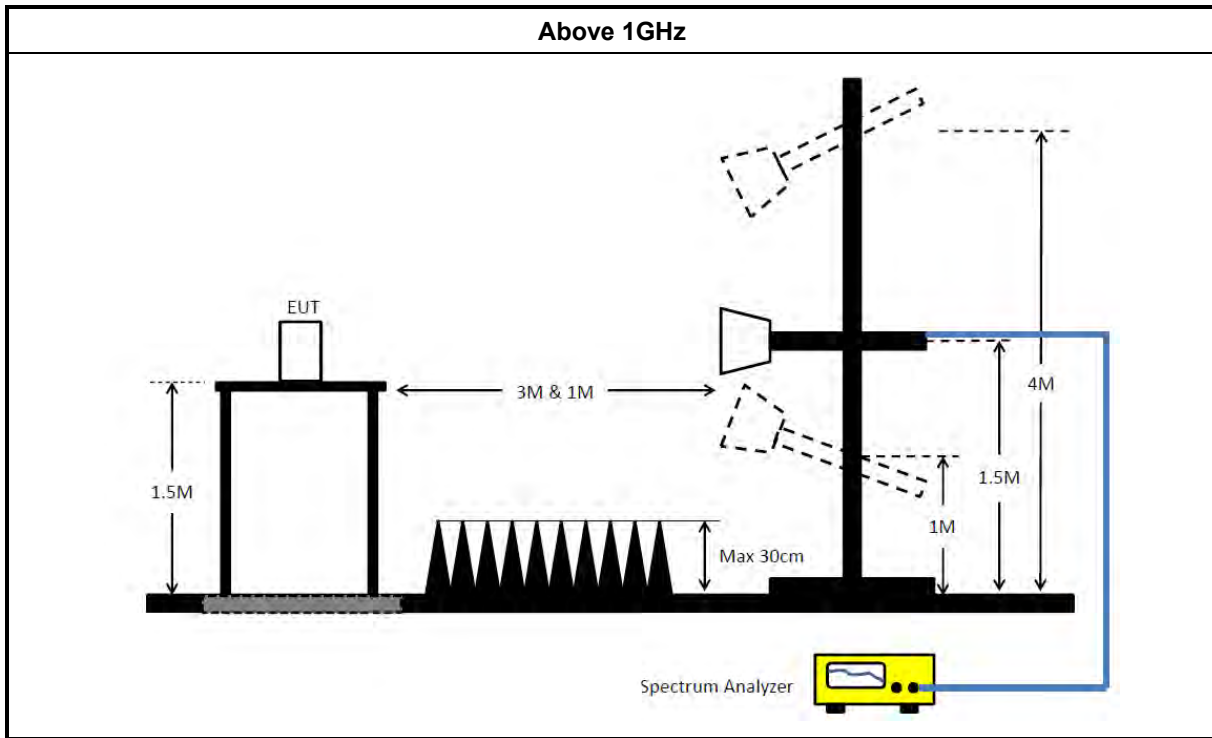

3.5.5 Transmitter Unwanted Emissions (Below 30MHz)

All amplitude of spurious emissions that are attenuated by more than 20 dB below the permissible value has no need to be reported.



3.5.6 Test Result of Transmitter Unwanted Emissions

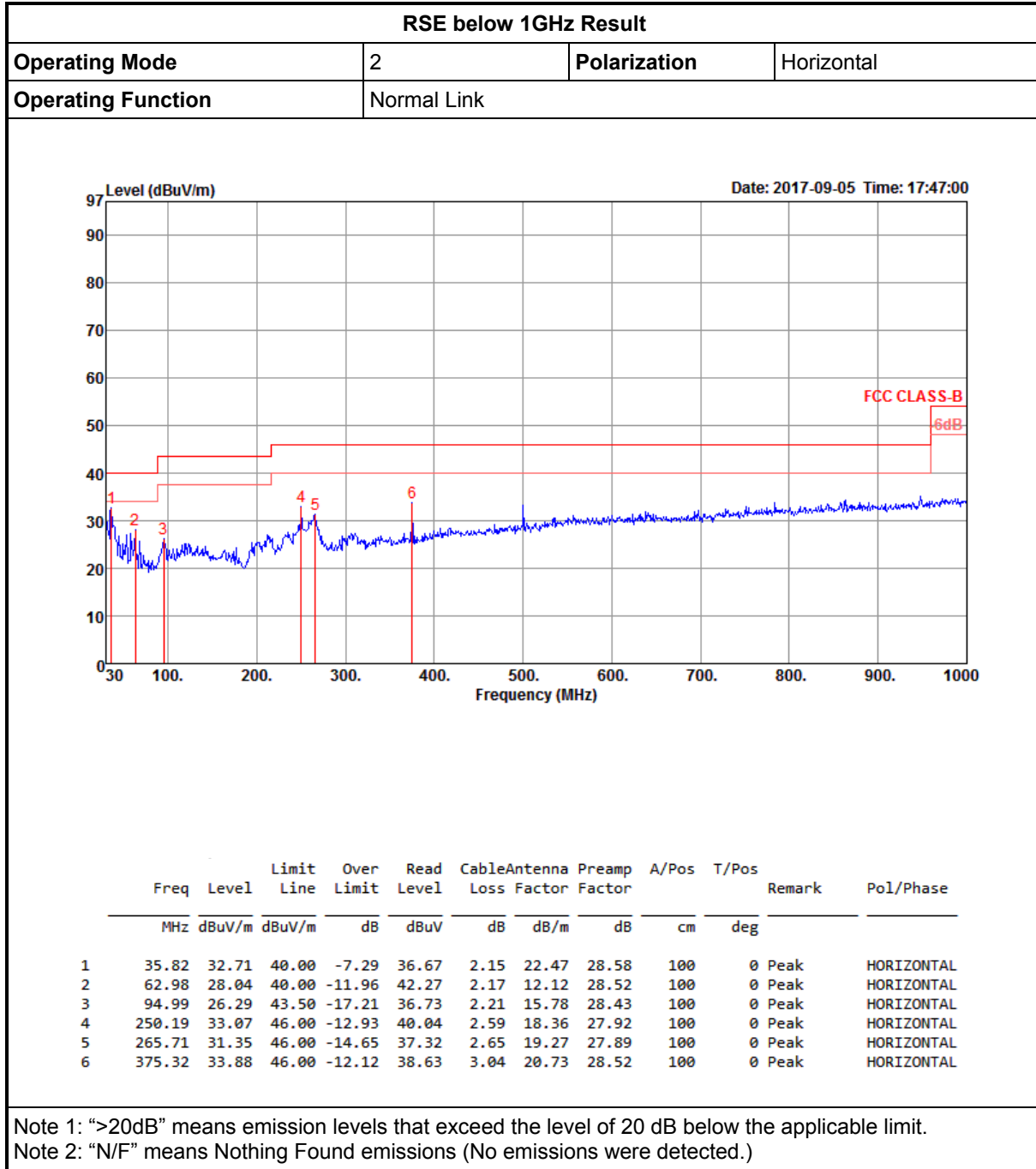



RSE below 1GHz Result

Operating Mode	2	Polarization	Vertical
Operating Function	Normal Link		

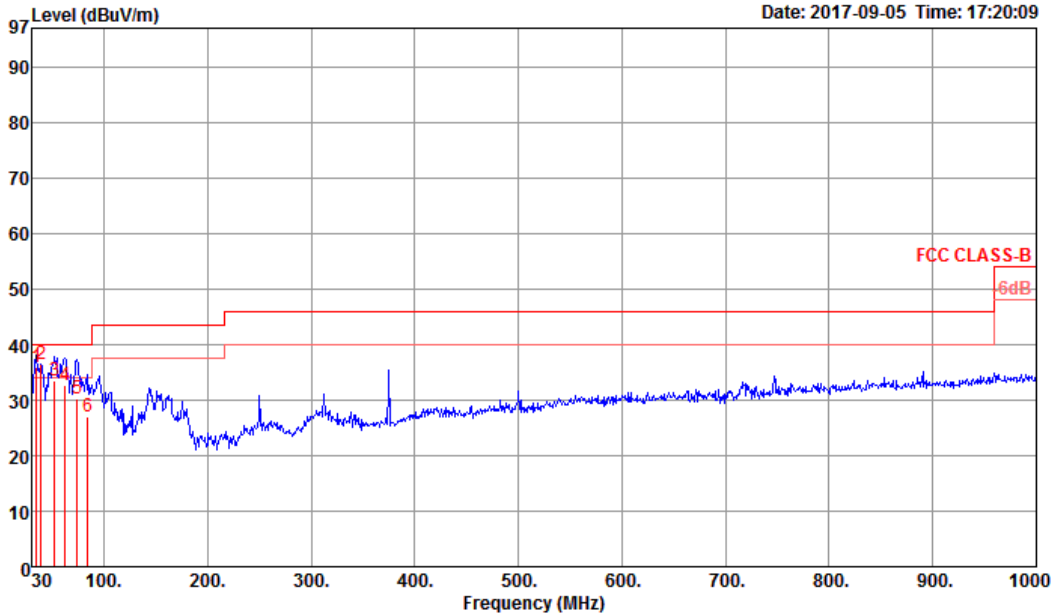

	Freq	Level	Limit	Over	Read	Cable	Antenna	Preamp	A/Pos	T/Pos	Remark	Pol/Phase
	MHz	dBuV/m	dBuV/m	dB	dBuV	dB	dB/m	dB	cm	deg		
1	34.85	35.89	40.00	-4.11	39.20	2.16	23.11	28.58	227	141	QP	VERTICAL
2	38.73	36.53	40.00	-3.47	42.44	2.12	20.55	28.58	100	221	Peak	VERTICAL
3	52.31	33.48	40.00	-6.52	46.40	2.17	13.47	28.56	100	74	QP	VERTICAL
4	62.01	32.76	40.00	-7.24	47.00	2.17	12.11	28.52	145	8	QP	VERTICAL
5	73.65	30.22	40.00	-9.78	44.10	2.19	12.42	28.49	100	8	QP	VERTICAL
6	84.32	26.95	40.00	-13.05	39.40	2.20	13.81	28.46	100	196	QP	VERTICAL

Note 1: ">20dB" means emission levels that exceed the level of 20 dB below the applicable limit.
 Note 2: "N/F" means Nothing Found emissions (No emissions were detected.)



RSE Above 1GHz Result Summary

Mode	Result	Type	Freq (Hz)	Level (dBuV/m)	Limit (dBuV/m)	Margin (dB)	Factor (dB)	Dist (m)	Pol. (H/V)	Azimuth (°)	Height (m)	Comments
802.11ac VHT20_Nss1,(MCS0)_2TX	-	-	-	-	-	-	-	-	-	-	-	-
5.47-5.725GHz	Pass	AV	5.7252G	53.97	54.00	-0.03	9.91	3	H	253	1.02	-

802.11a_(6Mbps)_2TX

5260MHz_TX

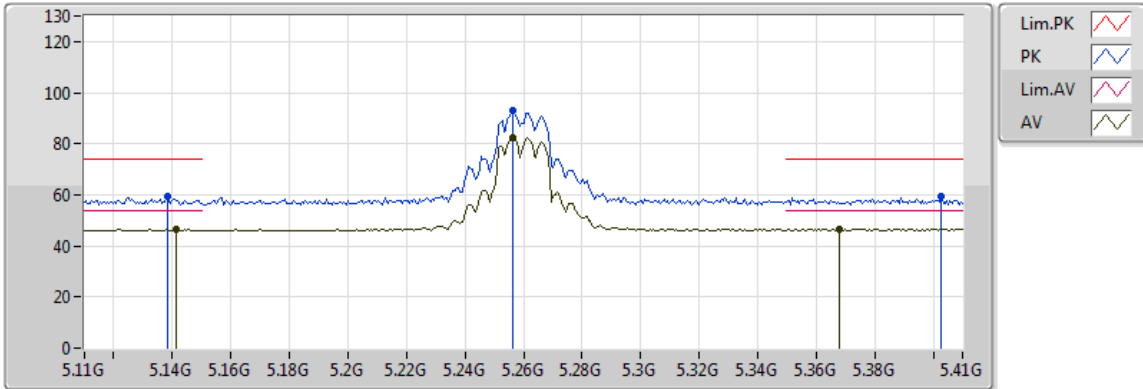

20170831
EUT_Z_2TX
Setting 22
02-Z-1-10
FSU

Type	Freq(Hz)	Level(dBuV/m)	Limit(dBuV/m)	Margin(dB)	Factor(dB)	Dist(m)	Pol.(H/V)	Azimuth(°)	Height(m)	Comments
AV	5.1412G	46.31	54.00	-7.69	9.01	3	V	311	1.02	-
AV	5.2564G	82.62	Inf	-Inf	9.27	3	V	311	1.02	-
AV	5.368G	46.62	54.00	-7.38	9.47	3	V	311	1.02	-
PK	5.1382G	59.57	74.00	-14.43	9.01	3	V	311	1.02	-
PK	5.2564G	93.16	Inf	-Inf	9.27	3	V	311	1.02	-
PK	5.4028G	59.22	74.00	-14.78	9.53	3	V	311	1.02	-

802.11a_(6Mbps)_2TX

5260MHz_TX

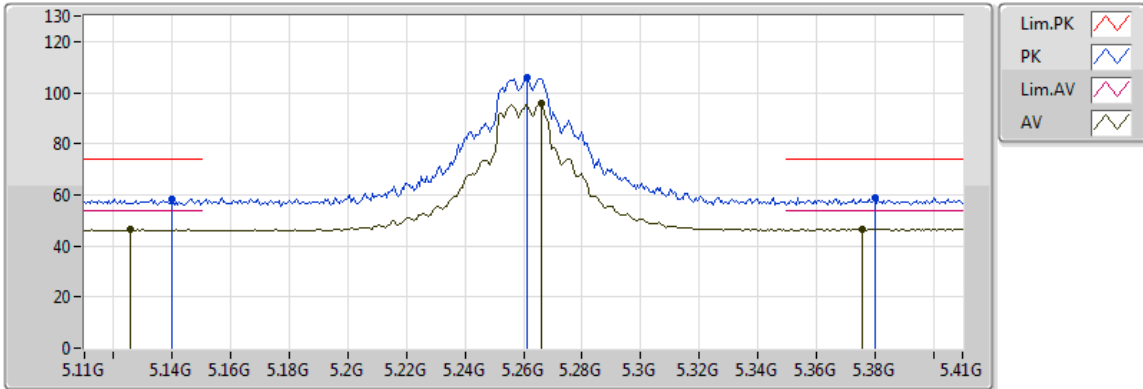

20170831
EUT_Z_2TX
Setting 22
02-Z-1-10
FSU

Type	Freq(Hz)	Level(dBuV/m)	Limit(dBuV/m)	Margin(dB)	Factor(dB)	Dist(m)	Pol.(H/V)	Azimuth(°)	Height(m)	Comments
AV	5.1256G	46.32	54.00	-7.68	8.97	3	H	87	1.03	-
AV	5.266G	95.58	Inf	-Inf	9.29	3	H	87	1.03	-
AV	5.3758G	46.66	54.00	-7.34	9.48	3	H	87	1.03	-
PK	5.14G	58.35	74.00	-15.65	9.01	3	H	87	1.03	-
PK	5.2612G	105.80	Inf	-Inf	9.28	3	H	87	1.03	-
PK	5.38G	58.97	74.00	-15.03	9.49	3	H	87	1.03	-



802.11a_(6Mbps)_2TX

5260MHz_TX

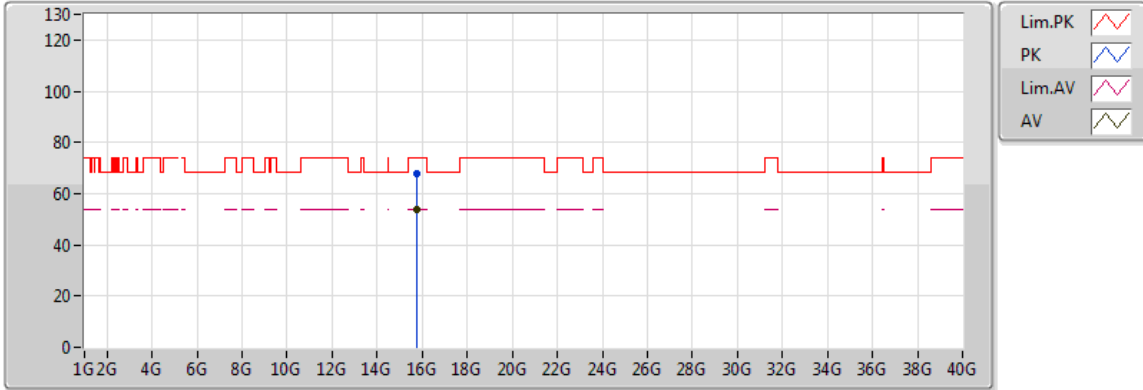

20170831
 EUT_Z_2TX
 Setting 22
 02-Z-1
 FSU

Type	Freq(Hz)	Level(dBuV/m)	Limit(dBuV/m)	Margin(dB)	Factor(dB)	Dist(m)	Pol.(H/V)	Azimuth(°)	Height(m)	Comments
AV	15.77784G	53.68	54.00	-0.32	17.51	3	V	320	2.14	-
PK	15.78212G	67.62	74.00	-6.38	17.50	3	V	320	2.14	-



802.11a_(6Mbps)_2TX

5260MHz_TX

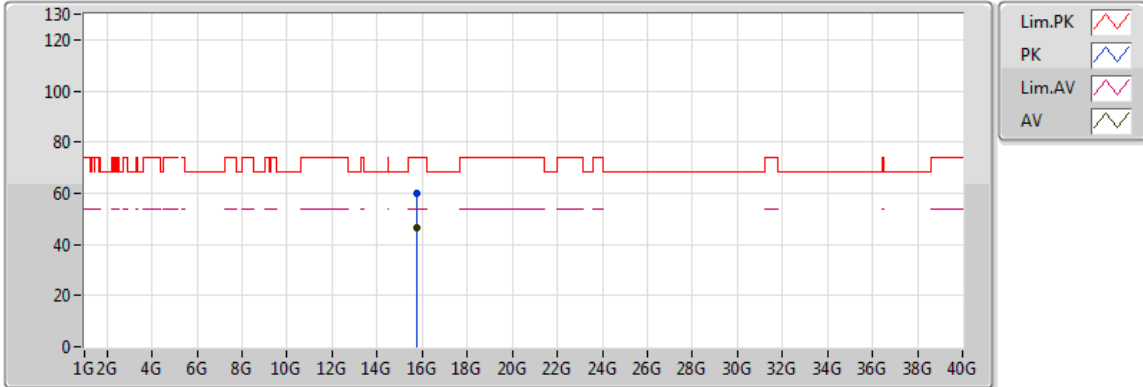

20170831
 EUT_Z_2TX
 Setting 22
 02-Z-1
 FSU

Type	Freq(Hz)	Level(dBuV/m)	Limit(dBuV/m)	Margin(dB)	Factor(dB)	Dist(m)	Pol.(H/V)	Azimuth(°)	Height(m)	Comments
AV	15.77764G	46.76	54.00	-7.24	17.51	3	H	210	1.02	-
PK	15.77676G	59.98	74.00	-14.02	17.51	3	H	210	1.02	-



802.11a_(6Mbps)_2TX

5300MHz_TX

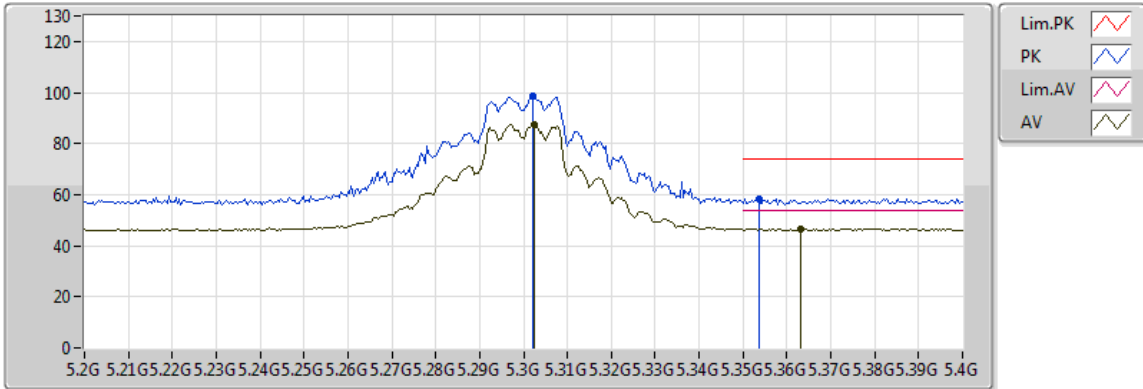

20170831
 EUT_Z_2TX
 Setting 22.5
 02-Z-1-10
 FSU

Type	Freq(Hz)	Level(dBuV/m)	Limit(dBuV/m)	Margin(dB)	Factor(dB)	Dist(m)	Pol.(H/V)	Azimuth(°)	Height(m)	Comments
AV	5.3024G	87.46	Inf	-Inf	9.35	3	V	13	2.67	-
AV	5.3632G	46.55	54.00	-7.45	9.46	3	V	13	2.67	-
PK	5.302G	98.73	Inf	-Inf	9.35	3	V	13	2.67	-
PK	5.3536G	58.40	74.00	-15.60	9.44	3	V	13	2.67	-

802.11a_(6Mbps)_2TX

5300MHz_TX

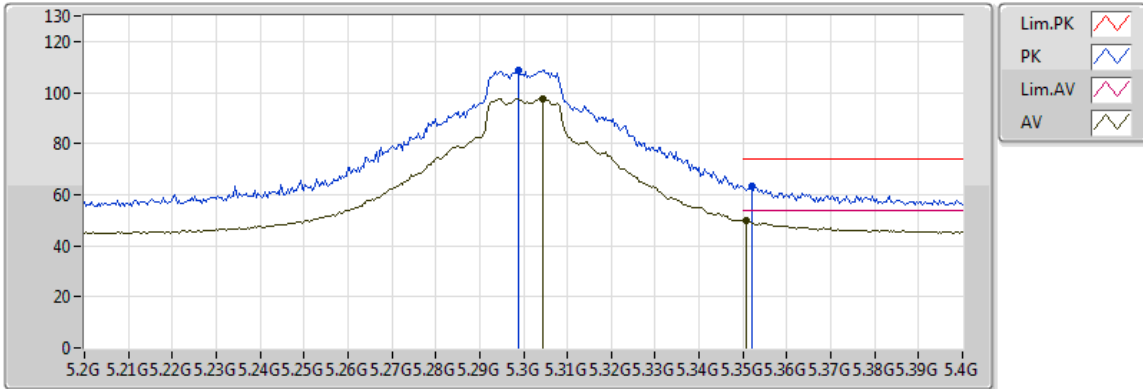

20170831
 EUT_Z_2TX
 Setting 22.5
 02-Z-1-10
 FSU

Type	Freq(Hz)	Level(dBuV/m)	Limit(dBuV/m)	Margin(dB)	Factor(dB)	Dist(m)	Pol.(H/V)	Azimuth(°)	Height(m)	Comments
AV	5.3044G	97.74	Inf	-Inf	9.36	3	H	55	1.80	-
AV	5.3508G	49.68	54.00	-4.32	9.44	3	H	55	1.80	-
PK	5.2988G	108.76	Inf	-Inf	9.35	3	H	55	1.80	-
PK	5.352G	63.41	74.00	-10.59	9.44	3	H	55	1.80	-



802.11a_(6Mbps)_2TX

5300MHz_TX

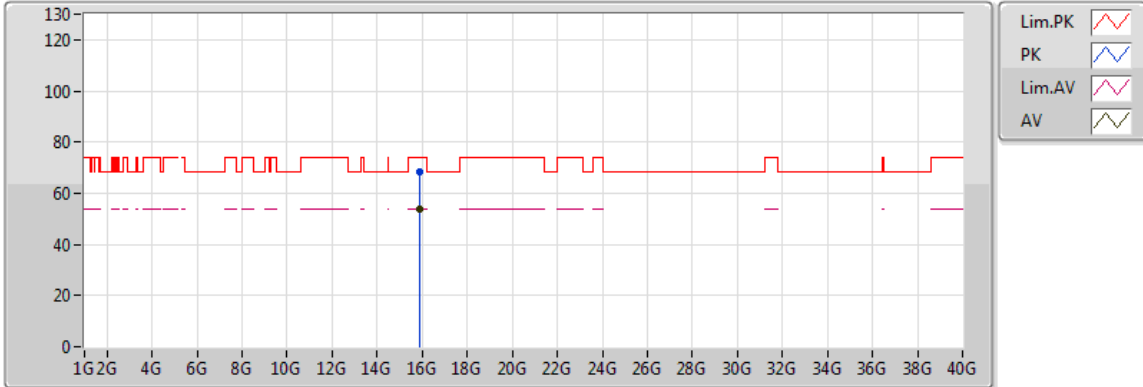

20170831
EUT_Z_2TX
Setting 22.5
02-Z-1
FSU

Type	Freq(Hz)	Level(dBuV/m)	Limit(dBuV/m)	Margin(dB)	Factor(dB)	Dist(m)	Pol.(H/V)	Azimuth(°)	Height(m)	Comments
AV	15.90388G	53.92	54.00	-0.08	17.24	3	V	342	2.14	-
PK	15.9088G	68.27	74.00	-5.73	17.23	3	V	342	2.14	-



802.11a_(6Mbps)_2TX

5300MHz_TX

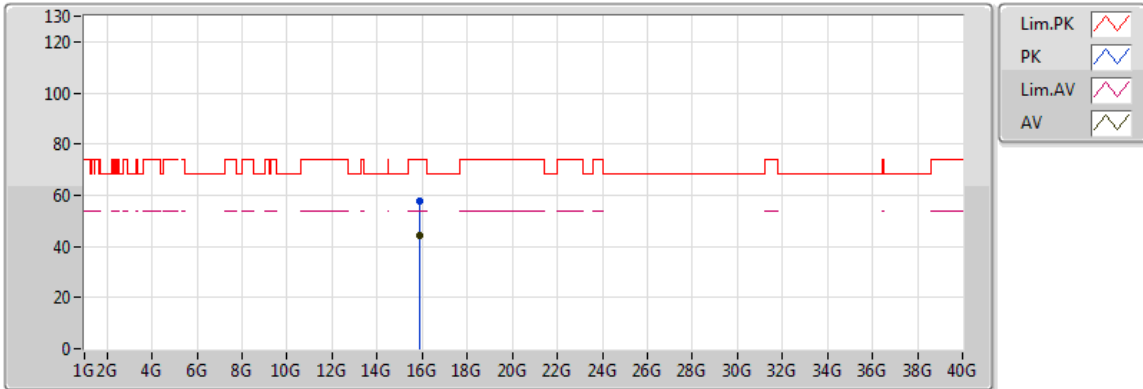

20170831
 EUT_Z_2TX
 Setting 22.5
 02-Z-1
 FSU

Type	Freq(Hz)	Level(dBuV/m)	Limit(dBuV/m)	Margin(dB)	Factor(dB)	Dist(m)	Pol.(H/V)	Azimuth(°)	Height(m)	Comments
AV	15.89796G	44.46	54.00	-9.54	17.25	3	H	192	2.50	-
PK	15.89392G	57.45	74.00	-16.55	17.26	3	H	192	2.50	-

802.11a_(6Mbps)_2TX

5320MHz_TX

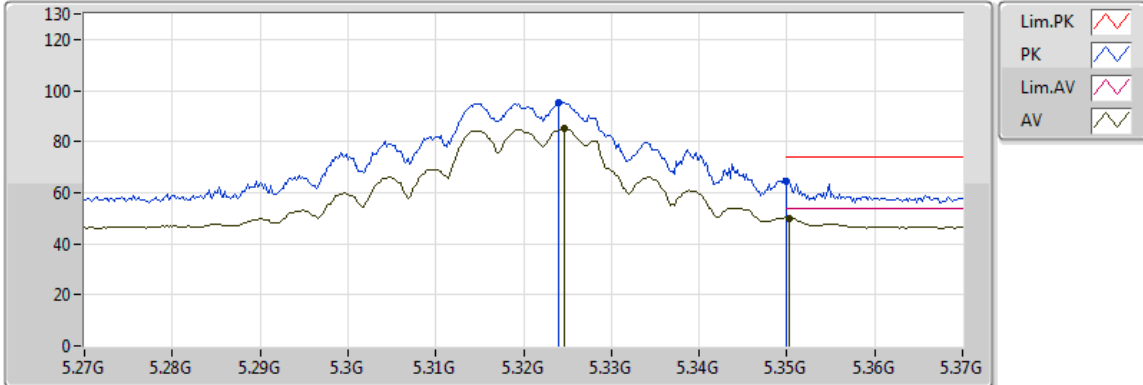

20170831
EUT_Z_2TX
Setting 21.5
02-Z-1-10
FSU

Type	Freq(Hz)	Level(dBuV/m)	Limit(dBuV/m)	Margin(dB)	Factor(dB)	Dist(m)	Pol.(H/V)	Azimuth(°)	Height(m)	Comments
AV	5.3246G	84.91	Inf	-Inf	9.39	3	V	257	2.33	-
AV	5.3502G	50.13	54.00	-3.87	9.44	3	V	257	2.33	-
PK	5.324G	95.52	Inf	-Inf	9.39	3	V	257	2.33	-
PK	5.350005G	64.58	74.00	-9.42	9.44	3	V	257	2.33	-



802.11a_(6Mbps)_2TX

5320MHz_TX

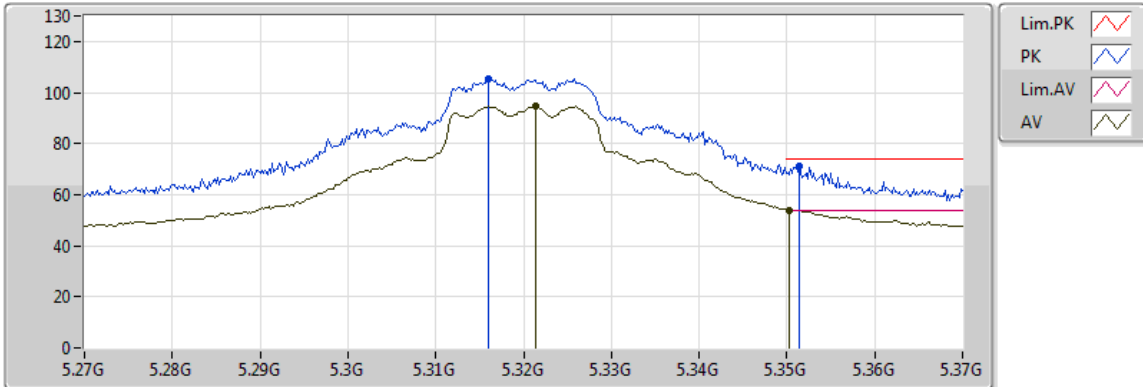

20170831
EUT_Z_2TX
Setting 21.5
02-Z-1-10
FSU

Type	Freq(Hz)	Level(dBuV/m)	Limit(dBuV/m)	Margin(dB)	Factor(dB)	Dist(m)	Pol.(H/V)	Azimuth(°)	Height(m)	Comments
AV	5.3214G	94.69	Inf	-Inf	9.39	3	H	99	1.12	-
AV	5.3502G	53.56	54.00	-0.44	9.44	3	H	99	1.12	-
PK	5.316G	105.44	Inf	-Inf	9.38	3	H	99	1.12	-
PK	5.3514G	71.24	74.00	-2.76	9.44	3	H	99	1.12	-



802.11a_(6Mbps)_2TX

5320MHz_TX

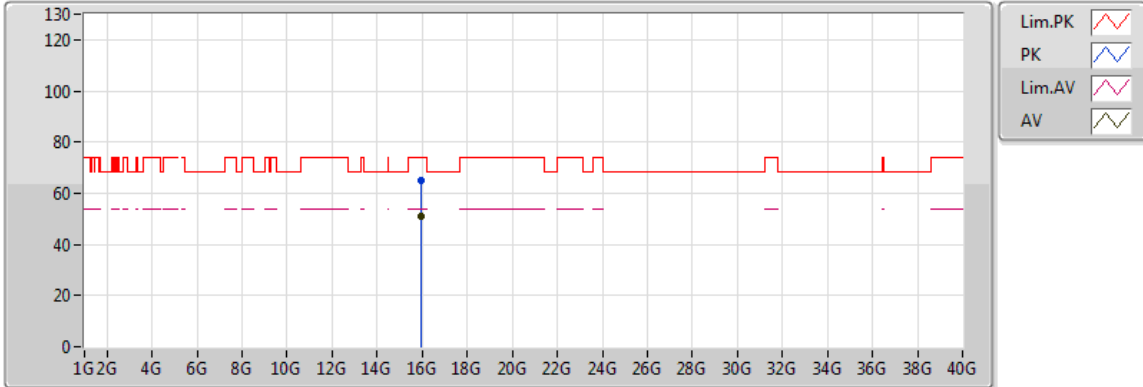

20170831
EUT_Z_2TX
Setting 21.5
02-Z-1
FSU

Type	Freq(Hz)	Level(dBuV/m)	Limit(dBuV/m)	Margin(dB)	Factor(dB)	Dist(m)	Pol.(H/V)	Azimuth(°)	Height(m)	Comments
AV	15.95888G	50.73	54.00	-3.27	17.12	3	V	331	1.11	-
PK	15.95844G	65.21	74.00	-8.79	17.12	3	V	331	1.11	-



802.11a_(6Mbps)_2TX

5320MHz_TX

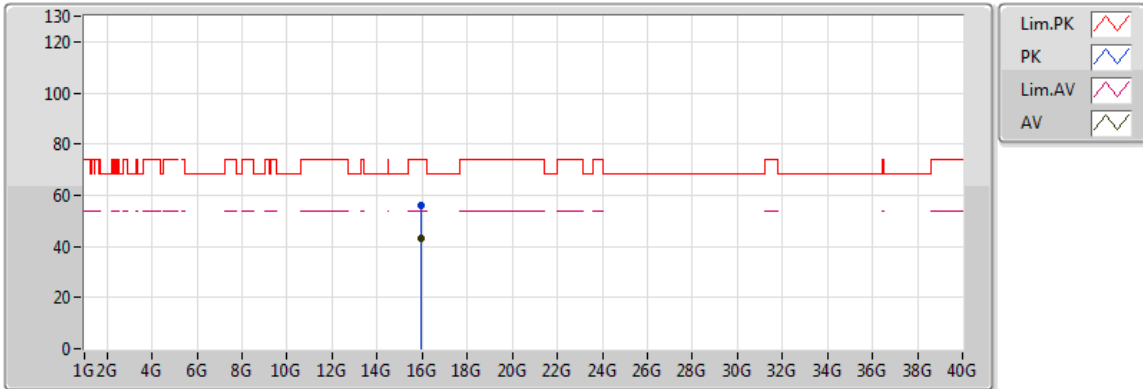

20170831
 EUT_Z_2TX
 Setting 21.5
 02-Z-1
 FSU

Type	Freq(Hz)	Level(dBuV/m)	Limit(dBuV/m)	Margin(dB)	Factor(dB)	Dist(m)	Pol.(H/V)	Azimuth(°)	Height(m)	Comments
AV	15.95888G	43.29	54.00	-10.71	17.12	3	H	155	2.45	-
PK	15.95808G	55.89	74.00	-18.11	17.12	3	H	155	2.45	-



802.11a_(6Mbps)_2TX

5500MHz_TX

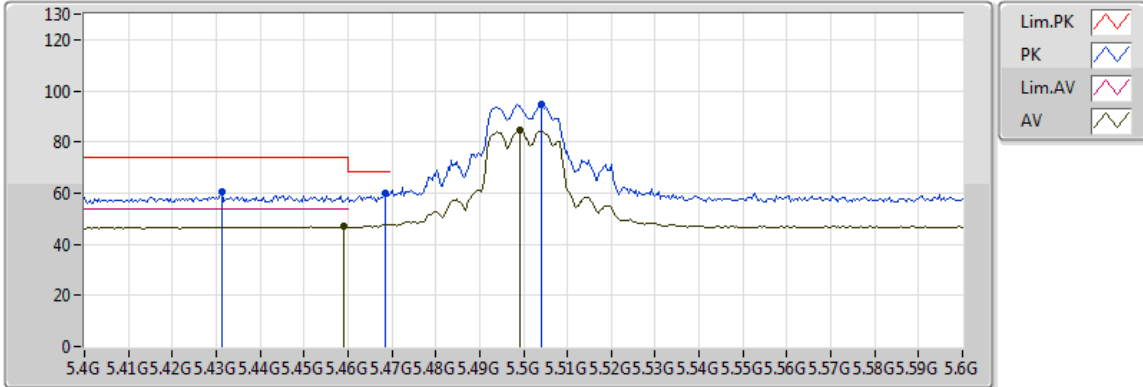

20170831
 EUT_Z_2TX
 Setting 21.5
 02-Z-1-10
 FSU

Type	Freq(Hz)	Level(dBuV/m)	Limit(dBuV/m)	Margin(dB)	Factor(dB)	Dist(m)	Pol.(H/V)	Azimuth(°)	Height(m)	Comments
AV	5.4592G	46.93	54.00	-7.07	9.68	3	V	285	1.08	-
AV	5.4992G	84.61	Inf	-Inf	9.79	3	V	285	1.08	-
PK	5.4312G	60.47	74.00	-13.53	9.60	3	V	285	1.08	-
PK	5.4684G	59.80	68.20	-8.40	9.70	3	V	285	1.08	-
PK	5.504G	94.67	Inf	-Inf	9.79	3	V	285	1.08	-



802.11a_(6Mbps)_2TX

5500MHz_TX

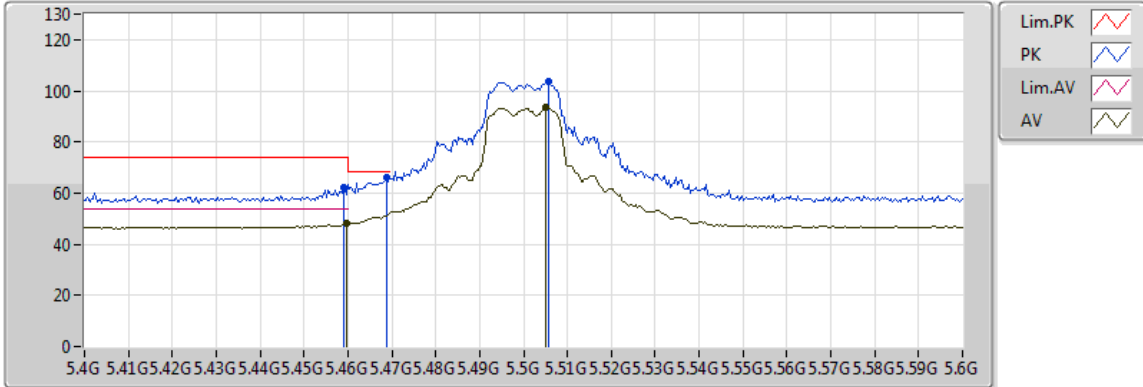

20170831
 EUT_Z_2TX
 Setting 21.5
 02-Z-1-10
 FSU

Type	Freq(Hz)	Level(dBuV/m)	Limit(dBuV/m)	Margin(dB)	Factor(dB)	Dist(m)	Pol.(H/V)	Azimuth(°)	Height(m)	Comments
AV	5.4596G	48.26	54.00	-5.74	9.68	3	H	267	1.03	-
AV	5.5052G	93.47	Inf	-Inf	9.79	3	H	267	1.03	-
PK	5.4592G	62.02	74.00	-11.98	9.68	3	H	267	1.03	-
PK	5.4688G	66.12	68.20	-2.08	9.71	3	H	267	1.03	-
PK	5.5056G	103.72	Inf	-Inf	9.80	3	H	267	1.03	-



802.11a_(6Mbps)_2TX

5500MHz_TX

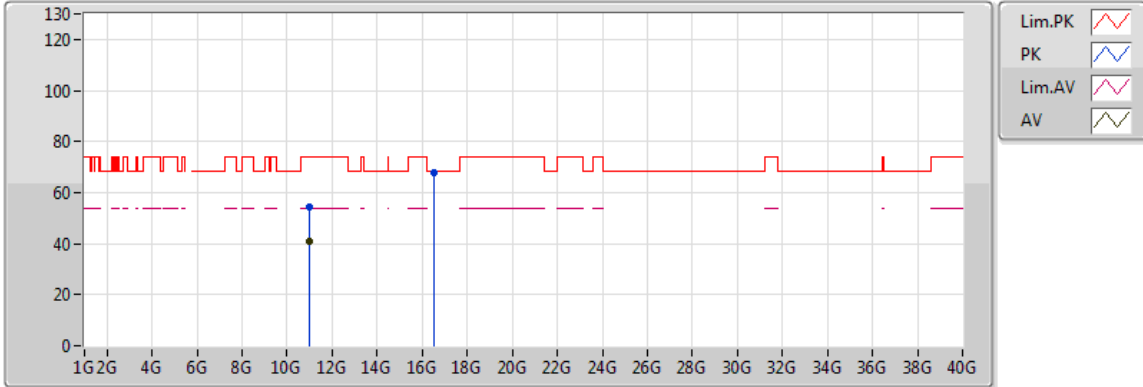

20170831
 EUT_Z_2TX
 Setting 21.5
 02-Z-1
 FSU

Type	Freq(Hz)	Level(dBuV/m)	Limit(dBuV/m)	Margin(dB)	Factor(dB)	Dist(m)	Pol.(H/V)	Azimuth(°)	Height(m)	Comments
AV	10.99128G	41.13	54.00	-12.87	15.83	3	V	154	1.48	-
PK	10.99604G	54.20	74.00	-19.80	15.83	3	V	154	1.48	-
PK	16.494G	67.94	68.20	-0.26	18.95	3	V	357	2.65	-

802.11a_(6Mbps)_2TX

5500MHz_TX

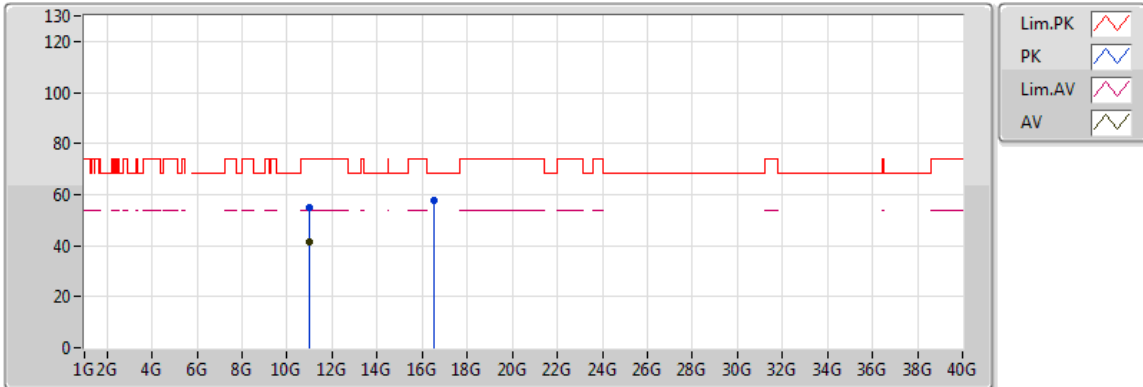

20170831
EUT_Z_2TX
Setting 21.5
02-Z-1
FSU

Type	Freq(Hz)	Level(dBuV/m)	Limit(dBuV/m)	Margin(dB)	Factor(dB)	Dist(m)	Pol.(H/V)	Azimuth(°)	Height(m)	Comments
AV	10.99012G	41.24	54.00	-12.76	15.83	3	H	240	1.73	-
PK	11.00444G	54.88	74.00	-19.12	15.83	3	H	240	1.73	-
PK	16.50468G	57.64	68.20	-10.56	18.99	3	H	17	1.50	-



802.11a_(6Mbps)_2TX

5580MHz_TX

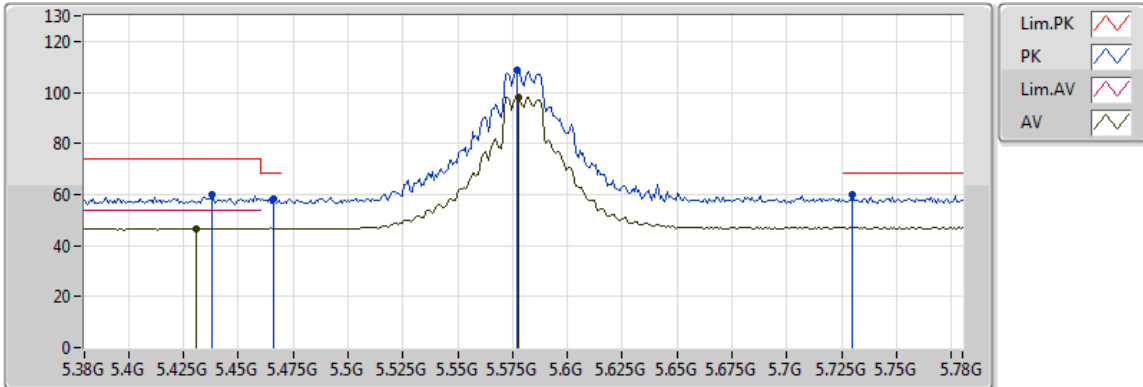

20170831
 EUT_Z_2TX
 Setting 23
 02-Z-1-10
 FSU

Type	Freq(Hz)	Level(dBuV/m)	Limit(dBuV/m)	Margin(dB)	Factor(dB)	Dist(m)	Pol.(H/V)	Azimuth(°)	Height(m)	Comments
AV	5.4312G	46.74	54.00	-7.26	9.60	3	V	220	2.48	-
AV	5.5776G	98.14	Inf	-Inf	9.86	3	V	220	2.48	-
PK	5.4384G	59.80	74.00	-14.20	9.62	3	V	220	2.48	-
PK	5.4664G	58.54	68.20	-9.66	9.70	3	V	220	2.48	-
PK	5.5768G	108.67	Inf	-Inf	9.86	3	V	220	2.48	-
PK	5.7296G	59.71	68.20	-8.49	9.91	3	V	220	2.48	-

802.11a_(6Mbps)_2TX

5580MHz_TX

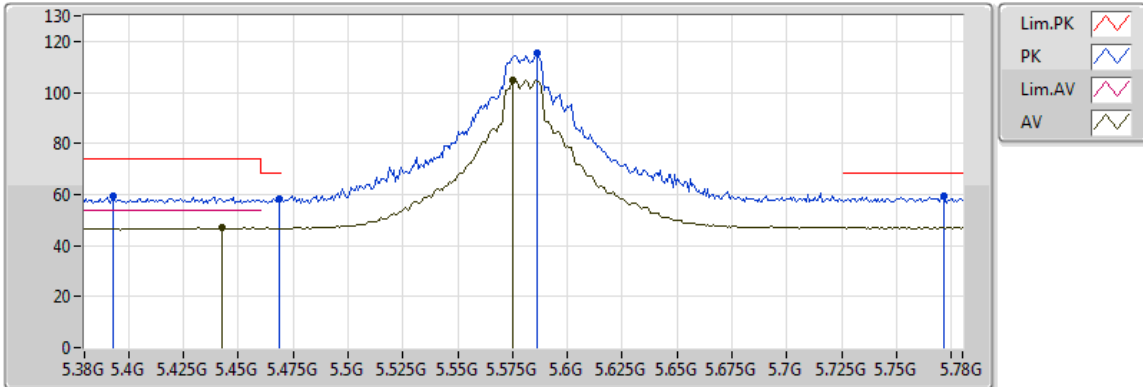

20170831
EUT_Z_2TX
Setting 23
02-Z-1-10
FSU

Type	Freq(Hz)	Level(dBuV/m)	Limit(dBuV/m)	Margin(dB)	Factor(dB)	Dist(m)	Pol.(H/V)	Azimuth(°)	Height(m)	Comments
AV	5.4424G	46.93	54.00	-7.07	9.63	3	H	253	1.11	-
AV	5.5752G	104.69	Inf	-Inf	9.86	3	H	253	1.11	-
PK	5.3928G	59.15	74.00	-14.85	9.51	3	H	253	1.11	-
PK	5.4688G	58.24	68.20	-9.96	9.71	3	H	253	1.11	-
PK	5.5864G	115.60	Inf	-Inf	9.87	3	H	253	1.11	-
PK	5.7712G	59.34	68.20	-8.86	9.91	3	H	253	1.11	-

802.11a_(6Mbps)_2TX

5580MHz_TX

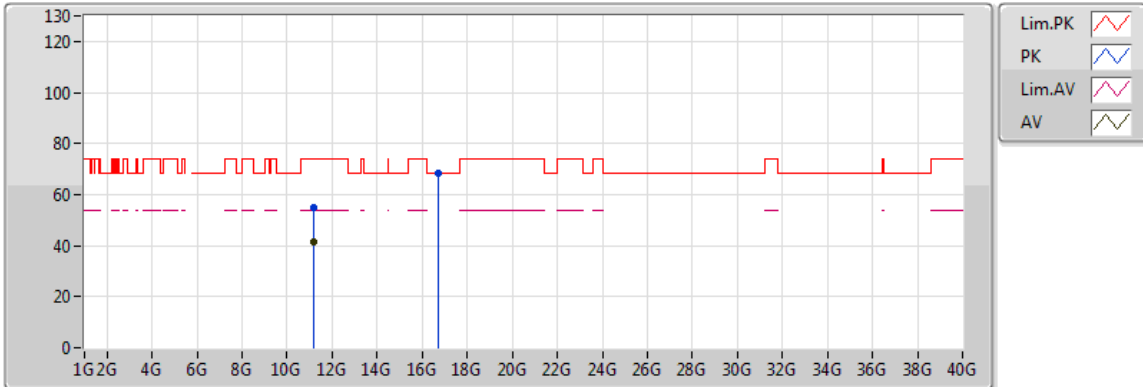

20170831
EUT_Z_2TX
Setting 23
02-Z-1
FSU

Type	Freq(Hz)	Level(dBuV/m)	Limit(dBuV/m)	Margin(dB)	Factor(dB)	Dist(m)	Pol.(H/V)	Azimuth(°)	Height(m)	Comments
AV	11.1626G	41.23	54.00	-12.77	16.01	3	V	260	2.19	-
PK	11.16472G	54.95	74.00	-19.05	16.01	3	V	260	2.19	-
PK	16.7394G	68.12	68.20	-0.08	19.90	3	V	305	2.59	-

802.11a_(6Mbps)_2TX

5580MHz_TX

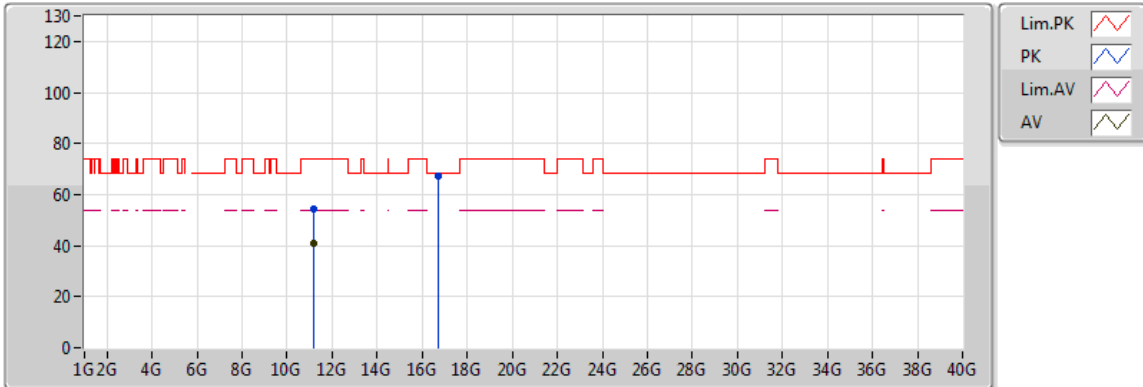

20170831
EUT_Z_2TX
Setting 23
02-Z-1
FSU

Type	Freq(Hz)	Level(dBuV/m)	Limit(dBuV/m)	Margin(dB)	Factor(dB)	Dist(m)	Pol.(H/V)	Azimuth(°)	Height(m)	Comments
AV	11.1596G	41.10	54.00	-12.90	16.00	3	H	37	1.52	-
PK	11.16644G	54.63	74.00	-19.37	16.01	3	H	37	1.52	-
PK	16.74316G	67.23	68.20	-0.97	19.91	3	H	140	1.67	-



802.11a_(6Mbps)_2TX

5700MHz_TX

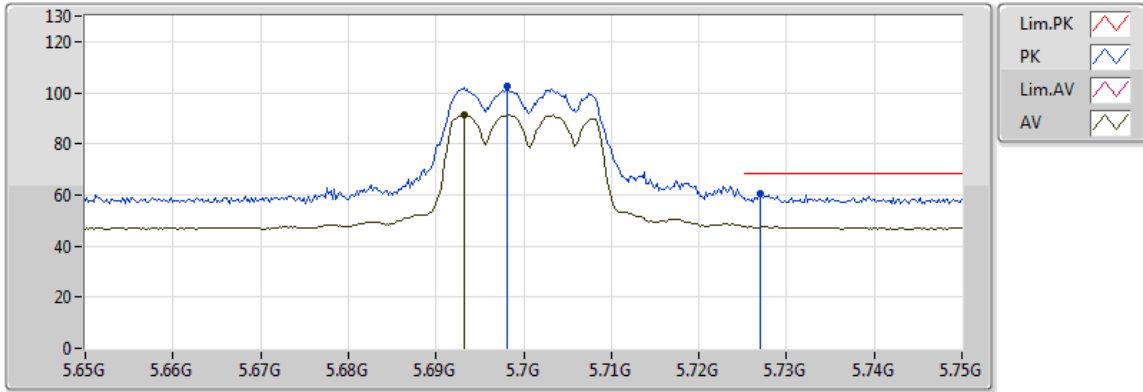

20170831
 EUT Z_2TX
 Setting 15.5
 02-Z-1-10
 FSU

Type	Freq(Hz)	Level(dBuV/m)	Limit(dBuV/m)	Margin(dB)	Factor(dB)	Dist(m)	Pol.(H/V)	Azimuth(°)	Height(m)	Comments
AV	5.6932G	91.53	Inf	-Inf	9.90	3	V	252	1.00	-
PK	5.6982G	102.38	Inf	-Inf	9.90	3	V	252	1.00	-
PK	5.727G	60.68	68.20	-7.52	9.91	3	V	252	1.00	-



802.11a_(6Mbps)_2TX

5700MHz_TX

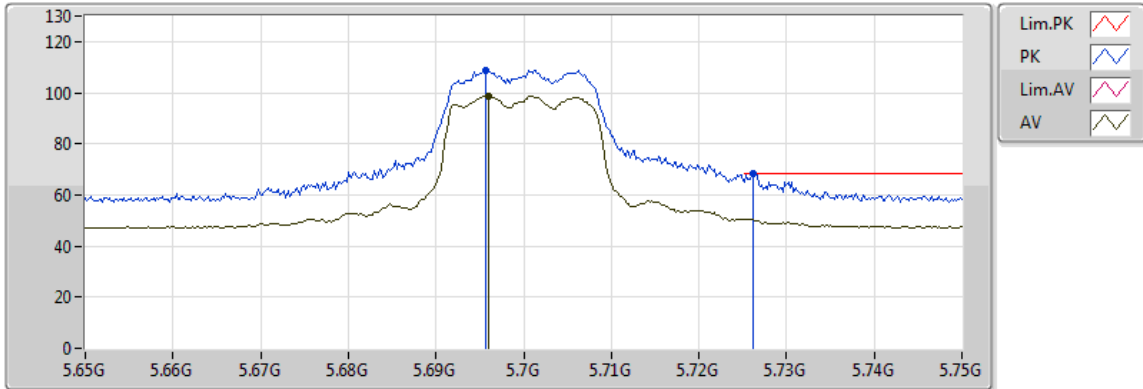

20170831
 EUT_Z_2TX
 Setting 15.5
 02-Z-1-10
 FSU

Type	Freq(Hz)	Level(dBuV/m)	Limit(dBuV/m)	Margin(dB)	Factor(dB)	Dist(m)	Pol.(H/V)	Azimuth(°)	Height(m)	Comments
AV	5.696G	98.67	Inf	-Inf	9.90	3	H	275	1.00	-
PK	5.6956G	108.85	Inf	-Inf	9.90	3	H	275	1.00	-
PK	5.7262G	68.17	68.20	-0.03	9.91	3	H	275	1.00	-



802.11a_(6Mbps)_2TX

5700MHz_TX

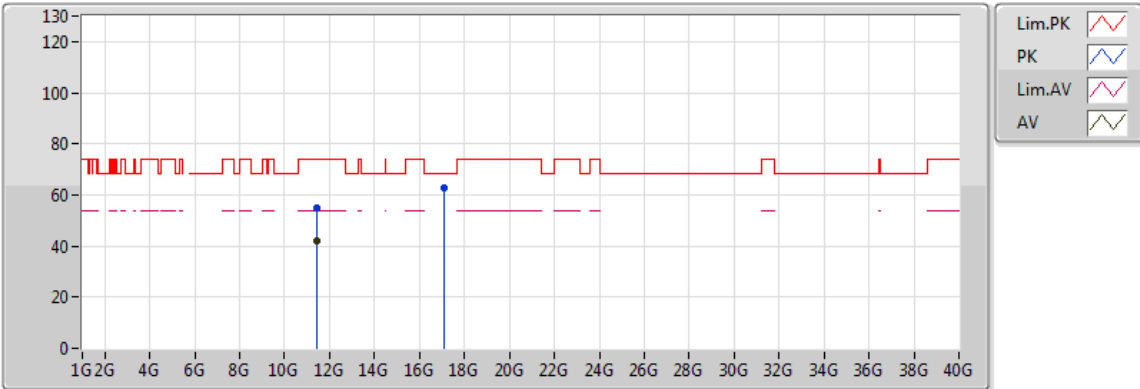

20170831
 EUT_Z_2TX
 Setting 15.5
 02-Z-1
 FSU

Type	Freq(Hz)	Level(dBuV/m)	Limit(dBuV/m)	Margin(dB)	Factor(dB)	Dist(m)	Pol.(H/V)	Azimuth(°)	Height(m)	Comments
AV	11.4078G	41.96	54.00	-12.04	16.27	3	V	213	1.58	-
PK	11.40304G	55.18	74.00	-18.82	16.27	3	V	213	1.58	-
PK	17.09516G	62.66	68.20	-5.54	21.46	3	V	347	2.09	-



802.11a_(6Mbps)_2TX

5700MHz_TX

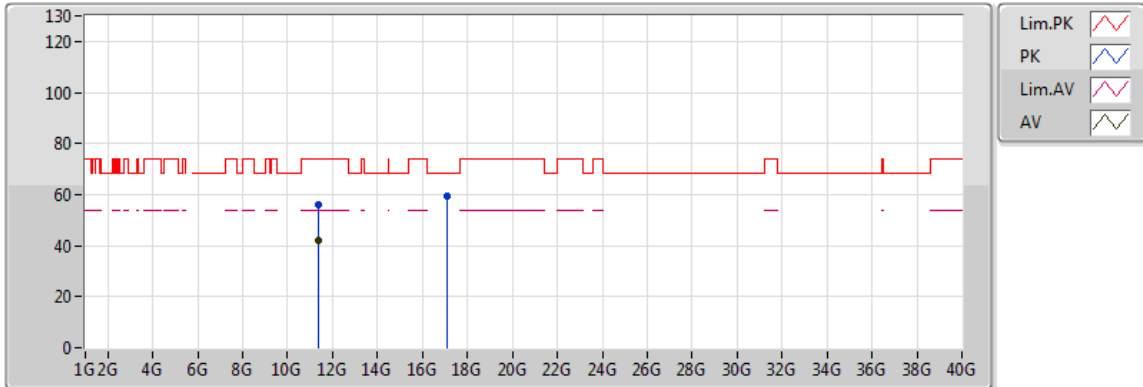

20170831
 EUT_Z_2TX
 Setting 15.5
 02-Z-1
 FSU

Type	Freq(Hz)	Level(dBuV/m)	Limit(dBuV/m)	Margin(dB)	Factor(dB)	Dist(m)	Pol.(H/V)	Azimuth(°)	Height(m)	Comments
AV	11.3996G	41.90	54.00	-12.10	16.27	3	H	231	1.51	-
PK	11.39292G	55.86	74.00	-18.14	16.26	3	H	231	1.51	-
PK	17.10852G	59.57	68.20	-8.63	21.54	3	H	70	2.20	-



802.11a_(6Mbps)_2TX

5720MHz_TX

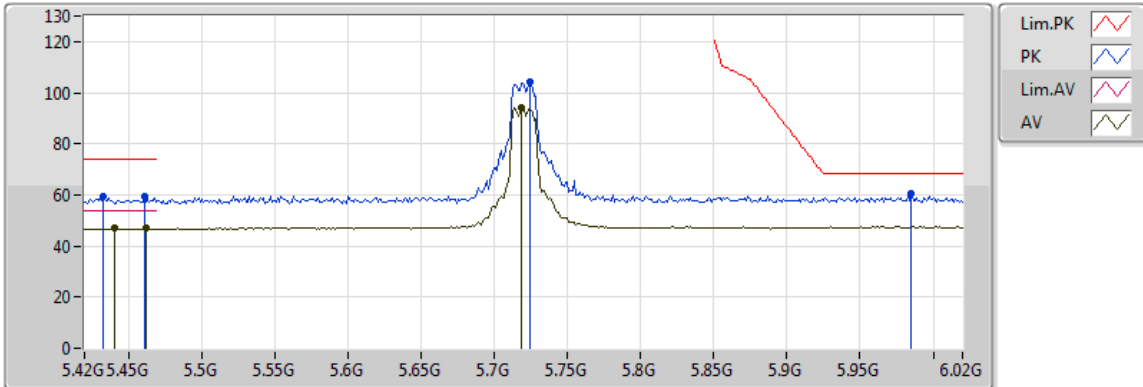

20170831
EUT_Z_2TX
Setting 18
02-J-6-10
FSU

Type	Freq(Hz)	Level(dBuV/m)	Limit(dBuV/m)	Margin(dB)	Factor(dB)	Dist(m)	Pol.(H/V)	Azimuth(°)	Height(m)	Comments
AV	5.4404G	46.79	54.00	-7.21	9.63	3	V	286	1.06	-
AV	5.462G	46.79	54.00	-7.21	9.69	3	V	286	1.06	-
AV	5.7188G	94.36	Inf	-Inf	9.90	3	V	286	1.06	-
PK	5.4332G	59.31	74.00	-14.69	9.61	3	V	286	1.06	-
PK	5.4608G	59.22	74.00	-14.78	9.68	3	V	286	1.06	-
PK	5.7248G	104.45	Inf	-Inf	9.90	3	V	286	1.06	-
PK	5.9852G	60.42	68.20	-7.78	10.18	3	V	286	1.06	-

802.11a_(6Mbps)_2TX

5720MHz_TX

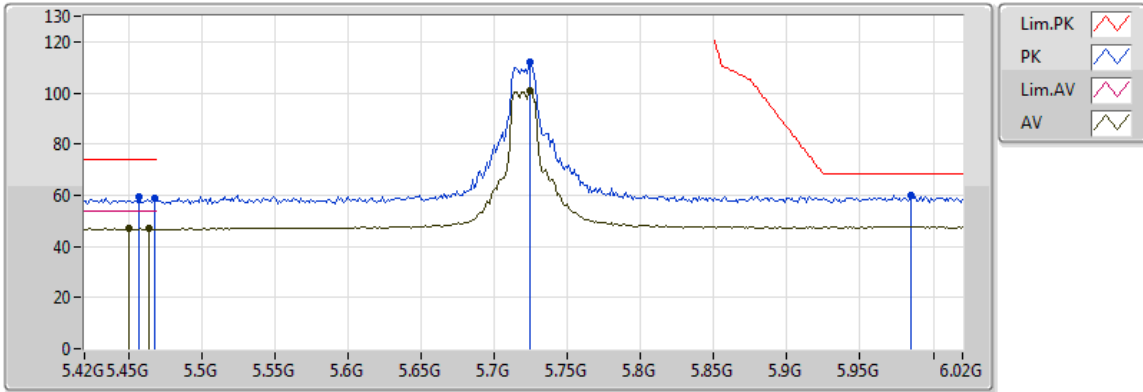

20170831
EUT_Z_2TX
Setting 18
02-J-6-10
FSU

Type	Freq(Hz)	Level(dBuV/m)	Limit(dBuV/m)	Margin(dB)	Factor(dB)	Dist(m)	Pol.(H/V)	Azimuth(°)	Height(m)	Comments
AV	5.45G	46.96	54.00	-7.04	9.66	3	H	276	1.03	-
AV	5.4644G	46.87	54.00	-7.13	9.69	3	H	276	1.03	-
AV	5.7248G	100.59	Inf	-Inf	9.90	3	H	276	1.03	-
PK	5.4572G	59.40	74.00	-14.60	9.67	3	H	276	1.03	-
PK	5.468G	58.73	74.00	-15.27	9.70	3	H	276	1.03	-
PK	5.7248G	112.17	Inf	-Inf	9.90	3	H	276	1.03	-
PK	5.9852G	60.05	68.20	-8.15	10.18	3	H	276	1.03	-



802.11a_(6Mbps)_2TX

5720MHz_TX

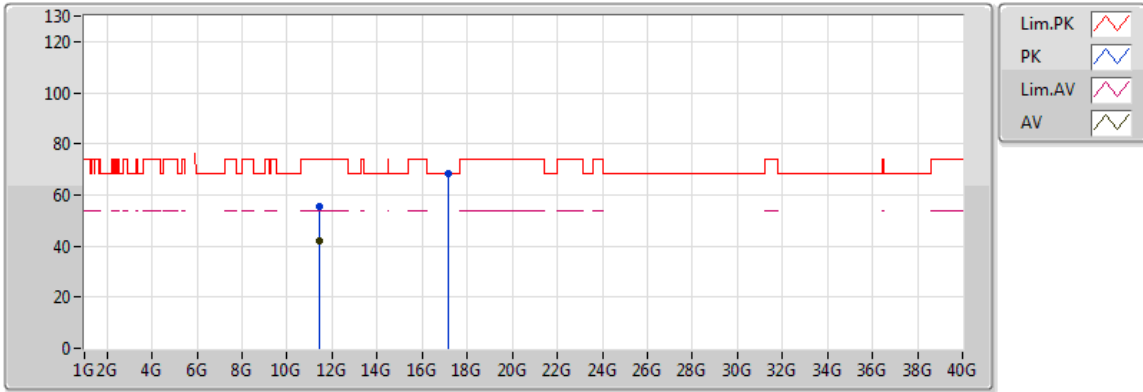

20170831
 EUT_Z_2TX
 Setting 18
 02-J-6
 FSU

Type	Freq(Hz)	Level(dBuV/m)	Limit(dBuV/m)	Margin(dB)	Factor(dB)	Dist(m)	Pol.(H/V)	Azimuth(°)	Height(m)	Comments
AV	11.44676G	41.98	54.00	-12.02	16.32	3	V	77	2.29	-
PK	11.43084G	55.35	74.00	-18.65	16.30	3	V	77	2.29	-
PK	17.15704G	68.15	68.20	-0.05	21.82	3	V	350	2.12	-



802.11a_(6Mbps)_2TX

5720MHz_TX

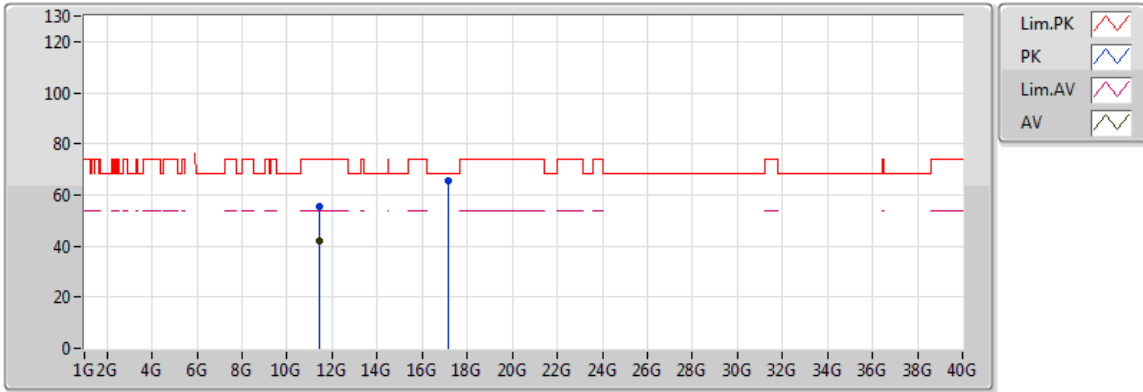

20170831
 EUT_Z_2TX
 Setting 18
 02-J-6
 FSU

Type	Freq(Hz)	Level(dBuV/m)	Limit(dBuV/m)	Margin(dB)	Factor(dB)	Dist(m)	Pol.(H/V)	Azimuth(°)	Height(m)	Comments
AV	11.43G	41.86	54.00	-12.14	16.30	3	H	280	1.43	-
PK	11.44076G	55.44	74.00	-18.56	16.31	3	H	280	1.43	-
PK	17.152G	65.60	68.20	-2.60	21.79	3	H	307	2.68	-



802.11ac VHT20_Nss1,(MCS0)_2TX

5260MHz_TX

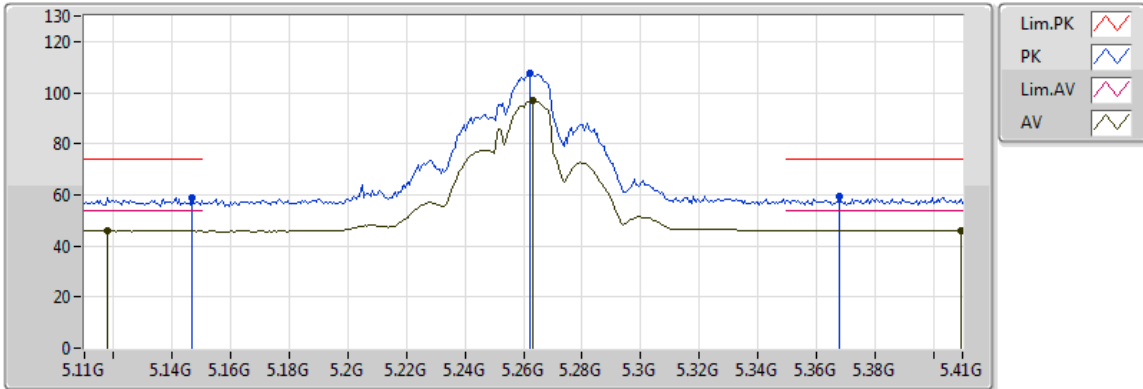

20170831
EUT_Z_2TX
Setting 23
02-J-6-10
FSU

Type	Freq(Hz)	Level(dBuV/m)	Limit(dBuV/m)	Margin(dB)	Factor(dB)	Dist(m)	Pol.(H/V)	Azimuth(°)	Height(m)	Comments
AV	5.1178G	45.85	54.00	-8.15	8.95	3	V	173	2.52	-
AV	5.263G	96.73	Inf	-Inf	9.28	3	V	173	2.52	-
AV	5.4094G	46.08	54.00	-7.92	9.55	3	V	173	2.52	-
PK	5.1466G	58.90	74.00	-15.10	9.03	3	V	173	2.52	-
PK	5.2624G	107.81	Inf	-Inf	9.28	3	V	173	2.52	-
PK	5.368G	59.16	74.00	-14.84	9.47	3	V	173	2.52	-



802.11ac VHT20_Nss1,(MCS0)_2TX

5260MHz_TX

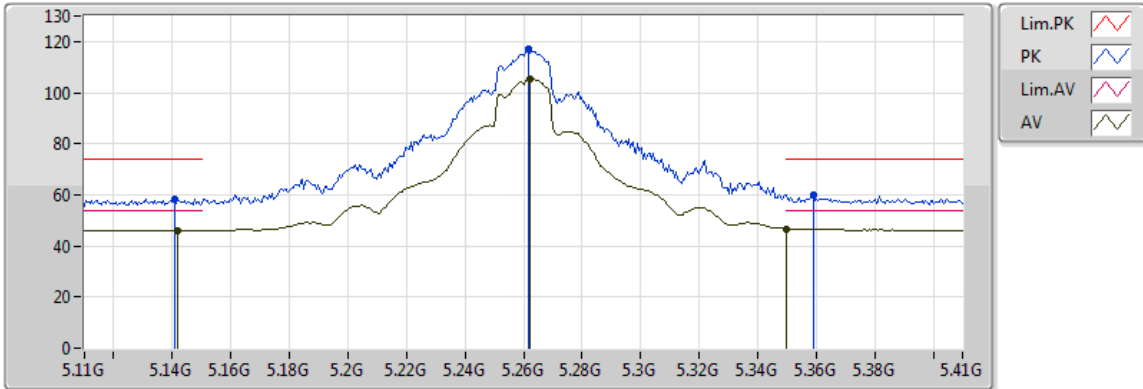

20170831
EUT_Z_2TX
Setting 23
02-J-6-10
FSU

Type	Freq(Hz)	Level(dBuV/m)	Limit(dBuV/m)	Margin(dB)	Factor(dB)	Dist(m)	Pol.(H/V)	Azimuth(°)	Height(m)	Comments
AV	5.1418G	45.97	54.00	-8.03	9.01	3	H	84	1.04	-
AV	5.2624G	105.44	Inf	-Inf	9.28	3	H	84	1.04	-
AV	5.350005G	46.71	54.00	-7.29	9.44	3	H	84	1.04	-
PK	5.1406G	58.44	74.00	-15.56	9.01	3	H	84	1.04	-
PK	5.2618G	116.92	Inf	-Inf	9.28	3	H	84	1.04	-
PK	5.359G	60.02	74.00	-13.98	9.45	3	H	84	1.04	-



802.11ac VHT20_Nss1,(MCS0)_2TX

5260MHz_TX

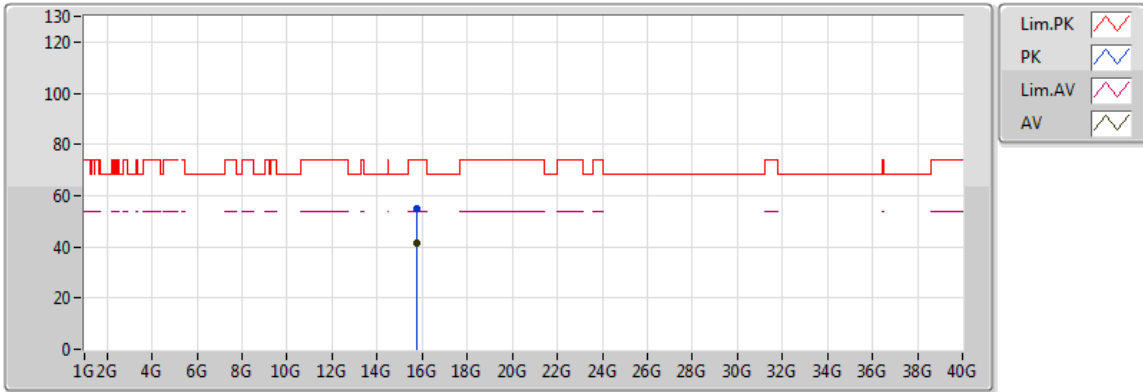

20170831
 EUT_Z_2TX
 Setting 23
 02-J-6
 FSU

Type	Freq(Hz)	Level(dBuV/m)	Limit(dBuV/m)	Margin(dB)	Factor(dB)	Dist(m)	Pol.(H/V)	Azimuth(°)	Height(m)	Comments
AV	15.77076G	41.42	54.00	-12.58	17.53	3	V	49	1.82	-
PK	15.77256G	54.99	74.00	-19.01	17.52	3	V	49	1.82	-



802.11ac VHT20_Nss1,(MCS0)_2TX

5260MHz_TX

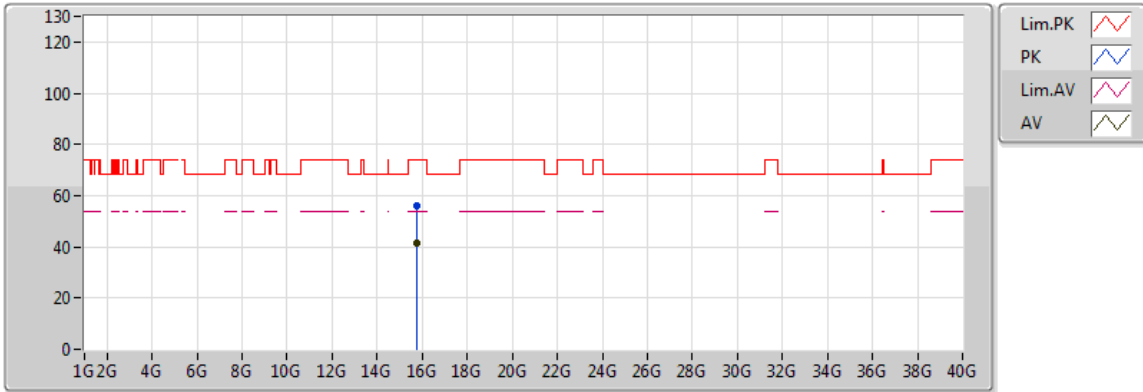

20170831
 EUT_Z_2TX
 Setting 23
 02-J-6
 FSU

Type	Freq(Hz)	Level(dBuV/m)	Limit(dBuV/m)	Margin(dB)	Factor(dB)	Dist(m)	Pol.(H/V)	Azimuth(°)	Height(m)	Comments
AV	15.77476G	41.38	54.00	-12.62	17.52	3	H	264	2.03	-
PK	15.78672G	56.02	74.00	-17.98	17.49	3	H	264	2.03	-



802.11ac VHT20_Nss1,(MCS0)_2TX

5300MHz_TX

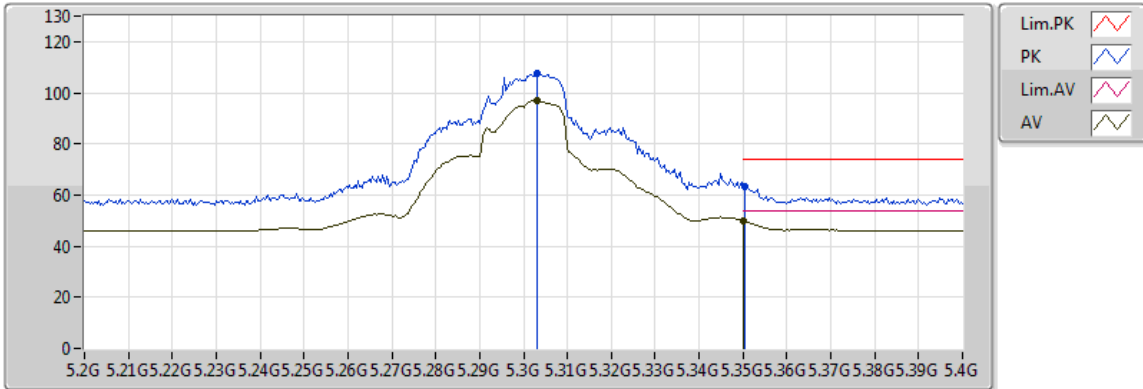

20170831
EUT_Z_2TX
Setting 22
02-J-6-10
FSU

Type	Freq(Hz)	Level(dBuV/m)	Limit(dBuV/m)	Margin(dB)	Factor(dB)	Dist(m)	Pol.(H/V)	Azimuth(°)	Height(m)	Comments
AV	5.3032G	96.73	Inf	-Inf	9.36	3	V	134	2.57	-
AV	5.350005G	49.94	54.00	-4.06	9.44	3	V	134	2.57	-
PK	5.3032G	107.83	Inf	-Inf	9.36	3	V	134	2.57	-
PK	5.3504G	63.16	74.00	-10.84	9.44	3	V	134	2.57	-



802.11ac VHT20_Nss1,(MCS0)_2TX

5300MHz_TX

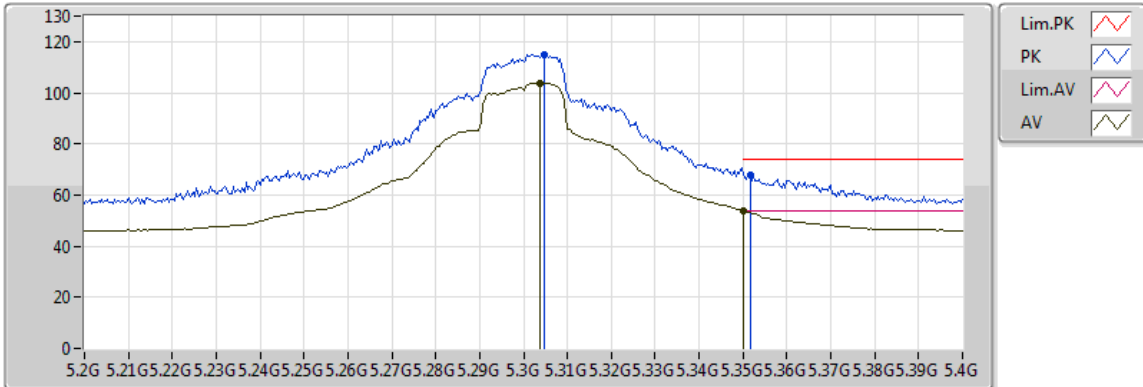

20170831
EUT_Z_2TX
Setting 22
02-J-6-10
FSU

Type	Freq(Hz)	Level(dBuV/m)	Limit(dBuV/m)	Margin(dB)	Factor(dB)	Dist(m)	Pol.(H/V)	Azimuth(°)	Height(m)	Comments
AV	5.3036G	103.94	Inf	-Inf	9.36	3	H	77	2.54	-
AV	5.350005G	53.94	54.00	-0.06	9.44	3	H	77	2.54	-
PK	5.3048G	114.84	Inf	-Inf	9.36	3	H	77	2.54	-
PK	5.3516G	67.92	74.00	-6.08	9.44	3	H	77	2.54	-



802.11ac VHT20_Nss1,(MCS0)_2TX

5300MHz_TX

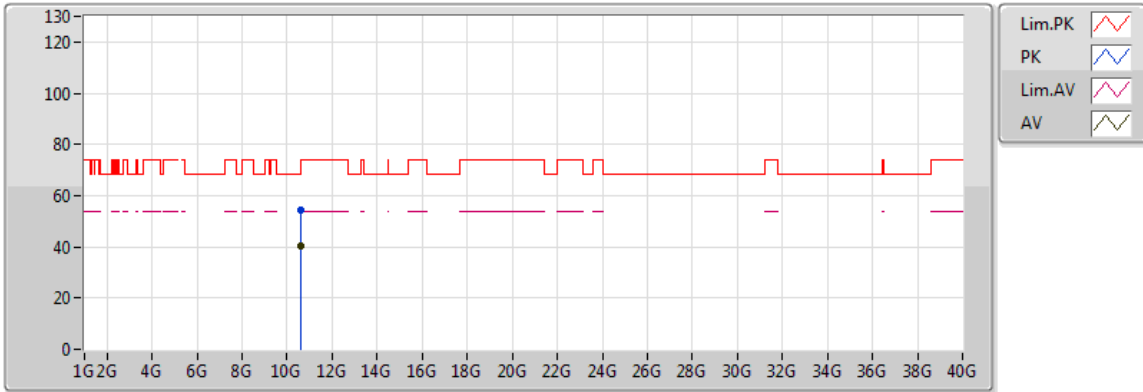

20170831
 EUT_Z_2TX
 Setting 22
 02-J-6
 FSU

Type	Freq(Hz)	Level(dBuV/m)	Limit(dBuV/m)	Margin(dB)	Factor(dB)	Dist(m)	Pol.(H/V)	Azimuth(°)	Height(m)	Comments
AV	10.60988G	40.20	54.00	-13.80	15.90	3	V	171	2.49	-
PK	10.60248G	54.29	74.00	-19.71	15.90	3	V	171	2.49	-



802.11ac VHT20_Nss1,(MCS0)_2TX

5300MHz_TX

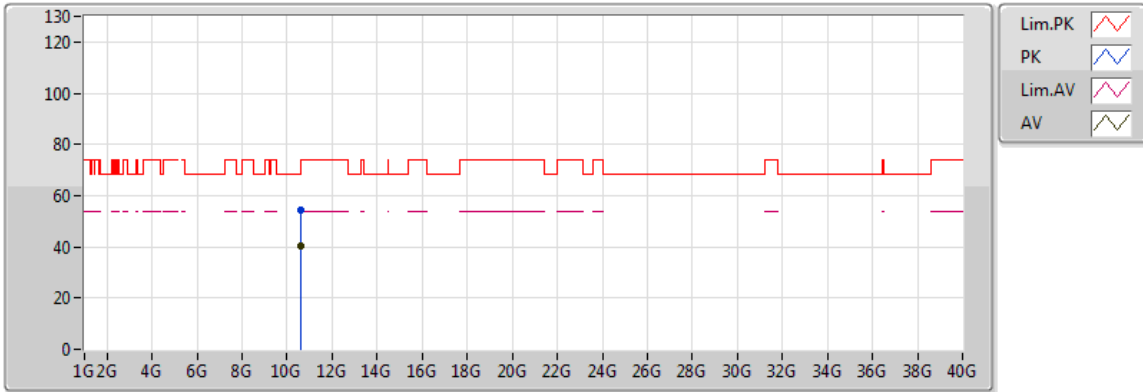

20170831
 EUT_Z_2TX
 Setting 22
 02-J-6
 FSU

Type	Freq(Hz)	Level(dBuV/m)	Limit(dBuV/m)	Margin(dB)	Factor(dB)	Dist(m)	Pol.(H/V)	Azimuth(°)	Height(m)	Comments
AV	10.60014G	40.24	54.00	-13.76	15.90	3	H	186	1.40	-
PK	10.6012G	54.11	74.00	-19.89	15.90	3	H	186	1.40	-



802.11ac VHT20_Nss1,(MCS0)_2TX

5320MHz_TX

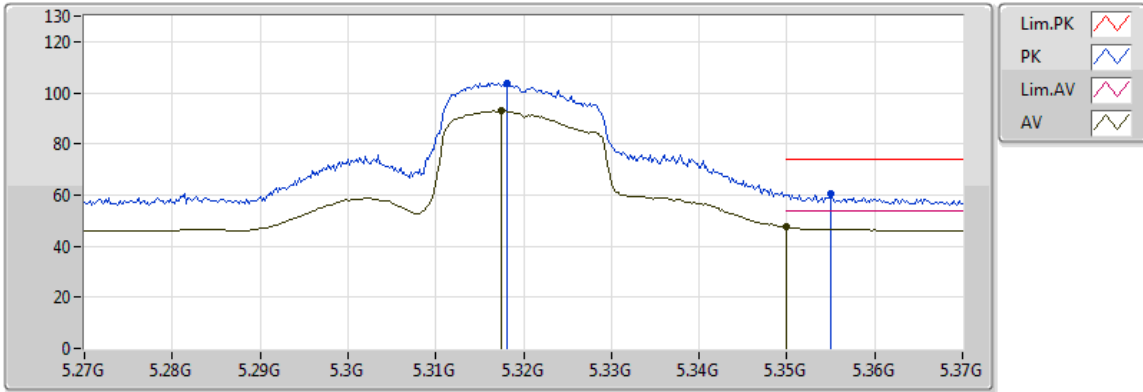

20170831
 EUT_Z_2TX
 Setting 18
 02-J-6-10
 FSU

Type	Freq(Hz)	Level(dBuV/m)	Limit(dBuV/m)	Margin(dB)	Factor(dB)	Dist(m)	Pol.(H/V)	Azimuth(°)	Height(m)	Comments
AV	5.3174G	92.78	Inf	-Inf	9.38	3	V	191	2.60	-
AV	5.350005G	47.41	54.00	-6.59	9.44	3	V	191	2.60	-
PK	5.3182G	103.90	Inf	-Inf	9.38	3	V	191	2.60	-
PK	5.355G	60.67	74.00	-13.33	9.44	3	V	191	2.60	-

802.11ac VHT20_Nss1,(MCS0)_2TX

5320MHz_TX

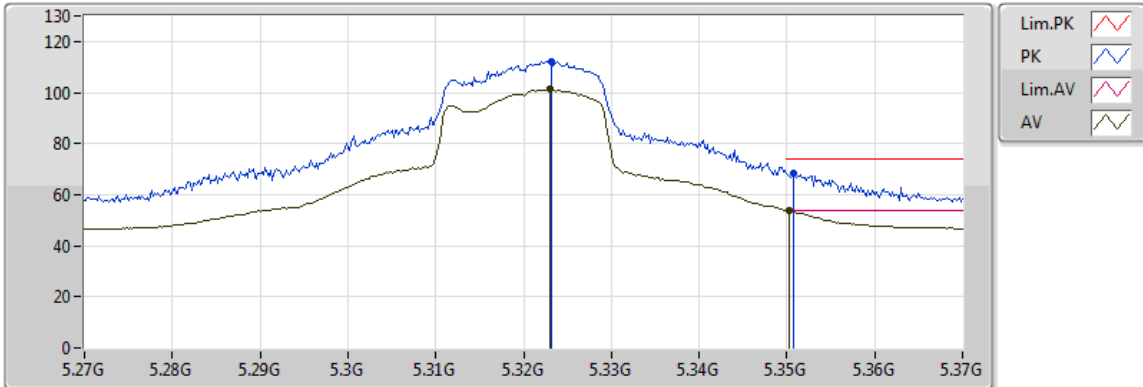

20170831
EUT_Z_2TX
Setting 18
02-J-6-10
FSU

Type	Freq(Hz)	Level(dBuV/m)	Limit(dBuV/m)	Margin(dB)	Factor(dB)	Dist(m)	Pol.(H/V)	Azimuth(°)	Height(m)	Comments
AV	5.323G	101.26	Inf	-Inf	9.39	3	H	68	1.02	-
AV	5.3502G	53.92	54.00	-0.08	9.44	3	H	68	1.02	-
PK	5.3232G	112.27	Inf	-Inf	9.39	3	H	68	1.02	-
PK	5.3508G	68.62	74.00	-5.38	9.44	3	H	68	1.02	-

802.11ac VHT20_Nss1,(MCS0)_2TX

5320MHz_TX

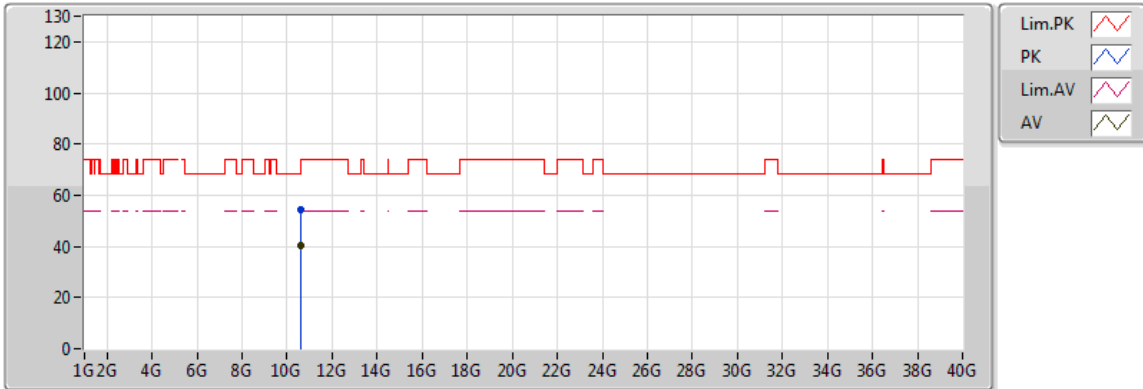

20170831
EUT_Z_2TX
Setting 18
02-J-6
FSU

Type	Freq(Hz)	Level(dBuV/m)	Limit(dBuV/m)	Margin(dB)	Factor(dB)	Dist(m)	Pol.(H/V)	Azimuth(°)	Height(m)	Comments
AV	10.63016G	40.20	54.00	-13.80	15.89	3	V	245	1.72	-
PK	10.63424G	54.42	74.00	-19.58	15.89	3	V	245	1.72	-

802.11ac VHT20_Nss1,(MCS0)_2TX

5320MHz_TX

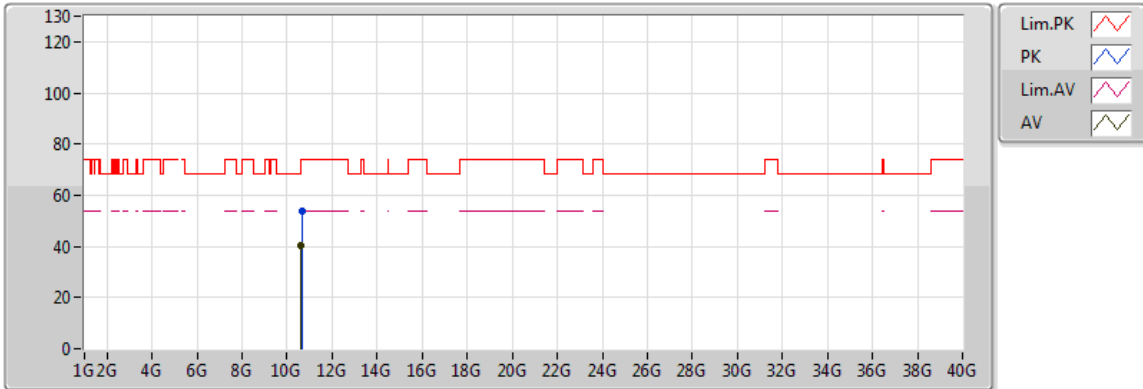

20170831
EUT_Z_2TX
Setting 18
02-J-6
FSU

Type	Freq(Hz)	Level(dBuV/m)	Limit(dBuV/m)	Margin(dB)	Factor(dB)	Dist(m)	Pol.(H/V)	Azimuth(°)	Height(m)	Comments
AV	10.6326G	40.21	54.00	-13.79	15.89	3	H	69	1.78	-
PK	10.64656G	54.03	74.00	-19.97	15.89	3	H	69	1.78	-

802.11ac VHT20_Nss1,(MCS0)_2TX

5500MHz_TX

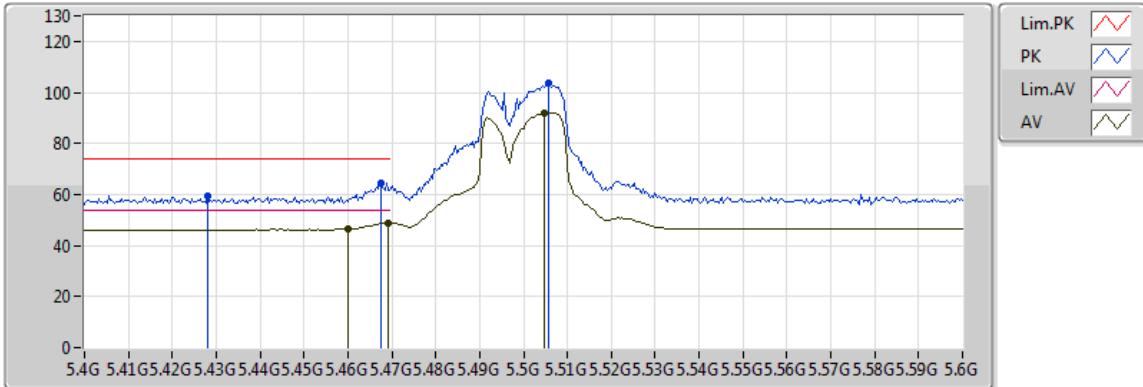

20170831
EUT_Z_2TX
Setting 19
02-J-6-10
FSU

Type	Freq(Hz)	Level(dBuV/m)	Limit(dBuV/m)	Margin(dB)	Factor(dB)	Dist(m)	Pol.(H/V)	Azimuth(°)	Height(m)	Comments
AV	5.46G	46.46	54.00	-7.54	9.68	3	V	131	2.71	-
AV	5.4692G	48.79	54.00	-5.21	9.71	3	V	131	2.71	-
AV	5.5048G	92.06	Inf	-Inf	9.79	3	V	131	2.71	-
PK	5.428G	59.26	74.00	-14.74	9.60	3	V	131	2.71	-
PK	5.4676G	64.56	74.00	-9.44	9.70	3	V	131	2.71	-
PK	5.5056G	103.50	Inf	-Inf	9.80	3	V	131	2.71	-

802.11ac VHT20_Nss1,(MCS0)_2TX

5500MHz_TX

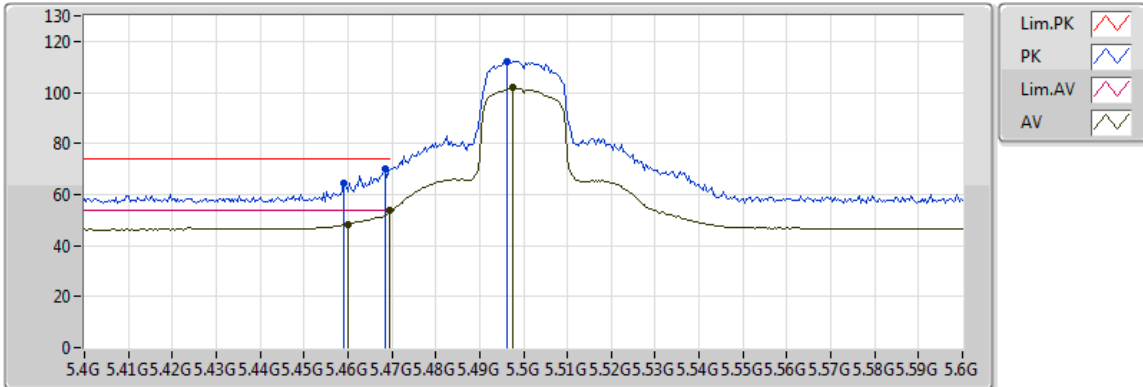

20170831
EUT_Z_2TX
Setting 19
02-J-6-10
FSU

Type	Freq(Hz)	Level(dBuV/m)	Limit(dBuV/m)	Margin(dB)	Factor(dB)	Dist(m)	Pol.(H/V)	Azimuth(°)	Height(m)	Comments
AV	5.46G	48.36	54.00	-5.64	9.68	3	H	255	1.00	-
AV	5.4696G	53.61	54.00	-0.39	9.71	3	H	255	1.00	-
AV	5.4976G	101.72	Inf	-Inf	9.78	3	H	255	1.00	-
PK	5.4592G	64.52	74.00	-9.48	9.68	3	H	255	1.00	-
PK	5.4684G	70.23	74.00	-3.77	9.70	3	H	255	1.00	-
PK	5.4964G	112.30	Inf	-Inf	9.78	3	H	255	1.00	-

802.11ac VHT20_Nss1,(MCS0)_2TX

5500MHz_TX

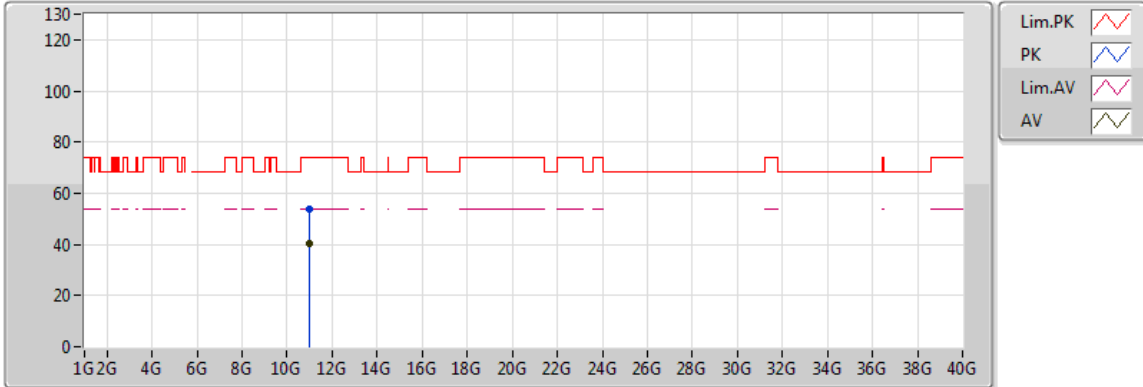

20170831
EUT_Z_2TX
Setting 19
02-J-6
FSU

Type	Freq(Hz)	Level(dBuV/m)	Limit(dBuV/m)	Margin(dB)	Factor(dB)	Dist(m)	Pol.(H/V)	Azimuth(°)	Height(m)	Comments
AV	10.99268G	40.26	54.00	-13.74	15.83	3	V	217	1.47	-
PK	10.99156G	53.91	74.00	-20.09	15.83	3	V	217	1.47	-

802.11ac VHT20_Nss1,(MCS0)_2TX

5500MHz_TX

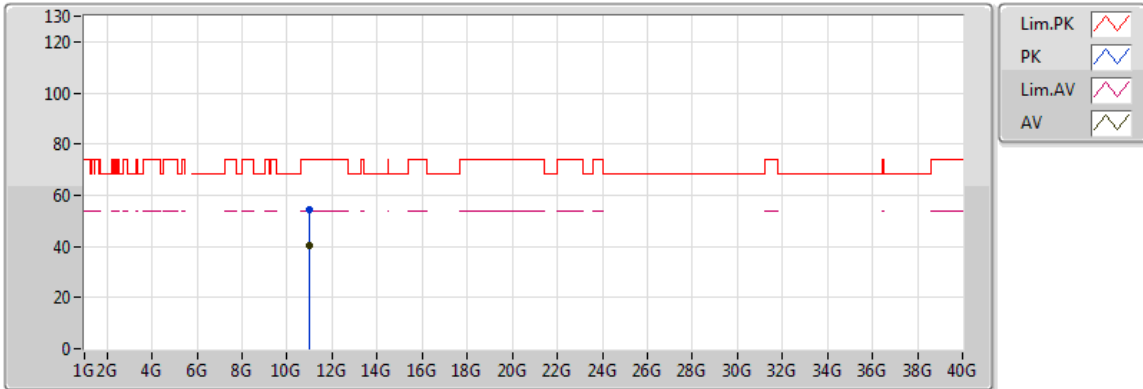

20170831
 EUT_Z_2TX
 Setting 19
 02-J-6
 FSU

Type	Freq(Hz)	Level(dBuV/m)	Limit(dBuV/m)	Margin(dB)	Factor(dB)	Dist(m)	Pol.(H/V)	Azimuth(°)	Height(m)	Comments
AV	10.99012G	40.28	54.00	-13.72	15.83	3	H	5	1.69	-
PK	10.99976G	54.57	74.00	-19.43	15.83	3	H	5	1.69	-

802.11ac VHT20_Nss1,(MCS0)_2TX

5580MHz_TX

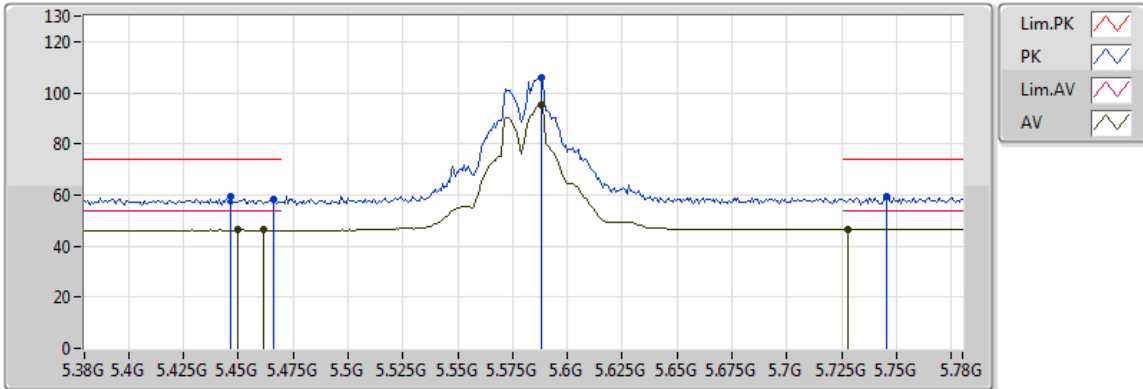

20170831
EUT_Z_2TX
Setting 23
02-J-6-10
FSU

Type	Freq(Hz)	Level(dBuV/m)	Limit(dBuV/m)	Margin(dB)	Factor(dB)	Dist(m)	Pol.(H/V)	Azimuth(°)	Height(m)	Comments
AV	5.4496G	46.26	54.00	-7.74	9.65	3	V	135	2.62	-
AV	5.4616G	46.26	54.00	-7.74	9.69	3	V	135	2.62	-
AV	5.588G	95.05	Inf	-Inf	9.87	3	V	135	2.62	-
AV	5.728G	46.62	54.00	-7.38	9.91	3	V	135	2.62	-
PK	5.4464G	59.33	74.00	-14.67	9.65	3	V	135	2.62	-
PK	5.4664G	58.53	74.00	-15.47	9.70	3	V	135	2.62	-
PK	5.588G	105.67	Inf	-Inf	9.87	3	V	135	2.62	-
PK	5.7456G	59.14	74.00	-14.86	9.91	3	V	135	2.62	-

802.11ac VHT20_Nss1,(MCS0)_2TX

5580MHz_TX

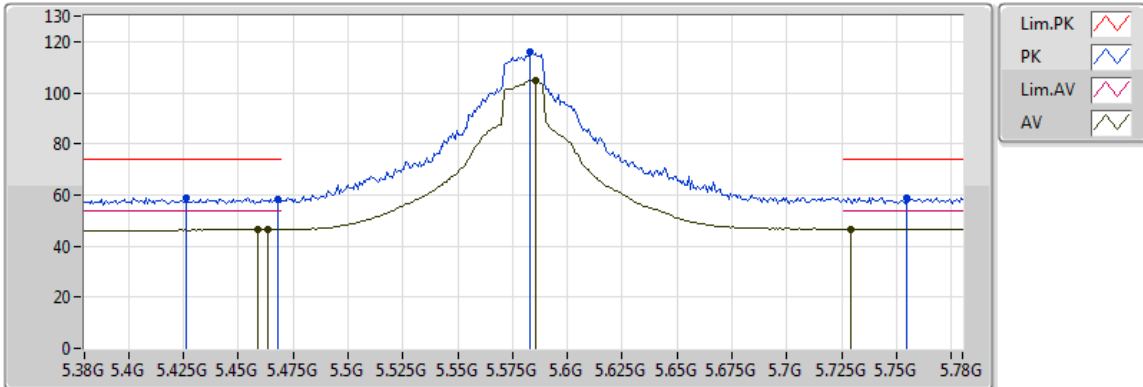

20170831
EUT_Z_2TX
Setting 23
02-J-6-10
FSU

Type	Freq(Hz)	Level(dBuV/m)	Limit(dBuV/m)	Margin(dB)	Factor(dB)	Dist(m)	Pol.(H/V)	Azimuth(°)	Height(m)	Comments
AV	5.4592G	46.43	54.00	-7.57	9.68	3	H	234	1.00	-
AV	5.4632G	46.50	54.00	-7.50	9.69	3	H	234	1.00	-
AV	5.5856G	104.68	Inf	-Inf	9.87	3	H	234	1.00	-
AV	5.7288G	46.69	54.00	-7.31	9.91	3	H	234	1.00	-
PK	5.4264G	58.96	74.00	-15.04	9.59	3	H	234	1.00	-
PK	5.468G	58.42	74.00	-15.58	9.70	3	H	234	1.00	-
PK	5.5832G	115.73	Inf	-Inf	9.86	3	H	234	1.00	-
PK	5.7544G	58.97	74.00	-15.03	9.91	3	H	234	1.00	-



802.11ac VHT20_Nss1,(MCS0)_2TX

5580MHz_TX

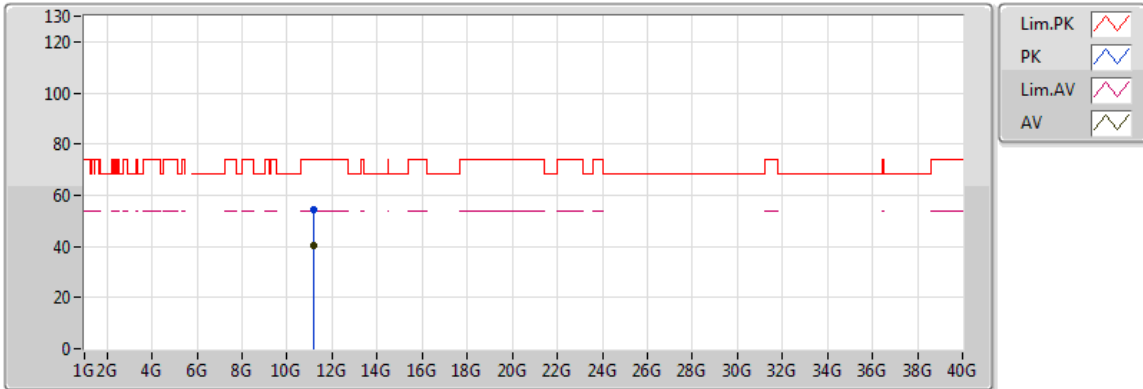

20170831
 EUT_Z_2TX
 Setting 23
 02-J-6
 FSU

Type	Freq(Hz)	Level(dBuV/m)	Limit(dBuV/m)	Margin(dB)	Factor(dB)	Dist(m)	Pol.(H/V)	Azimuth(°)	Height(m)	Comments
AV	11.16388G	40.28	54.00	-13.72	16.01	3	V	159	1.19	-
PK	11.15228G	54.21	74.00	-19.79	16.00	3	V	159	1.19	-



802.11ac VHT20_Nss1,(MCS0)_2TX

5580MHz_TX

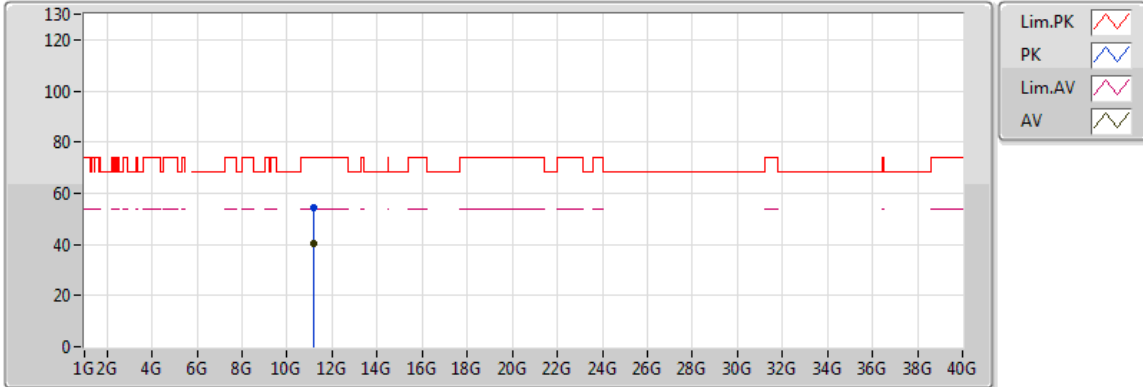

20170831
 EUT_Z_2TX
 Setting 23
 02-J-6
 FSU

Type	Freq(Hz)	Level(dBuV/m)	Limit(dBuV/m)	Margin(dB)	Factor(dB)	Dist(m)	Pol.(H/V)	Azimuth(°)	Height(m)	Comments
AV	11.16484G	40.29	54.00	-13.71	16.01	3	H	105	1.21	-
PK	11.15792G	54.44	74.00	-19.56	16.00	3	H	105	1.21	-

802.11ac VHT20_Nss1,(MCS0)_2TX

5700MHz_TX

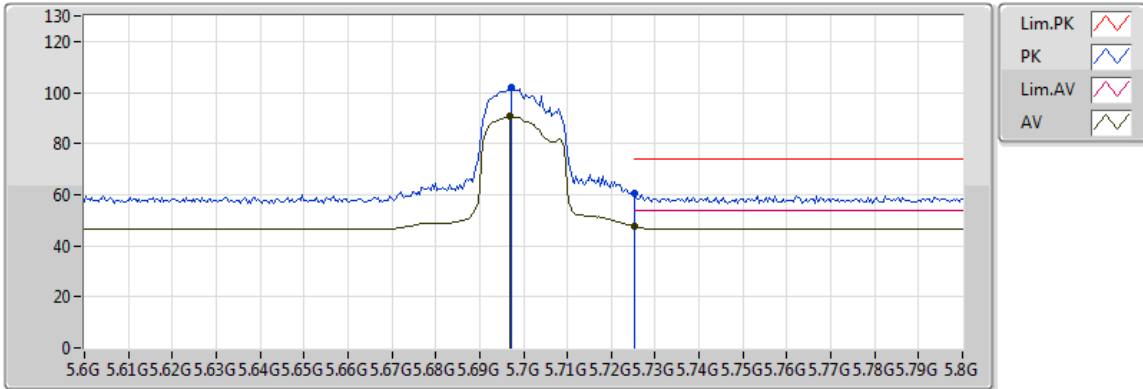

20170831
EUT_Z_2TX
Setting 16.5
02-J-6-10
FSU

Type	Freq(Hz)	Level(dBuV/m)	Limit(dBuV/m)	Margin(dB)	Factor(dB)	Dist(m)	Pol.(H/V)	Azimuth(°)	Height(m)	Comments
AV	5.6968G	90.74	Inf	-Inf	9.90	3	V	208	2.66	-
AV	5.7252G	47.51	54.00	-6.49	9.91	3	V	208	2.66	-
PK	5.6972G	102.07	Inf	-Inf	9.90	3	V	208	2.66	-
PK	5.7252G	60.62	74.00	-13.38	9.91	3	V	208	2.66	-

802.11ac VHT20_Nss1,(MCS0)_2TX

5700MHz_TX

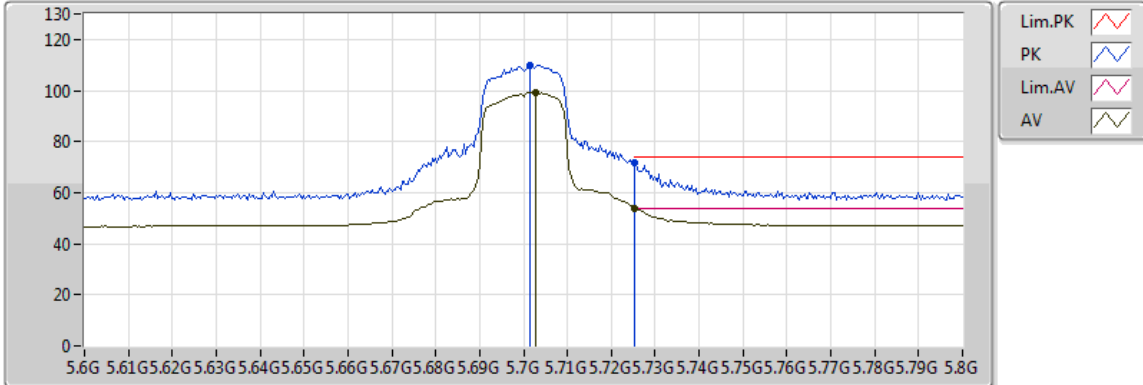

20170831
EUT_Z_2TX
Setting 16.5
02-J-6-10
FSU

Type	Freq(Hz)	Level(dBuV/m)	Limit(dBuV/m)	Margin(dB)	Factor(dB)	Dist(m)	Pol.(H/V)	Azimuth(°)	Height(m)	Comments
AV	5.7028G	99.39	Inf	-Inf	9.90	3	H	253	1.02	-
AV	5.7252G	53.97	54.00	-0.03	9.91	3	H	253	1.02	-
PK	5.7016G	109.84	Inf	-Inf	9.90	3	H	253	1.02	-
PK	5.7252G	71.99	74.00	-2.01	9.91	3	H	253	1.02	-



802.11ac VHT20_Nss1,(MCS0)_2TX

5700MHz_TX

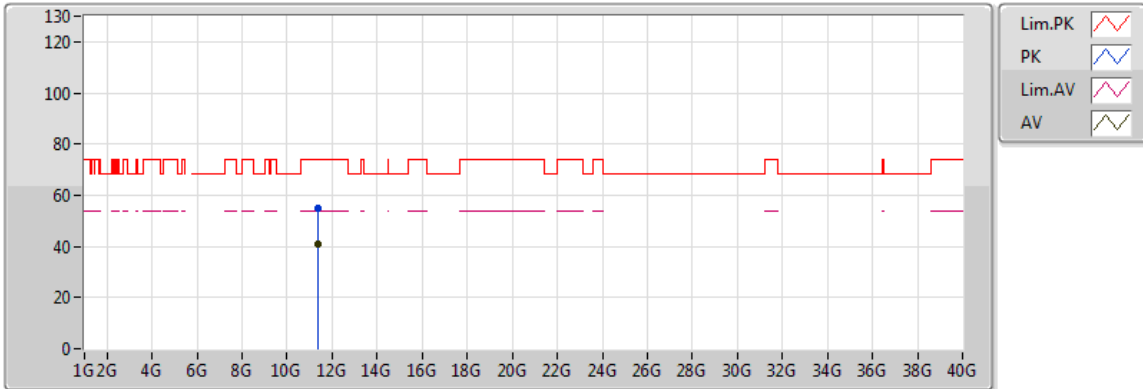

20170831
EUT_Z_2TX
Setting 16.5
02-J-6
FSU

Type	Freq(Hz)	Level(dBuV/m)	Limit(dBuV/m)	Margin(dB)	Factor(dB)	Dist(m)	Pol.(H/V)	Azimuth(°)	Height(m)	Comments
AV	11.39672G	41.00	54.00	-13.00	16.26	3	V	252	1.37	-
PK	11.40064G	55.00	74.00	-19.00	16.27	3	V	252	1.37	-



802.11ac VHT20_Nss1,(MCS0)_2TX

5700MHz_TX

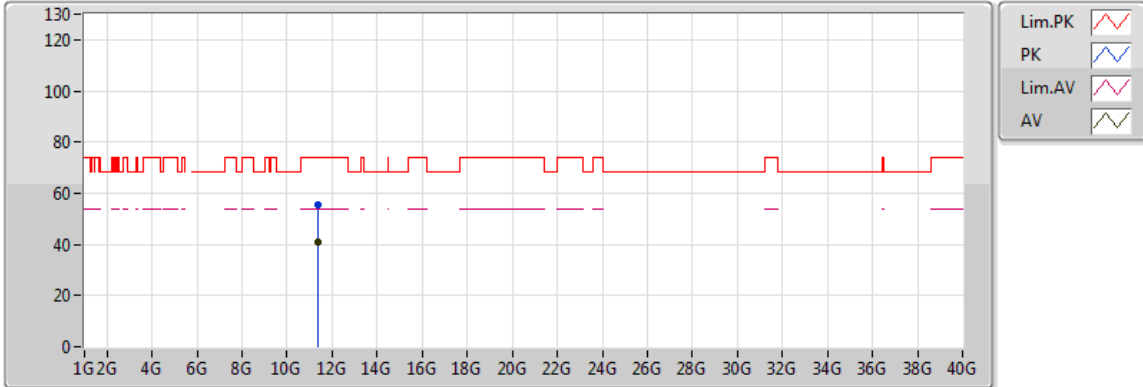

20170831
 EUT_Z_2TX
 Setting 16.5
 02-J-6
 FSU

Type	Freq(Hz)	Level(dBuV/m)	Limit(dBuV/m)	Margin(dB)	Factor(dB)	Dist(m)	Pol.(H/V)	Azimuth(°)	Height(m)	Comments
AV	11.40004G	41.01	54.00	-12.99	16.27	3	H	254	1.45	-
PK	11.39888G	55.42	74.00	-18.58	16.26	3	H	254	1.45	-

802.11ac VHT20_Nss1,(MCS0)_2TX
5720MHz Straddle 5.47-5.725GHz_TX

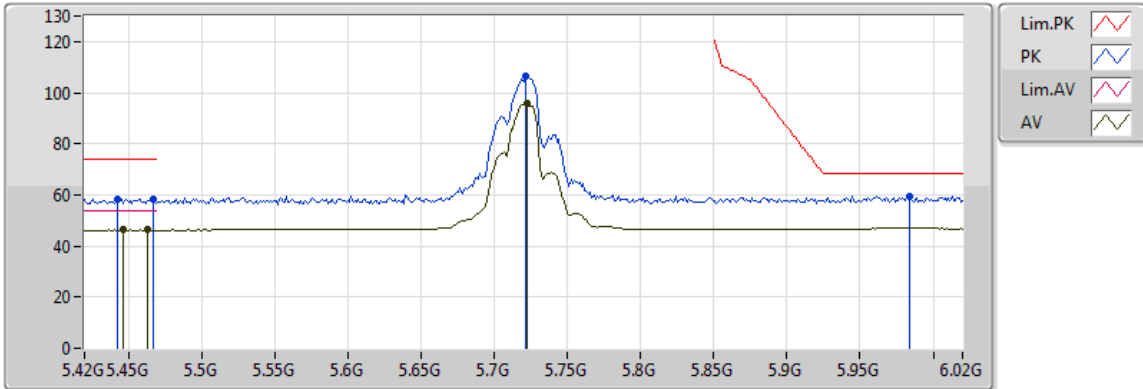

20170831
 EUT_Z_2TX
 Setting 23
 02-J-6-10
 FSU

Type	Freq(Hz)	Level(dBuV/m)	Limit(dBuV/m)	Margin(dB)	Factor(dB)	Dist(m)	Pol.(H/V)	Azimuth(°)	Height(m)	Comments
AV	5.4464G	46.27	54.00	-7.73	9.65	3	V	146	2.63	-
AV	5.4632G	46.27	54.00	-7.73	9.69	3	V	146	2.63	-
AV	5.7224G	95.89	Inf	-Inf	9.90	3	V	146	2.63	-
PK	5.4428G	58.44	74.00	-15.56	9.64	3	V	146	2.63	-
PK	5.4668G	58.09	74.00	-15.91	9.70	3	V	146	2.63	-
PK	5.7212G	106.24	Inf	-Inf	9.90	3	V	146	2.63	-
PK	5.984G	59.60	68.20	-8.60	10.18	3	V	146	2.63	-

802.11ac VHT20_Nss1,(MCS0)_2TX

5720MHz Straddle 5.47-5.725GHz_TX

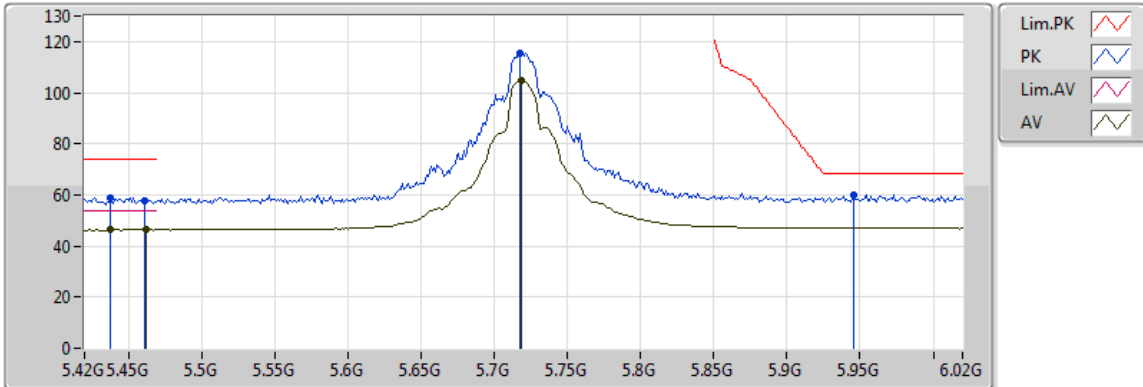

20170831
EUT_Z_2TX
Setting 23
02-J-6-10
FSU

Type	Freq(Hz)	Level(dBuV/m)	Limit(dBuV/m)	Margin(dB)	Factor(dB)	Dist(m)	Pol.(H/V)	Azimuth(°)	Height(m)	Comments
AV	5.438G	46.36	54.00	-7.64	9.62	3	H	280	1.01	-
AV	5.462G	46.32	54.00	-7.68	9.69	3	H	280	1.01	-
AV	5.7188G	104.96	Inf	-Inf	9.90	3	H	280	1.01	-
PK	5.438G	58.77	74.00	-15.23	9.62	3	H	280	1.01	-
PK	5.4608G	57.99	74.00	-16.01	9.68	3	H	280	1.01	-
PK	5.7176G	115.53	Inf	-Inf	9.90	3	H	280	1.01	-
PK	5.9456G	60.20	68.20	-8.00	10.12	3	H	280	1.01	-

802.11ac VHT20_Nss1,(MCS0)_2TX
5720MHz Straddle 5.47-5.725GHz_TX

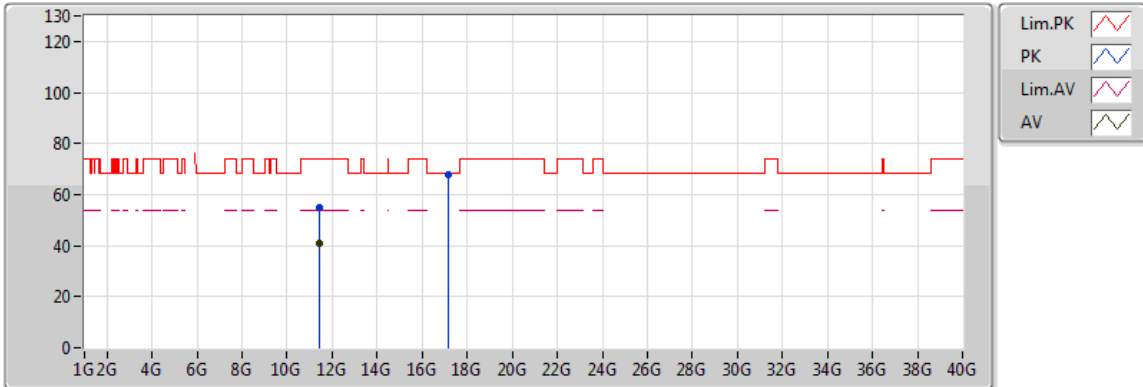

20170831
 EUT_Z_2TX
 Setting 23
 02-J-6
 FSU

Type	Freq(Hz)	Level(dBuV/m)	Limit(dBuV/m)	Margin(dB)	Factor(dB)	Dist(m)	Pol.(H/V)	Azimuth(°)	Height(m)	Comments
AV	11.44872G	41.10	54.00	-12.90	16.32	3	V	8	2.19	-
PK	11.4422G	55.09	74.00	-18.91	16.31	3	V	8	2.19	-
PK	17.1744G	67.89	68.20	-0.31	21.92	3	V	98	1.03	-

802.11ac VHT20_Nss1,(MCS0)_2TX
5720MHz Straddle 5.47-5.725GHz_TX

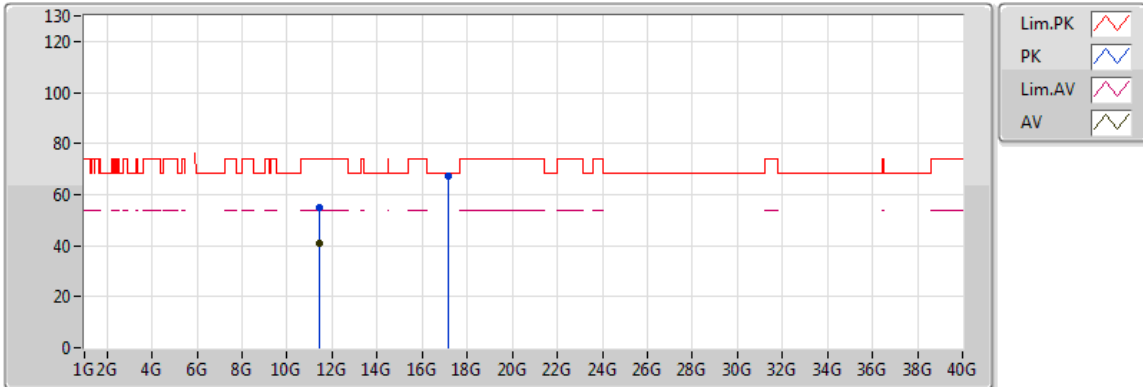

20170831
 EUT_Z_2TX
 Setting 23
 02-J-6
 FSU

Type	Freq(Hz)	Level(dBuV/m)	Limit(dBuV/m)	Margin(dB)	Factor(dB)	Dist(m)	Pol.(H/V)	Azimuth(°)	Height(m)	Comments
AV	11.441G	41.11	54.00	-12.89	16.31	3	H	142	2.10	-
PK	11.43368G	54.65	74.00	-19.35	16.30	3	H	142	2.10	-
PK	17.1675G	66.97	68.20	-1.23	21.88	3	H	284	2.05	-

802.11ac VHT40_Nss1,(MCS0)_2TX

5270MHz_TX

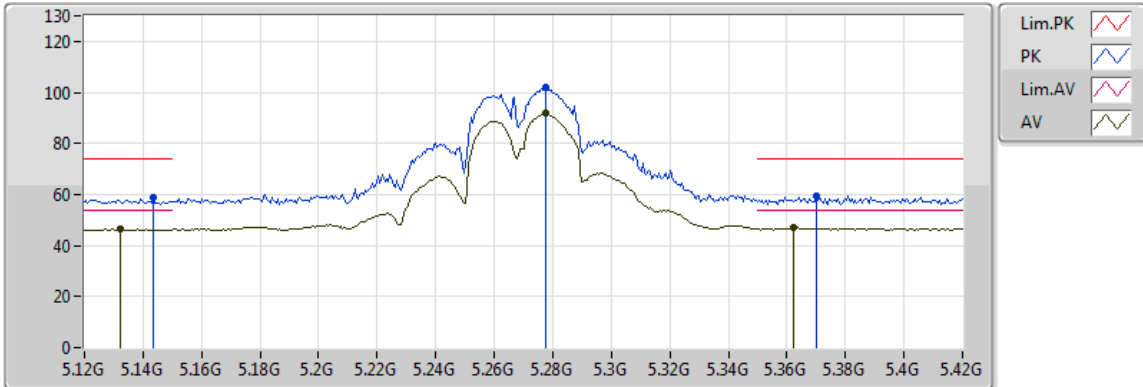

20170831
EUT_Z_2TX
Setting 20.5
02-J-6-10
FSU

Type	Freq(Hz)	Level(dBuV/m)	Limit(dBuV/m)	Margin(dB)	Factor(dB)	Dist(m)	Pol.(H/V)	Azimuth(°)	Height(m)	Comments
AV	5.132G	46.53	54.00	-7.47	8.99	3	V	191	2.54	-
AV	5.2778G	91.87	Inf	-Inf	9.31	3	V	191	2.54	-
AV	5.3624G	46.95	54.00	-7.05	9.46	3	V	191	2.54	-
PK	5.1434G	59.04	74.00	-14.96	9.02	3	V	191	2.54	-
PK	5.2778G	101.84	Inf	-Inf	9.31	3	V	191	2.54	-
PK	5.3702G	59.33	74.00	-14.67	9.47	3	V	191	2.54	-

802.11ac VHT40_Nss1,(MCS0)_2TX

5270MHz_TX

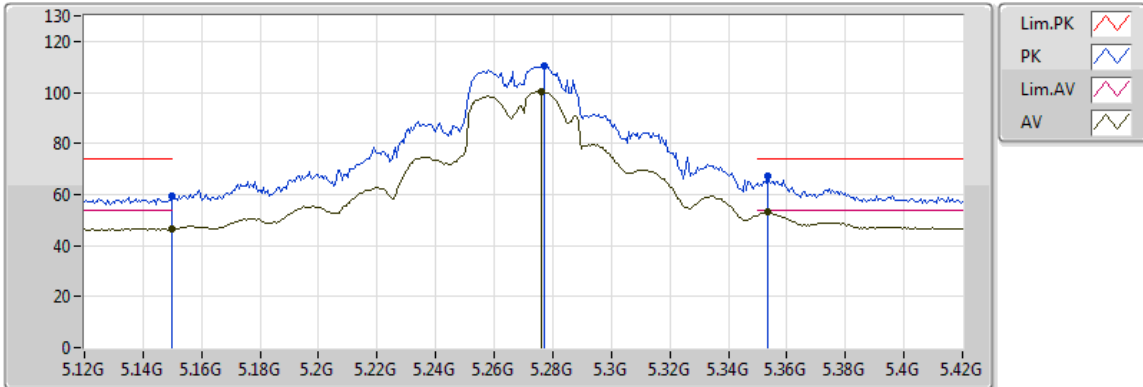

20170831
EUT_Z_2TX
Setting 20.5
02-J-6-10
FSU

Type	Freq(Hz)	Level(dBuV/m)	Limit(dBuV/m)	Margin(dB)	Factor(dB)	Dist(m)	Pol.(H/V)	Azimuth(°)	Height(m)	Comments
AV	5.149995G	46.65	54.00	-7.35	9.03	3	H	77	1.42	-
AV	5.276G	100.55	Inf	-Inf	9.30	3	H	77	1.42	-
AV	5.3534G	53.43	54.00	-0.57	9.44	3	H	77	1.42	-
PK	5.149995G	59.31	74.00	-14.69	9.03	3	H	77	1.42	-
PK	5.2772G	110.44	Inf	-Inf	9.31	3	H	77	1.42	-
PK	5.3534G	67.11	74.00	-6.89	9.44	3	H	77	1.42	-



802.11ac VHT40_Nss1,(MCS0)_2TX

5270MHz_TX

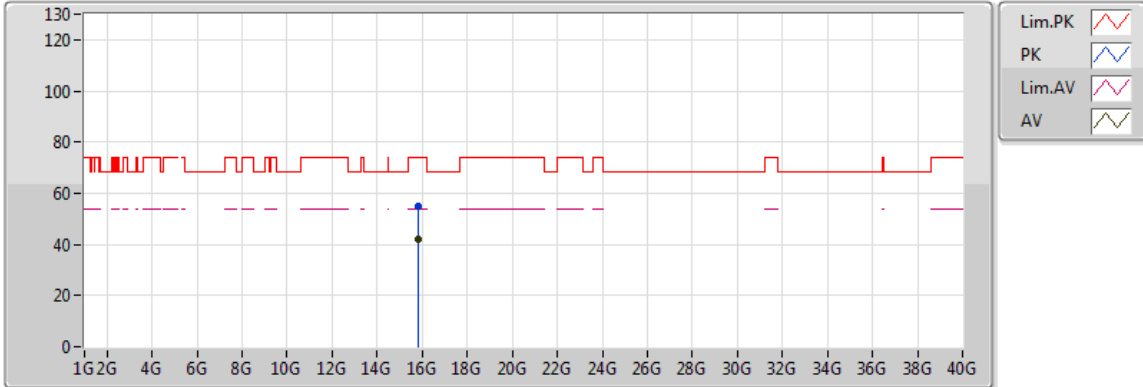

20170831
 EUT_Z_2TX
 Setting 20.5
 02-J-6
 FSU

Type	Freq(Hz)	Level(dBuV/m)	Limit(dBuV/m)	Margin(dB)	Factor(dB)	Dist(m)	Pol.(H/V)	Azimuth(°)	Height(m)	Comments
AV	15.80272G	41.86	54.00	-12.14	17.46	3	V	142	1.11	-
PK	15.8122G	55.16	74.00	-18.84	17.44	3	V	142	1.11	-



802.11ac VHT40_Nss1,(MCS0)_2TX

5270MHz_TX

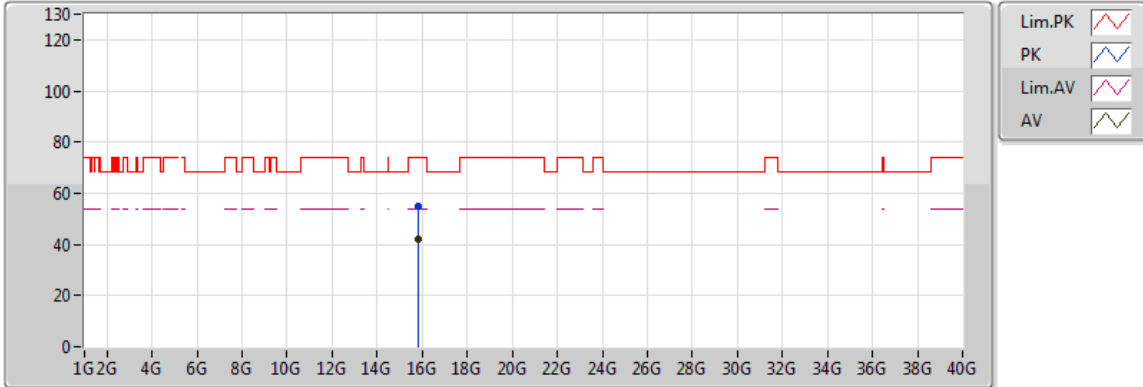

20170831
EUT_Z_2TX
Setting 20.5
02-J-6
FSU

Type	Freq(Hz)	Level(dBuV/m)	Limit(dBuV/m)	Margin(dB)	Factor(dB)	Dist(m)	Pol.(H/V)	Azimuth(°)	Height(m)	Comments
AV	15.8116G	41.90	54.00	-12.10	17.44	3	H	241	2.24	-
PK	15.81152G	54.82	74.00	-19.18	17.44	3	H	241	2.24	-



802.11ac VHT40_Nss1,(MCS0)_2TX

5310MHz_TX

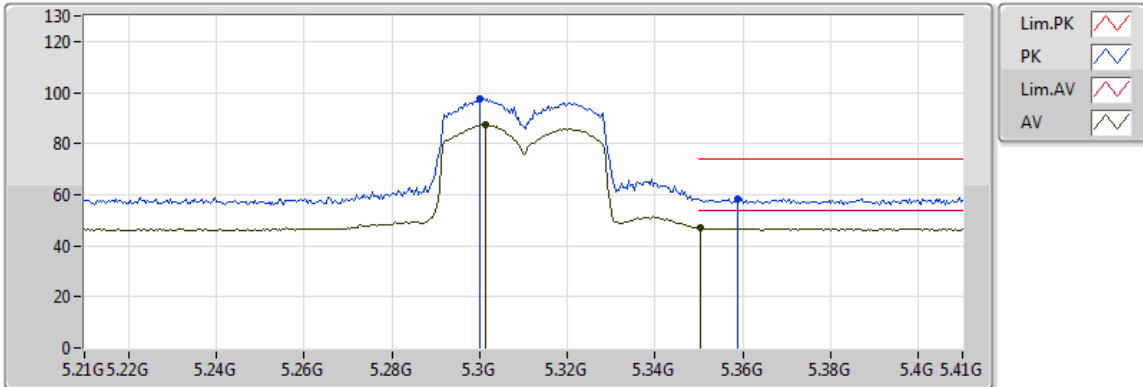

20170831
EUT_Z_2TX
Setting 15.5
02-J-6-10
FSU

Type	Freq(Hz)	Level(dBuV/m)	Limit(dBuV/m)	Margin(dB)	Factor(dB)	Dist(m)	Pol.(H/V)	Azimuth(°)	Height(m)	Comments
AV	5.3012G	87.58	Inf	-Inf	9.35	3	V	18	2.68	-
AV	5.3504G	47.06	54.00	-6.94	9.44	3	V	18	2.68	-
PK	5.3G	97.68	Inf	-Inf	9.35	3	V	18	2.68	-
PK	5.3588G	58.38	74.00	-15.62	9.45	3	V	18	2.68	-

802.11ac VHT40_Nss1,(MCS0)_2TX

5310MHz_TX

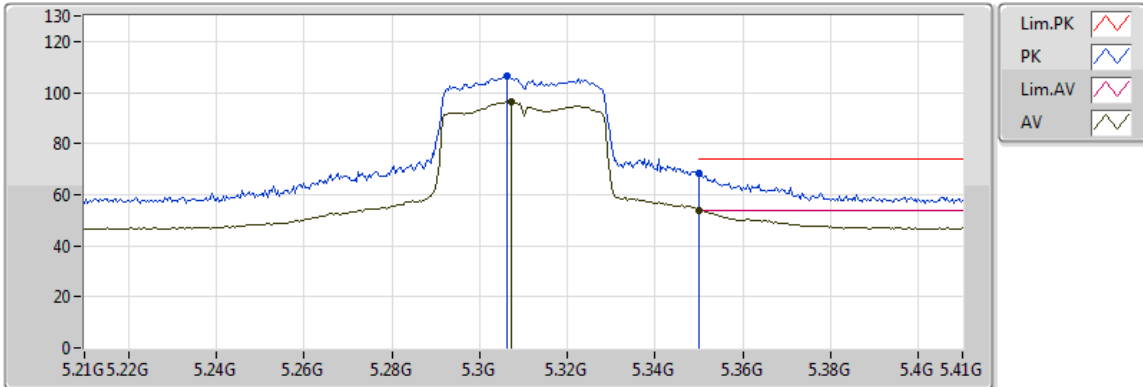

20170831
 EUT_Z_2TX
 Setting 15.5
 02-J-6-10
 FSU

Type	Freq(Hz)	Level(dBuV/m)	Limit(dBuV/m)	Margin(dB)	Factor(dB)	Dist(m)	Pol.(H/V)	Azimuth(°)	Height(m)	Comments
AV	5.3072G	96.57	Inf	-Inf	9.36	3	H	112	1.16	-
AV	5.350005G	53.96	54.00	-0.04	9.44	3	H	112	1.16	-
PK	5.3064G	106.70	Inf	-Inf	9.36	3	H	112	1.16	-
PK	5.350005G	68.40	74.00	-5.60	9.44	3	H	112	1.16	-



802.11ac VHT40_Nss1,(MCS0)_2TX

5310MHz_TX

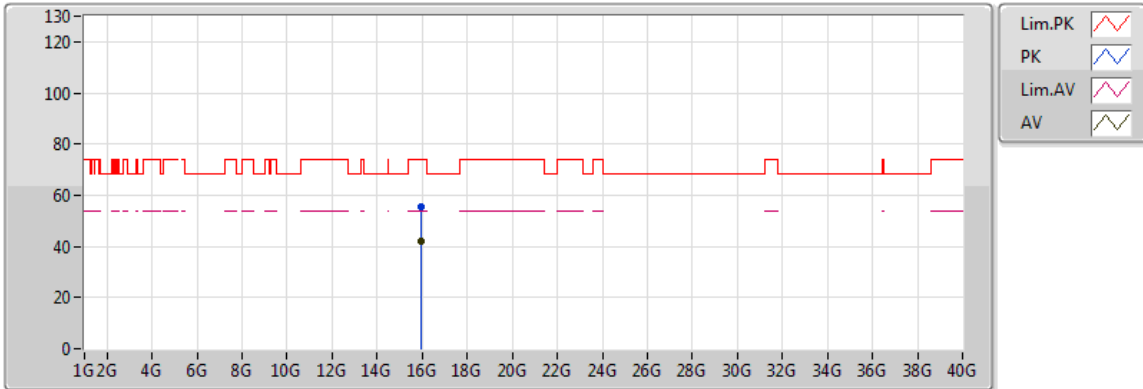

20170831
 EUT_Z_2TX
 Setting 15.5
 02-J-6
 FSU

Type	Freq(Hz)	Level(dBuV/m)	Limit(dBuV/m)	Margin(dB)	Factor(dB)	Dist(m)	Pol.(H/V)	Azimuth(°)	Height(m)	Comments
AV	15.9298G	42.01	54.00	-11.99	17.18	3	V	173	2.25	-
PK	15.93928G	55.30	74.00	-18.70	17.16	3	V	173	2.25	-



802.11ac VHT40_Nss1,(MCS0)_2TX

5310MHz_TX

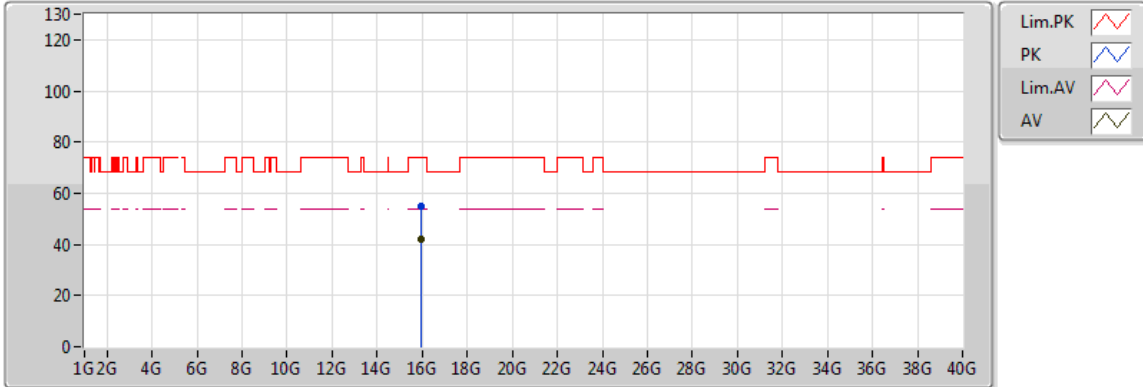

20170831
EUT_Z_2TX
Setting 15.5
02-J-6
FSU

Type	Freq(Hz)	Level(dBuV/m)	Limit(dBuV/m)	Margin(dB)	Factor(dB)	Dist(m)	Pol.(H/V)	Azimuth(°)	Height(m)	Comments
AV	15.92608G	42.12	54.00	-11.88	17.19	3	H	200	1.60	-
PK	15.93452G	54.97	74.00	-19.03	17.17	3	H	200	1.60	-