

Meraki MR74

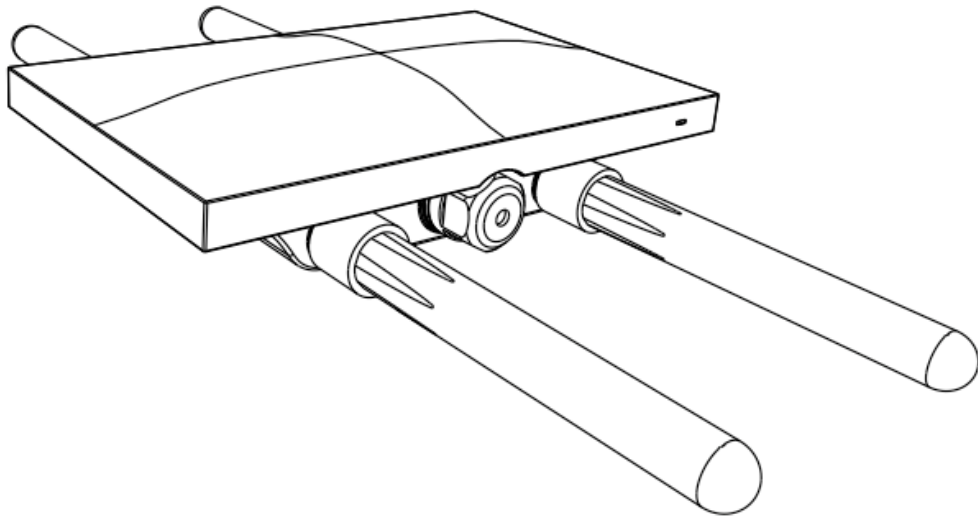

Hardware Installation Guide

Trademarks

Cisco, Cisco Meraki, Meraki, Meraki MR74, and Meraki Cloud Controller

are trademarks of Cisco Systems, Inc. Other brand and product names are registered trademarks or trademarks of their respective holders.

Warranty

Cisco Systems, Inc. provides a one year warranty on this product. Warranty details may be found at www.meraki.cisco.com/support.

Table of Contents

- . 1 Scope of Document and Related Publications
- . 2 MR74 Overview
- . 3 Pre-Install Preparation
- . 4 Installation Instructions
- . 5 Troubleshooting
- . 6 Regulatory

1 Scope of Document and Related Publications

The MR74 Hardware Installation Guide describes the installation procedure for the MR74 access point.

Additional reference documents are available online at

meraki.cisco.com/support

2 MR74 Overview

The Meraki MR74 is an enterprise-class, 802.11abgn/ac AP outdoor designed for rugged environments. When connected to the Meraki Cloud Controller, the MR74 enables the creation of high-speed and reliable networks that cover large outdoor and industrial areas quickly, easily, and cost-effectively.

The Meraki MR74 has an operating temperature of -40° to 60° C.

2.1 Package Contents

The MR74 package contains the following:

- MR74 access point
- Wall screws & anchors
- Mounting plate
- Cable gland
- Mounting straps

2.2 Antennas and Ports

The Meraki MR74 has two radios. Each radio has two external antenna connectors; both connectors for a particular radio should be attached to the same type of antenna. The 5 GHz radio is used for mesh or client communication. The 2.4 GHz radio is primarily used for client communication. However, it can also communicate with Meraki 2.4 GHz access points.

Meraki offers a number of different antennas for use with the MR74: MA-ANT-20, MA-ANT-21, MA-ANT-23, MA-ANT-25, MA-ANT-27, and Cisco AIR-ANT2513P4M-N.

The Meraki MA-ANT-20 omni-directional antennas must be installed vertically.

The Meraki MA-ANT-21, MA-ANT-23, MA-ANT-25, MA-ANT-27, and Cisco AIR-ANT2513P4M-N antennas must be installed facing downward, at least 30 degrees from the horizon line.

2.3 Power Source Options

The MR74 access point can be powered using either an 802.3af capable PoE switch or the Meraki 802.3af PoE injector (sold separately).

2.4 LED Indicators and Run Dark Mode

Your MR74 uses a single LED to inform the user of the device's status.

Function	LED Status	Meaning
Power Up/ Boot	Solid Orange	Power is applied
Connecting	Rainbow	Device in process of connecting to the Meraki Dashboard
Connected	Solid White	Fully operational
Upgrading	Flashing White	During boot or no WAN link

The MR74 may be operated in “Run Dark” mode for additional security and to reduce the visibility of the access point. In this mode, the LED will not be illuminated. This mode may be enabled through Meraki Dashboard.

3 Pre-Install Preparation

You should complete the following steps before going on-site to perform an installation.

3.1 Configure Your Network in Dashboard

Meraki recommends that you add your MR74 to a network in Dashboard before mounting it in the field. The following is a brief overview only of the steps required to add an MR74 to your network. For detailed instructions about creating, configuring and managing Meraki wireless networks, refer to the Meraki Cloud Controller Manual (cisco.meraki.com/support/#documentation).

1. Login to <http://dashboard.meraki.com>. If this is your first time, create a new account.
2. Find the network to which you plan to add your nodes or create a new network.
3. Add your nodes to your network. You will need your Meraki order number (found on your invoice if you ordered directly from Meraki) or the serial number of each node, which looks like Qxxx-xxxx-xxxx, and is found on the bottom of the unit.
4. Finally, go to the map / floor plan view and place each node on the map by clicking and dragging it to the location where you plan to mount it. You can always modify the location later.

3.2 Check and Upgrade Firmware

To ensure your MR74 performs optimally immediately following installation, Meraki recommends that you facilitate a firmware upgrade prior to mounting your MR74.

1. Attach your MR74 to power and a wired Internet connection.
2. The MR74 will turn on and the LED will glow solid orange. If the unit does not require a firmware upgrade, the LED will turn solid white

within 30 seconds.

* If the unit requires an upgrade, the LED will cycle rainbow until the upgrade is complete, at which point the Power LED will turn solid white. You should allow about an hour for the firmware upgrade to complete, depending on the speed of your internet connection.

3.3 Check and Configure Firewall Settings

If your network will be located behind a firewall, it must allow outgoing connections on particular ports to particular IP addresses in order for the MR74 to be able to seamlessly communicate with the Cloud Controller. The most current list of outbound ports and IP addresses can be found here: https://documentation.meraki.com/zGeneral_Administration/Other_Topics/Firewall_Rules_for_Cloud_Connectivity

3.4 Assigning IP Addresses to MR74s

All gateway MR74s (MR74s with Ethernet connections to the LAN) must be assigned routable IP addresses. These IP addresses can be dynamically assigned via DHCP or statically assigned.

3.4.1 Dynamic Assignment

When using DHCP, the DHCP server should be configured to assign a static IP address for each MAC address belonging to a Meraki AP. Other features of the wireless network, such as 802.1X authentication, may rely on the property that the APs have static IP addresses.

3.4.2 Static Assignment

Static IPs are assigned using the local web server on each AP. The following procedure describes how to set the static IP:

1. Using a client machine (e.g., a laptop), connect to the AP either wirelessly (by associating to any SSID broadcast by the AP) or over a wired connection. If using a wired connection, connect the client machine to the MR74 either through a PoE switch or a Meraki PoE Injector. If using a PoE switch, plug an Ethernet cable into the MR74's Ethernet jack, and the other end into a PoE switch. Then connect the client machine over Ethernet cable to the PoE switch. If

- using a Meraki PoE Injector, connect the MR74 to the “PoE” port of the Injector, and the client machine to the “LAN” port.
2. Using a web browser on the client machine, access the AP’s built-in web server by browsing to <http://ap.meraki.com>. Alternatively, browse to <http://10.128.128.128>.
 3. Click on the “Static IP Configuration” tab. Log in. The default user name is the AP’s serial number, with hyphens included (e.g., Q2BD-551C-ZYW3), and the default password is blank.
 4. Configure the static IP address, net mask, gateway IP address and DNS servers that this AP will use on its wired connection.
 5. If necessary, reconnect the AP to the LAN.

3.5 Collect Tools

You will need the following tools to perform an installation:

- Flat-head screwdriver
- Drill with appropriate bits for mounting wall anchors (if mounting to a wall)
- Phillips screwdriver
- Tin snips (if mounting with hose clamps)
- Power screwdriver with 5/16” (8 mm) nut driver, Phillips & flat heads (recommended)

3.6 Collect Additional Hardware for Installation

- Network cables with RJ45 connectors long enough for your particular mounting location
- 802.3af PoE power source (either PoE switch or Meraki 802.3af PoE Injector)

- Connection to the internet (if you are setting up your MR74 as a gateway to the internet)
- Appropriately sized metal straps (if mounting to a pole larger than 3.9” in diameter)
- Specialized mounting hardware if mounting to surface other than wood, stucco or stone
- Laptop with wireless to verify setup (recommended)

4 Installation Instructions

4.1 Choose Your Mounting Location

A good mounting location is important to getting the best performance out of your MR74 access point. Keep the following in mind:

1. The device should have unobstructed line of sight to most coverage areas. For example, if installing in an office filled with workspaces divided by mid-height cubicle walls, installing on the ceiling or high on a wall would be ideal.
2. Power over Ethernet supports a maximum cable length of 300 ft (100 m).
3. If being used in a mesh deployment, the MR74 should have line of sight to at least two other Meraki devices. For more detailed instructions regarding access point location selection, reference the Meraki Network Design Guide (cisco.meraki.com/support/#documentation).
4. The antennas should be as unobstructed as possible. Make sure that there is clearance around the MR74 for installation of all of your chosen antennas.

Safety note on mounting locations:

It is recommended that the MR74 be mounted to at a minimum, a 13 mm thick plywood/concrete wall or ceiling using the mount plate with 6.35 mm in diameter of screws for physical security reasons.

4.2 Install the MR74

For most mounting scenarios, the MR74 mount plate provides a quick, simple, and flexible means of mounting your device. The installation should be done in two steps. First, install the mount plate to your selected location. Then attach the MR74 to the mount plate.

4.2.1 Remove the Mount Plate from the Access Point

Before installing the mount plate, you must remove it from the back of the access point.

1. Unscrew the mount plate attachment screw.
2. Lift the mount plate release tab upwards.
3. While holding the mount plate release tab up, slide the mount plate off the access point.

4.2.2 Attach the Mount Plate

The MR74 mount plate can be used to install your access point in a wide range of scenarios.

4.2.2.1 Wall or Solid Ceiling Mount Using Mount Plate

Using included wall anchors and screws, attach the mount plate to your mounting wall or ceiling.

It is recommended that the MR74 be mounted to a wall or solid ceiling using the mount plate for physical security reasons.

4.2.2.2 Pole Mount Using Mount Plate

Use the included mounting straps to mount the AP to a pole less than 3.9” in diameter. Thread the mounting straps through the mounting strap slots to secure the mount plate in a horizontal or vertical orientation.

4.2.3 Mount the MR74

Insert the posts on the mount plate into the attachment slots on the access point.

4.2.3.1 Attach Antennas

Remove protective plastic covers from all four N-type RF connectors. Attach appropriate antennas (and protective boots if included).

4.2.3.2 Aim Antennas

If you are using directional antennas, aim them appropriately to ensure optimal performance for your specific network topography. Omnidirectional antennas perform best in a mesh network when oriented vertically.

4.2.3.3 Powering the MR74 with the Meraki 802.3at Power over Ethernet Injector (sold separately)

1. Plug the power cord into the PoE Injector and the other end into wall power.
2. Plug an Ethernet cable that is connected to an active Ethernet connection into the “IN” port on the injector.
3. Route Ethernet cable from the “OUT” port on the injector to the Ethernet port in the bay of the MR74.

For more details, see Meraki 802.3at Power Over Ethernet Injector datasheet.

4.2.3.4 Powering the MR74 with an 802.3at Power over Ethernet Switch

Route Ethernet cable from a port on an active 802.3at PoE switch to the Ethernet port in the bay of the MR74.

The MR74 is Gigabit Ethernet-capable. To maximize device performance, a Gigabit Ethernet-capable switch should be used.

4.2.3.5 Attach Power over Ethernet to the MR74

1. Remove the dust cover from the Ethernet port of the MR74. Unscrew it with a coin or flathead screwdriver.
2. Route the Ethernet cable from the PoE Injector “OUT” port to the MR74.
3. Install a cable gland on the MR74 end of the cable.
4. Plug the Ethernet cable into the Ethernet port of the Meraki MR74.
 - a. Connect the cable to the Ethernet port on the MR74.

b. Screw the gland body into the threaded hole of the port. Use an adjustable wrench to make sure the gland body is fully seated in the hole.

c. Insert the split ring gasket into the gland body.

d. Screw the cap tightly onto the gland. You may need a wrench to fully tighten the cap, but take care not to damage the cable in the process.

Optional: Make the MR74 a gateway

1. Connect an active internet connection to the “IN” port of the PoE injector.

4.2.3.6 Attach Grounding Strap

Connect one end of grounding strap to grounding post with included screw and washer. Securely attach the other end nearby metal structure.

Note on Outdoor Locations:

The equipment contains no operator access areas and is certified only for installation, by trained personnel only.

The suitability of the mounting surface to hold the weight of the equipment shall be evaluated in the installation instructions.

The equipment is intended for use in dry locations.

To protect the equipment in an outdoor location:

a. Ensure the conductive part of the equipment is connected to protective earth to carry potential fault currents. This equipment is designed to permit the connection of an 18AWG additional Green/Yellow earthed conductor to earthing stud of a metal wall mount bracket of the equipment.

b. The equipment enclosure is IP67 rated

4.4 Verify Device Functionality and Test Network Coverage

1. Check LEDs The Radio Power LED should be solid white. If it is cycling rainbow, the firmware is automatically upgrading and the LED should turn white when the upgrade is completed (normally in under thirty minutes).

2. **Note:** Your MR74 must have an active route to the Internet to check and upgrade its firmware.
3. **Verify access point connectivity** Use any 802.11 client device to connect to the MR74 and verify proper connectivity using the client's web browser.
4. **Check network coverage** Confirm that you have good signal strength throughout your coverage area. You can use the signal strength meter on a laptop, smart phone, or other wireless device.

5 Troubleshooting

Reference the Meraki knowledge base at <http://meraki.com/support/#kb> for additional information and troubleshooting tips.

6 Regulatory

Professional installation instruction

1. Installation personnel

This product is designed for specific application and needs to be installed by a qualified personal who has RF and related rule knowledge. The general user shall not attempt to install or change the setting.

2. Professional Installation Requirements

The following requirements for installation and operation of outdoor systems must be addressed:

Operation in the 5600-5650-MHz band is not authorized for 5-GHz WLAN systems, whether operating indoors or outdoors. This does not pose a problem for Cisco® WLAN since this band is not accessible for Cisco products.

Use of indoor-only equipment outdoors can lead to FCC enforcement action, such as fines or requirements to disable the system. This includes installations where the access point is placed indoors and the antenna is placed outdoors, as well as installations involving retractable roofs (for example, football stadiums).

For **WLAN systems being installed outdoors**, the following requirements must be met.

- a) Systems must be **professionally installed** by a qualified engineer familiar with WLAN, including Cisco trained partners and resellers.
- b) Operation in the 5600-5650-MHz band is prohibited.
- c) It is recommended that the installer register the installation of their system in the Wireless Internet Service Providers Association (WISPA database). This is especially important for systems that are installed within 35 km of the FAA TDWR.

(Please see the links later in this document to WISPA database with TDWR locations.)

d) When within 35 km distance of a TDWR, the center frequency of the WLAN must be separated from the TDWR center frequency by 30 MHz.

a. If the radar is operating from 5600-5610 MHz, disable the use of channel 116 (5580 MHz).

b. If the radar is operating from 5630-5650 MHz, disable the use of channel 132 (5660 MHz).

Note: Cisco will be disabling channels 116 and 132 for outdoor systems in the future, the instructions in (d) only applies to systems that currently have the channels enabled.







e) Additional mitigation techniques can include first, not orienting the antennas in the main beam of the weather radar, and second, ensuring that the antenna is not positioned in line-of-sight of the FAA TDWR.

f) Verify that the antennas used are approved for use with Cisco WLAN systems. Installers or operators using non-approved antennas or making any unauthorized changes may be subject to enforcement action.

g) Operation in the 5150-5250MHz is restricted to indoor use only.

Installers and operators shall consult the Wireless Internet Service Providers Association (WISPA) database to determine if they are within 35 km of the Terminal Doppler Weather Radar (TDWR), as well as to register the system if operating within this range of the TDWR.

For outdoor operation of the AP in the 5150-5250 MHz band, the maximum output power shall not exceed 1W. EIRP at any elevation angle above 30 degrees (as measured from the horizon) shall not exceed 125mW, per the FCC Part 15.407 rules. The highest antenna gains from the horizon above 30 degrees are as below:

Radio	Ant. No.	Antenna Gain (dBi)	Antenna Install Degree
2	20	-1	
	21	11.2	
	25	1.8	
	27	9.7	
	AIR-ANT2513P4M-N	0.77	
3	-	5.20	

3. Installation location

The product shall be installed at a location where the radiating antenna can be kept 36cm from nearby person in normal operation condition to meet regulatory RF exposure requirement.

4. External antenna

Use only the antennas which have been approved by the applicant. The non-approved antenna(s) may produce unwanted spurious or excessive RF transmitting power which may lead to the violation of FCC limit and is prohibited.

5. Installation procedure

Please refer to user's manual for the detail.

6. Warning

Please carefully select the installation position and make sure that the final output power does not exceed the limit set force in relevant rules. The violation of the rule could lead to serious federal penalty.

Instructions d'installation professionnelle

1. Installation

Ce produit est destine a un usage specifique et doit etre installe par un personnel qualifie maitrisant les radiofrequences et les regles s'y rapportant. L'installation et les reglages ne doivent pas etre modifies par l'utilisateur final.

2. Emplacement d'installation

En usage normal, afin de respecter les exigences reglementaires concernant l'exposition aux radiofrequences, ce produit doit etre installe de facon a respecter une distance de 36 cm entre l'antenne emettrice et les personnes.

3. Antenn externe.

Utiliser uniiquement les antennes approuvees par le fabricant. L'utilisation d'autres antennes peut conduire a un niveau de rayonnement essentiel ou non essentiel depassant les niveaux limites definis par FCC, ce qui est interdit.

4. Procedure d'installation

Consulter le manuel d'utilisation.

5. Avertissement

Choisir avec soin la position d'installation et s'assurer que la puissance de sortie ne depasse pas les limites en vigueur. La violation de cette regle peut conduire a de serieuses penalites federales.

FCC Compliance Statement

This device complies with part 15 of the FCC rules. Operation is subject to the following two conditions: (1) This device may not cause harmful interference, and (2) this device must accept any interference received, including interference that may cause undesired operation.

FCC Interference Statement

This equipment has been tested and found to comply with the limits for a Class B digital device, pursuant to part 15 of the FCC Rules. These limits are designed to provide reasonable protection against harmful interference in a residential installation. This equipment generates, uses and can radiate radio frequency energy and, if not installed and used in accordance with the instructions, may cause harmful interference to radio communications. However, there is no guarantee that interference will not occur in a particular installation. If this equipment does cause harmful interference to radio or television reception, which can be determined by turning the equipment off and on, the user is encouraged to correct the interference by one of the following measures:

- Reorient or relocate the receiving antenna.
- Increase the separation between the equipment and receiver.
- Connect the equipment into an outlet on a circuit different from which the receiver is connected.
- Consult the dealer or an experienced radio/TV technician for help.

FCC Caution

Any changes or modifications not expressly approved by Meraki could void the user's authority to operate this equipment. This Transmitter must not be co-located or operation in conjunction with any other antenna or transmitter.

FCC Radiation Exposure Statement

This equipment complies with FCC radiation exposure limits set forth for an uncontrolled environment. This equipment should be installed and operated with minimum distance 36 cm between the radiator and your body. This transmitter must not be co-located or operating in conjunction with any other antenna or transmitter.

IEEE 802.11b or 802.11g operation of this product in the USA is firmware-

limited to channels 1 through 11.

If the device is going to be operated in the 5.15 - 5.25 frequency range, then it is restricted to indoor environment only. This device meets all other requirements specified in Part 15E, Section 15.407 of the FCC Rules.

Professional installation instruction

1. Installation personal

This product is designed for specific applications and needs to be installed by qualified personnel who have appropriate RF and related regulation knowledge. The general user shall not attempt to install or change the setting.

2. Installation location

The product shall be installed at a location where the radiating antenna can be kept at least 43cm away from nearby persons while in normal operating conditions to meet regulatory RF exposure requirements

3. External antennas

Use only the antennas that have been approved by the applicant. Unapproved antenna(s) may produce unwanted spurious or excessive RF transmitting power that may lead to violation of IC limits and is prohibited.

4. Installation procedure

Please follow details listed in the appropriate install guides and user manuals.

5. Warning

Select an installation position that ensures that the final output power does not exceed the limit set forth in the relevant rules. Violation of this rule could lead to serious federal penalty

Instructions d'installation professionnelle

1. Installation

Ce produit est destiné à un usage spécifique et doit être installé par un personnel qualifié maîtrisant les radiofréquences et les règles s'y rapportant. L'installation et les réglages ne doivent pas être modifiés par l'utilisateur final.

2. Emplacement d'installation

En usage normal, afin de respecter les exigences réglementaires concernant l'exposition aux radiofréquences, ce produit doit être installé de façon à respecter une distance de 43 cm entre l'antenne émettrice et les personnes.

3. Antenne externe.

Utiliser uniquement les antennes approuvées par le fabricant. L'utilisation d'autres antennes peut conduire à un niveau de rayonnement essentiel ou non essentiel dépassant les niveaux limites définis par IC, ce qui est interdit.

4. Procédure d'installation

Consulter le manuel d'utilisation.

5. Avertissement

Choisir avec soin la position d'installation et s'assurer que la puissance de sortie ne dépasse pas les limites en vigueur. La violation de cette règle peut conduire à de sérieuses pénalités fédérales.

Industry Canada Statement

This device complies with RSS-247 of the Industry Canada Rules. Operation is subject to the following two conditions: (1) This device may not cause harmful interference, and (2) this device must accept any interference received, including interference that may cause undesired operation. (3) this device subject to this section shall not be capable of transmitting in the band 5600-5650 MHz. This restriction is for the protection of Environment Canada's weather radars operating in this band.

Ce dispositif est conforme à la norme CNR-247 d'Industrie Canada applicable aux appareils radio exempts de licence. Son fonctionnement est sujet aux deux conditions suivantes: (1) le dispositif ne doit pas produire de brouillage préjudiciable, et (2) ce dispositif doit accepter tout brouillage reçu, y compris un brouillage susceptible de provoquer un fonctionnement indésirable. (3) Ce dispositif soumis au présent article ne doit pas pouvoir émettre dans la bande 5600-5650 MHz. Cette restriction vise la protection des radars météorologiques d'Environnement Canada qui fonctionnent dans cette bande.

Industry Canada Caution

(i) the device for operation in the band 5150-5250 MHz is only for indoor use to reduce the potential for harmful interference to co-channel mobile satellite systems;

(ii) high-power radars are allocated as primary users (i.e. priority users) of the bands 5250-5350 MHz and 5650-5850 MHz and that these radars could cause interference and/or damage to LE-LAN devices.

Avertissement:

(i) les dispositifs fonctionnant dans la bande 5 150-5 250 MHz sont réservés uniquement pour une utilisation à l'intérieur afin de réduire les risques de brouillage préjudiciable aux systèmes de satellites mobiles utilisant les mêmes canaux;

(ii) De plus, les utilisateurs devraient aussi être avisés que les utilisateurs de radars de haute puissance sont désignés utilisateurs principaux (c.-à-d., qu'ils ont la priorité) pour les bandes 5 250-5 350 MHz et 5 650-5 850 MHz et que ces

radars pourraient causer du brouillage et/ou des dommages aux dispositifs LAN-EL.

Industry Canada Radiation Exposure Statement

This equipment complies with IC radiation exposure limits set forth for an uncontrolled environment. This equipment should be installed and operated with minimum distance 43cm between the radiator & your body.

Déclaration d'exposition aux radiations

Cet équipement est conforme aux limites d'exposition aux rayonnements IC établies pour un environnement non contrôlé. Cet équipement doit être

installé et utilisé avec un minimum de 43 cm de distance entre la source de rayonnement et votre corps.

低功率電波輻射性電機管理辦法

第十二條 經型式認證合格之低功率射頻電機，非經許可，公司、商號或使用者均不得擅自變更頻率、加大功率或變更原設計之特性及功能。

第十四條 低功率射頻電機之使用不得影響飛航安全及干擾合法通信；經發現有干擾現象時，應立即停用，並改善至無干擾時方得繼續使用。前項合法通信，指依電信法規定作業之無線電通信。低功率射頻電機須忍受合法通信或工業、科學及醫療用電波輻射性電機設備之干擾。

電磁波曝露量MPE標準值 $1\text{mW}/\text{cm}^2$ ，本產品使用時建議應距離人體 36 cm。

[警語內容]

1. 使用此產品時應避免影響附近雷達系統之操作。
2. 高增益指向性天線不得應用於固定式點對點系統。