

FCC Test Report

Report No.: RF170314C06-1

FCC ID: UDX-60053010

Model: Z3-HW

Received Date: Mar. 14, 2017

Test Date: Apr. 13 ~ Apr. 20, 2017

Issued Date: May 03, 2017

Applicant: Cisco Systems, Inc.

Address: 170 West Tasman Drive, San Jose, CA 95134

Issued By: Bureau Veritas Consumer Products Services (H.K.) Ltd., Taoyuan Branch

Lab Address: No. 47-2, 14th Ling, Chia Pau Vil., Lin Kou Dist., New Taipei City, Taiwan, R.O.C.

Test Location: No.19, Hwa Ya 2nd Rd., Wen Hwa Vil., Kwei Shan Dist., Taoyuan City 33383, TAIWAN (R.O.C.)



This report is for your exclusive use. Any copying or replication of this report to or for any other person or entity, or use of our name or trademark, is permitted only with our prior written permission. This report sets forth our findings solely with respect to the test samples identified herein. The results set forth in this report are not indicative or representative of the quality or characteristics of the lot from which a test sample was taken or any similar or identical product unless specifically and expressly noted. Our report includes all of the tests requested by you and the results thereof based upon the information that you provided to us. You have 60 days from date of issuance of this report to notify us of any material error or omission caused by our negligence, provided, however, that such notice shall be in writing and shall specifically address the issue you wish to raise. A failure to raise such issue within the prescribed time shall constitute your unqualified acceptance of the completeness of this report, the tests conducted and the correctness of the report contents. Unless specific mention, the uncertainty of measurement has been explicitly taken into account to declare the compliance or non-compliance to the specification. This report should not be used by the client to claim product certification, approval, or endorsement by TAF or any government agencies.

Table of Contents

Release Control Record	4
1 Certificate of Conformity	5
2 Summary of Test Results	6
2.1 Measurement Uncertainty.....	6
2.2 Modification Record.....	6
3 General Information	7
3.1 General Description of EUT.....	7
3.2 Description of Test Modes.....	8
3.2.1 Test Mode Applicability and Tested Channel Detail.....	9
3.3 Duty Cycle of Test Signal.....	11
3.4 Description of Support Units.....	12
3.4.1 Configuration of System under Test.....	12
3.5 General Description of Applied Standards.....	13
4 Test Types and Results	14
4.1 Radiated Emission and Bandedge Measurement.....	14
4.1.1 Limits of Radiated Emission and Bandedge Measurement.....	14
4.1.2 Test Instruments.....	15
4.1.3 Test Procedures.....	16
4.1.4 Deviation from Test Standard.....	16
4.1.5 Test Set Up.....	17
4.1.6 EUT Operating Conditions.....	18
4.1.7 Test Results.....	19
4.2 Conducted Emission Measurement.....	32
4.2.1 Limits of Conducted Emission Measurement.....	32
4.2.2 Test Instruments.....	32
4.2.3 Test Procedures.....	32
4.2.4 Deviation from Test Standard.....	32
4.2.5 Test Setup.....	33
4.2.6 EUT Operating Conditions.....	33
4.2.7 Test Results.....	34
4.3 6dB Bandwidth Measurement.....	36
4.3.1 Limits of 6dB Bandwidth Measurement.....	36
4.3.2 Test Setup.....	36
4.3.3 Test Instruments.....	36
4.3.4 Test Procedure.....	36
4.3.5 Deviation from Test Standard.....	36
4.3.6 EUT Operating Conditions.....	36
4.3.7 Test Result.....	37
4.4 Conducted Output Power Measurement.....	39
4.4.1 Limits of Conducted Output Power Measurement.....	39
4.4.2 Test Setup.....	39
4.4.3 Test Instruments.....	39
4.4.4 Test Procedures.....	39
4.4.5 Deviation from Test Standard.....	39
4.4.6 EUT Operating Conditions.....	39
4.4.7 Test Results.....	40
4.5 Power Spectral Density Measurement.....	42
4.5.1 Limits of Power Spectral Density Measurement.....	42
4.5.2 Test Setup.....	42
4.5.3 Test Instruments.....	42
4.5.4 Test Procedure.....	42
4.5.5 Deviation from Test Standard.....	43
4.5.6 EUT Operating Condition.....	43

4.5.7 Test Results	44
4.6 Conducted Out of Band Emission Measurement.....	47
4.6.1 Limits of Conducted Out of Band Emission Measurement	47
4.6.2 Test Setup.....	47
4.6.3 Test Instruments	47
4.6.4 Test Procedure	47
4.6.5 Deviation from Test Standard	47
4.6.6 EUT Operating Condition	48
4.6.7 Test Results	48
5 Pictures of Test Arrangements.....	57
Appendix – Information on the Testing Laboratories	58

Release Control Record

Issue No.	Description	Date Issued
RF170314C06-1	Original release.	May 03, 2017

1 Certificate of Conformity

Product: 802.11a/b/g/n/ac Wireless Security Appliance

Brand: Cisco

Model: Z3-HW

Sample Status: Engineering sample

Applicant: Cisco Systems, Inc.

Test Date: Apr. 13 ~ Apr. 20, 2017

Standards: 47 CFR FCC Part 15, Subpart C (Section 15.247)
ANSI C63.10:2013

The above equipment has been tested by **Bureau Veritas Consumer Products Services (H.K.) Ltd., Taoyuan Branch**, and found compliance with the requirement of the above standards. The test record, data evaluation & Equipment Under Test (EUT) configurations represented herein are true and accurate accounts of the measurements of the sample's EMC characteristics under the conditions specified in this report.

Prepared by :  , **Date:** May 03, 2017
Pettie Chen / Senior Specialist

Approved by :  , **Date:** May 03, 2017
Ken Liu / Senior Manager

2 Summary of Test Results

47 CFR FCC Part 15, Subpart C (Section 15.247)			
FCC Clause	Test Item	Result	Remarks
15.207	AC Power Conducted Emission	Pass	Meet the requirement of limit. Minimum passing margin is -15.96dB at 0.40415MHz
15.205 / 15.209 / 15.247(d)	Radiated Emissions and Band Edge Measurement	Pass	Meet the requirement of limit. Minimum passing margin is -1.1dB at 2483.50MHz.
15.247(d)	Antenna Port Emission	Pass	Meet the requirement of limit.
15.247(a)(2)	6dB bandwidth	Pass	Meet the requirement of limit.
15.247(b)	Conducted power	Pass	Meet the requirement of limit.
15.247(e)	Power Spectral Density	Pass	Meet the requirement of limit.
15.203	Antenna Requirement	Pass	Antenna connector is IPEX not a standard connector.

2.1 Measurement Uncertainty

Where relevant, the following measurement uncertainty levels have been estimated for tests performed on the EUT as specified in CISPR 16-4-2:

Measurement	Frequency	Expanded Uncertainty (k=2) (\pm)
Conducted Emissions at mains ports	150kHz ~ 30MHz	2.94 dB
Radiated Emissions up to 1 GHz	30MHz ~ 200MHz	3.59 dB
	200MHz ~ 1000MHz	3.60 dB
Radiated Emissions above 1 GHz	1GHz ~ 18GHz	2.29 dB
	18GHz ~ 40GHz	2.29 dB

2.2 Modification Record

There were no modifications required for compliance.

3 General Information

3.1 General Description of EUT

Product	802.11a/b/g/n/ac Wireless Security Appliance
Brand	Cisco
Model	Z3-HW
Sample Status	Engineering sample
Power Supply Rating	54Vdc (adapter)
Modulation Type	CCK, DQPSK, DBPSK for DSSS 64QAM, 16QAM, QPSK, BPSK for OFDM
Modulation Technology	DSSS, OFDM
Transfer Rate	802.11b: 11.0/ 5.5/ 2.0/ 1.0Mbps 802.11g: 54.0/ 48.0/ 36.0/ 24.0/ 18.0/ 12.0/ 9.0/ 6.0Mbps 802.11n: up to 300Mbps
Operating Frequency	2412 ~ 2462MHz
Number of Channel	11 for 802.11b, 802.11g, 802.11n (HT20) 7 for 802.11n (HT40)
Output Power	CDD Mode : 422.950mW Beamforming Mode: 111.085mW
Antenna Type	Antenna 1: PIFA antenna with 4.54dBi gain Antenna 2: PIFA antenna with 5.71dBi gain
Antenna Connector	IPEX
Accessory Device	Adapter
Data Cable Supplied	NA

Note:

- The EUT incorporates a MIMO function. Physically, the EUT provides 2 completed transmitters and 2 receivers.

Modulation Mode	TX Function	Beamforming
802.11b	2TX	Not Support
802.11g	2TX	Not Support
802.11n (HT20)	2TX	Support
802.11n (HT40)	2TX	Support

* For 2.4GHz band, CDD mode is the worst case for final radiated emission below 1GHz and power line conducted emission tests after pretesting CDD mode and beamforming mode.

- The EUT consumes power from the following adapter.

Adapter	
Brand	Cisco
Model	MA-PWR-50WAC
Input Power	100-240VAC, 50/60Hz, 2A
Output Power	54V, 0.92A
Power Line	1.5m non-shielded DC cable without core 1.7m non-shielded AC cable without core

- WLAN 2.4GHz, 5GHz & BT LE technology can transmit at same time.
- Spurious emission of the simultaneous operation (WLAN 2.4GHz, 5GHz & BT LE) has been evaluated and no non-compliance was found.

3.2 Description of Test Modes

11 channels are provided for 802.11b, 802.11g and 802.11n (HT20):

Channel	Frequency	Channel	Frequency
1	2412MHz	7	2442MHz
2	2417MHz	8	2447MHz
3	2422MHz	9	2452MHz
4	2427MHz	10	2457MHz
5	2432MHz	11	2462MHz
6	2437MHz		

7 channels are provided for 802.11n (HT40):

Channel	Frequency	Channel	Frequency
3	2422MHz	7	2442MHz
4	2427MHz	8	2447MHz
5	2432MHz	9	2452MHz
6	2437MHz		

3.2.1 Test Mode Applicability and Tested Channel Detail

EUT CONFIGURE MODE	APPLICABLE TO				DESCRIPTION
	RE≥1G	RE<1G	PLC	APCM	
-	√	√	√	√	-

Where **RE≥1G**: Radiated Emission above 1GHz & Bandedge Measurement
RE<1G: Radiated Emission below 1GHz
PLC: Power Line Conducted Emission
APCM: Antenna Port Conducted Measurement

Note:

- The EUT had been pre-tested on the positioned of each 3 axis. The worst case was found when positioned on Y-plane.

Radiated Emission Test (Above 1GHz):

- Pre-Scan has been conducted to determine the worst-case mode from all possible combinations between available modulations, data rates and antenna ports (if EUT with antenna diversity architecture).
- Following channel(s) was (were) selected for the final test as listed below.

EUT CONFIGURE MODE	MODE	AVAILABLE CHANNEL	TESTED CHANNEL	MODULATION TECHNOLOGY	MODULATION TYPE	DATA RATE (Mbps)
-	802.11b	1 to 11	1, 6, 11	DSSS	DBPSK	1.0
-	802.11g	1 to 11	1, 6, 11	OFDM	BPSK	6.0
-	802.11n (HT20)	1 to 11	1, 6, 11	OFDM	BPSK	6.5
-	802.11n (HT40)	3 to 9	3, 6, 9	OFDM	BPSK	13.5

Radiated Emission Test (Below 1GHz):

- Pre-Scan has been conducted to determine the worst-case mode from all possible combinations between available modulations, data rates and antenna ports (if EUT with antenna diversity architecture).
- Following channel(s) was (were) selected for the final test as listed below.

EUT CONFIGURE MODE	MODE	AVAILABLE CHANNEL	TESTED CHANNEL	MODULATION TECHNOLOGY	MODULATION TYPE	DATA RATE (Mbps)
-	802.11b	1 to 11	1	DSSS	DBPSK	1.0

Power Line Conducted Emission Test:

- Pre-Scan has been conducted to determine the worst-case mode from all possible combinations between available modulations, data rates and antenna ports (if EUT with antenna diversity architecture).
- Following channel(s) was (were) selected for the final test as listed below.

EUT CONFIGURE MODE	MODE	AVAILABLE CHANNEL	TESTED CHANNEL	MODULATION TECHNOLOGY	MODULATION TYPE	DATA RATE (Mbps)
-	802.11b	1 to 11	1	DSSS	DBPSK	1.0

Antenna Port Conducted Measurement:

- This item includes all test value of each mode, but only includes spectrum plot of worst value of each mode.
- Pre-Scan has been conducted to determine the worst-case mode from all possible combinations between available modulations, data rates and antenna ports (if EUT with antenna diversity architecture).
- Following channel(s) was (were) selected for the final test as listed below.

EUT CONFIGURE MODE	MODE	AVAILABLE CHANNEL	TESTED CHANNEL	MODULATION TECHNOLOGY	MODULATION TYPE	DATA RATE (Mbps)
-	802.11b	1 to 11	1, 6, 11	DSSS	DBPSK	1.0
-	802.11g	1 to 11	1, 6, 11	OFDM	BPSK	6.0
-	802.11n (HT20)	1 to 11	1, 6, 11	OFDM	BPSK	6.5
-	802.11n (HT40)	3 to 9	3, 6, 9	OFDM	BPSK	13.5

Test Condition:

APPLICABLE TO	ENVIRONMENTAL CONDITIONS	INPUT POWER	TESTED BY
RE \geq 1G	23deg. C, 71%RH	120Vac, 60Hz	James Yang
RE<1G	23deg. C, 71%RH	120Vac, 60Hz	Jones Chang
PLC	25deg. C, 75%RH	120Vac, 60Hz	James Yang
APCM	25deg. C, 60%RH	120Vac, 60Hz	Ted Chang

3.3 Duty Cycle of Test Signal

Duty cycle of test signal is 100 %, duty factor is not required.

Duty cycle of test signal is < 98%, duty factor shall be considered.

802.11b: Duty cycle = 100%

802.11g: Duty cycle = $2.025/2.14 = 0.946$, Duty factor = $10 * \log(1/0.946) = 0.24$

802.11n (HT20): Duty cycle = $4.955/5.055 = 0.978$, Duty factor = $10 * \log(1/0.978) = 0.10$

802.11n (HT40): Duty cycle = $2.403/2.495 = 0.963$, Duty factor = $10 * \log(1/0.963) = 0.16$

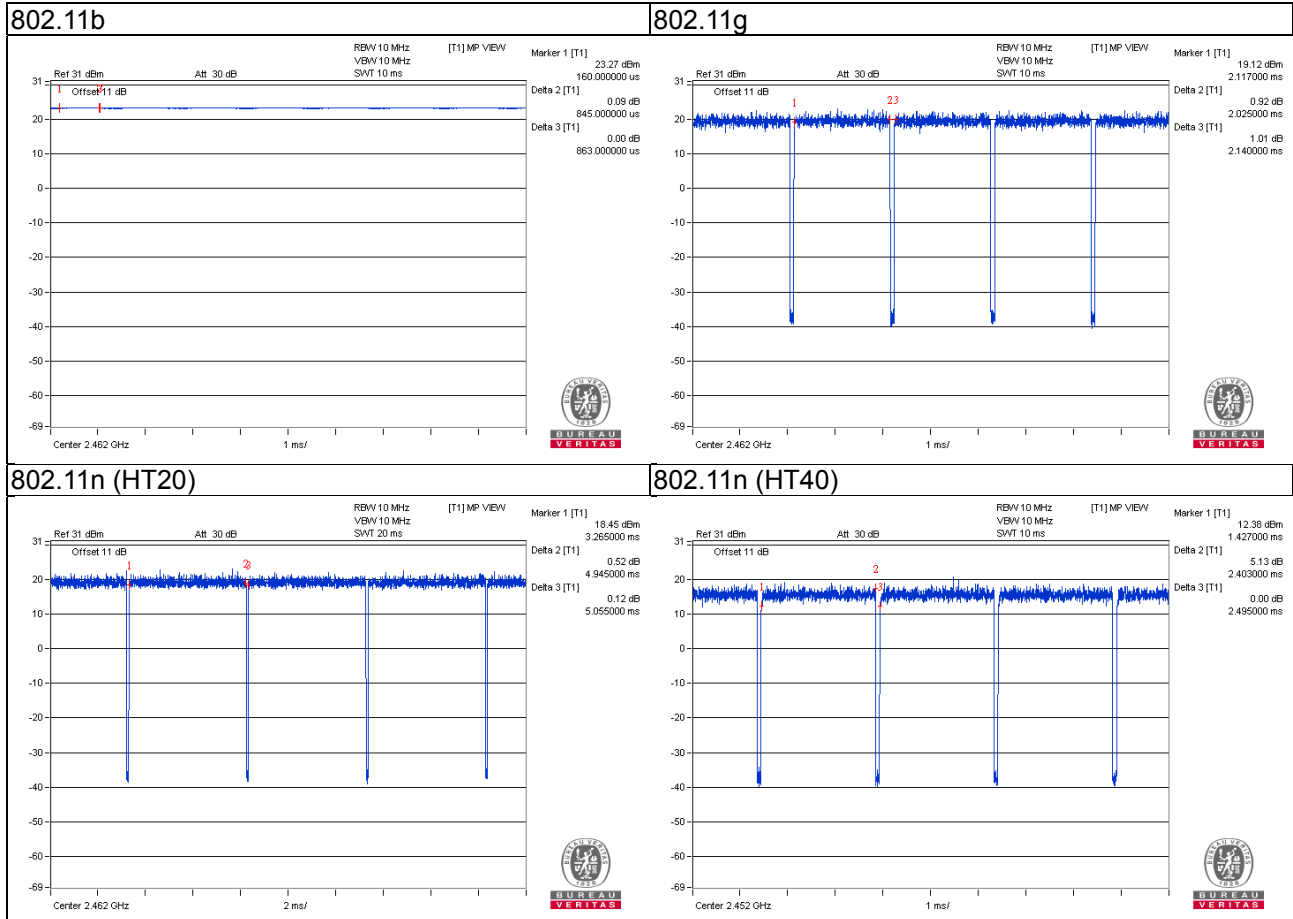

3.4 Description of Support Units

The EUT has been tested as an independent unit together with other necessary accessories or support units. The following support units or accessories were used to form a representative test configuration during the tests.

ID	Product	Brand	Model No.	Serial No.	FCC ID	Remarks
A.	Notebook	DELL	E5410	1HC2XM1	FCC DoC Approved	-
B.	Load	N/A	N/A	N/A	N/A	-
C.	USB 3.0 Flash	HP	v250W	01	N/A	-

Note:

1. All power cords of the above support units are non-shielded (1.8m).
2. Item A acted as communication partner to transfer data.

ID	Descriptions	Qty.	Length (m)	Shielding (Yes/No)	Cores (Qty.)	Remarks
1.	RJ45 Cable	4	1.8	N	0	Cat5e
2.	RJ45 Cable	1	10	N	0	Cat5e

3.4.1 Configuration of System under Test

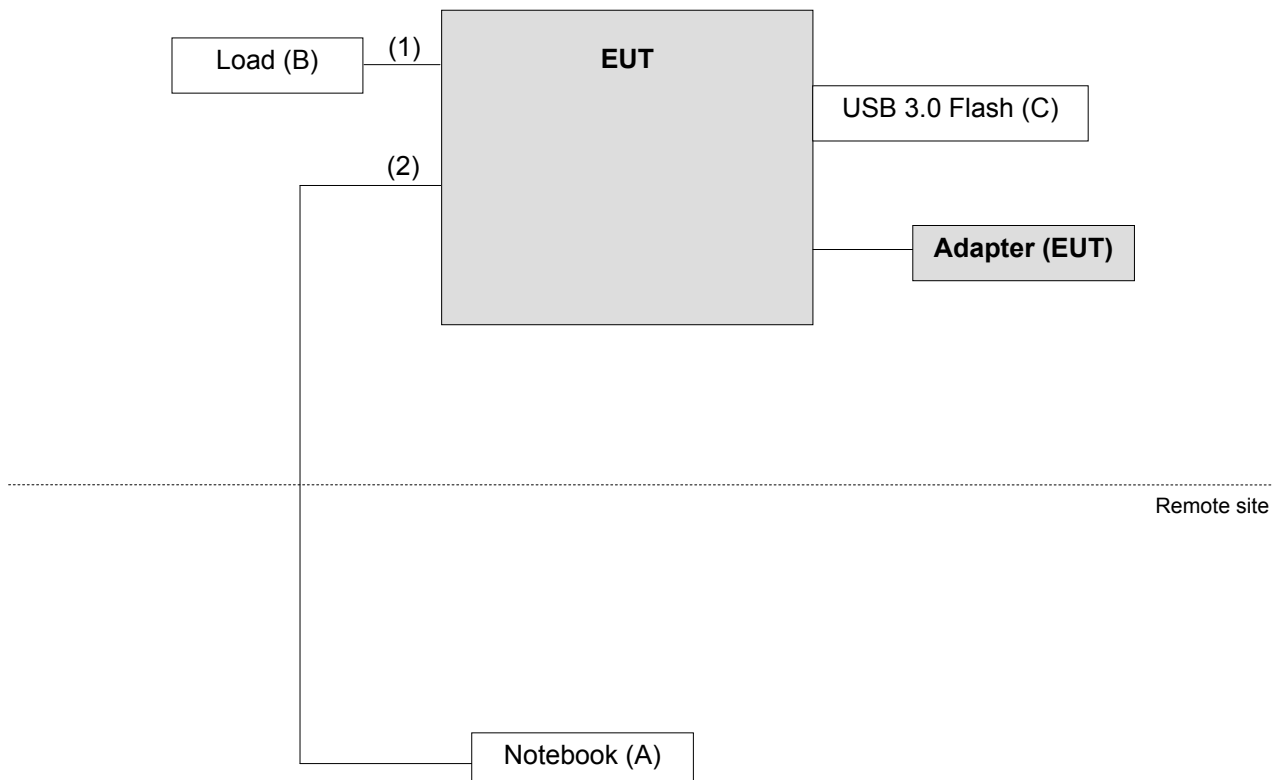

3.5 General Description of Applied Standards

The EUT is a RF Product. According to the specifications of the manufacturer, it must comply with the requirements of the following standards:

FCC Part 15, Subpart C (15.247)

KDB 558074 D01 DTS Meas Guidance v04

KDB 662911 D01 Multiple Transmitter Output v02r01

ANSI C63.10-2013

All test items have been performed and recorded as per the above standards.

Note: The EUT is also considered as a kind of computer peripheral, because the connection to computer is necessary for typical use. It has been verified to comply with the requirements of FCC Part 15, Subpart B, Class B (DoC). The test report has been issued separately.

4 Test Types and Results

4.1 Radiated Emission and Bandedge Measurement

4.1.1 Limits of Radiated Emission and Bandedge Measurement

Radiated emissions which fall in the restricted bands must comply with the radiated emission limits specified as below table. Other emissions shall be at least 30dB below the highest level of the desired power:

Frequencies (MHz)	Field Strength (microvolts/meter)	Measurement Distance (meters)
0.009 ~ 0.490	2400/F(kHz)	300
0.490 ~ 1.705	24000/F(kHz)	30
1.705 ~ 30.0	30	30
30 ~ 88	100	3
88 ~ 216	150	3
216 ~ 960	200	3
Above 960	500	3

Note:

1. The lower limit shall apply at the transition frequencies.
2. Emission level (dBuV/m) = 20 log Emission level (uV/m).
3. For frequencies above 1000MHz, the field strength limits are based on average detector, however, the peak field strength of any emission shall not exceed the maximum permitted average limits, specified above by more than 30dB under any condition of modulation.

4.1.2 Test Instruments

Description & Manufacturer	Model No.	Serial No.	Cal. Date	Cal. Due
Test Receiver KEYSIGHT	N9038A	MY55420137	Mar. 27, 2017	Mar. 26, 2018
Spectrum Analyzer ROHDE & SCHWARZ	FSP40	100041	Nov. 16, 2016	Nov. 15, 2017
BILOG Antenna SCHWARZBECK	VULB9168	9168-171	Dec. 28, 2016	Dec. 27, 2017
HORN Antenna SCHWARZBECK	9120D	209	Dec. 27, 2016	Dec. 26, 2017
HORN Antenna SCHWARZBECK	BBHA 9170	BBHA9170241	Dec. 14, 2016	Dec. 13, 2017
Loop Antenna	EM-6879	269	Aug. 11, 2016	Aug. 10, 2017
Preamplifier Agilent	8447D	2944A10738	Aug. 22, 2016	Aug. 21, 2017
Preamplifier Agilent	8449B	3008A01922	Sep. 18, 2016	Sep. 17, 2017
RF signal cable HUBER+SUHNER	SUCOFLEX 104	Cable-CH3-03 (214378)	Aug. 22, 2016	Aug. 21, 2017
RF signal cable HUBER+SUHNER	SUCOFLEX 106	Cable-CH3-03 (309224+12738)	Aug. 22, 2016	Aug. 21, 2017
Software BV ADT	ADT_Radiated_ V7.6.15.9.4	NA	NA	NA
Antenna Tower inn-co GmbH	MA 4000	013303	NA	NA
Antenna Tower Controller BV ADT	AT100	AT93021702	NA	NA
Turn Table BV ADT	TT100	TT93021702	NA	NA
Turn Table Controller BV ADT	SC100	SC93021702	NA	NA
Turn Table BV ADT	TT100	TT93021705	NA	NA
Turn Table Controller BV ADT	SC100	SC93021705	NA	NA
High Speed Peak Power Meter	ML2495A	0824012	Aug. 11, 2016	Aug. 10, 2017
Power Sensor	MA2411B	0738171	Aug. 11, 2016	Aug. 10, 2017

- Note:
1. The calibration interval of the above test instruments is 12 months and the calibrations are traceable to NML/ROC and NIST/USA.
 2. The test was performed in HwaYa Chamber 3.
 3. The horn antenna and preamplifier (model: 8449B) are used only for the measurement of emission frequency above 1GHz if tested.
 4. The FCC Site Registration No. is 988962.
 5. The IC Site Registration No. is IC 7450F-3.

4.1.3 Test Procedures

For Radiated emission below 30MHz

- a. The EUT was placed on the top of a rotating table 0.8 meters above the ground at a 3 meter chamber room. The table was rotated 360 degrees to determine the position of the highest radiation.
- b. The EUT was set 3 meters away from the interference-receiving antenna, which was mounted on the top of a variable-height antenna tower.
- c. Both X and Y axes of the antenna are set to make the measurement.
- d. For each suspected emission, the EUT was arranged to its worst case and the rotatable table was turned from 0 degrees to 360 degrees to find the maximum reading.
- e. The test-receiver system was set to Quasi-Peak Detect Function and Specified Bandwidth with Maximum Hold Mode.

NOTE:

1. The resolution bandwidth and video bandwidth of test receiver/spectrum analyzer is 9kHz at frequency below 30MHz.

For Radiated emission above 30MHz

- a. The EUT was placed on the top of a rotating table 0.8 meters (for 30MHz ~ 1GHz) / 1.5 meters (for above 1GHz) above the ground at 3 meter chamber room for test. The table was rotated 360 degrees to determine the position of the highest radiation.
- b. The EUT was set 3 meters away from the interference-receiving antenna, which was mounted on the top of a variable-height antenna tower.
- c. The height of antenna is varied from one meter to four meters above the ground to determine the maximum value of the field strength. Both horizontal and vertical polarizations of the antenna are set to make the measurement.
- d. For each suspected emission, the EUT was arranged to its worst case and then the antenna was tuned to heights from 1 meter to 4 meters and the rotatable table was turned from 0 degrees to 360 degrees to find the maximum reading.
- e. The test-receiver system was set to quasi-peak detect function and specified bandwidth with maximum hold mode when the test frequency is below 1 GHz.
- f. The test-receiver system was set to peak and average detect function and specified bandwidth with maximum hold mode when the test frequency is above 1 GHz. If the peak reading value also meets average limit, measurement with the average detector is unnecessary.

Note:

1. The resolution bandwidth and video bandwidth of test receiver/spectrum analyzer is 120kHz for Quasi-peak detection (QP) at frequency below 1GHz.
2. The resolution bandwidth of test receiver/spectrum analyzer is 1 MHz and the video bandwidth is 3 MHz for Peak detection (PK) at frequency above 1GHz.
3. The resolution bandwidth of test receiver/spectrum analyzer is 1 MHz and the video bandwidth is $\geq 1/T$ (Duty cycle < 98%) or 3 x RBW (Duty cycle $\geq 98\%$) for Average detection (AV) at frequency above 1GHz.
4. All modes of operation were investigated and the worst-case emissions are reported.

4.1.4 Deviation from Test Standard

No deviation.

4.1.5 Test Set Up

For Radiated emission below 30MHz

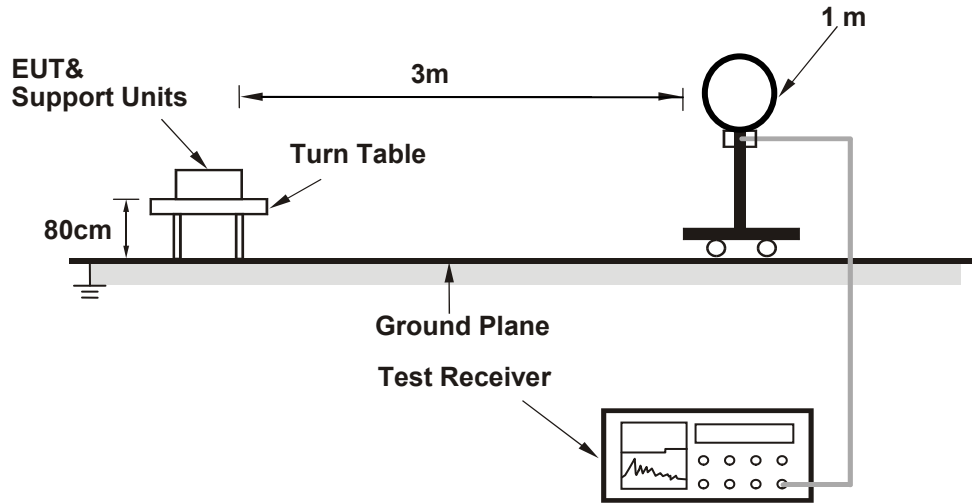

For Radiated emission 30MHz to 1GHz

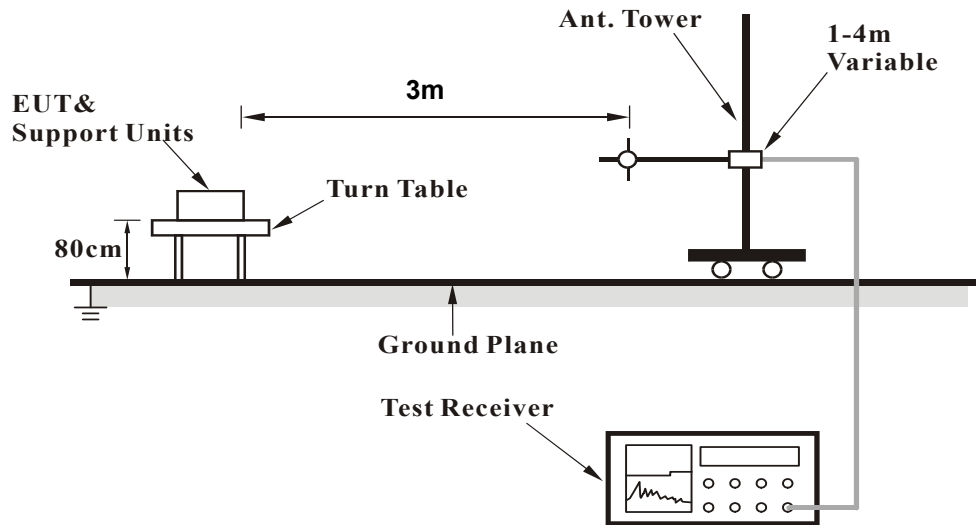

For Radiated emission above 1GHz

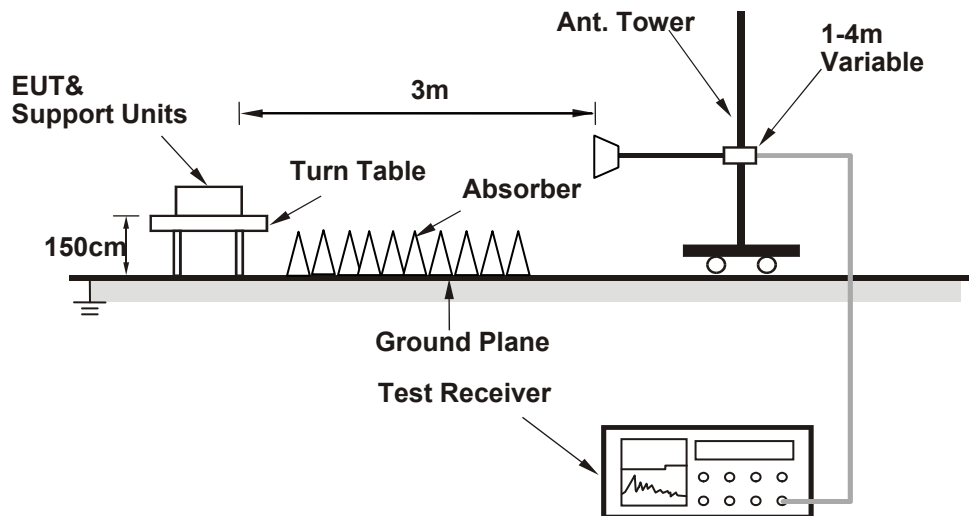

For the actual test configuration, please refer to the attached file (Test Setup Photo).

4.1.6 EUT Operating Conditions

- Placed the EUT on the testing table.
- Prepared a notebook to act as a communication partner and placed it outside of testing area.
- The communication partner connected with EUT via a RJ45 cable and ran a test program (provided by manufacturer) to enable EUT under transmission condition continuously at specific channel frequency.
- The communication partner sent data to EUT by command "PING".

4.1.7 Test Results

Above 1GHz worst-Case data:

802.11b

CHANNEL	TX Channel 1	DETECTOR FUNCTION	Peak (PK)
FREQUENCY RANGE	1GHz ~ 25GHz		Average (AV)

ANTENNA POLARITY & TEST DISTANCE: HORIZONTAL AT 3 M								
NO.	FREQ. (MHz)	EMISSION LEVEL (dBuV/m)	LIMIT (dBuV/m)	MARGIN (dB)	ANTENNA HEIGHT (m)	TABLE ANGLE (Degree)	RAW VALUE (dBuV)	CORRECTION FACTOR (dB/m)
1	2390.00	60.6 PK	74.0	-13.4	1.75 H	17	29.6	31.0
2	2390.00	52.3 AV	54.0	-1.7	1.75 H	17	21.3	31.0
3	*2412.00	113.1 PK			1.81 H	23	81.9	31.2
4	*2412.00	110.8 AV			1.81 H	23	79.6	31.2
5	4824.00	48.1 PK	74.0	-25.9	2.45 H	324	47.6	0.5
6	4824.00	38.8 AV	54.0	-15.2	2.45 H	324	38.3	0.5
ANTENNA POLARITY & TEST DISTANCE: VERTICAL AT 3 M								
NO.	FREQ. (MHz)	EMISSION LEVEL (dBuV/m)	LIMIT (dBuV/m)	MARGIN (dB)	ANTENNA HEIGHT (m)	TABLE ANGLE (Degree)	RAW VALUE (dBuV)	CORRECTION FACTOR (dB/m)
1	2390.00	58.8 PK	74.0	-15.2	1.69 V	3	27.8	31.0
2	2390.00	50.9 AV	54.0	-3.1	1.69 V	3	19.9	31.0
3	*2412.00	113.0 PK			1.68 V	352	81.8	31.2
4	*2412.00	109.0 AV			1.68 V	352	77.8	31.2
5	4824.00	47.3 PK	74.0	-26.7	1.59 V	29	46.8	0.5
6	4824.00	37.0 AV	54.0	-17.0	1.59 V	29	36.5	0.5

REMARKS:

1. Emission Level(dBuV/m) = Raw Value(dBuV) + Correction Factor(dB/m)
2. Correction Factor(dB/m) = Antenna Factor(dB/m) + Cable Factor(dB)
3. The other emission levels were very low against the limit.
4. Margin value = Emission Level – Limit value
5. " * " : Fundamental frequency.

CHANNEL	TX Channel 6	DETECTOR FUNCTION	Peak (PK)
FREQUENCY RANGE	1GHz ~ 25GHz		Average (AV)

ANTENNA POLARITY & TEST DISTANCE: HORIZONTAL AT 3 M

NO.	FREQ. (MHz)	EMISSION LEVEL (dBuV/m)	LIMIT (dBuV/m)	MARGIN (dB)	ANTENNA HEIGHT (m)	TABLE ANGLE (Degree)	RAW VALUE (dBuV)	CORRECTION FACTOR (dB/m)
1	*2437.00	113.3 PK			1.75 H	21	82.0	31.3
2	*2437.00	109.2 AV			1.75 H	21	77.9	31.3
3	4874.00	49.5 PK	74.0	-24.5	1.50 H	244	48.9	0.6
4	4874.00	40.5 AV	54.0	-13.5	1.50 H	244	39.9	0.6

ANTENNA POLARITY & TEST DISTANCE: VERTICAL AT 3 M

NO.	FREQ. (MHz)	EMISSION LEVEL (dBuV/m)	LIMIT (dBuV/m)	MARGIN (dB)	ANTENNA HEIGHT (m)	TABLE ANGLE (Degree)	RAW VALUE (dBuV)	CORRECTION FACTOR (dB/m)
1	*2437.00	111.6 PK			1.02 V	37	80.3	31.3
2	*2437.00	107.6 AV			1.02 V	37	76.3	31.3
3	4874.00	48.9 PK	74.0	-25.1	1.00 V	323	48.3	0.6
4	4874.00	39.9 AV	54.0	-14.1	1.00 V	323	39.3	0.6

REMARKS:

1. Emission Level(dBuV/m) = Raw Value(dBuV) + Correction Factor(dB/m)
2. Correction Factor(dB/m) = Antenna Factor(dB/m) + Cable Factor(dB)
3. The other emission levels were very low against the limit.
4. Margin value = Emission Level – Limit value
5. " * " : Fundamental frequency.

CHANNEL	TX Channel 11	DETECTOR FUNCTION	Peak (PK)
FREQUENCY RANGE	1GHz ~ 25GHz		Average (AV)

ANTENNA POLARITY & TEST DISTANCE: HORIZONTAL AT 3 M

NO.	FREQ. (MHz)	EMISSION LEVEL (dBuV/m)	LIMIT (dBuV/m)	MARGIN (dB)	ANTENNA HEIGHT (m)	TABLE ANGLE (Degree)	RAW VALUE (dBuV)	CORRECTION FACTOR (dB/m)
1	*2462.00	108.7 PK			1.00 H	31	77.3	31.4
2	*2462.00	105.0 AV			1.00 H	31	73.6	31.4
3	2483.50	60.4 PK	74.0	-13.6	1.00 H	36	28.9	31.5
4	2483.50	52.8 AV	54.0	-1.2	1.00 H	36	21.3	31.5
5	4924.00	47.9 PK	74.0	-26.1	1.54 H	1	47.3	0.6
6	4924.00	37.2 AV	54.0	-16.8	1.54 H	1	36.6	0.6

ANTENNA POLARITY & TEST DISTANCE: VERTICAL AT 3 M

NO.	FREQ. (MHz)	EMISSION LEVEL (dBuV/m)	LIMIT (dBuV/m)	MARGIN (dB)	ANTENNA HEIGHT (m)	TABLE ANGLE (Degree)	RAW VALUE (dBuV)	CORRECTION FACTOR (dB/m)
1	*2462.00	111.3 PK			1.26 V	7	79.9	31.4
2	*2462.00	107.5 AV			1.26 V	7	76.1	31.4
3	2483.50	60.2 PK	74.0	-13.8	1.45 V	359	28.7	31.5
4	2483.50	52.4 AV	54.0	-1.6	1.45 V	359	20.9	31.5
5	4924.00	48.1 PK	74.0	-25.9	1.29 V	324	47.5	0.6
6	4924.00	37.8 AV	54.0	-16.2	1.29 V	324	37.2	0.6

REMARKS:

1. Emission Level(dBuV/m) = Raw Value(dBuV) + Correction Factor(dB/m)
2. Correction Factor(dB/m) = Antenna Factor(dB/m) + Cable Factor(dB)
3. The other emission levels were very low against the limit.
4. Margin value = Emission Level – Limit value
5. " * " : Fundamental frequency.

802.11g

CHANNEL	TX Channel 1	DETECTOR FUNCTION	Peak (PK)
FREQUENCY RANGE	1GHz ~ 25GHz		Average (AV)

ANTENNA POLARITY & TEST DISTANCE: HORIZONTAL AT 3 M

NO.	FREQ. (MHz)	EMISSION LEVEL (dBuV/m)	LIMIT (dBuV/m)	MARGIN (dB)	ANTENNA HEIGHT (m)	TABLE ANGLE (Degree)	RAW VALUE (dBuV)	CORRECTION FACTOR (dB/m)
1	2390.00	68.2 PK	74.0	-5.8	2.44 H	19	37.2	31.0
2	2390.00	52.6 AV	54.0	-1.4	2.44 H	19	21.6	31.0
3	*2412.00	110.0 PK			1.41 H	27	78.8	31.2
4	*2412.00	98.9 AV			1.41 H	27	67.7	31.2
5	4824.00	45.8 PK	74.0	-28.2	1.83 H	224	45.3	0.5
6	4824.00	33.4 AV	54.0	-20.6	1.83 H	224	32.9	0.5

ANTENNA POLARITY & TEST DISTANCE: VERTICAL AT 3 M

NO.	FREQ. (MHz)	EMISSION LEVEL (dBuV/m)	LIMIT (dBuV/m)	MARGIN (dB)	ANTENNA HEIGHT (m)	TABLE ANGLE (Degree)	RAW VALUE (dBuV)	CORRECTION FACTOR (dB/m)
1	2390.00	67.4 PK	74.0	-6.6	3.23 V	343	36.4	31.0
2	2390.00	52.5 AV	54.0	-1.5	3.23 V	343	21.5	31.0
3	*2412.00	109.4 PK			2.23 V	70	78.2	31.2
4	*2412.00	98.9 AV			2.23 V	70	67.7	31.2
5	4824.00	46.1 PK	74.0	-27.9	2.08 V	312	45.6	0.5
6	4824.00	33.2 AV	54.0	-20.8	2.08 V	312	32.7	0.5

REMARKS:

1. Emission Level(dBuV/m) = Raw Value(dBuV) + Correction Factor(dB/m)
2. Correction Factor(dB/m) = Antenna Factor(dB/m) + Cable Factor(dB)
3. The other emission levels were very low against the limit.
4. Margin value = Emission Level – Limit value
5. " * " : Fundamental frequency.

CHANNEL	TX Channel 6	DETECTOR FUNCTION	Peak (PK)
FREQUENCY RANGE	1GHz ~ 25GHz		Average (AV)

ANTENNA POLARITY & TEST DISTANCE: HORIZONTAL AT 3 M

NO.	FREQ. (MHz)	EMISSION LEVEL (dBuV/m)	LIMIT (dBuV/m)	MARGIN (dB)	ANTENNA HEIGHT (m)	TABLE ANGLE (Degree)	RAW VALUE (dBuV)	CORRECTION FACTOR (dB/m)
1	*2437.00	114.1 PK			1.29 H	23	82.8	31.3
2	*2437.00	103.2 AV			1.29 H	23	71.9	31.3
3	4874.00	46.8 PK	74.0	-27.2	1.96 H	143	46.2	0.6
4	4874.00	33.8 AV	54.0	-20.2	1.96 H	143	33.2	0.6

ANTENNA POLARITY & TEST DISTANCE: VERTICAL AT 3 M

NO.	FREQ. (MHz)	EMISSION LEVEL (dBuV/m)	LIMIT (dBuV/m)	MARGIN (dB)	ANTENNA HEIGHT (m)	TABLE ANGLE (Degree)	RAW VALUE (dBuV)	CORRECTION FACTOR (dB/m)
1	*2437.00	113.1 PK			1.00 V	4	81.8	31.3
2	*2437.00	103.4 AV			1.00 V	4	72.1	31.3
3	4874.00	46.9 PK	74.0	-27.1	1.83 V	54	46.3	0.6
4	4874.00	34.2 AV	54.0	-19.8	1.83 V	54	33.6	0.6

REMARKS:

1. Emission Level(dBuV/m) = Raw Value(dBuV) + Correction Factor(dB/m)
2. Correction Factor(dB/m) = Antenna Factor(dB/m) + Cable Factor(dB)
3. The other emission levels were very low against the limit.
4. Margin value = Emission Level – Limit value
5. " * ": Fundamental frequency.

CHANNEL	TX Channel 11	DETECTOR FUNCTION	Peak (PK)
FREQUENCY RANGE	1GHz ~ 25GHz		Average (AV)

ANTENNA POLARITY & TEST DISTANCE: HORIZONTAL AT 3 M

NO.	FREQ. (MHz)	EMISSION LEVEL (dBuV/m)	LIMIT (dBuV/m)	MARGIN (dB)	ANTENNA HEIGHT (m)	TABLE ANGLE (Degree)	RAW VALUE (dBuV)	CORRECTION FACTOR (dB/m)
1	*2462.00	108.5 PK			1.18 H	31	77.1	31.4
2	*2462.00	98.3 AV			1.18 H	31	66.9	31.4
3	2483.50	66.7 PK	74.0	-7.3	1.00 H	18	35.2	31.5
4	2483.50	52.3 AV	54.0	-1.7	1.00 H	18	20.8	31.5
5	4924.00	47.9 PK	74.0	-26.1	1.83 H	54	47.3	0.6
6	4924.00	34.2 AV	54.0	-19.8	1.83 H	54	33.6	0.6

ANTENNA POLARITY & TEST DISTANCE: VERTICAL AT 3 M

NO.	FREQ. (MHz)	EMISSION LEVEL (dBuV/m)	LIMIT (dBuV/m)	MARGIN (dB)	ANTENNA HEIGHT (m)	TABLE ANGLE (Degree)	RAW VALUE (dBuV)	CORRECTION FACTOR (dB/m)
1	*2462.00	107.6 PK			1.31 V	357	76.2	31.4
2	*2462.00	97.5 AV			1.31 V	357	66.1	31.4
3	2483.50	68.4 PK	74.0	-5.6	1.20 V	28	36.9	31.5
4	2483.50	52.4 AV	54.0	-1.6	1.20 V	28	20.9	31.5
5	4924.00	46.9 PK	74.0	-27.1	1.64 V	225	46.3	0.6
6	4924.00	33.5 AV	54.0	-20.5	1.64 V	225	32.9	0.6

REMARKS:

1. Emission Level(dBuV/m) = Raw Value(dBuV) + Correction Factor(dB/m)
2. Correction Factor(dB/m) = Antenna Factor(dB/m) + Cable Factor(dB)
3. The other emission levels were very low against the limit.
4. Margin value = Emission Level – Limit value
5. " * " : Fundamental frequency.

802.11n (HT20)

CHANNEL	TX Channel 1	DETECTOR FUNCTION	Peak (PK)
FREQUENCY RANGE	1GHz ~ 25GHz		Average (AV)

ANTENNA POLARITY & TEST DISTANCE: HORIZONTAL AT 3 M

NO.	FREQ. (MHz)	EMISSION LEVEL (dBuV/m)	LIMIT (dBuV/m)	MARGIN (dB)	ANTENNA HEIGHT (m)	TABLE ANGLE (Degree)	RAW VALUE (dBuV)	CORRECTION FACTOR (dB/m)
1	2390.00	68.8 PK	74.0	-5.2	1.49 H	15	37.8	31.0
2	2390.00	52.8 AV	54.0	-1.2	1.49 H	15	21.8	31.0
3	*2412.00	109.0 PK			1.42 H	28	77.8	31.2
4	*2412.00	98.1 AV			1.42 H	28	66.9	31.2
5	4824.00	46.3 PK	74.0	-27.7	1.86 H	174	45.8	0.5
6	4824.00	32.8 AV	54.0	-21.2	1.86 H	174	32.3	0.5

ANTENNA POLARITY & TEST DISTANCE: VERTICAL AT 3 M

NO.	FREQ. (MHz)	EMISSION LEVEL (dBuV/m)	LIMIT (dBuV/m)	MARGIN (dB)	ANTENNA HEIGHT (m)	TABLE ANGLE (Degree)	RAW VALUE (dBuV)	CORRECTION FACTOR (dB/m)
1	2390.00	67.2 PK	74.0	-6.8	1.45 V	13	36.2	31.0
2	2390.00	50.8 AV	54.0	-3.2	1.45 V	13	19.8	31.0
3	*2412.00	109.4 PK			1.46 V	16	78.2	31.2
4	*2412.00	98.1 AV			1.46 V	16	66.9	31.2
5	4824.00	46.6 PK	74.0	-27.4	1.57 V	26	46.1	0.5
6	4824.00	34.1 AV	54.0	-19.9	1.57 V	26	33.6	0.5

REMARKS:

1. Emission Level(dBuV/m) = Raw Value(dBuV) + Correction Factor(dB/m)
2. Correction Factor(dB/m) = Antenna Factor(dB/m) + Cable Factor(dB)
3. The other emission levels were very low against the limit.
4. Margin value = Emission Level – Limit value
5. " * " : Fundamental frequency.

CHANNEL	TX Channel 6	DETECTOR FUNCTION	Peak (PK)
FREQUENCY RANGE	1GHz ~ 25GHz		Average (AV)

ANTENNA POLARITY & TEST DISTANCE: HORIZONTAL AT 3 M

NO.	FREQ. (MHz)	EMISSION LEVEL (dBuV/m)	LIMIT (dBuV/m)	MARGIN (dB)	ANTENNA HEIGHT (m)	TABLE ANGLE (Degree)	RAW VALUE (dBuV)	CORRECTION FACTOR (dB/m)
1	*2437.00	112.1 PK			1.39 H	27	80.8	31.3
2	*2437.00	100.7 AV			1.39 H	27	69.4	31.3
3	4874.00	47.4 PK	74.0	-26.6	1.89 H	246	46.8	0.6
4	4874.00	33.3 AV	54.0	-20.7	1.89 H	246	32.7	0.6

ANTENNA POLARITY & TEST DISTANCE: VERTICAL AT 3 M

NO.	FREQ. (MHz)	EMISSION LEVEL (dBuV/m)	LIMIT (dBuV/m)	MARGIN (dB)	ANTENNA HEIGHT (m)	TABLE ANGLE (Degree)	RAW VALUE (dBuV)	CORRECTION FACTOR (dB/m)
1	*2437.00	112.7 PK			1.36 V	15	81.4	31.3
2	*2437.00	101.8 AV			1.36 V	15	70.5	31.3
3	4874.00	46.4 PK	74.0	-27.6	1.45 V	37	45.8	0.6
4	4874.00	33.8 AV	54.0	-20.2	1.45 V	37	33.2	0.6

REMARKS:

1. Emission Level(dBuV/m) = Raw Value(dBuV) + Correction Factor(dB/m)
2. Correction Factor(dB/m) = Antenna Factor(dB/m) + Cable Factor(dB)
3. The other emission levels were very low against the limit.
4. Margin value = Emission Level – Limit value
5. " * " : Fundamental frequency.

CHANNEL	TX Channel 11	DETECTOR FUNCTION	Peak (PK)
FREQUENCY RANGE	1GHz ~ 25GHz		Average (AV)

ANTENNA POLARITY & TEST DISTANCE: HORIZONTAL AT 3 M

NO.	FREQ. (MHz)	EMISSION LEVEL (dBuV/m)	LIMIT (dBuV/m)	MARGIN (dB)	ANTENNA HEIGHT (m)	TABLE ANGLE (Degree)	RAW VALUE (dBuV)	CORRECTION FACTOR (dB/m)
1	*2462.00	107.9 PK			1.14 H	23	76.5	31.4
2	*2462.00	96.9 AV			1.14 H	23	65.5	31.4
3	2483.50	69.0 PK	74.0	-5.0	1.12 H	21	37.5	31.5
4	2483.50	51.8 AV	54.0	-2.2	1.12 H	21	20.3	31.5
5	4924.00	46.4 PK	74.0	-27.6	1.67 H	160	45.8	0.6
6	4924.00	33.1 AV	54.0	-20.9	1.67 H	160	32.5	0.6

ANTENNA POLARITY & TEST DISTANCE: VERTICAL AT 3 M

NO.	FREQ. (MHz)	EMISSION LEVEL (dBuV/m)	LIMIT (dBuV/m)	MARGIN (dB)	ANTENNA HEIGHT (m)	TABLE ANGLE (Degree)	RAW VALUE (dBuV)	CORRECTION FACTOR (dB/m)
1	*2462.00	109.0 PK			1.06 V	357	77.6	31.4
2	*2462.00	97.8 AV			1.06 V	357	66.4	31.4
3	2483.50	70.0 PK	74.0	-4.0	1.15 V	14	38.5	31.5
4	2483.50	52.9 AV	54.0	-1.1	1.15 V	14	21.4	31.5
5	4924.00	47.1 PK	74.0	-26.9	2.67 V	259	46.5	0.6
6	4924.00	33.6 AV	54.0	-20.4	2.67 V	259	33.0	0.6

REMARKS:

1. Emission Level(dBuV/m) = Raw Value(dBuV) + Correction Factor(dB/m)
2. Correction Factor(dB/m) = Antenna Factor(dB/m) + Cable Factor(dB)
3. The other emission levels were very low against the limit.
4. Margin value = Emission Level – Limit value
5. " * " : Fundamental frequency.

802.11n (HT40)

CHANNEL	TX Channel 3	DETECTOR FUNCTION	Peak (PK)
FREQUENCY RANGE	1GHz ~ 25GHz		Average (AV)

ANTENNA POLARITY & TEST DISTANCE: HORIZONTAL AT 3 M

NO.	FREQ. (MHz)	EMISSION LEVEL (dBuV/m)	LIMIT (dBuV/m)	MARGIN (dB)	ANTENNA HEIGHT (m)	TABLE ANGLE (Degree)	RAW VALUE (dBuV)	CORRECTION FACTOR (dB/m)
1	2390.00	69.9 PK	74.0	-4.1	1.22 H	28	38.9	31.0
2	2390.00	52.6 AV	54.0	-1.4	1.22 H	28	21.6	31.0
3	*2422.00	103.8 PK			1.00 H	19	72.6	31.2
4	*2422.00	94.2 AV			1.00 H	19	63.0	31.2
5	4844.00	45.8 PK	74.0	-28.2	2.43 H	292	45.4	0.4
6	4844.00	32.6 AV	54.0	-21.4	2.43 H	292	32.2	0.4

ANTENNA POLARITY & TEST DISTANCE: VERTICAL AT 3 M

NO.	FREQ. (MHz)	EMISSION LEVEL (dBuV/m)	LIMIT (dBuV/m)	MARGIN (dB)	ANTENNA HEIGHT (m)	TABLE ANGLE (Degree)	RAW VALUE (dBuV)	CORRECTION FACTOR (dB/m)
1	2390.00	70.4 PK	74.0	-3.6	1.00 V	24	39.4	31.0
2	2390.00	51.9 AV	54.0	-2.1	1.00 V	24	20.9	31.0
3	*2422.00	104.6 PK			1.00 V	355	73.4	31.2
4	*2422.00	95.5 AV			1.00 V	355	64.3	31.2
5	4844.00	46.0 PK	74.0	-28.0	2.23 V	108	45.6	0.4
6	4844.00	32.8 AV	54.0	-21.2	2.23 V	108	32.4	0.4

REMARKS:

1. Emission Level(dBuV/m) = Raw Value(dBuV) + Correction Factor(dB/m)
2. Correction Factor(dB/m) = Antenna Factor(dB/m) + Cable Factor(dB)
3. The other emission levels were very low against the limit.
4. Margin value = Emission Level – Limit value
5. " * " : Fundamental frequency.

CHANNEL	TX Channel 6	DETECTOR FUNCTION	Peak (PK)
FREQUENCY RANGE	1GHz ~ 25GHz		Average (AV)

ANTENNA POLARITY & TEST DISTANCE: HORIZONTAL AT 3 M

NO.	FREQ. (MHz)	EMISSION LEVEL (dBuV/m)	LIMIT (dBuV/m)	MARGIN (dB)	ANTENNA HEIGHT (m)	TABLE ANGLE (Degree)	RAW VALUE (dBuV)	CORRECTION FACTOR (dB/m)
1	2390.00	63.1 PK	74.0	-10.9	1.27 H	18	32.1	31.0
2	2390.00	49.4 AV	54.0	-4.6	1.27 H	18	18.4	31.0
3	*2437.00	105.0 PK			1.24 H	22	73.7	31.3
4	*2437.00	95.3 AV			1.24 H	22	64.0	31.3
5	2483.50	66.1 PK	74.0	-7.9	1.10 H	28	34.6	31.5
6	2483.50	52.5 AV	54.0	-1.5	1.10 H	28	21.0	31.5
7	4874.00	46.2 PK	74.0	-27.8	2.09 H	328	45.6	0.6
8	4874.00	33.2 AV	54.0	-20.8	2.09 H	328	32.6	0.6

ANTENNA POLARITY & TEST DISTANCE: VERTICAL AT 3 M

NO.	FREQ. (MHz)	EMISSION LEVEL (dBuV/m)	LIMIT (dBuV/m)	MARGIN (dB)	ANTENNA HEIGHT (m)	TABLE ANGLE (Degree)	RAW VALUE (dBuV)	CORRECTION FACTOR (dB/m)
1	2390.00	61.4 PK	74.0	-12.6	1.00 V	51	30.4	31.0
2	2390.00	47.7 AV	54.0	-6.3	1.00 V	51	16.7	31.0
3	*2437.00	104.5 PK			1.00 V	349	73.2	31.3
4	*2437.00	95.4 AV			1.00 V	349	64.1	31.3
5	2483.50	64.3 PK	74.0	-9.7	1.00 V	49	32.8	31.5
6	2483.50	50.1 AV	54.0	-3.9	1.00 V	49	18.6	31.5
7	4874.00	46.2 PK	74.0	-27.8	1.86 V	242	45.6	0.6
8	4874.00	33.0 AV	54.0	-21.0	1.86 V	242	32.4	0.6

REMARKS:

1. Emission Level(dBuV/m) = Raw Value(dBuV) + Correction Factor(dB/m)
2. Correction Factor(dB/m) = Antenna Factor(dB/m) + Cable Factor(dB)
3. The other emission levels were very low against the limit.
4. Margin value = Emission Level – Limit value
5. " * ": Fundamental frequency.

CHANNEL	TX Channel 9	DETECTOR FUNCTION	Peak (PK)
FREQUENCY RANGE	1GHz ~ 25GHz		Average (AV)

ANTENNA POLARITY & TEST DISTANCE: HORIZONTAL AT 3 M

NO.	FREQ. (MHz)	EMISSION LEVEL (dBuV/m)	LIMIT (dBuV/m)	MARGIN (dB)	ANTENNA HEIGHT (m)	TABLE ANGLE (Degree)	RAW VALUE (dBuV)	CORRECTION FACTOR (dB/m)
1	*2452.00	103.3 PK			1.82 H	19	71.9	31.4
2	*2452.00	93.6 AV			1.82 H	19	62.2	31.4
3	2483.50	68.3 PK	74.0	-5.7	2.62 H	24	36.8	31.5
4	2483.50	52.4 AV	54.0	-1.6	2.62 H	24	20.9	31.5
5	4904.00	46.3 PK	74.0	-27.7	2.46 H	256	45.8	0.5
6	4904.00	33.3 AV	54.0	-20.7	2.46 H	256	32.8	0.5

ANTENNA POLARITY & TEST DISTANCE: VERTICAL AT 3 M

NO.	FREQ. (MHz)	EMISSION LEVEL (dBuV/m)	LIMIT (dBuV/m)	MARGIN (dB)	ANTENNA HEIGHT (m)	TABLE ANGLE (Degree)	RAW VALUE (dBuV)	CORRECTION FACTOR (dB/m)
1	*2452.00	104.2 PK			1.59 V	351	72.8	31.4
2	*2452.00	94.6 AV			1.59 V	351	63.2	31.4
3	2483.50	68.7 PK	74.0	-5.3	1.83 V	0	37.2	31.5
4	2483.50	51.4 AV	54.0	-2.6	1.83 V	0	19.9	31.5
5	4904.00	47.3 PK	74.0	-26.7	2.73 V	241	46.8	0.5
6	4904.00	33.2 AV	54.0	-20.8	2.73 V	241	32.7	0.5

REMARKS:

1. Emission Level(dBuV/m) = Raw Value(dBuV) + Correction Factor(dB/m)
2. Correction Factor(dB/m) = Antenna Factor(dB/m) + Cable Factor(dB)
3. The other emission levels were very low against the limit.
4. Margin value = Emission Level – Limit value
5. " * " : Fundamental frequency.

Below 1GHz worst-case data:

802.11b

CHANNEL	TX Channel 1	DETECTOR FUNCTION	Quasi-Peak (QP)
FREQUENCY RANGE	30MHz ~ 1GHz		

ANTENNA POLARITY & TEST DISTANCE: HORIZONTAL AT 3 M								
NO.	FREQ. (MHz)	EMISSION LEVEL (dBuV/m)	LIMIT (dBuV/m)	MARGIN (dB)	ANTENNA HEIGHT (m)	TABLE ANGLE (Degree)	RAW VALUE (dBuV)	CORRECTION FACTOR (dB/m)
1	70.73	28.0 QP	40.0	-12.0	1.99 H	252	44.4	-16.4
2	113.50	36.2 QP	43.5	-7.3	1.50 H	107	53.1	-16.9
3	156.28	38.3 QP	43.5	-5.2	1.00 H	257	52.0	-13.7
4	191.28	33.3 QP	43.5	-10.2	1.00 H	239	49.4	-16.1
5	212.66	33.1 QP	43.5	-10.4	1.00 H	255	49.0	-15.9
6	309.88	27.7 QP	46.0	-18.3	1.00 H	255	39.5	-11.8
ANTENNA POLARITY & TEST DISTANCE: VERTICAL AT 3 M								
NO.	FREQ. (MHz)	EMISSION LEVEL (dBuV/m)	LIMIT (dBuV/m)	MARGIN (dB)	ANTENNA HEIGHT (m)	TABLE ANGLE (Degree)	RAW VALUE (dBuV)	CORRECTION FACTOR (dB/m)
1	30.00	36.2 QP	40.0	-3.8	1.49 V	120	52.6	-16.4
2	37.68	33.9 QP	40.0	-6.1	1.49 V	177	49.3	-15.4
3	50.40	37.9 QP	40.0	-2.1	1.00 V	0	52.3	-14.4
4	60.83	37.8 QP	40.0	-2.2	1.00 V	11	52.9	-15.1
5	73.08	38.0 QP	40.0	-2.0	1.00 V	237	54.8	-16.8
6	121.28	33.7 QP	43.5	-9.8	1.00 V	186	49.8	-16.1

Remarks:

1. Emission Level(dBuV/m) = Raw Value(dBuV) + Correction Factor(dB/m)
2. Correction Factor(dB/m) = Antenna Factor(dB/m) + Cable Factor(dB)
3. The other emission levels were very low against the limit.
4. Margin value = Emission Level – Limit value

4.2 Conducted Emission Measurement

4.2.1 Limits of Conducted Emission Measurement

Frequency (MHz)	Conducted Limit (dBuV)	
	Quasi-peak	Average
0.15 - 0.5	66 - 56	56 - 46
0.50 - 5.0	56	46
5.0 - 30.0	60	50

Note: 1. The lower limit shall apply at the transition frequencies.
2. The limit decreases in line with the logarithm of the frequency in the range of 0.15 to 0.50MHz.

4.2.2 Test Instruments

Description & Manufacturer	Model No.	Serial No.	Cal. Date	Cal. Due
Test Receiver ROHDE & SCHWARZ	ESCI	100613	Nov. 21, 2016	Nov. 20, 2017
RF signal cable (with 10dB PAD) Woken	5D-FB	Cable-cond1-01	Dec. 22, 2016	Dec. 21, 2017
LISN ROHDE & SCHWARZ (EUT)	ESH3-Z5	835239/001	Mar. 10, 2017	Mar. 09, 2018
LISN ROHDE & SCHWARZ (Peripheral)	ESH3-Z5	100311	Jul. 28, 2016	Jul. 27, 2017
Software ADT	BV ADT_Cond_ V7.3.7.3	NA	NA	NA

Note: 1. The calibration interval of the above test instruments is 12 months and the calibrations are traceable to NML/ROC and NIST/USA.
2. The test was performed in HwaYa Shielded Room 1.
3. The VCCI Site Registration No. is C-2040.

4.2.3 Test Procedures

- The EUT was placed 0.4 meters from the conducting wall of the shielded room with EUT being connected to the power mains through a line impedance stabilization network (LISN). Other support units were connected to the power mains through another LISN. The two LISNs provide 50 ohm/ 50uH of coupling impedance for the measuring instrument.
- Both lines of the power mains connected to the EUT were checked for maximum conducted interference.
- The frequency range from 150kHz to 30MHz was searched. Emission levels under (Limit - 20dB) was not recorded.

Note: The resolution bandwidth and video bandwidth of test receiver is 9kHz for quasi-peak detection (QP) and average detection (AV) at frequency 0.15MHz-30MHz.

4.2.4 Deviation from Test Standard

No deviation.

4.2.5 Test Setup

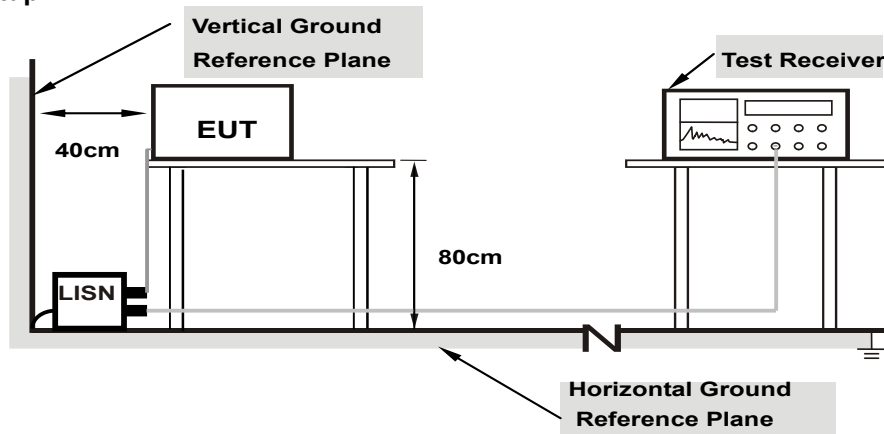

Note: 1.Support units were connected to second LISN.

For the actual test configuration, please refer to the attached file (Test Setup Photo).

4.2.6 EUT Operating Conditions

Same as 4.1.6.

4.2.7 Test Results

Phase	Line (L)	Detector Function	Quasi-Peak (QP) / Average (AV)
-------	----------	-------------------	--------------------------------

No	Freq. [MHz]	Corr. Factor (dB)	Reading Value [dB (uV)]		Emission Level [dB (uV)]		Limit [dB (uV)]		Margin (dB)	
			Q.P.	AV.	Q.P.	AV.	Q.P.	AV.	Q.P.	AV.
	1	0.16139	10.35	29.57	13.72	39.92	24.07	65.39	55.39	-25.47
2	0.40415	10.40	26.09	21.41	36.49	31.81	57.77	47.77	-21.28	-15.96
3	1.29954	10.42	14.13	13.00	24.55	23.42	56.00	46.00	-31.45	-22.58
4	2.33960	10.48	12.77	9.84	23.25	20.32	56.00	46.00	-32.75	-25.68
5	8.83411	10.78	12.91	9.56	23.69	20.34	60.00	50.00	-36.31	-29.66
6	16.16536	11.15	13.88	9.13	25.03	20.28	60.00	50.00	-34.97	-29.72

Remarks:

1. Q.P. and AV. are abbreviations of quasi-peak and average individually.
2. The emission levels of other frequencies were very low against the limit.
3. Margin value = Emission level - Limit value
4. Correction factor = Insertion loss + Cable loss
5. Emission Level = Correction Factor + Reading Value.

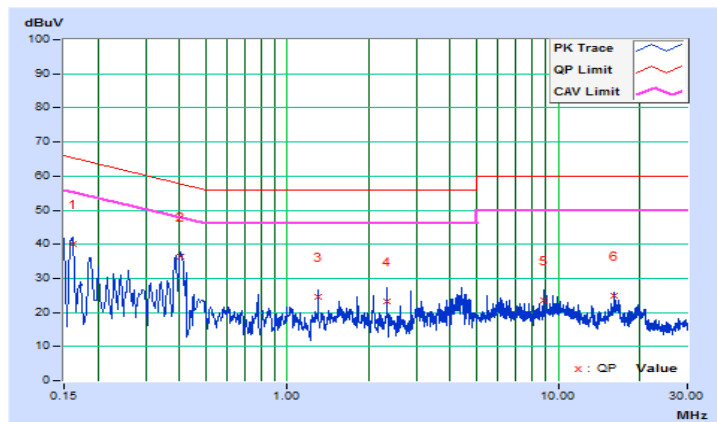

Phase	Neutral (N)	Detector Function	Quasi-Peak (QP) / Average (AV)
-------	-------------	-------------------	--------------------------------

No	Freq. [MHz]	Corr. Factor (dB)	Reading Value		Emission Level		Limit		Margin	
			[dB (uV)]		[dB (uV)]		[dB (uV)]		(dB)	
			Q.P.	AV.	Q.P.	AV.	Q.P.	AV.	Q.P.	AV.
1	0.22429	10.14	16.26	7.18	26.40	17.32	62.66	52.66	-36.26	-35.34
2	0.42000	10.16	19.77	9.69	29.93	19.85	57.45	47.45	-27.52	-27.60
3	0.53318	10.16	7.60	2.23	17.76	12.39	56.00	46.00	-38.24	-33.61
4	1.10013	10.18	2.43	-2.17	12.61	8.01	56.00	46.00	-43.39	-37.99
5	9.09228	10.52	13.13	7.85	23.65	18.37	60.00	50.00	-36.35	-31.63
6	16.16536	10.80	12.38	8.00	23.18	18.80	60.00	50.00	-36.82	-31.20

Remarks:

1. Q.P. and AV. are abbreviations of quasi-peak and average individually.
2. The emission levels of other frequencies were very low against the limit.
3. Margin value = Emission level - Limit value
4. Correction factor = Insertion loss + Cable loss
5. Emission Level = Correction Factor + Reading Value.

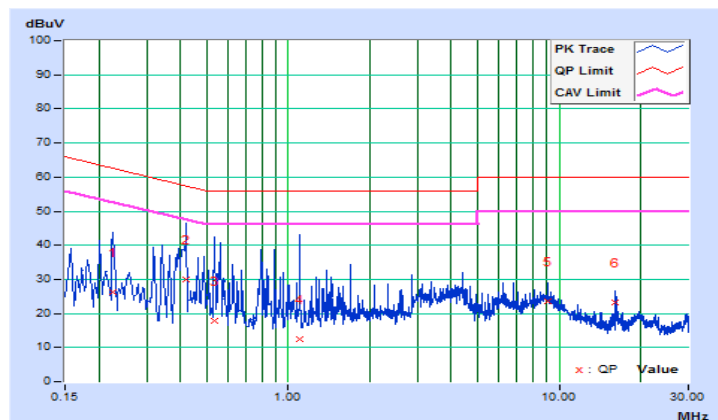

4.3 6dB Bandwidth Measurement

4.3.1 Limits of 6dB Bandwidth Measurement

The minimum of 6dB Bandwidth Measurement is 0.5 MHz.

4.3.2 Test Setup

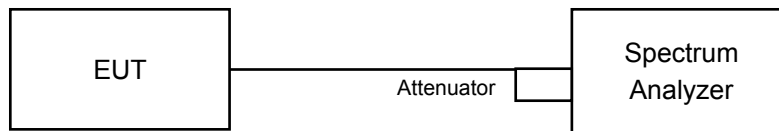

4.3.3 Test Instruments

Refer to section 4.1.2 to get information of above instrument.

4.3.4 Test Procedure

- Set resolution bandwidth (RBW) = 100kHz
- Set the video bandwidth (VBW) $\geq 3 \times$ RBW, Detector = average.
- Trace mode = max hold.
- Sweep = auto couple.
- Measure the maximum width of the emission that is constrained by the frequencies associated with the two amplitude points (upper and lower) that are attenuated by 6 dB relative to the maximum level measured in the fundamental emission

4.3.5 Deviation from Test Standard

No deviation.

4.3.6 EUT Operating Conditions

The software provided by client to enable the EUT under transmission condition continuously at lowest, middle and highest channel frequencies individually.

4.3.7 Test Result

802.11b

Channel	Frequency (MHz)	6dB Bandwidth (MHz)		Minimum Limit (MHz)	Pass / Fail
		Chain 0	Chain 1		
1	2412	8.59	9.07	0.5	Pass
6	2437	10.11	10.12	0.5	Pass
11	2462	9.04	9.04	0.5	Pass

802.11g

Channel	Frequency (MHz)	6dB Bandwidth (MHz)		Minimum Limit (MHz)	Pass / Fail
		Chain 0	Chain 1		
1	2412	16.39	16.42	0.5	Pass
6	2437	16.36	16.38	0.5	Pass
11	2462	16.38	16.39	0.5	Pass

802.11n (HT20)

Channel	Frequency (MHz)	6dB Bandwidth (MHz)		Minimum Limit (MHz)	Pass / Fail
		Chain 0	Chain 1		
1	2412	17.63	17.63	0.5	Pass
6	2437	17.59	17.60	0.5	Pass
11	2462	17.61	17.62	0.5	Pass

802.11n (HT40)

Channel	Frequency (MHz)	6dB Bandwidth (MHz)		Minimum Limit (MHz)	Pass / Fail
		Chain 0	Chain 1		
3	2422	35.23	35.25	0.5	Pass
6	2437	35.19	35.26	0.5	Pass
9	2452	35.14	35.21	0.5	Pass

Spectrum Plot of Worst Value

802.11b

802.11g

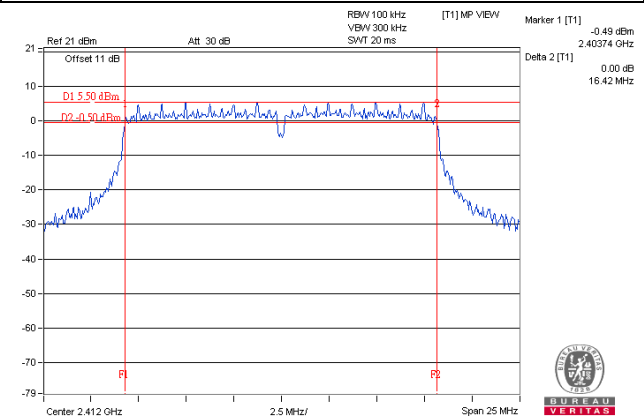
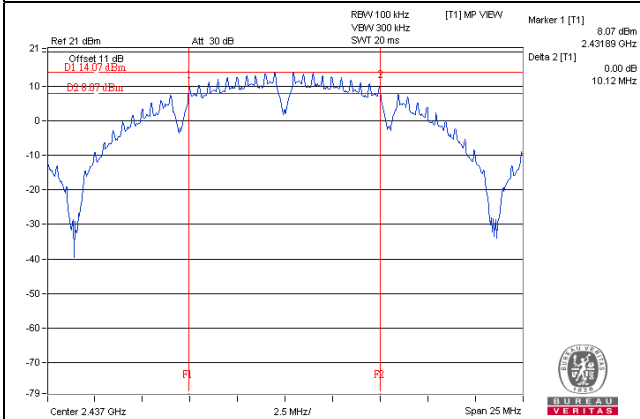

802.11n (HT20)

802.11n (HT40)

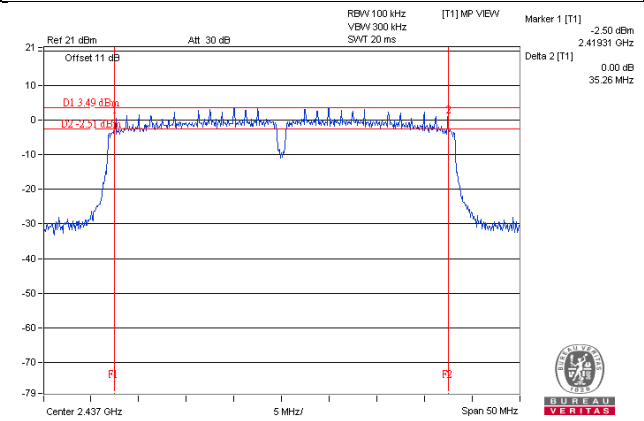
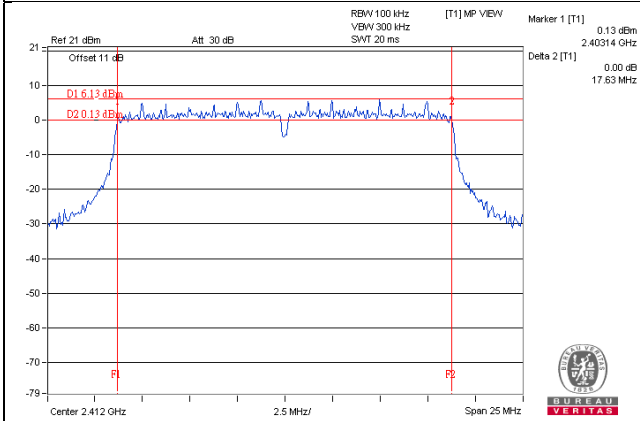

4.4 Conducted Output Power Measurement

4.4.1 Limits of Conducted Output Power Measurement

For systems using digital modulation in the 2400–2483.5 MHz bands: 1 Watt (30dBm)

Per KDB 662911 D01 Multiple Transmitter Output Method of conducted output power measurement on IEEE 802.11 devices,

Array Gain = 0 dB (i.e., no array gain) for $NANT \leq 4$;

Array Gain = 0 dB (i.e., no array gain) for channel widths ≥ 40 MHz for any NANT;

Array Gain = $5 \log(NANT/NSS)$ dB or 3 dB, whichever is less for 20-MHz channel widths with $NANT \geq 5$.

For power measurements on all other devices: Array Gain = $10 \log(NANT/NSS)$ dB.

4.4.2 Test Setup

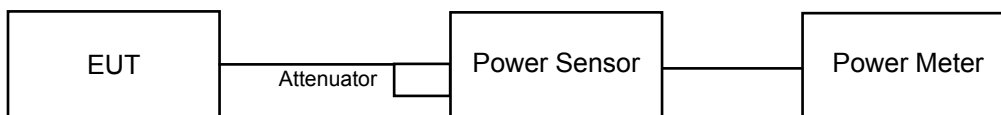

4.4.3 Test Instruments

Refer to section 4.1.2 to get information of above instrument.

4.4.4 Test Procedures

An average power sensor was used on the output port of the EUT. A power meter was used to read the response of the average power sensor. Record the power level.

4.4.5 Deviation from Test Standard

No deviation.

4.4.6 EUT Operating Conditions

Same as Item 4.3.6.

4.4.7 Test Results

CDD Mode

802.11b

Channel	Frequency (MHz)	Average Power (dBm)		Total Power (mW)	Total Power (dBm)	Limit (dBm)	Pass / Fail
		Chain 0	Chain 1				
1	2412	21.12	20.68	246.370	23.92	30	Pass
6	2437	23.40	23.10	422.950	26.26	30	Pass
11	2462	20.31	19.62	199.021	22.99	30	Pass

802.11g

Channel	Frequency (MHz)	Average Power (dBm)		Total Power (mW)	Total Power (dBm)	Limit (dBm)	Pass / Fail
		Chain 0	Chain 1				
1	2412	16.73	16.38	90.549	19.57	30	Pass
6	2437	21.40	21.24	271.083	24.33	30	Pass
11	2462	16.17	16.13	82.420	19.16	30	Pass

802.11n (HT20)

Channel	Frequency (MHz)	Average Power (dBm)		Total Power (mW)	Total Power (dBm)	Limit (dBm)	Pass / Fail
		Chain 0	Chain 1				
1	2412	16.67	16.44	90.507	19.57	30	Pass
6	2437	20.56	20.35	222.156	23.47	30	Pass
11	2462	15.82	15.78	76.038	18.81	30	Pass

802.11n (HT40)

Channel	Frequency (MHz)	Average Power (dBm)		Total Power (mW)	Total Power (dBm)	Limit (dBm)	Pass / Fail
		Chain 0	Chain 1				
3	2422	15.88	15.69	75.794	18.80	30	Pass
6	2437	17.02	16.77	97.884	19.91	30	Pass
9	2452	15.44	15.19	68.032	18.33	30	Pass

Beamforming Mode

802.11n (HT20)

Channel	Frequency (MHz)	Average Power (dBm)		Total Power (mW)	Total Power (dBm)	Limit (dBm)	Pass / Fail
		Chain 0	Chain 1				
1	2412	13.66	13.43	45.257	16.56	27.85	Pass
6	2437	17.55	17.34	111.085	20.46	27.85	Pass
11	2462	12.81	12.77	38.022	15.80	27.85	Pass

Note: Directional gain = $10 \log[(10^{G1/20} + 10^{G2/20} + \dots + 10^{GN/20})^2/2] = 8.15\text{dBi} > 6\text{dBi}$, so the power limit shall be reduced to $30-(8.15-6) = 27.85\text{dBm}$.

802.11n (HT40)

Channel	Frequency (MHz)	Average Power (dBm)		Total Power (mW)	Total Power (dBm)	Limit (dBm)	Pass / Fail
		Chain 0	Chain 1				
3	2422	12.87	12.68	37.900	15.79	27.85	Pass
6	2437	14.01	13.76	48.945	16.90	27.85	Pass
9	2452	12.43	12.18	34.018	15.32	27.85	Pass

Note: Directional gain = $10 \log[(10^{G1/20} + 10^{G2/20} + \dots + 10^{GN/20})^2/2] = 8.15\text{dBi} > 6\text{dBi}$, so the power limit shall be reduced to $30-(8.15-6) = 27.85\text{dBm}$.

4.5 Power Spectral Density Measurement

4.5.1 Limits of Power Spectral Density Measurement

The Maximum of Power Spectral Density Measurement is 8dBm.

4.5.2 Test Setup

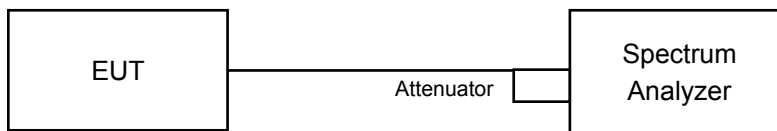

4.5.3 Test Instruments

Refer to section 4.1.2 to get information of above instrument.

4.5.4 Test Procedure

For duty cycle $\geq 98\%$

- Set instrument center frequency to DTS channel center frequency.
- Set span to at least 1.5 times the OBW.
- Set RBW to: $3 \text{ kHz} \leq \text{RBW} \leq 100 \text{ kHz}$.
- Set VBW $\geq 3 \times \text{RBW}$.
- Detector = power averaging (RMS) or sample detector (when RMS not available).
- Ensure that the number of measurement points in the sweep $\geq 2 \times \text{span}/\text{RBW}$.
- Sweep time = auto couple.
- Employ trace averaging (RMS) mode over a minimum of 100 traces.
- Use the peak marker function to determine the maximum amplitude level.

For duty cycle $< 98\%$

- Measure the duty cycle (x).
- Set instrument center frequency to DTS channel center frequency.
- Set span to at least 1.5 times the OBW.
- Set RBW to: $3 \text{ kHz} \leq \text{RBW} \leq 100 \text{ kHz}$.
- Set VBW $\geq 3 \times \text{RBW}$.
- Detector = power averaging (RMS) or sample detector (when RMS not available).
- Ensure that the number of measurement points in the sweep $\geq 2 \times \text{span}/\text{RBW}$.
- Sweep time = auto couple.
- Do not use sweep triggering. Allow sweep to "free run".
- Employ trace averaging (RMS) mode over a minimum of 100 traces.
- Use the peak marker function to determine the maximum amplitude level.
- Add $10 \log (1/x)$, where x is the duty cycle measured in step (a), to the measured PSD to compute the average PSD during the actual transmission time.

4.5.5 Deviation from Test Standard

No deviation.

4.5.6 EUT Operating Condition

Same as Item 4.3.6

4.5.7 Test Results

802.11b

TX chain	Channel	Frequency (MHz)	PSD (dBm)	10 log (N=2) dB	Total PSD (dBm)	Limit (dBm)	Pass / Fail
0	1	2412	-6.66	3.01	-3.65	5.85	Pass
	6	2437	-5.07	3.01	-2.06	5.85	Pass
	11	2462	-7.34	3.01	-4.33	5.85	Pass
1	1	2412	-7.32	3.01	-4.31	5.85	Pass
	6	2437	-6.24	3.01	-3.23	5.85	Pass
	11	2462	-7.56	3.01	-4.55	5.85	Pass

Note:

- Method 1 of power density measurement of KDB 662911 is using for calculating total power density. Total power density is summing entire spectra across corresponding frequency bins on the various outputs by computer.
- Directional gain = $10 \log[(10^{G1/20} + 10^{G2/20} + \dots + 10^{GN/20})^2/2] = 8.15 > 6\text{dBi}$, so the power density limit shall be reduced to $8-(8.15-6) = 5.85\text{dBm}$

802.11g

TX chain	Channel	Frequency (MHz)	PSD (dBm)	10 log (N=2) dB	Duty Factor	Total PSD with Duty Factor (dBm)	Limit (dBm)	Pass / Fail
0	1	2412	-14.57	3.01	0.24	-11.32	5.85	Pass
	6	2437	-9.46	3.01	0.24	-6.21	5.85	Pass
	11	2462	-14.52	3.01	0.24	-11.27	5.85	Pass
1	1	2412	-14.54	3.01	0.24	-11.29	5.85	Pass
	6	2437	-9.86	3.01	0.24	-6.61	5.85	Pass
	11	2462	-14.55	3.01	0.24	-11.30	5.85	Pass

Note:

- Method 1 of power density measurement of KDB 662911 is using for calculating total power density. Total power density is summing entire spectra across corresponding frequency bins on the various outputs by computer.
- Directional gain = $10 \log[(10^{G1/20} + 10^{G2/20} + \dots + 10^{GN/20})^2/2] = 8.15 > 6\text{dBi}$, so the power density limit shall be reduced to $8-(8.15-6) = 5.85\text{dBm}$
- Refer to section 3.3 for duty cycle spectrum plot.

802.11n (HT20)

TX chain	Channel	Frequency (MHz)	PSD (dBm)	10 log (N=2) dB	Duty Factor	Total PSD with Duty Factor (dBm)	Limit (dBm)	Pass / Fail
0	1	2412	-14.37	3.01	0.10	-11.26	5.85	Pass
	6	2437	-10.34	3.01	0.10	-7.23	5.85	Pass
	11	2462	-15.38	3.01	0.10	-12.27	5.85	Pass
1	1	2412	-14.89	3.01	0.10	-11.78	5.85	Pass
	6	2437	-11.26	3.01	0.10	-8.15	5.85	Pass
	11	2462	-15.74	3.01	0.10	-12.63	5.85	Pass

Note:

- Method 1 of power density measurement of KDB 662911 is using for calculating total power density. Total power density is summing entire spectra across corresponding frequency bins on the various outputs by computer.
- Directional gain = $10 \log[(10^{G1/20} + 10^{G2/20} + \dots + 10^{GN/20})^2/2] = 8.15 > 6\text{dBi}$, so the power density limit shall be reduced to $8-(8.15-6) = 5.85\text{dBm}$

802.11n (HT40)

TX chain	Channel	Frequency (MHz)	PSD (dBm)	10 log (N=2) dB	Duty Factor	Total PSD with Duty Factor (dBm)	Limit (dBm)	Pass / Fail
0	3	2422	-18.33	3.01	0.16	-15.16	5.85	Pass
	6	2437	-17.49	3.01	0.16	-14.32	5.85	Pass
	9	2452	-18.63	3.01	0.16	-15.46	5.85	Pass
1	3	2422	-18.45	3.01	0.16	-15.28	5.85	Pass
	6	2437	-17.32	3.01	0.16	-14.15	5.85	Pass
	9	2452	-18.64	3.01	0.16	-15.47	5.85	Pass

Note:

- Method 1 of power density measurement of KDB 662911 is using for calculating total power density. Total power density is summing entire spectra across corresponding frequency bins on the various outputs by computer.
- Directional gain = $10 \log[(10^{G1/20} + 10^{G2/20} + \dots + 10^{GN/20})^2/2] = 8.15 > 6\text{dBi}$, so the power density limit shall be reduced to $8-(8.15-6) = 5.85\text{dBm}$
- Refer to section 3.3 for duty cycle spectrum plot.

Spectrum Plot of Worst Value

802.11b

802.11g

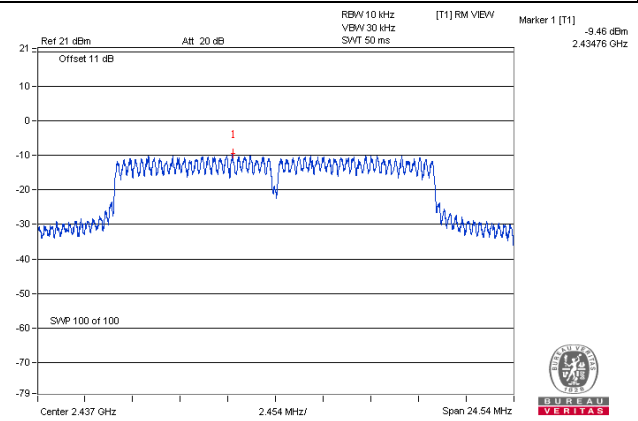
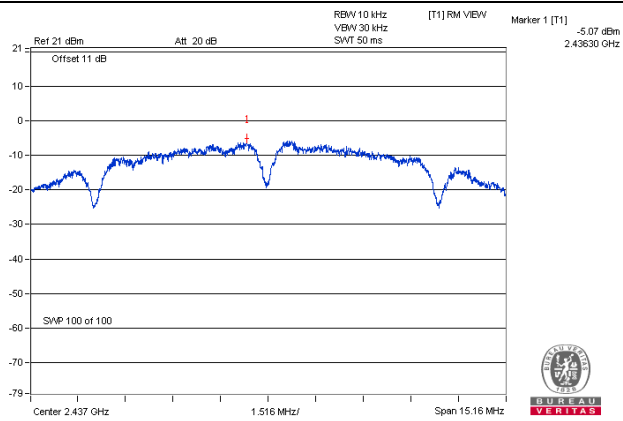

802.11n (HT20)

802.11n (HT40)

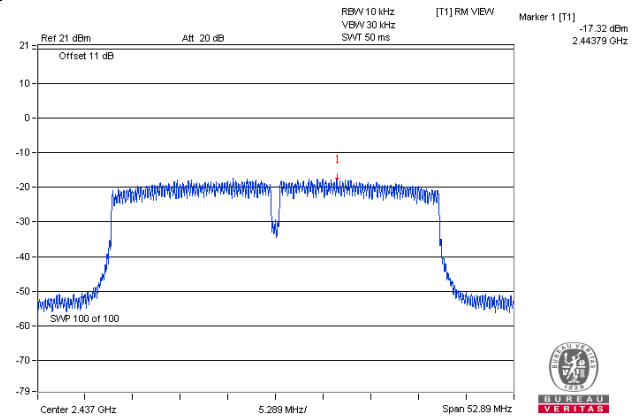
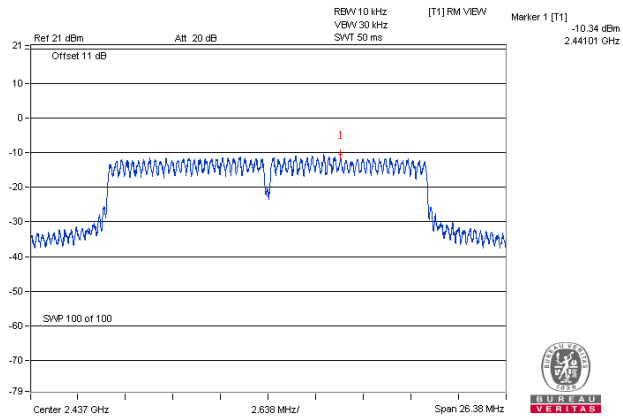

4.6 Conducted Out of Band Emission Measurement

4.6.1 Limits of Conducted Out of Band Emission Measurement

Below 30dB of the highest emission level of operating band (in 100kHz Resolution Bandwidth).

4.6.2 Test Setup

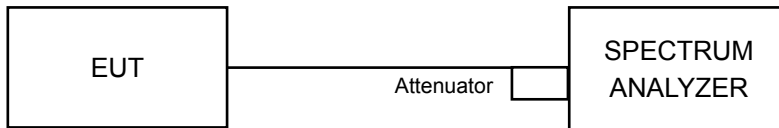

4.6.3 Test Instruments

Refer to section 4.1.2 to get information of above instrument.

4.6.4 Test Procedure

MEASUREMENT PROCEDURE REF

- Set the RBW = 100 kHz.
- Set the VBW \geq 300 kHz.
- Detector = average.
- Sweep time = auto couple.
- Trace mode = max hold.
- Allow trace to fully stabilize.
- Use the peak marker function to determine the maximum power level in any 100 kHz band segment within the fundamental EBW.

MEASUREMENT PROCEDURE OOBE

- Set RBW = 100 kHz.
- Set VBW \geq 300 kHz.
- Ensure that the number of measurement points \geq span/RBW
- According to measurement points to set differ measurement span.
- Detector = average.
- Trace Mode = max hold.
- Sweep = auto couple.

4.6.5 Deviation from Test Standard

No deviation.

4.6.6 EUT Operating Condition

Same as Item 4.3.6

4.6.7 Test Results

The spectrum plots are attached on the following pages. D1 line indicates the highest level, and D2 line indicates the 30dB offset below D1. It shows compliance with the requirement.

802.11b_Chain 0

CH 1

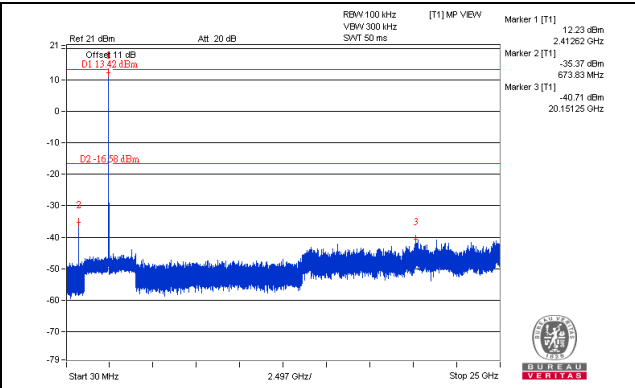
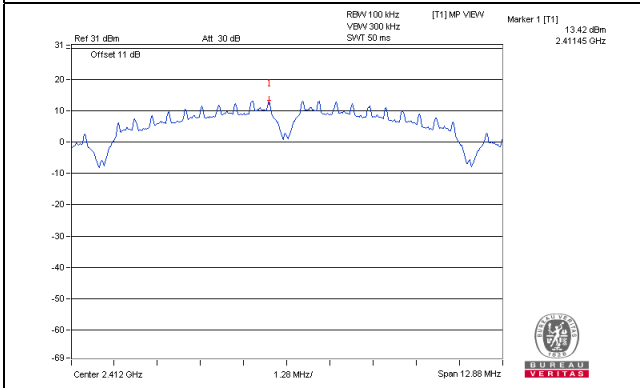

CH 6

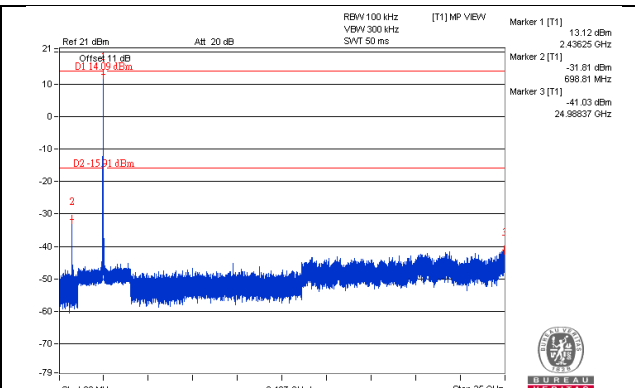
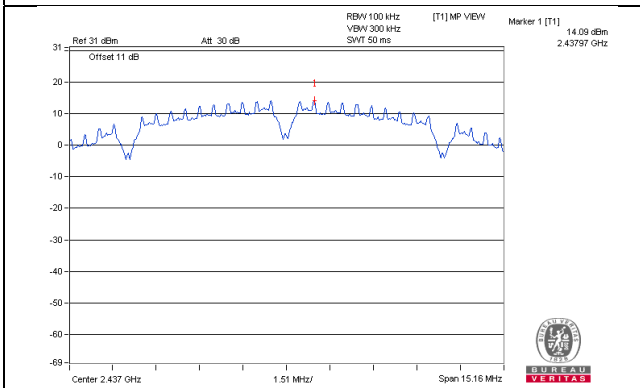

CH 11

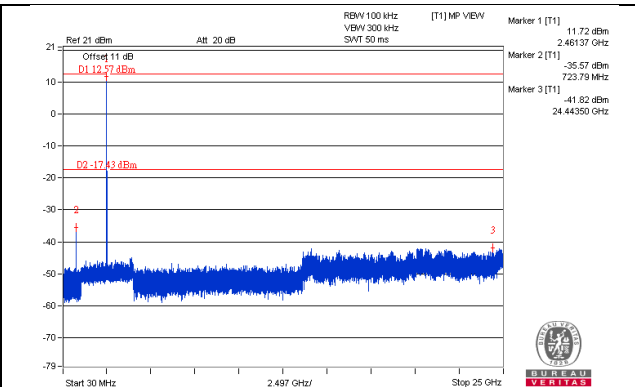
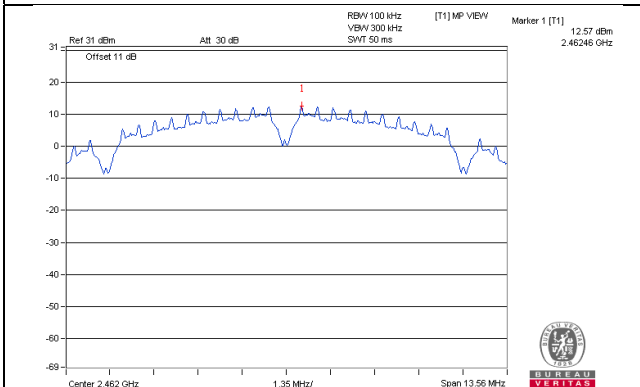

CH 1 Band edge

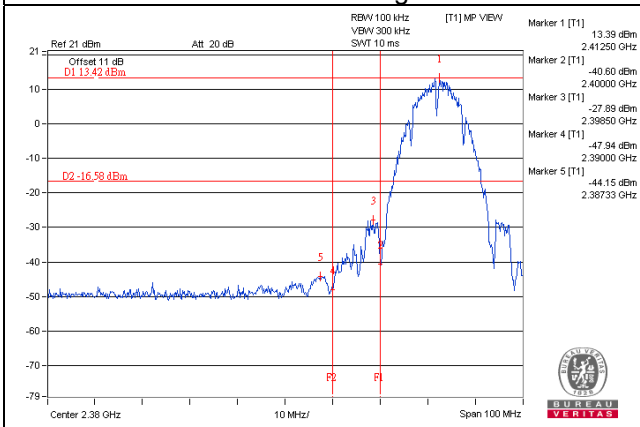

CH 11 Band edge

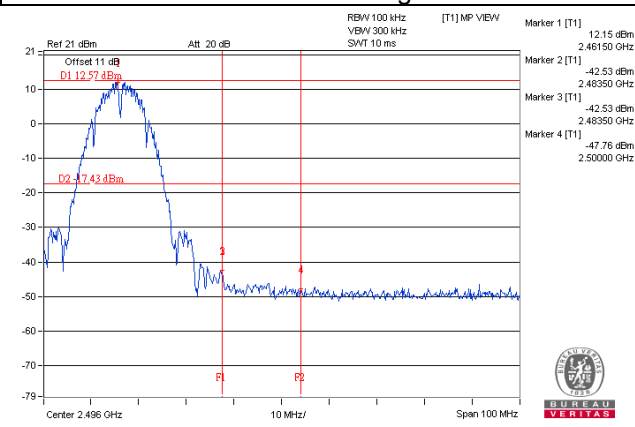

802.11b_Chain 1

CH 1

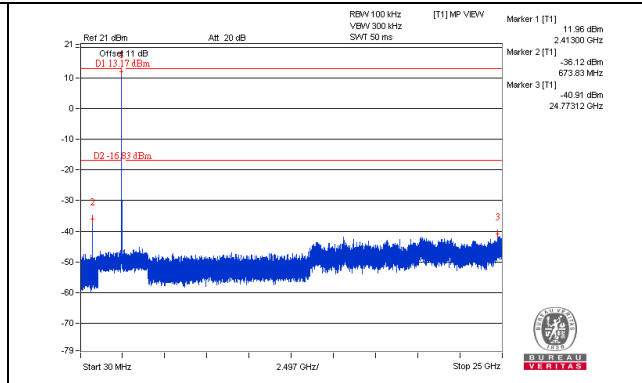
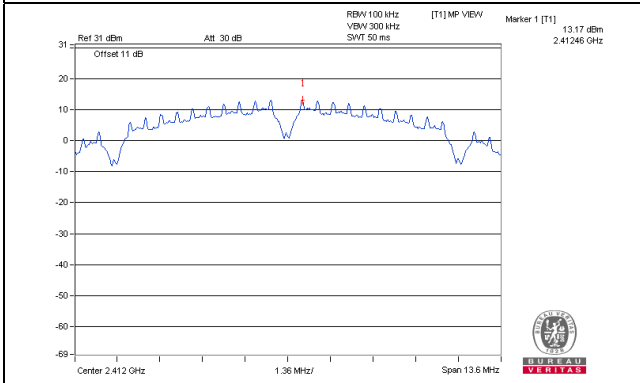

CH 6

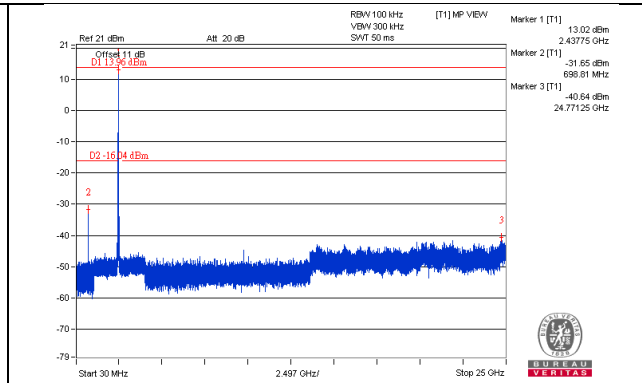
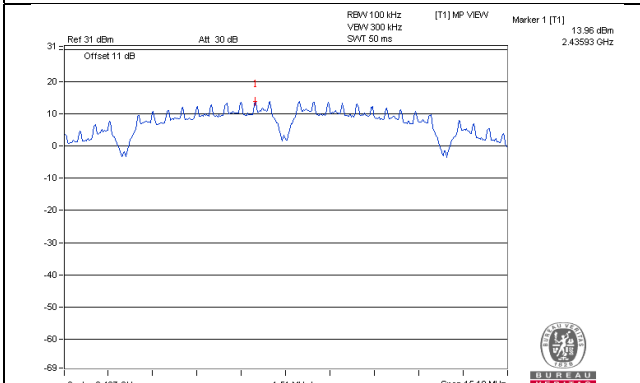

CH 11

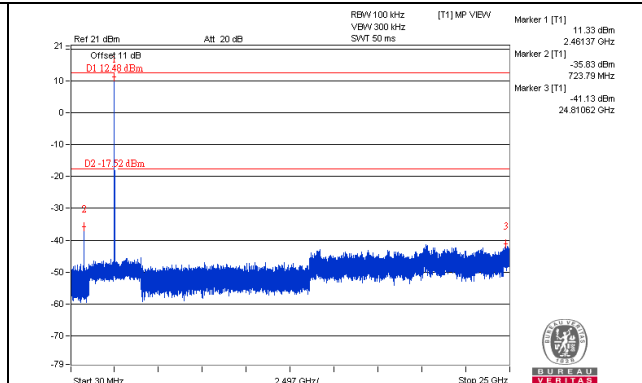
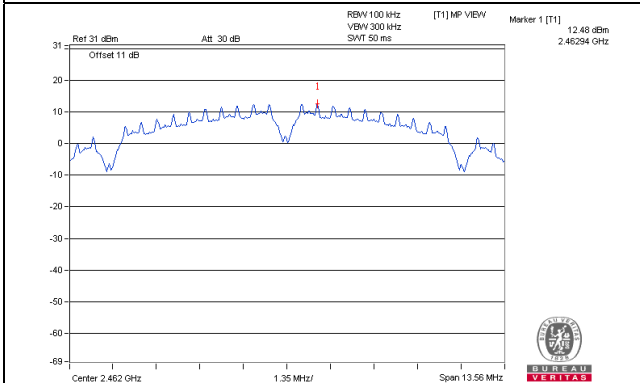

CH 1 Band edge

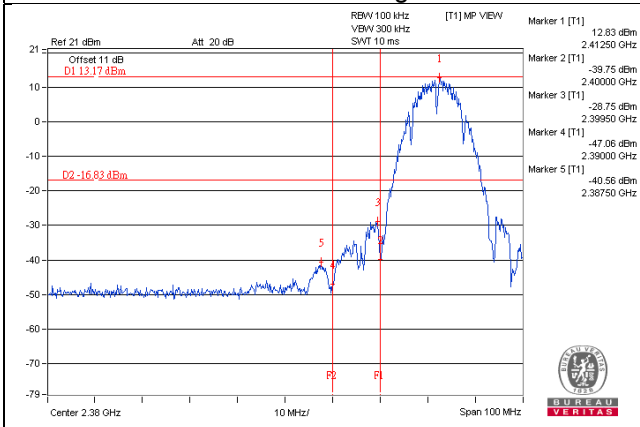

CH 11 Band edge

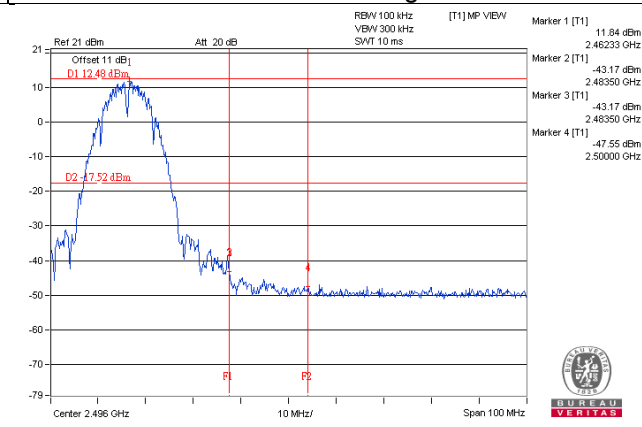

802.11g_Chain 0

CH 1

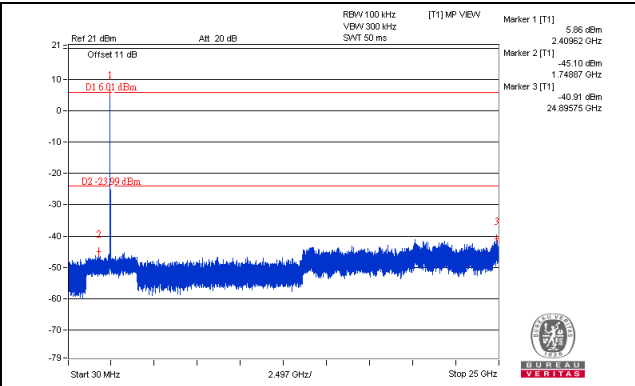
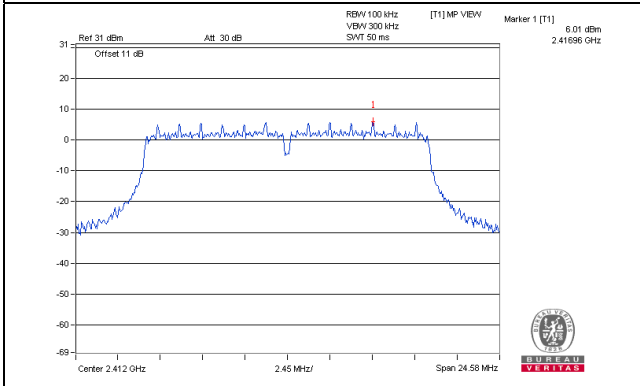

CH 6

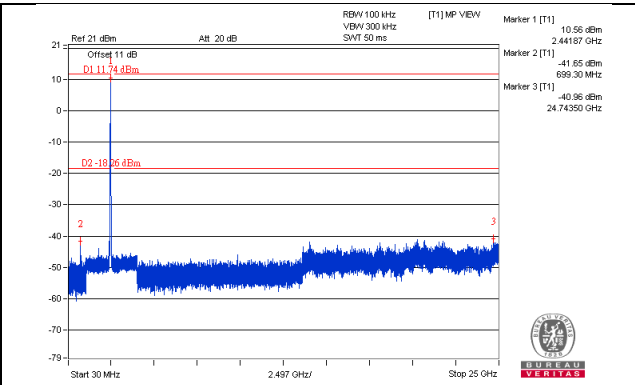
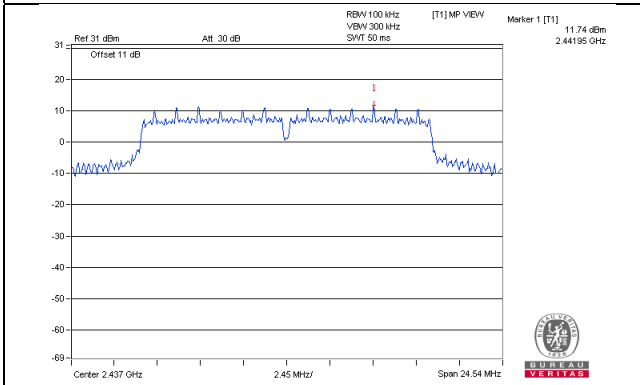

CH 11

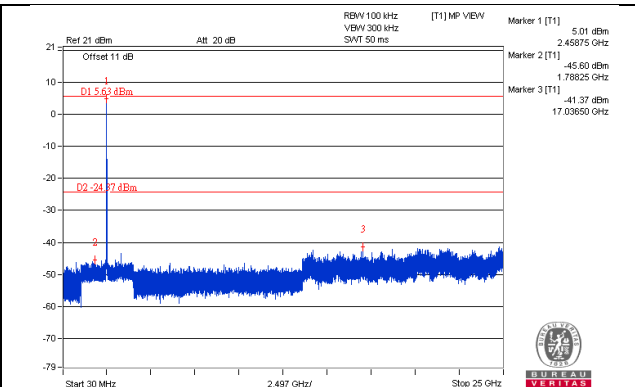
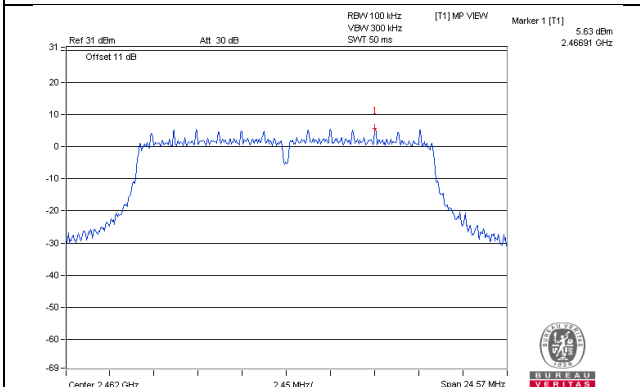

CH 1 Band edge

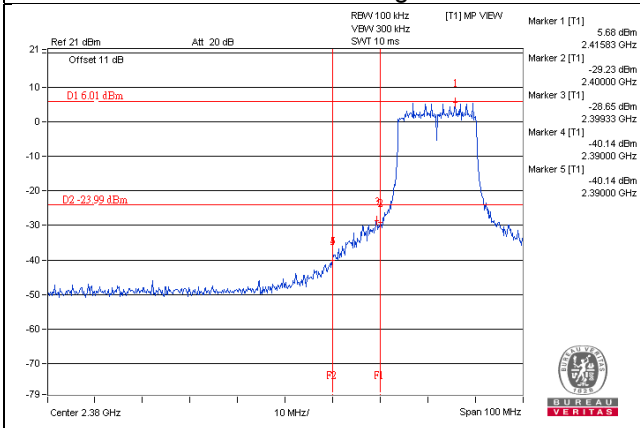

CH 11 Band edge

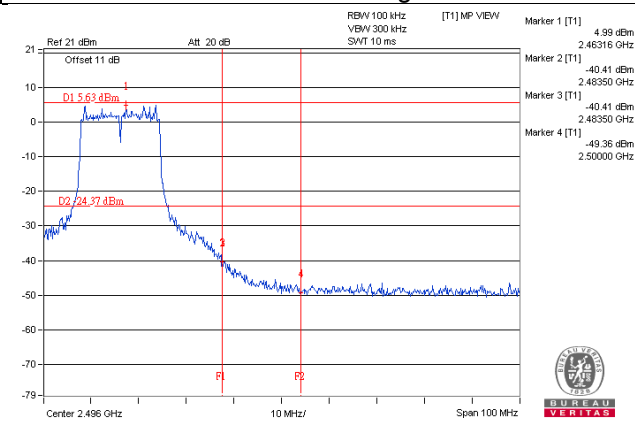

802.11g_Chain 1

CH 1

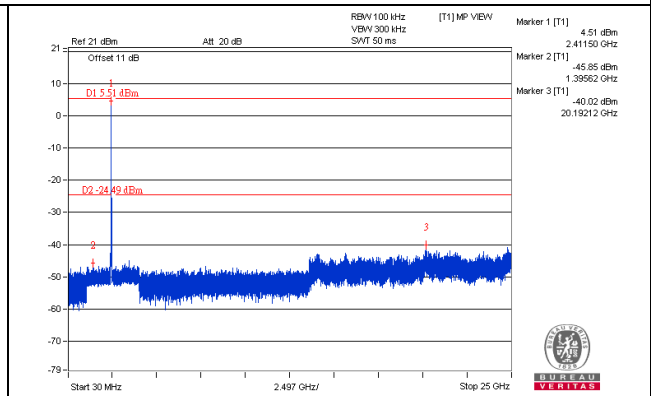
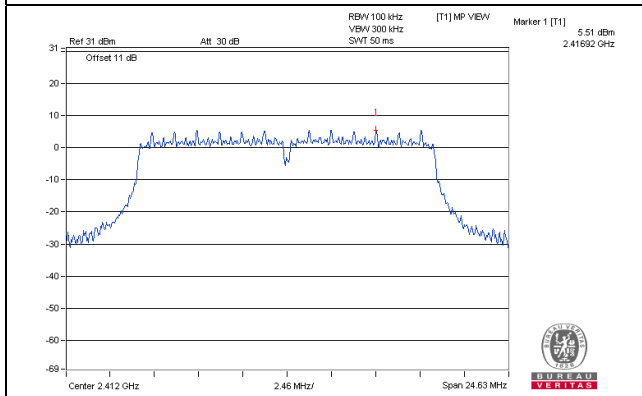

CH 6

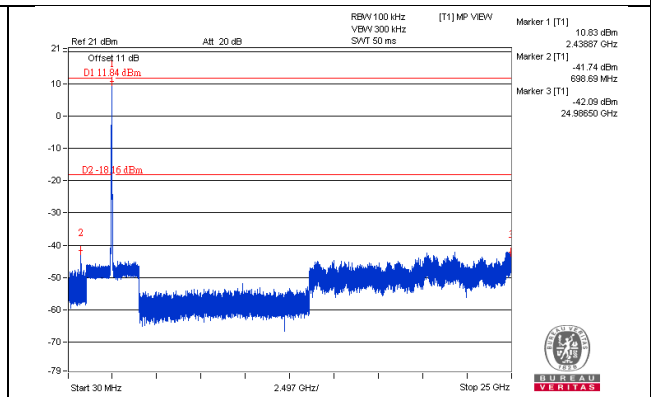
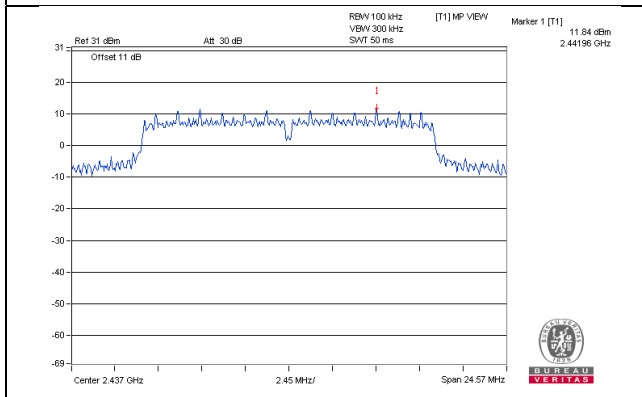

CH 11

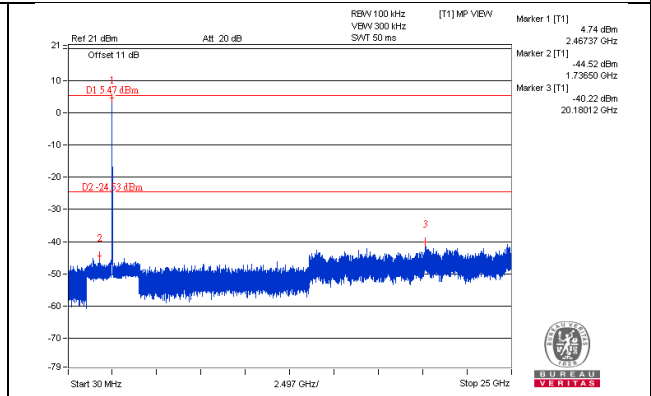
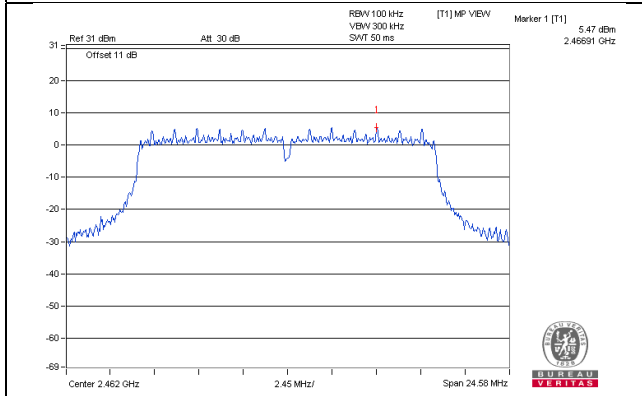

CH 1 Band edge

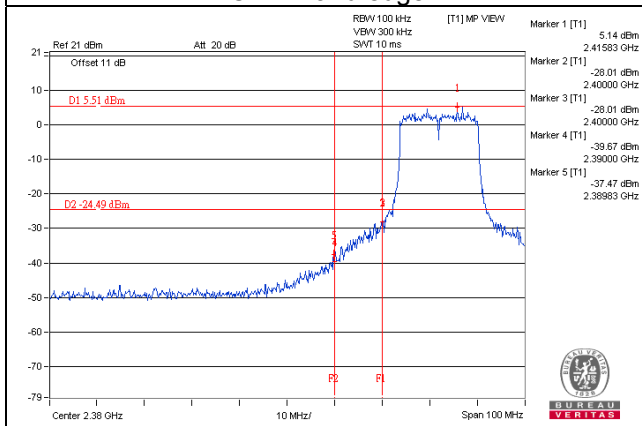

CH 11 Band edge

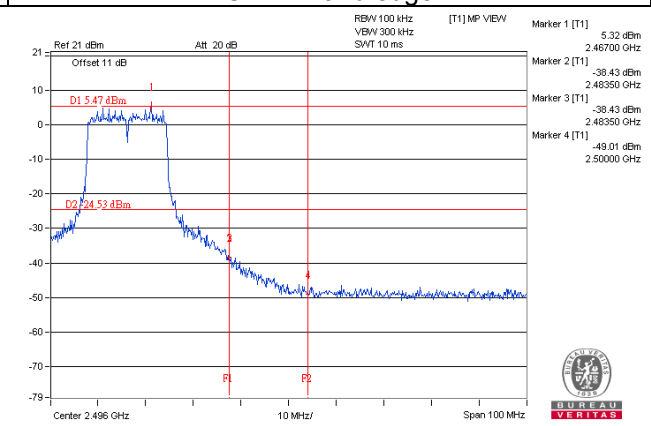

802.11n (HT20)_Chain 0

CH 1

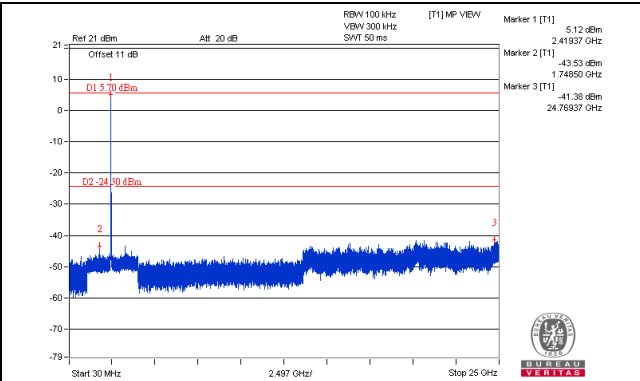
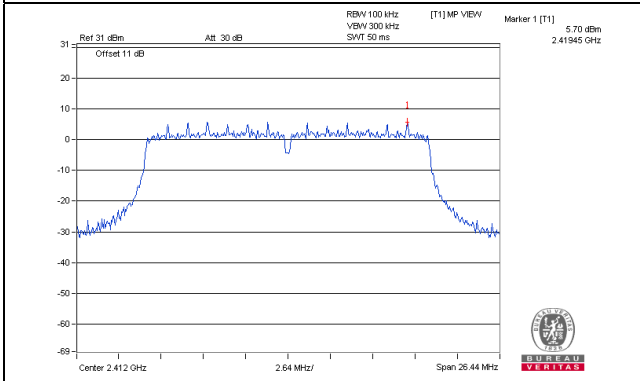

CH 6

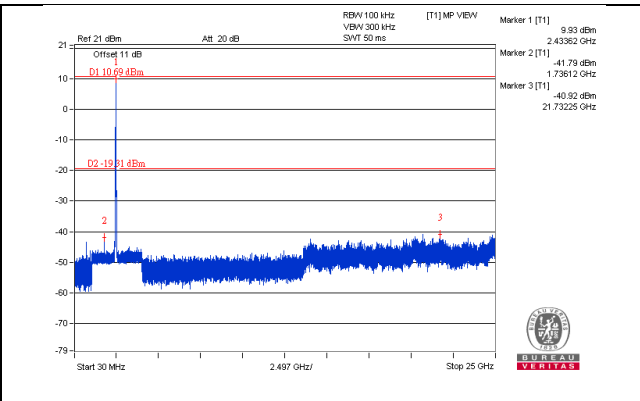
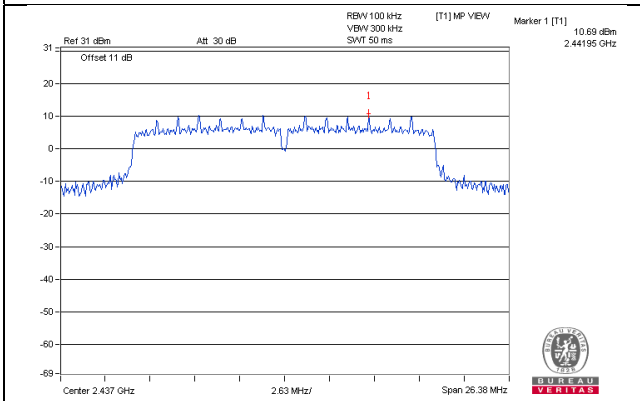

CH 11

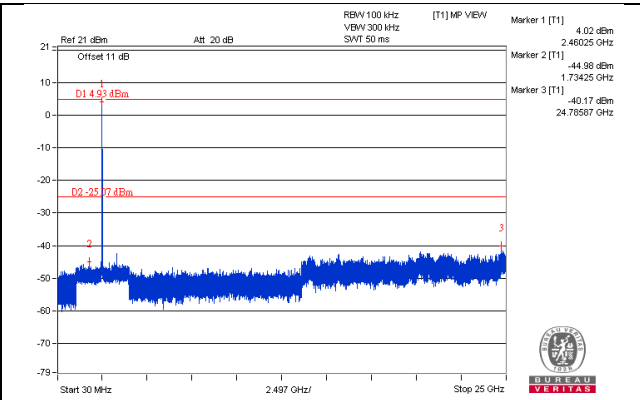
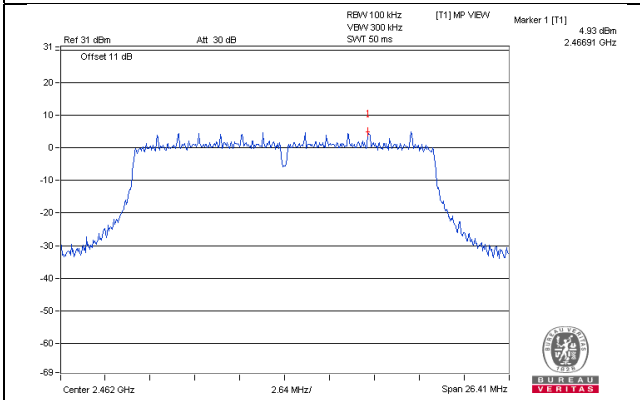

CH 1 Band edge

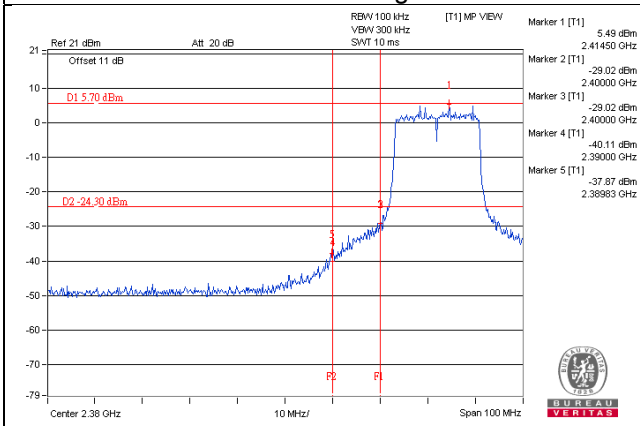

CH 11 Band edge

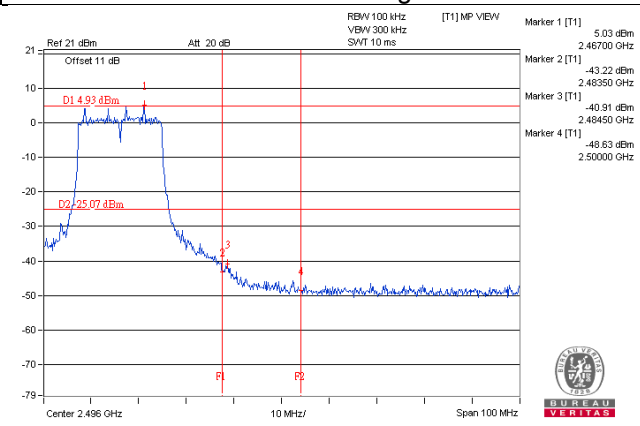

802.11n (HT20)_Chain 1

CH 1

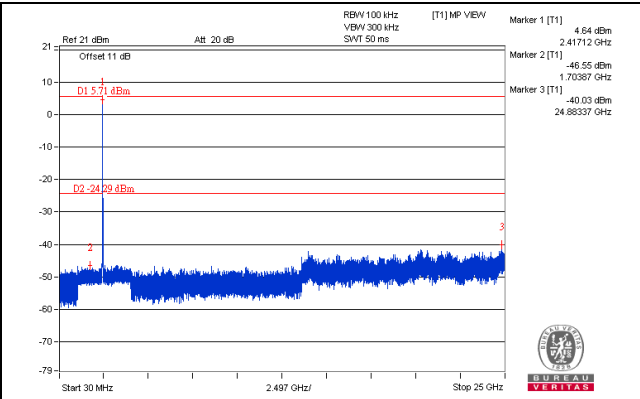
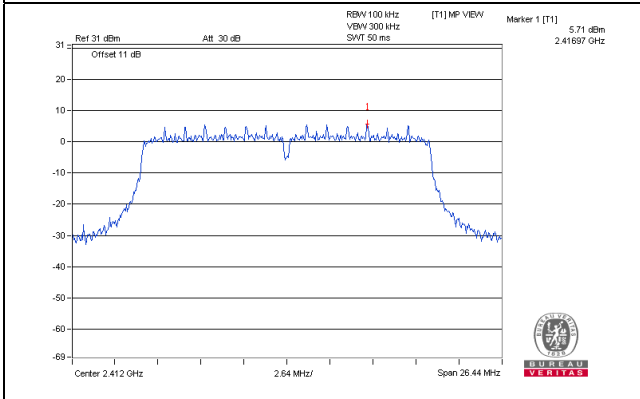

CH 6

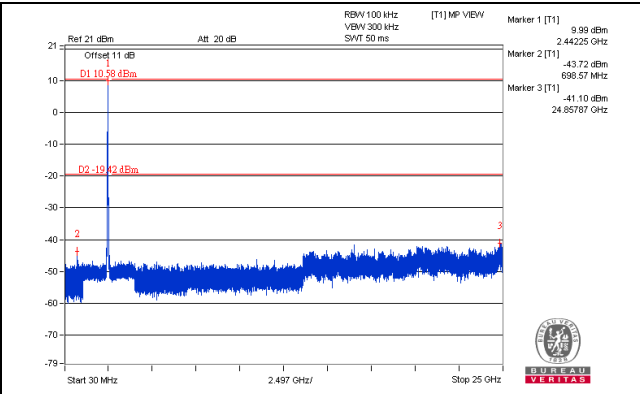
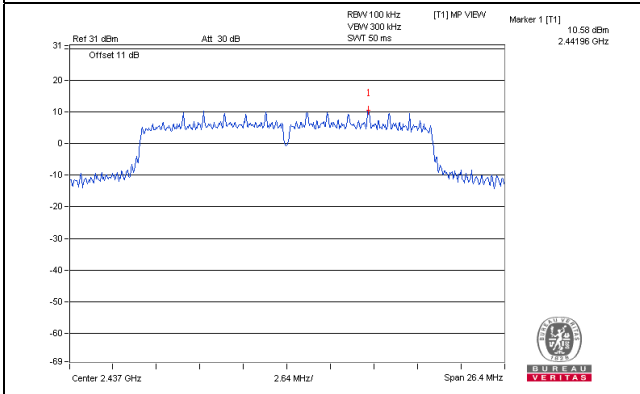

CH 11

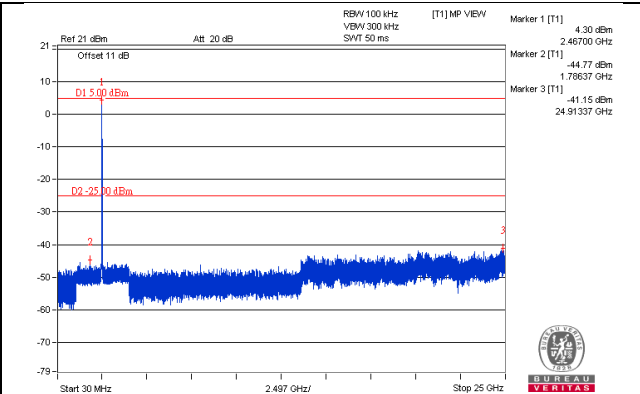
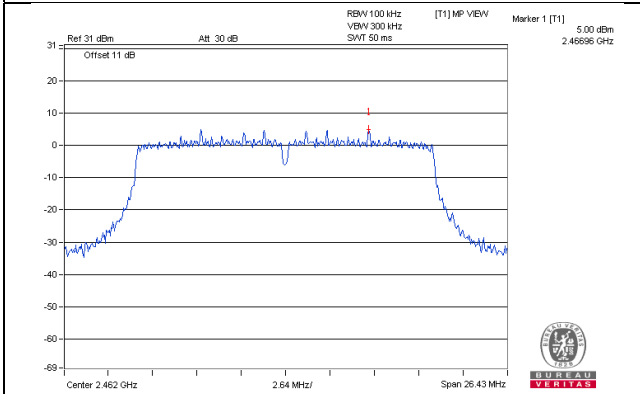

CH 1 Band edge

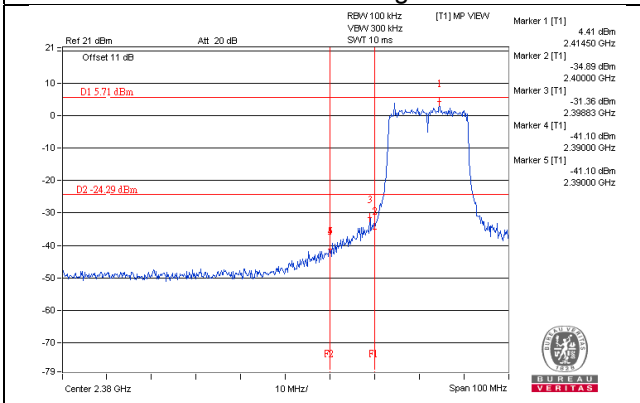

CH 11 Band edge

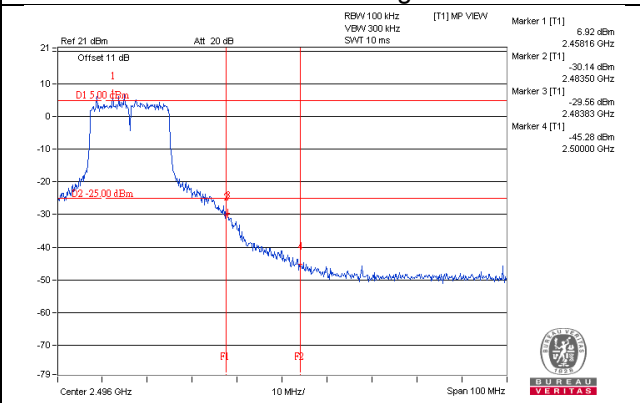

802.11n (HT40)_Chain 0

CH 3

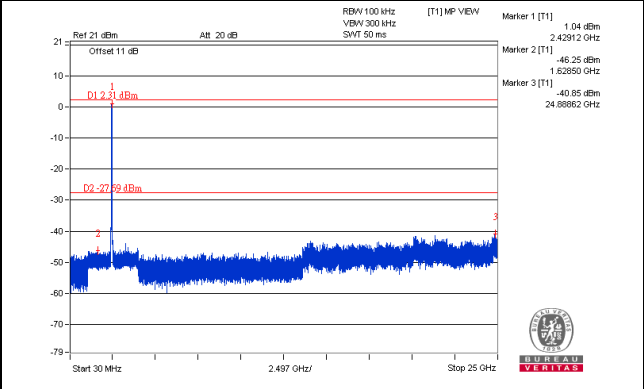
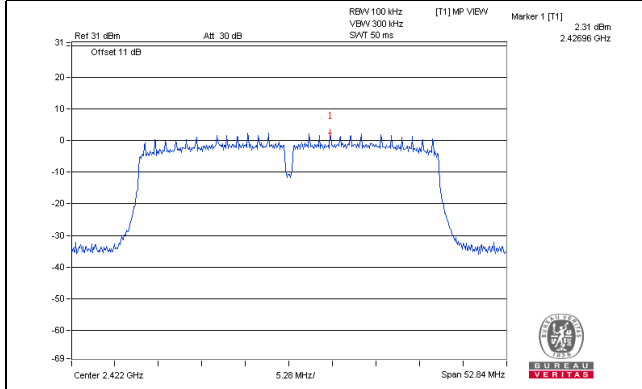

CH 6

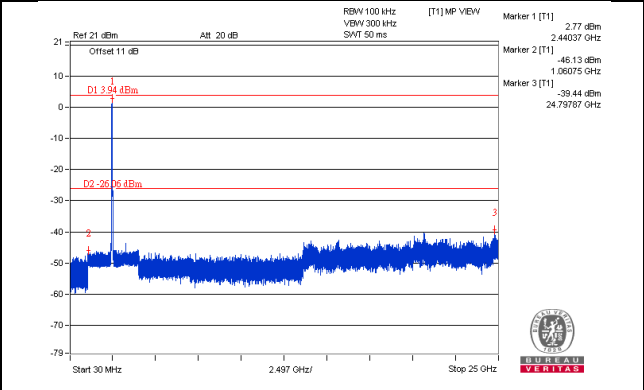
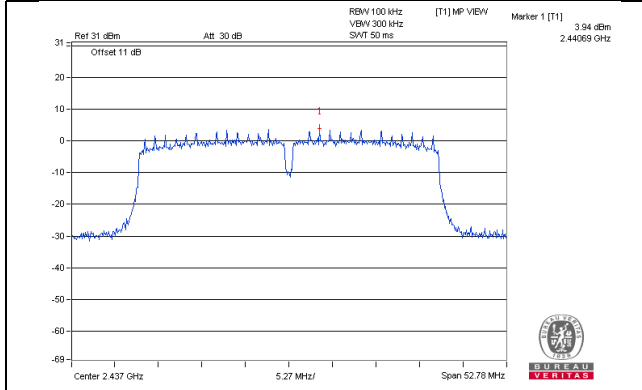

CH 9

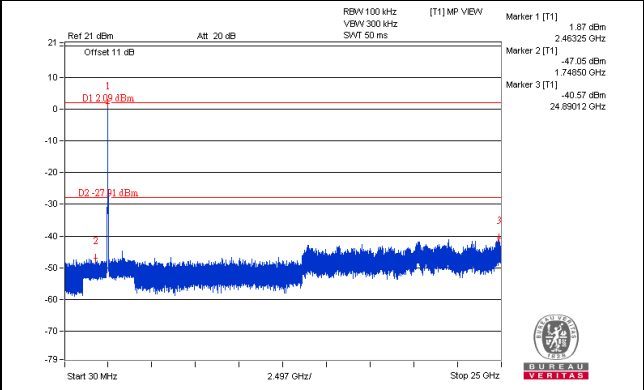
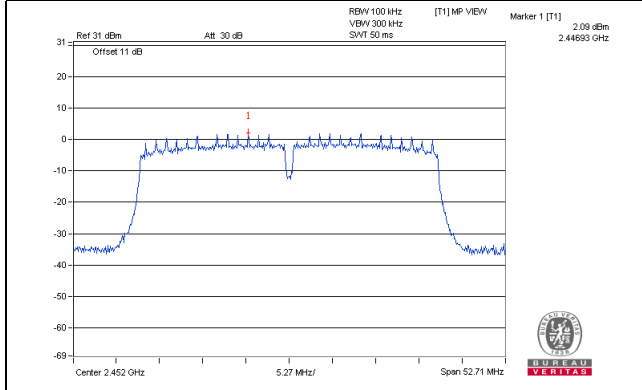

CH 3 Band edge

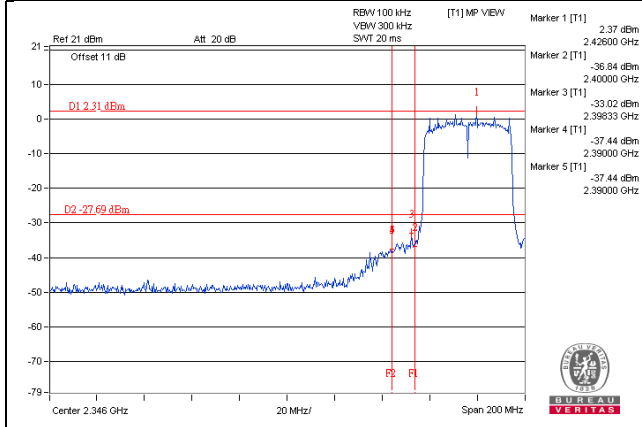

CH 9 Band edge

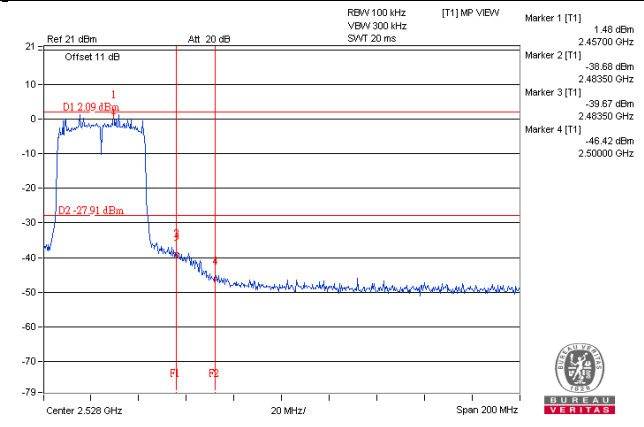

802.11n (HT40)_Chain 1

CH 3

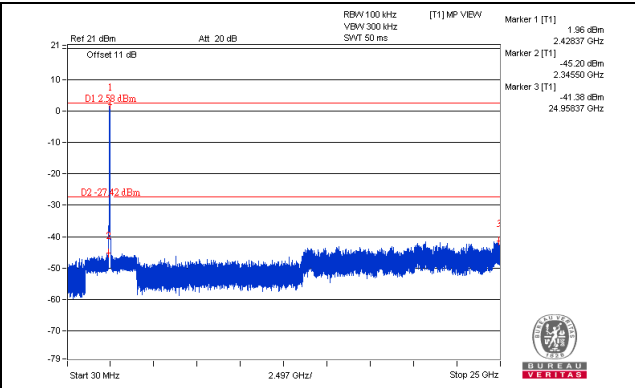
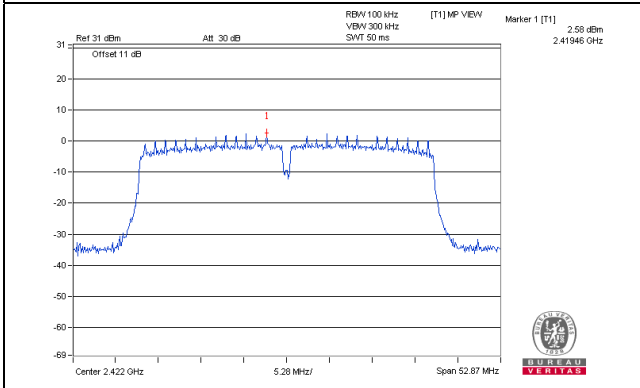

CH 6

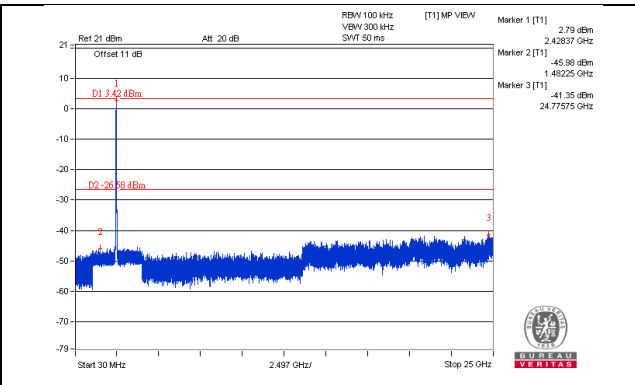
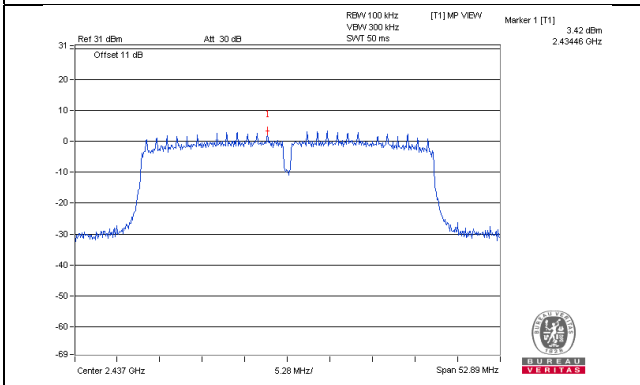

CH 9

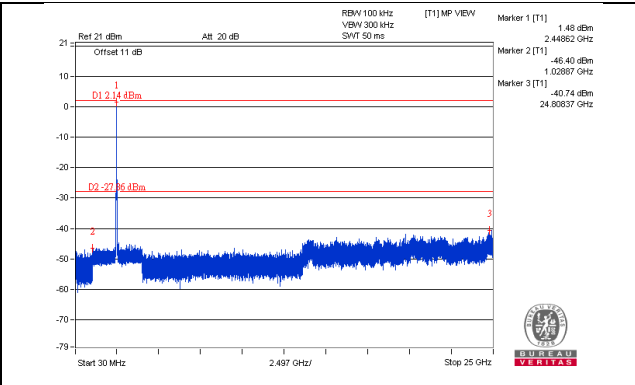
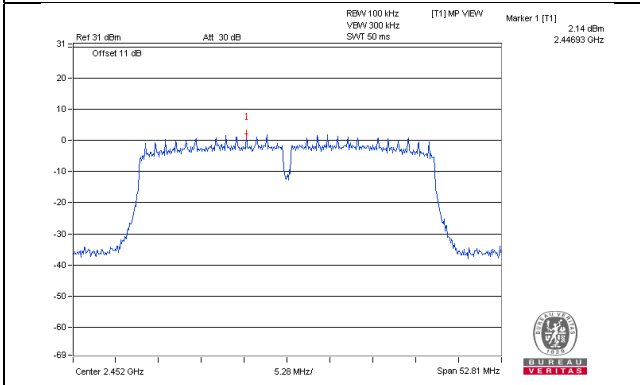

CH 3 Band edge

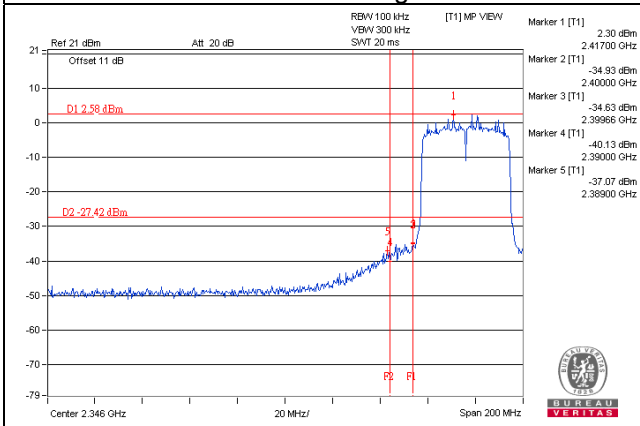

CH 9 Band edge

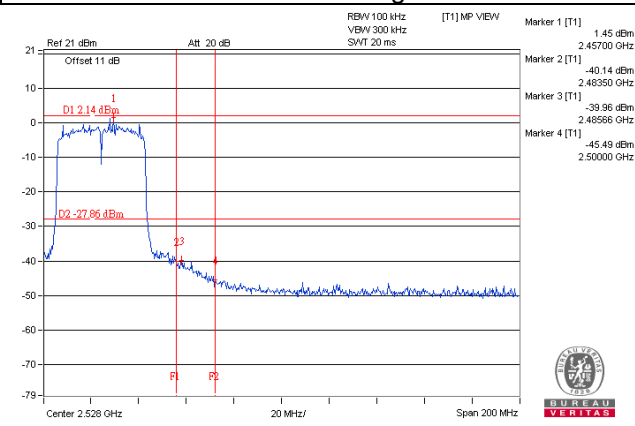

5 Pictures of Test Arrangements

Please refer to the attached file (Test Setup Photo).

Appendix – Information on the Testing Laboratories

We, Bureau Veritas Consumer Products Services (H.K.) Ltd., Taoyuan Branch, were founded in 1988 to provide our best service in EMC, Radio, Telecom and Safety consultation. Our laboratories are accredited and approved according to ISO/IEC 17025.

If you have any comments, please feel free to contact us at the following:

Linko EMC/RF Lab

Tel: 886-2-26052180

Fax: 886-2-26051924

Hsin Chu EMC/RF/Telecom Lab

Tel: 886-3-6668565

Fax: 886-3-6668323

Hwa Ya EMC/RF/Safety Lab

Tel: 886-3-3183232

Fax: 886-3-3270892

Email: service.adt@tw.bureauveritas.com

Web Site: www.bureauveritas-adt.com

The address and road map of all our labs can be found in our web site also.

--- END ---