

## FCC Test Report

**Report No.:** RF170314C06A

**FCC ID:** UDX-60053010

**Test Model:** Z3-HW

**Received Date:** Mar. 14, 2017

**Test Date:** Mar. 27 ~ May 03, 2017

**Issued Date:** May 09, 2017

**Applicant:** Cisco Systems, Inc.

**Address:** 170 West Tasman Drive, San Jose, CA 95134

**Issued By:** Bureau Veritas Consumer Products Services (H.K.) Ltd., Taoyuan Branch

**Lab Address:** No. 47-2, 14th Ling, Chia Pau Vil., Lin Kou Dist., New Taipei City, Taiwan, R.O.C.

**Test Location:** No. 19, Hwa Ya 2nd Rd., Wen Hwa Vil., Kwei Shan Dist., Taoyuan City 33383, TAIWAN (R.O.C.)



This report is for your exclusive use. Any copying or replication of this report to or for any other person or entity, or use of our name or trademark, is permitted only with our prior written permission. This report sets forth our findings solely with respect to the test samples identified herein. The results set forth in this report are not indicative or representative of the quality or characteristics of the lot from which a test sample was taken or any similar or identical product unless specifically and expressly noted. Our report includes all of the tests requested by you and the results thereof based upon the information that you provided to us. You have 60 days from date of issuance of this report to notify us of any material error or omission caused by our negligence, provided, however, that such notice shall be in writing and shall specifically address the issue you wish to raise. A failure to raise such issue within the prescribed time shall constitute your unqualified acceptance of the completeness of this report, the tests conducted and the correctness of the report contents. Unless specifically mentioned, the uncertainty of measurement has been explicitly taken into account to declare the compliance or non-compliance to the specification. The report must not be used by the client to claim product certification, approval, or endorsement by TAF or any government agencies.

## Table of Contents

<b>Release Control Record</b> .....	<b>4</b>
<b>1 Certificate of Conformity</b> .....	<b>5</b>
<b>2 Summary of Test Results</b> .....	<b>6</b>
2.1 Measurement Uncertainty.....	6
2.2 Modification Record.....	6
<b>3 General Information</b> .....	<b>7</b>
3.1 General Description of EUT.....	7
3.2 Description of Test Modes.....	9
3.2.1 Test Mode Applicability and Tested Channel Detail.....	10
3.3 Duty Cycle of Test Signal.....	12
3.4 Description of Support Units.....	13
3.4.1 Configuration of System under Test.....	13
3.5 General Description of Applied Standards.....	14
<b>4 Test Types and Results</b> .....	<b>15</b>
4.1 Radiated Emission and Bandedge Measurement.....	15
4.1.1 Limits of Radiated Emission and Bandedge Measurement.....	15
4.1.2 Test Instruments.....	16
4.1.3 Test Procedures.....	17
4.1.4 Deviation from Test Standard.....	18
4.1.5 Test Setup.....	18
4.1.6 EUT Operating Conditions.....	19
4.1.7 Test Results.....	20
4.2 Conducted Emission Measurement.....	40
4.2.1 Limits of Conducted Emission Measurement.....	40
4.2.2 Test Instruments.....	40
4.2.3 Test Procedures.....	41
4.2.4 Deviation from Test Standard.....	41
4.2.5 Test Setup.....	41
4.2.6 EUT Operating Conditions.....	41
4.2.7 Test Results.....	42
4.3 Transmit Power Measurement.....	44
4.3.1 Limits of Transmit Power Measurement.....	44
4.3.2 Test Setup.....	44
4.3.3 Test Instruments.....	44
4.3.4 Test Procedure.....	45
4.3.5 Deviation from Test Standard.....	45
4.3.6 EUT Operating Conditions.....	45
4.3.7 Test Result.....	46
4.4 Occupied Bandwidth Measurement.....	53
4.4.1 Test Setup.....	53
4.4.2 Test Instruments.....	53
4.4.3 Test Procedure.....	53
4.4.4 Test Result.....	54
4.5 Peak Power Spectral Density Measurement.....	58
4.5.1 Limits of Peak Power Spectral Density Measurement.....	58
4.5.2 Test Setup.....	58
4.5.3 Test Instruments.....	58
4.5.4 Test Procedures.....	58
4.5.5 Deviation from Test Standard.....	58
4.5.6 EUT Operating Conditions.....	58
4.5.7 Test Results.....	59
4.6 Frequency Stability.....	62
4.6.1 Limits of Frequency Stability Measurement.....	62

4.6.2 Test Setup.....	62
4.6.3 Test Instruments .....	62
4.6.4 Test Procedure .....	62
4.6.5 Deviation from Test Standard .....	62
4.6.6 EUT Operating Condition .....	62
4.6.7 Test Results .....	63
<b>5 Pictures of Test Arrangements.....</b>	<b>64</b>
<b>Appendix – Information on the Testing Laboratories .....</b>	<b>65</b>

### Release Control Record

Issue No.	Description	Date Issued
RF170314C06A	Original release	May 09, 2017

## 1 Certificate of Conformity

**Product:** 802.11a/b/g/n/ac Wireless Security Appliance

**Brand:** Cisco

**Test Model:** Z3-HW

**Sample Status:** Engineering sample

**Applicant:** Cisco Systems, Inc.

**Test Date:** Mar. 27 ~ May 03, 2017

**Standards:** 47 CFR FCC Part 15, Subpart E (Section 15.407)  
ANSI C63.10:2013

The above equipment has been tested by **Bureau Veritas Consumer Products Services (H.K.) Ltd., Taoyuan Branch**, and found compliance with the requirement of the above standards. The test record, data evaluation & Equipment Under Test (EUT) configurations represented herein are true and accurate accounts of the measurements of the sample's EMC characteristics under the conditions specified in this report.

**Prepared by :**  , **Date:** May 09, 2017  
Pettie Chen / Senior Specialist

**Approved by :**  , **Date:** May 09, 2017  
Ken Liu / Senior Manager

## 2 Summary of Test Results

47 CFR FCC Part 15, Subpart E (Section 15.407)			
FCC Clause	Test Item	Result	Remarks
15.407(b)(6)	AC Power Conducted Emissions	Pass	Meet the requirement of limit. Minimum passing margin is -18.66dB at 0.38401MHz.
15.407(b) (1/2/3/4(i/ii)/6)	Radiated Emissions & Band Edge Measurement	Pass	Meet the requirement of limit. Minimum passing margin is -1.2dB at 5725.00MHz.
15.407(a) (1/2/3)	Max Average Transmit Power	Pass	Meet the requirement of limit.
---	Occupied Bandwidth Measurement	-	Reference only.
15.407(a) (1/2/3)	Peak Power Spectral Density	Pass	Meet the requirement of limit.
15.407(g)	Frequency Stability	Pass	Meet the requirement of limit.
15.203	Antenna Requirement	Pass	Antenna connector is IPEX not a standard connector.

### 2.1 Measurement Uncertainty

Where relevant, the following measurement uncertainty levels have been estimated for tests performed on the EUT as specified in CISPR 16-4-2:

Measurement	Frequency	Expanded Uncertainty (k=2) ( $\pm$ )
Conducted Emissions at mains ports	150kHz ~ 30MHz	2.94 dB
Radiated Emissions up to 1 GHz	30MHz ~ 200MHz	3.59 dB
	200MHz ~ 1000MHz	3.60 dB
Radiated Emissions above 1 GHz	1GHz ~ 18GHz	2.29 dB
	18GHz ~ 40GHz	2.29 dB

### 2.2 Modification Record

There were no modifications required for compliance.

### 3 General Information

#### 3.1 General Description of EUT

Product	802.11a/b/g/n/ac Wireless Security Appliance
Brand	Cisco
Test Model	Z3-HW
Status of EUT	Engineering sample
Power Supply Rating	54Vdc (adapter)
Modulation Type	256QAM, 64QAM, 16QAM, QPSK, BPSK for OFDM
Modulation Technology	OFDM
Transfer Rate	802.11a: 54/48/36/24/18/12/9/6Mbps 802.11n: up to 300Mbps 802.11ac: up to 867Mbps
Operating Frequency	5260 ~ 5320MHz, 5500 ~ 5700MHz
Number of Channel	5260 ~ 5320MHz: 802.11a, 802.11n (HT20), 802.11ac (VHT20): 4 802.11n (HT40), 802.11ac (VHT40): 2 802.11ac (VHT80): 1 5500 ~ 5700MHz: 802.11a, 802.11n (HT20), 802.11ac (VHT20): 11 802.11n (HT40), 802.11ac (VHT40): 5 802.11ac (VHT80): 2
Output Power	CDD Mode 5260 ~ 5320MHz: 162.945mW 5500 ~ 5700MHz: 182.091mW Beamforming Mode 5260 ~ 5320MHz: 81.478mW 5500 ~ 5700MHz: 91.052mW
Antenna Type	Antenna 1: PIFA antenna with 5.20dBi gain Antenna 2: PIFA antenna with 5.80dBi gain
Antenna Connector	IPEX
Accessory Device	Adapter
Data Cable Supplied	NA

Note:

1. This report is prepared for FCC class II permissive change. The differences compared with the original report (BV ADT report no.: RF170314C06-2) is adding 5.26GHz to 5.32GHz & 5.50GHz to 5.70GHz by software.

2. The EUT incorporates a MIMO function. Physically, the EUT provides 2 completed transmitters and 2 receivers.

Band	Modulation Mode	TX Function	Beamforming
5GHz	802.11a	2TX	Not Support
	802.11n (HT20)	2TX	Support
	802.11n (HT40)	2TX	Support
	802.11ac (VHT20)	2TX	Support
	802.11ac (VHT40)	2TX	Support
	802.11ac (VHT80)	2TX	Support

\* The modulation and bandwidth are similar for 802.11n mode for 20MHz/40MHz and 802.11ac mode for 20MHz/40MHz, therefore investigated worst case to representative mode in test report. (Final test mode refer section 3.2.1)

\* For 5GHz band 802.11n and 802.11ac, CDD mode is the worst case for final radiated emission and power line conducted emission tests after pretesting CDD mode and beamforming mode.

3. The EUT consumes power from the following adapter.

Adapter	
Brand	Cisco
Model	MA-PWR-50WAC
Input Power	100-240VAC, 50/60Hz, 2A
Output Power	54V, 0.92A
Power Line	1.5m non-shielded DC cable without core 1.7m non-shielded AC cable without core



### 3.2 Description of Test Modes

#### For 5260 ~ 5320MHz

4 channels are provided for 802.11a, 802.11n (HT20), 802.11ac (VHT20):

Channel	Frequency	Channel	Frequency
52	5260 MHz	60	5300 MHz
56	5280 MHz	64	5320 MHz

2 channels are provided for 802.11n (HT40), 802.11ac (VHT40):

Channel	Frequency	Channel	Frequency
54	5270 MHz	62	5310 MHz

1 channel is provided for 802.11ac (VHT80):

Channel	Frequency
58	5290 MHz

#### For 5500 ~ 5700MHz

11 channels are provided for 802.11a, 802.11n (HT20), 802.11ac (VHT20):

Channel	Frequency	Channel	Frequency
100	5500 MHz	124	5620 MHz
104	5520 MHz	128	5640 MHz
108	5540 MHz	132	5660 MHz
112	5560 MHz	136	5680 MHz
116	5580 MHz	140	5700 MHz
120	5600 MHz		

5 channels are provided for 802.11n (HT40), 802.11ac (VHT40):

Channel	Frequency	Channel	Frequency
102	5510 MHz	126	5630 MHz
110	5550 MHz	134	5670 MHz
118	5590 MHz		

2 channels are provided for 802.11ac (VHT80):

Channel	Frequency	Channel	Frequency
106	5530MHz	122	5610 MHz

### 3.2.1 Test Mode Applicability and Tested Channel Detail

EUT CONFIGURE MODE	APPLICABLE TO				DESCRIPTION
	RE≥1G	RE<1G	PLC	APCM	
-	√	√	√	√	-

Where **RE≥1G**: Radiated Emission above 1GHz & Bandedge Measurement  
**RE<1G**: Radiated Emission below 1GHz  
**PLC**: Power Line Conducted Emission  
**APCM**: Antenna Port Conducted Measurement

Note:

1. The EUT had been pre-tested on the positioned of each 3 axis. The worst case was found when positioned on **X-plane**.
2. "-": Means no effect.

#### Radiated Emission Test (Above 1GHz):

- Pre-Scan has been conducted to determine the worst-case mode from all possible combinations between available modulations, data rates and antenna ports (if EUT with antenna diversity architecture).
- Following channel(s) was (were) selected for the final test as listed below.

EUT CONFIGURE MODE	MODE	FREQ. BAND (MHz)	AVAILABLE CHANNEL	TESTED CHANNEL	MODULATION TECHNOLOGY	MODULATION TYPE	DATA RATE (Mbps)
-	802.11a	5260-5320	52 to 64	52, 60, 64	OFDM	BPSK	6.0
-	802.11n (HT20)		52 to 64	52, 60, 64	OFDM	BPSK	6.5
-	802.11n (HT40)		54 to 62	54, 62	OFDM	BPSK	13.5
-	802.11ac (VHT80)		58	58	OFDM	BPSK	58.5
-	802.11a	5500-5700	100 to 140	100, 116, 140	OFDM	BPSK	6.0
-	802.11n (HT20)		100 to 140	100, 116, 140	OFDM	BPSK	6.5
-	802.11n (HT40)		102 to 134	102, 110, 134	OFDM	BPSK	13.5
-	802.11ac (VHT80)		106	106	OFDM	BPSK	58.5

#### Radiated Emission Test (Below 1GHz):

- Pre-Scan has been conducted to determine the worst-case mode from all possible combinations between available modulations, data rates and antenna ports (if EUT with antenna diversity architecture).
- Following channel(s) was (were) selected for the final test as listed below.

EUT CONFIGURE MODE	MODE	FREQ. BAND (MHz)	AVAILABLE CHANNEL	TESTED CHANNEL	MODULATION TECHNOLOGY	MODULATION TYPE	DATA RATE (Mbps)
-	802.11a	5260-5320, 5500-5700	52 to 64 52 to 140	60	OFDM	BPSK	6.0

**Power Line Conducted Emission Test:**

- Pre-Scan has been conducted to determine the worst-case mode from all possible combinations between available modulations, data rates and antenna ports (if EUT with antenna diversity architecture).
- Following channel(s) was (were) selected for the final test as listed below.

EUT CONFIGURE MODE	MODE	FREQ. BAND (MHz)	AVAILABLE CHANNEL	TESTED CHANNEL	MODULATION TECHNOLOGY	MODULATION TYPE	DATA RATE (Mbps)
-	802.11a	5260-5320, 5500-5700	52 to 64 52 to 140	60	OFDM	BPSK	6.0

**Antenna Port Conducted Measurement:**

- This item includes all test value of each mode, but only includes spectrum plot of worst value of each mode.
- Pre-Scan has been conducted to determine the worst-case mode from all possible combinations between available modulations, data rates and antenna ports (if EUT with antenna diversity architecture).
- Following channel(s) was (were) selected for the final test as listed below.

EUT CONFIGURE MODE	MODE	FREQ. BAND (MHz)	AVAILABLE CHANNEL	TESTED CHANNEL	MODULATION TECHNOLOGY	MODULATION TYPE	DATA RATE (Mbps)
-	802.11a	5260-5320	52 to 64	52, 60, 64	OFDM	BPSK	6.0
-	802.11n (HT20)		52 to 64	52, 60, 64	OFDM	BPSK	6.5
-	802.11n (HT40)		54 to 62	54, 62	OFDM	BPSK	13.5
-	802.11ac (VHT80)		58	58	OFDM	BPSK	58.5
-	802.11a	5500-5700	100 to 140	100, 116, 140	OFDM	BPSK	6.0
-	802.11n (HT20)		100 to 140	100, 116, 140	OFDM	BPSK	6.5
-	802.11n (HT40)		102 to 134	102, 110, 134	OFDM	BPSK	13.5
-	802.11ac (VHT80)		106	106	OFDM	BPSK	58.5

**Test Condition:**

APPLICABLE TO	ENVIRONMENTAL CONDITIONS	INPUT POWER	TESTED BY
RE $\geq$ 1G	23deg. C, 71%RH	120Vac, 60Hz	James Yang
RE $<$ 1G	23deg. C, 71%RH	120Vac, 60Hz	Jones Chang
PLC	25deg. C, 75%RH	120Vac, 60Hz	James Yang
APCM	25deg. C, 60%RH	120Vac, 60Hz	Ted Chang

### 3.3 Duty Cycle of Test Signal

Duty cycle of test signal is > 98%, duty factor is not required.

Duty cycle of test signal is < 98 %, duty factor is required.

802.11a: Duty cycle =  $2.017/2.120 = 0.951$ , Duty factor =  $10 * \log(1/0.951) = 0.22$

802.11n (HT20): Duty cycle =  $4.950/5.045 = 0.981$

802.11n (HT40): Duty cycle =  $2.398/2.490 = 0.963$ , Duty factor =  $10 * \log(1/0.963) = 0.16$

802.11ac (VHT80): Duty cycle =  $1.124/1.222 = 0.920$ , Duty factor =  $10 * \log(1/0.920) = 0.36$

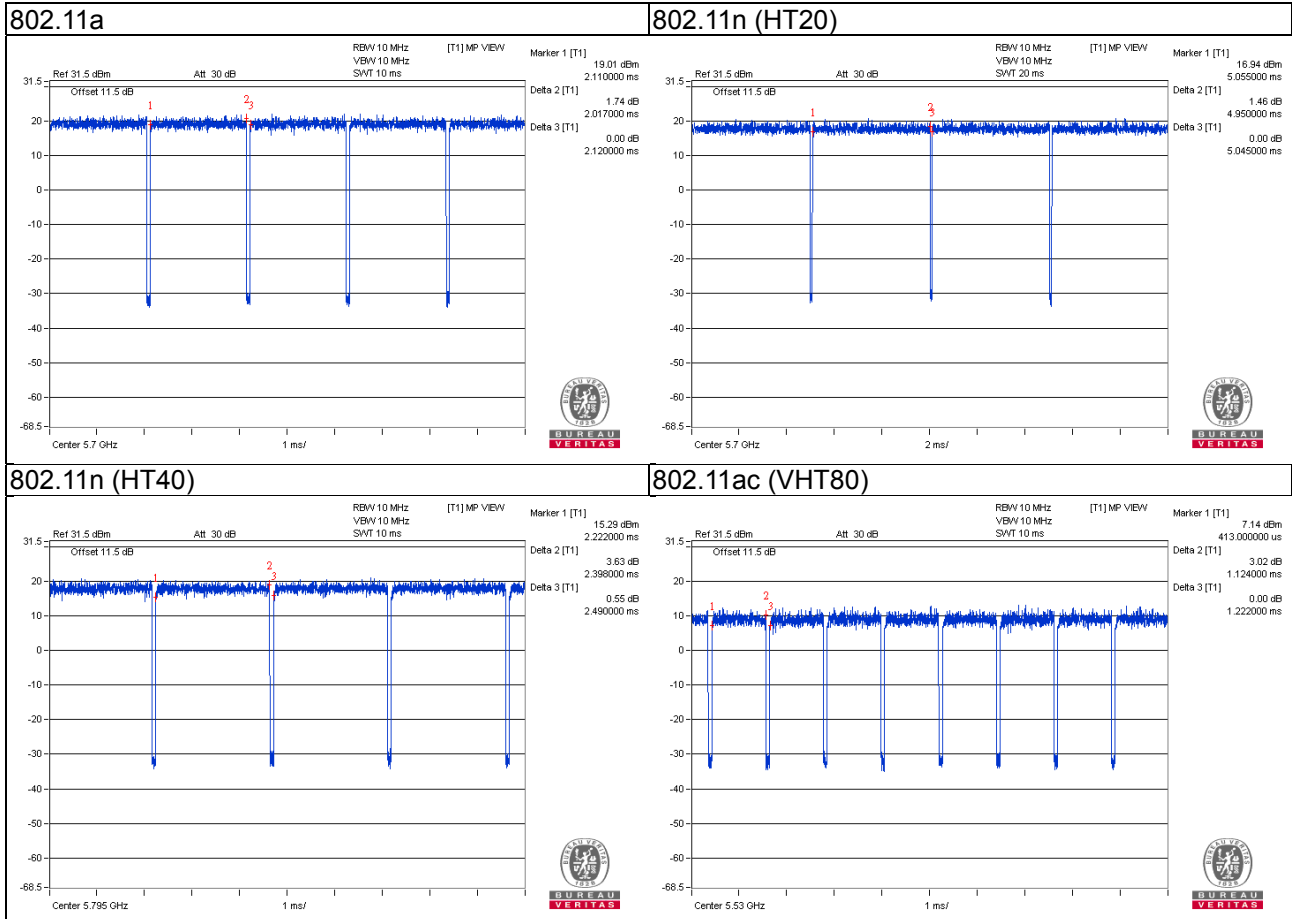

### 3.4 Description of Support Units

The EUT has been tested as an independent unit together with other necessary accessories or support units. The following support units or accessories were used to form a representative test configuration during the tests.

ID	Product	Brand	Model No.	Serial No.	FCC ID	Remarks
A.	Notebook	DELL	E5410	1HC2XM1	FCC DoC Approved	-
B.	Load	N/A	N/A	N/A	N/A	-
C.	USB 3.0 Flash	HP	v250W	01	N/A	-

Note:

1. All power cords of the above support units are non-shielded (1.8m).
2. Item A acted as communication partner to transfer data.

ID	Descriptions	Qty.	Length (m)	Shielding (Yes/No)	Cores (Qty.)	Remarks
1.	RJ45 Cable	4	1.8	N	0	Cat5e
2.	RJ45 Cable	1	10	N	0	Cat5e

#### 3.4.1 Configuration of System under Test

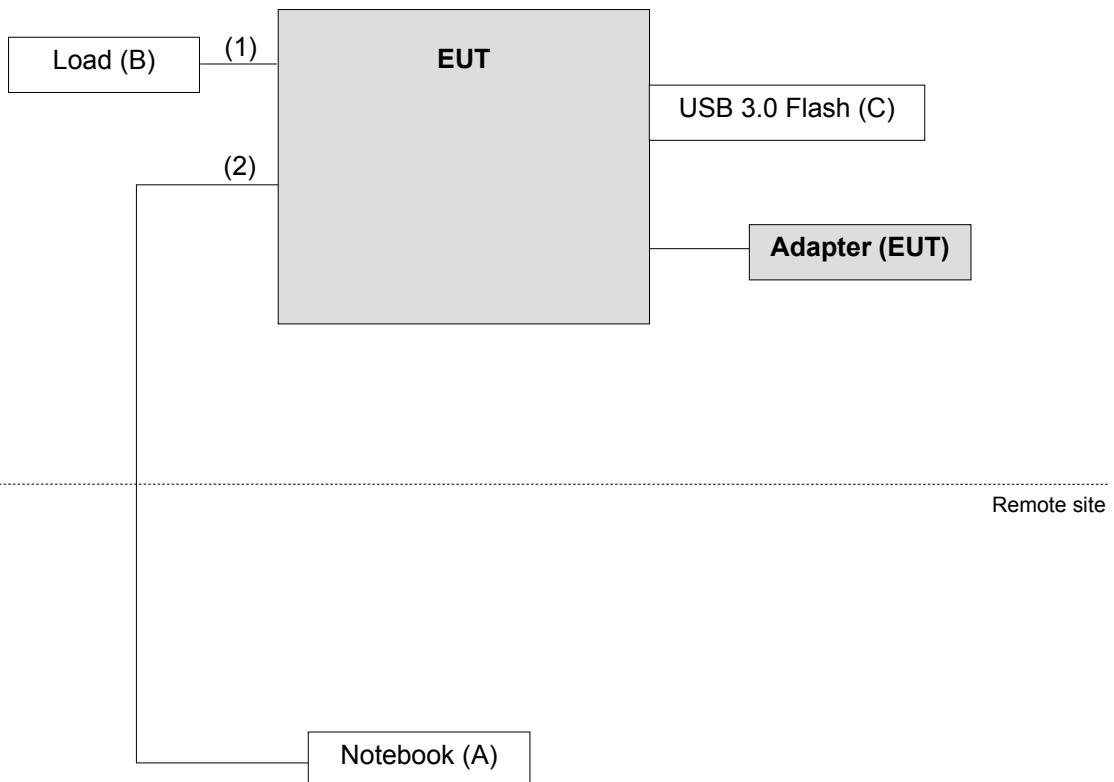

### **3.5 General Description of Applied Standards**

The EUT is a RF Product. According to the specifications of the manufacturer, it must comply with the requirements of the following standards:

**FCC Part 15, Subpart E (15.407)**

**KDB 789033 D02 General UNII Test Procedure New Rules v01r04**

**KDB 662911 D01 Multiple Transmitter Output v02r01**

ANSI C63.10-2013

All test items have been performed and recorded as per the above standards.

Note: The EUT has been verified to comply with the requirements of FCC Part 15, Subpart B, Class B (DoC).  
The test report has been issued separately.

## 4 Test Types and Results

### 4.1 Radiated Emission and Bandedge Measurement

#### 4.1.1 Limits of Radiated Emission and Bandedge Measurement

Radiated emissions which fall in the restricted bands must comply with the radiated emission limits specified as below table.

Frequencies (MHz)	Field Strength (microvolts/meter)	Measurement Distance (meters)
0.009 ~ 0.490	2400/F(kHz)	300
0.490 ~ 1.705	24000/F(kHz)	30
1.705 ~ 30.0	30	30
30 ~ 88	100	3
88 ~ 216	150	3
216 ~ 960	200	3
Above 960	500	3

**Note:**

1. The lower limit shall apply at the transition frequencies.
2. Emission level (dBuV/m) = 20 log Emission level (uV/m).
3. For frequencies above 1000MHz, the field strength limits are based on average detector, however, the peak field strength of any emission shall not exceed the maximum permitted average limits, specified above by more than 20dB under any condition of modulation.

Limits of unwanted emission out of the restricted bands

Applicable To		Limit	
789033 D02 General UNII Test Procedure New Rules v01r04		Field Strength at 3m	
		PK:74 (dBuV/m)	AV:54 (dBuV/m)
Frequency Band	Applicable To	EIRP Limit	Equivalent Field Strength at 3m
5150~5250 MHz	15.407(b)(1)	PK:-27 (dBm/MHz)	PK:68.2(dBuV/m)
5250~5350 MHz	15.407(b)(2)		
5470~5725 MHz	15.407(b)(3)		
5725~5850 MHz	<input type="checkbox"/> 15.407(b)(4)(i)	PK:-27 (dBm/MHz) <sup>*1</sup> PK:10 (dBm/MHz) <sup>*2</sup> PK:15.6 (dBm/MHz) <sup>*3</sup> PK:27 (dBm/MHz) <sup>*4</sup>	PK: 68.2(dBuV/m) <sup>*1</sup> PK:105.2 (dBuV/m) <sup>*2</sup> PK: 110.8(dBuV/m) <sup>*3</sup> PK:122.2 (dBuV/m) <sup>*4</sup>
	<input type="checkbox"/> 15.407(b)(4)(ii)	Emission limits in section 15.247(d)	
<sup>*1</sup> beyond 75 MHz or more above of the band edge.		<sup>*2</sup> below the band edge increasing linearly to 10 dBm/MHz at 25 MHz above.	
<sup>*3</sup> below the band edge increasing linearly to a level of 15.6 dBm/MHz at 5 MHz above.		<sup>*4</sup> from 5 MHz above or below the band edge increasing linearly to a level of 27 dBm/MHz at the band edge.	

**Note:** The following formula is used to convert the equipment isotropic radiated power (eirp) to field strength:

$$E = \frac{1000000\sqrt{30P}}{3} \mu\text{V/m, where P is the eirp (Watts).$$

#### 4.1.2 Test Instruments

Description & Manufacturer	Model No.	Serial No.	Cal. Date	Cal. Due
Test Receiver KEYSIGHT	N9038A	MY55420137	Mar. 27, 2017	Mar. 26, 2018
Spectrum Analyzer ROHDE & SCHWARZ	FSP40	100041	Nov. 16, 2016	Nov. 15, 2017
BILOG Antenna SCHWARZBECK	VULB9168	9168-171	Dec. 28, 2016	Dec. 27, 2017
HORN Antenna SCHWARZBECK	9120D	209	Dec. 27, 2016	Dec. 26, 2017
HORN Antenna SCHWARZBECK	BBHA 9170	BBHA9170241	Dec. 14, 2016	Dec. 13, 2017
Loop Antenna	EM-6879	269	Aug. 11, 2016	Aug. 10, 2017
Preamplifier Agilent	8447D	2944A10738	Aug. 22, 2016	Aug. 21, 2017
Preamplifier Agilent	8449B	3008A01922	Sep. 18, 2016	Sep. 17, 2017
RF signal cable HUBER+SUHNER	SUCOFLEX 104	Cable-CH3-03 (214378)	Aug. 22, 2016	Aug. 21, 2017
RF signal cable HUBER+SUHNER	SUCOFLEX 106	Cable-CH3-03 (309224+12738)	Aug. 22, 2016	Aug. 21, 2017
Software BV ADT	ADT_Radiated_ V7.6.15.9.4	NA	NA	NA
Antenna Tower inn-co GmbH	MA 4000	013303	NA	NA
Antenna Tower Controller BV ADT	AT100	AT93021702	NA	NA
Turn Table BV ADT	TT100	TT93021702	NA	NA
Turn Table Controller BV ADT	SC100	SC93021702	NA	NA
Turn Table BV ADT	TT100	TT93021705	NA	NA
Turn Table Controller BV ADT	SC100	SC93021705	NA	NA
26GHz ~ 40GHz Amplifier	EM26400	815221	Oct. 17, 2016	Oct. 16, 2017
High Speed Peak Power Meter	ML2495A	0824012	Aug. 11, 2016	Aug. 10, 2017
Power Sensor	MA2411B	0738171	Aug. 11, 2016	Aug. 10, 2017
WIT Standard Temperature And Humidity Chamber	TH-4S-C	W981030	Jun. 08, 2016	Jun. 07, 2017

- Note: 1. The calibration interval of the above test instruments is 12 months and the calibrations are traceable to NML/ROC and NIST/USA.  
 2. The test was performed in HwaYa Chamber 3.  
 3. The horn antenna and preamplifier (model: 8449B) are used only for the measurement of emission frequency above 1GHz if tested.  
 4. The FCC Site Registration No. is 988962.  
 5. The IC Site Registration No. is IC 7450F-3.



### 4.1.3 Test Procedures

#### For Radiated emission below 30MHz

- a. The EUT was placed on the top of a rotating table 0.8 meters above the ground at a 3 meter chamber room. The table was rotated 360 degrees to determine the position of the highest radiation.
- b. The EUT was set 3 meters away from the interference-receiving antenna, which was mounted on the top of a variable-height antenna tower.
- c. Both X and Y axes of the antenna are set to make the measurement.
- d. For each suspected emission, the EUT was arranged to its worst case and the rotatable table was turned from 0 degrees to 360 degrees to find the maximum reading.
- e. The test-receiver system was set to Quasi-Peak Detect Function and Specified Bandwidth with Maximum Hold Mode.

#### Note:

1. The resolution bandwidth and video bandwidth of test receiver/spectrum analyzer is 9kHz at frequency below 30MHz.

#### For Radiated emission above 30MHz

- a. The EUT was placed on the top of a rotating table 0.8 meters (for 30MHz ~ 1GHz) / 1.5 meters (for above 1GHz) above the ground at 3 meter chamber room for test. The table was rotated 360 degrees to determine the position of the highest radiation.
- b. The EUT was set 3 meters away from the interference-receiving antenna, which was mounted on the top of a variable-height antenna tower.
- c. The height of antenna is varied from one meter to four meters above the ground to determine the maximum value of the field strength. Both horizontal and vertical polarizations of the antenna are set to make the measurement.
- d. For each suspected emission, the EUT was arranged to its worst case and then the antenna was tuned to heights from 1 meter to 4 meters and the rotatable table was turned from 0 degrees to 360 degrees to find the maximum reading.
- e. The test-receiver system was set to quasi-peak detect function and specified bandwidth with maximum hold mode when the test frequency is below 1 GHz.
- f. The test-receiver system was set to peak and average detect function and specified bandwidth with maximum hold mode when the test frequency is above 1 GHz. If the peak reading value also meets average limit, measurement with the average detector is unnecessary.

#### Note:

1. The resolution bandwidth and video bandwidth of test receiver/spectrum analyzer is 120kHz for Quasi-peak detection (QP) at frequency below 1GHz.
2. The resolution bandwidth of test receiver/spectrum analyzer is 1 MHz and the video bandwidth is 3 MHz for Peak detection (PK) at frequency above 1GHz.
3. The resolution bandwidth of test receiver/spectrum analyzer is 1MHz and the video bandwidth is  $\geq 1/T$  (Duty cycle < 98%) or 10Hz (Duty cycle  $\geq 98\%$ ) for Average detection (AV) at frequency above 1GHz.
4. All modes of operation were investigated and the worst-case emissions are reported.

#### 4.1.4 Deviation from Test Standard

No deviation.

#### 4.1.5 Test Setup

For Radiated emission below 30MHz

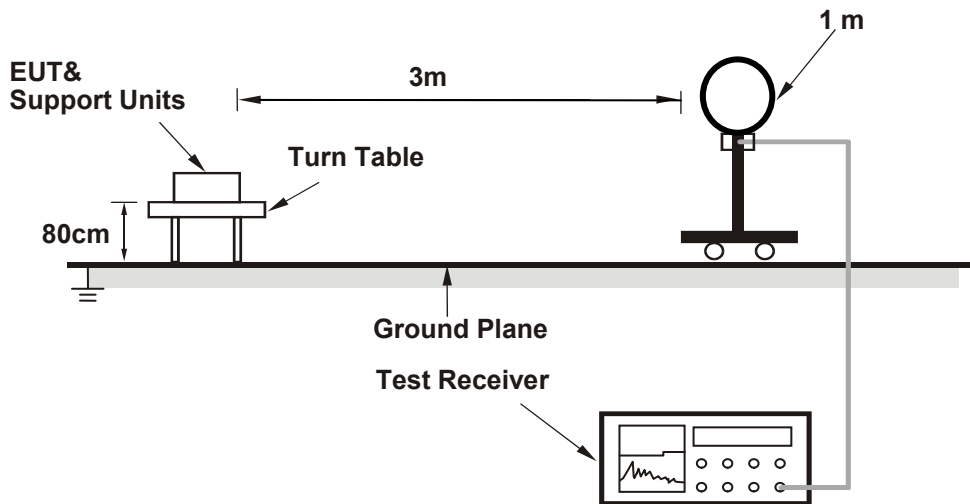

For Radiated emission 30MHz to 1GHz

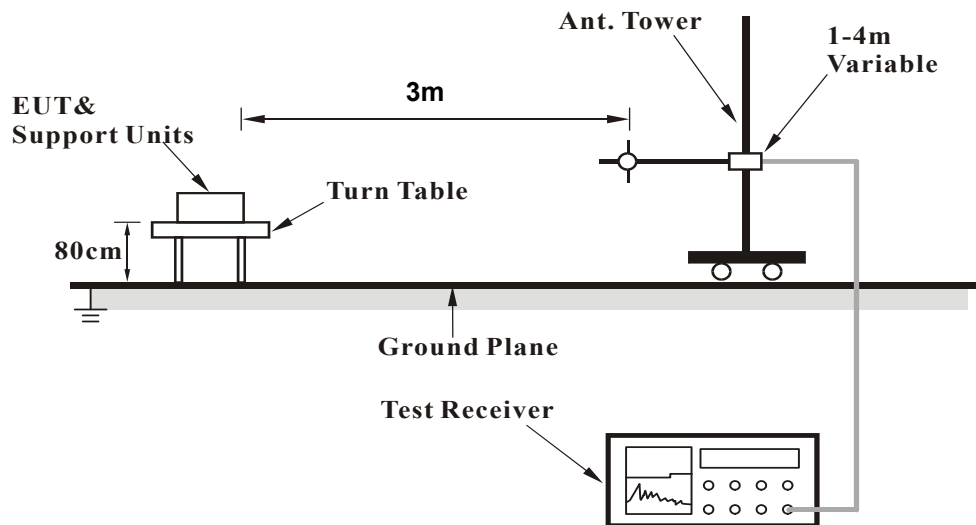

### For Radiated emission above 1GHz

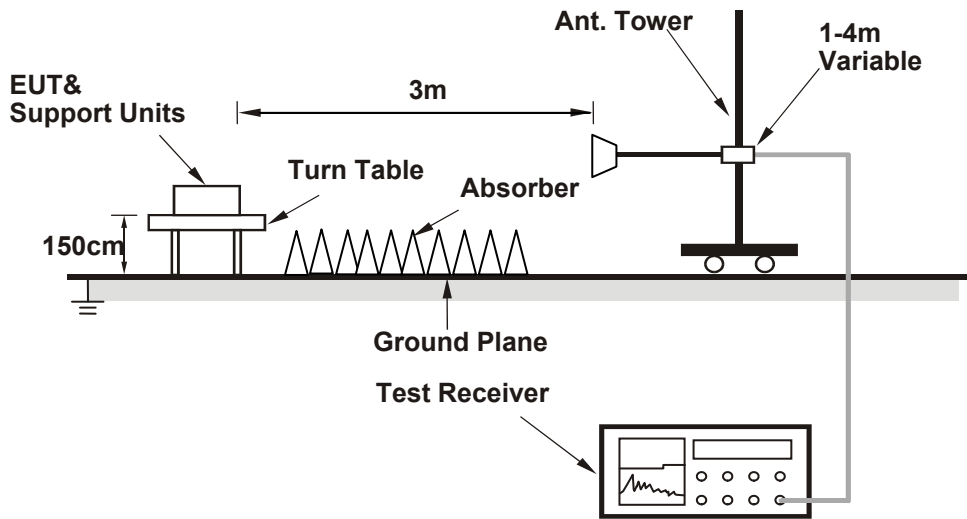

For the actual test configuration, please refer to the attached file (Test Setup Photo).

#### 4.1.6 EUT Operating Conditions

- a. Placed the EUT on the testing table.
- b. Prepared a notebook to act as a communication partner and placed it outside of testing area.
- c. The communication partner connected with EUT via a RJ45 cable and ran a test program (provided by manufacturer) to enable EUT under transmission condition continuously at specific channel frequency.
- d. The communication partner sent data to EUT by command "PING".

#### 4.1.7 Test Results

Above 1GHz Worst-Case Data:

802.11a

CHANNEL	TX Channel 52	DETECTOR FUNCTION	Peak (PK) Average (AV)
FREQUENCY RANGE	1GHz ~ 40GHz		

ANTENNA POLARITY & TEST DISTANCE: HORIZONTAL AT 3 M								
NO.	FREQ. (MHz)	EMISSION LEVEL (dBuV/m)	LIMIT (dBuV/m)	MARGIN (dB)	ANTENNA HEIGHT (m)	TABLE ANGLE (Degree)	RAW VALUE (dBuV)	CORRECTION FACTOR (dB/m)
1	5150.00	54.9 PK	74.0	-19.1	1.63 H	359	54.1	0.8
2	5150.00	43.0 AV	54.0	-11.0	1.63 H	359	42.2	0.8
3	*5260.00	108.5 PK			1.00 H	67	69.7	38.8
4	*5260.00	98.1 AV			1.00 H	67	59.3	38.8
5	#10520.00	58.4 PK	74.0	-15.6	2.02 H	37	44.7	13.7
6	#10520.00	45.6 AV	54.0	-8.4	2.02 H	37	31.9	13.7
ANTENNA POLARITY & TEST DISTANCE: VERTICAL AT 3 M								
NO.	FREQ. (MHz)	EMISSION LEVEL (dBuV/m)	LIMIT (dBuV/m)	MARGIN (dB)	ANTENNA HEIGHT (m)	TABLE ANGLE (Degree)	RAW VALUE (dBuV)	CORRECTION FACTOR (dB/m)
1	5150.00	55.1 PK	74.0	-18.9	2.59 V	155	54.3	0.8
2	5150.00	42.9 AV	54.0	-11.1	2.59 V	155	42.1	0.8
3	*5260.00	109.2 PK			3.62 V	100	70.4	38.8
4	*5260.00	99.6 AV			3.62 V	100	60.8	38.8
5	#10520.00	58.8 PK	74.0	-15.2	2.29 V	79	45.1	13.7
6	#10520.00	45.8 AV	54.0	-8.2	2.29 V	79	32.1	13.7

Remark:

- Emission Level(dBuV/m) = Raw Value(dBuV) + Correction Factor(dB/m)
- Correction Factor(dB/m) = Antenna Factor(dB/m) + Cable Factor(dB) – Pre-Amplifier Factor(dB)
- The other emission levels were very low against the limit.
- Margin value = Emission Level – Limit value
- " \* ": Fundamental frequency.
- " # ": The radiated frequency is out of the restricted band.

CHANNEL	TX Channel 60	DETECTOR FUNCTION	Peak (PK)
FREQUENCY RANGE	1GHz ~ 40GHz		Average (AV)

**ANTENNA POLARITY & TEST DISTANCE: HORIZONTAL AT 3 M**

NO.	FREQ. (MHz)	EMISSION LEVEL (dBuV/m)	LIMIT (dBuV/m)	MARGIN (dB)	ANTENNA HEIGHT (m)	TABLE ANGLE (Degree)	RAW VALUE (dBuV)	CORRECTION FACTOR (dB/m)
1	*5300.00	107.5 PK			1.04 H	63	68.6	38.9
2	*5300.00	97.2 AV			1.04 H	63	58.3	38.9
3	10600.00	58.6 PK	74.0	-15.4	1.89 H	32	44.8	13.8
4	10600.00	45.9 AV	54.0	-8.1	1.89 H	32	32.1	13.8

**ANTENNA POLARITY & TEST DISTANCE: VERTICAL AT 3 M**

NO.	FREQ. (MHz)	EMISSION LEVEL (dBuV/m)	LIMIT (dBuV/m)	MARGIN (dB)	ANTENNA HEIGHT (m)	TABLE ANGLE (Degree)	RAW VALUE (dBuV)	CORRECTION FACTOR (dB/m)
1	*5300.00	109.0 PK			2.74 V	112	70.1	38.9
2	*5300.00	99.2 AV			2.74 V	112	60.3	38.9
3	10600.00	58.1 PK	74.0	-15.9	2.01 V	203	44.3	13.8
4	10600.00	45.7 AV	54.0	-8.3	2.01 V	203	31.9	13.8

**Remark:**

1. Emission Level(dBuV/m) = Raw Value(dBuV) + Correction Factor(dB/m)
2. Correction Factor(dB/m) = Antenna Factor(dB/m) + Cable Factor(dB) – Pre-Amplifier Factor(dB)
3. The other emission levels were very low against the limit.
4. Margin value = Emission Level – Limit value
5. " \* ": Fundamental frequency.
6. " # ": The radiated frequency is out of the restricted band.

CHANNEL	TX Channel 64	DETECTOR FUNCTION	Peak (PK)
FREQUENCY RANGE	1GHz ~ 40GHz		Average (AV)

## ANTENNA POLARITY &amp; TEST DISTANCE: HORIZONTAL AT 3 M

NO.	FREQ. (MHz)	EMISSION LEVEL (dBuV/m)	LIMIT (dBuV/m)	MARGIN (dB)	ANTENNA HEIGHT (m)	TABLE ANGLE (Degree)	RAW VALUE (dBuV)	CORRECTION FACTOR (dB/m)
1	*5320.00	107.9 PK			1.05 H	103	68.9	39.0
2	*5320.00	98.4 AV			1.05 H	103	59.4	39.0
3	5350.00	61.2 PK	74.0	-12.8	1.09 H	111	60.1	1.1
4	5350.00	49.7 AV	54.0	-4.3	1.09 H	111	48.6	1.1
5	10640.00	59.2 PK	74.0	-14.8	1.91 H	270	45.3	13.9
6	10640.00	46.8 AV	54.0	-7.2	1.91 H	270	32.9	13.9

## ANTENNA POLARITY &amp; TEST DISTANCE: VERTICAL AT 3 M

NO.	FREQ. (MHz)	EMISSION LEVEL (dBuV/m)	LIMIT (dBuV/m)	MARGIN (dB)	ANTENNA HEIGHT (m)	TABLE ANGLE (Degree)	RAW VALUE (dBuV)	CORRECTION FACTOR (dB/m)
1	*5320.00	107.9 PK			2.53 V	98	68.9	39.0
2	*5320.00	98.3 AV			2.53 V	98	59.3	39.0
3	5350.00	62.8 PK	74.0	-11.2	3.59 V	90	61.7	1.1
4	5350.00	48.7 AV	54.0	-5.3	3.59 V	90	47.6	1.1
5	10640.00	58.3 PK	74.0	-15.7	1.93 V	50	44.4	13.9
6	10640.00	45.9 AV	54.0	-8.1	1.93 V	50	32.0	13.9

## Remark:

1. Emission Level(dBuV/m) = Raw Value(dBuV) + Correction Factor(dB/m)
2. Correction Factor(dB/m) = Antenna Factor(dB/m) + Cable Factor(dB)  
– Pre-Amplifier Factor(dB)
3. The other emission levels were very low against the limit.
4. Margin value = Emission Level – Limit value
5. " \* ": Fundamental frequency.
6. " # ": The radiated frequency is out of the restricted band.

CHANNEL	TX Channel 100	DETECTOR FUNCTION	Peak (PK)
FREQUENCY RANGE	1GHz ~ 40GHz		Average (AV)

**ANTENNA POLARITY & TEST DISTANCE: HORIZONTAL AT 3 M**

NO.	FREQ. (MHz)	EMISSION LEVEL (dBuV/m)	LIMIT (dBuV/m)	MARGIN (dB)	ANTENNA HEIGHT (m)	TABLE ANGLE (Degree)	RAW VALUE (dBuV)	CORRECTION FACTOR (dB/m)
1	5460.00	62.5 PK	74.0	-11.5	1.15 H	100	61.3	1.2
2	5460.00	46.6 AV	54.0	-7.4	1.15 H	100	45.4	1.2
3	#5470.00	67.5 PK	74.0	-6.5	1.12 H	104	66.3	1.2
4	#5470.00	51.2 AV	54.0	-2.8	1.12 H	104	50.0	1.2
5	*5500.00	110.5 PK			1.04 H	103	71.2	39.3
6	*5500.00	100.4 AV			1.04 H	103	61.1	39.3
7	11000.00	59.5 PK	74.0	-14.5	1.71 H	200	44.2	15.3
8	11000.00	46.7 AV	54.0	-7.3	1.71 H	200	31.4	15.3

**ANTENNA POLARITY & TEST DISTANCE: VERTICAL AT 3 M**

NO.	FREQ. (MHz)	EMISSION LEVEL (dBuV/m)	LIMIT (dBuV/m)	MARGIN (dB)	ANTENNA HEIGHT (m)	TABLE ANGLE (Degree)	RAW VALUE (dBuV)	CORRECTION FACTOR (dB/m)
1	5460.00	63.2 PK	74.0	-10.8	2.80 V	80	62.0	1.2
2	5460.00	46.8 AV	54.0	-7.2	2.80 V	80	45.6	1.2
3	#5470.00	70.3 PK	74.0	-3.7	2.85 V	89	69.1	1.2
4	#5470.00	52.7 AV	54.0	-1.3	2.85 V	89	51.5	1.2
5	*5500.00	113.8 PK			2.88 V	119	74.5	39.3
6	*5500.00	103.6 AV			2.88 V	119	64.3	39.3
7	11000.00	59.9 PK	74.0	-14.1	1.88 V	123	44.6	15.3
8	11000.00	46.9 AV	54.0	-7.1	1.88 V	123	31.6	15.3

**Remark:**

1. Emission Level(dBuV/m) = Raw Value(dBuV) + Correction Factor(dB/m)
2. Correction Factor(dB/m) = Antenna Factor(dB/m) + Cable Factor(dB)  
– Pre-Amplifier Factor(dB)
3. The other emission levels were very low against the limit.
4. Margin value = Emission Level – Limit value
5. " \* ": Fundamental frequency.
6. " # ": The radiated frequency is out of the restricted band.

CHANNEL	TX Channel 116	DETECTOR FUNCTION	Peak (PK)
FREQUENCY RANGE	1GHz ~ 40GHz		Average (AV)

**ANTENNA POLARITY & TEST DISTANCE: HORIZONTAL AT 3 M**

NO.	FREQ. (MHz)	EMISSION LEVEL (dBuV/m)	LIMIT (dBuV/m)	MARGIN (dB)	ANTENNA HEIGHT (m)	TABLE ANGLE (Degree)	RAW VALUE (dBuV)	CORRECTION FACTOR (dB/m)
1	*5580.00	112.4 PK			1.00 H	105	72.9	39.5
2	*5580.00	102.5 AV			1.00 H	105	63.0	39.5
3	11160.00	60.1 PK	74.0	-13.9	1.61 H	359	45.2	14.9
4	11160.00	47.4 AV	54.0	-6.6	1.61 H	359	32.5	14.9

**ANTENNA POLARITY & TEST DISTANCE: VERTICAL AT 3 M**

NO.	FREQ. (MHz)	EMISSION LEVEL (dBuV/m)	LIMIT (dBuV/m)	MARGIN (dB)	ANTENNA HEIGHT (m)	TABLE ANGLE (Degree)	RAW VALUE (dBuV)	CORRECTION FACTOR (dB/m)
1	*5580.00	116.1 PK			2.55 V	113	76.6	39.5
2	*5580.00	106.1 AV			2.55 V	113	66.6	39.5
3	11160.00	61.2 PK	74.0	-12.8	2.43 V	221	46.3	14.9
4	11160.00	48.8 AV	54.0	-5.2	2.43 V	221	33.9	14.9

**Remark:**

1. Emission Level(dBuV/m) = Raw Value(dBuV) + Correction Factor(dB/m)
2. Correction Factor(dB/m) = Antenna Factor(dB/m) + Cable Factor(dB)  
– Pre-Amplifier Factor(dB)
3. The other emission levels were very low against the limit.
4. Margin value = Emission Level – Limit value
5. " \* ": Fundamental frequency.
6. " # ": The radiated frequency is out of the restricted band.



CHANNEL	TX Channel 140	DETECTOR FUNCTION	Peak (PK)
FREQUENCY RANGE	1GHz ~ 40GHz		Average (AV)

## ANTENNA POLARITY &amp; TEST DISTANCE: HORIZONTAL AT 3 M

NO.	FREQ. (MHz)	EMISSION LEVEL (dBuV/m)	LIMIT (dBuV/m)	MARGIN (dB)	ANTENNA HEIGHT (m)	TABLE ANGLE (Degree)	RAW VALUE (dBuV)	CORRECTION FACTOR (dB/m)
1	*5700.00	110.7 PK			1.22 H	103	70.9	39.8
2	*5700.00	100.7 AV			1.22 H	103	60.9	39.8
3	#5725.00	64.7 PK	74.0	-9.3	1.43 H	105	62.7	2.0
4	#5725.00	51.4 AV	54.0	-2.6	1.43 H	105	49.4	2.0
5	11400.00	60.0 PK	74.0	-14.0	1.86 H	201	45.5	14.5
6	11400.00	46.5 AV	54.0	-7.5	1.86 H	201	32.0	14.5

## ANTENNA POLARITY &amp; TEST DISTANCE: VERTICAL AT 3 M

NO.	FREQ. (MHz)	EMISSION LEVEL (dBuV/m)	LIMIT (dBuV/m)	MARGIN (dB)	ANTENNA HEIGHT (m)	TABLE ANGLE (Degree)	RAW VALUE (dBuV)	CORRECTION FACTOR (dB/m)
1	*5700.00	113.2 PK			2.52 V	123	73.4	39.8
2	*5700.00	103.1 AV			2.52 V	123	63.3	39.8
3	#5725.00	67.3 PK	74.0	-6.7	3.53 V	101	65.3	2.0
4	#5725.00	52.5 AV	54.0	-1.5	3.53 V	101	50.5	2.0
5	11400.00	60.6 PK	74.0	-13.4	2.33 V	322	46.1	14.5
6	11400.00	47.6 AV	54.0	-6.4	2.33 V	322	33.1	14.5

## Remark:

1. Emission Level(dBuV/m) = Raw Value(dBuV) + Correction Factor(dB/m)
2. Correction Factor(dB/m) = Antenna Factor(dB/m) + Cable Factor(dB)  
– Pre-Amplifier Factor(dB)
3. The other emission levels were very low against the limit.
4. Margin value = Emission Level – Limit value
5. " \* ": Fundamental frequency.
6. " # ": The radiated frequency is out of the restricted band.

802.11n (HT20)

CHANNEL	TX Channel 52	DETECTOR FUNCTION	Peak (PK)
FREQUENCY RANGE	1GHz ~ 40GHz		Average (AV)

ANTENNA POLARITY & TEST DISTANCE: HORIZONTAL AT 3 M

NO.	FREQ. (MHz)	EMISSION LEVEL (dBuV/m)	LIMIT (dBuV/m)	MARGIN (dB)	ANTENNA HEIGHT (m)	TABLE ANGLE (Degree)	RAW VALUE (dBuV)	CORRECTION FACTOR (dB/m)
1	5150.00	56.4 PK	74.0	-17.6	1.73 H	21	55.6	0.8
2	5150.00	44.1 AV	54.0	-9.9	1.73 H	21	43.3	0.8
3	*5260.00	108.7 PK			1.00 H	104	69.9	38.8
4	*5260.00	98.2 AV			1.00 H	104	59.4	38.8
5	#10520.00	57.6 PK	74.0	-16.4	2.15 H	69	43.9	13.7
6	#10520.00	45.5 AV	54.0	-8.5	2.15 H	69	31.8	13.7

ANTENNA POLARITY & TEST DISTANCE: VERTICAL AT 3 M

NO.	FREQ. (MHz)	EMISSION LEVEL (dBuV/m)	LIMIT (dBuV/m)	MARGIN (dB)	ANTENNA HEIGHT (m)	TABLE ANGLE (Degree)	RAW VALUE (dBuV)	CORRECTION FACTOR (dB/m)
1	5150.00	57.5 PK	74.0	-16.5	2.90 V	89	56.7	0.8
2	5150.00	44.7 AV	54.0	-9.3	2.90 V	89	43.9	0.8
3	*5260.00	111.1 PK			3.73 V	93	72.3	38.8
4	*5260.00	100.0 AV			3.73 V	93	61.2	38.8
5	#10520.00	60.0 PK	74.0	-14.0	2.35 V	305	46.3	13.7
6	#10520.00	47.0 AV	54.0	-7.0	2.35 V	305	33.3	13.7

Remark:

1. Emission Level(dBuV/m) = Raw Value(dBuV) + Correction Factor(dB/m)
2. Correction Factor(dB/m) = Antenna Factor(dB/m) + Cable Factor(dB)  
- Pre-Amplifier Factor(dB)
3. The other emission levels were very low against the limit.
4. Margin value = Emission Level – Limit value
5. " \* ": Fundamental frequency.
6. " # ": The radiated frequency is out of the restricted band.

CHANNEL	TX Channel 60	DETECTOR FUNCTION	Peak (PK)
FREQUENCY RANGE	1GHz ~ 40GHz		Average (AV)

**ANTENNA POLARITY & TEST DISTANCE: HORIZONTAL AT 3 M**

NO.	FREQ. (MHz)	EMISSION LEVEL (dBuV/m)	LIMIT (dBuV/m)	MARGIN (dB)	ANTENNA HEIGHT (m)	TABLE ANGLE (Degree)	RAW VALUE (dBuV)	CORRECTION FACTOR (dB/m)
1	*5300.00	112.2 PK			1.04 H	100	68.7	43.5
2	*5300.00	102.1 AV			1.04 H	100	58.6	43.5
3	10600.00	58.8 PK	74.0	-15.2	2.01 H	19	45.0	13.8
4	10600.00	46.3 AV	54.0	-7.7	2.01 H	19	32.5	13.8

**ANTENNA POLARITY & TEST DISTANCE: VERTICAL AT 3 M**

NO.	FREQ. (MHz)	EMISSION LEVEL (dBuV/m)	LIMIT (dBuV/m)	MARGIN (dB)	ANTENNA HEIGHT (m)	TABLE ANGLE (Degree)	RAW VALUE (dBuV)	CORRECTION FACTOR (dB/m)
1	*5300.00	109.7 PK			3.63 V	94	70.8	38.9
2	*5300.00	99.1 AV			3.63 V	94	60.2	38.9
3	10600.00	59.2 PK	74.0	-14.8	2.22 V	44	45.4	13.8
4	10600.00	46.4 AV	54.0	-7.6	2.22 V	44	32.6	13.8

**Remark:**

1. Emission Level(dBuV/m) = Raw Value(dBuV) + Correction Factor(dB/m)
2. Correction Factor(dB/m) = Antenna Factor(dB/m) + Cable Factor(dB) – Pre-Amplifier Factor(dB)
3. The other emission levels were very low against the limit.
4. Margin value = Emission Level – Limit value
5. " \* ": Fundamental frequency.
6. " # ": The radiated frequency is out of the restricted band.

CHANNEL	TX Channel 64	DETECTOR FUNCTION	Peak (PK)
FREQUENCY RANGE	1GHz ~ 40GHz		Average (AV)

## ANTENNA POLARITY &amp; TEST DISTANCE: HORIZONTAL AT 3 M

NO.	FREQ. (MHz)	EMISSION LEVEL (dBuV/m)	LIMIT (dBuV/m)	MARGIN (dB)	ANTENNA HEIGHT (m)	TABLE ANGLE (Degree)	RAW VALUE (dBuV)	CORRECTION FACTOR (dB/m)
1	*5320.00	107.8 PK			1.04 H	102	68.8	39.0
2	*5320.00	97.5 AV			1.04 H	102	58.5	39.0
3	5350.00	64.0 PK	74.0	-10.0	1.06 H	71	62.9	1.1
4	5350.00	51.7 AV	54.0	-2.3	1.06 H	71	50.6	1.1
5	10640.00	58.3 PK	74.0	-15.7	1.92 H	350	44.4	13.9
6	10640.00	46.1 AV	54.0	-7.9	1.92 H	350	32.2	13.9

## ANTENNA POLARITY &amp; TEST DISTANCE: VERTICAL AT 3 M

NO.	FREQ. (MHz)	EMISSION LEVEL (dBuV/m)	LIMIT (dBuV/m)	MARGIN (dB)	ANTENNA HEIGHT (m)	TABLE ANGLE (Degree)	RAW VALUE (dBuV)	CORRECTION FACTOR (dB/m)
1	*5320.00	110.8 PK			3.62 V	91	71.8	39.0
2	*5320.00	100.1 AV			3.62 V	91	61.1	39.0
3	5350.00	63.5 PK	74.0	-10.5	3.04 V	110	62.4	1.1
4	5350.00	49.7 AV	54.0	-4.3	3.04 V	110	48.6	1.1
5	10640.00	60.2 PK	74.0	-13.8	2.33 V	200	46.3	13.9
6	10640.00	47.4 AV	54.0	-6.6	2.33 V	200	33.5	13.9

## Remark:

1. Emission Level(dBuV/m) = Raw Value(dBuV) + Correction Factor(dB/m)
2. Correction Factor(dB/m) = Antenna Factor(dB/m) + Cable Factor(dB)  
– Pre-Amplifier Factor(dB)
3. The other emission levels were very low against the limit.
4. Margin value = Emission Level – Limit value
5. " \* ": Fundamental frequency.
6. " # ": The radiated frequency is out of the restricted band.

CHANNEL	TX Channel 100	DETECTOR FUNCTION	Peak (PK)
FREQUENCY RANGE	1GHz ~ 40GHz		Average (AV)

ANTENNA POLARITY & TEST DISTANCE: HORIZONTAL AT 3 M								
NO.	FREQ. (MHz)	EMISSION LEVEL (dBuV/m)	LIMIT (dBuV/m)	MARGIN (dB)	ANTENNA HEIGHT (m)	TABLE ANGLE (Degree)	RAW VALUE (dBuV)	CORRECTION FACTOR (dB/m)
1	5460.00	55.6 PK	74.0	-18.4	1.20 H	77	54.4	1.2
2	5460.00	43.4 AV	54.0	-10.6	1.20 H	77	42.2	1.2
3	#5470.00	65.5 PK	74.0	-8.5	1.18 H	73	64.3	1.2
4	#5470.00	48.8 AV	54.0	-5.2	1.18 H	73	47.6	1.2
5	*5500.00	108.8 PK			1.12 H	103	69.5	39.3
6	*5500.00	98.7 AV			1.12 H	103	59.4	39.3
7	11000.00	60.7 PK	74.0	-13.3	1.77 H	123	45.4	15.3
8	11000.00	48.4 AV	54.0	-5.6	1.77 H	123	33.1	15.3
ANTENNA POLARITY & TEST DISTANCE: VERTICAL AT 3 M								
NO.	FREQ. (MHz)	EMISSION LEVEL (dBuV/m)	LIMIT (dBuV/m)	MARGIN (dB)	ANTENNA HEIGHT (m)	TABLE ANGLE (Degree)	RAW VALUE (dBuV)	CORRECTION FACTOR (dB/m)
1	5460.00	59.2 PK	74.0	-14.8	2.48 V	114	58.0	1.2
2	5460.00	44.5 AV	54.0	-9.5	2.48 V	114	43.3	1.2
3	#5470.00	67.5 PK	74.0	-6.5	2.45 V	113	66.3	1.2
4	#5470.00	52.6 AV	54.0	-1.4	2.45 V	113	51.4	1.2
5	*5500.00	113.1 PK			2.84 V	124	73.8	39.3
6	*5500.00	102.7 AV			2.84 V	124	63.4	39.3
7	11000.00	60.0 PK	74.0	-14.0	2.08 V	166	44.7	15.3
8	11000.00	47.4 AV	54.0	-6.6	2.08 V	166	32.1	15.3

Remark:

1. Emission Level(dBuV/m) = Raw Value(dBuV) + Correction Factor(dB/m)
2. Correction Factor(dB/m) = Antenna Factor(dB/m) + Cable Factor(dB)  
– Pre-Amplifier Factor(dB)
3. The other emission levels were very low against the limit.
4. Margin value = Emission Level – Limit value
5. " \* ": Fundamental frequency.
6. " # ": The radiated frequency is out of the restricted band.

CHANNEL	TX Channel 116	DETECTOR FUNCTION	Peak (PK)
FREQUENCY RANGE	1GHz ~ 40GHz		Average (AV)

**ANTENNA POLARITY & TEST DISTANCE: HORIZONTAL AT 3 M**

NO.	FREQ. (MHz)	EMISSION LEVEL (dBuV/m)	LIMIT (dBuV/m)	MARGIN (dB)	ANTENNA HEIGHT (m)	TABLE ANGLE (Degree)	RAW VALUE (dBuV)	CORRECTION FACTOR (dB/m)
1	*5580.00	113.0 PK			1.15 H	100	73.5	39.5
2	*5580.00	102.9 AV			1.15 H	100	63.4	39.5
3	11160.00	61.8 PK	74.0	-12.2	2.01 H	99	46.9	14.9
4	11160.00	48.6 AV	54.0	-5.4	2.01 H	99	33.7	14.9

**ANTENNA POLARITY & TEST DISTANCE: VERTICAL AT 3 M**

NO.	FREQ. (MHz)	EMISSION LEVEL (dBuV/m)	LIMIT (dBuV/m)	MARGIN (dB)	ANTENNA HEIGHT (m)	TABLE ANGLE (Degree)	RAW VALUE (dBuV)	CORRECTION FACTOR (dB/m)
1	*5580.00	115.9 PK			2.85 V	114	76.4	39.5
2	*5580.00	105.2 AV			2.85 V	114	65.7	39.5
3	11160.00	59.6 PK	74.0	-14.4	1.89 V	89	44.7	14.9
4	11160.00	47.2 AV	54.0	-6.8	1.89 V	89	32.3	14.9

**Remark:**

1. Emission Level(dBuV/m) = Raw Value(dBuV) + Correction Factor(dB/m)
2. Correction Factor(dB/m) = Antenna Factor(dB/m) + Cable Factor(dB)  
– Pre-Amplifier Factor(dB)
3. The other emission levels were very low against the limit.
4. Margin value = Emission Level – Limit value
5. " \* ": Fundamental frequency.
6. " # ": The radiated frequency is out of the restricted band.

CHANNEL	TX Channel 140	DETECTOR FUNCTION	Peak (PK)
FREQUENCY RANGE	1GHz ~ 40GHz		Average (AV)

ANTENNA POLARITY & TEST DISTANCE: HORIZONTAL AT 3 M

NO.	FREQ. (MHz)	EMISSION LEVEL (dBuV/m)	LIMIT (dBuV/m)	MARGIN (dB)	ANTENNA HEIGHT (m)	TABLE ANGLE (Degree)	RAW VALUE (dBuV)	CORRECTION FACTOR (dB/m)
1	*5700.00	108.5 PK			1.16 H	103	68.7	39.8
2	*5700.00	98.0 AV			1.16 H	103	58.2	39.8
3	#5725.00	63.1 PK	74.0	-10.9	1.10 H	76	61.1	2.0
4	#5725.00	51.5 AV	54.0	-2.5	1.10 H	76	49.5	2.0
5	11400.00	60.3 PK	74.0	-13.7	1.85 H	296	45.8	14.5
6	11400.00	47.8 AV	54.0	-6.2	1.85 H	296	33.3	14.5

ANTENNA POLARITY & TEST DISTANCE: VERTICAL AT 3 M

NO.	FREQ. (MHz)	EMISSION LEVEL (dBuV/m)	LIMIT (dBuV/m)	MARGIN (dB)	ANTENNA HEIGHT (m)	TABLE ANGLE (Degree)	RAW VALUE (dBuV)	CORRECTION FACTOR (dB/m)
1	*5700.00	111.9 PK			2.85 V	117	72.1	39.8
2	*5700.00	101.5 AV			2.85 V	117	61.7	39.8
3	#5725.00	66.5 PK	74.0	-7.5	2.26 V	116	64.5	2.0
<b>4</b>	<b>#5725.00</b>	<b>52.8 AV</b>	<b>54.0</b>	<b>-1.2</b>	<b>2.26 V</b>	<b>116</b>	<b>50.8</b>	<b>2.0</b>
5	11400.00	60.0 PK	74.0	-14.0	1.75 V	106	45.5	14.5
6	11400.00	47.4 AV	54.0	-6.6	1.75 V	106	32.9	14.5

Remark:

1. Emission Level(dBuV/m) = Raw Value(dBuV) + Correction Factor(dB/m)
2. Correction Factor(dB/m) = Antenna Factor(dB/m) + Cable Factor(dB)  
- Pre-Amplifier Factor(dB)
3. The other emission levels were very low against the limit.
4. Margin value = Emission Level – Limit value
5. " \* ": Fundamental frequency.
6. " # ": The radiated frequency is out of the restricted band.

802.11n (HT40)

CHANNEL	TX Channel 54	DETECTOR FUNCTION	Peak (PK) Average (AV)
FREQUENCY RANGE	1GHz ~ 40GHz		

ANTENNA POLARITY & TEST DISTANCE: HORIZONTAL AT 3 M

NO.	FREQ. (MHz)	EMISSION LEVEL (dBuV/m)	LIMIT (dBuV/m)	MARGIN (dB)	ANTENNA HEIGHT (m)	TABLE ANGLE (Degree)	RAW VALUE (dBuV)	CORRECTION FACTOR (dB/m)
1	*5270.00	104.6 PK			1.06 H	65	65.7	38.9
2	*5270.00	94.6 AV			1.06 H	65	55.7	38.9
3	5350.00	59.2 PK	74.0	-14.8	1.11 H	69	58.1	1.1
4	5350.00	45.1 AV	54.0	-8.9	1.11 H	69	44.0	1.1
5	#10540.00	60.2 PK	74.0	-13.8	1.79 H	23	46.5	13.7
6	#10540.00	47.1 AV	54.0	-6.9	1.79 H	23	33.4	13.7

ANTENNA POLARITY & TEST DISTANCE: VERTICAL AT 3 M

NO.	FREQ. (MHz)	EMISSION LEVEL (dBuV/m)	LIMIT (dBuV/m)	MARGIN (dB)	ANTENNA HEIGHT (m)	TABLE ANGLE (Degree)	RAW VALUE (dBuV)	CORRECTION FACTOR (dB/m)
1	*5270.00	103.6 PK			3.55 V	217	64.7	38.9
2	*5270.00	93.8 AV			3.55 V	217	54.9	38.9
3	5350.00	56.9 PK	74.0	-17.1	3.13 V	83	55.8	1.1
4	5350.00	45.5 AV	54.0	-8.5	3.13 V	83	44.4	1.1
5	#10540.00	58.5 PK	74.0	-15.5	2.55 V	177	44.8	13.7
6	#10540.00	45.5 AV	54.0	-8.5	2.55 V	177	31.8	13.7

Remark:

1. Emission Level(dBuV/m) = Raw Value(dBuV) + Correction Factor(dB/m)
2. Correction Factor(dB/m) = Antenna Factor(dB/m) + Cable Factor(dB)  
– Pre-Amplifier Factor(dB)
3. The other emission levels were very low against the limit.
4. Margin value = Emission Level – Limit value
5. " \* ": Fundamental frequency.
6. " # ": The radiated frequency is out of the restricted band.



CHANNEL	TX Channel 62	DETECTOR FUNCTION	Peak (PK)
FREQUENCY RANGE	1GHz ~ 40GHz		Average (AV)

## ANTENNA POLARITY &amp; TEST DISTANCE: HORIZONTAL AT 3 M

NO.	FREQ. (MHz)	EMISSION LEVEL (dBuV/m)	LIMIT (dBuV/m)	MARGIN (dB)	ANTENNA HEIGHT (m)	TABLE ANGLE (Degree)	RAW VALUE (dBuV)	CORRECTION FACTOR (dB/m)
1	*5310.00	100.5 PK			1.08 H	101	61.6	38.9
2	*5310.00	90.9 AV			1.08 H	101	52.0	38.9
3	5350.00	62.4 PK	74.0	-11.6	1.04 H	60	61.3	1.1
4	5350.00	50.2 AV	54.0	-3.8	1.04 H	60	49.1	1.1
5	10620.00	57.6 PK	74.0	-16.4	1.56 H	340	43.8	13.8
6	10620.00	45.9 AV	54.0	-8.1	1.56 H	340	32.1	13.8

## ANTENNA POLARITY &amp; TEST DISTANCE: VERTICAL AT 3 M

NO.	FREQ. (MHz)	EMISSION LEVEL (dBuV/m)	LIMIT (dBuV/m)	MARGIN (dB)	ANTENNA HEIGHT (m)	TABLE ANGLE (Degree)	RAW VALUE (dBuV)	CORRECTION FACTOR (dB/m)
1	*5310.00	102.2 PK			3.55 V	87	63.3	38.9
2	*5310.00	92.8 AV			3.55 V	87	53.9	38.9
3	5350.00	49.4 AV	74.0	-24.6	3.55 V	87	48.3	1.1
4	5350.00	52.2 AV	54.0	-1.8	3.55 V	87	51.1	1.1
5	10620.00	57.6 PK	74.0	-16.4	2.43 V	123	43.8	13.8
6	10620.00	45.1 AV	54.0	-8.9	2.43 V	123	31.3	13.8

## Remark:

1. Emission Level(dBuV/m) = Raw Value(dBuV) + Correction Factor(dB/m)
2. Correction Factor(dB/m) = Antenna Factor(dB/m) + Cable Factor(dB)  
– Pre-Amplifier Factor(dB)
3. The other emission levels were very low against the limit.
4. Margin value = Emission Level – Limit value
5. " \* ": Fundamental frequency.
6. " # ": The radiated frequency is out of the restricted band.

CHANNEL	TX Channel 102	DETECTOR FUNCTION	Peak (PK)
FREQUENCY RANGE	1GHz ~ 40GHz		Average (AV)

ANTENNA POLARITY & TEST DISTANCE: HORIZONTAL AT 3 M								
NO.	FREQ. (MHz)	EMISSION LEVEL (dBuV/m)	LIMIT (dBuV/m)	MARGIN (dB)	ANTENNA HEIGHT (m)	TABLE ANGLE (Degree)	RAW VALUE (dBuV)	CORRECTION FACTOR (dB/m)
1	5460.00	61.7 PK	74.0	-12.3	1.20 H	110	60.5	1.2
2	5460.00	45.5 AV	54.0	-8.5	1.20 H	110	44.3	1.2
3	#5470.00	66.6 PK	74.0	-7.4	1.15 H	106	65.4	1.2
4	#5470.00	50.3 AV	54.0	-3.7	1.15 H	106	49.1	1.2
5	*5510.00	105.2 PK			2.56 H	103	65.9	39.3
6	*5510.00	95.8 AV			2.56 H	103	56.5	39.3
7	11020.00	60.0 PK	74.0	-14.0	1.56 H	210	44.8	15.2
8	11020.00	47.0 AV	54.0	-7.0	1.56 H	210	31.8	15.2
ANTENNA POLARITY & TEST DISTANCE: VERTICAL AT 3 M								
NO.	FREQ. (MHz)	EMISSION LEVEL (dBuV/m)	LIMIT (dBuV/m)	MARGIN (dB)	ANTENNA HEIGHT (m)	TABLE ANGLE (Degree)	RAW VALUE (dBuV)	CORRECTION FACTOR (dB/m)
1	5460.00	62.6 PK	74.0	-11.4	2.52 V	104	61.4	1.2
2	5460.00	49.1 AV	54.0	-4.9	2.52 V	104	47.9	1.2
3	#5470.00	58.7 PK	74.0	-15.3	2.48 V	76	57.5	1.2
4	#5470.00	52.5 AV	54.0	-1.5	2.48 V	76	51.3	1.2
5	*5510.00	107.6 PK			2.65 V	115	68.3	39.3
6	*5510.00	98.0 AV			2.65 V	115	58.7	39.3
7	11020.00	59.0 PK	74.0	-15.0	1.75 V	199	43.8	15.2
8	11020.00	47.0 AV	54.0	-7.0	1.75 V	199	31.8	15.2

Remark:

1. Emission Level(dBuV/m) = Raw Value(dBuV) + Correction Factor(dB/m)
2. Correction Factor(dB/m) = Antenna Factor(dB/m) + Cable Factor(dB)  
– Pre-Amplifier Factor(dB)
3. The other emission levels were very low against the limit.
4. Margin value = Emission Level – Limit value
5. " \* ": Fundamental frequency.
6. " # ": The radiated frequency is out of the restricted band.

CHANNEL	TX Channel 110	DETECTOR FUNCTION	Peak (PK)
FREQUENCY RANGE	1GHz ~ 40GHz		Average (AV)

ANTENNA POLARITY & TEST DISTANCE: HORIZONTAL AT 3 M								
NO.	FREQ. (MHz)	EMISSION LEVEL (dBuV/m)	LIMIT (dBuV/m)	MARGIN (dB)	ANTENNA HEIGHT (m)	TABLE ANGLE (Degree)	RAW VALUE (dBuV)	CORRECTION FACTOR (dB/m)
1	5460.00	61.3 PK	74.0	-12.7	2.60 H	330	60.1	1.2
2	5460.00	48.3 AV	54.0	-5.7	2.60 H	330	47.1	1.2
3	#5470.00	65.8 PK	74.0	-8.2	2.64 H	337	64.6	1.2
4	#5470.00	51.2 AV	54.0	-2.8	2.64 H	337	50.0	1.2
5	*5550.00	111.0 PK			2.61 H	104	71.7	39.3
6	*5550.00	100.9 AV			2.61 H	104	61.6	39.3
7	11100.00	63.5 PK	74.0	-10.5	2.61 H	334	48.7	14.8
8	11100.00	50.1 AV	54.0	-3.9	2.61 H	334	35.3	14.8
ANTENNA POLARITY & TEST DISTANCE: VERTICAL AT 3 M								
NO.	FREQ. (MHz)	EMISSION LEVEL (dBuV/m)	LIMIT (dBuV/m)	MARGIN (dB)	ANTENNA HEIGHT (m)	TABLE ANGLE (Degree)	RAW VALUE (dBuV)	CORRECTION FACTOR (dB/m)
1	5460.00	61.3 PK	74.0	-12.7	2.77 V	111	60.1	1.2
2	5460.00	50.5 AV	54.0	-3.5	2.77 V	111	49.3	1.2
3	#5470.00	67.1 PK	74.0	-6.9	2.84 V	85	65.9	1.2
4	#5470.00	51.9 AV	54.0	-2.1	2.84 V	85	50.7	1.2
5	*5550.00	113.4 PK			2.32 V	111	74.1	39.3
6	*5550.00	103.2 AV			2.32 V	111	63.9	39.3
7	11100.00	60.3 PK	74.0	-13.7	2.11 V	230	45.5	14.8
8	11100.00	47.1 AV	54.0	-6.9	2.11 V	230	32.3	14.8

Remark:

1. Emission Level(dBuV/m) = Raw Value(dBuV) + Correction Factor(dB/m)
2. Correction Factor(dB/m) = Antenna Factor(dB/m) + Cable Factor(dB)  
– Pre-Amplifier Factor(dB)
3. The other emission levels were very low against the limit.
4. Margin value = Emission Level – Limit value
5. " \* ": Fundamental frequency.
6. " # ": The radiated frequency is out of the restricted band.

CHANNEL	TX Channel 134	DETECTOR FUNCTION	Peak (PK)
FREQUENCY RANGE	1GHz ~ 40GHz		Average (AV)

ANTENNA POLARITY & TEST DISTANCE: HORIZONTAL AT 3 M								
NO.	FREQ. (MHz)	EMISSION LEVEL (dBuV/m)	LIMIT (dBuV/m)	MARGIN (dB)	ANTENNA HEIGHT (m)	TABLE ANGLE (Degree)	RAW VALUE (dBuV)	CORRECTION FACTOR (dB/m)
1	*5670.00	107.8 PK			1.10 H	102	68.1	39.7
2	*5670.00	98.1 AV			1.10 H	102	58.4	39.7
3	#5725.00	65.6 PK	74.0	-8.4	2.49 H	103	63.6	2.0
4	#5725.00	50.7 AV	54.0	-3.3	2.49 H	103	48.7	2.0
5	11340.00	61.7 PK	74.0	-12.3	2.59 H	337	47.0	14.7
6	11340.00	48.6 AV	54.0	-5.4	2.59 H	337	33.9	14.7
ANTENNA POLARITY & TEST DISTANCE: VERTICAL AT 3 M								
NO.	FREQ. (MHz)	EMISSION LEVEL (dBuV/m)	LIMIT (dBuV/m)	MARGIN (dB)	ANTENNA HEIGHT (m)	TABLE ANGLE (Degree)	RAW VALUE (dBuV)	CORRECTION FACTOR (dB/m)
1	*5670.00	111.1 PK			2.61 V	119	71.4	39.7
2	*5670.00	101.2 AV			2.61 V	119	61.5	39.7
3	#5725.00	64.1 PK	74.0	-9.9	2.48 V	115	62.1	2.0
4	#5725.00	52.2 AV	54.0	-1.8	2.48 V	115	50.2	2.0
5	11340.00	60.0 PK	74.0	-14.0	2.22 V	133	45.3	14.7
6	11340.00	47.3 AV	54.0	-6.7	2.22 V	133	32.6	14.7

Remark:

1. Emission Level(dBuV/m) = Raw Value(dBuV) + Correction Factor(dB/m)
2. Correction Factor(dB/m) = Antenna Factor(dB/m) + Cable Factor(dB)  
– Pre-Amplifier Factor(dB)
3. The other emission levels were very low against the limit.
4. Margin value = Emission Level – Limit value
5. " \* ": Fundamental frequency.
6. " # ": The radiated frequency is out of the restricted band.

802.11ac (VHT80)

CHANNEL	TX Channel 58	DETECTOR FUNCTION	Peak (PK)
FREQUENCY RANGE	1GHz ~ 40GHz		Average (AV)

ANTENNA POLARITY & TEST DISTANCE: HORIZONTAL AT 3 M

NO.	FREQ. (MHz)	EMISSION LEVEL (dBuV/m)	LIMIT (dBuV/m)	MARGIN (dB)	ANTENNA HEIGHT (m)	TABLE ANGLE (Degree)	RAW VALUE (dBuV)	CORRECTION FACTOR (dB/m)
1	5150.00	58.6 PK	74.0	-15.4	1.10 H	56	57.8	0.8
2	5150.00	44.8 AV	54.0	-9.2	1.10 H	56	44.0	0.8
3	*5290.00	95.8 PK			1.15 H	105	56.9	38.9
4	*5290.00	85.7 AV			1.15 H	105	46.8	38.9
5	5350.00	61.9 PK	74.0	-12.1	1.00 H	64	60.8	1.1
6	5350.00	50.3 AV	54.0	-3.7	1.00 H	64	49.2	1.1
7	#10580.00	59.3 PK	74.0	-14.7	1.61 H	312	45.5	13.8
8	#10580.00	46.4 AV	54.0	-7.6	1.61 H	312	32.6	13.8

ANTENNA POLARITY & TEST DISTANCE: VERTICAL AT 3 M

NO.	FREQ. (MHz)	EMISSION LEVEL (dBuV/m)	LIMIT (dBuV/m)	MARGIN (dB)	ANTENNA HEIGHT (m)	TABLE ANGLE (Degree)	RAW VALUE (dBuV)	CORRECTION FACTOR (dB/m)
1	5150.00	57.0 PK	74.0	-17.0	3.66 V	100	56.2	0.8
2	5150.00	44.1 AV	54.0	-9.9	3.66 V	100	43.3	0.8
3	*5290.00	98.7 PK			3.52 V	95	59.8	38.9
4	*5290.00	89.1 AV			3.52 V	95	50.2	38.9
5	5350.00	64.6 PK	74.0	-9.4	3.71 V	97	63.5	1.1
6	5350.00	52.4 AV	54.0	-1.6	3.71 V	97	51.3	1.1
7	#10580.00	57.8 PK	74.0	-16.2	2.50 V	169	44.0	13.8
8	#10580.00	45.8 AV	54.0	-8.2	2.50 V	169	32.0	13.8

Remark:

1. Emission Level(dBuV/m) = Raw Value(dBuV) + Correction Factor(dB/m)
2. Correction Factor(dB/m) = Antenna Factor(dB/m) + Cable Factor(dB)  
- Pre-Amplifier Factor(dB)
3. The other emission levels were very low against the limit.
4. Margin value = Emission Level – Limit value
5. " \* ": Fundamental frequency.
6. " # ": The radiated frequency is out of the restricted band.

CHANNEL	TX Channel 106	DETECTOR FUNCTION	Peak (PK)
FREQUENCY RANGE	1GHz ~ 40GHz		Average (AV)

ANTENNA POLARITY & TEST DISTANCE: HORIZONTAL AT 3 M								
NO.	FREQ. (MHz)	EMISSION LEVEL (dBuV/m)	LIMIT (dBuV/m)	MARGIN (dB)	ANTENNA HEIGHT (m)	TABLE ANGLE (Degree)	RAW VALUE (dBuV)	CORRECTION FACTOR (dB/m)
1	5460.00	61.7 PK	74.0	-12.3	2.54 H	102	60.5	1.2
2	5460.00	49.8 AV	54.0	-4.2	2.54 H	102	48.6	1.2
3	#5470.00	60.7 PK	74.0	-13.3	2.65 H	106	59.5	1.2
4	#5470.00	48.3 AV	54.0	-5.7	2.65 H	106	47.1	1.2
5	*5530.00	100.5 PK			2.55 H	105	61.2	39.3
6	*5530.00	91.0 AV			2.55 H	105	51.7	39.3
7	#5725.00	57.3 PK	74.0	-16.7	1.46 H	84	55.3	2.0
8	#5725.00	44.5 AV	54.0	-9.5	1.46 H	84	42.5	2.0
9	11060.00	60.0 PK	74.0	-14.0	1.66 H	0	45.1	14.9
10	11060.00	46.9 AV	54.0	-7.1	1.66 H	0	32.0	14.9

ANTENNA POLARITY & TEST DISTANCE: VERTICAL AT 3 M								
NO.	FREQ. (MHz)	EMISSION LEVEL (dBuV/m)	LIMIT (dBuV/m)	MARGIN (dB)	ANTENNA HEIGHT (m)	TABLE ANGLE (Degree)	RAW VALUE (dBuV)	CORRECTION FACTOR (dB/m)
1	5460.00	64.5 PK	74.0	-9.5	2.63 V	114	63.3	1.2
2	5460.00	52.2 AV	54.0	-1.8	2.63 V	114	51.0	1.2
3	#5470.00	60.8 PK	74.0	-13.2	2.58 V	142	59.6	1.2
4	#5470.00	48.8 AV	54.0	-5.2	2.58 V	142	47.6	1.2
5	*5530.00	103.9 PK			2.56 V	119	64.6	39.3
6	*5530.00	93.9 AV			2.56 V	119	54.6	39.3
7	#5725.00	58.1 PK	74.0	-15.9	2.14 V	102	56.1	2.0
8	#5725.00	45.0 AV	54.0	-9.0	2.14 V	102	43.0	2.0
9	11060.00	59.2 PK	74.0	-14.8	2.00 V	151	44.3	14.9
10	11060.00	46.5 AV	54.0	-7.5	2.00 V	151	31.6	14.9

Remark:

1. Emission Level(dBuV/m) = Raw Value(dBuV) + Correction Factor(dB/m)
2. Correction Factor(dB/m) = Antenna Factor(dB/m) + Cable Factor(dB)  
– Pre-Amplifier Factor(dB)
3. The other emission levels were very low against the limit.
4. Margin value = Emission Level – Limit value
5. " \* ": Fundamental frequency.
6. " # ": The radiated frequency is out of the restricted band.

Below 1GHz Worst-Case Data: 802.11a

CHANNEL	TX Channel 60	DETECTOR FUNCTION	Quasi-Peak (QP)
FREQUENCY RANGE	9kHz ~ 1GHz		

ANTENNA POLARITY & TEST DISTANCE: HORIZONTAL AT 3 M								
NO.	FREQ. (MHz)	EMISSION LEVEL (dBuV/m)	LIMIT (dBuV/m)	MARGIN (dB)	ANTENNA HEIGHT (m)	TABLE ANGLE (Degree)	RAW VALUE (dBuV)	CORRECTION FACTOR (dB/m)
1	57.12	27.4 QP	40.0	-12.6	2.00 H	31	42.0	-14.6
2	134.89	37.1 QP	43.5	-6.4	2.00 H	256	51.9	-14.8
3	164.06	39.0 QP	43.5	-4.5	1.51 H	256	52.7	-13.7
4	201.00	35.0 QP	43.5	-8.5	1.00 H	255	51.3	-16.3
5	280.71	29.5 QP	46.0	-16.5	1.00 H	284	41.9	-12.4
6	595.69	27.2 QP	46.0	-18.8	1.51 H	144	32.7	-5.5

ANTENNA POLARITY & TEST DISTANCE: VERTICAL AT 3 M								
NO.	FREQ. (MHz)	EMISSION LEVEL (dBuV/m)	LIMIT (dBuV/m)	MARGIN (dB)	ANTENNA HEIGHT (m)	TABLE ANGLE (Degree)	RAW VALUE (dBuV)	CORRECTION FACTOR (dB/m)
1	64.90	36.7 QP	40.0	-3.3	1.00 V	338	52.2	-15.5
2	132.95	32.8 QP	43.5	-10.7	1.49 V	190	47.8	-15.0
3	197.11	32.1 QP	43.5	-11.4	1.00 V	251	48.3	-16.2
4	263.21	22.9 QP	46.0	-23.1	1.99 V	202	36.3	-13.4
5	599.58	27.4 QP	46.0	-18.6	1.00 V	267	32.8	-5.4
6	712.35	26.7 QP	46.0	-19.3	1.99 V	333	30.1	-3.4

Remarks:

1. Emission Level(dBuV/m) = Raw Value(dBuV) + Correction Factor(dB/m)
2. Correction Factor(dB/m) = Antenna Factor(dB/m) + Cable Factor(dB) – Pre-Amplifier Factor(dB)
3. The other emission levels were very low against the limit.
4. Margin value = Emission Level – Limit value

## 4.2 Conducted Emission Measurement

### 4.2.1 Limits of Conducted Emission Measurement

Frequency (MHz)	Conducted Limit (dBuV)	
	Quasi-peak	Average
0.15 - 0.5	66 - 56	56 - 46
0.50 - 5.0	56	46
5.0 - 30.0	60	50

- Note:** 1. The lower limit shall apply at the transition frequencies.  
 2. The limit decreases in line with the logarithm of the frequency in the range of 0.15 to 0.50MHz.

### 4.2.2 Test Instruments

Description & Manufacturer	Model No.	Serial No.	Cal. Date	Cal. Due
Test Receiver ROHDE & SCHWARZ	ESCI	100613	Nov. 21, 2016	Nov. 20, 2017
RF signal cable (with 10dB PAD) Woken	5D-FB	Cable-cond1-01	Dec. 22, 2016	Dec. 21, 2017
LISN ROHDE & SCHWARZ (EUT)	ESH3-Z5	835239/001	Mar. 10, 2017	Mar. 09, 2018
LISN ROHDE & SCHWARZ (Peripheral)	ESH3-Z5	100311	Jul. 28, 2016	Jul. 27, 2017
Software ADT	BV ADT_Cond_ V7.3.7.3	NA	NA	NA

- Note:** 1. The calibration interval of the above test instruments is 12 months and the calibrations are traceable to NML/ROC and NIST/USA.  
 2. The test was performed in HwaYa Shielded Room 1.  
 3. The VCCI Site Registration No. is C-2040.



#### 4.2.3 Test Procedures

- The EUT was placed 0.4 meters from the conducting wall of the shielded room with EUT being connected to the power mains through a line impedance stabilization network (LISN). Other support units were connected to the power mains through another LISN. The two LISNs provide 50 ohm/ 50uH of coupling impedance for the measuring instrument.
- Both lines of the power mains connected to the EUT were checked for maximum conducted interference.
- The frequency range from 150kHz to 30MHz was searched. Emission levels under (Limit - 20dB) was not recorded.

**Note:** The resolution bandwidth and video bandwidth of test receiver is 9kHz for quasi-peak detection (QP) and average detection (AV) at frequency 0.15MHz-30MHz.

#### 4.2.4 Deviation from Test Standard

No deviation.

#### 4.2.5 Test Setup

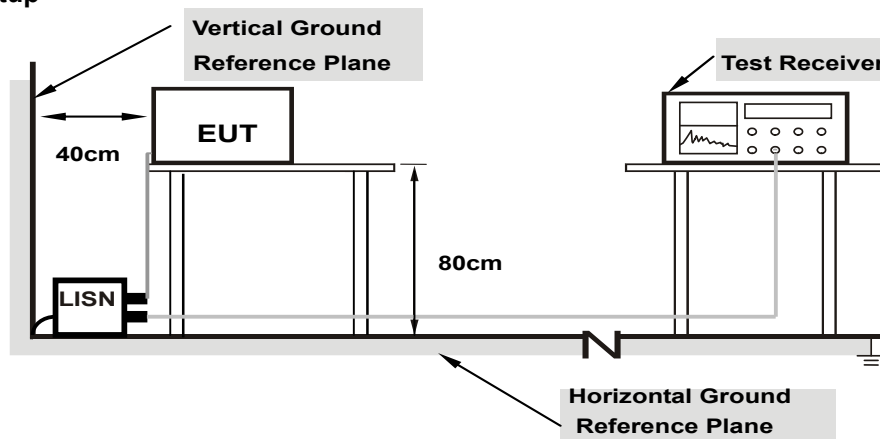

**Note:** 1.Support units were connected to second LISN.

For the actual test configuration, please refer to the attached file (Test Setup Photo).

#### 4.2.6 EUT Operating Conditions

Same as 4.1.6.

#### 4.2.7 Test Results

Phase	Line (L)	Detector Function	Quasi-Peak (QP) / Average (AV)
-------	----------	-------------------	--------------------------------

No	Freq. [MHz]	Corr. Factor (dB)	Reading Value [dB (uV)]		Emission Level [dB (uV)]		Limit [dB (uV)]		Margin (dB)	
			Q.P.	AV.	Q.P.	AV.	Q.P.	AV.	Q.P.	AV.
			1	0.15782	10.35	31.42	15.29	41.77	25.64	65.58
2	0.17346	10.36	26.57	12.30	36.93	22.66	64.79	54.79	-27.86	-32.13
3	0.21256	10.37	21.67	8.84	32.04	19.21	63.10	53.10	-31.06	-33.89
4	0.38099	10.40	18.85	15.28	29.25	25.68	58.26	48.26	-29.01	-22.58
5	3.75111	10.56	16.40	13.79	26.96	24.35	56.00	46.00	-29.04	-21.65
6	9.25248	10.80	16.26	12.84	27.06	23.64	60.00	50.00	-32.94	-26.36

Remarks:

1. Q.P. and AV. are abbreviations of quasi-peak and average individually.
2. The emission levels of other frequencies were very low against the limit.
3. Margin value = Emission level - Limit value
4. Correction factor = Insertion loss + Cable loss
5. Emission Level = Correction Factor + Reading Value.

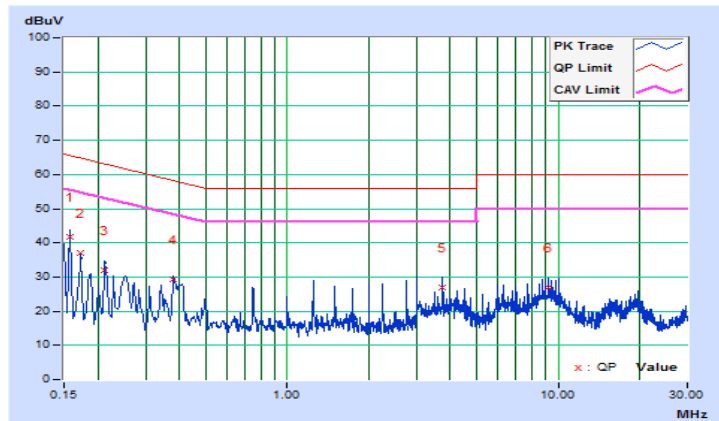

Phase	Neutral (N)	Detector Function	Quasi-Peak (QP) / Average (AV)
-------	-------------	-------------------	--------------------------------

No	Freq. [MHz]	Corr. Factor (dB)	Reading Value [dB (uV)]		Emission Level [dB (uV)]		Limit [dB (uV)]		Margin (dB)	
			Q.P.	AV.	Q.P.	AV.	Q.P.	AV.	Q.P.	AV.
			1	0.15391	10.11	32.22	16.22	42.33	26.33	65.79
2	0.18519	10.13	23.93	10.54	34.06	20.67	64.25	54.25	-30.19	-33.58
<b>3</b>	<b>0.38401</b>	<b>10.16</b>	<b>21.68</b>	<b>19.37</b>	<b>31.84</b>	<b>29.53</b>	<b>58.19</b>	<b>48.19</b>	<b>-26.35</b>	<b>-18.66</b>
4	1.24871	10.18	15.16	14.97	25.34	25.15	56.00	46.00	-30.66	-20.85
5	3.00039	10.29	17.26	15.96	27.55	26.25	56.00	46.00	-28.45	-19.75
6	9.50272	10.53	15.21	12.20	25.74	22.73	60.00	50.00	-34.26	-27.27

Remarks:

1. Q.P. and AV. are abbreviations of quasi-peak and average individually.
2. The emission levels of other frequencies were very low against the limit.
3. Margin value = Emission level - Limit value
4. Correction factor = Insertion loss + Cable loss
5. Emission Level = Correction Factor + Reading Value.

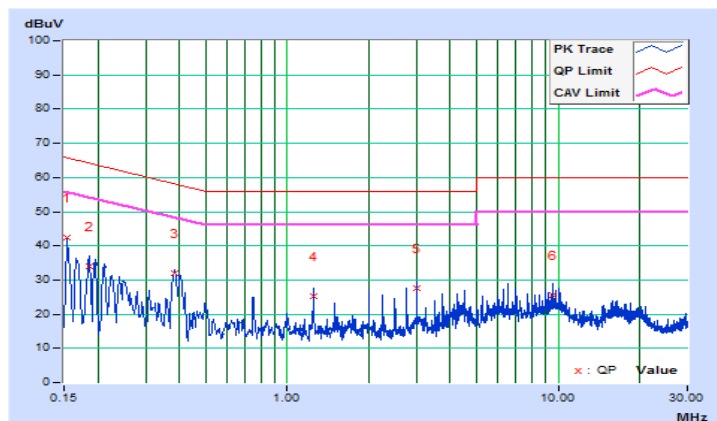

### 4.3 Transmit Power Measurement

#### 4.3.1 Limits of Transmit Power Measurement

Operation Band	EUT Category		LIMIT
U-NII-1	---	Outdoor Access Point	1 Watt (30 dBm) (Max. e.i.r.p $\leq$ 125mW(21 dBm) at any elevation angle above 30 degrees as measured from the horizon)
	---	Fixed point-to-point Access Point	1 Watt (30 dBm)
	---	Indoor Access Point	1 Watt (30 dBm)
	---	Mobile and Portable client device	250mW (24 dBm)
U-NII-2A	√		250mW (24 dBm) or 11 dBm+10 log B*
U-NII-2C	√		250mW (24 dBm) or 11 dBm+10 log B*
U-NII-3	---		1 Watt (30 dBm)

\*B is the 26 dB emission bandwidth in megahertz

Per KDB 662911 Method of conducted output power measurement on IEEE 802.11 devices,

Array Gain = 0 dB (i.e., no array gain) for  $N_{ANT} \leq 4$ ;

Array Gain = 0 dB (i.e., no array gain) for channel widths  $\geq 40$  MHz for any  $N_{ANT}$ ;

Array Gain =  $5 \log(N_{ANT}/N_{SS})$  dB or 3 dB, whichever is less for 20-MHz channel widths with  $N_{ANT} \geq 5$ .

For power measurements on all other devices: Array Gain =  $10 \log(N_{ANT}/N_{SS})$  dB.

#### 4.3.2 Test Setup

For Power Output Measurement

802.11a, 802.11n (HT20), 802.11n (HT40)

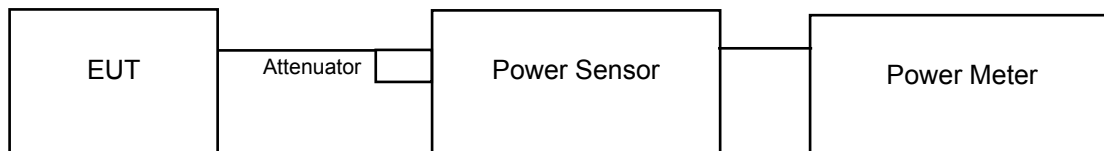

802.11ac (VHT80)

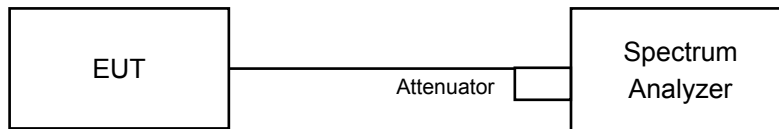

For 26dB Bandwidth

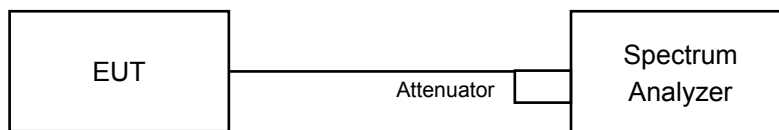

#### 4.3.3 Test Instruments

Refer to section 4.1.2 to get information of above instrument.

#### 4.3.4 Test Procedure

##### For Average Power Measurement

##### For 802.11a, 802.11n (HT20), 802.11n (HT40)

Method PM is used to perform output power measurement, trigger and gating function of wide band power meter is enabled to measure max output power of TX on burst. Duty factor is not added to measured value.

##### For 802.11ac (VHT80)

- a. Set span to encompass the entire 26 dB EBW (or, alternatively, the entire 99% occupied bandwidth) of the signal.
- b. Set sweep trigger to “free run”.
- c. Set RBW = 1 MHz.
- d. Set VBW  $\geq$  3 MHz
- e. Number of points in sweep  $\geq$  2 Span / RBW.
- f. Sweep time  $\leq$  (number of points in sweep) \* T
- g. Using emission bandwidth to determine the frequency span for integration the channel bandwidth.
- h. Detector = RMS.
- i. Trace mode = max hold.
- j. Allow max hold to run for at least 60 seconds, or longer as needed to allow the trace to stabilize.
- k. Compute power by integrating the spectrum across the EBW (or, alternatively, the entire 99% occupied bandwidth) of the signal using the instrument’s band power measurement function with band limits set equal to the EBW (or occupied bandwidth) band edges. If the instrument does not have a band power function, sum the spectrum levels (in power units) at 1 MHz intervals extending across the EBW (or, alternatively, the entire 99% occupied bandwidth) of the spectrum.

##### For 26dB Bandwidth

- a. Set RBW = approximately 1% of the emission bandwidth.
- b. Set the VBW > RBW.
- c. Detector = Peak.
- d. Trace mode = max hold.
- e. Measure the maximum width of the emission that is 26 dB down from the peak of the emission. Compare this with the RBW setting of the analyzer. Readjust RBW and repeat measurement as needed until the RBW/EBW ratio is approximately 1%.

#### 4.3.5 Deviation from Test Standard

No deviation.

#### 4.3.6 EUT Operating Conditions

The software provided by client to enable the EUT under transmission condition continuously at lowest, middle and highest channel frequencies individually.

### 4.3.7 Test Result

Power Output:

CDD Mode

802.11a

Chan.	Freq. (MHz)	Maximum Conducted Power (dBm)		Total Power (mW)	Total Power (dBm)	Power Limit (dBm)	Pass / Fail
		Chain 0	Chain 1				
52	5260	18.56	18.50	142.574	21.54	24.00	Pass
60	5300	18.45	18.69	143.945	21.58	24.00	Pass
64	5320	18.66	18.56	145.230	21.62	24.00	Pass
100	5500	16.87	17.36	103.091	20.13	24.00	Pass
116	5580	18.79	18.94	154.026	21.88	24.00	Pass
140	5700	16.67	16.79	94.205	19.74	24.00	Pass

Note:

Chain 0

1.  $11\text{dBm} + 10\log ( 36.15 ) = 26.58 > 24.00\text{dBm}$
2.  $11\text{dBm} + 10\log ( 35.22 ) = 26.47 > 24.00\text{dBm}$
3.  $11\text{dBm} + 10\log ( 31.25 ) = 25.95 > 24.00\text{dBm}$
4.  $11\text{dBm} + 10\log ( 20.08 ) = 24.03 > 24.00\text{dBm}$
5.  $11\text{dBm} + 10\log ( 34.49 ) = 26.38 > 24.00\text{dBm}$
6.  $11\text{dBm} + 10\log ( 28.82 ) = 25.60 > 24.00\text{dBm}$

Chain 1

1.  $11\text{dBm} + 10\log ( 35.82 ) = 26.54 > 24.00\text{dBm}$
2.  $11\text{dBm} + 10\log ( 34.37 ) = 26.36 > 24.00\text{dBm}$
3.  $11\text{dBm} + 10\log ( 33.05 ) = 26.19 > 24.00\text{dBm}$
4.  $11\text{dBm} + 10\log ( 28.47 ) = 25.54 > 24.00\text{dBm}$
5.  $11\text{dBm} + 10\log ( 42.94 ) = 27.33 > 24.00\text{dBm}$
6.  $11\text{dBm} + 10\log ( 32.72 ) = 26.15 > 24.00\text{dBm}$

## 802.11n (HT20)

Chan.	Freq. (MHz)	Maximum Conducted Power (dBm)		Total Power (mW)	Total Power (dBm)	Power Limit (dBm)	Pass / Fail
		Chain 0	Chain 1				
52	5260	18.63	18.47	143.253	21.56	24.00	Pass
60	5300	18.69	18.64	147.075	21.68	24.00	Pass
64	5320	18.79	18.64	148.797	21.73	24.00	Pass
100	5500	16.08	16.21	82.334	19.16	24.00	Pass
116	5580	18.72	18.68	148.263	21.71	24.00	Pass
140	5700	14.91	15.17	63.859	18.05	24.00	Pass

## Note:

## Chain 0

1.  $11\text{dBm} + 10\log ( 38.17 ) = 26.82 > 24.00\text{dBm}$
2.  $11\text{dBm} + 10\log ( 35.67 ) = 26.52 > 24.00\text{dBm}$
3.  $11\text{dBm} + 10\log ( 34.51 ) = 26.38 > 24.00\text{dBm}$
4.  $11\text{dBm} + 10\log ( 20.76 ) = 24.17 > 24.00\text{dBm}$
5.  $11\text{dBm} + 10\log ( 37.62 ) = 26.75 > 24.00\text{dBm}$
6.  $11\text{dBm} + 10\log ( 20.95 ) = 24.21 > 24.00\text{dBm}$

## Chain 1

1.  $11\text{dBm} + 10\log ( 38.77 ) = 26.88 > 24.00\text{dBm}$
2.  $11\text{dBm} + 10\log ( 36.13 ) = 26.58 > 24.00\text{dBm}$
3.  $11\text{dBm} + 10\log ( 37.35 ) = 26.72 > 24.00\text{dBm}$
4.  $11\text{dBm} + 10\log ( 21.69 ) = 24.36 > 24.00\text{dBm}$
5.  $11\text{dBm} + 10\log ( 43.30 ) = 27.36 > 24.00\text{dBm}$
6.  $11\text{dBm} + 10\log ( 20.96 ) = 24.21 > 24.00\text{dBm}$

### 802.11n (HT40)

Chan.	Freq. (MHz)	Maximum Conducted Power (dBm)		Total Power (mW)	Total Power (dBm)	Power Limit (dBm)	Pass / Fail
		Chain 0	Chain 1				
54	5270	19.14	19.08	<b>162.945</b>	22.12	24.00	Pass
62	5310	15.36	15.38	68.870	18.38	24.00	Pass
102	5510	14.25	14.34	53.771	17.31	24.00	Pass
110	5550	19.74	19.44	<b>182.091</b>	22.60	24.00	Pass
134	5670	16.61	16.58	91.313	19.61	24.00	Pass

Note:

Chain 0

1.  $11\text{dBm} + 10\log ( 81.86 ) = 30.13 > 24.00\text{dBm}$
2.  $11\text{dBm} + 10\log ( 41.18 ) = 27.15 > 24.00\text{dBm}$
3.  $11\text{dBm} + 10\log ( 40.93 ) = 27.12 > 24.00\text{dBm}$
4.  $11\text{dBm} + 10\log ( 86.78 ) = 30.38 > 24.00\text{dBm}$
5.  $11\text{dBm} + 10\log ( 67.95 ) = 29.32 > 24.00\text{dBm}$

Chain 1

1.  $11\text{dBm} + 10\log ( 88.39 ) = 30.46 > 24.00\text{dBm}$
2.  $11\text{dBm} + 10\log ( 40.86 ) = 27.11 > 24.00\text{dBm}$
3.  $11\text{dBm} + 10\log ( 40.90 ) = 27.12 > 24.00\text{dBm}$
4.  $11\text{dBm} + 10\log ( 92.26 ) = 30.65 > 24.00\text{dBm}$
5.  $11\text{dBm} + 10\log ( 76.41 ) = 29.83 > 24.00\text{dBm}$

### 802.11ac (VHT80)

Chan.	Freq. (MHz)	Maximum Conducted Power (dBm)		Total Power (mW)	Total Power (dBm)	Power Limit (dBm)	Pass / Fail
		Chain 0	Chain 1				
58	5290	14.68	14.62	58.349	17.66	24.00	Pass
106	5530	13.59	13.63	45.923	16.62	24.00	Pass

Note:

Chain 0

1.  $11\text{dBm} + 10\log ( 84.27 ) = 30.26 > 24\text{dBm}$
2.  $11\text{dBm} + 10\log ( 84.28 ) = 30.26 > 24\text{dBm}$

Chain 1

1.  $11\text{dBm} + 10\log ( 83.73 ) = 30.23 > 24\text{dBm}$
2.  $11\text{dBm} + 10\log ( 83.81 ) = 30.23 > 24\text{dBm}$



Beamforming Mode

802.11n (HT20)

Chan.	Freq. (MHz)	Maximum Conducted Power (dBm)		Total Power (mW)	Total Power (dBm)	Power Limit (dBm)	Pass / Fail
		Chain 0	Chain 1				
52	5260	15.62	15.46	71.631	18.55	24.00	Pass
60	5300	15.68	15.63	73.542	18.67	24.00	Pass
64	5320	15.78	15.63	74.404	18.72	24.00	Pass
100	5500	13.07	13.20	41.170	16.15	24.00	Pass
116	5580	15.71	15.67	74.137	18.70	24.00	Pass
140	5700	11.90	12.16	31.932	15.04	24.00	Pass

Note:

Chain 0

1.  $11\text{dBm} + 10\log ( 38.17 ) = 26.82 > 24.00\text{dBm}$
2.  $11\text{dBm} + 10\log ( 35.67 ) = 26.52 > 24.00\text{dBm}$
3.  $11\text{dBm} + 10\log ( 34.51 ) = 26.38 > 24.00\text{dBm}$
4.  $11\text{dBm} + 10\log ( 20.76 ) = 24.17 > 24.00\text{dBm}$
5.  $11\text{dBm} + 10\log ( 37.62 ) = 26.75 > 24.00\text{dBm}$
6.  $11\text{dBm} + 10\log ( 20.95 ) = 24.21 > 24.00\text{dBm}$

Chain 1

1.  $11\text{dBm} + 10\log ( 38.77 ) = 26.88 > 24.00\text{dBm}$
2.  $11\text{dBm} + 10\log ( 36.13 ) = 26.58 > 24.00\text{dBm}$
3.  $11\text{dBm} + 10\log ( 37.35 ) = 26.72 > 24.00\text{dBm}$
4.  $11\text{dBm} + 10\log ( 21.69 ) = 24.36 > 24.00\text{dBm}$
5.  $11\text{dBm} + 10\log ( 43.30 ) = 27.36 > 24.00\text{dBm}$
6.  $11\text{dBm} + 10\log ( 20.96 ) = 24.21 > 24.00\text{dBm}$

### 802.11n (HT40)

Chan.	Freq. (MHz)	Maximum Conducted Power (dBm)		Total Power (mW)	Total Power (dBm)	Power Limit (dBm)	Pass / Fail
		Chain 0	Chain 1				
54	5270	16.13	16.07	<b>81.478</b>	19.11	24.00	Pass
62	5310	12.35	12.37	34.437	15.37	24.00	Pass
102	5510	11.24	11.33	26.888	14.30	24.00	Pass
110	5550	16.73	16.43	<b>91.052</b>	19.59	24.00	Pass
134	5670	13.60	13.57	45.660	16.60	24.00	Pass

Note:

Chain 0

1.  $11\text{dBm} + 10\log ( 81.86 ) = 30.13 > 24.00\text{dBm}$
2.  $11\text{dBm} + 10\log ( 41.18 ) = 27.15 > 24.00\text{dBm}$
3.  $11\text{dBm} + 10\log ( 40.93 ) = 27.12 > 24.00\text{dBm}$
4.  $11\text{dBm} + 10\log ( 86.78 ) = 30.38 > 24.00\text{dBm}$
5.  $11\text{dBm} + 10\log ( 67.95 ) = 29.32 > 24.00\text{dBm}$

Chain 1

1.  $11\text{dBm} + 10\log ( 88.39 ) = 30.46 > 24.00\text{dBm}$
2.  $11\text{dBm} + 10\log ( 40.86 ) = 27.11 > 24.00\text{dBm}$
3.  $11\text{dBm} + 10\log ( 40.90 ) = 27.12 > 24.00\text{dBm}$
4.  $11\text{dBm} + 10\log ( 92.26 ) = 30.65 > 24.00\text{dBm}$
5.  $11\text{dBm} + 10\log ( 76.41 ) = 29.83 > 24.00\text{dBm}$

### 802.11ac (VHT80)

Chan.	Freq. (MHz)	Maximum Conducted Power (dBm)		Total Power (mW)	Total Power (dBm)	Power Limit (dBm)	Pass / Fail
		Chain 0	Chain 1				
58	5290	11.67	11.61	29.177	14.65	24.00	Pass
106	5530	10.58	10.62	22.963	13.61	24.00	Pass

Note:

Chain 0

1.  $11\text{dBm} + 10\log ( 84.27 ) = 30.26 > 24\text{dBm}$
2.  $11\text{dBm} + 10\log ( 84.28 ) = 30.26 > 24\text{dBm}$

Chain 1

1.  $11\text{dBm} + 10\log ( 83.73 ) = 30.23 > 24\text{dBm}$
2.  $11\text{dBm} + 10\log ( 83.81 ) = 30.23 > 24\text{dBm}$

26dB Bandwidth:

802.11a

Chan.	Freq. (MHz)	26dBc Bandwidth (MHz)	
		Chain 0	Chain 1
52	5260	36.15	35.82
60	5300	35.22	34.37
64	5320	31.25	33.05
100	5500	20.08	28.47
116	5580	34.49	42.94
140	5700	28.82	32.72

802.11n (HT20)

Chan.	Freq. (MHz)	26dBc Bandwidth (MHz)	
		Chain 0	Chain 1
52	5260	38.17	38.77
60	5300	35.67	36.13
64	5320	34.51	37.35
100	5500	20.76	21.69
116	5580	37.62	43.30
140	5700	20.95	20.96

802.11n (HT40)

Chan.	Freq. (MHz)	26dBc Bandwidth (MHz)	
		Chain 0	Chain 1
54	5270	81.86	88.39
62	5310	41.18	40.86
102	5510	40.93	40.90
110	5550	86.78	92.26
134	5670	67.95	76.41

802.11ac (VHT80)

Chan.	Freq. (MHz)	26dBc Bandwidth (MHz)	
		Chain 0	Chain 1
58	5290	84.27	83.73
106	5530	84.28	83.81

### Spectrum Plot of Worst Value

802.11a

802.11n (HT20)

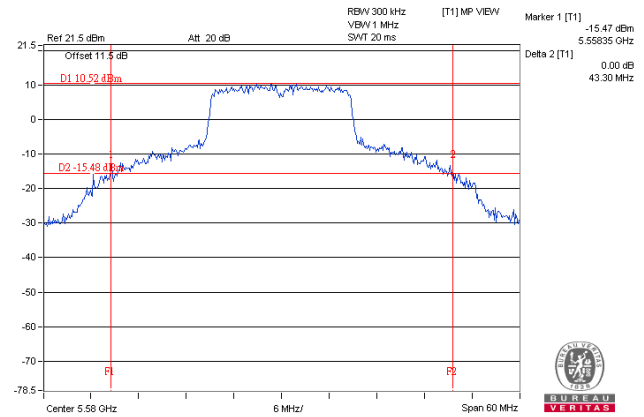
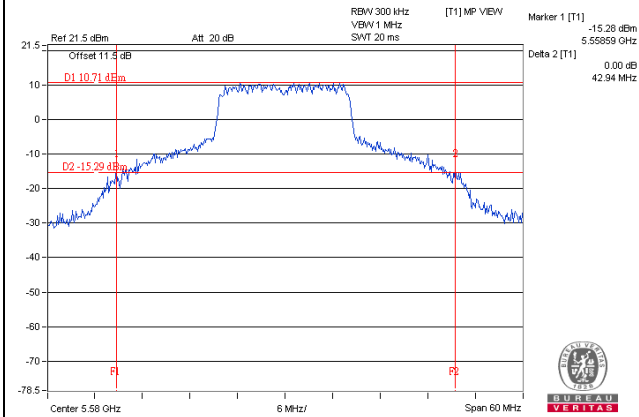

802.11n (HT40)

802.11ac (VHT80)

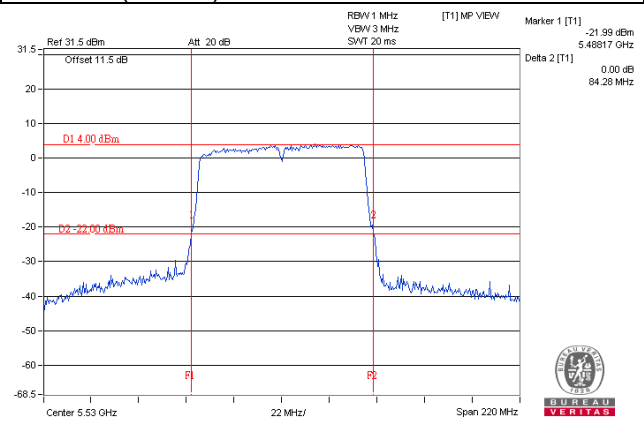
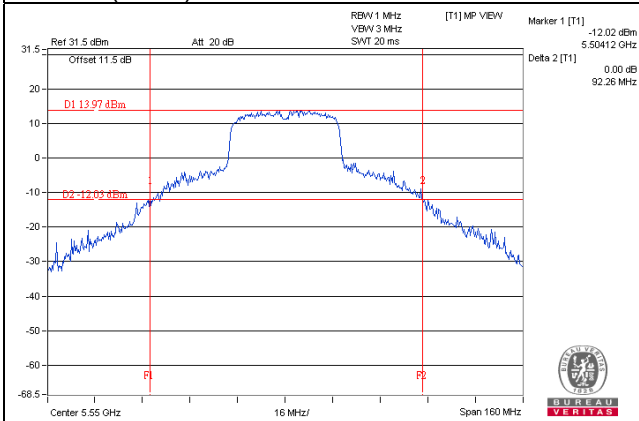

## 4.4 Occupied Bandwidth Measurement

### 4.4.1 Test Setup

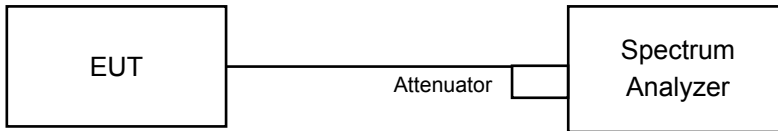

### 4.4.2 Test Instruments

Refer to section 4.1.2 to get information of above instrument.

### 4.4.3 Test Procedure

The transmitter output was connected to the spectrum analyzer through an attenuator. The bandwidth of the fundamental frequency was measured by spectrum analyzer with resolution bandwidth in the range of 1% to 5% of the anticipated emission bandwidth, and a video bandwidth at least 3x the resolution bandwidth and set the detector to sample. The width of a frequency band such that, below the lower and above the upper frequency limits, the mean powers emitted are each equal to a specified percentage 0.5 %of the total mean power of a given emission.

#### 4.4.4 Test Result

##### 802.11a

Chan.	Freq. (MHz)	Occupied Bandwidth (MHz)	
		Chain 0	Chain 1
52	5260	17.28	17.40
60	5300	17.04	17.16
64	5320	16.68	17.16
100	5500	16.56	16.92
116	5580	17.40	23.64
140	5700	16.68	16.68

##### 802.11n (HT20)

Chan.	Freq. (MHz)	Occupied Bandwidth (MHz)	
		Chain 0	Chain 1
52	5260	18.48	18.24
60	5300	18.12	18.36
64	5320	18.00	18.24
100	5500	17.64	17.76
116	5580	18.48	24.60
140	5700	17.76	17.64

##### 802.11n (HT40)

Chan.	Freq. (MHz)	Occupied Bandwidth (MHz)	
		Chain 0	Chain 1
54	5270	36.84	36.96
62	5310	36.36	36.36
102	5510	36.24	36.36
110	5550	37.08	41.64
134	5670	36.60	36.60

##### 802.11ac (VHT80)

Chan.	Freq. (MHz)	Occupied Bandwidth (MHz)	
		Chain 0	Chain 1
58	5290	75.84	76.08
106	5530	75.84	76.08

### Spectrum Plot of Worst Value

**802.11a**

**802.11n (HT20)**

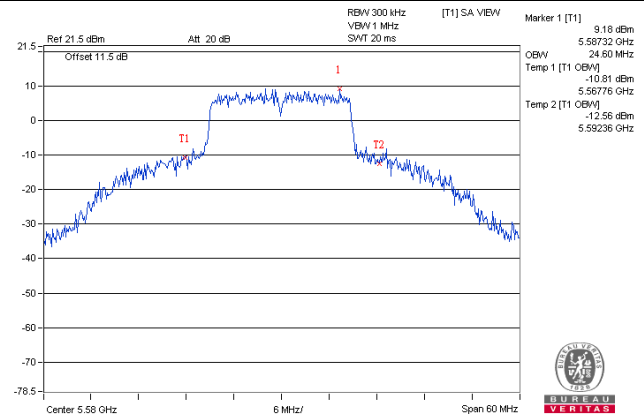
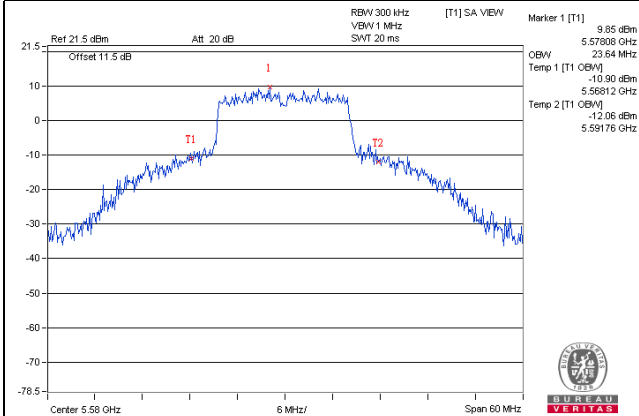

**802.11n (HT40)**

**802.11ac (VHT80)**

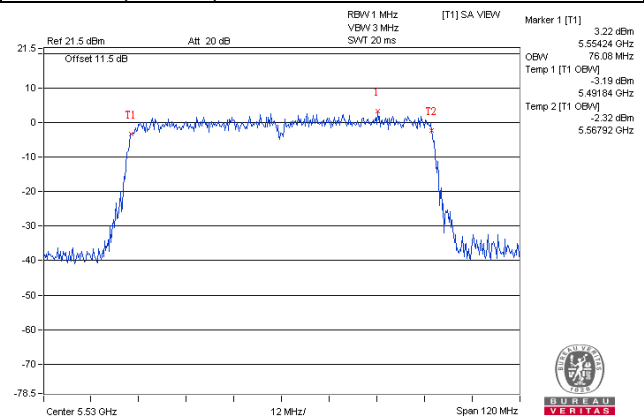
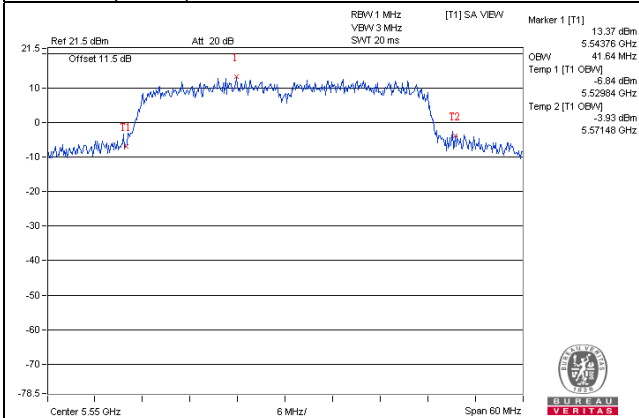

## EUT MAXIMUM CONDUCTED POWER

CDD Mode

802.11a

Frequency Band (MHz)	Max. Power	
	Output Power (mW)	Output Power (dBm)
5250~5350	145.230	21.62
5470~5725	154.026	21.88

802.11n (HT20)

Frequency Band (MHz)	Max. Power	
	Output Power (mW)	Output Power (dBm)
5250~5350	148.797	21.73
5470~5725	148.263	21.71

802.11n (HT40)

Frequency Band (MHz)	Max. Power	
	Output Power (mW)	Output Power (dBm)
5250~5350	162.945	22.12
5470~5725	182.091	22.60

802.11ac (VHT80)

Frequency Band (MHz)	Max. Power	
	Output Power (mW)	Output Power (dBm)
5250~5350	58.349	17.66
5470~5725	45.923	16.62



### Beamforming Mode

#### 802.11n (HT20)

Frequency Band (MHz)	Max. Power	
	Output Power (mW)	Output Power (dBm)
5250~5350	74.404	18.72
5470~5725	74.137	18.70

#### 802.11n (HT40)

Frequency Band (MHz)	Max. Power	
	Output Power (mW)	Output Power (dBm)
5250~5350	81.478	19.11
5470~5725	91.052	19.59

#### 802.11ac (VHT80)

Frequency Band (MHz)	Max. Power	
	Output Power (mW)	Output Power (dBm)
5250~5350	29.177	14.65
5470~5725	22.963	13.61

## 4.5 Peak Power Spectral Density Measurement

### 4.5.1 Limits of Peak Power Spectral Density Measurement

Operation Band	EUT Category		LIMIT
U-NII-1	---	Outdoor Access Point	17dBm/ MHz
	---	Fixed point-to-point Access Point	
	---	Indoor Access Point	
	---	Mobile and Portable client device	11dBm/ MHz
U-NII-2A	√		11dBm/ MHz
U-NII-2C	√		11dBm/ MHz
U-NII-3	---		30dBm/ 500kHz

### 4.5.2 Test Setup

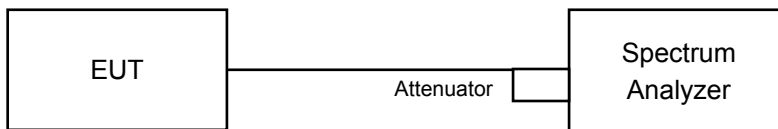

### 4.5.3 Test Instruments

Refer to section 4.1.2 to get information of above instrument.

### 4.5.4 Test Procedures

Using method SA-1, Duty cycle >98%:

- Set span to encompass the entire emission bandwidth (EBW) of the signal.
- Set RBW = 1 MHz, Set VBW ≥ 3 MHz, Detector = RMS
- Sweep time = auto, trigger set to “free run”.
- Trace average at least 100 traces in power averaging mode.
- Record the max value

Using method SA-2, Duty cycle <98%

- Set span to encompass the entire emission bandwidth (EBW) of the signal.
- Set RBW = 1 MHz, Set VBW ≥ 3 MHz, Detector = RMS
- Sweep time = auto, trigger set to “free run”.
- Trace average at least 100 traces in power averaging mode.
- Record the max value and add 10 log (1/duty cycle)

### 4.5.5 Deviation from Test Standard

No deviation.

### 4.5.6 EUT Operating Conditions

Same as Item 4.3.6.

#### 4.5.7 Test Results

##### 802.11a

Chan.	Freq. (MHz)	PSD W/O Duty Factor (dBm)		Duty Factor (dB)	Total PSD With Duty Factor (dBm)	Max. Limit (dBm)	Pass / Fail
		Chain 0	Chain 1				
52	5260	4.86	4.70	0.22	8.01	8.48	Pass
60	5300	4.61	4.15	0.22	7.61	8.48	Pass
64	5320	4.44	3.99	0.22	7.45	8.48	Pass
100	5500	2.52	1.97	0.22	5.48	8.48	Pass
116	5580	4.63	4.78	0.22	7.93	8.48	Pass
140	5700	3.13	2.89	0.22	6.24	8.48	Pass

Note:

1. Method 1 of power density measurement of KDB 662911 is using for calculating total power density. Total power density is summing entire spectra across corresponding frequency bins on the various outputs by computer.
2. Directional gain =  $10 \log[(10^{G1/20} + 10^{G2/20} + \dots + 10^{GN/20})^2/2] = 8.52 \text{ dBi} > 6 \text{ dBi}$ , so the power density limit shall be reduced to  $11 - (8.52 - 6) = 8.48 \text{ dBm}$ .
3. Refer to section 3.3 for duty cycle spectrum plot.

##### 802.11n (HT20)

Chan.	Freq. (MHz)	PSD W/O Duty Factor (dBm)		Total PSD (dBm)	Max. Limit (dBm)	Pass / Fail
		Chain 0	Chain 1			
52	5260	4.51	4.43	7.48	8.48	Pass
60	5300	4.14	3.99	7.08	8.48	Pass
64	5320	3.89	3.80	6.86	8.48	Pass
100	5500	1.10	0.78	3.95	8.48	Pass
116	5580	4.56	4.53	7.56	8.48	Pass
140	5700	1.14	0.94	4.05	8.48	Pass

Note:

1. Method 1 of power density measurement of KDB 662911 is using for calculating total power density. Total power density is summing entire spectra across corresponding frequency bins on the various outputs by computer.
2. Directional gain =  $10 \log[(10^{G1/20} + 10^{G2/20} + \dots + 10^{GN/20})^2/2] = 8.52 \text{ dBi} > 6 \text{ dBi}$ , so the power density limit shall be reduced to  $11 - (8.52 - 6) = 8.48 \text{ dBm}$ .

802.11n (HT40)

Chan.	Freq. (MHz)	PSD W/O Duty Factor (dBm)		Duty Factor (dB)	Total PSD With Duty Factor (dBm)	Max. Limit (dBm)	Pass / Fail
		Chain 0	Chain 1				
54	5270	2.20	2.09	0.16	5.32	8.48	Pass
62	5310	-2.03	-2.26	0.16	1.03	8.48	Pass
102	5510	-3.36	-3.34	0.16	-0.18	8.48	Pass
110	5550	2.11	2.53	0.16	5.50	8.48	Pass
134	5670	0.39	0.16	0.16	3.45	8.48	Pass

Note:

1. Method 1 of power density measurement of KDB 662911 is using for calculating total power density. Total power density is summing entire spectra across corresponding frequency bins on the various outputs by computer.
2. Directional gain =  $10 \log[(10^{G1/20} + 10^{G2/20} + \dots + 10^{GN/20})^2/2] = 8.52 \text{ dBi} > 6\text{dBi}$ , so the power density limit shall be reduced to  $11-(8.52-6) = 8.48\text{dBm}$ .
3. Refer to section 3.3 for duty cycle spectrum plot.

802.11ac (VHT80)

Chan.	Freq. (MHz)	PSD W/O Duty Factor (dBm)		Duty Factor (dB)	Total PSD With Duty Factor (dBm)	Max. Limit (dBm)	Pass / Fail
		Chain 0	Chain 1				
58	5290	-6.10	-6.25	0.36	-2.80	8.48	Pass
106	5530	-6.97	-7.47	0.36	-3.84	8.48	Pass

Note:

1. Method 1 of power density measurement of KDB 662911 is using for calculating total power density. Total power density is summing entire spectra across corresponding frequency bins on the various outputs by computer.
2. Directional gain =  $10 \log[(10^{G1/20} + 10^{G2/20} + \dots + 10^{GN/20})^2/2] = 8.52 \text{ dBi} > 6\text{dBi}$ , so the power density limit shall be reduced to  $11-(8.52-6) = 8.48\text{dBm}$ .
3. Refer to section 3.3 for duty cycle spectrum plot.

### Spectrum Plot of Worst Value

802.11a / Chain 0 / CH 52

802.11n (HT20) / Chain 0 / CH 116

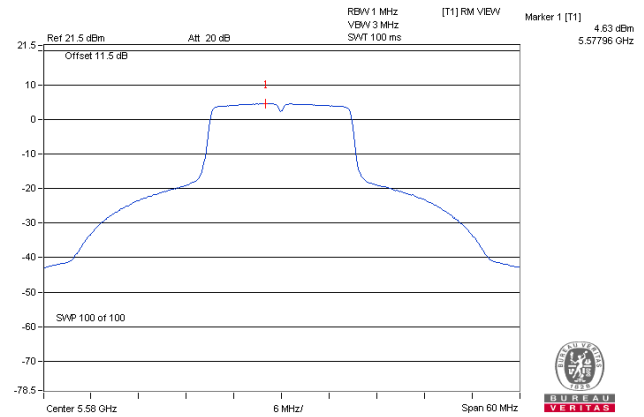
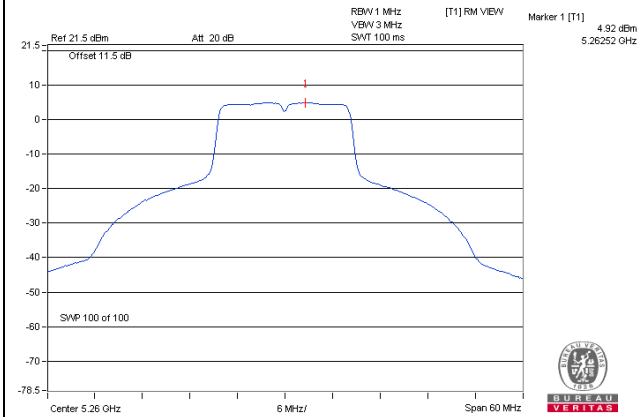

802.11n (HT40) / Chain 1 / CH 110

802.11ac (VHT80) / Chain 0 / CH 58

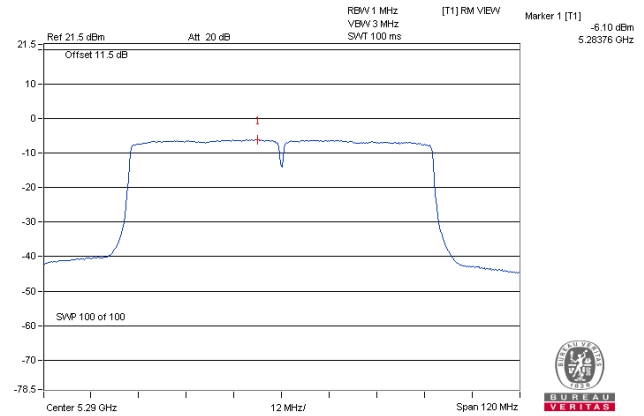
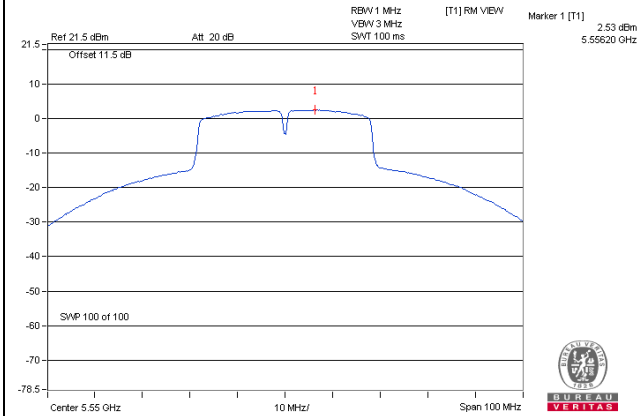

## 4.6 Frequency Stability

### 4.6.1 Limits of Frequency Stability Measurement

The frequency of the carrier signal shall be maintained within band of operation

### 4.6.2 Test Setup

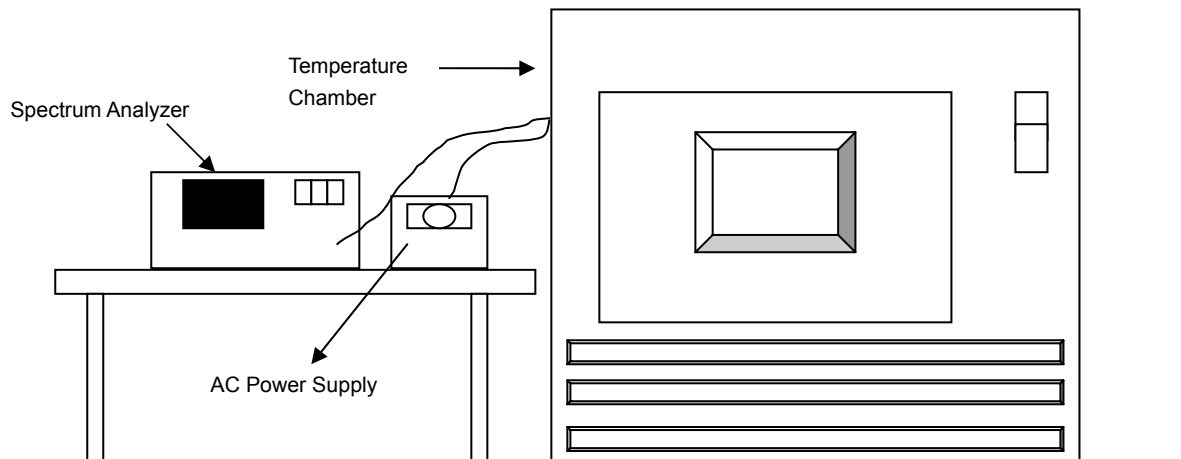

### 4.6.3 Test Instruments

Refer to section 4.1.2 to get information of above instrument.

### 4.6.4 Test Procedure

- The EUT was placed inside the environmental test chamber and powered by nominal AC voltage.
- Turn the EUT on and couple its output to a spectrum analyzer.
- Turn the EUT off and set the chamber to the highest temperature specified.
- Allow sufficient time (approximately 30 min) for the temperature of the chamber to stabilize, turn the EUT on and measure the operating frequency after 2, 5, and 10 minutes.
- Repeat step 2 and 3 with the temperature chamber set to the lowest temperature.
- The test chamber was allowed to stabilize at +20 degree C for a minimum of 30 minutes. The supply voltage was then adjusted on the EUT from 85% to 115% and the frequency record.

### 4.6.5 Deviation from Test Standard

No deviation.

### 4.6.6 EUT Operating Condition

Set the EUT transmit at un-modulation mode to test frequency stability.

#### 4.6.7 Test Results

Frequency Stability Versus Temp.									
Operating Frequency: 5700MHz									
Temp. (°C)	Power Supply (Vac)	0 Minute		2 Minute		5 Minute		10 Minute	
		Measured Frequency (MHz)	Frequency Drift (%)	Measured Frequency (MHz)	Frequency Drift (%)	Measured Frequency (MHz)	Frequency Drift (%)	Measured Frequency (MHz)	Frequency Drift (%)
50	120	5699.9921	-0.00014	5699.9894	-0.00019	5699.9930	-0.00012	5699.9938	-0.00011
40	120	5699.9944	-0.00010	5699.9964	-0.00006	5699.9913	-0.00015	5699.9920	-0.00014
30	120	5700.0117	0.00021	5700.0118	0.00021	5700.0095	0.00017	5700.0119	0.00021
20	120	5699.9900	-0.00018	5699.9903	-0.00017	5699.9913	-0.00015	5699.9908	-0.00016
10	120	5699.9773	-0.00040	5699.9795	-0.00036	5699.9773	-0.00040	5699.9747	-0.00044
0	120	5699.9901	-0.00017	5699.9909	-0.00016	5699.9919	-0.00014	5699.9903	-0.00017
-10	120	5700.0161	0.00028	5700.0121	0.00021	5700.0130	0.00023	5700.0160	0.00028
-20	120	5700.0125	0.00022	5700.0143	0.00025	5700.0145	0.00025	5700.0107	0.00019
-30	120	5699.9907	-0.00016	5699.9935	-0.00011	5699.9894	-0.00019	5699.9929	-0.00012

Frequency Stability Versus Voltage									
Operating Frequency: 5700MHz									
Temp. (°C)	Power Supply (Vac)	0 Minute		2 Minute		5 Minute		10 Minute	
		Measured Frequency (MHz)	Frequency Drift (%)	Measured Frequency (MHz)	Frequency Drift (%)	Measured Frequency (MHz)	Frequency Drift (%)	Measured Frequency (MHz)	Frequency Drift (%)
20	138	5699.9898	-0.00018	5699.9894	-0.00019	5699.9923	-0.00014	5699.9916	-0.00015
	120	5699.9900	-0.00018	5699.9903	-0.00017	5699.9913	-0.00015	5699.9908	-0.00016
	102	5699.9902	-0.00017	5699.9892	-0.00019	5699.9915	-0.00015	5699.9899	-0.00018

## 5 Pictures of Test Arrangements

Please refer to the attached file (Test Setup Photo).



## Appendix – Information on the Testing Laboratories

We, Bureau Veritas Consumer Products Services (H.K.) Ltd., Taoyuan Branch, were founded in 1988 to provide our best service in EMC, Radio, Telecom and Safety consultation. Our laboratories are accredited and approved according to ISO/IEC 17025.

If you have any comments, please feel free to contact us at the following:

### **Linko EMC/RF Lab**

Tel: 886-2-26052180

Fax: 886-2-26051924

### **Hsin Chu EMC/RF/Telecom Lab**

Tel: 886-3-6668565

Fax: 886-3-6668323

### **Hwa Ya EMC/RF/Safety Lab**

Tel: 886-3-3183232

Fax: 886-3-3270892

**Email:** [service.adt@tw.bureauveritas.com](mailto:service.adt@tw.bureauveritas.com)

**Web Site:** [www.bureauveritas-adt.com](http://www.bureauveritas-adt.com)

The address and road map of all our labs can be found in our web site also.

--- END ---