

FCC Test Report

Report No.: RF170314C06-2

FCC ID: UDX-60053010

Model: Z3-HW

Received Date: Mar. 14, 2017

Test Date: Apr. 13 ~ Apr. 20, 2017

Issued Date: May 03, 2017

Applicant: Cisco Systems, Inc.

Address: 170 West Tasman Drive, San Jose, CA 95134

Issued By: Bureau Veritas Consumer Products Services (H.K.) Ltd., Taoyuan Branch

Lab Address: No. 47-2, 14th Ling, Chia Pau Vil., Lin Kou Dist., New Taipei City, Taiwan (R.O.C.)

Test Location: No.19, Hwa Ya 2nd Rd., Wen Hwa Vil., Kwei Shan Dist., Taoyuan City 33383, TAIWAN (R.O.C.)



This report is for your exclusive use. Any copying or replication of this report to or for any other person or entity, or use of our name or trademark, is permitted only with our prior written permission. This report sets forth our findings solely with respect to the test samples identified herein. The results set forth in this report are not indicative or representative of the quality or characteristics of the lot from which a test sample was taken or any similar or identical product unless specifically and expressly noted. Our report includes all of the tests requested by you and the results thereof based upon the information that you provided to us. You have 60 days from date of issuance of this report to notify us of any material error or omission caused by our negligence, provided, however, that such notice shall be in writing and shall specifically address the issue you wish to raise. A failure to raise such issue within the prescribed time shall constitute your unqualified acceptance of the completeness of this report, the tests conducted and the correctness of the report contents. Unless specific mention, the uncertainty of measurement has been explicitly taken into account to declare the compliance or non-compliance to the specification. The report must not be used by the client to claim product certification, approval, or endorsement by TAF or any government agencies.

Table of Contents

Release Control Record	4
1 Certificate of Conformity	5
2 Summary of Test Results	6
2.1 Measurement Uncertainty.....	6
2.2 Modification Record.....	6
3 General Information	7
3.1 General Description of EUT.....	7
3.2 Description of Test Modes.....	8
3.2.1 Test Mode Applicability and Tested Channel Detail.....	9
3.3 Duty Cycle of Test Signal.....	11
3.4 Description of Support Units.....	12
3.4.1 Configuration of System under Test.....	12
3.5 General Description of Applied Standards.....	13
4 Test Types and Results	14
4.1 Radiated Emission and Bandedge Measurement.....	14
4.1.1 Limits of Radiated Emission and Bandedge Measurement.....	14
4.1.2 Test Instruments.....	15
4.1.3 Test Procedures.....	16
4.1.4 Deviation from Test Standard.....	16
4.1.5 Test Set Up.....	17
4.1.6 EUT Operating Conditions.....	18
4.1.7 Test Results.....	19
4.2 Conducted Emission Measurement.....	38
4.2.1 Limits of Conducted Emission Measurement.....	38
4.2.2 Test Instruments.....	38
4.2.3 Test Procedures.....	39
4.2.4 Deviation from Test Standard.....	39
4.2.5 Test Setup.....	39
4.2.6 EUT Operating Conditions.....	39
4.2.7 Test Results.....	40
4.3 Transmit Power Measurement.....	42
4.3.1 Limits of Transmit Power Measurement.....	42
4.3.2 Test Setup.....	42
4.3.3 Test Instruments.....	42
4.3.4 Test Procedure.....	43
4.3.5 Deviation from Test Standard.....	43
4.3.6 EUT Operating Conditions.....	43
4.3.7 Test Result.....	44
4.4 Occupied Bandwidth Measurement.....	48
4.4.1 Test Setup.....	48
4.4.2 Test Instruments.....	48
4.4.3 Test Procedure.....	48
4.4.4 Test Result.....	49
4.5 Peak Power Spectral Density Measurement.....	51
4.5.1 Limits of Peak Power Spectral Density Measurement.....	51
4.5.2 Test Setup.....	51
4.5.3 Test Instruments.....	51
4.5.4 Test Procedures.....	52
4.5.5 Deviation from Test Standard.....	52
4.5.6 EUT Operating Conditions.....	52
4.5.7 Test Results.....	53
4.6 Frequency Stability.....	57
4.6.1 Limits of Frequency Stability Measurement.....	57

4.6.2	Test Setup.....	57
4.6.3	Test Procedure	57
4.6.4	Deviation from Test Standard	57
4.6.5	EUT Operating Condition	57
4.6.6	Test Results	58
4.7	6dB Bandwidth Measurement.....	59
4.7.1	Limits of 6dB Bandwidth Measurement.....	59
4.7.2	Test Setup.....	59
4.7.3	Test Instruments	59
4.7.4	Test Procedure	59
4.7.5	Deviation from Test Standard	59
4.7.6	EUT Operating Condition	59
4.7.7	Test Results	60
5	Pictures of Test Arrangements.....	62
	Annex A- Radiated Out of Band Emission (OOBE) Measurement (For U-NII-3 band).....	63
	Appendix – Information on the Testing Laboratories	66

Release Control Record

Issue No.	Description	Date Issued
RF170314C06-2	Original release	May 03, 2017

1 Certificate of Conformity

Product: 802.11a/b/g/n/ac Wireless Security Appliance

Brand: Cisco

Model: Z3-HW

Sample Status: Engineering sample

Applicant: Cisco Systems, Inc.

Test Date: Apr. 13 ~ Apr. 20, 2017

Standards: 47 CFR FCC Part 15, Subpart E (Section 15.407)
ANSI C63.10:2013

The above equipment has been tested by **Bureau Veritas Consumer Products Services (H.K.) Ltd., Taoyuan Branch**, and found compliance with the requirement of the above standards. The test record, data evaluation & Equipment Under Test (EUT) configurations represented herein are true and accurate accounts of the measurements of the sample's EMC characteristics under the conditions specified in this report.

Prepared by :  , **Date:** May 03, 2017
Pettie Chen / Senior Specialist

Approved by :  , **Date:** May 03, 2017
Ken Liu / Senior Manager

2 Summary of Test Results

47 CFR FCC Part 15, Subpart E (Section 15.407)			
FCC Clause	Test Item	Result	Remarks
15.407(b)(6)	AC Power Conducted Emissions	Pass	Meet the requirement of limit. Minimum passing margin is -14.34dB at 0.38808MHz
15.407(b)(1/2/3/4(i/ii)/6)	Radiated Emissions & Band Edge Measurement	Pass	Meet the requirement of limit. Minimum passing margin is -1.5dB at 5150.00MHz
15.407(a)(1/2/3)	Max Average Transmit Power	Pass	Meet the requirement of limit.
---	Occupied Bandwidth Measurement	-	Reference only.
15.407(a)(1/2/3)	Peak Power Spectral Density	Pass	Meet the requirement of limit.
15.407(e)	6dB bandwidth	Pass	Meet the requirement of limit. (U-NII-3 Band only)
15.407(g)	Frequency Stability	Pass	Meet the requirement of limit.
15.203	Antenna Requirement	Pass	Antenna connector is IPEX not a standard connector.

*For U-NII-3 band compliance with rule part 15.407(b)(4)(i), the OOB test plots were recorded in Annex A.

2.1 Measurement Uncertainty

Where relevant, the following measurement uncertainty levels have been estimated for tests performed on the EUT as specified in CISPR 16-4-2:

Measurement	Frequency	Expanded Uncertainty (k=2) (\pm)
Conducted Emissions at mains ports	150kHz ~ 30MHz	2.94 dB
Radiated Emissions up to 1 GHz	30MHz ~ 200MHz	3.59 dB
	200MHz ~ 1000MHz	3.60 dB
Radiated Emissions above 1 GHz	1GHz ~ 18GHz	2.29 dB
	18GHz ~ 40GHz	2.29 dB

2.2 Modification Record

There were no modifications required for compliance.

3 General Information

3.1 General Description of EUT

Product	802.11a/b/g/n/ac Wireless Security Appliance
Brand	Cisco
Model	Z3-HW
Status of EUT	Engineering sample
Power Supply Rating	54Vdc (adapter)
Modulation Type	256QAM, 64QAM, 16QAM, QPSK, BPSK for OFDM
Modulation Technology	OFDM
Transfer Rate	802.11a: 54.0/ 48.0/ 36.0/ 24.0/ 18.0/ 12.0/ 9.0/ 6.0Mbps 802.11n: up to 300Mbps 802.11ac: up to 867Mbps
Operating Frequency	5180 ~ 5240MHz, 5745 ~ 5825MHz
Number of Channel	5180 ~ 5240MHz: 4 for 802.11a, 802.11n (HT20), 802.11ac (VHT20) 2 for 802.11n (HT40), 802.11ac (VHT40) 1 for 802.11ac (VHT80) 5745 ~ 5825MHz: 5 for 802.11a, 802.11n (HT20), 802.11ac (VHT20) 2 for 802.11n (HT40), 802.11ac (VHT40) 1 for 802.11ac (VHT80)
Output Power	CDD mode: 5180 ~ 5240MHz: 146.081mW 5745 ~ 5825MHz: 151.720mW Beamforming Mode: 5180 ~ 5240MHz: 73.046mW 5745 ~ 5825MHz: 75.694mW
Antenna Type	Antenna 1: PIFA antenna with 5.20dBi gain Antenna 2: PIFA antenna with 5.80dBi gain
Antenna Connector	IPEX
Accessory Device	Adapter
Data Cable Supplied	NA

Note:

- The EUT incorporates a MIMO function. Physically, the EUT provides 2 completed transmitters and 2 receivers.

Modulation Mode	TX Function	Beamforming
802.11a	2TX	Not Support
802.11n (HT20)	2TX	Support
802.11n (HT40)	2TX	Support
802.11ac (VHT20)	2TX	Support
802.11ac (VHT40)	2TX	Support
802.11ac (VHT80)	2TX	Support

*The modulation and bandwidth are similar for 802.11n mode for HT20/HT40 and 802.11ac mode for VHT20/VHT40, therefore investigated worst case to representative mode in test report. (Final test mode

refer section 3.2.1)

* For 5GHz band, CDD mode is the worst case for final radiated emission below 1GHz and power line conducted emission tests after pretesting CDD mode and beamforming mode.

2. The EUT consumes power from the following adapter.

Adapter	
Brand	Cisco
Model	MA-PWR-50WAC
Input Power	100-240VAC, 50/60Hz, 2A
Output Power	54V, 0.92A
Power Line	1.5m non-shielded DC cable without core 1.7m non-shielded AC cable without core

3. WLAN 2.4GHz, 5GHz & BT LE technology can transmit at same time.

4. Spurious emission of the simultaneous operation (WLAN 2.4GHz, 5GHz & BT LE) has been evaluated and no non-compliance was found.

3.2 Description of Test Modes

For 5180 ~ 5240MHz

4 channels are provided for 802.11a, 802.11n (HT20), 802.11ac (VHT20):

Channel	Frequency	Channel	Frequency
36	5180 MHz	44	5220 MHz
40	5200 MHz	48	5240 MHz

2 channels are provided for 802.11n (HT40), 802.11ac (VHT40):

Channel	Frequency	Channel	Frequency
38	5190 MHz	46	5230 MHz

1 channel is provided for 802.11ac (VHT80):

Channel	Frequency
42	5210MHz

For 5745 ~ 5825MHz:

5 channels are provided for 802.11a, 802.11n (HT20), 802.11ac (VHT20):

Channel	Frequency	Channel	Frequency
149	5745MHz	161	5805MHz
153	5765MHz	165	5825MHz
157	5785MHz		

2 channels are provided for 802.11n (HT40), 802.11ac (VHT40):

Channel	Frequency	Channel	Frequency
151	5755MHz	159	5795MHz

1 channel is provided for 802.11ac (VHT80):

Channel	Frequency
155	5775MHz

3.2.1 Test Mode Applicability and Tested Channel Detail

EUT CONFIGURE MODE	APPLICABLE TO				DESCRIPTION
	RE≥1G	RE<1G	PLC	APCM	
-	√	√	√	√	-

Where **RE≥1G**: Radiated Emission above 1GHz & Bandedge Measurement
RE<1G: Radiated Emission below 1GHz
PLC: Power Line Conducted Emission
APCM: Antenna Port Conducted Measurement

Note: The EUT had been pre-tested on the positioned of each 3 axis. The worst case was found when positioned on **X-plane**.

Radiated Emission Test (Above 1GHz):

- Pre-Scan has been conducted to determine the worst-case mode from all possible combinations between available modulations, data rates and antenna ports (if EUT with antenna diversity architecture).
- Following channel(s) was (were) selected for the final test as listed below.

EUT CONFIGURE MODE	MODE	FREQ. BAND (MHz)	AVAILABLE CHANNEL	TESTED CHANNEL	MODULATION TECHNOLOGY	MODULATION TYPE	DATA RATE (Mbps)
-	802.11a	5180-5240	36 to 48	36, 40, 48	OFDM	BPSK	6.0
-	802.11n (HT20)		36 to 48	36, 40, 48	OFDM	BPSK	6.5
-	802.11n (HT40)		38 to 46	38, 46	OFDM	BPSK	13.5
-	802.11ac (VHT80)		42	42	OFDM	BPSK	58.5
-	802.11a	5745-5825	149 to 165	149, 157, 165	OFDM	BPSK	6.0
-	802.11n (HT20)		149 to 165	149, 157, 165	OFDM	BPSK	6.5
-	802.11n (HT40)		151 to 159	151, 159	OFDM	BPSK	13.5
-	802.11ac (VHT80)		155	155	OFDM	BPSK	58.5

Radiated Emission Test (Below 1GHz):

- Pre-Scan has been conducted to determine the worst-case mode from all possible combinations between available modulations, data rates and antenna ports (if EUT with antenna diversity architecture).
- Following channel(s) was (were) selected for the final test as listed below.

EUT CONFIGURE MODE	MODE	FREQ. BAND (MHz)	AVAILABLE CHANNEL	TESTED CHANNEL	MODULATION TECHNOLOGY	MODULATION TYPE	DATA RATE (Mbps)
-	802.11a	5180-5240	36 to 48	36	OFDM	BPSK	6.0
	802.11a	5745-5825	149 to 165		OFDM	BPSK	6.0

Power Line Conducted Emission Test:

- Pre-Scan has been conducted to determine the worst-case mode from all possible combinations between available modulations, data rates and antenna ports (if EUT with antenna diversity architecture).
- Following channel(s) was (were) selected for the final test as listed below.

EUT CONFIGURE MODE	MODE	FREQ. BAND (MHz)	AVAILABLE CHANNEL	TESTED CHANNEL	MODULATION TECHNOLOGY	MODULATION TYPE	DATA RATE (Mbps)
-	802.11a	5180-5240	36 to 48	36	OFDM	BPSK	6.0
	802.11a	5745-5825	149 to 165		OFDM	BPSK	6.0

Antenna Port Conducted Measurement:

- This item includes all test value of each mode, but only includes spectrum plot of worst value of each mode.
- Pre-Scan has been conducted to determine the worst-case mode from all possible combinations between available modulations, data rates and antenna ports (if EUT with antenna diversity architecture).
- Following channel(s) was (were) selected for the final test as listed below.

EUT CONFIGURE MODE	MODE	FREQ. BAND (MHz)	AVAILABLE CHANNEL	TESTED CHANNEL	MODULATION TECHNOLOGY	MODULATION TYPE	DATA RATE (Mbps)
-	802.11a	5180-5240	36 to 48	36, 40, 48	OFDM	BPSK	6.0
-	802.11n (HT20)		36 to 48	36, 40, 48	OFDM	BPSK	6.5
-	802.11n (HT40)		38 to 46	38, 46	OFDM	BPSK	13.5
-	802.11ac (VHT80)		42	42	OFDM	BPSK	58.5
-	802.11a	5745-5825	149 to 165	149, 157, 165	OFDM	BPSK	6.0
-	802.11n (HT20)		149 to 165	149, 157, 165	OFDM	BPSK	6.5
-	802.11n (HT40)		151 to 159	151, 159	OFDM	BPSK	13.5
-	802.11ac (VHT80)		155	155	OFDM	BPSK	58.5

Test Condition:

APPLICABLE TO	ENVIRONMENTAL CONDITIONS	INPUT POWER	TESTED BY
RE \geq 1G	23deg. C, 71%RH	120Vac, 60Hz	James Yang
RE $<$ 1G	23deg. C, 71%RH	120Vac, 60Hz	Jones Chang
PLC	25deg. C, 75%RH	120Vac, 60Hz	James Yang
APCM	25deg. C, 60%RH	120Vac, 60Hz	Ted Chang

3.3 Duty Cycle of Test Signal

Duty cycle of test signal is > 98%, duty factor is not required.

Duty cycle of test signal is < 98 %, duty factor is required.

802.11a: Duty cycle = $2.017/2.120 = 0.951$, Duty factor = $10 * \log(1/0.951) = 0.22$

802.11n (HT20): Duty cycle = $4.950/5.045 = 0.981$

802.11n (HT40): Duty cycle = $2.398/2.490 = 0.963$, Duty factor = $10 * \log(1/0.963) = 0.16$

802.11ac (VHT80): Duty cycle = $1.124/1.222 = 0.920$, Duty factor = $10 * \log(1/0.920) = 0.36$

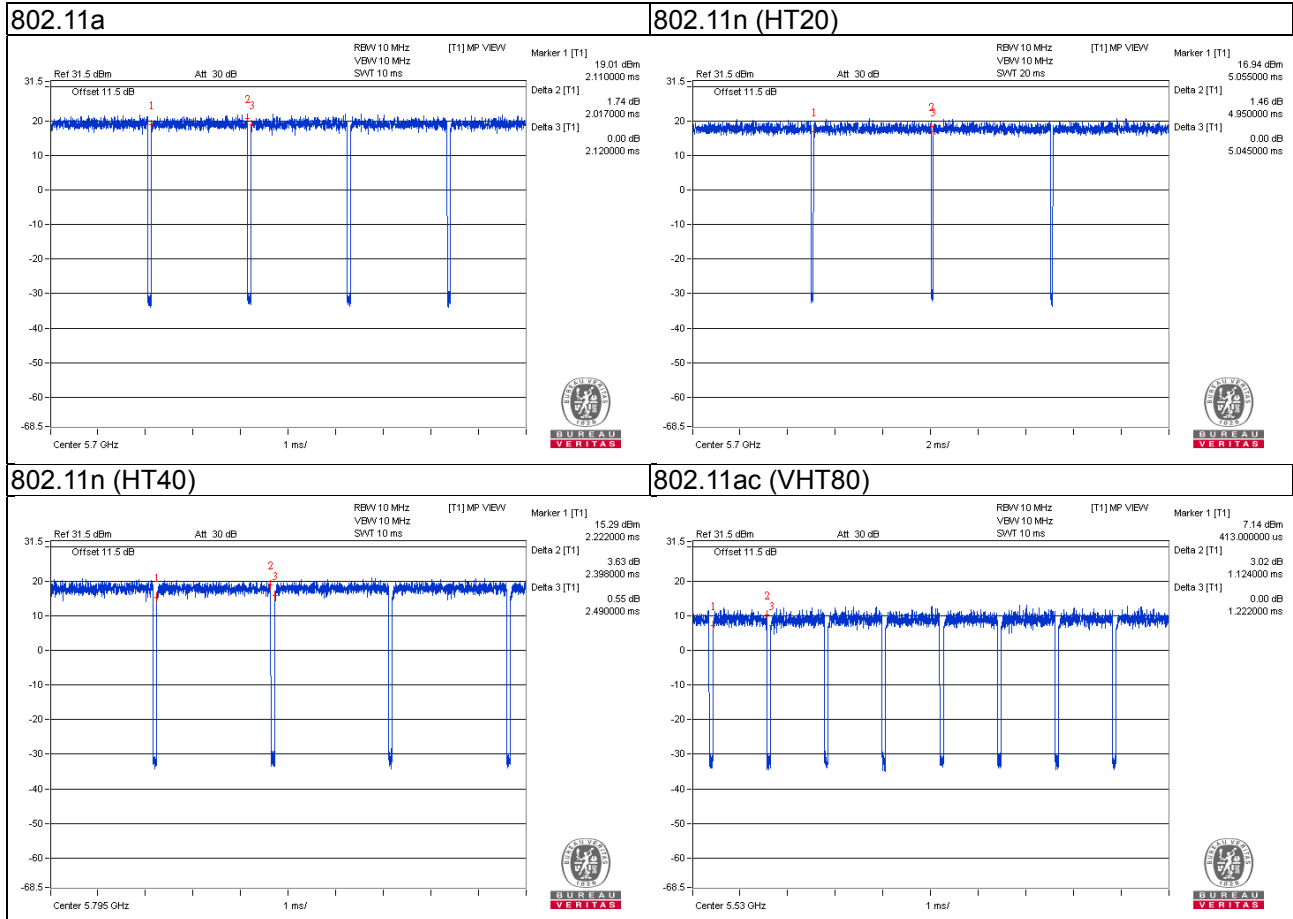

3.4 Description of Support Units

The EUT has been tested as an independent unit together with other necessary accessories or support units. The following support units or accessories were used to form a representative test configuration during the tests.

ID	Product	Brand	Model No.	Serial No.	FCC ID	Remarks
A.	Notebook	DELL	E5410	1HC2XM1	FCC DoC Approved	-
B.	Load	N/A	N/A	N/A	N/A	-
C.	USB 3.0 Flash	HP	v250W	01	N/A	-

Note:

1. All power cords of the above support units are non-shielded (1.8m).
2. Item A acted as communication partner to transfer data.

ID	Descriptions	Qty.	Length (m)	Shielding (Yes/No)	Cores (Qty.)	Remarks
1.	RJ45 Cable	4	1.8	N	0	Cat5e
2.	RJ45 Cable	1	10	N	0	Cat5e

3.4.1 Configuration of System under Test

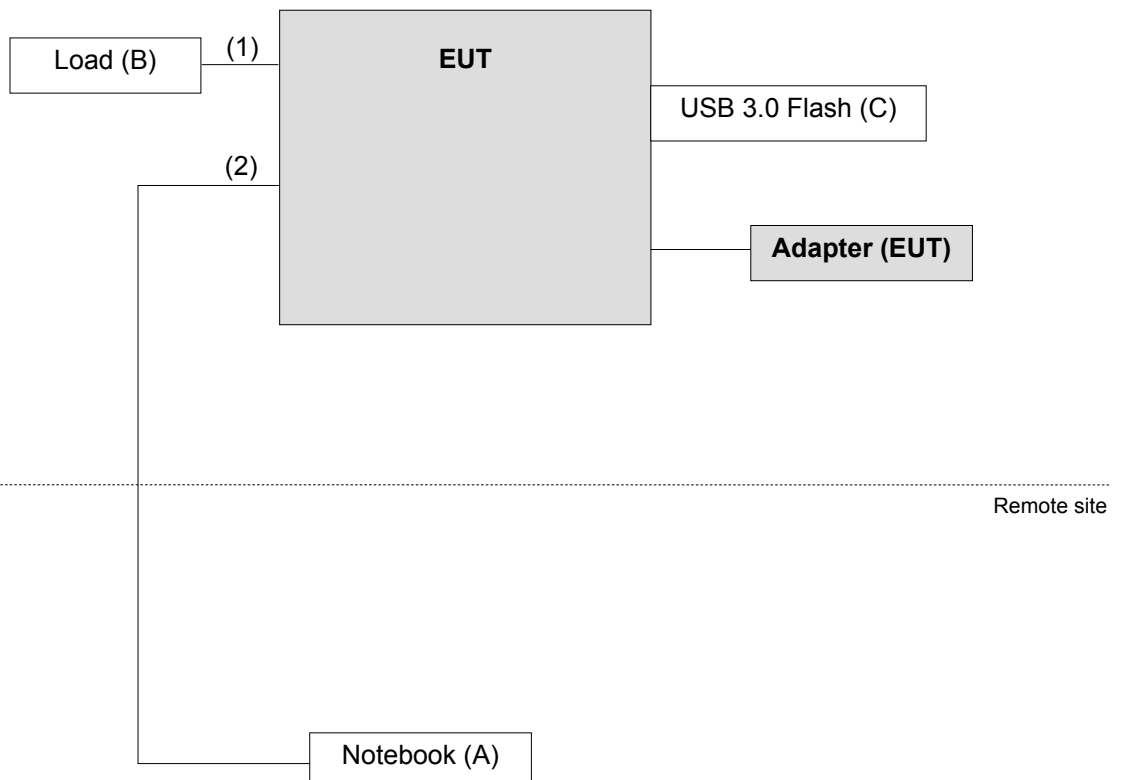

3.5 General Description of Applied Standards

The EUT is a RF Product. According to the specifications of the manufacturer, it must comply with the requirements of the following standards:

FCC Part 15, Subpart E (15.407)

KDB 789033 D02 General UNII Test Procedure New Rules v01r04

KDB 662911 D01 Multiple Transmitter Output v02r01

ANSI C63.10-2013

All test items have been performed and recorded as per the above standards.

Note: The EUT is also considered as a kind of computer peripheral, because the connection to computer is necessary for typical use. It has been verified to comply with the requirements of FCC Part 15, Subpart B, Class B (DoC). The test report has been issued separately.

4 Test Types and Results

4.1 Radiated Emission and Bandedge Measurement

4.1.1 Limits of Radiated Emission and Bandedge Measurement

Radiated emissions which fall in the restricted bands must comply with the radiated emission limits specified as below table.

Frequencies (MHz)	Field Strength (microvolts/meter)	Measurement Distance (meters)
0.009 ~ 0.490	2400/F(kHz)	300
0.490 ~ 1.705	24000/F(kHz)	30
1.705 ~ 30.0	30	30
30 ~ 88	100	3
88 ~ 216	150	3
216 ~ 960	200	3
Above 960	500	3

NOTE:

1. The lower limit shall apply at the transition frequencies.
2. Emission level (dBuV/m) = 20 log Emission level (uV/m).
3. For frequencies above 1000MHz, the field strength limits are based on average detector, however, the peak field strength of any emission shall not exceed the maximum permitted average limits, specified above by more than 20dB under any condition of modulation.

Limits of unwanted emission out of the restricted bands

Applicable To		Limit	
789033 D02 General UNII Test Procedure New Rules v01r04		Field Strength at 3m	
		PK:74 (dBuV/m)	AV:54 (dBuV/m)
Frequency Band	Applicable To	EIRP Limit	Equivalent Field Strength at 3m
5150~5250 MHz	15.407(b)(1)	PK:-27 (dBm/MHz)	PK:68.2(dBuV/m)
5250~5350 MHz	15.407(b)(2)		
5470~5725 MHz	15.407(b)(3)		
5725~5850 MHz	<input checked="" type="checkbox"/> 15.407(b)(4)(i)	PK:-27 (dBm/MHz) ^{*1} PK:10 (dBm/MHz) ^{*2} PK:15.6 (dBm/MHz) ^{*3} PK:27 (dBm/MHz) ^{*4}	PK: 68.2(dBuV/m) ^{*1} PK:105.2 (dBuV/m) ^{*2} PK: 110.8(dBuV/m) ^{*3} PK:122.2 (dBuV/m) ^{*4}
	<input type="checkbox"/> 15.407(b)(4)(ii)	Emission limits in section 15.247(d)	
^{*1} beyond 75 MHz or more above of the band edge.		^{*2} below the band edge increasing linearly to 10 dBm/MHz at 25 MHz above.	
^{*3} below the band edge increasing linearly to a level of 15.6 dBm/MHz at 5 MHz above.		^{*4} from 5 MHz above or below the band edge increasing linearly to a level of 27 dBm/MHz at the band edge.	

Note: The following formula is used to convert the equipment isotropic radiated power (eirp) to field strength:

$$E = \frac{1000000\sqrt{30P}}{3} \mu\text{V/m, where P is the eirp (Watts).}$$

4.1.2 Test Instruments

Description & Manufacturer	Model No.	Serial No.	Cal. Date	Cal. Due
Test Receiver KEYSIGHT	N9038A	MY55420137	Mar. 27, 2017	Mar. 26, 2018
Spectrum Analyzer ROHDE & SCHWARZ	FSP40	100041	Nov. 16, 2016	Nov. 15, 2017
BILOG Antenna SCHWARZBECK	VULB9168	9168-171	Dec. 28, 2016	Dec. 27, 2017
HORN Antenna SCHWARZBECK	9120D	209	Dec. 27, 2016	Dec. 26, 2017
HORN Antenna SCHWARZBECK	BBHA 9170	BBHA9170241	Dec. 14, 2016	Dec. 13, 2017
Loop Antenna	EM-6879	269	Aug. 11, 2016	Aug. 10, 2017
Preamplifier Agilent	8447D	2944A10738	Aug. 22, 2016	Aug. 21, 2017
Preamplifier Agilent	8449B	3008A01922	Sep. 18, 2016	Sep. 17, 2017
RF signal cable HUBER+SUHNER	SUCOFLEX 104	Cable-CH3-03 (214378)	Aug. 22, 2016	Aug. 21, 2017
RF signal cable HUBER+SUHNER	SUCOFLEX 106	Cable-CH3-03 (309224+12738)	Aug. 22, 2016	Aug. 21, 2017
Software BV ADT	ADT_Radiated_ V7.6.15.9.4	NA	NA	NA
Antenna Tower inn-co GmbH	MA 4000	013303	NA	NA
Antenna Tower Controller BV ADT	AT100	AT93021702	NA	NA
Turn Table BV ADT	TT100	TT93021702	NA	NA
Turn Table Controller BV ADT	SC100	SC93021702	NA	NA
Turn Table BV ADT	TT100	TT93021705	NA	NA
Turn Table Controller BV ADT	SC100	SC93021705	NA	NA
26GHz ~ 40GHz Amplifier	EM26400	815221	Oct. 17, 2016	Oct. 16, 2017
High Speed Peak Power Meter	ML2495A	0824012	Aug. 11, 2016	Aug. 10, 2017
Power Sensor	MA2411B	0738171	Aug. 11, 2016	Aug. 10, 2017
WIT Standard Temperature And Humidity Chamber	TH-4S-C	W981030	Jun. 08, 2016	Jun. 07, 2017

- Note: 1. The calibration interval of the above test instruments is 12 months and the calibrations are traceable to NML/ROC and NIST/USA.
2. The test was performed in HwaYa Chamber 3.
3. The horn antenna and preamplifier (model: 8449B) are used only for the measurement of emission frequency above 1GHz if tested.
4. The FCC Site Registration No. is 988962.
5. The IC Site Registration No. is IC 7450F-3.

4.1.3 Test Procedures

For Radiated emission below 30MHz

- a. The EUT was placed on the top of a rotating table 0.8 meters above the ground at a 3 meter chamber room. The table was rotated 360 degrees to determine the position of the highest radiation.
- b. The EUT was set 3 meters away from the interference-receiving antenna, which was mounted on the top of a variable-height antenna tower.
- c. Both X and Y axes of the antenna are set to make the measurement.
- d. For each suspected emission, the EUT was arranged to its worst case and the rotatable table was turned from 0 degrees to 360 degrees to find the maximum reading.
- e. The test-receiver system was set to Quasi-Peak Detect Function and Specified Bandwidth with Maximum Hold Mode.

NOTE:

1. The resolution bandwidth and video bandwidth of test receiver/spectrum analyzer is 9kHz at frequency below 30MHz.

For Radiated emission above 30MHz

- a. The EUT was placed on the top of a rotating table 0.8 meters (for 30MHz ~ 1GHz) / 1.5 meters (for above 1GHz) above the ground at 3 meter chamber room for test. The table was rotated 360 degrees to determine the position of the highest radiation.
- b. The EUT was set 3 meters away from the interference-receiving antenna, which was mounted on the top of a variable-height antenna tower.
- c. The height of antenna is varied from one meter to four meters above the ground to determine the maximum value of the field strength. Both horizontal and vertical polarizations of the antenna are set to make the measurement.
- d. For each suspected emission, the EUT was arranged to its worst case and then the antenna was tuned to heights from 1 meter to 4 meters and the rotatable table was turned from 0 degrees to 360 degrees to find the maximum reading.
- e. The test-receiver system was set to quasi-peak detect function and specified bandwidth with maximum hold mode when the test frequency is below 1 GHz.
- f. The test-receiver system was set to peak and average detect function and specified bandwidth with maximum hold mode when the test frequency is above 1 GHz. If the peak reading value also meets average limit, measurement with the average detector is unnecessary.

Note:

1. The resolution bandwidth and video bandwidth of test receiver/spectrum analyzer is 120kHz for Quasi-peak detection (QP) at frequency below 1GHz.
2. The resolution bandwidth of test receiver/spectrum analyzer is 1 MHz and the video bandwidth is 3 MHz for Peak detection (PK) at frequency above 1GHz.
3. The resolution bandwidth of test receiver/spectrum analyzer is 1 MHz and the video bandwidth is $\geq 1/T$ (Duty cycle < 98%) or 3 x RBW (Duty cycle $\geq 98\%$) for Average detection (AV) at frequency above 1GHz.
4. All modes of operation were investigated and the worst-case emissions are reported.

4.1.4 Deviation from Test Standard

No deviation.

4.1.5 Test Set Up

For Radiated emission below 30MHz

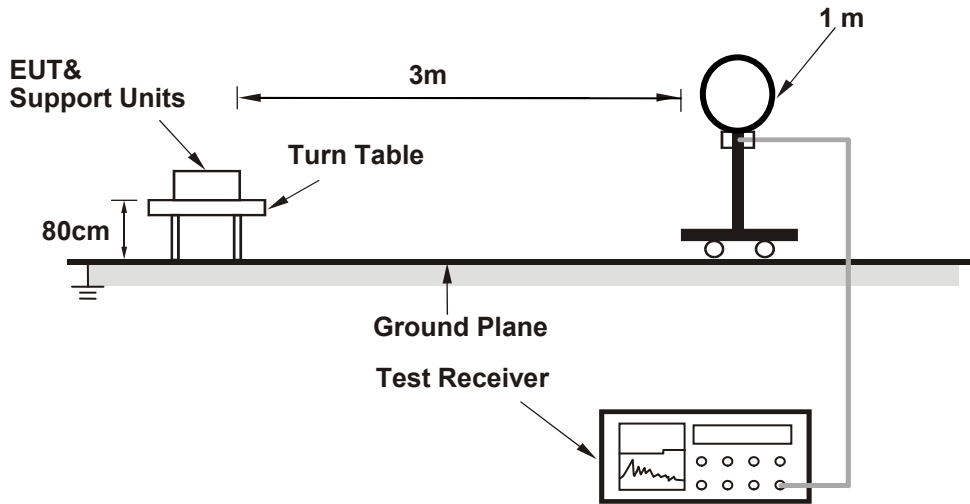

For Radiated emission 30MHz to 1GHz

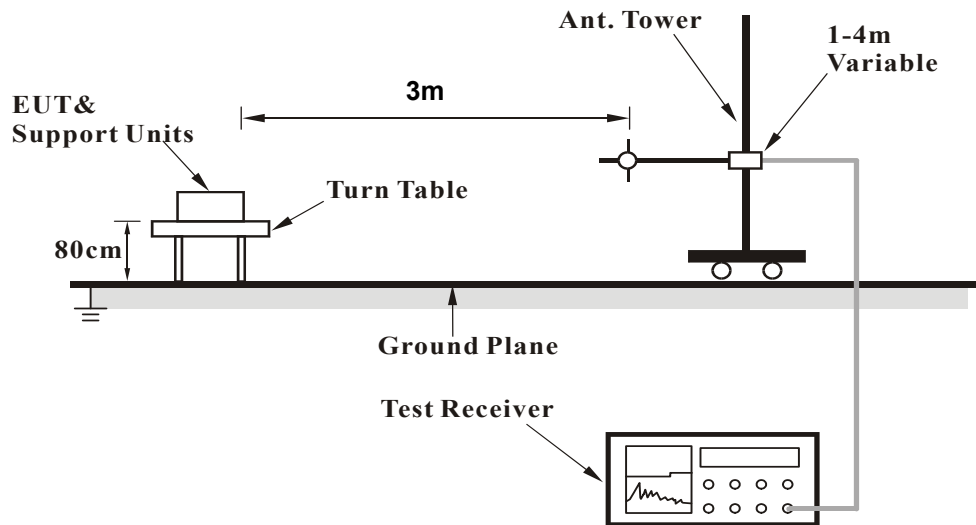

For Radiated emission above 1GHz

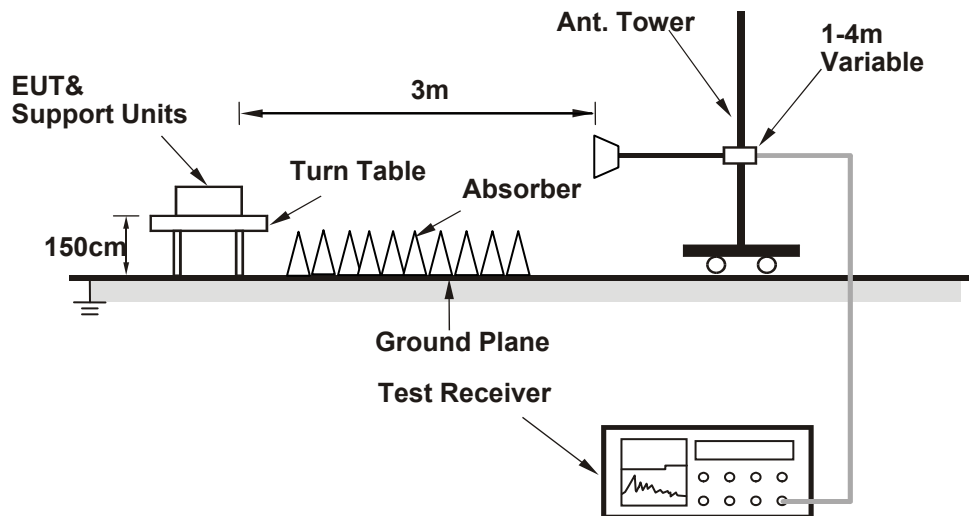

For the actual test configuration, please refer to the attached file (Test Setup Photo).

4.1.6 EUT Operating Conditions

- a. Placed the EUT on the testing table.
- b. Prepared a notebook to act as a communication partner and placed it outside of testing area.
- c. The communication partner connected with EUT via a RJ45 cable and ran a test program (provided by manufacturer) to enable EUT under transmission condition continuously at specific channel frequency.
- d. The communication partner sent data to EUT by command "PING".

4.1.7 Test Results

Above 1GHz Worst-Case Data:

802.11a

CHANNEL	TX Channel 36	DETECTOR	Peak (PK)
FREQUENCY RANGE	1GHz ~ 40GHz	FUNCTION	Average (AV)

ANTENNA POLARITY & TEST DISTANCE: HORIZONTAL AT 3 M

NO.	FREQ. (MHz)	EMISSION LEVEL (dBuV/m)	LIMIT (dBuV/m)	MARGIN (dB)	ANTENNA HEIGHT (m)	TABLE ANGLE (Degree)	RAW VALUE (dBuV)	CORRECTION FACTOR (dB/m)
1	5150.00	65.0 PK	74.0	-9.0	1.24 H	64	64.2	0.8
2	5150.00	51.3 AV	54.0	-2.7	1.24 H	64	50.5	0.8
3	*5180.00	111.4 PK			1.53 H	58	72.7	38.7
4	*5180.00	101.2 AV			1.53 H	58	62.5	38.7
5	#10360.00	57.6 PK	74.0	-16.4	2.28 H	153	44.9	12.7
6	#10360.00	44.5 AV	54.0	-9.5	2.28 H	153	31.8	12.7

ANTENNA POLARITY & TEST DISTANCE: VERTICAL AT 3 M

NO.	FREQ. (MHz)	EMISSION LEVEL (dBuV/m)	LIMIT (dBuV/m)	MARGIN (dB)	ANTENNA HEIGHT (m)	TABLE ANGLE (Degree)	RAW VALUE (dBuV)	CORRECTION FACTOR (dB/m)
1	5150.00	64.9 PK	74.0	-9.1	3.01 V	84	64.1	0.8
2	5150.00	52.3 AV	54.0	-1.7	3.01 V	84	51.5	0.8
3	*5180.00	112.8 PK			2.32 V	114	74.1	38.7
4	*5180.00	101.9 AV			2.32 V	114	63.2	38.7
5	#10360.00	56.8 PK	74.0	-17.2	1.82 V	146	44.1	12.7
6	#10360.00	44.4 AV	54.0	-9.6	1.82 V	146	31.7	12.7

Remarks:

1. Emission Level(dBuV/m) = Raw Value(dBuV) + Correction Factor(dB/m)
2. Correction Factor(dB/m) = Antenna Factor(dB/m) + Cable Factor(dB)
3. The other emission levels were very low against the limit.
4. Margin value = Emission Level – Limit value
5. " * ": Fundamental frequency.
6. " # ": The radiated frequency is out of the restricted band.

CHANNEL	TX Channel 40	DETECTOR	Peak (PK)
FREQUENCY RANGE	1GHz ~ 40GHz	FUNCTION	Average (AV)

ANTENNA POLARITY & TEST DISTANCE: HORIZONTAL AT 3 M

NO.	FREQ. (MHz)	EMISSION LEVEL (dBuV/m)	LIMIT (dBuV/m)	MARGIN (dB)	ANTENNA HEIGHT (m)	TABLE ANGLE (Degree)	RAW VALUE (dBuV)	CORRECTION FACTOR (dB/m)
1	*5200.00	111.3 PK			1.53 H	63	72.6	38.7
2	*5200.00	100.9 AV			1.53 H	63	62.2	38.7
3	#10400.00	56.9 PK	74.0	-17.1	1.96 H	116	44.2	12.7
4	#10400.00	44.3 AV	54.0	-9.7	1.96 H	116	31.6	12.7

ANTENNA POLARITY & TEST DISTANCE: VERTICAL AT 3 M

NO.	FREQ. (MHz)	EMISSION LEVEL (dBuV/m)	LIMIT (dBuV/m)	MARGIN (dB)	ANTENNA HEIGHT (m)	TABLE ANGLE (Degree)	RAW VALUE (dBuV)	CORRECTION FACTOR (dB/m)
1	*5200.00	114.2 PK			2.71 V	113	75.5	38.7
2	*5200.00	103.4 AV			2.71 V	113	64.7	38.7
3	#10400.00	56.5 PK	74.0	-17.5	2.15 V	185	43.8	12.7
4	#10400.00	44.2 AV	54.0	-9.8	2.15 V	185	31.5	12.7

Remarks:

1. Emission Level(dBuV/m) = Raw Value(dBuV) + Correction Factor(dB/m)
2. Correction Factor(dB/m) = Antenna Factor(dB/m) + Cable Factor(dB)
3. The other emission levels were very low against the limit.
4. Margin value = Emission Level – Limit value
5. " * ": Fundamental frequency.
6. " # ": The radiated frequency is out of the restricted band.

CHANNEL	TX Channel 48	DETECTOR FUNCTION	Peak (PK)
FREQUENCY RANGE	1GHz ~ 40GHz		Average (AV)

ANTENNA POLARITY & TEST DISTANCE: HORIZONTAL AT 3 M

NO.	FREQ. (MHz)	EMISSION LEVEL (dBuV/m)	LIMIT (dBuV/m)	MARGIN (dB)	ANTENNA HEIGHT (m)	TABLE ANGLE (Degree)	RAW VALUE (dBuV)	CORRECTION FACTOR (dB/m)
1	*5240.00	111.1 PK			1.27 H	63	72.3	38.8
2	*5240.00	101.3 AV			1.27 H	63	62.5	38.8
3	5350.00	54.6 PK	74.0	-19.4	1.42 H	50	53.5	1.1
4	5350.00	42.3 AV	54.0	-11.7	1.42 H	50	41.2	1.1
5	#10480.00	57.8 PK	74.0	-16.2	1.59 H	94	44.3	13.5
6	#10480.00	44.5 AV	54.0	-9.5	1.59 H	94	31.0	13.5

ANTENNA POLARITY & TEST DISTANCE: VERTICAL AT 3 M

NO.	FREQ. (MHz)	EMISSION LEVEL (dBuV/m)	LIMIT (dBuV/m)	MARGIN (dB)	ANTENNA HEIGHT (m)	TABLE ANGLE (Degree)	RAW VALUE (dBuV)	CORRECTION FACTOR (dB/m)
1	*5240.00	114.1 PK			2.78 V	112	75.3	38.8
2	*5240.00	103.7 AV			2.78 V	112	64.9	38.8
3	5350.00	55.4 PK	74.0	-18.6	2.68 V	102	54.3	1.1
4	5350.00	42.4 AV	54.0	-11.6	2.68 V	102	41.3	1.1
5	#10480.00	57.6 PK	74.0	-16.4	1.91 V	154	44.1	13.5
6	#10480.00	44.6 AV	54.0	-9.4	1.91 V	154	31.1	13.5

Remarks:

1. Emission Level(dBuV/m) = Raw Value(dBuV) + Correction Factor(dB/m)
2. Correction Factor(dB/m) = Antenna Factor(dB/m) + Cable Factor(dB)
3. The other emission levels were very low against the limit.
4. Margin value = Emission Level – Limit value
5. " * ": Fundamental frequency.
6. " # ": The radiated frequency is out of the restricted band.

CHANNEL	TX Channel 149	DETECTOR FUNCTION	Peak (PK)
FREQUENCY RANGE	1GHz ~ 40GHz		Average (AV)

ANTENNA POLARITY & TEST DISTANCE: HORIZONTAL AT 3 M

NO.	FREQ. (MHz)	EMISSION LEVEL (dBuV/m)	LIMIT (dBuV/m)	MARGIN (dB)	ANTENNA HEIGHT (m)	TABLE ANGLE (Degree)	RAW VALUE (dBuV)	CORRECTION FACTOR (dB/m)
1	#5647.20	55.7 PK	68.2	-12.5	1.06 H	100	54.0	1.7
2	*5745.00	113.9 PK			1.06 H	100	74.0	39.9
3	*5745.00	103.3 AV			1.06 H	100	63.4	39.9
4	#5960.00	57.6 PK	68.2	-10.6	1.06 H	100	55.0	2.6
5	11490.00	60.3 PK	74.0	-13.7	1.06 H	100	45.8	14.5
6	11490.00	47.3 AV	54.0	-6.7	1.06 H	100	32.8	14.5

ANTENNA POLARITY & TEST DISTANCE: VERTICAL AT 3 M

NO.	FREQ. (MHz)	EMISSION LEVEL (dBuV/m)	LIMIT (dBuV/m)	MARGIN (dB)	ANTENNA HEIGHT (m)	TABLE ANGLE (Degree)	RAW VALUE (dBuV)	CORRECTION FACTOR (dB/m)
1	#5632.80	57.3 PK	68.2	-10.9	2.57 V	115	55.6	1.7
2	*5745.00	116.1 PK			2.57 V	115	76.2	39.9
3	*5745.00	106.4 AV			2.57 V	115	66.5	39.9
4	#5928.80	59.2 PK	68.2	-9.0	2.57 V	115	56.6	2.6
5	11490.00	61.1 PK	74.0	-12.9	2.58 V	178	46.6	14.5
6	11490.00	47.4 AV	54.0	-6.6	2.58 V	178	32.9	14.5

Remarks:

1. Emission Level(dBuV/m) = Raw Value(dBuV) + Correction Factor(dB/m)
2. Correction Factor(dB/m) = Antenna Factor(dB/m) + Cable Factor(dB)
3. The other emission levels were very low against the limit.
4. Margin value = Emission Level – Limit value
5. " * ": Fundamental frequency.
6. " # ": The radiated frequency is out of the restricted band.

CHANNEL	TX Channel 157	DETECTOR FUNCTION	Peak (PK)
FREQUENCY RANGE	1GHz ~ 40GHz		Average (AV)

ANTENNA POLARITY & TEST DISTANCE: HORIZONTAL AT 3 M

NO.	FREQ. (MHz)	EMISSION LEVEL (dBuV/m)	LIMIT (dBuV/m)	MARGIN (dB)	ANTENNA HEIGHT (m)	TABLE ANGLE (Degree)	RAW VALUE (dBuV)	CORRECTION FACTOR (dB/m)
1	#5615.20	57.1 PK	68.2	-11.1	1.07 H	101	55.4	1.7
2	*5785.00	112.9 PK			1.07 H	101	72.8	40.1
3	*5785.00	102.9 AV			1.07 H	101	62.8	40.1
4	#5950.40	58.2 PK	68.2	-10.0	1.07 H	101	55.6	2.6
5	11570.00	60.3 PK	74.0	-13.7	1.88 H	212	46.0	14.3
6	11570.00	47.0 AV	54.0	-7.0	1.88 H	212	32.7	14.3

ANTENNA POLARITY & TEST DISTANCE: VERTICAL AT 3 M

NO.	FREQ. (MHz)	EMISSION LEVEL (dBuV/m)	LIMIT (dBuV/m)	MARGIN (dB)	ANTENNA HEIGHT (m)	TABLE ANGLE (Degree)	RAW VALUE (dBuV)	CORRECTION FACTOR (dB/m)
1	#5638.40	56.6 PK	68.2	-11.6	2.54 V	106	54.9	1.7
2	*5785.00	114.2 PK			2.54 V	106	74.1	40.1
3	*5785.00	104.4 AV			2.54 V	106	64.3	40.1
4	#5948.00	58.1 PK	68.2	-10.1	2.54 V	106	55.5	2.6
5	11570.00	61.3 PK	74.0	-12.7	2.60 V	199	47.0	14.3
6	11570.00	47.6 AV	54.0	-6.4	2.60 V	199	33.3	14.3

Remarks:

1. Emission Level(dBuV/m) = Raw Value(dBuV) + Correction Factor(dB/m)
2. Correction Factor(dB/m) = Antenna Factor(dB/m) + Cable Factor(dB)
3. The other emission levels were very low against the limit.
4. Margin value = Emission Level – Limit value
5. " * ": Fundamental frequency.

CHANNEL	TX Channel 165	DETECTOR	Peak (PK)
FREQUENCY RANGE	1GHz ~ 40GHz	FUNCTION	Average (AV)

ANTENNA POLARITY & TEST DISTANCE: HORIZONTAL AT 3 M

NO.	FREQ. (MHz)	EMISSION LEVEL (dBuV/m)	LIMIT (dBuV/m)	MARGIN (dB)	ANTENNA HEIGHT (m)	TABLE ANGLE (Degree)	RAW VALUE (dBuV)	CORRECTION FACTOR (dB/m)
1	#5624.00	57.1 PK	68.2	-11.1	1.15 H	105	55.4	1.7
2	*5825.00	113.7 PK			1.15 H	105	73.5	40.2
3	*5825.00	103.6 AV			1.15 H	105	63.4	40.2
4	#5958.40	58.4 PK	68.2	-9.8	1.05 H	115	55.8	2.6
5	11650.00	60.1 PK	74.0	-13.9	1.90 H	201	45.7	14.4
6	11650.00	47.3 AV	54.0	-6.7	1.90 H	201	32.9	14.4

ANTENNA POLARITY & TEST DISTANCE: VERTICAL AT 3 M

NO.	FREQ. (MHz)	EMISSION LEVEL (dBuV/m)	LIMIT (dBuV/m)	MARGIN (dB)	ANTENNA HEIGHT (m)	TABLE ANGLE (Degree)	RAW VALUE (dBuV)	CORRECTION FACTOR (dB/m)
1	#5617.60	57.2 PK	68.2	-11.0	2.52 V	113	55.5	1.7
2	*5825.00	114.8 PK			2.52 V	113	74.6	40.2
3	*5825.00	104.4 AV			2.52 V	113	64.2	40.2
4	#5974.40	57.8 PK	68.2	-10.4	2.52 V	113	55.1	2.7
5	11650.00	61.7 PK	74.0	-12.3	2.34 V	81	47.3	14.4
6	11650.00	47.7 AV	54.0	-6.3	2.34 V	81	33.3	14.4

Remarks:

1. Emission Level(dBuV/m) = Raw Value(dBuV) + Correction Factor(dB/m)
2. Correction Factor(dB/m) = Antenna Factor(dB/m) + Cable Factor(dB)
3. The other emission levels were very low against the limit.
4. Margin value = Emission Level – Limit value
5. " * ": Fundamental frequency.
6. " # ": The radiated frequency is out of the restricted band.

802.11n (HT20)

CHANNEL	TX Channel 36	DETECTOR FUNCTION	Peak (PK)
FREQUENCY RANGE	1GHz ~ 40GHz		Average (AV)

ANTENNA POLARITY & TEST DISTANCE: HORIZONTAL AT 3 M

NO.	FREQ. (MHz)	EMISSION LEVEL (dBuV/m)	LIMIT (dBuV/m)	MARGIN (dB)	ANTENNA HEIGHT (m)	TABLE ANGLE (Degree)	RAW VALUE (dBuV)	CORRECTION FACTOR (dB/m)
1	5150.00	64.0 PK	74.0	-10.0	1.36 H	103	63.2	0.8
2	5150.00	51.1 AV	54.0	-2.9	1.36 H	103	50.3	0.8
3	*5180.00	111.2 PK			1.37 H	61	72.5	38.7
4	*5180.00	101.1 AV			1.37 H	61	62.4	38.7
5	#10360.00	56.6 PK	74.0	-17.4	1.43 H	86	43.9	12.7
6	#10360.00	44.2 AV	54.0	-9.8	1.43 H	86	31.5	12.7

ANTENNA POLARITY & TEST DISTANCE: VERTICAL AT 3 M

NO.	FREQ. (MHz)	EMISSION LEVEL (dBuV/m)	LIMIT (dBuV/m)	MARGIN (dB)	ANTENNA HEIGHT (m)	TABLE ANGLE (Degree)	RAW VALUE (dBuV)	CORRECTION FACTOR (dB/m)
1	5150.00	66.3 PK	74.0	-7.7	2.67 V	112	65.5	0.8
2	5150.00	52.2 AV	54.0	-1.8	2.67 V	112	51.4	0.8
3	*5180.00	112.8 PK			2.49 V	88	74.1	38.7
4	*5180.00	101.6 AV			2.49 V	88	62.9	38.7
5	#10360.00	56.5 PK	74.0	-17.5	2.16 V	164	43.8	12.7
6	#10360.00	44.4 AV	54.0	-9.6	2.16 V	164	31.7	12.7

Remarks:

1. Emission Level(dBuV/m) = Raw Value(dBuV) + Correction Factor(dB/m)
2. Correction Factor(dB/m) = Antenna Factor(dB/m) + Cable Factor(dB)
3. The other emission levels were very low against the limit.
4. Margin value = Emission Level – Limit value
5. " * ": Fundamental frequency.
6. " # ": The radiated frequency is out of the restricted band.

CHANNEL	TX Channel 40	DETECTOR	Peak (PK)
FREQUENCY RANGE	1GHz ~ 40GHz	FUNCTION	Average (AV)

ANTENNA POLARITY & TEST DISTANCE: HORIZONTAL AT 3 M

NO.	FREQ. (MHz)	EMISSION LEVEL (dBuV/m)	LIMIT (dBuV/m)	MARGIN (dB)	ANTENNA HEIGHT (m)	TABLE ANGLE (Degree)	RAW VALUE (dBuV)	CORRECTION FACTOR (dB/m)
1	*5200.00	111.1 PK			1.40 H	62	72.4	38.7
2	*5200.00	101.0 AV			1.40 H	62	62.3	38.7
3	#10400.00	57.2 PK	74.0	-16.8	1.64 H	55	44.5	12.7
4	#10400.00	44.1 AV	54.0	-9.9	1.64 H	55	31.4	12.7

ANTENNA POLARITY & TEST DISTANCE: VERTICAL AT 3 M

NO.	FREQ. (MHz)	EMISSION LEVEL (dBuV/m)	LIMIT (dBuV/m)	MARGIN (dB)	ANTENNA HEIGHT (m)	TABLE ANGLE (Degree)	RAW VALUE (dBuV)	CORRECTION FACTOR (dB/m)
1	*5200.00	113.0 PK			2.66 V	111	74.3	38.7
2	*5200.00	102.3 AV			2.66 V	111	63.6	38.7
3	#10400.00	56.8 PK	74.0	-17.2	1.85 V	136	44.1	12.7
4	#10400.00	44.2 AV	54.0	-9.8	1.85 V	136	31.5	12.7

Remarks:

1. Emission Level(dBuV/m) = Raw Value(dBuV) + Correction Factor(dB/m)
2. Correction Factor(dB/m) = Antenna Factor(dB/m) + Cable Factor(dB)
3. The other emission levels were very low against the limit.
4. Margin value = Emission Level – Limit value
5. " * ": Fundamental frequency.
6. " # ": The radiated frequency is out of the restricted band.

CHANNEL	TX Channel 48	DETECTOR FUNCTION	Peak (PK)
FREQUENCY RANGE	1GHz ~ 40GHz		Average (AV)

ANTENNA POLARITY & TEST DISTANCE: HORIZONTAL AT 3 M

NO.	FREQ. (MHz)	EMISSION LEVEL (dBuV/m)	LIMIT (dBuV/m)	MARGIN (dB)	ANTENNA HEIGHT (m)	TABLE ANGLE (Degree)	RAW VALUE (dBuV)	CORRECTION FACTOR (dB/m)
1	*5240.00	110.1 PK			1.45 H	113	71.3	38.8
2	*5240.00	100.9 AV			1.45 H	113	62.1	38.8
3	5350.00	54.6 PK	74.0	-19.4	1.34 H	69	53.5	1.1
4	5350.00	41.7 AV	54.0	-12.3	1.34 H	69	40.6	1.1
5	#10480.00	57.8 PK	74.0	-16.2	1.54 H	119	44.3	13.5
6	#10480.00	44.5 AV	54.0	-9.5	1.54 H	119	31.0	13.5

ANTENNA POLARITY & TEST DISTANCE: VERTICAL AT 3 M

NO.	FREQ. (MHz)	EMISSION LEVEL (dBuV/m)	LIMIT (dBuV/m)	MARGIN (dB)	ANTENNA HEIGHT (m)	TABLE ANGLE (Degree)	RAW VALUE (dBuV)	CORRECTION FACTOR (dB/m)
1	*5240.00	112.7 PK			2.84 V	107	73.9	38.8
2	*5240.00	102.5 AV			2.84 V	107	63.7	38.8
3	5350.00	55.2 PK	74.0	-18.8	2.62 V	120	54.1	1.1
4	5350.00	42.5 AV	54.0	-11.5	2.62 V	120	41.4	1.1
5	#10480.00	57.2 PK	74.0	-16.8	2.02 V	144	43.7	13.5
6	#10480.00	44.5 AV	54.0	-9.5	2.02 V	144	31.0	13.5

Remarks:

1. Emission Level(dBuV/m) = Raw Value(dBuV) + Correction Factor(dB/m)
2. Correction Factor(dB/m) = Antenna Factor(dB/m) + Cable Factor(dB)
3. The other emission levels were very low against the limit.
4. Margin value = Emission Level – Limit value
5. " * ": Fundamental frequency.
6. " # ": The radiated frequency is out of the restricted band.

CHANNEL	TX Channel 149	DETECTOR FUNCTION	Peak (PK)
FREQUENCY RANGE	1GHz ~ 40GHz		Average (AV)

ANTENNA POLARITY & TEST DISTANCE: HORIZONTAL AT 3 M

NO.	FREQ. (MHz)	EMISSION LEVEL (dBuV/m)	LIMIT (dBuV/m)	MARGIN (dB)	ANTENNA HEIGHT (m)	TABLE ANGLE (Degree)	RAW VALUE (dBuV)	CORRECTION FACTOR (dB/m)
1	#5640.00	56.0 PK	68.2	-12.2	1.22 H	99	54.3	1.7
2	*5745.00	111.7 PK			1.22 H	99	71.8	39.9
3	*5745.00	101.5 AV			1.22 H	99	61.6	39.9
4	#5963.20	57.8 PK	68.2	-10.4	1.22 H	99	55.2	2.6
5	11490.00	60.8 PK	74.0	-13.2	2.00 H	244	46.3	14.5
6	11490.00	47.7 AV	54.0	-6.3	2.00 H	244	33.2	14.5

ANTENNA POLARITY & TEST DISTANCE: VERTICAL AT 3 M

NO.	FREQ. (MHz)	EMISSION LEVEL (dBuV/m)	LIMIT (dBuV/m)	MARGIN (dB)	ANTENNA HEIGHT (m)	TABLE ANGLE (Degree)	RAW VALUE (dBuV)	CORRECTION FACTOR (dB/m)
1	#5605.60	57.0 PK	68.2	-11.2	3.05 V	120	55.3	1.7
2	*5745.00	116.5 PK			3.05 V	120	76.6	39.9
3	*5745.00	105.8 AV			3.05 V	120	65.9	39.9
4	#5967.20	57.5 PK	68.2	-10.7	3.05 V	120	54.8	2.7
5	11490.00	60.4 PK	74.0	-13.6	1.87 V	323	45.9	14.5
6	11490.00	46.8 AV	54.0	-7.2	1.87 V	323	32.3	14.5

Remarks:

1. Emission Level(dBuV/m) = Raw Value(dBuV) + Correction Factor(dB/m)
2. Correction Factor(dB/m) = Antenna Factor(dB/m) + Cable Factor(dB)
3. The other emission levels were very low against the limit.
4. Margin value = Emission Level – Limit value
5. " * ": Fundamental frequency.
6. " # ": The radiated frequency is out of the restricted band.

CHANNEL	TX Channel 157	DETECTOR FUNCTION	Peak (PK)
FREQUENCY RANGE	1GHz ~ 40GHz		Average (AV)

ANTENNA POLARITY & TEST DISTANCE: HORIZONTAL AT 3 M

NO.	FREQ. (MHz)	EMISSION LEVEL (dBuV/m)	LIMIT (dBuV/m)	MARGIN (dB)	ANTENNA HEIGHT (m)	TABLE ANGLE (Degree)	RAW VALUE (dBuV)	CORRECTION FACTOR (dB/m)
1	#5643.20	55.8 PK	68.2	-12.4	1.22 H	104	54.1	1.7
2	*5785.00	112.7 PK			1.22 H	104	72.6	40.1
3	*5785.00	102.5 AV			1.22 H	104	62.4	40.1
4	#5929.60	57.3 PK	68.2	-10.9	1.22 H	104	54.7	2.6
5	11570.00	59.2 PK	74.0	-14.8	1.89 H	234	44.9	14.3
6	11570.00	47.0 AV	54.0	-7.0	1.89 H	234	32.7	14.3

ANTENNA POLARITY & TEST DISTANCE: VERTICAL AT 3 M

NO.	FREQ. (MHz)	EMISSION LEVEL (dBuV/m)	LIMIT (dBuV/m)	MARGIN (dB)	ANTENNA HEIGHT (m)	TABLE ANGLE (Degree)	RAW VALUE (dBuV)	CORRECTION FACTOR (dB/m)
1	#5644.00	56.5 PK	68.2	-11.7	3.01 V	120	54.8	1.7
2	*5785.00	115.0 PK			3.01 V	120	74.9	40.1
3	*5785.00	104.5 AV			3.01 V	120	64.4	40.1
4	#5952.00	57.5 PK	68.2	-10.7	3.01 V	120	54.9	2.6
5	11570.00	60.4 PK	74.0	-13.6	1.92 V	222	46.1	14.3
6	11570.00	47.3 AV	54.0	-6.7	1.92 V	222	33.0	14.3

Remarks:

1. Emission Level(dBuV/m) = Raw Value(dBuV) + Correction Factor(dB/m)
2. Correction Factor(dB/m) = Antenna Factor(dB/m) + Cable Factor(dB)
3. The other emission levels were very low against the limit.
4. Margin value = Emission Level – Limit value
5. " * ": Fundamental frequency.

CHANNEL	TX Channel 165	DETECTOR FUNCTION	Peak (PK)
FREQUENCY RANGE	1GHz ~ 40GHz		Average (AV)

ANTENNA POLARITY & TEST DISTANCE: HORIZONTAL AT 3 M

NO.	FREQ. (MHz)	EMISSION LEVEL (dBuV/m)	LIMIT (dBuV/m)	MARGIN (dB)	ANTENNA HEIGHT (m)	TABLE ANGLE (Degree)	RAW VALUE (dBuV)	CORRECTION FACTOR (dB/m)
1	#5610.40	55.9 PK	68.2	-12.3	2.82 H	333	54.2	1.7
2	*5825.00	112.7 PK			2.82 H	333	72.5	40.2
3	*5825.00	102.4 AV			2.82 H	333	62.2	40.2
4	#5949.60	57.4 PK	68.2	-10.8	2.82 H	333	54.8	2.6
5	11650.00	59.4 PK	74.0	-14.6	2.10 H	345	45.0	14.4
6	11650.00	46.8 AV	54.0	-7.2	2.10 H	345	32.4	14.4

ANTENNA POLARITY & TEST DISTANCE: VERTICAL AT 3 M

NO.	FREQ. (MHz)	EMISSION LEVEL (dBuV/m)	LIMIT (dBuV/m)	MARGIN (dB)	ANTENNA HEIGHT (m)	TABLE ANGLE (Degree)	RAW VALUE (dBuV)	CORRECTION FACTOR (dB/m)
1	#5608.80	56.3 PK	68.2	-11.9	3.00 V	87	54.6	1.7
2	*5825.00	115.6 PK			3.00 V	87	75.4	40.2
3	*5825.00	104.8 AV			3.00 V	87	64.6	40.2
4	#5943.20	56.8 PK	68.2	-11.4	3.00 V	87	54.2	2.6
5	11650.00	60.0 PK	74.0	-14.0	1.90 V	330	45.6	14.4
6	11650.00	47.1 AV	54.0	-6.9	1.90 V	330	32.7	14.4

Remarks:

1. Emission Level(dBuV/m) = Raw Value(dBuV) + Correction Factor(dB/m)
2. Correction Factor(dB/m) = Antenna Factor(dB/m) + Cable Factor(dB)
3. The other emission levels were very low against the limit.
4. Margin value = Emission Level – Limit value
5. " * ": Fundamental frequency.
6. " # ": The radiated frequency is out of the restricted band.

802.11n (HT40)

CHANNEL	TX Channel 38	DETECTOR FUNCTION	Peak (PK)
FREQUENCY RANGE	1GHz ~ 40GHz		Average (AV)

ANTENNA POLARITY & TEST DISTANCE: HORIZONTAL AT 3 M

NO.	FREQ. (MHz)	EMISSION LEVEL (dBuV/m)	LIMIT (dBuV/m)	MARGIN (dB)	ANTENNA HEIGHT (m)	TABLE ANGLE (Degree)	RAW VALUE (dBuV)	CORRECTION FACTOR (dB/m)
1	5150.00	65.2 PK	74.0	-8.8	1.10 H	64	64.4	0.8
2	5150.00	51.3 AV	54.0	-2.7	1.10 H	64	50.5	0.8
3	*5190.00	102.1 PK			1.05 H	60	63.4	38.7
4	*5190.00	93.6 AV			1.05 H	60	54.9	38.7
5	#10380.00	57.4 PK	74.0	-16.6	1.55 H	345	44.6	12.8
6	#10380.00	45.4 AV	54.0	-8.6	1.55 H	345	32.6	12.8

ANTENNA POLARITY & TEST DISTANCE: VERTICAL AT 3 M

NO.	FREQ. (MHz)	EMISSION LEVEL (dBuV/m)	LIMIT (dBuV/m)	MARGIN (dB)	ANTENNA HEIGHT (m)	TABLE ANGLE (Degree)	RAW VALUE (dBuV)	CORRECTION FACTOR (dB/m)
1	5150.00	66.8 PK	74.0	-7.2	3.65 V	89	66.0	0.8
2	5150.00	52.5 AV	54.0	-1.5	3.65 V	89	51.7	0.8
3	*5190.00	102.1 PK			2.51 V	112	63.4	38.7
4	*5190.00	92.7 AV			2.51 V	112	54.0	38.7
5	#10380.00	58.1 PK	74.0	-15.9	1.89 V	60	45.3	12.8
6	#10380.00	45.5 AV	54.0	-8.5	1.89 V	60	32.7	12.8

Remarks:

1. Emission Level(dBuV/m) = Raw Value(dBuV) + Correction Factor(dB/m)
2. Correction Factor(dB/m) = Antenna Factor(dB/m) + Cable Factor(dB)
3. The other emission levels were very low against the limit.
4. Margin value = Emission Level – Limit value
5. " * ": Fundamental frequency.
6. " # ": The radiated frequency is out of the restricted band.

CHANNEL	TX Channel 46	DETECTOR FUNCTION	Peak (PK)
FREQUENCY RANGE	1GHz ~ 40GHz		Average (AV)

ANTENNA POLARITY & TEST DISTANCE: HORIZONTAL AT 3 M								
NO.	FREQ. (MHz)	EMISSION LEVEL (dBuV/m)	LIMIT (dBuV/m)	MARGIN (dB)	ANTENNA HEIGHT (m)	TABLE ANGLE (Degree)	RAW VALUE (dBuV)	CORRECTION FACTOR (dB/m)
1	5150.00	60.3 PK	74.0	-13.7	1.03 H	68	59.5	0.8
2	5150.00	47.7 AV	54.0	-6.3	1.03 H	68	46.9	0.8
3	*5230.00	105.9 PK			1.60 H	69	67.1	38.8
4	*5230.00	97.3 AV			1.60 H	69	58.5	38.8
5	#10460.00	58.2 PK	74.0	-15.8	1.79 H	360	44.9	13.3
6	#10460.00	45.5 AV	54.0	-8.5	1.79 H	360	32.2	13.3

ANTENNA POLARITY & TEST DISTANCE: VERTICAL AT 3 M								
NO.	FREQ. (MHz)	EMISSION LEVEL (dBuV/m)	LIMIT (dBuV/m)	MARGIN (dB)	ANTENNA HEIGHT (m)	TABLE ANGLE (Degree)	RAW VALUE (dBuV)	CORRECTION FACTOR (dB/m)
1	5150.00	59.7 PK	74.0	-14.3	2.04 V	80	58.9	0.8
2	5150.00	46.4 AV	54.0	-7.6	2.04 V	80	45.6	0.8
3	*5230.00	106.9 PK			3.07 V	98	68.1	38.8
4	*5230.00	97.4 AV			3.07 V	98	58.6	38.8
5	#10460.00	59.4 PK	74.0	-14.6	1.90 V	211	46.1	13.3
6	#10460.00	46.3 AV	54.0	-7.7	1.90 V	211	33.0	13.3

Remarks:

1. Emission Level(dBuV/m) = Raw Value(dBuV) + Correction Factor(dB/m)
2. Correction Factor(dB/m) = Antenna Factor(dB/m) + Cable Factor(dB)
3. The other emission levels were very low against the limit.
4. Margin value = Emission Level – Limit value
5. " * ": Fundamental frequency.
6. " # ": The radiated frequency is out of the restricted band.

CHANNEL	TX Channel 151	DETECTOR FUNCTION	Peak (PK)
FREQUENCY RANGE	1GHz ~ 40GHz		Average (AV)

ANTENNA POLARITY & TEST DISTANCE: HORIZONTAL AT 3 M

NO.	FREQ. (MHz)	EMISSION LEVEL (dBuV/m)	LIMIT (dBuV/m)	MARGIN (dB)	ANTENNA HEIGHT (m)	TABLE ANGLE (Degree)	RAW VALUE (dBuV)	CORRECTION FACTOR (dB/m)
1	#5648.80	57.2 PK	68.2	-11.0	1.17 H	104	55.5	1.7
2	*5755.00	110.6 PK			1.15 H	102	70.7	39.9
3	*5755.00	100.5 AV			1.15 H	102	60.6	39.9
4	#5961.60	57.7 PK	68.2	-10.5	1.17 H	104	55.1	2.6
5	11510.00	59.3 PK	74.0	-14.7	1.75 H	302	44.8	14.5
6	11510.00	47.2 AV	54.0	-6.8	1.75 H	302	32.7	14.5

ANTENNA POLARITY & TEST DISTANCE: VERTICAL AT 3 M

NO.	FREQ. (MHz)	EMISSION LEVEL (dBuV/m)	LIMIT (dBuV/m)	MARGIN (dB)	ANTENNA HEIGHT (m)	TABLE ANGLE (Degree)	RAW VALUE (dBuV)	CORRECTION FACTOR (dB/m)
1	#5639.20	57.0 PK	68.2	-11.2	2.87 V	124	55.3	1.7
2	*5755.00	112.7 PK			2.87 V	124	72.8	39.9
3	*5755.00	102.9 AV			2.87 V	124	63.0	39.9
4	#5971.20	58.4 PK	68.2	-9.8	2.87 V	124	55.7	2.7
5	11510.00	59.6 PK	74.0	-14.4	2.44 V	156	45.1	14.5
6	11510.00	46.8 AV	54.0	-7.2	2.44 V	156	32.3	14.5

Remarks:

1. Emission Level(dBuV/m) = Raw Value(dBuV) + Correction Factor(dB/m)
2. Correction Factor(dB/m) = Antenna Factor(dB/m) + Cable Factor(dB)
3. The other emission levels were very low against the limit.
4. Margin value = Emission Level – Limit value
5. " * ": Fundamental frequency.
6. " # ": The radiated frequency is out of the restricted band.

CHANNEL	TX Channel 159	DETECTOR FUNCTION	Peak (PK)
FREQUENCY RANGE	1GHz ~ 40GHz		Average (AV)

ANTENNA POLARITY & TEST DISTANCE: HORIZONTAL AT 3 M

NO.	FREQ. (MHz)	EMISSION LEVEL (dBuV/m)	LIMIT (dBuV/m)	MARGIN (dB)	ANTENNA HEIGHT (m)	TABLE ANGLE (Degree)	RAW VALUE (dBuV)	CORRECTION FACTOR (dB/m)
1	#5635.20	56.6 PK	68.2	-11.6	1.19 H	106	54.9	1.7
2	*5795.00	110.2 PK			1.19 H	106	70.1	40.1
3	*5795.00	100.2 AV			1.19 H	106	60.1	40.1
4	#5932.00	58.8 PK	68.2	-9.4	1.19 H	106	56.2	2.6
5	11590.00	60.1 PK	74.0	-13.9	1.58 H	339	45.8	14.3
6	11590.00	47.1 AV	54.0	-6.9	1.58 H	339	32.8	14.3

ANTENNA POLARITY & TEST DISTANCE: VERTICAL AT 3 M

NO.	FREQ. (MHz)	EMISSION LEVEL (dBuV/m)	LIMIT (dBuV/m)	MARGIN (dB)	ANTENNA HEIGHT (m)	TABLE ANGLE (Degree)	RAW VALUE (dBuV)	CORRECTION FACTOR (dB/m)
1	#5615.20	57.6 PK	68.2	-10.6	2.91 V	122	55.9	1.7
2	*5795.00	111.7 PK			2.91 V	122	71.6	40.1
3	*5795.00	102.0 AV			2.91 V	122	61.9	40.1
4	#5962.40	57.6 PK	68.2	-10.6	2.91 V	122	55.0	2.6
5	11590.00	60.4 PK	74.0	-13.6	2.50 V	180	46.1	14.3
6	11590.00	47.4 AV	54.0	-6.6	2.50 V	180	33.1	14.3

Remarks:

1. Emission Level(dBuV/m) = Raw Value(dBuV) + Correction Factor(dB/m)
2. Correction Factor(dB/m) = Antenna Factor(dB/m) + Cable Factor(dB)
3. The other emission levels were very low against the limit.
4. Margin value = Emission Level – Limit value
5. " * ": Fundamental frequency.
6. " # ": The radiated frequency is out of the restricted band.

802.11ac (VHT80)

CHANNEL	TX Channel 42	DETECTOR FUNCTION	Peak (PK)
FREQUENCY RANGE	1GHz ~ 40GHz		Average (AV)

ANTENNA POLARITY & TEST DISTANCE: HORIZONTAL AT 3 M

NO.	FREQ. (MHz)	EMISSION LEVEL (dBuV/m)	LIMIT (dBuV/m)	MARGIN (dB)	ANTENNA HEIGHT (m)	TABLE ANGLE (Degree)	RAW VALUE (dBuV)	CORRECTION FACTOR (dB/m)
1	5150.00	63.5 PK	74.0	-10.5	1.10 H	60	62.7	0.8
2	5150.00	51.7 AV	54.0	-2.3	1.10 H	60	50.9	0.8
3	*5210.00	97.0 PK			1.14 H	63	58.3	38.7
4	*5210.00	87.4 AV			1.14 H	63	48.7	38.7
5	#10420.00	56.9 PK	74.0	-17.1	2.20 H	166	44.0	12.9
6	#10420.00	44.5 AV	54.0	-9.5	2.20 H	166	31.6	12.9

ANTENNA POLARITY & TEST DISTANCE: VERTICAL AT 3 M

NO.	FREQ. (MHz)	EMISSION LEVEL (dBuV/m)	LIMIT (dBuV/m)	MARGIN (dB)	ANTENNA HEIGHT (m)	TABLE ANGLE (Degree)	RAW VALUE (dBuV)	CORRECTION FACTOR (dB/m)
1	5150.00	64.1 PK	74.0	-9.9	3.54 V	89	63.3	0.8
2	5150.00	52.2 AV	54.0	-1.8	3.54 V	89	51.4	0.8
3	*5210.00	98.7 PK			3.03 V	96	60.0	38.7
4	*5210.00	88.5 AV			3.03 V	96	49.8	38.7
5	5350.00	56.0 PK	74.0	-18.0	2.54 V	77	54.9	1.1
6	5350.00	43.9 AV	54.0	-10.1	2.54 V	77	42.8	1.1
7	#10420.00	56.8 PK	74.0	-17.2	2.02 V	359	43.9	12.9
8	#10420.00	44.8 AV	54.0	-9.2	2.02 V	359	31.9	12.9

Remarks:

1. Emission Level(dBuV/m) = Raw Value(dBuV) + Correction Factor(dB/m)
2. Correction Factor(dB/m) = Antenna Factor(dB/m) + Cable Factor(dB)
3. The other emission levels were very low against the limit.
4. Margin value = Emission Level – Limit value
5. " * ": Fundamental frequency.
6. " # ": The radiated frequency is out of the restricted band.

CHANNEL	TX Channel 155	DETECTOR FUNCTION	Peak (PK)
FREQUENCY RANGE	1GHz ~ 40GHz		Average (AV)

ANTENNA POLARITY & TEST DISTANCE: HORIZONTAL AT 3 M

NO.	FREQ. (MHz)	EMISSION LEVEL (dBuV/m)	LIMIT (dBuV/m)	MARGIN (dB)	ANTENNA HEIGHT (m)	TABLE ANGLE (Degree)	RAW VALUE (dBuV)	CORRECTION FACTOR (dB/m)
1	#5648.00	59.5 PK	68.2	-8.7	1.03 H	101	57.8	1.7
2	#5650.00	65.5 PK	68.2	-2.7	1.25 H	103	63.8	1.7
3	*5775.00	104.9 PK			1.03 H	101	64.9	40.0
4	*5775.00	95.1 AV			1.03 H	101	55.1	40.0
5	#5925.00	59.6 PK	68.2	-8.6	1.34 H	120	57.0	2.6
6	#5929.60	59.7 PK	68.2	-8.5	1.03 H	101	57.1	2.6
7	11550.00	58.9 PK	74.0	-15.1	1.67 H	330	44.4	14.5
8	11550.00	46.4 AV	54.0	-7.6	1.67 H	330	31.9	14.5

ANTENNA POLARITY & TEST DISTANCE: VERTICAL AT 3 M

NO.	FREQ. (MHz)	EMISSION LEVEL (dBuV/m)	LIMIT (dBuV/m)	MARGIN (dB)	ANTENNA HEIGHT (m)	TABLE ANGLE (Degree)	RAW VALUE (dBuV)	CORRECTION FACTOR (dB/m)
1	#5643.20	62.8 PK	68.2	-5.4	2.90 V	115	61.1	1.7
2	#5650.00	66.5 PK	68.2	-1.7	2.87 V	117	64.8	1.7
3	*5775.00	106.6 PK			2.90 V	115	66.6	40.0
4	*5775.00	97.3 AV			2.90 V	115	57.3	40.0
5	#5925.00	63.2 PK	68.2	-5.0	2.91 V	202	60.6	2.6
6	#5928.00	59.4 PK	68.2	-8.8	2.90 V	115	56.8	2.6
7	11550.00	59.9 PK	74.0	-14.1	1.68 V	230	45.4	14.5
8	11550.00	46.9 AV	54.0	-7.1	1.68 V	230	32.4	14.5

Remarks:

1. Emission Level(dBuV/m) = Raw Value(dBuV) + Correction Factor(dB/m)
2. Correction Factor(dB/m) = Antenna Factor(dB/m) + Cable Factor(dB)
3. The other emission levels were very low against the limit.
4. Margin value = Emission Level – Limit value
5. " * ": Fundamental frequency.
6. " # ": The radiated frequency is out of the restricted band.

Below 1GHz Worst-Case Data:

802.11a

CHANNEL	TX Channel 36	DETECTOR FUNCTION	Quasi-Peak (QP)
FREQUENCY RANGE	30MHz ~ 1GHz		

ANTENNA POLARITY & TEST DISTANCE: HORIZONTAL AT 3 M								
NO.	FREQ. (MHz)	EMISSION LEVEL (dBuV/m)	LIMIT (dBuV/m)	MARGIN (dB)	ANTENNA HEIGHT (m)	TABLE ANGLE (Degree)	RAW VALUE (dBuV)	CORRECTION FACTOR (dB/m)
1	57.12	27.4 QP	40.0	-12.6	1.99 H	251	42.0	-14.6
2	99.89	27.4 QP	43.5	-16.1	1.99 H	261	46.0	-18.6
3	134.89	37.0 QP	43.5	-6.5	1.99 H	261	51.8	-14.8
4	158.22	38.9 QP	43.5	-4.6	1.49 H	243	52.5	-13.6
5	166.00	38.4 QP	43.5	-5.1	1.49 H	249	52.3	-13.9
6	193.22	35.1 QP	43.5	-8.4	1.49 H	238	51.3	-16.2

ANTENNA POLARITY & TEST DISTANCE: VERTICAL AT 3 M								
NO.	FREQ. (MHz)	EMISSION LEVEL (dBuV/m)	LIMIT (dBuV/m)	MARGIN (dB)	ANTENNA HEIGHT (m)	TABLE ANGLE (Degree)	RAW VALUE (dBuV)	CORRECTION FACTOR (dB/m)
1	47.80	34.2 QP	40.0	-5.8	1.50 V	188	48.7	-14.5
2	65.60	37.7 QP	40.0	-2.3	1.00 V	11	53.4	-15.7
3	96.01	39.2 QP	43.5	-4.3	1.00 V	294	58.3	-19.1
4	131.00	36.7 QP	43.5	-6.8	1.00 V	197	52.1	-15.4
5	195.16	37.4 QP	43.5	-6.1	1.00 V	249	53.7	-16.3
6	267.10	25.6 QP	46.0	-20.4	1.50 V	216	38.8	-13.2

Remarks:

1. Emission Level(dBuV/m) = Raw Value(dBuV) + Correction Factor(dB/m)
2. Correction Factor(dB/m) = Antenna Factor(dB/m) + Cable Factor(dB)
3. The other emission levels were very low against the limit.
4. Margin value = Emission Level – Limit value

4.2 Conducted Emission Measurement

4.2.1 Limits of Conducted Emission Measurement

Frequency (MHz)	Conducted Limit (dBuV)	
	Quasi-peak	Average
0.15 - 0.5	66 - 56	56 - 46
0.50 - 5.0	56	46
5.0 - 30.0	60	50

- Note:** 1. The lower limit shall apply at the transition frequencies.
2. The limit decreases in line with the logarithm of the frequency in the range of 0.15 to 0.50MHz.

4.2.2 Test Instruments

Description & Manufacturer	Model No.	Serial No.	Cal. Date	Cal. Due
Test Receiver ROHDE & SCHWARZ	ESCI	100613	Nov. 21, 2016	Nov. 20, 2017
RF signal cable (with 10dB PAD) Woken	5D-FB	Cable-cond1-01	Dec. 22, 2016	Dec. 21, 2017
LISN ROHDE & SCHWARZ (EUT)	ESH3-Z5	835239/001	Mar. 10, 2017	Mar. 09, 2018
LISN ROHDE & SCHWARZ (Peripheral)	ESH3-Z5	100311	Jul. 28, 2016	Jul. 27, 2017
Software ADT	BV ADT_Cond_ V7.3.7.3	NA	NA	NA

- Note:** 1. The calibration interval of the above test instruments is 12 months and the calibrations are traceable to NML/ROC and NIST/USA.
2. The test was performed in HwaYa Shielded Room 1.
3. The VCCI Site Registration No. is C-2040.

4.2.3 Test Procedures

- The EUT was placed 0.4 meters from the conducting wall of the shielded room with EUT being connected to the power mains through a line impedance stabilization network (LISN). Other support units were connected to the power mains through another LISN. The two LISNs provide 50 ohm/ 50uH of coupling impedance for the measuring instrument.
- Both lines of the power mains connected to the EUT were checked for maximum conducted interference.
- The frequency range from 150kHz to 30MHz was searched. Emission levels under (Limit - 20dB) was not recorded.

NOTE: The resolution bandwidth and video bandwidth of test receiver is 9kHz for quasi-peak detection (QP) and average detection (AV) at frequency 0.15MHz-30MHz.

4.2.4 Deviation from Test Standard

No deviation.

4.2.5 Test Setup

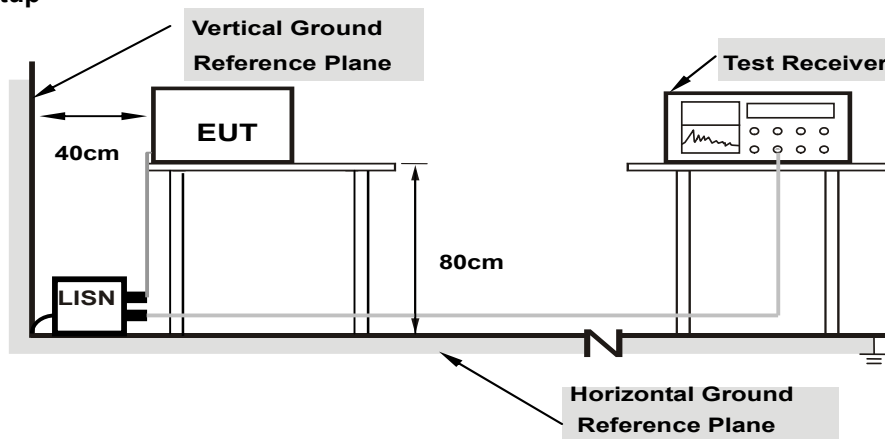

Note: 1.Support units were connected to second LISN.

For the actual test configuration, please refer to the attached file (Test Setup Photo).

4.2.6 EUT Operating Conditions

Same as 4.1.6.

4.2.7 Test Results

Phase	Line (L)	Detector Function	Quasi-Peak (QP) / Average (AV)
-------	----------	-------------------	--------------------------------

No	Freq. [MHz]	Corr. Factor (dB)	Reading Value [dB (uV)]		Emission Level [dB (uV)]		Limit [dB (uV)]		Margin (dB)	
			Q.P.	AV.	Q.P.	AV.	Q.P.	AV.	Q.P.	AV.
			1	0.19305	10.37	25.35	11.27	35.72	21.64	63.90
2	0.39219	10.40	26.18	17.67	36.58	28.07	58.02	48.02	-21.44	-19.95
3	2.33960	10.48	13.10	10.03	23.58	20.51	56.00	46.00	-32.42	-25.49
4	2.85963	10.51	15.90	14.52	26.41	25.03	56.00	46.00	-29.59	-20.97
5	9.87808	10.82	11.59	7.34	22.41	18.16	60.00	50.00	-37.59	-31.84
6	16.16927	11.15	12.63	8.02	23.78	19.17	60.00	50.00	-36.22	-30.83

Remarks:

1. Q.P. and AV. are abbreviations of quasi-peak and average individually.
2. The emission levels of other frequencies were very low against the limit.
3. Margin value = Emission level - Limit value
4. Correction factor = Insertion loss + Cable loss
5. Emission Level = Correction Factor + Reading Value.

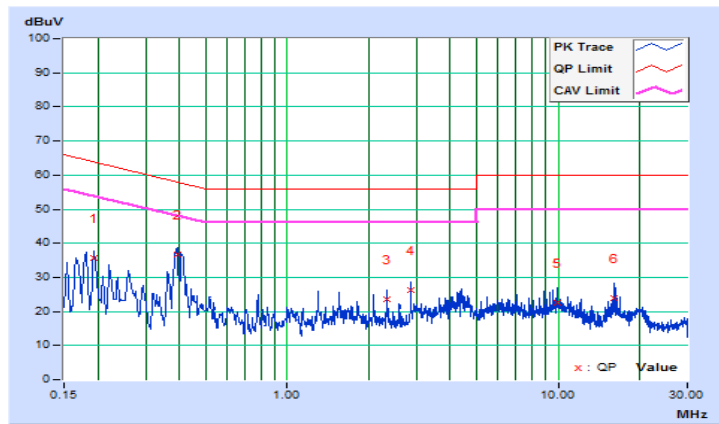

Phase	Neutral (N)	Detector Function	Quasi-Peak (QP) / Average (AV)
-------	-------------	-------------------	--------------------------------

No	Freq. [MHz]	Corr. Factor (dB)	Reading Value [dB (uV)]		Emission Level [dB (uV)]		Limit [dB (uV)]		Margin (dB)	
			Q.P.	AV.	Q.P.	AV.	Q.P.	AV.	Q.P.	AV.
			1	0.15000	10.10	30.19	14.96	40.29	25.06	66.00
2	0.38808	10.16	26.95	23.60	37.11	33.76	58.10	48.10	-20.99	-14.34
3	0.77951	10.17	14.80	13.86	24.97	24.03	56.00	46.00	-31.03	-21.97
4	2.85572	10.28	16.11	14.38	26.39	24.66	56.00	46.00	-29.61	-21.34
5	8.83802	10.51	14.23	9.72	24.74	20.23	60.00	50.00	-35.26	-29.77
6	16.22792	10.80	14.43	10.15	25.23	20.95	60.00	50.00	-34.77	-29.05

Remarks:

1. Q.P. and AV. are abbreviations of quasi-peak and average individually.
2. The emission levels of other frequencies were very low against the limit.
3. Margin value = Emission level - Limit value
4. Correction factor = Insertion loss + Cable loss
5. Emission Level = Correction Factor + Reading Value.

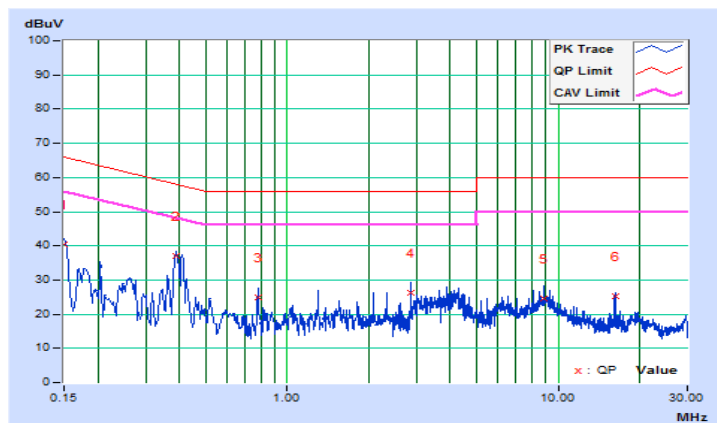

4.3 Transmit Power Measurement

4.3.1 Limits of Transmit Power Measurement

Operation Band	EUT Category		LIMIT
U-NII-1		Outdoor Access Point	1 Watt (30 dBm) (Max. e.i.r.p \leq 125mW(21 dBm) at any elevation angle above 30 degrees as measured from the horizon)
		Fixed point-to-point Access Point	1 Watt (30 dBm)
	√	Indoor Access Point	1 Watt (30 dBm)
		Mobile and Portable client device	250mW (24 dBm)
U-NII-2A	---		250mW (24 dBm) or 11 dBm+10 log B*
U-NII-2C	---		250mW (24 dBm) or 11 dBm+10 log B*
U-NII-3	√		1 Watt (30 dBm)

*B is the 26 dB emission bandwidth in megahertz

Per KDB 662911 Method of conducted output power measurement on IEEE 802.11 devices,

Array Gain = 0 dB (i.e., no array gain) for $N_{ANT} \leq 4$;

Array Gain = 0 dB (i.e., no array gain) for channel widths ≥ 40 MHz for any N_{ANT} ;

Array Gain = $5 \log(N_{ANT}/N_{SS})$ dB or 3 dB, whichever is less for 20-MHz channel widths with $N_{ANT} \geq 5$.

For power measurements on all other devices: Array Gain = $10 \log(N_{ANT}/N_{SS})$ dB.

4.3.2 Test Setup

For Power Output Measurement

802.11a, 802.11n (HT20), 802.11n (HT40)

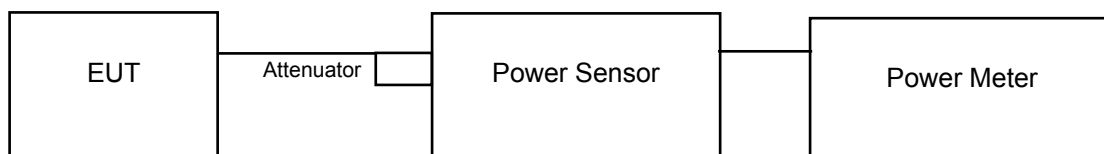

802.11ac (VHT80)

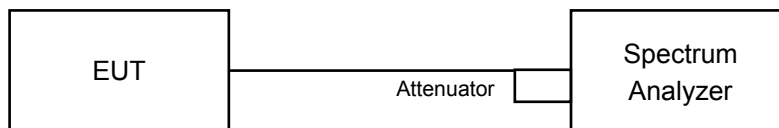

For 26dB Bandwidth

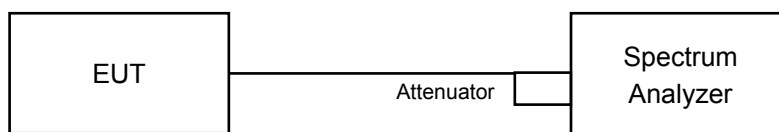

4.3.3 Test Instruments

Refer to section 4.1.2 to get information of above instrument.

4.3.4 Test Procedure

For Average Power Measurement

For 802.11a, 802.11n (HT20), 802.11n (HT40)

Method PM is used to perform output power measurement, trigger and gating function of wide band power meter is enabled to measure max output power of TX on burst. Duty factor is not added to measured value.

For 802.11ac (VHT80)

- a. Set span to encompass the entire 26 dB EBW (or, alternatively, the entire 99% occupied bandwidth) of the signal.
- b. Set sweep trigger to "free run".
- c. Set RBW = 1 MHz.
- d. Set VBW \geq 3 MHz
- e. Number of points in sweep \geq 2 Span / RBW.
- f. Sweep time \leq (number of points in sweep) * T
- g. Using emission bandwidth to determine the frequency span for integration the channel bandwidth.
- h. Detector = RMS.
- i. Trace mode = max hold.
- j. Allow max hold to run for at least 60 seconds, or longer as needed to allow the trace to stabilize.
- k. Compute power by integrating the spectrum across the EBW (or, alternatively, the entire 99% occupied bandwidth) of the signal using the instrument's band power measurement function with band limits set equal to the EBW (or occupied bandwidth) band edges. If the instrument does not have a band power function, sum the spectrum levels (in power units) at 1 MHz intervals extending across the EBW (or, alternatively, the entire 99% occupied bandwidth) of the spectrum.

For 26dB Bandwidth

- a. Set RBW = approximately 1% of the emission bandwidth.
- b. Set the VBW > RBW.
- c. Detector = Peak.
- d. Trace mode = max hold.
- e. Measure the maximum width of the emission that is 26 dB down from the peak of the emission. Compare this with the RBW setting of the analyzer. Readjust RBW and repeat measurement as needed until the RBW/EBW ratio is approximately 1%.

4.3.5 Deviation from Test Standard

No deviation.

4.3.6 EUT Operating Conditions

The software provided by client to enable the EUT under transmission condition continuously at lowest, middle and highest channel frequencies individually.

4.3.7 Test Result

Power Output:

CDD Mode

802.11a

Chan.	Freq. (MHz)	Maximum Conducted Power (dBm)		Total Power (mW)	Total Power (dBm)	Power Limit (dBm)	Pass / Fail
		Chain 0	Chain 1				
36	5180	17.62	17.73	117.103	20.69	30	Pass
40	5200	17.91	18.05	125.628	20.99	30	Pass
48	5240	18.51	18.48	141.427	21.51	30	Pass
149	5745	18.48	18.70	144.600	21.60	30	Pass
157	5785	18.65	18.85	150.018	21.76	30	Pass
165	5825	18.83	18.77	151.720	21.81	30	Pass

802.11n (HT20)

Chan.	Freq. (MHz)	Maximum Conducted Power (dBm)		Total Power (mW)	Total Power (dBm)	Power Limit (dBm)	Pass / Fail
		Chain 0	Chain 1				
36	5180	17.71	17.81	119.415	20.77	30	Pass
40	5200	18.04	17.99	126.631	21.03	30	Pass
48	5240	18.50	18.61	143.406	21.57	30	Pass
149	5745	18.35	18.66	141.842	21.52	30	Pass
157	5785	18.52	18.92	149.104	21.73	30	Pass
165	5825	18.84	18.74	151.377	21.80	30	Pass

802.11n (HT40)

Chan.	Freq. (MHz)	Maximum Conducted Power (dBm)		Total Power (mW)	Total Power (dBm)	Power Limit (dBm)	Pass / Fail
		Chain 0	Chain 1				
38	5190	14.15	14.27	52.732	17.22	30	Pass
46	5230	18.56	18.71	146.081	21.65	30	Pass
151	5755	18.35	18.66	141.842	21.52	30	Pass
159	5795	18.52	18.92	149.104	21.73	30	Pass

802.11ac (VHT80)

Chan.	Freq. (MHz)	Maximum Conducted Power (dBm)		Total Power (mW)	Total Power (dBm)	Power Limit (dBm)	Pass / Fail
		Chain 0	Chain 1				
42	5210	13.22	13.21	41.930	16.23	30	Pass
155	5775	17.96	18.28	129.815	21.13	30	Pass

Beamforming Mode

802.11n (HT20)

Chan.	Freq. (MHz)	Maximum Conducted Power (dBm)		Total Power (mW)	Total Power (dBm)	Power Limit (dBm)	Pass / Fail
		Chain 0	Chain 1				
36	5180	14.70	14.80	59.712	17.76	27.48	Pass
40	5200	15.03	14.98	63.319	18.02	27.48	Pass
48	5240	15.49	15.60	71.708	18.56	27.48	Pass
149	5745	15.34	15.65	70.926	18.51	27.48	Pass
157	5785	15.51	15.91	74.557	18.72	27.48	Pass
165	5825	15.83	15.73	75.694	18.79	27.48	Pass

Note: Directional gain = $10 \log[(10^{G1/20} + 10^{G2/20} + \dots + 10^{GN/20})^2/2]$ = 8.52 dBi > 6dBi , so the power limit shall be reduced to $30-(8.52-6) = 27.48\text{dBm}$.

802.11n (HT40)

Chan.	Freq. (MHz)	Maximum Conducted Power (dBm)		Total Power (mW)	Total Power (dBm)	Power Limit (dBm)	Pass / Fail
		Chain 0	Chain 1				
38	5190	11.14	11.26	26.368	14.21	27.48	Pass
46	5230	15.55	15.70	73.046	18.64	27.48	Pass
151	5755	15.34	15.65	70.926	18.51	27.48	Pass
159	5795	15.51	15.91	74.557	18.72	27.48	Pass

Note: Directional gain = $10 \log[(10^{G1/20} + 10^{G2/20} + \dots + 10^{GN/20})^2/2]$ = 8.52 dBi > 6dBi , so the power limit shall be reduced to $30-(8.52-6) = 27.48\text{dBm}$.

802.11ac (VHT80)

Chan.	Freq. (MHz)	Maximum Conducted Power (dBm)		Total Power (mW)	Total Power (dBm)	Power Limit (dBm)	Pass / Fail
		Chain 0	Chain 1				
42	5210	10.21	10.20	20.967	13.22	27.48	Pass
155	5775	14.95	15.27	64.912	18.12	27.48	Pass

Note: Directional gain = $10 \log[(10^{G1/20} + 10^{G2/20} + \dots + 10^{GN/20})^2/2]$ = 8.52 dBi > 6dBi , so the power limit shall be reduced to $30-(8.52-6) = 27.48\text{dBm}$.

26dB Bandwidth:

802.11a

Chan.	Freq. (MHz)	26dBc Bandwidth (MHz)		Pass / Fail
		Chain 0	Chain 1	
36	5180	36.13	35.04	Pass
40	5200	38.31	35.19	Pass
48	5240	37.71	35.25	Pass

802.11n (HT20)

Chan.	Freq. (MHz)	26dBc Bandwidth (MHz)		Pass / Fail
		Chain 0	Chain 1	
36	5180	38.07	35.24	Pass
40	5200	39.31	37.29	Pass
48	5240	38.64	38.83	Pass

802.11n (HT40)

Chan.	Freq. (MHz)	26dBc Bandwidth (MHz)		Pass / Fail
		Chain 0	Chain 1	
38	5190	40.98	41.32	Pass
46	5230	82.07	89.00	Pass

802.11ac (VHT80)

Chan.	Freq. (MHz)	26dBc Bandwidth (MHz)		Pass / Fail
		Chain 0	Chain 1	
42	5210	84.05	83.12	Pass

Spectrum Plot of Worst Value

802.11a

802.11n (HT20)

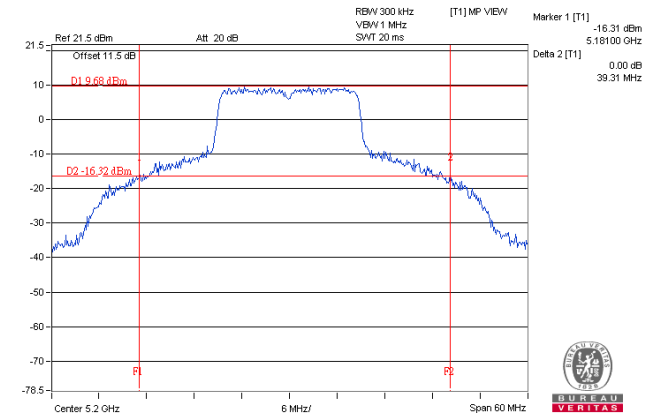
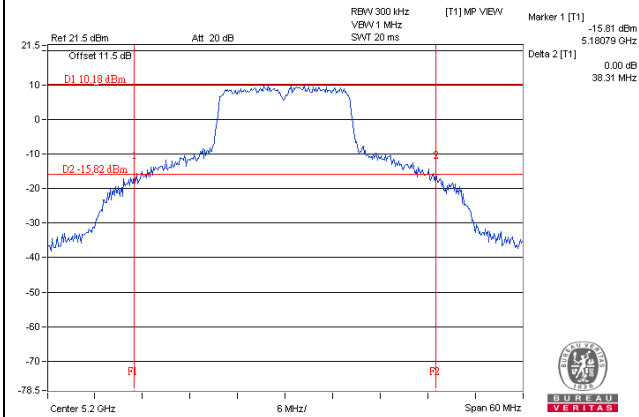

802.11n (HT40)

802.11ac (VHT80)

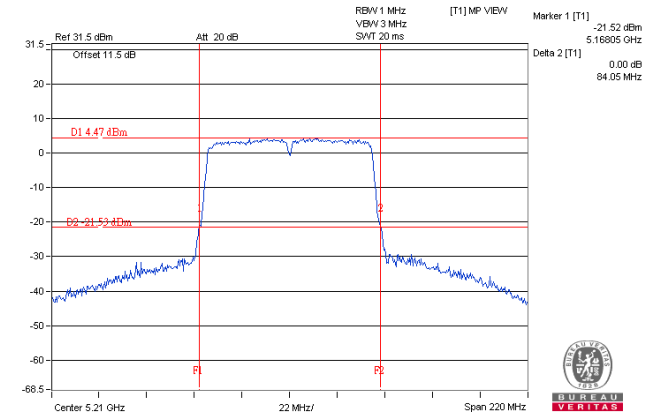
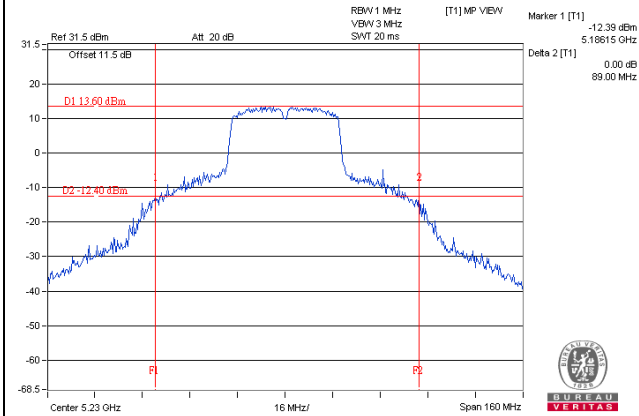

4.4 Occupied Bandwidth Measurement

4.4.1 Test Setup

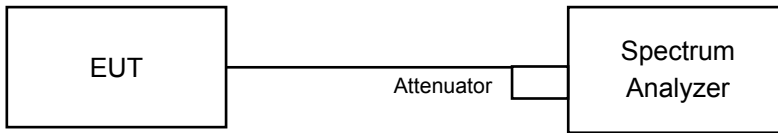

4.4.2 Test Instruments

Refer to section 4.1.2 to get information of above instrument.

4.4.3 Test Procedure

The transmitter output was connected to the spectrum analyzer through an attenuator. The bandwidth of the fundamental frequency was measured by spectrum analyzer with resolution bandwidth in the range of 1% to 5% of the anticipated emission bandwidth, and a video bandwidth at least 3x the resolution bandwidth and set the detector to Sample. The width of a frequency band such that, below the lower and above the upper frequency limits, the mean powers emitted are each equal to a specified percentage 0.5 %of the total mean power of a given emission.

4.4.4 Test Result

802.11a

Chan.	Freq. (MHz)	Occupied Bandwidth (MHz)	
		Chain 0	Chain 1
36	5180	17.40	17.04
40	5200	17.40	17.28
48	5240	17.76	17.52
149	5745	18.84	19.44
157	5785	19.80	18.84
165	5825	19.20	18.24

802.11n (HT20)

Chan.	Freq. (MHz)	Occupied Bandwidth (MHz)	
		Chain 0	Chain 1
36	5180	18.60	18.24
40	5200	19.08	18.48
48	5240	19.08	18.48
149	5745	20.16	19.92
157	5785	20.76	19.80
165	5825	19.44	19.68

802.11n (HT40)

Chan.	Freq. (MHz)	Occupied Bandwidth (MHz)	
		Chain 0	Chain 1
38	5190	36.24	36.36
46	5230	37.44	37.08
151	5755	38.16	38.28
159	5795	38.16	37.68

802.11ac (VHT80)

Chan.	Freq. (MHz)	Occupied Bandwidth (MHz)	
		Chain 0	Chain 1
42	5210	75.84	75.84
155	5775	76.56	76.08

Spectrum Plot of Worst Value

802.11a

802.11n (HT20)

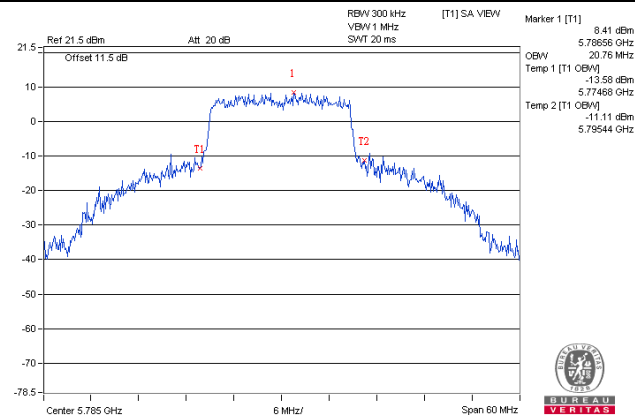
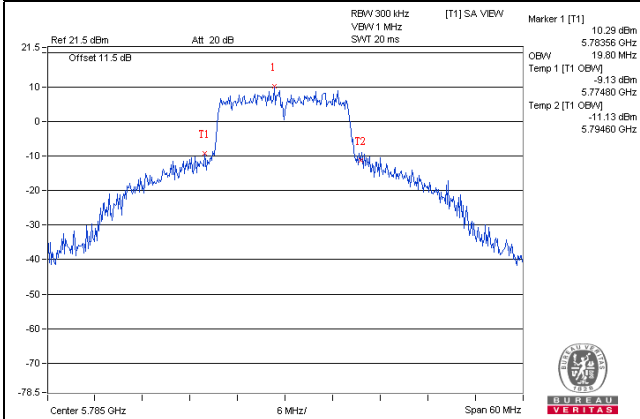

802.11n (HT40)

802.11ac (VHT80)

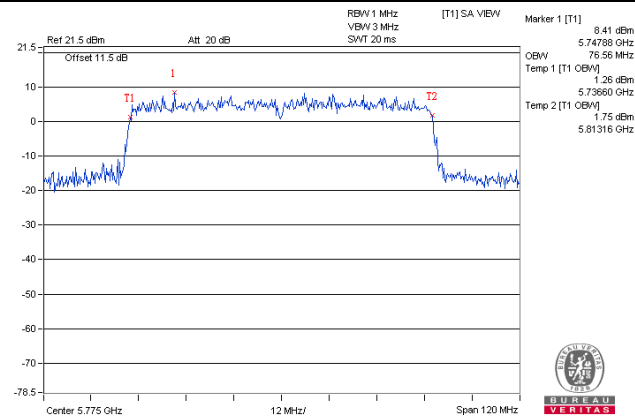
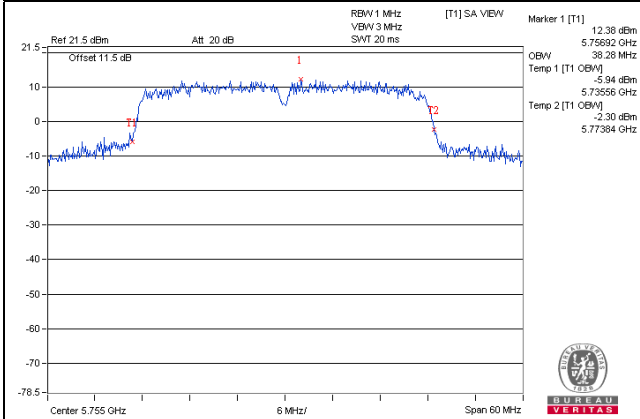

4.5 Peak Power Spectral Density Measurement

4.5.1 Limits of Peak Power Spectral Density Measurement

Operation Band	EUT Category		LIMIT
U-NII-1		Outdoor Access Point	17dBm/ MHz
		Fixed point-to-point Access Point	
	√	Indoor Access Point	
		Mobile and Portable client device	11dBm/ MHz
U-NII-2A	---		11dBm/ MHz
U-NII-2C	---		11dBm/ MHz
U-NII-3	√		30dBm/ 500kHz

4.5.2 Test Setup

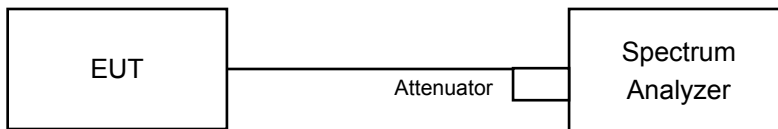

4.5.3 Test Instruments

Refer to section 4.1.2 to get information of above instrument.

4.5.4 Test Procedures

For U-NII-1 band:

Using method SA-1, Duty cycle >98%:

- a. Set span to encompass the entire emission bandwidth (EBW) of the signal.
- b. Set RBW = 1 MHz, Set VBW \geq 3 MHz, Detector = RMS
- c. Sweep time = auto, trigger set to "free run".
- d. Trace average at least 100 traces in power averaging mode.
- e. Record the max value

Using method SA-2, Duty cycle <98%

- a. Set span to encompass the entire emission bandwidth (EBW) of the signal.
- b. Set RBW = 1 MHz, Set VBW \geq 3 MHz, Detector = RMS
- c. Sweep time = auto, trigger set to "free run".
- d. Trace average at least 100 traces in power averaging mode.
- e. Record the max value and add $10 \log (1/\text{duty cycle})$

For U-NII-3 band:

Duty cycle >98%

- a. Set span to encompass the entire emission bandwidth (EBW) of the signal.
- b. Set RBW = 300 kHz, Set VBW \geq 1 MHz, Detector = RMS
- c. Use the peak marker function to determine the maximum power level in any 300 kHz band segment within the fundamental EBW.
- d. Scale the observed power level to an equivalent value in 500 kHz by adjusting (reducing) the measured power by a bandwidth correction factor (BWCF) where $\text{BWCF} = 10\log(500 \text{ kHz}/300\text{kHz})$
- e. Sweep time = auto, trigger set to "free run".
- f. Trace average at least 100 traces in power averaging mode.
- g. Record the max value

Duty cycle <98%

- a. Set span to encompass the entire emission bandwidth (EBW) of the signal.
- b. Set RBW = 300 kHz, Set VBW \geq 1 MHz, Detector = RMS
- c. Use the peak marker function to determine the maximum power level in any 300 kHz band segment within the fundamental EBW.
- d. Scale the observed power level to an equivalent value in 500 kHz by adjusting (reducing) the measured power by a bandwidth correction factor (BWCF) where $\text{BWCF} = 10\log(500 \text{ kHz}/300\text{kHz})$
- e. Sweep time = auto, trigger set to "free run".
- f. Trace average at least 100 traces in power averaging mode.
- g. Record the max value and add $10 \log (1/\text{duty cycle})$

4.5.5 Deviation from Test Standard

No deviation.

4.5.6 EUT Operating Conditions

Same as Item 4.3.6.

4.5.7 Test Results

For U-NII-1 Band

802.11a

Chan.	Freq. (MHz)	PSD (dBm)		Total PSD w/o duty factor (dBm)	Duty factor	Total PSD with duty factor (dBm)	Max. Limit (dBm)	Pass / Fail
		Chain 0	Chain 1					
36	5180	3.85	3.80	6.83	0.22	7.05	14.48	Pass
40	5200	4.41	4.42	7.42	0.22	7.64	14.48	Pass
48	5240	5.04	4.75	7.91	0.22	8.13	14.48	Pass

Note:

- Method 1 of power density measurement of KDB 662911 is using for calculating total power density. Total power density is summing entire spectra across corresponding frequency bins on the various outputs by computer.
- Directional gain = $10 \log[(10^{G1/20} + 10^{G2/20} + \dots + 10^{GN/20})^2/2] = 8.52 \text{ dBi} > 6\text{dBi}$, so the power density limit shall be reduced to $17-(8.52-6) = 14.48\text{dBm}$.
- Refer to section 3.3 for duty cycle spectrum plot.

802.11n (HT20)

Chan.	Freq. (MHz)	PSD (dBm)		Total PSD (dBm)	Max. Limit (dBm)	Pass / Fail
		Chain 0	Chain 1			
36	5180	3.35	3.69	6.53	14.48	Pass
40	5200	3.95	4.19	7.08	14.48	Pass
48	5240	4.50	4.56	7.54	14.48	Pass

Note:

- Method 1 of power density measurement of KDB 662911 is using for calculating total power density. Total power density is summing entire spectra across corresponding frequency bins on the various outputs by computer.
- Directional gain = $10 \log[(10^{G1/20} + 10^{G2/20} + \dots + 10^{GN/20})^2/2] = 8.52 \text{ dBi} > 6\text{dBi}$, so the power density limit shall be reduced to $17-(8.52-6) = 14.48\text{dBm}$.

802.11n (HT40)

Chan.	Freq. (MHz)	PSD (dBm)		Total PSD w/o duty factor (dBm)	Duty factor	Total PSD with duty factor (dBm)	Max. Limit (dBm)	Pass / Fail
		Chain 0	Chain 1					
38	5190	-2.51	-2.60	0.46	0.16	0.62	14.48	Pass
46	5230	2.40	2.26	5.34	0.16	5.50	14.48	Pass

Note:

- Method 1 of power density measurement of KDB 662911 is using for calculating total power density. Total power density is summing entire spectra across corresponding frequency bins on the various outputs by computer.
- Directional gain = $10 \log[(10^{G1/20} + 10^{G2/20} + \dots + 10^{GN/20})^2/2] = 8.52 \text{ dBi} > 6\text{dBi}$, so the power density limit shall be reduced to $17-(8.52-6) = 14.48\text{dBm}$.
- Refer to section 3.3 for duty cycle spectrum plot.

802.11ac (VHT80)

Chan.	Freq. (MHz)	PSD (dBm)		Total PSD w/o duty factor (dBm)	Duty factor	Total PSD with duty factor (dBm)	Max. Limit (dBm)	Pass / Fail
		Chain 0	Chain 1					
42	5210	-6.82	-6.99	-3.89	0.36	-3.53	14.48	Pass

Note:

- Method 1 of power density measurement of KDB 662911 is using for calculating total power density. Total power density is summing entire spectra across corresponding frequency bins on the various outputs by computer.
- Directional gain = $10 \log[(10^{G1/20} + 10^{G2/20} + \dots + 10^{GN/20})^2/2] = 8.52 \text{ dBi} > 6 \text{ dBi}$, so the power density limit shall be reduced to $17 - (8.52 - 6) = 14.48 \text{ dBm}$.
- Refer to section 3.3 for duty cycle spectrum plot.

Spectrum Plot of Worst Value

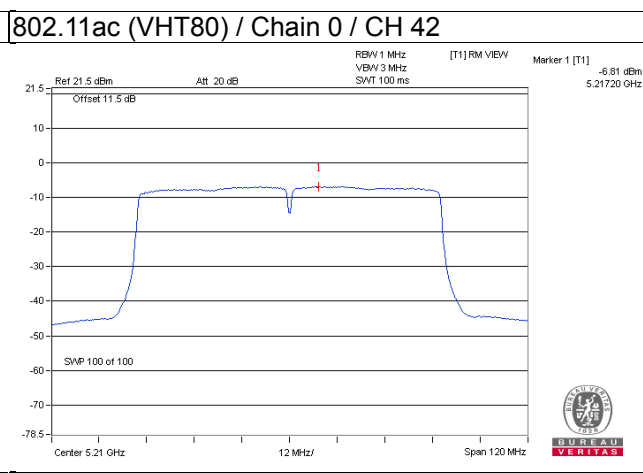
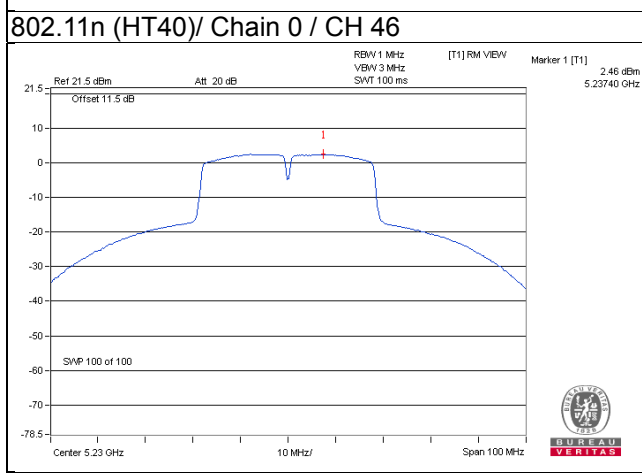
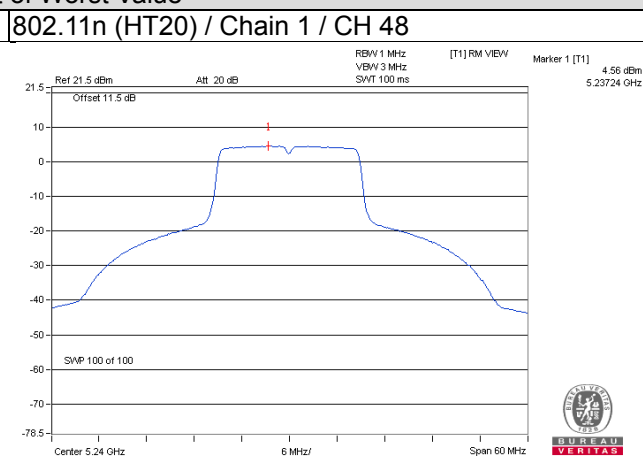
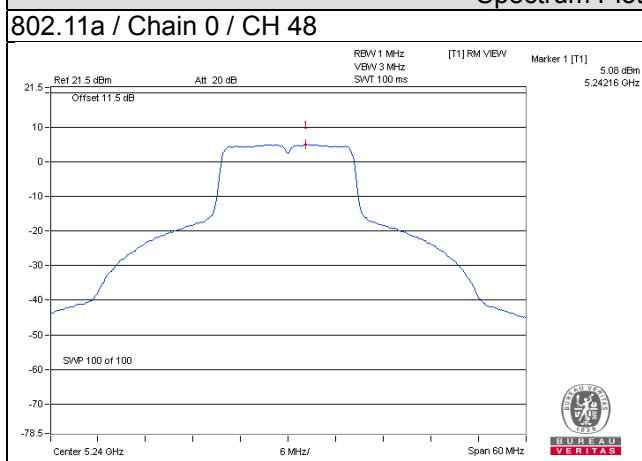

For U-NII-3 Band

802.11a

TX chain	Chan.	Freq. (MHz)	PSD (dBm/300 kHz)	PSD (dBm/500 kHz)	10 log (N=2) dB	Duty factor	Total PSD (dBm/500 kHz)	Limit (dBm/500 kHz)	Pass / Fail
0	149	5745	-3.23	-1.01	3.01	0.22	2.22	27.48	Pass
	157	5785	-3.47	-1.25	3.01	0.22	1.98	27.48	Pass
	165	5825	-3.95	-1.73	3.01	0.22	1.50	27.48	Pass
1	149	5745	-3.45	-1.23	3.01	0.22	2.00	27.48	Pass
	157	5785	-3.84	-1.62	3.01	0.22	1.61	27.48	Pass
	165	5825	-4.10	-1.88	3.01	0.22	1.35	27.48	Pass

Note:

1. Directional gain = $10 \log[(10^{G1/20} + 10^{G2/20} + \dots + 10^{GN/20})^2/2] = 8.52 \text{ dBi} > 6\text{dBi}$, so the power density limit shall be reduced to $30-(8.52-6) = 27.48\text{dBm}$.
2. Refer to section 3.3 for duty cycle spectrum plot.

802.11n (HT20)

TX chain	Chan.	Freq. (MHz)	PSD (dBm/300 kHz)	PSD (dBm/500 kHz)	10 log (N=2) dB	Total PSD (dBm/500 kHz)	Limit (dBm/500 kHz)	Pass / Fail
0	149	5745	-3.45	-1.23	3.01	1.78	27.48	Pass
	157	5785	-3.65	-1.43	3.01	1.58	27.48	Pass
	165	5825	-4.09	-1.87	3.01	1.14	27.48	Pass
1	149	5745	-3.74	-1.52	3.01	1.49	27.48	Pass
	157	5785	-4.01	-1.79	3.01	1.22	27.48	Pass
	165	5825	-4.32	-2.10	3.01	0.91	27.48	Pass

Note:

1. Directional gain = $10 \log[(10^{G1/20} + 10^{G2/20} + \dots + 10^{GN/20})^2/2] = 8.52 \text{ dBi} > 6\text{dBi}$, so the power density limit shall be reduced to $30-(8.52-6) = 27.48\text{dBm}$.

802.11n (HT40)

TX chain	Chan.	Freq. (MHz)	PSD (dBm/300 kHz)	PSD (dBm/500 kHz)	10 log (N=2) dB	Duty factor	Total PSD (dBm/500 kHz)	Limit (dBm/500 kHz)	Pass / Fail
0	151	5755	-5.79	-3.57	3.01	0.16	-0.40	27.48	Pass
	159	5795	-6.14	-3.92	3.01	0.16	-0.75	27.48	Pass
1	151	5755	-6.31	-4.09	3.01	0.16	-0.92	27.48	Pass
	159	5795	-6.53	-4.31	3.01	0.16	-1.14	27.48	Pass

Note:

1. Directional gain = $10 \log[(10^{G1/20} + 10^{G2/20} + \dots + 10^{GN/20})^2/2] = 8.52 \text{ dBi} > 6\text{dBi}$, so the power density limit shall be reduced to $30-(8.52-6) = 27.48\text{dBm}$.
2. Refer to section 3.3 for duty cycle spectrum plot.

802.11ac (VHT80)

TX chain	Chan.	Freq. (MHz)	PSD (dBm/300 kHz)	PSD (dBm/500 kHz)	10 log (N=2) dB	Duty factor	Total PSD (dBm/500 kHz)	Limit (dBm/500 kHz)	Pass / Fail
0	155	5775	-10.92	-8.70	3.01	0.36	-5.33	27.48	Pass
1	155	5775	-11.19	-8.97	3.01	0.36	-5.60	27.48	Pass

Note:

- Directional gain = $10 \log[(10^{G1/20} + 10^{G2/20} + \dots + 10^{GN/20})^2/2] = 8.52 \text{ dBi} > 6\text{dBi}$, so the power density limit shall be reduced to $30 - (8.52 - 6) = 27.48\text{dBm}$.
- Refer to section 3.3 for duty cycle spectrum plot.

Spectrum Plot of Worst Value

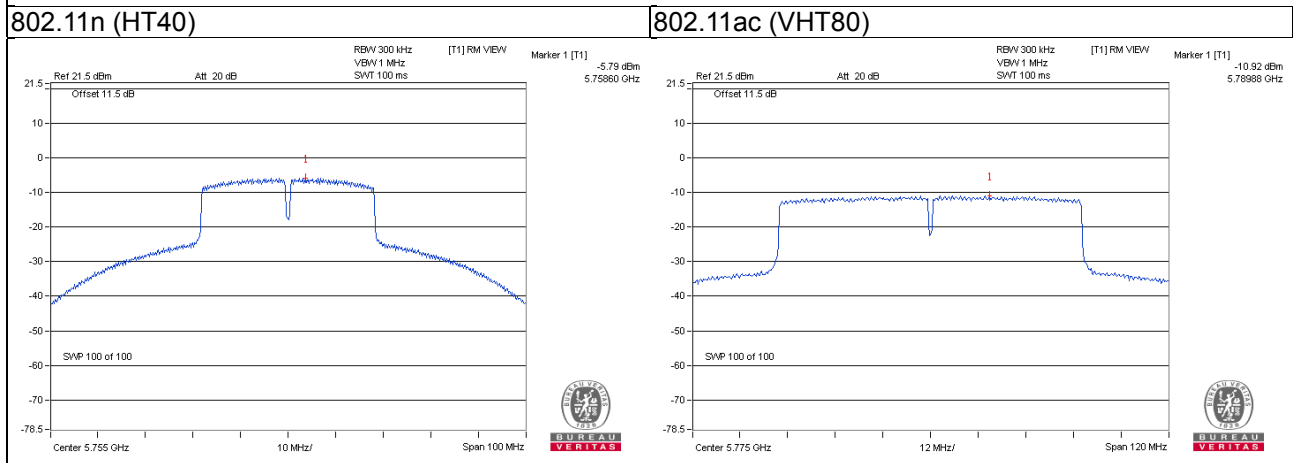
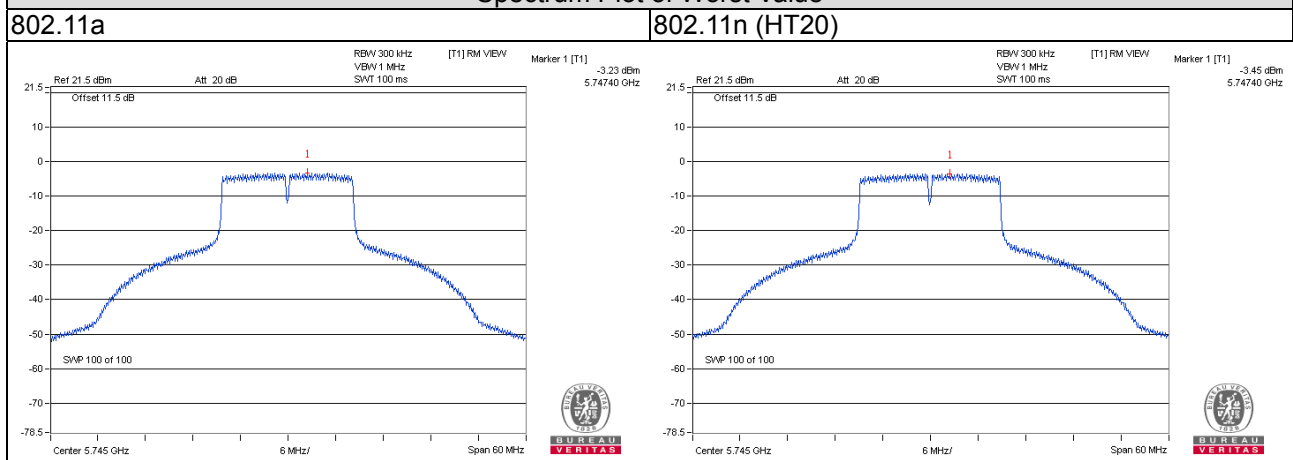

4.6 Frequency Stability

4.6.1 Limits of Frequency Stability Measurement

The frequency of the carrier signal shall be maintained within band of operation

4.6.2 Test Setup

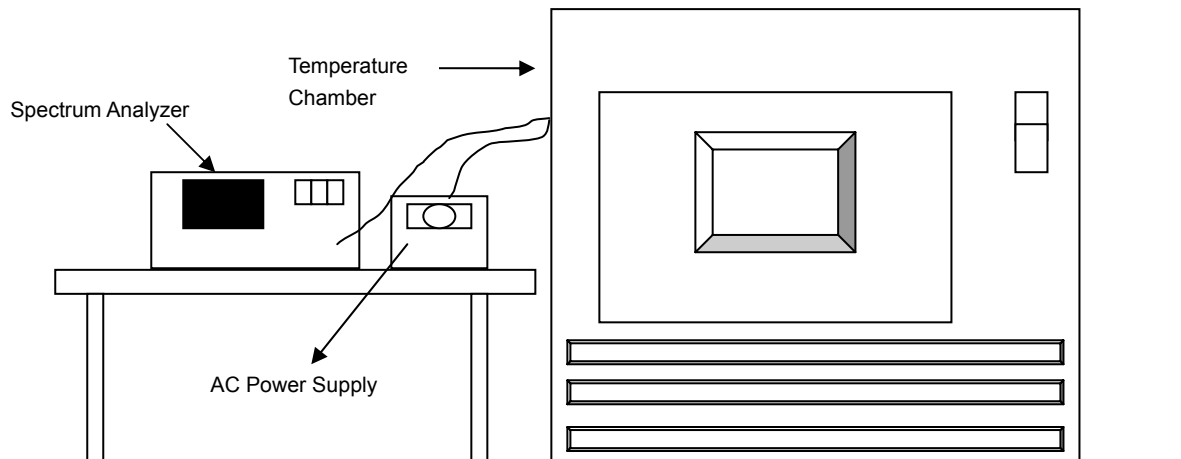

4.6.3 Test Procedure

- The EUT was placed inside the environmental test chamber and powered by nominal AC voltage.
- Turn the EUT on and couple its output to a spectrum analyzer.
- Turn the EUT off and set the chamber to the highest temperature specified.
- Allow sufficient time (approximately 30 min) for the temperature of the chamber to stabilize, turn the EUT on and measure the operating frequency after 2, 5, and 10 minutes.
- Repeat step 2 and 3 with the temperature chamber set to the lowest temperature.
- The test chamber was allowed to stabilize at +20 degree C for a minimum of 30 minutes. The supply voltage was then adjusted on the EUT from 85% to 115% and the frequency record.

4.6.4 Deviation from Test Standard

No deviation.

4.6.5 EUT Operating Condition

Set the EUT transmit at un-modulation mode to test frequency stability.

4.6.6 Test Results

Frequency Stability Versus Temp.									
Operating Frequency: 5180MHz									
Temp. (°C)	Power Supply (Vac)	0 Minute		2 Minute		5 Minute		10 Minute	
		Measured Frequency (MHz)	Result	Measured Frequency (MHz)	Result	Measured Frequency (MHz)	Result	Measured Frequency (MHz)	Result
50	120	5179.9964	-0.00007	5179.9983	-0.00003	5179.9984	-0.00003	5179.9950	-0.00010
40	120	5179.9759	-0.00047	5179.9735	-0.00051	5179.9733	-0.00052	5179.9754	-0.00047
30	120	5180.0085	0.00016	5180.0111	0.00021	5180.0111	0.00021	5180.0091	0.00018
20	120	5179.9753	-0.00048	5179.9760	-0.00046	5179.9723	-0.00053	5179.9749	-0.00048
10	120	5180.0131	0.00025	5180.0136	0.00026	5180.0154	0.00030	5180.0140	0.00027
0	120	5180.0169	0.00033	5180.0187	0.00036	5180.0181	0.00035	5180.0154	0.00030
-10	120	5180.0030	0.00006	5180.0029	0.00006	5180.0029	0.00006	5180.0049	0.00009
-20	120	5180.0168	0.00032	5180.0133	0.00026	5180.0154	0.00030	5180.0159	0.00031
-30	120	5179.9868	-0.00025	5179.9845	-0.00030	5179.9842	-0.00031	5179.9843	-0.00030

Frequency Stability Versus Voltage									
Operating Frequency: 5180MHz									
Temp. (°C)	Power Supply (Vac)	0 Minute		2 Minute		5 Minute		10 Minute	
		Measured Frequency (MHz)	Result	Measured Frequency (MHz)	Result	Measured Frequency (MHz)	Result	Measured Frequency (MHz)	Result
20	138	5179.9759	-0.00047	5179.9757	-0.00047	5179.9723	-0.00053	5179.9739	-0.00050
	120	5179.9753	-0.00048	5179.9760	-0.00046	5179.9723	-0.00053	5179.9749	-0.00048
	102	5179.9753	-0.00048	5179.9760	-0.00046	5179.9719	-0.00054	5179.9746	-0.00049

4.7 6dB Bandwidth Measurement

4.7.1 Limits of 6dB Bandwidth Measurement

The minimum of 6dB Bandwidth Measurement is 0.5MHz.

4.7.2 Test Setup

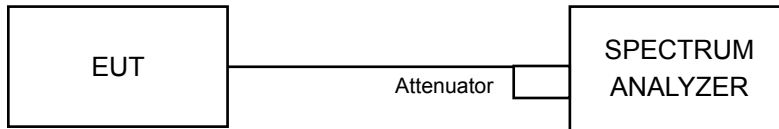

4.7.3 Test Instruments

Refer to section 4.1.2 to get information of above instrument.

4.7.4 Test Procedure

MEASUREMENT PROCEDURE REF

- Set resolution bandwidth (RBW) = 100kHz
- Set the video bandwidth (VBW) $\geq 3 \times$ RBW, Detector = Peak.
- Trace mode = max hold.
- Sweep = auto couple.
- Measure the maximum width of the emission that is constrained by the frequencies associated with the two amplitude points (upper and lower) that are attenuated by 6 dB relative to the maximum level measured in the fundamental emission

4.7.5 Deviation from Test Standard

No deviation.

4.7.6 EUT Operating Condition

The software provided by client to enable the EUT under transmission condition continuously at lowest, middle and highest channel frequencies individually.

4.7.7 Test Results

802.11a

Channel	Frequency (MHz)	6dB Bandwidth (MHz)		Minimum Limit (MHz)	Pass / Fail
		Chain 0	Chain 1		
149	5745	16.37	16.37	0.5	Pass
157	5785	16.38	16.38	0.5	Pass
165	5825	16.38	16.40	0.5	Pass

802.11n (HT20)

Channel	Frequency (MHz)	6dB Bandwidth (MHz)		Minimum Limit (MHz)	Pass / Fail
		Chain 0	Chain 1		
149	5745	17.58	17.62	0.5	Pass
157	5785	17.59	17.66	0.5	Pass
165	5825	17.58	17.57	0.5	Pass

802.11n (HT40)

Channel	Frequency (MHz)	6dB Bandwidth (MHz)		Minimum Limit (MHz)	Pass / Fail
		Chain 0	Chain 1		
151	5755	35.51	35.26	0.5	Pass
159	5795	36.40	35.30	0.5	Pass

802.11ac (VHT80)

Channel	Frequency (MHz)	6dB Bandwidth (MHz)		Minimum Limit (MHz)	Pass / Fail
		Chain 0	Chain 1		
155	5775	75.98	75.70	0.5	Pass

Spectrum Plot of Worst Value

802.11a

802.11n (HT20)

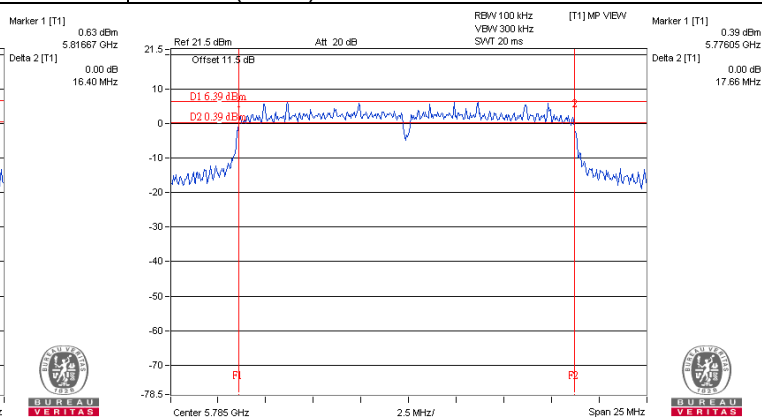
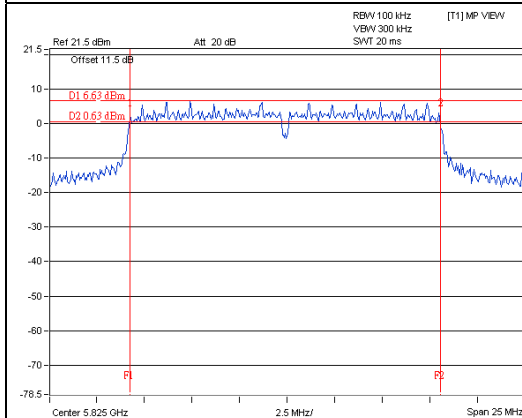

802.11n (HT40)

802.11ac (VHT80)

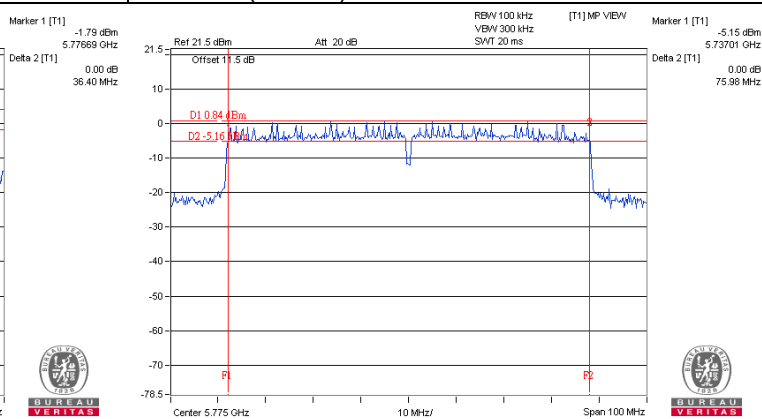
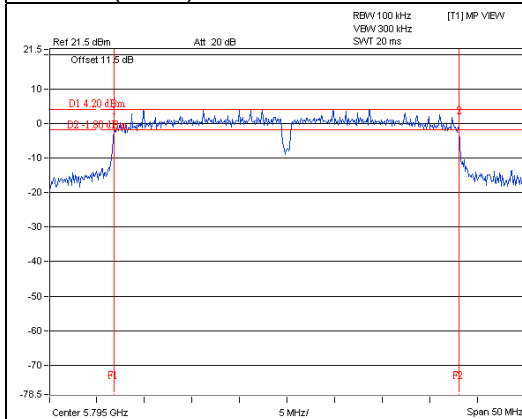

5 Pictures of Test Arrangements

Please refer to the attached file (Test Setup Photo).

Annex A- Radiated Out of Band Emission (OOBE) Measurement (For U-NII-3 band)

802.11a

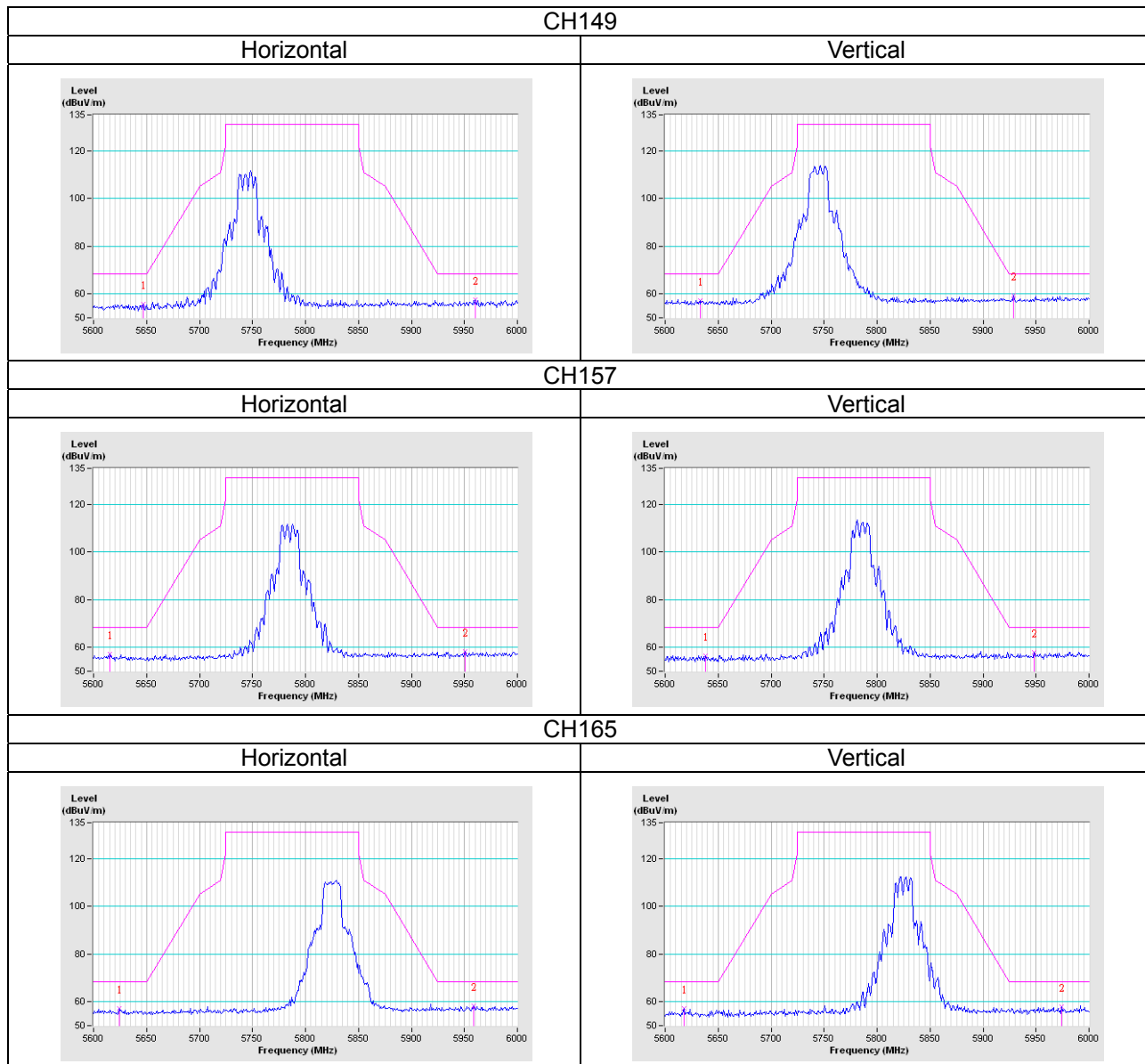

802.11n (HT20)

CH149

Horizontal

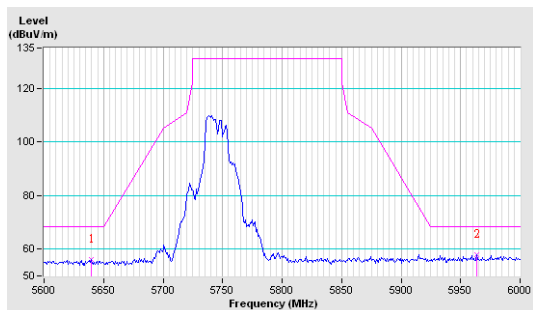

Vertical

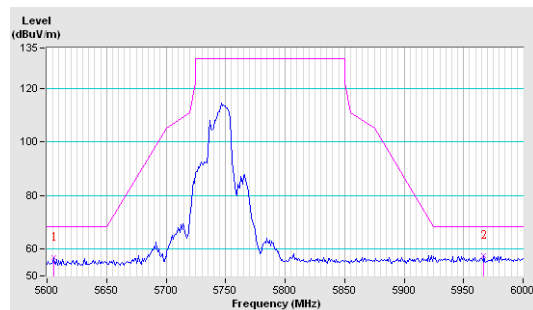

CH157

Horizontal

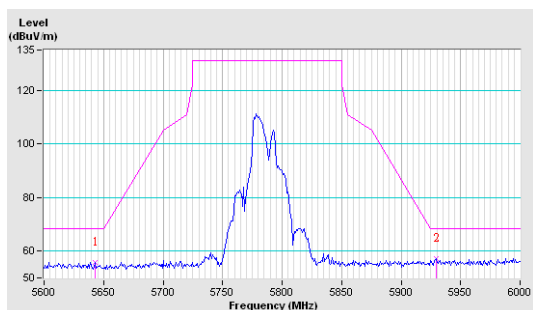

Vertical

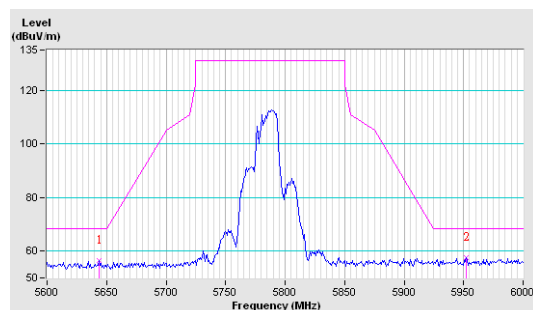

CH165

Horizontal

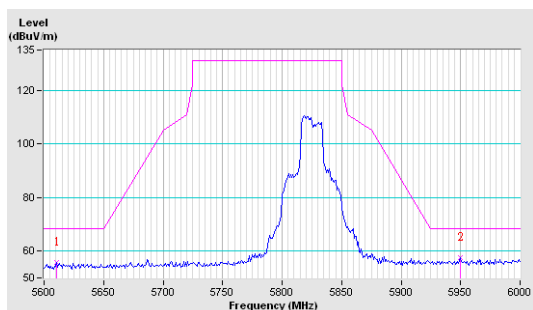

Vertical

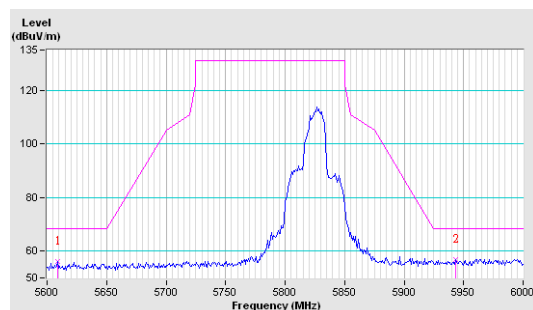

802.11n (HT40)

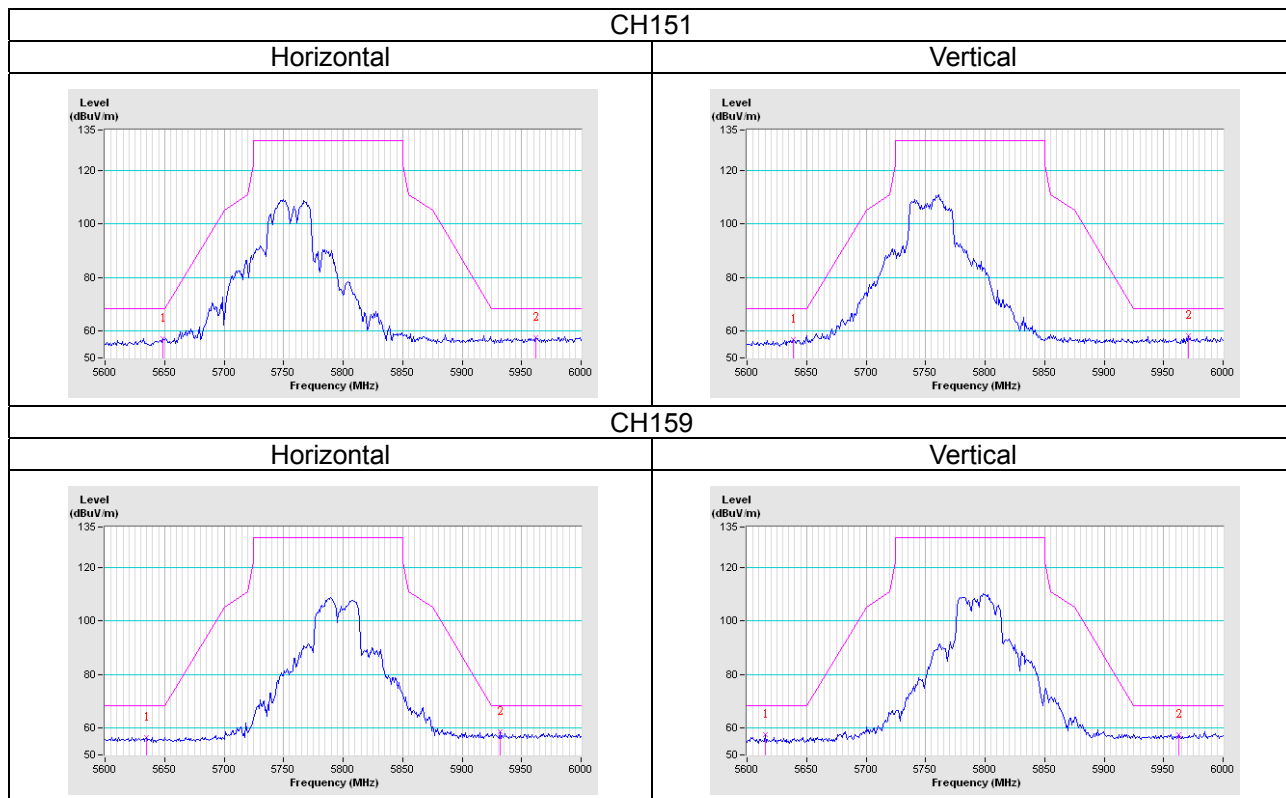

802.11ac (VHT80)

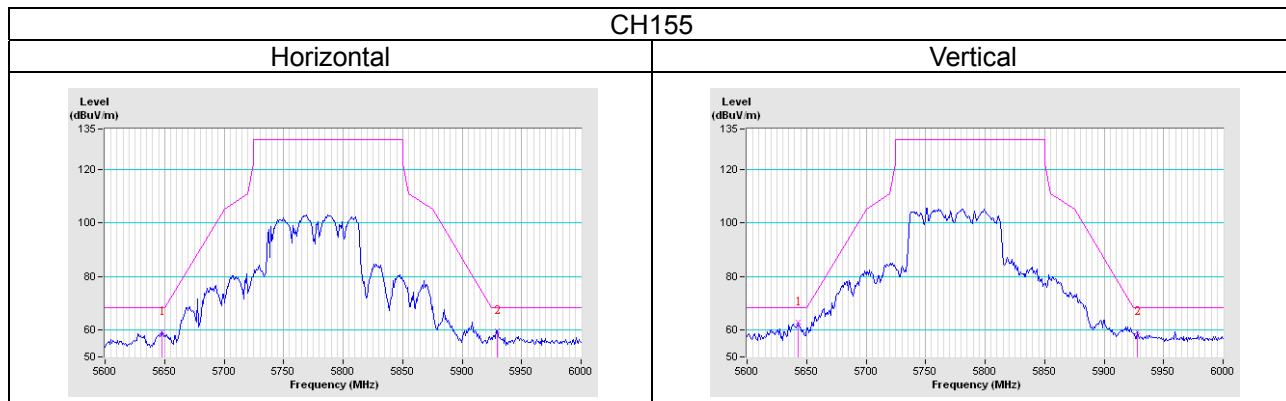

Appendix – Information on the Testing Laboratories

We, Bureau Veritas Consumer Products Services (H.K.) Ltd., Taoyuan Branch, were founded in 1988 to provide our best service in EMC, Radio, Telecom and Safety consultation. Our laboratories are accredited and approved according to ISO/IEC 17025.

If you have any comments, please feel free to contact us at the following:

Linko EMC/RF Lab

Tel: 886-2-26052180

Fax: 886-2-26051924

Hsin Chu EMC/RF/Telecom Lab

Tel: 886-3-6668565

Fax: 886-3-6668323

Hwa Ya EMC/RF/Safety Lab

Tel: 886-3-3183232

Fax: 886-3-3270892

Email: service.adt@tw.bureauveritas.com

Web Site: www.bureauveritas-adt.com

The address and road map of all our labs can be found in our web site also.

--- END ---