



RADIO TEST REPORT

FCC ID : UDX-60052010
Equipment : Wireless 802.11 abgn/ac indoor AP
Brand Name : CISCO
Model Name : MR33-HW
Applicant : Cisco Systems, Inc.
170 West Tasman Drive, San Jose, CA 95134, USA
Manufacturer : Cisco Systems, Inc.
170 West Tasman Drive, San Jose, CA 95134, USA
Standard : 47 CFR FCC Part 15 Subpart C § 15.249

The product was received on Aug. 24, 2021, and testing was started from Sep. 20, 2021 and completed on Oct. 04, 2021. We, Sporton International Inc. Hsinchu Laboratory, would like to declare that the tested sample has been evaluated in accordance with the procedures given in ANSI C63.10-2013, 47 CFR FCC Part 15 Subpart C and shown compliance with the applicable technical standards.

The test results in this report apply exclusively to the tested model / sample. Without written approval of Sporton International Inc. Hsinchu Laboratory, the test report shall not be reproduced except in full.

Approved by: Sam Chen

Sporton International Inc. Hsinchu Laboratory

No.8, Ln. 724, Bo'ai St., Zhubei City, Hsinchu County 302010, Taiwan (R.O.C.)



Table of Contents

History of this test report.....	3
Summary of Test Result.....	4
1. General Information	5
1.1. Product Details	5
1.2. Antenna Information	5
1.3. Accessories	5
1.4. Table for Carrier Frequencies	6
1.5. Table for Test Modes	7
1.6. Table for Parameters of Test Software Setting	7
1.7. Applicable Standards	8
1.8. Table for Testing Locations	8
1.9. Measurement Uncertainty	8
1.10. Table for Supporting Units	9
1.11. Duty Cycle	9
1.12. Test Setup Diagram	10
2. Test Result	12
2.1. AC Power Line Conducted Emissions Measurement	12
2.2. Field Strength of Fundamental Emissions Measurement	15
2.3. 20dB Spectrum Bandwidth Measurement.....	17
2.4. Radiated Emissions Measurement	18
2.5. Band Edge Emissions Measurement	23
2.6. Antenna Requirements	25
3. List of Measuring Equipments	26
Appendix A. Test Results of AC Power-line Conducted Emissions	
Appendix B. Test Results of Field Strength of Fundamental Emissions / Radiated Emissions	
/ Band Edge Emissions	
Appendix C. Test Results of 20dB Spectrum Bandwidth	
Appendix D. Test Photos	
Photographs of EUT v01	



Summary of Test Result

Report Clause	Ref Std. Clause	Test Items	Result (PASS/FAIL)	Remark
2.1	15.207	AC Power Line Conducted Emissions	PASS	-
2.2	15.249(a)	Field Strength of Fundamental Emissions	PASS	-
2.3	15.215(c)	20dB Spectrum Bandwidth	PASS	-
2.4	15.249(a)/(d)	Radiated Emissions	PASS	-
2.5	15.249(d)	Band Edge Emissions	PASS	-
2.6	15.203	Antenna Requirements	PASS	-

Declaration of Conformity:

1. The test results with all measurement uncertainty excluded are presented in accordance with the regulation limits or requirements declared by manufacturers. It's means measurement values may risk exceeding the limit of regulation standards, if measurement uncertainty is include in test results.
2. The measurement uncertainty please refer to report "Measurement Uncertainty".

Comments and Explanations:

The declared of product specification for EUT presented in the report are provided by the manufacturer, and the manufacturer takes all the responsibilities for the accuracy of product specification.

Reviewed by: Sam Chen

Report Producer: Sandy Chuang



1. General Information

1.1. Product Details

Items	Description
Power Type	From power adapter or PoE
Modulation	O-QPSK
Frequency Range	2400 ~ 2483.5MHz
Operation Frequency Range	2404.053 ~ 2479.285 MHz
Channel Number	11
Channel Bandwidth (99%)	2.16 MHz
Max. Field Strength	90.48 dBuV/m at 3m (Average)
Carrier Frequencies	Please refer to section 1.4

Note: The above information was declared by manufacturer.

1.2. Antenna Information

Ant.	Port	Brand	Model Name	Antenna Type	Connector	Gain (dBi)
1	1	-	-	Printed	I-PEX	5.67

Note: The above information was declared by manufacturer.

1.3. Accessories

N/A



1.4. Table for Carrier Frequencies

Frequency Band	Channel No.	Frequency
2400 ~ 2483.5MHz	0	2404.053 MHz
	1	2410.002 MHz
	2	2421.899 MHz
	3	2424.698 MHz
	4	2441.844 MHz
	5	2449.192 MHz
	6	2461.789 MHz
	7	2469.487 MHz
	8	2474.386 MHz
	9	2476.835 MHz
	10	2479.285 MHz



1.5. Table for Test Modes

The following table is a list of the test modes shown in this test report.

Test Items	Mode	Channel
AC Power Line Conducted Emissions Test Voltage: 120Vac / 60Hz	CTX	-
Field Strength of Fundamental Emissions 20dB Spectrum Bandwidth	CTX	0/4/10
Radiated Emissions 30MHz ~ 1GHz	CTX	-
Radiated Emissions 1GHz~10 th Harmonic	CTX	0/4/10
Band Edge Emissions	CTX	0/4/10

Note 1: CTX=continuously transmitting

Note 2: The Adapter and PoE below are for measurement only, would not be marketed.

The Adapter and PoE information as below:

Support Unit	Brand	Model Name
PoE	CISCO	MA-INJ4
Adapter	DELTA	ADP-30KR B

For Conducted Emission test:

Mode 1. EUT + Adapter

Mode 2. EUT + PoE

Mode 2 generated the worst test result, so it was recorded in this report.

For Radiated Emission below 1GHz test:

The EUT can be placed in X axis, Y axis and Z axis. EUT X in axis has been evaluated to be the worst case at Radiated Emission <Above 1GHz>; thus, the measurement will follow this same test configuration.

Mode 1. EUT in X axis + Adapter

Mode 2. EUT in X axis + PoE

Mode 1 generated the worst test result, so it was recorded in this report.

For Radiated Emission above 1GHz test:

The EUT was performed at X axis, Y axis and Z axis position, and the worst case as below:

Mode 1. EUT in X axis

1.6. Table for Parameters of Test Software Setting

Frequency	2404.053 MHz	2441.844 MHz	2479.285 MHz
Software Setting	Default	Default	Default



1.7. Applicable Standards

According to the specifications of the manufacturer, the EUT must comply with the requirements of the following standards:

- ◆ ANSI C63.10-2013
- ◆ 47 CFR FCC Part 15 Subpart C

The following reference test guidance is not within the scope of accreditation of TAF.

- ◆ FCC KDB 414788 D01 v01r01

1.8. Table for Testing Locations

Testing Location Information	
Test Lab. : Sporton International Inc. Hsinchu Laboratory	
Hsinchu	ADD: No.8, Ln. 724, Bo'ai St., Zhubei City, Hsinchu County 302010, Taiwan (R.O.C.)
(TAF: 3787)	TEL: 886-3-656-9065 FAX: 886-3-656-9085
Test site Designation No. TW3787 with FCC.	
Conformity Assessment Body Identifier (CABID) TW3787 with ISED.	

Test Condition	Test Site No.	Test Engineer	Test Environment (°C / %)	Test Date
RF Conducted	TH02-CB	Lucas Haung	23.8~24.4 / 54~57	Sep. 20, 2021
Radiated (Below 1GHz)	03CH05-CB	Simmon Zheng	23.5-24.6 / 55-59	Sep. 20, 2021~ Oct. 04, 2021
Radiated (Above 1GHz)	03CH02-CB	Simmon Zheng	24.6-25.7 / 55-58	Sep. 20, 2021~ Oct. 04, 2021
AC Conduction	CO02-CB	Peter Wu	24~25 / 58~59	Oct. 01, 2021

1.9. Measurement Uncertainty

Test Items	Uncertainty	Remark
Conducted Emission (150kHz ~ 30MHz)	2.0 dB	Confidence levels of 95%
Radiated Emission (9kHz ~ 30MHz)	4.2 dB	Confidence levels of 95%
Radiated Emission (30MHz ~ 1,000MHz)	5.5 dB	Confidence levels of 95%
Radiated Emission (1GHz ~ 18GHz)	4.7 dB	Confidence levels of 95%
Radiated Emission (18GHz ~ 40GHz)	4.2 dB	Confidence levels of 95%
Conducted Emission	2.5 dB	Confidence levels of 95%



1.10. Table for Supporting Units

For AC Power Line Conducted Emissions test:

No.	Support Unit	Brand	Model	FCC ID
A	PoE	CISCO	MA-INJ4	N/A

For Radiated Emissions test and other tests:

No.	Support Unit	Brand	Model	FCC ID
A	Adapter	DELTA	ADP-30KR B	N/A

1.11. Duty Cycle

Duty cycle (%)	Correction Duty Factor (dB)
0.3	-10.46

1.12. Test Setup Diagram

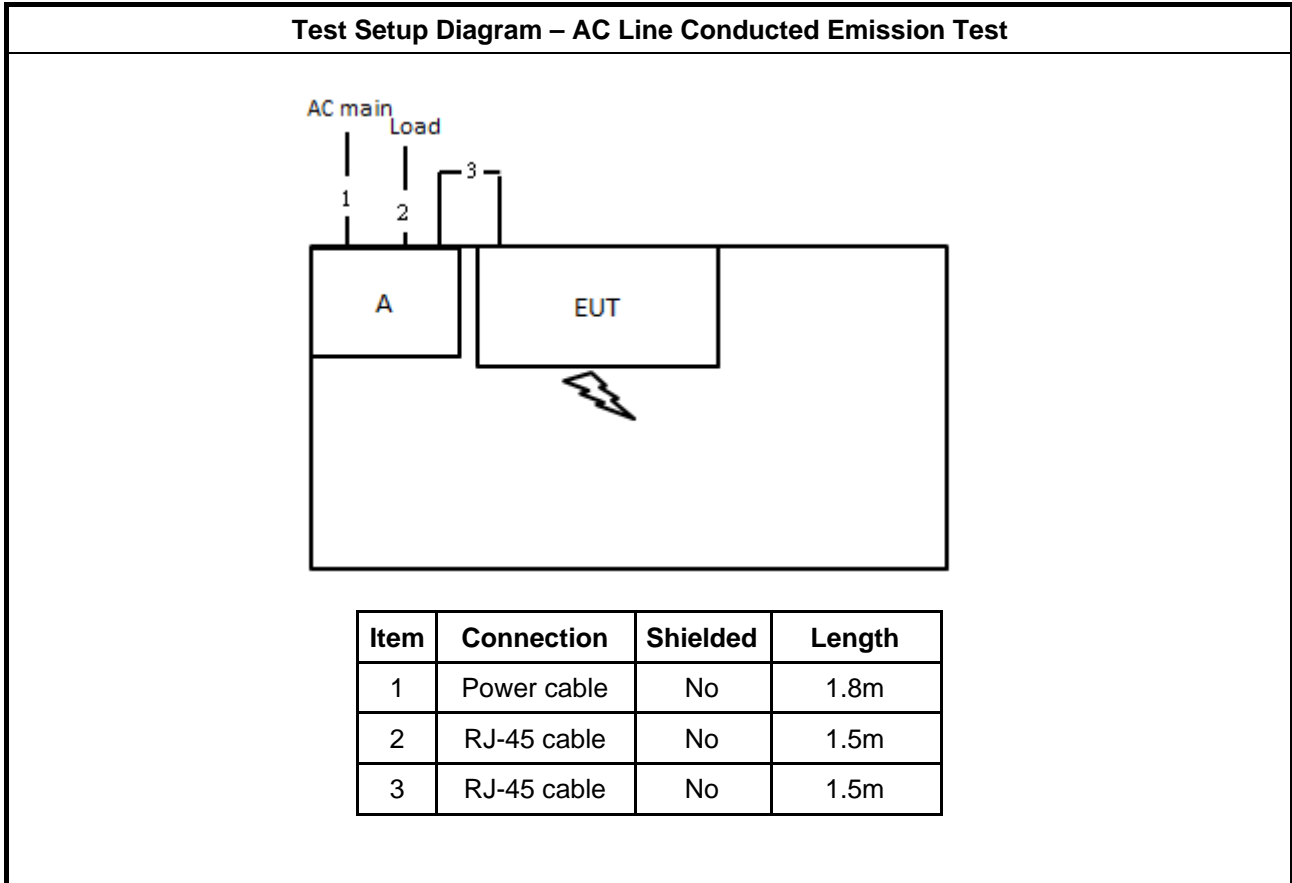



Test Setup Diagram - Radiated Test

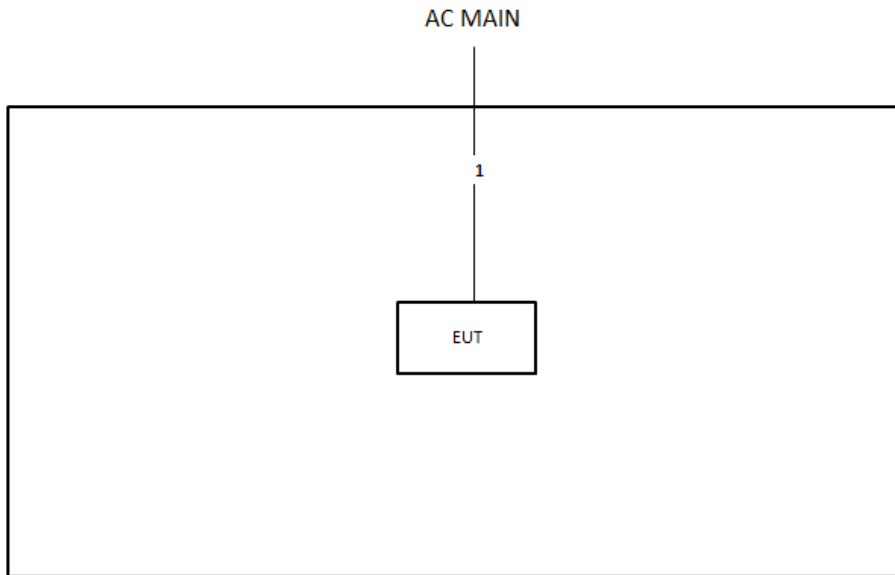

Item	Connection	Shielded	Length
1	Power cable	No	3.7m



2. Test Result

2.1. AC Power Line Conducted Emissions Measurement

2.1.1. Limit

For this product which is designed to be connected to the AC power line, the radio frequency voltage that is conducted back onto the AC power line on any frequency or frequencies within the band 150 kHz to 30 MHz shall not exceed below limits table.

Frequency (MHz)	QP Limit (dBuV)	AV Limit (dBuV)
0.15~0.5	66~56	56~46
0.5~5	56	46
5~30	60	50

2.1.2. Measuring Instruments and Setting

Refer a test equipment and calibration data table in this test report. The following table is the setting of the receiver.

Receiver Parameters	Setting
Attenuation	10 dB
Start Frequency	0.15 MHz
Stop Frequency	30 MHz
IF Bandwidth	9 kHz

2.1.3. Test Procedures

1. Configure the EUT according to ANSI C63.10. The EUT or host of EUT has to be placed 0.4 meter far from the conducting wall of the shielding room and at least 80 centimeters from any other grounded conducting surface.
2. Connect EUT or host of EUT to the power mains through a line impedance stabilization network (LISN).
3. All the support units are connected to the other LISNs. The LISN should provide 50uH/50ohms coupling impedance.
4. The frequency range from 150 kHz to 30 MHz was searched.
5. Set the test-receiver system to Peak Detect Function and Specified Bandwidth with Maximum Hold Mode.
6. The measurement has to be done between each power line and ground at the power terminal.

2.1.4. Test Setup Layout

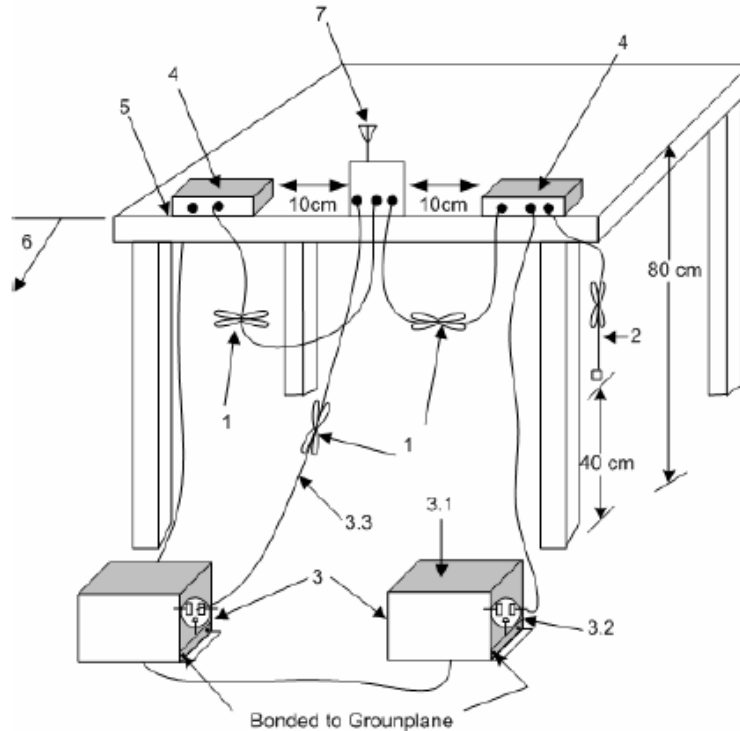

- 1—Interconnecting cables that hang closer than 40 cm to the ground plane shall be folded back and forth in the center forming a bundle 30 cm to 40 cm long.
- 2—The I/O cables that are not connected to an accessory shall be bundled in the center. The end of the cable may be terminated, if required, using the correct terminating impedance. The overall length shall not exceed 1 m.
- 3—EUT connected to one LISN. Unused LISN measuring port connectors shall be terminated in 50 Ω loads. LISN may be placed on top of, or immediately beneath, reference ground plane.
 - 3.1—All other equipment powered from additional LISN(s).
 - 3.2—A multiple-outlet strip may be used for multiple power cords of non-EUT equipment.
 - 3.3—LISN at least 80 cm from nearest part of EUT chassis.
- 4—Non-EUT components of EUT system being tested.
- 5—Rear of EUT, including peripherals, shall all be aligned and flush with edge of tabletop.
- 6—Edge of tabletop shall be 40 cm removed from a vertical conducting plane that is bonded to the ground plane.
- 7—Antenna can be integral or detachable. If detachable, then the antenna shall be attached for this test.



2.1.5. Test Deviation

There is no deviation with the original standard.

2.1.6. EUT Operation during Test

The EUT was placed on the test table and programmed in normal function.

2.1.7. Measurement Results Calculation

The measured Level is calculated using:

- a. Corrected Reading: LISN Factor (LISN) + Attenuator (AT/AUX) + Cable Loss (CL) + Read Level (Raw)
= Level
- b. Margin = -Limit + Level

2.1.8. Results of AC Power Line Conducted Emissions Measurement

Refer as Appendix A



2.2. Field Strength of Fundamental Emissions Measurement

2.2.1. Limit

The field strength of fundamental emissions within these bands specified at a distance of 3 meters (measurement instrumentation employing an average detector) shall comply with the following table.

Frequency Band (MHz)	Fundamental Emissions Limit (dBuV/m) at 3m
2400-2483.5	94 (Average)
	114 (Peak)

2.2.2. Measuring Instruments and Setting

Refer a test equipment and calibration data table in this test report. The following table is the setting of the spectrum analyzer.

Power Meter Parameter	Setting
RBW	1 MHz Peak / 3MHz Peak
VBW	1 MHz Peak / 1/T Average
Detector	Peak
Trace	Max Hold
Sweep Time	Auto

2.2.3. Test Procedures

1. Configure the EUT according to ANSI C63.10. The EUT was placed on the top of the turntable 1.8 meter above ground. The phase center of the receiving antenna mounted on the top of a height-variable antenna tower was placed 3 meters far away from the turntable.
2. Power on the EUT and all the supporting units. The turntable was rotated by 360 degrees to determine the position of the highest radiation.
3. The height of the broadband receiving antenna was varied between one meter and four meters above ground to find the maximum emissions field strength of both horizontal and vertical polarization.
4. For each suspected emissions, the antenna tower was scan (from 1 M to 4 M) and then the turntable was rotated (from 0 degree to 360 degrees) to find the maximum reading.
5. For Fundamental emissions, use 1MHz VBW and 3MHz RBW for peak reading. Then 1MHz RBW and 1/T VBW for average reading in spectrum analyzer.
6. When the radiated emissions limits are expressed in terms of the average value of the emissions, and pulsed operation is employed, the measurement field strength shall be determined by averaging over one complete pulse train, including blanking intervals, as long as the pulse train does not exceed 0.1 seconds. As an alternative (provided the transmitter operates for longer than 0.1 seconds) or in cases where the pulse train exceeds 0.1 seconds, the measured field strength shall be determined

from the average absolute voltage during a 0.1 second interval during which the field strength is at its maximum value.

2.2.4. Test Setup Layout

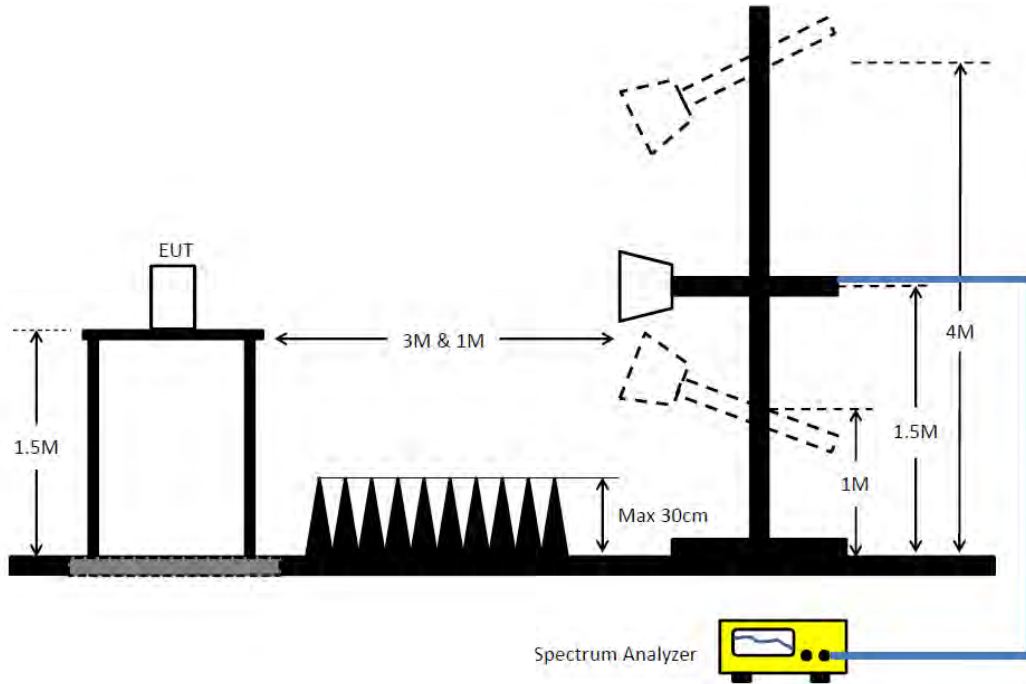

2.2.5. Test Deviation

There is no deviation with the original standard.

2.2.6. EUT Operation during Test

The EUT was programmed to be in continuously transmitting mode.

2.2.7. Measurement Results Calculation

The measured Level is calculated using:

Corrected Reading: Antenna factor (AF) + Cable loss (CL) + Read level (Raw) - Preamp factor (PA)(if applicable) = Level.

2.2.8. Test Result of Field Strength of Fundamental Emissions

Refer as Appendix B

2.3. 20dB Spectrum Bandwidth Measurement

2.3.1. Limit

Intentional radiators must be designed to ensure that the 20 dB bandwidth of the emissions in the specific band (2400 ~ 2483.5MHz).

2.3.2. Measuring Instruments and Setting

Refer a test equipment and calibration data table in this test report. The following table is the setting of the spectrum analyzer.

Spectrum Parameters	Setting
Attenuation	Auto
Span Frequency	> 20dB Bandwidth
RBW	100 kHz
VBW	100 kHz
Detector	Peak
Trace	Max Hold
Sweep Time	Auto

2.3.3. Test Procedures

1. The transmitter output (antenna port) was connected to the spectrum analyzer in peak hold mode.
2. The resolution bandwidth of 100 kHz and the video bandwidth of 100 kHz were used.
3. Measured the spectrum width with power higher than 20dB below carrier.

2.3.4. Test Setup Layout

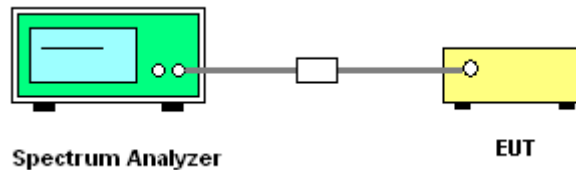

2.3.5. Test Deviation

There is no deviation with the original standard.

2.3.6. EUT Operation during Test

The EUT was programmed to be in continuously transmitting mode.

2.3.7. Test Result of 20dB Spectrum Bandwidth

Refer as Appendix C



2.4. Radiated Emissions Measurement

2.4.1. Limit

Harmonic emissions limits comply with below 54 dBuV/m at 3m. Other emissions radiated outside of the specified frequency bands, except for harmonics, shall be attenuated by at least 50 dB below the level of the fundamental or comply with the radiated emissions limits specified in section 15.209(a) limit in the table below has to be followed.

Frequencies (MHz)	Field Strength (micorvolts/meter)	Measurement Distance (meters)
0.009~0.490	2400/F(kHz)	300
0.490~1.705	24000/F(kHz)	30
1.705~30.0	30	30
30~88	100	3
88~216	150	3
216~960	200	3
Above 960	500	3

2.4.2. Measuring Instruments and Setting

Refer a test equipment and calibration data table in this test report. The following table is the setting of the spectrum analyzer and receiver.

Spectrum Parameter	Setting
Attenuation	Auto
Start Frequency	1000 MHz
Stop Frequency	10th carrier harmonic
RBW / VBW (Emission in restricted band)	1MHz / 3MHz for Peak, 1 MHz / 1/T for Average
RBW / VBW (Emission in non-restricted band)	100kHz/300kHz for Peak

Receiver Parameter	Setting
Attenuation	Auto
Start ~ Stop Frequency	9kHz~150kHz / RBW 200Hz for QP
Start ~ Stop Frequency	150kHz~30MHz / RBW 9kHz for QP
Start ~ Stop Frequency	30MHz~1000MHz / RBW 120kHz for QP



2.4.3. Test Procedures

1. Configure the EUT according to ANSI C63.10. The EUT was placed on the top of the turntable 1.5 meter above ground. The phase center of the receiving antenna mounted on the top of a height-variable antenna tower was placed 3 meters far away from the turntable.
2. Power on the EUT and all the supporting units. The turntable was rotated by 360 degrees to determine the position of the highest radiation.
3. The height of the broadband receiving antenna was varied between one meter and four meters above ground to find the maximum emissions field strength of both horizontal and vertical polarization.
4. For each suspected emissions, the antenna tower was scan (from 1 M to 4 M) and then the turntable was rotated (from 0 degree to 360 degrees) to find the maximum reading.
5. Set the test-receiver system to Peak or CISPR quasi-peak Detect Function with specified bandwidth under Maximum Hold Mode.
6. For emissions above 1GHz, use 1MHz VBW and 3MHz RBW for peak reading. Then 1MHz RBW and 1/T VBW for average reading in spectrum analyzer.
7. When the radiated emissions limits are expressed in terms of the average value of the emissions, and pulsed operation is employed, the measurement field strength shall be determined by averaging over one complete pulse train, including blanking intervals, as long as the pulse train does not exceed 0.1 seconds. As an alternative (provided the transmitter operates for longer than 0.1 seconds) or in cases where the pulse train exceeds 0.1 seconds, the measured field strength shall be determined from the average absolute voltage during a 0.1 second interval during which the field strength is at its maximum value.
8. If the emissions level of the EUT in peak mode was 3 dB lower than the average limit specified, then testing will be stopped and peak values of EUT will be reported, otherwise, the emissions which do not have 3 dB margin will be repeated one by one using the quasi-peak method for below 1GHz.
9. For testing above 1GHz, the emissions level of the EUT in peak mode was lower than average limit (that means the emissions level in peak mode also complies with the limit in average mode), then testing will be stopped and peak values of EUT will be reported, otherwise, the emissions will be measured in average mode again and reported.
10. In case the emission is lower than 30MHz, loop antenna has to be used for measurement and the recorded data should be QP measured by receiver. High – Low scan is not required in this case.

2.4.4. Test Setup Layout

For Radiated Emissions: 9kHz ~30MHz

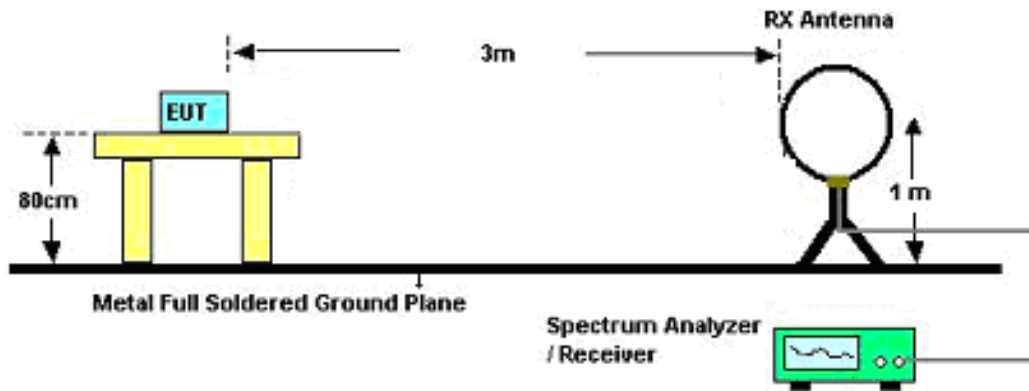

For Radiated Emissions: 30MHz~1GHz

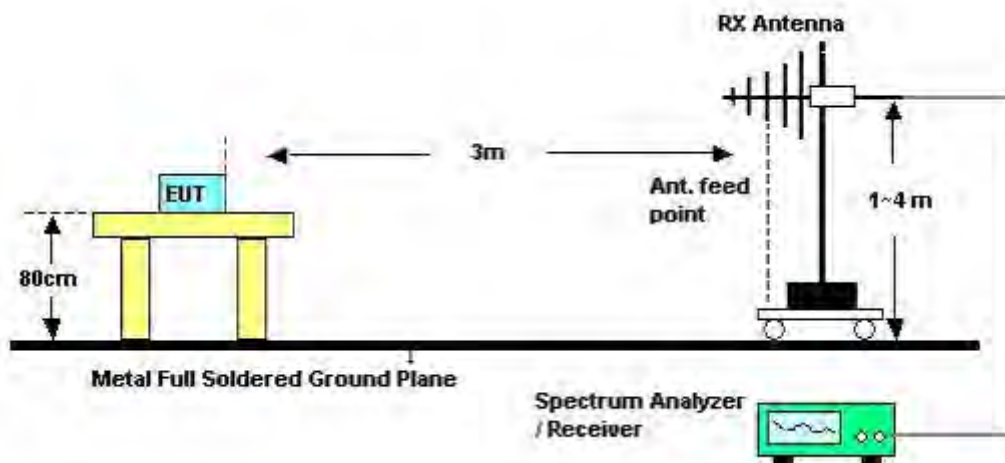

For Radiated Emissions: Above 1GHz

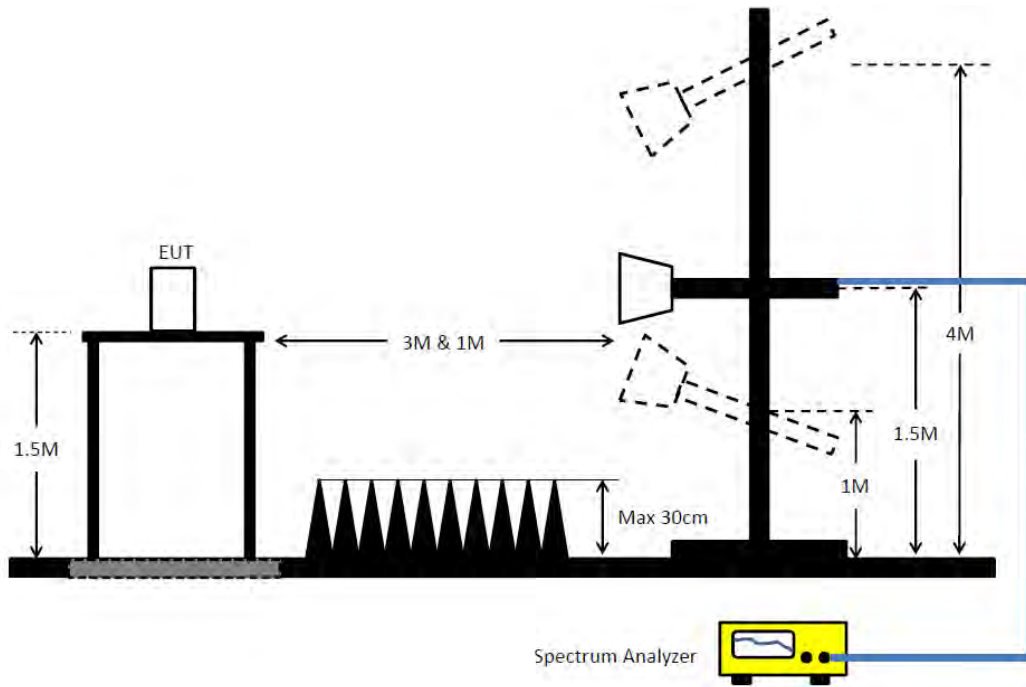

2.4.5. Test Deviation

There is no deviation with the original standard.

2.4.6. EUT Operation during Test

The EUT was programmed to be in continuously transmitting mode.

2.4.7. Measurement Results Calculation

The measured Level is calculated using:

Corrected Reading: Antenna factor (AF) + Cable loss (CL) + Read level (Raw) - Preamp factor (PA)(if applicable) = Level.



2.4.8. Radiated Emissions (9kHz~30MHz)

There is a comparison data of both open-field test site and alternative test site - semi-Anechoic chamber according to KDB414788 Radiated Test Site, and the result came out very similar.

The amplitude of spurious emissions which are attenuated by more than 20dB below the permissible value has no need to be reported.

The radiated emissions were investigated from 9 kHz or the lowest frequency generated within the device, up to the 10 harmonic or 40 GHz, whichever is appropriate.

Distance extrapolation factor = $40 \log(\text{specific distance} / \text{test distance})$ (dB);

Limit line = specific limits (dBuV) + distance extrapolation factor.

2.4.9. Results of Radiated Emissions

Refer as Appendix B



2.5. Band Edge Emissions Measurement

2.5.1. Limit

Band edge emissions radiated outside of the specified frequency bands shall be attenuated by at least 50 dB below the level of the fundamental or comply with the radiated emissions limits specified in section 15.209(a) limit in the table below has to be followed.

Frequencies (MHz)	Field Strength (micorvolts/meter)	Measurement Distance (meters)
0.009~0.490	2400/F(kHz)	300
0.490~1.705	24000/F(kHz)	30
1.705~30.0	30	30
30~88	100	3
88~216	150	3
216~960	200	3
Above 960	500	3

2.5.2. Measuring Instruments and Setting

Refer a test equipment and calibration data table in this test report. The following table is the setting of the spectrum analyzer.

Spectrum Parameter	Setting
Attenuation	Auto
Span Frequency	100 MHz
RBW / VBW (Emission in restricted band)	1MHz / 3MHz for Peak, 1 MHz / 1/T for Average
RBW / VBW (Emission in non-restricted band)	100kHz/300kHz for Peak

2.5.3. Test Procedures

The test procedure is the same as section 2.4.3.

2.5.4. Test Setup Layout

This test setup layout is the same as that shown in section 2.4.4.

2.5.5. Test Deviation

There is no deviation with the original standard.

2.5.6. EUT Operation during Test

The EUT was programmed to be in continuously transmitting mode.



2.5.7. Measurement Results Calculation

The measured Level is calculated using:

Corrected Reading: Antenna factor (AF) + Cable loss (CL) + Read level (Raw) - Preamp factor (PA)(if applicable) = Level.

2.5.8. Test Result of Band Edge and Fundamental Emissions

Refer as Appendix B



2.6. Antenna Requirements

2.6.1. Limit

Except for special regulations, the Low-power Radio-frequency Devices must not be equipped with any jacket for installing an antenna with extension cable. An intentional radiator shall be designed to ensure that no antenna other than that furnished by the responsible party shall be used with the device. The use of a permanently attached antenna or of an antenna that uses a unique coupling to the intentional radiator shall be considered sufficient to comply with the provisions of this Section. The manufacturer may design the unit so that the user can replace a broken antenna, but the use of a standard antenna jack or electrical connector is prohibited.

2.6.2. Antenna Connector Construction

The antenna connector complied with the requirements.

**3. List of Measuring Equipments**

Instrument	Brand	Model No.	Serial No.	Characteristics	Calibration Date	Calibration Due Date	Remark
LISN	Schwarzbeck	NSLK 8127	8127650	9kHz ~ 30MHz	Dec. 04, 2020	Dec. 03, 2021	Conduction (CO02-CB)
LISN	Schwarzbeck	NSLK 8127	8127478	9kHz ~ 30MHz	Nov. 20, 2020	Nov. 19, 2021	Conduction (CO02-CB)
EMI Receiver	Agilent	N9038A	MY52260140	9kHz ~ 8.4GHz	May 05, 2021	May 04, 2022	Conduction (CO02-CB)
Pulse Limiter	Schwarzbeck	VTSD 9561F-N	00378	9kHz ~ 30MHz	Mar. 18, 2021	Mar. 17, 2022	Conduction (CO02-CB)
COND Cable	Woken	Cable	2	0.15MHz ~ 30MHz	Oct. 20, 2020	Oct. 19, 2021	Conduction (CO02-CB)
Software	SPORTON	SENSE	V5.10	-	N.C.R.	N.C.R.	Conduction (CO02-CB)
Loop Antenna	Teseq	HLA 6120	24155	9kHz - 30 MHz	Apr. 14, 2021	Apr. 13, 2022	Radiation (03CH05-CB)
3m Semi Anechoic Chamber NSA	TDK	SAC-3M	03CH05-CB	30 MHz ~ 1 GHz	Aug. 09, 2021	Aug. 08, 2022	Radiation (03CH05-CB)
Bilog Antenna with 6dB Attenuator	TESEQ & EMCI	CBL 6112D & N-6-06	35236 & AT-N0610	30MHz ~ 2GHz	Mar. 26, 2021	Mar. 25, 2022	Radiation (03CH05-CB)
Pre-Amplifier	EMCI	EMC330N	980331	20MHz ~ 3GHz	Apr. 27, 2021	Apr. 26, 2022	Radiation (03CH05-CB)
Spectrum Analyzer	R&S	FSP40	100304	9kHz ~ 40GHz	Nov. 10, 2020	Nov. 09, 2021	Radiation (03CH05-CB)
EMI Test Receiver	R&S	ESCS	826547/017	9kHz ~ 2.75GHz	Jun. 21, 2021	Jun. 20, 2022	Radiation (03CH05-CB)
RF Cable-low	Woken	RG402	Low Cable-04+23	30MHz~1GHz	Oct. 05, 2020	Oct. 04, 2021	Radiation (03CH05-CB)
Test Software	SPORTON	SENSE	V5.10	-	N.C.R.	N.C.R.	Radiation (03CH05-CB)
3m Semi Anechoic Chamber VSWR	RIKEN	SAC-3M	03CH02-CB	1GHz ~18GHz 3m	Mar. 27, 2021	Mar. 26, 2022	Radiation (03CH02-CB)
Horn Antenna	EMCO	3115	9610-4976	1GHz ~ 18GHz	May 04, 2021	May 03, 2022	Radiation (03CH02-CB)
Horn Antenna	Schwarzbeck	BBHA 9170	BBHA9170252	15GHz ~ 40GHz	Aug. 05, 2021	Aug. 04, 2022	Radiation (03CH02-CB)
Pre-Amplifier	Agilent	83017A	MY39501305	1GHz ~ 26.5GHz	Jul. 12, 2021	Jul. 11, 2022	Radiation (03CH02-CB)
Pre-Amplifier	MITEQ	TTA1840-35-HG	1864479	18GHz ~ 40GHz	Jul. 13, 2021	Jul. 12, 2022	Radiation (03CH02-CB)
Spectrum analyzer	R&S	FSU	100015	9kHz~26GHz	Oct. 15, 2020	Oct. 14, 2021	Radiation (03CH02-CB)
RF Cable-high	Woken	RG402	High Cable-18	1GHz ~ 18GHz	Oct. 05, 2020	Oct. 04, 2021	Radiation (03CH02-CB)
RF Cable-high	Woken	RG402	High Cable-18+19	1GHz ~ 18GHz	Oct. 05, 2020	Oct. 04, 2021	Radiation (03CH02-CB)



Instrument	Brand	Model No.	Serial No.	Characteristics	Calibration Date	Calibration Due Date	Remark
Test Software	SPORTON	SENSE	V5.10	-	N.C.R.	N.C.R.	Radiation (03CH02-CB)
Spectrum analyzer	R&S	FSV40	101027	9kHz~40GHz	Aug. 02, 2021	Aug. 01, 2022	Conducted (TH02-CB)
Power Sensor	Anritsu	MA2411B	1531343	300MHz~40GHz	Aug. 15, 2021	Aug. 14, 2022	Conducted (TH02-CB)
Power Meter	Anritsu	ML2495A	1728001	300MHz~40GHz	Aug. 15, 2021	Aug. 14, 2022	Conducted (TH02-CB)
RF Cable-high	Woken	RG402	High Cable-01	1 GHz – 18 GHz	Oct. 05, 2020	Oct. 04, 2021	Conducted (TH02-CB)
RF Cable-high	Woken	RG402	High Cable-02	1 GHz – 18 GHz	Oct. 05, 2020	Oct. 04, 2021	Conducted (TH02-CB)
RF Cable-high	Woken	RG402	High Cable-03	1 GHz – 18 GHz	Oct. 05, 2020	Oct. 04, 2021	Conducted (TH02-CB)
RF Cable-high	Woken	RG402	High Cable-04	1 GHz – 18 GHz	Oct. 05, 2020	Oct. 04, 2021	Conducted (TH02-CB)
RF Cable-high	Woken	RG402	High Cable-05	1 GHz – 18 GHz	Oct. 05, 2020	Oct. 04, 2021	Conducted (TH02-CB)
Test Software	SPORTON	SENSE	V5.10	-	N.C.R.	N.C.R.	Conducted (TH02-CB)

Note: Calibration Interval of instruments listed above is one year.

N.C.R. means Non-Calibration required.



Summary

Mode	Result	Type	Freq (Hz)	Level (dBuV)	Limit (dBuV)	Margin (dB)	Condition
Mode 2	Pass	AV	478.5k	20.31	46.36	-26.05	Line

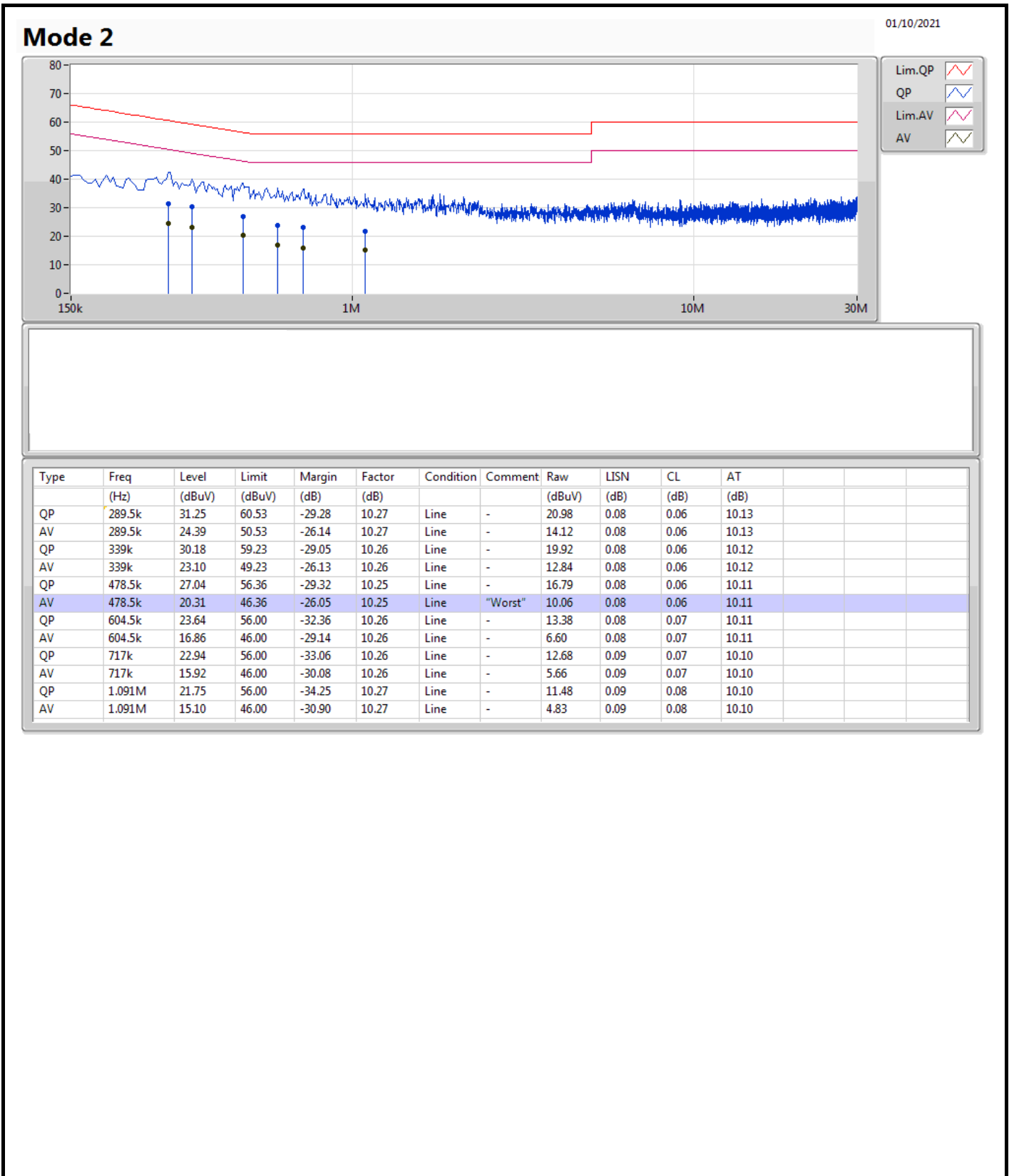

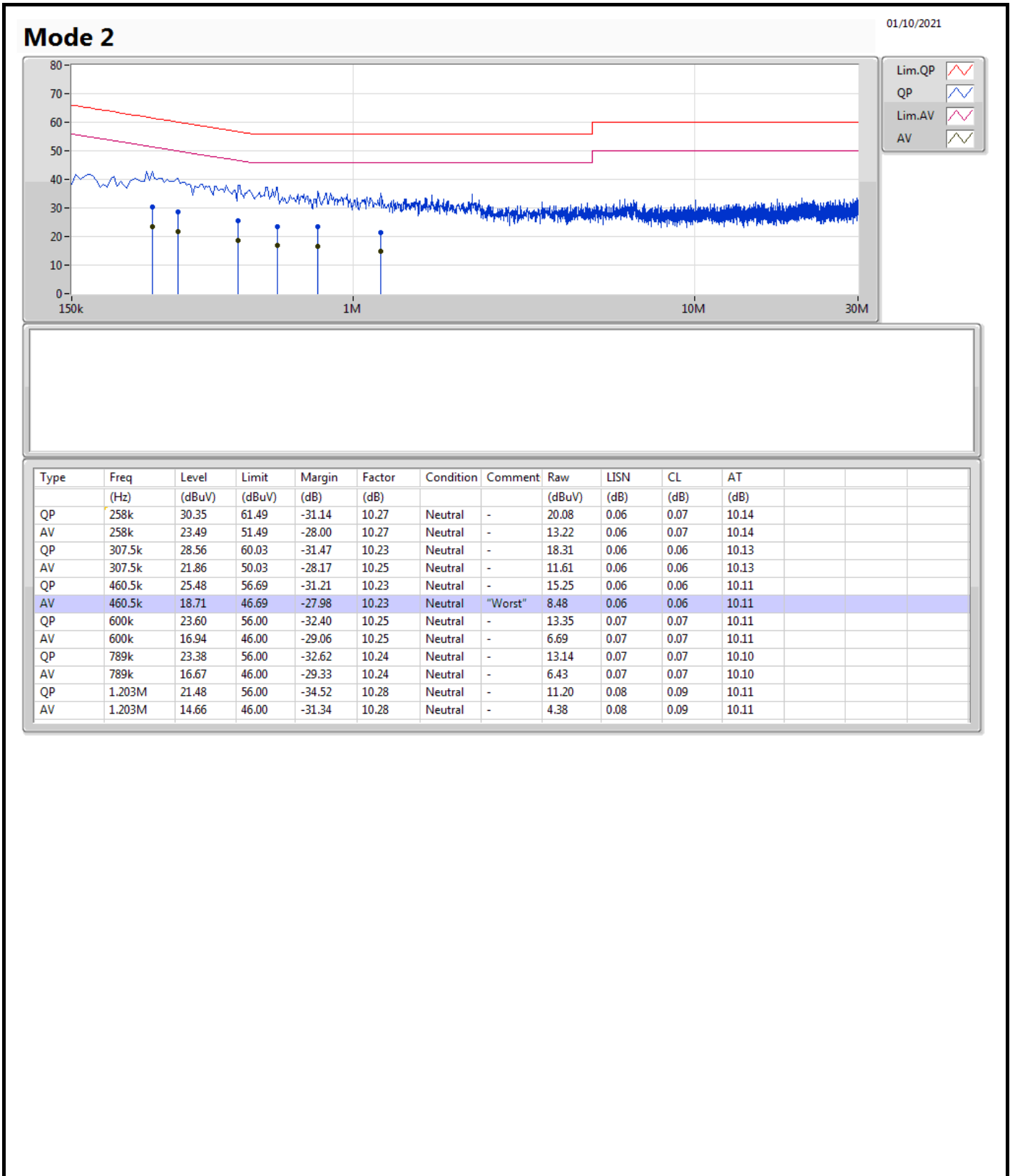



Summary

Mode	Result	Type	Freq (Hz)	Level (dBuV/m)	Limit (dBuV/m)	Margin (dB)	Condition
Mode 1	Pass	QP	875.84M	41.57	46.00	-4.43	Vertical

Mode 1

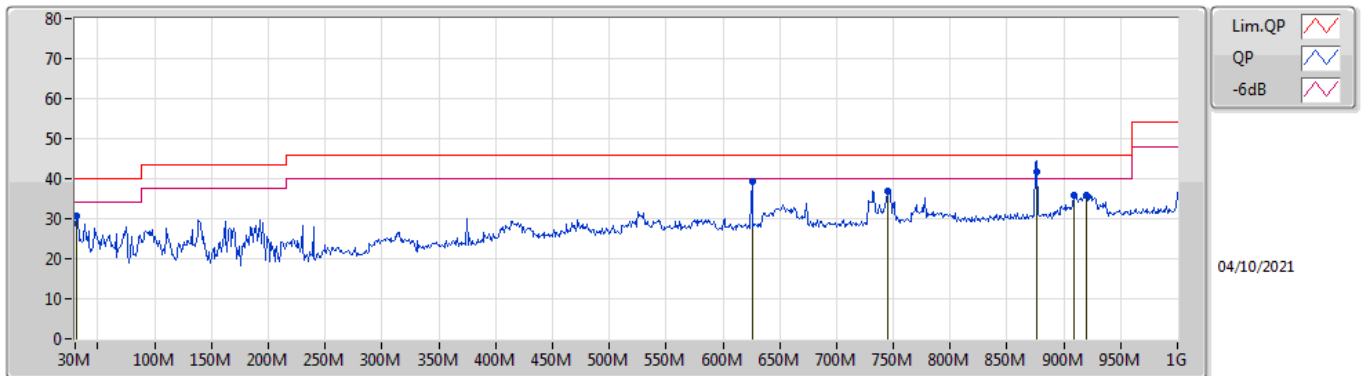

Type	Freq (Hz)	Level (dBuV/m)	Limit (dBuV/m)	Margin (dB)	Factor (dB/m)	Dist (m)	Condition	Azimuth (°)	Height (m)	Comment	Raw (dBuV/m)	AF (dB/m)	CL (dB)	PA (dB)
PK	30.97M	30.85	40.00	-9.15	-7.41	3	Vertical	251	1.25	-	38.26	23.68	0.42	31.51
PK	625.58M	39.26	46.00	-6.74	-4.76	3	Vertical	191	1.50	-	44.02	24.51	3.25	32.52
PK	744.89M	36.94	46.00	-9.06	-3.94	3	Vertical	228	2.00	-	40.88	25.17	3.59	32.70
QP	875.84M	41.57	46.00	-4.43	-2.43	3	Vertical	360	1.50	"Worst"	44.00	26.10	4.11	32.64
PK	908.82M	35.90	46.00	-10.10	-2.14	3	Vertical	103	1.50	-	38.04	26.20	4.30	32.64
PK	920.46M	35.74	46.00	-10.26	-2.15	3	Vertical	47	2.00	-	37.89	26.17	4.30	32.62

Mode 1

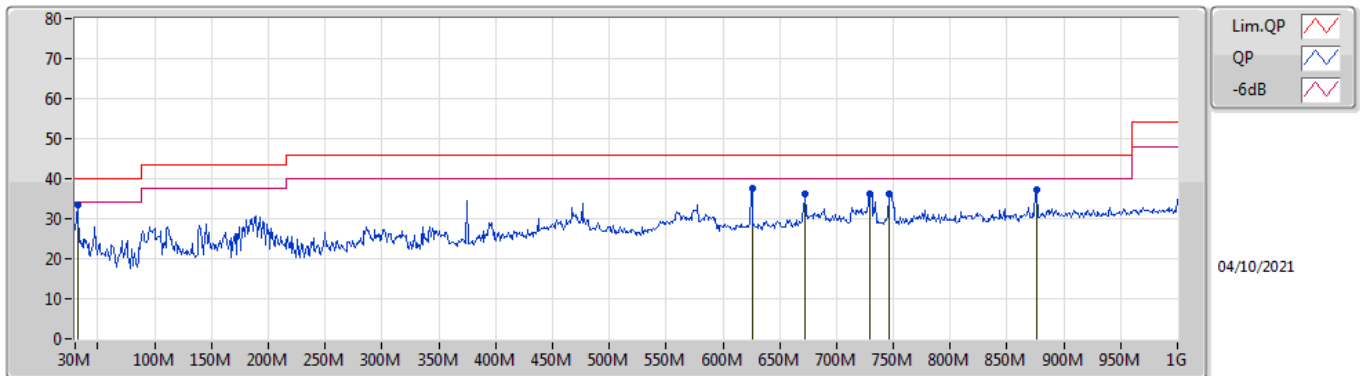

Type	Freq (Hz)	Level (dBuV/m)	Limit (dBuV/m)	Margin (dB)	Factor (dB/m)	Dist (m)	Condition	Azimuth (°)	Height (m)	Comment	Raw (dBuV/m)	AF (dB/m)	CL (dB)	PA (dB)
PK	31.94M	33.53	40.00	-6.47	-8.09	3	Horizontal	2	1.00	"Worst"	41.62	23.00	0.44	31.53
PK	625.58M	37.57	46.00	-8.43	-4.76	3	Horizontal	18	1.50	-	42.33	24.51	3.25	32.52
PK	672.14M	36.29	46.00	-9.71	-4.64	3	Horizontal	156	1.25	-	40.93	24.56	3.39	32.59
PK	729.37M	36.36	46.00	-9.64	-4.20	3	Horizontal	360	1.25	-	40.56	24.93	3.56	32.69
PK	745.86M	36.32	46.00	-9.68	-3.95	3	Horizontal	150	1.00	-	40.27	25.17	3.59	32.71
PK	875.84M	37.38	46.00	-8.62	-2.43	3	Horizontal	100	1.00	-	39.81	26.10	4.11	32.64



**Field Strength of Fundamental Emissions /
Radiated Emissions Above 1GHz / Band Edge Emissions**

Appendix B.2

Summary

Mode	Result	Type	Freq (Hz)	Level (dBuV/m)	Limit (dBuV/m)	Margin (dB)	Dist (m)	Condition	Azimuth (°)	Height (m)	Comments
2.4-2.4835GHz	-	-	-	-	-	-	-	-	-	-	-
O-QPSK	Pass	AV	2.39997G	53.63	54.00	-0.37	3	Horizontal	15	2.59	-

O-QPSK

2404.053MHz_TX

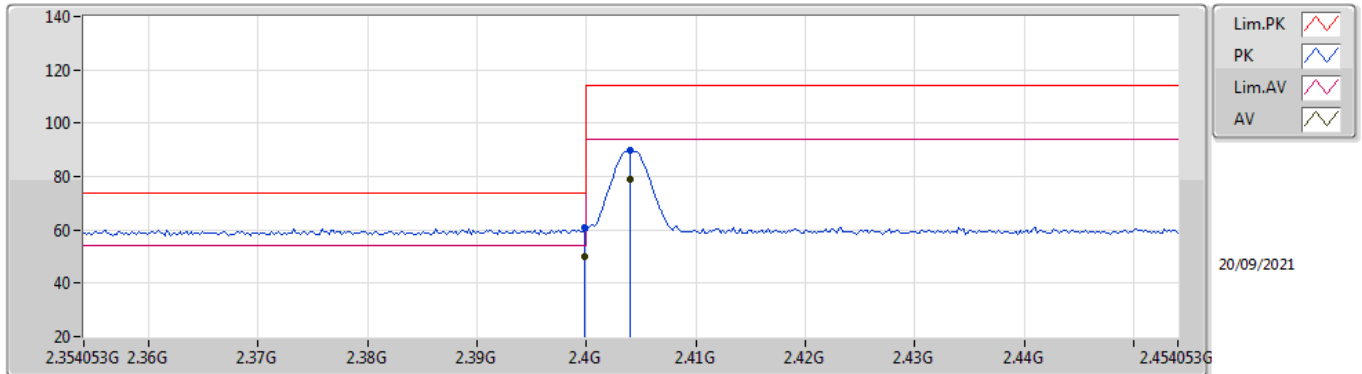

EUT X_1TX
Setting Default
02-B-S-8

Type	Freq (Hz)	Level (dBuV/m)	Limit (dBuV/m)	Margin (dB)	Raw (dBuV)	Dist (m)	Condition	Azimuth (°)	Height (m)	Comment	AF (dB)	CL (dB)	PA (dB)
PK	2.39987G	60.63	74.00	-13.37	29.83	3	Vertical	72	3.00	-	28.40	2.40	-
AV	2.39987G	50.17	54.00	-3.83	19.37	3	Vertical	72	3.00	-	28.40	2.40	-
PK	2.40405G	89.67	114.00	-24.33	58.87	3	Vertical	72	3.00	-	28.40	2.40	-
AV	2.40405G	79.21	94.00	-14.79	48.41	3	Vertical	72	3.00	-	28.40	2.40	-

O-QPSK
2404.053MHz_TX

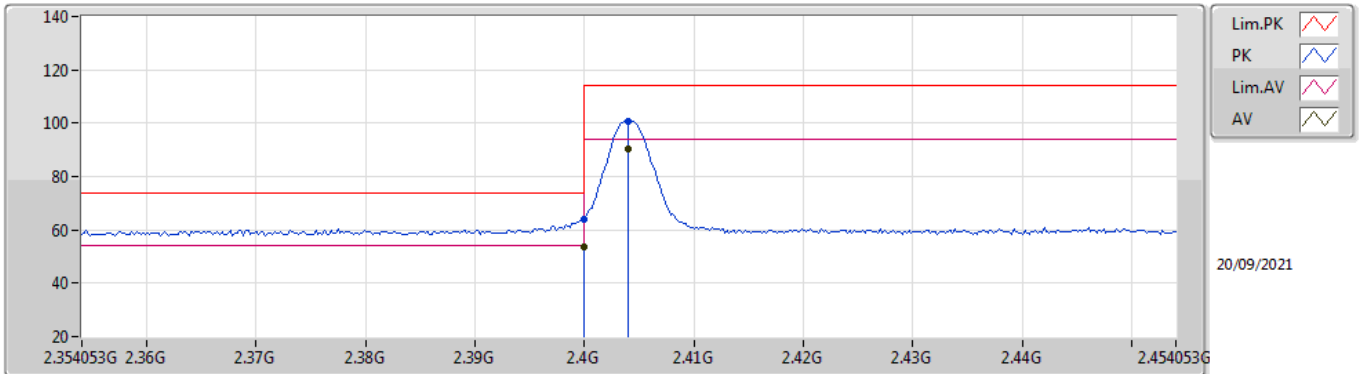

EUT X_1TX
Setting Default
02-B-S-8

Type	Freq (Hz)	Level (dBuV/m)	Limit (dBuV/m)	Margin (dB)	Raw (dBuV)	Dist (m)	Condition	Azimuth (°)	Height (m)	Comment	AF (dB)	CL (dB)	PA (dB)
PK	2.39997G	64.09	74.00	-9.91	33.29	3	Horizontal	15	2.59	-	28.40	2.40	-
AV	2.39997G	53.63	54.00	-0.37	22.83	3	Horizontal	15	2.59	-	28.40	2.40	-
PK	2.40405G	100.94	114.00	-13.06	70.14	3	Horizontal	15	2.59	-	28.40	2.40	-
AV	2.40405G	90.48	94.00	-3.52	59.68	3	Horizontal	15	2.59	-	28.40	2.40	-

O-QPSK

2404.053MHz_TX

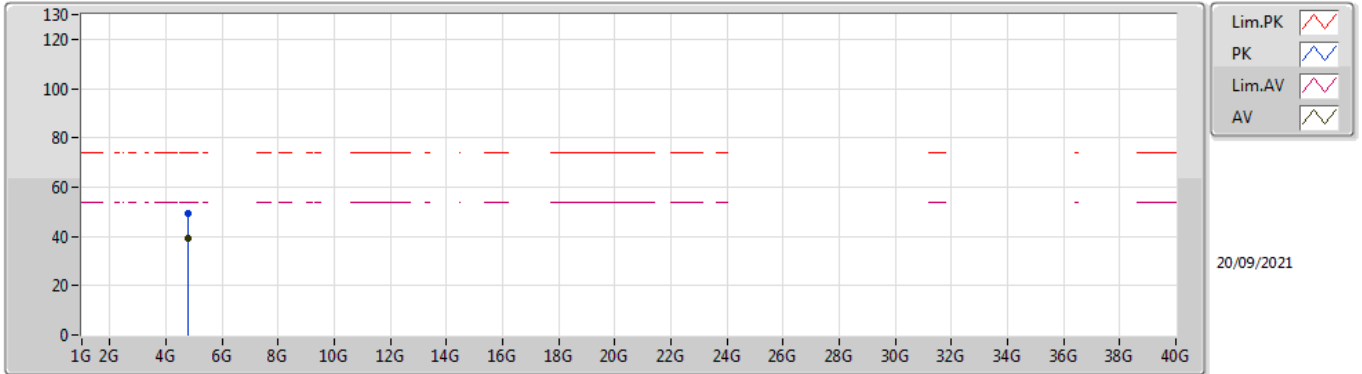

EUT_X_1TX
Setting Default
02-B-S-8

Type	Freq (Hz)	Level (dBuV/m)	Limit (dBuV/m)	Margin (dB)	Raw (dBuV)	Dist (m)	Condition	Azimuth (°)	Height (m)	Comment	AF (dB)	CL (dB)	PA (dB)
PK	4.80792G	49.43	74.00	-24.57	44.23	3	Vertical	16	2.04	-	32.73	4.70	32.23
AV	4.80803G	38.97	54.00	-15.03	33.77	3	Vertical	16	2.04	-	32.73	4.70	32.23

O-QPSK
2404.053MHz_TX

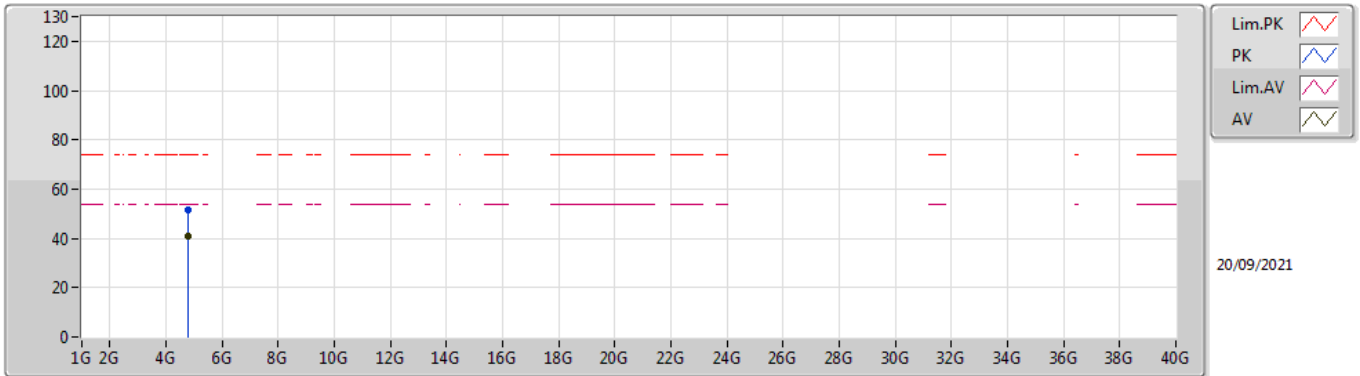

EUT_X_1TX
Setting Default
02-B-S-8

Type	Freq (Hz)	Level (dBuV/m)	Limit (dBuV/m)	Margin (dB)	Raw (dBuV)	Dist (m)	Condition	Azimuth (°)	Height (m)	Comment	AF (dB)	CL (dB)	PA (dB)
PK	4.80815G	51.45	74.00	-22.55	46.25	3	Horizontal	2	1.75	-	32.73	4.70	32.23
AV	4.80815G	40.99	54.00	-13.01	35.79	3	Horizontal	2	1.75	-	32.73	4.70	32.23

**O-QPSK
2441.844MHz_TX**

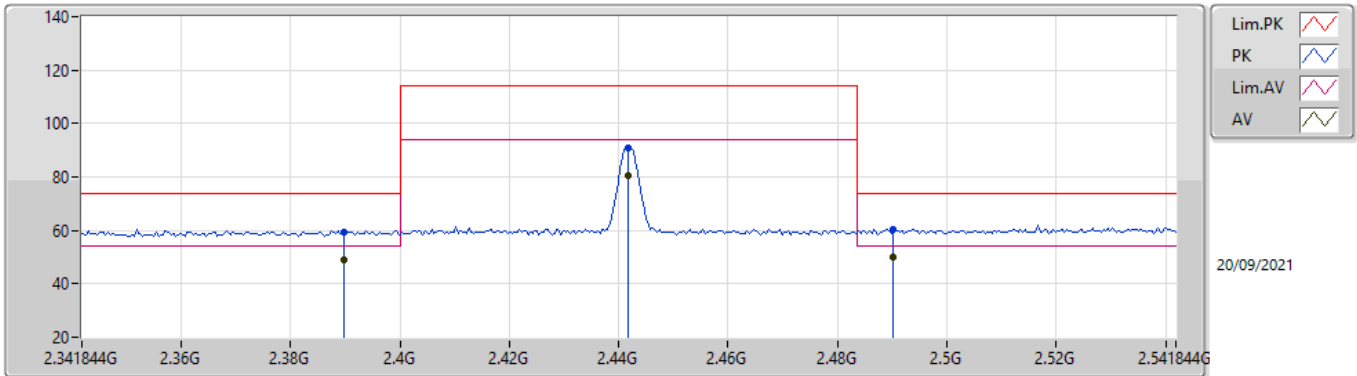

EUTX_1TX
Setting Default
02-B-S-8

Type	Freq (Hz)	Level (dBuV/m)	Limit (dBuV/m)	Margin (dB)	Raw (dBuV)	Dist (m)	Condition	Azimuth (°)	Height (m)	Comment	AF (dB)	CL (dB)	PA (dB)
PK	2.38984G	59.53	74.00	-14.47	28.74	3	Vertical	300	2.97	-	28.38	2.41	-
AV	2.38984G	49.07	54.00	-4.93	18.28	3	Vertical	300	2.97	-	28.38	2.41	-
PK	2.44184G	91.07	114.00	-22.93	60.25	3	Vertical	300	2.97	-	28.40	2.42	-
AV	2.44184G	80.61	94.00	-13.39	49.79	3	Vertical	300	2.97	-	28.40	2.42	-
PK	2.49024G	60.54	74.00	-13.46	29.53	3	Vertical	300	2.97	-	28.56	2.45	-
AV	2.49024G	50.08	54.00	-3.92	19.07	3	Vertical	300	2.97	-	28.56	2.45	-

O-QPSK
2441.844MHz_TX

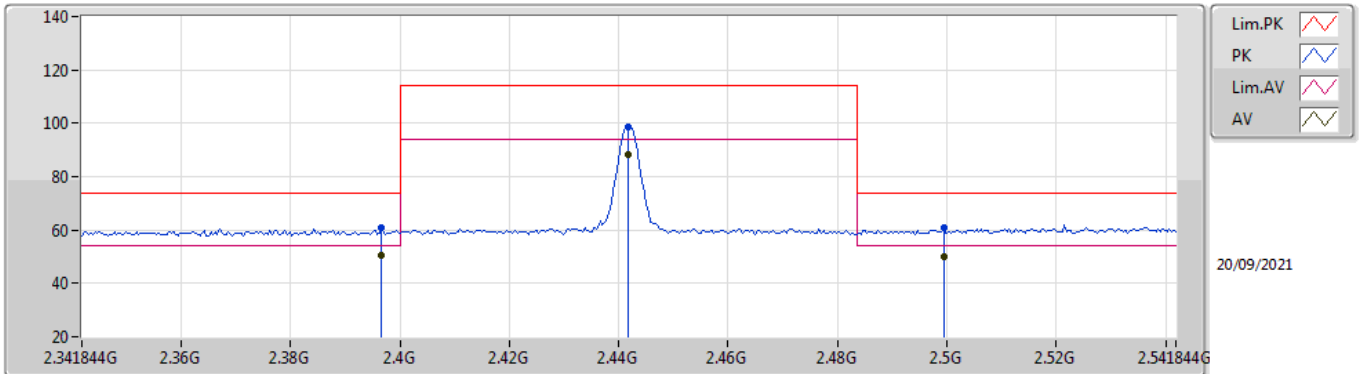

EUT_X_1TX
Setting Default
02-B-S-8

Type	Freq (Hz)	Level (dBuV/m)	Limit (dBuV/m)	Margin (dB)	Raw (dBuV)	Dist (m)	Condition	Azimuth (°)	Height (m)	Comment	AF (dB)	CL (dB)	PA (dB)
PK	2.39664G	61.10	74.00	-12.90	30.31	3	Horizontal	15	1.31	-	28.39	2.40	-
AV	2.39664G	50.64	54.00	-3.36	19.85	3	Horizontal	15	1.31	-	28.39	2.40	-
PK	2.44184G	98.55	114.00	-15.45	67.73	3	Horizontal	15	1.31	-	28.40	2.42	-
AV	2.44184G	88.09	94.00	-5.91	57.27	3	Horizontal	15	1.31	-	28.40	2.42	-
PK	2.49944G	60.70	74.00	-13.30	29.65	3	Horizontal	15	1.31	-	28.60	2.45	-
AV	2.49944G	50.24	54.00	-3.76	19.19	3	Horizontal	15	1.31	-	28.60	2.45	-

O-QPSK
2441.844MHz_TX

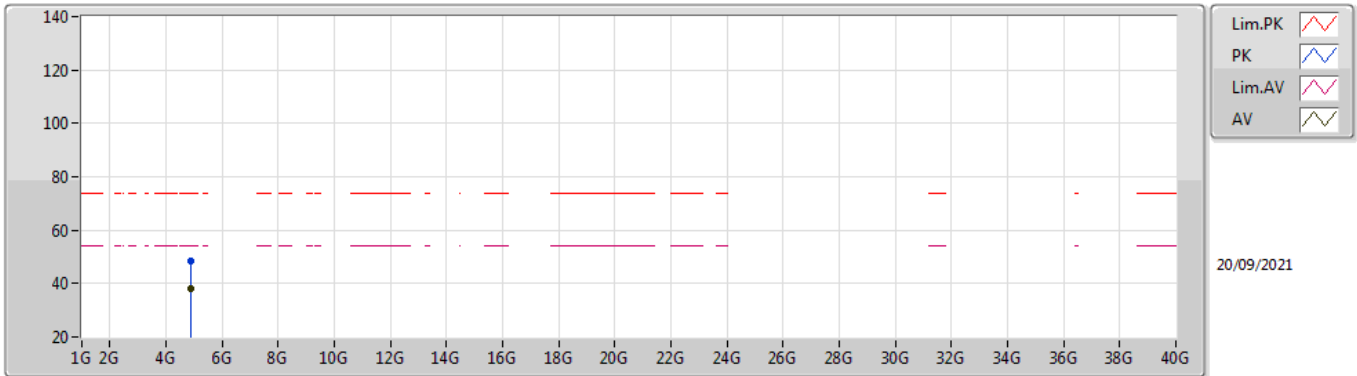

EUT X_2TX
Setting Default
02-B-S-8

Type	Freq (Hz)	Level (dBuV/m)	Limit (dBuV/m)	Margin (dB)	Raw (dBuV)	Dist (m)	Condition	Azimuth (°)	Height (m)	Comment	AF (dB)	CL (dB)	PA (dB)
PK	4.88333G	48.57	74.00	-25.43	43.10	3	Vertical	21	1.98	-	32.97	4.70	32.20
AV	4.88333G	38.11	54.00	-15.89	32.64	3	Vertical	21	1.98	-	32.97	4.70	32.20

O-QPSK
2441.844MHz_TX

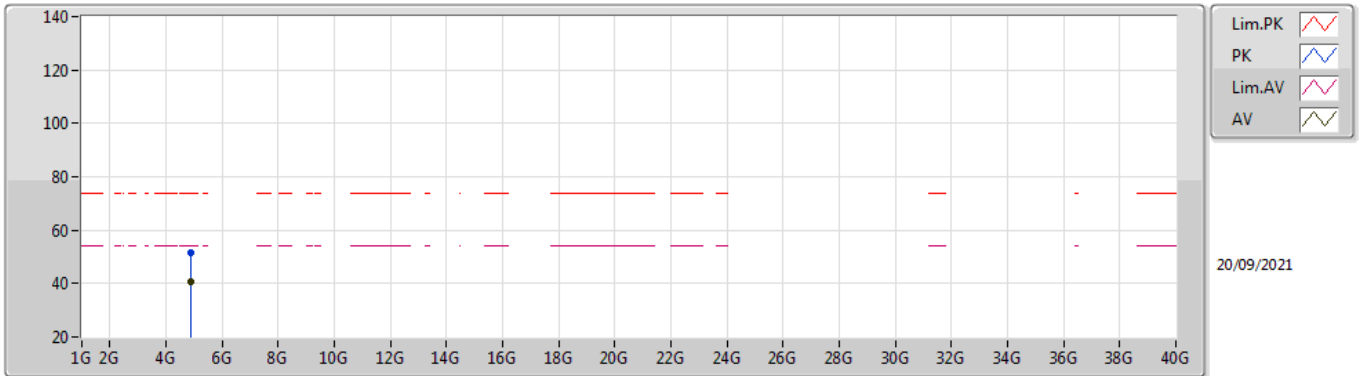

EUT X_2TX
Setting Default
02-B-S-8

Type	Freq (Hz)	Level (dBuV/m)	Limit (dBuV/m)	Margin (dB)	Raw (dBuV)	Dist (m)	Condition	Azimuth (°)	Height (m)	Comment	AF (dB)	CL (dB)	PA (dB)
PK	4.88352G	51.37	74.00	-22.63	45.90	3	Horizontal	4	1.80	-	32.97	4.70	32.20
AV	4.88352G	40.91	54.00	-13.09	35.44	3	Horizontal	4	1.80	-	32.97	4.70	32.20

O-QPSK
2479.285MHz_TX

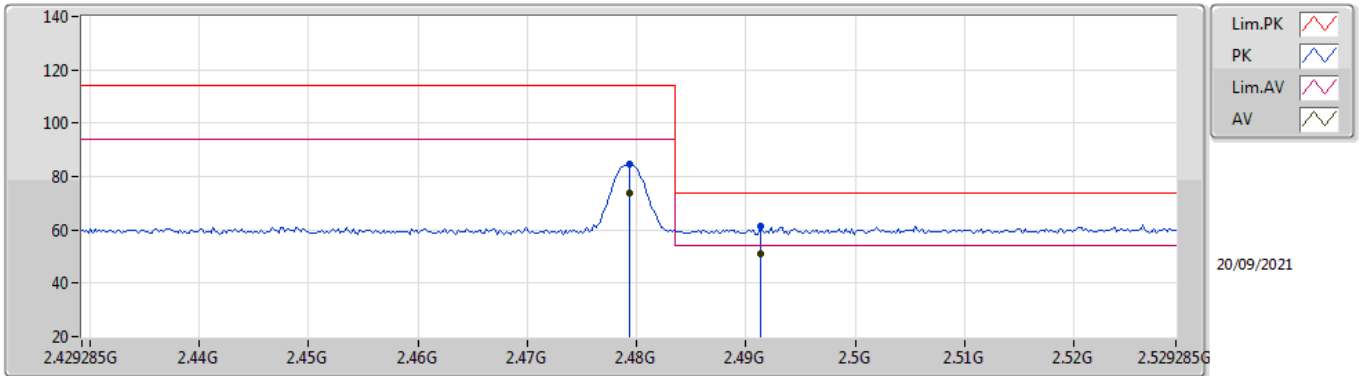

EUT_X_2TX
Setting Default
02-B-S-8

Type	Freq (Hz)	Level (dBuV/m)	Limit (dBuV/m)	Margin (dB)	Raw (dBuV)	Dist (m)	Condition	Azimuth (°)	Height (m)	Comment	AF (dB)	CL (dB)	PA (dB)
PK	2.47929G	84.44	114.00	-29.56	53.48	3	Vertical	91	2.44	-	28.52	2.44	-
AV	2.47929G	73.98	94.00	-20.02	43.02	3	Vertical	91	2.44	-	28.52	2.44	-
PK	2.49129G	61.33	74.00	-12.67	30.31	3	Vertical	91	2.44	-	28.57	2.45	-
AV	2.49129G	50.87	54.00	-3.13	19.85	3	Vertical	91	2.44	-	28.57	2.45	-

O-QPSK

2479.285MHz_TX

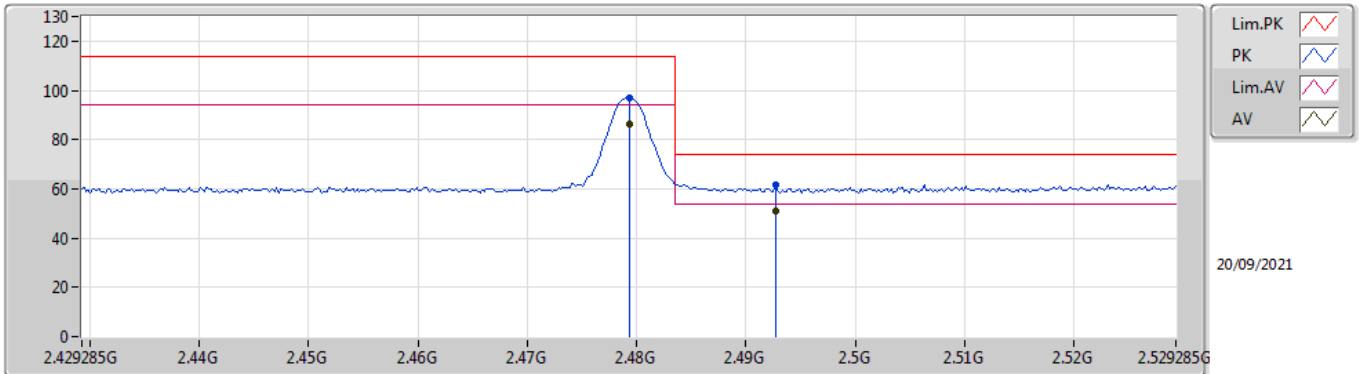

EUT_X_2TX
Setting Default
02-B-S-8

Type	Freq (Hz)	Level (dBuV/m)	Limit (dBuV/m)	Margin (dB)	Raw (dBuV)	Dist (m)	Condition	Azimuth (°)	Height (m)	Comment	AF (dB)	CL (dB)	PA (dB)
PK	2.47929G	96.77	114.00	-17.23	65.81	3	Horizontal	345	2.13	-	28.52	2.44	-
AV	2.47929G	86.31	94.00	-7.69	55.35	3	Horizontal	345	2.13	-	28.52	2.44	-
PK	2.49269G	61.54	74.00	-12.46	30.52	3	Horizontal	345	2.13	-	28.57	2.45	-
AV	2.49269G	51.08	54.00	-2.92	20.06	3	Horizontal	345	2.13	-	28.57	2.45	-

O-QPSK
2479.285MHz_TX

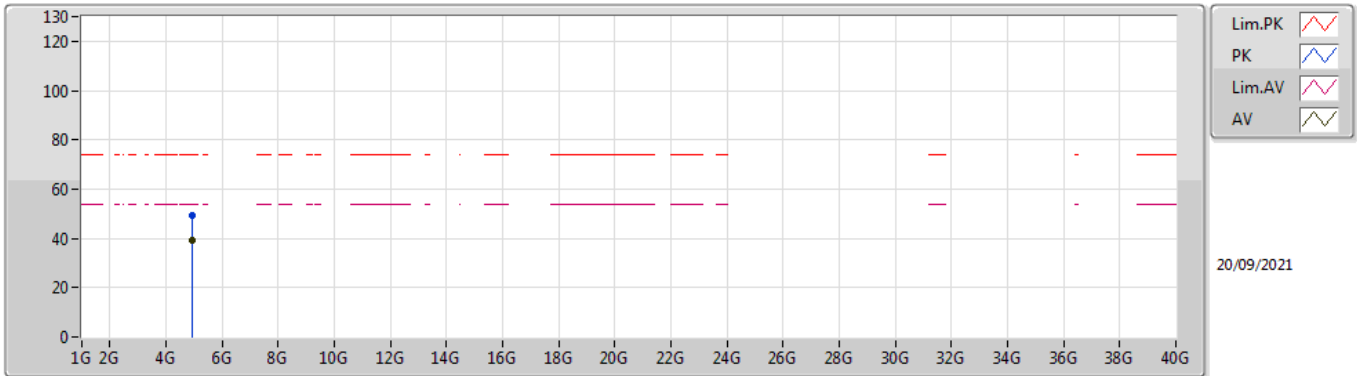

EUT X_2TX
Setting Default
02-B-S-8

Type	Freq (Hz)	Level (dBuV/m)	Limit (dBuV/m)	Margin (dB)	Raw (dBuV)	Dist (m)	Condition	Azimuth (°)	Height (m)	Comment	AF (dB)	CL (dB)	PA (dB)
PK	4.95871G	49.49	74.00	-24.51	43.68	3	Vertical	319	1.03	-	33.28	4.70	32.17
AV	4.95871G	39.03	54.00	-14.97	33.22	3	Vertical	319	1.03	-	33.28	4.70	32.17

O-QPSK
2479.285MHz_TX

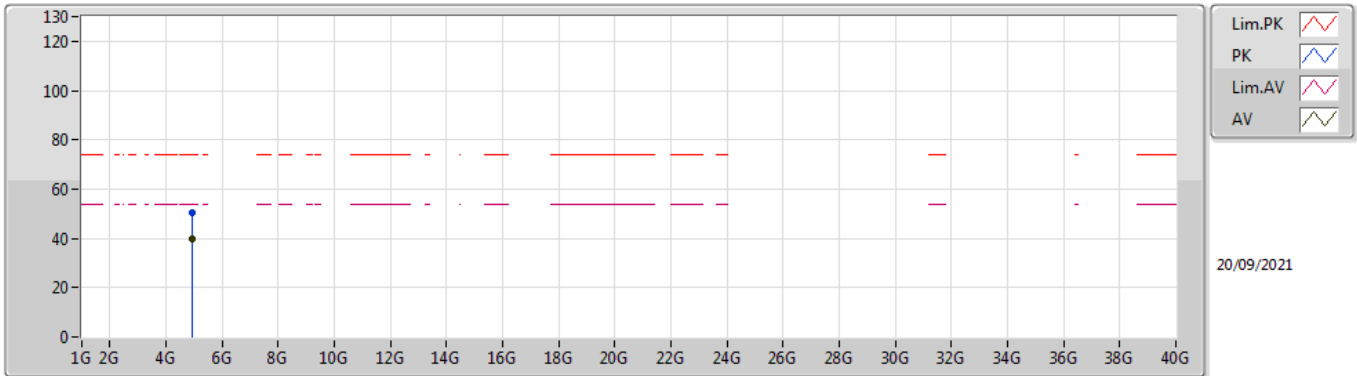

EUT_X_2TX
Setting Default
02-B-S-8

Type	Freq (Hz)	Level (dBuV/m)	Limit (dBuV/m)	Margin (dB)	Raw (dBuV)	Dist (m)	Condition	Azimuth (°)	Height (m)	Comment	AF (dB)	CL (dB)	PA (dB)
PK	4.95829G	50.33	74.00	-23.67	44.53	3	Horizontal	340	2.28	-	33.28	4.70	32.18
AV	4.95829G	39.87	54.00	-14.13	34.07	3	Horizontal	340	2.28	-	33.28	4.70	32.18

Frequency (MHz)	20dB BW (MHz)	99% OBW (MHz)	Frequency range (MHz) $f_L > 2400\text{MHz}$	Frequency range (MHz) $f_H < 2483.5\text{MHz}$	Test Result
2404.053	1.220	1.68	2403.4130	-	PASS
2441.844	1.209	1.72	-	-	PASS
2479.285	1.255	2.16	-	2478.6150	PASS

20 dB and 99% Bandwidth Plot on 2404.053 MHz

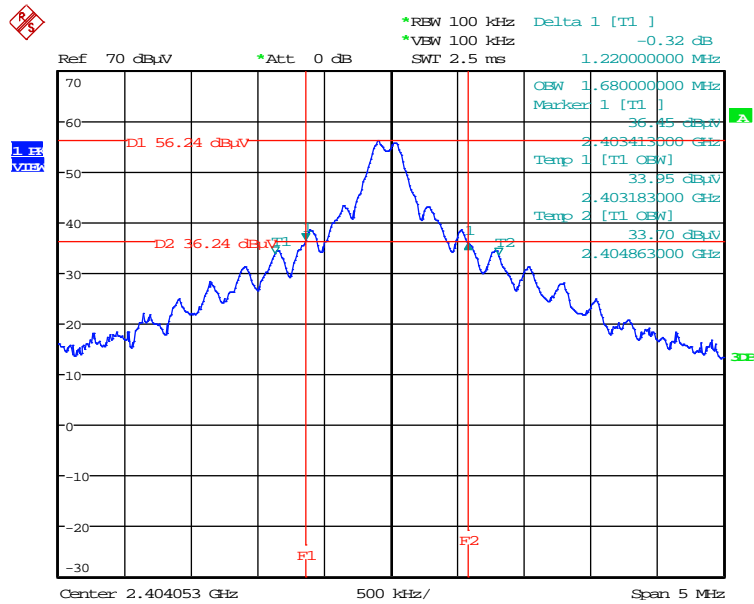

Date: 20.SEP.2021 17:26:15

20 dB and 99% Bandwidth Plot on 2441.844 MHz

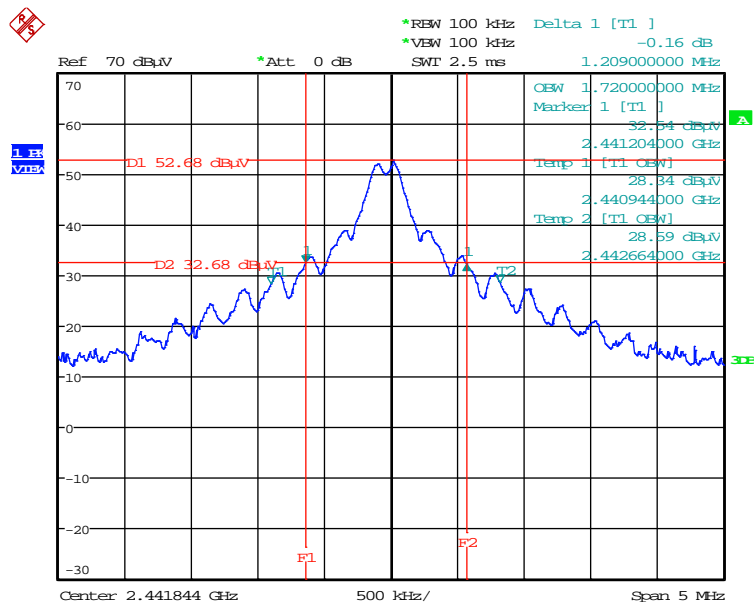

Date: 20.SEP.2021 17:34:32

20 dB and 99% Bandwidth Plot on 2479.285 MHz

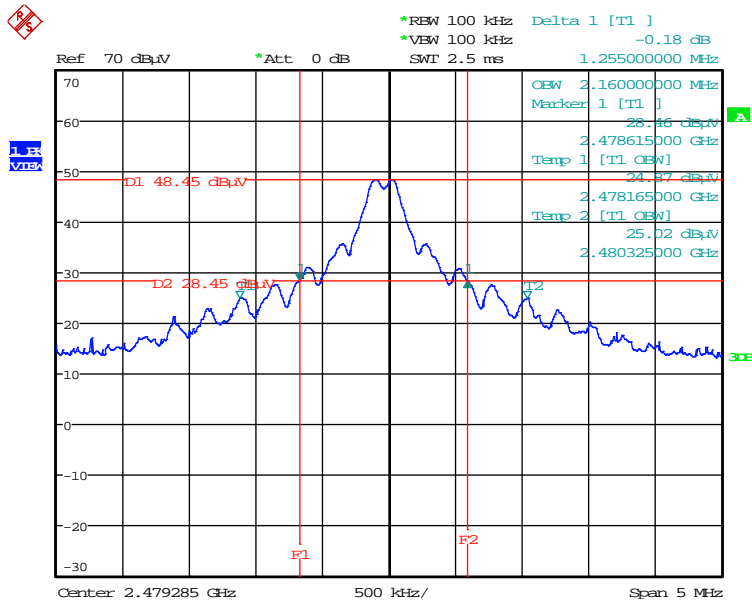

Date: 20.SEP.2021 17:22:12