



RADIO TEST REPORT

FCC ID : UDX-60051010
Equipment : Wireless 802.11 abgn/ac indoor AP
Brand Name : CISCO
Model Name : MR30H-HW
Applicant : Cisco Systems, Inc.
170 West Tasman Drive, San Jose, CA 95134, USA
Manufacturer : Cisco Systems, Inc.
170 West Tasman Drive, San Jose, CA 95134, USA
Standard : 47 CFR FCC Part 15 Subpart C § 15.249

The product was received on Aug. 24, 2021, and testing was started from Sep. 20, 2021 and completed on Oct. 01, 2021. We, Sporton International Inc. Hsinchu Laboratory, would like to declare that the tested sample has been evaluated in accordance with the procedures given in ANSI C63.10-2013, 47 CFR FCC Part 15 Subpart C, and shown compliance with the applicable technical standards.

The test results in this report apply exclusively to the tested model / sample. Without written approval of Sporton International Inc. Hsinchu Laboratory, the test report shall not be reproduced except in full.

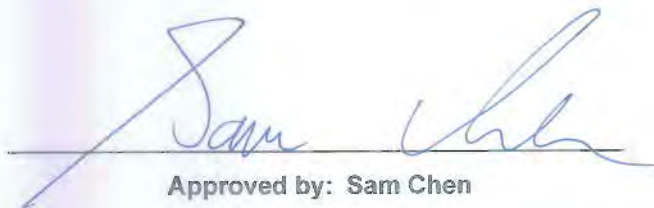

Approved by: Sam Chen

Sporton International Inc. Hsinchu Laboratory
No.8, Ln. 724, Bo'ai St., Zhubei City, Hsinchu County 302010, Taiwan (R.O.C.)



Table of Contents

History of this test report.....	3
Summary of Test Result.....	4
1. General Information	5
1.1. Product Details	5
1.2. Accessories	5
1.3. Table for Carrier Frequencies	5
1.4. Table for Test Modes	6
1.5. Applicable Standards	7
1.6. Table for Testing Locations	7
1.7. Measurement Uncertainty	7
1.8. Table for Supporting Units	8
1.9. Duty Cycle	8
1.10. Table for Parameters of Test Software Setting	8
1.11. Test Configurations	9
2. Test Result	11
2.1. AC Power Line Conducted Emissions Measurement	11
2.2. Field Strength of Fundamental Emissions Measurement	14
2.3. 20dB Spectrum Bandwidth Measurement.....	16
2.4. Radiated Emissions Measurement	18
2.5. Band Edge Emissions Measurement	23
2.6. Antenna Requirements	25
3. List of Measuring Equipments	26
Appendix A. Test Results of AC Power-line Conducted Emissions	
Appendix B. Test Results of Field Strength of Fundamental Emissions / Radiated Emissions	
/ Band Edge Emissions	
Appendix C. Test Results of 20dB Spectrum Bandwidth	
Appendix D. Test Photos	
Photographs of EUT v01	



Summary of Test Result

Report Clause	Ref Std. Clause	Test Items	Result (PASS/FAIL)	Remark
2.1	15.207	AC Power Line Conducted Emissions	PASS	-
2.2	15.249(a)	Field Strength of Fundamental Emissions	PASS	-
2.3	15.215(c)	20dB Spectrum Bandwidth	PASS	-
2.4	15.249(a)/(d)	Radiated Emissions	PASS	-
2.5	15.249(d)	Band Edge Emissions	PASS	-
2.6	15.203	Antenna Requirements	PASS	-

Declaration of Conformity:

The test results with all measurement uncertainty excluded are presented in accordance with the regulation limits or requirements declared by manufacturers.

Comments and Explanations:

The declared of product specification for EUT presented in the report are provided by the manufacturer, and the manufacturer takes all the responsibilities for the accuracy of product specification.

Reviewed by: Sam Chen

Report Producer: Wendy Pan



1. General Information

1.1. Product Details

Items	Description
Power Type	From Power PoE
Modulation	O-QPSK
Frequency Range	2400 ~ 2483.5MHz
Operation Frequency Range	2404.053 ~ 2479.285 MHz
Channel Number	11
Channel Bandwidth (99%)	1.69 MHz
Max. Field Strength	79.83 dBuV/m at 3m (Average)
Carrier Frequencies	Please refer to section 1.3
Antenna	Type: Chip Antenna (Without any antenna connector) Gain: 2.66 dBi

Note: The above information was declared by manufacturer.

1.2. Accessories

Wall Bracket*1

1.3. Table for Carrier Frequencies

Frequency Band	Channel No.	Frequency
2400 ~ 2483.5MHz	0	2404.053 MHz
	1	2410.002 MHz
	2	2421.899 MHz
	3	2424.698 MHz
	4	2441.844 MHz
	5	2449.192 MHz
	6	2461.789 MHz
	7	2469.487 MHz
	8	2474.386 MHz
	9	2476.835 MHz
	10	2479.285 MHz



1.4. Table for Test Modes

The following table is a list of the test modes shown in this test report.

Test Items	Mode	Channel
AC Power Line Conducted Emissions Test Voltage: 120Vac / 60Hz	CTX	-
Field Strength of Fundamental Emissions 20dB Spectrum Bandwidth	CTX	0/4/10
Radiated Emissions 30MHz ~ 1GHz	CTX	-
Radiated Emissions 1GHz~10 th Harmonic	CTX	0/4/10
Band Edge Emissions	CTX	0/4/10

Note: CTX=continuously transmitting

Note 2: The PoE below is for measurement only, would not be marketed.

The PoE information as below:

Support Unit	Brand	Model Name
PoE	CISCO	MA-INJ4

For Conducted Emission test:

Mode 1. EUT + PoE

For Radiated Emission below 1GHz test:

The EUT was performed at X axis, Y axis and Z axis position for Radiated emission above 1GHz test, and the worst case was found at X axis. So the measurement will follow this same test configuration.

Mode 1. EUT in X axis + PoE

For Radiated Emission above 1GHz test:

The EUT was performed at X axis, Y axis and Z axis position, and the worst case was found at X axis. So the measurement will follow this same test configuration.

Mode 1. EUT in X axis



1.5. Applicable Standards

According to the specifications of the manufacturer, the EUT must comply with the requirements of the following standards:

- ◆ ANSI C63.10-2013
- ◆ 47 CFR FCC Part 15 Subpart C

The following reference test guidance is not within the scope of accreditation of TAF.

- ◆ FCC KDB 414788 D01 v01r01

1.6. Table for Testing Locations

Testing Location Information	
Test Lab. : Sporton International Inc. Hsinchu Laboratory	
Hsinchu	ADD: No.8, Ln. 724, Bo'ai St., Zhubei City, Hsinchu County 302010, Taiwan (R.O.C.)
(TAF: 3787)	TEL: 886-3-656-9065 FAX: 886-3-656-9085
Test site Designation No. TW3787 with FCC.	
Conformity Assessment Body Identifier (CABID) TW3787 with ISED.	

Test Condition	Test Site No.	Test Engineer	Test Environment (°C / %)	Test Date
RF Conducted	TH01-CB	Nyle Chang	23.5~24.4 / 53~56	Sep. 20, 2021
Radiated<1GHz	03CH05-CB	Nyle Chang	23.5-24.6 / 55-59	Sep. 20, 2021~ Sep. 25, 2021
Radiated>1GHz	03CH04-CB	Nyle Chang	24.3-25.4 / 55-58	Sep. 20, 2021~ Sep. 25, 2021
AC Conduction	CO02-CB	Peter Wu	24~25 / 58~59	Oct. 01, 2021

1.7. Measurement Uncertainty

Test Items	Uncertainty	Remark
Conducted Emission (150kHz ~ 30MHz)	2.0 dB	Confidence levels of 95%
Radiated Emission (9kHz ~ 30MHz)	4.2 dB	Confidence levels of 95%
Radiated Emission (30MHz ~ 1,000MHz)	5.5 dB	Confidence levels of 95%
Radiated Emission (1GHz ~ 18GHz)	4.7 dB	Confidence levels of 95%
Radiated Emission (18GHz ~ 40GHz)	4.2 dB	Confidence levels of 95%
Conducted Emission	2.5 dB	Confidence levels of 95%



1.8. Table for Supporting Units

No.	Support Unit	Brand	Model	FCC ID
A	PoE	CISCO	MA-INJ-4	N/A

1.9. Duty Cycle

Duty cycle (%)	Duty Factor (dB)
30	-10.46

1.10. Table for Parameters of Test Software Setting

Frequency	2404.053 MHz	2441.844 MHz	2479.285 MHz
Software Setting	Default	Default	Default

1.11. Test Configurations

1.11.1. AC Power Line Conduction Emissions Test Configuration

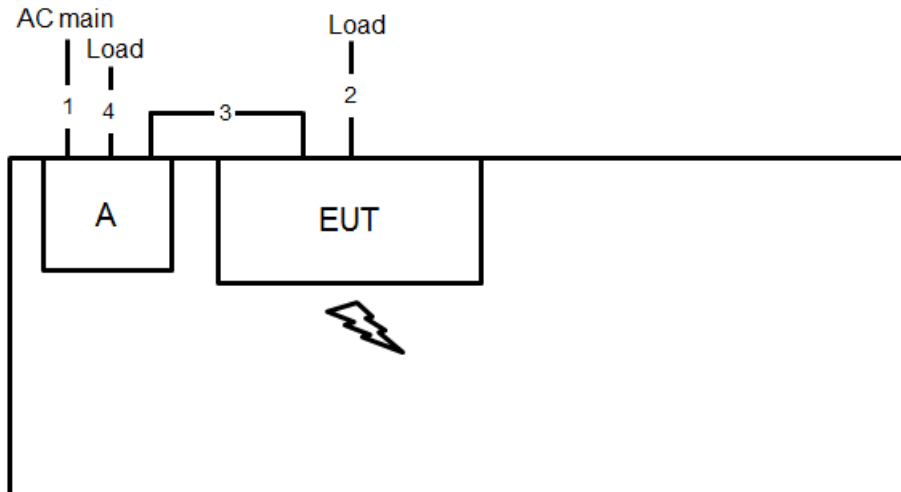

Item	Connection	Shielded	Length
1	Power cable	No	1.8m
2	RJ-45 cable*3	No	1.5m
3	RJ-45 cable	No	1.5m
4	RJ-45 cable	No	1.5m

1.11.2. Radiation Emissions Test Configuration

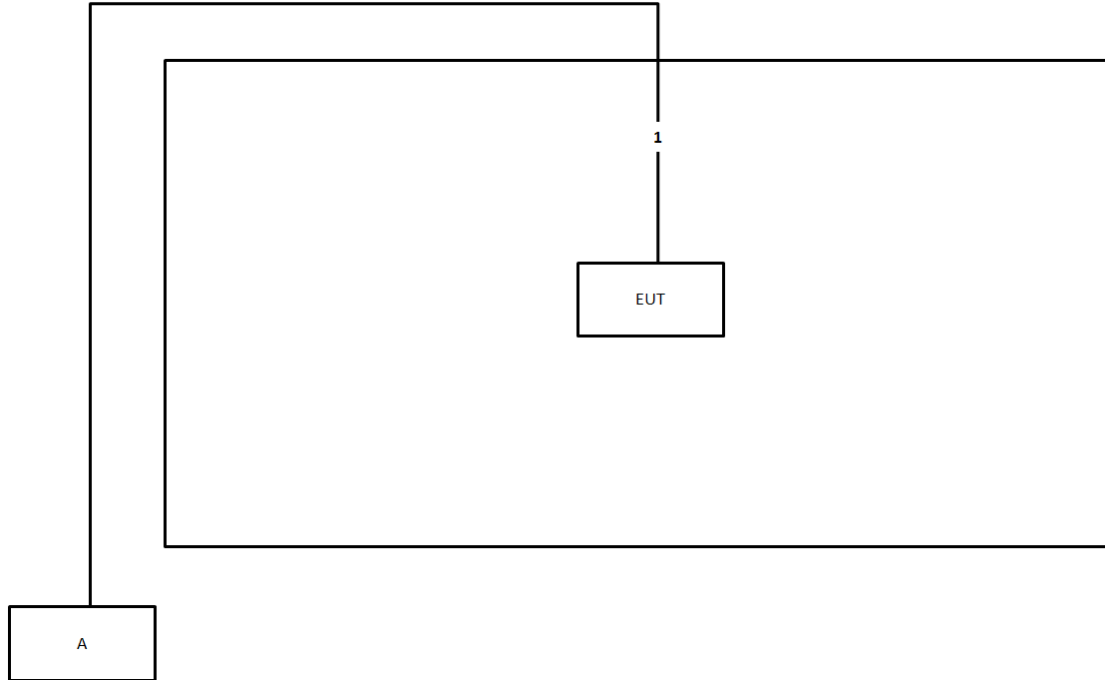

Item	Connection	Shielded	Length
1	RJ-45 cable	No	10m



2. Test Result

2.1. AC Power Line Conducted Emissions Measurement

2.1.1. Limit

For this product which is designed to be connected to the AC power line, the radio frequency voltage that is conducted back onto the AC power line on any frequency or frequencies within the band 150 kHz to 30 MHz shall not exceed below limits table.

Frequency (MHz)	QP Limit (dBuV)	AV Limit (dBuV)
0.15~0.5	66~56	56~46
0.5~5	56	46
5~30	60	50

2.1.2. Measuring Instruments and Setting

Refer a test equipment and calibration data table in this test report. The following table is the setting of the receiver.

Receiver Parameters	Setting
Attenuation	10 dB
Start Frequency	0.15 MHz
Stop Frequency	30 MHz
IF Bandwidth	9 kHz

2.1.3. Test Procedures

1. Configure the EUT according to ANSI C63.10. The EUT or host of EUT has to be placed 0.4 meter far from the conducting wall of the shielding room and at least 80 centimeters from any other grounded conducting surface.
2. Connect EUT or host of EUT to the power mains through a line impedance stabilization network (LISN).
3. All the support units are connected to the other LISNs. The LISN should provide 50uH/50ohms coupling impedance.
4. The frequency range from 150 kHz to 30 MHz was searched.
5. Set the test-receiver system to Peak Detect Function and Specified Bandwidth with Maximum Hold Mode.
6. The measurement has to be done between each power line and ground at the power terminal.

2.1.4. Test Setup Layout

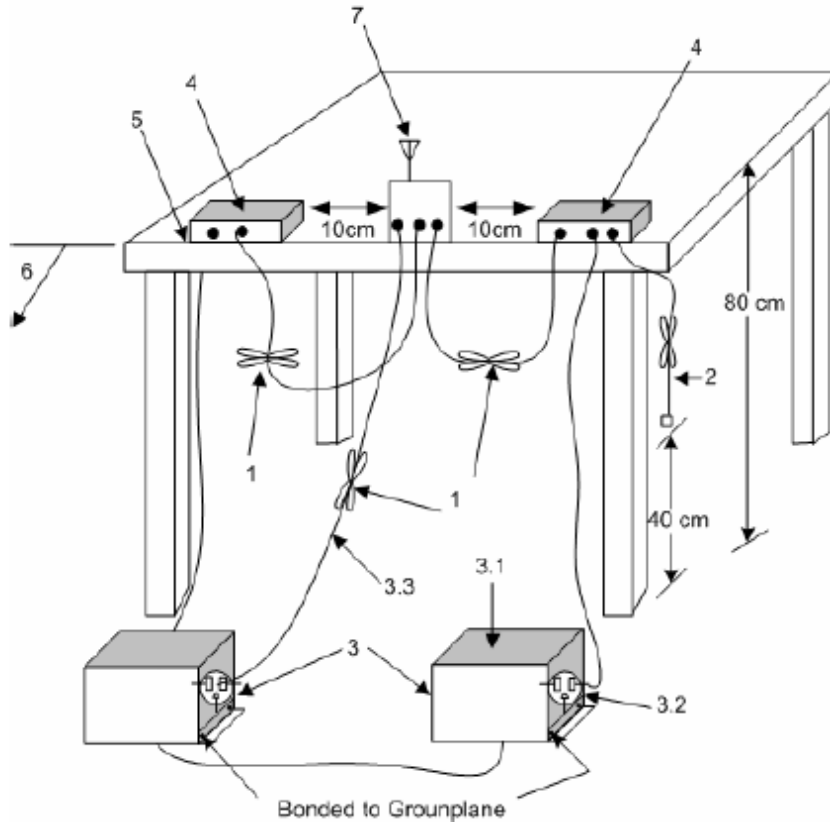

- 1—Interconnecting cables that hang closer than 40 cm to the ground plane shall be folded back and forth in the center forming a bundle 30 cm to 40 cm long.
- 2—The I/O cables that are not connected to an accessory shall be bundled in the center. The end of the cable may be terminated, if required, using the correct terminating impedance. The overall length shall not exceed 1 m.
- 3—EUT connected to one LISN. Unused LISN measuring port connectors shall be terminated in 50 Ω loads. LISN may be placed on top of, or immediately beneath, reference ground plane.
 - 3.1—All other equipment powered from additional LISN(s).
 - 3.2—A multiple-outlet strip may be used for multiple power cords of non-EUT equipment.
 - 3.3—LISN at least 80 cm from nearest part of EUT chassis.
- 4—Non-EUT components of EUT system being tested.
- 5—Rear of EUT, including peripherals, shall all be aligned and flush with edge of tabletop.
- 6—Edge of tabletop shall be 40 cm removed from a vertical conducting plane that is bonded to the ground plane.
- 7—Antenna can be integral or detachable. If detachable, then the antenna shall be attached for this test.

2.1.5. Test Deviation

There is no deviation with the original standard.

2.1.6. EUT Operation during Test

The EUT was placed on the test table and programmed in normal function.



2.1.7. Measurement Results Calculation

The measured Level is calculated using:

- a. Corrected Reading: LISN Factor (LISN) + Attenuator (AT/AUX) + Cable Loss (CL) + Read Level (Raw)
= Level
- b. Margin = -Limit + Level

2.1.8. Results of AC Power Line Conducted Emissions Measurement

Refer as Appendix A



2.2. Field Strength of Fundamental Emissions Measurement

2.2.1. Limit

The field strength of fundamental emissions within these bands specified at a distance of 3 meters (measurement instrumentation employing an average detector) shall comply with the following table.

Frequency Band (MHz)	Fundamental Emissions Limit (dBuV/m) at 3m
2400-2483.5	94 (Average)
	114 (Peak)

Measuring Instruments and Setting

Refer a test equipment and calibration data table in this test report. The following table is the setting of the spectrum analyzer.

Power Meter Parameter	Setting
RBW	1 MHz Peak / 3MHz Peak
VBW	1 MHz Peak / 1/T Average
Detector	Peak
Trace	Max Hold
Sweep Time	Auto

2.2.2. Test Procedures

1. Configure the EUT according to ANSI C63.10. The EUT was placed on the top of the turntable 1.8 meter above ground. The phase center of the receiving antenna mounted on the top of a height-variable antenna tower was placed 3 meters far away from the turntable.
2. Power on the EUT and all the supporting units. The turntable was rotated by 360 degrees to determine the position of the highest radiation.
3. The height of the broadband receiving antenna was varied between one meter and four meters above ground to find the maximum emissions field strength of both horizontal and vertical polarization.
4. For each suspected emissions, the antenna tower was scan (from 1 M to 4 M) and then the turntable was rotated (from 0 degree to 360 degrees) to find the maximum reading.
5. For Fundamental emissions, use 1MHz VBW and 3MHz RBW for peak reading. Then 1MHz RBW and 1/T VBW for average reading in spectrum analyzer.
6. When the radiated emissions limits are expressed in terms of the average value of the emissions, and pulsed operation is employed, the measurement field strength shall be determined by averaging over one complete pulse train, including blanking intervals, as long as the pulse train does not exceed 0.1 seconds. As an alternative (provided the transmitter operates for longer than 0.1 seconds) or in cases where the pulse train exceeds 0.1 seconds, the measured field strength shall be determined

from the average absolute voltage during a 0.1 second interval during which the field strength is at its maximum value.

2.2.3. Test Setup Layout

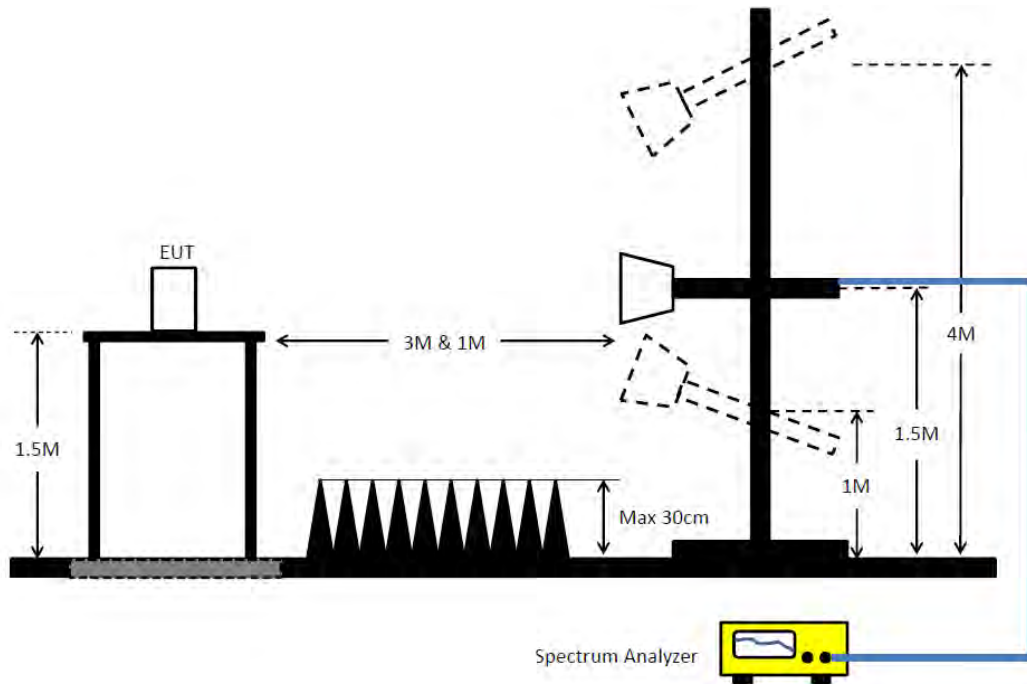

2.2.4. Test Deviation

There is no deviation with the original standard.

2.2.5. EUT Operation during Test

The EUT was programmed to be in continuously transmitting mode.

2.2.6. Measurement Results Calculation

The measured Level is calculated using:

Corrected Reading: Antenna factor (AF) + Cable loss (CL) + Read level (Raw) - Preamp factor (PA)(if applicable) = Level.

2.2.7. Test Result of Field Strength of Fundamental Emissions

Refer as Appendix B

2.3. 20dB Spectrum Bandwidth Measurement

2.3.1. Limit

Intentional radiators must be designed to ensure that the 20 dB bandwidth of the emissions in the specific band (2400 ~ 2483.5MHz).

2.3.2. Measuring Instruments and Setting

Refer a test equipment and calibration data table in this test report. The following table is the setting of the spectrum analyzer.

Spectrum Parameters	Setting
Attenuation	Auto
Span Frequency	> 20dB Bandwidth
RBW	100 kHz
VBW	100 kHz
Detector	Peak
Trace	Max Hold
Sweep Time	Auto

2.3.3. Test Procedures

1. The transmitter output (antenna port) was connected to the spectrum analyzer in peak hold mode.
2. The resolution bandwidth of 100 kHz and the video bandwidth of 100 kHz were used.
3. Measured the spectrum width with power higher than 20dB below carrier.

2.3.4. Test Setup Layout

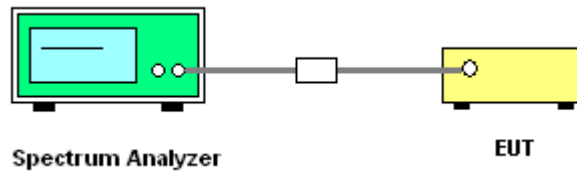

2.3.5. Test Deviation

There is no deviation with the original standard.

2.3.6. EUT Operation during Test

The EUT was programmed to be in continuously transmitting mode.



2.3.7. Test Result of 20dB Spectrum Bandwidth

Refer as Appendix C



2.4. Radiated Emissions Measurement

2.4.1. Limit

Harmonic emissions limits comply with below 54 dBuV/m at 3m. Other emissions radiated outside of the specified frequency bands, except for harmonics, shall be attenuated by at least 50 dB below the level of the fundamental or comply with the radiated emissions limits specified in section 15.209(a) limit in the table below has to be followed.

Frequencies (MHz)	Field Strength (micorvolts/meter)	Measurement Distance (meters)
0.009~0.490	2400/F(kHz)	300
0.490~1.705	24000/F(kHz)	30
1.705~30.0	30	30
30~88	100	3
88~216	150	3
216~960	200	3
Above 960	500	3

2.4.2. Measuring Instruments and Setting

Refer a test equipment and calibration data table in this test report. The following table is the setting of the spectrum analyzer and receiver.

Spectrum Parameter	Setting
Attenuation	Auto
Start Frequency	1000 MHz
Stop Frequency	10th carrier harmonic
RBW / VBW (Emission in restricted band)	1MHz / 3MHz for Peak, 1 MHz / 1/T for Average
RBW / VBW (Emission in non-restricted band)	100kHz/300kHz for Peak

Receiver Parameter	Setting
Attenuation	Auto
Start ~ Stop Frequency	9kHz~150kHz / RBW 200Hz for QP
Start ~ Stop Frequency	150kHz~30MHz / RBW 9kHz for QP
Start ~ Stop Frequency	30MHz~1000MHz / RBW 120kHz for QP

**2.4.3. Test Procedures**

1. Configure the EUT according to ANSI C63.10. The EUT was placed on the top of the turntable 1.5 meter above ground. The phase center of the receiving antenna mounted on the top of a height-variable antenna tower was placed 3 meters far away from the turntable.
2. Power on the EUT and all the supporting units. The turntable was rotated by 360 degrees to determine the position of the highest radiation.
3. The height of the broadband receiving antenna was varied between one meter and four meters above ground to find the maximum emissions field strength of both horizontal and vertical polarization.
4. For each suspected emissions, the antenna tower was scan (from 1 M to 4 M) and then the turntable was rotated (from 0 degree to 360 degrees) to find the maximum reading.
5. Set the test-receiver system to Peak or CISPR quasi-peak Detect Function with specified bandwidth under Maximum Hold Mode.
6. For emissions above 1GHz, use 1MHz VBW and 3MHz RBW for peak reading. Then 1MHz RBW and 1/T VBW for average reading in spectrum analyzer.
7. When the radiated emissions limits are expressed in terms of the average value of the emissions, and pulsed operation is employed, the measurement field strength shall be determined by averaging over one complete pulse train, including blanking intervals, as long as the pulse train does not exceed 0.1 seconds. As an alternative (provided the transmitter operates for longer than 0.1 seconds) or in cases where the pulse train exceeds 0.1 seconds, the measured field strength shall be determined from the average absolute voltage during a 0.1 second interval during which the field strength is at its maximum value.
8. If the emissions level of the EUT in peak mode was 3 dB lower than the average limit specified, then testing will be stopped and peak values of EUT will be reported, otherwise, the emissions which do not have 3 dB margin will be repeated one by one using the quasi-peak method for below 1GHz.
9. For testing above 1GHz, the emissions level of the EUT in peak mode was lower than average limit (that means the emissions level in peak mode also complies with the limit in average mode), then testing will be stopped and peak values of EUT will be reported, otherwise, the emissions will be measured in average mode again and reported.
10. In case the emission is lower than 30MHz, loop antenna has to be used for measurement and the recorded data should be QP measured by receiver. High – Low scan is not required in this case.

2.4.4. Test Setup Layout

For Radiated Emissions: 9kHz ~30MHz

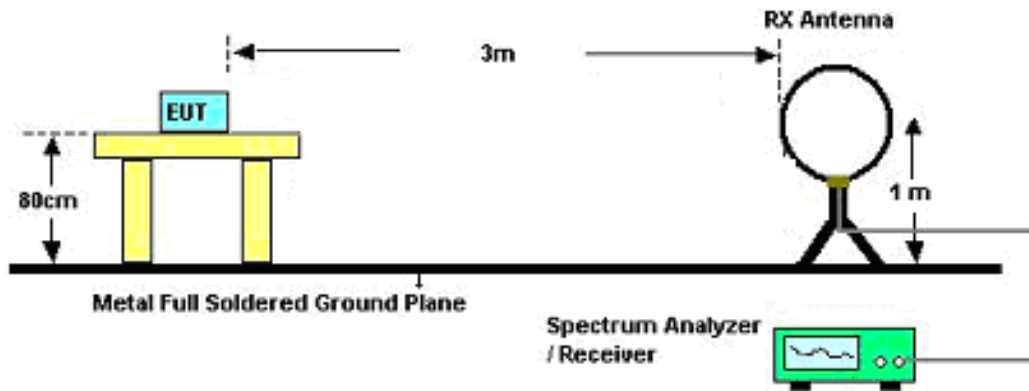

For Radiated Emissions: 30MHz~1GHz

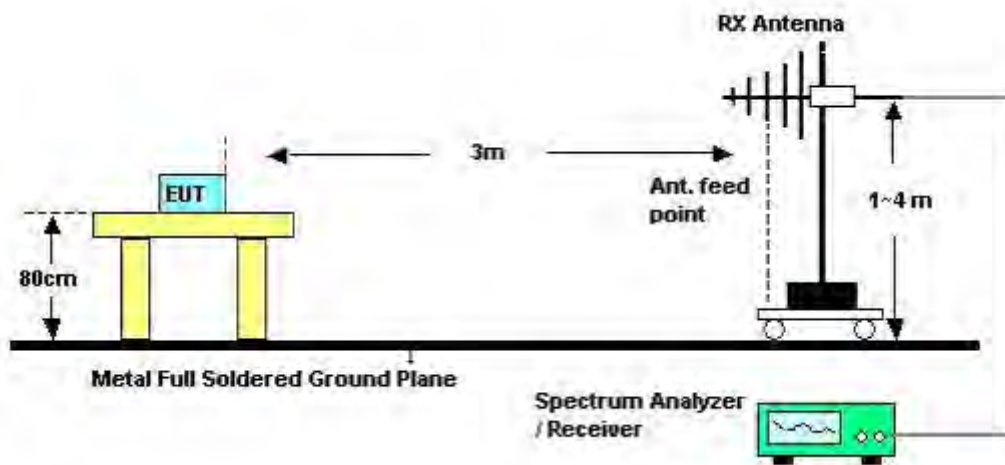

For Radiated Emissions: Above 1GHz

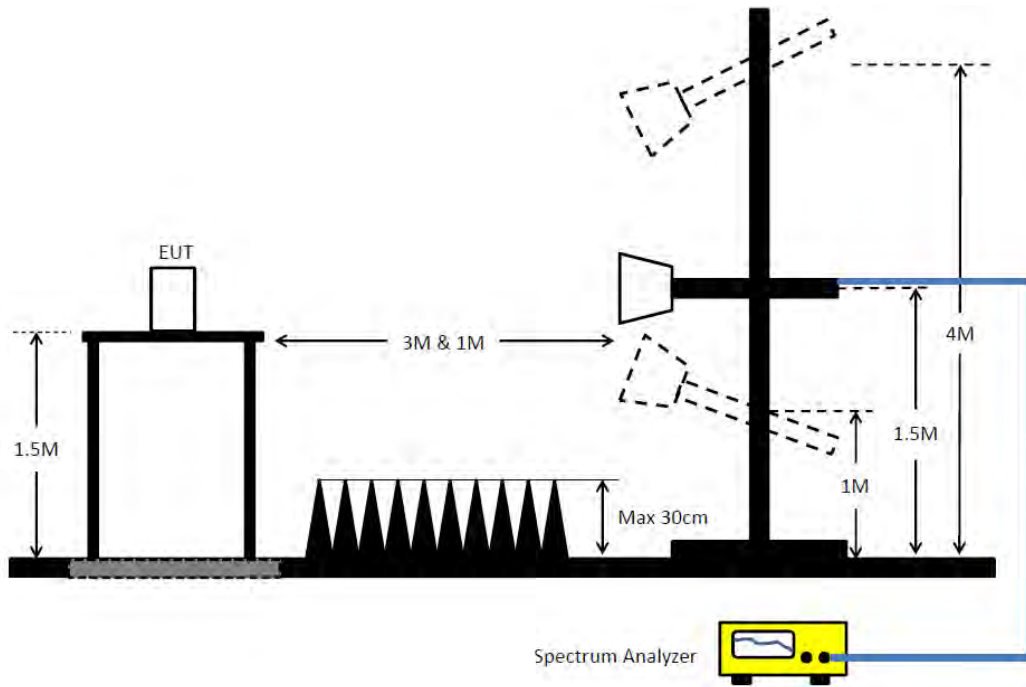

2.4.5. Test Deviation

There is no deviation with the original standard.

2.4.6. EUT Operation during Test

The EUT was programmed to be in continuously transmitting mode.

2.4.7. Measurement Results Calculation

The measured Level is calculated using:

Corrected Reading: Antenna factor (AF) + Cable loss (CL) + Read level (Raw) - Preamp factor (PA)(if applicable) = Level.



2.4.8. Results of Radiated Emissions (9kHz~30MHz)

There is a comparison data of both open-field test site and alternative test site - semi-Anechoic chamber according to KDB414788 Radiated Test Site, and the result came out very similar.

The amplitude of spurious emissions which are attenuated by more than 20dB below the permissible value has no need to be reported.

The radiated emissions were investigated from 9 kHz or the lowest frequency generated within the device, up to the 10 harmonic or 40 GHz, whichever is appropriate.

Distance extrapolation factor = $40 \log(\text{specific distance} / \text{test distance})$ (dB);

Limit line = specific limits (dBuV) + distance extrapolation factor.

2.4.9. Results of Radiated Emissions (30MHz~1GHz)

Refer as Appendix B



2.5. Band Edge Emissions Measurement

2.5.1. Limit

Band edge emissions radiated outside of the specified frequency bands shall be attenuated by at least 50 dB below the level of the fundamental or comply with the radiated emissions limits specified in section 15.209(a) limit in the table below has to be followed.

Frequencies (MHz)	Field Strength (micorvolts/meter)	Measurement Distance (meters)
0.009~0.490	2400/F(kHz)	300
0.490~1.705	24000/F(kHz)	30
1.705~30.0	30	30
30~88	100	3
88~216	150	3
216~960	200	3
Above 960	500	3

2.5.2. Measuring Instruments and Setting

Refer a test equipment and calibration data table in this test report. The following table is the setting of the spectrum analyzer.

Spectrum Parameter	Setting
Attenuation	Auto
Span Frequency	100 MHz
RBW / VBW (Emission in restricted band)	1MHz / 3MHz for Peak, 1 MHz / 1/T for Average
RBW / VBW (Emission in non-restricted band)	100kHz/300kHz for Peak

2.5.3. Test Procedures

The test procedure is the same as section 2.4.3.

2.5.4. Test Setup Layout

This test setup layout is the same as that shown in section 2.4.4.

2.5.5. Test Deviation

There is no deviation with the original standard.

2.5.6. EUT Operation during Test

The EUT was programmed to be in continuously transmitting mode.



2.5.7. Measurement Results Calculation

The measured Level is calculated using:

Corrected Reading: Antenna factor (AF) + Cable loss (CL) + Read level (Raw) - Preamp factor (PA)(if applicable) = Level.

2.5.8. Test Result of Band Edge and Fundamental Emissions

Refer as Appendix B



2.6. Antenna Requirements

2.6.1. Limit

Except for special regulations, the Low-power Radio-frequency Devices must not be equipped with any jacket for installing an antenna with extension cable. An intentional radiator shall be designed to ensure that no antenna other than that furnished by the responsible party shall be used with the device. The use of a permanently attached antenna or of an antenna that uses a unique coupling to the intentional radiator shall be considered sufficient to comply with the provisions of this Section. The manufacturer may design the unit so that the user can replace a broken antenna, but the use of a standard antenna jack or electrical connector is prohibited.

2.6.2. Antenna Connector Construction

The antenna connector complied with the requirements.



3. List of Measuring Equipments

Instrument	Brand	Model No.	Serial No.	Characteristics	Calibration Date	Calibration Due Date	Remark
LISN	Schwarzbeck	NSLK 8127	8127650	9kHz ~ 30MHz	Dec. 04, 2020	Dec. 03, 2021	Conduction (CO02-CB)
LISN	Schwarzbeck	NSLK 8127	8127478	9kHz ~ 30MHz	Nov. 20, 2020	Nov. 19, 2021	Conduction (CO02-CB)
EMI Receiver	Agilent	N9038A	MY52260140	9kHz ~ 8.4GHz	May 05, 2021	May 04, 2022	Conduction (CO02-CB)
Pulse Limiter	Schwarzbeck	VTSD 9561F-N	00378	9kHz ~ 30MHz	Mar. 18, 2021	Mar. 17, 2022	Conduction (CO02-CB)
COND Cable	Woken	Cable	2	0.15MHz ~ 30MHz	Oct. 20, 2020	Oct. 19, 2021	Conduction (CO02-CB)
Software	SPORTON	SENSE	V5.10	-	N.C.R.	N.C.R.	Conduction (CO02-CB)
Loop Antenna	Teseq	HLA 6120	24155	9kHz - 30 MHz	Apr. 14, 2021	Apr. 13, 2022	Radiation (03CH05-CB)
3m Semi Anechoic Chamber NSA	TDK	SAC-3M	03CH05-CB	30 MHz ~ 1 GHz	Aug. 09, 2021	Aug. 08, 2022	Radiation (03CH05-CB)
Bilog Antenna with 6dB Attenuator	TESEQ & EMCI	CBL 6112D & N-6-06	35236 & AT-N0610	30MHz ~ 2GHz	Mar. 26, 2021	Mar. 25, 2022	Radiation (03CH05-CB)
Pre-Amplifier	EMCI	EMC330N	980331	20MHz ~ 3GHz	Apr. 27, 2021	Apr. 26, 2022	Radiation (03CH05-CB)
Spectrum Analyzer	R&S	FSP40	100304	9kHz ~ 40GHz	Nov. 10, 2020	Nov. 09, 2021	Radiation (03CH05-CB)
EMI Test Receiver	R&S	ESCS	826547/017	9kHz ~ 2.75GHz	Jun. 21, 2021	Jun. 20, 2022	Radiation (03CH05-CB)
RF Cable-low	Woken	RG402	Low Cable-04+23	30MHz~1GHz	Oct. 05, 2020	Oct. 04, 2021	Radiation (03CH05-CB)
Test Software	SPORTON	SENSE	V5.10	-	N.C.R.	N.C.R.	Radiation (03CH05-CB)
3m Semi Anechoic Chamber VSWR	TDK	SAC-3M	03CH04-CB	1GHz ~18GHz 3m	Feb. 25, 2021	Feb. 24, 2022	Radiation (03CH04-CB)
Horn Antenna	ETS-Lindgren	3115	00143147	750MHz~18GHz	Oct. 23, 2020	Oct. 22, 2021	Radiation (03CH04-CB)
Horn Antenna	Schwarzbeck	BBHA 9170	BBHA9170252	15GHz ~ 40GHz	Aug. 05, 2021	Aug. 04, 2022	Radiation (03CH04-CB)
Pre-Amplifier	Agilent	83017A	MY53270063	0.5GHz ~ 26.5GHz	Jul. 12, 2021	Jul. 11, 2022	Radiation (03CH04-CB)
Pre-Amplifier	MITEQ	TTA1840-35-HG	1864479	18GHz ~ 40GHz	Jul. 13, 2021	Jul. 12, 2022	Radiation (03CH04-CB)
Spectrum Analyzer	R&S	FSP40	100142	9kHz~40GHz	Feb. 19, 2021	Feb. 18, 2022	Radiation (03CH04-CB)
RF Cable-high	Woken	RG402	High Cable-21	1GHz - 18GHz	Oct. 05, 2020	Oct. 04, 2021	Radiation (03CH04-CB)
RF Cable-high	Woken	RG402	High Cable-21+67	1GHz - 18GHz	Nov. 05, 2020	Nov. 04, 2021	Radiation (03CH04-CB)
RF Cable-high	Woken	RG402	High Cable-40G#1	18GHz ~ 40 GHz	Jul. 15, 2021	Jul. 14, 2022	Radiation (03CH04-CB)
RF Cable-high	Woken	RG402	High Cable-40G#2	18GHz ~ 40 GHz	Jul. 15, 2021	Jul. 14, 2022	Radiation (03CH04-CB)
Test Software	SPORTON	SENSE	V5.10	-	N.C.R.	N.C.R.	Radiation (03CH04-CB)
Spectrum analyzer	R&S	FSV40	100979	9kHz~40GHz	May 21, 2021	May 20, 2022	Conducted (TH01-CB)
RF Cable-high	Woken	RG402	High Cable-06	1 GHz ~ 26.5 GHz	Oct. 05, 2020	Oct. 04, 2021	Conducted (TH01-CB)
RF Cable-high	Woken	RG402	High Cable-07	1 GHz ~26.5 GHz	Oct. 05, 2020	Oct. 04, 2021	Conducted (TH01-CB)
RF Cable-high	Woken	RG402	High Cable-08	1 GHz ~26.5 GHz	Oct. 05, 2020	Oct. 04, 2021	Conducted (TH01-CB)



Instrument	Brand	Model No.	Serial No.	Characteristics	Calibration Date	Calibration Due Date	Remark
RF Cable-high	Woken	RG402	High Cable-09	1 GHz –26.5 GHz	Oct. 05, 2020	Oct. 04, 2021	Conducted (TH01-CB)
RF Cable-high	Woken	RG402	High Cable-10	1 GHz –26.5 GHz	Oct. 05, 2020	Oct. 04, 2021	Conducted (TH01-CB)
RF Cable-high	Woken	RG402	High Cable-30	1 GHz –26.5 GHz	Oct. 05, 2020	Oct. 04, 2021	Conducted (TH01-CB)
Power Sensor	Agilent	E9327A	US40442088	50MHz~18GHz	Feb. 23, 2021	Feb. 22, 2022	Conducted (TH01-CB)
Power Meter	Agilent	E4416A	GB41291199	50MHz~18GHz	Feb. 23, 2021	Feb. 22, 2022	Conducted (TH01-CB)
Test Software	SPORTON	SENSE	V5.10	-	N.C.R.	N.C.R.	Conducted (TH01-CB)

Note: Calibration Interval of instruments listed above is one year.

N.C.R. means Non-Calibration required



Summary

Mode	Result	Type	Freq (Hz)	Level (dBuV)	Limit (dBuV)	Margin (dB)	Condition
Mode 1	Pass	AV	307.5k	23.86	50.03	-26.17	Line

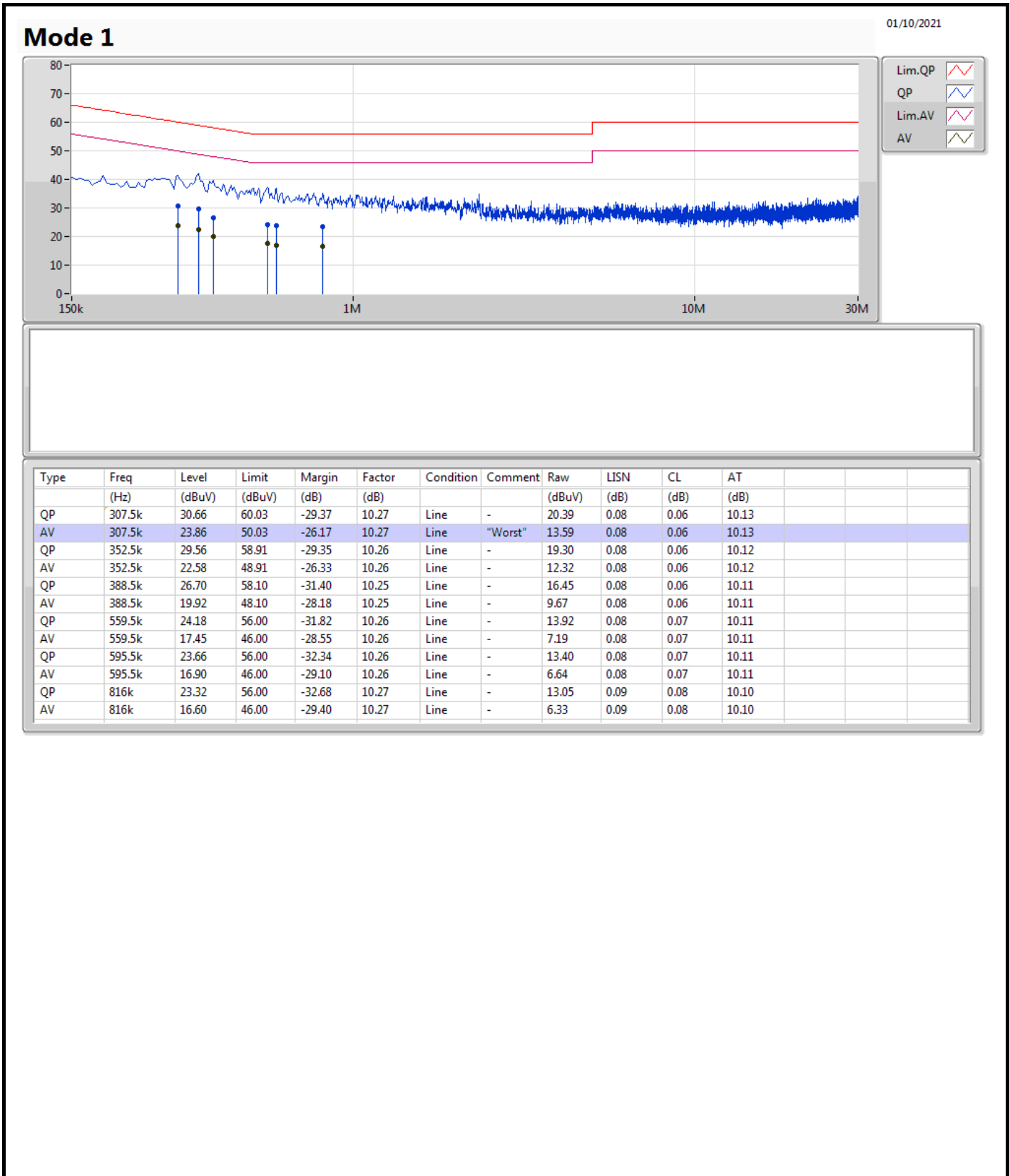

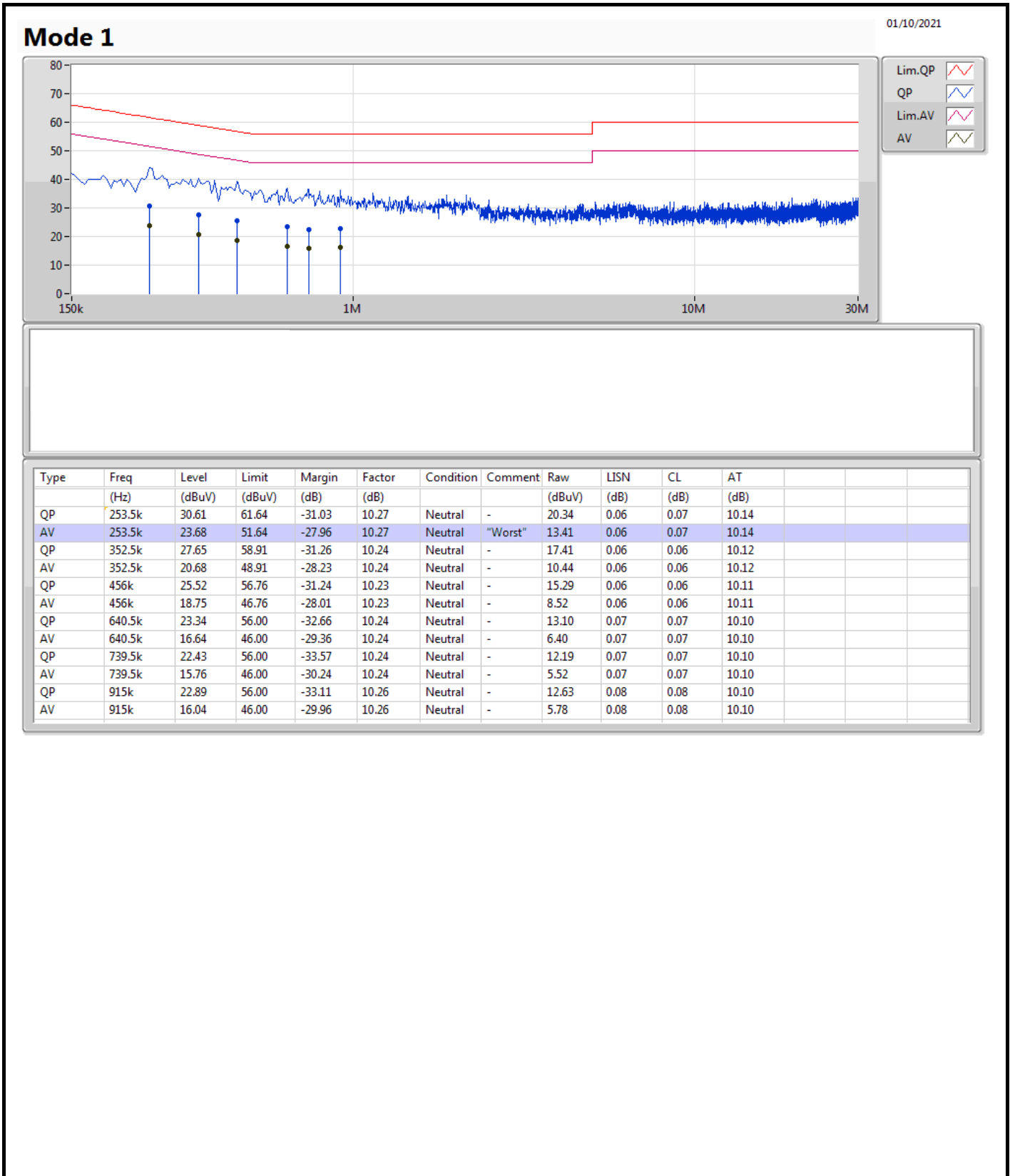



Summary

Mode	Result	Type	Freq (Hz)	Level (dBuV/m)	Limit (dBuV/m)	Margin (dB)	Condition
Mode 1	Pass	PK	729.37M	36.73	46.00	-9.27	Vertical

Mode 1

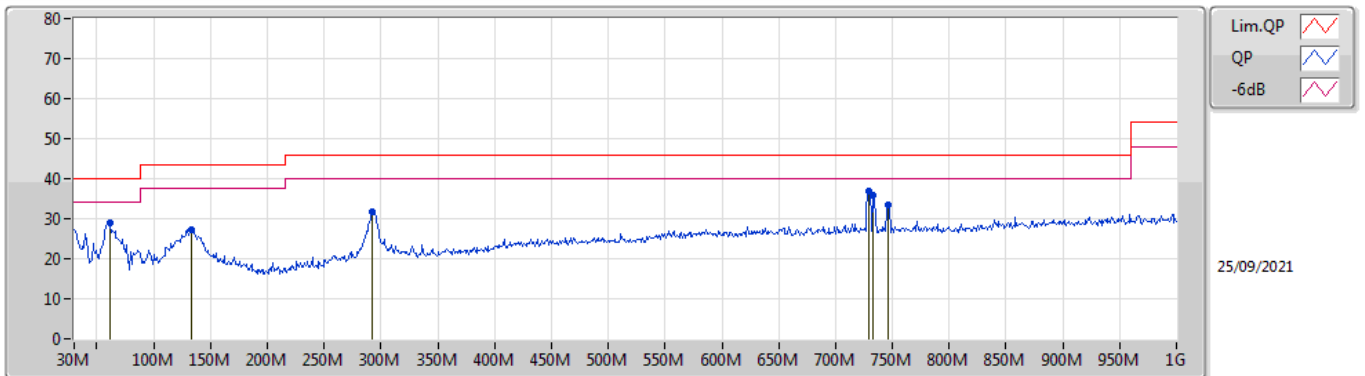

Type	Freq (Hz)	Level (dBuV/m)	Limit (dBuV/m)	Margin (dB)	Factor (dB/m)	Dist (m)	Condition	Azimuth (°)	Height (m)	Comment	Raw (dBuV/m)	AF (dB/m)	CL (dB)	PA (dB)
PK	61.04M	28.99	40.00	-11.01	-18.85	3	Vertical	18	1.25	-	47.84	12.20	0.80	31.85
PK	132.82M	27.33	43.50	-16.17	-13.16	3	Vertical	1	1.25	-	40.49	17.49	1.30	31.95
PK	291.9M	31.87	46.00	-14.13	-11.11	3	Vertical	21	2.00	-	42.98	18.81	2.15	32.07
PK	729.37M	36.73	46.00	-9.27	-4.20	3	Vertical	0	1.25	"Worst"	40.93	24.93	3.56	32.69
PK	733.25M	35.84	46.00	-10.16	-4.12	3	Vertical	2	2.00	-	39.96	25.00	3.57	32.69
PK	745.86M	33.38	46.00	-12.62	-3.95	3	Vertical	11	1.00	-	37.33	25.17	3.59	32.71

Radiated Emissions below 1GHz_Mode 1

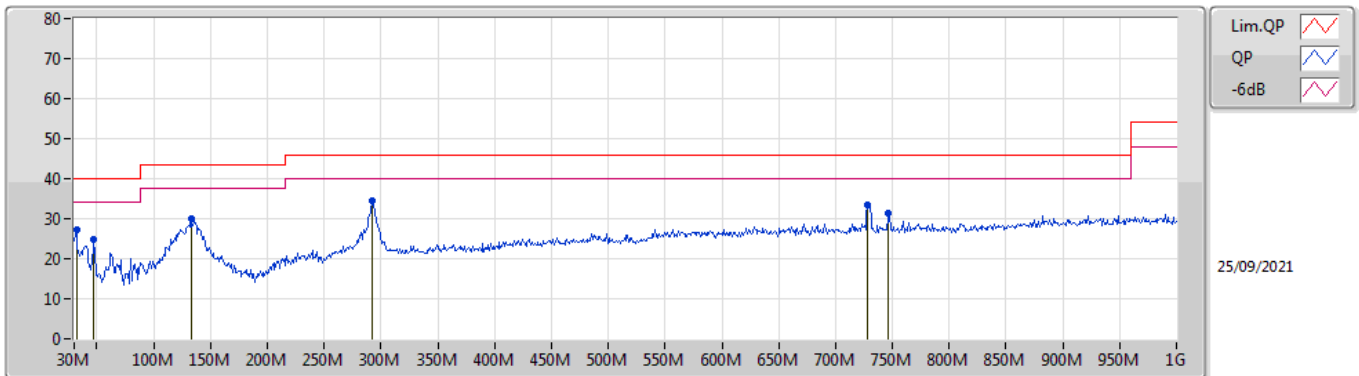

Type	Freq (Hz)	Level (dBuV/m)	Limit (dBuV/m)	Margin (dB)	Factor (dB/m)	Dist (m)	Condition	Azimuth (°)	Height (m)	Comment	Raw (dBuV/m)	AF (dB/m)	CL (dB)	PA (dB)
PK	31.94M	27.24	40.00	-12.76	-8.09	3	Horizontal	184	1.00	-	35.33	23.00	0.44	31.53
PK	47.46M	24.74	40.00	-15.26	-16.24	3	Horizontal	167	3.00	-	40.98	14.90	0.60	31.74
PK	132.82M	30.06	43.50	-13.44	-13.16	3	Horizontal	98	1.50	-	43.22	17.49	1.30	31.95
PK	291.9M	34.55	46.00	-11.45	-11.11	3	Horizontal	231	1.00	"Worst"	45.66	18.81	2.15	32.07
PK	728.4M	33.50	46.00	-12.50	-4.22	3	Horizontal	151	1.25	-	37.72	24.90	3.56	32.68
PK	746.83M	31.21	46.00	-14.79	-3.95	3	Horizontal	177	1.25	-	35.16	25.17	3.59	32.71



**Field Strength of Fundamental Emissions /
Radiated Emissions Above 1GHz / Band Edge Emissions**

Appendix B.2

Summary

Mode	Result	Type	Freq (Hz)	Level (dBuV/m)	Limit (dBuV/m)	Margin (dB)	Dist (m)	Condition	Azimuth (°)	Height (m)	Comments
2.4-2.4835GHz	-	-	-	-	-	-	-	-	-	-	-
O-QPSK	Pass	AV	2.37625G	46.02	54.00	-7.98	3	Horizontal	215	1.10	-

O-QPSK

2404.053MHz_TX

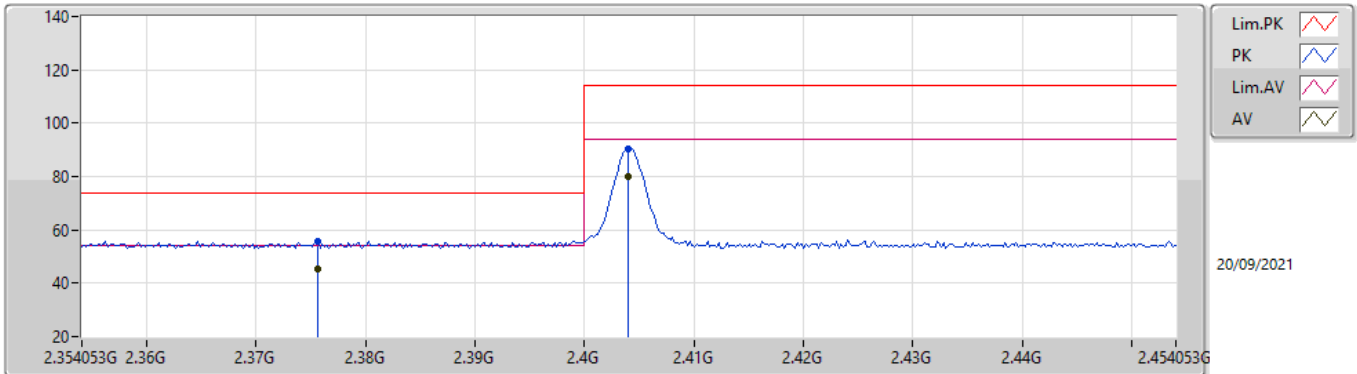

EUTX_1TX
Setting Default
04-C-N-2

Type	Freq (Hz)	Level (dBuV/m)	Limit (dBuV/m)	Margin (dB)	Raw (dBuV)	Dist (m)	Condition	Azimuth (°)	Height (m)	Comment	AF (dB)	CL (dB)	PA (dB)
PK	2.37565G	55.67	74.00	-18.33	25.02	3	Vertical	21	1.13	-	27.45	3.20	-
AV	2.37565G	45.21	54.00	-8.79	14.56	3	Vertical	21	1.13	-	27.45	3.20	-
PK	2.40405G	90.26	114.00	-23.74	59.55	3	Vertical	21	1.13	-	27.51	3.20	-
AV	2.40405G	79.80	94.00	-14.20	49.09	3	Vertical	21	1.13	-	27.51	3.20	-

O-QPSK

2404.053MHz_TX

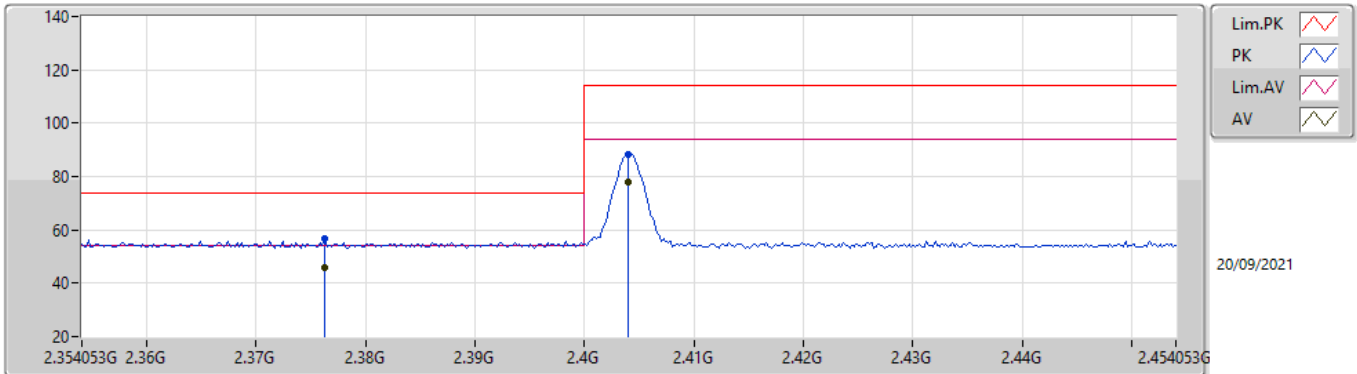

EUTX_1TX
Setting Default
04-C-N-2

Type	Freq (Hz)	Level (dBuV/m)	Limit (dBuV/m)	Margin (dB)	Raw (dBuV)	Dist (m)	Condition	Azimuth (°)	Height (m)	Comment	AF (dB)	CL (dB)	PA (dB)
PK	2.37625G	56.48	74.00	-17.52	25.83	3	Horizontal	215	1.10	-	27.45	3.20	-
AV	2.37625G	46.02	54.00	-7.98	15.37	3	Horizontal	215	1.10	-	27.45	3.20	-
PK	2.40405G	88.40	114.00	-25.60	57.69	3	Horizontal	215	1.10	-	27.51	3.20	-
AV	2.40405G	77.94	94.00	-16.06	47.23	3	Horizontal	215	1.10	-	27.51	3.20	-

O-QPSK

2404.053MHz_TX

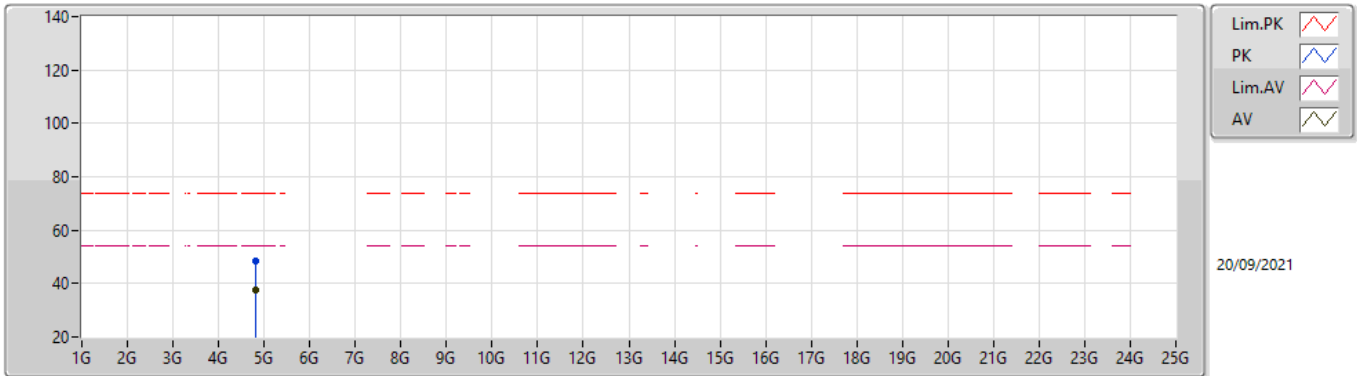

EUTX_1TX
Setting Default
04-C-N-2

Type	Freq (Hz)	Level (dBuV/m)	Limit (dBuV/m)	Margin (dB)	Raw (dBuV)	Dist (m)	Condition	Azimuth (°)	Height (m)	Comment	AF (dB)	CL (dB)	PA (dB)
PK	4.81763G	48.25	74.00	-25.75	43.58	3	Vertical	233	1.50	-	32.51	5.41	33.25
AV	4.81763G	37.79	54.00	-16.21	33.12	3	Vertical	233	1.50	-	32.51	5.41	33.25

O-QPSK
2404.053MHz_TX

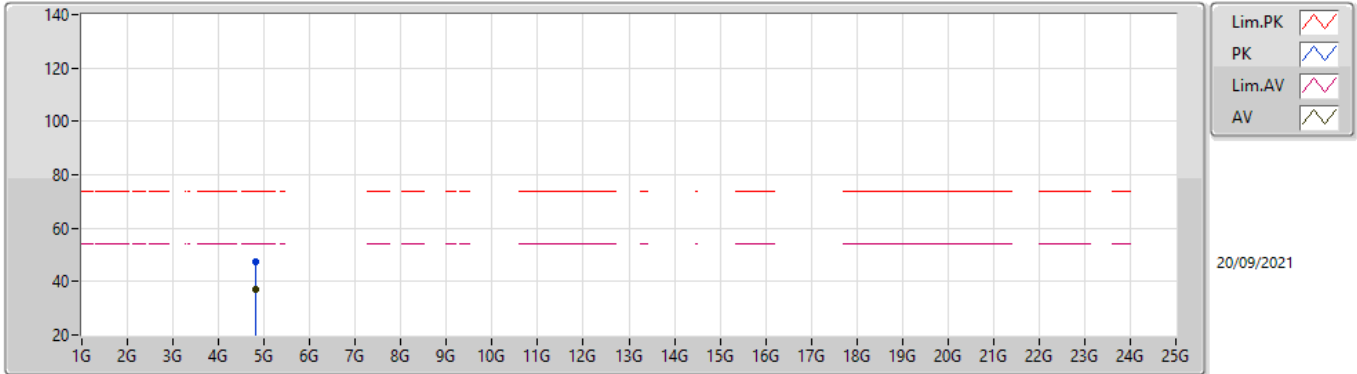

EUTX_1TX
Setting Default
04-C-N-2

Type	Freq (Hz)	Level (dBuV/m)	Limit (dBuV/m)	Margin (dB)	Raw (dBuV)	Dist (m)	Condition	Azimuth (°)	Height (m)	Comment	AF (dB)	CL (dB)	PA (dB)
PK	4.79883G	47.61	74.00	-26.39	43.07	3	Horizontal	199	2.33	-	32.40	5.40	33.26
AV	4.79883G	37.15	54.00	-16.85	32.61	3	Horizontal	199	2.33	-	32.40	5.40	33.26

**O-QPSK
2441.844MHz_TX**

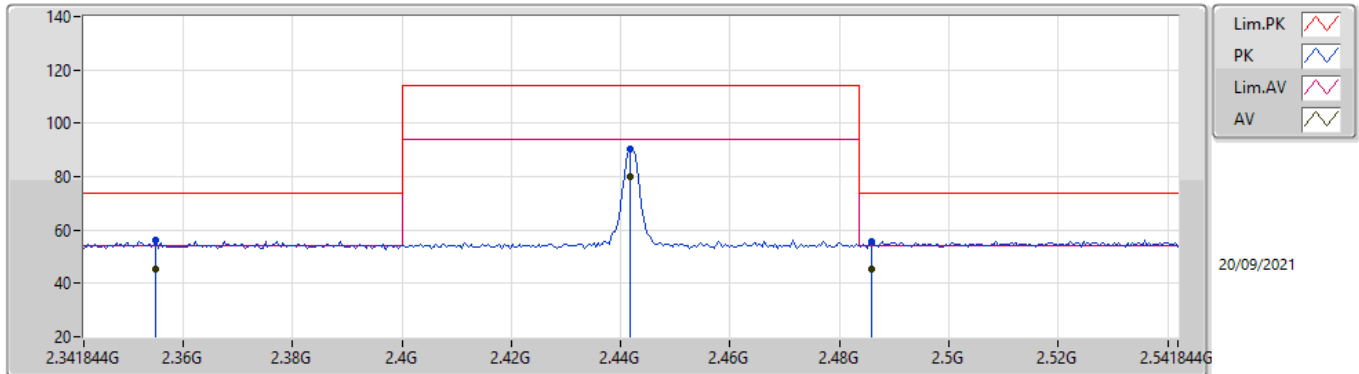

EUTX_1TX
Setting Default
04-C-N-2

Type	Freq (Hz)	Level (dBuV/m)	Limit (dBuV/m)	Margin (dB)	Raw (dBuV)	Dist (m)	Condition	Azimuth (°)	Height (m)	Comment	AF (dB)	CL (dB)	PA (dB)
PK	2.35504G	56.01	74.00	-17.99	25.40	3	Vertical	33	1.13	-	27.41	3.20	-
AV	2.35504G	45.55	54.00	-8.45	14.94	3	Vertical	33	1.13	-	27.41	3.20	-
PK	2.44184G	90.29	114.00	-23.71	59.47	3	Vertical	33	1.13	-	27.58	3.24	-
AV	2.44184G	79.83	94.00	-14.17	49.01	3	Vertical	33	1.13	-	27.58	3.24	-
PK	2.48584G	55.60	74.00	-18.40	24.57	3	Vertical	33	1.13	-	27.74	3.29	-
AV	2.48584G	45.14	54.00	-8.86	14.11	3	Vertical	33	1.13	-	27.74	3.29	-

**O-QPSK
2441.844MHz_TX**

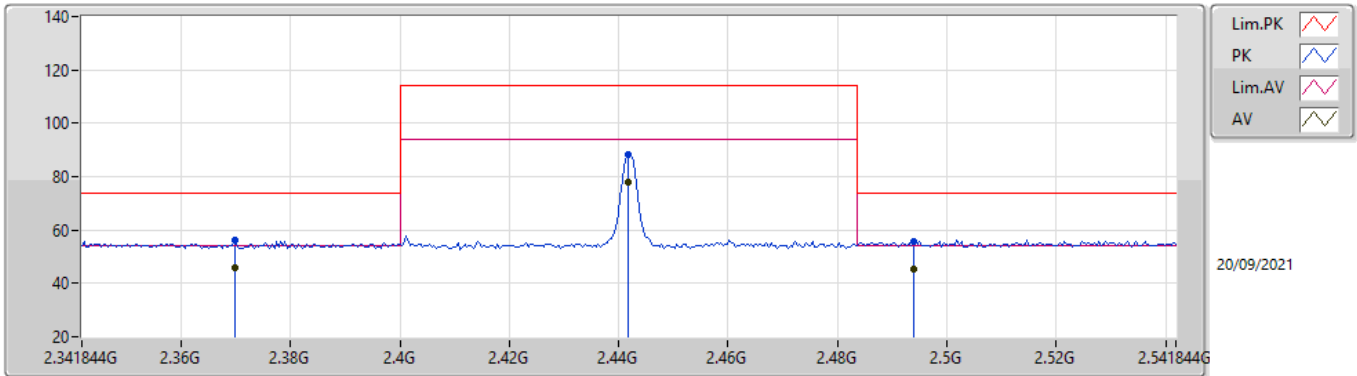

EUTX_1TX
Setting Default
04-C-N-2

Type	Freq (Hz)	Level (dBuV/m)	Limit (dBuV/m)	Margin (dB)	Raw (dBuV)	Dist (m)	Condition	Azimuth (°)	Height (m)	Comment	AF (dB)	CL (dB)	PA (dB)
PK	2.36984G	56.07	74.00	-17.93	25.43	3	Horizontal	327	1.05	-	27.44	3.20	-
AV	2.36984G	45.61	54.00	-8.39	14.97	3	Horizontal	327	1.05	-	27.44	3.20	-
PK	2.44184G	88.37	114.00	-25.63	57.55	3	Horizontal	327	1.05	-	27.58	3.24	-
AV	2.44184G	77.91	94.00	-16.09	47.09	3	Horizontal	327	1.05	-	27.58	3.24	-
PK	2.49384G	55.64	74.00	-18.36	24.57	3	Horizontal	327	1.05	-	27.78	3.29	-
AV	2.49384G	45.18	54.00	-8.82	14.11	3	Horizontal	327	1.05	-	27.78	3.29	-

O-QPSK
2441.844MHz_TX

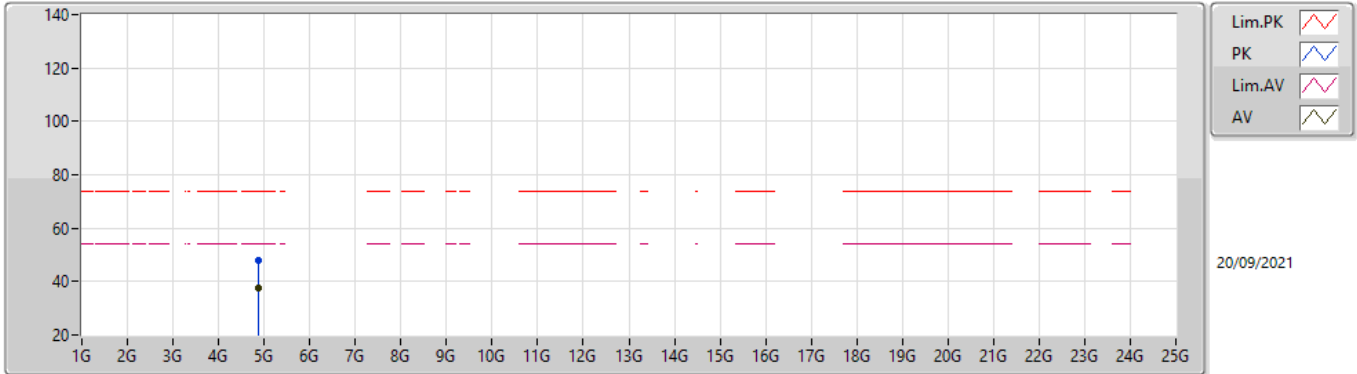

EUTX_1TX
Setting Default
04-C-N-2

Type	Freq (Hz)	Level (dBuV/m)	Limit (dBuV/m)	Margin (dB)	Raw (dBuV)	Dist (m)	Condition	Azimuth (°)	Height (m)	Comment	AF (dB)	CL (dB)	PA (dB)
PK	4.88369G	48.06	74.00	-25.94	43.07	3	Vertical	7	1.16	-	32.77	5.44	33.22
AV	4.88369G	37.60	54.00	-16.40	32.61	3	Vertical	7	1.16	-	32.77	5.44	33.22

O-QPSK
2441.844MHz_TX

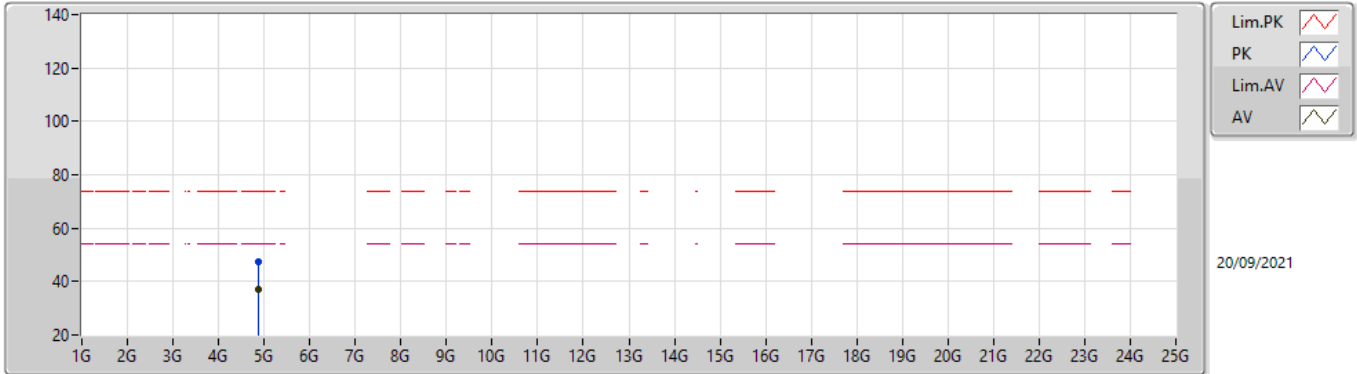

EUTX_1TX
Setting Default
04-C-N-2

Type	Freq (Hz)	Level (dBuV/m)	Limit (dBuV/m)	Margin (dB)	Raw (dBuV)	Dist (m)	Condition	Azimuth (°)	Height (m)	Comment	AF (dB)	CL (dB)	PA (dB)
PK	4.88321G	47.31	74.00	-26.69	42.32	3	Horizontal	305	1.00	-	32.77	5.44	33.22
AV	4.88321G	36.85	54.00	-17.15	31.86	3	Horizontal	305	1.00	-	32.77	5.44	33.22

O-QPSK

2479.285MHz_TX

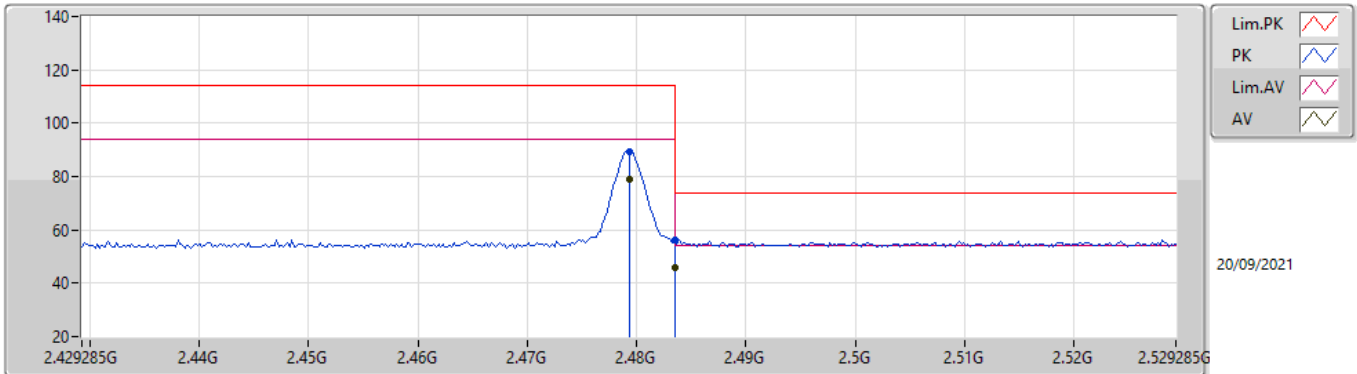

EUTX_1TX
Setting Default
04-C-N-2

Type	Freq (Hz)	Level (dBuV/m)	Limit (dBuV/m)	Margin (dB)	Raw (dBuV)	Dist (m)	Condition	Azimuth (°)	Height (m)	Comment	AF (dB)	CL (dB)	PA (dB)
PK	2.47929G	89.42	114.00	-24.58	58.42	3	Vertical	15	1.05	-	27.72	3.28	-
AV	2.47929G	78.96	94.00	-15.04	47.96	3	Vertical	15	1.05	-	27.72	3.28	-
PK	2.4835G	56.23	74.00	-17.77	25.22	3	Vertical	15	1.05	-	27.73	3.28	-
AV	2.4835G	45.77	54.00	-8.23	14.76	3	Vertical	15	1.05	-	27.73	3.28	-

O-QPSK

2479.285MHz_TX

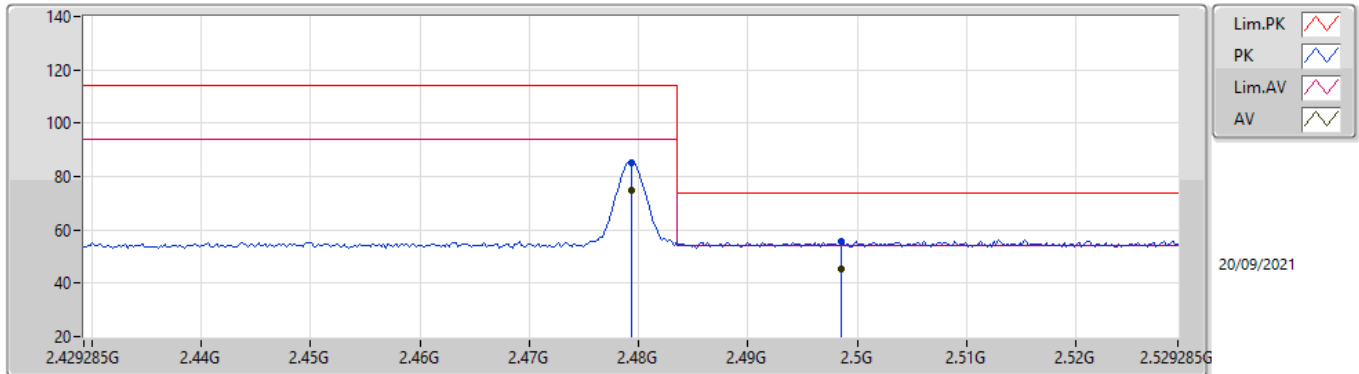

EUTX_1TX
Setting Default
04-C-N-2

Type	Freq (Hz)	Level (dBuV/m)	Limit (dBuV/m)	Margin (dB)	Raw (dBuV)	Dist (m)	Condition	Azimuth (°)	Height (m)	Comment	AF (dB)	CL (dB)	PA (dB)
PK	2.47929G	85.40	114.00	-28.60	54.40	3	Horizontal	329	1.07	-	27.72	3.28	-
AV	2.47929G	74.94	94.00	-19.06	43.94	3	Horizontal	329	1.07	-	27.72	3.28	-
PK	2.49849G	55.70	74.00	-18.30	24.61	3	Horizontal	329	1.07	-	27.79	3.30	-
AV	2.49849G	45.24	54.00	-8.76	14.15	3	Horizontal	329	1.07	-	27.79	3.30	-

O-QPSK
2479.285MHz_TX

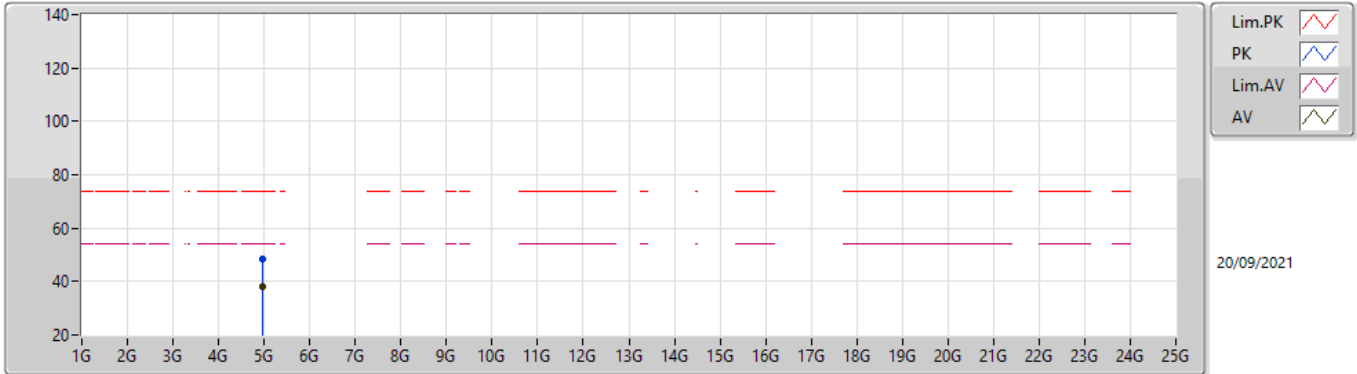

EUTX_1TX
Setting Default
04-C-N-2

Type	Freq (Hz)	Level (dBuV/m)	Limit (dBuV/m)	Margin (dB)	Raw (dBuV)	Dist (m)	Condition	Azimuth (°)	Height (m)	Comment	AF (dB)	CL (dB)	PA (dB)
PK	4.94985G	48.37	74.00	-25.63	43.09	3	Vertical	8	1.00	-	33.00	5.47	33.19
AV	4.94985G	37.91	54.00	-16.09	32.63	3	Vertical	8	1.00	-	33.00	5.47	33.19

O-QPSK
2479.285MHz_TX

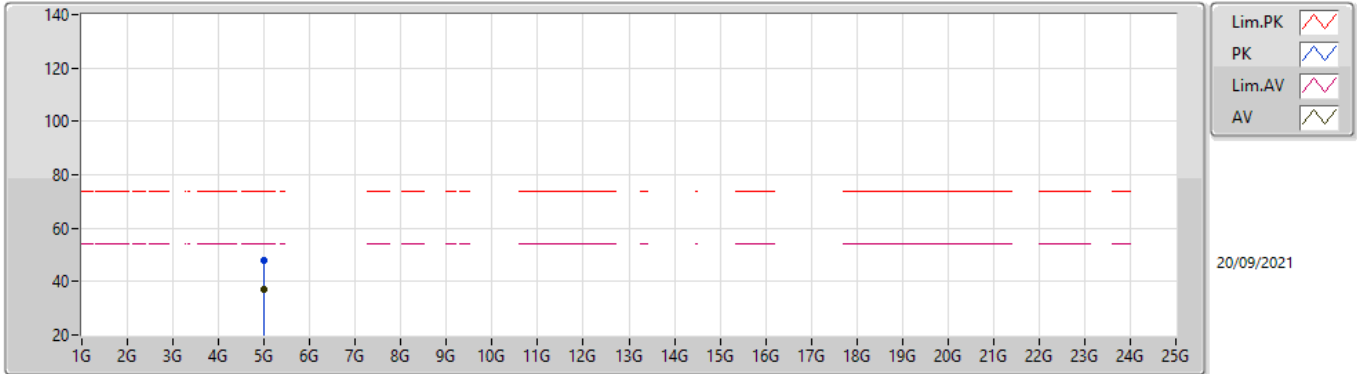

EUTX_1TX
Setting Default
04-C-N-2

Type	Freq (Hz)	Level (dBuV/m)	Limit (dBuV/m)	Margin (dB)	Raw (dBuV)	Dist (m)	Condition	Azimuth (°)	Height (m)	Comment	AF (dB)	CL (dB)	PA (dB)
PK	4.99577G	47.78	74.00	-26.22	42.53	3	Horizontal	311	1.04	-	32.91	5.50	33.16
AV	4.99577G	37.32	54.00	-16.68	32.07	3	Horizontal	311	1.04	-	32.91	5.50	33.16



Frequency (MHz)	20dB BW (MHz)	99% OBW (MHz)	Frequency range (MHz) $f_L > 2400\text{MHz}$	Frequency range (MHz) $f_H < 2483.5\text{MHz}$	Test Result
2404.053	1.228	1.69	2403.4250	-	PASS
2441.844	1.231	1.68	-	-	PASS
2479.285	1.240	1.69	-	2478.4050	PASS

20 dB + 99%Bandwidth Plot on 2404.053 MHz

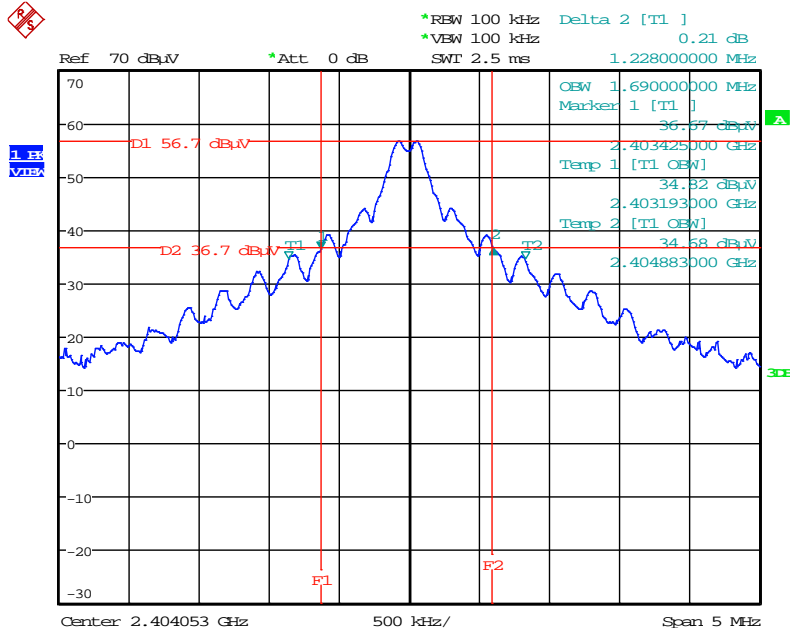

Date: 20.SEP.2021 16:18:47

20 dB + 99% Bandwidth Plot on 2441.844 MHz

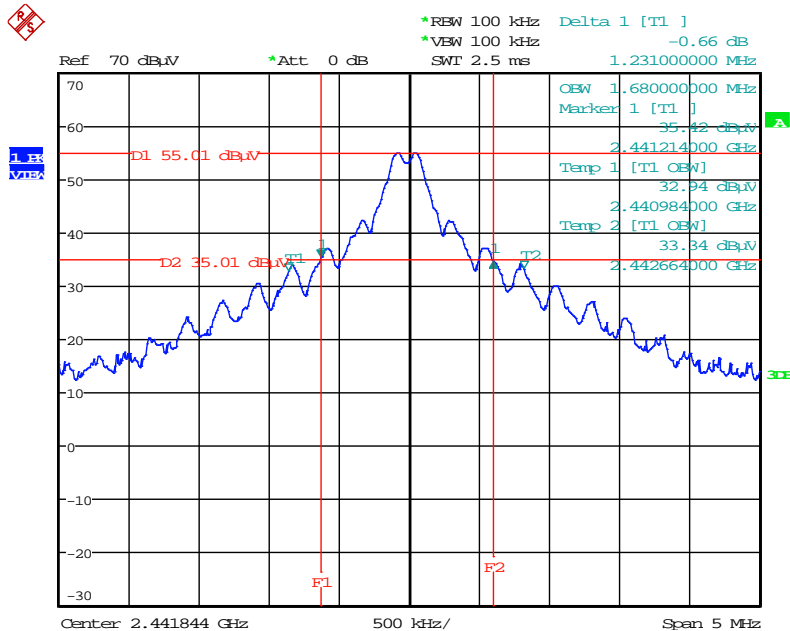

Date: 20.SEP.2021 16:38:16

20 dB + 99% Bandwidth Plot on 2479.285 MHz

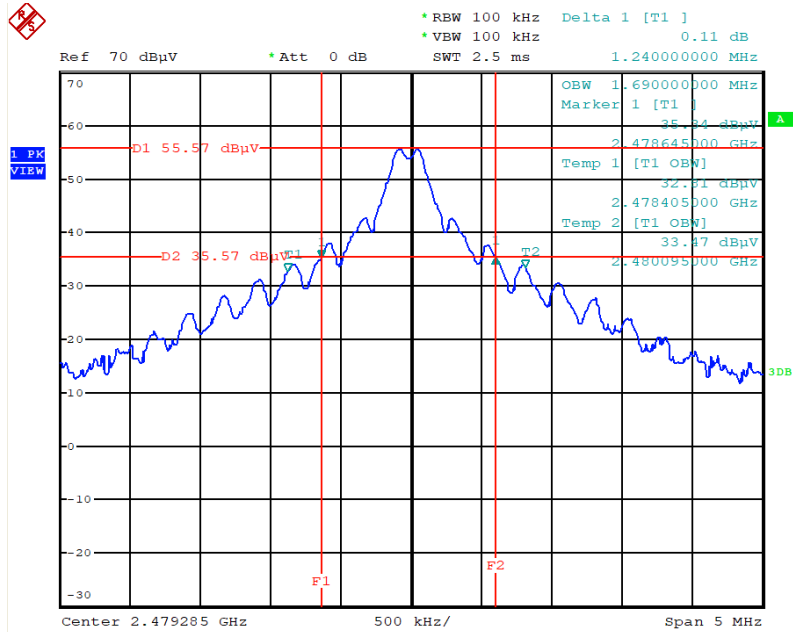

Date: 20.SEP.2021 16:40:19