

FCC Test Report

Report No.: RF160720C36B

FCC ID: UDX-60051010

Test Model: MR30H-HW

Received Date: Jul. 11, 2016

Test Date: Jul. 11 ~ Sep. 13, 2016

Issued Date: Sep. 14, 2016

Applicant: Cisco Systems, Inc.

Address: 170 West Tasman Drive, San Jose, CA 95134

Issued By: Bureau Veritas Consumer Products Services (H.K.) Ltd., Taoyuan Branch

Lab Address: No. 47-2, 14th Ling, Chia Pau Vil., Lin Kou Dist., New Taipei City, Taiwan, R.O.C.

Test Location: No. 19, Hwa Ya 2nd Rd., Wen Hwa Vil., Kwei Shan Dist., Taoyuan City 33383, TAIWAN (R.O.C.)



This report is for your exclusive use. Any copying or replication of this report to or for any other person or entity, or use of our name or trademark, is permitted only with our prior written permission. This report sets forth our findings solely with respect to the test samples identified herein. The results set forth in this report are not indicative or representative of the quality or characteristics of the lot from which a test sample was taken or any similar or identical product unless specifically and expressly noted. Our report includes all of the tests requested by you and the results thereof based upon the information that you provided to us. You have 60 days from date of issuance of this report to notify us of any material error or omission caused by our negligence, provided, however, that such notice shall be in writing and shall specifically address the issue you wish to raise. A failure to raise such issue within the prescribed time shall constitute your unqualified acceptance of the completeness of this report, the tests conducted and the correctness of the report contents. Unless specific mention, the uncertainty of measurement has been explicitly taken into account to declare the compliance or non-compliance to the specification. The report must not be used by the client to claim product certification, approval, or endorsement by TAF or any government agencies.



Table of Contents

Release Control Record	4
1 Certificate of Conformity	5
2 Summary of Test Results	6
2.1 Measurement Uncertainty.....	6
2.2 Modification Record.....	6
3 General Information	7
3.1 General Description of EUT.....	7
3.2 Description of Test Modes.....	9
3.2.1 Test Mode Applicability and Tested Channel Detail.....	10
3.3 Duty Cycle of Test Signal.....	13
3.4 Description of Support Units.....	16
3.4.1 Configuration of System under Test.....	16
3.5 General Description of Applied Standards.....	17
4 Test Types and Results	18
4.1 Radiated Emission and Bandedge Measurement.....	18
4.1.1 Limits of Radiated Emission and Bandedge Measurement.....	18
4.1.2 Test Instruments.....	19
4.1.3 Test Procedures.....	20
4.1.4 Deviation from Test Standard.....	20
4.1.5 Test Setup.....	21
4.1.6 EUT Operating Conditions.....	21
4.1.7 Test Results.....	22
4.2 Conducted Emission Measurement.....	75
4.2.1 Limits of Conducted Emission Measurement.....	75
4.2.2 Test Instruments.....	75
4.2.3 Test Procedures.....	75
4.2.4 Deviation from Test Standard.....	75
4.2.5 Test Setup.....	76
4.2.6 EUT Operating Conditions.....	76
4.2.7 Test Results.....	77
4.3 Transmit Power Measurement.....	81
4.3.1 Limits of Transmit Power Measurement.....	81
4.3.2 Test Setup.....	81
4.3.3 Test Instruments.....	82
4.3.4 Test Procedure.....	82
4.3.5 Deviation from Test Standard.....	82
4.3.6 EUT Operating Conditions.....	82
4.3.7 Test Result.....	83
4.4 Peak Power Spectral Density Measurement.....	107
4.4.1 Limits of Peak Power Spectral Density Measurement.....	107
4.4.2 Test Setup.....	107
4.4.3 Test Instruments.....	107
4.4.4 Test Procedures.....	107
4.4.5 Deviation from Test Standard.....	107
4.4.6 EUT Operating Conditions.....	107
4.4.7 Test Results.....	108
4.5 Frequency Stability.....	115
4.5.1 Limits of Frequency Stability Measurement.....	115
4.5.2 Test Setup.....	115
4.5.3 Test Instruments.....	115
4.5.4 Test Procedure.....	115
4.5.5 Deviation from Test Standard.....	115
4.5.6 EUT Operating Condition.....	115

4.5.7 Test Results	116
5 Pictures of Test Arrangements.....	118
Appendix – Information on the Testing Laboratories	119



Release Control Record

Issue No.	Description	Date Issued
RF160720C36B	Original release	Sep. 14, 2016

1 Certificate of Conformity

Product: Wireless 802.11 abgn/ac indoor AP

Brand: Cisco

Test Model: MR30H-HW

Sample Status: Engineering sample

Applicant: Cisco Systems, Inc.

Test Date: Jul. 11 ~ Sep. 13, 2016

Standards: 47 CFR FCC Part 15, Subpart E (Section 15.407)
ANSI C63.10:2013

The above equipment has been tested by **Bureau Veritas Consumer Products Services (H.K.) Ltd., Taoyuan Branch**, and found compliance with the requirement of the above standards. The test record, data evaluation & Equipment Under Test (EUT) configurations represented herein are true and accurate accounts of the measurements of the sample's EMC characteristics under the conditions specified in this report.

Prepared by :  , **Date:** Sep. 14, 2016
Pettie Chen / Senior Specialist

Approved by :  , **Date:** Sep. 14, 2016
Ken Liu / Senior Manager

2 Summary of Test Results

47 CFR FCC Part 15, Subpart E (SECTION 15.407)			
FCC Clause	Test Item	Result	Remarks
15.407(b)(6)	AC Power Conducted Emissions	Pass	Meet the requirement of limit. Minimum passing margin is -9.23dB at 0.55411MHz.
15.407(b) (1/2/3/4/6)	Radiated Emissions & Band Edge Measurement	Pass	Meet the requirement of limit. Minimum passing margin is -1.0dB at 5350.00MHz.
15.407(a)(1/2 /3)	Max Average Transmit Power	Pass	Meet the requirement of limit.
15.407(a)(1/2 /3)	Peak Power Spectral Density	Pass	Meet the requirement of limit.
15.407(g)	Frequency Stability	Pass	Meet the requirement of limit.
15.203	Antenna Requirement	Pass	Radio 2: Antenna connector is IPEX not a standard connector. Radio 3: No antenna connector is used.

2.1 Measurement Uncertainty

Where relevant, the following measurement uncertainty levels have been estimated for tests performed on the EUT as specified in CISPR 16-4-2:

Measurement	Frequency	Expanded Uncertainty (k=2) (\pm)
Conducted Emissions at mains ports	150kHz ~ 30MHz	2.44 dB
Radiated Emissions up to 1 GHz	30MHz ~ 200MHz	3.86 dB
	200MHz ~ 1000MHz	3.87 dB
Radiated Emissions above 1 GHz	1GHz ~ 18GHz	2.29 dB
	18GHz ~ 40GHz	2.29 dB

2.2 Modification Record

There were no modifications required for compliance.

3 General Information

3.1 General Description of EUT

Product	Wireless 802.11 abgn/ac indoor AP
Brand	Cisco
Test Model	MR30H-HW
Status of EUT	Engineering sample
Power Supply Rating	48Vdc (POE)
Modulation Type	256QAM, 64QAM, 16QAM, QPSK, BPSK
Modulation Technology	OFDM
Transfer Rate	802.11a: 54.0/ 48.0/ 36.0/ 24.0/ 18.0/ 12.0/ 9.0/ 6.0Mbps 802.11n: up to 300.0Mbps 802.11ac: up to 867Mbps
Operating Frequency	5260 ~ 5320MHz, 5500 ~ 5700MHz
Number of Channel	5260 ~ 5320MHz: 4 for 802.11a, 802.11n (HT20), 802.11ac (VHT20) 2 for 802.11n (HT40), 802.11ac (VHT40) 1 for 802.11ac (VHT80) 5500 ~ 5700MHz: 8 for 802.11a, 802.11n (HT20), 802.11ac (VHT20) 3 for 802.11n (HT40), 802.11ac (VHT40) 1 for 802.11ac (VHT80)
Output Power	Radio 2: CDD Mode 5260 ~ 5320MHz: 188.182mW 5500 ~ 5700MHz: 175.218mW Beamforming Mode 5260 ~ 5320MHz: 154.738mW 5500 ~ 5700MHz: 156.340mW Radio 3: CDD Mode 5260 ~ 5320MHz: 69.823mW 5500 ~ 5700MHz: 57.280mW
Antenna Type	Refer to Note 3
Antenna Connector	Refer to Note 3
Accessory Device	N/A
Data Cable Supplied	N/A

Note:

1. This report is prepared for FCC class III permissive change. This report is issued as a supplementary report of the original report no.: RF160720C36-1. The difference compared with original report is adding 5.26GHz to 5.32GHz and 5.50GHz to 5.70GHz by software.
2. The EUT incorporates a MIMO function. Physically, the EUT provides 2 completed transmitters and 2 receivers.

Modulation Mode	TX Function	Beamforming	Remark
802.11a	2TX	Not Support	Radio 2
802.11n (HT20)	2TX	Support	
802.11n (HT40)	2TX	Support	
802.11ac (VHT20)	2TX	Support	
802.11ac (VHT40)	2TX	Support	
802.11ac (VHT80)	2TX	Support	
802.11a	1TX	Not Support	Radio 3
802.11n (HT20)	1TX	Not Support	
802.11n (HT40)	1TX	Not Support	
802.11ac (VHT20)	1TX	Not Support	
802.11ac (VHT40)	1TX	Not Support	
802.11ac (VHT80)	1TX	Not Support	

*The modulation and bandwidth are similar for 802.11n mode for HT20/HT40 and 802.11ac mode for VHT20/VHT40, therefore investigated worst case to representative mode in test report. (Final test mode refer section 3.2.1)

* For 5GHz band, CDD mode is the worst case for final radiated emission (Frequency below 1GHz) and power line conducted emission tests after pretesting CDD mode and beamforming mode.

3. The EUT with follow antennas gain is listed as table below.

No.	Type	Connector	Gain(dBi)		Remark
			2.4GHz	5GHz	
1	PIFA	IPEX	3.99	4.84	2.4G for Radio 1 (WLAN)
2	PIFA	IPEX	3.42	4.87	5G for Radio 2 (WLAN)
3	Chip	NA	2.27	5.18	Radio 3 (WLAN)
4	Chip	NA	2.66	-	Radio 4 (BT LE)

4. The EUT consumes power from the following POE. (Support unit only)

POE	
Brand	EnGenius
Model	EPE-48GR
Power Rating	48Vdc, 0.8A, 38.4W Max

Adapter for POE	
Brand	Powertron Electronics Corp.
Model	PA1040-480IB080
Input Power	100-240Vac, 50-60Hz, 1.5A
Output Power	48Vdc, 0.8A, 38.4W Max
Power Line	1.55m cable with one core attached on adapter

5. Spurious emission of the simultaneous operation (2.4GHz and 5GHz) has been evaluated and no non-compliance was found.
6. The EUT doesn't operate in 5600 ~ 5650MHz via software controls.
7. The above EUT information is declared by manufacturer and for more detailed features description, please refer to the manufacturer's specifications or user's manual.

3.2 Description of Test Modes

For 5260 ~ 5320MHz

4 channels are provided for 802.11a, 802.11n (HT20), 802.11ac (VHT20):

Channel	Frequency	Channel	Frequency
52	5260 MHz	60	5300 MHz
56	5280 MHz	64	5320 MHz

2 channels are provided for 802.11n (HT40), 802.11ac (VHT40):

Channel	Frequency	Channel	Frequency
54	5270 MHz	62	5310 MHz

1 channel is provided for 802.11ac (VHT80):

Channel	Frequency
58	5290 MHz

For 5500 ~ 5700MHz

8 channels are provided for 802.11a, 802.11n (HT20), 802.11ac (VHT20):

Channel	Frequency	Channel	Frequency
100	5500 MHz	116	5580 MHz
104	5520 MHz	132	5660 MHz
108	5540 MHz	136	5680 MHz
112	5560 MHz	140	5700 MHz

3 channels are provided for 802.11n (HT40), 802.11ac (VHT40):

Channel	Frequency	Channel	Frequency
102	5510 MHz	134	5670 MHz
110	5550 MHz		

1 channel is provided for 802.11ac (VHT80):

Channel	Frequency
106	5530MHz

3.2.1 Test Mode Applicability and Tested Channel Detail

EUT CONFIGURE MODE	APPLICABLE TO				DESCRIPTION
	RE \geq 1G	RE<1G	PLC	APCM	
-	√	√	√	√	-

Where **RE \geq 1G**: Radiated Emission above 1GHz & Bandedge Measurement
RE<1G: Radiated Emission below 1GHz
PLC: Power Line Conducted Emission
APCM: Antenna Port Conducted Measurement

Note: The EUT had been pre-tested on the positioned of each 3 axis. The worst case was found when positioned on **Z-plane**.

Radiated Emission Test (Above 1GHz):

Pre-Scan has been conducted to determine the worst-case mode from all possible combinations between available modulations, data rates and antenna ports (if EUT with antenna diversity architecture).

Following channel(s) was (were) selected for the final test as listed below.

EUT CONFIGURE MODE	MODE	FREQ. BAND (MHz)	AVAILABLE CHANNEL	TESTED CHANNEL	MODULATION TECHNOLOGY	MODULATION TYPE	DATA RATE (Mbps)	Remark
CDD Mode								
-	802.11a	5260-5320	52 to 64	52, 60, 64	OFDM	BPSK	6.0	Radio 2 (2TX)
-	802.11a		52 to 64	52, 60, 64	OFDM	BPSK	6.0	Radio 3 (1TX)
-	802.11n (HT20)		52 to 64	52, 60, 64	OFDM	BPSK	6.5	Radio 2 (2TX)
-	802.11n (HT20)		52 to 64	52, 60, 64	OFDM	BPSK	6.5	Radio 3 (1TX)
-	802.11n (HT40)		54 to 62	54, 62	OFDM	BPSK	13.5	Radio 2 (2TX)
-	802.11n (HT40)		54 to 62	54, 62	OFDM	BPSK	13.5	Radio 3 (1TX)
-	802.11ac (VHT80)		58	58	OFDM	BPSK	58.5	Radio 2 (2TX)
-	802.11ac (VHT80)		58	58	OFDM	BPSK	29.3	Radio 3 (1TX)
-	802.11a	5500-5700	100 to 140	100, 116, 140	OFDM	BPSK	6.0	Radio 2 (2TX)
-	802.11a		100 to 140	100, 116, 140	OFDM	BPSK	6.0	Radio 3 (1TX)
-	802.11n (HT20)		100 to 140	100, 116, 140	OFDM	BPSK	6.5	Radio 2 (2TX)
-	802.11n (HT20)		100 to 140	100, 116, 140	OFDM	BPSK	6.5	Radio 3 (1TX)
-	802.11n (HT40)		102 to 134	102, 110, 134	OFDM	BPSK	13.5	Radio 2 (2TX)
-	802.11n (HT40)		102 to 134	102, 110, 134	OFDM	BPSK	13.5	Radio 3 (1TX)
-	802.11ac (VHT80)		106	106	OFDM	BPSK	58.5	Radio 2 (2TX)
-	802.11ac (VHT80)		106	106	OFDM	BPSK	29.3	Radio 3 (1TX)
Beamforming Mode								
-	802.11ac (VHT20)	5260-5320	52 to 64	52, 60, 64	OFDM	BPSK	6.5	Radio 2 (2TX)
-	802.11ac (VHT40)		54 to 62	54, 62	OFDM	BPSK	13.5	Radio 2 (2TX)
-	802.11ac (VHT80)		58	58	OFDM	BPSK	58.5	Radio 2 (2TX)
-	802.11ac (VHT20)	5500-5700	100 to 140	100, 116, 140	OFDM	BPSK	6.5	Radio 2 (2TX)
-	802.11ac (VHT40)		102 to 134	102, 110, 134	OFDM	BPSK	13.5	Radio 2 (2TX)
-	802.11ac (VHT80)		106	106	OFDM	BPSK	58.5	Radio 2 (2TX)

Radiated Emission Test (Below 1GHz):

- Pre-Scan has been conducted to determine the worst-case mode from all possible combinations between available modulations, data rates and antenna ports (if EUT with antenna diversity architecture).
- Following channel(s) was (were) selected for the final test as listed below.

EUT CONFIGURE MODE	MODE	FREQ. BAND (MHz)	AVAILABLE CHANNEL	TESTED CHANNEL	MODULATION TECHNOLOGY	MODULATION TYPE	DATA RATE (Mbps)	Remark
CDD Mode								
-	802.11a	5260-5320,	52 to 64, 100 to 140	52	OFDM	BPSK	6.0	Radio 2 (2TX)
-	802.11a	5500-5700	52 to 64, 100 to 140	52	OFDM	BPSK	6.0	Radio 3 (1TX)

Power Line Conducted Emission Test:

- Pre-Scan has been conducted to determine the worst-case mode from all possible combinations between available modulations, data rates and antenna ports (if EUT with antenna diversity architecture).
- Following channel(s) was (were) selected for the final test as listed below.

EUT CONFIGURE MODE	MODE	FREQ. BAND (MHz)	AVAILABLE CHANNEL	TESTED CHANNEL	MODULATION TECHNOLOGY	MODULATION TYPE	DATA RATE (Mbps)	Remark
CDD Mode								
-	802.11a	5260-5320,	52 to 64, 100 to 140	52	OFDM	BPSK	6.0	Radio 2 (2TX)
-	802.11a	5500-5700	52 to 64, 100 to 140	52	OFDM	BPSK	6.0	Radio 3 (1TX)



Antenna Port Conducted Measurement:

- This item includes all test value of each mode, but only includes spectrum plot of worst value of each mode.
- Pre-Scan has been conducted to determine the worst-case mode from all possible combinations between available modulations, data rates and antenna ports (if EUT with antenna diversity architecture).
- Following channel(s) was (were) selected for the final test as listed below.

EUT CONFIGURE MODE	MODE	FREQ. BAND (MHz)	AVAILABLE CHANNEL	TESTED CHANNEL	MODULATION TECHNOLOGY	MODULATION TYPE	DATA RATE (Mbps)	Remark
CDD Mode								
-	802.11a	5260-5320	52 to 64	52, 60, 64	OFDM	BPSK	6.0	Radio 2 (2TX)
-	802.11a		52 to 64	52, 60, 64	OFDM	BPSK	6.0	Radio 3 (1TX)
-	802.11n (HT20)		52 to 64	52, 60, 64	OFDM	BPSK	6.5	Radio 2 (2TX)
-	802.11n (HT20)		52 to 64	52, 60, 64	OFDM	BPSK	6.5	Radio 3 (1TX)
-	802.11n (HT40)		54 to 62	54, 62	OFDM	BPSK	13.5	Radio 2 (2TX)
-	802.11n (HT40)		54 to 62	54, 62	OFDM	BPSK	13.5	Radio 3 (1TX)
-	802.11ac (VHT80)		58	58	OFDM	BPSK	58.5	Radio 2 (2TX)
-	802.11ac (VHT80)		58	58	OFDM	BPSK	29.3	Radio 3 (1TX)
-	802.11a	5500-5700	100 to 140	100, 116, 140	OFDM	BPSK	6.0	Radio 2 (2TX)
-	802.11a		100 to 140	100, 116, 140	OFDM	BPSK	6.0	Radio 3 (1TX)
-	802.11n (HT20)		100 to 140	100, 116, 140	OFDM	BPSK	6.5	Radio 2 (2TX)
-	802.11n (HT20)		100 to 140	100, 116, 140	OFDM	BPSK	6.5	Radio 3 (1TX)
-	802.11n (HT40)		102 to 134	102, 110, 134	OFDM	BPSK	13.5	Radio 2 (2TX)
-	802.11n (HT40)		102 to 134	102, 110, 134	OFDM	BPSK	13.5	Radio 3 (1TX)
-	802.11ac (VHT80)		106	106	OFDM	BPSK	58.5	Radio 2 (2TX)
-	802.11ac (VHT80)		106	106	OFDM	BPSK	29.3	Radio 3 (1TX)
Beamforming Mode								
-	802.11ac (VHT20)	5260-5320	52 to 64	52, 60, 64	OFDM	BPSK	6.5	Radio 2 (2TX)
-	802.11ac (VHT40)		54 to 62	54, 62	OFDM	BPSK	13.5	Radio 2 (2TX)
-	802.11ac (VHT80)		58	58	OFDM	BPSK	58.5	Radio 2 (2TX)
-	802.11ac (VHT20)	5500-5700	100 to 140	100, 116, 140	OFDM	BPSK	6.5	Radio 2 (2TX)
-	802.11ac (VHT40)		102 to 134	102, 110, 134	OFDM	BPSK	13.5	Radio 2 (2TX)
-	802.11ac (VHT80)		106	106	OFDM	BPSK	58.5	Radio 2 (2TX)

Test Condition:

APPLICABLE TO	ENVIRONMENTAL CONDITIONS	INPUT POWER	TESTED BY
RE \geq 1G	16 deg. C, 70% RH 18 deg. C, 70% RH	120Vac, 60Hz	James Yang
RE<1G	19 deg. C, 70% RH	120Vac, 60Hz	Jones Chang
PLC	20 deg. C, 71% RH	120Vac, 60Hz	Jones Chang
APCM	25 deg. C, 60% RH	120Vac, 60Hz	Frank Liu Ted Chang

3.3 Duty Cycle of Test Signal

Radio 2

CDD Mode

Duty cycle of test signal is < 98 %, duty factor is required

802.11a: Duty cycle = $2.025/2.112 = 0.959$, Duty factor = $10 * \log(1/0.959) = 0.18$

802.11n (HT20): Duty cycle = $4.955/5.060 = 0.979$, Duty factor = $10 * \log(1/0.979) = 0.09$

802.11n (HT40): Duty cycle = $2.408/2.505 = 0.961$, Duty factor = $10 * \log(1/0.961) = 0.17$

802.11ac (VHT80): Duty cycle = $1.132/1.227 = 0.923$, Duty factor = $10 * \log(1/0.923) = 0.35$

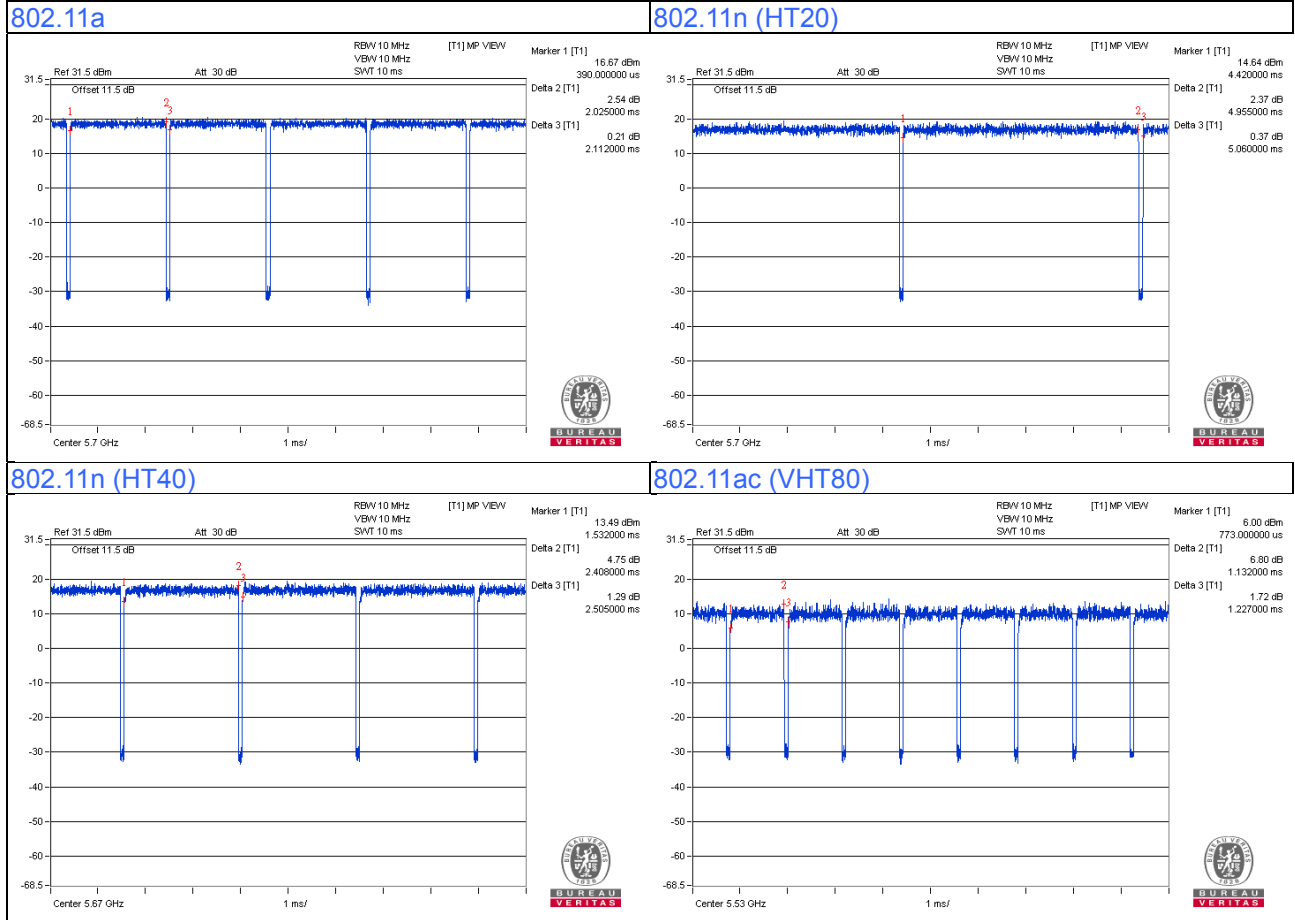

Beamforming Mode

Duty cycle of test signal is < 98 %, duty factor is required

802.11ac (VHT20): Duty cycle = $4.99/5.11 = 0.977$, Duty factor = $10 * \log(1/0.977) = 0.10$

802.11ac (VHT40): Duty cycle = $2.422/2.512 = 0.964$, Duty factor = $10 * \log(1/0.964) = 0.16$

802.11ac (VHT80): Duty cycle = $1.145/1.23 = 0.931$, Duty factor = $10 * \log(1/0.931) = 0.31$

802.11ac (VHT20)

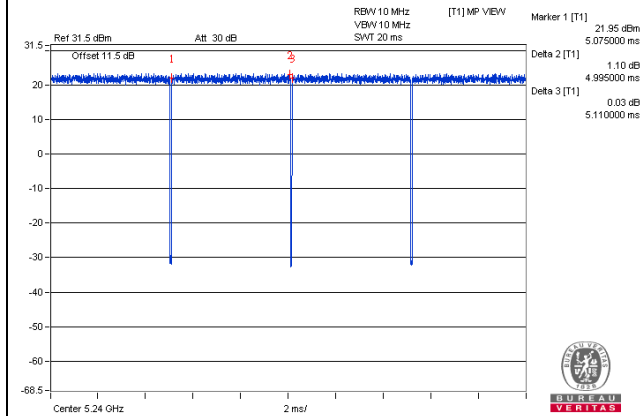

802.11ac (VHT40)

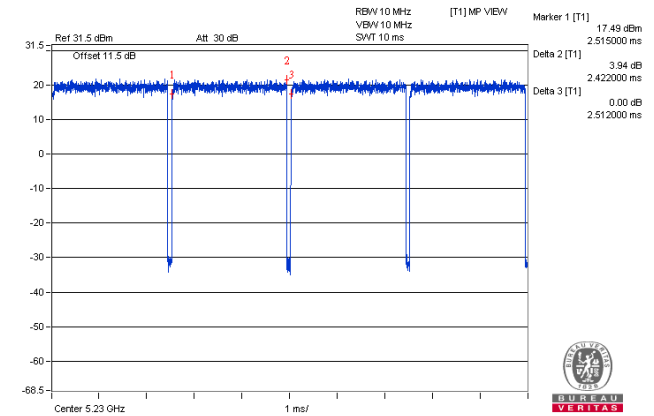

802.11ac (VHT80)

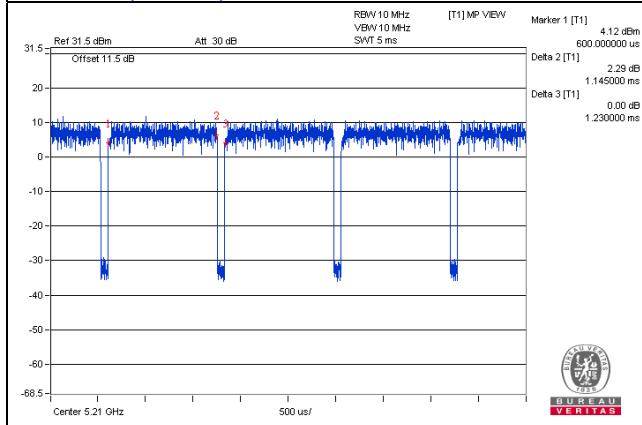

Radio 3
CDD Mode

Duty cycle of test signal is < 98 %, duty factor is required

802.11a: Duty cycle = 2.025/2.127 = 0.952, Duty factor = $10 * \log(1/0.952) = 0.21$

802.11n (HT20): Duty cycle = 1.890/1.960 = 0.964, Duty factor = $10 * \log(1/0.964) = 0.16$

802.11n (HT40): Duty cycle = 0.917/1.007 = 0.911, Duty factor = $10 * \log(1/0.911) = 0.41$

802.11ac (VHT80): Duty cycle = 0.450/0.545 = 0.826, Duty factor = $10 * \log(1/0.826) = 0.83$

802.11a

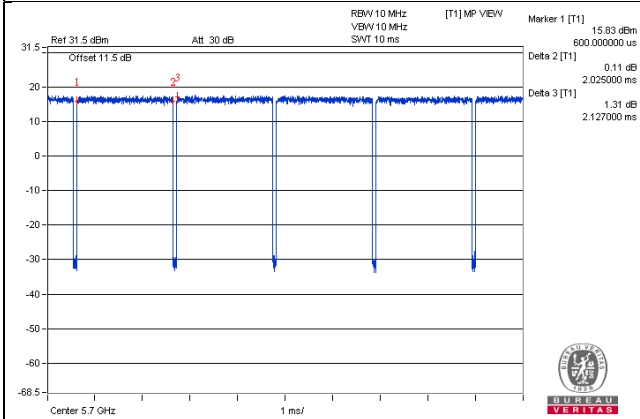

802.11n (HT20)

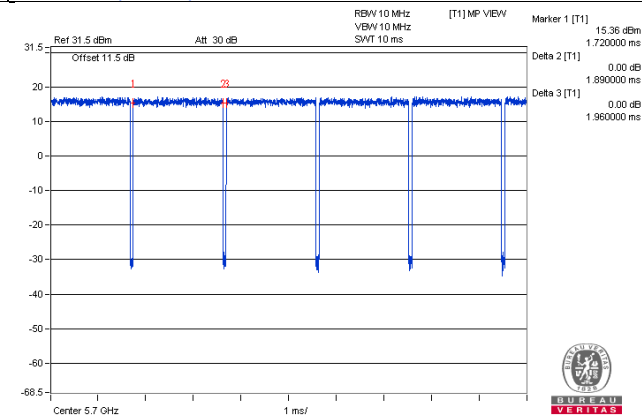

802.11n (HT40)

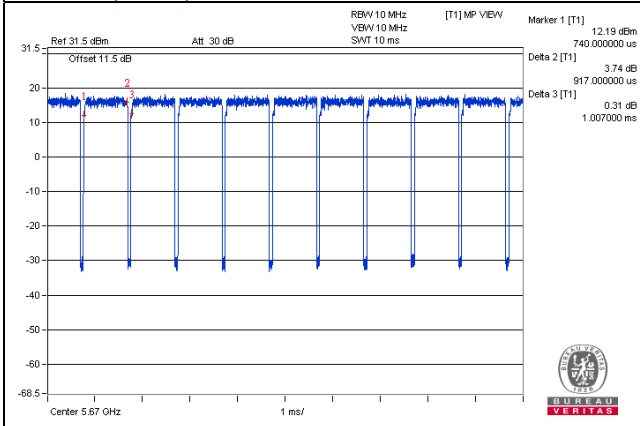

802.11ac (VHT80)

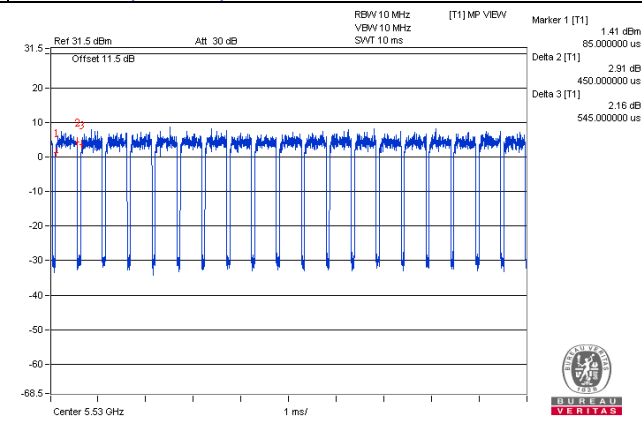

3.4 Description of Support Units

The EUT has been tested as an independent unit together with other necessary accessories or support units. The following support units or accessories were used to form a representative test configuration during the tests.

ID	Product	Brand	Model No.	Serial No.	FCC ID	Remarks
A.	Load	N/A	N/A	N/A	N/A	-
B.	POE	EnGenius	EPE-48GR	N/A	N/A	Provided by client
C.	Notebook	DELL	Latitude E6420	HPFC5Q1	FCC DoC Approved	-

Note:

1. All power cords of the above support units are non-shielded (1.8m).
2. Item B, C acted as communication partner to transfer data.

ID	Descriptions	Qty.	Length (m)	Shielding (Yes/No)	Cores (Qty.)	Remarks
1.	RJ45, Cat5e	4	1.8	N	0	-
2.	RJ45, Cat5e	1	3	N	0	-
3.	RJ45, Cat5e	1	1.8	N	0	-

3.4.1 Configuration of System under Test

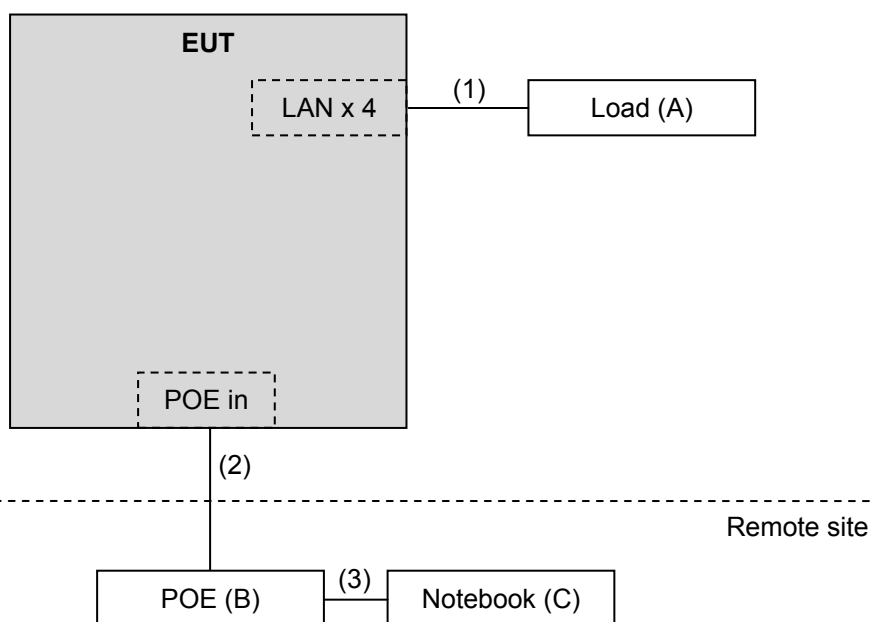

3.5 General Description of Applied Standards

The EUT is a RF Product. According to the specifications of the manufacturer, it must comply with the requirements of the following standards:

FCC Part 15, Subpart E (15.407)

KDB 789033 D02 General UNII Test Procedures New Rules v01r03

KDB 662911 D01 Multiple Transmitter Output v02r01

ANSI C63.10-2013

All test items have been performed and recorded as per the above standards.

NOTE: The EUT has been verified to comply with the requirements of FCC Part 15, Subpart B, Class B (DoC). The test report has been issued separately.

4 Test Types and Results

4.1 Radiated Emission and Bandedge Measurement

4.1.1 Limits of Radiated Emission and Bandedge Measurement

Radiated emissions which fall in the restricted bands must comply with the radiated emission limits specified as below table.

Frequencies (MHz)	Field Strength (microvolts/meter)	Measurement Distance (meters)
0.009 ~ 0.490	2400/F(kHz)	300
0.490 ~ 1.705	24000/F(kHz)	30
1.705 ~ 30.0	30	30
30 ~ 88	100	3
88 ~ 216	150	3
216 ~ 960	200	3
Above 960	500	3

NOTE:

1. The lower limit shall apply at the transition frequencies.
2. Emission level (dBuV/m) = 20 log Emission level (uV/m).
3. For frequencies above 1000MHz, the field strength limits are based on average detector, however, the peak field strength of any emission shall not exceed the maximum permitted average limits, specified above by more than 20dB under any condition of modulation.

LIMITS OF UNWANTED EMISSION OUT OF THE RESTRICTED BANDS

Applicable To		Limit	
789033 D02 General UNII Test Procedure New Rules v01r03		Field Strength at 3m	
		PK:74 (dBuV/m)	AV:54 (dBuV/m)
Frequency Band	Applicable To	EIRP Limit	Equivalent Field Strength at 3m
5150~5250 MHz	15.407(b)(1)	PK:-27 (dBm/MHz)	PK:68.2(dBuV/m)
5250~5350 MHz	15.407(b)(2)		
5470~5725 MHz	15.407(b)(3)		
5725~5850 MHz	<input checked="" type="checkbox"/> 15.407(b)(4)(i)	PK:-27 (dBm/MHz) ^{*1} PK:10 (dBm/MHz) ^{*2} PK:15.6 (dBm/MHz) ^{*3} PK:27 (dBm/MHz) ^{*4}	PK: 68.2(dBuV/m) ^{*1} PK:105.2 (dBuV/m) ^{*2} PK: 110.8(dBuV/m) ^{*3} PK:122.2 (dBuV/m) ^{*4}
	<input type="checkbox"/> 15.407(b)(4)(ii)	Emission limits in section 15.247(d)	
^{*1} beyond 75 MHz or more above of the band edge.		^{*2} below the band edge increasing linearly to 10 dBm/MHz at 25 MHz above.	
^{*3} below the band edge increasing linearly to a level of 15.6 dBm/MHz at 5 MHz above.		^{*4} from 5 MHz above or below the band edge increasing linearly to a level of 27 dBm/MHz at the band edge.	

NOTE: The following formula is used to convert the equipment isotropic radiated power (eirp) to field strength:

$$E = \frac{1000000 \sqrt{30P}}{3} \mu\text{V/m, where } P \text{ is the eirp (Watts).}$$

4.1.2 Test Instruments

Description & Manufacturer	Model No.	Serial No.	Cal. Date	Cal. Due
Test Receiver ROHDE & SCHWARZ	ESIB7	100187	Apr. 18, 2016	Apr. 17, 2017
Spectrum Analyzer ROHDE & SCHWARZ	FSP40	100269	Apr. 19, 2016	Apr. 18, 2017
BILOG Antenna SCHWARZBECK	VULB9168	9168-171	Jan. 07, 2016	Jan. 06, 2017
HORN Antenna SCHWARZBECK	9120D	209	Jan. 20, 2016	Jan. 19, 2017
HORN Antenna SCHWARZBECK	BBHA 9170	BBHA9170241	Jan. 18, 2016	Jan. 17, 2017
Preamplifier Agilent	8447D	2944A10738	Oct.18, 2015	Oct. 17, 2016
Preamplifier Agilent	8449B	3008A01964	Aug. 22, 2015	Aug. 21, 2016
			Aug. 22, 2016	Aug. 21, 2017
RF signal cable HUBER+SUHNER	SUCOFLEX 104	Cable-CH3-03 (214378)	Aug. 22, 2015	Aug. 21, 2016
			Aug. 22, 2016	Aug. 21, 2017
RF signal cable HUBER+SUHNER	SUCOFLEX 106	Cable-CH3-03 (309224+12738)	Aug. 22, 2015	Aug. 21, 2016
			Aug. 22, 2016	Aug. 21, 2017
Software BV ADT	ADT_Radiated_ V7.6.15.9.4	NA	NA	NA
Antenna Tower inn-co GmbH	MA 4000	013303	NA	NA
Antenna Tower Controller BV ADT	AT100	AT93021702	NA	NA
Turn Table BV ADT	TT100	TT93021702	NA	NA
Turn Table Controller BV ADT	SC100	SC93021702	NA	NA
26GHz ~ 40GHz Amplifier	EM26400	815221	Oct. 18, 2015	Oct. 17, 2016
High Speed Peak Power Meter	ML2495A	1232003	Oct. 07, 2015	Oct. 06, 2016
Power Sensor	MA2411B	1207333	Oct. 07, 2015	Oct. 06, 2016
WIT Standard Temperature And Humidity Chamber	TH-4S-C	W981030	Jun. 08, 2016	Jun. 07, 2017

- Note: 1. The calibration interval of the above test instruments is 12 months and the calibrations are traceable to NML/ROC and NIST/USA.
2. The test was performed in HwaYa Chamber 3.
3. The horn antenna and preamplifier (model: 8449B) are used only for the measurement of emission frequency above 1GHz if tested.
4. The FCC Site Registration No. is 988962.
5. The IC Site Registration No. is IC 7450F-3.

4.1.3 Test Procedures

- a. The EUT was placed on the top of a rotating table 0.8 meters (for below 1GHz) / 1.5 meters (for above 1GHz) above the ground at 3 meter chamber room for test. The table was rotated 360 degrees to determine the position of the highest radiation.
- b. The EUT was set 3 meters away from the interference-receiving antenna, which was mounted on the top of a variable-height antenna tower.
- c. The height of antenna is varied from one meter to four meters above the ground to determine the maximum value of the field strength. Both horizontal and vertical polarizations of the antenna are set to make the measurement.
- d. For each suspected emission, the EUT was arranged to its worst case and then the antenna was tuned to heights from 1 meter to 4 meters and the rotatable table was turned from 0 degrees to 360 degrees to find the maximum reading.
- e. The test-receiver system was set to quasi-peak detect function and specified bandwidth with maximum hold mode when the test frequency is below 1 GHz.
- f. The test-receiver system was set to peak and average detect function and specified bandwidth with maximum hold mode when the test frequency is above 1 GHz. If the peak reading value also meets average limit, measurement with the average detector is unnecessary.

Note:

1. The resolution bandwidth and video bandwidth of test receiver/spectrum analyzer is 120kHz for Quasi-peak detection (QP) at frequency below 1GHz.
2. The resolution bandwidth of test receiver/spectrum analyzer is 1 MHz and the video bandwidth is 3 MHz for Peak detection (PK) at frequency above 1GHz.
3. The resolution bandwidth of test receiver/spectrum analyzer is 1MHz and the video bandwidth is 3MHz for RMS Average (Duty cycle < 98%) for Average detection (AV) at frequency above 1GHz, then the measurement results was added to a correction factor ($10 \log(1/\text{duty cycle})$).
4. The resolution bandwidth of test receiver/spectrum analyzer is 1MHz and the video bandwidth is 10Hz (Duty cycle $\geq 98\%$) for Average detection (AV) at frequency above 1GHz.
5. All modes of operation were investigated and the worst-case emissions are reported.

4.1.4 Deviation from Test Standard

No deviation.

4.1.5 Test Setup

<Frequency Range 30MHz ~ 1GHz>

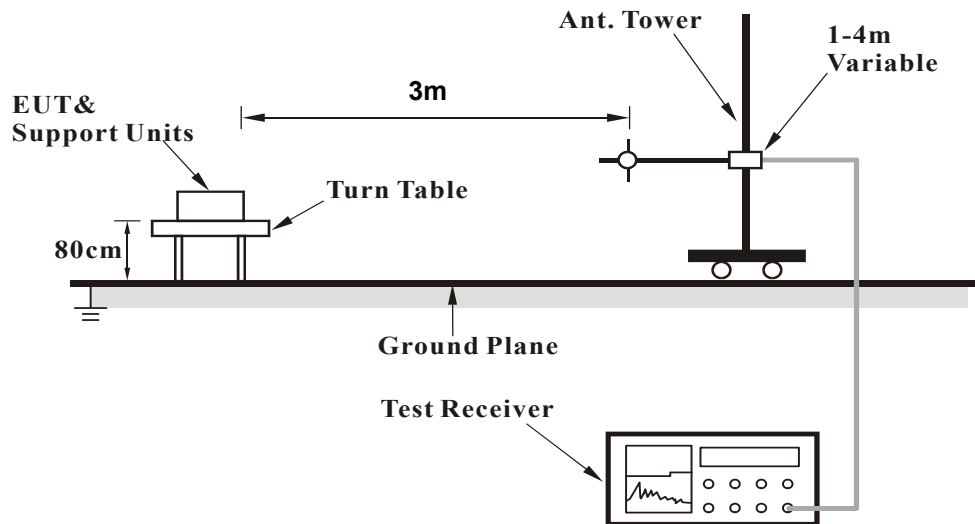

<Frequency Range above 1GHz>

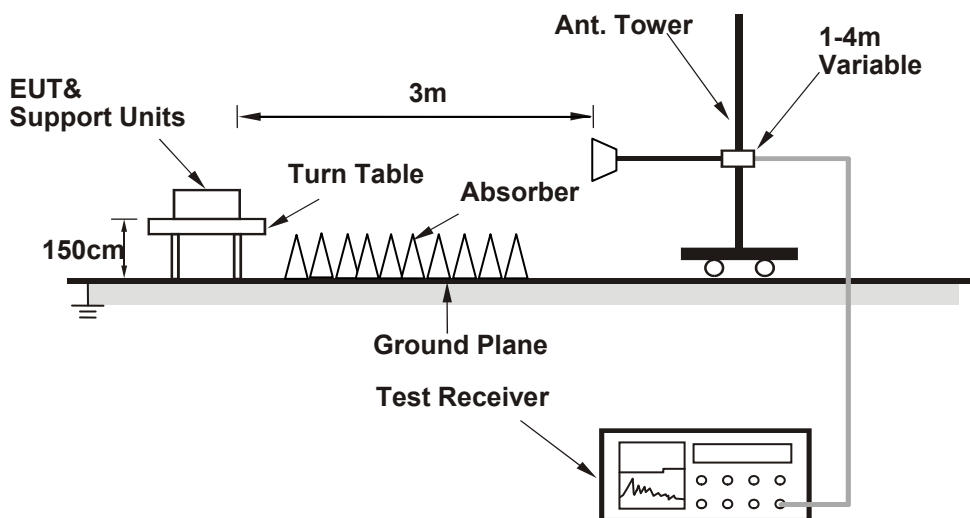

For the actual test configuration, please refer to the attached file (Test Setup Photo)

4.1.6 EUT Operating Conditions

- Placed the EUT on the testing table.
- Prepared a notebook to act as a communication partner and placed it outside of testing area.
- The communication partner connected with EUT via a RJ45 cable and ran a test program (provided by manufacturer) to enable EUT under transmission condition continuously at specific channel frequency.
- The communication partner sent data to EUT by command "PING".

4.1.7 Test Results

Above 1GHz data:

Radio 2

CDD Mode

802.11a

CHANNEL	TX Channel 52	DETECTOR FUNCTION	Peak (PK)
FREQUENCY RANGE	1GHz ~ 40GHz		Average (AV)

ANTENNA POLARITY & TEST DISTANCE: HORIZONTAL AT 3 M								
NO.	FREQ. (MHz)	EMISSION LEVEL (dBuV/m)	LIMIT (dBuV/m)	MARGIN (dB)	ANTENNA HEIGHT (m)	TABLE ANGLE (Degree)	RAW VALUE (dBuV)	CORRECTION FACTOR (dB/m)
1	*5260.00	115.4 PK			2.34 H	351	75.8	39.6
2	*5260.00	104.9 AV			2.34 H	351	65.3	39.6
3	5400.00	57.6 PK	74.0	-16.4	1.61 H	161	50.9	6.7
4	5400.00	46.3 AV	54.0	-7.7	1.61 H	161	39.6	6.7
5	#10520.00	60.8 PK	74.0	-13.2	2.00 H	0	41.9	18.9
6	#10520.00	48.0 AV	54.0	-6.0	2.00 H	0	29.1	18.9

ANTENNA POLARITY & TEST DISTANCE: VERTICAL AT 3 M								
NO.	FREQ. (MHz)	EMISSION LEVEL (dBuV/m)	LIMIT (dBuV/m)	MARGIN (dB)	ANTENNA HEIGHT (m)	TABLE ANGLE (Degree)	RAW VALUE (dBuV)	CORRECTION FACTOR (dB/m)
1	*5260.00	115.9 PK			1.84 V	294	76.3	39.6
2	*5260.00	105.7 AV			1.84 V	294	66.1	39.6
3	5400.00	57.3 PK	74.0	-16.7	1.63 V	78	50.6	6.7
4	5400.00	45.0 AV	54.0	-9.0	1.63 V	78	38.3	6.7
5	#10520.00	60.5 PK	74.0	-13.5	1.54 V	217	41.6	18.9
6	#10520.00	47.5 AV	54.0	-6.5	1.54 V	217	28.6	18.9

REMARKS:

1. Emission Level(dBuV/m) = Raw Value(dBuV) + Correction Factor(dB/m)
2. Correction Factor(dB/m) = Antenna Factor(dB/m) + Cable Factor(dB) – Pre-Amplifier Factor(dB)
3. The other emission levels were very low against the limit.
4. Margin value = Emission Level – Limit value
5. " * ": Fundamental frequency.
6. " # ": The radiated frequency is out of the restricted band.

CHANNEL	TX Channel 60	DETECTOR FUNCTION	Peak (PK)
FREQUENCY RANGE	1GHz ~ 40GHz		Average (AV)

ANTENNA POLARITY & TEST DISTANCE: HORIZONTAL AT 3 M

NO.	FREQ. (MHz)	EMISSION LEVEL (dBuV/m)	LIMIT (dBuV/m)	MARGIN (dB)	ANTENNA HEIGHT (m)	TABLE ANGLE (Degree)	RAW VALUE (dBuV)	CORRECTION FACTOR (dB/m)
1	*5300.00	115.8 PK			3.24 H	348	76.1	39.7
2	*5300.00	105.7 AV			3.24 H	348	66.0	39.7
3	10600.00	60.4 PK	74.0	-13.6	1.80 H	22	41.5	18.9
4	10600.00	47.5 AV	54.0	-6.5	1.80 H	22	28.6	18.9

ANTENNA POLARITY & TEST DISTANCE: VERTICAL AT 3 M

NO.	FREQ. (MHz)	EMISSION LEVEL (dBuV/m)	LIMIT (dBuV/m)	MARGIN (dB)	ANTENNA HEIGHT (m)	TABLE ANGLE (Degree)	RAW VALUE (dBuV)	CORRECTION FACTOR (dB/m)
1	*5300.00	115.8 PK			1.87 V	293	76.1	39.7
2	*5300.00	105.2 AV			1.87 V	293	65.5	39.7
3	10600.00	60.3 PK	74.0	-13.7	1.99 V	201	41.4	18.9
4	10600.00	47.5 AV	54.0	-6.5	1.99 V	201	28.6	18.9

REMARKS:

1. Emission Level(dBuV/m) = Raw Value(dBuV) + Correction Factor(dB/m)
2. Correction Factor(dB/m) = Antenna Factor(dB/m) + Cable Factor(dB) – Pre-Amplifier Factor(dB)
3. The other emission levels were very low against the limit.
4. Margin value = Emission Level – Limit value
5. " * ": Fundamental frequency.

CHANNEL	TX Channel 64	DETECTOR FUNCTION	Peak (PK)
FREQUENCY RANGE	1GHz ~ 40GHz		Average (AV)

ANTENNA POLARITY & TEST DISTANCE: HORIZONTAL AT 3 M

NO.	FREQ. (MHz)	EMISSION LEVEL (dBuV/m)	LIMIT (dBuV/m)	MARGIN (dB)	ANTENNA HEIGHT (m)	TABLE ANGLE (Degree)	RAW VALUE (dBuV)	CORRECTION FACTOR (dB/m)
1	*5320.00	114.1 PK			3.39 H	352	74.4	39.7
2	*5320.00	103.8 AV			3.39 H	352	64.1	39.7
3	5350.00	69.2 PK	74.0	-4.8	2.05 H	351	62.7	6.5
4	5350.00	52.5 AV	54.0	-1.5	2.05 H	351	46.0	6.5
5	10640.00	60.3 PK	74.0	-13.7	1.55 H	195	41.5	18.8
6	10640.00	46.9 AV	54.0	-7.1	1.55 H	195	28.1	18.8

ANTENNA POLARITY & TEST DISTANCE: VERTICAL AT 3 M

NO.	FREQ. (MHz)	EMISSION LEVEL (dBuV/m)	LIMIT (dBuV/m)	MARGIN (dB)	ANTENNA HEIGHT (m)	TABLE ANGLE (Degree)	RAW VALUE (dBuV)	CORRECTION FACTOR (dB/m)
1	*5320.00	113.6 PK			1.93 V	295	73.9	39.7
2	*5320.00	103.1 AV			1.93 V	295	63.4	39.7
3	5350.00	67.3 PK	74.0	-6.7	1.48 V	296	60.8	6.5
4	5350.00	52.1 AV	54.0	-1.9	1.48 V	296	45.6	6.5
5	10640.00	60.1 PK	74.0	-13.9	1.78 V	229	41.3	18.8
6	10640.00	47.1 AV	54.0	-6.9	1.78 V	229	28.3	18.8

REMARKS:

1. Emission Level(dBuV/m) = Raw Value(dBuV) + Correction Factor(dB/m)
2. Correction Factor(dB/m) = Antenna Factor(dB/m) + Cable Factor(dB) – Pre-Amplifier Factor(dB)
3. The other emission levels were very low against the limit.
4. Margin value = Emission Level – Limit value
5. " * ": Fundamental frequency.

CHANNEL	TX Channel 100	DETECTOR FUNCTION	Peak (PK)
FREQUENCY RANGE	1GHz ~ 40GHz		Average (AV)

ANTENNA POLARITY & TEST DISTANCE: HORIZONTAL AT 3 M

NO.	FREQ. (MHz)	EMISSION LEVEL (dBuV/m)	LIMIT (dBuV/m)	MARGIN (dB)	ANTENNA HEIGHT (m)	TABLE ANGLE (Degree)	RAW VALUE (dBuV)	CORRECTION FACTOR (dB/m)
1	5460.00	62.2 PK	74.0	-11.8	3.04 H	336	55.3	6.9
2	5460.00	47.1 AV	54.0	-6.9	3.04 H	336	40.2	6.9
3	#5470.00	66.4 PK	74.0	-7.6	3.54 H	334	59.5	6.9
4	#5470.00	52.3 AV	54.0	-1.7	3.54 H	334	45.4	6.9
5	*5500.00	113.5 PK			3.49 H	345	73.3	40.2
6	*5500.00	103.6 AV			3.49 H	345	63.4	40.2
7	11000.00	61.3 PK	74.0	-12.7	2.67 H	268	41.4	19.9
8	11000.00	48.3 AV	54.0	-5.7	2.67 H	268	28.4	19.9

ANTENNA POLARITY & TEST DISTANCE: VERTICAL AT 3 M

NO.	FREQ. (MHz)	EMISSION LEVEL (dBuV/m)	LIMIT (dBuV/m)	MARGIN (dB)	ANTENNA HEIGHT (m)	TABLE ANGLE (Degree)	RAW VALUE (dBuV)	CORRECTION FACTOR (dB/m)
1	5460.00	62.5 PK	74.0	-11.5	1.82 V	293	55.6	6.9
2	5460.00	47.3 AV	54.0	-6.7	1.82 V	293	40.4	6.9
3	#5470.00	67.6 PK	74.0	-6.4	1.20 V	294	60.7	6.9
4	#5470.00	51.5 AV	54.0	-2.5	1.20 V	294	44.6	6.9
5	*5500.00	112.9 PK			1.94 V	300	72.7	40.2
6	*5500.00	102.7 AV			1.94 V	300	62.5	40.2
7	11000.00	61.4 PK	74.0	-12.6	1.94 V	207	41.5	19.9
8	11000.00	48.3 AV	54.0	-5.7	1.94 V	207	28.4	19.9

REMARKS:

1. Emission Level(dBuV/m) = Raw Value(dBuV) + Correction Factor(dB/m)
2. Correction Factor(dB/m) = Antenna Factor(dB/m) + Cable Factor(dB) – Pre-Amplifier Factor(dB)
3. The other emission levels were very low against the limit.
4. Margin value = Emission Level – Limit value
5. " * ": Fundamental frequency.
6. " # ": The radiated frequency is out of the restricted band.

CHANNEL	TX Channel 116	DETECTOR FUNCTION	Peak (PK)
FREQUENCY RANGE	1GHz ~ 40GHz		Average (AV)

ANTENNA POLARITY & TEST DISTANCE: HORIZONTAL AT 3 M

NO.	FREQ. (MHz)	EMISSION LEVEL (dBuV/m)	LIMIT (dBuV/m)	MARGIN (dB)	ANTENNA HEIGHT (m)	TABLE ANGLE (Degree)	RAW VALUE (dBuV)	CORRECTION FACTOR (dB/m)
1	*5580.00	113.7 PK			2.58 H	352	73.4	40.3
2	*5580.00	103.7 AV			2.58 H	352	63.4	40.3
3	11600.00	60.6 PK	74.0	-13.4	1.55 H	35	41.8	18.8
4	11600.00	47.8 AV	54.0	-6.2	1.55 H	35	29.0	18.8

ANTENNA POLARITY & TEST DISTANCE: VERTICAL AT 3 M

NO.	FREQ. (MHz)	EMISSION LEVEL (dBuV/m)	LIMIT (dBuV/m)	MARGIN (dB)	ANTENNA HEIGHT (m)	TABLE ANGLE (Degree)	RAW VALUE (dBuV)	CORRECTION FACTOR (dB/m)
1	*5580.00	116.0 PK			1.85 V	297	75.7	40.3
2	*5580.00	105.6 AV			1.85 V	297	65.3	40.3
3	11600.00	60.3 PK	74.0	-13.7	1.67 V	221	41.5	18.8
4	11600.00	47.2 AV	54.0	-6.8	1.67 V	221	28.4	18.8

REMARKS:

1. Emission Level(dBuV/m) = Raw Value(dBuV) + Correction Factor(dB/m)
2. Correction Factor(dB/m) = Antenna Factor(dB/m) + Cable Factor(dB) – Pre-Amplifier Factor(dB)
3. The other emission levels were very low against the limit.
4. Margin value = Emission Level – Limit value
5. " * ": Fundamental frequency.

CHANNEL	TX Channel 140	DETECTOR FUNCTION	Peak (PK)
FREQUENCY RANGE	1GHz ~ 40GHz		Average (AV)

ANTENNA POLARITY & TEST DISTANCE: HORIZONTAL AT 3 M

NO.	FREQ. (MHz)	EMISSION LEVEL (dBuV/m)	LIMIT (dBuV/m)	MARGIN (dB)	ANTENNA HEIGHT (m)	TABLE ANGLE (Degree)	RAW VALUE (dBuV)	CORRECTION FACTOR (dB/m)
1	*5700.00	112.7 PK			3.24 H	345	72.3	40.4
2	*5700.00	102.2 AV			3.24 H	345	61.8	40.4
3	#5725.00	69.5 PK	74.0	-4.5	3.50 H	350	62.1	7.4
4	#5725.00	52.6 AV	54.0	-1.4	3.50 H	350	45.2	7.4
5	11400.00	60.6 PK	74.0	-13.4	1.85 H	319	41.8	18.8
6	11400.00	47.5 AV	54.0	-6.5	1.85 H	319	28.7	18.8

ANTENNA POLARITY & TEST DISTANCE: VERTICAL AT 3 M

NO.	FREQ. (MHz)	EMISSION LEVEL (dBuV/m)	LIMIT (dBuV/m)	MARGIN (dB)	ANTENNA HEIGHT (m)	TABLE ANGLE (Degree)	RAW VALUE (dBuV)	CORRECTION FACTOR (dB/m)
1	*5700.00	113.3 PK			1.81 V	294	72.9	40.4
2	*5700.00	103.1 AV			1.81 V	294	62.7	40.4
3	#5725.00	69.5 PK	74.0	-4.5	1.81 V	297	62.1	7.4
4	#5725.00	52.8 AV	54.0	-1.2	1.81 V	297	45.4	7.4
5	11400.00	60.5 PK	74.0	-13.5	1.65 V	177	41.7	18.8
6	11400.00	47.8 AV	54.0	-6.2	1.65 V	177	29.0	18.8

REMARKS:

1. Emission Level(dBuV/m) = Raw Value(dBuV) + Correction Factor(dB/m)
2. Correction Factor(dB/m) = Antenna Factor(dB/m) + Cable Factor(dB) – Pre-Amplifier Factor(dB)
3. The other emission levels were very low against the limit.
4. Margin value = Emission Level – Limit value
5. " * ": Fundamental frequency.
6. " # ": The radiated frequency is out of the restricted band.

802.11n (HT20)

CHANNEL	TX Channel 52	DETECTOR FUNCTION	Peak (PK)
FREQUENCY RANGE	1GHz ~ 40GHz		Average (AV)

ANTENNA POLARITY & TEST DISTANCE: HORIZONTAL AT 3 M								
NO.	FREQ. (MHz)	EMISSION LEVEL (dBuV/m)	LIMIT (dBuV/m)	MARGIN (dB)	ANTENNA HEIGHT (m)	TABLE ANGLE (Degree)	RAW VALUE (dBuV)	CORRECTION FACTOR (dB/m)
1	*5260.00	115.3 PK			2.85 H	350	75.7	39.6
2	*5260.00	105.1 AV			2.85 H	350	65.5	39.6
3	5350.00	57.2 PK	74.0	-16.8	1.57 H	265	50.7	6.5
4	5350.00	46.1 AV	54.0	-7.9	1.57 H	265	39.6	6.5
5	#10520.00	60.4 PK	74.0	-13.6	2.22 H	313	41.5	18.9
6	#10520.00	47.7 AV	54.0	-6.3	2.22 H	313	28.8	18.9

ANTENNA POLARITY & TEST DISTANCE: VERTICAL AT 3 M								
NO.	FREQ. (MHz)	EMISSION LEVEL (dBuV/m)	LIMIT (dBuV/m)	MARGIN (dB)	ANTENNA HEIGHT (m)	TABLE ANGLE (Degree)	RAW VALUE (dBuV)	CORRECTION FACTOR (dB/m)
1	*5260.00	117.1 PK			1.84 V	293	77.5	39.6
2	*5260.00	105.9 AV			1.84 V	293	66.3	39.6
3	5350.00	57.5 PK	74.0	-16.5	1.69 V	249	51.0	6.5
4	5350.00	45.1 AV	54.0	-8.9	1.69 V	249	38.6	6.5
5	#10520.00	60.4 PK	74.0	-13.6	1.95 V	170	41.5	18.9
6	#10520.00	47.4 AV	54.0	-6.6	1.95 V	170	28.5	18.9

REMARKS:

1. Emission Level(dBuV/m) = Raw Value(dBuV) + Correction Factor(dB/m)
2. Correction Factor(dB/m) = Antenna Factor(dB/m) + Cable Factor(dB) – Pre-Amplifier Factor(dB)
3. The other emission levels were very low against the limit.
4. Margin value = Emission Level – Limit value
5. " * ": Fundamental frequency.
6. " # ": The radiated frequency is out of the restricted band.

CHANNEL	TX Channel 60	DETECTOR FUNCTION	Peak (PK)
FREQUENCY RANGE	1GHz ~ 40GHz		Average (AV)

ANTENNA POLARITY & TEST DISTANCE: HORIZONTAL AT 3 M

NO.	FREQ. (MHz)	EMISSION LEVEL (dBuV/m)	LIMIT (dBuV/m)	MARGIN (dB)	ANTENNA HEIGHT (m)	TABLE ANGLE (Degree)	RAW VALUE (dBuV)	CORRECTION FACTOR (dB/m)
1	*5300.00	115.3 PK			3.25 H	355	75.6	39.7
2	*5300.00	104.7 AV			3.25 H	355	65.0	39.7
3	10600.00	60.7 PK	74.0	-13.3	2.22 H	255	41.8	18.9
4	10600.00	47.7 AV	54.0	-6.3	2.22 H	255	28.8	18.9

ANTENNA POLARITY & TEST DISTANCE: VERTICAL AT 3 M

NO.	FREQ. (MHz)	EMISSION LEVEL (dBuV/m)	LIMIT (dBuV/m)	MARGIN (dB)	ANTENNA HEIGHT (m)	TABLE ANGLE (Degree)	RAW VALUE (dBuV)	CORRECTION FACTOR (dB/m)
1	*5300.00	116.6 PK			1.80 V	290	76.9	39.7
2	*5300.00	105.4 AV			1.80 V	290	65.7	39.7
3	10600.00	60.7 PK	74.0	-13.3	1.60 V	140	41.8	18.9
4	10600.00	47.6 AV	54.0	-6.4	1.60 V	140	28.7	18.9

REMARKS:

1. Emission Level(dBuV/m) = Raw Value(dBuV) + Correction Factor(dB/m)
2. Correction Factor(dB/m) = Antenna Factor(dB/m) + Cable Factor(dB) – Pre-Amplifier Factor(dB)
3. The other emission levels were very low against the limit.
4. Margin value = Emission Level – Limit value
5. " * ": Fundamental frequency.

CHANNEL	TX Channel 64	DETECTOR FUNCTION	Peak (PK)
FREQUENCY RANGE	1GHz ~ 40GHz		Average (AV)

ANTENNA POLARITY & TEST DISTANCE: HORIZONTAL AT 3 M

NO.	FREQ. (MHz)	EMISSION LEVEL (dBuV/m)	LIMIT (dBuV/m)	MARGIN (dB)	ANTENNA HEIGHT (m)	TABLE ANGLE (Degree)	RAW VALUE (dBuV)	CORRECTION FACTOR (dB/m)
1	*5320.00	112.1 PK			2.54 H	348	72.4	39.7
2	*5320.00	101.6 AV			2.54 H	348	61.9	39.7
3	5350.00	66.9 PK	74.0	-7.1	2.89 H	350	60.4	6.5
4	5350.00	52.7 AV	54.0	-1.3	2.89 H	350	46.2	6.5
5	10640.00	59.8 PK	74.0	-14.2	2.33 H	320	41.0	18.8
6	10640.00	47.0 AV	54.0	-7.0	2.33 H	320	28.2	18.8

ANTENNA POLARITY & TEST DISTANCE: VERTICAL AT 3 M

NO.	FREQ. (MHz)	EMISSION LEVEL (dBuV/m)	LIMIT (dBuV/m)	MARGIN (dB)	ANTENNA HEIGHT (m)	TABLE ANGLE (Degree)	RAW VALUE (dBuV)	CORRECTION FACTOR (dB/m)
1	*5320.00	113.3 PK			1.94 V	298	73.6	39.7
2	*5320.00	102.7 AV			1.94 V	298	63.0	39.7
3	5350.00	66.8 PK	74.0	-7.2	2.31 V	304	60.3	6.5
4	5350.00	52.2 AV	54.0	-1.8	2.31 V	304	45.7	6.5
5	10640.00	59.6 PK	74.0	-14.4	1.92 V	183	40.8	18.8
6	10640.00	46.9 AV	54.0	-7.1	1.92 V	183	28.1	18.8

REMARKS:

1. Emission Level(dBuV/m) = Raw Value(dBuV) + Correction Factor(dB/m)
2. Correction Factor(dB/m) = Antenna Factor(dB/m) + Cable Factor(dB) – Pre-Amplifier Factor(dB)
3. The other emission levels were very low against the limit.
4. Margin value = Emission Level – Limit value
5. " * ": Fundamental frequency.



CHANNEL	TX Channel 100	DETECTOR FUNCTION	Peak (PK)
FREQUENCY RANGE	1GHz ~ 40GHz		Average (AV)

ANTENNA POLARITY & TEST DISTANCE: HORIZONTAL AT 3 M

NO.	FREQ. (MHz)	EMISSION LEVEL (dBuV/m)	LIMIT (dBuV/m)	MARGIN (dB)	ANTENNA HEIGHT (m)	TABLE ANGLE (Degree)	RAW VALUE (dBuV)	CORRECTION FACTOR (dB/m)
1	5460.00	58.9 PK	74.0	-15.1	2.90 H	355	52.0	6.9
2	5460.00	47.0 AV	54.0	-7.0	2.90 H	355	40.1	6.9
3	#5470.00	68.8 PK	74.0	-5.2	3.21 H	346	61.9	6.9
4	#5470.00	52.7 AV	54.0	-1.3	3.21 H	346	45.8	6.9
5	*5500.00	111.3 PK			3.16 H	349	71.1	40.2
6	*5500.00	100.6 AV			3.16 H	349	60.4	40.2
7	11000.00	61.1 PK	74.0	-12.9	2.00 H	22	41.2	19.9
8	11000.00	48.3 AV	54.0	-5.7	2.00 H	22	28.4	19.9

ANTENNA POLARITY & TEST DISTANCE: VERTICAL AT 3 M

NO.	FREQ. (MHz)	EMISSION LEVEL (dBuV/m)	LIMIT (dBuV/m)	MARGIN (dB)	ANTENNA HEIGHT (m)	TABLE ANGLE (Degree)	RAW VALUE (dBuV)	CORRECTION FACTOR (dB/m)
1	5460.00	62.0 PK	74.0	-12.0	1.80 V	290	55.1	6.9
2	5460.00	47.4 AV	54.0	-6.6	1.80 V	290	40.5	6.9
3	#5470.00	68.1 PK	74.0	-5.9	2.26 V	308	61.2	6.9
4	#5470.00	52.4 AV	54.0	-1.6	2.26 V	308	45.5	6.9
5	*5500.00	113.4 PK			1.73 V	296	73.2	40.2
6	*5500.00	102.0 AV			1.73 V	296	61.8	40.2
7	11000.00	61.7 PK	74.0	-12.3	1.63 V	216	41.8	19.9
8	11000.00	48.1 AV	54.0	-5.9	1.63 V	216	28.2	19.9

REMARKS:

1. Emission Level(dBuV/m) = Raw Value(dBuV) + Correction Factor(dB/m)
2. Correction Factor(dB/m) = Antenna Factor(dB/m) + Cable Factor(dB) – Pre-Amplifier Factor(dB)
3. The other emission levels were very low against the limit.
4. Margin value = Emission Level – Limit value
5. " * ": Fundamental frequency.
6. " # ": The radiated frequency is out of the restricted band.

CHANNEL	TX Channel 116	DETECTOR FUNCTION	Peak (PK)
FREQUENCY RANGE	1GHz ~ 40GHz		Average (AV)

ANTENNA POLARITY & TEST DISTANCE: HORIZONTAL AT 3 M

NO.	FREQ. (MHz)	EMISSION LEVEL (dBuV/m)	LIMIT (dBuV/m)	MARGIN (dB)	ANTENNA HEIGHT (m)	TABLE ANGLE (Degree)	RAW VALUE (dBuV)	CORRECTION FACTOR (dB/m)
1	*5580.00	115.0 PK			3.14 H	271	74.7	40.3
2	*5580.00	104.6 AV			3.14 H	271	64.3	40.3
3	11600.00	60.9 PK	74.0	-13.1	1.56 H	240	42.1	18.8
4	11600.00	48.0 AV	54.0	-6.0	1.56 H	240	29.2	18.8

ANTENNA POLARITY & TEST DISTANCE: VERTICAL AT 3 M

NO.	FREQ. (MHz)	EMISSION LEVEL (dBuV/m)	LIMIT (dBuV/m)	MARGIN (dB)	ANTENNA HEIGHT (m)	TABLE ANGLE (Degree)	RAW VALUE (dBuV)	CORRECTION FACTOR (dB/m)
1	*5580.00	116.7 PK			1.68 V	298	76.4	40.3
2	*5580.00	105.8 AV			1.68 V	298	65.5	40.3
3	11160.00	60.7 PK	74.0	-13.3	1.65 V	157	41.3	19.4
4	11160.00	47.5 AV	54.0	-6.5	1.65 V	157	28.1	19.4

REMARKS:

1. Emission Level(dBuV/m) = Raw Value(dBuV) + Correction Factor(dB/m)
2. Correction Factor(dB/m) = Antenna Factor(dB/m) + Cable Factor(dB) – Pre-Amplifier Factor(dB)
3. The other emission levels were very low against the limit.
4. Margin value = Emission Level – Limit value
5. " * ": Fundamental frequency.



CHANNEL	TX Channel 140	DETECTOR FUNCTION	Peak (PK)
FREQUENCY RANGE	1GHz ~ 40GHz		Average (AV)

ANTENNA POLARITY & TEST DISTANCE: HORIZONTAL AT 3 M

NO.	FREQ. (MHz)	EMISSION LEVEL (dBuV/m)	LIMIT (dBuV/m)	MARGIN (dB)	ANTENNA HEIGHT (m)	TABLE ANGLE (Degree)	RAW VALUE (dBuV)	CORRECTION FACTOR (dB/m)
1	*5700.00	111.8 PK			3.42 H	340	71.4	40.4
2	*5700.00	101.4 AV			3.42 H	340	61.0	40.4
3	#5725.00	63.5 PK	74.0	-10.5	2.27 H	338	56.1	7.4
4	#5725.00	49.4 AV	54.0	-4.6	2.27 H	338	42.0	7.4
5	11400.00	61.9 PK	74.0	-12.1	2.76 H	309	43.1	18.8
6	11400.00	47.5 AV	54.0	-6.5	2.76 H	309	28.7	18.8

ANTENNA POLARITY & TEST DISTANCE: VERTICAL AT 3 M

NO.	FREQ. (MHz)	EMISSION LEVEL (dBuV/m)	LIMIT (dBuV/m)	MARGIN (dB)	ANTENNA HEIGHT (m)	TABLE ANGLE (Degree)	RAW VALUE (dBuV)	CORRECTION FACTOR (dB/m)
1	*5700.00	111.8 PK			1.71 V	299	71.4	40.4
2	*5700.00	101.2 AV			1.71 V	299	60.8	40.4
3	#5725.00	66.2 PK	74.0	-7.8	1.81 V	300	58.8	7.4
4	#5725.00	52.5 AV	54.0	-1.5	1.81 V	300	45.1	7.4
5	11400.00	61.1 PK	74.0	-12.9	1.63 V	193	42.3	18.8
6	11400.00	47.6 AV	54.0	-6.4	1.63 V	193	28.8	18.8

REMARKS:

1. Emission Level(dBuV/m) = Raw Value(dBuV) + Correction Factor(dB/m)
2. Correction Factor(dB/m) = Antenna Factor(dB/m) + Cable Factor(dB) – Pre-Amplifier Factor(dB)
3. The other emission levels were very low against the limit.
4. Margin value = Emission Level – Limit value
5. " * ": Fundamental frequency.
6. " # ": The radiated frequency is out of the restricted band.

802.11n (HT40)

CHANNEL	TX Channel 54	DETECTOR FUNCTION	Peak (PK)
FREQUENCY RANGE	1GHz ~ 40GHz		Average (AV)

ANTENNA POLARITY & TEST DISTANCE: HORIZONTAL AT 3 M								
NO.	FREQ. (MHz)	EMISSION LEVEL (dBuV/m)	LIMIT (dBuV/m)	MARGIN (dB)	ANTENNA HEIGHT (m)	TABLE ANGLE (Degree)	RAW VALUE (dBuV)	CORRECTION FACTOR (dB/m)
1	*5270.00	112.1 PK			2.65 H	355	72.5	39.6
2	*5270.00	102.7 AV			2.65 H	355	63.1	39.6
3	5350.00	64.9 PK	74.0	-9.1	1.98 H	350	58.4	6.5
4	5350.00	51.3 AV	54.0	-2.7	1.98 H	350	44.8	6.5
5	#10540.00	60.7 PK	74.0	-13.3	2.22 H	0	41.7	19.0
6	#10540.00	48.0 AV	54.0	-6.0	2.22 H	0	29.0	19.0

ANTENNA POLARITY & TEST DISTANCE: VERTICAL AT 3 M								
NO.	FREQ. (MHz)	EMISSION LEVEL (dBuV/m)	LIMIT (dBuV/m)	MARGIN (dB)	ANTENNA HEIGHT (m)	TABLE ANGLE (Degree)	RAW VALUE (dBuV)	CORRECTION FACTOR (dB/m)
1	*5270.00	113.9 PK			1.94 V	296	74.3	39.6
2	*5270.00	103.8 AV			1.94 V	296	64.2	39.6
3	5350.00	64.5 PK	74.0	-9.5	1.94 V	293	58.0	6.5
4	5350.00	51.5 AV	54.0	-2.5	1.94 V	293	45.0	6.5
5	#10540.00	60.0 PK	74.0	-14.0	1.88 V	177	41.0	19.0
6	#10540.00	47.7 AV	54.0	-6.3	1.88 V	177	28.7	19.0

REMARKS:

1. Emission Level(dBuV/m) = Raw Value(dBuV) + Correction Factor(dB/m)
2. Correction Factor(dB/m) = Antenna Factor(dB/m) + Cable Factor(dB) – Pre-Amplifier Factor(dB)
3. The other emission levels were very low against the limit.
4. Margin value = Emission Level – Limit value
5. " * ": Fundamental frequency.
6. " # ": The radiated frequency is out of the restricted band.

CHANNEL	TX Channel 62	DETECTOR FUNCTION	Peak (PK)
FREQUENCY RANGE	1GHz ~ 40GHz		Average (AV)

ANTENNA POLARITY & TEST DISTANCE: HORIZONTAL AT 3 M

NO.	FREQ. (MHz)	EMISSION LEVEL (dBuV/m)	LIMIT (dBuV/m)	MARGIN (dB)	ANTENNA HEIGHT (m)	TABLE ANGLE (Degree)	RAW VALUE (dBuV)	CORRECTION FACTOR (dB/m)
1	*5310.00	107.9 PK			3.75 H	346	68.2	39.7
2	*5310.00	98.5 AV			3.75 H	346	58.8	39.7
3	5350.00	66.5 PK	74.0	-7.5	1.86 H	351	60.0	6.5
4	5350.00	52.4 AV	54.0	-1.6	1.86 H	351	45.9	6.5
5	10620.00	61.4 PK	74.0	-12.6	2.29 H	170	42.5	18.9
6	10620.00	47.5 AV	54.0	-6.5	2.29 H	170	28.6	18.9

ANTENNA POLARITY & TEST DISTANCE: VERTICAL AT 3 M

NO.	FREQ. (MHz)	EMISSION LEVEL (dBuV/m)	LIMIT (dBuV/m)	MARGIN (dB)	ANTENNA HEIGHT (m)	TABLE ANGLE (Degree)	RAW VALUE (dBuV)	CORRECTION FACTOR (dB/m)
1	*5310.00	107.2 PK			1.93 V	295	67.5	39.7
2	*5310.00	97.9 AV			1.93 V	295	58.2	39.7
3	5350.00	65.3 PK	74.0	-8.7	1.78 V	291	58.8	6.5
4	5350.00	51.6 AV	54.0	-2.4	1.78 V	291	45.1	6.5
5	10620.00	59.5 PK	74.0	-14.5	1.97 V	223	40.6	18.9
6	10620.00	47.4 AV	54.0	-6.6	1.97 V	223	28.5	18.9

REMARKS:

1. Emission Level(dBuV/m) = Raw Value(dBuV) + Correction Factor(dB/m)
2. Correction Factor(dB/m) = Antenna Factor(dB/m) + Cable Factor(dB) – Pre-Amplifier Factor(dB)
3. The other emission levels were very low against the limit.
4. Margin value = Emission Level – Limit value
5. " * ": Fundamental frequency.



CHANNEL	TX Channel 102	DETECTOR FUNCTION	Peak (PK)
FREQUENCY RANGE	1GHz ~ 40GHz		Average (AV)

ANTENNA POLARITY & TEST DISTANCE: HORIZONTAL AT 3 M

NO.	FREQ. (MHz)	EMISSION LEVEL (dBuV/m)	LIMIT (dBuV/m)	MARGIN (dB)	ANTENNA HEIGHT (m)	TABLE ANGLE (Degree)	RAW VALUE (dBuV)	CORRECTION FACTOR (dB/m)
1	5460.00	62.4 PK	74.0	-11.6	1.45 H	294	55.5	6.9
2	5460.00	48.9 AV	54.0	-5.1	1.45 H	294	42.0	6.9
3	#5470.00	66.9 PK	74.0	-7.1	1.48 H	0	60.0	6.9
4	#5470.00	52.3 AV	54.0	-1.7	1.48 H	0	45.4	6.9
5	*5510.00	107.9 PK			3.49 H	348	67.7	40.2
6	*5510.00	98.3 AV			3.49 H	348	58.1	40.2
7	11020.00	61.3 PK	74.0	-12.7	1.68 H	321	41.5	19.8
8	11020.00	48.4 AV	54.0	-5.6	1.68 H	321	28.6	19.8

ANTENNA POLARITY & TEST DISTANCE: VERTICAL AT 3 M

NO.	FREQ. (MHz)	EMISSION LEVEL (dBuV/m)	LIMIT (dBuV/m)	MARGIN (dB)	ANTENNA HEIGHT (m)	TABLE ANGLE (Degree)	RAW VALUE (dBuV)	CORRECTION FACTOR (dB/m)
1	5460.00	63.5 PK	74.0	-10.5	1.59 V	348	56.6	6.9
2	5460.00	48.9 AV	54.0	-5.1	1.59 V	348	42.0	6.9
3	#5470.00	66.6 PK	74.0	-7.4	1.43 V	301	59.7	6.9
4	#5470.00	52.7 AV	54.0	-1.3	1.43 V	301	45.8	6.9
5	*5510.00	107.2 PK			1.74 V	299	67.0	40.2
6	*5510.00	97.8 AV			1.74 V	299	57.6	40.2
7	11020.00	61.2 PK	74.0	-12.8	1.73 V	276	41.4	19.8
8	11020.00	48.0 AV	54.0	-6.0	1.73 V	276	28.2	19.8

REMARKS:

1. Emission Level(dBuV/m) = Raw Value(dBuV) + Correction Factor(dB/m)
2. Correction Factor(dB/m) = Antenna Factor(dB/m) + Cable Factor(dB) – Pre-Amplifier Factor(dB)
3. The other emission levels were very low against the limit.
4. Margin value = Emission Level – Limit value
5. " * ": Fundamental frequency.
6. " # ": The radiated frequency is out of the restricted band.

CHANNEL	TX Channel 110	DETECTOR FUNCTION	Peak (PK)
FREQUENCY RANGE	1GHz ~ 40GHz		Average (AV)

ANTENNA POLARITY & TEST DISTANCE: HORIZONTAL AT 3 M

NO.	FREQ. (MHz)	EMISSION LEVEL (dBuV/m)	LIMIT (dBuV/m)	MARGIN (dB)	ANTENNA HEIGHT (m)	TABLE ANGLE (Degree)	RAW VALUE (dBuV)	CORRECTION FACTOR (dB/m)
1	#5470.00	63.5 PK	74.0	-10.5	2.97 H	277	56.6	6.9
2	#5470.00	50.4 AV	54.0	-3.6	2.97 H	277	43.5	6.9
3	*5550.00	113.2 PK			3.18 H	260	73.0	40.2
4	*5550.00	103.5 AV			3.18 H	260	63.3	40.2
5	11100.00	60.1 PK	74.0	-13.9	1.88 H	349	40.9	19.2
6	11100.00	47.2 AV	54.0	-6.8	1.88 H	349	28.0	19.2

ANTENNA POLARITY & TEST DISTANCE: VERTICAL AT 3 M

NO.	FREQ. (MHz)	EMISSION LEVEL (dBuV/m)	LIMIT (dBuV/m)	MARGIN (dB)	ANTENNA HEIGHT (m)	TABLE ANGLE (Degree)	RAW VALUE (dBuV)	CORRECTION FACTOR (dB/m)
1	#5470.00	66.2 PK	74.0	-7.8	1.58 V	292	59.3	6.9
2	#5470.00	52.6 AV	54.0	-1.4	1.58 V	292	45.7	6.9
3	*5550.00	115.0 PK			1.92 V	298	74.8	40.2
4	*5550.00	104.4 AV			1.92 V	298	64.2	40.2
5	11100.00	60.3 PK	74.0	-13.7	1.37 V	243	41.1	19.2
6	11100.00	47.3 AV	54.0	-6.7	1.37 V	243	28.1	19.2

REMARKS:

1. Emission Level(dBuV/m) = Raw Value(dBuV) + Correction Factor(dB/m)
2. Correction Factor(dB/m) = Antenna Factor(dB/m) + Cable Factor(dB) – Pre-Amplifier Factor(dB)
3. The other emission levels were very low against the limit.
4. Margin value = Emission Level – Limit value
5. " * ": Fundamental frequency.

CHANNEL	TX Channel 134	DETECTOR FUNCTION	Peak (PK)
FREQUENCY RANGE	1GHz ~ 40GHz		Average (AV)

ANTENNA POLARITY & TEST DISTANCE: HORIZONTAL AT 3 M

NO.	FREQ. (MHz)	EMISSION LEVEL (dBuV/m)	LIMIT (dBuV/m)	MARGIN (dB)	ANTENNA HEIGHT (m)	TABLE ANGLE (Degree)	RAW VALUE (dBuV)	CORRECTION FACTOR (dB/m)
1	*5670.00	109.8 PK			3.17 H	281	69.5	40.3
2	*5670.00	100.1 AV			3.17 H	281	59.8	40.3
3	#5725.00	69.2 PK	74.0	-4.8	3.22 H	346	61.8	7.4
4	#5725.00	52.4 AV	54.0	-1.6	3.22 H	346	45.0	7.4
5	11340.00	60.2 PK	74.0	-13.8	2.56 H	109	41.0	19.2
6	11340.00	47.1 AV	54.0	-6.9	2.56 H	109	27.9	19.2

ANTENNA POLARITY & TEST DISTANCE: VERTICAL AT 3 M

NO.	FREQ. (MHz)	EMISSION LEVEL (dBuV/m)	LIMIT (dBuV/m)	MARGIN (dB)	ANTENNA HEIGHT (m)	TABLE ANGLE (Degree)	RAW VALUE (dBuV)	CORRECTION FACTOR (dB/m)
1	*5670.00	111.4 PK			1.92 V	298	71.1	40.3
2	*5670.00	101.7 AV			1.92 V	298	61.4	40.3
3	#5725.00	68.3 PK	74.0	-5.7	2.08 V	327	60.9	7.4
4	#5725.00	52.3 AV	54.0	-1.7	2.08 V	327	44.9	7.4
5	11340.00	60.2 PK	74.0	-13.8	1.77 V	269	41.0	19.2
6	11340.00	47.5 AV	54.0	-6.5	1.77 V	269	28.3	19.2

REMARKS:

1. Emission Level(dBuV/m) = Raw Value(dBuV) + Correction Factor(dB/m)
2. Correction Factor(dB/m) = Antenna Factor(dB/m) + Cable Factor(dB) – Pre-Amplifier Factor(dB)
3. The other emission levels were very low against the limit.
4. Margin value = Emission Level – Limit value
5. " * ": Fundamental frequency.
6. " # ": The radiated frequency is out of the restricted band.

802.11ac (VHT80)

CHANNEL	TX Channel 58	DETECTOR FUNCTION	Peak (PK)
FREQUENCY RANGE	1GHz ~ 40GHz		Average (AV)

ANTENNA POLARITY & TEST DISTANCE: HORIZONTAL AT 3 M								
NO.	FREQ. (MHz)	EMISSION LEVEL (dBuV/m)	LIMIT (dBuV/m)	MARGIN (dB)	ANTENNA HEIGHT (m)	TABLE ANGLE (Degree)	RAW VALUE (dBuV)	CORRECTION FACTOR (dB/m)
1	*5290.00	103.9 PK			3.10 H	353	64.2	39.7
2	*5290.00	93.6 AV			3.10 H	353	53.9	39.7
3	5350.00	66.5 PK	74.0	-7.5	2.33 H	351	60.0	6.5
4	5350.00	52.7 AV	54.0	-1.3	2.33 H	351	46.2	6.5
5	#10580.00	60.9 PK	74.0	-13.1	1.89 H	275	41.9	19.0
6	#10580.00	47.8 AV	54.0	-6.2	1.89 H	275	28.8	19.0

ANTENNA POLARITY & TEST DISTANCE: VERTICAL AT 3 M								
NO.	FREQ. (MHz)	EMISSION LEVEL (dBuV/m)	LIMIT (dBuV/m)	MARGIN (dB)	ANTENNA HEIGHT (m)	TABLE ANGLE (Degree)	RAW VALUE (dBuV)	CORRECTION FACTOR (dB/m)
1	*5290.00	103.0 PK			1.62 V	296	63.3	39.7
2	*5290.00	93.5 AV			1.62 V	296	53.8	39.7
3	5350.00	64.4 PK	74.0	-9.6	1.68 V	291	57.9	6.5
4	5350.00	52.6 AV	54.0	-1.4	1.68 V	291	46.1	6.5
5	#10580.00	60.8 PK	74.0	-13.2	1.64 V	195	41.8	19.0
6	#10580.00	48.5 AV	54.0	-5.5	1.64 V	195	29.5	19.0

REMARKS:

1. Emission Level(dBuV/m) = Raw Value(dBuV) + Correction Factor(dB/m)
2. Correction Factor(dB/m) = Antenna Factor(dB/m) + Cable Factor(dB) – Pre-Amplifier Factor(dB)
3. The other emission levels were very low against the limit.
4. Margin value = Emission Level – Limit value
5. " * ": Fundamental frequency.
6. " # ": The radiated frequency is out of the restricted band.



CHANNEL	TX Channel 106	DETECTOR FUNCTION	Peak (PK)
FREQUENCY RANGE	1GHz ~ 40GHz		Average (AV)

ANTENNA POLARITY & TEST DISTANCE: HORIZONTAL AT 3 M

NO.	FREQ. (MHz)	EMISSION LEVEL (dBuV/m)	LIMIT (dBuV/m)	MARGIN (dB)	ANTENNA HEIGHT (m)	TABLE ANGLE (Degree)	RAW VALUE (dBuV)	CORRECTION FACTOR (dB/m)
1	5460.00	64.9 PK	74.0	-9.1	3.21 H	344	58.0	6.9
2	5460.00	51.8 AV	54.0	-2.2	3.21 H	344	44.9	6.9
3	#5470.00	66.2 PK	74.0	-7.8	3.09 H	346	59.3	6.9
4	#5470.00	52.5 AV	54.0	-1.5	3.09 H	346	45.6	6.9
5	*5530.00	104.0 PK			3.24 H	343	63.8	40.2
6	*5530.00	94.8 AV			3.24 H	343	54.6	40.2
7	11060.00	61.0 PK	74.0	-13.0	2.42 H	262	41.5	19.5
8	11060.00	48.1 AV	54.0	-5.9	2.42 H	262	28.6	19.5

ANTENNA POLARITY & TEST DISTANCE: VERTICAL AT 3 M

NO.	FREQ. (MHz)	EMISSION LEVEL (dBuV/m)	LIMIT (dBuV/m)	MARGIN (dB)	ANTENNA HEIGHT (m)	TABLE ANGLE (Degree)	RAW VALUE (dBuV)	CORRECTION FACTOR (dB/m)
1	5460.00	55.3 PK	74.0	-18.7	2.29 V	304	48.4	6.9
2	5460.00	52.7 AV	54.0	-1.3	2.29 V	304	45.8	6.9
3	#5470.00	64.4 PK	74.0	-9.6	1.76 V	288	57.5	6.9
4	#5470.00	52.9 AV	54.0	-1.1	1.76 V	288	46.0	6.9
5	*5530.00	103.5 PK			1.99 V	309	63.3	40.2
6	*5530.00	93.8 AV			1.99 V	309	53.6	40.2
7	11060.00	60.9 PK	74.0	-13.1	1.98 V	245	41.4	19.5
8	11060.00	47.7 AV	54.0	-6.3	1.98 V	245	28.2	19.5

REMARKS:

1. Emission Level(dBuV/m) = Raw Value(dBuV) + Correction Factor(dB/m)
2. Correction Factor(dB/m) = Antenna Factor(dB/m) + Cable Factor(dB) – Pre-Amplifier Factor(dB)
3. The other emission levels were very low against the limit.
4. Margin value = Emission Level – Limit value
5. " * ": Fundamental frequency.
6. " # ": The radiated frequency is out of the restricted band.

Beamforming Mode

802.11ac (VHT20)

CHANNEL	TX Channel 52	DETECTOR FUNCTION	Peak (PK)
FREQUENCY RANGE	1GHz ~ 40GHz		Average (AV)

ANTENNA POLARITY & TEST DISTANCE: HORIZONTAL AT 3 M

NO.	FREQ. (MHz)	EMISSION LEVEL (dBuV/m)	LIMIT (dBuV/m)	MARGIN (dB)	ANTENNA HEIGHT (m)	TABLE ANGLE (Degree)	RAW VALUE (dBuV)	CORRECTION FACTOR (dB/m)
1	5150.00	55.1 PK	74.0	-18.9	3.08 H	320	50.3	4.8
2	5150.00	42.0 AV	54.0	-12.0	3.08 H	320	37.2	4.8
3	*5260.00	119.2 PK			2.91 H	351	80.3	38.9
4	*5260.00	108.5 AV			2.91 H	351	69.6	38.9
5	#10520.00	59.4 PK	74.0	-14.6	2.41 H	198	40.8	18.6
6	#10520.00	46.7 AV	54.0	-7.3	2.41 H	198	28.1	18.6

ANTENNA POLARITY & TEST DISTANCE: VERTICAL AT 3 M

NO.	FREQ. (MHz)	EMISSION LEVEL (dBuV/m)	LIMIT (dBuV/m)	MARGIN (dB)	ANTENNA HEIGHT (m)	TABLE ANGLE (Degree)	RAW VALUE (dBuV)	CORRECTION FACTOR (dB/m)
1	5150.00	55.0 PK	74.0	-19.0	1.85 V	274	50.2	4.8
2	5150.00	42.2 AV	54.0	-11.8	1.85 V	274	37.4	4.8
3	*5260.00	117.1 PK			1.38 V	300	78.2	38.9
4	*5260.00	105.1 AV			1.38 V	300	66.2	38.9
5	#10520.00	59.8 PK	74.0	-14.2	2.46 V	291	41.2	18.6
6	#10520.00	46.7 AV	54.0	-7.3	2.46 V	291	28.1	18.6

REMARKS:

1. Emission Level(dBuV/m) = Raw Value(dBuV) + Correction Factor(dB/m)
2. Correction Factor(dB/m) = Antenna Factor(dB/m) + Cable Factor(dB) – Pre-Amplifier Factor(dB)
3. The other emission levels were very low against the limit.
4. Margin value = Emission Level – Limit value
5. " * ": Fundamental frequency.
6. " # ": The radiated frequency is out of the restricted band.

CHANNEL	TX Channel 60	DETECTOR FUNCTION	Peak (PK)
FREQUENCY RANGE	1GHz ~ 40GHz		Average (AV)

ANTENNA POLARITY & TEST DISTANCE: HORIZONTAL AT 3 M

NO.	FREQ. (MHz)	EMISSION LEVEL (dBuV/m)	LIMIT (dBuV/m)	MARGIN (dB)	ANTENNA HEIGHT (m)	TABLE ANGLE (Degree)	RAW VALUE (dBuV)	CORRECTION FACTOR (dB/m)
1	*5300.00	118.2 PK			3.08 H	351	79.1	39.1
2	*5300.00	106.9 AV			3.08 H	351	67.8	39.1
3	10600.00	60.0 PK	74.0	-14.0	2.41 H	29	41.5	18.5
4	10600.00	46.4 AV	54.0	-7.6	2.41 H	29	27.9	18.5

ANTENNA POLARITY & TEST DISTANCE: VERTICAL AT 3 M

NO.	FREQ. (MHz)	EMISSION LEVEL (dBuV/m)	LIMIT (dBuV/m)	MARGIN (dB)	ANTENNA HEIGHT (m)	TABLE ANGLE (Degree)	RAW VALUE (dBuV)	CORRECTION FACTOR (dB/m)
1	*5300.00	117.8 PK			2.11 V	301	78.7	39.1
2	*5300.00	106.6 AV			2.11 V	301	67.5	39.1
3	10600.00	59.6 PK	74.0	-14.4	1.66 V	284	41.1	18.5
4	10600.00	46.7 AV	54.0	-7.3	1.66 V	284	28.2	18.5

REMARKS:

1. Emission Level(dBuV/m) = Raw Value(dBuV) + Correction Factor(dB/m)
2. Correction Factor(dB/m) = Antenna Factor(dB/m) + Cable Factor(dB) – Pre-Amplifier Factor(dB)
3. The other emission levels were very low against the limit.
4. Margin value = Emission Level – Limit value
5. " * ": Fundamental frequency.

CHANNEL	TX Channel 64	DETECTOR FUNCTION	Peak (PK)
FREQUENCY RANGE	1GHz ~ 40GHz		Average (AV)

ANTENNA POLARITY & TEST DISTANCE: HORIZONTAL AT 3 M

NO.	FREQ. (MHz)	EMISSION LEVEL (dBuV/m)	LIMIT (dBuV/m)	MARGIN (dB)	ANTENNA HEIGHT (m)	TABLE ANGLE (Degree)	RAW VALUE (dBuV)	CORRECTION FACTOR (dB/m)
1	*5320.00	116.6 PK			3.01 H	347	76.9	39.7
2	*5320.00	104.6 AV			3.01 H	347	64.9	39.7
3	5350.00	68.1 PK	74.0	-5.9	3.08 H	340	61.6	6.5
4	5350.00	53.0 AV	54.0	-1.0	3.08 H	340	46.5	6.5
5	10640.00	60.7 PK	74.0	-13.3	2.89 H	321	41.9	18.8
6	10640.00	48.1 AV	54.0	-5.9	2.89 H	321	29.3	18.8

ANTENNA POLARITY & TEST DISTANCE: VERTICAL AT 3 M

NO.	FREQ. (MHz)	EMISSION LEVEL (dBuV/m)	LIMIT (dBuV/m)	MARGIN (dB)	ANTENNA HEIGHT (m)	TABLE ANGLE (Degree)	RAW VALUE (dBuV)	CORRECTION FACTOR (dB/m)
1	*5320.00	114.3 PK			1.99 V	292	74.6	39.7
2	*5320.00	102.5 AV			1.99 V	292	62.8	39.7
3	5350.00	69.8 PK	74.0	-4.2	1.81 V	290	63.3	6.5
4	5350.00	52.5 AV	54.0	-1.5	1.81 V	290	46.0	6.5
5	10640.00	60.9 PK	74.0	-13.1	1.56 V	334	42.1	18.8
6	10640.00	47.9 AV	54.0	-6.1	1.56 V	334	29.1	18.8

REMARKS:

1. Emission Level(dBuV/m) = Raw Value(dBuV) + Correction Factor(dB/m)
2. Correction Factor(dB/m) = Antenna Factor(dB/m) + Cable Factor(dB) – Pre-Amplifier Factor(dB)
3. The other emission levels were very low against the limit.
4. Margin value = Emission Level – Limit value
5. " * ": Fundamental frequency.

CHANNEL	TX Channel 100	DETECTOR FUNCTION	Peak (PK)
FREQUENCY RANGE	1GHz ~ 40GHz		Average (AV)

ANTENNA POLARITY & TEST DISTANCE: HORIZONTAL AT 3 M

NO.	FREQ. (MHz)	EMISSION LEVEL (dBuV/m)	LIMIT (dBuV/m)	MARGIN (dB)	ANTENNA HEIGHT (m)	TABLE ANGLE (Degree)	RAW VALUE (dBuV)	CORRECTION FACTOR (dB/m)
1	5460.00	59.8 PK	74.0	-14.2	3.33 H	319	52.9	6.9
2	5460.00	47.1 AV	54.0	-6.9	3.33 H	319	40.2	6.9
3	#5470.00	66.9 PK	74.0	-7.1	3.33 H	319	60.0	6.9
4	#5470.00	50.4 AV	54.0	-3.6	3.33 H	319	43.5	6.9
5	*5500.00	110.6 PK			2.99 H	320	70.4	40.2
6	*5500.00	100.3 AV			2.99 H	320	60.1	40.2
7	11000.00	61.9 PK	74.0	-12.1	2.20 H	10	42.0	19.9
8	11000.00	48.8 AV	54.0	-5.2	2.20 H	10	28.9	19.9

ANTENNA POLARITY & TEST DISTANCE: VERTICAL AT 3 M

NO.	FREQ. (MHz)	EMISSION LEVEL (dBuV/m)	LIMIT (dBuV/m)	MARGIN (dB)	ANTENNA HEIGHT (m)	TABLE ANGLE (Degree)	RAW VALUE (dBuV)	CORRECTION FACTOR (dB/m)
1	5460.00	59.1 PK	74.0	-14.9	2.01 V	312	52.2	6.9
2	5460.00	48.3 AV	54.0	-5.7	2.01 V	312	41.4	6.9
3	#5470.00	66.3 PK	74.0	-7.7	2.01 V	312	59.4	6.9
4	#5470.00	49.3 AV	54.0	-4.7	2.01 V	312	42.4	6.9
5	*5500.00	112.2 PK			1.88 V	285	72.0	40.2
6	*5500.00	101.4 AV			1.88 V	285	61.2	40.2
7	11000.00	61.0 PK	74.0	-13.0	1.68 V	326	41.1	19.9
8	11000.00	48.0 AV	54.0	-6.0	1.68 V	326	28.1	19.9

REMARKS:

1. Emission Level(dBuV/m) = Raw Value(dBuV) + Correction Factor(dB/m)
2. Correction Factor(dB/m) = Antenna Factor(dB/m) + Cable Factor(dB) – Pre-Amplifier Factor(dB)
3. The other emission levels were very low against the limit.
4. Margin value = Emission Level – Limit value
5. " * ": Fundamental frequency.
6. " # ": The radiated frequency is out of the restricted band.

CHANNEL	TX Channel 116	DETECTOR FUNCTION	Peak (PK)
FREQUENCY RANGE	1GHz ~ 40GHz		Average (AV)

ANTENNA POLARITY & TEST DISTANCE: HORIZONTAL AT 3 M

NO.	FREQ. (MHz)	EMISSION LEVEL (dBuV/m)	LIMIT (dBuV/m)	MARGIN (dB)	ANTENNA HEIGHT (m)	TABLE ANGLE (Degree)	RAW VALUE (dBuV)	CORRECTION FACTOR (dB/m)
1	*5580.00	118.0 PK			3.10 H	351	78.2	39.8
2	*5580.00	106.4 AV			3.10 H	351	66.6	39.8
3	11160.00	60.1 PK	74.0	-13.9	2.98 H	317	40.6	19.5
4	11160.00	47.0 AV	54.0	-7.0	2.98 H	317	27.5	19.5

ANTENNA POLARITY & TEST DISTANCE: VERTICAL AT 3 M

NO.	FREQ. (MHz)	EMISSION LEVEL (dBuV/m)	LIMIT (dBuV/m)	MARGIN (dB)	ANTENNA HEIGHT (m)	TABLE ANGLE (Degree)	RAW VALUE (dBuV)	CORRECTION FACTOR (dB/m)
1	*5580.00	117.7 PK			1.72 V	330	77.9	39.8
2	*5580.00	108.4 AV			1.72 V	330	68.6	39.8
3	11160.00	60.0 PK	74.0	-14.0	2.64 V	223	40.5	19.5
4	11160.00	46.9 AV	54.0	-7.1	2.64 V	223	27.4	19.5

REMARKS:

1. Emission Level(dBuV/m) = Raw Value(dBuV) + Correction Factor(dB/m)
2. Correction Factor(dB/m) = Antenna Factor(dB/m) + Cable Factor(dB) – Pre-Amplifier Factor(dB)
3. The other emission levels were very low against the limit.
4. Margin value = Emission Level – Limit value
5. " * ": Fundamental frequency.

CHANNEL	TX Channel 140	DETECTOR FUNCTION	Peak (PK)
FREQUENCY RANGE	1GHz ~ 40GHz		Average (AV)

ANTENNA POLARITY & TEST DISTANCE: HORIZONTAL AT 3 M

NO.	FREQ. (MHz)	EMISSION LEVEL (dBuV/m)	LIMIT (dBuV/m)	MARGIN (dB)	ANTENNA HEIGHT (m)	TABLE ANGLE (Degree)	RAW VALUE (dBuV)	CORRECTION FACTOR (dB/m)
1	*5700.00	112.3 PK			3.13 H	275	71.9	40.4
2	*5700.00	101.1 AV			3.13 H	275	60.7	40.4
3	#5725.00	65.9 PK	74.0	-8.1	2.47 H	349	58.5	7.4
4	#5725.00	50.0 AV	54.0	-4.0	2.47 H	349	42.6	7.4
5	11400.00	60.4 PK	74.0	-13.6	2.33 H	301	41.6	18.8
6	11400.00	47.7 AV	54.0	-6.3	2.33 H	301	28.9	18.8

ANTENNA POLARITY & TEST DISTANCE: VERTICAL AT 3 M

NO.	FREQ. (MHz)	EMISSION LEVEL (dBuV/m)	LIMIT (dBuV/m)	MARGIN (dB)	ANTENNA HEIGHT (m)	TABLE ANGLE (Degree)	RAW VALUE (dBuV)	CORRECTION FACTOR (dB/m)
1	*5700.00	111.8 PK			1.82 V	301	71.4	40.4
2	*5700.00	99.9 AV			1.82 V	301	59.5	40.4
3	#5725.00	65.9 PK	74.0	-8.1	1.25 V	310	25.4	40.5
4	#5725.00	48.8 AV	54.0	-5.2	1.25 V	310	8.3	40.5
5	11400.00	60.6 PK	74.0	-13.4	2.34 V	356	41.9	18.7
6	11400.00	47.7 AV	54.0	-6.3	2.34 V	356	29.0	18.7

REMARKS:

1. Emission Level(dBuV/m) = Raw Value(dBuV) + Correction Factor(dB/m)
2. Correction Factor(dB/m) = Antenna Factor(dB/m) + Cable Factor(dB) – Pre-Amplifier Factor(dB)
3. The other emission levels were very low against the limit.
4. Margin value = Emission Level – Limit value
5. " * ": Fundamental frequency.
6. " # ": The radiated frequency is out of the restricted band.

802.11ac (VHT40)

CHANNEL	TX Channel 54	DETECTOR FUNCTION	Peak (PK)
FREQUENCY RANGE	1GHz ~ 40GHz		Average (AV)

ANTENNA POLARITY & TEST DISTANCE: HORIZONTAL AT 3 M								
NO.	FREQ. (MHz)	EMISSION LEVEL (dBuV/m)	LIMIT (dBuV/m)	MARGIN (dB)	ANTENNA HEIGHT (m)	TABLE ANGLE (Degree)	RAW VALUE (dBuV)	CORRECTION FACTOR (dB/m)
1	*5270.00	114.9 PK			1.32 H	334	75.9	39.0
2	*5270.00	104.6 AV			1.32 H	334	65.6	39.0
3	5350.00	66.3 PK	74.0	-7.7	1.29 H	325	60.8	5.5
4	5350.00	47.1 AV	54.0	-6.9	1.29 H	325	41.6	5.5
5	#10540.00	59.6 PK	74.0	-14.4	1.63 H	241	41.0	18.6
6	#10540.00	46.9 AV	54.0	-7.1	1.63 H	241	28.3	18.6

ANTENNA POLARITY & TEST DISTANCE: VERTICAL AT 3 M								
NO.	FREQ. (MHz)	EMISSION LEVEL (dBuV/m)	LIMIT (dBuV/m)	MARGIN (dB)	ANTENNA HEIGHT (m)	TABLE ANGLE (Degree)	RAW VALUE (dBuV)	CORRECTION FACTOR (dB/m)
1	*5270.00	114.8 PK			1.92 V	296	75.8	39.0
2	*5270.00	102.6 AV			1.92 V	296	63.6	39.0
3	5350.00	64.0 PK	74.0	-10.0	2.10 V	296	58.5	5.5
4	5350.00	49.6 AV	54.0	-4.4	2.10 V	296	44.1	5.5
5	#10540.00	59.4 PK	74.0	-14.6	2.24 V	286	40.8	18.6
6	#10540.00	46.6 AV	54.0	-7.4	2.24 V	286	28.0	18.6

REMARKS:

1. Emission Level(dBuV/m) = Raw Value(dBuV) + Correction Factor(dB/m)
2. Correction Factor(dB/m) = Antenna Factor(dB/m) + Cable Factor(dB) – Pre-Amplifier Factor(dB)
3. The other emission levels were very low against the limit.
4. Margin value = Emission Level – Limit value
5. " * ": Fundamental frequency.
6. " # ": The radiated frequency is out of the restricted band.

CHANNEL	TX Channel 62	DETECTOR FUNCTION	Peak (PK)
FREQUENCY RANGE	1GHz ~ 40GHz		Average (AV)

ANTENNA POLARITY & TEST DISTANCE: HORIZONTAL AT 3 M

NO.	FREQ. (MHz)	EMISSION LEVEL (dBuV/m)	LIMIT (dBuV/m)	MARGIN (dB)	ANTENNA HEIGHT (m)	TABLE ANGLE (Degree)	RAW VALUE (dBuV)	CORRECTION FACTOR (dB/m)
1	*5310.00	108.0 PK			2.96 H	344	68.3	39.7
2	*5310.00	96.9 AV			2.96 H	344	57.2	39.7
3	5350.00	73.0 PK	74.0	-1.0	3.08 H	350	66.5	6.5
4	5350.00	50.4 AV	54.0	-3.6	3.08 H	350	43.9	6.5
5	10620.00	60.5 PK	74.0	-13.5	2.56 H	321	41.6	18.9
6	10620.00	47.3 AV	54.0	-6.7	2.56 H	321	28.4	18.9

ANTENNA POLARITY & TEST DISTANCE: VERTICAL AT 3 M

NO.	FREQ. (MHz)	EMISSION LEVEL (dBuV/m)	LIMIT (dBuV/m)	MARGIN (dB)	ANTENNA HEIGHT (m)	TABLE ANGLE (Degree)	RAW VALUE (dBuV)	CORRECTION FACTOR (dB/m)
1	*5310.00	107.0 PK			1.90 V	296	67.3	39.7
2	*5310.00	94.9 AV			1.90 V	296	55.2	39.7
3	5350.00	72.2 PK	74.0	-1.8	1.91 V	290	65.7	6.5
4	5350.00	49.1 AV	54.0	-4.9	1.91 V	290	42.6	6.5
5	10620.00	59.7 PK	74.0	-14.3	1.38 V	262	40.8	18.9
6	10620.00	46.8 AV	54.0	-7.2	1.38 V	262	27.9	18.9

REMARKS:

1. Emission Level(dBuV/m) = Raw Value(dBuV) + Correction Factor(dB/m)
2. Correction Factor(dB/m) = Antenna Factor(dB/m) + Cable Factor(dB) – Pre-Amplifier Factor(dB)
3. The other emission levels were very low against the limit.
4. Margin value = Emission Level – Limit value
5. " * ": Fundamental frequency.



CHANNEL	TX Channel 102	DETECTOR FUNCTION	Peak (PK)
FREQUENCY RANGE	1GHz ~ 40GHz		Average (AV)

ANTENNA POLARITY & TEST DISTANCE: HORIZONTAL AT 3 M

NO.	FREQ. (MHz)	EMISSION LEVEL (dBuV/m)	LIMIT (dBuV/m)	MARGIN (dB)	ANTENNA HEIGHT (m)	TABLE ANGLE (Degree)	RAW VALUE (dBuV)	CORRECTION FACTOR (dB/m)
1	5460.00	70.4 PK	74.0	-3.6	2.93 H	352	63.5	6.9
2	5460.00	48.1 AV	54.0	-5.9	2.93 H	352	41.2	6.9
3	#5470.00	72.8 PK	74.0	-1.2	3.05 H	340	65.9	6.9
4	#5470.00	50.2 AV	54.0	-3.8	3.05 H	340	43.3	6.9
5	*5510.00	108.1 PK			2.96 H	346	67.9	40.2
6	*5510.00	95.1 AV			2.96 H	346	54.9	40.2
7	11020.00	60.9 PK	74.0	-13.1	2.03 H	234	41.1	19.8
8	11020.00	48.3 AV	54.0	-5.7	2.03 H	234	28.5	19.8

ANTENNA POLARITY & TEST DISTANCE: VERTICAL AT 3 M

NO.	FREQ. (MHz)	EMISSION LEVEL (dBuV/m)	LIMIT (dBuV/m)	MARGIN (dB)	ANTENNA HEIGHT (m)	TABLE ANGLE (Degree)	RAW VALUE (dBuV)	CORRECTION FACTOR (dB/m)
1	5460.00	67.2 PK	74.0	-6.8	1.77 V	293	60.3	6.9
2	5460.00	47.9 AV	54.0	-6.1	1.77 V	293	41.0	6.9
3	#5470.00	72.8 PK	74.0	-1.2	1.77 V	293	65.9	6.9
4	#5470.00	49.1 AV	54.0	-4.9	1.77 V	293	42.2	6.9
5	*5510.00	106.5 PK			1.68 V	289	66.3	40.2
6	*5510.00	95.1 AV			1.68 V	289	54.9	40.2
7	11020.00	60.7 PK	74.0	-13.3	2.00 V	270	40.9	19.8
8	11020.00	47.5 AV	54.0	-6.5	2.00 V	270	27.7	19.8

REMARKS:

1. Emission Level(dBuV/m) = Raw Value(dBuV) + Correction Factor(dB/m)
2. Correction Factor(dB/m) = Antenna Factor(dB/m) + Cable Factor(dB) – Pre-Amplifier Factor(dB)
3. The other emission levels were very low against the limit.
4. Margin value = Emission Level – Limit value
5. " * ": Fundamental frequency.
6. " # ": The radiated frequency is out of the restricted band.

CHANNEL	TX Channel 110	DETECTOR FUNCTION	Peak (PK)
FREQUENCY RANGE	1GHz ~ 40GHz		Average (AV)

ANTENNA POLARITY & TEST DISTANCE: HORIZONTAL AT 3 M

NO.	FREQ. (MHz)	EMISSION LEVEL (dBuV/m)	LIMIT (dBuV/m)	MARGIN (dB)	ANTENNA HEIGHT (m)	TABLE ANGLE (Degree)	RAW VALUE (dBuV)	CORRECTION FACTOR (dB/m)
1	#5470.00	64.3 PK	74.0	-9.7	2.81 H	350	58.6	5.7
2	#5470.00	49.4 AV	54.0	-4.6	2.81 H	350	43.7	5.7
3	*5550.00	115.8 PK			3.23 H	347	76.2	39.6
4	*5550.00	104.2 AV			3.23 H	347	64.6	39.6
5	11100.00	60.6 PK	74.0	-13.4	2.26 H	248	41.4	19.2
6	11100.00	47.1 AV	54.0	-6.9	2.26 H	248	27.9	19.2

ANTENNA POLARITY & TEST DISTANCE: VERTICAL AT 3 M

NO.	FREQ. (MHz)	EMISSION LEVEL (dBuV/m)	LIMIT (dBuV/m)	MARGIN (dB)	ANTENNA HEIGHT (m)	TABLE ANGLE (Degree)	RAW VALUE (dBuV)	CORRECTION FACTOR (dB/m)
1	#5470.00	67.1 PK	74.0	-6.9	2.02 V	301	61.4	5.7
2	#5470.00	49.5 AV	54.0	-4.5	2.02 V	301	43.8	5.7
3	*5550.00	115.1 PK			1.92 V	300	75.5	39.6
4	*5550.00	103.5 AV			1.92 V	300	63.9	39.6
5	11100.00	60.4 PK	74.0	-13.6	2.62 V	125	41.2	19.2
6	11100.00	47.4 AV	54.0	-6.6	2.62 V	125	28.2	19.2

REMARKS:

1. Emission Level(dBuV/m) = Raw Value(dBuV) + Correction Factor(dB/m)
2. Correction Factor(dB/m) = Antenna Factor(dB/m) + Cable Factor(dB) – Pre-Amplifier Factor(dB)
3. The other emission levels were very low against the limit.
4. Margin value = Emission Level – Limit value
5. " * ": Fundamental frequency.

CHANNEL	TX Channel 134	DETECTOR FUNCTION	Peak (PK)
FREQUENCY RANGE	1GHz ~ 40GHz		Average (AV)

ANTENNA POLARITY & TEST DISTANCE: HORIZONTAL AT 3 M

NO.	FREQ. (MHz)	EMISSION LEVEL (dBuV/m)	LIMIT (dBuV/m)	MARGIN (dB)	ANTENNA HEIGHT (m)	TABLE ANGLE (Degree)	RAW VALUE (dBuV)	CORRECTION FACTOR (dB/m)
1	*5670.00	109.5 PK			2.99 H	340	69.2	40.3
2	*5670.00	98.6 AV			2.99 H	340	58.3	40.3
3	#5725.00	72.5 PK	74.0	-1.5	3.11 H	337	65.1	7.4
4	#5725.00	50.1 AV	54.0	-3.9	3.11 H	337	42.7	7.4
5	11340.00	61.2 PK	74.0	-12.8	2.59 H	0	42.0	19.2
6	11340.00	48.0 AV	54.0	-6.0	2.59 H	0	28.8	19.2

ANTENNA POLARITY & TEST DISTANCE: VERTICAL AT 3 M

NO.	FREQ. (MHz)	EMISSION LEVEL (dBuV/m)	LIMIT (dBuV/m)	MARGIN (dB)	ANTENNA HEIGHT (m)	TABLE ANGLE (Degree)	RAW VALUE (dBuV)	CORRECTION FACTOR (dB/m)
1	*5670.00	108.6 PK			1.54 V	299	68.3	40.3
2	*5670.00	97.2 AV			1.54 V	299	56.9	40.3
3	#5725.00	70.6 PK	74.0	-3.4	1.50 V	300	63.2	7.4
4	#5725.00	47.9 AV	54.0	-6.1	1.50 V	300	40.5	7.4
5	11340.00	60.7 PK	74.0	-13.3	1.13 V	212	41.5	19.2
6	11340.00	47.9 AV	54.0	-6.1	1.13 V	212	28.7	19.2

REMARKS:

1. Emission Level(dBuV/m) = Raw Value(dBuV) + Correction Factor(dB/m)
2. Correction Factor(dB/m) = Antenna Factor(dB/m) + Cable Factor(dB) – Pre-Amplifier Factor(dB)
3. The other emission levels were very low against the limit.
4. Margin value = Emission Level – Limit value
5. " * ": Fundamental frequency.
6. " # ": The radiated frequency is out of the restricted band.

802.11ac (VHT80)

CHANNEL	TX Channel 58	DETECTOR FUNCTION	Peak (PK)
FREQUENCY RANGE	1GHz ~ 40GHz		Average (AV)

ANTENNA POLARITY & TEST DISTANCE: HORIZONTAL AT 3 M								
NO.	FREQ. (MHz)	EMISSION LEVEL (dBuV/m)	LIMIT (dBuV/m)	MARGIN (dB)	ANTENNA HEIGHT (m)	TABLE ANGLE (Degree)	RAW VALUE (dBuV)	CORRECTION FACTOR (dB/m)
1	*5290.00	102.7 PK			2.97 H	343	63.0	39.7
2	*5290.00	90.7 AV			2.97 H	343	51.0	39.7
3	5400.00	72.5 PK	74.0	-1.5	3.02 H	340	65.8	6.7
4	5400.00	50.5 AV	54.0	-3.5	3.02 H	340	43.8	6.7
5	#10580.00	60.1 PK	74.0	-13.9	2.65 H	19	41.1	19.0
6	#10580.00	46.9 AV	54.0	-7.1	2.65 H	19	27.9	19.0

ANTENNA POLARITY & TEST DISTANCE: VERTICAL AT 3 M								
NO.	FREQ. (MHz)	EMISSION LEVEL (dBuV/m)	LIMIT (dBuV/m)	MARGIN (dB)	ANTENNA HEIGHT (m)	TABLE ANGLE (Degree)	RAW VALUE (dBuV)	CORRECTION FACTOR (dB/m)
1	*5290.00	100.7 PK			1.53 V	297	61.0	39.7
2	*5290.00	89.5 AV			1.53 V	297	49.8	39.7
3	5360.00	62.8 PK	74.0	-11.2	1.30 V	280	56.3	6.5
4	5360.00	47.8 AV	54.0	-6.2	1.30 V	280	41.3	6.5
5	#10580.00	59.5 PK	74.0	-14.5	1.77 V	29	40.5	19.0
6	#10580.00	46.1 AV	54.0	-7.9	1.77 V	29	27.1	19.0

REMARKS:

1. Emission Level(dBuV/m) = Raw Value(dBuV) + Correction Factor(dB/m)
2. Correction Factor(dB/m) = Antenna Factor(dB/m) + Cable Factor(dB) – Pre-Amplifier Factor(dB)
3. The other emission levels were very low against the limit.
4. Margin value = Emission Level – Limit value
5. " * ": Fundamental frequency.
6. " # ": The radiated frequency is out of the restricted band.



CHANNEL	TX Channel 106	DETECTOR FUNCTION	Peak (PK)
FREQUENCY RANGE	1GHz ~ 40GHz		Average (AV)

ANTENNA POLARITY & TEST DISTANCE: HORIZONTAL AT 3 M

NO.	FREQ. (MHz)	EMISSION LEVEL (dBuV/m)	LIMIT (dBuV/m)	MARGIN (dB)	ANTENNA HEIGHT (m)	TABLE ANGLE (Degree)	RAW VALUE (dBuV)	CORRECTION FACTOR (dB/m)
1	5457.00	72.6 PK	74.0	-1.4	3.03 H	348	65.7	6.9
2	5457.00	50.5 AV	54.0	-3.5	3.03 H	348	43.6	6.9
3	#5470.00	69.2 PK	74.0	-4.8	3.03 H	348	62.3	6.9
4	#5470.00	47.8 AV	54.0	-6.2	3.03 H	348	40.9	6.9
5	*5530.00	103.1 PK			3.13 H	330	62.9	40.2
6	*5530.00	91.9 AV			3.13 H	330	51.7	40.2
7	10600.00	59.8 PK	74.0	-14.2	2.12 H	359	40.9	18.9
8	10600.00	46.7 AV	54.0	-7.3	2.12 H	359	27.8	18.9

ANTENNA POLARITY & TEST DISTANCE: VERTICAL AT 3 M

NO.	FREQ. (MHz)	EMISSION LEVEL (dBuV/m)	LIMIT (dBuV/m)	MARGIN (dB)	ANTENNA HEIGHT (m)	TABLE ANGLE (Degree)	RAW VALUE (dBuV)	CORRECTION FACTOR (dB/m)
1	5455.00	69.1 PK	74.0	-4.9	1.49 V	287	62.2	6.9
2	5455.00	47.9 AV	54.0	-6.1	1.49 V	287	41.0	6.9
3	#5470.00	63.8 PK	74.0	-10.2	1.53 V	297	56.9	6.9
4	#5470.00	47.3 AV	54.0	-6.7	1.53 V	297	40.4	6.9
5	*5530.00	102.1 PK			1.65 V	300	61.9	40.2
6	*5530.00	89.9 AV			1.65 V	300	49.7	40.2
7	10600.00	59.3 PK	74.0	-14.7	1.91 V	222	40.4	18.9
8	10600.00	46.1 AV	54.0	-7.9	1.91 V	222	27.2	18.9

REMARKS:

1. Emission Level(dBuV/m) = Raw Value(dBuV) + Correction Factor(dB/m)
2. Correction Factor(dB/m) = Antenna Factor(dB/m) + Cable Factor(dB) – Pre-Amplifier Factor(dB)
3. The other emission levels were very low against the limit.
4. Margin value = Emission Level – Limit value
5. " * ": Fundamental frequency.
6. " # ": The radiated frequency is out of the restricted band.

Radio 3

CDD Mode

802.11a

CHANNEL	TX Channel 52	DETECTOR	Peak (PK)
FREQUENCY RANGE	1GHz ~ 40GHz	FUNCTION	Average (AV)

ANTENNA POLARITY & TEST DISTANCE: HORIZONTAL AT 3 M

NO.	FREQ. (MHz)	EMISSION LEVEL (dBuV/m)	LIMIT (dBuV/m)	MARGIN (dB)	ANTENNA HEIGHT (m)	TABLE ANGLE (Degree)	RAW VALUE (dBuV)	CORRECTION FACTOR (dB/m)
1	5150.00	57.1 PK	74.0	-16.9	2.14 H	356	51.1	6.0
2	5150.00	44.1 AV	54.0	-9.9	2.14 H	356	38.1	6.0
3	*5260.00	109.6 PK			1.63 H	358	70.0	39.6
4	*5260.00	99.5 AV			1.63 H	358	59.9	39.6
5	#10520.00	59.8 PK	74.0	-14.2	1.90 H	218	40.9	18.9
6	#10520.00	47.4 AV	54.0	-6.6	1.90 H	218	28.5	18.9

ANTENNA POLARITY & TEST DISTANCE: VERTICAL AT 3 M

NO.	FREQ. (MHz)	EMISSION LEVEL (dBuV/m)	LIMIT (dBuV/m)	MARGIN (dB)	ANTENNA HEIGHT (m)	TABLE ANGLE (Degree)	RAW VALUE (dBuV)	CORRECTION FACTOR (dB/m)
1	5150.00	56.5 PK	74.0	-17.5	1.71 V	192	50.5	6.0
2	5150.00	43.6 AV	54.0	-10.4	1.71 V	192	37.6	6.0
3	*5260.00	106.6 PK			2.42 V	87	67.0	39.6
4	*5260.00	96.5 AV			2.42 V	87	56.9	39.6
5	#10520.00	60.6 PK	74.0	-13.4	1.55 V	205	41.7	18.9
6	#10520.00	47.3 AV	54.0	-6.7	1.55 V	205	28.4	18.9

REMARKS:

1. Emission Level(dBuV/m) = Raw Value(dBuV) + Correction Factor(dB/m)
2. Correction Factor(dB/m) = Antenna Factor(dB/m) + Cable Factor(dB) – Pre-Amplifier Factor(dB)
3. The other emission levels were very low against the limit.
4. Margin value = Emission Level – Limit value
5. " * ": Fundamental frequency.
6. " # ": The radiated frequency is out of the restricted band.

CHANNEL	TX Channel 60	DETECTOR FUNCTION	Peak (PK)
FREQUENCY RANGE	1GHz ~ 40GHz		Average (AV)

ANTENNA POLARITY & TEST DISTANCE: HORIZONTAL AT 3 M

NO.	FREQ. (MHz)	EMISSION LEVEL (dBuV/m)	LIMIT (dBuV/m)	MARGIN (dB)	ANTENNA HEIGHT (m)	TABLE ANGLE (Degree)	RAW VALUE (dBuV)	CORRECTION FACTOR (dB/m)
1	*5300.00	109.9 PK			1.66 H	357	70.2	39.7
2	*5300.00	99.9 AV			1.66 H	357	60.2	39.7
3	10600.00	59.4 PK	74.0	-14.6	1.86 H	168	40.5	18.9
4	10600.00	47.3 AV	54.0	-6.7	1.86 H	168	28.4	18.9

ANTENNA POLARITY & TEST DISTANCE: VERTICAL AT 3 M

NO.	FREQ. (MHz)	EMISSION LEVEL (dBuV/m)	LIMIT (dBuV/m)	MARGIN (dB)	ANTENNA HEIGHT (m)	TABLE ANGLE (Degree)	RAW VALUE (dBuV)	CORRECTION FACTOR (dB/m)
1	*5300.00	106.5 PK			2.53 V	87	66.8	39.7
2	*5300.00	96.6 AV			2.53 V	87	56.9	39.7
3	10600.00	60.4 PK	74.0	-13.6	1.84 V	156	41.5	18.9
4	10600.00	47.5 AV	54.0	-6.5	1.84 V	156	28.6	18.9

REMARKS:

1. Emission Level(dBuV/m) = Raw Value(dBuV) + Correction Factor(dB/m)
2. Correction Factor(dB/m) = Antenna Factor(dB/m) + Cable Factor(dB) – Pre-Amplifier Factor(dB)
3. The other emission levels were very low against the limit.
4. Margin value = Emission Level – Limit value
5. " * ": Fundamental frequency.

CHANNEL	TX Channel 64	DETECTOR FUNCTION	Peak (PK)
FREQUENCY RANGE	1GHz ~ 40GHz		Average (AV)

ANTENNA POLARITY & TEST DISTANCE: HORIZONTAL AT 3 M

NO.	FREQ. (MHz)	EMISSION LEVEL (dBuV/m)	LIMIT (dBuV/m)	MARGIN (dB)	ANTENNA HEIGHT (m)	TABLE ANGLE (Degree)	RAW VALUE (dBuV)	CORRECTION FACTOR (dB/m)
1	*5320.00	110.8 PK			3.07 H	357	71.1	39.7
2	*5320.00	100.8 AV			3.07 H	357	61.1	39.7
3	5350.00	66.8 PK	74.0	-7.2	2.81 H	0	60.3	6.5
4	5350.00	52.3 AV	54.0	-1.7	2.81 H	0	45.8	6.5
5	10640.00	59.7 PK	74.0	-14.3	2.22 H	186	40.9	18.8
6	10640.00	47.6 AV	54.0	-6.4	2.22 H	186	28.8	18.8

ANTENNA POLARITY & TEST DISTANCE: VERTICAL AT 3 M

NO.	FREQ. (MHz)	EMISSION LEVEL (dBuV/m)	LIMIT (dBuV/m)	MARGIN (dB)	ANTENNA HEIGHT (m)	TABLE ANGLE (Degree)	RAW VALUE (dBuV)	CORRECTION FACTOR (dB/m)
1	*5320.00	106.2 PK			2.16 V	84	66.5	39.7
2	*5320.00	96.1 AV			2.16 V	84	56.4	39.7
3	5350.00	62.7 PK	74.0	-11.3	2.09 V	82	56.2	6.5
4	5350.00	49.8 AV	54.0	-4.2	2.09 V	82	43.3	6.5
5	10640.00	59.6 PK	74.0	-14.4	1.82 V	123	40.8	18.8
6	10640.00	47.0 AV	54.0	-7.0	1.82 V	123	28.2	18.8

REMARKS:

1. Emission Level(dBuV/m) = Raw Value(dBuV) + Correction Factor(dB/m)
2. Correction Factor(dB/m) = Antenna Factor(dB/m) + Cable Factor(dB) – Pre-Amplifier Factor(dB)
3. The other emission levels were very low against the limit.
4. Margin value = Emission Level – Limit value
5. " * ": Fundamental frequency.



CHANNEL	TX Channel 100	DETECTOR FUNCTION	Peak (PK)
FREQUENCY RANGE	1GHz ~ 40GHz		Average (AV)

ANTENNA POLARITY & TEST DISTANCE: HORIZONTAL AT 3 M

NO.	FREQ. (MHz)	EMISSION LEVEL (dBuV/m)	LIMIT (dBuV/m)	MARGIN (dB)	ANTENNA HEIGHT (m)	TABLE ANGLE (Degree)	RAW VALUE (dBuV)	CORRECTION FACTOR (dB/m)
1	5460.00	60.2 PK	74.0	-13.8	3.04 H	320	53.3	6.9
2	5460.00	46.7 AV	54.0	-7.3	3.04 H	320	39.8	6.9
3	#5470.00	68.5 PK	74.0	-5.5	3.08 H	1	61.6	6.9
4	#5470.00	52.5 AV	54.0	-1.5	3.08 H	1	45.6	6.9
5	*5500.00	108.5 PK			2.76 H	324	68.3	40.2
6	*5500.00	98.3 AV			2.76 H	324	58.1	40.2
7	11000.00	60.3 PK	74.0	-13.7	2.09 H	213	40.4	19.9
8	11000.00	48.3 AV	54.0	-5.7	2.09 H	213	28.4	19.9

ANTENNA POLARITY & TEST DISTANCE: VERTICAL AT 3 M

NO.	FREQ. (MHz)	EMISSION LEVEL (dBuV/m)	LIMIT (dBuV/m)	MARGIN (dB)	ANTENNA HEIGHT (m)	TABLE ANGLE (Degree)	RAW VALUE (dBuV)	CORRECTION FACTOR (dB/m)
1	5460.00	57.5 PK	74.0	-16.5	1.85 V	87	50.6	6.9
2	5460.00	45.2 AV	54.0	-8.8	1.85 V	87	38.3	6.9
3	#5470.00	62.6 PK	74.0	-11.4	2.13 V	87	55.7	6.9
4	#5470.00	48.4 AV	54.0	-5.6	2.13 V	87	41.5	6.9
5	*5500.00	104.0 PK			2.27 V	91	63.8	40.2
6	*5500.00	93.7 AV			2.27 V	91	53.5	40.2
7	11000.00	60.6 PK	74.0	-13.4	1.99 V	165	40.7	19.9
8	11000.00	47.2 AV	54.0	-6.8	1.99 V	165	27.3	19.9

REMARKS:

1. Emission Level(dBuV/m) = Raw Value(dBuV) + Correction Factor(dB/m)
2. Correction Factor(dB/m) = Antenna Factor(dB/m) + Cable Factor(dB) – Pre-Amplifier Factor(dB)
3. The other emission levels were very low against the limit.
4. Margin value = Emission Level – Limit value
5. " * ": Fundamental frequency.
6. " # ": The radiated frequency is out of the restricted band.

CHANNEL	TX Channel 116	DETECTOR FUNCTION	Peak (PK)
FREQUENCY RANGE	1GHz ~ 40GHz		Average (AV)

ANTENNA POLARITY & TEST DISTANCE: HORIZONTAL AT 3 M

NO.	FREQ. (MHz)	EMISSION LEVEL (dBuV/m)	LIMIT (dBuV/m)	MARGIN (dB)	ANTENNA HEIGHT (m)	TABLE ANGLE (Degree)	RAW VALUE (dBuV)	CORRECTION FACTOR (dB/m)
1	*5580.00	110.6 PK			2.74 H	324	70.3	40.3
2	*5580.00	100.4 AV			2.74 H	324	60.1	40.3
3	11160.00	63.4 PK	74.0	-10.6	2.76 H	55	44.0	19.4
4	11160.00	50.5 AV	54.0	-3.5	2.76 H	55	31.1	19.4

ANTENNA POLARITY & TEST DISTANCE: VERTICAL AT 3 M

NO.	FREQ. (MHz)	EMISSION LEVEL (dBuV/m)	LIMIT (dBuV/m)	MARGIN (dB)	ANTENNA HEIGHT (m)	TABLE ANGLE (Degree)	RAW VALUE (dBuV)	CORRECTION FACTOR (dB/m)
1	*5580.00	106.8 PK			2.31 V	84	66.5	40.3
2	*5580.00	96.3 AV			2.31 V	84	56.0	40.3
3	11160.00	60.5 PK	74.0	-13.5	2.27 V	91	41.1	19.4
4	11160.00	47.5 AV	54.0	-6.5	2.27 V	91	28.1	19.4

REMARKS:

1. Emission Level(dBuV/m) = Raw Value(dBuV) + Correction Factor(dB/m)
2. Correction Factor(dB/m) = Antenna Factor(dB/m) + Cable Factor(dB) – Pre-Amplifier Factor(dB)
3. The other emission levels were very low against the limit.
4. Margin value = Emission Level – Limit value
5. " * ": Fundamental frequency.

CHANNEL	TX Channel 140	DETECTOR FUNCTION	Peak (PK)
FREQUENCY RANGE	1GHz ~ 40GHz		Average (AV)

ANTENNA POLARITY & TEST DISTANCE: HORIZONTAL AT 3 M

NO.	FREQ. (MHz)	EMISSION LEVEL (dBuV/m)	LIMIT (dBuV/m)	MARGIN (dB)	ANTENNA HEIGHT (m)	TABLE ANGLE (Degree)	RAW VALUE (dBuV)	CORRECTION FACTOR (dB/m)
1	*5700.00	108.7 PK			2.34 H	329	68.3	40.4
2	*5700.00	98.5 AV			2.34 H	329	58.1	40.4
3	#5725.00	66.6 PK	74.0	-7.4	2.50 H	326	59.2	7.4
4	#5725.00	52.6 AV	54.0	-1.4	2.50 H	326	45.2	7.4
5	11400.00	60.9 PK	74.0	-13.1	2.34 H	144	42.1	18.8
6	11400.00	47.5 AV	54.0	-6.5	2.34 H	144	28.7	18.8

ANTENNA POLARITY & TEST DISTANCE: VERTICAL AT 3 M

NO.	FREQ. (MHz)	EMISSION LEVEL (dBuV/m)	LIMIT (dBuV/m)	MARGIN (dB)	ANTENNA HEIGHT (m)	TABLE ANGLE (Degree)	RAW VALUE (dBuV)	CORRECTION FACTOR (dB/m)
1	*5700.00	102.8 PK			2.30 V	90	62.4	40.4
2	*5700.00	92.9 AV			2.30 V	90	52.5	40.4
3	#5725.00	58.6 PK	74.0	-15.4	2.23 V	85	51.2	7.4
4	#5725.00	46.2 AV	54.0	-7.8	2.23 V	85	38.8	7.4
5	11140.00	60.8 PK	74.0	-13.2	2.15 V	144	41.5	19.3
6	11140.00	47.3 AV	54.0	-6.7	2.15 V	144	28.0	19.3

REMARKS:

1. Emission Level(dBuV/m) = Raw Value(dBuV) + Correction Factor(dB/m)
2. Correction Factor(dB/m) = Antenna Factor(dB/m) + Cable Factor(dB) – Pre-Amplifier Factor(dB)
3. The other emission levels were very low against the limit.
4. Margin value = Emission Level – Limit value
5. " * ": Fundamental frequency.
6. " # ": The radiated frequency is out of the restricted band.

802.11n (HT20)

CHANNEL	TX Channel 52	DETECTOR FUNCTION	Peak (PK)
FREQUENCY RANGE	1GHz ~ 40GHz		Average (AV)

ANTENNA POLARITY & TEST DISTANCE: HORIZONTAL AT 3 M								
NO.	FREQ. (MHz)	EMISSION LEVEL (dBuV/m)	LIMIT (dBuV/m)	MARGIN (dB)	ANTENNA HEIGHT (m)	TABLE ANGLE (Degree)	RAW VALUE (dBuV)	CORRECTION FACTOR (dB/m)
1	5150.00	57.3 PK	74.0	-16.7	1.71 H	155	51.3	6.0
2	5150.00	44.5 AV	54.0	-9.5	1.71 H	155	38.5	6.0
3	*5260.00	109.9 PK			3.25 H	354	70.3	39.6
4	*5260.00	99.9 AV			3.25 H	354	60.3	39.6
5	#10520.00	59.7 PK	74.0	-14.3	2.10 H	214	40.8	18.9
6	#10520.00	47.5 AV	54.0	-6.5	2.10 H	214	28.6	18.9

ANTENNA POLARITY & TEST DISTANCE: VERTICAL AT 3 M								
NO.	FREQ. (MHz)	EMISSION LEVEL (dBuV/m)	LIMIT (dBuV/m)	MARGIN (dB)	ANTENNA HEIGHT (m)	TABLE ANGLE (Degree)	RAW VALUE (dBuV)	CORRECTION FACTOR (dB/m)
1	5150.00	57.2 PK	74.0	-16.8	1.60 V	73	51.2	6.0
2	5150.00	43.7 AV	54.0	-10.3	1.60 V	73	37.7	6.0
3	*5260.00	106.5 PK			2.44 V	85	66.9	39.6
4	*5260.00	96.4 AV			2.44 V	85	56.8	39.6
5	#10520.00	60.6 PK	74.0	-13.4	1.77 V	152	41.7	18.9
6	#10520.00	47.4 AV	54.0	-6.6	1.77 V	152	28.5	18.9

REMARKS:

1. Emission Level(dBuV/m) = Raw Value(dBuV) + Correction Factor(dB/m)
2. Correction Factor(dB/m) = Antenna Factor(dB/m) + Cable Factor(dB) – Pre-Amplifier Factor(dB)
3. The other emission levels were very low against the limit.
4. Margin value = Emission Level – Limit value
5. " * ": Fundamental frequency.
6. " # ": The radiated frequency is out of the restricted band.

CHANNEL	TX Channel 60	DETECTOR FUNCTION	Peak (PK)
FREQUENCY RANGE	1GHz ~ 40GHz		Average (AV)

ANTENNA POLARITY & TEST DISTANCE: HORIZONTAL AT 3 M

NO.	FREQ. (MHz)	EMISSION LEVEL (dBuV/m)	LIMIT (dBuV/m)	MARGIN (dB)	ANTENNA HEIGHT (m)	TABLE ANGLE (Degree)	RAW VALUE (dBuV)	CORRECTION FACTOR (dB/m)
1	*5300.00	109.8 PK			3.37 H	356	70.1	39.7
2	*5300.00	99.6 AV			3.37 H	356	59.9	39.7
3	10600.00	60.7 PK	74.0	-13.3	2.95 H	230	41.8	18.9
4	10600.00	47.9 AV	54.0	-6.1	2.95 H	230	29.0	18.9

ANTENNA POLARITY & TEST DISTANCE: VERTICAL AT 3 M

NO.	FREQ. (MHz)	EMISSION LEVEL (dBuV/m)	LIMIT (dBuV/m)	MARGIN (dB)	ANTENNA HEIGHT (m)	TABLE ANGLE (Degree)	RAW VALUE (dBuV)	CORRECTION FACTOR (dB/m)
1	*5300.00	105.9 PK			2.37 V	85	66.2	39.7
2	*5300.00	96.0 AV			2.37 V	85	56.3	39.7
3	10600.00	60.2 PK	74.0	-13.8	2.22 V	195	41.3	18.9
4	10600.00	47.5 AV	54.0	-6.5	2.22 V	195	28.6	18.9

REMARKS:

1. Emission Level(dBuV/m) = Raw Value(dBuV) + Correction Factor(dB/m)
2. Correction Factor(dB/m) = Antenna Factor(dB/m) + Cable Factor(dB) – Pre-Amplifier Factor(dB)
3. The other emission levels were very low against the limit.
4. Margin value = Emission Level – Limit value
5. " * ": Fundamental frequency.



CHANNEL	TX Channel 64	DETECTOR FUNCTION	Peak (PK)
FREQUENCY RANGE	1GHz ~ 40GHz		Average (AV)

ANTENNA POLARITY & TEST DISTANCE: HORIZONTAL AT 3 M

NO.	FREQ. (MHz)	EMISSION LEVEL (dBuV/m)	LIMIT (dBuV/m)	MARGIN (dB)	ANTENNA HEIGHT (m)	TABLE ANGLE (Degree)	RAW VALUE (dBuV)	CORRECTION FACTOR (dB/m)
1	*5320.00	109.3 PK			3.06 H	358	69.6	39.7
2	*5320.00	99.0 AV			3.06 H	358	59.3	39.7
3	5350.00	65.8 PK	74.0	-8.2	2.84 H	1	59.3	6.5
4	5350.00	52.5 AV	54.0	-1.5	2.84 H	1	46.0	6.5
5	10640.00	60.3 PK	74.0	-13.7	2.65 H	236	41.5	18.8
6	10640.00	47.5 AV	54.0	-6.5	2.65 H	236	28.7	18.8

ANTENNA POLARITY & TEST DISTANCE: VERTICAL AT 3 M

NO.	FREQ. (MHz)	EMISSION LEVEL (dBuV/m)	LIMIT (dBuV/m)	MARGIN (dB)	ANTENNA HEIGHT (m)	TABLE ANGLE (Degree)	RAW VALUE (dBuV)	CORRECTION FACTOR (dB/m)
1	*5320.00	106.0 PK			2.14 V	87	66.3	39.7
2	*5320.00	95.9 AV			2.14 V	87	56.2	39.7
3	5350.00	66.5 PK	74.0	-7.5	2.28 V	83	60.0	6.5
4	5350.00	51.6 AV	54.0	-2.4	2.28 V	83	45.1	6.5
5	10640.00	59.6 PK	74.0	-14.4	2.12 V	177	40.8	18.8
6	10640.00	46.7 AV	54.0	-7.3	2.12 V	177	27.9	18.8

REMARKS:

1. Emission Level(dBuV/m) = Raw Value(dBuV) + Correction Factor(dB/m)
2. Correction Factor(dB/m) = Antenna Factor(dB/m) + Cable Factor(dB) – Pre-Amplifier Factor(dB)
3. The other emission levels were very low against the limit.
4. Margin value = Emission Level – Limit value
5. " * ": Fundamental frequency.



CHANNEL	TX Channel 100	DETECTOR FUNCTION	Peak (PK)
FREQUENCY RANGE	1GHz ~ 40GHz		Average (AV)

ANTENNA POLARITY & TEST DISTANCE: HORIZONTAL AT 3 M

NO.	FREQ. (MHz)	EMISSION LEVEL (dBuV/m)	LIMIT (dBuV/m)	MARGIN (dB)	ANTENNA HEIGHT (m)	TABLE ANGLE (Degree)	RAW VALUE (dBuV)	CORRECTION FACTOR (dB/m)
1	5460.00	58.6 PK	74.0	-15.4	2.57 H	330	51.7	6.9
2	5460.00	46.3 AV	54.0	-7.7	2.57 H	330	39.4	6.9
3	#5470.00	67.1 PK	74.0	-6.9	2.88 H	324	60.2	6.9
4	#5470.00	52.3 AV	54.0	-1.7	2.88 H	324	45.4	6.9
5	*5500.00	108.1 PK			2.77 H	1	67.9	40.2
6	*5500.00	98.2 AV			2.77 H	1	58.0	40.2
7	11000.00	61.0 PK	74.0	-13.0	1.98 H	254	41.1	19.9
8	11000.00	47.8 AV	54.0	-6.2	1.98 H	254	27.9	19.9

ANTENNA POLARITY & TEST DISTANCE: VERTICAL AT 3 M

NO.	FREQ. (MHz)	EMISSION LEVEL (dBuV/m)	LIMIT (dBuV/m)	MARGIN (dB)	ANTENNA HEIGHT (m)	TABLE ANGLE (Degree)	RAW VALUE (dBuV)	CORRECTION FACTOR (dB/m)
1	5460.00	59.2 PK	74.0	-14.8	1.88 V	55	52.3	6.9
2	5460.00	44.8 AV	54.0	-9.2	1.88 V	55	37.9	6.9
3	#5470.00	62.1 PK	74.0	-11.9	1.99 V	68	55.2	6.9
4	#5470.00	48.1 AV	54.0	-5.9	1.99 V	68	41.2	6.9
5	*5500.00	103.3 PK			1.93 V	96	63.1	40.2
6	*5500.00	93.1 AV			1.93 V	96	52.9	40.2
7	11000.00	60.9 PK	74.0	-13.1	2.15 V	269	41.0	19.9
8	11000.00	48.0 AV	54.0	-6.0	2.15 V	269	28.1	19.9

REMARKS:

1. Emission Level(dBuV/m) = Raw Value(dBuV) + Correction Factor(dB/m)
2. Correction Factor(dB/m) = Antenna Factor(dB/m) + Cable Factor(dB) – Pre-Amplifier Factor(dB)
3. The other emission levels were very low against the limit.
4. Margin value = Emission Level – Limit value
5. " * ": Fundamental frequency.
6. " # ": The radiated frequency is out of the restricted band.

CHANNEL	TX Channel 116	DETECTOR FUNCTION	Peak (PK)
FREQUENCY RANGE	1GHz ~ 40GHz		Average (AV)

ANTENNA POLARITY & TEST DISTANCE: HORIZONTAL AT 3 M

NO.	FREQ. (MHz)	EMISSION LEVEL (dBuV/m)	LIMIT (dBuV/m)	MARGIN (dB)	ANTENNA HEIGHT (m)	TABLE ANGLE (Degree)	RAW VALUE (dBuV)	CORRECTION FACTOR (dB/m)
1	*5580.00	110.9 PK			2.90 H	324	70.6	40.3
2	*5580.00	100.5 AV			2.90 H	324	60.2	40.3
3	11160.00	63.7 PK	74.0	-10.3	2.59 H	54	44.3	19.4
4	11160.00	50.1 AV	54.0	-3.9	2.59 H	54	30.7	19.4

ANTENNA POLARITY & TEST DISTANCE: VERTICAL AT 3 M

NO.	FREQ. (MHz)	EMISSION LEVEL (dBuV/m)	LIMIT (dBuV/m)	MARGIN (dB)	ANTENNA HEIGHT (m)	TABLE ANGLE (Degree)	RAW VALUE (dBuV)	CORRECTION FACTOR (dB/m)
1	*5580.00	106.7 PK			2.31 V	81	66.4	40.3
2	*5580.00	96.0 AV			2.31 V	81	55.7	40.3
3	11160.00	60.2 PK	74.0	-13.8	1.57 V	154	40.8	19.4
4	11160.00	47.4 AV	54.0	-6.6	1.57 V	154	28.0	19.4

REMARKS:

1. Emission Level(dBuV/m) = Raw Value(dBuV) + Correction Factor(dB/m)
2. Correction Factor(dB/m) = Antenna Factor(dB/m) + Cable Factor(dB) – Pre-Amplifier Factor(dB)
3. The other emission levels were very low against the limit.
4. Margin value = Emission Level – Limit value
5. " * ": Fundamental frequency.

CHANNEL	TX Channel 140	DETECTOR FUNCTION	Peak (PK)
FREQUENCY RANGE	1GHz ~ 40GHz		Average (AV)

ANTENNA POLARITY & TEST DISTANCE: HORIZONTAL AT 3 M

NO.	FREQ. (MHz)	EMISSION LEVEL (dBuV/m)	LIMIT (dBuV/m)	MARGIN (dB)	ANTENNA HEIGHT (m)	TABLE ANGLE (Degree)	RAW VALUE (dBuV)	CORRECTION FACTOR (dB/m)
1	*5700.00	106.9 PK			2.40 H	330	66.5	40.4
2	*5700.00	96.9 AV			2.40 H	330	56.5	40.4
3	#5725.00	66.9 PK	74.0	-7.1	2.50 H	325	59.5	7.4
4	#5725.00	52.6 AV	54.0	-1.4	2.50 H	325	45.2	7.4
5	11400.00	59.9 PK	74.0	-14.1	2.16 H	207	41.1	18.8
6	11400.00	47.3 AV	54.0	-6.7	2.16 H	207	28.5	18.8

ANTENNA POLARITY & TEST DISTANCE: VERTICAL AT 3 M

NO.	FREQ. (MHz)	EMISSION LEVEL (dBuV/m)	LIMIT (dBuV/m)	MARGIN (dB)	ANTENNA HEIGHT (m)	TABLE ANGLE (Degree)	RAW VALUE (dBuV)	CORRECTION FACTOR (dB/m)
1	*5700.00	102.2 PK			2.23 V	88	61.8	40.4
2	*5700.00	92.4 AV			2.23 V	88	52.0	40.4
3	#5725.00	61.9 PK	74.0	-12.1	2.15 V	93	54.5	7.4
4	#5725.00	48.0 AV	54.0	-6.0	2.15 V	93	40.6	7.4
5	11400.00	60.7 PK	74.0	-13.3	1.57 V	255	41.9	18.8
6	11400.00	47.5 AV	54.0	-6.5	1.57 V	255	28.7	18.8

REMARKS:

1. Emission Level(dBuV/m) = Raw Value(dBuV) + Correction Factor(dB/m)
2. Correction Factor(dB/m) = Antenna Factor(dB/m) + Cable Factor(dB) – Pre-Amplifier Factor(dB)
3. The other emission levels were very low against the limit.
4. Margin value = Emission Level – Limit value
5. " * ": Fundamental frequency.
6. " # ": The radiated frequency is out of the restricted band.

802.11n (HT40)

CHANNEL	TX Channel 54	DETECTOR FUNCTION	Peak (PK)
FREQUENCY RANGE	1GHz ~ 40GHz		Average (AV)

ANTENNA POLARITY & TEST DISTANCE: HORIZONTAL AT 3 M								
NO.	FREQ. (MHz)	EMISSION LEVEL (dBuV/m)	LIMIT (dBuV/m)	MARGIN (dB)	ANTENNA HEIGHT (m)	TABLE ANGLE (Degree)	RAW VALUE (dBuV)	CORRECTION FACTOR (dB/m)
1	5150.00	58.1 PK	74.0	-15.9	2.88 H	355	52.1	6.0
2	5150.00	45.3 AV	54.0	-8.7	2.88 H	355	39.3	6.0
3	*5270.00	107.3 PK			2.93 H	358	67.7	39.6
4	*5270.00	97.0 AV			2.93 H	358	57.4	39.6
5	#10540.00	60.7 PK	74.0	-13.3	2.75 H	265	41.7	19.0
6	#10540.00	47.8 AV	54.0	-6.2	2.75 H	265	28.8	19.0

ANTENNA POLARITY & TEST DISTANCE: VERTICAL AT 3 M								
NO.	FREQ. (MHz)	EMISSION LEVEL (dBuV/m)	LIMIT (dBuV/m)	MARGIN (dB)	ANTENNA HEIGHT (m)	TABLE ANGLE (Degree)	RAW VALUE (dBuV)	CORRECTION FACTOR (dB/m)
1	5150.00	58.0 PK	74.0	-16.0	1.61 V	150	52.0	6.0
2	5150.00	44.0 AV	54.0	-10.0	1.61 V	150	38.0	6.0
3	*5270.00	103.1 PK			2.44 V	84	63.5	39.6
4	*5270.00	93.0 AV			2.44 V	84	53.4	39.6
5	#10540.00	60.8 PK	74.0	-13.2	1.77 V	210	41.8	19.0
6	#10540.00	47.9 AV	54.0	-6.1	1.77 V	210	28.9	19.0

REMARKS:

1. Emission Level(dBuV/m) = Raw Value(dBuV) + Correction Factor(dB/m)
2. Correction Factor(dB/m) = Antenna Factor(dB/m) + Cable Factor(dB) – Pre-Amplifier Factor(dB)
3. The other emission levels were very low against the limit.
4. Margin value = Emission Level – Limit value
5. " * ": Fundamental frequency.
6. " # ": The radiated frequency is out of the restricted band.

CHANNEL	TX Channel 62	DETECTOR FUNCTION	Peak (PK)
FREQUENCY RANGE	1GHz ~ 40GHz		Average (AV)

ANTENNA POLARITY & TEST DISTANCE: HORIZONTAL AT 3 M

NO.	FREQ. (MHz)	EMISSION LEVEL (dBuV/m)	LIMIT (dBuV/m)	MARGIN (dB)	ANTENNA HEIGHT (m)	TABLE ANGLE (Degree)	RAW VALUE (dBuV)	CORRECTION FACTOR (dB/m)
1	*5310.00	103.5 PK			3.31 H	358	63.8	39.7
2	*5310.00	93.3 AV			3.31 H	358	53.6	39.7
3	5350.00	66.4 PK	74.0	-7.6	1.42 H	357	59.9	6.5
4	5350.00	52.4 AV	54.0	-1.6	1.42 H	357	45.9	6.5
5	10620.00	60.9 PK	74.0	-13.1	1.86 H	246	42.0	18.9
6	10620.00	47.8 AV	54.0	-6.2	1.86 H	246	28.9	18.9

ANTENNA POLARITY & TEST DISTANCE: VERTICAL AT 3 M

NO.	FREQ. (MHz)	EMISSION LEVEL (dBuV/m)	LIMIT (dBuV/m)	MARGIN (dB)	ANTENNA HEIGHT (m)	TABLE ANGLE (Degree)	RAW VALUE (dBuV)	CORRECTION FACTOR (dB/m)
1	*5310.00	97.9 PK			2.15 V	91	58.2	39.7
2	*5310.00	87.8 AV			2.15 V	91	48.1	39.7
3	5350.00	61.8 PK	74.0	-12.2	2.44 V	86	55.3	6.5
4	5350.00	48.6 AV	54.0	-5.4	2.44 V	86	42.1	6.5
5	10620.00	60.1 PK	74.0	-13.9	2.77 V	236	41.2	18.9
6	10620.00	47.4 AV	54.0	-6.6	2.77 V	236	28.5	18.9

REMARKS:

1. Emission Level(dBuV/m) = Raw Value(dBuV) + Correction Factor(dB/m)
2. Correction Factor(dB/m) = Antenna Factor(dB/m) + Cable Factor(dB) – Pre-Amplifier Factor(dB)
3. The other emission levels were very low against the limit.
4. Margin value = Emission Level – Limit value
5. " * ": Fundamental frequency.



CHANNEL	TX Channel 102	DETECTOR FUNCTION	Peak (PK)
FREQUENCY RANGE	1GHz ~ 40GHz		Average (AV)

ANTENNA POLARITY & TEST DISTANCE: HORIZONTAL AT 3 M

NO.	FREQ. (MHz)	EMISSION LEVEL (dBuV/m)	LIMIT (dBuV/m)	MARGIN (dB)	ANTENNA HEIGHT (m)	TABLE ANGLE (Degree)	RAW VALUE (dBuV)	CORRECTION FACTOR (dB/m)
1	5460.00	59.7 PK	74.0	-14.3	2.71 H	3	52.8	6.9
2	5460.00	46.9 AV	54.0	-7.1	2.71 H	3	40.0	6.9
3	#5470.00	66.4 PK	74.0	-7.6	2.63 H	1	59.5	6.9
4	#5470.00	52.3 AV	54.0	-1.7	2.63 H	1	45.4	6.9
5	*5510.00	101.3 PK			2.76 H	0	61.1	40.2
6	*5510.00	91.4 AV			2.76 H	0	51.2	40.2
7	11020.00	61.1 PK	74.0	-12.9	2.37 H	196	41.3	19.8
8	11020.00	48.3 AV	54.0	-5.7	2.37 H	196	28.5	19.8

ANTENNA POLARITY & TEST DISTANCE: VERTICAL AT 3 M

NO.	FREQ. (MHz)	EMISSION LEVEL (dBuV/m)	LIMIT (dBuV/m)	MARGIN (dB)	ANTENNA HEIGHT (m)	TABLE ANGLE (Degree)	RAW VALUE (dBuV)	CORRECTION FACTOR (dB/m)
1	5460.00	58.2 PK	74.0	-15.8	2.22 V	78	51.3	6.9
2	5460.00	45.9 AV	54.0	-8.1	2.22 V	78	39.0	6.9
3	#5470.00	61.5 PK	74.0	-12.5	2.31 V	82	54.6	6.9
4	#5470.00	48.6 AV	54.0	-5.4	2.31 V	82	41.7	6.9
5	*5510.00	96.9 PK			2.20 V	87	56.7	40.2
6	*5510.00	87.2 AV			2.20 V	87	47.0	40.2
7	11020.00	61.0 PK	74.0	-13.0	1.57 V	147	41.2	19.8
8	11020.00	48.0 AV	54.0	-6.0	1.57 V	147	28.2	19.8

REMARKS:

1. Emission Level(dBuV/m) = Raw Value(dBuV) + Correction Factor(dB/m)
2. Correction Factor(dB/m) = Antenna Factor(dB/m) + Cable Factor(dB) – Pre-Amplifier Factor(dB)
3. The other emission levels were very low against the limit.
4. Margin value = Emission Level – Limit value
5. " * ": Fundamental frequency.
6. " # ": The radiated frequency is out of the restricted band.

CHANNEL	TX Channel 110	DETECTOR FUNCTION	Peak (PK)
FREQUENCY RANGE	1GHz ~ 40GHz		Average (AV)

ANTENNA POLARITY & TEST DISTANCE: HORIZONTAL AT 3 M

NO.	FREQ. (MHz)	EMISSION LEVEL (dBuV/m)	LIMIT (dBuV/m)	MARGIN (dB)	ANTENNA HEIGHT (m)	TABLE ANGLE (Degree)	RAW VALUE (dBuV)	CORRECTION FACTOR (dB/m)
1	#5470.00	67.6 PK	74.0	-6.4	2.92 H	319	60.7	6.9
2	#5470.00	52.5 AV	54.0	-1.5	2.92 H	319	45.6	6.9
3	*5550.00	107.1 PK			2.56 H	324	66.9	40.2
4	*5550.00	96.8 AV			2.56 H	324	56.6	40.2
5	11100.00	61.8 PK	74.0	-12.2	2.74 H	242	42.6	19.2
6	11100.00	48.8 AV	54.0	-5.2	2.74 H	242	29.6	19.2

ANTENNA POLARITY & TEST DISTANCE: VERTICAL AT 3 M

NO.	FREQ. (MHz)	EMISSION LEVEL (dBuV/m)	LIMIT (dBuV/m)	MARGIN (dB)	ANTENNA HEIGHT (m)	TABLE ANGLE (Degree)	RAW VALUE (dBuV)	CORRECTION FACTOR (dB/m)
1	#5470.00	62.6 PK	74.0	-11.4	2.29 V	81	55.7	6.9
2	#5470.00	48.6 AV	54.0	-5.4	2.29 V	81	41.7	6.9
3	*5550.00	102.7 PK			2.30 V	88	62.5	40.2
4	*5550.00	92.6 AV			2.30 V	88	52.4	40.2
5	11100.00	61.0 PK	74.0	-13.0	1.77 V	181	41.8	19.2
6	11100.00	47.8 AV	54.0	-6.2	1.77 V	181	28.6	19.2

REMARKS:

1. Emission Level(dBuV/m) = Raw Value(dBuV) + Correction Factor(dB/m)
2. Correction Factor(dB/m) = Antenna Factor(dB/m) + Cable Factor(dB) – Pre-Amplifier Factor(dB)
3. The other emission levels were very low against the limit.
4. Margin value = Emission Level – Limit value
5. " * ": Fundamental frequency.

CHANNEL	TX Channel 134	DETECTOR FUNCTION	Peak (PK)
FREQUENCY RANGE	1GHz ~ 40GHz		Average (AV)

ANTENNA POLARITY & TEST DISTANCE: HORIZONTAL AT 3 M

NO.	FREQ. (MHz)	EMISSION LEVEL (dBuV/m)	LIMIT (dBuV/m)	MARGIN (dB)	ANTENNA HEIGHT (m)	TABLE ANGLE (Degree)	RAW VALUE (dBuV)	CORRECTION FACTOR (dB/m)
1	*5670.00	107.0 PK			2.59 H	325	66.7	40.3
2	*5670.00	97.1 AV			2.59 H	325	56.8	40.3
3	#5725.00	67.8 PK	74.0	-6.2	2.52 H	325	60.4	7.4
4	#5725.00	52.6 AV	54.0	-1.4	2.52 H	325	45.2	7.4
5	11340.00	60.7 PK	74.0	-13.3	2.52 H	241	41.5	19.2
6	11340.00	47.4 AV	54.0	-6.6	2.52 H	241	28.2	19.2

ANTENNA POLARITY & TEST DISTANCE: VERTICAL AT 3 M

NO.	FREQ. (MHz)	EMISSION LEVEL (dBuV/m)	LIMIT (dBuV/m)	MARGIN (dB)	ANTENNA HEIGHT (m)	TABLE ANGLE (Degree)	RAW VALUE (dBuV)	CORRECTION FACTOR (dB/m)
1	*5670.00	102.0 PK			2.39 V	83	61.7	40.3
2	*5670.00	91.9 AV			2.39 V	83	51.6	40.3
3	#5725.00	61.5 PK	74.0	-12.5	2.31 V	85	54.1	7.4
4	#5725.00	48.4 AV	54.0	-5.6	2.31 V	85	41.0	7.4
5	11340.00	60.3 PK	74.0	-13.7	2.08 V	158	41.1	19.2
6	11340.00	47.4 AV	54.0	-6.6	2.08 V	158	28.2	19.2

REMARKS:

1. Emission Level(dBuV/m) = Raw Value(dBuV) + Correction Factor(dB/m)
2. Correction Factor(dB/m) = Antenna Factor(dB/m) + Cable Factor(dB) – Pre-Amplifier Factor(dB)
3. The other emission levels were very low against the limit.
4. Margin value = Emission Level – Limit value
5. " * ": Fundamental frequency.
6. " # ": The radiated frequency is out of the restricted band.

802.11ac (VHT80)

CHANNEL	TX Channel 58	DETECTOR FUNCTION	Peak (PK)
FREQUENCY RANGE	1GHz ~ 40GHz		Average (AV)

ANTENNA POLARITY & TEST DISTANCE: HORIZONTAL AT 3 M								
NO.	FREQ. (MHz)	EMISSION LEVEL (dBuV/m)	LIMIT (dBuV/m)	MARGIN (dB)	ANTENNA HEIGHT (m)	TABLE ANGLE (Degree)	RAW VALUE (dBuV)	CORRECTION FACTOR (dB/m)
1	*5290.00	96.2 PK			2.63 H	359	56.5	39.7
2	*5290.00	85.1 AV			2.63 H	359	45.4	39.7
3	5350.00	67.7 PK	74.0	-6.3	1.43 H	358	61.2	6.5
4	5350.00	52.8 AV	54.0	-1.2	1.43 H	358	46.3	6.5
5	#10580.00	61.3 PK	74.0	-12.7	1.97 H	260	42.3	19.0
6	#10580.00	48.1 AV	54.0	-5.9	1.97 H	260	29.1	19.0

ANTENNA POLARITY & TEST DISTANCE: VERTICAL AT 3 M								
NO.	FREQ. (MHz)	EMISSION LEVEL (dBuV/m)	LIMIT (dBuV/m)	MARGIN (dB)	ANTENNA HEIGHT (m)	TABLE ANGLE (Degree)	RAW VALUE (dBuV)	CORRECTION FACTOR (dB/m)
1	*5290.00	91.7 PK			2.07 V	81	52.0	39.7
2	*5290.00	81.2 AV			2.07 V	81	41.5	39.7
3	5350.00	61.5 PK	74.0	-12.5	2.07 V	88	55.0	6.5
4	5350.00	49.4 AV	54.0	-4.6	2.07 V	88	42.9	6.5
5	#10580.00	61.9 PK	74.0	-12.1	2.22 V	145	42.9	19.0
6	#10580.00	47.6 AV	54.0	-6.4	2.22 V	145	28.6	19.0

REMARKS:

1. Emission Level(dBuV/m) = Raw Value(dBuV) + Correction Factor(dB/m)
2. Correction Factor(dB/m) = Antenna Factor(dB/m) + Cable Factor(dB) – Pre-Amplifier Factor(dB)
3. The other emission levels were very low against the limit.
4. Margin value = Emission Level – Limit value
5. " * ": Fundamental frequency.
6. " # ": The radiated frequency is out of the restricted band.



CHANNEL	TX Channel 106	DETECTOR FUNCTION	Peak (PK)
FREQUENCY RANGE	1GHz ~ 40GHz		Average (AV)

ANTENNA POLARITY & TEST DISTANCE: HORIZONTAL AT 3 M

NO.	FREQ. (MHz)	EMISSION LEVEL (dBuV/m)	LIMIT (dBuV/m)	MARGIN (dB)	ANTENNA HEIGHT (m)	TABLE ANGLE (Degree)	RAW VALUE (dBuV)	CORRECTION FACTOR (dB/m)
1	5460.00	62.1 PK	74.0	-11.9	2.69 H	4	55.2	6.9
2	5460.00	49.0 AV	54.0	-5.0	2.69 H	4	42.1	6.9
3	#5470.00	68.2 PK	74.0	-5.8	3.06 H	0	61.3	6.9
4	#5470.00	52.9 AV	54.0	-1.1	3.06 H	0	46.0	6.9
5	*5530.00	97.6 PK			3.13 H	321	57.4	40.2
6	*5530.00	85.9 AV			3.13 H	321	45.7	40.2
7	10600.00	60.7 PK	74.0	-13.3	2.91 H	257	41.8	18.9
8	10600.00	48.1 AV	54.0	-5.9	2.91 H	257	29.2	18.9

ANTENNA POLARITY & TEST DISTANCE: VERTICAL AT 3 M

NO.	FREQ. (MHz)	EMISSION LEVEL (dBuV/m)	LIMIT (dBuV/m)	MARGIN (dB)	ANTENNA HEIGHT (m)	TABLE ANGLE (Degree)	RAW VALUE (dBuV)	CORRECTION FACTOR (dB/m)
1	5460.00	59.8 PK	74.0	-14.2	2.20 V	94	52.9	6.9
2	5460.00	46.5 AV	54.0	-7.5	2.20 V	94	39.6	6.9
3	#5470.00	62.6 PK	74.0	-11.4	2.31 V	80	55.7	6.9
4	#5470.00	49.1 AV	54.0	-4.9	2.31 V	80	42.2	6.9
5	*5530.00	92.0 PK			2.28 V	87	51.8	40.2
6	*5530.00	81.4 AV			2.28 V	87	41.2	40.2
7	10600.00	60.8 PK	74.0	-13.2	1.54 V	189	41.9	18.9
8	10600.00	47.3 AV	54.0	-6.7	1.54 V	189	28.4	18.9

REMARKS:

1. Emission Level(dBuV/m) = Raw Value(dBuV) + Correction Factor(dB/m)
2. Correction Factor(dB/m) = Antenna Factor(dB/m) + Cable Factor(dB) – Pre-Amplifier Factor(dB)
3. The other emission levels were very low against the limit.
4. Margin value = Emission Level – Limit value
5. " * ": Fundamental frequency.
6. " # ": The radiated frequency is out of the restricted band.

Below 1GHz worst-case data:

Radio 2

CDD Mode

802.11a

CHANNEL	TX Channel 52	DETECTOR FUNCTION	Quasi-Peak (QP)
FREQUENCY RANGE	9kHz ~ 1GHz		

ANTENNA POLARITY & TEST DISTANCE: HORIZONTAL AT 3 M

NO.	FREQ. (MHz)	EMISSION LEVEL (dBuV/m)	LIMIT (dBuV/m)	MARGIN (dB)	ANTENNA HEIGHT (m)	TABLE ANGLE (Degree)	RAW VALUE (dBuV)	CORRECTION FACTOR (dB/m)
1	57.12	31.5 QP	40.0	-8.5	1.99 H	194	46.1	-14.6
2	78.51	31.4 QP	40.0	-8.6	1.49 H	194	49.8	-18.4
3	146.56	34.0 QP	43.5	-9.5	1.99 H	161	48.1	-14.1
4	300.16	38.8 QP	46.0	-7.2	1.00 H	104	51.0	-12.2
5	708.46	36.8 QP	46.0	-9.2	1.99 H	48	40.8	-4.0
6	920.38	32.1 QP	46.0	-13.9	1.99 H	165	31.8	0.3

ANTENNA POLARITY & TEST DISTANCE: VERTICAL AT 3 M

NO.	FREQ. (MHz)	EMISSION LEVEL (dBuV/m)	LIMIT (dBuV/m)	MARGIN (dB)	ANTENNA HEIGHT (m)	TABLE ANGLE (Degree)	RAW VALUE (dBuV)	CORRECTION FACTOR (dB/m)
1	29.90	34.3 QP	40.0	-5.7	1.00 V	207	50.5	-16.2
2	69.91	38.8 QP	40.0	-1.2	1.00 V	153	55.1	-16.3
3	150.45	30.9 QP	43.5	-12.6	1.50 V	225	44.8	-13.9
4	302.10	29.8 QP	46.0	-16.2	1.50 V	197	42.0	-12.2
5	519.86	26.5 QP	46.0	-19.5	1.00 V	5	34.3	-7.8
6	708.46	37.0 QP	46.0	-9.0	1.50 V	173	41.0	-4.0

REMARKS:

1. Emission Level(dBuV/m) = Raw Value(dBuV) + Correction Factor(dB/m)
2. Correction Factor(dB/m) = Antenna Factor(dB/m) + Cable Factor(dB)
3. The other emission levels were very low against the limit.
4. Margin value = Emission Level – Limit value

Radio 3

CDD Mode

802.11a

CHANNEL	TX Channel 52	DETECTOR FUNCTION	Quasi-Peak (QP)
FREQUENCY RANGE	9kHz ~ 1GHz		

ANTENNA POLARITY & TEST DISTANCE: HORIZONTAL AT 3 M

NO.	FREQ. (MHz)	EMISSION LEVEL (dBuV/m)	LIMIT (dBuV/m)	MARGIN (dB)	ANTENNA HEIGHT (m)	TABLE ANGLE (Degree)	RAW VALUE (dBuV)	CORRECTION FACTOR (dB/m)
1	57.12	30.1 QP	40.0	-9.9	2.00 H	210	44.7	-14.6
2	76.56	32.2 QP	40.0	-7.8	1.50 H	178	50.2	-18.0
3	162.11	33.8 QP	43.5	-9.7	1.50 H	107	47.6	-13.8
4	302.10	37.4 QP	46.0	-8.6	1.00 H	94	49.6	-12.2
5	706.51	29.1 QP	46.0	-16.9	2.00 H	165	33.1	-4.0
6	1000.10	32.0 QP	54.0	-22.0	1.50 H	3	30.9	1.1

ANTENNA POLARITY & TEST DISTANCE: VERTICAL AT 3 M

NO.	FREQ. (MHz)	EMISSION LEVEL (dBuV/m)	LIMIT (dBuV/m)	MARGIN (dB)	ANTENNA HEIGHT (m)	TABLE ANGLE (Degree)	RAW VALUE (dBuV)	CORRECTION FACTOR (dB/m)
1	29.90	31.3 QP	40.0	-8.7	1.00 V	161	47.5	-16.2
2	68.79	38.2 QP	40.0	-1.8	1.49 V	10	54.4	-16.2
3	142.67	29.9 QP	43.5	-13.6	1.00 V	117	44.2	-14.3
4	302.10	30.1 QP	46.0	-15.9	1.49 V	69	42.3	-12.2
5	350.71	25.3 QP	46.0	-20.7	1.49 V	10	36.6	-11.3
6	708.46	29.1 QP	46.0	-16.9	2.00 V	10	33.1	-4.0

REMARKS:

1. Emission Level(dBuV/m) = Raw Value(dBuV) + Correction Factor(dB/m)
2. Correction Factor(dB/m) = Antenna Factor(dB/m) + Cable Factor(dB)
3. The other emission levels were very low against the limit.
4. Margin value = Emission Level – Limit value

4.2 Conducted Emission Measurement

4.2.1 Limits of Conducted Emission Measurement

Frequency (MHz)	Conducted Limit (dBuV)	
	Quasi-peak	Average
0.15 - 0.5	66 - 56	56 - 46
0.50 - 5.0	56	46
5.0 - 30.0	60	50

- Note:** 1. The lower limit shall apply at the transition frequencies.
 2. The limit decreases in line with the logarithm of the frequency in the range of 0.15 to 0.50MHz.

4.2.2 Test Instruments

Description & Manufacturer	Model No.	Serial No.	Cal. Date	Cal. Due
Test Receiver ROHDE & SCHWARZ	ESCI	100613	Nov. 16, 2015	Nov. 15, 2016
RF signal cable (with 10dB PAD) Woken	5D-FB	Cable-cond1-01	Dec. 26, 2015	Dec. 25, 2016
LISN/AMN ROHDE & SCHWARZ (EUT)	ESH3-Z5	835239/001	Feb. 26, 2016	Feb. 25, 2017
LISN/AMN ROHDE & SCHWARZ (Peripheral)	ESH3-Z5	100311	Jul. 28, 2016	Jul. 27, 2017
Software ADT	BV ADT_Cond_ V7.3.7.3	NA	NA	NA

- Note:** 1. The calibration interval of the above test instruments is 12 months and the calibrations are traceable to NML/ROC and NIST/USA.
 2. The test was performed in HwaYa Shielded Room 1.
 3. The VCCI Site Registration No. is C-2040.

4.2.3 Test Procedures

- The EUT was placed 0.4 meters from the conducting wall of the shielded room with EUT being connected to the power mains through a line impedance stabilization network (LISN). Other support units were connected to the power mains through another LISN. The two LISNs provide 50 ohm/ 50uH of coupling impedance for the measuring instrument.
- Both lines of the power mains connected to the EUT were checked for maximum conducted interference.
- The frequency range from 150kHz to 30MHz was searched. Emission levels under (Limit - 20dB) was not recorded.

NOTE: The resolution bandwidth and video bandwidth of test receiver is 9kHz for quasi-peak detection (QP) and average detection (AV) at frequency 0.15MHz-30MHz.

4.2.4 Deviation from Test Standard

No deviation.

4.2.5 Test Setup

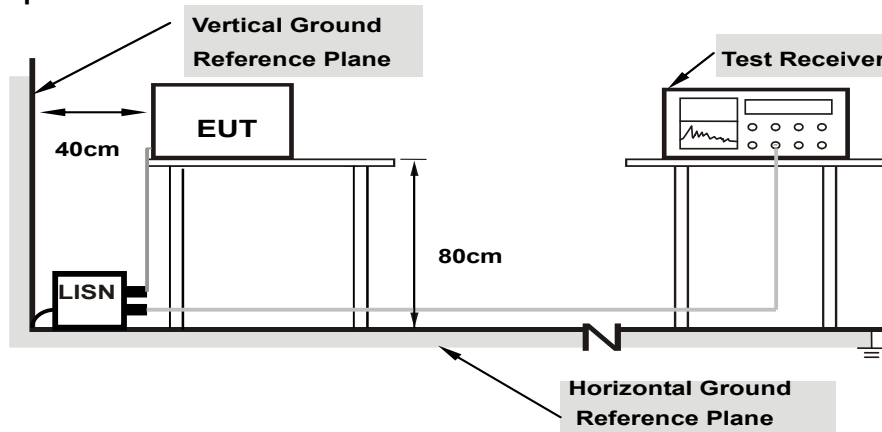

Note: 1.Support units were connected to second LISN.

For the actual test configuration, please refer to the attached file (Test Setup Photo).

4.2.6 EUT Operating Conditions

Same as 4.1.6.

4.2.7 Test Results

Radio 2

Phase	Line (L)	Detector Function	Quasi-Peak (QP) / Average (AV)
-------	----------	-------------------	--------------------------------

No	Freq. [MHz]	Corr. Factor (dB)	Reading Value [dB (uV)]		Emission Level [dB (uV)]		Limit [dB (uV)]		Margin (dB)	
			Q.P.	AV.	Q.P.	AV.	Q.P.	AV.	Q.P.	AV.
			1	0.16190	10.08	30.11	15.33	40.19	25.41	65.37
2	0.20631	10.08	26.73	15.43	36.81	25.51	63.35	53.35	-26.54	-27.84
3	0.56200	10.20	33.87	25.25	44.07	35.45	56.00	46.00	-11.93	-10.55
4	0.69400	10.23	24.10	14.16	34.33	24.39	56.00	46.00	-21.67	-21.61
5	0.98600	10.29	23.72	15.40	34.01	25.69	56.00	46.00	-21.99	-20.31
6	20.49800	11.45	16.38	9.06	27.83	20.51	60.00	50.00	-32.17	-29.49

REMARKS:

1. Q.P. and AV. are abbreviations of quasi-peak and average individually.
2. The emission levels of other frequencies were very low against the limit.
3. Margin value = Emission level - Limit value
4. Correction factor = Insertion loss + Cable loss
5. Emission Level = Correction Factor + Reading Value.

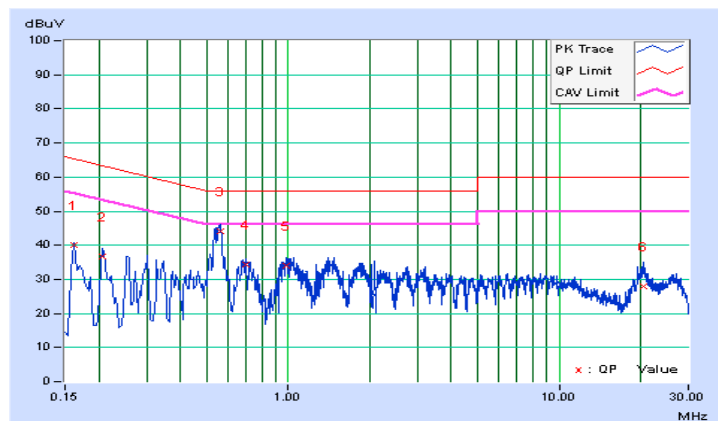

Phase	Neutral (N)	Detector Function	Quasi-Peak (QP) / Average (AV)
-------	-------------	-------------------	--------------------------------

No	Freq. [MHz]	Corr. Factor (dB)	Reading Value		Emission Level		Limit		Margin	
			[dB (uV)]		[dB (uV)]		[dB (uV)]		(dB)	
			Q.P.	AV.	Q.P.	AV.	Q.P.	AV.	Q.P.	AV.
1	0.15400	10.08	23.22	3.03	33.30	13.11	65.78	55.78	-32.48	-42.67
2	0.20631	10.09	24.89	13.77	34.98	23.86	63.35	53.35	-28.37	-29.49
3	0.55411	10.25	34.48	26.52	44.73	36.77	56.00	46.00	-11.27	-9.23
4	0.69400	10.26	24.44	14.78	34.70	25.04	56.00	46.00	-21.30	-20.96
5	1.03000	10.29	24.12	16.02	34.41	26.31	56.00	46.00	-21.59	-19.69
6	20.03000	11.58	13.51	5.06	25.09	16.64	60.00	50.00	-34.91	-33.36

REMARKS:

1. Q.P. and AV. are abbreviations of quasi-peak and average individually.
2. The emission levels of other frequencies were very low against the limit.
3. Margin value = Emission level - Limit value
4. Correction factor = Insertion loss + Cable loss
5. Emission Level = Correction Factor + Reading Value.

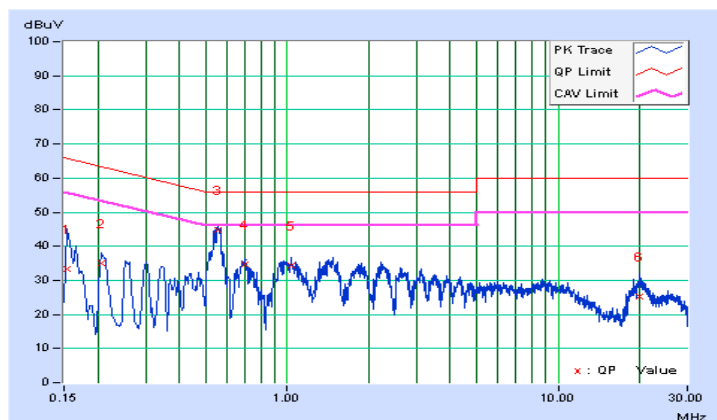

Radio 3

Phase	Line (L)	Detector Function	Quasi-Peak (QP) / Average (AV)
-------	----------	-------------------	--------------------------------

No	Freq. [MHz]	Corr. Factor (dB)	Reading Value [dB (uV)]		Emission Level [dB (uV)]		Limit [dB (uV)]		Margin (dB)	
			Q.P.	AV.	Q.P.	AV.	Q.P.	AV.	Q.P.	AV.
			1	0.17022	10.08	31.07	22.93	41.15	33.01	64.95
2	0.21805	10.09	24.39	14.80	34.48	24.89	62.89	52.89	-28.41	-28.00
3	0.55000	10.20	34.65	26.34	44.85	36.54	56.00	46.00	-11.15	-9.46
4	1.04005	10.29	23.84	15.02	34.13	25.31	56.00	46.00	-21.87	-20.69
5	1.46873	10.33	23.23	16.07	33.56	26.40	56.00	46.00	-22.44	-19.60
6	19.93400	11.42	13.16	4.86	24.58	16.28	60.00	50.00	-35.42	-33.72

REMARKS:

1. Q.P. and AV. are abbreviations of quasi-peak and average individually.
2. The emission levels of other frequencies were very low against the limit.
3. Margin value = Emission level - Limit value
4. Correction factor = Insertion loss + Cable loss
5. Emission Level = Correction Factor + Reading Value.

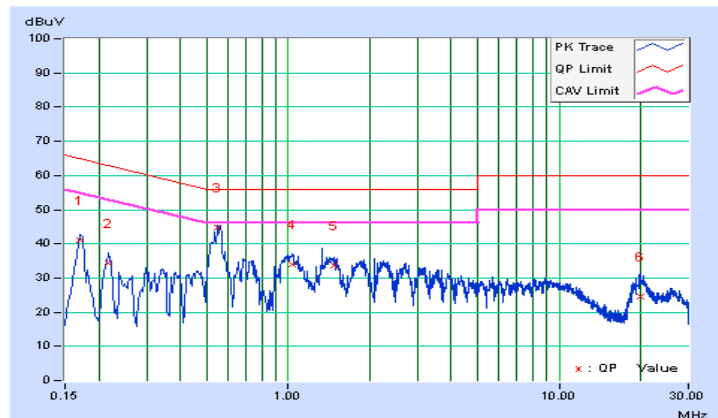

Phase	Neutral (N)	Detector Function	Quasi-Peak (QP) / Average (AV)
-------	-------------	-------------------	--------------------------------

No	Freq. [MHz]	Corr. Factor (dB)	Reading Value		Emission Level		Limit		Margin	
			[dB (uV)]		[dB (uV)]		[dB (uV)]		(dB)	
			Q.P.	AV.	Q.P.	AV.	Q.P.	AV.	Q.P.	AV.
1	0.16200	10.08	29.95	15.49	40.03	25.57	65.36	55.36	-25.33	-29.79
2	0.21000	10.09	27.62	19.10	37.71	29.19	63.21	53.21	-25.50	-24.02
3	0.54542	10.25	34.79	25.52	45.04	35.77	56.00	46.00	-10.96	-10.23
4	0.98667	10.29	24.14	15.55	34.43	25.84	56.00	46.00	-21.57	-20.16
5	1.43810	10.33	23.13	15.56	33.46	25.89	56.00	46.00	-22.54	-20.11
6	19.87400	11.57	16.22	8.81	27.79	20.38	60.00	50.00	-32.21	-29.62

REMARKS:

1. Q.P. and AV. are abbreviations of quasi-peak and average individually.
2. The emission levels of other frequencies were very low against the limit.
3. Margin value = Emission level - Limit value
4. Correction factor = Insertion loss + Cable loss
5. Emission Level = Correction Factor + Reading Value.

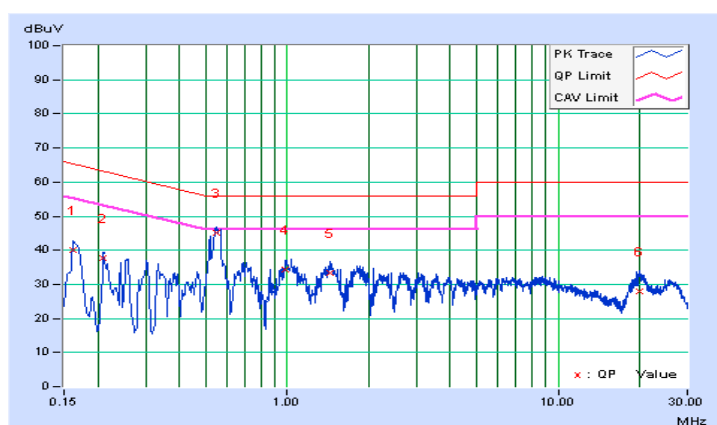

4.3 Transmit Power Measurement

4.3.1 Limits of Transmit Power Measurement

Operation Band	EUT Category		LIMIT
U-NII-1	-	Outdoor Access Point	1 Watt (30 dBm) (Max. e.i.r.p \leq 125mW(21 dBm) at any elevation angle above 30 degrees as measured from the horizon)
	-	Fixed point-to-point Access Point	1 Watt (30 dBm)
	-	Indoor Access Point	1 Watt (30 dBm)
	-	Mobile and Portable client device	250mW (24 dBm)
U-NII-2A	√		250mW (24 dBm) or 11 dBm+10 log B*
U-NII-2C	√		250mW (24 dBm) or 11 dBm+10 log B*
U-NII-3	-		1 Watt (30 dBm)

*B is the 26 dB emission bandwidth in megahertz

Per KDB 662911 Method of conducted output power measurement on IEEE 802.11 devices,

Array Gain = 0 dB (i.e., no array gain) for $N_{ANT} \leq 4$;

Array Gain = 0 dB (i.e., no array gain) for channel widths ≥ 40 MHz for any N_{ANT} ;

Array Gain = $5 \log(N_{ANT}/N_{SS})$ dB or 3 dB, whichever is less for 20-MHz channel widths with $N_{ANT} \geq 5$.

For power measurements on all other devices: Array Gain = $10 \log(N_{ANT}/N_{SS})$ dB.

4.3.2 Test Setup

For Power Output Measurement

For 802.11a, 802.11n (HT20), 802.11n (HT40), 802.11ac (VHT20), 802.11ac (VHT40)

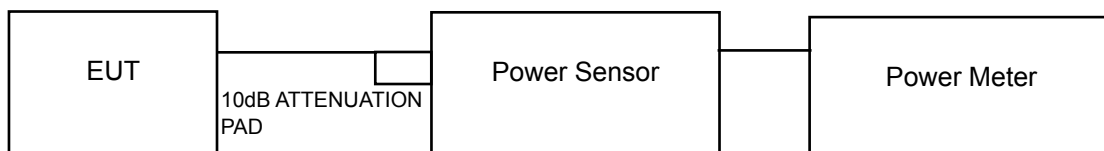

For 802.11ac (VHT80)

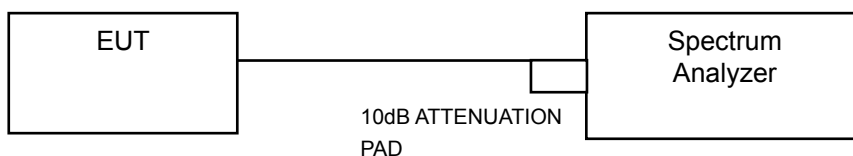

For 26dB and Occupied Bandwidth

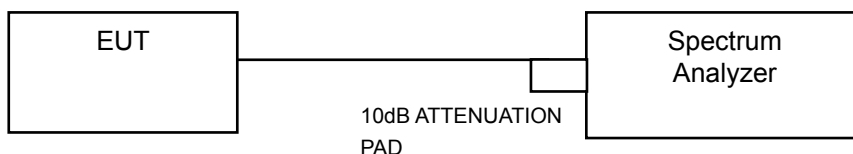

4.3.3 Test Instruments

Refer to section 4.1.2 to get information of above instrument.

4.3.4 Test Procedure

FOR AVERAGE POWER MEASUREMENT

For 802.11a, 802.11n (HT20), 802.11n (HT40), 802.11ac (VHT20), 802.11ac (VHT40)

Method PM is used to perform output power measurement, trigger and gating function of wide band power meter is enabled to measure max output power of TX on burst. Duty factor is not added to measured value.

For 802.11ac (VHT80)

- 1) Set span to encompass the entire 26 dB EBW (or, alternatively, the entire 99% occupied bandwidth) of the signal.
- 2) Set sweep trigger to "free run".
- 3) Set RBW = 1 MHz.
- 4) Set VBW \geq 3 MHz
- 5) Number of points in sweep \geq 2 Span / RBW.
- 6) Sweep time \leq (number of points in sweep) * T
- 7) Using emission bandwidth to determine the frequency span for integration the channel bandwidth.
- 8) Detector = RMS.
- 9) Trace mode = max hold.
- 10) Allow max hold to run for at least 60 seconds, or longer as needed to allow the trace to stabilize.

For 26dB Bandwidth

- 1) Set RBW = approximately 1% of the emission bandwidth.
- 2) Set the VBW > RBW.
- 3) Detector = Peak.
- 4) Trace mode = max hold.
- 5) Measure the maximum width of the emission that is 26 dB down from the peak of the emission. Compare this with the RBW setting of the analyzer. Readjust RBW and repeat measurement as needed until the RBW/EBW ratio is approximately 1%.

For Occupied Bandwidth

The transmitter output was connected to the spectrum analyzer through an attenuator. The bandwidth of the fundamental frequency was measured by spectrum analyzer with resolution bandwidth in the range of 1% to 5% of the anticipated emission bandwidth, and a video bandwidth at least 3x the resolution bandwidth and set the detector to sampling detector. The width of a frequency band such that, below the lower and above the upper frequency limits, the mean powers emitted are each equal to a specified percentage 0.5 % of the total mean power of a given emission.

4.3.5 Deviation from Test Standard

No deviation.

4.3.6 EUT Operating Conditions

The software provided by client to enable the EUT under transmission condition continuously at lowest, middle and highest channel frequencies individually.

4.3.7 Test Result

POWER OUTPUT:

Radio 2

CDD Mode

802.11a

Chan.	Freq. (MHz)	Maximum Conducted Power (dBm)		Total Power (mW)	Total Power (dBm)	Power Limit (dBm)	Pass / Fail
		Chain 0	Chain 1				
52	5260	18.93	19.18	160.957	22.07	24.00	Pass
60	5300	18.85	19.12	158.394	22.00	24.00	Pass
64	5320	16.44	16.36	87.306	19.41	24.00	Pass
100	5500	16.27	15.92	81.448	19.11	24.00	Pass
116	5580	18.97	18.63	151.832	21.81	24.00	Pass
140	5700	16.31	16.05	83.028	19.19	24.00	Pass

Note:

Chain 0

1. $11\text{dBm} + 10\log (40.11) = 27.03 > 24\text{dBm}$
2. $11\text{dBm} + 10\log (39.81) = 27.00 > 24\text{dBm}$
3. $11\text{dBm} + 10\log (20.25) = 24.06 > 24\text{dBm}$
4. $11\text{dBm} + 10\log (26.19) = 25.18 > 24\text{dBm}$
5. $11\text{dBm} + 10\log (42.41) = 27.27 > 24\text{dBm}$
6. $11\text{dBm} + 10\log (32.66) = 26.14 > 24\text{dBm}$

Chain 1

1. $11\text{dBm} + 10\log (39.63) = 26.98 > 24\text{dBm}$
2. $11\text{dBm} + 10\log (36.53) = 26.63 > 24\text{dBm}$
3. $11\text{dBm} + 10\log (20.99) = 24.22 > 24\text{dBm}$
4. $11\text{dBm} + 10\log (23.92) = 24.79 > 24\text{dBm}$
5. $11\text{dBm} + 10\log (41.88) = 27.22 > 24\text{dBm}$
6. $11\text{dBm} + 10\log (32.89) = 26.17 > 24\text{dBm}$



802.11n (HT20)

Chan.	Freq. (MHz)	Maximum Conducted Power (dBm)		Total Power (mW)	Total Power (dBm)	Power Limit (dBm)	Pass / Fail
		Chain 0	Chain 1				
52	5260	18.89	19.04	157.614	21.98	24.00	Pass
60	5300	18.94	19.04	158.511	22.00	24.00	Pass
64	5320	16.33	16.27	85.318	19.31	24.00	Pass
100	5500	15.83	15.64	74.926	18.75	24.00	Pass
116	5580	18.78	18.99	154.759	21.90	24.00	Pass
140	5700	14.71	14.33	56.682	17.53	24.00	Pass

Note:

Chain 0

1. $11\text{dBm} + 10\log (42.86) = 27.32 > 24\text{dBm}$
2. $11\text{dBm} + 10\log (40.41) = 27.06 > 24\text{dBm}$
3. $11\text{dBm} + 10\log (22.92) = 24.60 > 24\text{dBm}$
4. $11\text{dBm} + 10\log (26.04) = 25.16 > 24\text{dBm}$
5. $11\text{dBm} + 10\log (47.12) = 27.73 > 24\text{dBm}$
6. $11\text{dBm} + 10\log (21.23) = 24.27 > 24\text{dBm}$

Chain 1

1. $11\text{dBm} + 10\log (41.36) = 27.17 > 24\text{dBm}$
2. $11\text{dBm} + 10\log (39.78) = 27.00 > 24\text{dBm}$
3. $11\text{dBm} + 10\log (21.50) = 24.32 > 24\text{dBm}$
4. $11\text{dBm} + 10\log (22.13) = 24.45 > 24\text{dBm}$
5. $11\text{dBm} + 10\log (44.13) = 27.45 > 24\text{dBm}$
6. $11\text{dBm} + 10\log (21.51) = 24.33 > 24\text{dBm}$

802.11n (HT40)

Chan.	Freq. (MHz)	Maximum Conducted Power (dBm)		Total Power (mW)	Total Power (dBm)	Power Limit (dBm)	Pass / Fail
		Chain 0	Chain 1				
54	5270	19.67	19.80	188.182	22.75	24.00	Pass
62	5310	13.81	13.91	48.648	16.87	24.00	Pass
102	5510	13.72	13.35	45.177	16.55	24.00	Pass
110	5550	19.49	19.36	175.218	22.44	24.00	Pass
134	5670	17.04	16.88	99.335	19.97	24.00	Pass

Note:

Chain 0

1. $11\text{dBm} + 10\log (94.20) = 30.74 > 24\text{dBm}$
2. $11\text{dBm} + 10\log (40.68) = 27.09 > 24\text{dBm}$
3. $11\text{dBm} + 10\log (40.57) = 27.08 > 24\text{dBm}$
4. $11\text{dBm} + 10\log (100.37) = 31.02 > 24\text{dBm}$
5. $11\text{dBm} + 10\log (81.44) = 30.11 > 24\text{dBm}$

Chain 1

1. $11\text{dBm} + 10\log (92.65) = 30.67 > 24\text{dBm}$
2. $11\text{dBm} + 10\log (40.82) = 27.11 > 24\text{dBm}$
3. $11\text{dBm} + 10\log (40.81) = 27.11 > 24\text{dBm}$
4. $11\text{dBm} + 10\log (95.34) = 30.79 > 24\text{dBm}$
5. $11\text{dBm} + 10\log (83.09) = 30.20 > 24\text{dBm}$

802.11ac (VHT80)

Chan.	Freq. (MHz)	Maximum Conducted Power (dBm)		Total Power (mW)	Total Power (dBm)	Power Limit (dBm)	Pass / Fail
		Chain 0	Chain 1				
58	5290	12.75	12.77	37.759	15.77	24.00	Pass
106	5530	12.86	12.77	38.243	15.83	24.00	Pass

Note:

Chain 0

1. $11\text{dBm} + 10\log (83.65) = 30.22 > 24\text{dBm}$
2. $11\text{dBm} + 10\log (83.70) = 30.23 > 24\text{dBm}$

Chain 1

1. $11\text{dBm} + 10\log (84.26) = 30.26 > 24\text{dBm}$
2. $11\text{dBm} + 10\log (83.78) = 30.23 > 24\text{dBm}$

Beamforming Mode

802.11ac (VHT20)

Chan.	Freq. (MHz)	Maximum Conducted Power (dBm)		Total Power (mW)	Total Power (dBm)	Power Limit (dBm)	Pass / Fail
		Chain 0	Chain 1				
52	5260	18.79	18.85	152.419	21.83	22.13	Pass
60	5300	18.75	18.96	153.694	21.87	22.13	Pass
64	5320	16.79	16.62	93.673	19.72	22.13	Pass
100	5500	16.23	16.13	82.996	19.19	22.13	Pass
116	5580	18.72	18.95	152.997	21.85	22.13	Pass
140	5700	14.44	14.55	56.307	17.51	22.13	Pass

*Directional gain = $10 \log[(10^{G1/20} + 10^{G2/20} + \dots + 10^{GN/20})^2/N]$ = 7.87dBi > 6dBi, so the power limit shall be reduced to $24-(7.87-6) = 22.13\text{dBm}$.

Note:

Chain 0

1. $11\text{dBm} + 10\log (40.87) = 27.11 > 22.13\text{dBm}$
2. $11\text{dBm} + 10\log (38.40) = 26.84 > 22.13\text{dBm}$
3. $11\text{dBm} + 10\log (20.99) = 24.22 > 22.13\text{dBm}$
4. $11\text{dBm} + 10\log (21.03) = 24.23 > 22.13\text{dBm}$
5. $11\text{dBm} + 10\log (43.97) = 27.43 > 22.13\text{dBm}$
6. $11\text{dBm} + 10\log (20.83) = 24.19 > 22.13\text{dBm}$

Chain 1

1. $11\text{dBm} + 10\log (42.91) = 27.33 > 22.13\text{dBm}$
2. $11\text{dBm} + 10\log (42.19) = 27.25 > 22.13\text{dBm}$
3. $11\text{dBm} + 10\log (21.30) = 24.28 > 22.13\text{dBm}$
4. $11\text{dBm} + 10\log (21.01) = 24.22 > 22.13\text{dBm}$
5. $11\text{dBm} + 10\log (45.25) = 27.56 > 22.13\text{dBm}$
6. $11\text{dBm} + 10\log (21.08) = 24.24 > 22.13\text{dBm}$

802.11ac (VHT40)

Chan.	Freq. (MHz)	Maximum Conducted Power (dBm)		Total Power (mW)	Total Power (dBm)	Power Limit (dBm)	Pass / Fail
		Chain 0	Chain 1				
54	5270	18.81	18.96	154.738	21.90	22.13	Pass
62	5310	12.12	11.85	31.604	15.00	22.13	Pass
102	5510	12.42	12.48	35.159	15.46	22.13	Pass
110	5550	18.99	18.87	156.340	21.94	22.13	Pass
134	5670	14.67	14.57	57.951	17.63	22.13	Pass

*Directional gain = $10 \log[(10^{G1/20} + 10^{G2/20} + \dots + 10^{GN/20})^2/N]$ = 7.87dBi > 6dBi, so the power limit shall be reduced to $24-(7.87-6) = 22.13$ dBm.

Note:

Chain 0

1. 11dBm + 10log (86.75) = 30.38 > 22.13dBm
2. 11dBm + 10log (41.09) = 27.14 > 22.13dBm
3. 11dBm + 10log (40.95) = 27.12 > 22.13dBm
4. 11dBm + 10log (91.70) = 30.62 > 22.13dBm
5. 11dBm + 10log (41.39) = 27.17 > 22.13dBm

Chain 1

1. 11dBm + 10log (83.88) = 30.24 > 22.13dBm
2. 11dBm + 10log (41.25) = 27.15 > 22.13dBm
3. 11dBm + 10log (41.06) = 27.13 > 22.13dBm
4. 11dBm + 10log (90.60) = 30.57 > 22.13dBm
5. 11dBm + 10log (42.83) = 27.32 > 22.13dBm

802.11ac (VHT80)

Chan.	Freq. (MHz)	Maximum Conducted Power (dBm)		Total Power (mW)	Total Power (dBm)	Power Limit (dBm)	Pass / Fail
		Chain 0	Chain 1				
58	5290	9.94	10.06	20.002	13.01	22.13	Pass
106	5530	11.29	11.32	27.011	14.32	22.13	Pass

*Directional gain = $10 \log[(10^{G1/20} + 10^{G2/20} + \dots + 10^{GN/20})^2/N]$ = 7.87dBi > 6dBi, so the power limit shall be reduced to $24-(7.87-6) = 22.13$ dBm.

Note:

Chain 0

1. 11dBm + 10log (84.27) = 30.26 > 22.13dBm
2. 11dBm + 10log (84.05) = 30.25 > 22.13dBm

Chain 1

1. 11dBm + 10log (83.39) = 30.21 > 22.13dBm
2. 11dBm + 10log (83.89) = 30.24 > 22.13dBm



Radio 3

CDD Mode

802.11a

Chan.	Freq. (MHz)	Maximum Conducted Power (mW)	Maximum Conducted Power (dBm)	Power Limit (dBm)	Pass / Fail
52	5260	69.823	18.44	24.00	Pass
60	5300	62.087	17.93	24.00	Pass
64	5320	47.315	16.75	24.00	Pass
100	5500	27.733	14.43	24.00	Pass
116	5580	56.885	17.55	24.00	Pass
140	5700	28.708	14.58	24.00	Pass

Note:

1. $11\text{dBm} + 10\log (43.78) = 27.41 > 24\text{dBm}$
2. $11\text{dBm} + 10\log (44.73) = 27.51 > 24\text{dBm}$
3. $11\text{dBm} + 10\log (42.67) = 27.30 > 24\text{dBm}$
4. $11\text{dBm} + 10\log (37.81) = 26.78 > 24\text{dBm}$
5. $11\text{dBm} + 10\log (45.27) = 27.56 > 24\text{dBm}$
6. $11\text{dBm} + 10\log (29.75) = 25.73 > 24\text{dBm}$

802.11n (HT20)

Chan.	Freq. (MHz)	Maximum Conducted Power (mW)	Maximum Conducted Power (dBm)	Power Limit (dBm)	Pass / Fail
52	5260	67.453	18.29	24.00	Pass
60	5300	61.660	17.90	24.00	Pass
64	5320	47.863	16.80	24.00	Pass
100	5500	29.648	14.72	24.00	Pass
116	5580	57.280	17.58	24.00	Pass
140	5700	26.182	14.18	24.00	Pass

Note:

1. $11\text{dBm} + 10\log (46.53) = 27.68 > 24\text{dBm}$
2. $11\text{dBm} + 10\log (47.60) = 27.78 > 24\text{dBm}$
3. $11\text{dBm} + 10\log (45.26) = 27.56 > 24\text{dBm}$
4. $11\text{dBm} + 10\log (37.50) = 26.74 > 24\text{dBm}$
5. $11\text{dBm} + 10\log (48.36) = 27.84 > 24\text{dBm}$
6. $11\text{dBm} + 10\log (30.01) = 25.77 > 24\text{dBm}$



802.11n (HT40)

Chan.	Freq. (MHz)	Maximum Conducted Power (mW)	Maximum Conducted Power (dBm)	Power Limit (dBm)	Pass / Fail
54	5270	65.615	18.17	24.00	Pass
62	5310	18.793	12.74	24.00	Pass
102	5510	10.139	10.06	24.00	Pass
110	5550	48.978	16.90	24.00	Pass
134	5670	45.499	16.58	24.00	Pass

Note:

1. $11\text{dBm} + 10\log (97.54) = 30.89 > 24\text{dBm}$
2. $11\text{dBm} + 10\log (56.85) = 28.55 > 24\text{dBm}$
3. $11\text{dBm} + 10\log (52.67) = 28.22 > 24\text{dBm}$
4. $11\text{dBm} + 10\log (93.01) = 30.69 > 24\text{dBm}$
5. $11\text{dBm} + 10\log (86.02) = 30.35 > 24\text{dBm}$

802.11ac (VHT80)

Chan.	Freq. (MHz)	Maximum Conducted Power (mW)	Maximum Conducted Power (dBm)	Power Limit (dBm)	Pass / Fail
58	5290	8.831	9.46	24.00	Pass
106	5530	6.039	7.81	24.00	Pass

Note:

1. $11\text{dBm} + 10\log (103.44) = 31.15 > 24\text{dBm}$
2. $11\text{dBm} + 10\log (100.95) = 31.04 > 24\text{dBm}$

26dB BANDWIDTH:
Radio 2
CDD Mode
802.11a

Chan.	Freq. (MHz)	26dBc Bandwidth (MHz)		Pass / Fail
		Chain 0	Chain 1	
52	5260	40.11	39.63	Pass
60	5300	39.81	36.53	Pass
64	5320	20.25	20.99	Pass
100	5500	26.19	23.92	Pass
116	5580	42.41	41.88	Pass
140	5700	32.66	32.89	Pass

802.11n (HT20)

Chan.	Freq. (MHz)	26dBc Bandwidth (MHz)		Pass / Fail
		Chain 0	Chain 1	
52	5260	42.86	41.36	Pass
60	5300	40.41	39.78	Pass
64	5320	22.92	21.50	Pass
100	5500	26.04	22.13	Pass
116	5580	47.12	44.13	Pass
140	5700	21.23	21.51	Pass

802.11n (HT40)

Chan.	Freq. (MHz)	26dBc Bandwidth (MHz)		Pass / Fail
		Chain 0	Chain 1	
54	5270	94.20	92.65	Pass
62	5310	40.68	40.82	Pass
102	5510	40.57	40.81	Pass
110	5550	100.37	95.34	Pass
134	5670	81.44	83.09	Pass



802.11ac (VHT80)

Chan.	Freq. (MHz)	26dBc Bandwidth (MHz)		Pass / Fail
		Chain 0	Chain 1	
58	5290	83.65	84.26	Pass
106	5530	83.70	83.78	Pass

Spectrum Plot of Worst Value

802.11a

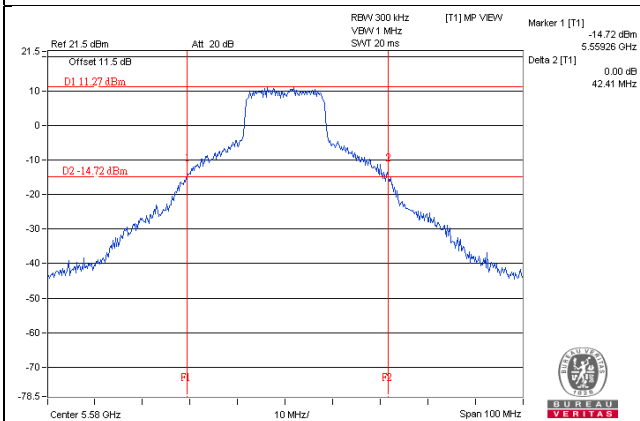

802.11n (HT20)

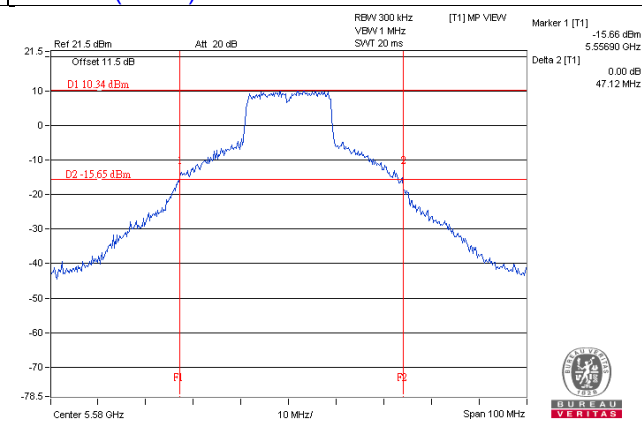

802.11n (HT40)

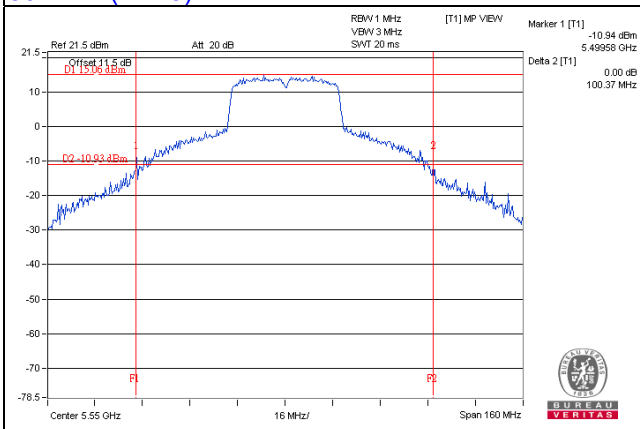

802.11ac (VHT80)

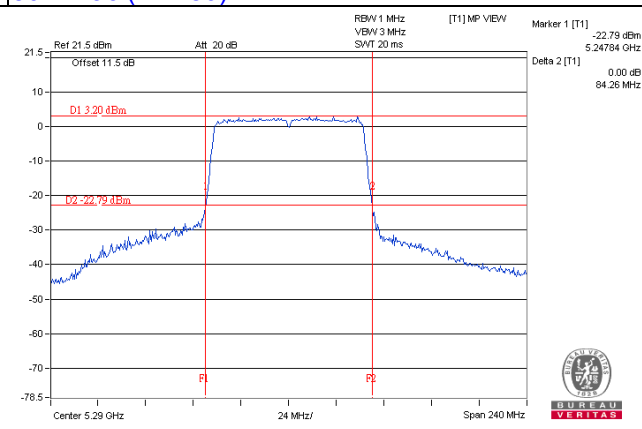

Beamforming Mode

802.11ac (VHT20)

Chan.	Freq. (MHz)	26dBc Bandwidth (MHz)		Pass / Fail
		Chain 0	Chain 1	
52	5260	40.87	42.91	Pass
60	5300	38.40	42.19	Pass
64	5320	20.99	21.30	Pass
100	5500	21.03	21.01	Pass
116	5580	43.97	45.25	Pass
140	5700	20.83	21.08	Pass

802.11ac (VHT40)

Chan.	Freq. (MHz)	26dBc Bandwidth (MHz)		Pass / Fail
		Chain 0	Chain 1	
54	5270	86.75	83.88	Pass
62	5310	41.09	41.25	Pass
102	5510	40.95	41.06	Pass
110	5550	91.70	90.60	Pass
134	5670	41.39	42.83	Pass

802.11ac (VHT80)

Chan.	Freq. (MHz)	26dBc Bandwidth (MHz)		Pass / Fail
		Chain 0	Chain 1	
58	5290	84.27	83.39	Pass
106	5530	84.05	83.89	Pass



Spectrum Plot of Worst Value

802.11ac (VHT20)

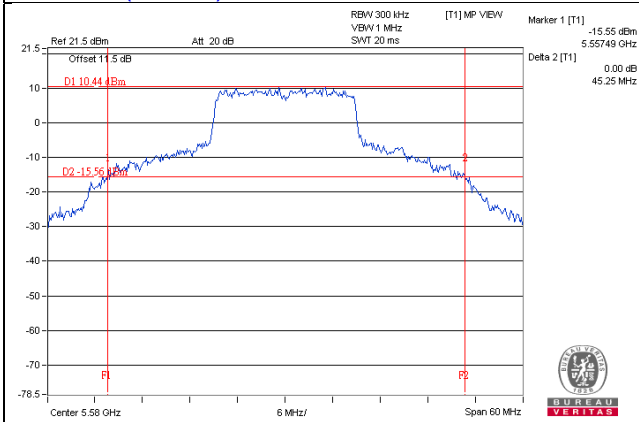

802.11ac (VHT40)

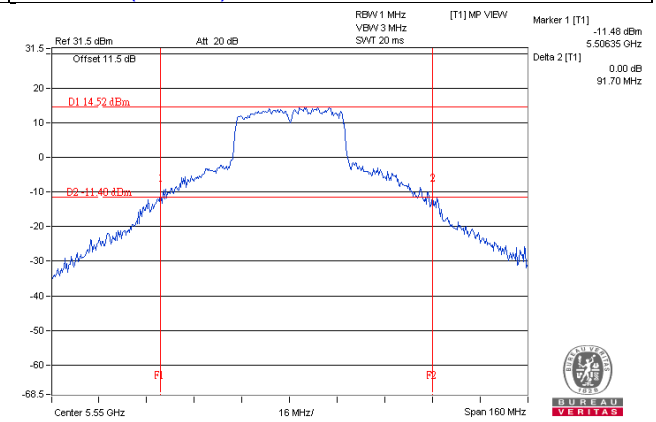

802.11ac (VHT80)

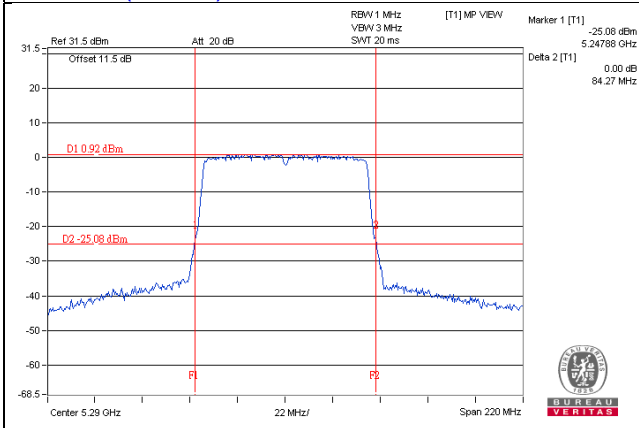

Radio 3

CDD Mode

802.11a

Chan.	Freq. (MHz)	26dBc Bandwidth (MHz)	Pass / Fail
52	5260	43.78	Pass
60	5300	44.73	Pass
64	5320	42.67	Pass
100	5500	37.81	Pass
116	5580	45.27	Pass
140	5700	29.75	Pass

802.11n (HT20)

Chan.	Freq. (MHz)	26dBc Bandwidth (MHz)	Pass / Fail
52	5260	46.53	Pass
60	5300	47.60	Pass
64	5320	45.26	Pass
100	5500	37.50	Pass
116	5580	48.36	Pass
140	5700	30.01	Pass

802.11n (HT40)

Chan.	Freq. (MHz)	26dBc Bandwidth (MHz)	Pass / Fail
54	5270	97.54	Pass
62	5310	56.85	Pass
102	5510	52.67	Pass
110	5550	93.01	Pass
134	5670	86.02	Pass

802.11ac (VHT80)

Chan.	Freq. (MHz)	26dBc Bandwidth (MHz)	Pass / Fail
58	5290	103.44	Pass
106	5530	100.95	Pass



BUREAU VERITAS

Spectrum Plot of Worst Value

802.11a

802.11n (HT20)

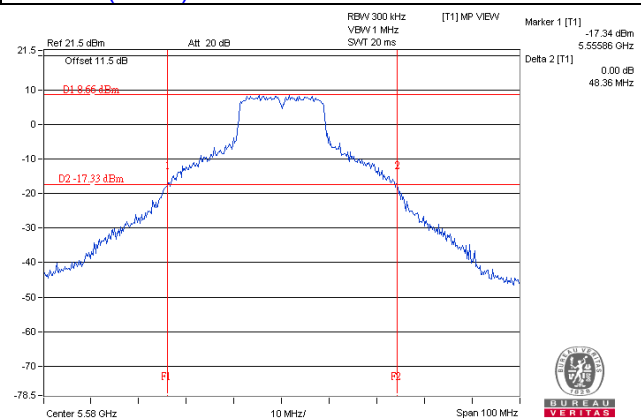
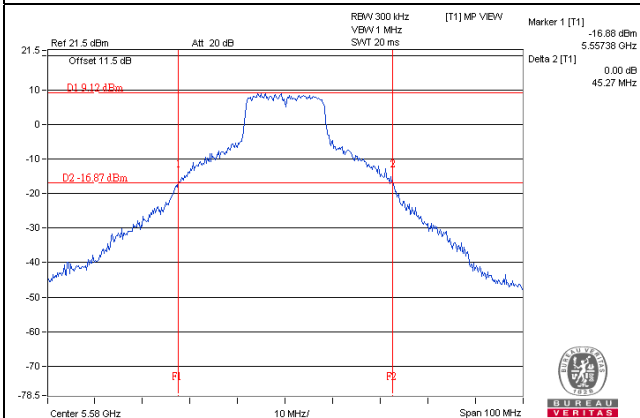

802.11n (HT40)

802.11ac (VHT80)

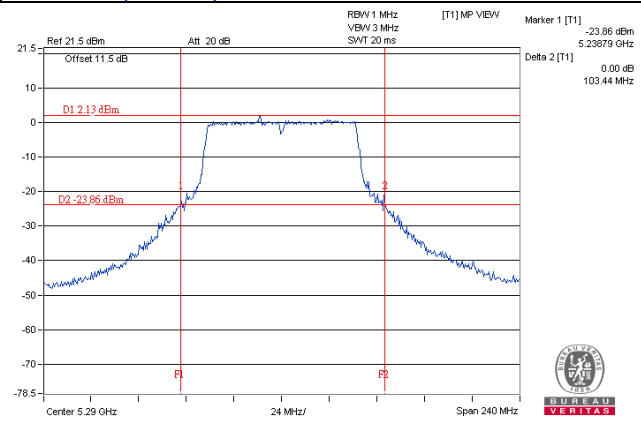
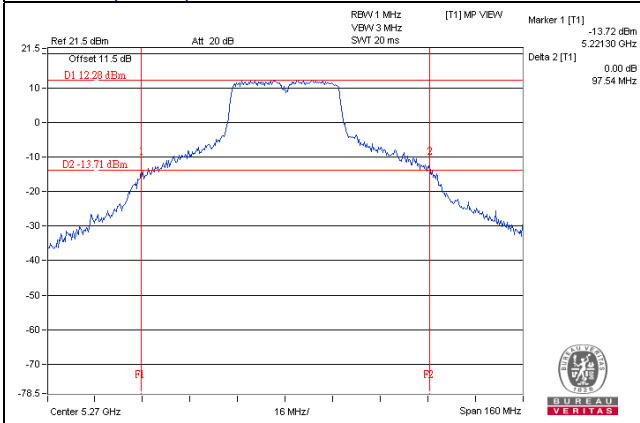

OCCUPIED BANDWIDTH:
Radio 2
CDD Mode
802.11a

Chan.	Freq. (MHz)	Occupied Bandwidth (MHz)	
		Chain 0	Chain 1
52	5260	22.44 (Note)	20.40 (Note)
60	5300	20.52	19.08
64	5320	16.44	16.68
100	5500	16.68	16.68
116	5580	27.60	24.60
140	5700	17.04	16.92

Note: Refer to next page for spectral power density plot

802.11n (HT20)

Chan.	Freq. (MHz)	Occupied Bandwidth (MHz)	
		Chain 0	Chain 1
52	5260	23.40 (Note)	21.48 (Note)
60	5300	21.72	19.80
64	5320	17.76	17.76
100	5500	17.76	17.64
116	5580	28.92	26.16
140	5700	17.64	17.64

Note: Refer to next page for spectral power density plot

802.11n (HT40)

Chan.	Freq. (MHz)	Occupied Bandwidth (MHz)	
		Chain 0	Chain 1
54	5270	39.84	38.04
62	5310	36.12	36.24
102	5510	36.12	36.24
110	5550	44.64	41.64
134	5670	36.84	36.72



BUREAU VERITAS

802.11ac (VHT80)

Chan.	Freq. (MHz)	Occupied Bandwidth (MHz)	
		Chain 0	Chain 1
58	5290	75.60	75.88
106	5530	75.88	75.60

Spectrum Plot of Worst Value

802.11a

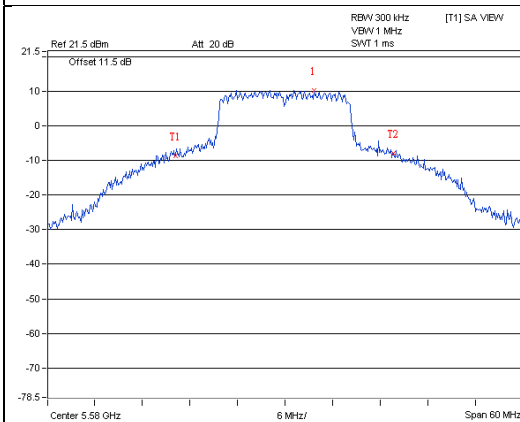

802.11n (HT20)

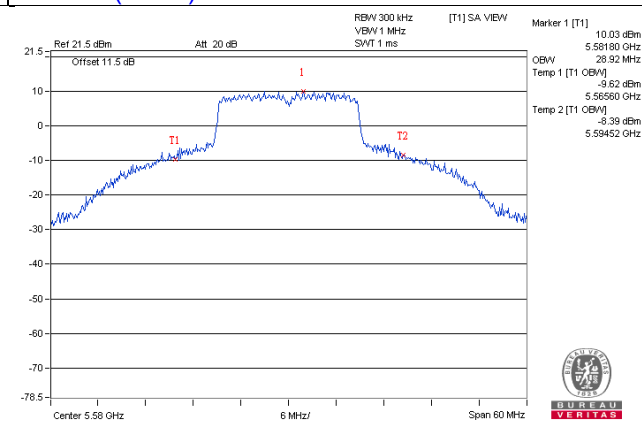

802.11n (HT40)

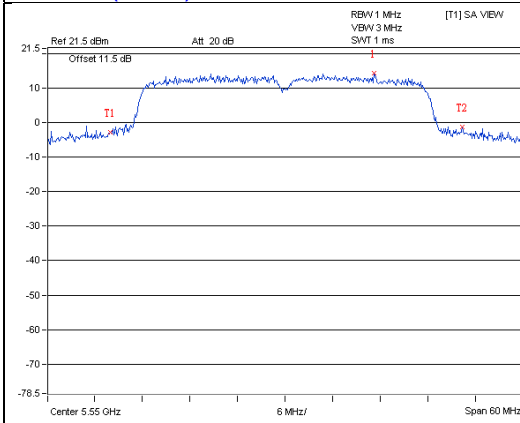

802.11ac (VHT80)

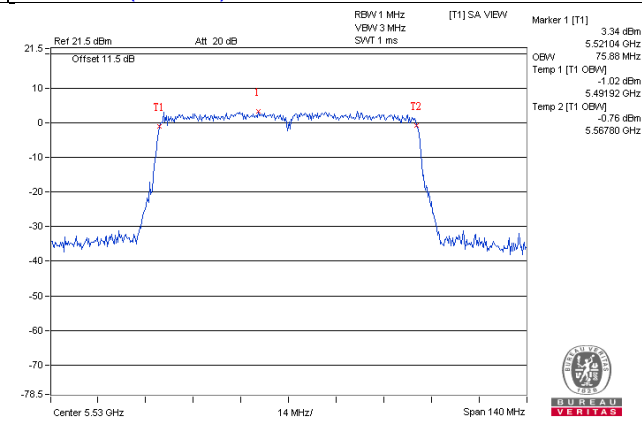



The spectral power density for operation within the band 5150-5250 MHz.

802.11a / Chain 0

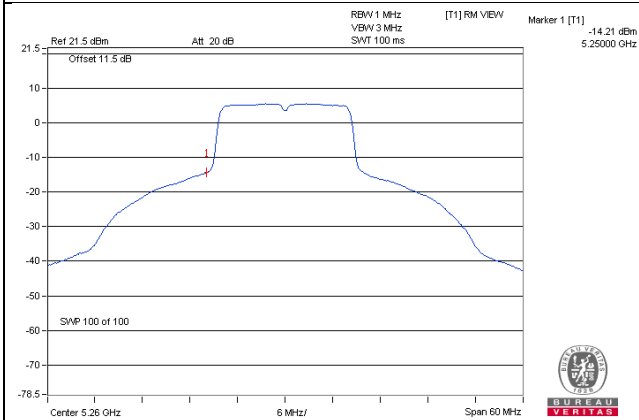

802.11a / Chain 1

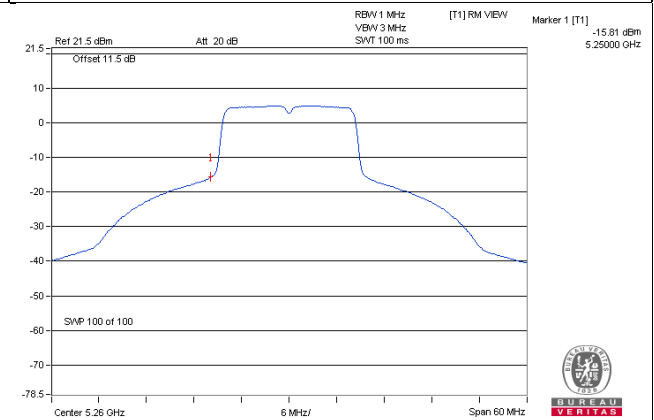

802.11n (HT20) / Chain 0

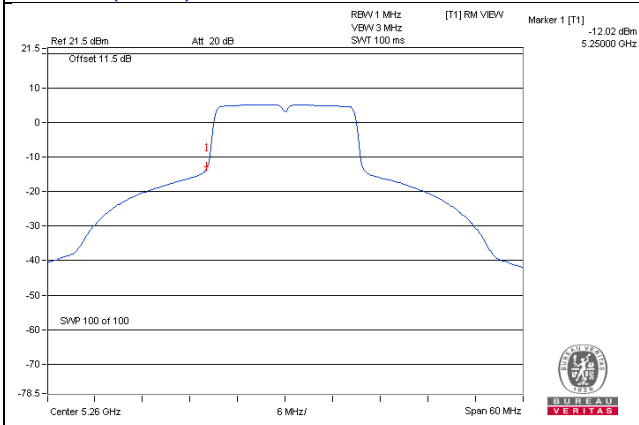

802.11n (HT20) / Chain 1

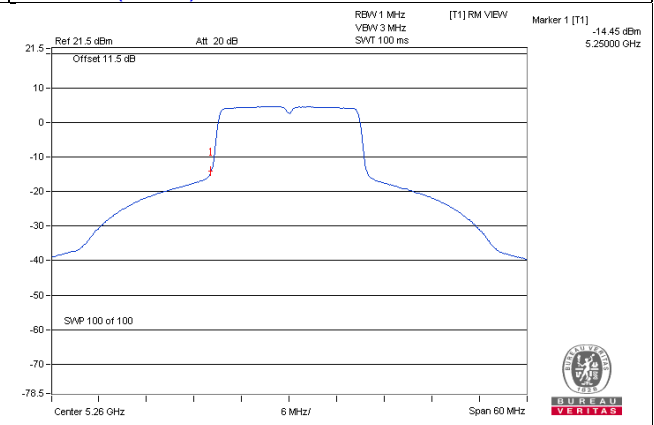

Beamforming Mode

802.11ac (VHT20)

Chan.	Freq. (MHz)	Occupied Bandwidth (MHz)	
		Chain 0	Chain 1
52	5260	19.80	21.12 (Note)
60	5300	18.36	19.44
64	5320	17.76	17.76
100	5500	17.76	17.76
116	5580	24.84	26.40
140	5700	17.64	17.64

Note: Refer to next page for spectral power density plot

802.11ac (VHT40)

Chan.	Freq. (MHz)	Occupied Bandwidth (MHz)	
		Chain 0	Chain 1
54	5270	38.16	39.00
62	5310	36.24	36.36
102	5510	36.36	36.36
110	5550	42.12	44.16
134	5670	36.48	36.36

802.11ac (VHT80)

Chan.	Freq. (MHz)	Occupied Bandwidth (MHz)	
		Chain 0	Chain 1
58	5290	75.84	75.84
106	5530	75.84	75.84



BUREAU VERITAS

Spectrum Plot of Worst Value

802.11ac (VHT20)

802.11ac (VHT40)

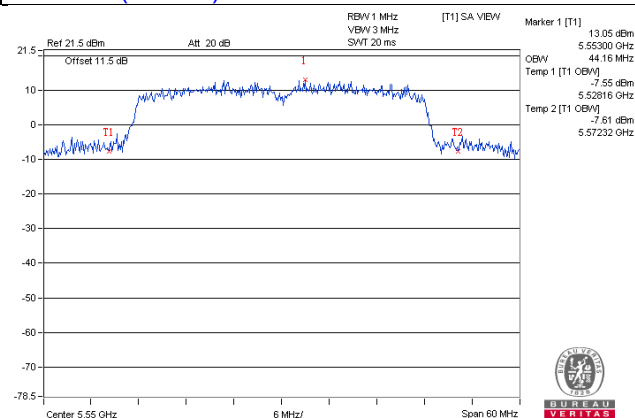
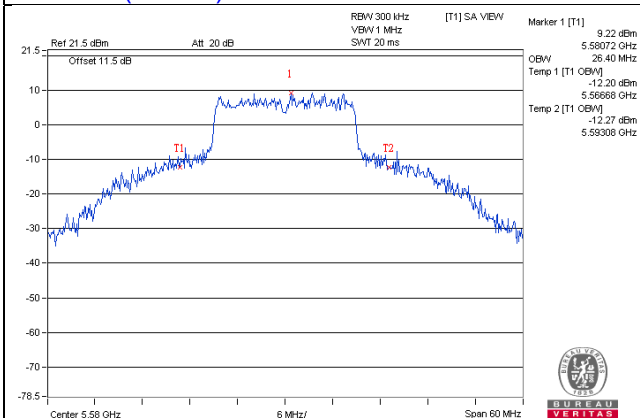

802.11ac (VHT80)

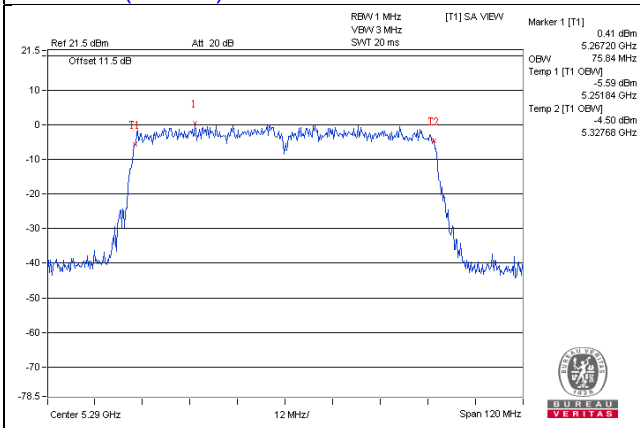

The spectral power density for operation within the band 5150-5250 MHz.

802.11ac (VHT20) / Chain 1

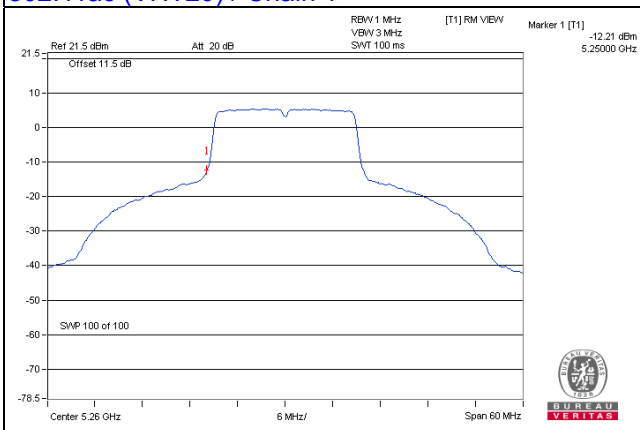

Radio 3

CDD Mode

802.11a

Chan.	Freq. (MHz)	Occupied Bandwidth (MHz)
52	5260	27.12 (Note)
60	5300	27.60
64	5320	25.44
100	5500	21.96
116	5580	29.64
140	5700	18.12

Note: Refer to next page for spectral power density plot

802.11n (HT20)

Chan.	Freq. (MHz)	Occupied Bandwidth (MHz)
52	5260	28.08 (Note)
60	5300	28.56
64	5320	26.28
100	5500	21.48
116	5580	30.48
140	5700	18.60

Note: Refer to next page for spectral power density plot

802.11n (HT40)

Chan.	Freq. (MHz)	Occupied Bandwidth (MHz)
54	5270	41.04 (Note)
62	5310	37.68
102	5510	37.32
110	5550	41.52
134	5670	38.88

Note: Refer to next page for spectral power density plot

802.11ac (VHT80)

Chan.	Freq. (MHz)	Occupied Bandwidth (MHz)
58	5290	76.44
106	5530	76.16



Spectrum Plot of Worst Value

802.11a

802.11n (HT20)

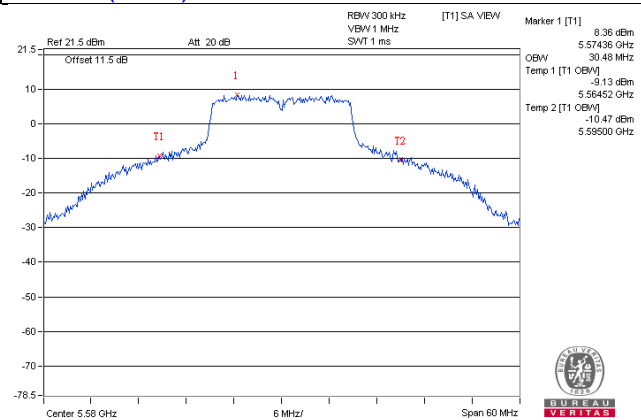
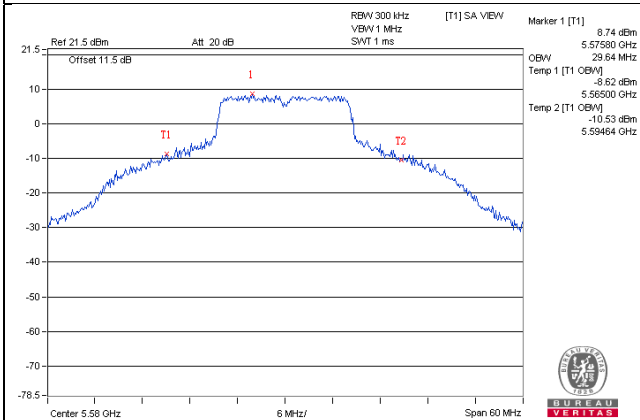

802.11n (HT40)

802.11ac (VHT80)

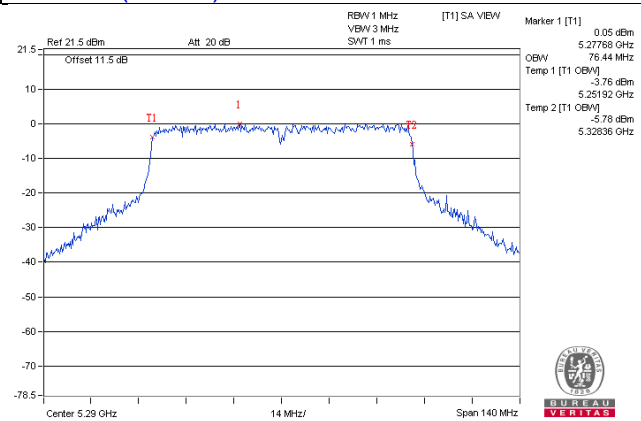
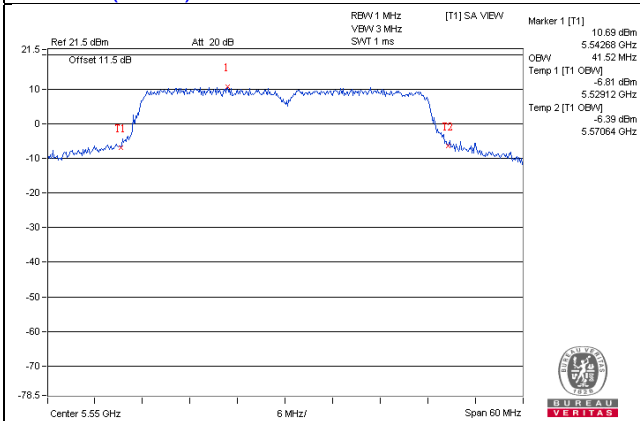



The spectral power density for operation within the band 5150-5250 MHz.

802.11a

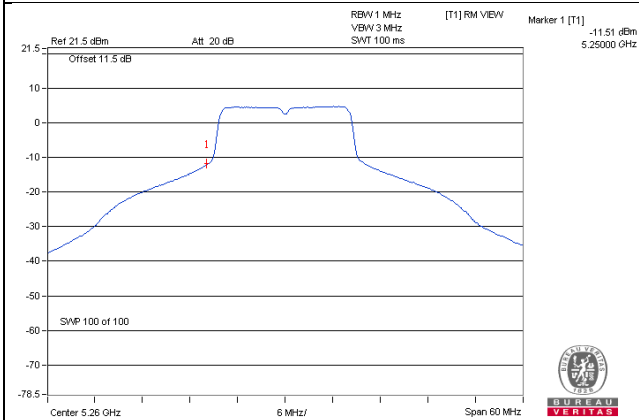

802.11n (HT20)

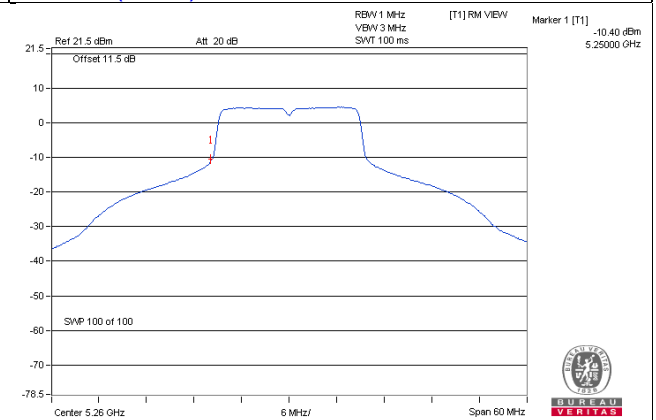

802.11n (HT40)

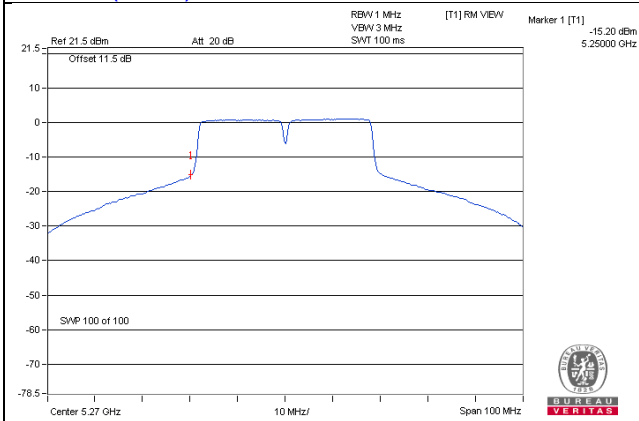

EUT MAXIMUM CONDUCTED POWER

Radio 2

CDD Mode

802.11a

Frequency Band (MHz)	Max. Power	
	Output Power (mW)	Output Power (dBm)
5250~5350	160.957	22.07
5470~5725	151.832	21.81

Note: Manufacturer provides Transmit Power Control description to meet this requirement.

802.11n (HT20)

Frequency Band (MHz)	Max. Power	
	Output Power (mW)	Output Power (dBm)
5250~5350	158.511	22.00
5470~5725	154.759	21.90

Note: Manufacturer provides Transmit Power Control description to meet this requirement.

802.11n (HT40)

Frequency Band (MHz)	Max. Power	
	Output Power (mW)	Output Power (dBm)
5250~5350	188.182	22.75
5470~5725	175.218	22.44

Note: Manufacturer provides Transmit Power Control description to meet this requirement.

802.11ac (VHT80)

Frequency Band (MHz)	Max. Power	
	Output Power (mW)	Output Power (dBm)
5250~5350	37.759	15.77
5470~5725	38.243	15.83

Note: Manufacturer provides Transmit Power Control description to meet this requirement.

Beamforming Mode

802.11ac (VHT20)

Frequency Band (MHz)	Max. Power	
	Output Power (mW)	Output Power (dBm)
5250~5350	153.694	21.87
5470~5725	152.997	21.85

Note: Manufacturer provides Transmit Power Control description to meet this requirement.

802.11ac (VHT40)

Frequency Band (MHz)	Max. Power	
	Output Power (mW)	Output Power (dBm)
5250~5350	154.738	21.90
5470~5725	156.340	21.94

Note: Manufacturer provides Transmit Power Control description to meet this requirement.

802.11ac (VHT80)

Frequency Band (MHz)	Max. Power	
	Output Power (mW)	Output Power (dBm)
5250~5350	20.002	13.01
5470~5725	27.011	14.32

Note: Manufacturer provides Transmit Power Control description to meet this requirement.

Radio 3

CDD Mode

802.11a

Frequency Band (MHz)	Max. Power	
	Output Power (mW)	Output Power (dBm)
5250~5350	69.823	18.44
5470~5725	56.885	17.55

Note: Manufacturer provides Transmit Power Control description to meet this requirement.

802.11n (HT20)

Frequency Band (MHz)	Max. Power	
	Output Power (mW)	Output Power (dBm)
5250~5350	67.453	18.29
5470~5725	57.280	17.58

Note: Manufacturer provides Transmit Power Control description to meet this requirement.

802.11n (HT40)

Frequency Band (MHz)	Max. Power	
	Output Power (mW)	Output Power (dBm)
5250~5350	65.615	18.17
5470~5725	48.978	16.90

Note: Manufacturer provides Transmit Power Control description to meet this requirement.

802.11ac (VHT80)

Frequency Band (MHz)	Max. Power	
	Output Power (mW)	Output Power (dBm)
5250~5350	8.831	9.46
5470~5725	6.039	7.81

Note: Manufacturer provides Transmit Power Control description to meet this requirement.

4.4 Peak Power Spectral Density Measurement

4.4.1 Limits of Peak Power Spectral Density Measurement

Operation Band	EUT Category		LIMIT
U-NII-1	-	Outdoor Access Point	17dBm/ MHz
	-	Fixed point-to-point Access Point	
	-	Indoor Access Point	
	-	Mobile and Portable client device	11dBm/ MHz
U-NII-2A	√		11dBm/ MHz
U-NII-2C	√		11dBm/ MHz
U-NII-3	-		30dBm/ 500kHz

4.4.2 Test Setup

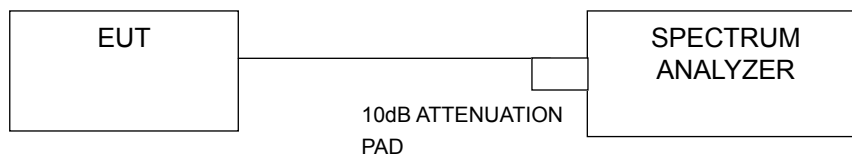

4.4.3 Test Instruments

Refer to section 4.1.2 to get information of above instrument.

4.4.4 Test Procedures

Using method SA-2

- Set span to encompass the entire emission bandwidth (EBW) of the signal.
- Set RBW = 1 MHz, Set VBW \geq 3 MHz, Detector = RMS
- Sweep time = auto, trigger set to "free run".
- Trace average at least 100 traces in power averaging mode.
- Record the max value and add 10 log (1/duty cycle)

4.4.5 Deviation from Test Standard

No deviation.

4.4.6 EUT Operating Conditions

Same as Item 4.3.6.

4.4.7 Test Results

Radio 2

CDD Mode

802.11a

Chan.	Freq. (MHz)	PSD (dBm)		Total PSD w/o duty factor (dBm)	Duty factor	Total PSD with duty factor (dBm)	Max. Limit (dBm)	Pass / Fail
		Chain 0	Chain 1					
52	5260	5.55	4.89	8.24	0.18	8.42	9.13	Pass
60	5300	5.56	4.98	8.29	0.18	8.47	9.13	Pass
64	5320	2.86	2.71	5.80	0.18	5.98	9.13	Pass
100	5500	3.07	2.68	5.89	0.18	6.07	9.13	Pass
116	5580	5.34	4.90	8.14	0.18	8.32	9.13	Pass
140	5700	2.49	2.09	5.31	0.18	5.49	9.13	Pass

Note:

- Method 1 of power density measurement of KDB 662911 is using for calculating total power density. Total power density is summing entire spectra across corresponding frequency bins on the various outputs by computer.
- Directional gain = $10 \log[(10^{G1/20} + 10^{G2/20} + \dots + 10^{GN/20})^2/2] = 7.87\text{dBi} > 6\text{dBi}$, so the power density limit shall be reduced to $11 - (7.87 - 6) = 9.13\text{dBm}$.
- Refer to section 3.3 for duty cycle spectrum plot.

802.11n (HT20)

Chan.	Freq. (MHz)	PSD (dBm)		Total PSD w/o duty factor (dBm)	Duty factor	Total PSD with duty factor (dBm)	Max. Limit (dBm)	Pass / Fail
		Chain 0	Chain 1					
52	5260	5.24	4.62	7.95	0.09	8.04	9.13	Pass
60	5300	5.22	4.77	8.01	0.09	8.10	9.13	Pass
64	5320	2.56	2.33	5.46	0.09	5.55	9.13	Pass
100	5500	2.06	2.27	5.18	0.09	5.27	9.13	Pass
116	5580	5.24	4.64	7.96	0.09	8.05	9.13	Pass
140	5700	0.64	0.11	3.40	0.09	3.49	9.13	Pass

Note:

- Method 1 of power density measurement of KDB 662911 is using for calculating total power density. Total power density is summing entire spectra across corresponding frequency bins on the various outputs by computer.
- Directional gain = $10 \log[(10^{G1/20} + 10^{G2/20} + \dots + 10^{GN/20})^2/2] = 7.87\text{dBi} > 6\text{dBi}$, so the power density limit shall be reduced to $11 - (7.87 - 6) = 9.13\text{dBm}$.

802.11n (HT40)

Chan.	Freq. (MHz)	PSD (dBm)		Total PSD w/o duty factor (dBm)	Duty factor	Total PSD with duty factor (dBm)	Max. Limit (dBm)	Pass / Fail
		Chain 0	Chain 1					
54	5270	3.31	2.63	6.00	0.17	6.17	9.13	Pass
62	5310	-2.63	-3.20	0.11	0.17	0.28	9.13	Pass
102	5510	-2.79	-2.75	0.24	0.17	0.41	9.13	Pass
110	5550	3.19	2.75	5.99	0.17	6.16	9.13	Pass
134	5670	0.34	-0.11	3.13	0.17	3.30	9.13	Pass

Note:

- Method 1 of power density measurement of KDB 662911 is using for calculating total power density. Total power density is summing entire spectra across corresponding frequency bins on the various outputs by computer.
- Directional gain = $10 \log[(10^{G1/20} + 10^{G2/20} + \dots + 10^{GN/20})^2/2] = 7.87\text{dBi} > 6\text{dBi}$, so the power density limit shall be reduced to $11 - (7.87 - 6) = 9.13\text{dBm}$.
- Refer to section 3.3 for duty cycle spectrum plot.

802.11ac (VHT80)

Chan.	Freq. (MHz)	PSD (dBm)		Total PSD w/o duty factor (dBm)	Duty factor	Total PSD with duty factor (dBm)	Max. Limit (dBm)	Pass / Fail
		Chain 0	Chain 1					
58	5290	-7.32	-7.91	-4.60	0.35	-4.25	9.13	Pass
106	5530	-7.04	-6.96	-3.99	0.35	-3.64	9.13	Pass

Note:

- Method 1 of power density measurement of KDB 662911 is using for calculating total power density. Total power density is summing entire spectra across corresponding frequency bins on the various outputs by computer.
- Directional gain = $10 \log[(10^{G1/20} + 10^{G2/20} + \dots + 10^{GN/20})^2/2] = 7.87\text{dBi} > 6\text{dBi}$, so the power density limit shall be reduced to $11 - (7.87 - 6) = 9.13\text{dBm}$.
- Refer to section 3.3 for duty cycle spectrum plot.

Spectrum Plot of Worst Value

802.11a / Ch 60 / Chain 0

802.11n (HT20) / Ch 52 / Chain 0

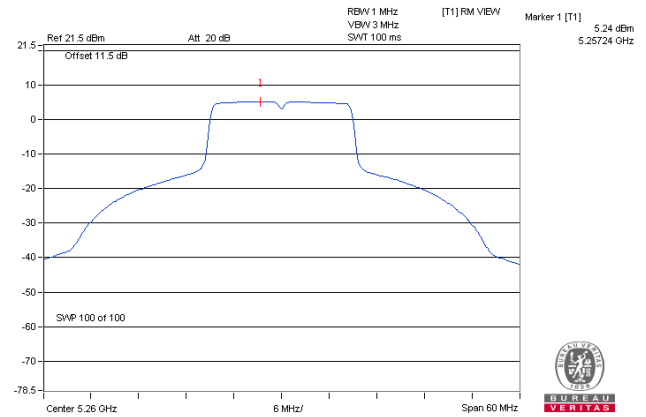
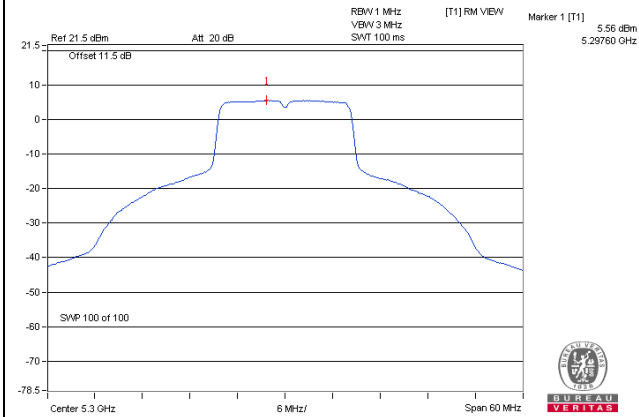

802.11n (HT40) / Ch 110 / Chain 0

802.11ac (VHT80) / Ch 106 / Chain 1

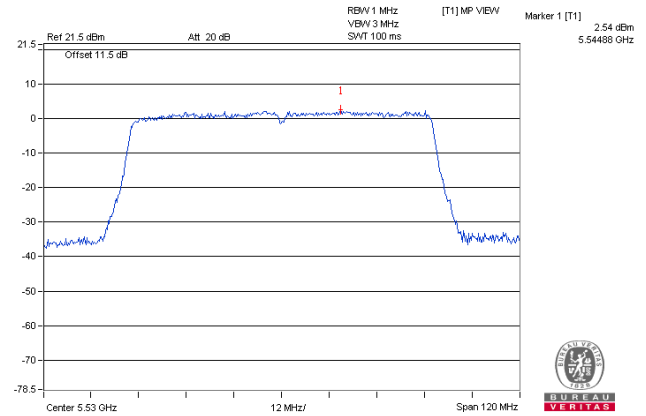
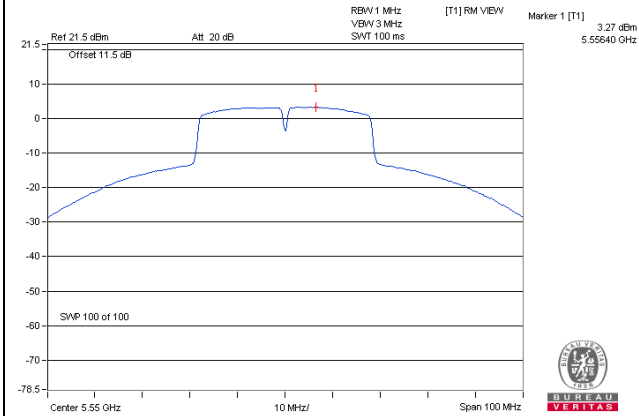



Beamforming Mode

802.11ac (VHT20)

Chan.	Freq. (MHz)	PSD (dBm)		Total PSD w/o duty factor (dBm)	Duty factor	Total PSD with duty factor (dBm)	Max. Limit (dBm)	Pass / Fail
		Chain 0	Chain 1					
52	5260	5.66	5.43	8.56	0.10	8.66	9.13	Pass
60	5300	5.53	5.17	8.37	0.10	8.47	9.13	Pass
64	5320	3.07	2.48	5.80	0.10	5.90	9.13	Pass
100	5500	1.81	0.97	4.42	0.10	4.52	9.13	Pass
116	5580	5.38	4.49	7.97	0.10	8.07	9.13	Pass
140	5700	0.94	0.13	3.57	0.10	3.67	9.13	Pass

Note:

1. Method 1 of power density measurement of KDB 662911 is using for calculating total power density. Total power density is summing entire spectra across corresponding frequency bins on the various outputs by computer.
2. Directional gain = $10 \log[(10^{G1/20} + 10^{G2/20} + \dots + 10^{GN/20})^2/2] = 7.87\text{dBi} > 6\text{dBi}$, so the power density limit shall be reduced to $11-(7.87-6) = 9.13\text{dBm}$.

802.11ac (VHT40)

Chan.	Freq. (MHz)	PSD (dBm)		Total PSD w/o duty factor (dBm)	Duty factor	Total PSD with duty factor (dBm)	Max. Limit (dBm)	Pass / Fail
		Chain 0	Chain 1					
54	5270	3.43	3.42	6.43	0.16	6.59	9.13	Pass
62	5310	-4.57	-4.81	-1.68	0.16	-1.52	9.13	Pass
102	5510	-4.90	-5.49	-2.18	0.16	-2.02	9.13	Pass
110	5550	3.20	2.46	5.86	0.16	6.02	9.13	Pass
134	5670	-1.96	-3.00	0.56	0.16	0.72	9.13	Pass

Note:

1. Method 1 of power density measurement of KDB 662911 is using for calculating total power density. Total power density is summing entire spectra across corresponding frequency bins on the various outputs by computer.
2. Directional gain = $10 \log[(10^{G1/20} + 10^{G2/20} + \dots + 10^{GN/20})^2/2] = 7.87\text{dBi} > 6\text{dBi}$, so the power density limit shall be reduced to $11-(7.87-6) = 9.13\text{dBm}$.
3. Refer to section 3.3 for duty cycle spectrum plot.



802.11ac (VHT80)

Chan.	Freq. (MHz)	PSD (dBm)		Total PSD w/o duty factor (dBm)	Duty factor	Total PSD with duty factor (dBm)	Max. Limit (dBm)	Pass / Fail
		Chain 0	Chain 1					
58	5290	-9.92	-10.34	-7.11	0.31	-6.80	9.13	Pass
106	5530	-9.24	-10.27	-6.71	0.31	-6.40	9.13	Pass

Note:

- Method 1 of power density measurement of KDB 662911 is using for calculating total power density. Total power density is summing entire spectra across corresponding frequency bins on the various outputs by computer.
- Directional gain = $10 \log[(10^{G1/20} + 10^{G2/20} + \dots + 10^{GN/20})^2/2] = 7.87 \text{dBi} > 6 \text{dBi}$, so the power density limit shall be reduced to $11 - (7.87 - 6) = 9.13 \text{dBm}$.
- Refer to section 3.3 for duty cycle spectrum plot.

Spectrum Plot of Worst Value

802.11ac (VHT20) / Ch 52 / Chain 0

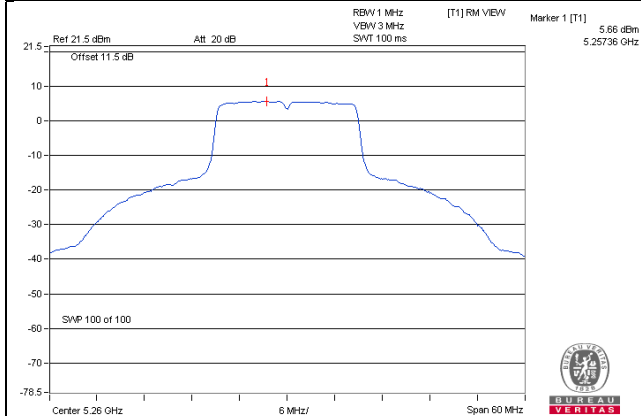

802.11ac (VHT40) / Ch 54 / Chain 0

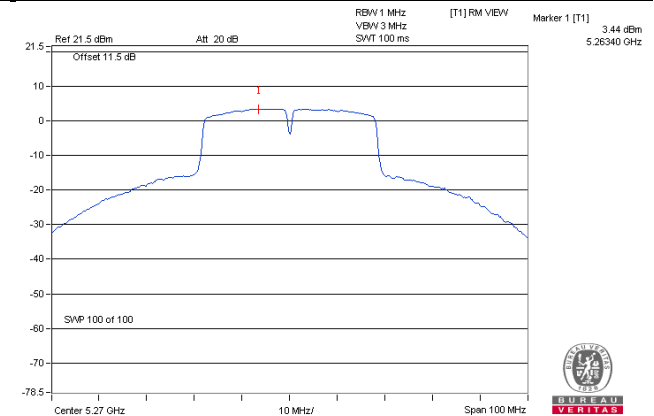

802.11ac (VHT80) / Ch 106 / Chain 0

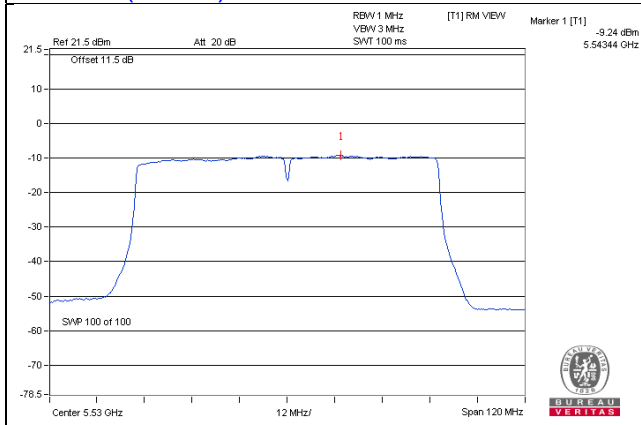

Radio 3

CDD Mode

802.11a

Chan.	Freq. (MHz)	PSD w/o duty factor (dBm)	Duty factor	PSD with duty factor (dBm)	Max. Limit (dBm)	Pass / Fail
52	5260	4.77	0.21	4.98	11.00	Pass
60	5300	4.22	0.21	4.43	11.00	Pass
64	5320	3.57	0.21	3.78	11.00	Pass
100	5500	1.39	0.21	1.60	11.00	Pass
116	5580	3.92	0.21	4.13	11.00	Pass
140	5700	1.17	0.21	1.38	11.00	Pass

802.11n (HT20)

Chan.	Freq. (MHz)	PSD w/o duty factor (dBm)	Duty factor	PSD with duty factor (dBm)	Max. Limit (dBm)	Pass / Fail
52	5260	4.55	0.16	4.71	11.00	Pass
60	5300	4.01	0.16	4.17	11.00	Pass
64	5320	3.23	0.16	3.39	11.00	Pass
100	5500	0.73	0.16	0.89	11.00	Pass
116	5580	3.62	0.16	3.78	11.00	Pass
140	5700	0.39	0.16	0.55	11.00	Pass

802.11n (HT40)

Chan.	Freq. (MHz)	PSD w/o duty factor (dBm)	Duty factor	PSD with duty factor (dBm)	Max. Limit (dBm)	Pass / Fail
54	5270	1.15	0.41	1.55	11.00	Pass
62	5310	-3.91	0.41	-3.51	11.00	Pass
102	5510	-6.53	0.41	-6.13	11.00	Pass
110	5550	-0.29	0.41	0.11	11.00	Pass
134	5670	0.00	0.41	0.40	11.00	Pass

802.11ac (VHT80)

Chan.	Freq. (MHz)	PSD w/o duty factor (dBm)	Duty factor	PSD with duty factor (dBm)	Max. Limit (dBm)	Pass / Fail
58	5290	-10.33	0.83	-9.50	11.00	Pass
106	5530	-12.05	0.83	-11.22	11.00	Pass



BUREAU
VERITAS

Spectrum Plot of Worst Value

802.11a / Ch 52

802.11n (HT20) / Ch 52

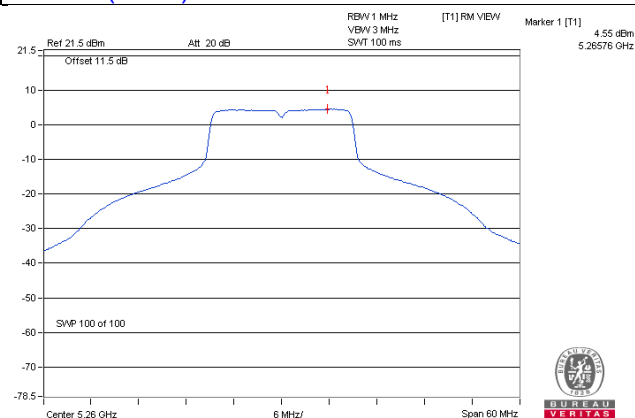
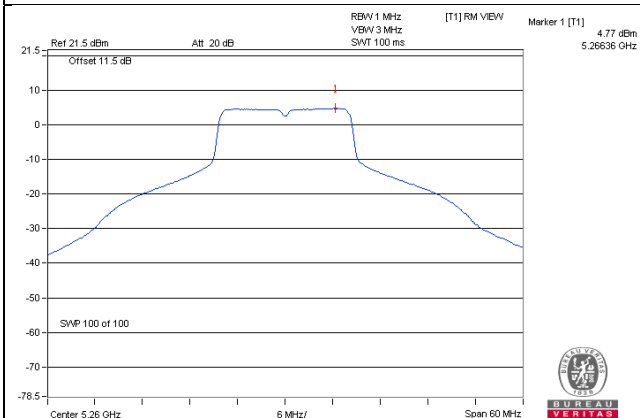

802.11n (HT40) / Ch 54

802.11ac (VHT80) / Ch 58

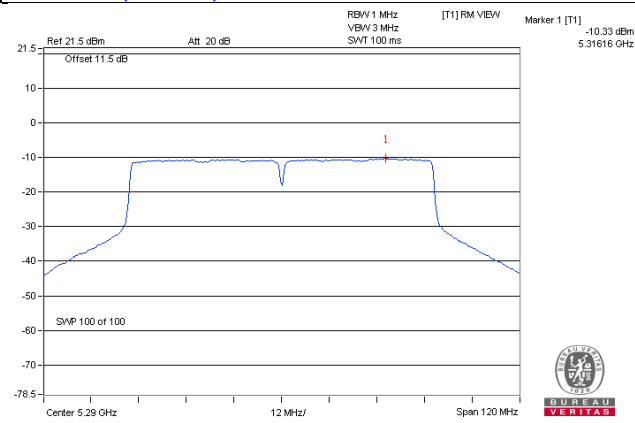
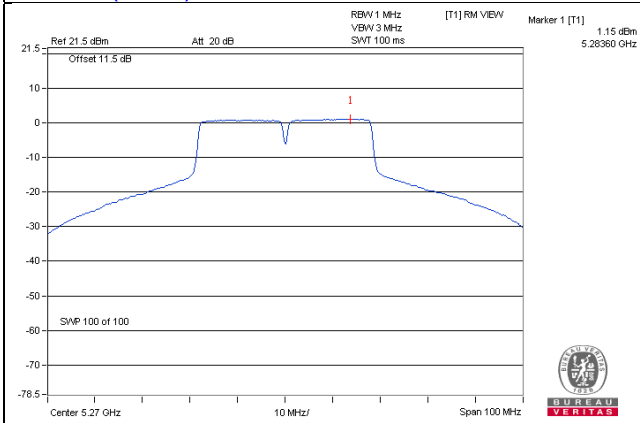

4.5 Frequency Stability

4.5.1 Limits of Frequency Stability Measurement

The frequency of the carrier signal shall be maintained within band of operation

4.5.2 Test Setup

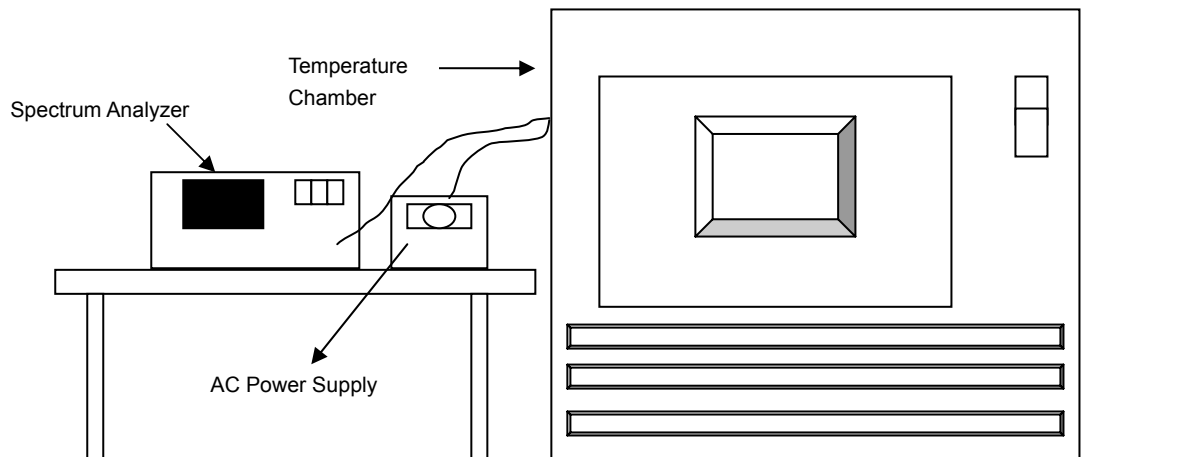

4.5.3 Test Instruments

Refer to section 4.1.2 to get information of above instrument.

4.5.4 Test Procedure

- The EUT was placed inside the environmental test chamber and powered by nominal AC voltage.
- Turn the EUT on and couple its output to a spectrum analyzer.
- Turn the EUT off and set the chamber to the highest temperature specified.
- Allow sufficient time (approximately 30 min) for the temperature of the chamber to stabilize, turn the EUT on and measure the operating frequency after 2, 5, and 10 minutes.
- Repeat step 2 and 3 with the temperature chamber set to the lowest temperature.
- The test chamber was allowed to stabilize at +20 degree C for a minimum of 30 minutes. The supply voltage was then adjusted on the EUT from 85% to 115% and the frequency record.

4.5.5 Deviation from Test Standard

No deviation.

4.5.6 EUT Operating Condition

Set the EUT transmit at un-modulation mode to test frequency stability.

4.5.7 Test Results

Radio 2

CDD Mode

Frequency Stability Versus Temp.									
Operating Frequency: 5320MHz									
Temp. (°C)	Power Supply (Vac)	0 Minute		2 Minute		5 Minute		10 Minute	
		Measured Frequency (MHz)	Frequency Drift (%)	Measured Frequency (MHz)	Frequency Drift (%)	Measured Frequency (MHz)	Frequency Drift (%)	Measured Frequency (MHz)	Frequency Drift (%)
50	120	5319.9935	-0.00012	5319.9954	-0.00009	5319.9944	-0.00011	5319.9907	-0.00017
40	120	5320.0086	0.00016	5320.0079	0.00015	5320.0061	0.00011	5320.0060	0.00011
30	120	5319.9751	-0.00047	5319.9761	-0.00045	5319.9764	-0.00044	5319.9760	-0.00045
20	120	5319.9894	-0.00020	5319.9893	-0.00020	5319.9875	-0.00023	5319.9891	-0.00020
10	120	5320.0027	0.00005	5320.0023	0.00004	5319.9993	-0.00001	5320.0012	0.00002
0	120	5319.9892	-0.00020	5319.9905	-0.00018	5319.9874	-0.00024	5319.9874	-0.00024
-10	120	5319.9844	-0.00029	5319.9883	-0.00022	5319.9854	-0.00027	5319.9883	-0.00022
-20	120	5320.0135	0.00025	5320.0140	0.00026	5320.0168	0.00032	5320.0130	0.00024
-30	120	5319.9828	-0.00032	5319.9823	-0.00033	5319.9810	-0.00036	5319.9851	-0.00028

Frequency Stability Versus Voltage									
Operating Frequency: 5320MHz									
Temp. (°C)	Power Supply (Vac)	0 Minute		2 Minute		5 Minute		10 Minute	
		Measured Frequency (MHz)	Frequency Drift (%)	Measured Frequency (MHz)	Frequency Drift (%)	Measured Frequency (MHz)	Frequency Drift (%)	Measured Frequency (MHz)	Frequency Drift (%)
20	138	5319.9886	-0.00021	5319.9903	-0.00018	5319.9884	-0.00022	5319.9895	-0.00020
	120	5319.9894	-0.00020	5319.9893	-0.00020	5319.9875	-0.00023	5319.9891	-0.00020
	102	5319.9889	-0.00021	5319.9883	-0.00022	5319.9869	-0.00025	5319.9892	-0.00020

Radio 3

CDD Mode

802.11a

Frequency Stability Versus Temp.									
Operating Frequency: 5320MHz									
Temp. (°C)	Power Supply (Vac)	0 Minute		2 Minute		5 Minute		10 Minute	
		Measured Frequency (MHz)	Frequency Drift (%)	Measured Frequency (MHz)	Frequency Drift (%)	Measured Frequency (MHz)	Frequency Drift (%)	Measured Frequency (MHz)	Frequency Drift (%)
50	120	5319.9789	-0.00040	5319.9758	-0.00045	5319.9783	-0.00041	5319.9788	-0.00040
40	120	5320.0087	0.00016	5320.0120	0.00023	5320.0072	0.00014	5320.0115	0.00022
30	120	5319.9936	-0.00012	5319.9930	-0.00013	5319.9958	-0.00008	5319.9967	-0.00006
20	120	5319.9977	-0.00004	5319.9971	-0.00005	5319.9990	-0.00002	5319.9955	-0.00008
10	120	5320.0077	0.00014	5320.0039	0.00007	5320.0043	0.00008	5320.0074	0.00014
0	120	5320.0077	0.00014	5320.0072	0.00014	5320.0090	0.00017	5320.0072	0.00014
-10	120	5320.0086	0.00016	5320.0076	0.00014	5320.0058	0.00011	5320.0052	0.00010
-20	120	5320.0000	0.00000	5320.0037	0.00007	5320.0022	0.00004	5320.0019	0.00004
-30	120	5319.9803	-0.00037	5319.9795	-0.00039	5319.9785	-0.00040	5319.9796	-0.00038

Frequency Stability Versus Voltage									
Operating Frequency: 5320MHz									
Temp. (°C)	Power Supply (Vac)	0 Minute		2 Minute		5 Minute		10 Minute	
		Measured Frequency (MHz)	Frequency Drift (%)	Measured Frequency (MHz)	Frequency Drift (%)	Measured Frequency (MHz)	Frequency Drift (%)	Measured Frequency (MHz)	Frequency Drift (%)
20	138	5319.9986	-0.00003	5319.9971	-0.00005	5319.9985	-0.00003	5319.9956	-0.00008
	120	5319.9977	-0.00004	5319.9971	-0.00005	5319.9990	-0.00002	5319.9955	-0.00008
	102	5319.9973	-0.00005	5319.9969	-0.00006	5319.9982	-0.00003	5319.9965	-0.00007

5 Pictures of Test Arrangements

Please refer to the attached file (Test Setup Photo).

Appendix – Information on the Testing Laboratories

We, Bureau Veritas Consumer Products Services (H.K.) Ltd., Taoyuan Branch, were founded in 1988 to provide our best service in EMC, Radio, Telecom and Safety consultation. Our laboratories are accredited and approved according to ISO/IEC 17025.

If you have any comments, please feel free to contact us at the following:

Linko EMC/RF Lab

Tel: 886-2-26052180

Fax: 886-2-26051924

Hsin Chu EMC/RF/Telecom Lab

Tel: 886-3-6668565

Fax: 886-3-6668323

Hwa Ya EMC/RF/Safety

Tel: 886-3-3183232

Fax: 886-3-3270892

Email: service.adt@tw.bureauveritas.com

Web Site: www.bureauveritas-adt.com

The address and road map of all our labs can be found in our web site also.

--- END ---