



# SPORTON International Inc.

No. 52, Hwa Ya 1st Rd., Hwa Ya Technology Park, Kwei-Shan Hsiang, Tao Yuan Hsien, Taiwan, R.O.C.  
Ph: 886-3-327-3456 / FAX: 886-3-327-0973 / www.sporton.com.tw

## FCC RADIO TEST REPORT

Applicant's company	Cisco Systems, Inc.
Applicant Address	170 West Tasman Drive San Jose, CA 95134 USA
FCC ID	UDX-60042010
Manufacturer's company	Accton Technology Corporation
Manufacturer Address	1, Creation Road 3, Hsinchu Science Park Hsinchu 20077, Taiwan R.O.C.

Product Name	802.11a/b/g/n/ac Wireless Access Point
Brand Name	CISCO
Model No.	MR53-HW
Test Rule Part(s)	47 CFR FCC Part 15 Subpart C § 15.247
Test Freq. Range	2400 ~ 2483.5MHz
Received Date	Aug. 31, 2015
Final Test Date	Dec. 27, 2015
Submission Type	Original Equipment

### Statement

**Test result included is only for the IEEE 802.11b/g, IEEE 802.11n and IEEE 802.11ac of the product.**

The test result in this report refers exclusively to the presented test model / sample.

Without written approval of SPORTON International Inc., the test report shall not be reproduced except in full.

The measurements and test results shown in this test report were made in accordance with the procedures and found in compliance with the limit given in **ANSI C63.10-2013, 47 CFR FCC Part 15 Subpart C, KDB558074 D01 v03r05, KDB 662911 D01 v02r01.**

The test equipment used to perform the test is calibrated and traceable to NML/ROC.





## Table of Contents

<b>1. VERIFICATION OF COMPLIANCE</b> .....	<b>1</b>
<b>2. SUMMARY OF THE TEST RESULT</b> .....	<b>2</b>
<b>3. GENERAL INFORMATION</b> .....	<b>3</b>
3.1. Product Details.....	3
3.2. Accessories.....	6
3.3. Table for Filed Antenna.....	7
3.4. Table for Carrier Frequencies .....	10
3.5. Table for Test Modes.....	11
3.6. Table for Testing Locations.....	16
3.7. Table for Supporting Units .....	17
3.8. Table for Parameters of Test Software Setting .....	18
3.9. EUT Operation during Test .....	19
3.10. Duty Cycle.....	20
3.11. Test Configurations .....	21
<b>4. TEST RESULT</b> .....	<b>25</b>
4.1. AC Power Line Conducted Emissions Measurement.....	25
4.2. Maximum Conducted Output Power Measurement.....	29
4.3. Power Spectral Density Measurement .....	35
4.4. 6dB Spectrum Bandwidth Measurement .....	69
4.5. Radiated Emissions Measurement .....	126
4.6. Emissions Measurement .....	228
4.7. Antenna Requirements .....	358
<b>5. LIST OF MEASURING EQUIPMENTS</b> .....	<b>359</b>
<b>6. MEASUREMENT UNCERTAINTY</b> .....	<b>361</b>
<b>APPENDIX A. TEST PHOTOS</b> .....	<b>A1 ~ A5</b>
<b>APPENDIX B. RADIATED EMISSION CO-LOCATION REPORT</b> .....	<b>B1 ~ B5</b>



## History of This Test Report

REPORT NO.	VERSION	DESCRIPTION	ISSUED DATE
FR590419-03AA	Rev. 01	Initial issue of report	Mar. 04, 2016



## 1. VERIFICATION OF COMPLIANCE

Product Name : 802.11 a/b/g/n/ac Wireless Access Point  
Brand Name : CISCO  
Model No. : MR53-HW  
Applicant : Cisco Systems, Inc.  
Test Rule Part(s) : 47 CFR FCC Part 15 Subpart C § 15.247

Sporton International as requested by the applicant to evaluate the EMC performance of the product sample received on Aug. 31, 2015 would like to declare that the tested sample has been evaluated and found to be in compliance with the tested rule parts. The data recorded as well as the test configuration specified is true and accurate for showing the sample's EMC nature.

A handwritten signature in blue ink that reads 'Sam Chen'. The signature is written in a cursive style and is positioned above a horizontal line.

Sam Chen

SPORTON INTERNATIONAL INC.

## 2. SUMMARY OF THE TEST RESULT

Applied Standard: 47 CFR FCC Part 15 Subpart C				
Part	Rule Section	Description of Test	Result	Under Limit
4.1	15.207	AC Power Line Conducted Emissions	Complies	10.58 dB
4.2	15.247(b)(3)	Maximum Conducted Output Power	Complies	0.2 dB
4.3	15.247(e)	Power Spectral Density	Complies	4.94 dB
4.4	15.247(a)(2)	6dB Spectrum Bandwidth	Complies	-
4.5	15.247(d)	Radiated Emissions	Complies	0.27 dB
4.6	15.247(d)	Band Edge Emissions	Complies	0.02 dB
4.7	15.203	Antenna Requirements	Complies	-

### 3. GENERAL INFORMATION

#### 3.1. Product Details

Items	Description
Product Type	For Radio 1: WLAN (4TX, 4RX) For Radio 3: WLAN (1TX, 1RX)
Radio Type	Intentional Transceiver
Power Type	From power adapter or PoE
Modulation	IEEE 802.11b: DSSS IEEE 802.11g: OFDM IEEE 802.11n/ac: see the below table
Data Modulation	IEEE 802.11b: DSSS (BPSK / QPSK / CCK) IEEE 802.11g/n: OFDM (BPSK / QPSK / 16QAM / 64QAM) IEEE 802.11ac: OFDM (BPSK / QPSK / 16QAM / 64QAM / 256QAM)
Data Rate (Mbps)	IEEE 802.11b: DSSS (1/ 2/ 5.5/11) IEEE 802.11g: OFDM (6/9/12/18/24/36/48/54) IEEE 802.11n/ac: see the below table
Frequency Range	2400 ~ 2483.5MHz
Channel Number	11 for 20MHz bandwidth ; 7 for 40MHz bandwidth

Note: The MIMO transmission mode is correlated.

<p>Channel Band Width (99%)</p>	<p><b>&lt;For Radio 1 Non-beamforming Mode&gt;</b></p> <p>IEEE 802.11b: 14.33 MHz</p> <p>IEEE 802.11g: 22.92 MHz</p> <p>IEEE 802.11ac MCS0/Nss1 (VHT20): 18.93 MHz</p> <p>IEEE 802.11ac MCS0/Nss1 (VHT40): 36.90 MHz</p> <p>IEEE 802.11ac MCS0/Nss4 (VHT20): 19.97 MHz</p> <p>IEEE 802.11ac MCS0/Nss4 (VHT40): 40.67 MHz</p> <p><b>&lt;For Radio 1 Beamforming Mode&gt;</b></p> <p>IEEE 802.11ac MCS0/Nss1 (VHT20): 22.14 MHz</p> <p>IEEE 802.11ac MCS0/Nss1 (VHT40): 36.76 MHz</p> <p>IEEE 802.11ac MCS0/Nss2 (VHT20): 38.21 MHz</p> <p>IEEE 802.11ac MCS0/Nss2 (VHT40): 36.76 MHz</p> <p>IEEE 802.11ac MCS0/Nss3 (VHT20): 22.05 MHz</p> <p>IEEE 802.11ac MCS0/Nss3 (VHT40): 37.19 MHz</p> <p><b>&lt;For Radio 3 Mode&gt;</b></p> <p>IEEE 802.11b: 16.06 MHz</p> <p>IEEE 802.11g: 27.44 MHz</p> <p>IEEE 802.11ac MCS0/Nss1 (VHT20): 26.31 MHz</p> <p>IEEE 802.11ac MCS0/Nss1 (VHT40): 37.05 MHz</p>
---------------------------------	--

Maximum Conducted Output Power	<p><b>&lt;For Radio 1 Non-beamforming Mode&gt;</b></p> <p>IEEE 802.11b: 29.80 dBm          IEEE 802.11g: 28.64 dBm          IEEE 802.11ac MCS0/Nss1 (VHT20): 28.07 dBm          IEEE 802.11ac MCS0/Nss1 (VHT40): 21.47 dBm          IEEE 802.11ac MCS0/Nss4 (VHT20): 27.76 dBm          IEEE 802.11ac MCS0/Nss4 (VHT40): 21.51 dBm</p> <p><b>&lt;For Radio 1 Beamforming Mode&gt;</b></p> <p>IEEE 802.11ac MCS0/Nss1 (VHT20): 27.73 dBm          IEEE 802.11ac MCS0/Nss1 (VHT40): 20.12 dBm          IEEE 802.11ac MCS0/Nss2 (VHT20): 27.84 dBm          IEEE 802.11ac MCS0/Nss2 VHT40): 20.93 dBm          IEEE 802.11ac MCS0/Nss3 VHT20): 27.44 dBm          IEEE 802.11ac MCS0/Nss3 VHT40): 19.69 dBm</p> <p><b>&lt;For Radio 3 Mode&gt;</b></p> <p>IEEE 802.11b: 25.64 dBm          IEEE 802.11g: 24.33 dBm          IEEE 802.11ac MCS0/Nss1 (VHT20): 23.86 dBm          IEEE 802.11ac MCS0/Nss1 (VHT40): 18.16 dBm</p>
Carrier Frequencies	Please refer to section 3.4
Antenna	Please refer to section 3.3

Items	Description	
Beamforming Function	<input checked="" type="checkbox"/> With beamforming for 802.11n/ac in 2.4GHz /5GHz.	<input type="checkbox"/> Without beamforming



**Antenna and Band width**

Antenna	Single (TX)			Four (TX)		
	20 MHz	40 MHz	80 MHz	20 MHz	40 MHz	80 MHz
IEEE 802.11b	V	X	X	V	X	X
IEEE 802.11g	V	X	X	V	X	X
IEEE 802.11n	V	V	X	V	V	X
IEEE 802.11ac	V	V	V	V	V	V

**IEEE 802.11n/ac Spec.**

Protocol		Number of Transmit Chains (NTX)	Data Rate / MCS
Radio 1	802.11n (HT20)	4	MCS0-31
	802.11n (HT40)	4	MCS0-31
	802.11ac (VHT20)	4	MCS 0-9/Nss1-4
	802.11ac (VHT40)	4	MCS 0-9/Nss1-4
Radio 3	802.11n (HT20)	1	MCS0-7
	802.11n (HT40)	1	MCS0-7
	802.11ac (VHT20)	1	MCS 0-9/Nss1
	802.11ac (VHT40)	1	MCS 0-9/Nss1

Note 1: IEEE Std. 802.11n modulation consists of HT20 and HT40 (HT: High Throughput).  
Then EUT supports HT20 and HT40.

Note 2: IEEE Std. 802.11ac modulation consists of VHT20, VHT40, VHT80 and VHT160 (VHT: Very High Throughput). Then EUT supports VHT20, VHT40 in 2.4GHz.

Note 3: Modulation modes consist of below configuration:  
HT20/HT40: IEEE 802.11n, VHT20/VHT40: IEEE 802.11ac

**3.2. Accessories**

Wall-mounted rack\*1

### 3.3. Table for Filed Antenna

Radio	Ant.	Brand	P/N	Antenna Type	Connector	Gain		
						2.4GHz	5GHz	Bluetooth
Radio 1	1	Accton	120G00000132A	Metal	MHF	Note		-
	2	Accton	120G00000132A	Metal	MHF			
	3	Accton	120G00000132A	Metal	MHF			
	4	Accton	120G00000132A	Metal	MHF			
Radio 2	5	Accton	120G00000132A	Metal	MHF			
	6	Accton	120G00000132A	Metal	MHF			
	7	Accton	120G00000132A	Metal	MHF			
	8	Accton	120G00000132A	Metal	MHF			
Radio 3	9	Accton	120G00000134A	Metal	MHF	4.32	5.72	-
Radio 4	10	Accton	120G00000133A	Metal	MHF	-	-	4.99

Note:

<Radio 1 >

Ant.	Frequency (MHz)		
	2412, 2422	2437	2452, 2462
1	2.97	3.72	3.89
2	3.34	3.62	3.51
3	3.42	3.69	4.10
4	4.99	5.04	4.38

Frequency (MHz)	Correlated Composite Gain			Uncorrelated Composite Gain
	(4TX, 1S)	(4TX, 2S)	(4TX, 3S)	(4TX, 4S)
2412, 2422	7.15	4.43	2.67	1.42
2437	7.02	4.45	2.68	1.44
2452, 2462	6.87	4.44	2.68	1.43

**<Radio 2>**

Ant.	Band 1	Band 2	Band 3	Band 4
5	3.85	3.64	4.97	5.58
6	5.24	5.68	5.04	5.74
7	4.97	4.78	6.50	6.44
8	5.05	4.77	4.75	5.10

Band	Correlated Composite Gain			Uncorrelated Composite Gain
	(4TX, 1S)	(4TX, 2S)	(4TX, 3S)	(4TX, 4S)
1	6.97	4.94	3.18	1.93
2	5.47	4.14	2.38	1.13
3	7.11	4.69	2.93	1.68
4	10.05	7.16	5.40	4.15

Note: The EUT has ten antennas.

The EUT has four radios, Radio 1 supports WLAN 2.4GHz, Radio 2 supports WLAN 5GHz, Radio 3 supports WLAN 2.4GHz + 5GHz (scanning radio) and Radio 4 supports Bluetooth function.

**<For Radio 1 / 2.4GHz Function>**

Chain 1, Chain 2, Chain 3 and Chain 4 can be used as transmitting/receiving antenna.

Chain 1, Chain 2, Chain 3 and Chain 4 could transmit/receive simultaneously.

**<For Radio 2 / 5GHz Function>**

Chain 5, Chain 6, Chain 7 and Chain 8 can be used as transmitting/receiving antenna.

Chain 5, Chain 6, Chain 7 and Chain 8 could transmit/receive simultaneously.

**<<For Radio 3 Mode> / 2.4GHz + 5GHz Functions>**

Only Chain 9 could transmit/receive.

**<For Radio 4 / Bluetooth Functions>**

Only Chain 10 could transmit/receive.

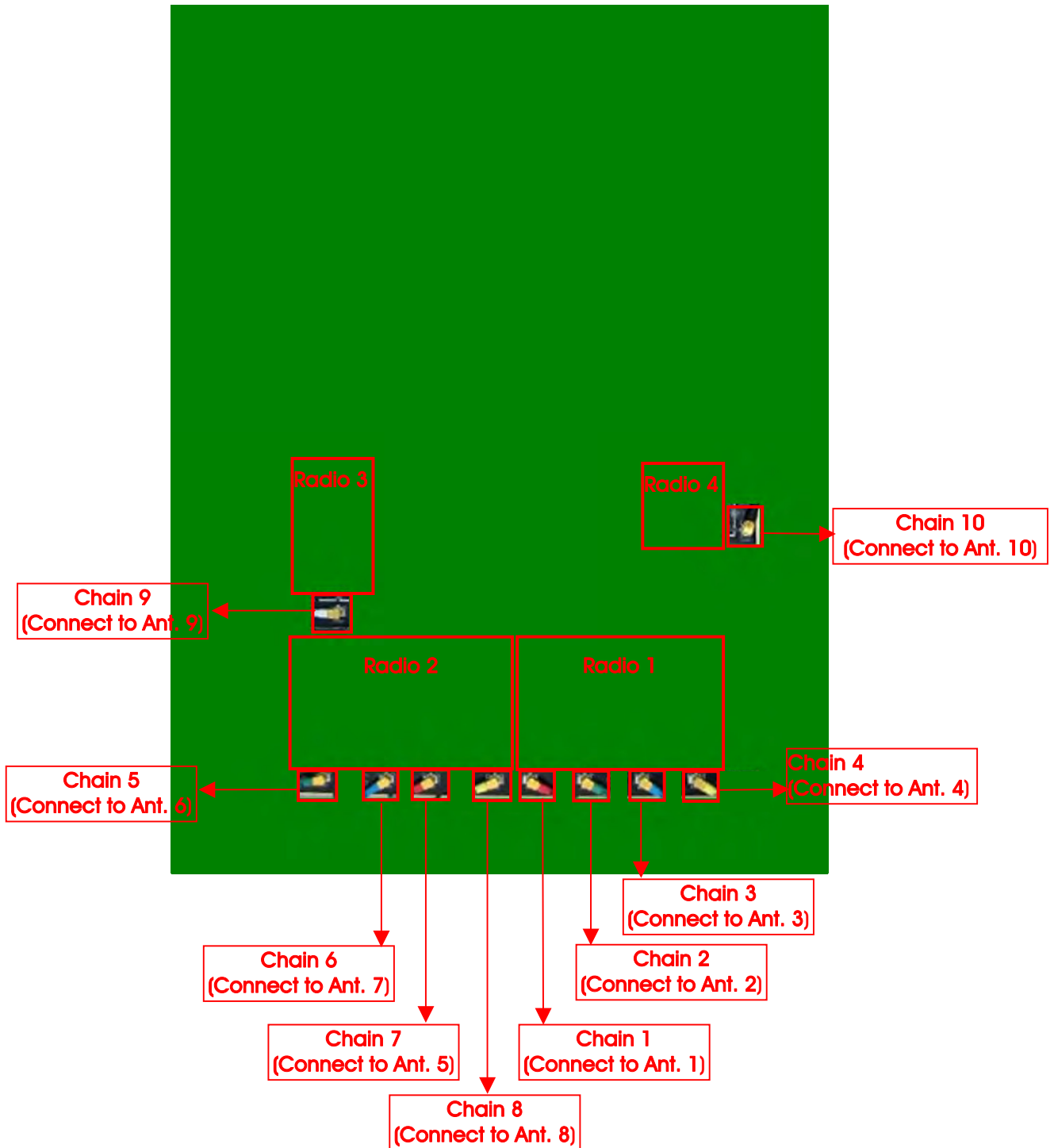

### 3.4. Table for Carrier Frequencies

There are two bandwidth systems.

For 20MHz bandwidth systems, use Channel 1~Channel 11.

For 40MHz bandwidth systems, use Channel 3~Channel 9.

Frequency Band	Channel No.	Frequency	Channel No.	Frequency
2400~2483.5MHz	1	2412 MHz	7	2442 MHz
	2	2417 MHz	8	2447 MHz
	3	2422 MHz	9	2452 MHz
	4	2427 MHz	10	2457 MHz
	5	2432 MHz	11	2462 MHz
	6	2437 MHz	-	-

### 3.5. Table for Test Modes

Preliminary tests were performed in different data rate to find the worst radiated emission. The data rate shown in the table below is the worst-case rate with respect to the specific test item. Investigation has been done on all the possible configurations for searching the worst cases. The following table is a list of the test modes shown in this test report.

#### For Radio 1:

Test Items	Mode	Data Rate	Channel	Chain
AC Power Line Conducted Emissions	Normal Link	-	-	-
Maximum Conducted Output Power	<b>&lt;For Non-Beamforming Mode&gt;</b>			
	11b/CCK	1 Mbps	1/6/11	1+2+3+4
	11g/BPSK	6 Mbps	1/6/11	1+2+3+4
	11ac VHT20	MCS0/Nss1	1/6/11	1+2+3+4
	11ac VHT40	MCS0/Nss1	3/6/9	1+2+3+4
	11ac VHT20	MCS0/Nss4	1/6/11	1+2+3+4
	11ac VHT40	MCS0/Nss4	3/6/9	1+2+3+4
	<b>&lt;For Beamforming Mode&gt;</b>			
	11ac VHT20	MCS0/Nss1	1/6/11	1+2+3+4
	11ac VHT40	MCS0/Nss1	3/6/9	1+2+3+4
	11ac VHT20	MCS0/Nss2	1/6/11	1+2+3+4
	11ac VHT40	MCS0/Nss2	3/6/9	1+2+3+4
	11ac VHT20	MCS0/Nss3	1/6/11	1+2+3+4
	11ac VHT40	MCS0/Nss3	3/6/9	1+2+3+4
Power Spectral Density	<b>&lt;For Non-Beamforming Mode&gt;</b>			
	11b/CCK	1 Mbps	1/6/11	1+2+3+4
	11g/BPSK	6 Mbps	1/6/11	1+2+3+4
	11ac VHT20	MCS0/Nss1	1/6/11	1+2+3+4
	11ac VHT40	MCS0/Nss1	3/6/9	1+2+3+4
	11ac VHT20	MCS0/Nss4	1/6/11	1+2+3+4
	11ac VHT40	MCS0/Nss4	3/6/9	1+2+3+4
	<b>&lt;For Beamforming Mode&gt;</b>			
	11ac VHT20	MCS0/Nss1	1/6/11	1+2+3+4
	11ac VHT40	MCS0/Nss1	3/6/9	1+2+3+4
	11ac VHT20	MCS0/Nss2	1/6/11	1+2+3+4
	11ac VHT40	MCS0/Nss2	3/6/9	1+2+3+4
	11ac VHT20	MCS0/Nss3	1/6/11	1+2+3+4
	11ac VHT40	MCS0/Nss3	3/6/9	1+2+3+4

6dB Spectrum Bandwidth	<b>&lt;For Non-Beamforming Mode&gt;</b>			
	11b/CCK	1 Mbps	1/6/11	1/2/3/4
	11g/BPSK	6 Mbps	1/6/11	1/2/3/4
	11ac VHT20	MCS0/Nss1	1/6/11	1/2/3/4
	11ac VHT40	MCS0/Nss1	3/6/9	1/2/3/4
	11ac VHT20	MCS0/Nss4	1/6/11	1/2/3/4
	11ac VHT40	MCS0/Nss4	3/6/9	1/2/3/4
	<b>&lt;For Beamforming Mode&gt;</b>			
	11ac VHT20	MCS0/Nss1	1/6/11	1/2/3/4
	11ac VHT40	MCS0/Nss1	3/6/9	1/2/3/4
	11ac VHT20	MCS0/Nss2	1/6/11	1/2/3/4
	11ac VHT40	MCS0/Nss2	3/6/9	1/2/3/4
	11ac VHT20	MCS0/Nss3	1/6/11	1/2/3/4
	11ac VHT40	MCS0/Nss3	3/6/9	1/2/3/4
Radiated Emissions Below 1GHz	Normal Link	-	-	-
Radiated Emissions Above 1GHz	<b>&lt;For Non-Beamforming Mode&gt;</b>			
	11b/CCK	1 Mbps	1/6/11	1+2+3+4
	11g/BPSK	6 Mbps	1/6/11	1+2+3+4
	11ac VHT20	MCS0/Nss1	1/6/11	1+2+3+4
	11ac VHT40	MCS0/Nss1	3/6/9	1+2+3+4
	11ac VHT20	MCS0/Nss4	1/6/11	1+2+3+4
	11ac VHT40	MCS0/Nss4	3/6/9	1+2+3+4
	<b>&lt;For Beamforming Mode&gt;</b>			
	11ac VHT20	MCS0/Nss1	1/6/11	1+2+3+4
	11ac VHT40	MCS0/Nss1	3/6/9	1+2+3+4
	11ac VHT20	MCS0/Nss2	1/6/11	1+2+3+4
	11ac VHT40	MCS0/Nss2	3/6/9	1+2+3+4
	11ac VHT20	MCS0/Nss3	1/6/11	1+2+3+4
	11ac VHT40	MCS0/Nss3	3/6/9	1+2+3+4

Band Edge Emissions	<b>&lt;For Non-Beamforming Mode&gt;</b>			
	11b/CCK	1 Mbps	1/6/11	1+2+3+4
	11g/BPSK	6 Mbps	1/6/11	1+2+3+4
	11ac VHT20	MCS0/Nss1	1/6/11	1+2+3+4
	11ac VHT40	MCS0/Nss1	3/6/9	1+2+3+4
	11ac VHT20	MCS0/Nss4	1/6/11	1+2+3+4
	11ac VHT40	MCS0/Nss4	3/6/9	1+2+3+4
	<b>&lt;For Beamforming Mode&gt;</b>			
	11ac VHT20	MCS0/Nss1	1/6/11	1+2+3+4
	11ac VHT40	MCS0/Nss1	3/6/9	1+2+3+4
	11ac VHT20	MCS0/Nss2	1/6/11	1+2+3+4
	11ac VHT40	MCS0/Nss2	3/6/9	1+2+3+4
	11ac VHT20	MCS0/Nss3	1/6/11	1+2+3+4
	11ac VHT40	MCS0/Nss3	3/6/9	1+2+3+4



## &lt;For Radio 3 Mode&gt;

Test Items	Mode	Data Rate	Channel	Chain
AC Power Line Conducted Emissions	Normal Link	-	-	-
Maximum Conducted Output Power	11b/CCK	1 Mbps	1/6/11	9
	11g/BPSK	6 Mbps	1/6/11	9
	11ac VHT20	MCS0/Nss1	1/6/11	9
	11ac VHT40	MCS0/Nss1	3/6/9	9
Power Spectral Density	11b/CCK	1 Mbps	1/6/11	9
	11g/BPSK	6 Mbps	1/6/11	9
	11ac VHT20	MCS0/Nss1	1/6/11	9
	11ac VHT40	MCS0/Nss1	3/6/9	9
6dB Spectrum Bandwidth	11b/CCK	1 Mbps	1/6/11	9
	11g/BPSK	6 Mbps	1/6/11	9
	11ac VHT20	MCS0/Nss1	1/6/11	9
	11ac VHT40	MCS0/Nss1	3/6/9	9
Radiated Emissions Below 1GHz	Normal Link	-	-	-
Radiated Emissions Above 1GHz	11b/CCK	1 Mbps	1/6/11	9
	11g/BPSK	6 Mbps	1/6/11	9
	11ac VHT20	MCS0/Nss1	1/6/11	9
	11ac VHT40	MCS0/Nss1	3/6/9	9
Band Edge Emissions	11b/CCK	1 Mbps	1/6/11	9
	11g/BPSK	6 Mbps	1/6/11	9
	11ac VHT20	MCS0/Nss1	1/6/11	9
	11ac VHT40	MCS0/Nss1	3/6/9	9

Note 1: VHT20/VHT40 covers HT20/HT40, due to same modulation. The power setting for 802.11n HT20 and HT40 are the same or lower than 802.11ac VHT20 and VHT40.

Note 2: There are two modes of EUT, one is beamforming mode, and the other is non-beamforming mode for 802.11n/ac. All test results were recorded in the report.

Note 3: Adapter and PoE information as below, and the Adapter and PoE are for measurement only, would not be marketed.

Power	Brand	Model
Adapter	ITE	MU30-5120250-A1
PoE	Motorola	PD-7001G

The following test modes were performed for all tests:

Conducted Emission test	
Mode	Description
1	Radio 1 (2.4GHz WLAN function) + Radio 2 (5GHz WLAN function) + Radio 3 (2.4GHz WLAN function) + Bluetooth with Adapter
2	Radio 1 (2.4GHz WLAN function) + Radio 2 (5GHz WLAN function) + Radio 3 (5GHz WLAN function) + Bluetooth with Adapter
Mode 1 generated the worst test result, so it was recorded in this report.	

Radiated Emission test<Below 1GHz>	
Mode	Description
1	Radio 1 (2.4GHz WLAN function) + Radio 2 (5GHz WLAN function) + Radio 3 (2.4GHz WLAN function) + Bluetooth with Adapter - Z axis
2	Radio 1 (2.4GHz WLAN function) + Radio 2 (5GHz WLAN function) + Radio 3 (2.4GHz WLAN function) + Bluetooth with Adapter - Y axis
Mode 2 has been evaluated to be the worst case among Mode 1~2, thus measurement for Mode 3 will follow this same test mode.	
3	Radio 1 (2.4GHz WLAN function) + Radio 2 (5GHz WLAN function) + Radio 3 (5GHz WLAN function) + Bluetooth with Adapter - Y axis
Mode 3 has been evaluated to be the worst case among Mode 1~3, thus measurement for Mode 4 will follow this same test mode.	
4	Radio 1 (2.4GHz WLAN function) + Radio 2 (5GHz WLAN function) + Radio 3 (5GHz WLAN function) + Bluetooth with PoE - Y axis
Mode 4 generated the worst test result, so it was recorded in this report.	

Radiated Emission test<Above 1GHz>	
The EUT was performed at X axis, Y axis and Z axis position for Radiated emission above 1GHz test, and the worst case was found at Y axis. So the measurement will follow this same test configuration.	
Mode	Description
1	CTX - Y axis

Co-location MPE and Radiated Emission Co-location Test	
Mode	Description
1	Radio 1 (2.4GHz WLAN function) + Radio 2 (5GHz WLAN function) + Radio 3 (2.4GHz WLAN function) + Bluetooth
2	Radio 1 (2.4GHz WLAN function) + Radio 2 (5GHz WLAN function) + Radio 3 (5GHz WLAN function) + Bluetooth

Therefore Co-location Maximum Permissible Exposure (Please refer to FA590419-03) and Radiated Emission Co-location (please refer to Appendix B) tests are added for simultaneously transmit.

### 3.6. Table for Testing Locations

Test Site Location				
Address:	No.8, Lane 724, Bo-ai St., Jhubei City, Hsinchu County 302, Taiwan, R.O.C.			
TEL:	886-3-656-9065			
FAX:	886-3-656-9085			
Test Site No.	Site Category	Location	FCC Reg. No.	IC File No.
03CH01-CB	SAC	Hsin Chu	262045	IC 4086D
CO01-CB	Conduction	Hsin Chu	262045	IC 4086D
TH01-CB	OVEN Room	Hsin Chu	-	-

Open Area Test Site (OATS); Semi Anechoic Chamber (SAC).

### 3.7. Table for Supporting Units

For Test Site No: 03CH01-CB (Below 1GHz)

Support Unit	Brand	Model	FCC ID
NB*4	DELL	E4300	DoC
NB*2	Apple	Mac Book	DoC
Bluetooth dongle	WPI	CC2540	DoC
Device	CISCO	MR53-HW	UDX-60042010
PoE	Motorola	PD-7001G	N/A

For Test Site No: 03CH01-CB (Above 1GHz)

<For Non-beamforming Mode>

Support Unit	Brand	Model	FCC ID
NB	DELL	E4300	DoC
PoE	Motorola	PD-7001G	DoC

<For Beamforming Mode>

Support Unit	Brand	Model	FCC ID
NB*2	DELL	E4300	DoC
PoE	Motorola	PD-7001G	DoC
RX Device	CISCO	MR52-HW	UDX-60041010

For Test Site No: CO01-CB

Support Unit	Brand	Model	FCC ID
NB*6	DELL	E6430	DoC
Bluetooth dongle	WPI	CC2540	DoC
Device	CISCO	MR53-HW	UDX-60042010
Adapter	ITE	MU30-5120250-A1	N/A

For Test Site No: TH01-CB

Support Unit	Brand	Model	FCC ID
NB	DELL	E4300	DoC
Adapter	ITE	MU30-5120250-A1	N/A

### 3.8. Table for Parameters of Test Software Setting

During testing, Channel and Power Controlling Software provided by the customer was used to control the operating channel as well as the output power level. The RF output power selection is for the setting of RF output power expected by the customer and is going to be fixed on the firmware of the final end product.

#### < For Radio 1 Non-beamforming Mode >

Test Software Version	QCAQML-QLIB V6190,QPHONEMS					
Mode	Test Frequency (MHz)					
	NCB: 20MHz			NCB: 40MHz		
	2412 MHz	2437 MHz	2462 MHz	2422 MHz	2437 MHz	2452 MHz
802.11b	20	22.5	21	-	-	-
802.11g	14	22	18	-	-	-
802.11ac MCS0/Nss1 VHT20	13	21.5	18	-	-	-
802.11ac MCS0/Nss1 VHT40	-	-	-	10	13.5	14
802.11ac MCS0/Nss4 VHT20	12.5	20.5	15	-	-	-
802.11ac MCS0/Nss4 VHT40	-	-	-	9.5	13	14

#### < For Radio 1 Beamforming Mode >

Test Software Version	QCAQML-QLIB V6190,QPHONEMS					
Mode	Test Frequency (MHz)					
	NCB: 20MHz			NCB: 40MHz		
	2412 MHz	2437 MHz	2462 MHz	2422 MHz	2437 MHz	2452 MHz
802.11ac MCS0/Nss1 VHT20	18	28	22	-	-	-
802.11ac MCS0/Nss1 VHT40	-	-	-	15	19	18
802.11ac MCS0/Nss2 VHT20	20	30	24	-	-	-
802.11ac MCS0/Nss2 VHT40	-	-	-	16	20	19
802.11ac MCS0/Nss3 VHT20	19	27	21	-	-	-
802.11ac MCS0/Nss3 VHT40	-	-	-	16	19	19

#### <For Radio 3 Mode >

Test Software Version	QCAQML-QLIB V6190,QPHONEMS					
Mode	Test Frequency (MHz)					
	NCB: 20MHz			NCB: 40MHz		
	2412 MHz	2437 MHz	2462 MHz	2422 MHz	2437 MHz	2452 MHz
802.11b	21.5	28	23.5	-	-	-
802.11g	18	25.5	19	-	-	-
802.11ac MCS0/Nss1 VHT20	17.5	25	18.5	-	-	-
802.11ac MCS0/Nss1 VHT40	-	-	-	12.5	19	15

### 3.9. EUT Operation during Test

#### <For Non-beamforming Mode>

The EUT was programmed to be in continuously transmitting mode.

#### <For Beamforming Mode>

For Conducted Mode:

The EUT was programmed to be in continuously transmitting mode.

For Radiated Mode:

During the test, the following programs under WIN XP were executed.

The program was executed as follows:

1. During the test, the EUT operation to normal function.
2. Executed command fixed test channel under DOS.
3. Executed "Lantest.exe " to link with the remote workstation to receive and transmit packet by RX Device and transmit duty cycle no less 98%

### 3.10. Duty Cycle

#### < For Radio 1 Non-beamforming Mode >

Mode	On Time (ms)	On+Off Time (ms)	Duty Cycle (%)	Duty Factor (dB)	1/T Minimum VBW (kHz)
802.11b	1.000	1.000	100.00%	0.00	0.01
802.11g	2.040	2.112	96.59%	0.15	0.49
11ac MCS0/Nss1 VHT20	4.992	5.056	98.73%	0.06	0.01
11ac MCS0/Nss1 VHT40	2.394	2.478	96.59%	0.15	0.42
11ac MCS0/Nss4 VHT20	4.980	5.060	98.42%	0.07	0.01
11ac MCS0/Nss4 VHT40	2.388	2.506	95.28%	0.21	0.42

#### < For Radio 1 Beamforming Mode >

Mode	On Time (ms)	On+Off Time (ms)	Duty Cycle (%)	Duty Factor (dB)	1/T Minimum VBW (kHz)
11ac MCS0/Nss1 VHT20	8.800	9.548	92.17%	0.35	0.11
11ac MCS0/Nss1 VHT40	1.650	1.850	89.19%	0.50	0.61
11ac MCS0/Nss2 VHT20	8.580	8.776	97.77%	0.10	0.12
11ac MCS0/Nss2 VHT40	1.657	1.867	88.75%	0.52	0.60
11ac MCS0/Nss3 VHT20	8.316	8.622	96.45%	0.16	0.12
11ac MCS0/Nss3 VHT40	1.674	1.872	89.42%	0.49	0.60

#### <For Radio 3 Mode>:

Mode	On Time (ms)	On+Off Time (ms)	Duty Cycle (%)	Duty Factor (dB)	1/T Minimum VBW (kHz)
802.11b	1.000	1.000	100.00%	0.00	0.01
802.11g	2.057	2.125	96.80%	0.14	0.49
11ac MCS0/Nss1 VHT20	1.932	2.006	96.31%	0.16	0.52
11ac MCS0/Nss1 VHT40	0.936	1.010	92.67%	0.33	1.07

### 3.11. Test Configurations

#### 3.11.1. AC Power Line Conduction Emissions Test Configuration

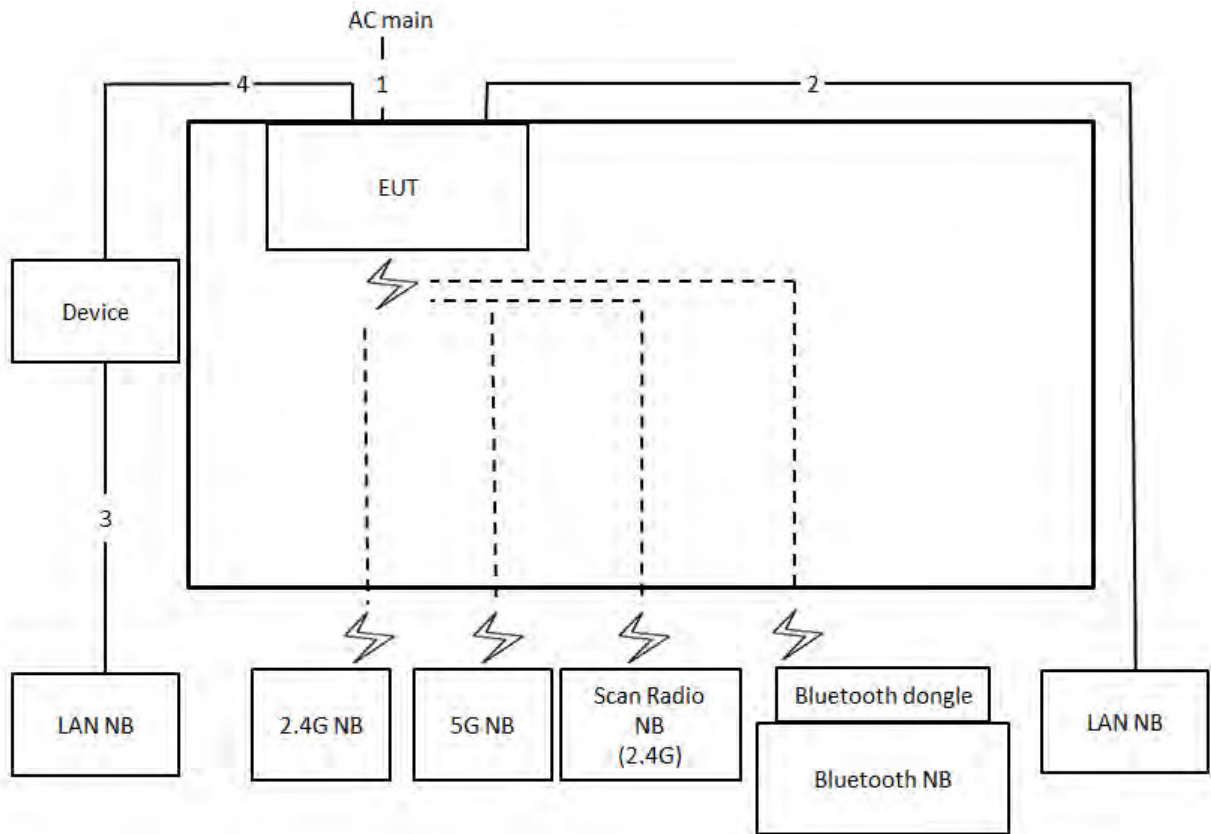

Item	Connection	Shielded	Length
1	Power cable	No	1.5m
2	RJ-45 cable	No	10m
3	RJ-45 cable	No	10m
4	RJ-45 cable	No	1.5m



### 3.11.2. Radiation Emissions Test Configuration

Test Configuration: 30MHz~1GHz

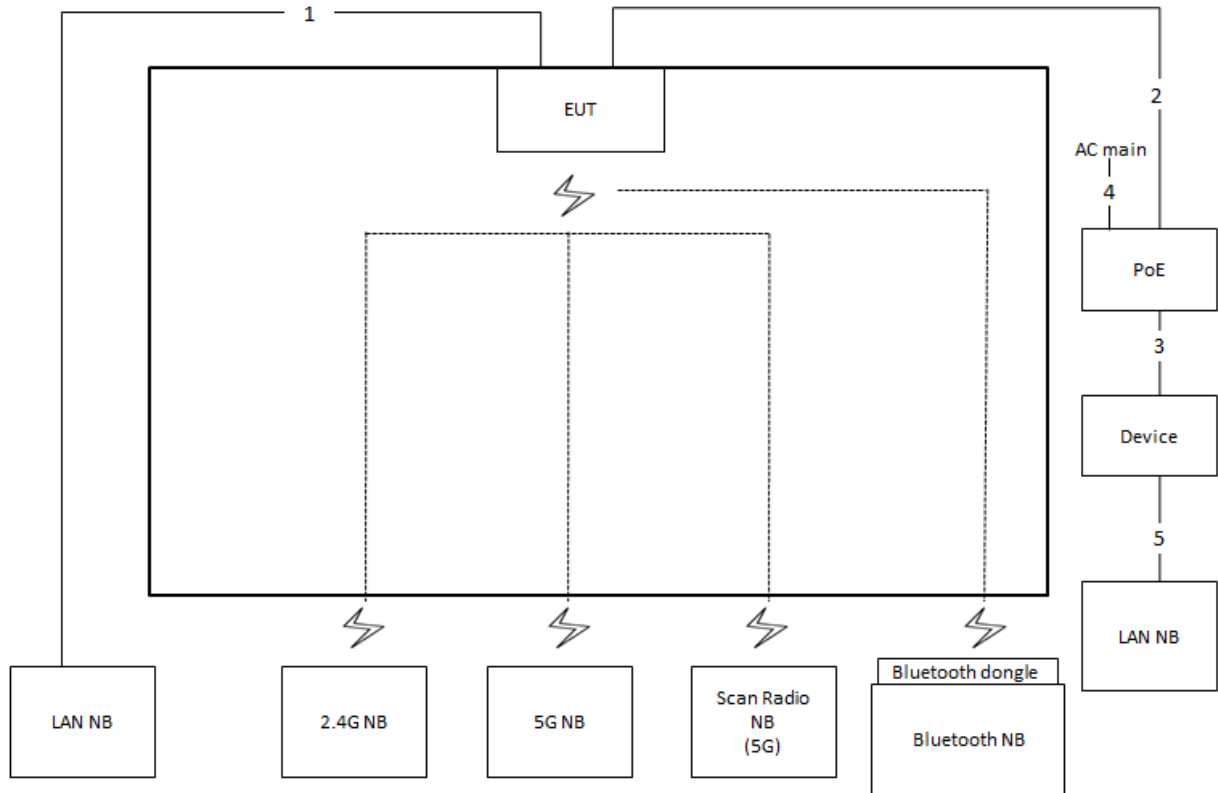

Item	Connection	Shielded	Length
1	RJ-45 cable	No	10m
2	RJ-45 cable	No	10m
3	RJ-45 cable	No	1.5m
4	Power cable	No	1.8m
5	RJ-45 cable	No	1.5m

Test Configuration: above 1GHz  
 <For Non-Beamforming Mode>

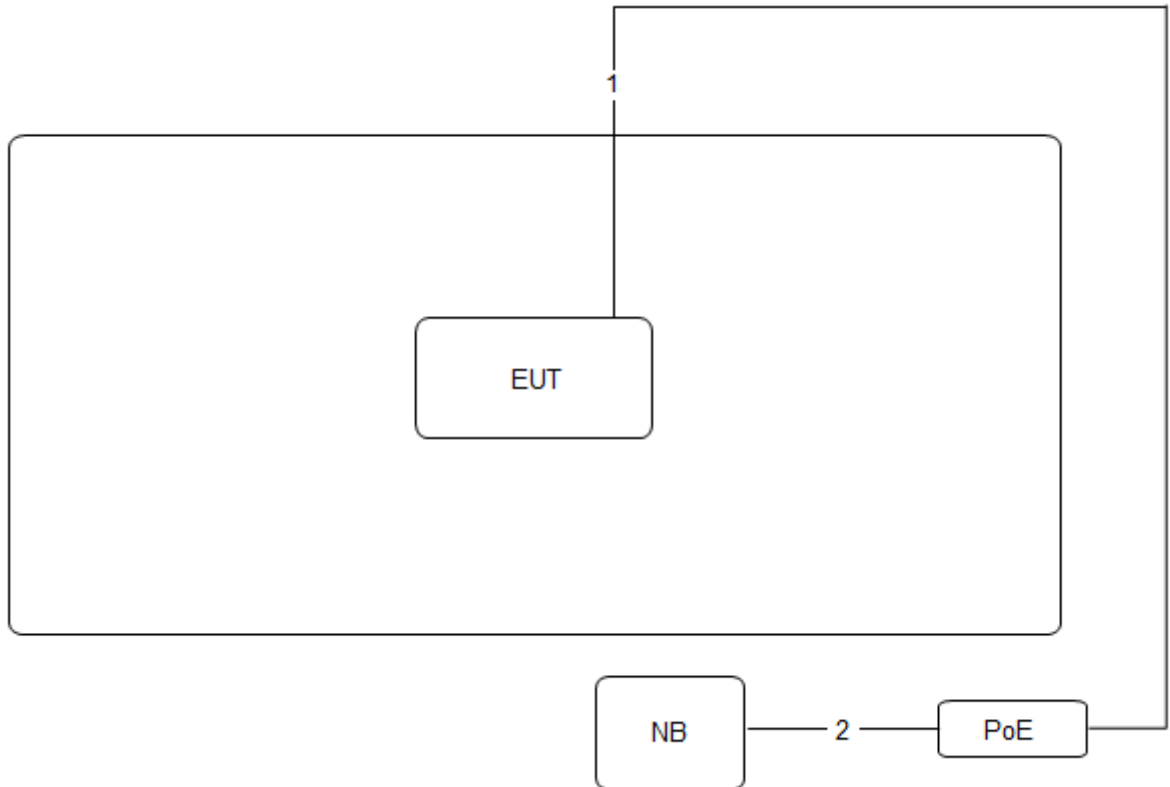

Item	Connection	Shielded	Length
1	RJ-45 cable	No	10m
2	RJ-45 cable	No	1.5m

<For Beamforming Mode>

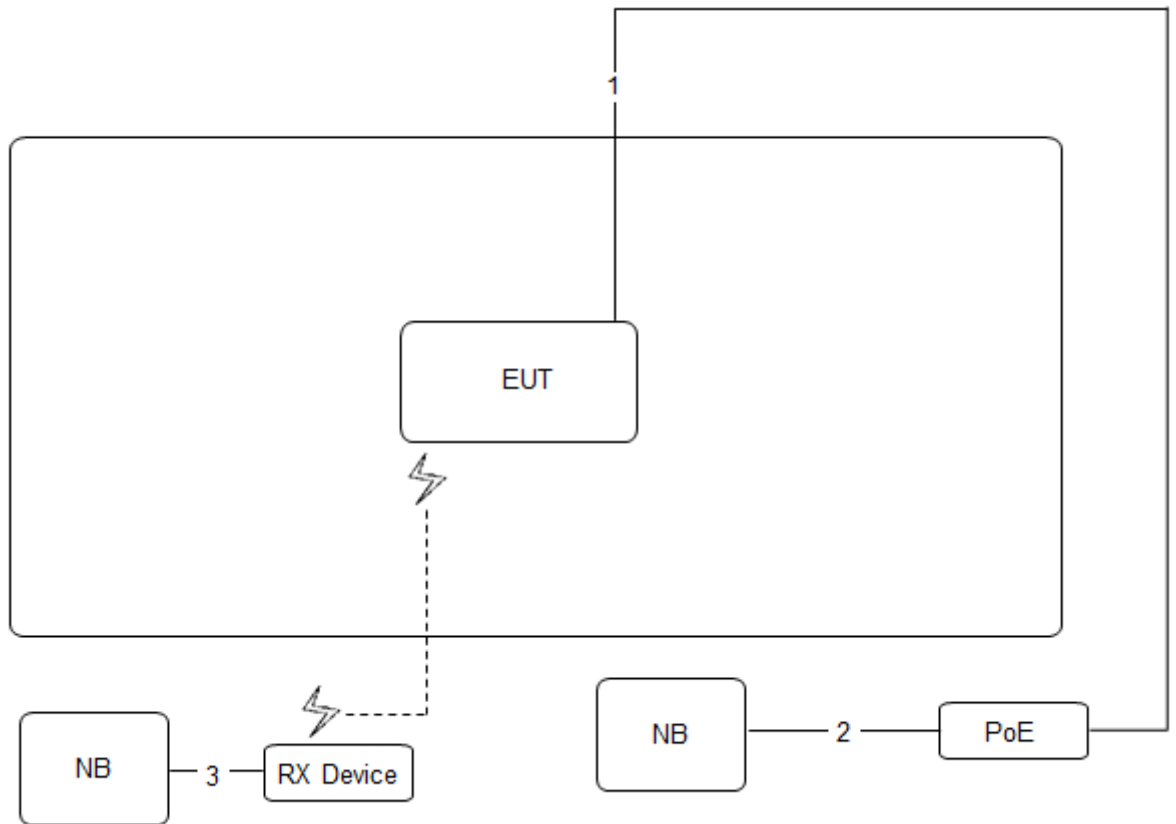

Item	Connection	Shielded	Length
1	RJ-45 cable	No	10m
2	RJ-45 cable	No	1.5m
3	RF-45 cable	No	1.5m

## 4. TEST RESULT

### 4.1. AC Power Line Conducted Emissions Measurement

#### 4.1.1. Limit

For this product which is designed to be connected to the AC power line, the radio frequency voltage that is conducted back onto the AC power line on any frequency or frequencies within the band 150 kHz to 30 MHz shall not exceed below limits table.

Frequency (MHz)	QP Limit (dBuV)	AV Limit (dBuV)
0.15~0.5	66~56	56~46
0.5~5	56	46
5~30	60	50

#### 4.1.2. Measuring Instruments and Setting

Please refer to section 5 of equipments list in this report. The following table is the setting of the receiver.

Receiver Parameters	Setting
Attenuation	10 dB
Start Frequency	0.15 MHz
Stop Frequency	30 MHz
IF Bandwidth	9 kHz

#### 4.1.3. Test Procedures

1. Configure the EUT according to ANSI C63.10. The EUT or host of EUT has to be placed 0.4 meter far from the conducting wall of the shielding room and at least 80 centimeters from any other grounded conducting surface.
2. Connect EUT or host of EUT to the power mains through a line impedance stabilization network (LISN).
3. All the support units are connected to the other LISNs. The LISN should provide 50uH/50ohms coupling impedance.
4. The frequency range from 150 kHz to 30 MHz was searched.
5. Set the test-receiver system to Peak Detect Function and Specified Bandwidth with Maximum Hold Mode.
6. The measurement has to be done between each power line and ground at the power terminal.

#### 4.1.4. Test Setup Layout

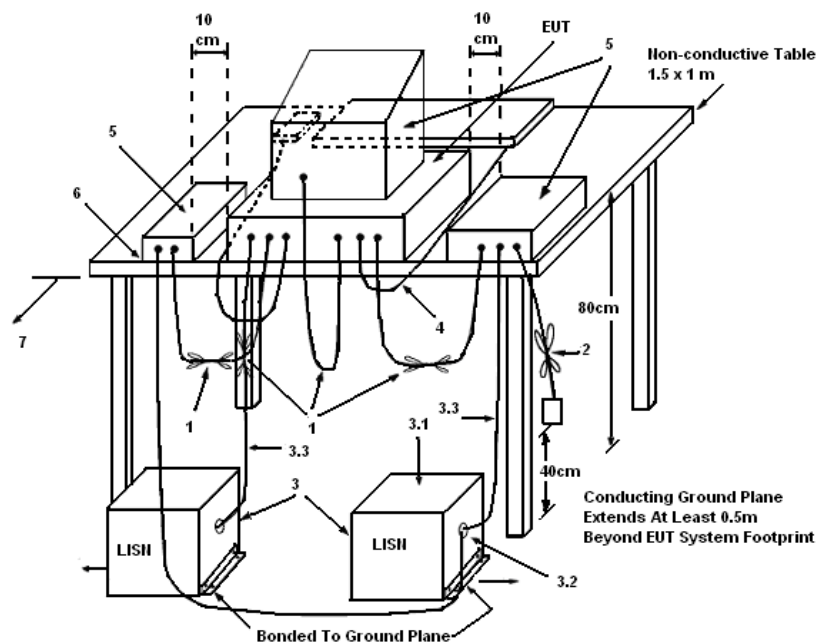

#### LEGEND:

- (1) Interconnecting cables that hang closer than 40 cm to the ground plane shall be folded back and forth in the center forming a bundle 30 to 40 cm long.
- (2) I/O cables that are not connected to a peripheral shall be bundled in the center. The end of the cable may be terminated, if required, using the correct terminating impedance. The overall length shall not exceed 1 m.
- (3) EUT connected to one LISN. Unused LISN measuring port connectors shall be terminated in 50 Ω. LISN can be placed on top of, or immediately beneath, reference ground plane.
  - (3.1) All other equipment powered from additional LISN(s).
  - (3.2) Multiple outlet strip can be used for multiple power cords of non-EUT equipment.
  - (3.3) LISN at least 80 cm from nearest part of EUT chassis.
- (4) Cables of hand-operated devices, such as keyboards, mice, etc., shall be placed as for normal use.
- (5) Non-EUT components of EUT system being tested.
- (6) Rear of EUT, including peripherals, shall all be aligned and flush with rear of tabletop.
- (7) Rear of tabletop shall be 40 cm removed from a vertical conducting plane that is bonded to the ground plane.

#### 4.1.5. Test Deviation

There is no deviation with the original standard.

#### 4.1.6. EUT Operation during Test

The EUT was placed on the test table and programmed in normal function.

4.1.7. Results of AC Power Line Conducted Emissions Measurement

Temperature	26°C	Humidity	55%
Test Engineer	Da Deng	Phase	Line
Configuration	Normal Link / Mode 1		

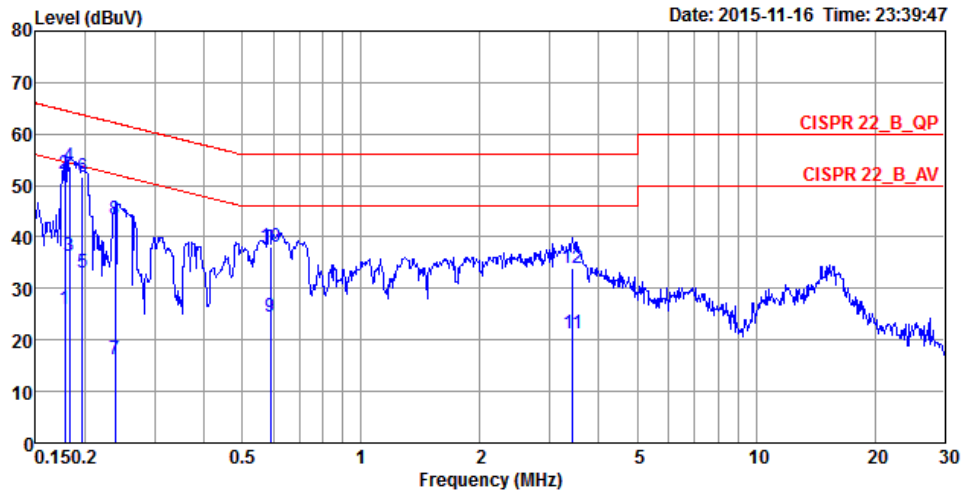

	Freq	Level	Over Limit	Limit Line	Read Level	LISN Factor	Cable Loss	Pol/Phase	Remark
	MHz	dBuV	dB	dBuV	dBuV	dB	dB		
1	0.1777	26.04	-28.55	54.59	16.09	9.93	0.02	LINE	Average
2	0.1777	52.21	-12.38	64.59	42.26	9.93	0.02	LINE	QP
3	0.1825	36.33	-18.04	54.37	26.38	9.93	0.02	LINE	Average
4	0.1825	53.61	-10.76	64.37	43.66	9.93	0.02	LINE	QP
5	0.1965	33.02	-20.74	53.76	23.07	9.93	0.02	LINE	Average
6	0.1965	51.71	-12.05	63.76	41.76	9.93	0.02	LINE	QP
7	0.2378	16.22	-35.95	52.17	6.26	9.93	0.03	LINE	Average
8	0.2378	43.44	-18.73	62.17	33.48	9.93	0.03	LINE	QP
9	0.5885	24.53	-21.47	46.00	14.55	9.94	0.04	LINE	Average
10	0.5885	38.04	-17.96	56.00	28.06	9.94	0.04	LINE	QP
11	3.4356	21.25	-24.75	46.00	11.18	10.01	0.06	LINE	Average
12	3.4356	34.05	-21.95	56.00	23.98	10.01	0.06	LINE	QP

Temperature	26°C	Humidity	55%
Test Engineer	Da Deng	Phase	Neutral
Configuration	Normal Link / Mode 1		

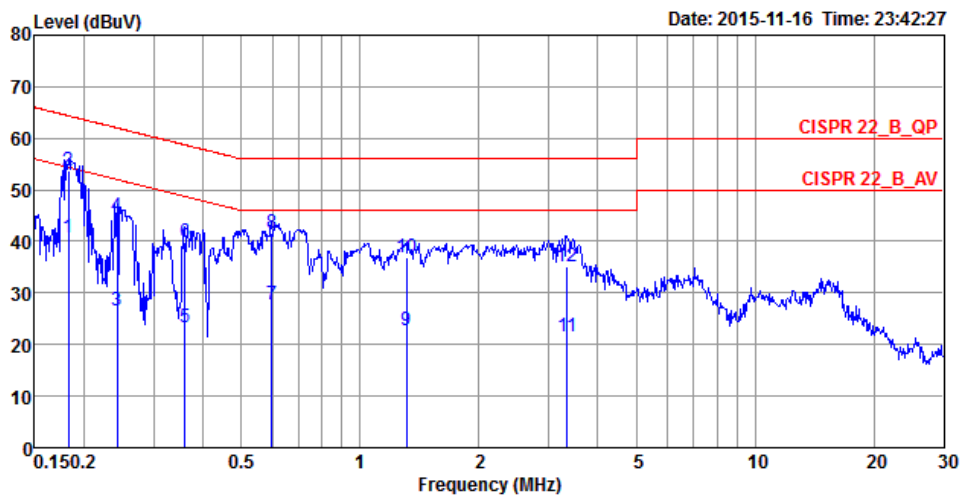

	Freq	Level	Over Limit	Limit Line	Read Level	LISN Factor	Cable Loss	Pol/Phase	Remark
	MHz	dBuV	dB	dBuV	dBuV	dB	dB		
1	0.1825	40.80	-13.57	54.37	30.99	9.79	0.02	NEUTRAL	Average
2	0.1825	53.79	-10.58	64.37	43.98	9.79	0.02	NEUTRAL	QP
3	0.2429	26.71	-25.29	52.00	16.89	9.79	0.03	NEUTRAL	Average
4	0.2429	44.76	-17.24	62.00	34.94	9.79	0.03	NEUTRAL	QP
5	0.3596	23.32	-25.42	48.74	13.49	9.79	0.04	NEUTRAL	Average
6	0.3596	39.77	-18.97	58.74	29.94	9.79	0.04	NEUTRAL	QP
7	0.5979	27.86	-18.14	46.00	18.02	9.80	0.04	NEUTRAL	Average
8	0.5979	41.74	-14.26	56.00	31.90	9.80	0.04	NEUTRAL	QP
9	1.3098	22.81	-23.19	46.00	12.94	9.82	0.05	NEUTRAL	Average
10	1.3098	36.86	-19.14	56.00	26.99	9.82	0.05	NEUTRAL	QP
11	3.3458	21.48	-24.52	46.00	11.56	9.86	0.06	NEUTRAL	Average
12	3.3458	35.18	-20.82	56.00	25.26	9.86	0.06	NEUTRAL	QP

Note:

Level = Read Level + LISN Factor + Cable Loss

## 4.2. Maximum Conducted Output Power Measurement

### 4.2.1. Limit

The limit for output power is 30dBm.

### 4.2.2. Measuring Instruments and Setting

Please refer to section 5 of equipments list in this report. The following table is the setting of the power meter.

Power Meter Parameter	Setting
Detector	Average

### 4.2.3. Test Procedures

1. Test procedures refer KDB558074 D01 v03r05 section 9.2.3.2 Measurement using a power meter (PM).
2. Multiple antenna system was performed in accordance with KDB 662911 D01 v02r01 Emissions Testing of Transmitters with Multiple Outputs in the Same Band.
3. This procedure provides an alternative for determining the RMS output power using a broadband RF average power meter with a thermocouple detector.

### 4.2.4. Test Setup Layout

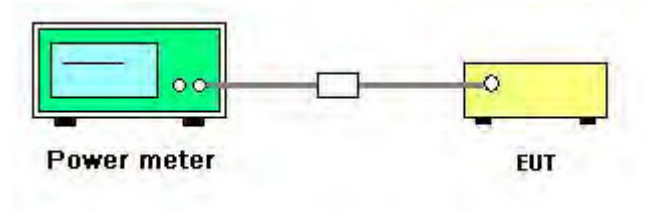

### 4.2.5. Test Deviation

There is no deviation with the original standard.

### 4.2.6. EUT Operation during Test

The EUT was programmed to be in continuously transmitting mode.



#### 4.2.7. Test Result of Maximum Conducted Output Power

Temperature	25°C	Humidity	45%
Test Engineer	Mars Lin	Test Date	Sep. 04, 2015 ~ Dec. 22, 2015

<For Radio 1 Non-beamforming Mode>

Mode	Frequency	Conducted Power (dBm)					Max. Limit (dBm)	Result
		Chain 1	Chain 2	Chain 3	Chain 4	Total		
802.11b	2412 MHz	21.49	21.63	20.75	21.64	27.41	30.00	Complies
	2437 MHz	23.68	24.08	23.25	24.06	29.80	30.00	Complies
	2462 MHz	22.22	22.56	22.11	22.2	28.30	30.00	Complies
802.11g	2412 MHz	14.62	14.67	14.59	14.96	20.73	30.00	Complies
	2437 MHz	22.43	22.81	22.58	22.63	28.64	30.00	Complies
	2462 MHz	18.67	18.71	18.68	18.74	24.72	30.00	Complies
11ac MCS0/Nss1 VHT20	2412 MHz	13.42	13.48	13.38	13.71	19.52	30.00	Complies
	2437 MHz	21.97	22.17	22.03	22.02	28.07	30.00	Complies
	2462 MHz	18.29	18.51	18.51	18.53	24.48	30.00	Complies
11ac MCS0/Nss1 VHT40	2422 MHz	11.91	11.87	11.98	11.99	17.96	30.00	Complies
	2437 MHz	14.96	15.07	15.21	15.07	21.10	30.00	Complies
	2452 MHz	15.29	15.48	15.54	15.5	21.47	30.00	Complies
11ac MCS0/Nss4 VHT20	2412 MHz	14.47	14.21	14.12	14.02	20.23	30.00	Complies
	2437 MHz	21.81	21.91	21.61	21.64	27.76	30.00	Complies
	2462 MHz	16.22	16.51	16.21	16.22	22.31	30.00	Complies
11ac MCS0/Nss4 VHT40	2422 MHz	11.51	11.71	11.21	11.37	17.47	30.00	Complies
	2437 MHz	14.52	14.67	14.71	14.73	20.68	30.00	Complies
	2452 MHz	15.61	15.57	15.36	15.43	21.51	30.00	Complies

## &lt;For Radio 1 Beamforming Mode&gt;

Mode	Frequency	Conducted Power (dBm)					Max. Limit (dBm)	Result
		Chain 1	Chain 2	Chain 3	Chain 4	Total		
11ac MCS0/Nss1 VHT20	2412 MHz	11.95	11.92	11.19	11.96	17.79	28.85	Complies
	2437 MHz	22.03	21.77	21.58	21.45	27.73	28.98	Complies
	2462 MHz	16.27	16.25	15.56	15.37	21.90	29.13	Complies
11ac MCS0/Nss1 VHT40	2422 MHz	10.13	10.11	9.36	9.95	15.92	28.85	Complies
	2437 MHz	14.36	14.22	14.12	13.66	20.12	28.98	Complies
	2452 MHz	12.27	13.33	13.01	12.25	18.76	29.13	Complies

Note:

$$2412, 2422 \text{ MHz } \textit{DirectionalGain} = 10 \cdot \log \left[ \frac{\sum_{j=1}^{N_{SS}} \left\{ \sum_{k=1}^{N_{ANT}} g_{j,k} \right\}^2}{N_{ANT}} \right] = 7.15 \text{ dBi, so limit} = 30 - (7.15 - 6) = 28.85 \text{ dBm.}$$

$$2437 \text{ MHz } \textit{DirectionalGain} = 10 \cdot \log \left[ \frac{\sum_{j=1}^{N_{SS}} \left\{ \sum_{k=1}^{N_{ANT}} g_{j,k} \right\}^2}{N_{ANT}} \right] = 7.02 \text{ dBi, so limit} = 30 - (7.02 - 6) = 28.98 \text{ dBm.}$$

$$2462 \text{ MHz } \textit{DirectionalGain} = 10 \cdot \log \left[ \frac{\sum_{j=1}^{N_{SS}} \left\{ \sum_{k=1}^{N_{ANT}} g_{j,k} \right\}^2}{N_{ANT}} \right] = 6.87 \text{ dBi, so limit} = 30 - (6.87 - 6) = 29.13 \text{ dBm.}$$

Mode	Frequency	Conducted Power (dBm)					Max. Limit (dBm)	Result
		Chain 1	Chain 2	Chain 3	Chain 4	Total		
11ac MCS0/Nss2 VHT20	2412 MHz	13.21	13.55	13.41	13.96	19.56	30.00	Complies
	2437 MHz	22.03	21.86	21.65	21.71	27.84	30.00	Complies
	2462 MHz	18.01	18.44	17.66	17.48	23.93	30.00	Complies
11ac MCS0/Nss2 VHT40	2422 MHz	10.63	10.98	10.73	10.66	16.77	30.00	Complies
	2437 MHz	14.85	15.14	14.81	14.82	20.93	30.00	Complies
	2452 MHz	13.52	13.97	13.69	13.49	19.69	30.00	Complies

Note:

$$2412, 2422 \text{ MHz } \textit{DirectionalGain} = 10 \cdot \log \left[ \frac{\sum_{j=1}^{N_{SS}} \left\{ \sum_{k=1}^{N_{ANT}} g_{j,k} \right\}^2}{N_{ANT}} \right] = 4.43 \text{ dBi}, < 6\text{dBi}, \text{ so the limit doesn't reduce.}$$

$$2437 \text{ MHz } \textit{DirectionalGain} = 10 \cdot \log \left[ \frac{\sum_{j=1}^{N_{SS}} \left\{ \sum_{k=1}^{N_{ANT}} g_{j,k} \right\}^2}{N_{ANT}} \right] = 4.45 \text{ dBi}, < 6\text{dBi}, \text{ so the limit doesn't reduce.}$$

$$2462 \text{ MHz } \textit{DirectionalGain} = 10 \cdot \log \left[ \frac{\sum_{j=1}^{N_{SS}} \left\{ \sum_{k=1}^{N_{ANT}} g_{j,k} \right\}^2}{N_{ANT}} \right] = 4.44 \text{ dBi}, < 6\text{dBi}, \text{ so the limit doesn't reduce.}$$

Mode	Frequency	Conducted Power (dBm)					Max. Limit (dBm)	Result
		Chain 1	Chain 2	Chain 3	Chain 4	Total		
11ac MCS0/Nss3 VHT20	2412 MHz	13.81	13.69	13.37	13.19	19.54	30.00	Complies
	2437 MHz	21.81	21.59	21.04	21.20	27.44	30.00	Complies
	2462 MHz	15.01	15.80	15.24	15.44	21.40	30.00	Complies
11ac MCS0/Nss3 VHT40	2422 MHz	11.25	10.54	10.62	11.33	16.97	30.00	Complies
	2437 MHz	13.62	13.32	13.47	14.21	19.69	30.00	Complies
	2452 MHz	13.43	13.37	13.21	13.69	19.45	30.00	Complies

Note:

$$2412, 2422 \text{ MHz } \textit{DirectionalGain} = 10 \cdot \log \left[ \frac{\sum_{j=1}^{N_{SS}} \left\{ \sum_{k=1}^{N_{ANT}} g_{j,k} \right\}^2}{N_{ANT}} \right] = 2.67 \text{ dBi}, < 6\text{dBi}, \text{ so the limit doesn't reduce.}$$

$$2437 \text{ MHz } \textit{DirectionalGain} = 10 \cdot \log \left[ \frac{\sum_{j=1}^{N_{SS}} \left\{ \sum_{k=1}^{N_{ANT}} g_{j,k} \right\}^2}{N_{ANT}} \right] = 2.68 \text{ dBi}, < 6\text{dBi}, \text{ so the limit doesn't reduce.}$$

$$2462 \text{ MHz } \textit{DirectionalGain} = 10 \cdot \log \left[ \frac{\sum_{j=1}^{N_{SS}} \left\{ \sum_{k=1}^{N_{ANT}} g_{j,k} \right\}^2}{N_{ANT}} \right] = 2.68 \text{ dBi}, < 6\text{dBi}, \text{ so the limit doesn't reduce.}$$

## &lt;For Radio 3 Mode&gt;

Mode	Frequency	Conducted Power (dBm)	Max. Limit (dBm)	Result
802.11b	2412 MHz	22.07	30.00	Complies
	2437 MHz	25.64	30.00	Complies
	2462 MHz	22.76	30.00	Complies
802.11g	2412 MHz	18.13	30.00	Complies
	2437 MHz	24.33	30.00	Complies
	2462 MHz	18.77	30.00	Complies
11ac MCS0/Nss1 VHT20	2412 MHz	17.52	30.00	Complies
	2437 MHz	23.86	30.00	Complies
	2462 MHz	18.18	30.00	Complies
11ac MCS0/Nss1 VHT40	2422 MHz	11.51	30.00	Complies
	2437 MHz	18.16	30.00	Complies
	2452 MHz	13.93	30.00	Complies

### 4.3. Power Spectral Density Measurement

#### 4.3.1. Limit

For digitally modulated systems, the power spectral density conducted from the intentional radiator to the antenna shall not be greater than 8dBm in any 3 kHz band during any time interval of continuous transmission.

#### 4.3.2. Measuring Instruments and Setting

Please refer to section 5 of equipments list in this report. The following table is the setting of the spectrum analyzer.

Spectrum Parameter	Setting
Attenuation	Auto
Span Frequency	Set the span to 1.5 times the DTS channel bandwidth.
RBW	$3 \text{ kHz} \leq \text{RBW} \leq 100\text{kHz}$
VBW	$\geq 3 \times \text{RBW}$
Detector	Peak
Trace	Max Hold
Sweep Time	Auto couple

#### 4.3.3. Test Procedures

1. Test was performed in accordance with KDB558074 D01 v03r05 for Performing Compliance Measurements on Digital Transmission Systems (DTS) - section 10.2 Method PKPSD (peak PSD) and KDB 662911 D01 v02r01 section In-Band Power Spectral Density (PSD) Measurements option (b) Measure and sum spectral maximal across the outputs.
2. Use this procedure when the maximum conducted output power in the fundamental emission is used to demonstrate compliance. The EUT must be configured to transmit continuously at full power over the measurement duration.
3. Ensure that the number of measurement points in the sweep  $\geq 2 \times \text{span}/\text{RBW}$  (use of a greater number of measurement points than this minimum requirement is recommended).
4. Use the peak marker function to determine the maximum level in any 3 kHz band segment within the fundamental EBW.
5. The resulting PSD level must be  $\leq 8 \text{ dBm}$ .

#### 4.3.4. Test Setup Layout

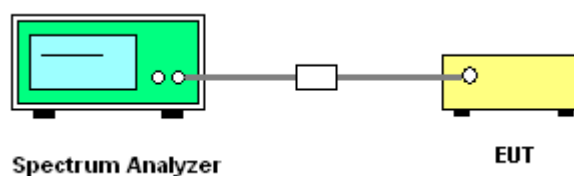

#### 4.3.5. Test Deviation

There is no deviation with the original standard.

#### 4.3.6. EUT Operation during Test

The EUT was programmed to be in continuously transmitting mode.

#### 4.3.7. Test Result of Power Spectral Density

Temperature	25°C	Humidity	45%
Test Engineer	Mars Lin		

<For Radio 1 Non-beamforming Mode>

Mode	Frequency	Power Density (dBm/3kHz)					Power Density Limit (dBm/3kHz)	Result
		Chain 1	Chain 2	Chain 3	Chain 4	Total		
802.11b	2412 MHz	-13.42	-12.81	-13.83	-12.95	-7.21	6.85	Complies
	2437 MHz	-11.35	-10.55	-11.21	-10.67	-4.91	6.98	Complies
	2462 MHz	-11.96	-11.82	-12.14	-11.54	-5.84	7.13	Complies
802.11g	2412 MHz	-14.64	-13.72	-14.62	-14.85	-8.41	6.85	Complies
	2437 MHz	-6.44	-5.47	-5.54	-6.81	-0.01	6.98	Complies
	2462 MHz	-8.17	-9.91	-10.30	-9.44	-3.36	7.13	Complies
11ac MCS0/Nss1 VHT20	2412 MHz	-14.93	-15.23	-14.99	-15.55	-9.15	6.85	Complies
	2437 MHz	-6.67	-6.97	-5.03	-7.35	-0.39	6.98	Complies
	2462 MHz	-11.21	-10.69	-10.69	-9.93	-4.59	7.13	Complies
11ac MCS0/Nss1 VHT40	2422 MHz	-19.83	-20.00	-20.74	-20.24	-14.17	6.85	Complies
	2437 MHz	-16.41	-16.33	-15.24	-15.69	-9.87	6.98	Complies
	2452 MHz	-16.99	-15.83	-16.63	-15.70	-10.23	7.13	Complies

Note:

$$2412, 2422 \text{ MHz } \textit{DirectionalGain} = 10 \cdot \log \left[ \frac{\sum_{j=1}^{N_{SS}} \left\{ \sum_{k=1}^{N_{ANT}} g_{j,k} \right\}^2}{N_{ANT}} \right] = 7.15 \text{ dBi, so limit} = 8 - (7.15 - 6) = 6.85 \text{ dBm/3kHz.}$$

$$2437 \text{ MHz } \textit{DirectionalGain} = 10 \cdot \log \left[ \frac{\sum_{j=1}^{N_{SS}} \left\{ \sum_{k=1}^{N_{ANT}} g_{j,k} \right\}^2}{N_{ANT}} \right] = 7.02 \text{ dBi, so limit} = 8 - (7.02 - 6) = 6.98 \text{ dBm/3kHz.}$$

$$2452, 2462 \text{ MHz } \textit{DirectionalGain} = 10 \cdot \log \left[ \frac{\sum_{j=1}^{N_{SS}} \left\{ \sum_{k=1}^{N_{ANT}} g_{j,k} \right\}^2}{N_{ANT}} \right] = 6.87 \text{ dBi, so limit} = 8 - (6.87 - 6) = 7.13 \text{ dBm/3kHz.}$$



Mode	Frequency	Power Density (dBm/3kHz)					Power Density Limit (dBm/3kHz)	Result
		Chain 1	Chain 2	Chain 3	Chain 4	Total		
11ac	2412 MHz	-14.97	-13.32	-15.02	-15.24	-8.54	8.00	Complies
MCS0/Nss4	2437 MHz	-6.84	-6.83	-7.58	-6.43	-0.88	8.00	Complies
VHT20	2462 MHz	-11.79	-11.61	-12.83	-11.44	-5.86	8.00	Complies
11ac	2422 MHz	-18.74	-18.63	-18.97	-19.37	-12.90	8.00	Complies
MCS0/Nss4	2437 MHz	-15.13	-14.30	-14.31	-15.39	-8.73	8.00	Complies
VHT40	2452 MHz	-14.21	-14.62	-15.23	-14.77	-8.67	8.00	Complies

## &lt;For Radio 1 Beamforming Mode&gt;

Mode	Frequency	Power Density (dBm/3kHz)					Power Density Limit (dBm/3kHz)	Result
		Chain 1	Chain 2	Chain 3	Chain 4	Total		
11ac	2412 MHz	-17.70	-17.38	-16.86	-17.13	-11.24	6.85	Complies
MCS0/Nss1	2437 MHz	-9.16	-8.91	-8.70	-7.48	-2.49	6.98	Complies
VHT20	2462 MHz	-15.47	-15.15	-14.56	-14.75	-8.95	7.13	Complies
11ac	2422 MHz	-20.52	-19.69	-19.94	-20.42	-14.11	6.85	Complies
MCS0/Nss1	2437 MHz	-18.28	-17.68	-17.09	-18.04	-11.73	6.98	Complies
VHT40	2452 MHz	-19.68	-18.86	-18.74	-19.19	-13.08	7.13	Complies

Note:

$$2412, 2422 \text{ MHz } \textit{DirectionalGain} = 10 \cdot \log \left[ \frac{\sum_{j=1}^{N_{SS}} \left\{ \sum_{k=1}^{N_{ANT}} g_{j,k} \right\}^2}{N_{ANT}} \right] = 7.15 \text{ dBi, so limit} = 8 - (7.15 - 6) = 6.85 \text{ dBm/3kHz.}$$

$$2437 \text{ MHz } \textit{DirectionalGain} = 10 \cdot \log \left[ \frac{\sum_{j=1}^{N_{SS}} \left\{ \sum_{k=1}^{N_{ANT}} g_{j,k} \right\}^2}{N_{ANT}} \right] = 7.02 \text{ dBi, so limit} = 8 - (7.02 - 6) = 6.98 \text{ dBm/3kHz.}$$

$$2452, 2462 \text{ MHz } \textit{DirectionalGain} = 10 \cdot \log \left[ \frac{\sum_{j=1}^{N_{SS}} \left\{ \sum_{k=1}^{N_{ANT}} g_{j,k} \right\}^2}{N_{ANT}} \right] = 6.87 \text{ dBi, so limit} = 8 - (6.87 - 6) = 7.13 \text{ dBm/3kHz.}$$

Mode	Frequency	Power Density (dBm/3kHz)					Power Density Limit (dBm/3kHz)	Result
		Chain 1	Chain 2	Chain 3	Chain 4	Total		
11ac	2412 MHz	-13.19	-12.32	-12.18	-13.05	-6.64	8.00	Complies
MCS0/Nss2	2437 MHz	-3.94	-2.51	-2.58	-2.94	3.06	8.00	Complies
VHT20	2462 MHz	-8.78	-8.05	-8.12	-7.85	-2.17	8.00	Complies
11ac	2422 MHz	-19.09	-19.31	-19.72	-19.04	-13.26	8.00	Complies
MCS0/Nss2	2437 MHz	-16.02	-15.25	-15.16	-15.07	-9.34	8.00	Complies
VHT40	2452 MHz	-15.87	-15.85	-15.34	-15.54	-9.62	8.00	Complies

Note:

$$2412, 2422 \text{ MHz } \textit{DirectionalGain} = 10 \cdot \log \left[ \frac{\sum_{j=1}^{N_{SS}} \left\{ \sum_{k=1}^{N_{ANT}} g_{j,k} \right\}^2}{N_{ANT}} \right] = 4.43 \text{ dBi}, < 6\text{dBi}, \text{ so the limit doesn't reduce.}$$

$$2437 \text{ MHz } \textit{DirectionalGain} = 10 \cdot \log \left[ \frac{\sum_{j=1}^{N_{SS}} \left\{ \sum_{k=1}^{N_{ANT}} g_{j,k} \right\}^2}{N_{ANT}} \right] = 4.45 \text{ dBi}, < 6\text{dBi}, \text{ so the limit doesn't reduce.}$$

$$2452, 2462 \text{ MHz } \textit{DirectionalGain} = 10 \cdot \log \left[ \frac{\sum_{j=1}^{N_{SS}} \left\{ \sum_{k=1}^{N_{ANT}} g_{j,k} \right\}^2}{N_{ANT}} \right] = 4.44 \text{ dBi}, < 6\text{dBi}, \text{ so the limit doesn't reduce.}$$

Mode	Frequency	Power Density (dBm/3kHz)					Power Density Limit (dBm/3kHz)	Result
		Chain 1	Chain 2	Chain 3	Chain 4	Total		
11ac	2412 MHz	-12.87	-11.91	-11.73	-12.07	-6.10	8.00	Complies
MCS0/Nss3	2437 MHz	-4.62	-3.71	-4.86	-4.88	1.53	8.00	Complies
VHT20	2462 MHz	-10.91	-9.59	-11.89	-11.28	-4.81	8.00	Complies
11ac	2422 MHz	-19.00	-18.32	-18.79	-18.75	-12.69	8.00	Complies
MCS0/Nss3	2437 MHz	-14.73	-15.08	-14.86	-15.20	-8.94	8.00	Complies
VHT40	2452 MHz	-15.36	-14.40	-14.76	-15.64	-8.99	8.00	Complies

Note:

$$2412, 2422 \text{ MHz } \textit{DirectionalGain} = 10 \cdot \log \left[ \frac{\sum_{j=1}^{N_{SS}} \left\{ \sum_{k=1}^{N_{ANT}} g_{j,k} \right\}^2}{N_{ANT}} \right] = 2.67 \text{ dBi}, < 6\text{dBi}, \text{ so the limit doesn't reduce.}$$

$$2437 \text{ MHz } \textit{DirectionalGain} = 10 \cdot \log \left[ \frac{\sum_{j=1}^{N_{SS}} \left\{ \sum_{k=1}^{N_{ANT}} g_{j,k} \right\}^2}{N_{ANT}} \right] = 2.68 \text{ dBi}, < 6\text{dBi}, \text{ so the limit doesn't reduce.}$$

$$2452, 2462 \text{ MHz } \textit{DirectionalGain} = 10 \cdot \log \left[ \frac{\sum_{j=1}^{N_{SS}} \left\{ \sum_{k=1}^{N_{ANT}} g_{j,k} \right\}^2}{N_{ANT}} \right] = 2.68 \text{ dBi}, < 6\text{dBi}, \text{ so the limit doesn't reduce.}$$

<b>Temperature</b>	25°C	<b>Humidity</b>	45%
<b>Test Engineer</b>	Mars Lin		

<For Radio 3 Mode>

Mode	Frequency	Power Density (dBm/3kHz)	Power Density Limit (dBm/3kHz)	Result
802.11b	2412 MHz	-4.59	8.00	Complies
	2437 MHz	1.43	8.00	Complies
	2462 MHz	-3.14	8.00	Complies
802.11g	2412 MHz	-10.35	8.00	Complies
	2437 MHz	-2.47	8.00	Complies
	2462 MHz	-9.26	8.00	Complies
11ac MCS0/Nss1 VHT20	2412 MHz	-9.34	8.00	Complies
	2437 MHz	-4.22	8.00	Complies
	2462 MHz	-9.99	8.00	Complies
11ac MCS0/Nss1 VHT40	2422 MHz	-17.29	8.00	Complies
	2437 MHz	-12.01	8.00	Complies
	2452 MHz	-16.46	8.00	Complies

Note: All the test values were listed in the report.

For plots, only the channel with worse result was shown.

<For Radio 1 Non-beamforming Mode>

Power Density Plot on Configuration IEEE 802.11b / 2437 MHz / Chain 1

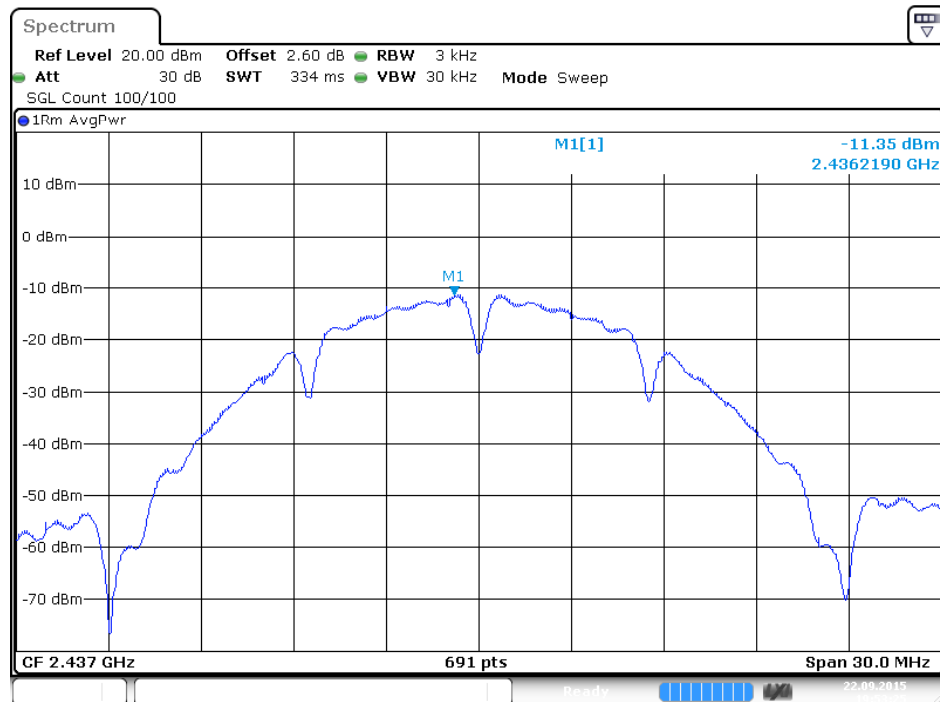

Power Density Plot on Configuration IEEE 802.11b / 2437 MHz / Chain 2

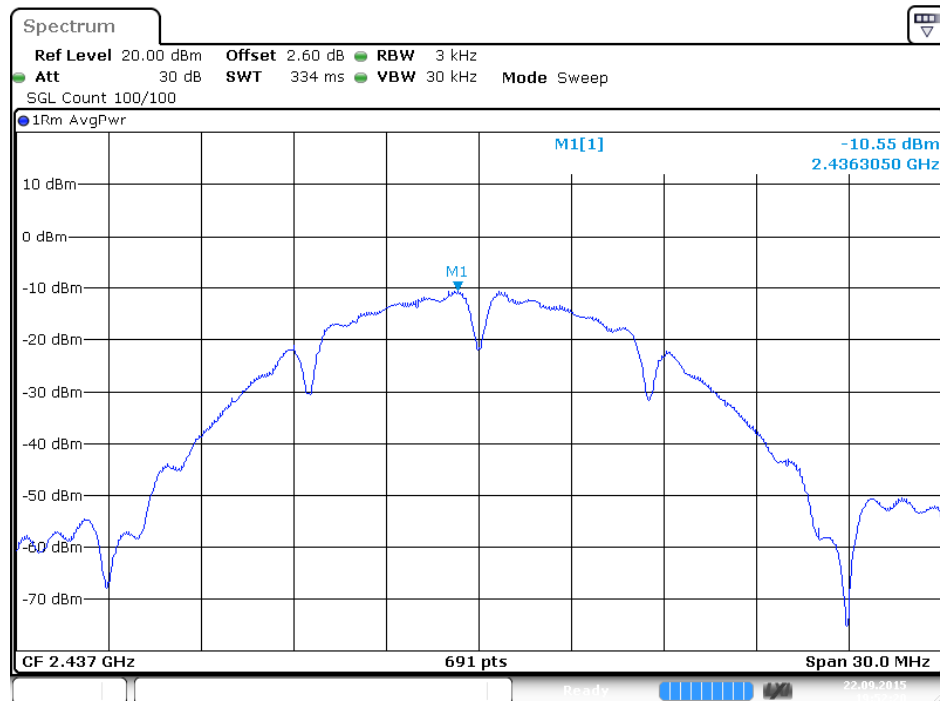

**Power Density Plot on Configuration IEEE 802.11b / 2437 MHz / Chain 3**

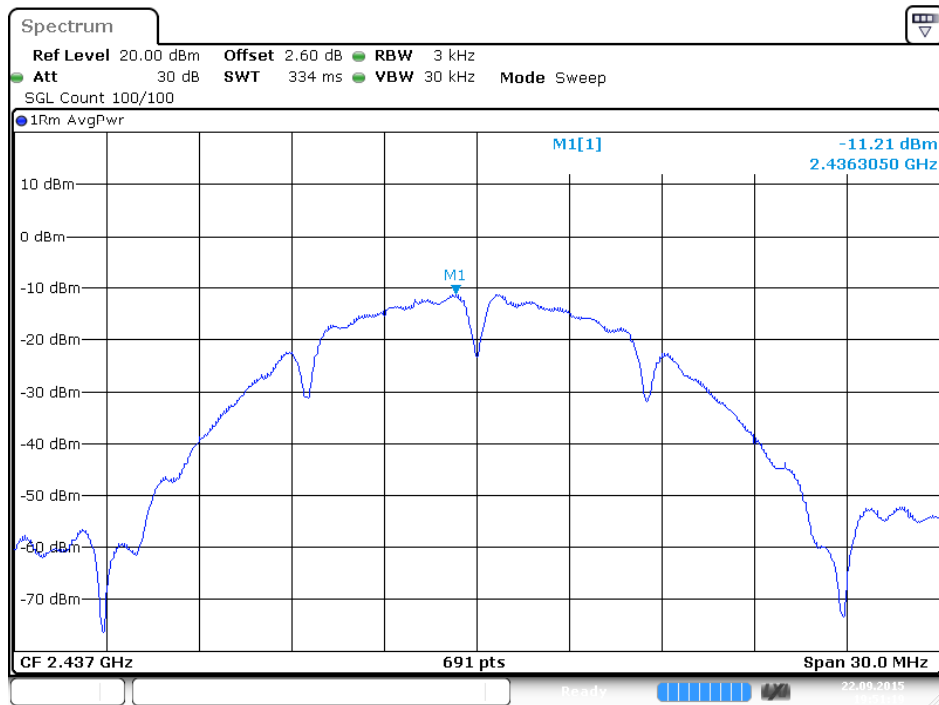

**Power Density Plot on Configuration IEEE 802.11b / 2437 MHz / Chain 4**

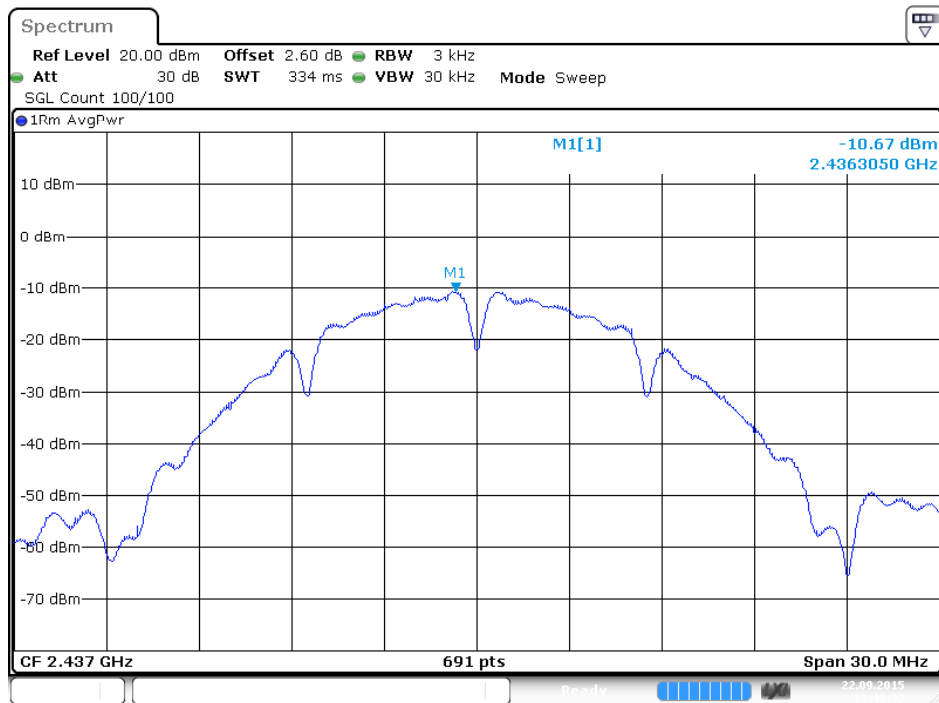

**Power Density Plot on Configuration IEEE 802.11g / 2437 MHz / Chain 1**

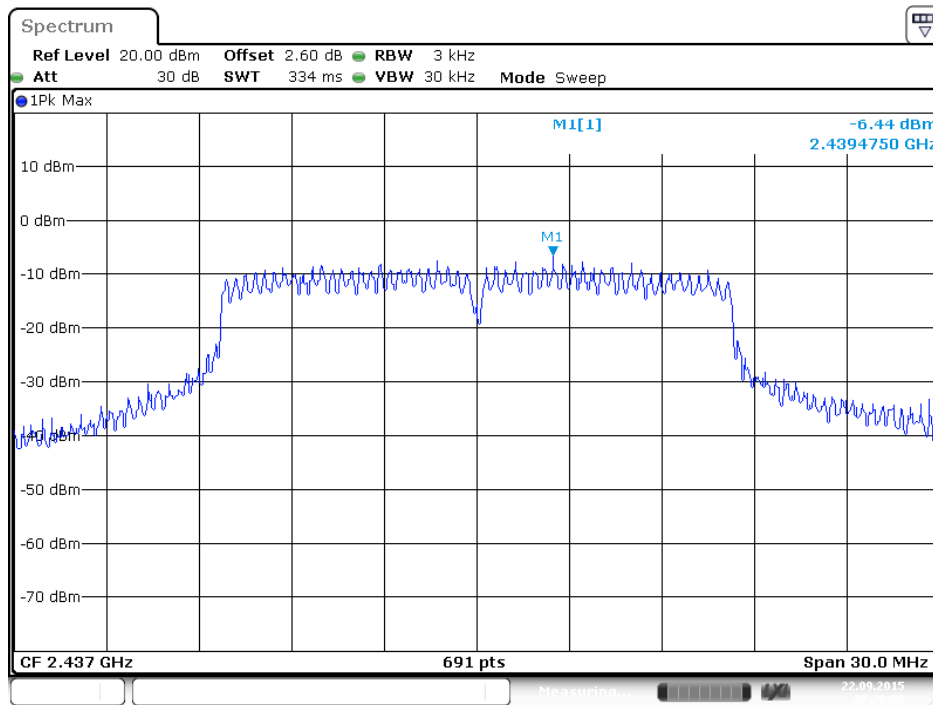

**Power Density Plot on Configuration IEEE 802.11g / 2437 MHz / Chain 2**

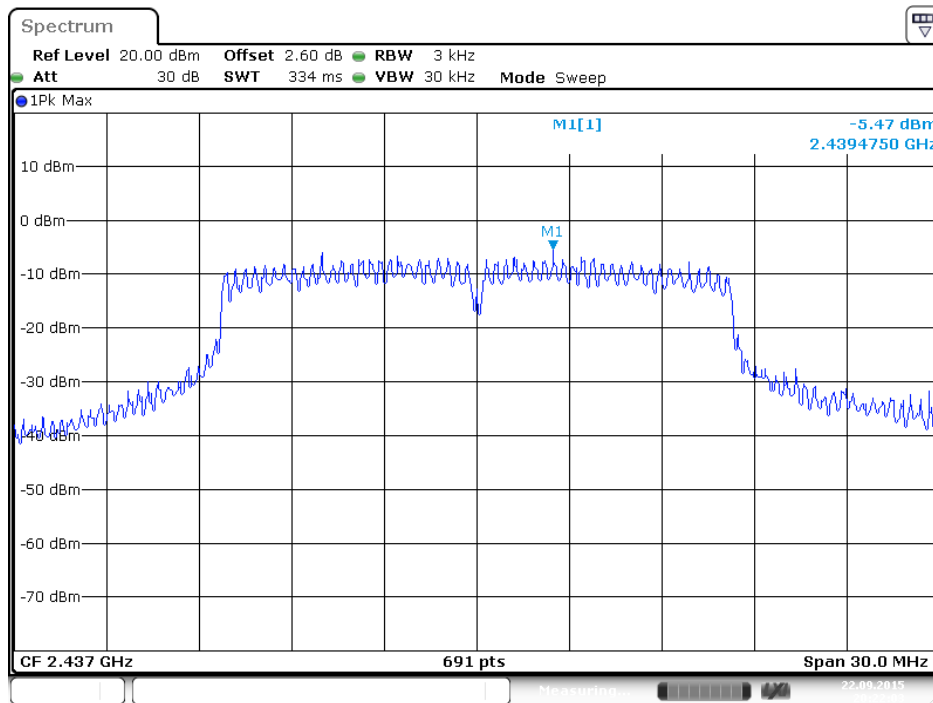



**Power Density Plot on Configuration IEEE 802.11g / 2437 MHz / Chain 3**

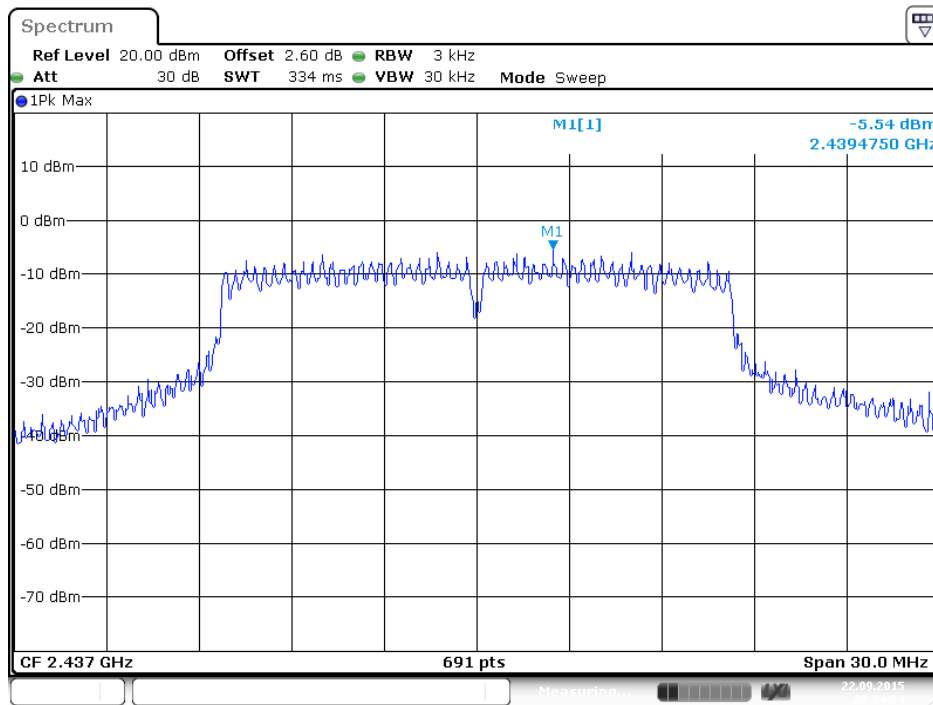

**Power Density Plot on Configuration IEEE 802.11g / 2437 MHz / Chain 4**

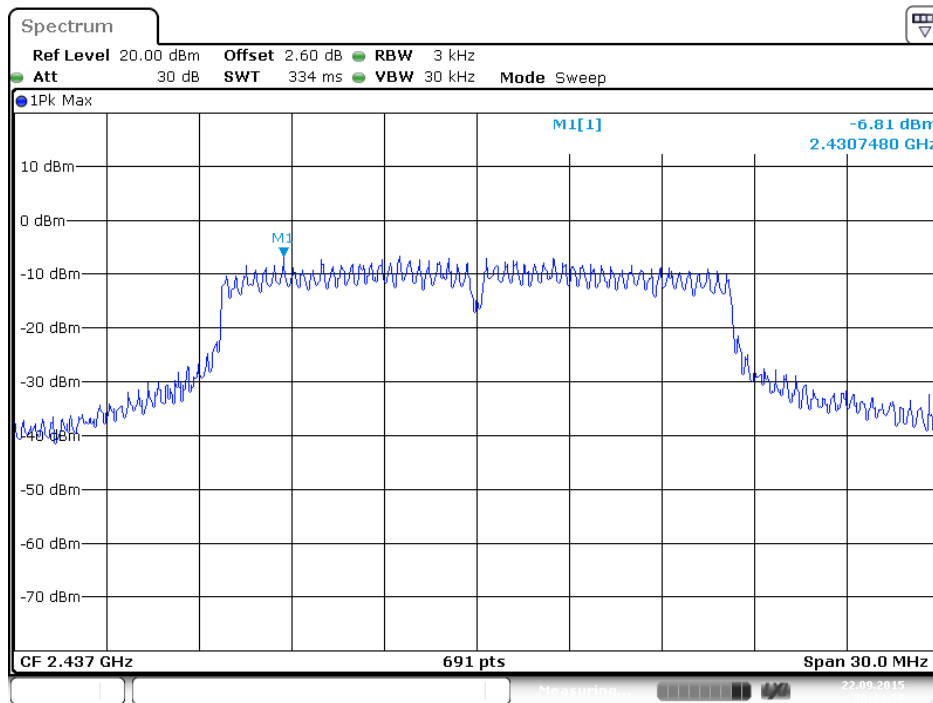

**Power Density Plot on Configuration IEEE 802. 11ac MCS0/Nss1 VHT20 / 2437 MHz / Chain 1**

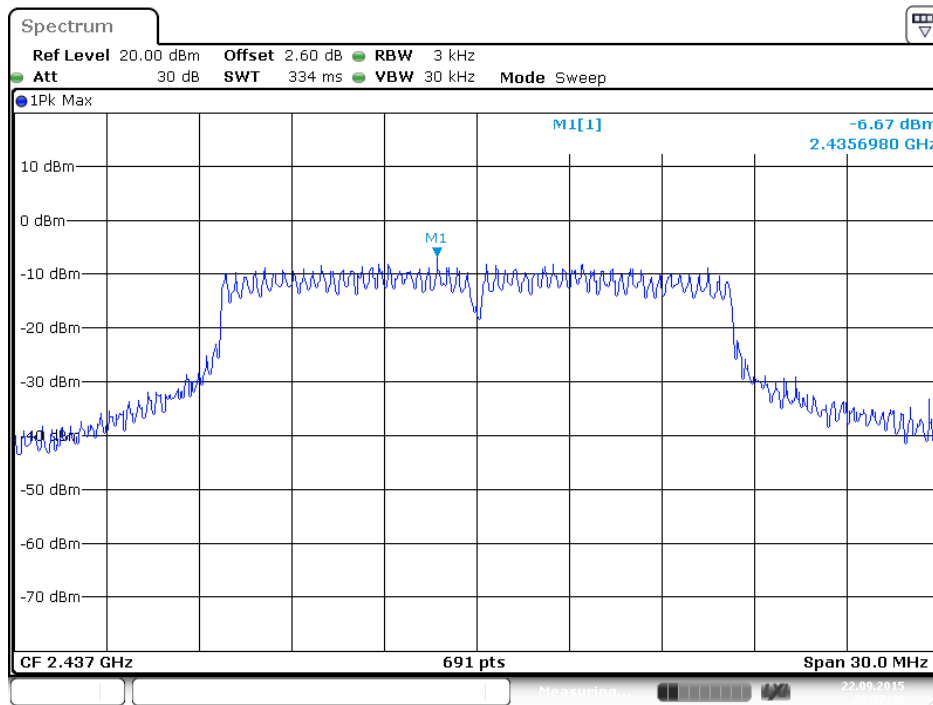

**Power Density Plot on Configuration IEEE 802. 11ac MCS0/Nss1 VHT20 / 2437 MHz / Chain 2**

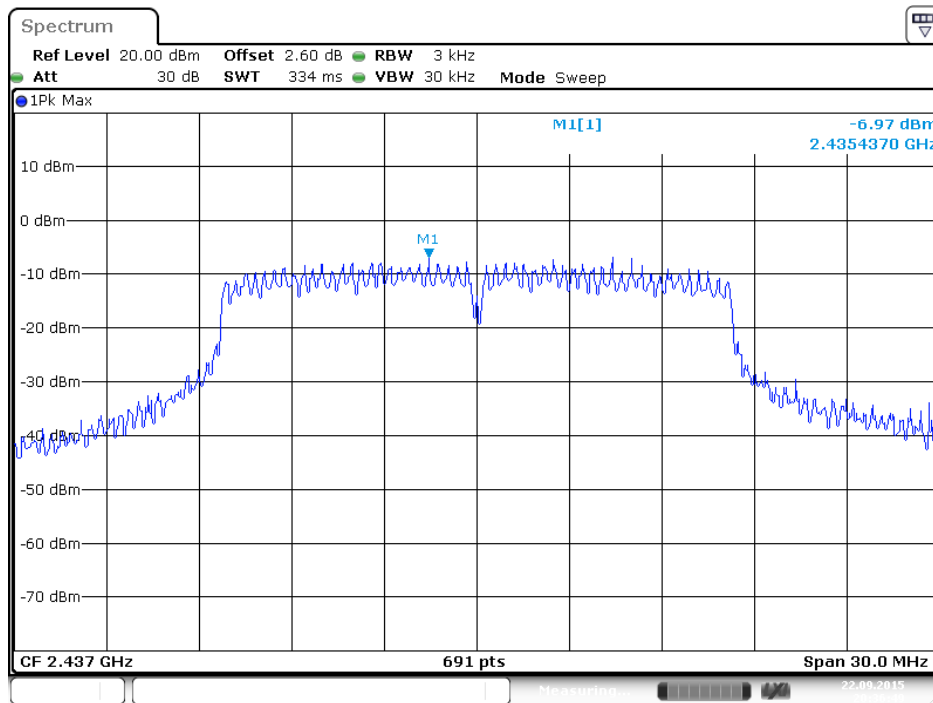

**Power Density Plot on Configuration IEEE 802. 11ac MCS0/Nss1 VHT20 / 2437 MHz / Chain 3**

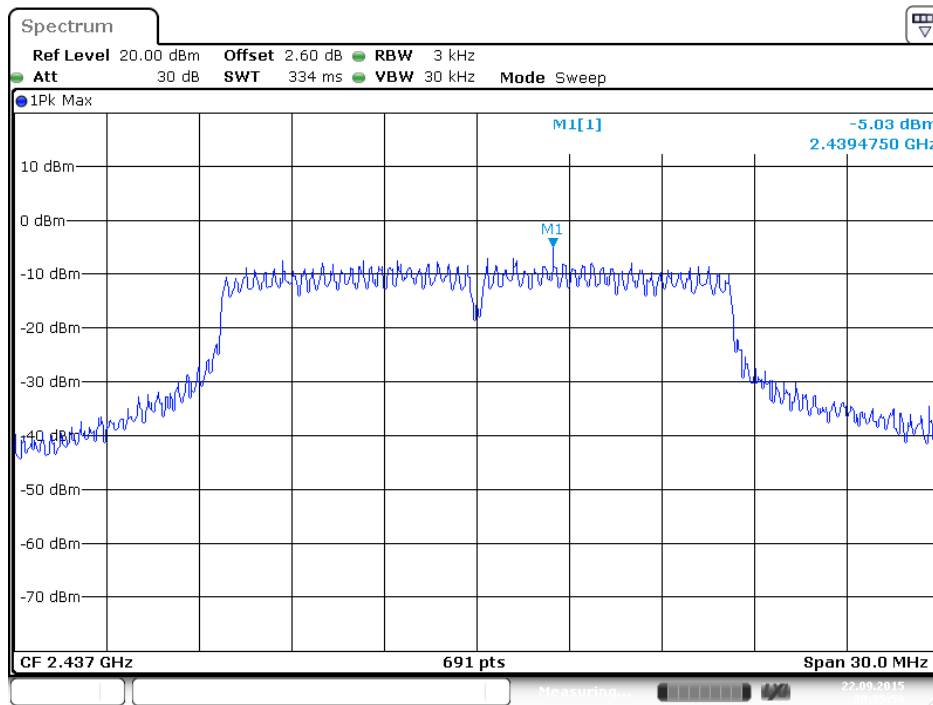

**Power Density Plot on Configuration IEEE 802. 11ac MCS0/Nss1 VHT20 / 2437 MHz / Chain 4**

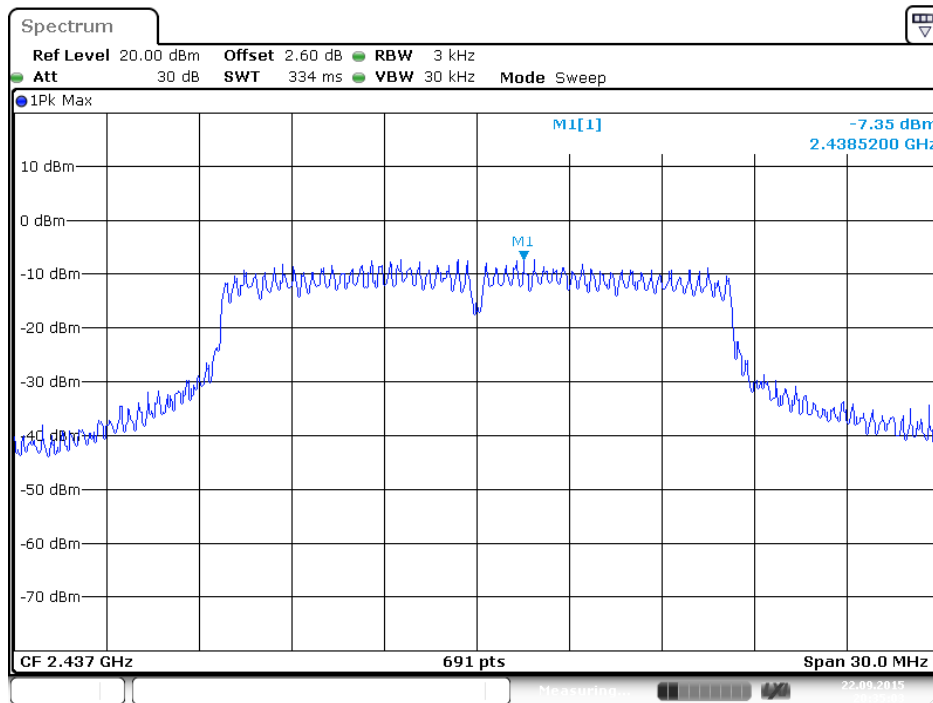

**Power Density Plot on Configuration IEEE 802.11ac MCS0/Nss1 VHT40 / 2437 MHz / Chain 1**

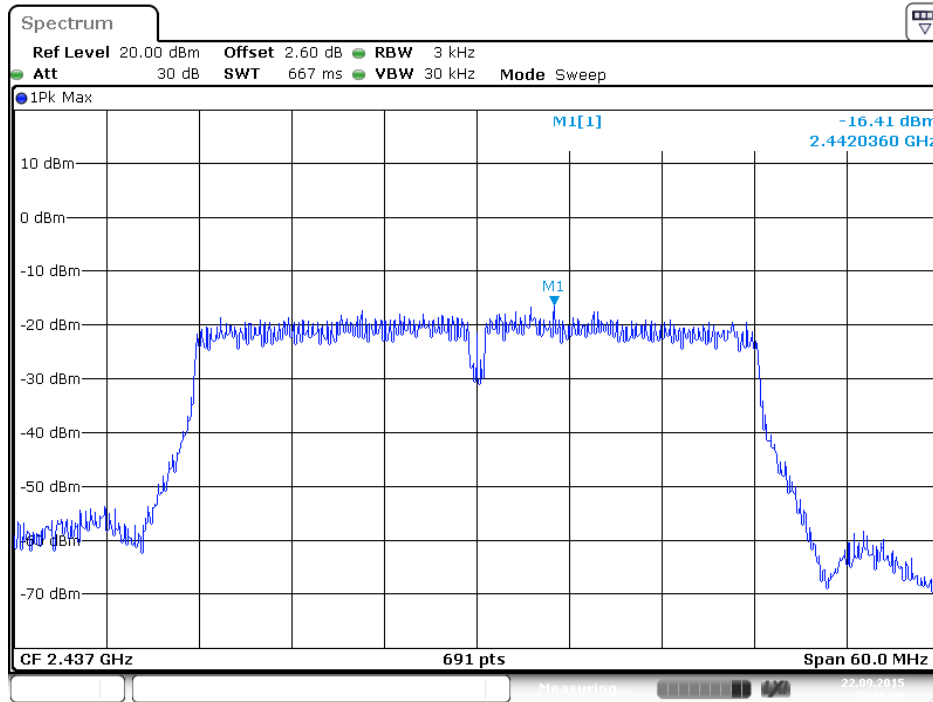

**Power Density Plot on Configuration IEEE 802.11ac MCS0/Nss1 VHT40 / 2437 MHz / Chain 2**

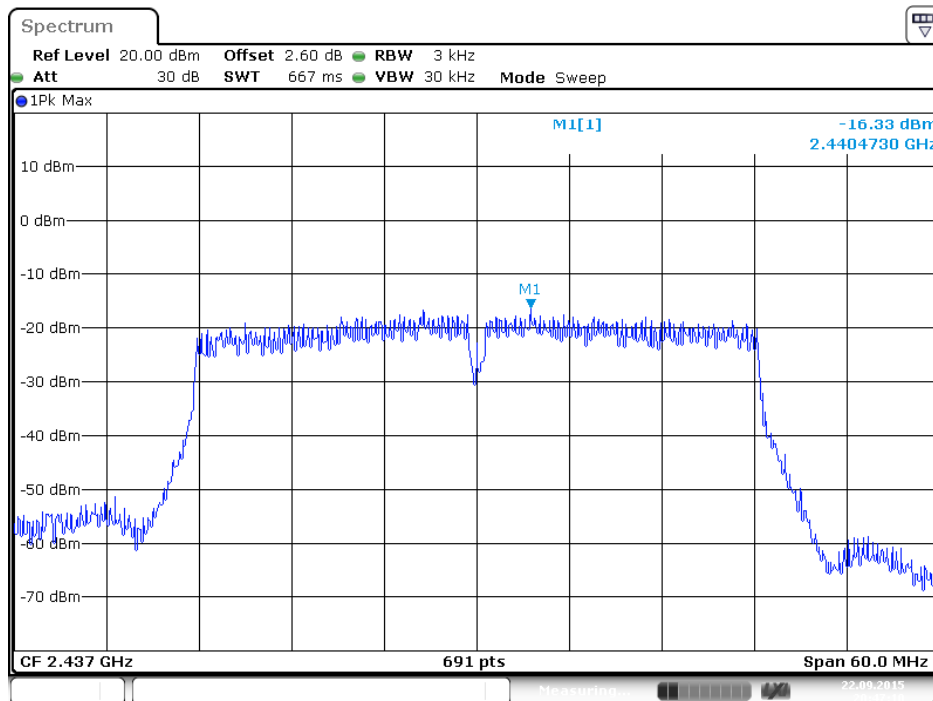

**Power Density Plot on Configuration IEEE 802.11ac MCS0/Nss1 VHT40 / 2437 MHz / Chain 3**

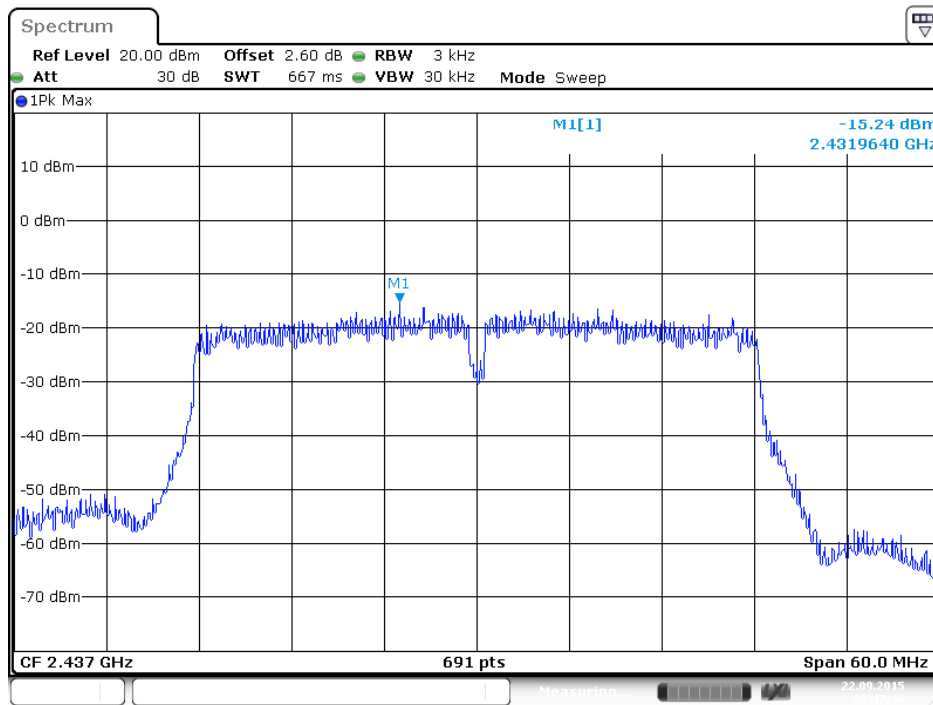

**Power Density Plot on Configuration IEEE 802.11ac MCS0/Nss1 VHT40 / 2437 MHz / Chain 4**

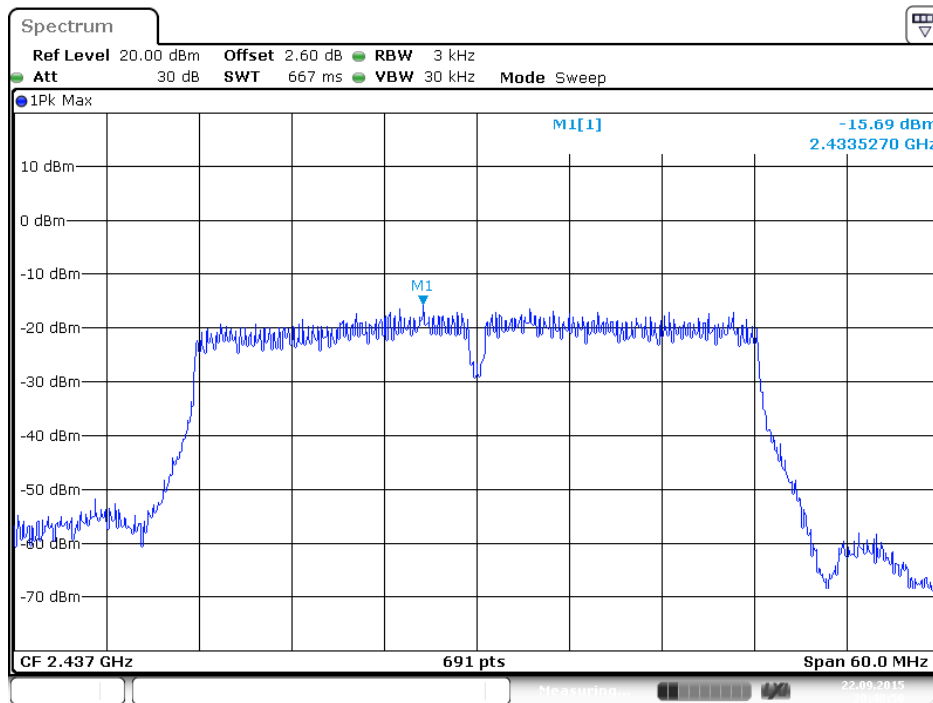

**Power Density Plot on Configuration IEEE 802. 11ac MCS0/Nss4 VHT20 / 2437 MHz / Chain 1**

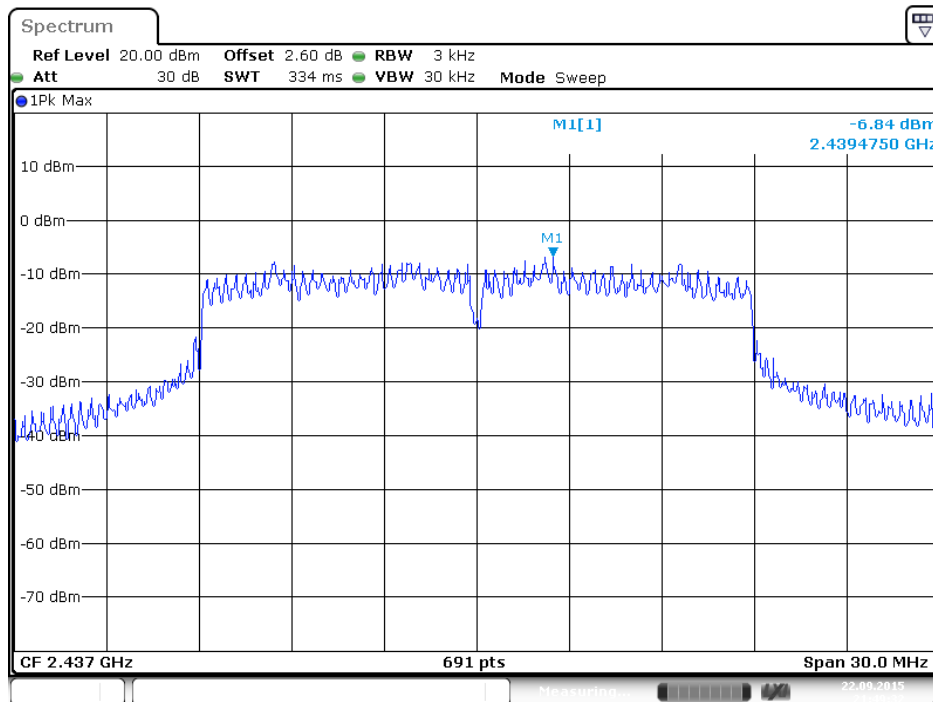

Date: 22.SEP.2015 21:49:32

**Power Density Plot on Configuration IEEE 802. 11ac MCS0/Nss4 VHT20 / 2437 MHz / Chain 2**

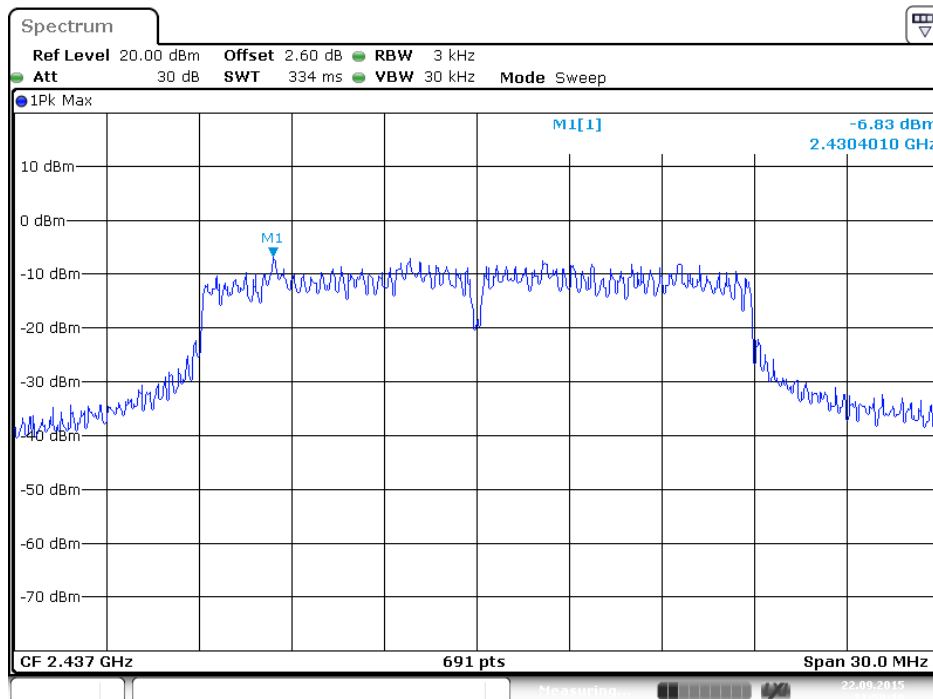

Date: 22.SEP.2015 21:50:10

**Power Density Plot on Configuration IEEE 802.11ac MCS0/Nss4 VHT20 / 2437 MHz / Chain 3**

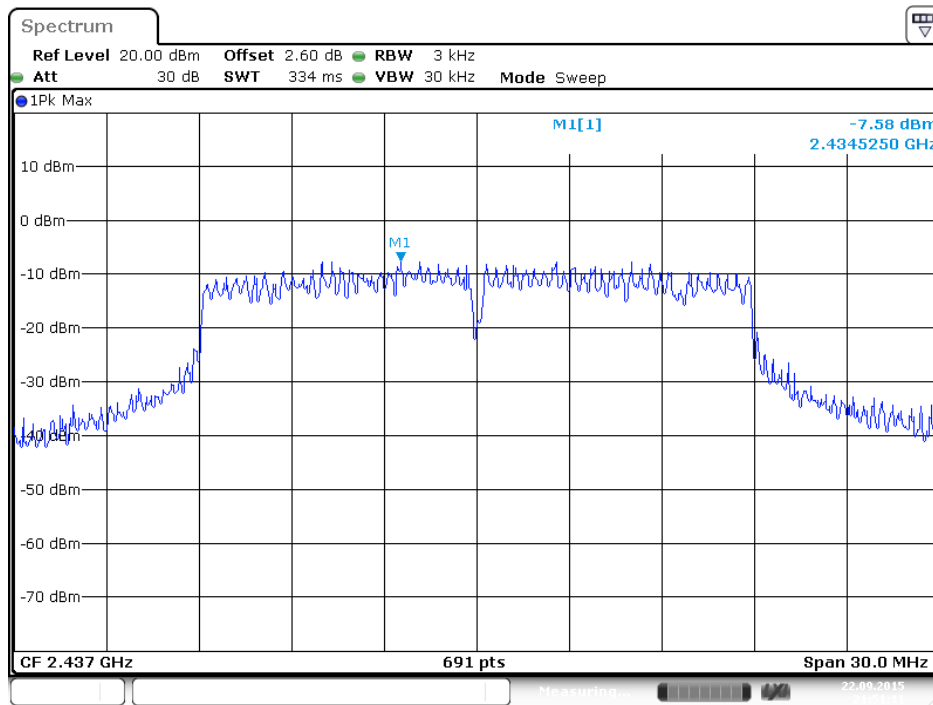

**Power Density Plot on Configuration IEEE 802.11ac MCS0/Nss4 VHT20 / 2437 MHz / Chain 4**

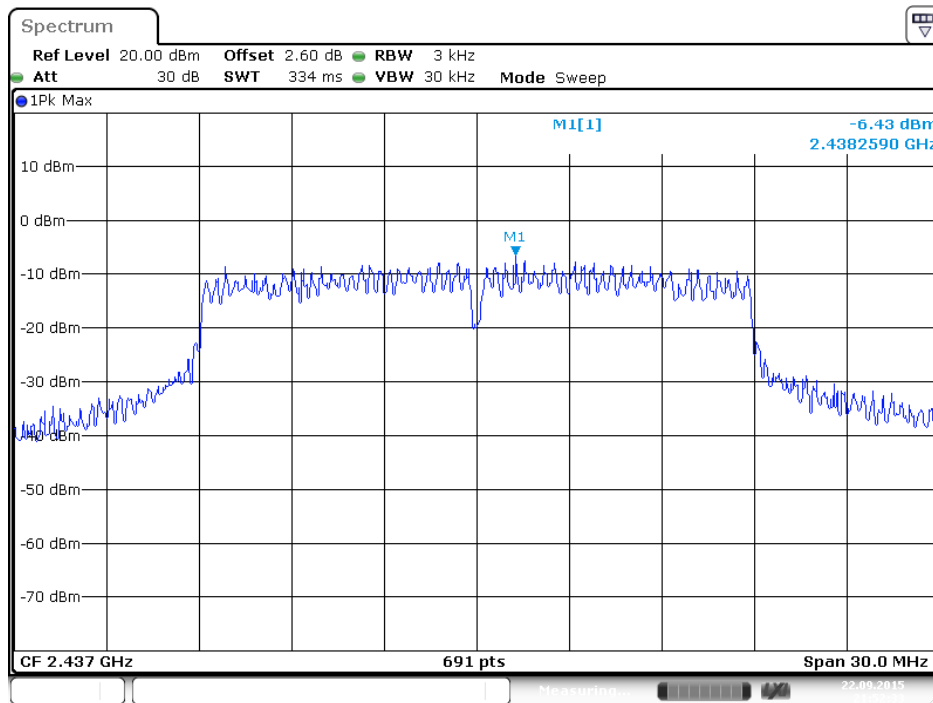

**Power Density Plot on Configuration IEEE 802.11ac MCS0/Nss4 VHT40 / 2437 MHz / Chain 1**

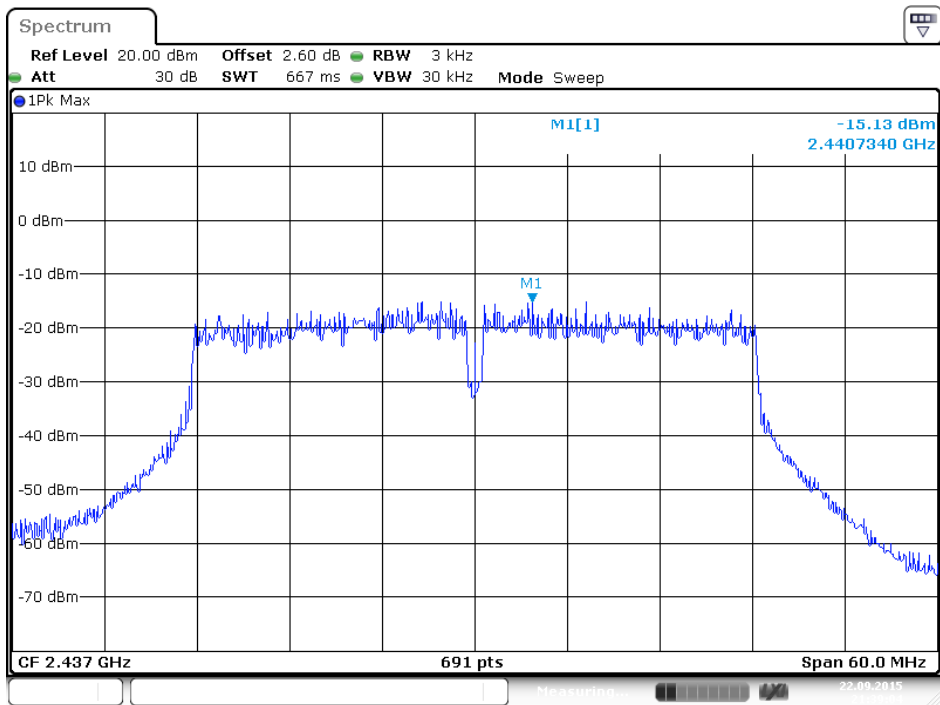

**Power Density Plot on Configuration IEEE 802.11ac MCS0/Nss4 VHT40 / 2437 MHz / Chain 2**

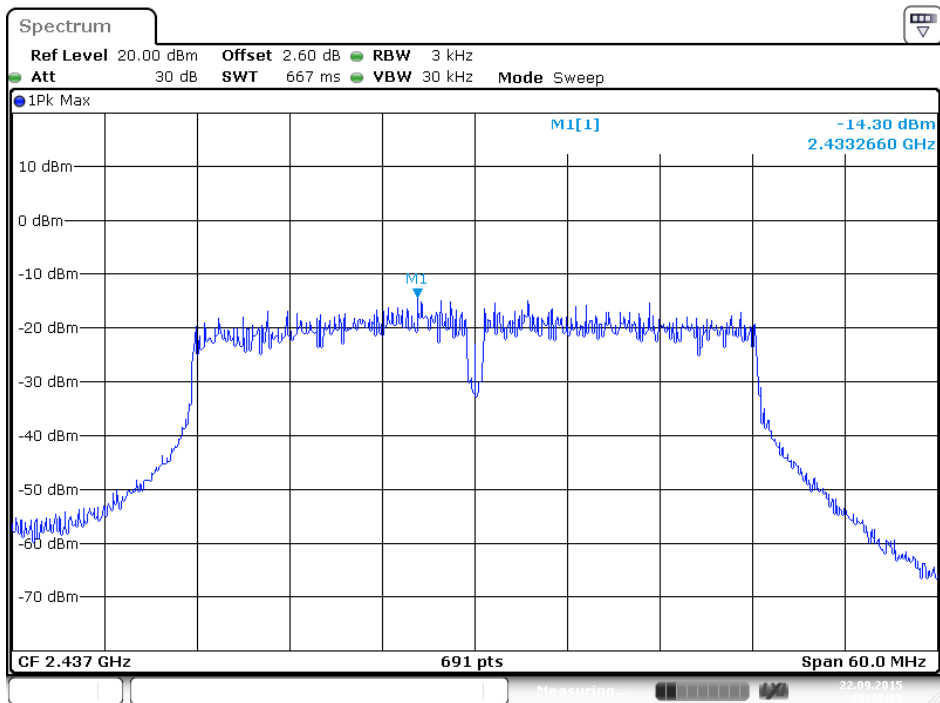



**Power Density Plot on Configuration IEEE 802. 11ac MCS0/Nss4 VHT40 / 2437 MHz / Chain 3**

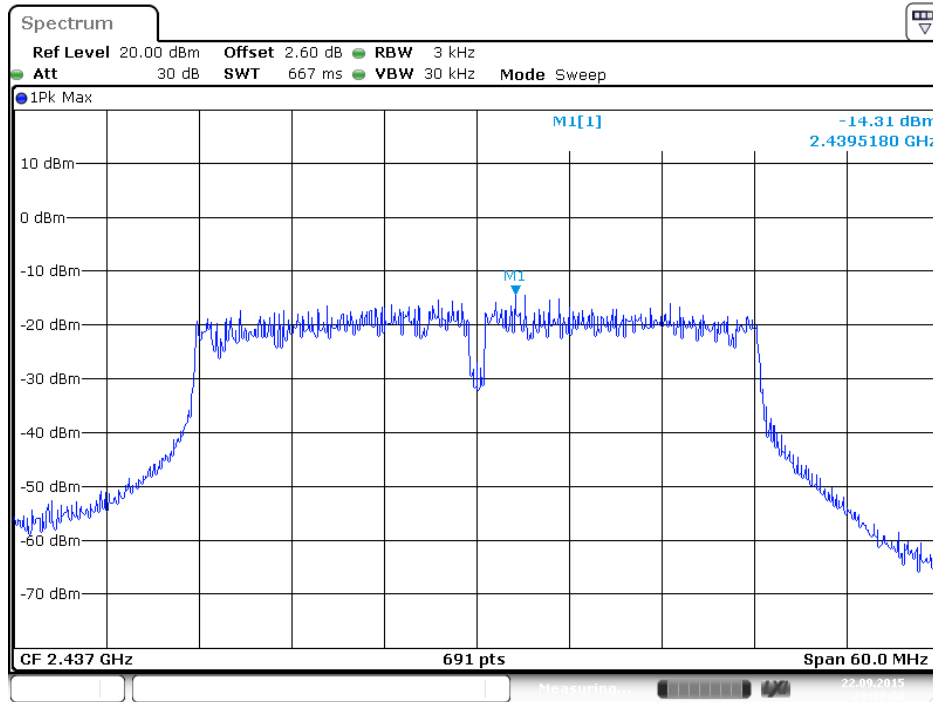

**Power Density Plot on Configuration IEEE 802. 11ac MCS0/Nss4 VHT40 / 2422 MHz / Chain 4**

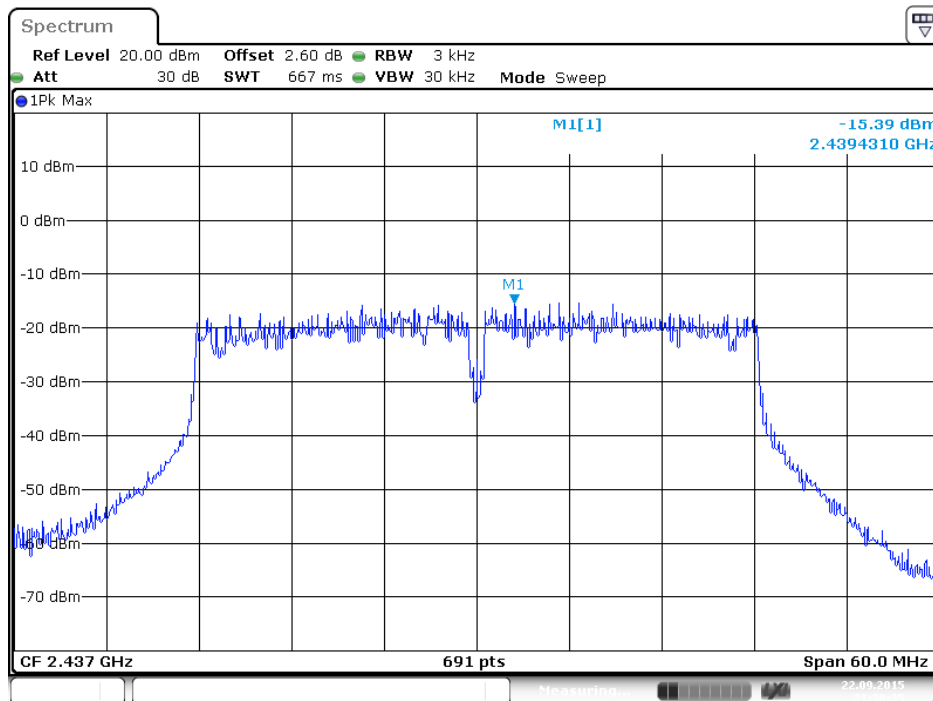

<For Radio 1 Beamforming Mode>

Power Density Plot on Configuration IEEE 802.11ac MCS0/Nss1 VHT20 / 2437 MHz / Chain 1

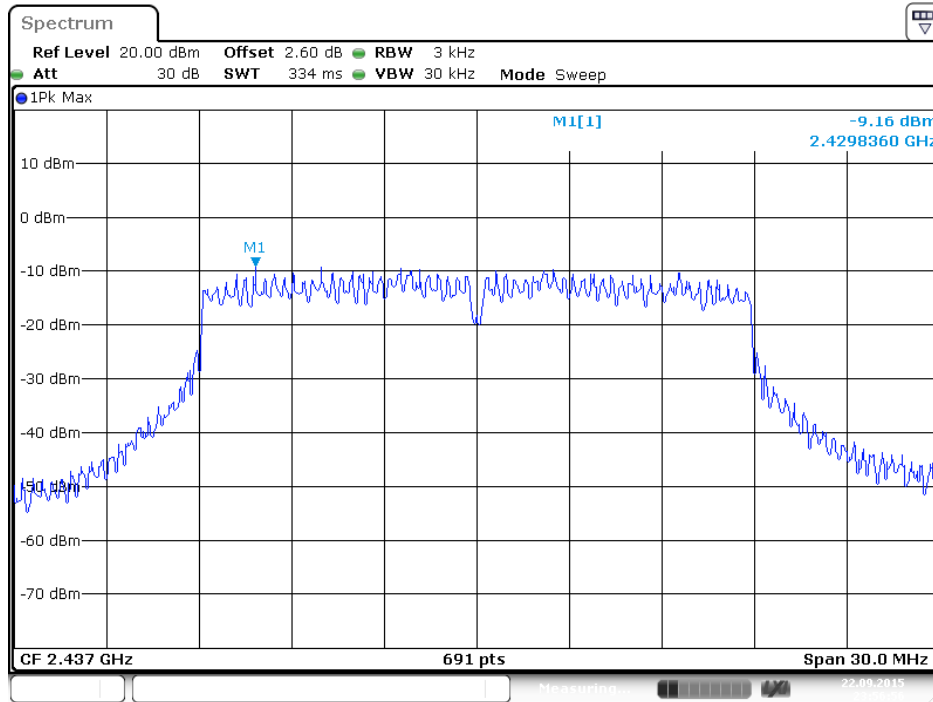

Power Density Plot on Configuration IEEE 802.11ac MCS0/Nss1 VHT20 / 2437 MHz / Chain 2

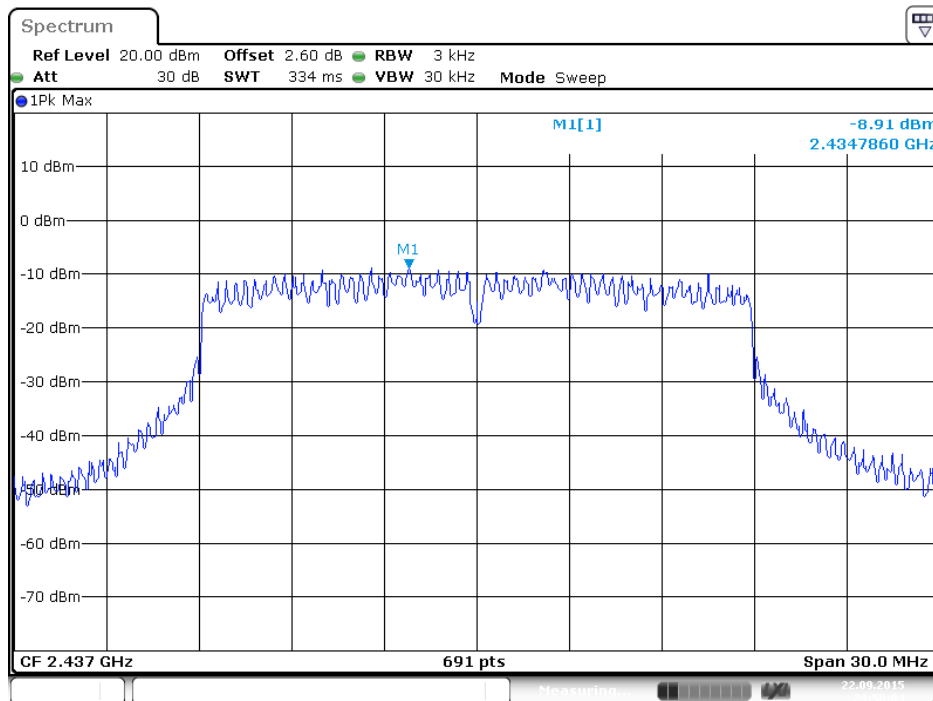

**Power Density Plot on Configuration IEEE 802. 11ac MCS0/Nss1 VHT20 / 2437 MHz / Chain 3**

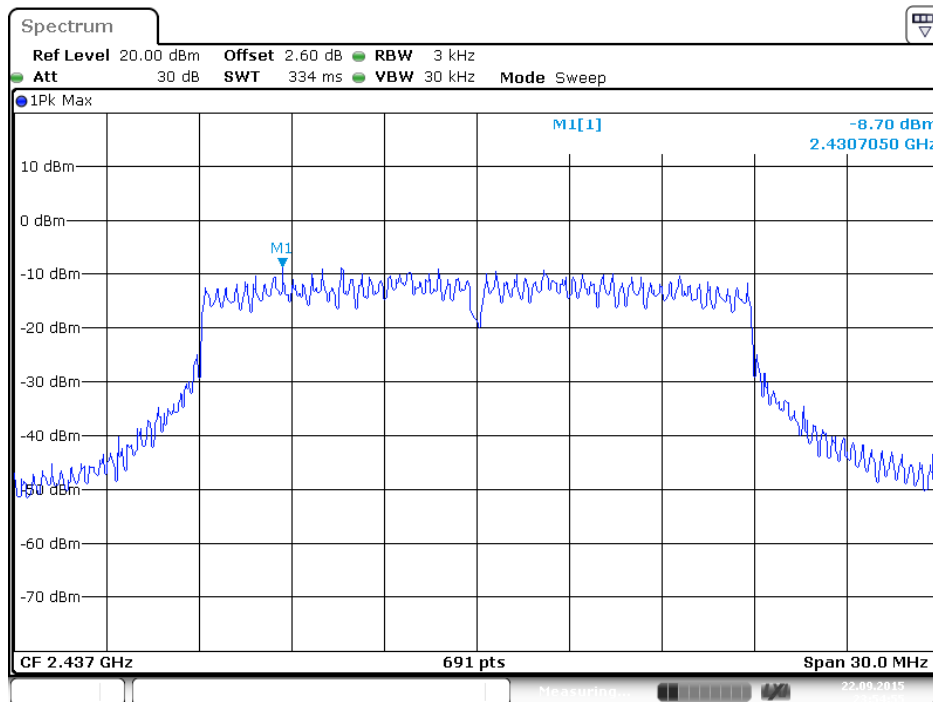

**Power Density Plot on Configuration IEEE 802. 11ac MCS0/Nss1 VHT20 / 2437 MHz / Chain 4**

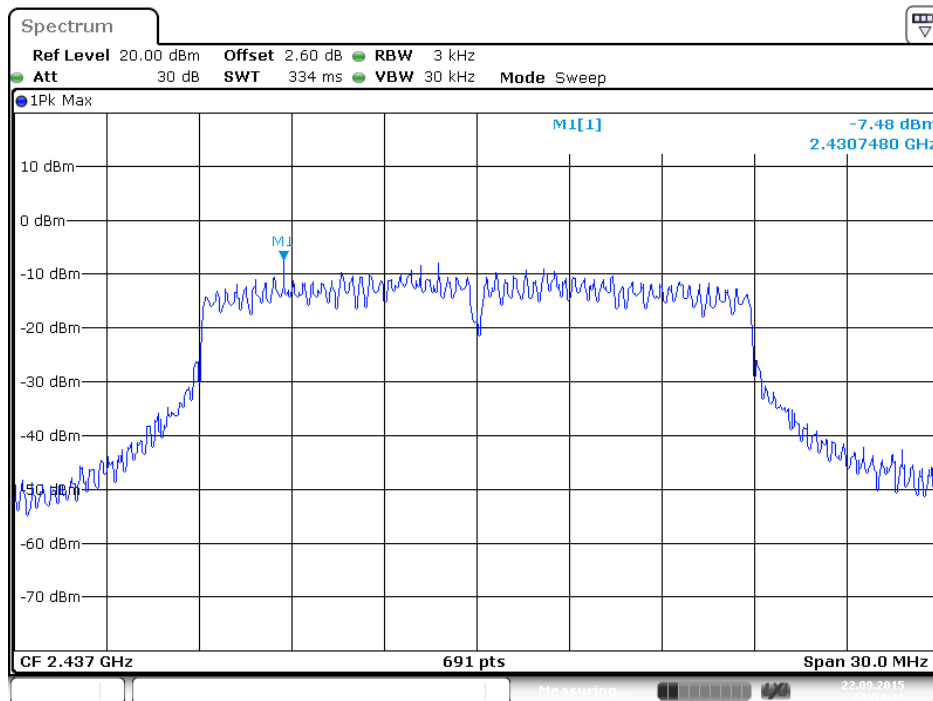

Power Density Plot on Configuration IEEE 802. 11ac MCS0/Nss1 VHT40 / 2437 MHz / Chain 1

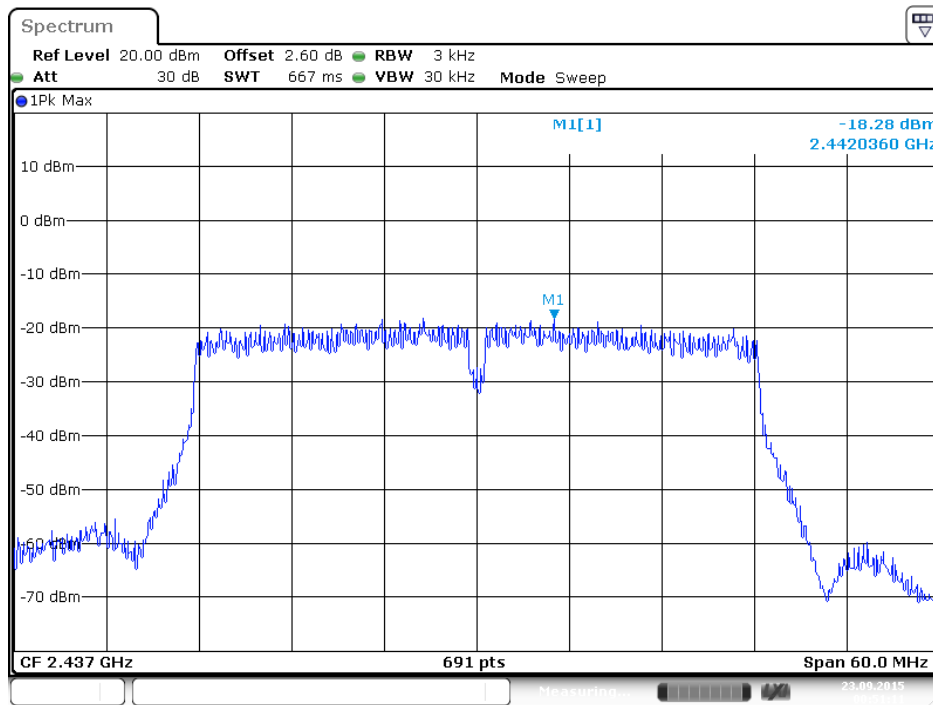

Power Density Plot on Configuration IEEE 802. 11ac MCS0/Nss1 VHT40 / 2437 MHz / Chain 2

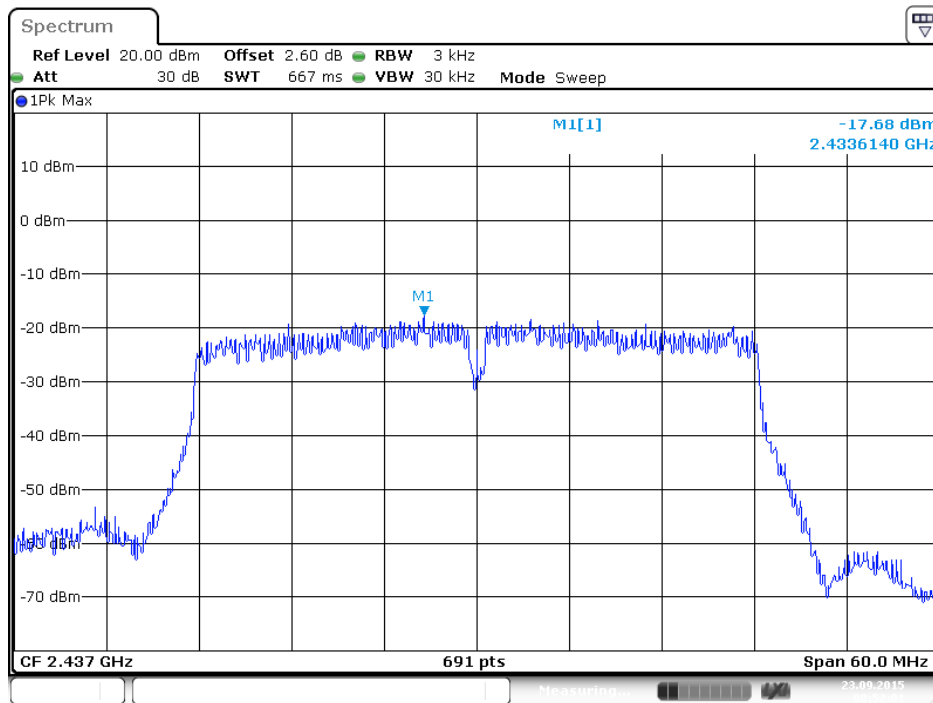

**Power Density Plot on Configuration IEEE 802. 11ac MCS0/Nss1 VHT40 / 2437 MHz / Chain 3**

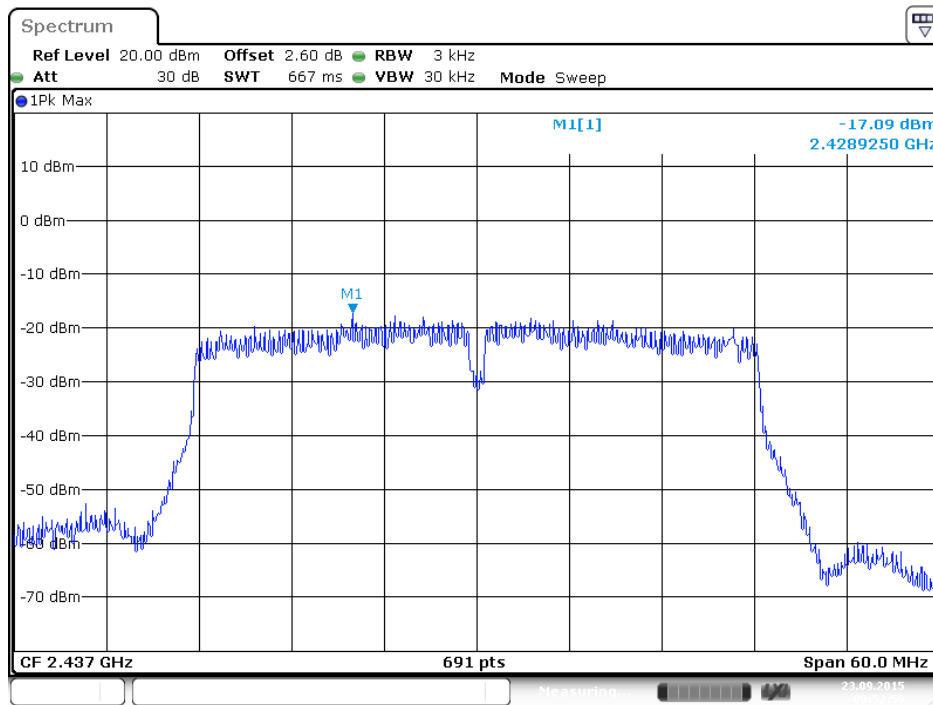

**Power Density Plot on Configuration IEEE 802. 11ac MCS0/Nss1 VHT40 / 2437 MHz / Chain 4**

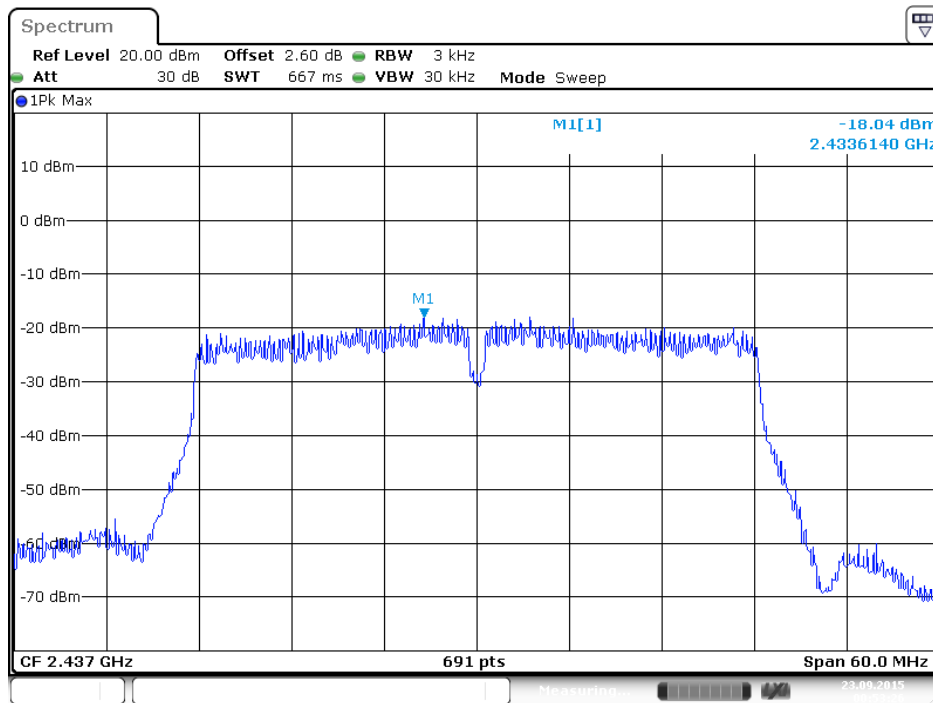

**Power Density Plot on Configuration IEEE 802. 11ac MCS0/Nss2 VHT20 / 2437 MHz / Chain 1**

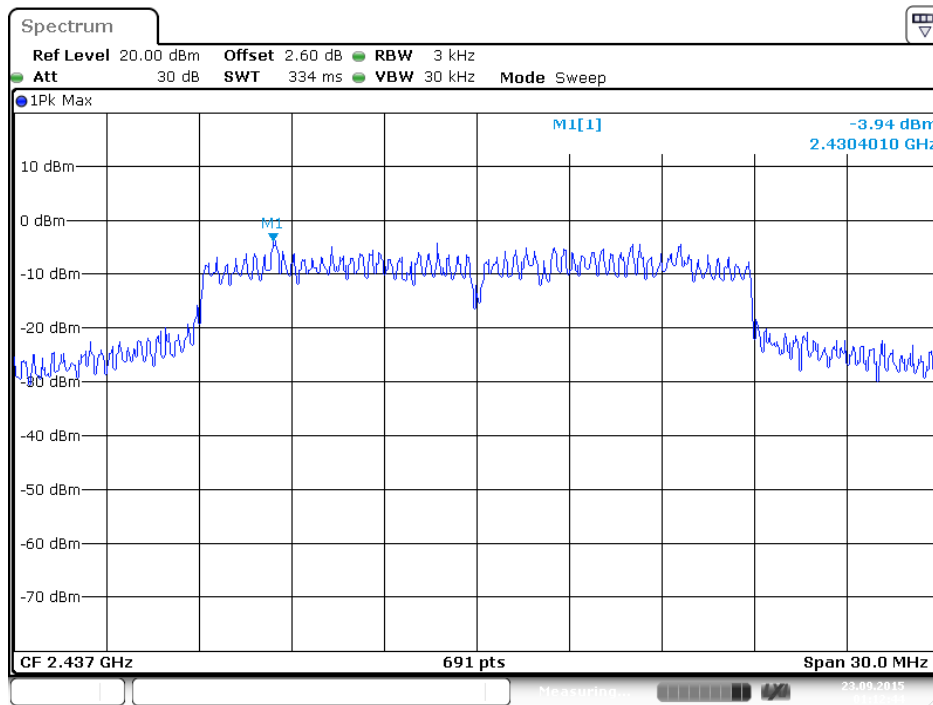

**P Power Density Plot on Configuration IEEE 802. 11ac MCS0/Nss2 VHT20 / 2437 MHz / Chain 2**

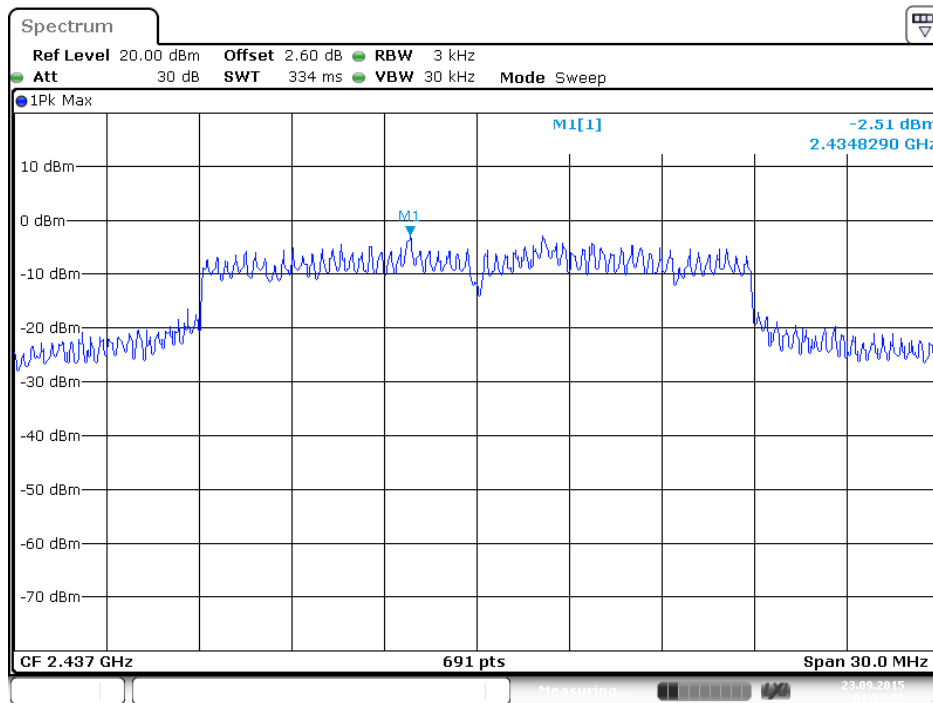

**Power Density Plot on Configuration IEEE 802. 11ac MCS0/Nss2 VHT20 / 2437 MHz / Chain 3**

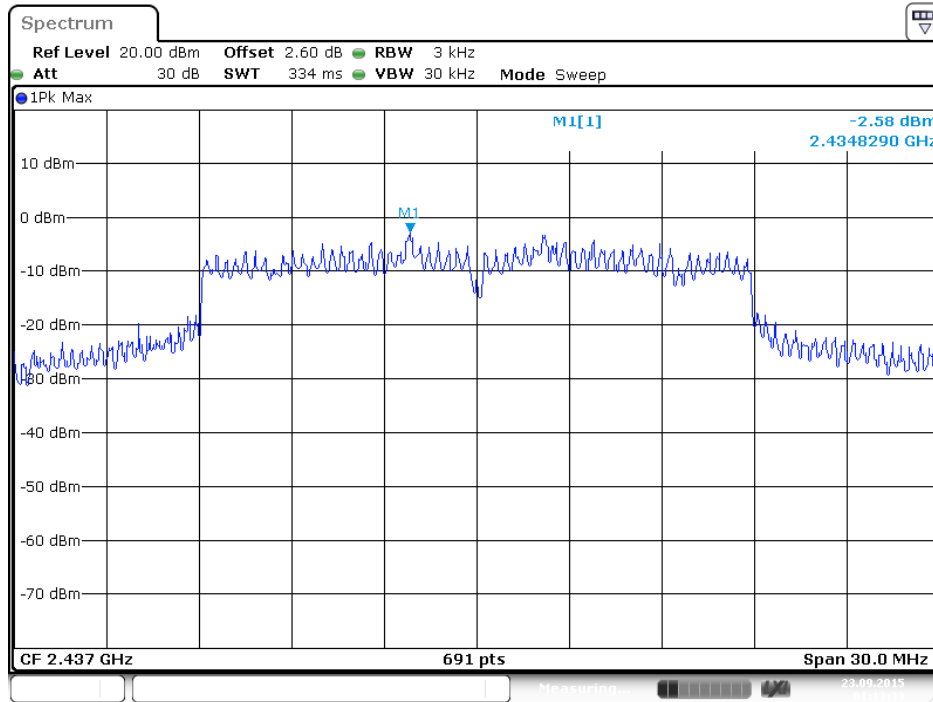

**Power Density Plot on Configuration IEEE 802. 11ac MCS0/Nss2 VHT20 / 2437 MHz / Chain 4**

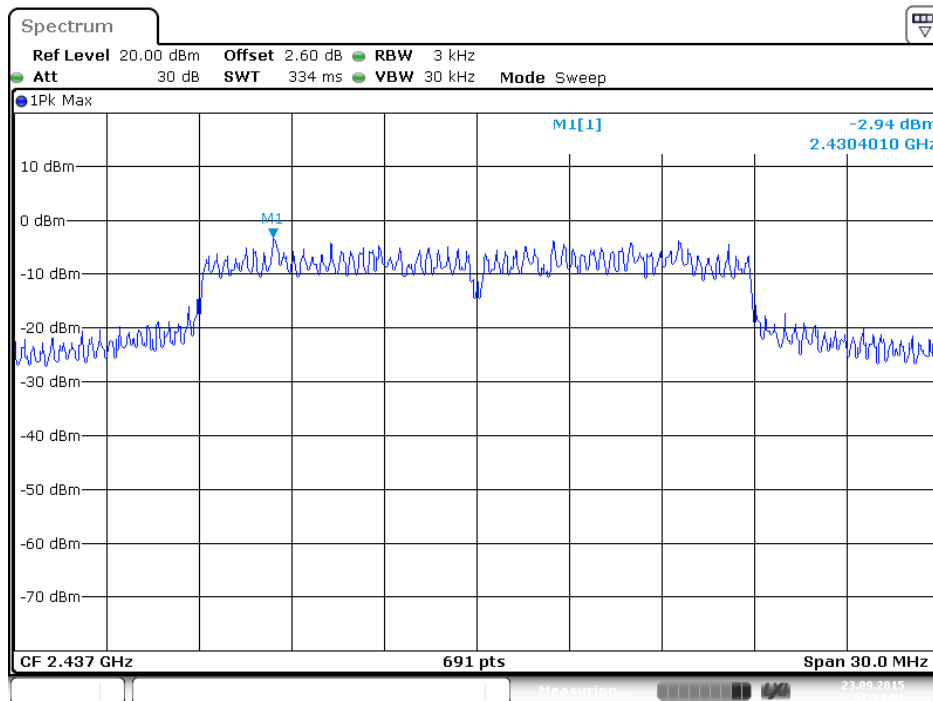

**Power Density Plot on Configuration IEEE 802.11ac MCS0/Nss2 VHT40 / 2437 MHz / Chain 1**

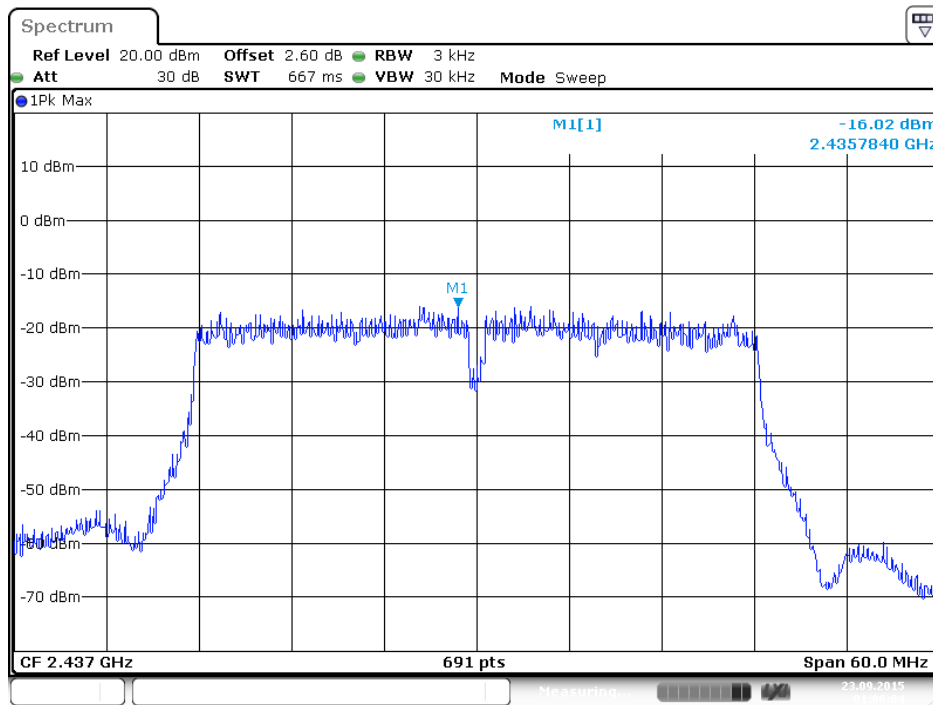

**Power Density Plot on Configuration IEEE 802.11ac MCS0/Nss2 VHT40 / 2437 MHz / Chain 2**

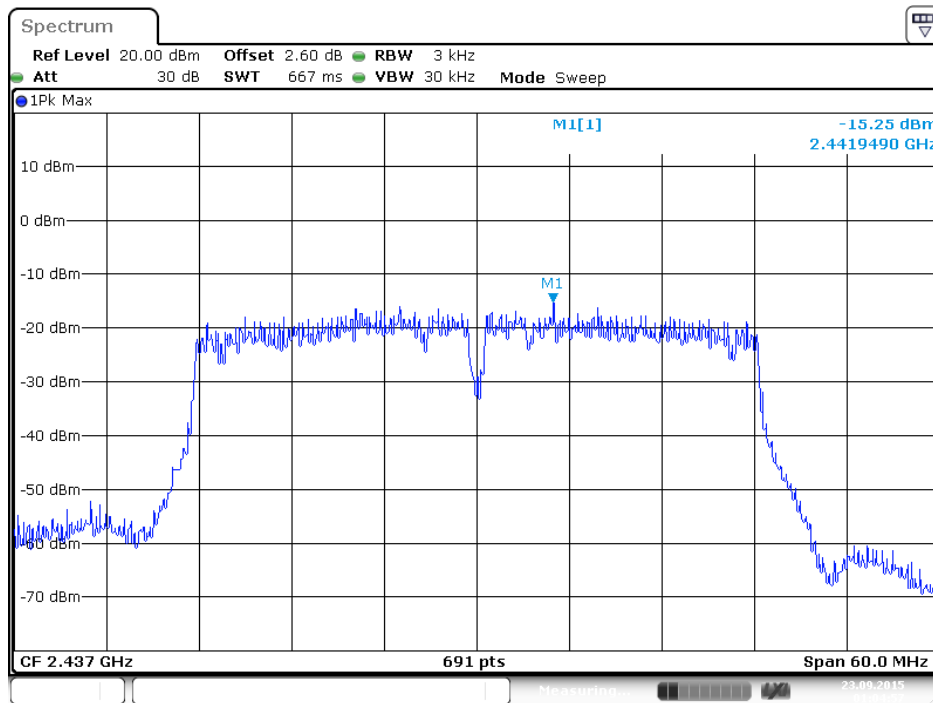



**Power Density Plot on Configuration IEEE 802.11ac MCS0/Nss2 VHT40 / 2437 MHz / Chain 3**

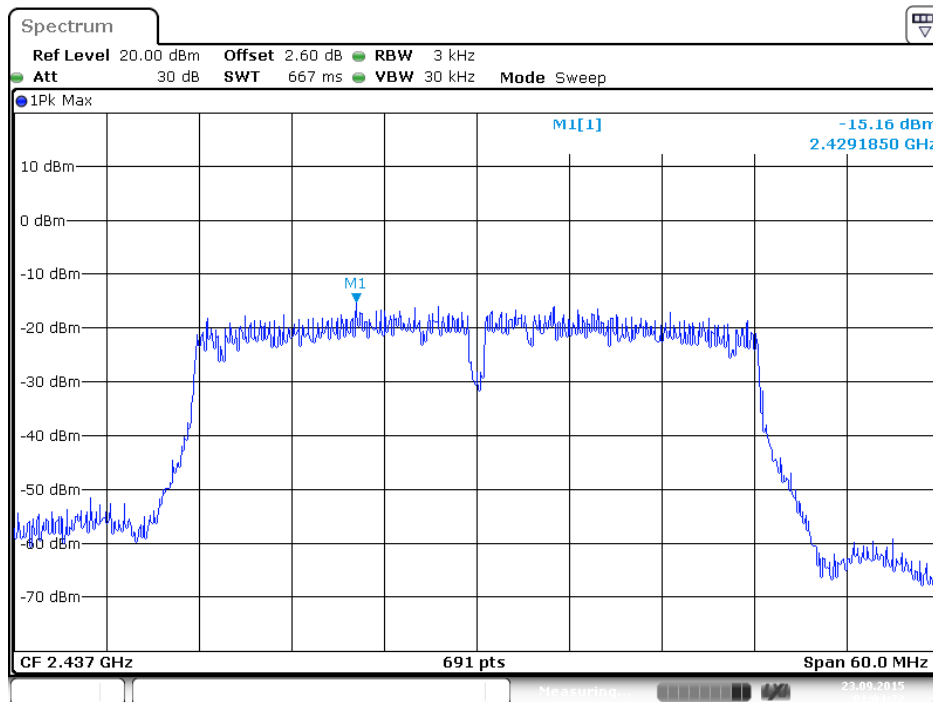

**Power Density Plot on Configuration IEEE 802.11ac MCS0/Nss2 VHT40 / 2437 MHz / Chain 4**

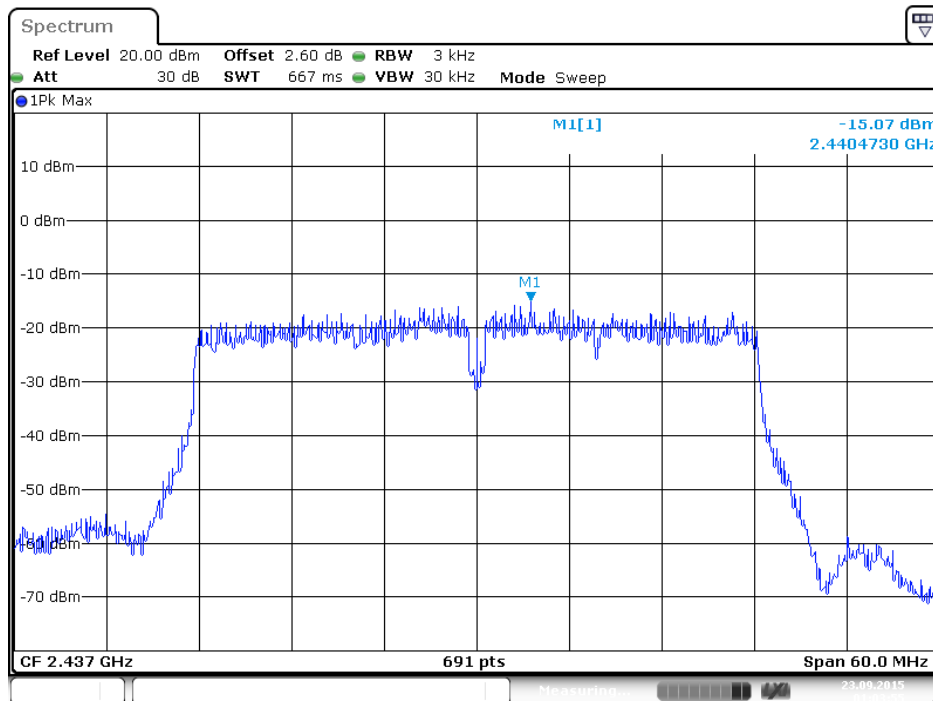

**Power Density Plot on Configuration IEEE 802. 11ac MCS0/Nss3 VHT20 / 2437 MHz / Chain 1**

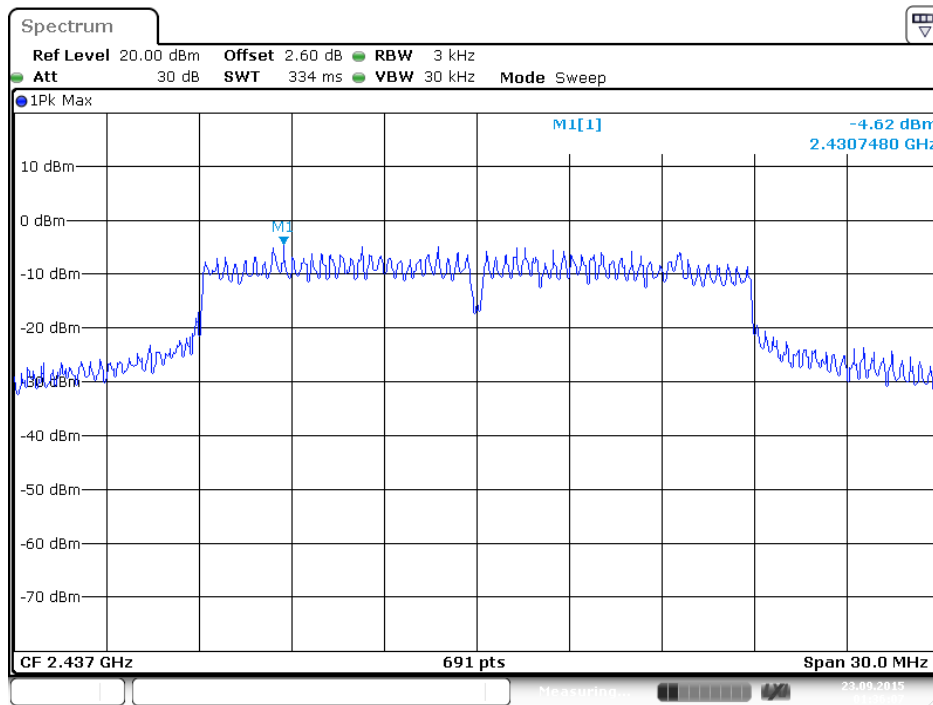

**P Power Density Plot on Configuration IEEE 802. 11ac MCS0/Nss3 VHT20 / 2437 MHz / Chain 2**

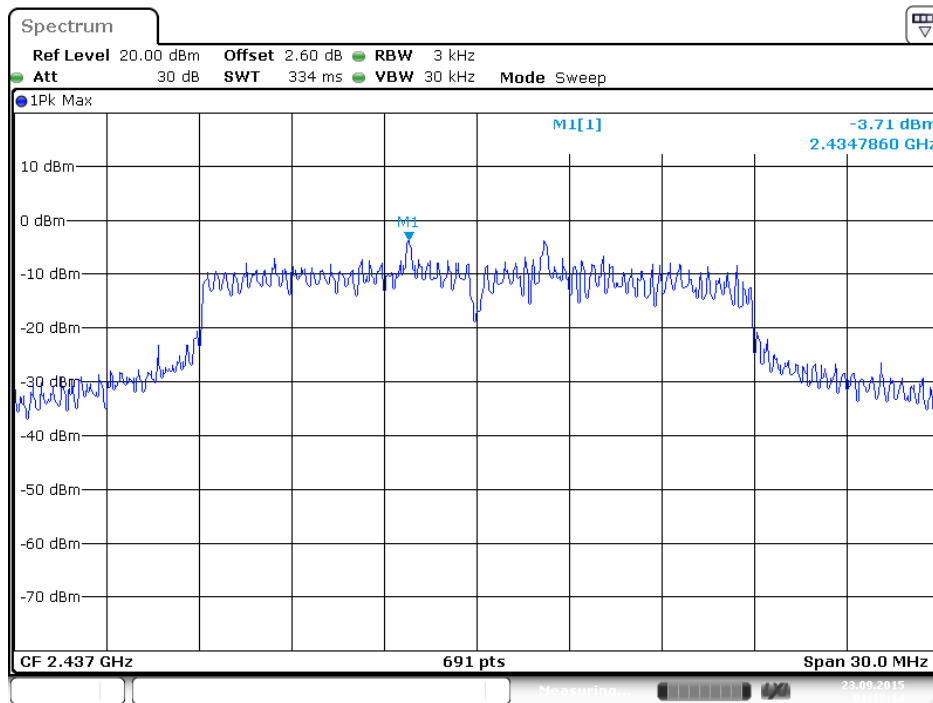

**Power Density Plot on Configuration IEEE 802.11ac MCS0/Nss3 VHT20 / 2437 MHz / Chain 3**

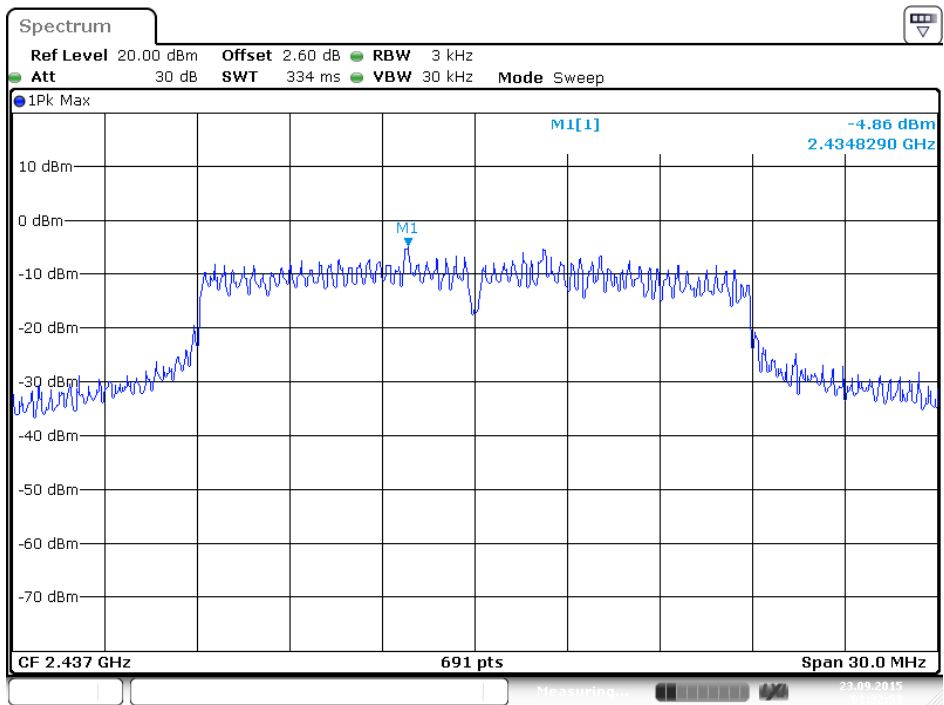

**Power Density Plot on Configuration IEEE 802.11ac MCS0/Nss3 VHT20 / 2437 MHz / Chain 4**

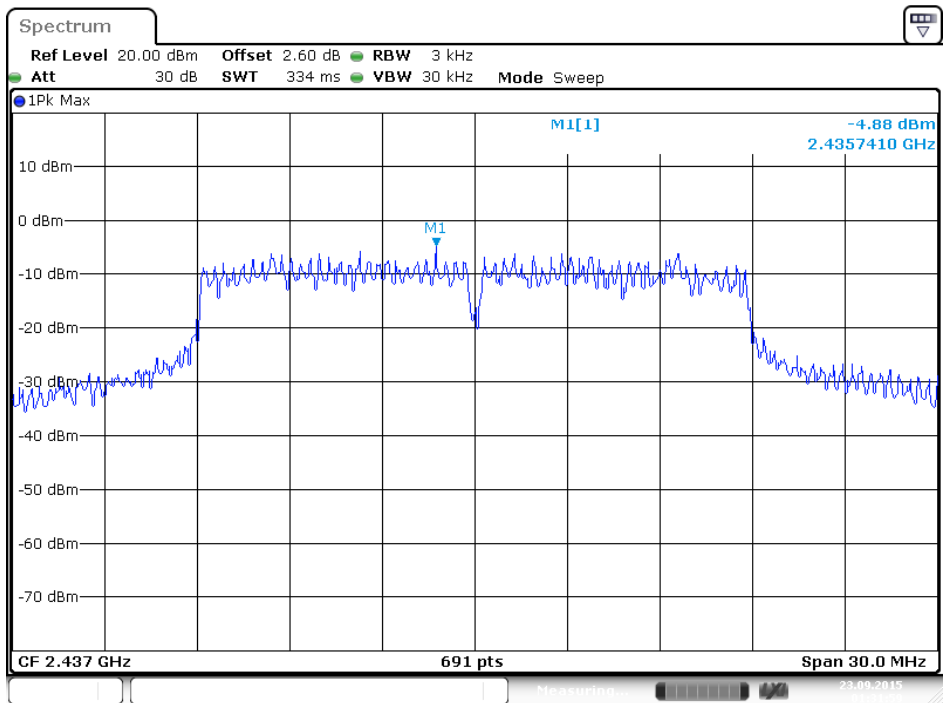

**Power Density Plot on Configuration IEEE 802.11ac MCS0/Nss3 VHT40 / 2437 MHz / Chain 1**

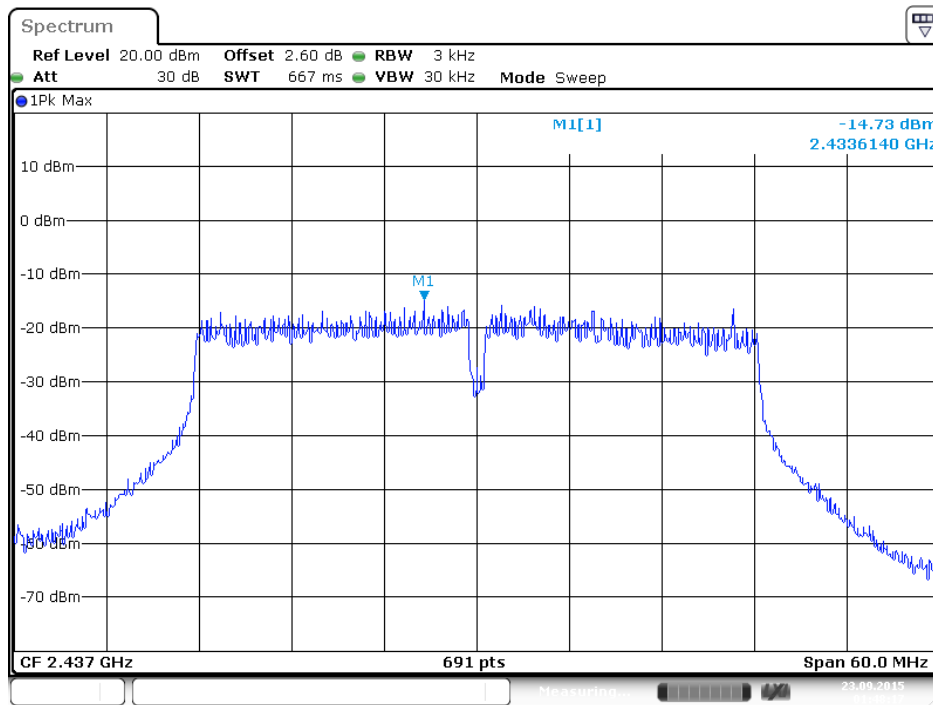

**Power Density Plot on Configuration IEEE 802.11ac MCS0/Nss3 VHT40 / 2437 MHz / Chain 2**

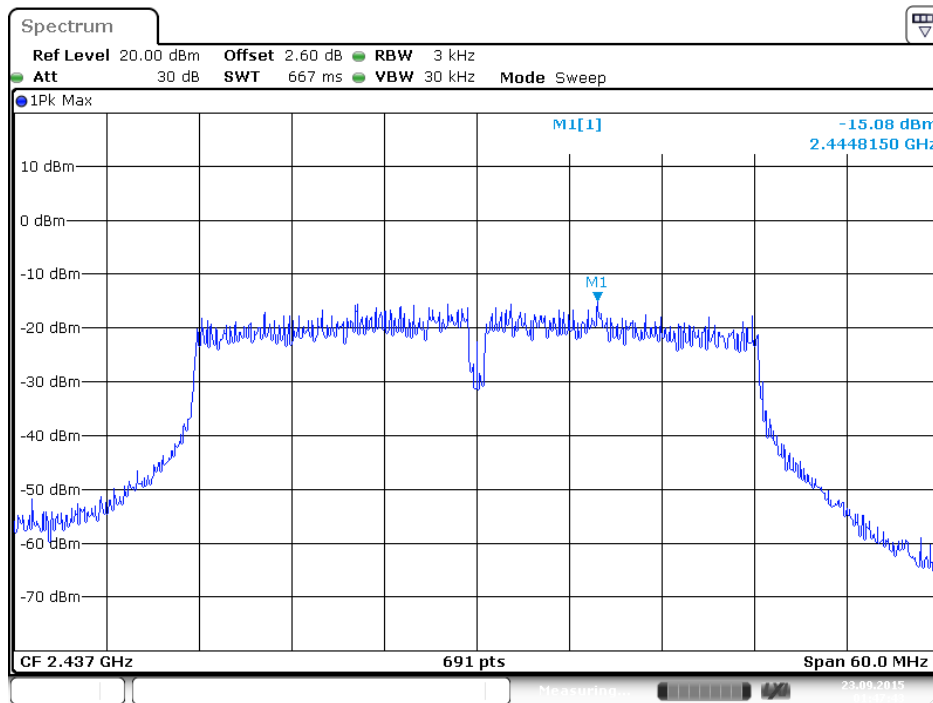

**Power Density Plot on Configuration IEEE 802. 11ac MCS0/Nss3 VHT40 / 2437 MHz / Chain 3**

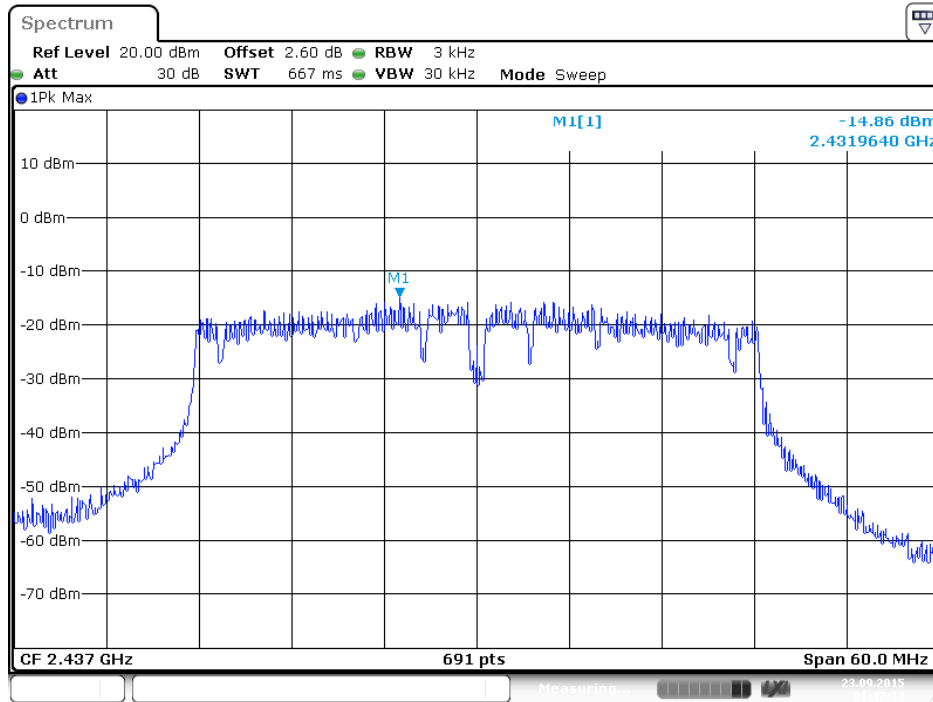

**Power Density Plot on Configuration IEEE 802. 11ac MCS0/Nss3 VHT40 / 2437 MHz / Chain 4**

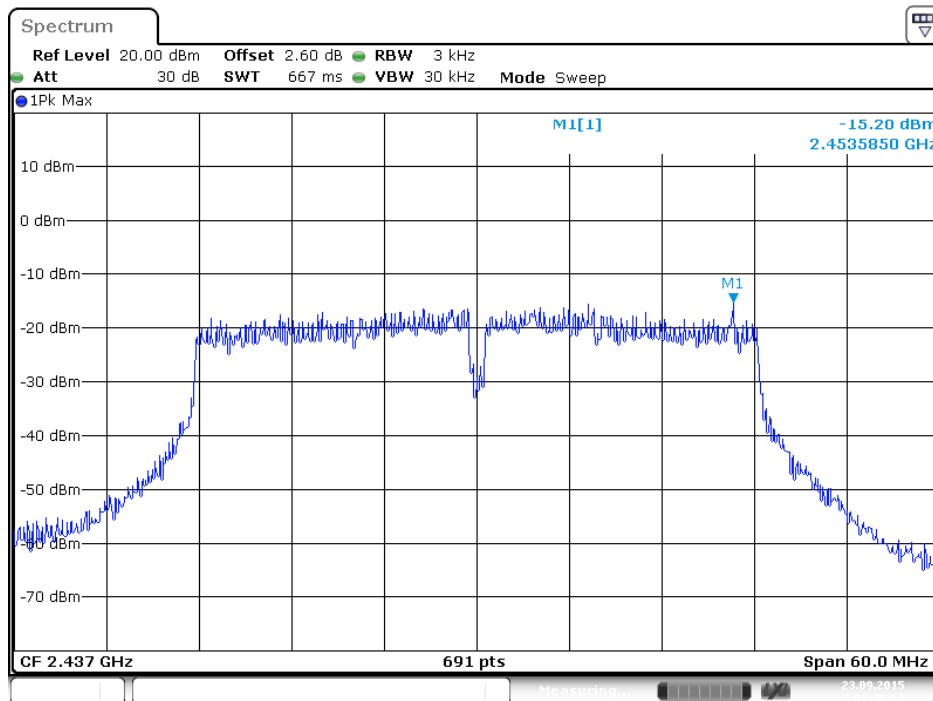

<For Radio 3 Mode>

Power Density Plot on Configuration IEEE 802.11b / 2437 MHz / Chain 9

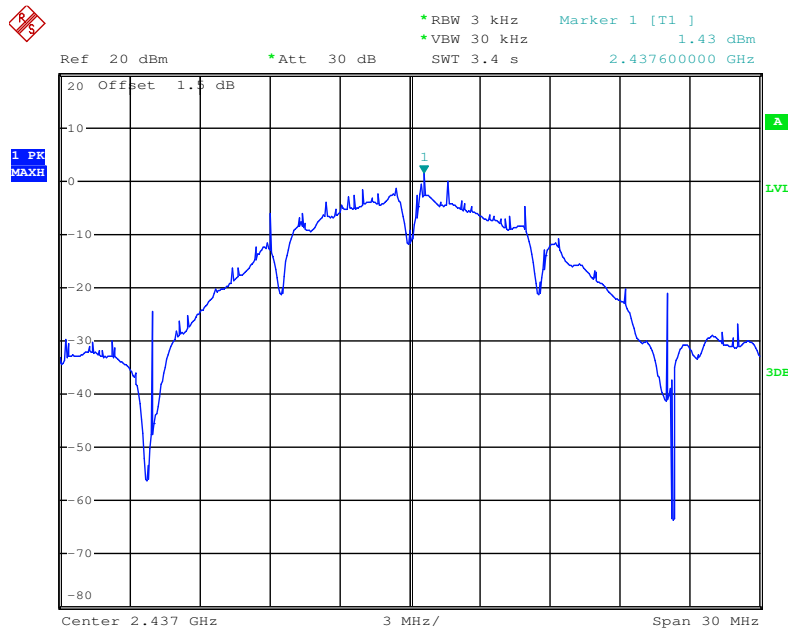

Date: 16.SEP.2015 20:36:19

Power Density Plot on Configuration IEEE 802.11g / 2437 MHz / Chain 9

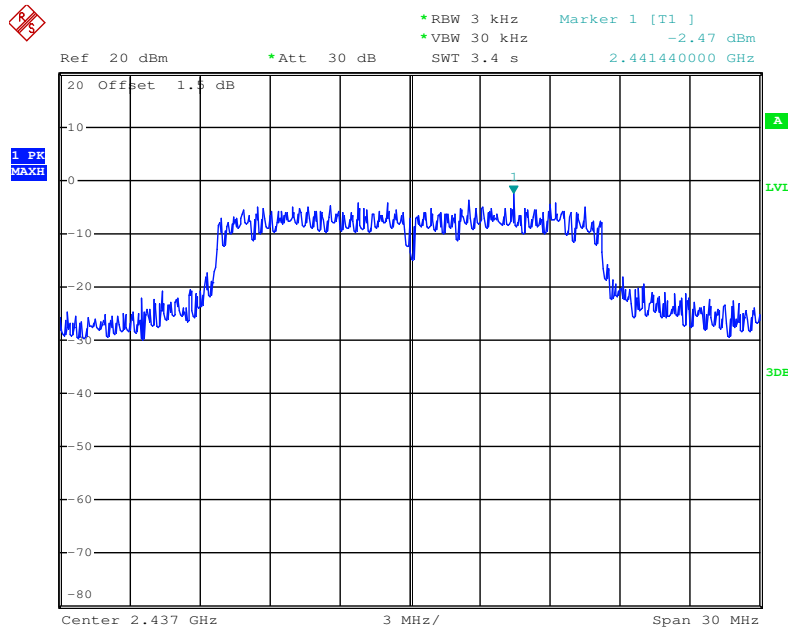

Date: 16.SEP.2015 20:38:22

**Power Density Plot on Configuration IEEE 802.11ac MCS0/Nss1 VHT20 / 2437 MHz / Chain 9**

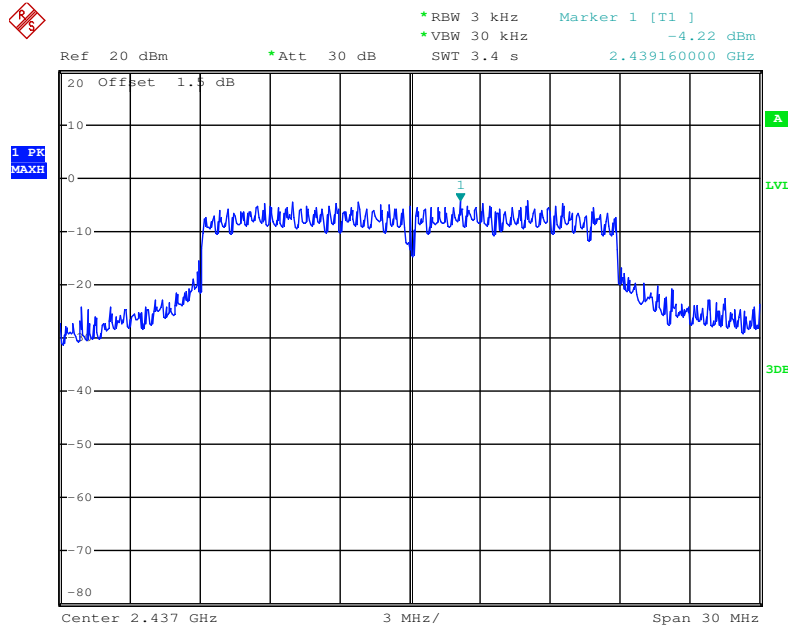

Date: 16.SEP.2015 20:43:45

**Power Density Plot on Configuration IEEE 802.11ac MCS0/Nss1 VHT40 / 2437 MHz / Chain 9**

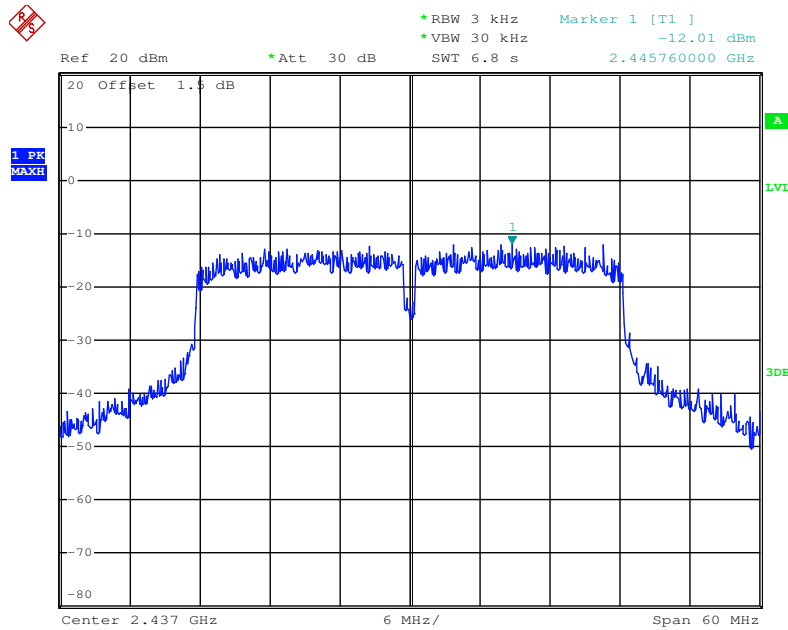

Date: 16.SEP.2015 20:47:05

## 4.4. 6dB Spectrum Bandwidth Measurement

### 4.4.1. Limit

For digital modulation systems, the minimum 6dB bandwidth shall be at least 500 kHz.

### 4.4.2. Measuring Instruments and Setting

Please refer to section 5 of equipments list in this report. The following table is the setting of spectrum analyzer.

6dB Spectrum Bandwidth	
Spectrum Parameters	Setting
Attenuation	Auto
Span Frequency	> 6dB Bandwidth
RBW	100kHz
VBW	$\geq 3 \times \text{RBW}$
Detector	Peak
Trace	Max Hold
Sweep Time	Auto
99% Occupied Bandwidth	
Spectrum Parameters	Setting
Span	1.5 times to 5.0 times the OBW
RBW	1 % to 5 % of the OBW
VBW	$\geq 3 \times \text{RBW}$
Detector	Peak
Trace	Max Hold

### 4.4.3. Test Procedures

1. The transmitter was conducted to the spectrum analyzer in peak hold mode.
2. Test was performed in accordance with KDB558074 D01 v03r05 for Performing Compliance Measurements on Digital Transmission Systems (DTS) Operating Under §15.247 section 8.0 DTS 6-dB signal bandwidth option 1.
3. Multiple antenna system was performed in accordance with KDB 662911 D01 v02r01 Emissions Testing of Transmitters with Multiple Outputs in the Same Band.
4. Measurement perform conducted of each port.
5. Measured the spectrum width with power higher than 6dB below carrier.



#### **4.4.4. Test Setup Layout**

This test setup layout is the same as that shown in section 4.3.4.

#### **4.4.5. Test Deviation**

There is no deviation with the original standard.

#### **4.4.6. EUT Operation during Test**

The EUT was programmed to be in continuously transmitting mode.

## 4.4.7. Test Result of 6dB Spectrum Bandwidth

Temperature	25°C	Humidity	45%
Test Engineer	Mars Lin		

&lt;For Radio 1 Non-beamforming Mode&gt;

Mode	Frequency	6dB Bandwidth (MHz)				99% Occupied Bandwidth (MHz)				Min. Limit (kHz)	Test Result
		Chain				Chain					
		1	2	3	4	1	2	3	4		
802.11b	2412 MHz	8.12	8.06	8.12	8.06	13.02	12.94	13.11	12.76	500	Complies
	2437 MHz	8.06	8.06	9.10	8.52	13.98	14.33	14.07	13.89	500	Complies
	2462 MHz	8.06	8.12	9.04	8.06	13.20	13.11	13.72	13.20	500	Complies
802.11g	2412 MHz	16.35	15.71	16.29	15.94	16.50	16.41	16.41	16.41	500	Complies
	2437 MHz	15.65	16.35	16.35	16.29	18.84	19.62	22.92	19.62	500	Complies
	2462 MHz	16.12	16.35	16.00	16.35	16.50	16.50	16.41	16.50	500	Complies
11ac MCS0/Nss1 VHT20	2412 MHz	17.62	17.62	17.62	17.57	17.63	17.63	17.63	17.63	500	Complies
	2437 MHz	17.62	16.93	15.65	17.22	18.15	18.41	18.93	18.15	500	Complies
	2462 MHz	16.93	17.62	17.62	17.22	17.71	17.63	17.63	17.63	500	Complies
11ac MCS0/Nss1 VHT40	2422 MHz	35.13	35.13	35.13	35.71	36.61	36.47	36.76	36.61	500	Complies
	2437 MHz	34.09	35.13	35.13	32.93	36.61	36.90	36.61	36.47	500	Complies
	2452 MHz	33.16	35.36	35.71	35.13	36.61	36.61	36.61	36.61	500	Complies
11ac MCS0/Nss4 VHT20	2412 MHz	17.68	17.68	17.68	17.74	17.80	17.80	17.89	17.89	500	Complies
	2437 MHz	17.68	17.68	17.74	17.62	18.93	19.71	19.97	19.45	500	Complies
	2462 MHz	17.74	17.74	17.74	17.68	17.89	17.80	17.89	17.97	500	Complies
11ac MCS0/Nss4 VHT40	2422 MHz	36.17	36.29	35.94	36.17	38.78	40.23	38.49	39.07	500	Complies
	2437 MHz	36.17	36.29	36.41	36.17	38.78	40.52	38.64	38.93	500	Complies
	2452 MHz	36.17	36.29	36.41	36.17	39.07	40.67	38.78	39.36	500	Complies

## &lt;For Radio 1 Beamforming Mode&gt;

Mode	Frequency	6dB Bandwidth (MHz)				99% Occupied Bandwidth (MHz)				Min. Limit (kHz)	Test Result
		Chain				Chain					
		1	2	3	4	1	2	3	4		
11ac MCS0/Nss1	2412 MHz	16.58	17.62	17.57	17.62	17.63	17.63	17.63	17.63	500	Complies
	2437 MHz	17.33	17.22	17.74	17.62	18.49	18.93	22.14	19.36	500	Complies
	VHT20	2462 MHz	17.62	17.62	15.71	17.62	17.63	17.63	17.63	17.63	500
11ac MCS0/Nss1	2422 MHz	35.71	35.01	34.67	35.01	36.47	36.76	36.61	36.47	500	Complies
	2437 MHz	35.71	35.13	35.01	35.13	36.61	36.76	36.61	36.47	500	Complies
	VHT40	2452 MHz	35.48	35.13	35.71	35.13	36.61	36.61	36.61	36.61	500
11ac MCS0/Nss2	2412 MHz	17.51	17.68	17.62	17.68	17.71	17.71	17.71	17.71	500	Complies
	2437 MHz	17.62	17.68	17.68	17.62	32.30	37.25	38.21	33.78	500	Complies
	VHT20	2462 MHz	17.57	17.62	17.62	17.57	17.71	17.80	17.80	17.80	500
11ac MCS0/Nss2	2422 MHz	35.48	35.83	35.83	35.48	36.18	36.32	36.32	36.18	500	Complies
	2437 MHz	35.48	35.83	35.83	35.48	36.76	36.61	36.61	36.61	500	Complies
	VHT40	2452 MHz	35.59	35.48	35.83	36.17	36.61	36.61	36.61	500	Complies
11ac MCS0/Nss3	2412 MHz	17.68	17.68	17.80	17.57	17.80	17.80	17.89	17.89	500	Complies
	2437 MHz	17.62	17.33	16.06	17.74	19.97	22.05	21.88	20.14	500	Complies
	VHT20	2462 MHz	17.68	17.33	17.74	17.68	17.89	17.80	17.89	17.97	500
11ac MCS0/Nss3	2422 MHz	36.41	36.06	35.13	36.41	37.05	36.90	37.05	37.05	500	Complies
	2437 MHz	36.41	36.06	35.13	36.41	37.05	36.90	37.05	37.19	500	Complies
	VHT40	2452 MHz	36.41	35.71	35.13	36.41	37.05	36.90	37.05	37.19	500

## &lt;For Radio 3 Mode&gt;

Mode	Frequency	6dB Bandwidth (MHz)	99% Occupied Bandwidth (MHz)	Min. Limit (kHz)	Test Result
802.11b	2412 MHz	6.55	12.16	500	Complies
	2437 MHz	8.06	16.06	500	Complies
	2462 MHz	7.07	13.63	500	Complies
802.11g	2412 MHz	16.29	16.76	500	Complies
	2437 MHz	15.77	27.44	500	Complies
	2462 MHz	15.77	17.11	500	Complies
11ac MCS0/Nss1 VHT20	2412 MHz	16.58	17.89	500	Complies
	2437 MHz	16.52	26.31	500	Complies
	2462 MHz	16.29	17.97	500	Complies
11ac MCS0/Nss1 VHT40	2422 MHz	35.13	37.05	500	Complies
	2437 MHz	35.36	36.90	500	Complies
	2452 MHz	35.13	36.90	500	Complies

Note: All the test values were listed in the report.

For plots, only the channel with worse result was shown.

<For Radio 1 Non-beamforming Mode>

6 dB Bandwidth Plot on Configuration IEEE 802.11b / 2437 MHz / Chain 1

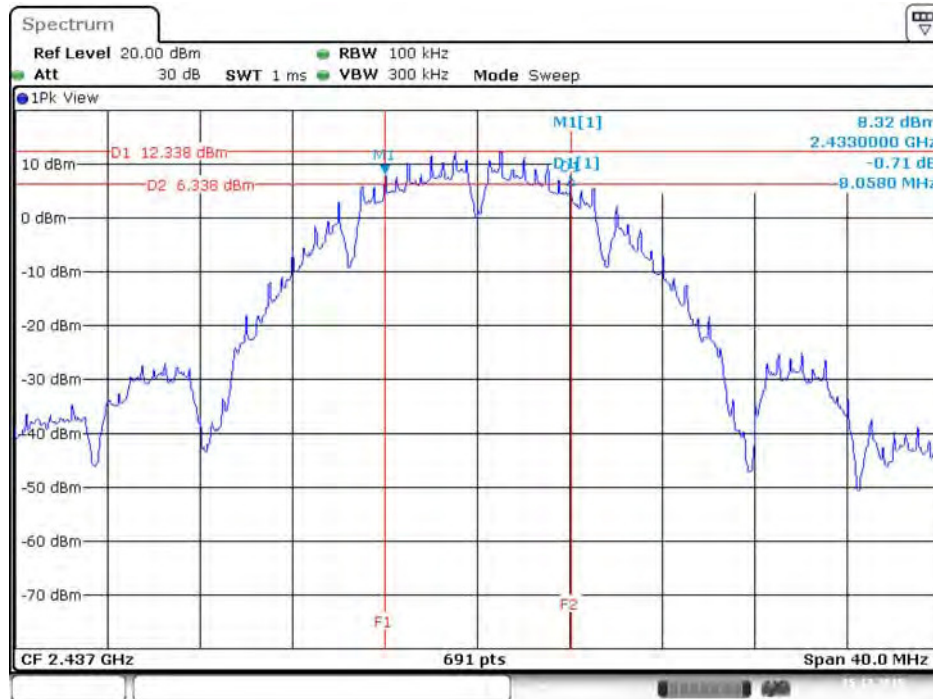

Date: 15.DEC.2015 11:00:38

99% Occupied Bandwidth Plot on Configuration IEEE 802.11b / 2437 MHz / Chain 1



Date: 15.DEC.2015 16:13:30

6 dB Bandwidth Plot on Configuration IEEE 802.11b / 2437 MHz / Chain 2

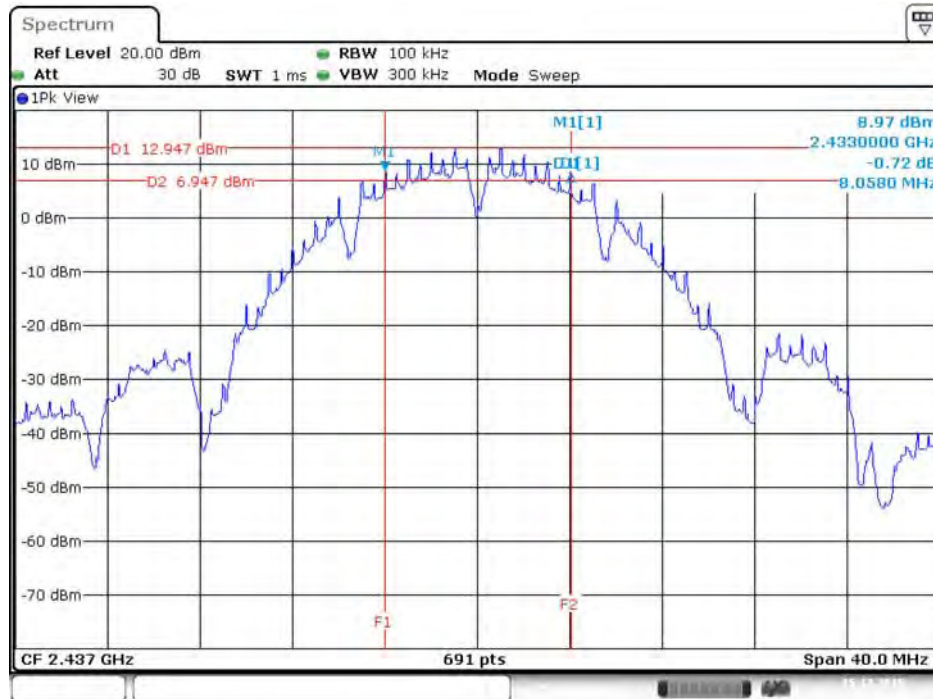

Date: 15.DEC.2015 11:00:25

99% Occupied Bandwidth Plot on Configuration IEEE 802.11b / 2437 MHz / Chain 2



Date: 15.DEC.2015 16:13:44

6 dB Bandwidth Plot on Configuration IEEE 802.11b / 2412 MHz / Chain 3

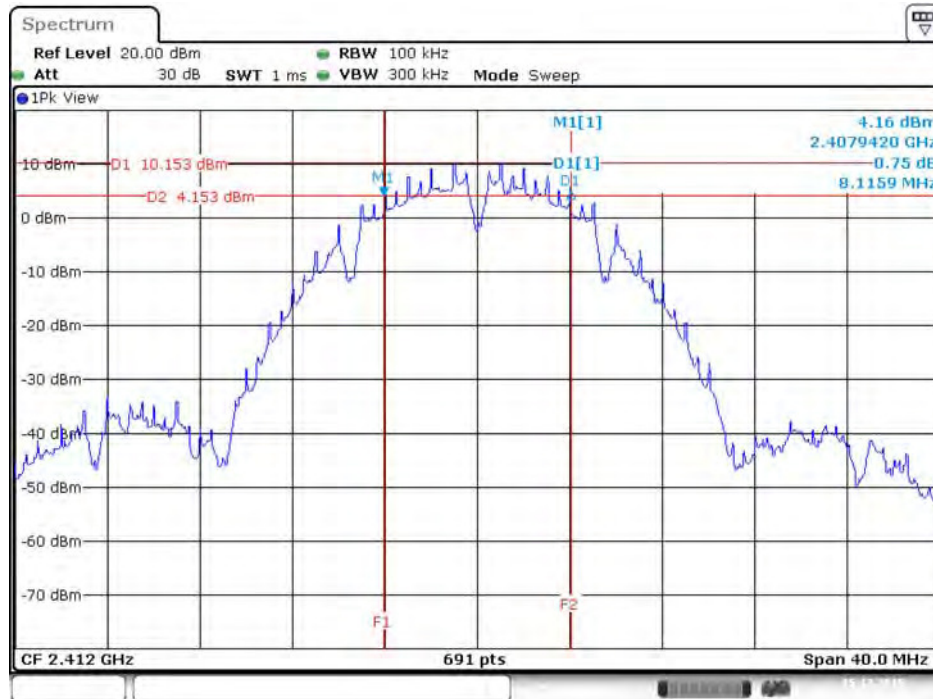

Date: 15.DEC.2015 10:58:43

99% Occupied Bandwidth Plot on Configuration IEEE 802.11b / 2437 MHz / Chain 3



Date: 15.DEC.2015 16:13:56

6 dB Bandwidth Plot on Configuration IEEE 802.11b / 2412 MHz / Chain 4

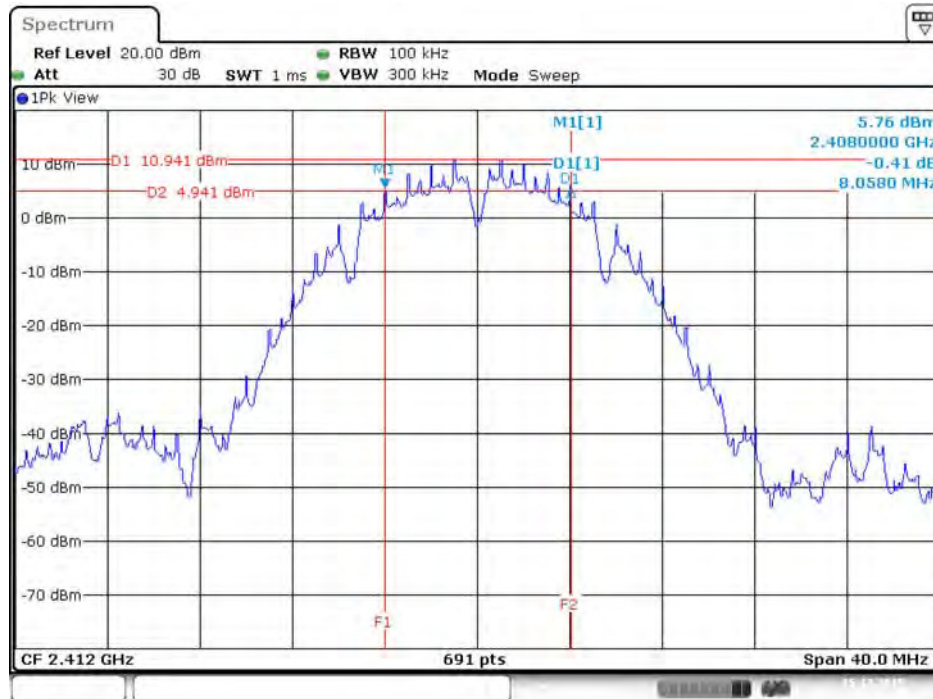

Date: 15.DEC.2015 10:58:54

99% Occupied Bandwidth Plot on Configuration IEEE 802.11b / 2437 MHz / Chain 4



Date: 15.DEC.2015 16:14:07



6 dB Bandwidth Plot on Configuration IEEE 802.11g / 2437 MHz / Chain 1

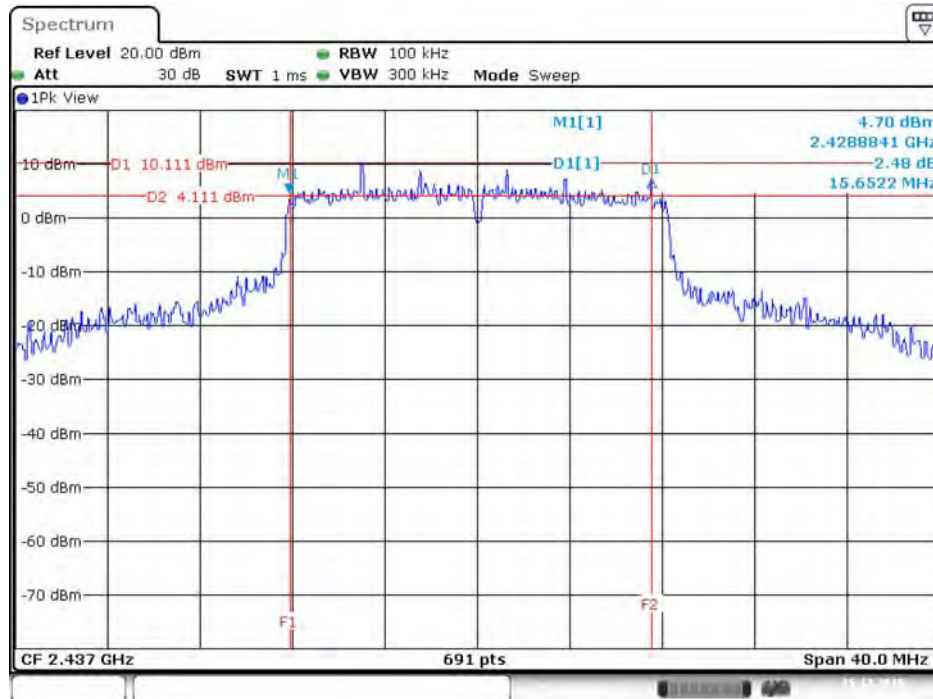

Date: 15.DEC.2015 11:05:33

99% Occupied Bandwidth Plot on Configuration IEEE 802.11g / 2437 MHz / Chain 1



Date: 15.DEC.2015 16:20:09

6 dB Bandwidth Plot on Configuration IEEE 802.11g / 2412 MHz / Chain 2

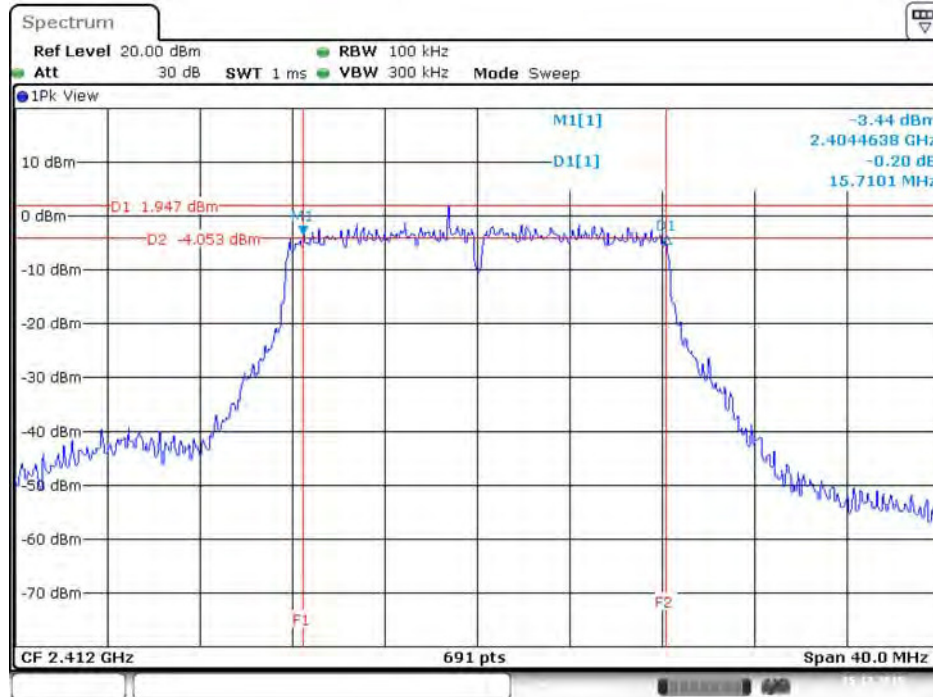

Date: 15.DEC.2015 11:04:29

99% Occupied Bandwidth Plot on Configuration IEEE 802.11g / 2437 MHz / Chain 2

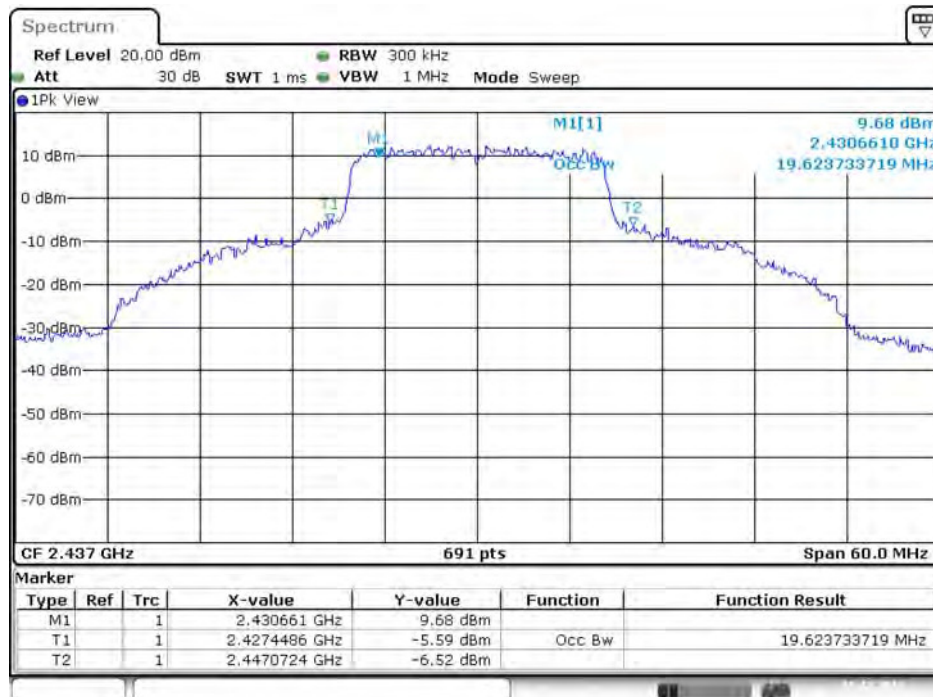

Date: 15.DEC.2015 16:19:48

6 dB Bandwidth Plot on Configuration IEEE 802.11g / 2462 MHz / Chain 3

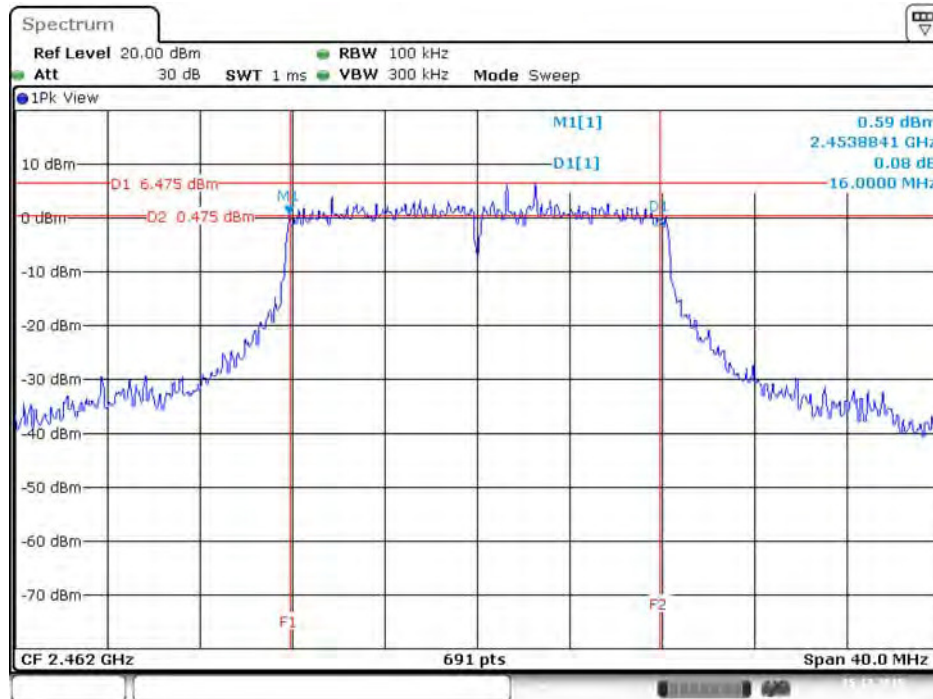

Date: 15.DEC.2015 11:13:43

99% Occupied Bandwidth Plot on Configuration IEEE 802.11g / 2437 MHz / Chain 3



Date: 15.DEC.2015 16:19:18

6 dB Bandwidth Plot on Configuration IEEE 802.11g / 2412 MHz / Chain 4

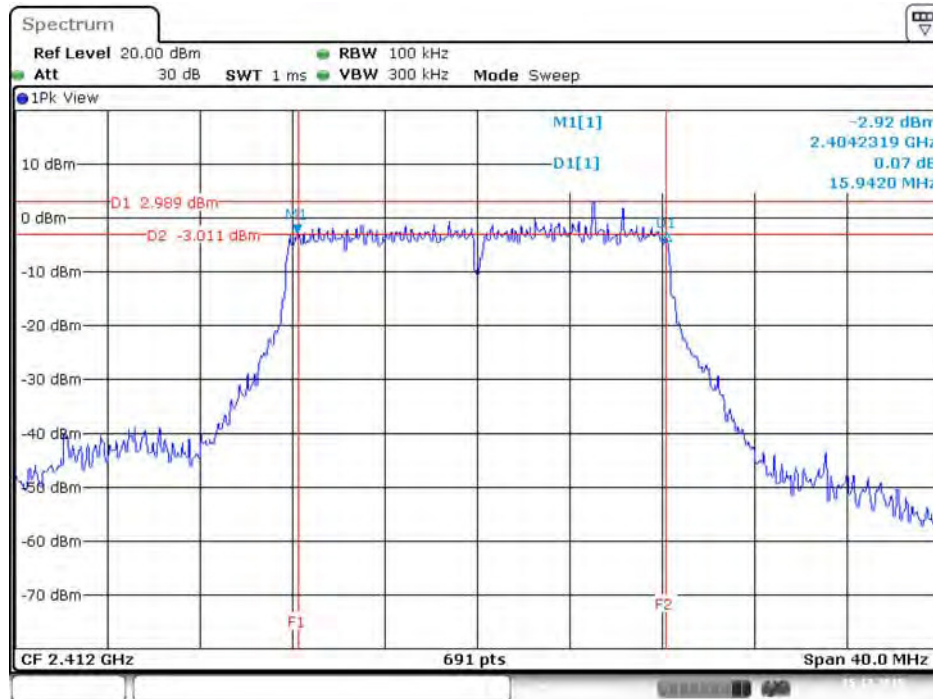

Date: 15.DEC.2015 11:04:15

99% Occupied Bandwidth Plot on Configuration IEEE 802.11g / 2437 MHz / Chain 4

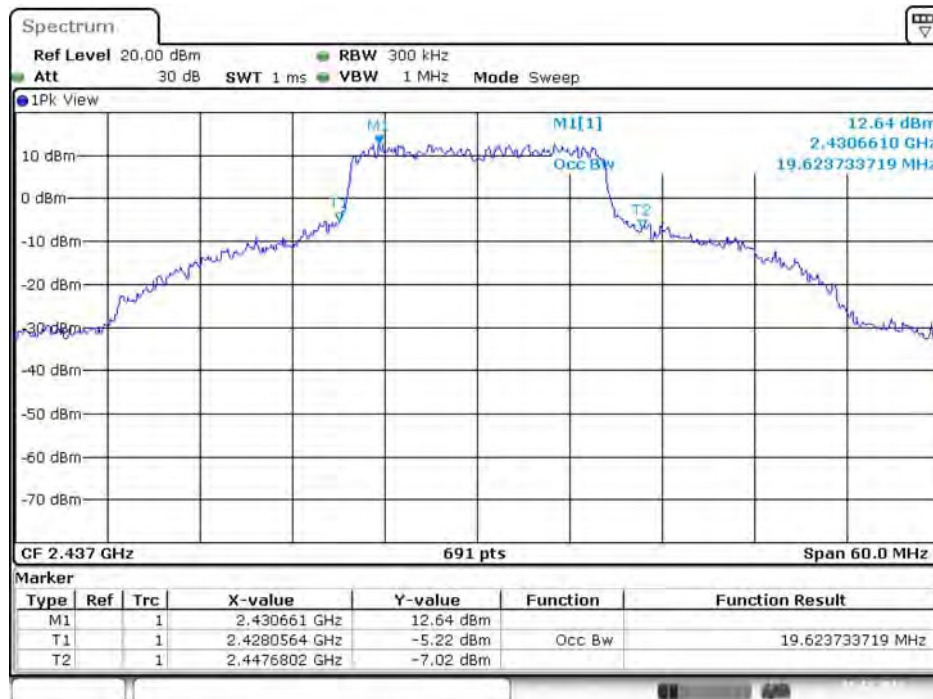

Date: 15.DEC.2015 16:19:00

6 dB Bandwidth Plot on Configuration IEEE 802.11ac MCS0/Nss1 VHT20 / 2462 MHz / Chain 1

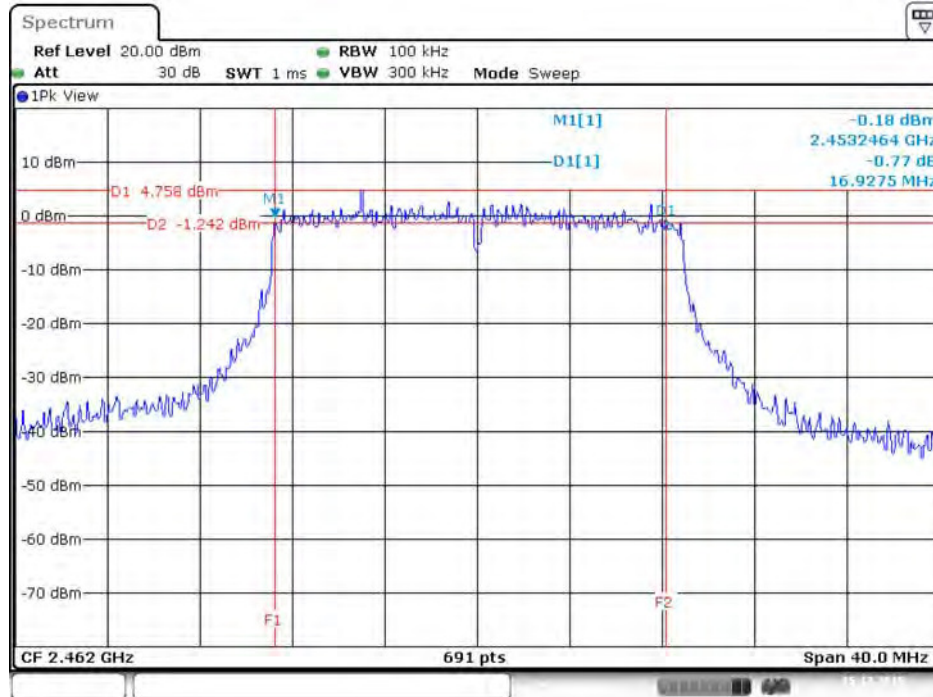

Date: 15.DEC.2015 11:19:51

99% Occupied Bandwidth Plot on Configuration IEEE 802.11ac MCS0/Nss1 VHT20 / 2437 MHz / Chain 1

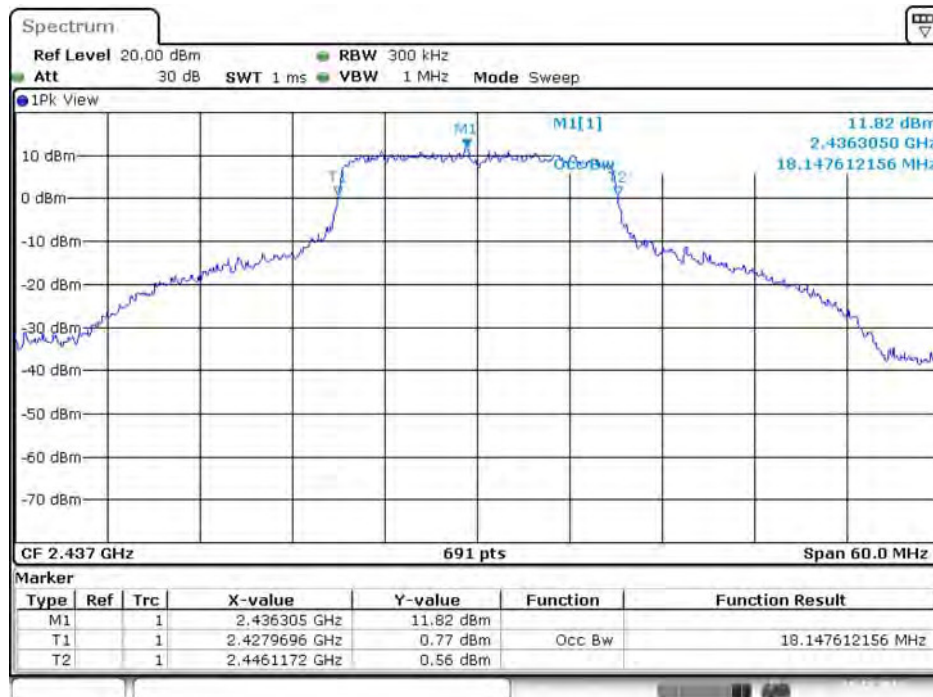

Date: 15.DEC.2015 15:44:35

6 dB Bandwidth Plot on Configuration IEEE 802.11ac MCS0/Nss1 VHT20 / 2437 MHz / Chain 2

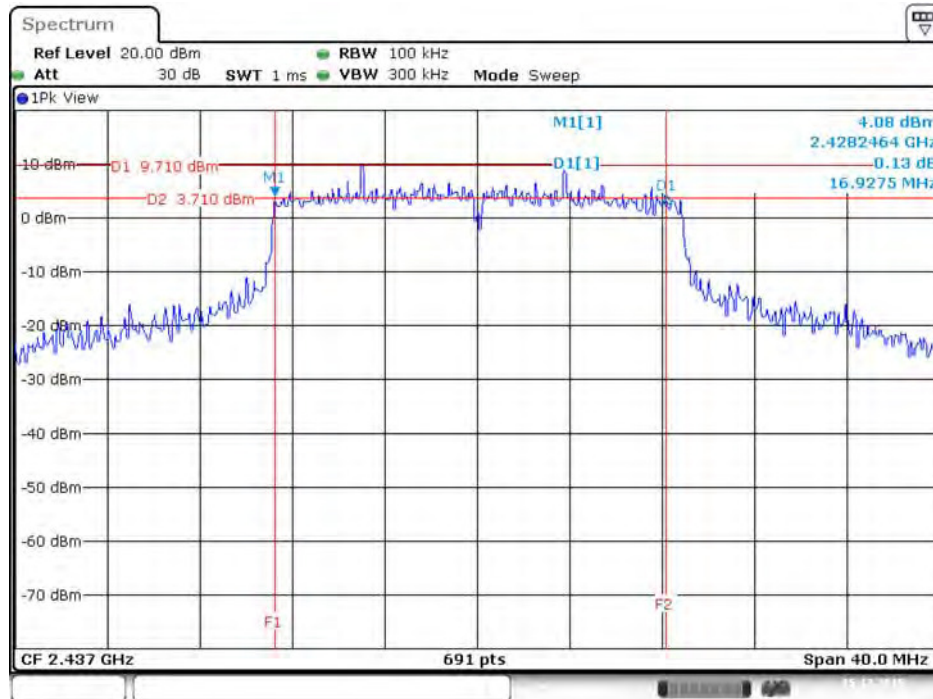

Date: 15.DEC.2015 11:18:40

99% Occupied Bandwidth Plot on Configuration IEEE 802.11ac MCS0/Nss1 VHT20 / 2437 MHz / Chain 2



Date: 15.DEC.2015 15:44:56

6 dB Bandwidth Plot on Configuration IEEE 802.11ac MCS0/Nss1 VHT20 / 2437 MHz / Chain 3

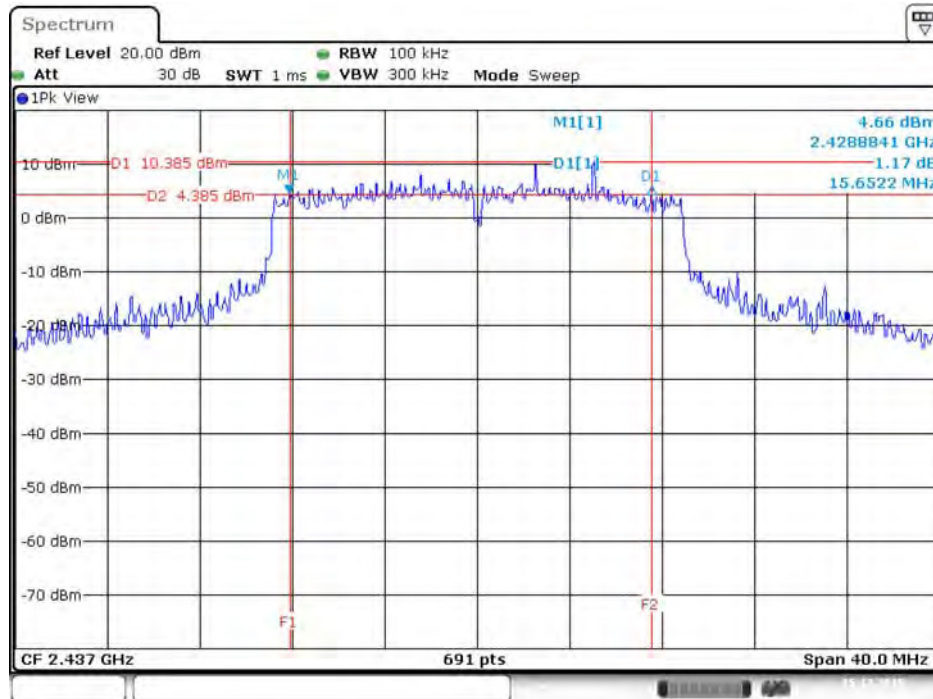

Date: 15.DEC.2015 11:18:29

99% Occupied Bandwidth Plot on Configuration IEEE 802.11ac MCS0/Nss1 VHT20 / 2437 MHz / Chain 3



Date: 15.DEC.2015 15:45:11

6 dB Bandwidth Plot on Configuration IEEE 802.11ac MCS0/Nss1 VHT20 / 2437 MHz / Chain 4

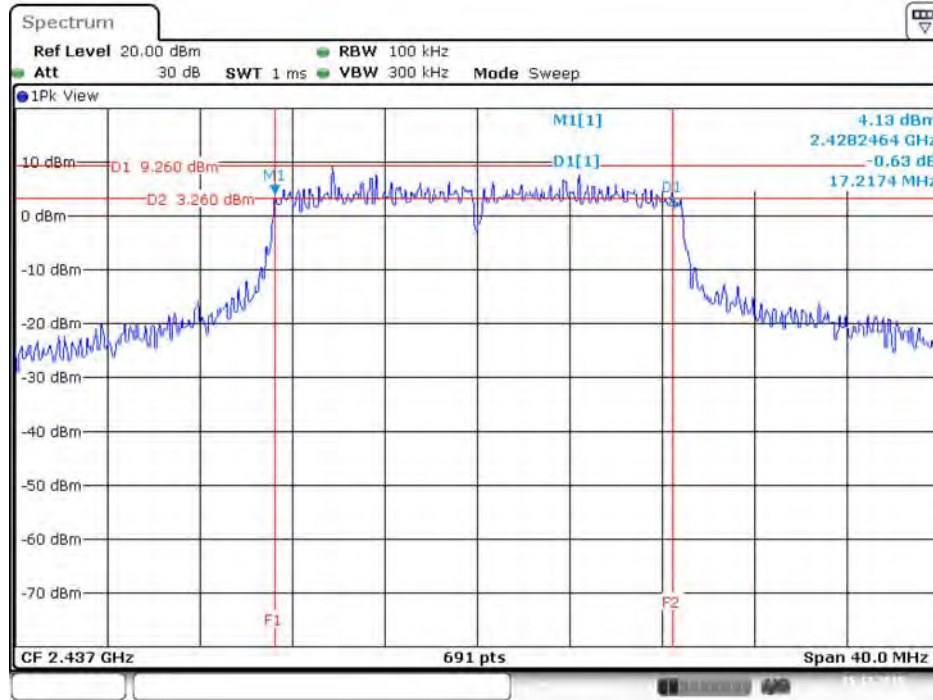

Date: 15.DEC.2015 11:18:14

99% Occupied Bandwidth Plot on Configuration IEEE 802.11ac MCS0/Nss1 VHT20 / 2437 MHz / Chain 4



Date: 15.DEC.2015 15:45:30



6 dB Bandwidth Plot on Configuration IEEE 802.11ac MCS0/Nss1 VHT40 / 2452 MHz / Chain 1

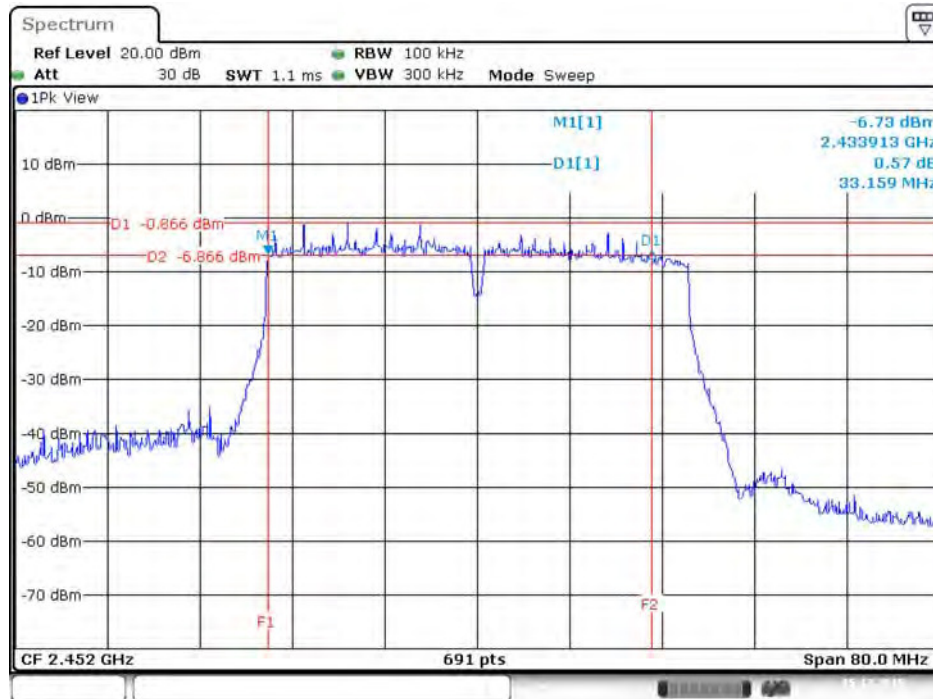

Date: 15.DEC.2015 11:28:56

99% Occupied Bandwidth Plot on Configuration IEEE 802.11ac MCS0/Nss1 VHT40 / 2437 MHz / Chain 1

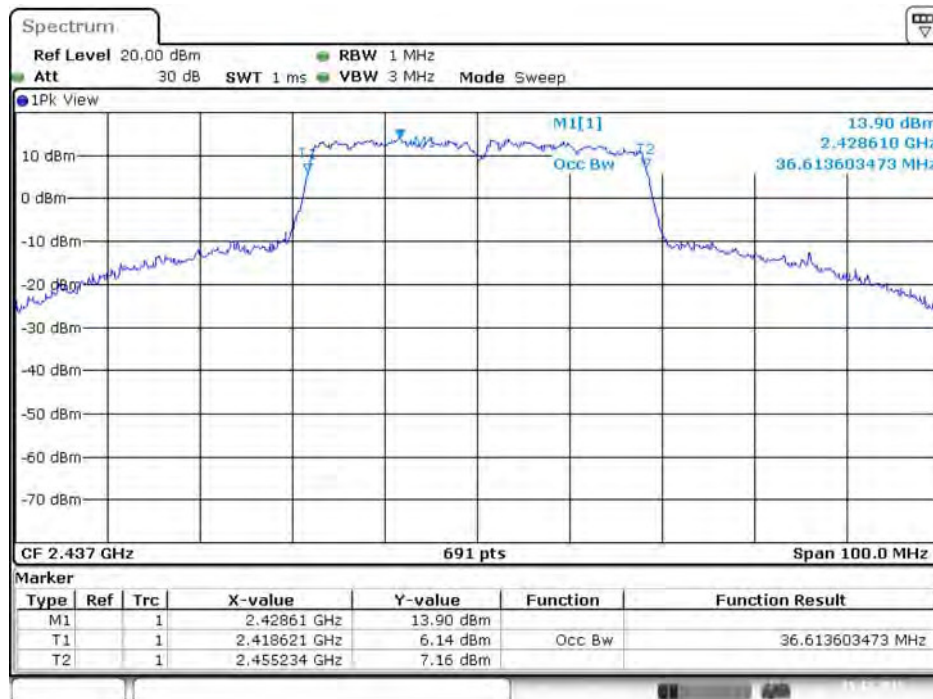

Date: 15.DEC.2015 14:59:16

6 dB Bandwidth Plot on Configuration IEEE 802.11ac MCS0/Nss1 VHT40 / 2437 MHz / Chain 2

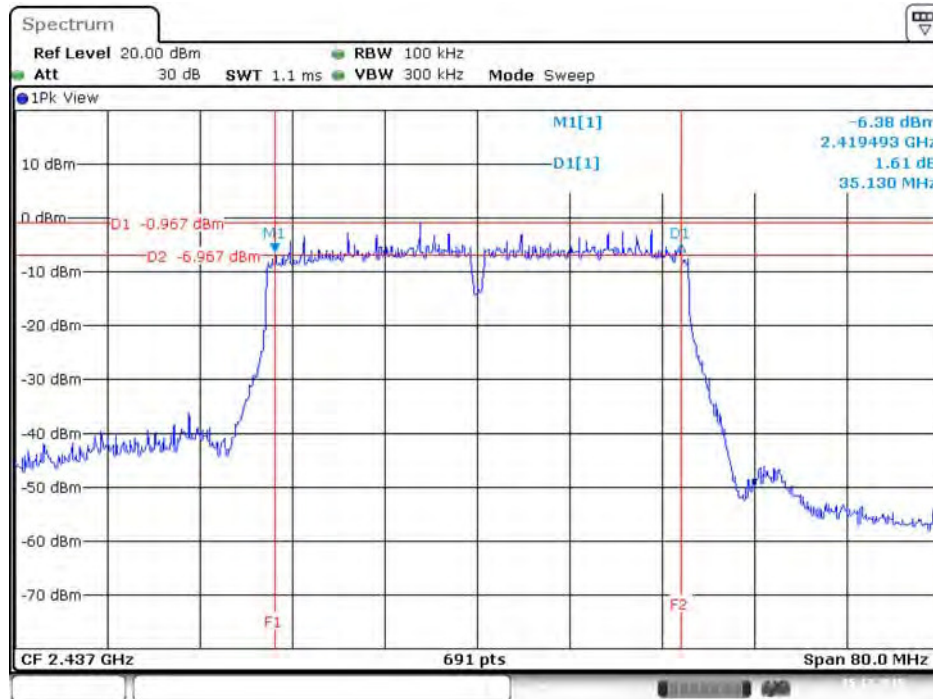

Date: 15.DEC.2015 11:26:00

99% Occupied Bandwidth Plot on Configuration IEEE 802.11ac MCS0/Nss1 VHT40 / 2437 MHz / Chain 2

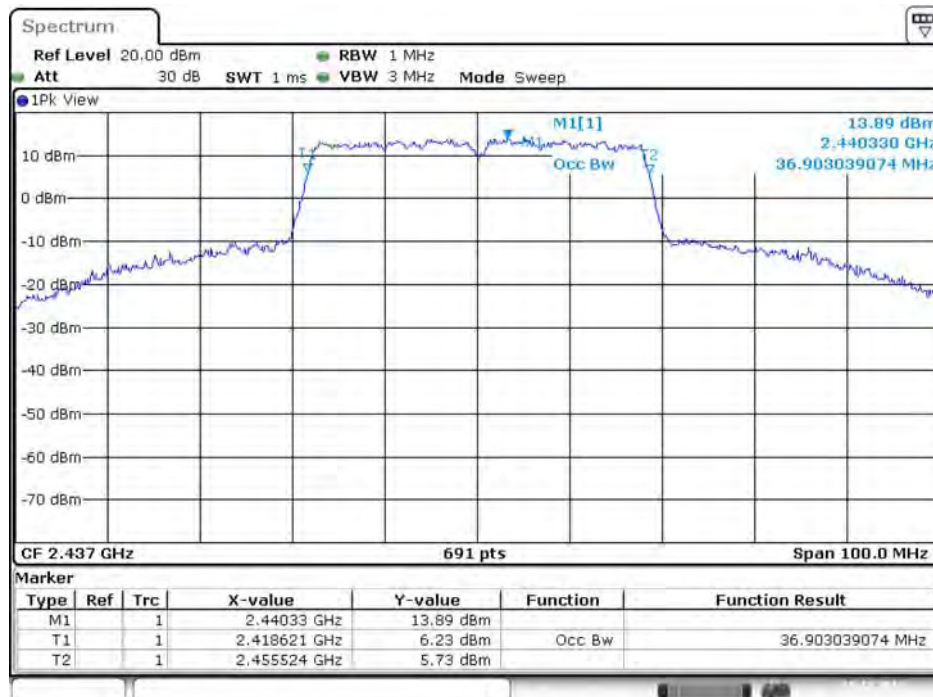

Date: 15.DEC.2015 14:59:00

6 dB Bandwidth Plot on Configuration IEEE 802.11ac MCS0/Nss1 VHT40 / 2437 MHz / Chain 3

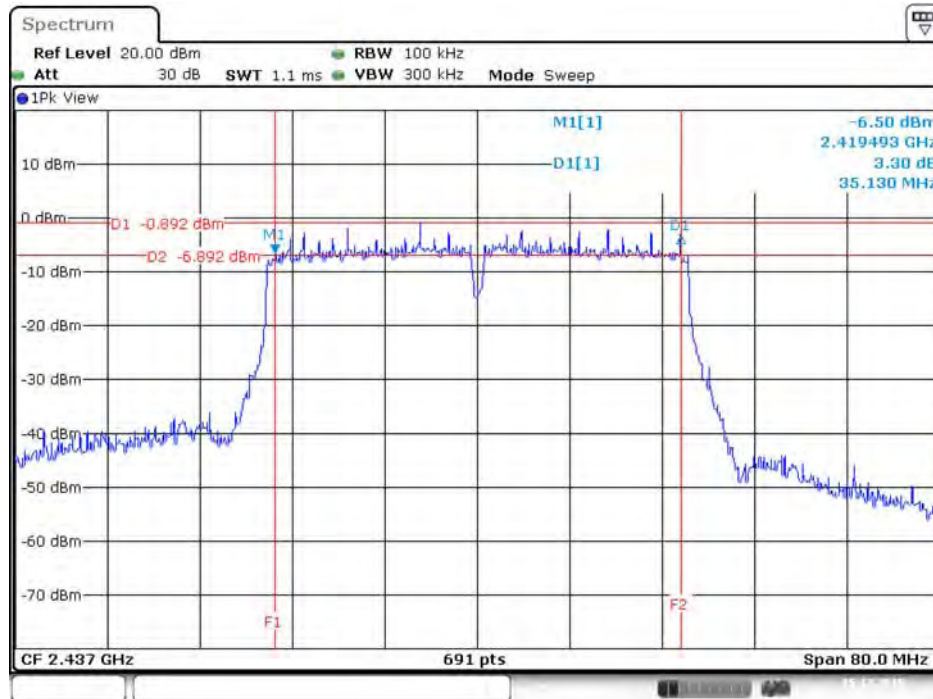

Date: 15.DEC.2015 11:26:14

99% Occupied Bandwidth Plot on Configuration IEEE 802.11ac MCS0/Nss1 VHT40 / 2422 MHz / Chain 3

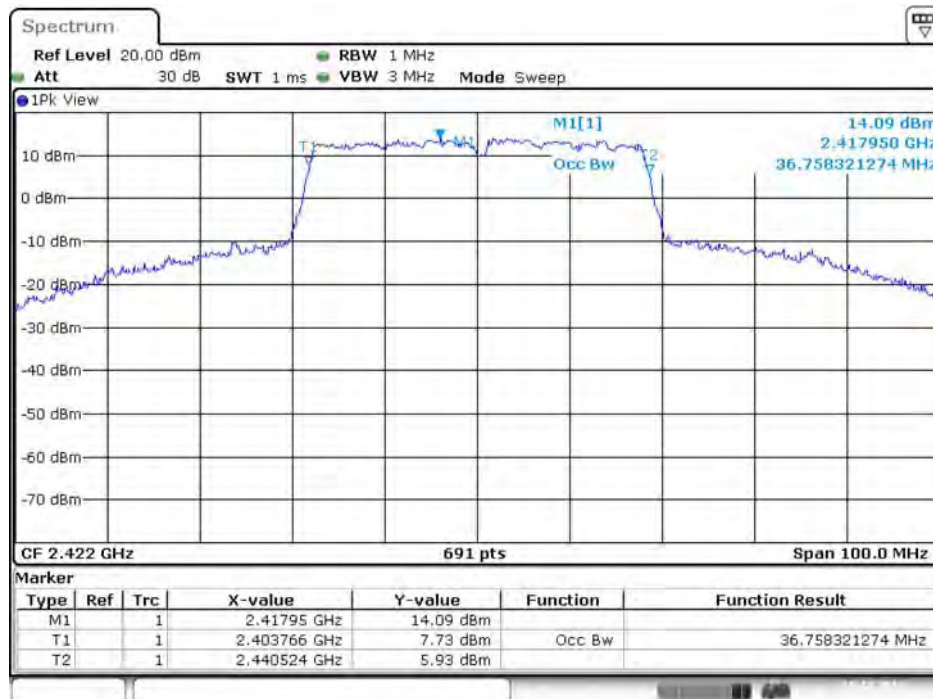

Date: 15.DEC.2015 14:57:08

6 dB Bandwidth Plot on Configuration IEEE 802.11ac MCS0/Nss1 VHT40 / 2437 MHz / Chain 4

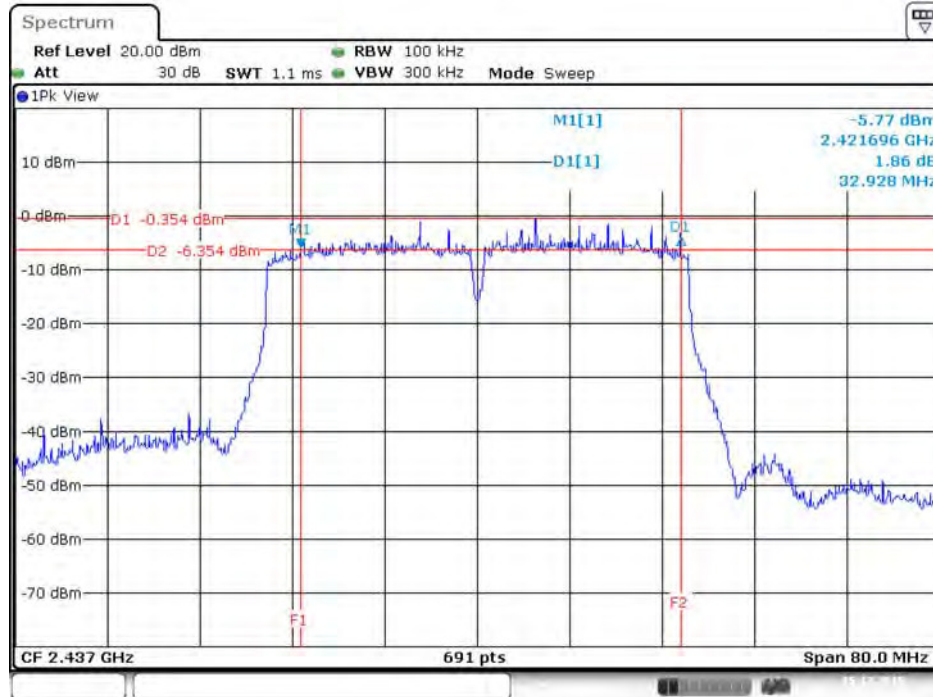

Date: 15.DEC.2015 11:26:34

99% Occupied Bandwidth Plot on Configuration IEEE 802.11ac MCS0/Nss1 VHT40 / 2422 MHz / Chain 4

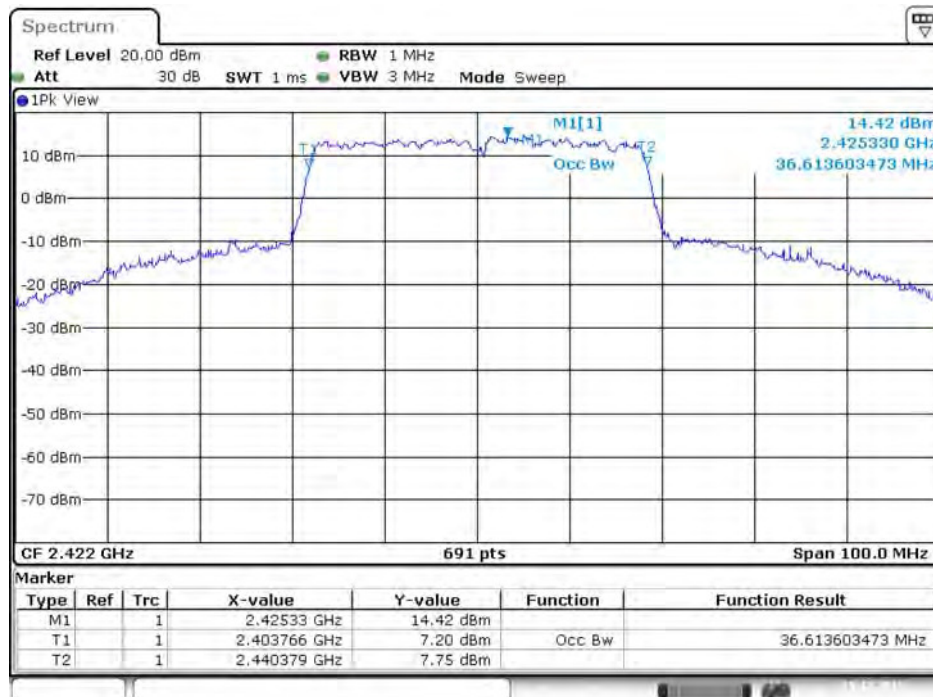

Date: 15.DEC.2015 14:57:20

6 dB Bandwidth Plot on Configuration IEEE 802.11ac MCS0/Nss4 VHT20 / 2437 MHz / Chain 1

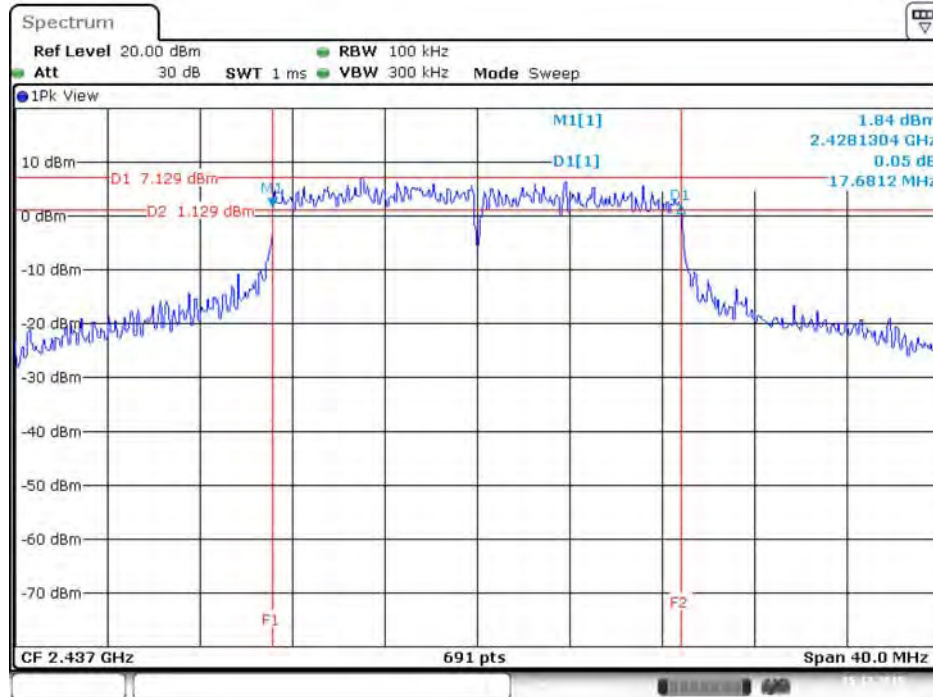

Date: 15.DEC.2015 11:36:51

99% Occupied Bandwidth Plot on Configuration IEEE 802.11ac MCS0/Nss4 VHT20 / 2437 MHz / Chain 1



Date: 15.DEC.2015 15:37:19

6 dB Bandwidth Plot on Configuration IEEE 802.11ac MCS0/Nss4 VHT20 / 2437 MHz / Chain 2

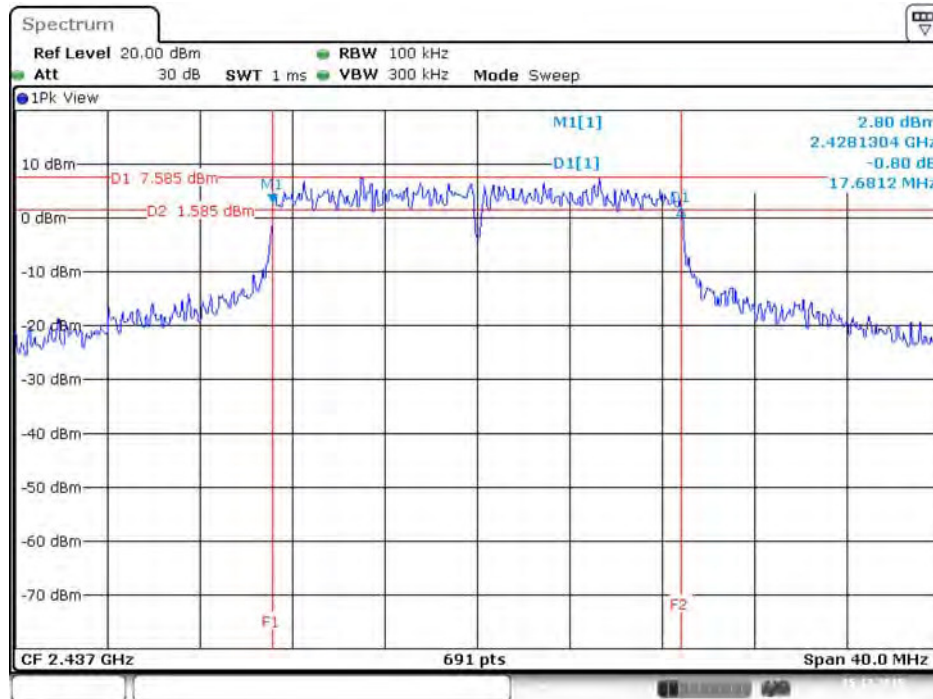

Date: 15.DEC.2015 11:36:39

99% Occupied Bandwidth Plot on Configuration IEEE 802.11ac MCS0/Nss4 VHT20 / 2437 MHz / Chain 2



Date: 15.DEC.2015 15:37:01

6 dB Bandwidth Plot on Configuration IEEE 802. 11ac MCS0/Nss4 VHT20 / 2412 MHz / Chain 3

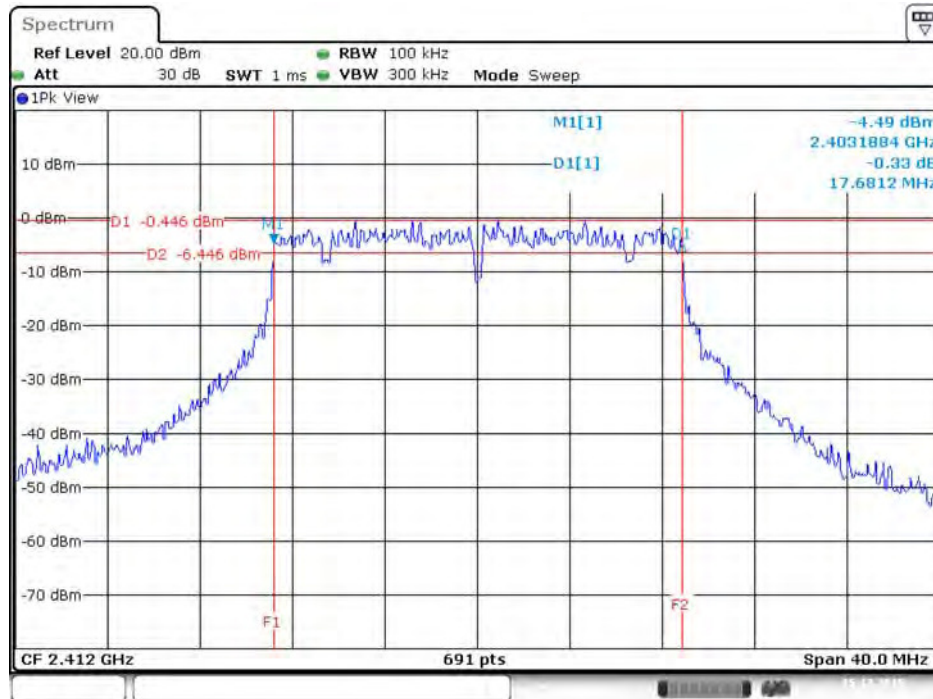

Date: 15.DEC.2015 11:34:13

99% Occupied Bandwidth Plot on Configuration IEEE 802. 11ac MCS0/Nss4 VHT20 / 2437 MHz / Chain 3

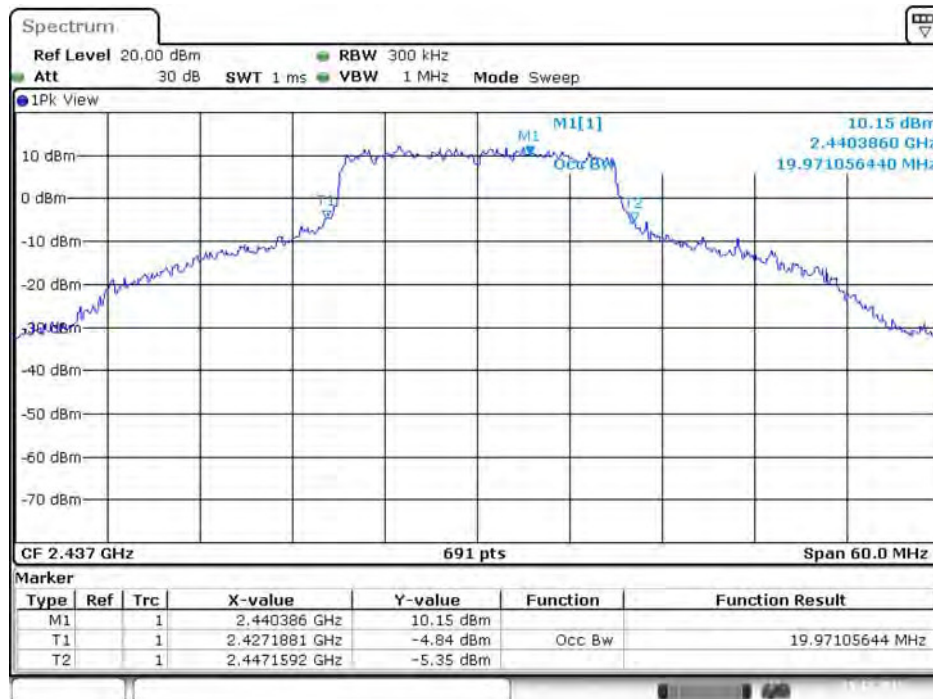

Date: 15.DEC.2015 15:36:05

6 dB Bandwidth Plot on Configuration IEEE 802.11ac MCS0/Nss4 VHT20 / 2437 MHz / Chain 4

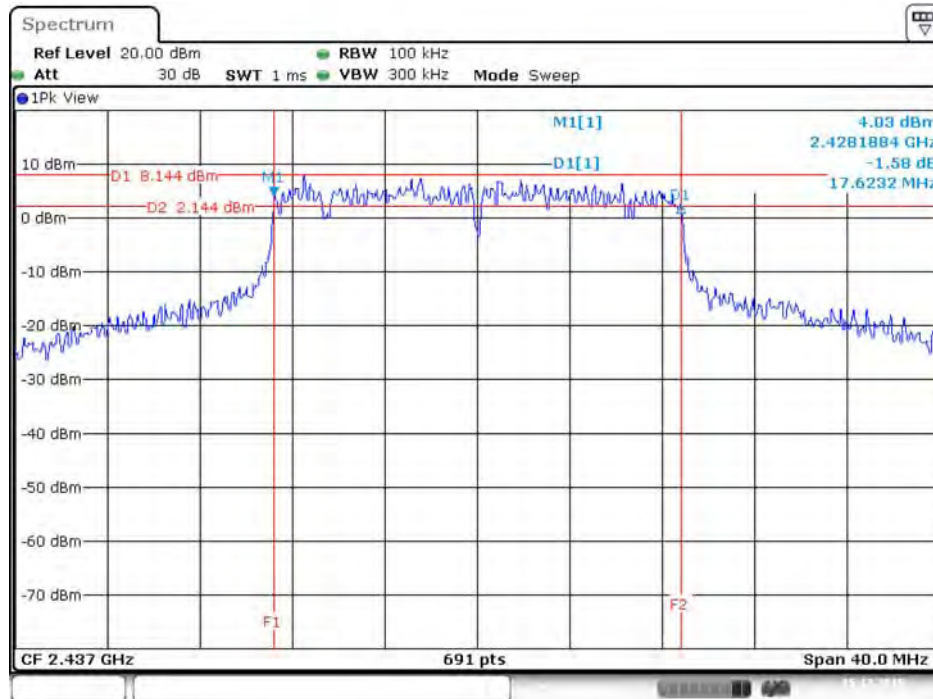

Date: 15.DEC.2015 11:36:15

99% Occupied Bandwidth Plot on Configuration IEEE 802.11ac MCS0/Nss4 VHT20 / 2437 MHz / Chain 4



Date: 15.DEC.2015 15:35:52



6 dB Bandwidth Plot on Configuration IEEE 802.11ac MCS0/Nss4 VHT40 / 2437 MHz / Chain 1

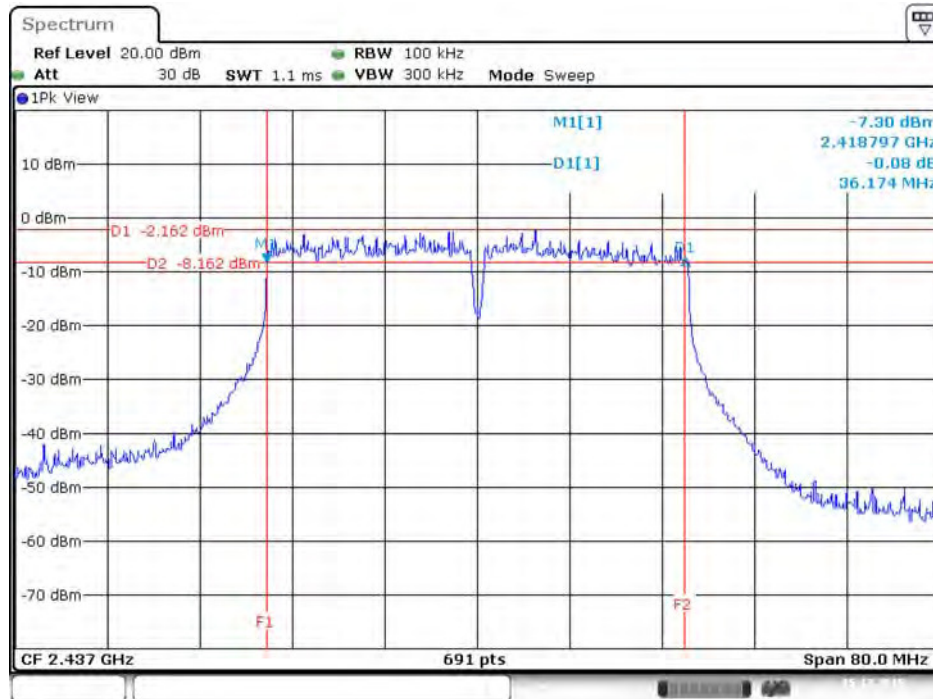

Date: 15.DEC.2015 11:47:31

99% Occupied Bandwidth Plot on Configuration IEEE 802.11ac MCS0/Nss4 VHT40 / 2452 MHz / Chain 1

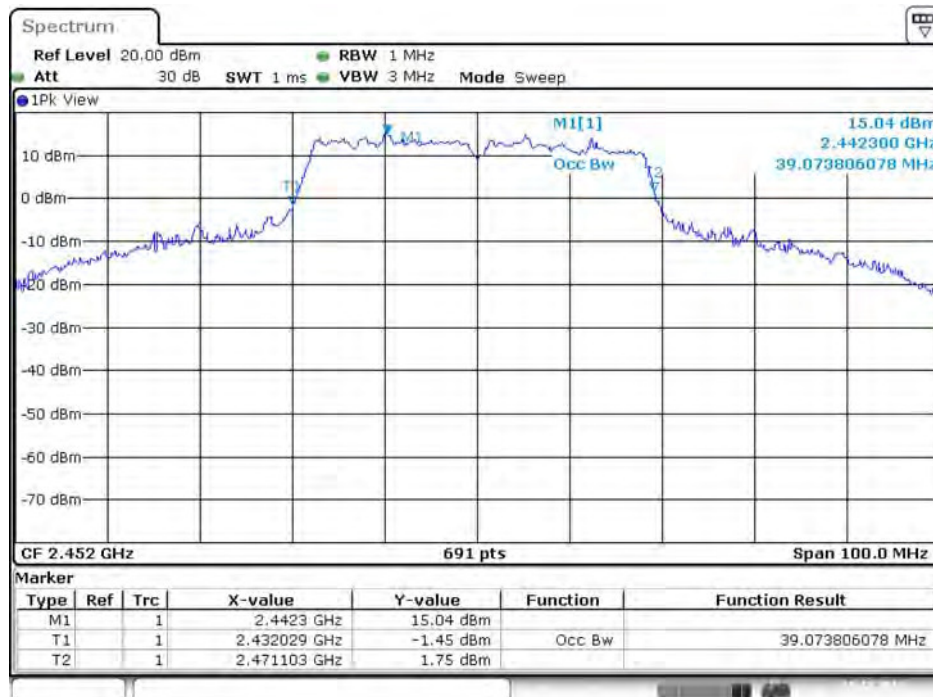

Date: 15.DEC.2015 15:06:26

6 dB Bandwidth Plot on Configuration IEEE 802.11ac MCS0/Nss4 VHT40 / 2452 MHz / Chain 2

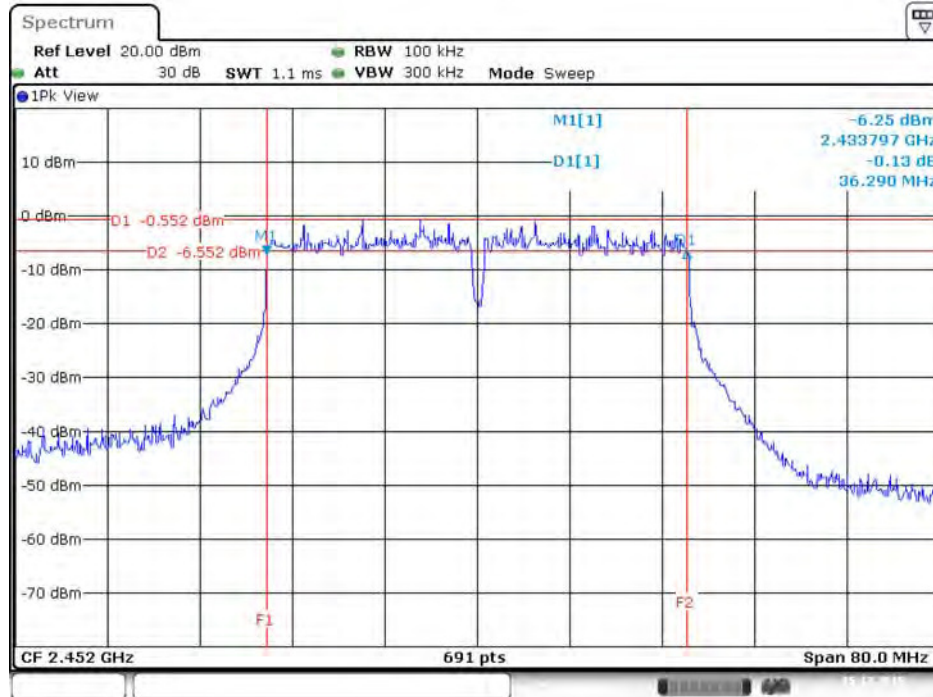

Date: 15.DEC.2015 11:49:04

99% Occupied Bandwidth Plot on Configuration IEEE 802.11ac MCS0/Nss4 VHT40 / 2452 MHz / Chain 2

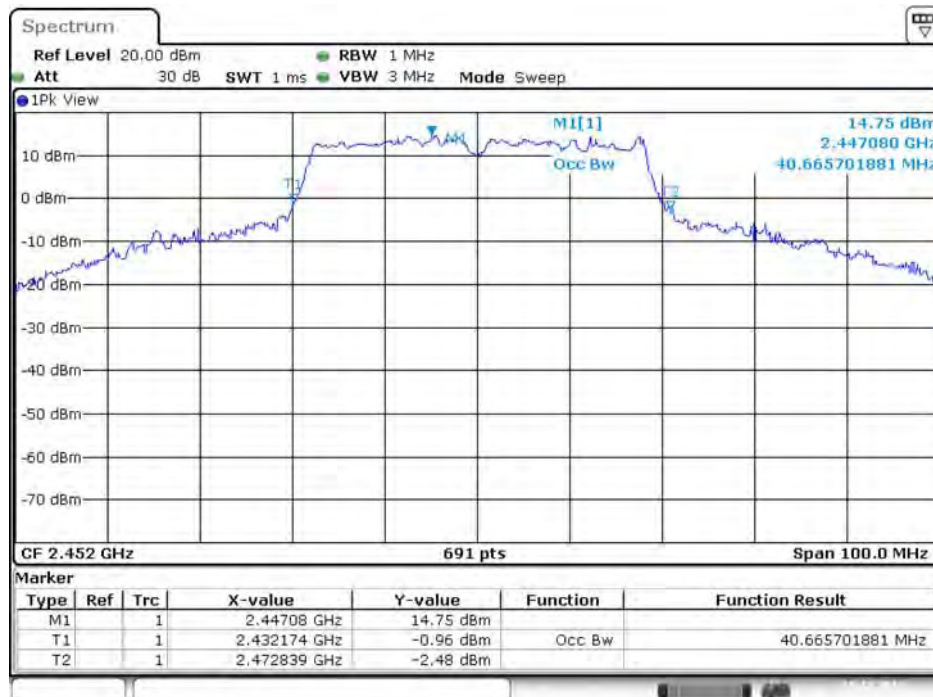

Date: 15.DEC.2015 15:06:06

6 dB Bandwidth Plot on Configuration IEEE 802.11ac MCS0/Nss4 VHT40 / 2422 MHz / Chain 3

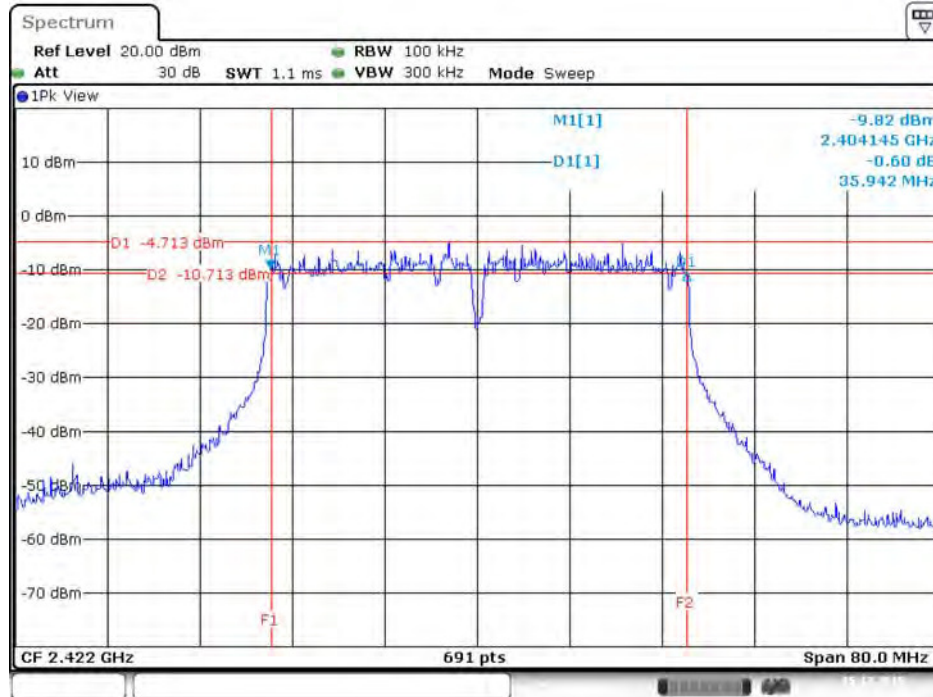

Date: 15.DEC.2015 11:44:48

99% Occupied Bandwidth Plot on Configuration IEEE 802.11ac MCS0/Nss4 VHT40 / 2452 MHz / Chain 3



Date: 15.DEC.2015 15:05:54

6 dB Bandwidth Plot on Configuration IEEE 802.11ac MCS0/Nss4 VHT40 / 2452 MHz / Chain 4

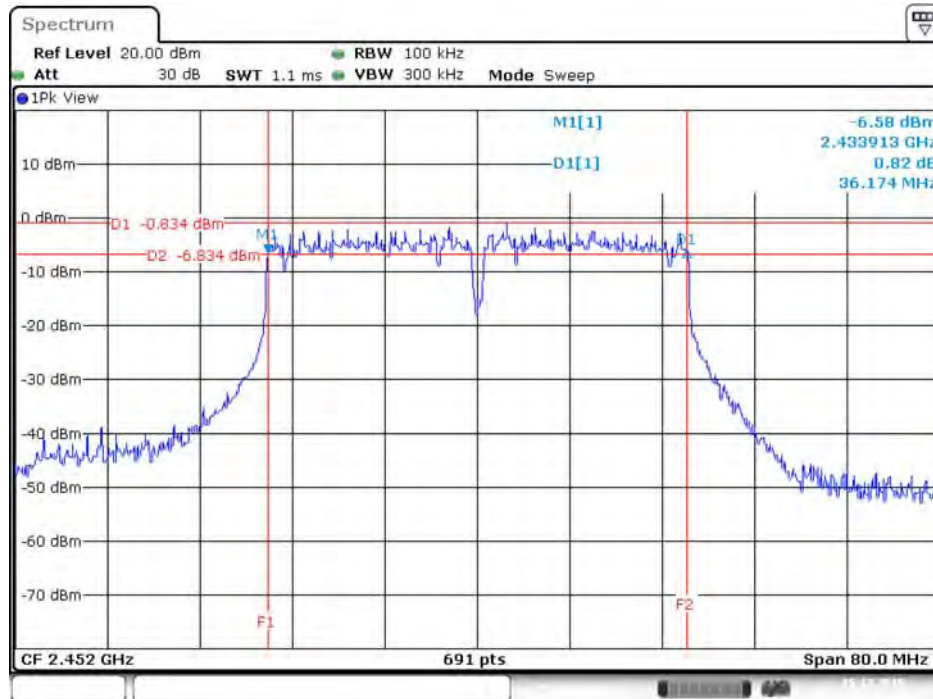

Date: 15.DEC.2015 11:49:27

99% Occupied Bandwidth Plot on Configuration IEEE 802.11ac MCS0/Nss4 VHT40 / 2422 MHz / Chain 4

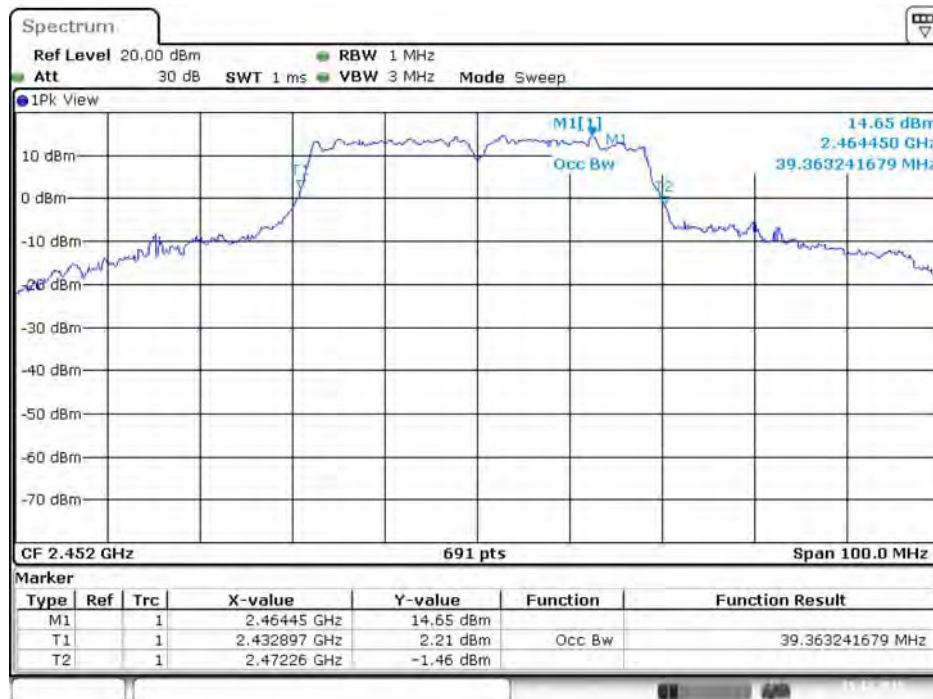

Date: 15.DEC.2015 15:05:29

<For Radio 1 Beamforming Mode>

6 dB Bandwidth Plot on Configuration IEEE 802.11ac MCS0/Nss1 VHT20 / 2412 MHz / Chain 1

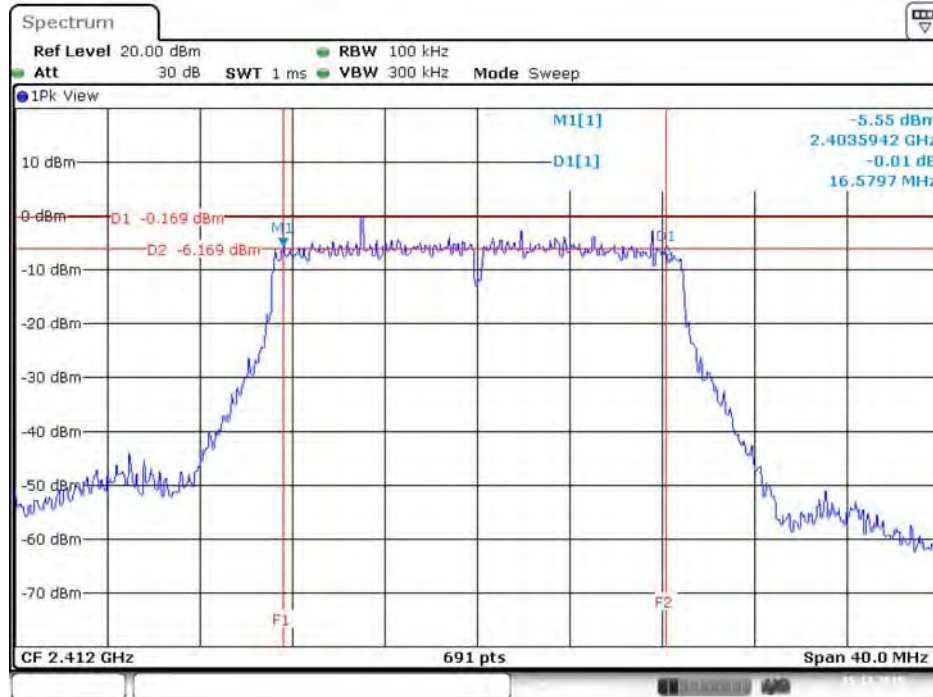

Date: 15.DEC.2015 11:53:05

99% Occupied Bandwidth Plot on Configuration IEEE 802.11ac MCS0/Nss1 VHT20 / 2437 MHz / Chain 1

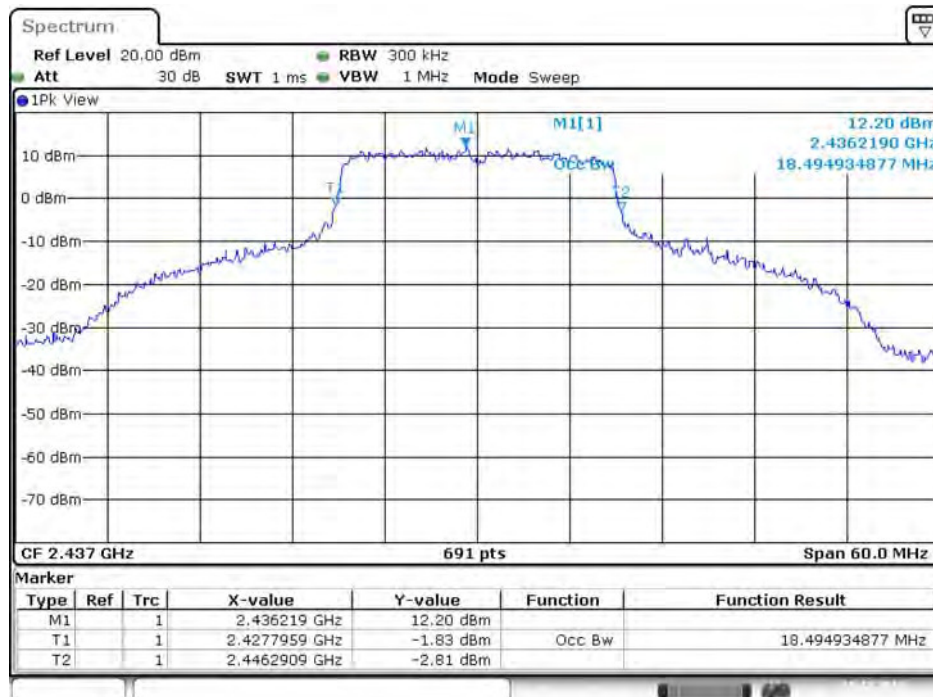

Date: 15.DEC.2015 16:24:59

6 dB Bandwidth Plot on Configuration IEEE 802.11ac MCS0/Nss1 VHT20 / 2437 MHz / Chain 2

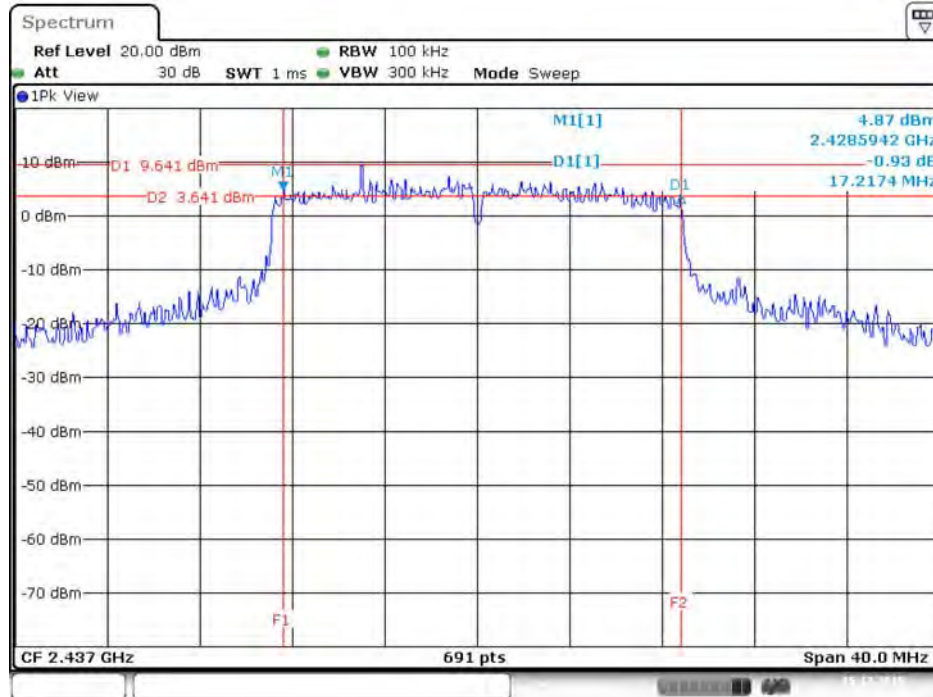

Date: 15.DEC.2015 11:55:37

99% Occupied Bandwidth Plot on Configuration IEEE 802.11ac MCS0/Nss1 VHT20 / 2437 MHz / Chain 2



Date: 15.DEC.2015 16:25:11

6 dB Bandwidth Plot on Configuration IEEE 802.11ac MCS0/Nss1 VHT20 / 2462 MHz / Chain 3

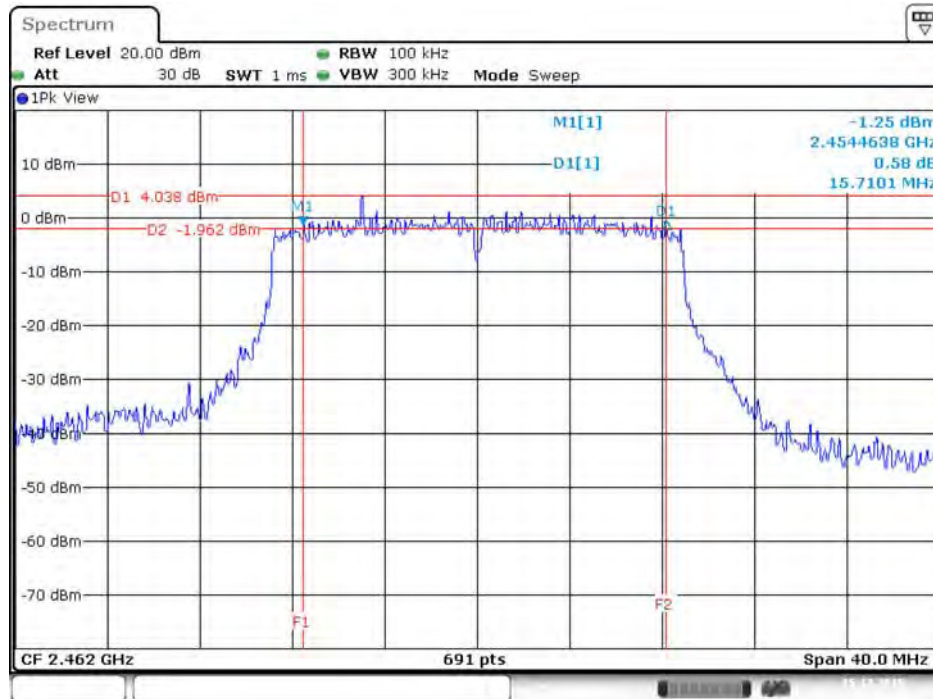

Date: 15.DEC.2015 11:57:09

99% Occupied Bandwidth Plot on Configuration IEEE 802.11ac MCS0/Nss1 VHT20 / 2437 MHz / Chain 3

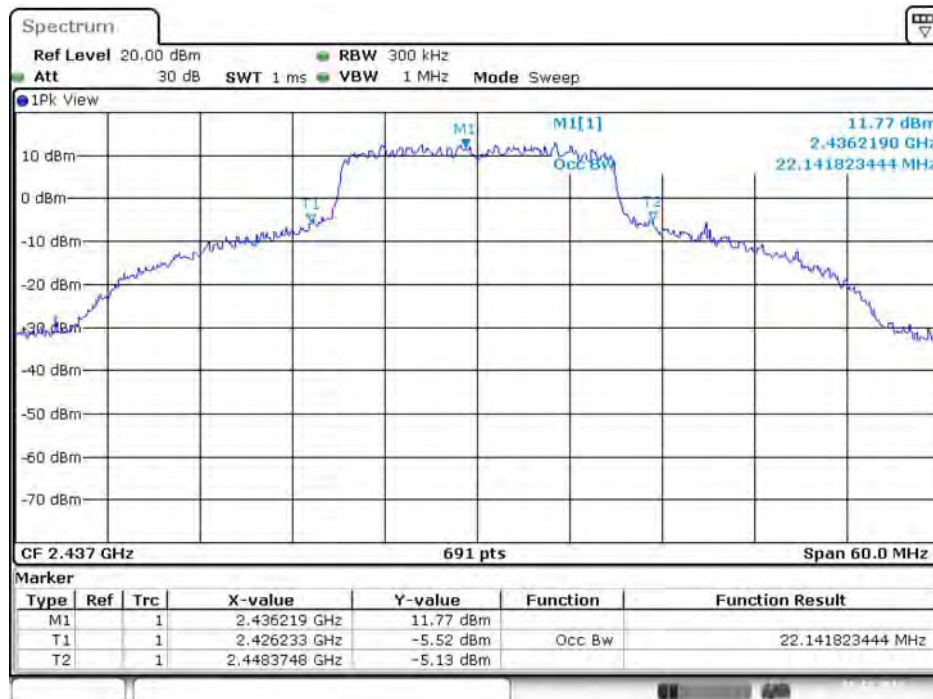

Date: 15.DEC.2015 16:25:23

6 dB Bandwidth Plot on Configuration IEEE 802.11ac MCS0/Nss1 VHT20 / 2437 MHz / Chain 4

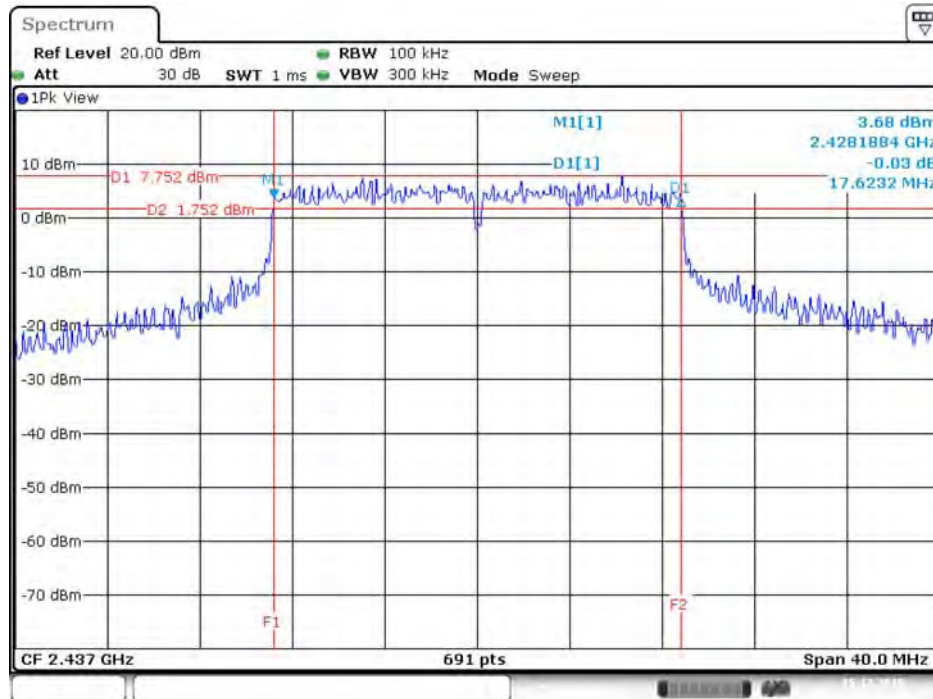

Date: 15.DEC.2015 11:55:59

99% Occupied Bandwidth Plot on Configuration IEEE 802.11ac MCS0/Nss1 VHT20 / 2437 MHz / Chain 4

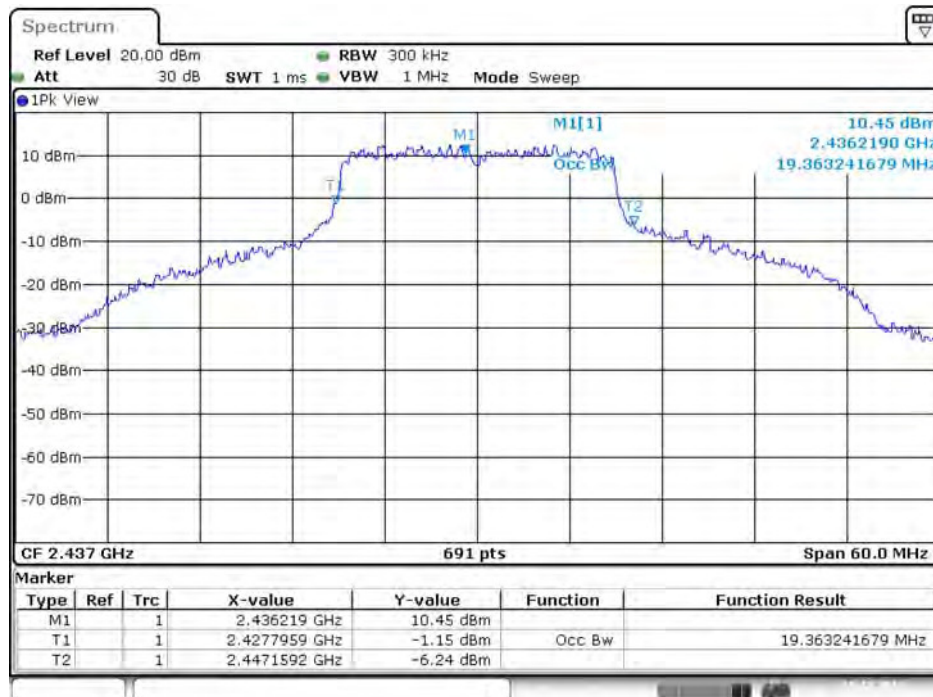

Date: 15.DEC.2015 16:25:36



6 dB Bandwidth Plot on Configuration IEEE 802.11ac MCS0/Nss1 VHT40 / 2452 MHz / Chain 1

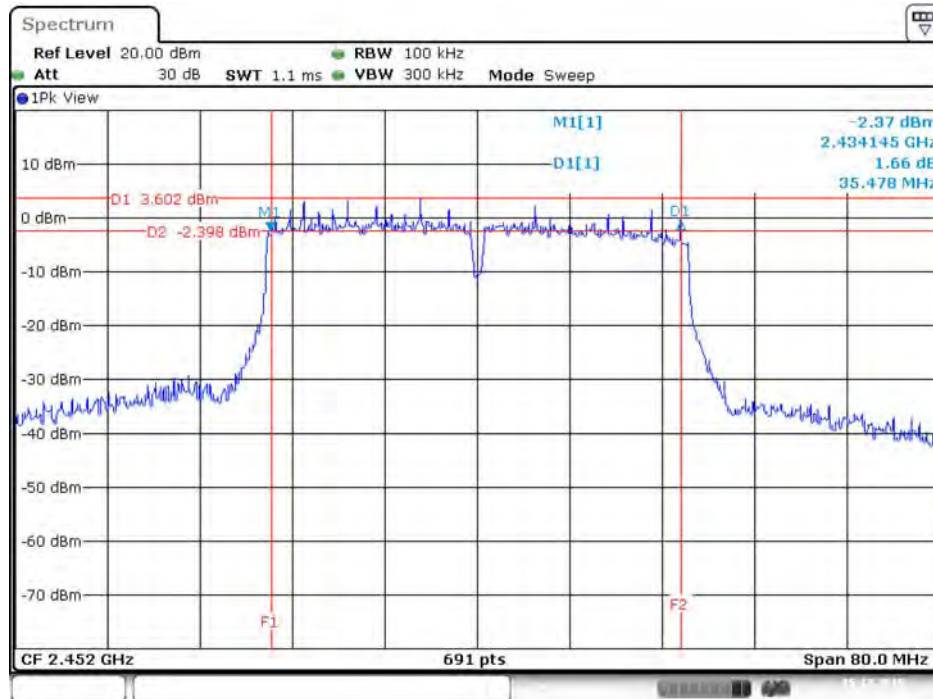

Date: 15.DEC.2015 13:39:54

99% Occupied Bandwidth Plot on Configuration IEEE 802.11ac MCS0/Nss1 VHT40 / 2437 MHz / Chain 1

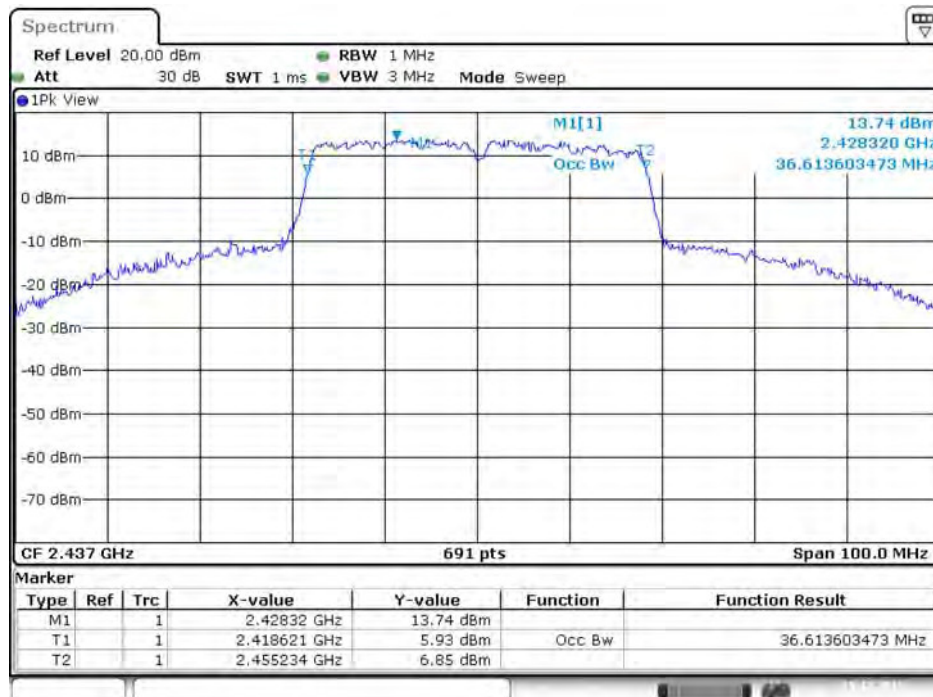

Date: 15.DEC.2015 14:50:06

6 dB Bandwidth Plot on Configuration IEEE 802.11ac MCS0/Nss1 VHT40 / 2422 MHz / Chain 2

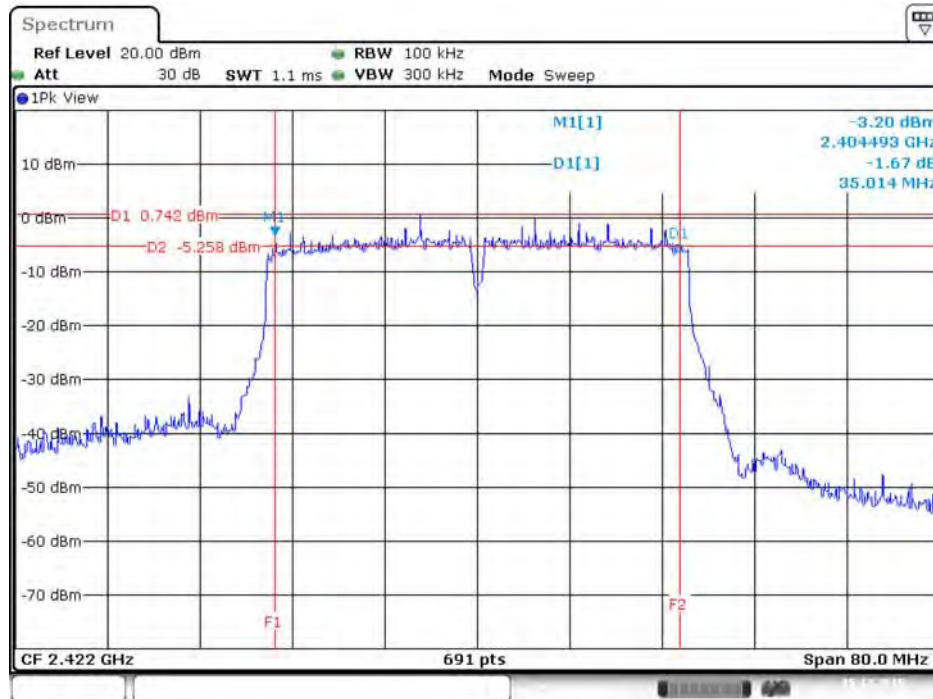

Date: 15.DEC.2015 13:36:23

99% Occupied Bandwidth Plot on Configuration IEEE 802.11ac MCS0/Nss1 VHT40 / 2437 MHz / Chain 2



Date: 15.DEC.2015 14:49:58

6 dB Bandwidth Plot on Configuration IEEE 802.11ac MCS0/Nss1 VHT40 / 2422 MHz / Chain 3

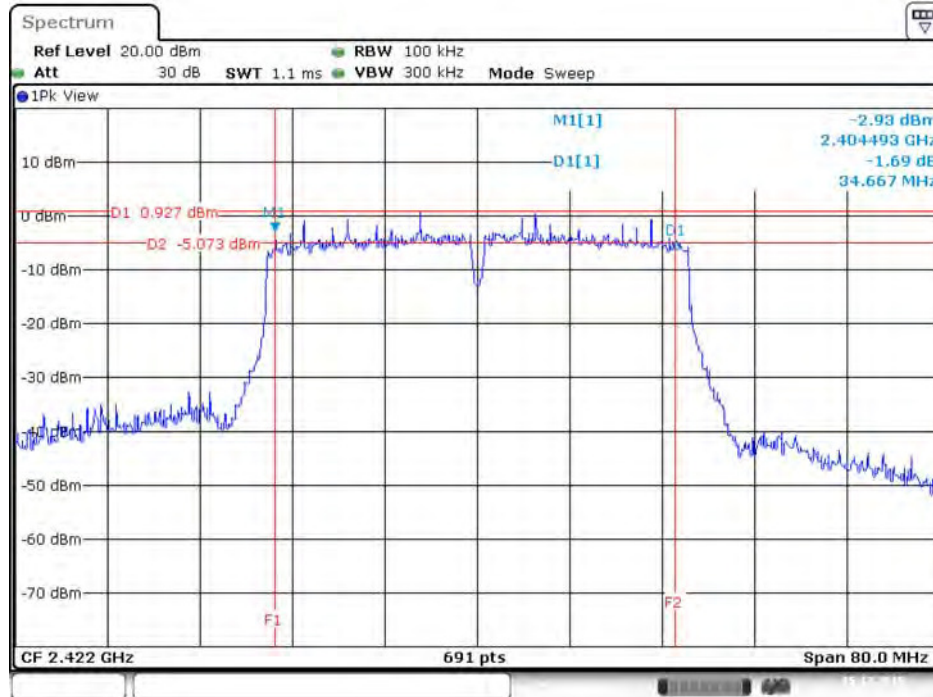

Date: 15.DEC.2015 13:36:34

99% Occupied Bandwidth Plot on Configuration IEEE 802.11ac MCS0/Nss1 VHT40 / 2437 MHz / Chain 3

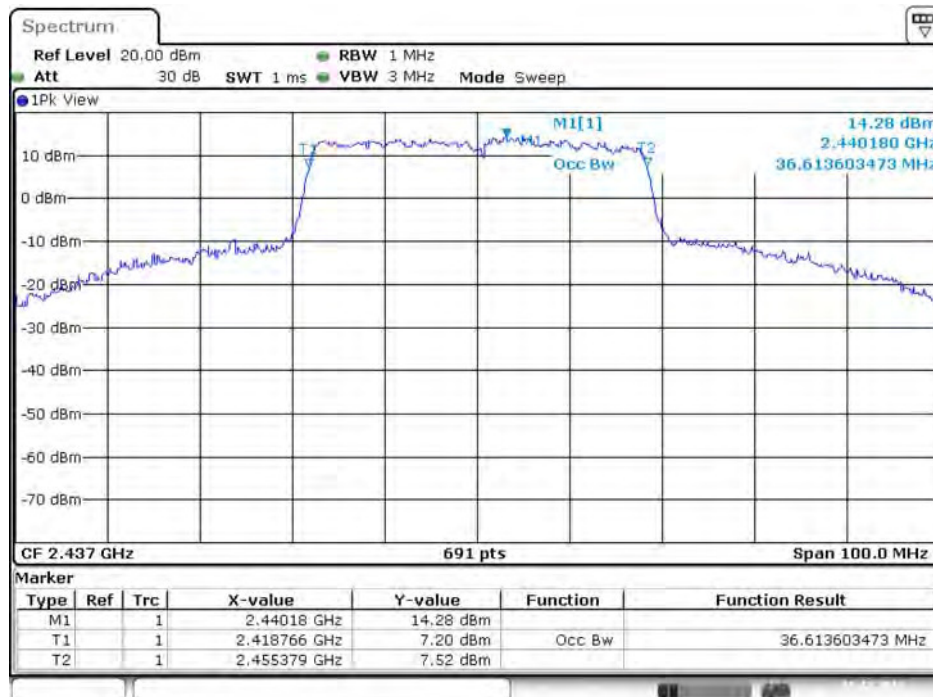

Date: 15.DEC.2015 14:49:50

6 dB Bandwidth Plot on Configuration IEEE 802.11ac MCS0/Nss1 VHT40 / 2422 MHz / Chain 4

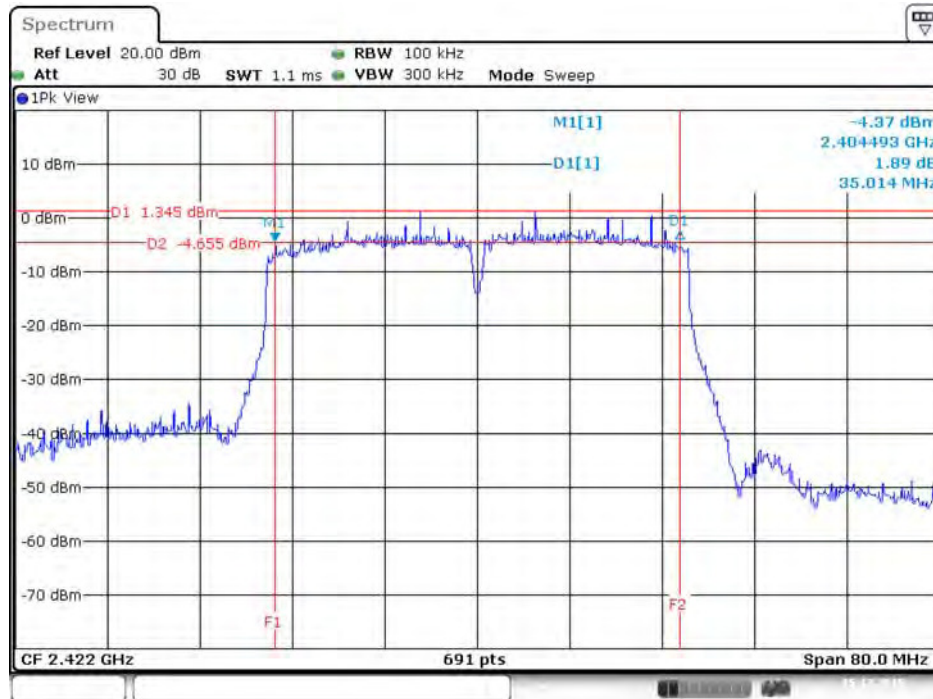

Date: 15.DEC.2015 13:36:46

99% Occupied Bandwidth Plot on Configuration IEEE 802.11ac MCS0/Nss1 VHT40 / 2452 MHz / Chain 4

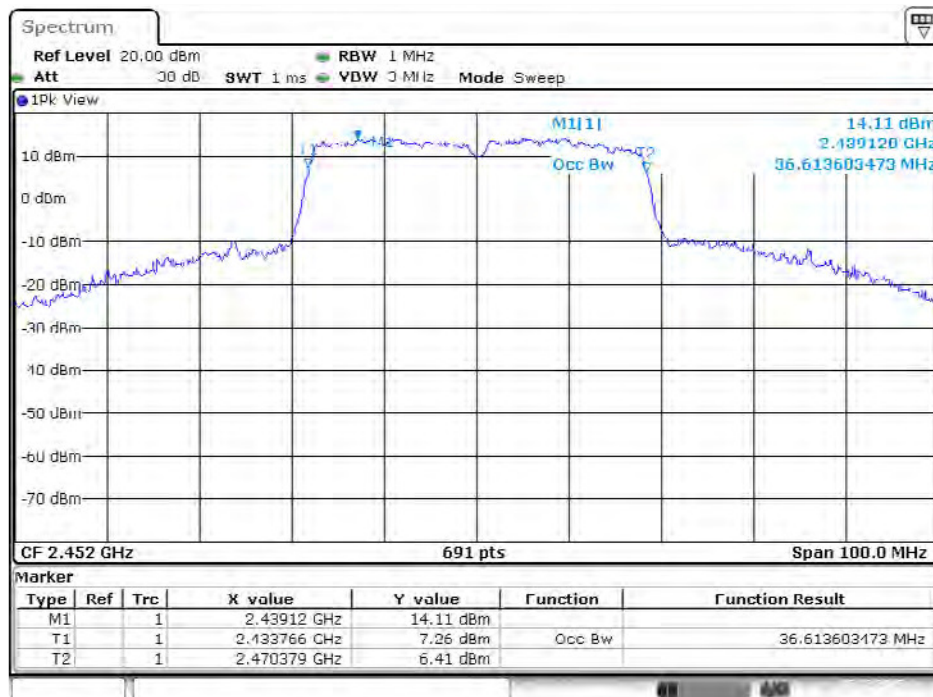

Date: 15.DEC.2015 14:51:16

6 dB Bandwidth Plot on Configuration IEEE 802. 11ac MCS0/Nss2 VHT20 / 2412 MHz / Chain 1

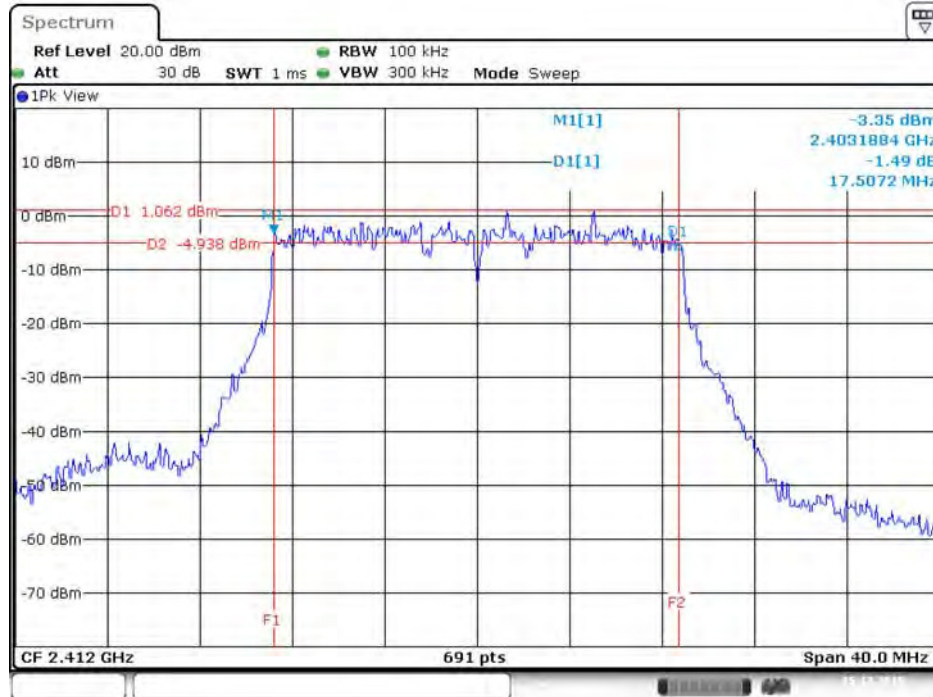

Date: 15.DEC.2015 13:42:34

99% Occupied Bandwidth Plot on Configuration IEEE 802. 11ac MCS0/Nss2 VHT20 / 2437 MHz / Chain 1

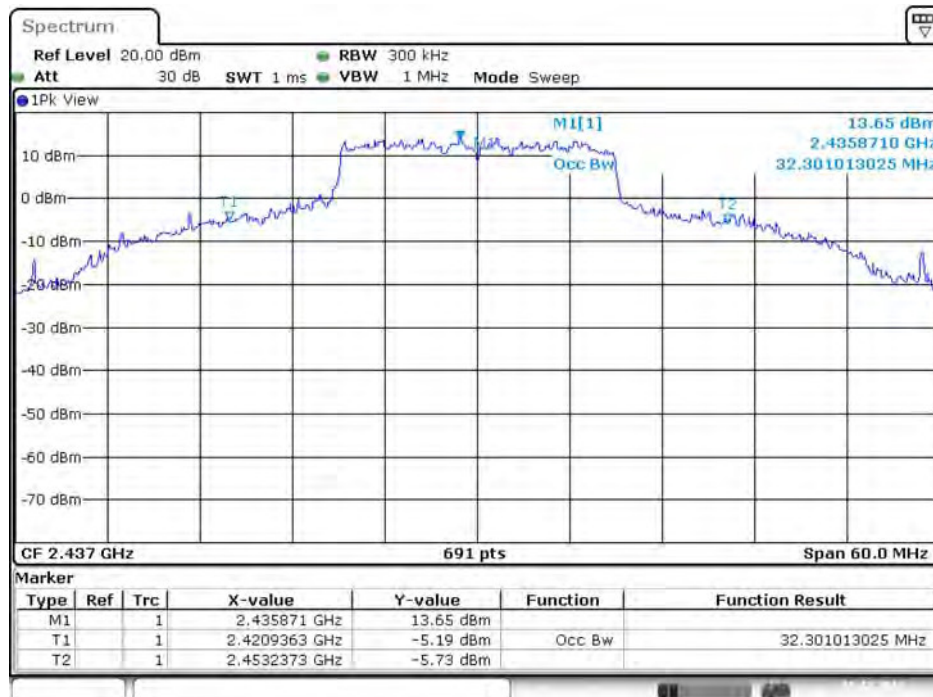

Date: 15.DEC.2015 16:34:24

6 dB Bandwidth Plot on Configuration IEEE 802.11ac MCS0/Nss2 VHT20 / 2462 MHz / Chain 2

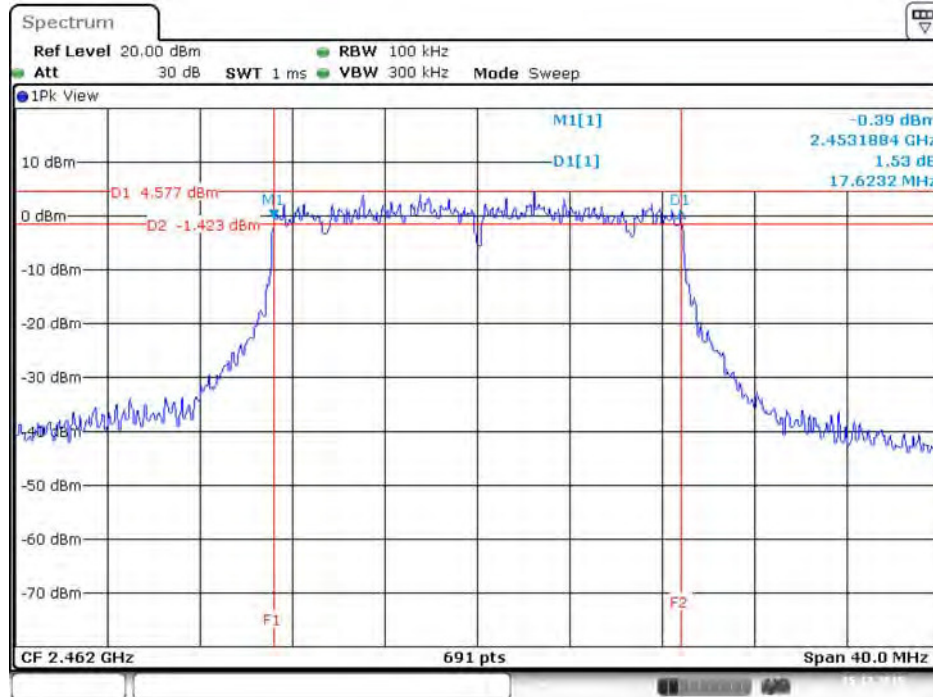

Date: 15.DEC.2015 13:51:50

99% Occupied Bandwidth Plot on Configuration IEEE 802.11ac MCS0/Nss2 VHT20 / 2437 MHz / Chain 2

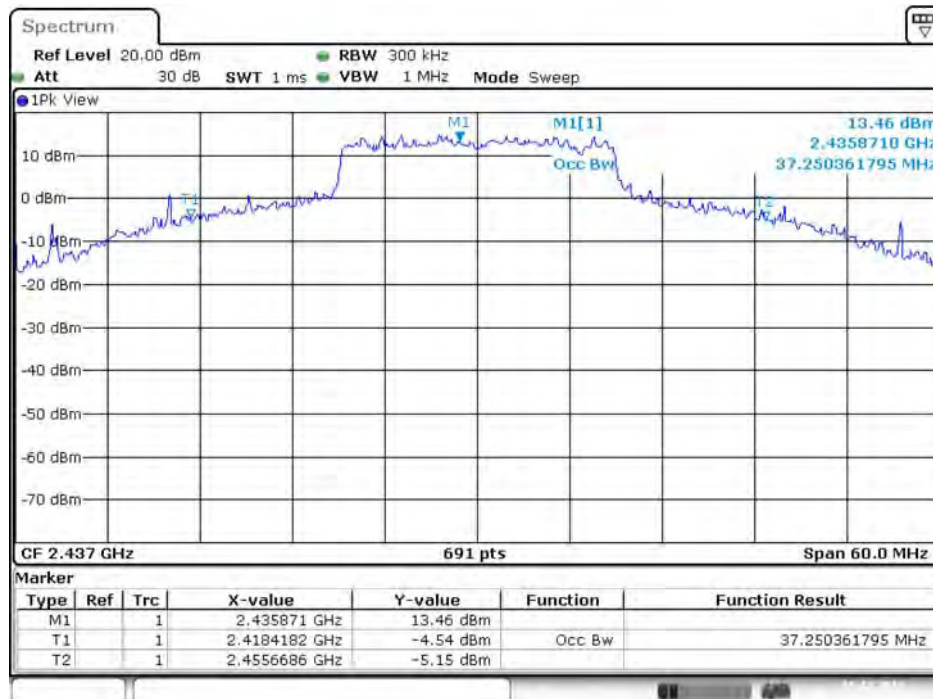

Date: 15.DEC.2015 16:34:10

6 dB Bandwidth Plot on Configuration IEEE 802.11ac MCS0/Nss2 VHT20 / 2412 MHz / Chain 3

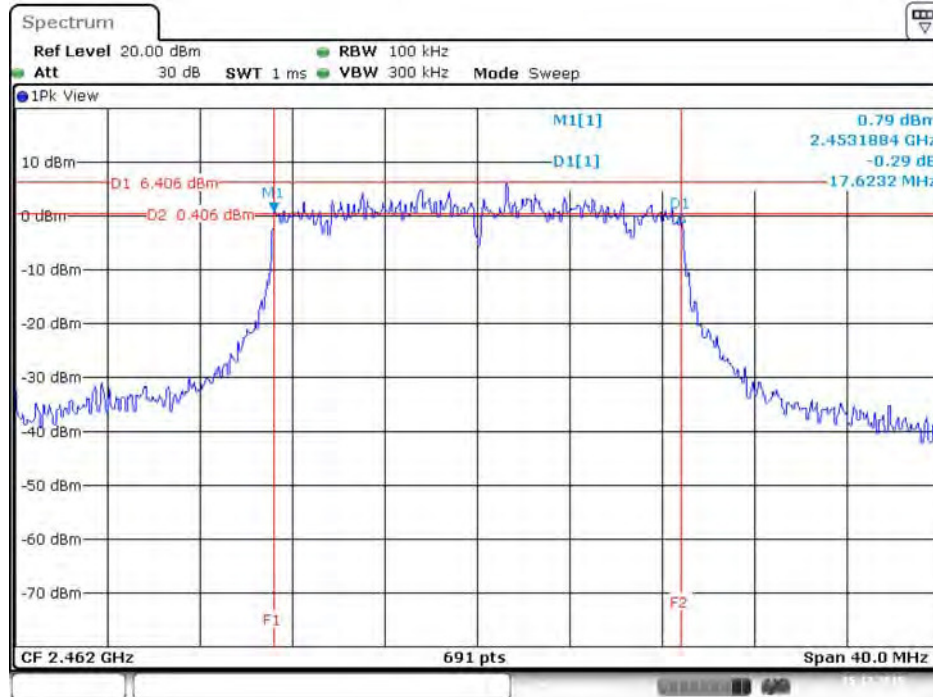

Date: 15.DEC.2015 13:48:36

99% Occupied Bandwidth Plot on Configuration IEEE 802.11ac MCS0/Nss2 VHT20 / 2437 MHz / Chain 3

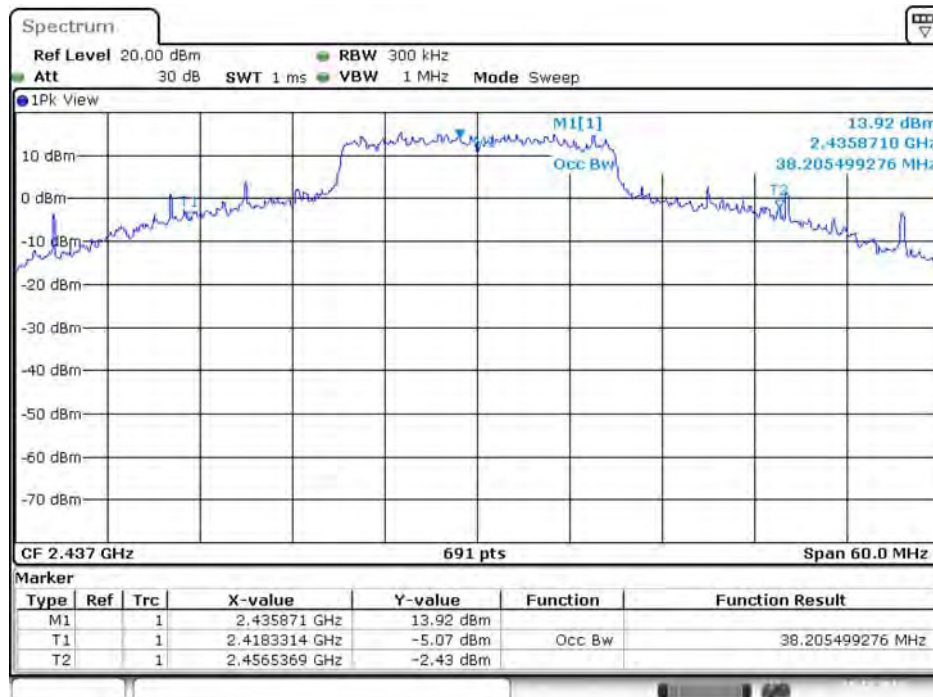

Date: 15.DEC.2015 16:33:40

6 dB Bandwidth Plot on Configuration IEEE 802.11ac MCS0/Nss2 VHT20 / 2462 MHz / Chain 4

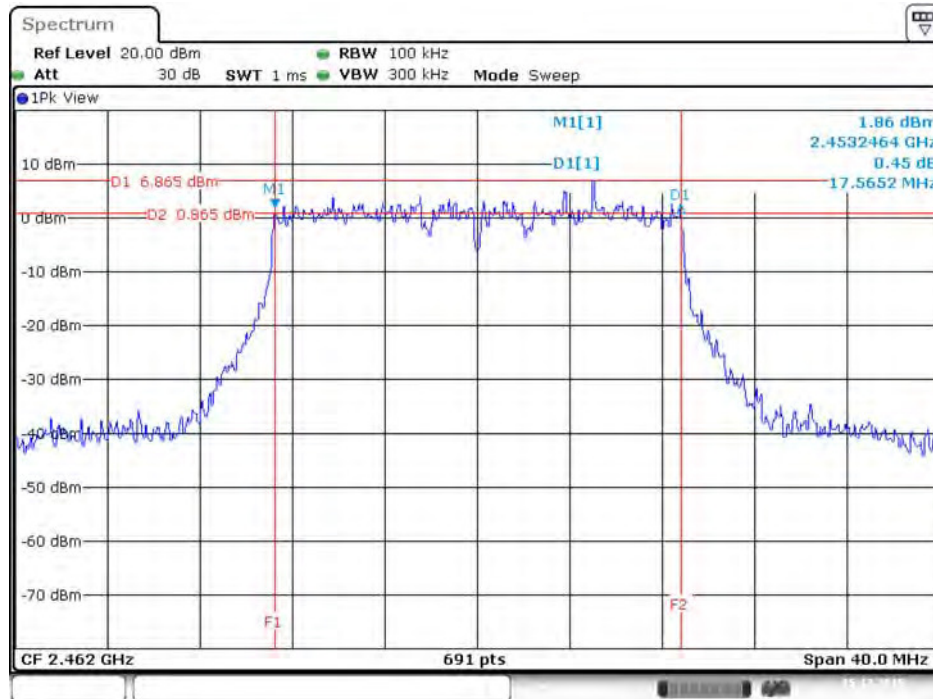

Date: 15.DEC.2015 13:48:12

99% Occupied Bandwidth Plot on Configuration IEEE 802.11ac MCS0/Nss2 VHT20 / 2437 MHz / Chain 4

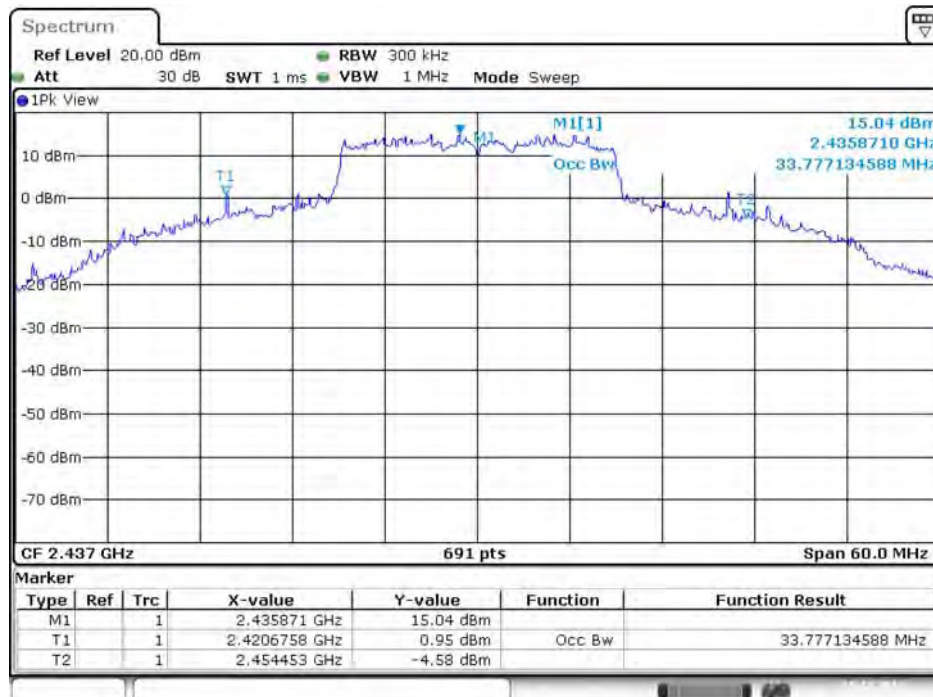

Date: 15.DEC.2015 16:33:15



6 dB Bandwidth Plot on Configuration IEEE 802.11ac MCS0/Nss2 VHT40 / 2437 MHz / Chain 1

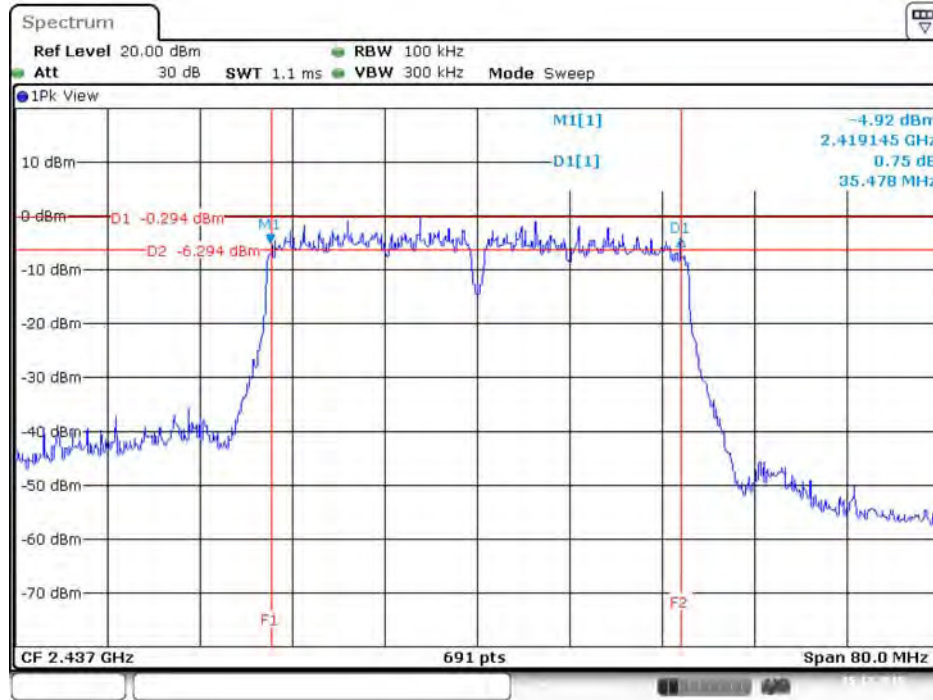

Date: 15.DEC.2015 13:56:23

99% Occupied Bandwidth Plot on Configuration IEEE 802.11ac MCS0/Nss2 VHT40 / 2437 MHz / Chain 1

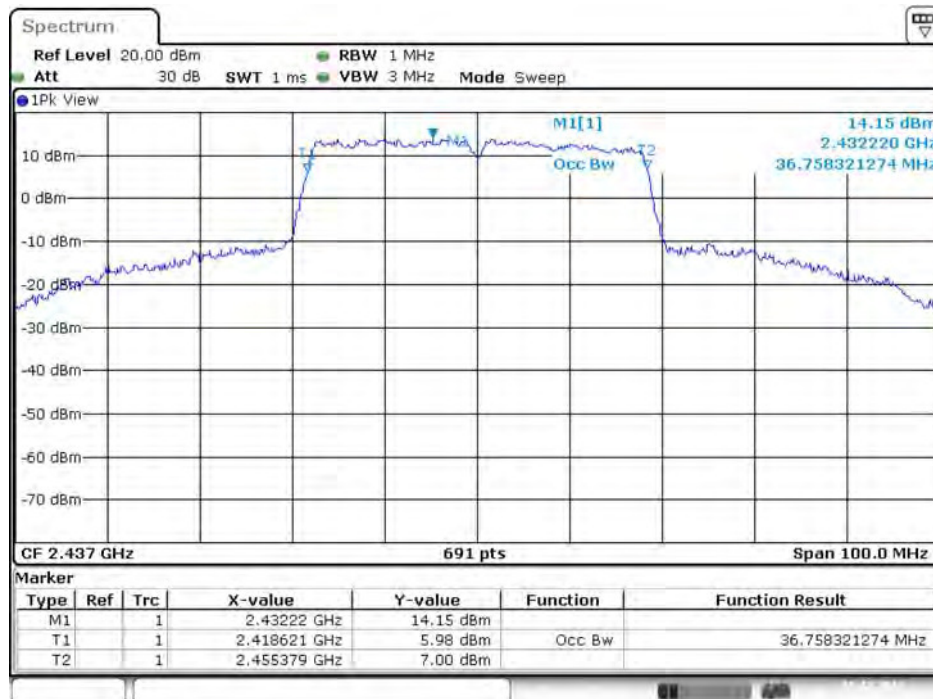

Date: 15.DEC.2015 14:41:47

6 dB Bandwidth Plot on Configuration IEEE 802.11ac MCS0/Nss2 VHT40 / 2452 MHz / Chain 2

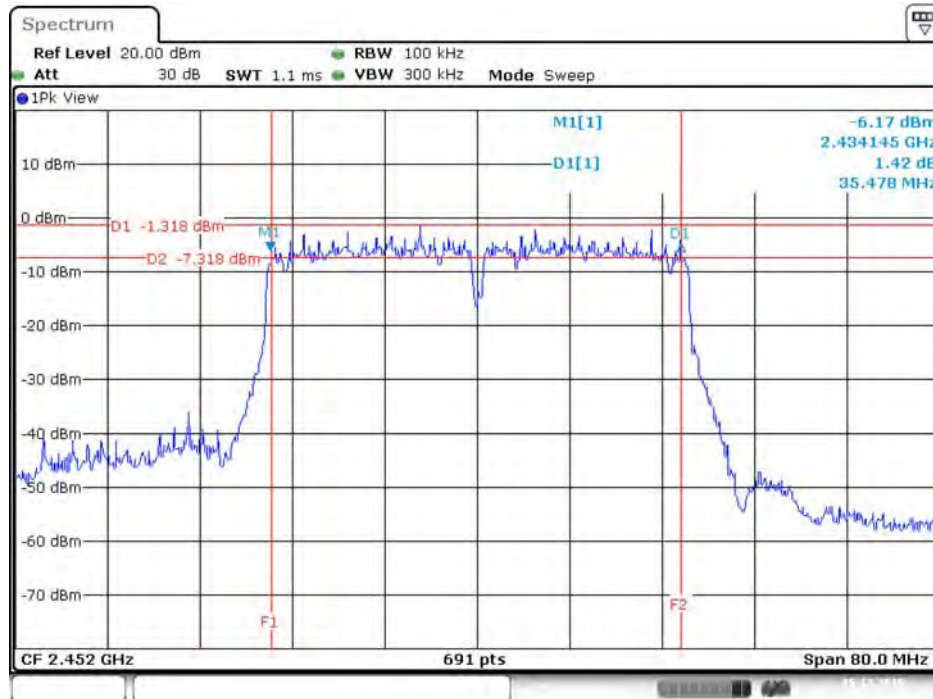

Date: 15.DEC.2015 13:58:04

99% Occupied Bandwidth Plot on Configuration IEEE 802.11ac MCS0/Nss2 VHT40 / 2437 MHz / Chain 2

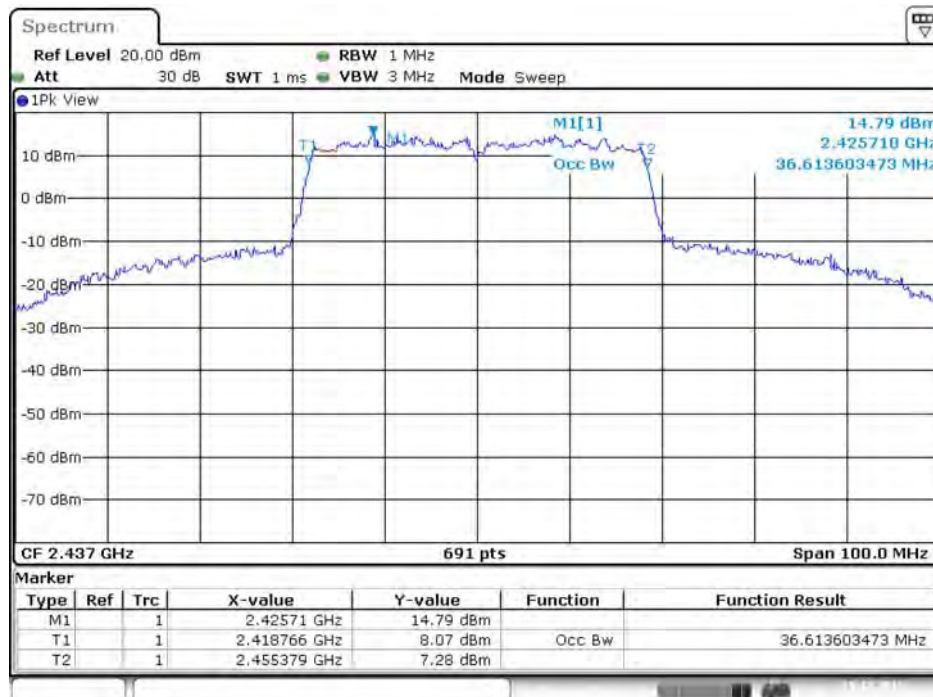

Date: 15.DEC.2015 14:42:00

6 dB Bandwidth Plot on Configuration IEEE 802.11ac MCS0/Nss2 VHT40 / 2437 MHz / Chain 3

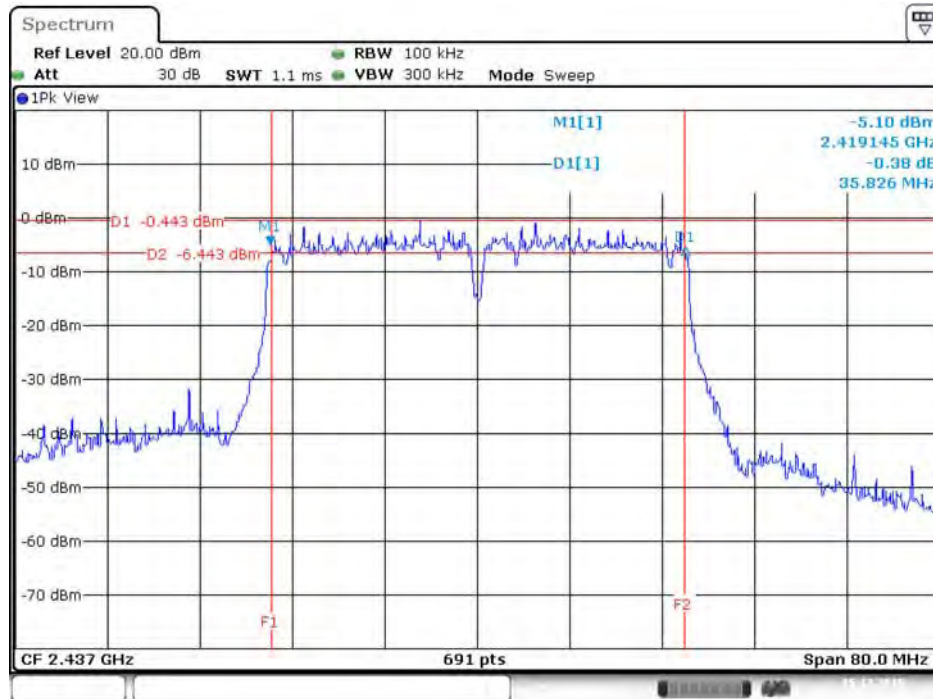

Date: 15.DEC.2015 13:55:59

99% Occupied Bandwidth Plot on Configuration IEEE 802.11ac MCS0/Nss2 VHT40 / 2437 MHz / Chain 3

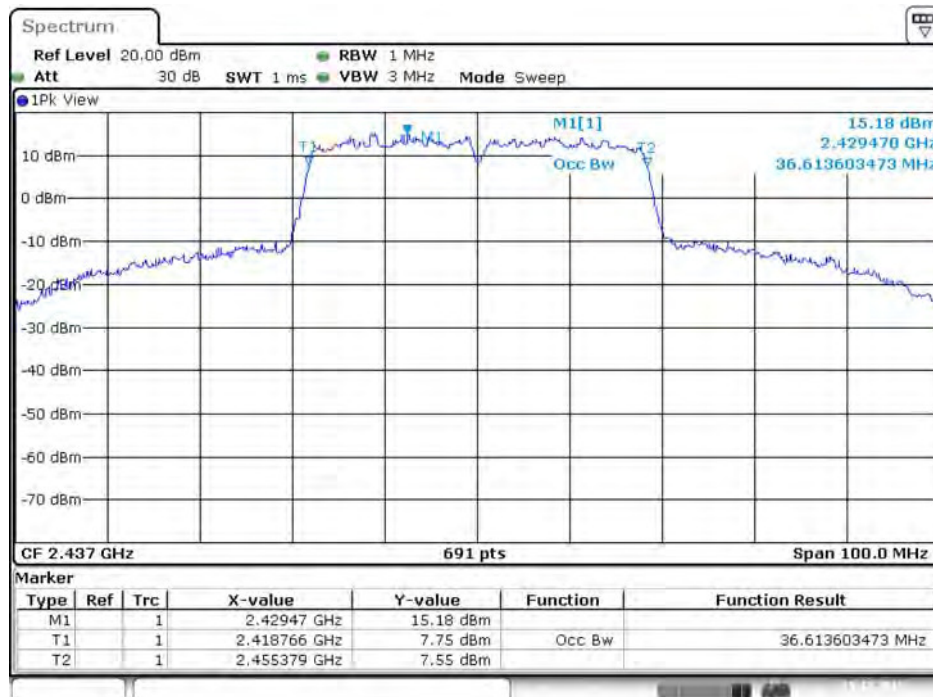

Date: 15.DEC.2015 14:42:11

6 dB Bandwidth Plot on Configuration IEEE 802.11ac MCS0/Nss2 VHT40 / 2437 MHz / Chain 4

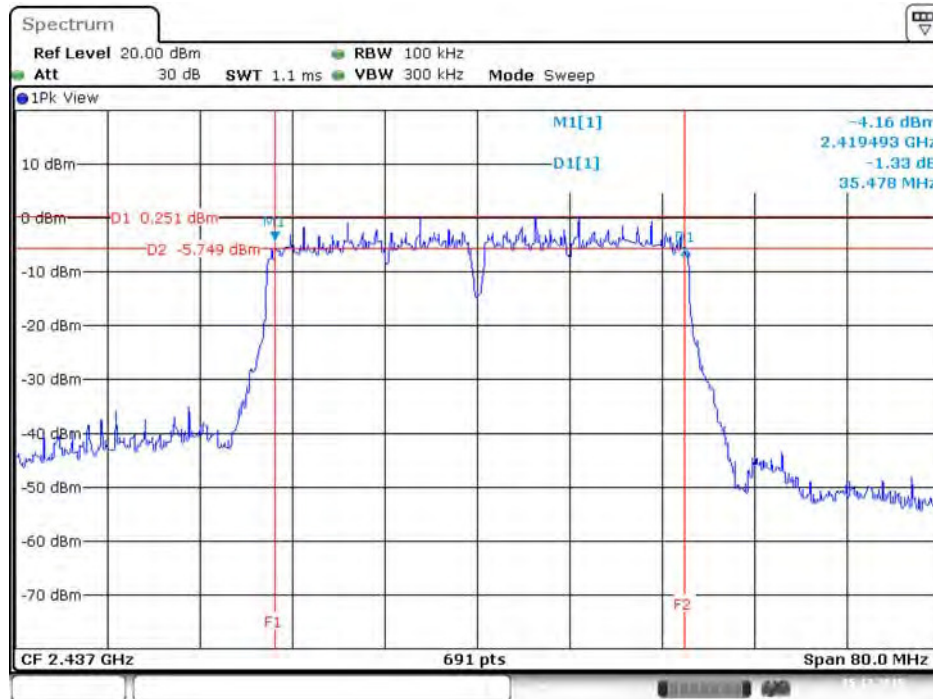

Date: 15.DEC.2015 13:55:43

99% Occupied Bandwidth Plot on Configuration IEEE 802.11ac MCS0/Nss2 VHT40 / 2437 MHz / Chain 4

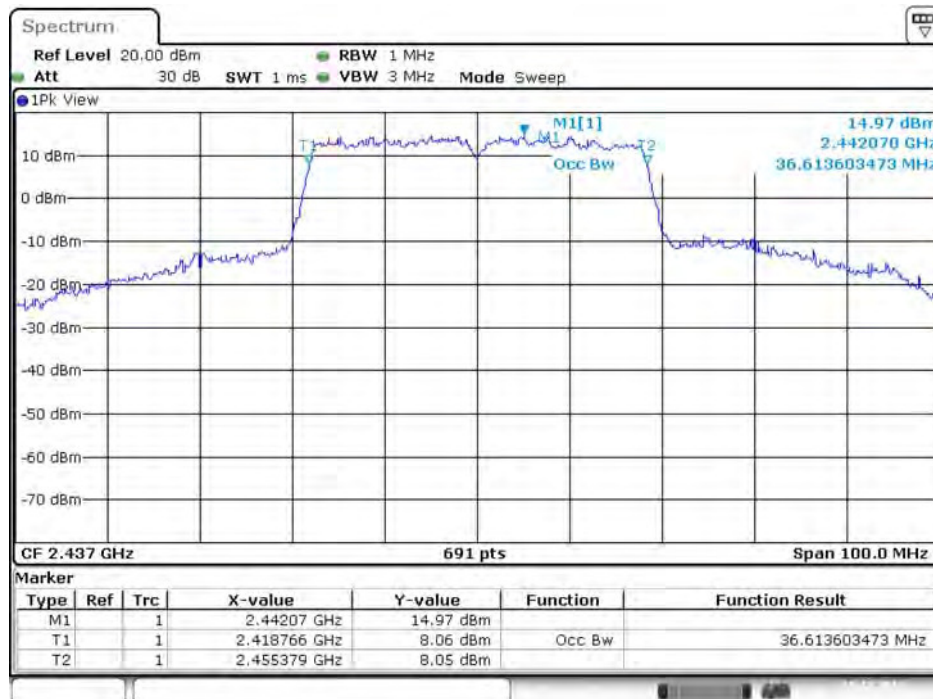

Date: 15.DEC.2015 14:42:20

6 dB Bandwidth Plot on Configuration IEEE 802.11ac MCS0/Nss3 VHT20 / 2437 MHz / Chain 1

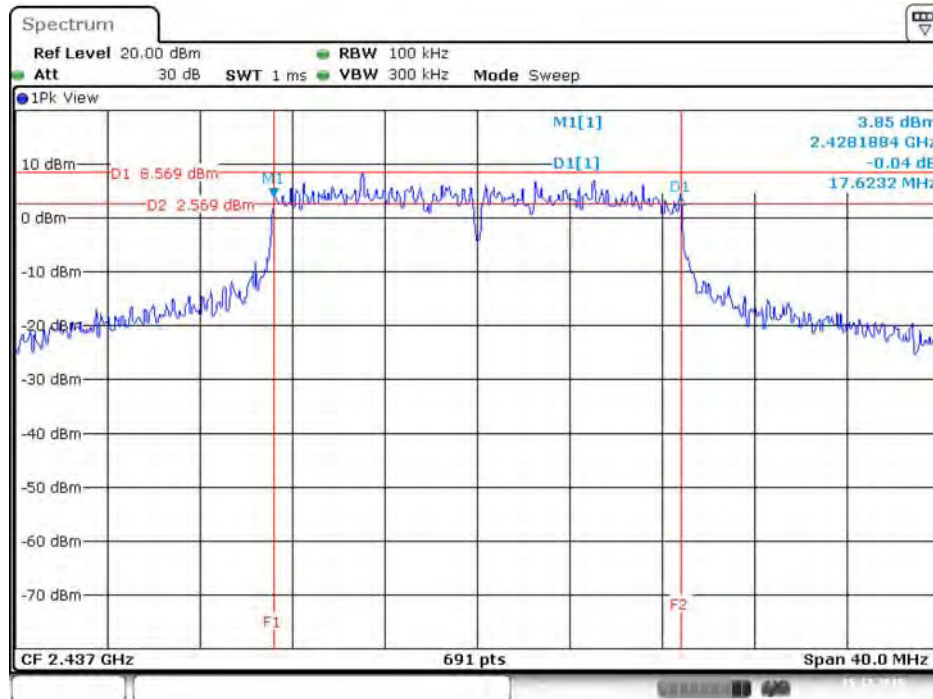

Date: 15.DEC.2015 14:06:28

99% Occupied Bandwidth Plot on Configuration IEEE 802.11ac MCS0/Nss3 VHT20 / 2437 MHz / Chain 1



Date: 15.DEC.2015 16:40:29

6 dB Bandwidth Plot on Configuration IEEE 802.11ac MCS0/Nss3 VHT20 / 2437 MHz / Chain 2

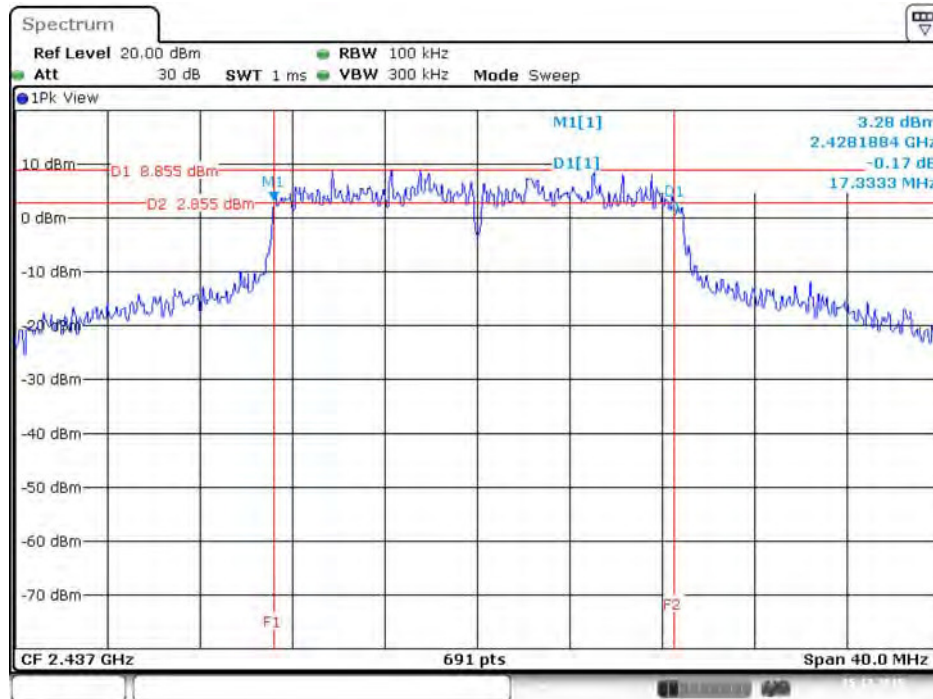

Date: 15.DEC.2015 14:06:16

99% Occupied Bandwidth Plot on Configuration IEEE 802.11ac MCS0/Nss3 VHT20 / 2437 MHz / Chain 2

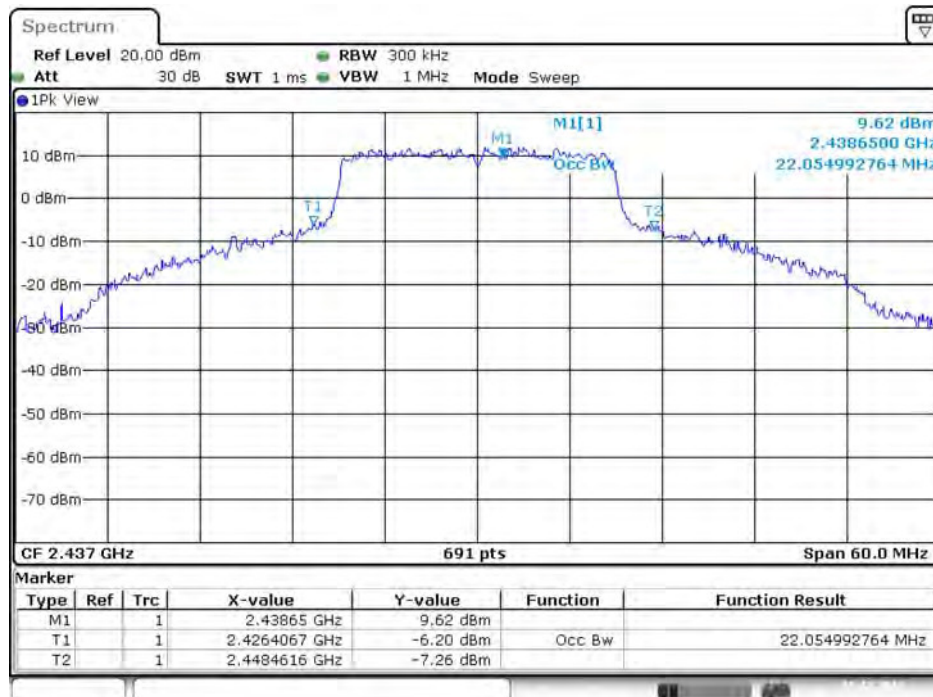

Date: 15.DEC.2015 16:40:41

6 dB Bandwidth Plot on Configuration IEEE 802.11ac MCS0/Nss3 VHT20 / 2437 MHz / Chain 3

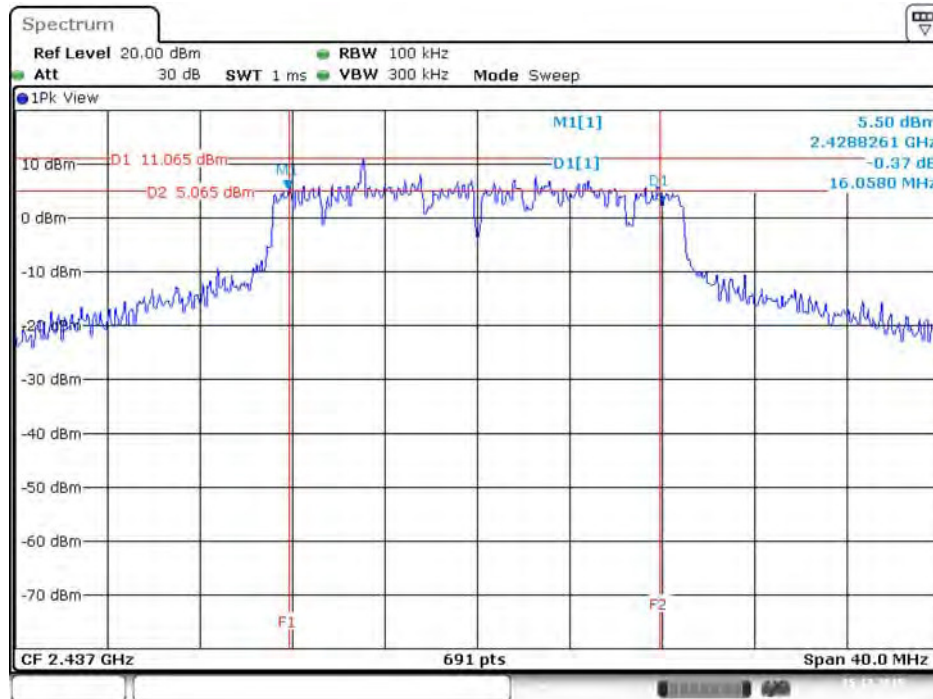

Date: 15.DEC.2015 14:06:01

99% Occupied Bandwidth Plot on Configuration IEEE 802.11ac MCS0/Nss3 VHT20 / 2437 MHz / Chain 3

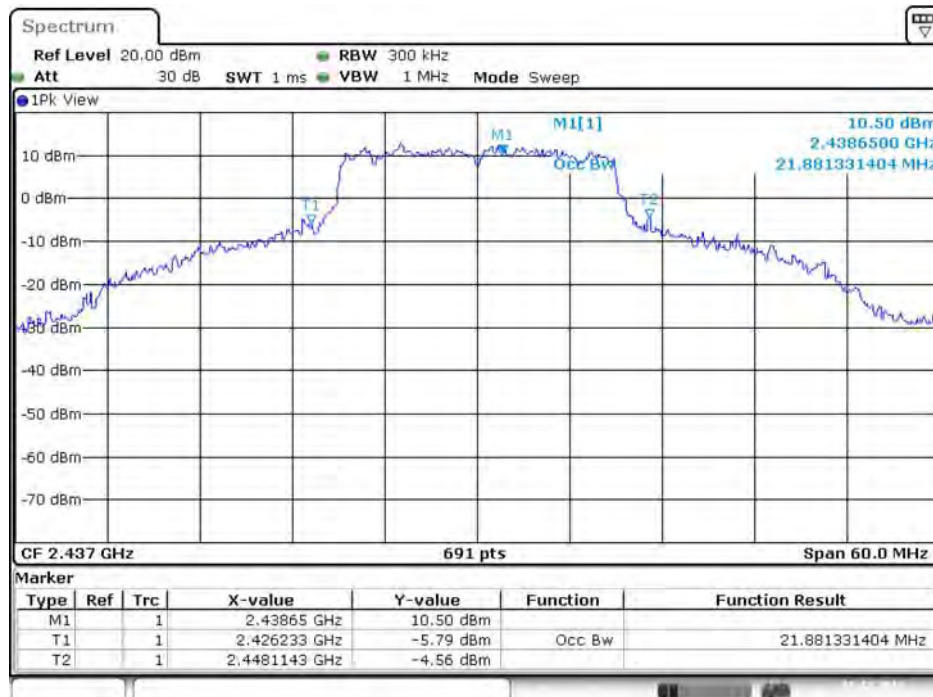

Date: 15.DEC.2015 16:40:52

6 dB Bandwidth Plot on Configuration IEEE 802. 11ac MCS0/Nss3 VHT20 / 2412 MHz / Chain 4

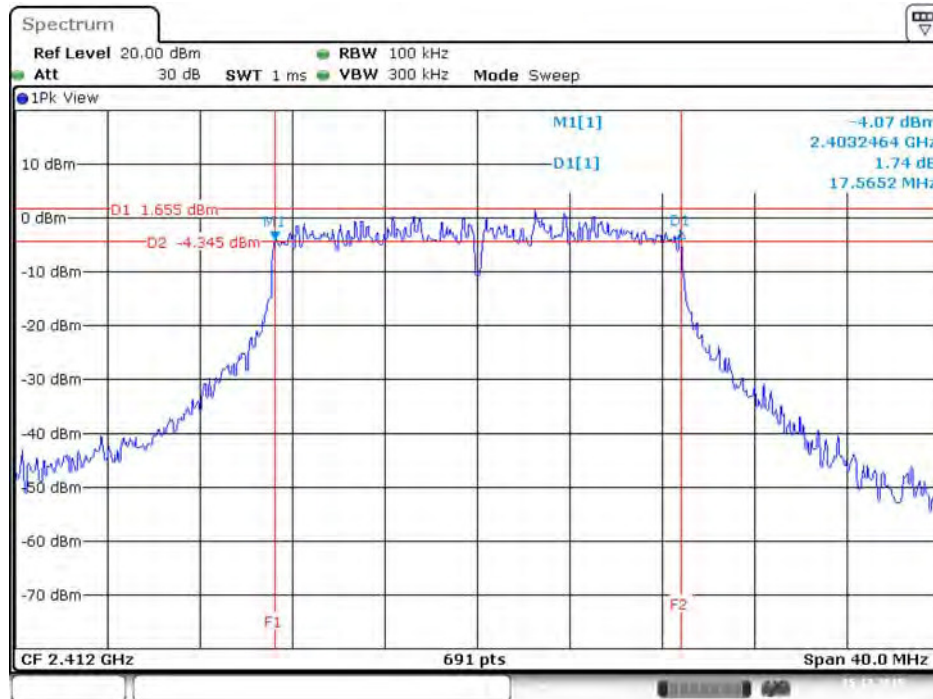

Date: 15.DEC.2015 14:01:01

99% Occupied Bandwidth Plot on Configuration IEEE 802. 11ac MCS0/Nss3 VHT20 / 2437 MHz / Chain 4

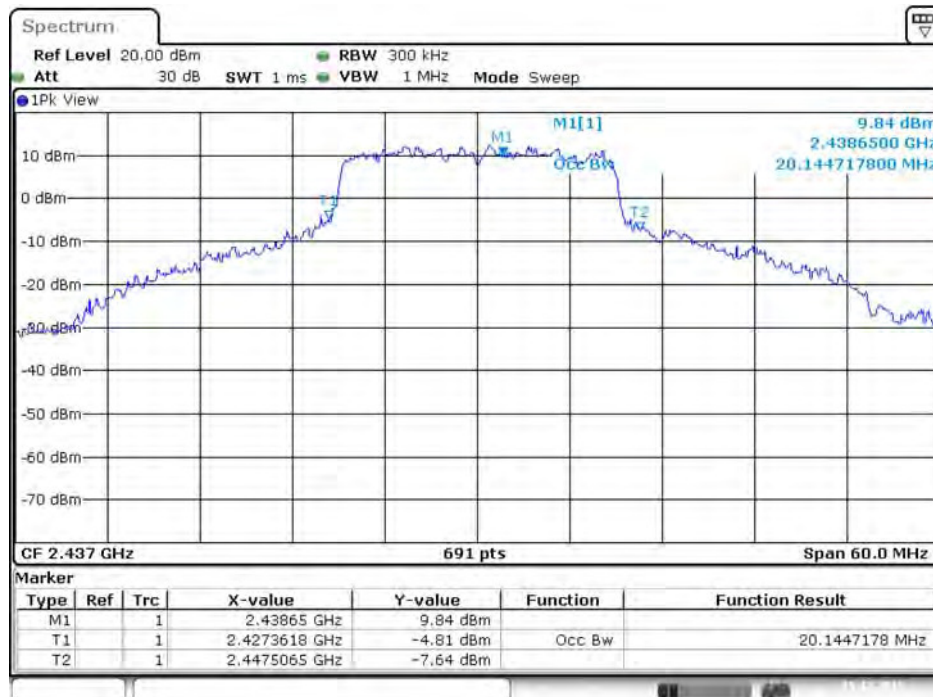

Date: 15.DEC.2015 16:41:03



6 dB Bandwidth Plot on Configuration IEEE 802. 11ac MCS0/Nss3 VHT40 / 2437 MHz / Chain 1

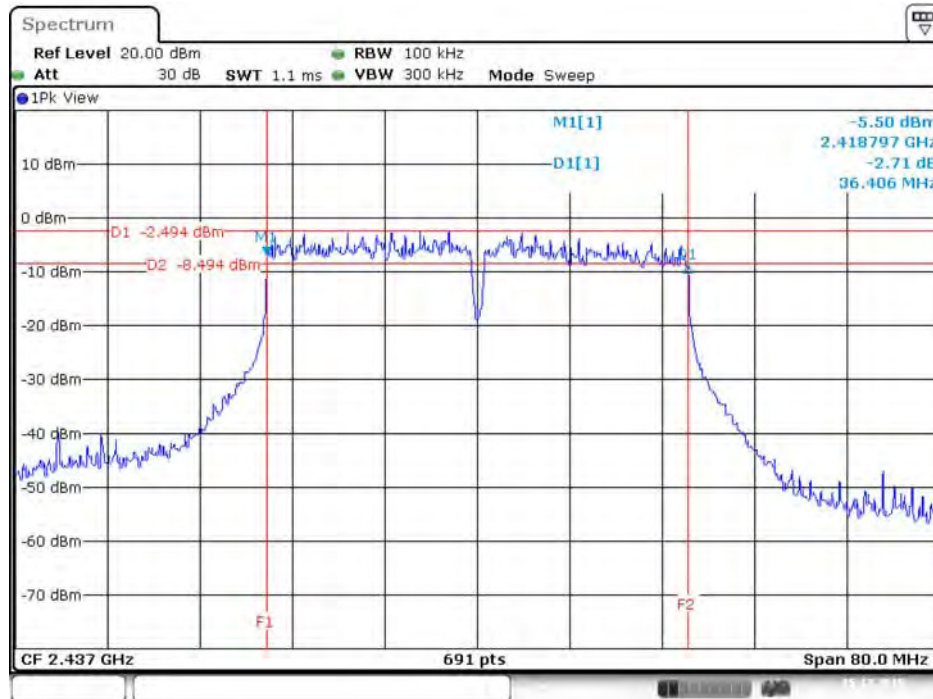

Date: 15.DEC.2015 14:13:41

99% Occupied Bandwidth Plot on Configuration IEEE 802. 11ac MCS0/Nss3 VHT40 / 2437 MHz / Chain 1

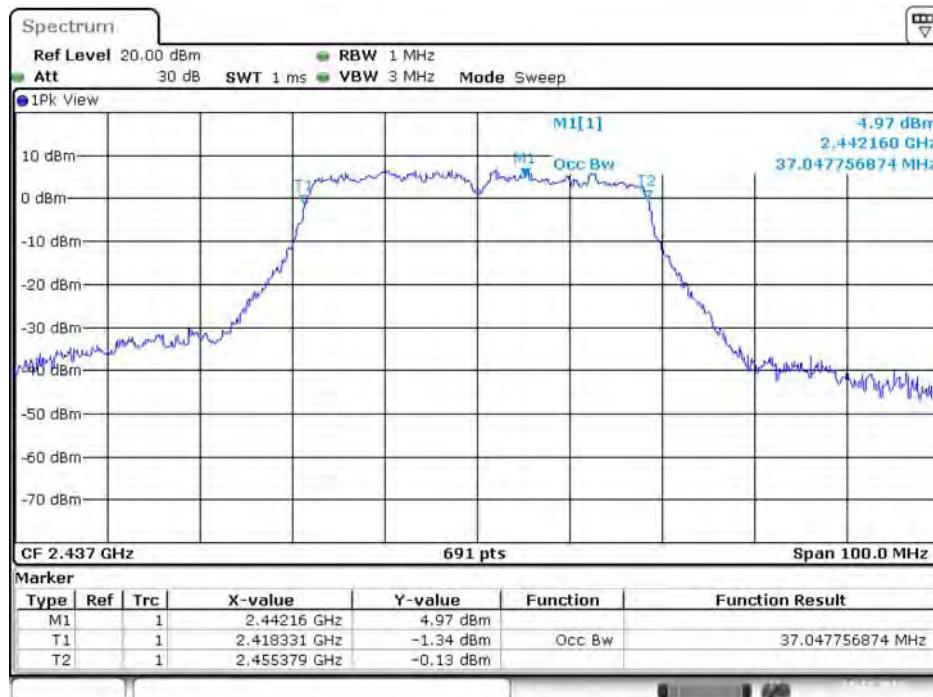

Date: 15.DEC.2015 14:30:13

6 dB Bandwidth Plot on Configuration IEEE 802.11ac MCS0/Nss3 VHT40 / 2452 MHz / Chain 2

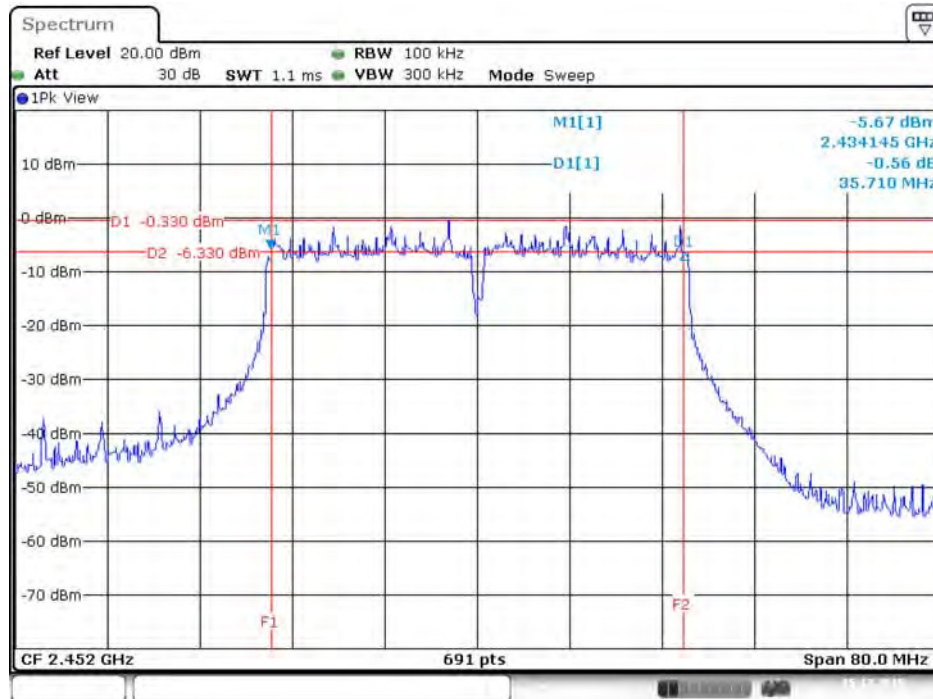

Date: 15.DEC.2015 14:18:40

99% Occupied Bandwidth Plot on Configuration IEEE 802.11ac MCS0/Nss3 VHT40 / 2437 MHz / Chain 2



Date: 15.DEC.2015 14:30:02

6 dB Bandwidth Plot on Configuration IEEE 802.11ac MCS0/Nss3 VHT40 / 2437 MHz / Chain 3

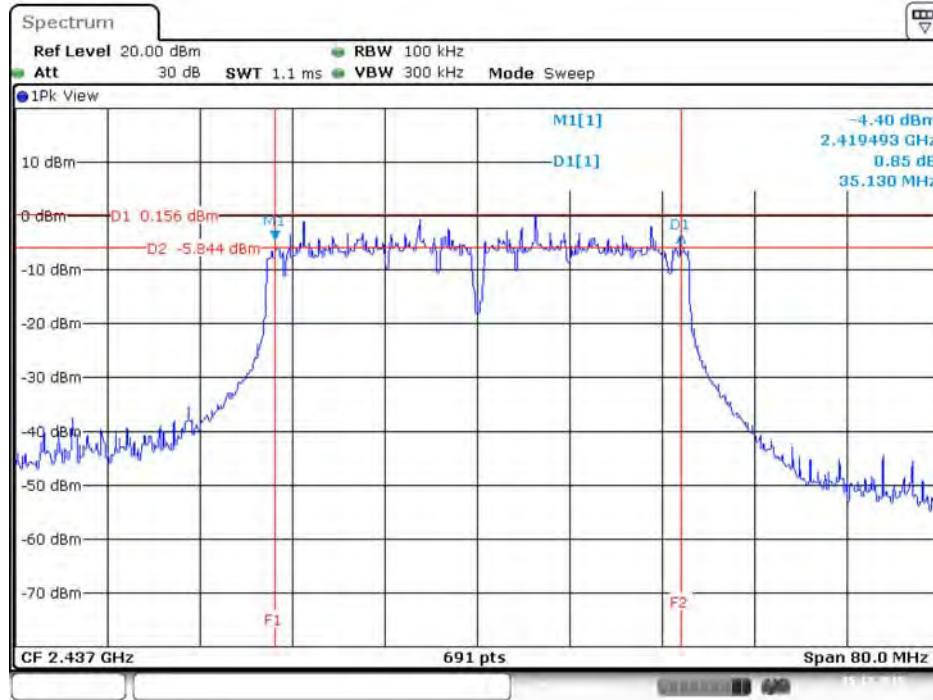

Date: 15.DEC.2015 14:14:11

99% Occupied Bandwidth Plot on Configuration IEEE 802.11ac MCS0/Nss3 VHT40 / 2437 MHz / Chain 3

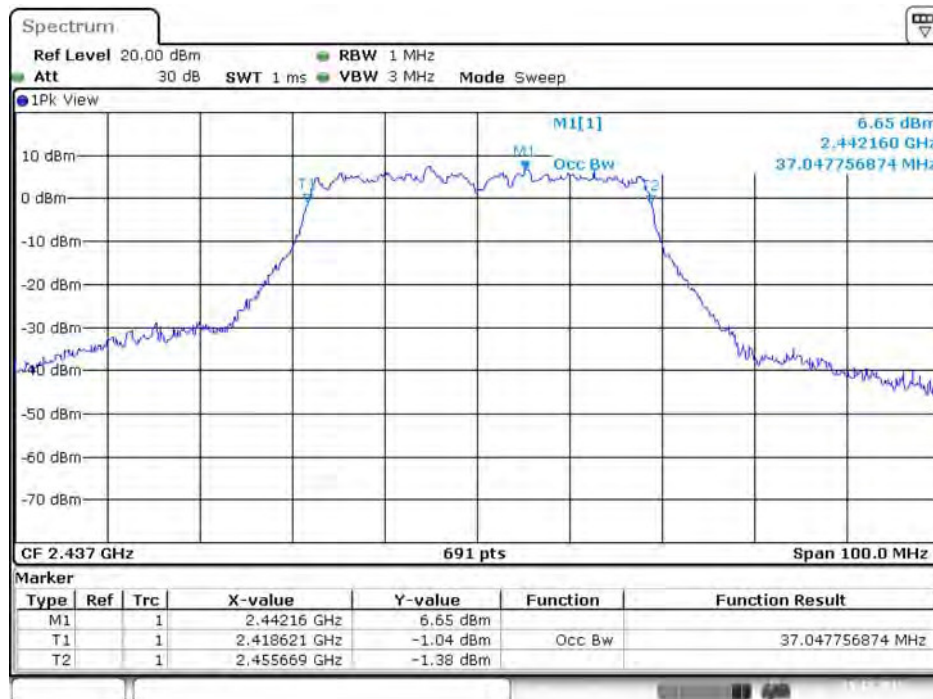

Date: 15.DEC.2015 14:29:51

6 dB Bandwidth Plot on Configuration IEEE 802.11ac MCS0/Nss3 VHT40 / 2437 MHz / Chain 4

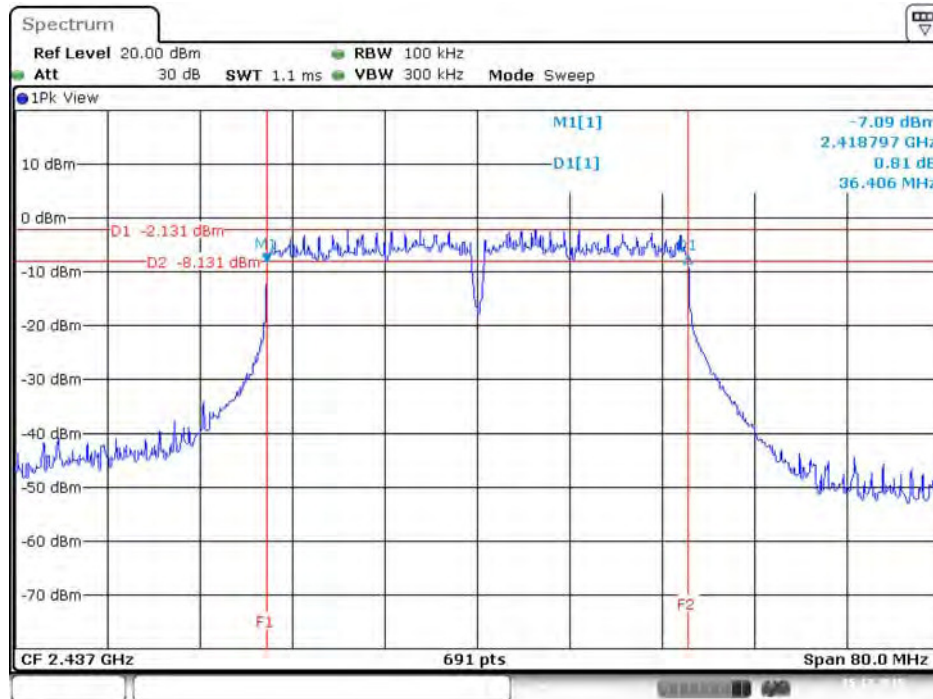

Date: 15.DEC.2015 14:14:22

99% Occupied Bandwidth Plot on Configuration IEEE 802.11ac MCS0/Nss3 VHT40 / 2437 MHz / Chain 4

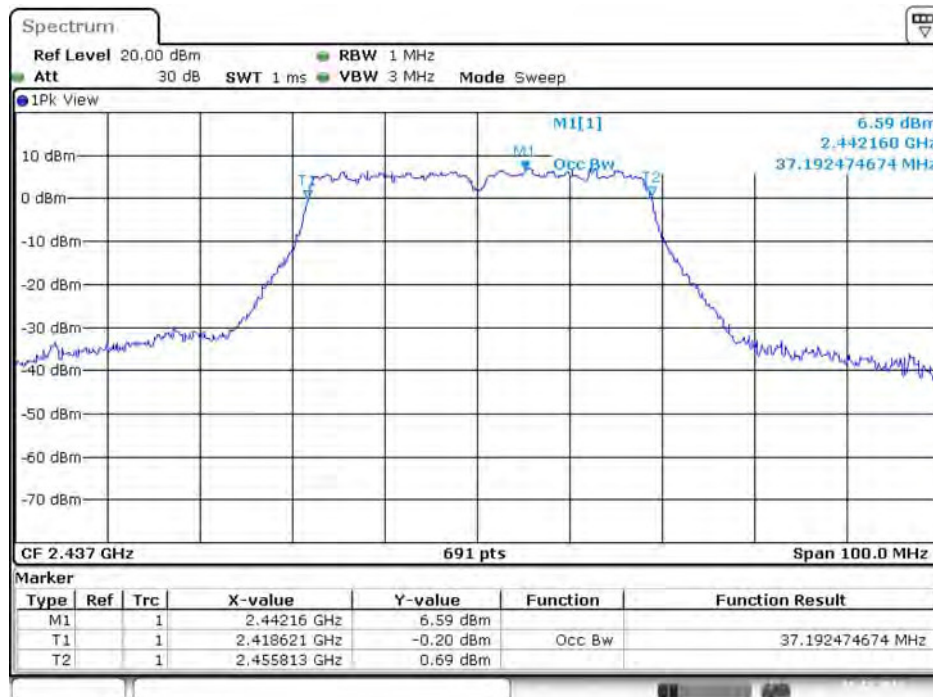

Date: 15.DEC.2015 14:29:35

<For Radio 3 Mode>

6 dB Bandwidth Plot on Configuration IEEE 802.11b / 2412 MHz / Chain 9

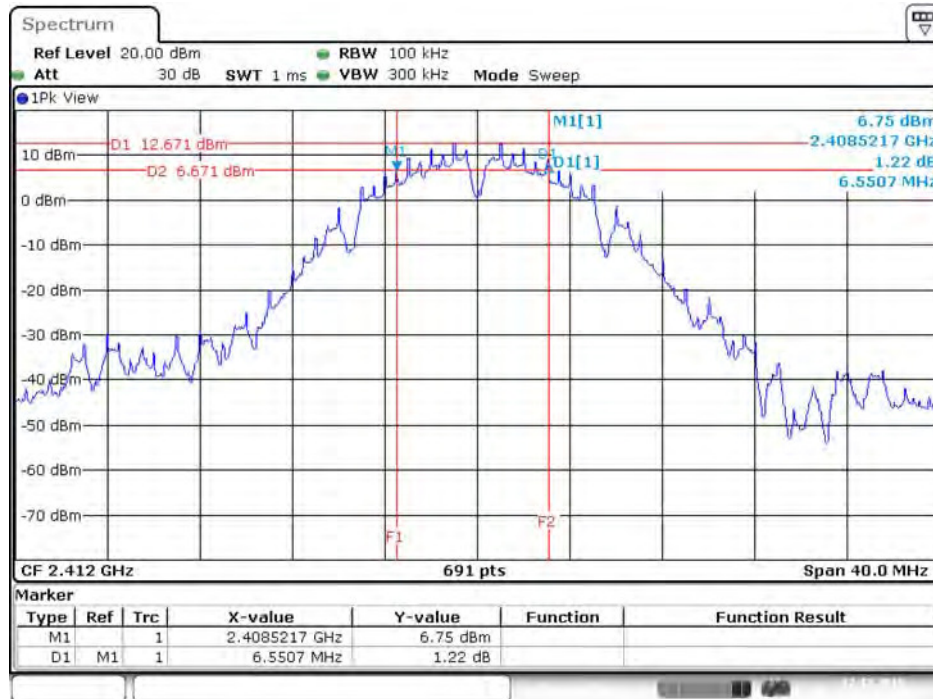

Date: 22.DEC.2015 14:30:00

99% Occupied Bandwidth Plot on Configuration IEEE 802.11b / 2437 MHz / Chain 9



Date: 22.DEC.2015 15:03:47

6 dB Bandwidth Plot on Configuration IEEE 802.11g / 2437 MHz / Chain 9

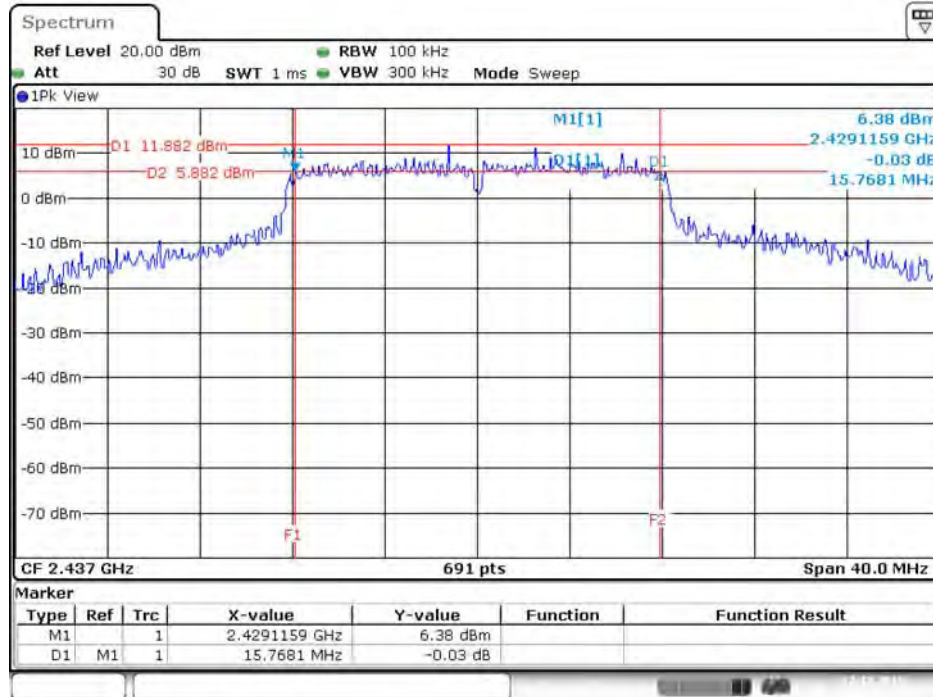

Date: 22.DEC.2015 14:38:02

99% Occupied Bandwidth Plot on Configuration IEEE 802.11g / 2437 MHz / Chain 9

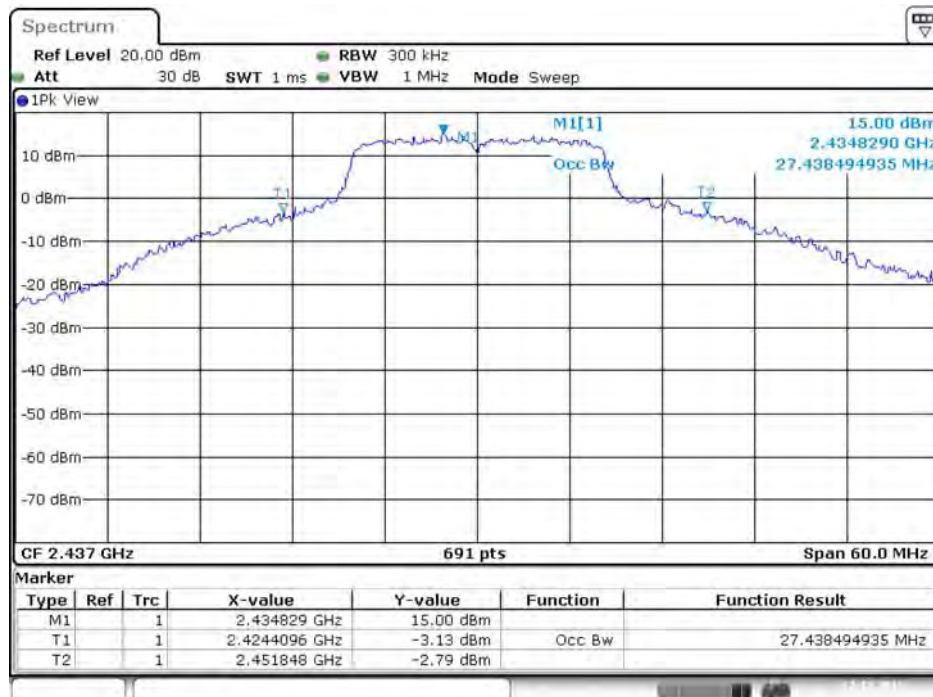

Date: 22.DEC.2015 14:59:27

6 dB Bandwidth Plot on Configuration IEEE 802.11ac MCS0/Nss1 VHT20 / 2462 MHz / Chain 9

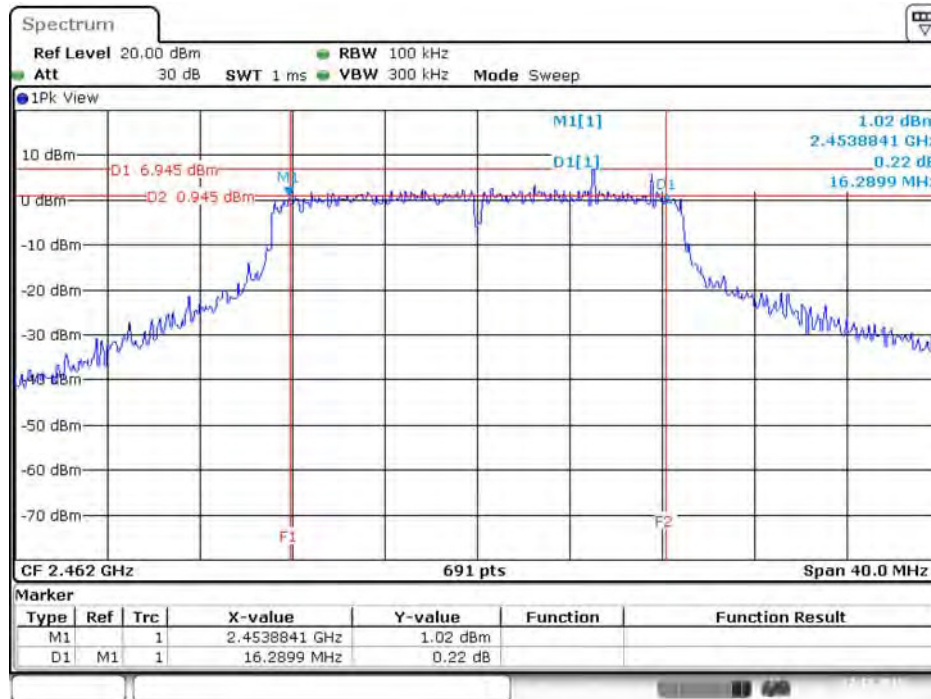

Date: 22.DEC.2015 14:42:05

99% Occupied Bandwidth Plot on Configuration IEEE 802.11ac MCS0/Nss1 VHT20 / 2437 MHz / Chain 9

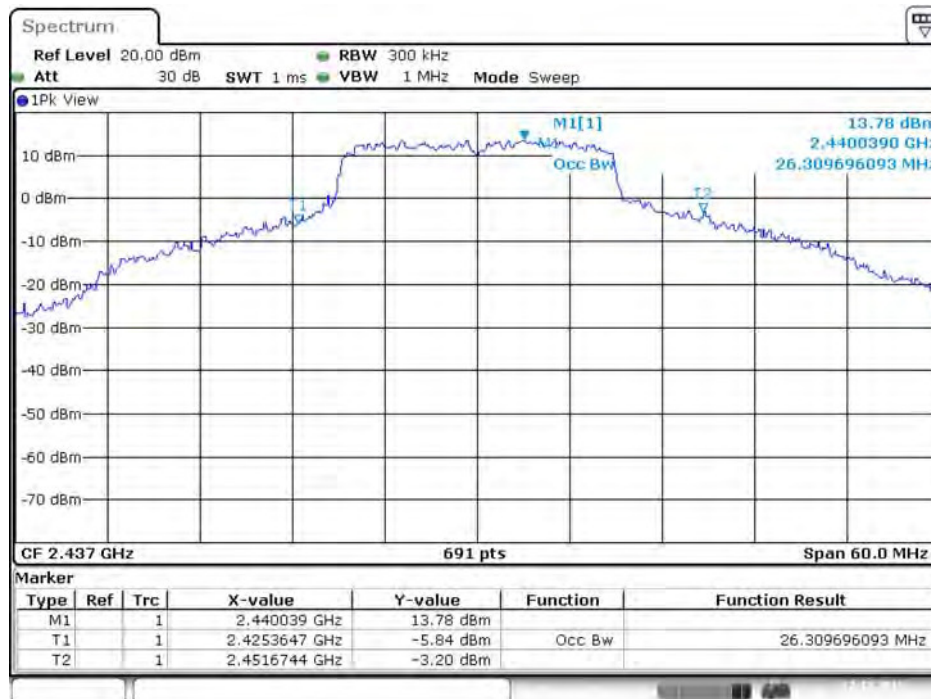

Date: 22.DEC.2015 14:55:01

6 dB Bandwidth Plot on Configuration IEEE 802. 11ac MCS0/Nss1 VHT40 / 2422 MHz / Chain 9

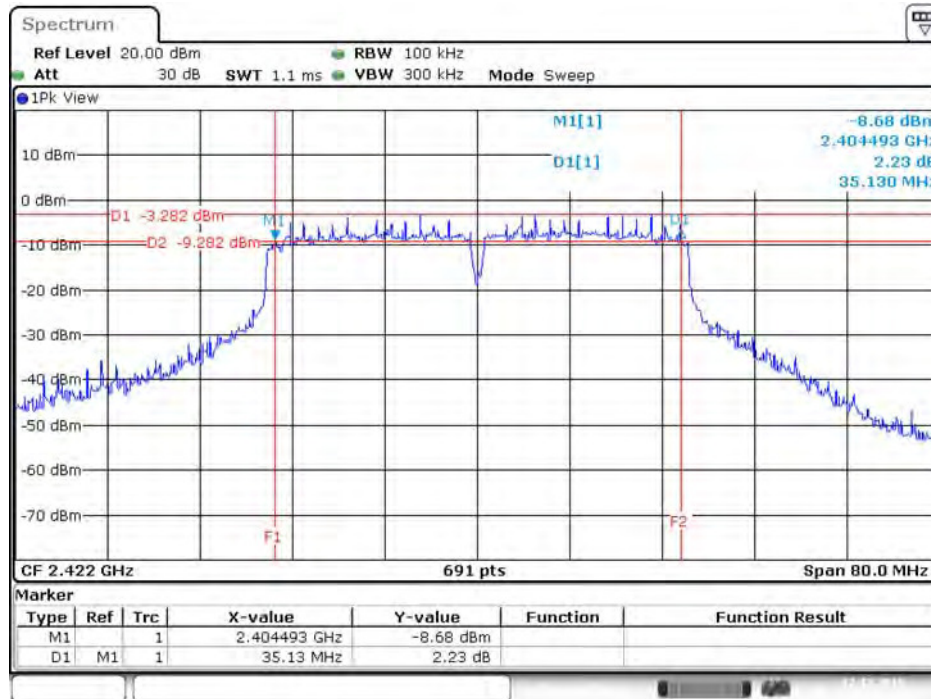

Date: 22.DEC.2015 14:48:27

99% Occupied Bandwidth Plot on Configuration IEEE 802. 11ac MCS0/Nss1 VHT40 / 2422 MHz / Chain 9



Date: 22.DEC.2015 14:50:30



## 4.5. Radiated Emissions Measurement

### 4.5.1. Limit

30dBc in any 100 kHz bandwidth outside the operating frequency band. In case the emission fall within the restricted band specified on 15.205(a), then the 15.209(a) limit in the table below has to be followed.

Frequencies (MHz)	Field Strength (micorvolts/meter)	Measurement Distance (meters)
0.009~0.490	2400/F(kHz)	300
0.490~1.705	24000/F(kHz)	30
1.705~30.0	30	30
30~88	100	3
88~216	150	3
216~960	200	3
Above 960	500	3

### 4.5.2. Measuring Instruments and Setting

Please refer to section 5 of equipments list in this report. The following table is the setting of spectrum analyzer and receiver.

Spectrum Parameter	Setting
Attenuation	Auto
Start Frequency	1000 MHz
Stop Frequency	10th carrier harmonic
RBW / VBW (Emission in restricted band)	1MHz / 3MHz for Peak, 1MHz / 1/T for Average
RBW / VBW (Emission in non-restricted band)	100kHz / 300kHz for peak

Receiver Parameter	Setting
Attenuation	Auto
Start ~ Stop Frequency	9kHz~150kHz / RBW 200Hz for QP
Start ~ Stop Frequency	150kHz~30MHz / RBW 9kHz for QP
Start ~ Stop Frequency	30MHz~1GHz / RBW 120kHz for QP

#### 4.5.3. Test Procedures

1. Configure the EUT according to ANSI C63.10. The EUT was placed on the top of the turntable 1.5 meter above ground. The phase center of the receiving antenna mounted on the top of a height-variable antenna tower was placed 1m & 3m far away from the turntable.
2. Power on the EUT and all the supporting units. The turntable was rotated by 360 degrees to determine the position of the highest radiation.
3. The height of the broadband receiving antenna was varied between one meter and four meters above ground to find the maximum emissions field strength of both horizontal and vertical polarization.
4. For each suspected emissions, the antenna tower was scan (from 1 M to 4 M) and then the turntable was rotated (from 0 degree to 360 degrees) to find the maximum reading.
5. Set the test-receiver system to Peak or CISPR quasi-peak Detect Function with specified bandwidth under Maximum Hold Mode.
6. For emissions above 1GHz, use 1MHz VBW and 3MHz RBW for peak reading. Then 1MHz RBW and 1/T VBW for average reading in spectrum analyzer.
7. If the emissions level of the EUT in peak mode was 3 dB lower than the average limit specified, then testing will be stopped and peak values of EUT will be reported, otherwise, the emissions which do not have 3 dB margin will be repeated one by one using the quasi-peak method for below 1GHz.
8. For testing above 1GHz, the emissions level of the EUT in peak mode was lower than average limit (that means the emissions level in peak mode also complies with the limit in average mode), then testing will be stopped and peak values of EUT will be reported, otherwise, the emissions will be measured in average mode again and reported.
9. In case the emission is lower than 30MHz, loop antenna has to be used for measurement and the recorded data should be QP measured by receiver. High – Low scan is not required in this case.

#### 4.5.4. Test Setup Layout

For Radiated Emissions: 9kHz ~30MHz

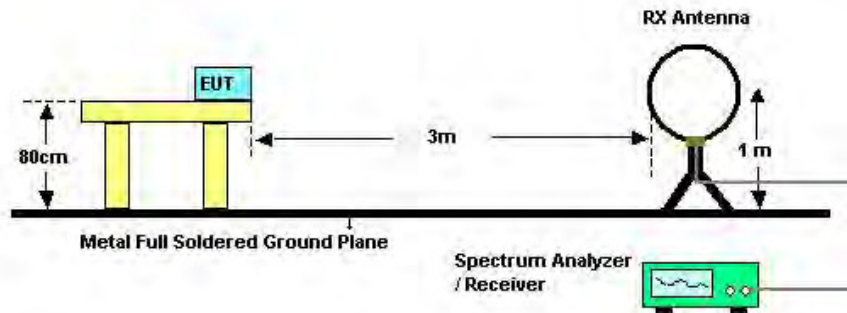

For Radiated Emissions: 30MHz~1GHz

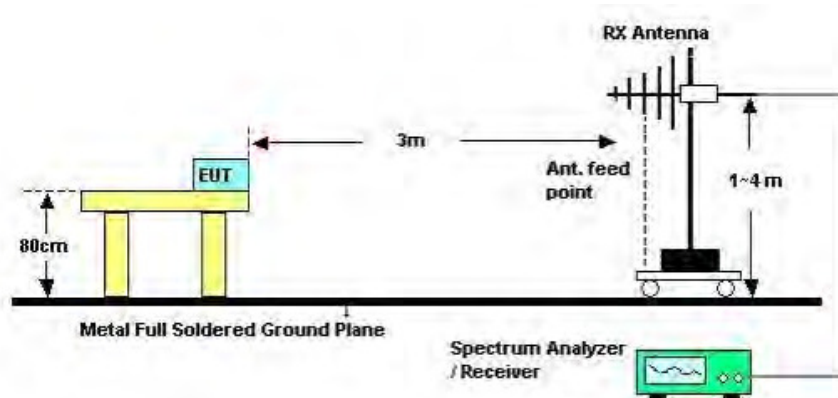

For Radiated Emissions: Above 1GHz

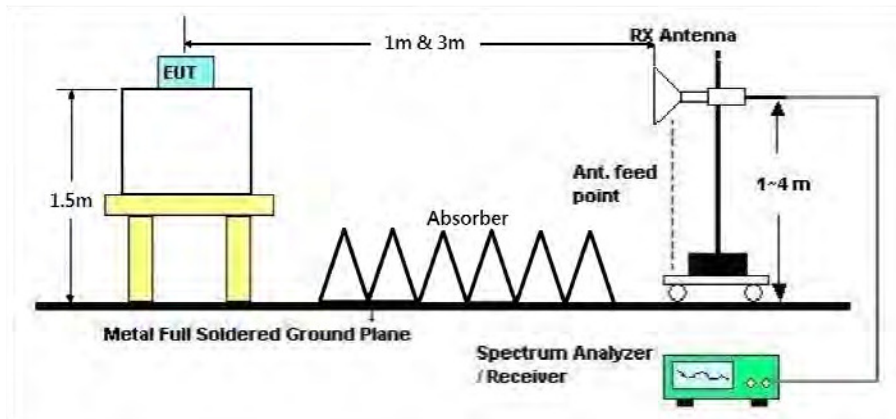

#### 4.5.5. Test Deviation

There is no deviation with the original standard.

#### 4.5.6. EUT Operation during Test

<For Non-beamforming Mode>

The EUT was programmed to be in continuously transmitting mode.

<For Beamforming Mode>

The EUT was programmed to be in beamforming transmitting mode.

#### 4.5.7. Results of Radiated Emissions (9kHz~30MHz)

<b>Temperature</b>	25°C	<b>Humidity</b>	56%
<b>Test Engineer</b>	Stim Sung	<b>Configurations</b>	Normal Link / Mode 4
<b>Test Date</b>	Dec. 27, 2015		

<b>Freq. (MHz)</b>	<b>Level (dBuV)</b>	<b>Over Limit (dB)</b>	<b>Limit Line (dBuV)</b>	<b>Remark</b>
-	-	-	-	See Note

Note:

The amplitude of spurious emissions that are attenuated by more than 20 dB below the permissible value has no need to be reported.

Distance extrapolation factor =  $40 \log(\text{specific distance} / \text{test distance})$  (dB);

Limit line = specific limits (dBuV) + distance extrapolation factor.

4.5.8. Results of Radiated Emissions (30MHz~1GHz)

Temperature	25°C	Humidity	56%
Test Engineer	Stim Sung	Configurations	Normal Link / Mode 4

Horizontal

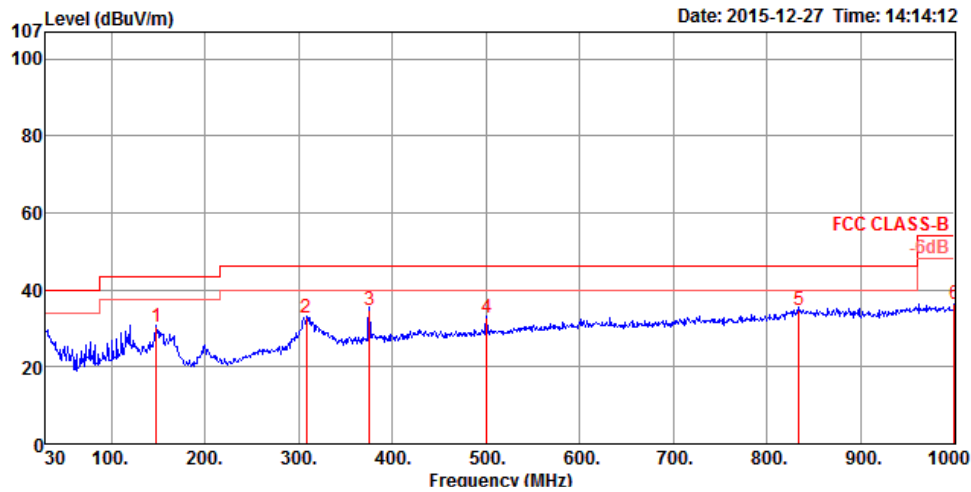

	Freq	Level	Limit	Over	Read	Cable	Preamp	Antenna		T/Pos	A/Pos	Remark
	MHz	dBuV/m	dBuV/m	dB	dBuV	dB	dB	dB/m	Pol/Phase	deg	cm	
1	148.34	30.21	43.50	-13.29	49.87	1.48	32.56	11.42	HORIZONTAL	72	175	QP
2	308.39	32.73	46.00	-13.27	49.03	2.07	32.52	14.15	HORIZONTAL	211	125	QP
3	375.32	34.87	46.00	-11.13	49.24	2.24	32.54	15.93	HORIZONTAL	3	300	QP
4	500.45	32.80	46.00	-13.20	44.87	2.61	32.61	17.93	HORIZONTAL	28	125	QP
5	834.13	34.91	46.00	-11.09	42.80	3.28	32.20	21.03	HORIZONTAL	1	150	QP
6	1000.00	36.46	54.00	-17.54	41.83	3.41	30.98	22.20	HORIZONTAL	261	200	QP

**Vertical**

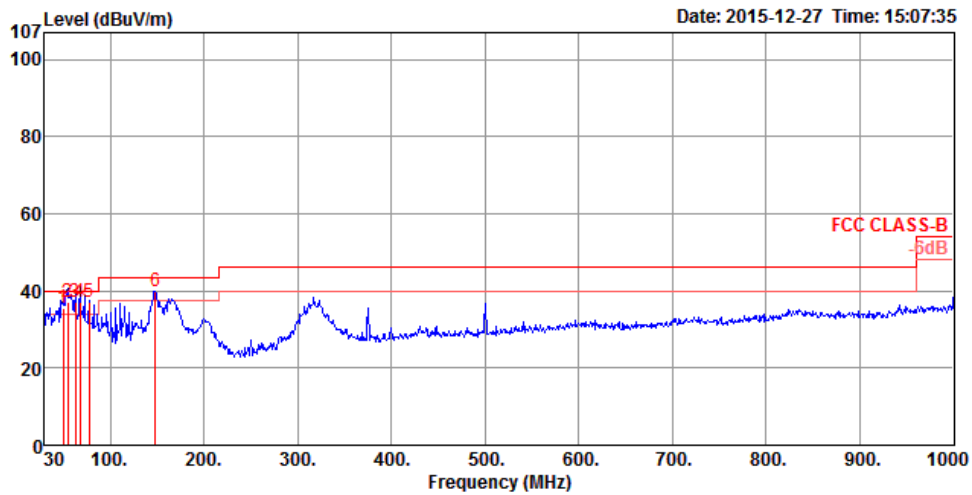

	Freq	Level	Limit	Over	Read	Cable	Preamp	Antenna		T/Pos	A/Pos	Remark
	MHz	dBuV/m	dBuV/m	dB	dBuV	dB	dB	dB/m		deg	cm	
1	49.40	35.34	40.00	-4.66	57.73	0.95	32.63	9.29	VERTICAL	298	100	QP
2	54.25	36.94	40.00	-3.06	60.58	0.95	32.62	8.03	VERTICAL	119	125	QP
3	62.98	36.98	40.00	-3.02	61.69	1.10	32.61	6.80	VERTICAL	354	100	QP
4	67.83	36.94	40.00	-3.06	61.64	1.10	32.60	6.80	VERTICAL	134	100	QP
5	77.53	36.92	40.00	-3.08	60.89	1.21	32.59	7.41	VERTICAL	198	100	QP
6	148.34	39.90	43.50	-3.60	59.56	1.48	32.56	11.42	VERTICAL	26	100	QP

**Note:**

The amplitude of spurious emissions that are attenuated by more than 20dB below the permissible value has no need to be reported.

Emission level (dBuV/m) = 20 log Emission level (uV/m).

Corrected Reading: Antenna Factor + Cable Loss + Read Level - Preamp Factor = Level.

4.5.9. Results for Radiated Emissions (1GHz~10<sup>th</sup> Harmonic)

<For Radio 1 Non-beamforming Mode>

Temperature	26°C	Humidity	57%
Test Engineer	Roki Liu	Configurations	IEEE 802.11b CH 1 / Chain 1 + Chain 2 + Chain 3 + Chain 4

Horizontal

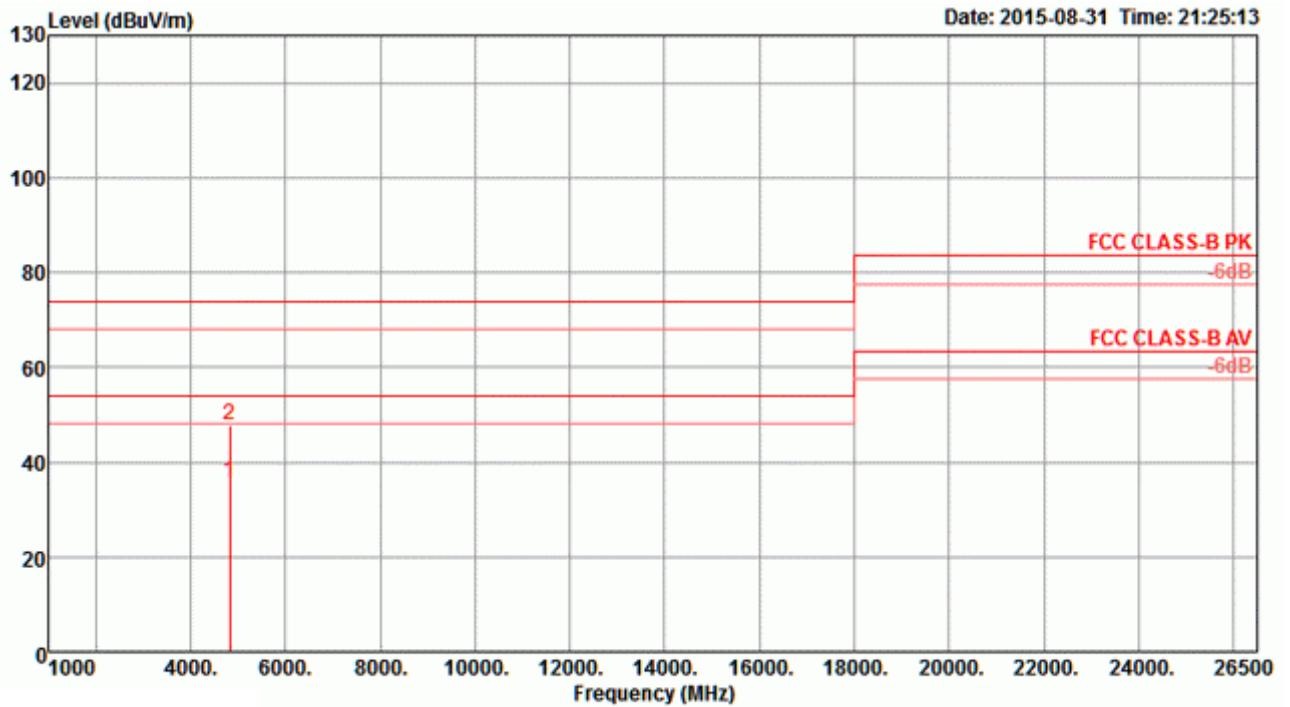

	Freq	Level	Limit	Over	Read	CableAntenna	Preamp	T/Pos	A/Pos	Remark	Pol/Phase
	MHz	dBuV/m	dBuV/m	dB	dBuV	dB	dB/m	dB	deg	cm	
1	4823.92	35.84	54.00	-18.16	33.57	4.10	32.69	34.52	251	199 Average	HORIZONTAL
2	4825.06	47.88	74.00	-26.12	45.61	4.10	32.69	34.52	251	199 Peak	HORIZONTAL

**Vertical**

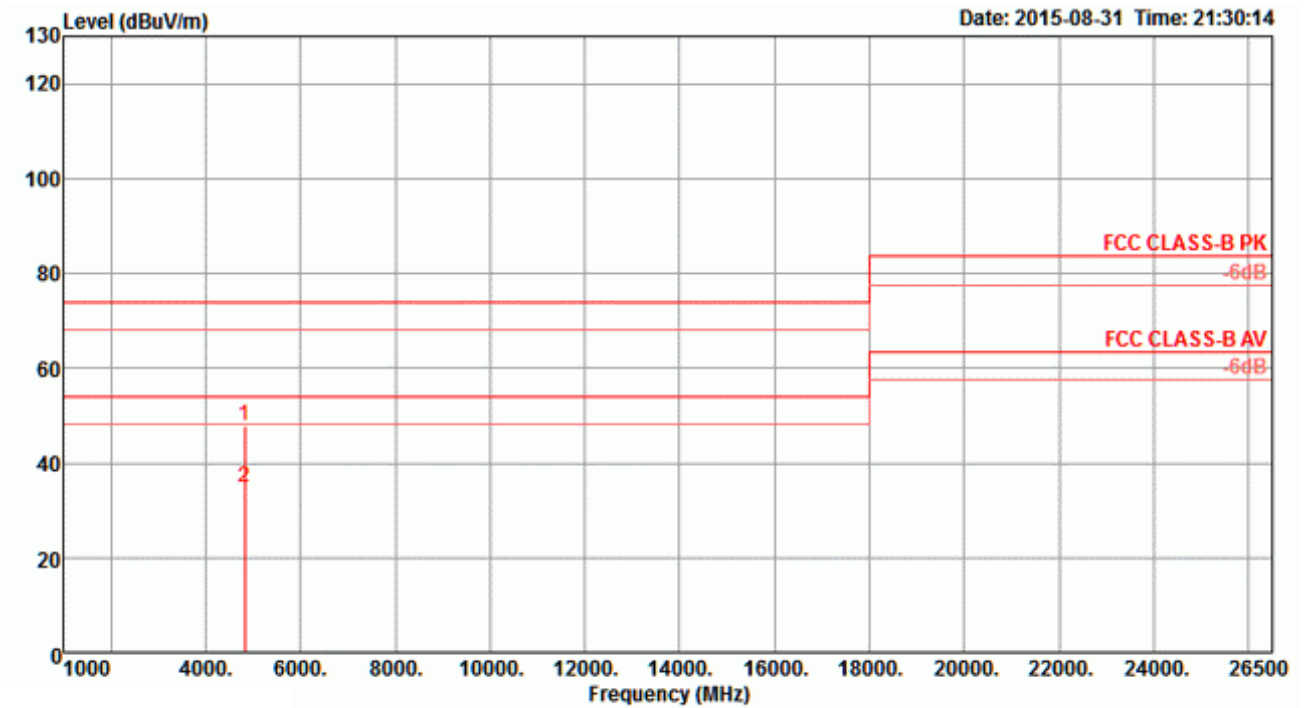

	Freq	Level	Limit	Over	Read	CableAntenna	Preamp	T/Pos	A/Pos	Remark	Pol/Phase
	MHz	dBuV/m	dBuV/m	dB	dBuV	dB	dB/m	dB	deg	cm	
1	4819.54	47.85	74.00	-26.15	45.58	4.10	32.69	34.52	252	180 Peak	VERTICAL
2	4823.94	34.80	54.00	-19.20	32.53	4.10	32.69	34.52	252	180 Average	VERTICAL



Temperature	26°C	Humidity	57%
Test Engineer	Roki Liu	Configurations	IEEE 802.11b CH 6 / Chain 1 + Chain 2 + Chain 3 + Chain 4

**Horizontal**

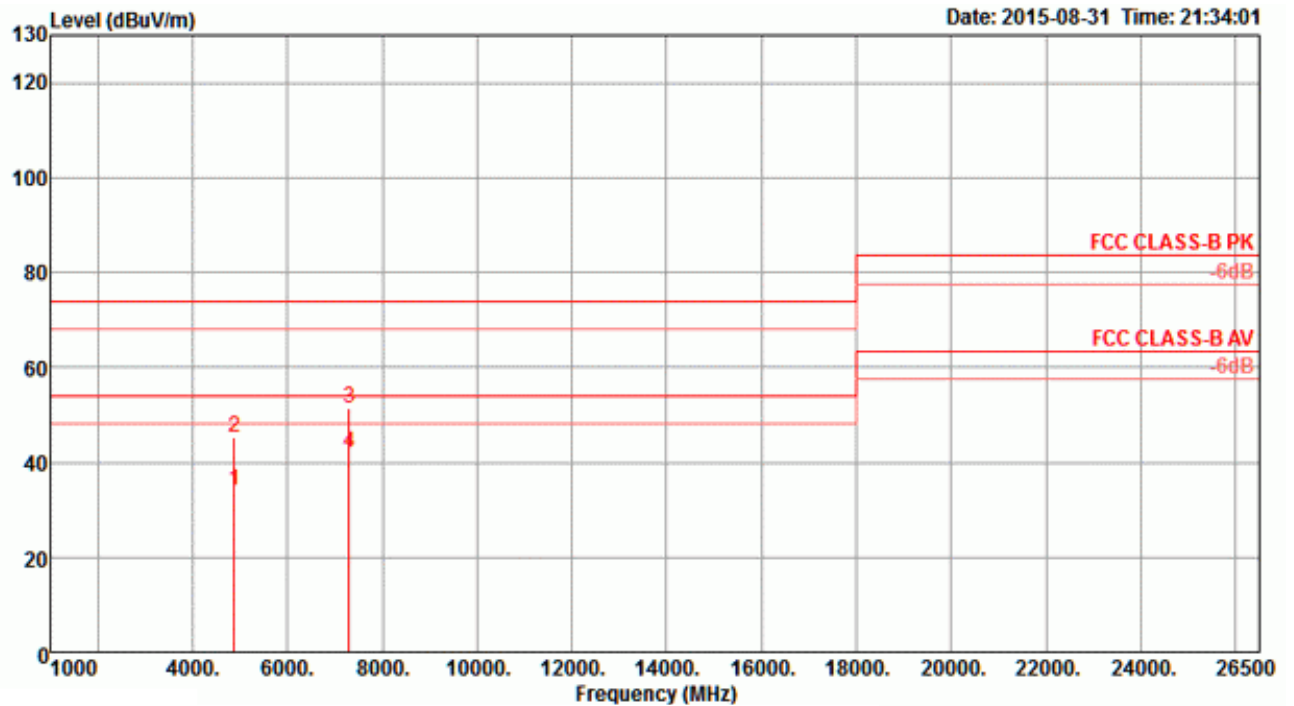

	Freq	Level	Limit	Over	Read	CableAntenna	Preamp	T/Pos	A/Pos	Remark	Pol/Phase
	MHz	dBuV/m	dBuV/m	dB	dBuV	dB	dB/m	deg	cm		
1	4874.00	34.04	54.00	-19.96	31.64	4.13	32.78	34.51	99	231 Average	HORIZONTAL
2	4876.84	45.18	74.00	-28.82	42.78	4.13	32.78	34.51	99	231 Peak	HORIZONTAL
3	7309.36	51.34	74.00	-22.66	43.78	5.09	37.23	34.76	302	147 Peak	HORIZONTAL
4	7310.04	42.06	54.00	-11.94	34.50	5.09	37.23	34.76	302	147 Average	HORIZONTAL

**Vertical**

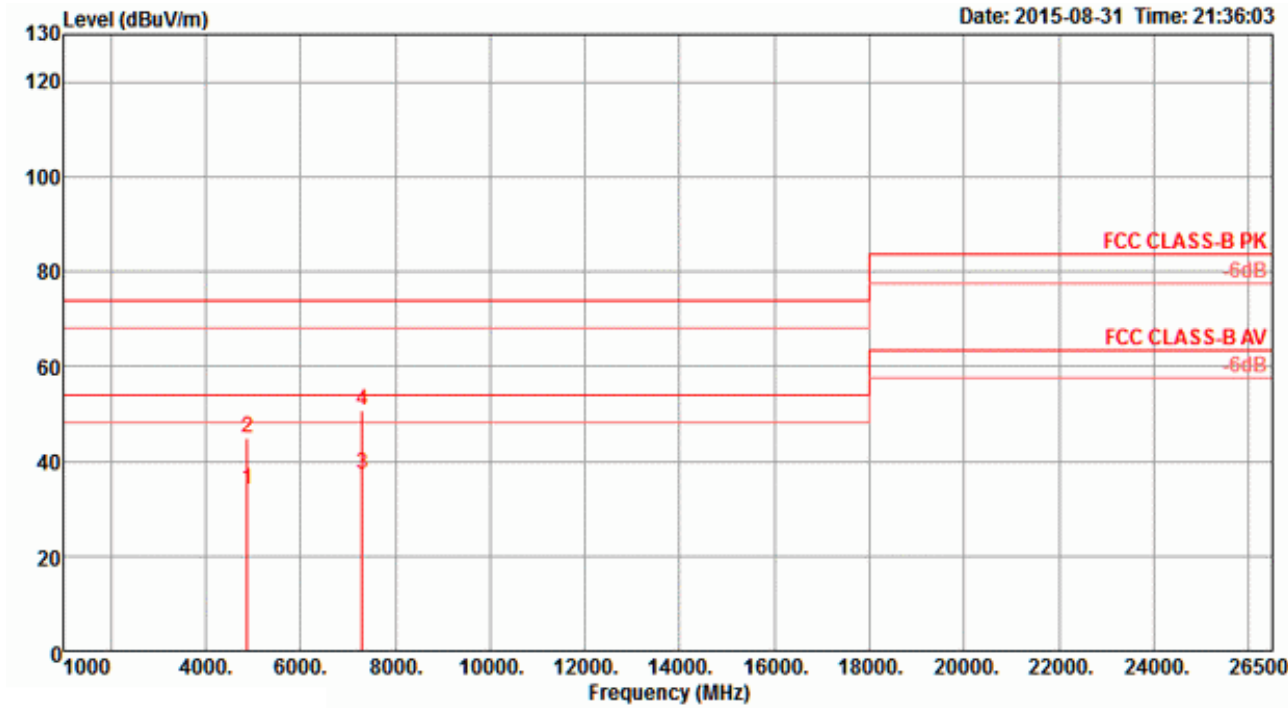

	Freq	Level	Limit	Over	Read	CableAntenna	Preamp	T/Pos	A/Pos	Remark	Pol/Phase
	MHz	dBuV/m	dBuV/m	dB	dBuV	dB	dB/m	dB	deg	cm	
1	4874.08	34.11	54.00	-19.89	31.71	4.13	32.78	34.51	56	193 Average	VERTICAL
2	4876.72	45.04	74.00	-28.96	42.64	4.13	32.78	34.51	56	193 Peak	VERTICAL
3	7310.95	37.37	54.00	-16.63	29.81	5.09	37.23	34.76	296	193 Average	VERTICAL
4	7311.02	50.54	74.00	-23.46	42.98	5.09	37.23	34.76	296	193 Peak	VERTICAL

Temperature	26°C	Humidity	57%
Test Engineer	Roki Liu	Configurations	IEEE 802.11b CH 11 / Chain 1 + Chain 2 + Chain 3 + Chain 4

**Horizontal**

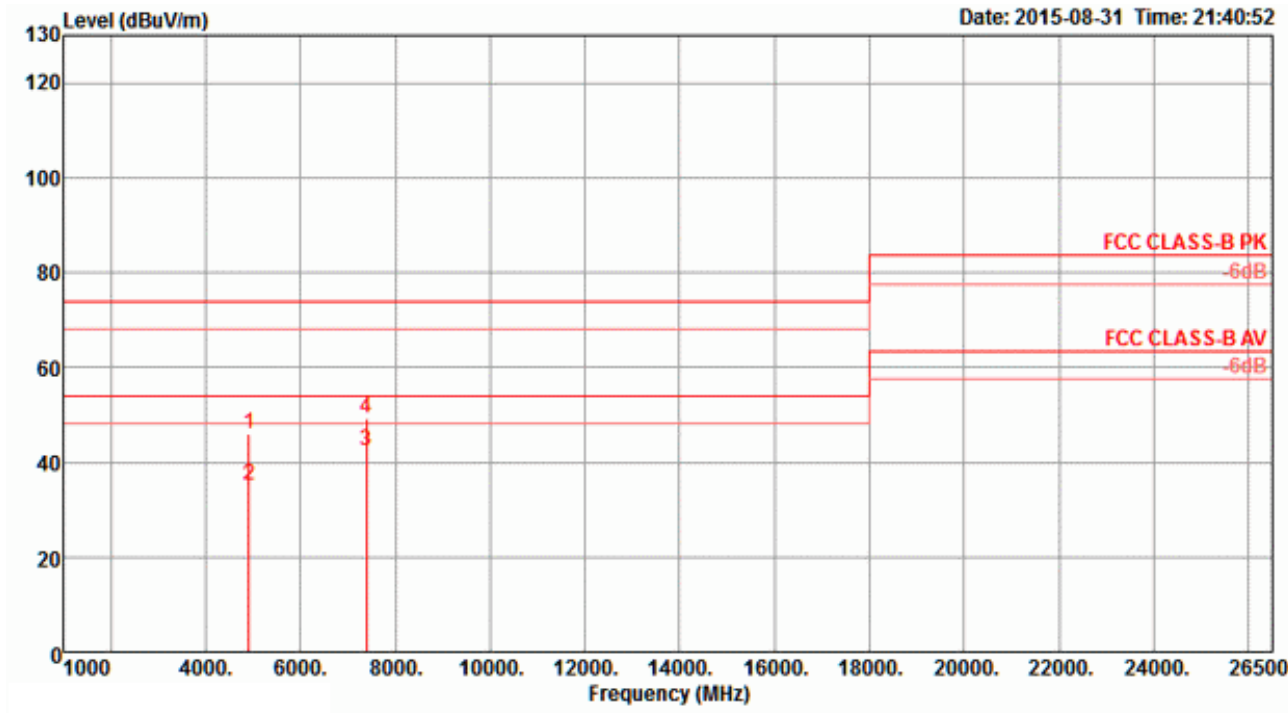

	Freq	Level	Limit	Over	Read	CableAntenna	Preamp	T/Pos	A/Pos	Remark	Pol/Phase
	MHz	dBuV/m	dBuV/m	dB	dBuV	dB	dB/m	dB	deg	cm	
1	4924.00	45.96	74.00	-28.04	43.42	4.15	32.88	34.49	183	164 Peak	HORIZONTAL
2	4924.04	35.18	54.00	-18.82	32.64	4.15	32.88	34.49	183	164 Average	HORIZONTAL
3	7386.80	42.49	54.00	-11.51	34.78	5.12	37.36	34.77	158	196 Average	HORIZONTAL
4	7393.40	49.09	74.00	-24.91	41.38	5.12	37.36	34.77	158	196 Peak	HORIZONTAL

**Vertical**

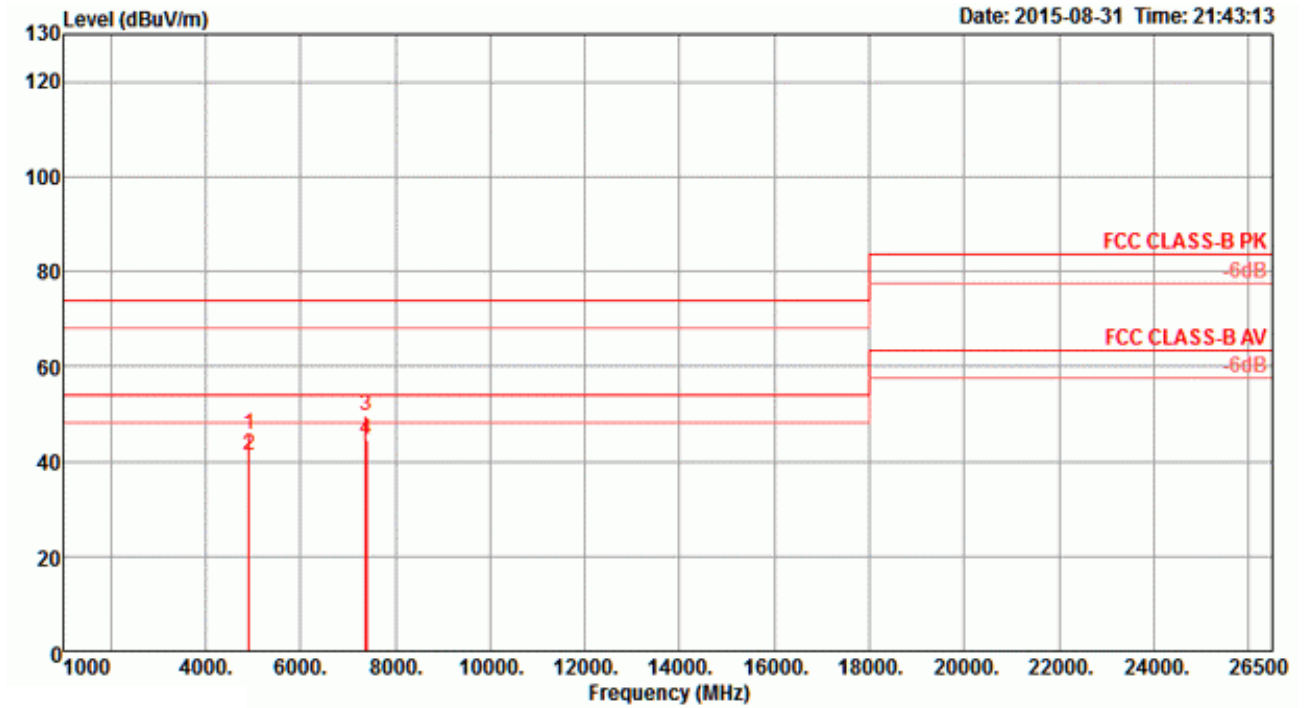

	Freq	Level	Limit	Over	Read	CableAntenna	Preamp	T/Pos	A/Pos	Remark	Pol/Phase
	MHz	dBuV/m	dBuV/m	dB	dBuV	dB	dB/m	dB	cm		
1	4923.80	45.80	74.00	-28.20	43.26	4.15	32.88	34.49	16	200 Peak	VERTICAL
2	4923.96	41.41	54.00	-12.59	38.87	4.15	32.88	34.49	16	200 Average	VERTICAL
3	7383.28	49.55	74.00	-24.45	41.88	5.11	37.33	34.77	78	187 Peak	VERTICAL
4	7387.76	44.50	54.00	-9.50	36.79	5.12	37.36	34.77	78	187 Average	VERTICAL

Temperature	26°C	Humidity	57%
Test Engineer	Roki Liu	Configurations	IEEE 802.11g CH 1 / Chain 1 + Chain 2 + Chain 3 + Chain 4

**Horizontal**

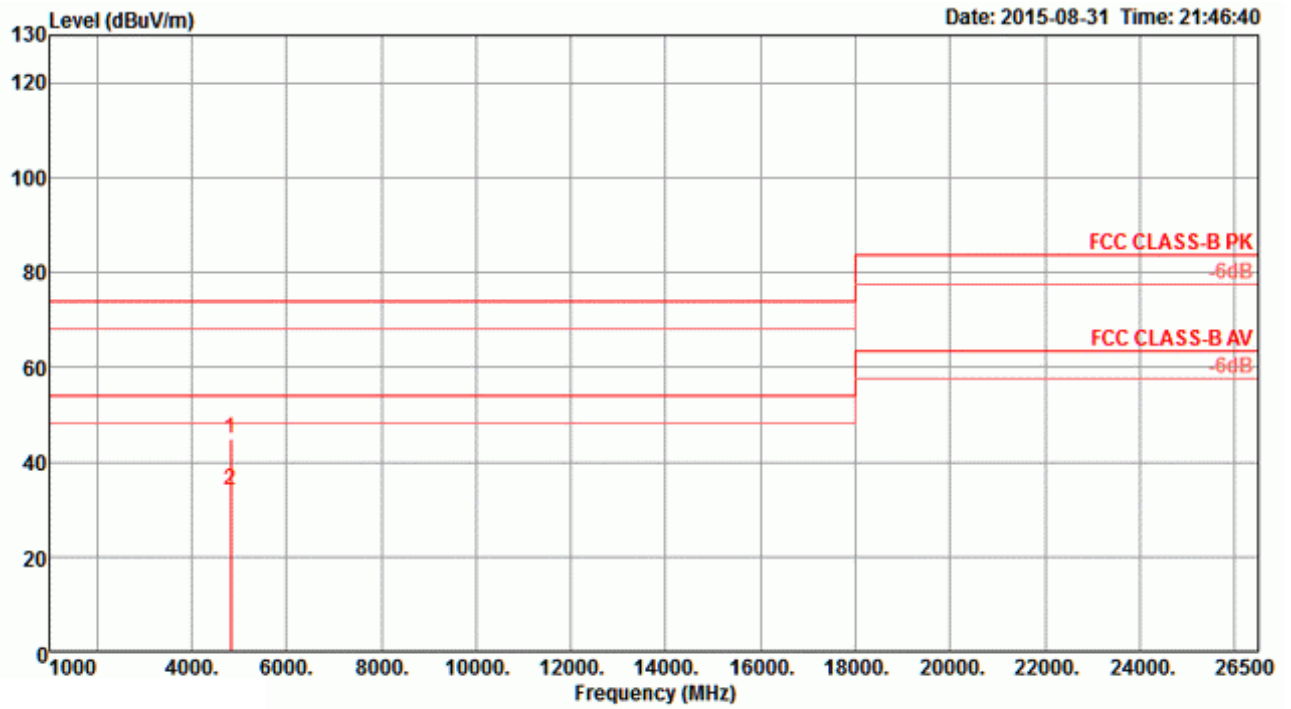

	Freq	Level	Limit	Over	Read	Cable	Antenna	Preamp	T/Pos	A/Pos	Remark	Pol/Phase
	MHz	dBuV/m	dBuV/m	dB	dBuV	Loss	Factor	Factor	deg	cm		
1	4827.96	45.04	74.00	-28.96	42.77	4.10	32.69	34.52	60	165	Peak	HORIZONTAL
2	4829.88	34.08	54.00	-19.92	31.81	4.10	32.69	34.52	60	165	Average	HORIZONTAL

**Vertical**

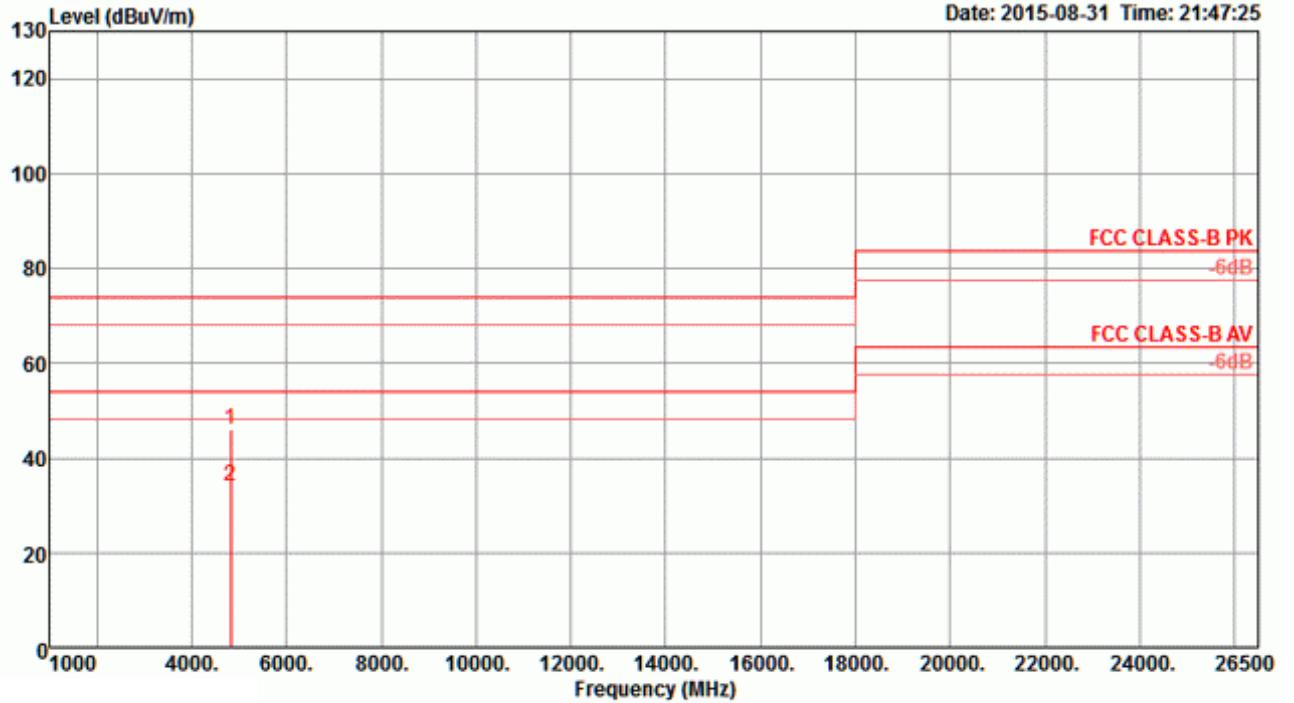

	Freq	Level	Limit	Over	Read	CableAntenna	Preamp	T/Pos	A/Pos	Remark	Pol/Phase
	MHz	dBuV/m	dBuV/m	dB	dBuV	dB	dB/m	dB	cm		
1	4819.88	45.90	74.00	-28.10	43.63	4.10	32.69	34.52	107	165 Peak	VERTICAL
2	4828.44	33.97	54.00	-20.03	31.70	4.10	32.69	34.52	107	165 Average	VERTICAL

Temperature	26°C	Humidity	57%
Test Engineer	Roki Liu	Configurations	IEEE 802.11g CH 6 / Chain 1 + Chain 2 + Chain 3 + Chain 4

**Horizontal**

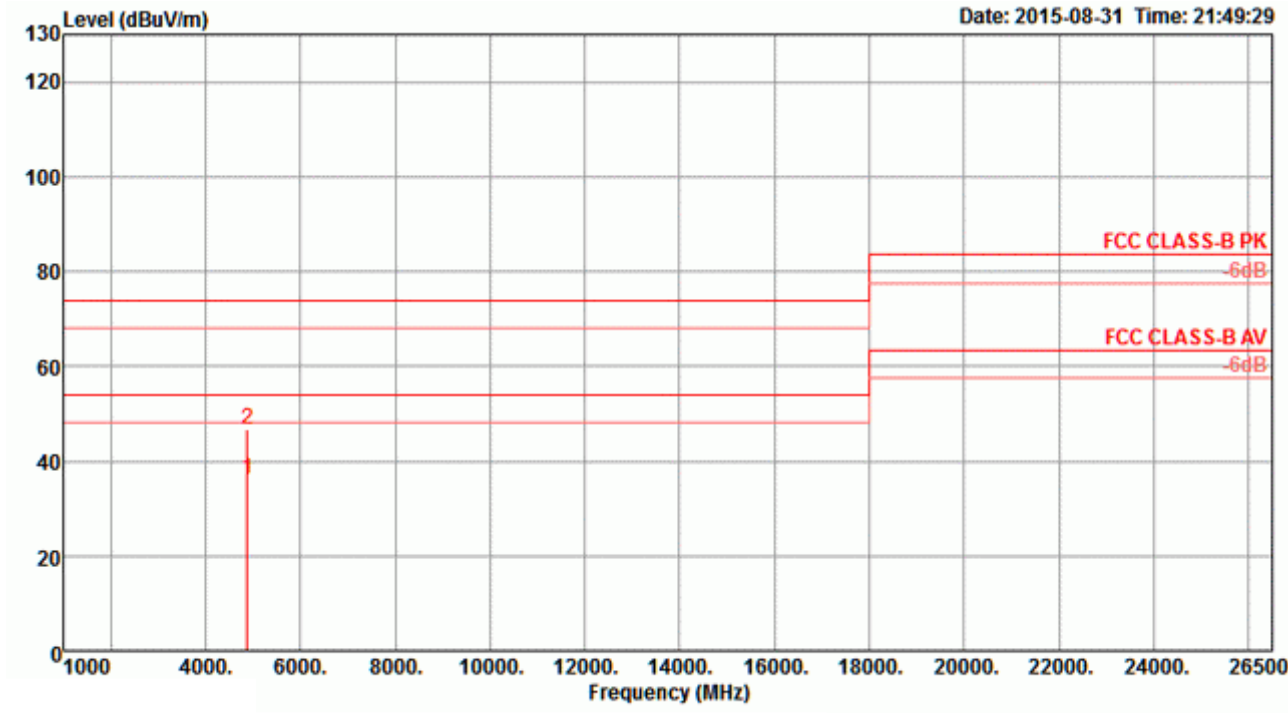

	Freq	Level	Limit	Over	Read	Cable	Antenna	Preamp	T/Pos	A/Pos	Remark	Pol/Phase
	MHz	dBuV/m	dBuV/m	dB	dBuV	Loss	Factor	Factor	deg	cm		
1	4876.44	36.09	54.00	-17.91	33.69	4.13	32.78	34.51	328	165	Average	HORIZONTAL
2	4876.52	46.75	74.00	-27.25	44.35	4.13	32.78	34.51	328	165	Peak	HORIZONTAL

**Vertical**

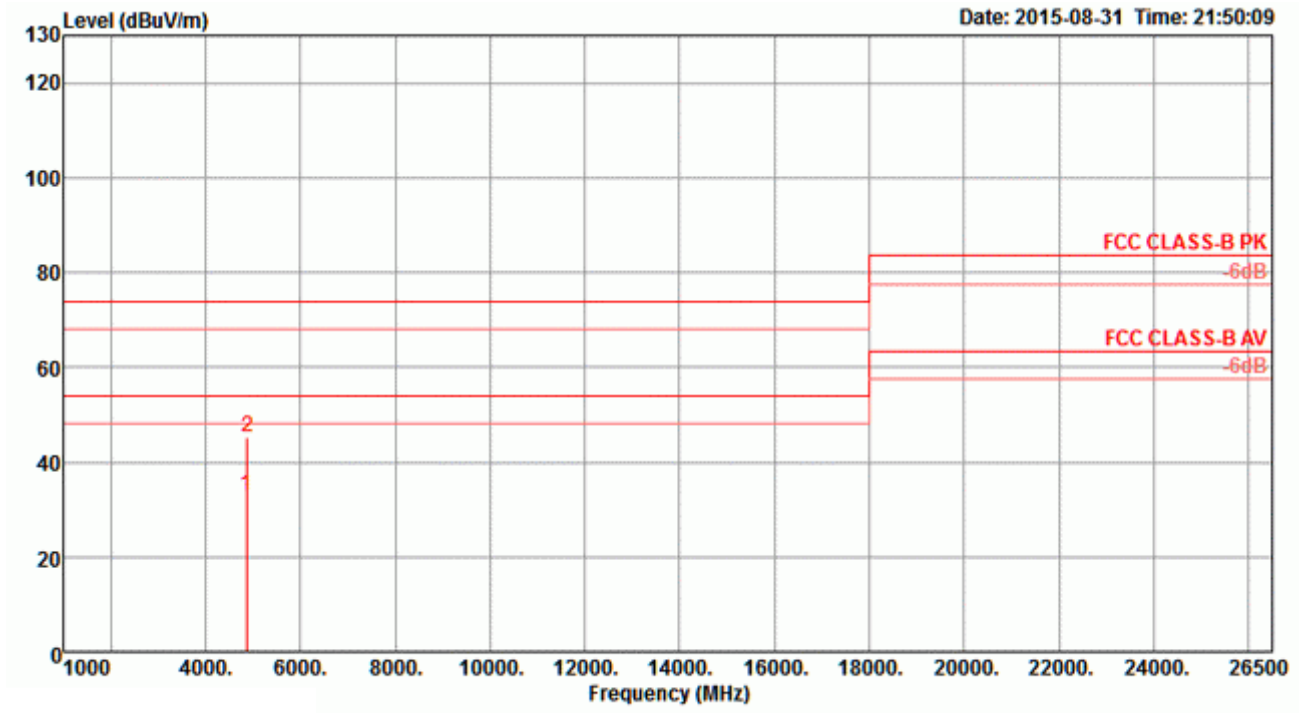

	Freq	Level	Limit	Over	Read	CableAntenna	Preamp	T/Pos	A/Pos	Remark	Pol/Phase
	MHz	dBuV/m	dBuV/m	dB	dBuV	Loss	Factor	Factor	deg	cm	
1	4868.16	32.85	54.00	-21.15	30.45	4.13	32.78	34.51	291	165 Average	VERTICAL
2	4883.16	45.16	74.00	-28.84	42.76	4.13	32.78	34.51	291	165 Peak	VERTICAL



Temperature	26°C	Humidity	57%
Test Engineer	Roki Liu	Configurations	IEEE 802.11g CH 11 / Chain 1 + Chain 2 + Chain 3 + Chain 4

**Horizontal**

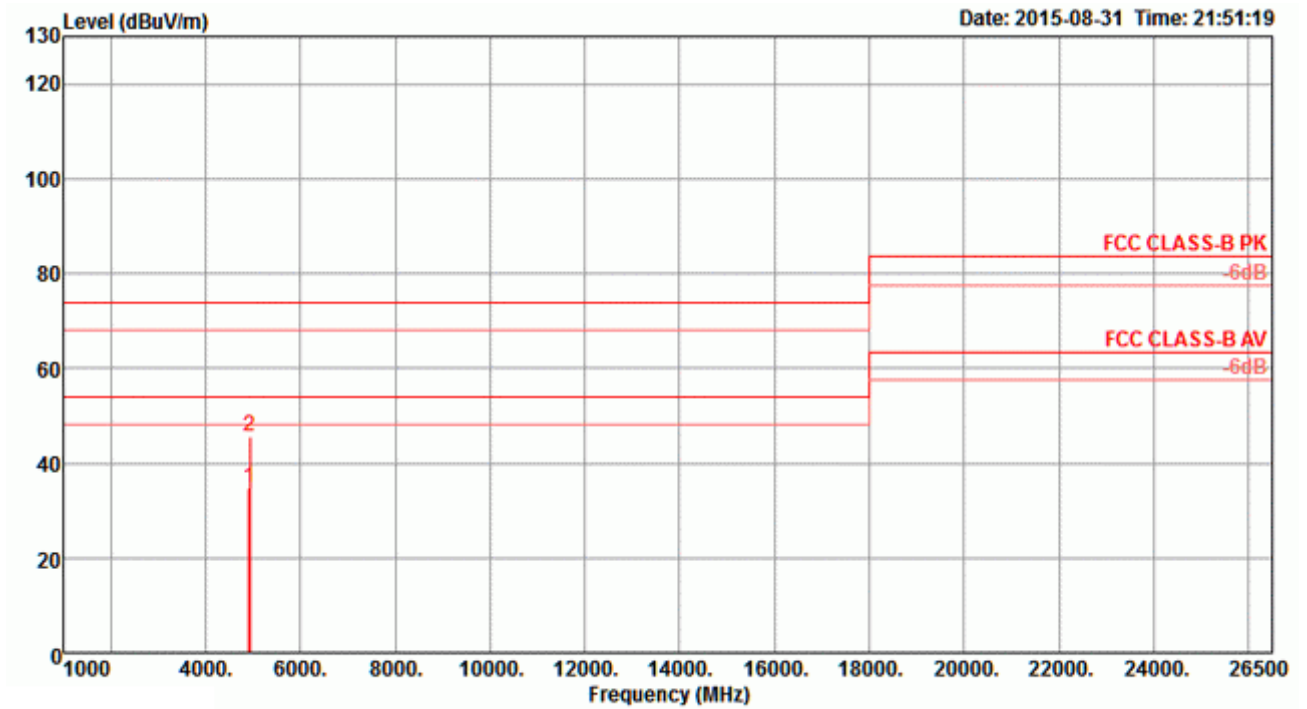

	Freq	Level	Limit	Over	Read	Cable	Antenna	Preamp	T/Pos	A/Pos	Remark	Pol/Phase
	MHz	dBuV/m	dBuV/m	dB	dBuV	Loss	Factor	Factor	deg	cm		
1	4920.12	34.63	54.00	-19.37	32.09	4.15	32.88	34.49	266	165	Average	HORIZONTAL
2	4926.04	45.71	74.00	-28.29	43.17	4.15	32.88	34.49	266	165	Peak	HORIZONTAL

**Vertical**

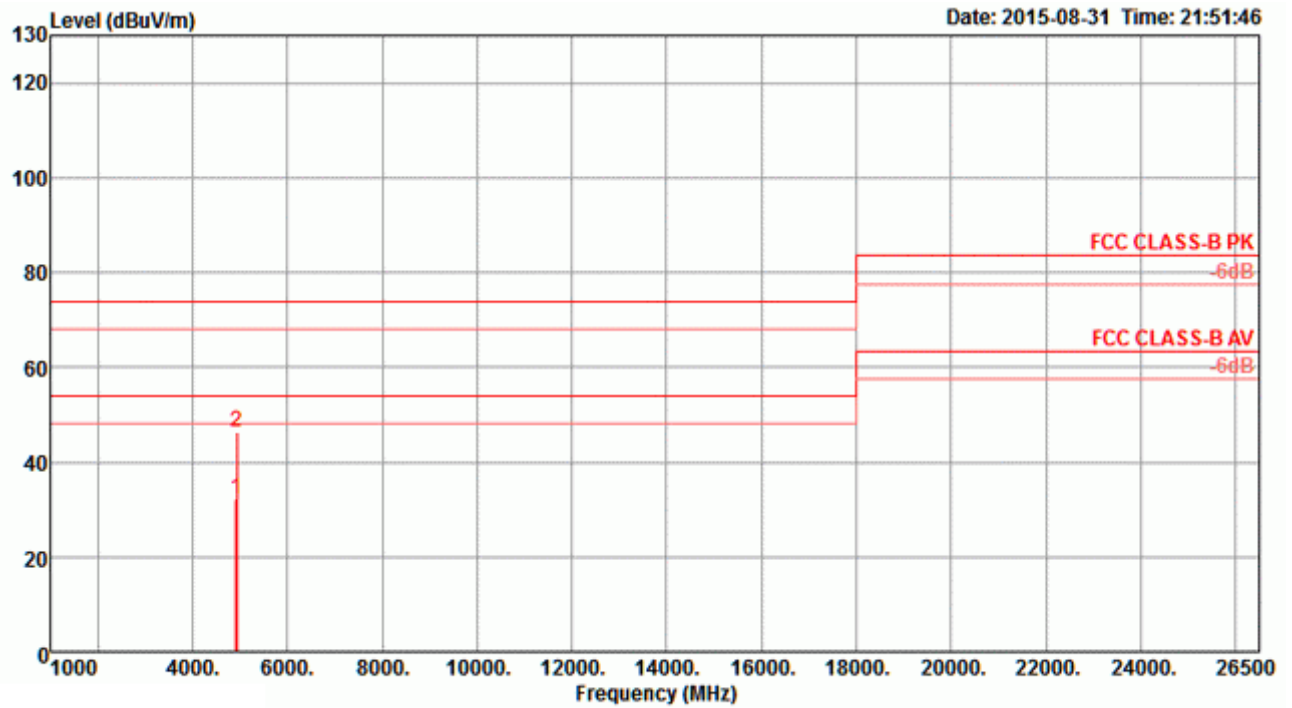

	Freq	Level	Limit	Over	Read	CableAntenna	Preamp	T/Pos	A/Pos	Remark	Pol/Phase
	MHz	dBuV/m	dBuV/m	dB	dBuV	dB	dB/m	dB	deg	cm	
1	4923.84	32.40	54.00	-21.60	29.86	4.15	32.88	34.49	234	165 Average	VERTICAL
2	4928.64	46.34	74.00	-27.66	43.80	4.15	32.88	34.49	234	165 Peak	VERTICAL

<b>Temperature</b>	26°C	<b>Humidity</b>	57%
<b>Test Engineer</b>	Roki Liu	<b>Configurations</b>	IEEE 802.11ac MCS0/Nss1 VHT20 CH 1 / Chain 1 + Chain 2 + Chain 3 + Chain 4

**Horizontal**

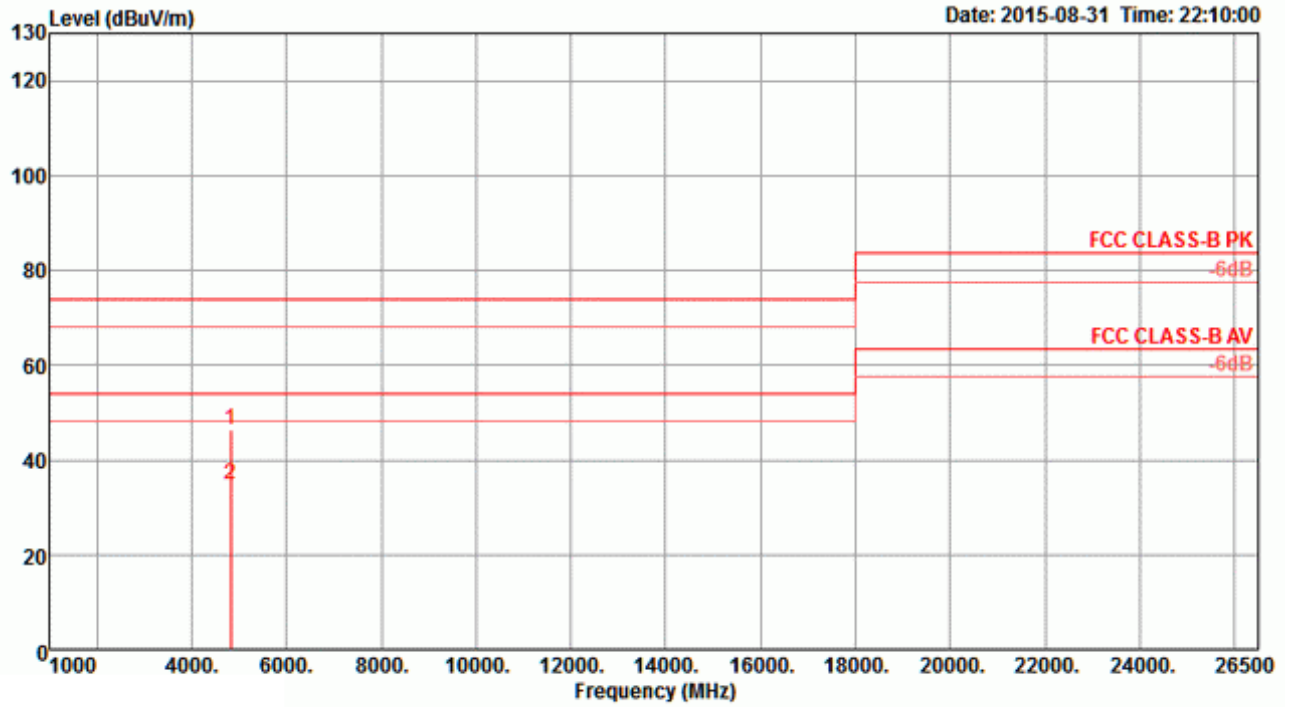

	Freq	Level	Limit	Over	Read	Cable	Antenna	Preamp	T/Pos	A/Pos	Remark	Pol/Phase
	MHz	dBuV/m	dBuV/m	dB	dBuV	Loss	Factor	Factor	deg	cm		
1	4829.92	46.52	74.00	-27.48	44.25	4.10	32.69	34.52	219	165	Peak	HORIZONTAL
2	4832.12	34.78	54.00	-19.22	32.51	4.10	32.69	34.52	219	165	Average	HORIZONTAL

**Vertical**

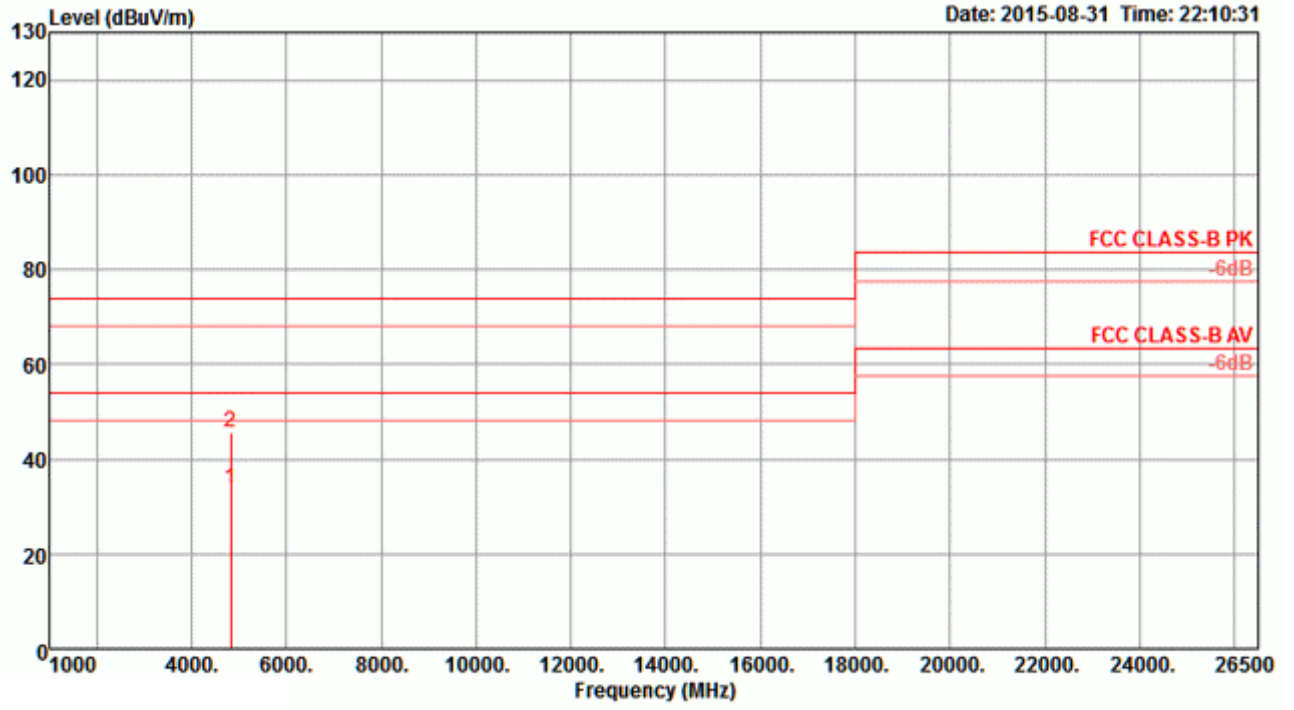

	Freq	Level	Limit	Over	Read	CableAntenna	Preamp	T/Pos	A/Pos	Remark	Pol/Phase
	MHz	dBuV/m	dBuV/m	dB	dBuV	dB	dB/m	deg	cm		
1	4831.32	33.84	54.00	-20.16	31.57	4.10	32.69	34.52	188	165 Average	VERTICAL
2	4833.44	45.52	74.00	-28.48	43.25	4.10	32.69	34.52	188	165 Peak	VERTICAL

Temperature	26°C	Humidity	57%
Test Engineer	Roki Liu	Configurations	IEEE 802.11ac MCS0/Nss1 VHT20 CH 6 / Chain 1 + Chain 2 + Chain 3 + Chain 4

**Horizontal**

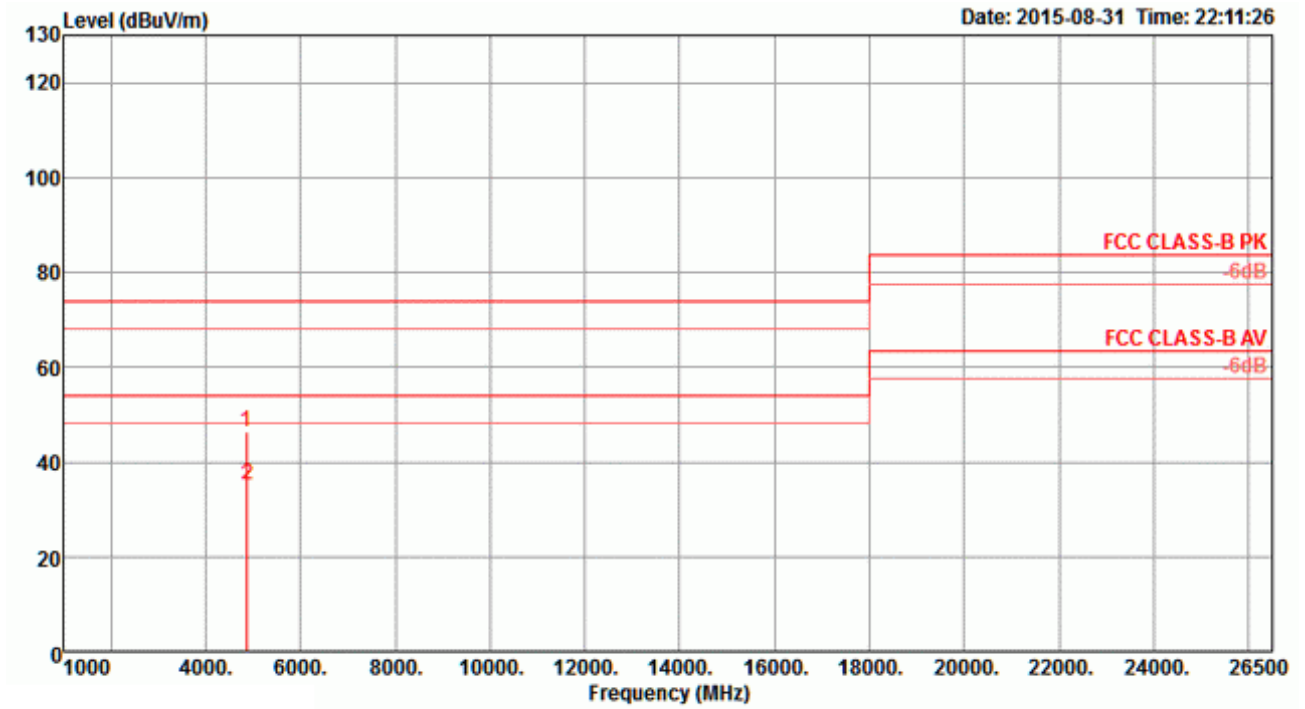

	Freq	Level	Limit	Over	Read	Cable	Antenna	Preamp	T/Pos	A/Pos	Remark	Pol/Phase
	MHz	dBuV/m	dBuV/m	dB	dBuV	dB	dB/m	dB	deg	cm		
1	4865.64	46.43	74.00	-27.57	44.07	4.12	32.75	34.51	157	165	Peak	HORIZONTAL
2	4875.32	34.96	54.00	-19.04	32.56	4.13	32.78	34.51	157	165	Average	HORIZONTAL

**Vertical**

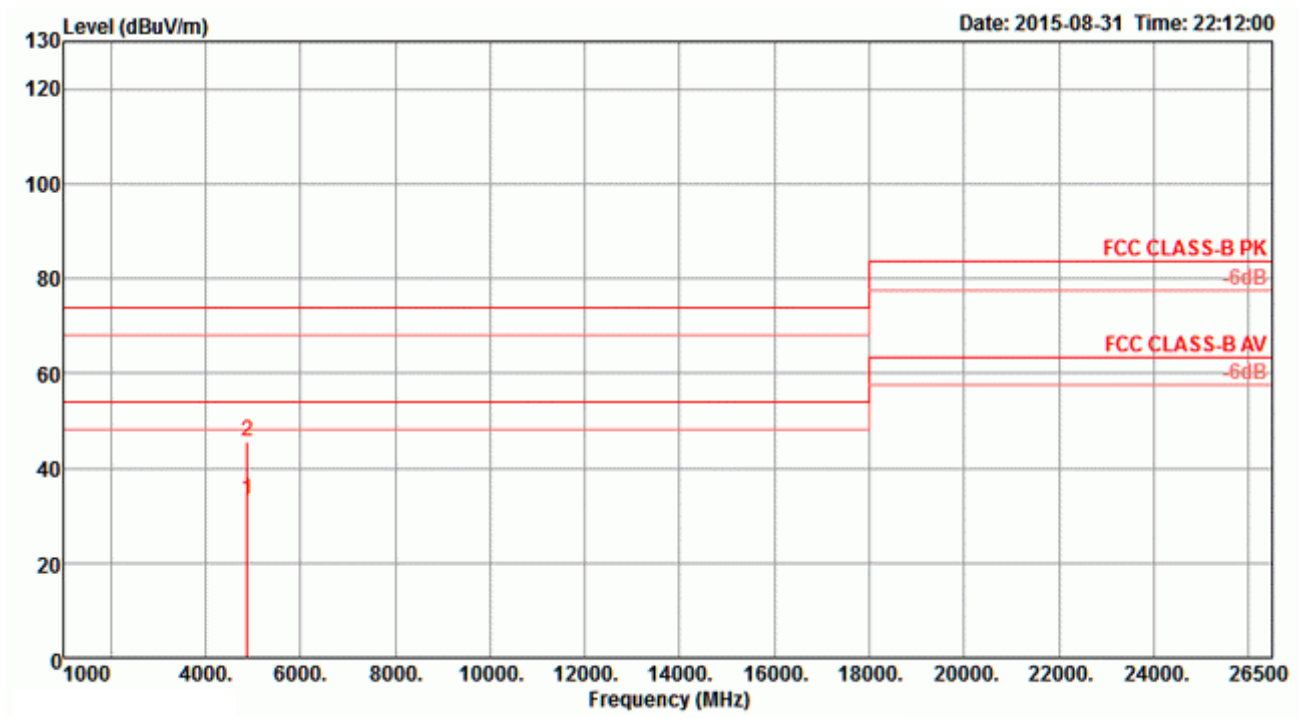

	Freq	Level	Limit	Over	Read	Cable	Antenna	Preamp	T/Pos	A/Pos	Remark	Pol/Phase
	MHz	dBuV/m	dBuV/m	dB	dBuV	dB	dB/m	dB	deg	cm		
1	4875.16	33.24	54.00	-20.76	30.84	4.13	32.78	34.51	132	165	Average	VERTICAL
2	4879.88	45.49	74.00	-28.51	43.09	4.13	32.78	34.51	132	165	Peak	VERTICAL