



# SPORTON International Inc.

No. 52, Hwa Ya 1st Rd., Hwa Ya Technology Park, Kwei-Shan Hsiang, Tao Yuan Hsien, Taiwan, R.O.C.  
Ph: 886-3-327-3456 / FAX: 886-3-327-0973 / www.sporton.com.tw

## FCC RADIO TEST REPORT

Applicant's company	Cisco Systems, Inc.
Applicant Address	170 West Tasman Drive San Jose, CA 95134 USA
FCC ID	UDX-60041010
Manufacturer's company	Accton Technology Corporation
Manufacturer Address	1, Creation Road 3, Hsinchu Science Park Hsinchu 20077, Taiwan R.O.C.

Product Name	802.11a/b/g/n/ac Wireless Access Point
Brand Name	CISCO
Model No.	MR52-HW
Test Rule Part(s)	47 CFR FCC Part 15 Subpart E § 15.407
Test Freq. Range	5150 ~ 5250 MHz / 5725 ~ 5850 MHz
Received Date	Aug. 31, 2015
Final Test Date	Dec. 22, 2015
Submission Type	Original Equipment

### Statement

Test result included is for the IEEE 802.11n and IEEE 802.11a/ac of the product.

The test result in this report refers exclusively to the presented test model / sample.

Without written approval of SPORTON International Inc., the test report shall not be reproduced except in full.

The measurements and test results shown in this test report were made in accordance with the procedures and found in compliance with the limit given in ANSI C63.10-2013, 47 CFR FCC Part 15 Subpart E, KDB 789033 D02 v01r01, KDB662911 D01 v02r01, KDB644545 D03 v01.

The test equipment used to perform the test is calibrated and traceable to NML/ROC.



Testing Laboratory  
1190

## Table of Contents

<b>1. VERIFICATION OF COMPLIANCE .....</b>	<b>1</b>
<b>2. SUMMARY OF THE TEST RESULT .....</b>	<b>2</b>
<b>3. GENERAL INFORMATION .....</b>	<b>3</b>
3.1. Product Details.....	3
3.2. Accessories.....	8
3.3. Table for Filed Antenna.....	9
3.4. Table for Carrier Frequencies .....	12
3.5. Table for 80+80 MHz Mode.....	12
3.6. Table for Test Modes .....	13
3.7. Table for Testing Locations.....	21
3.8. Table for Supporting Units .....	22
3.9. Table for Parameters of Test Software Setting .....	23
3.10. EUT Operation during Test .....	25
3.11. Duty Cycle.....	26
3.12. Test Configurations .....	27
<b>4. TEST RESULT .....</b>	<b>29</b>
4.1. AC Power Line Conducted Emissions Measurement.....	31
4.2. 26dB Bandwidth and 99% Occupied Bandwidth Measurement.....	35
4.3. 6dB Spectrum Bandwidth Measurement .....	186
4.4. Maximum Conducted Output Power Measurement.....	228
4.5. Power Spectral Density Measurement .....	237
4.6. Radiated Emissions Measurement .....	279
4.7. Band Edge Emissions Measurement .....	457
4.8. Frequency Stability Measurement .....	547
4.9. Antenna Requirements .....	560
<b>5. LIST OF MEASURING EQUIPMENTS .....</b>	<b>561</b>
<b>6. MEASUREMENT UNCERTAINTY.....</b>	<b>563</b>
<b>APPENDIX A. TEST PHOTOS .....</b>	<b>A1 ~ A5</b>
<b>APPENDIX B. RADIATED EMISSION CO-LOCATION REPORT .....</b>	<b>B1 ~ B5</b>



## History of This Test Report

REPORT NO.	VERSION	DESCRIPTION	ISSUED DATE
FR590419AB	Rev. 01	Initial issue of report	Jan. 15, 2016

## 1. VERIFICATION OF COMPLIANCE

Product Name : 802.11a/b/g/n/ac Wireless Access Point  
Brand Name : CISCO  
Model No. : MR52-HW  
Applicant : Cisco Systems, Inc.  
Test Rule Part(s) : 47 CFR FCC Part 15 Subpart E § 15.407

Sporton International as requested by the applicant to evaluate the EMC performance of the product sample received on Aug. 31, 2015 would like to declare that the tested sample has been evaluated and found to be in compliance with the tested rule parts. The data recorded as well as the test configuration specified is true and accurate for showing the sample's EMC nature.



Sam Chen

SPORTON INTERNATIONAL INC.

## 2. SUMMARY OF THE TEST RESULT

Applied Standard: 47 CFR FCC Part 15 Subpart E				
Part	Rule Section	Description of Test	Result	Under Limit
4.1	15.207	AC Power Line Conducted Emissions	Complies	7.67 dB
4.2	15.407(a)	26dB Spectrum Bandwidth and 99% Occupied Bandwidth	Complies	-
4.3	15.407(e)	6dB Spectrum Bandwidth	Complies	-
4.4	15.407(a)	Maximum Conducted Output Power	Complies	0.15 dB
4.5	15.407(a)	Power Spectral Density	Complies	0.05 dB
4.6	15.407(b)	Radiated Emissions	Complies	3.07 dB
4.7	15.407(b)	Band Edge Emissions	Complies	0.02 dB
4.8	15.407(g)	Frequency Stability	Complies	-
4.9	15.203	Antenna Requirements	Complies	-

### 3. GENERAL INFORMATION

#### 3.1. Product Details

Items	Description
Product Type	For Radio 2: WLAN (4TX, 4RX) For Radio 3: WLAN (1TX, 1RX)
Radio Type	Intentional Transceiver
Power Type	From power adapter or PoE
Modulation	IEEE 802.11a: OFDM IEEE 802.11n/ac: see the below table
Data Modulation	IEEE 802.11a/n: OFDM (BPSK / QPSK / 16QAM / 64QAM) IEEE 802.11ac: OFDM (BPSK / QPSK / 16QAM / 64QAM / 256QAM)
Data Rate (Mbps)	IEEE 802.11a: OFDM (6/9/12/18/24/36/48/54) IEEE 802.11n/ac: see the below table
Frequency Range	5150 ~ 5250 MHz / 5725 ~ 5850 MHz
Channel Number	9 for 20MHz bandwidth ; 4 for 40MHz bandwidth 2 for 80MHz bandwidth

Channel Band Width (99%)	<p>Band 1:</p> <p><b>&lt;For Radio 2 Non-beamforming Mode&gt;</b></p> <p>IEEE 802.11a: 17.19 MHz</p> <p>IEEE 802.11ac MCS0/Nss1 (VHT20): 18.06 MHz</p> <p>IEEE 802.11ac MCS0/Nss1 (VHT40): 36.32 MHz</p> <p>IEEE 802.11ac MCS0/Nss1 (VHT80): 75.83 MHz</p> <p>IEEE 802.11ac MCS0/Nss4 (VHT20): 18.41 MHz</p> <p>IEEE 802.11ac MCS0/Nss4 (VHT40): 37.19 MHz</p> <p>IEEE 802.11ac MCS0/Nss4 (VHT80): 76.41 MHz</p> <p>IEEE 802.11ac MCS0/Nss2 (VHT80+80): 75.83 MHz</p> <p><b>&lt;For Radio 2 Beamforming Mode&gt;</b></p> <p>IEEE 802.11ac MCS0/Nss1 (VHT20): 17.80 MHz</p> <p>IEEE 802.11ac MCS0/Nss1 (VHT40): 36.32 MHz</p> <p>IEEE 802.11ac MCS0/Nss1 (VHT80): 75.83 MHz</p> <p>IEEE 802.11ac MCS0/Nss2 (VHT20): 17.80 MHz</p> <p>IEEE 802.11ac MCS0/Nss2 (VHT40): 36.47 MHz</p> <p>IEEE 802.11ac MCS0/Nss2 (VHT80): 75.83 MHz</p> <p>IEEE 802.11ac MCS0/Nss3 (VHT20): 18.06 MHz</p> <p>IEEE 802.11ac MCS0/Nss3 (VHT40): 37.19 MHz</p> <p>IEEE 802.11ac MCS0/Nss3 (VHT80): 76.41 MHz</p> <p>IEEE 802.11ac MCS0/Nss2 (VHT80+80): 75.83 MHz</p> <p><b>&lt;For Radio 3 Mode&gt;</b></p> <p>IEEE 802.11a: 34.90 MHz</p> <p>IEEE 802.11ac MCS0/Nss1 (VHT20): 38.03 MHz</p> <p>IEEE 802.11ac MCS0/Nss1 (VHT40): 38.49 MHz</p> <p>IEEE 802.11ac MCS0/Nss1 (VHT80): 76.70 MHz</p>
--------------------------	---

Channel Band Width (99%)	<p>Band 4:</p> <p><b>&lt;For Radio 2 Non-beamforming Mode&gt;</b></p> <p>IEEE 802.11a: 26.74 MHz</p> <p>IEEE 802.11ac MCS0/Nss1 (VHT20): 27.26 MHz</p> <p>IEEE 802.11ac MCS0/Nss1 (VHT40): 36.47 MHz</p> <p>IEEE 802.11ac MCS0/Nss1 (VHT80): 75.83 MHz</p> <p>IEEE 802.11ac MCS0/Nss4 (VHT20): 18.84 MHz</p> <p>IEEE 802.11ac MCS0/Nss4 (VHT40): 37.34 MHz</p> <p>IEEE 802.11ac MCS0/Nss4 (VHT80): 76.70 MHz</p> <p>IEEE 802.11ac MCS0/Nss2 (VHT80+80): 75.83 MHz</p> <p><b>&lt;For Radio 2 Beamforming Mode&gt;</b></p> <p>IEEE 802.11ac MCS0/Nss1 (VHT20): 17.97 MHz</p> <p>IEEE 802.11ac MCS0/Nss1 (VHT40): 36.32 MHz</p> <p>IEEE 802.11ac MCS0/Nss1 (VHT80): 76.12 MHz</p> <p>IEEE 802.11ac MCS0/Nss2 (VHT20): 17.80 MHz</p> <p>IEEE 802.11ac MCS0/Nss2 (VHT40): 36.47 MHz</p> <p>IEEE 802.11ac MCS0/Nss2 (VHT80): 75.83 MHz</p> <p>IEEE 802.11ac MCS0/Nss3 (VHT20): 18.06 MHz</p> <p>IEEE 802.11ac MCS0/Nss3 (VHT40): 37.34 MHz</p> <p>IEEE 802.11ac MCS0/Nss3 (VHT80): 76.70 MHz</p> <p>IEEE 802.11ac MCS0/Nss2 (VHT80+80): 75.83 MHz</p> <p><b>&lt;For Radio 3 Mode&gt;</b></p> <p>IEEE 802.11a: 38.20 MHz</p> <p>IEEE 802.11ac MCS0/Nss1 (VHT20): 40.28 MHz</p> <p>IEEE 802.11ac MCS0/Nss1 (VHT40): 55.57 MHz</p> <p>IEEE 802.11ac MCS0/Nss1 (VHT80): 76.70 MHz</p>
--------------------------	---



<p>Maximum Conducted Output Power</p>	<p>Band 1:</p> <p><b>&lt;For Radio 2 Non-beamforming Mode&gt;</b></p> <p>IEEE 802.11a: 29.21 dBm</p> <p>IEEE 802.11ac MCS0/Nss1 (VHT20): 29.17 dBm</p> <p>IEEE 802.11ac MCS0/Nss1 (VHT40): 27.58 dBm</p> <p>IEEE 802.11ac MCS0/Nss1 (VHT80): 22.02 dBm</p> <p>IEEE 802.11ac MCS0/Nss4 (VHT20): 28.39 dBm</p> <p>IEEE 802.11ac MCS0/Nss4 (VHT40): 26.11 dBm</p> <p>IEEE 802.11ac MCS0/Nss4 (VHT80): 21.57 dBm</p> <p>IEEE 802.11ac MCS0/Nss2 (VHT80+80): 17.69 dBm</p> <p><b>&lt;For Radio 2 Beamforming Mode&gt;</b></p> <p>IEEE 802.11ac MCS0/Nss1 (VHT20): 23.77 dBm</p> <p>IEEE 802.11ac MCS0/Nss1 (VHT40): 24.90 dBm</p> <p>IEEE 802.11ac MCS0/Nss1 (VHT80): 20.72 dBm</p> <p>IEEE 802.11ac MCS0/Nss2 (VHT20): 22.91 dBm</p> <p>IEEE 802.11ac MCS0/Nss2 (VHT40): 23.89 dBm</p> <p>IEEE 802.11ac MCS0/Nss2 (VHT80): 20.56 dBm</p> <p>IEEE 802.11ac MCS0/Nss3 (VHT20): 23.67 dBm</p> <p>IEEE 802.11ac MCS0/Nss3 (VHT40): 23.85 dBm</p> <p>IEEE 802.11ac MCS0/Nss3 (VHT80): 20.85 dBm</p> <p>IEEE 802.11ac MCS0/Nss2 (VHT80+80): 20.42 dBm</p> <p><b>&lt;For Radio 3 Mode&gt;</b></p> <p>IEEE 802.11a: 21.37 dBm</p> <p>IEEE 802.11ac MCS0/Nss1 (VHT20): 21.78 dBm</p> <p>IEEE 802.11ac MCS0/Nss1 (VHT40): 16.91 dBm</p> <p>IEEE 802.11ac MCS0/Nss1 (VHT80): 11.61 dBm</p>
---------------------------------------	---

Maximum Conducted Output Power	<p>Band 4:</p> <p><b>&lt;For Radio 2 Non-beamforming Mode&gt;</b></p> <p>IEEE 802.11a: 29.85 dBm</p> <p>IEEE 802.11ac MCS0/Nss1 (VHT20): 29.81 dBm</p> <p>IEEE 802.11ac MCS0/Nss1 (VHT40): 26.21 dBm</p> <p>IEEE 802.11ac MCS0/Nss1 (VHT80): 18.18 dBm</p> <p>IEEE 802.11ac MCS0/Nss4 (VHT20): 28.15 dBm</p> <p>IEEE 802.11ac MCS0/Nss4 (VHT40): 25.32 dBm</p> <p>IEEE 802.11ac MCS0/Nss4 (VHT80): 21.32 dBm</p> <p>IEEE 802.11ac MCS0/Nss2 (VHT80+80): 17.02 dBm</p> <p><b>&lt;For Radio 2 Beamforming Mode&gt;</b></p> <p>IEEE 802.11ac MCS0/Nss1 (VHT20): 23.86 dBm</p> <p>IEEE 802.11ac MCS0/Nss1 (VHT40): 24.10 dBm</p> <p>IEEE 802.11ac MCS0/Nss1 (VHT80): 17.86 dBm</p> <p>IEEE 802.11ac MCS0/Nss2 (VHT20): 26.28 dBm</p> <p>IEEE 802.11ac MCS0/Nss2 (VHT40): 25.40 dBm</p> <p>IEEE 802.11ac MCS0/Nss2 (VHT80): 18.64 dBm</p> <p>IEEE 802.11ac MCS0/Nss3 (VHT20): 26.68 dBm</p> <p>IEEE 802.11ac MCS0/Nss3 (VHT40): 23.33 dBm</p> <p>IEEE 802.11ac MCS0/Nss3 (VHT80): 20.26 dBm</p> <p>IEEE 802.11ac MCS0/Nss2 (VHT80+80): 21.62 dBm</p> <p><b>&lt;For Radio 3 Mode&gt;</b></p> <p>IEEE 802.11a: 20.88 dBm</p> <p>IEEE 802.11ac MCS0/Nss1 (VHT20): 20.59 dBm</p> <p>IEEE 802.11ac MCS0/Nss1 (VHT40): 19.41 dBm</p> <p>IEEE 802.11ac MCS0/Nss1 (VHT80): 12.22 dBm</p>
Carrier Frequencies	Please refer to section 3.4
Antenna	Please refer to section 3.3

Note: The MIMO transmission mode is correlated.

Items	Description	
Communication Mode	<input checked="" type="checkbox"/> IP Based (Load Based)	<input type="checkbox"/> Frame Based
Beamforming Function	<input checked="" type="checkbox"/> With beamforming for 802.11n/ac in 2.4GHz /5GHz.	<input type="checkbox"/> Without beamforming
Operating Mode	<input type="checkbox"/> Outdoor access point	
	<input checked="" type="checkbox"/> Indoor access point	
	<input type="checkbox"/> Fixed point-to-point access points	
	<input type="checkbox"/> Mobile and portable client devices	

### Antenna and Band width

Antenna	Single (TX)			Four (TX)		
	20 MHz	40 MHz	80 MHz	20 MHz	40 MHz	80 MHz
IEEE 802.11a	V	X	X	V	X	X
IEEE 802.11n	V	V	X	V	V	X
IEEE 802.11ac	V	V	V	V	V	V

### IEEE 11n/ac Spec.

Protocol		Number of Transmit Chains (NTX)	Data Rate / MCS
Radio 2	802.11n (HT20)	4	MCS 0-31
	802.11n (HT40)	4	MCS 0-31
	802.11ac (VHT20)	4	MCS 0-9/Nss1-4
	802.11ac (VHT40)	4	MCS 0-9/Nss1-4
	802.11ac (VHT80)	4	MCS 0-9/Nss1-4
Radio 3	802.11n (HT20)	1	MCS 0-7
	802.11n (HT40)	1	MCS 0-7
	802.11ac (VHT20)	1	MCS 0-9/Nss1
	802.11ac (VHT40)	1	MCS 0-9/Nss1
	802.11ac (VHT80)	1	MCS 0-9/Nss1

Note 1: IEEE Std. 802.11n modulation consists of HT20 and HT40 (HT: High Throughput).

Then EUT supports HT20 and HT40.

Note 2: IEEE Std. 802.11ac modulation consists of VHT20, VHT40, VHT80 and VHT160 (VHT: Very High Throughput). Then EUT supports VHT20, VHT40 and VHT80.

Note 3: Modulation modes consist of below configuration:

HT20/HT40: IEEE 802.11n, VHT20/VHT40/VHT80: IEEE 802.11ac

## 3.2. Accessories

Wall-mounted rack\*1

### 3.3. Table for Filed Antenna

Radio	Ant.	Brand	P/N	Antenna Type	Connector	Gain		
						2.4GHz	5GHz	Buletooth
Radio 1	1	Accton	120G00000132A	Metal	MHF	Note		-
	2	Accton	120G00000132A	Metal	MHF			
	3	Accton	120G00000132A	Metal	MHF			
	4	Accton	120G00000132A	Metal	MHF			
Radio 2	5	Accton	120G00000132A	Metal	MHF			
	6	Accton	120G00000132A	Metal	MHF			
	7	Accton	120G00000132A	Metal	MHF			
	8	Accton	120G00000132A	Metal	MHF			
Radio 3	9	Accton	120G00000134A	Metal	MHF	4.32	5.72	-
Radio 4	10	Accton	120G00000133A	Metal	MHF	-	-	4.99

Note:

<Radio 1 >

Ant.	Frequency (MHz)		
	2412, 2422	2437	2452, 2462
1	2.97	3.72	3.89
2	3.34	3.62	3.51
3	3.42	3.69	4.10
4	4.99	5.04	4.38

Frequency (MHz)	Correlated Composite Gain			Uncorrelated Composite Gain
	(4TX, 1S)	(4TX, 2S)	(4TX, 3S)	(4TX, 4S)
2412, 2422	7.15	4.43	2.67	1.42
2437	7.02	4.45	2.68	1.44
2452, 2462	6.87	4.44	2.68	1.43

**<Radio 2>**

Ant.	Band 1	Band 4
5	3.85	5.58
6	5.24	5.74
7	4.97	6.44
8	5.05	5.10

Band	Correlated Composite Gain			Uncorrelated Composite Gain
	(4TX, 1S)	(4TX, 2S)	(4TX, 3S)	(4TX, 4S)
1	6.97	4.94	3.18	1.93
4	10.05	7.16	5.40	4.15

Note: The EUT has ten antennas.

The EUT has four radios, Radio 1 supports WLAN 2.4GHz, Radio 2 supports WLAN 5GHz, Radio 3 supports WLAN 2.4GHz + 5GHz (scanning radio) and Radio 4 supports Bluetooth function.

**<For Radio 1 / 2.4GHz Function>**

Chain 1, Chain 2, Chain 3 and Chain 4 can be used as transmitting/receiving antenna.

Chain 1, Chain 2, Chain 3 and Chain 4 could transmit/receive simultaneously.

**<For Radio 2 / 5GHz Function>**

Chain 5, Chain 6, Chain 7 and Chain 8 can be used as transmitting/receiving antenna.

Chain 5, Chain 6, Chain 7 and Chain 8 could transmit/receive simultaneously.

**<<For Radio 3 Mode> / 2.4GHz + 5GHz Functions>**

Only Chain 9 could transmit/receive.

**<For Radio 4 / Bluetooth Functions>**

Only Chain 10 could transmit/receive.

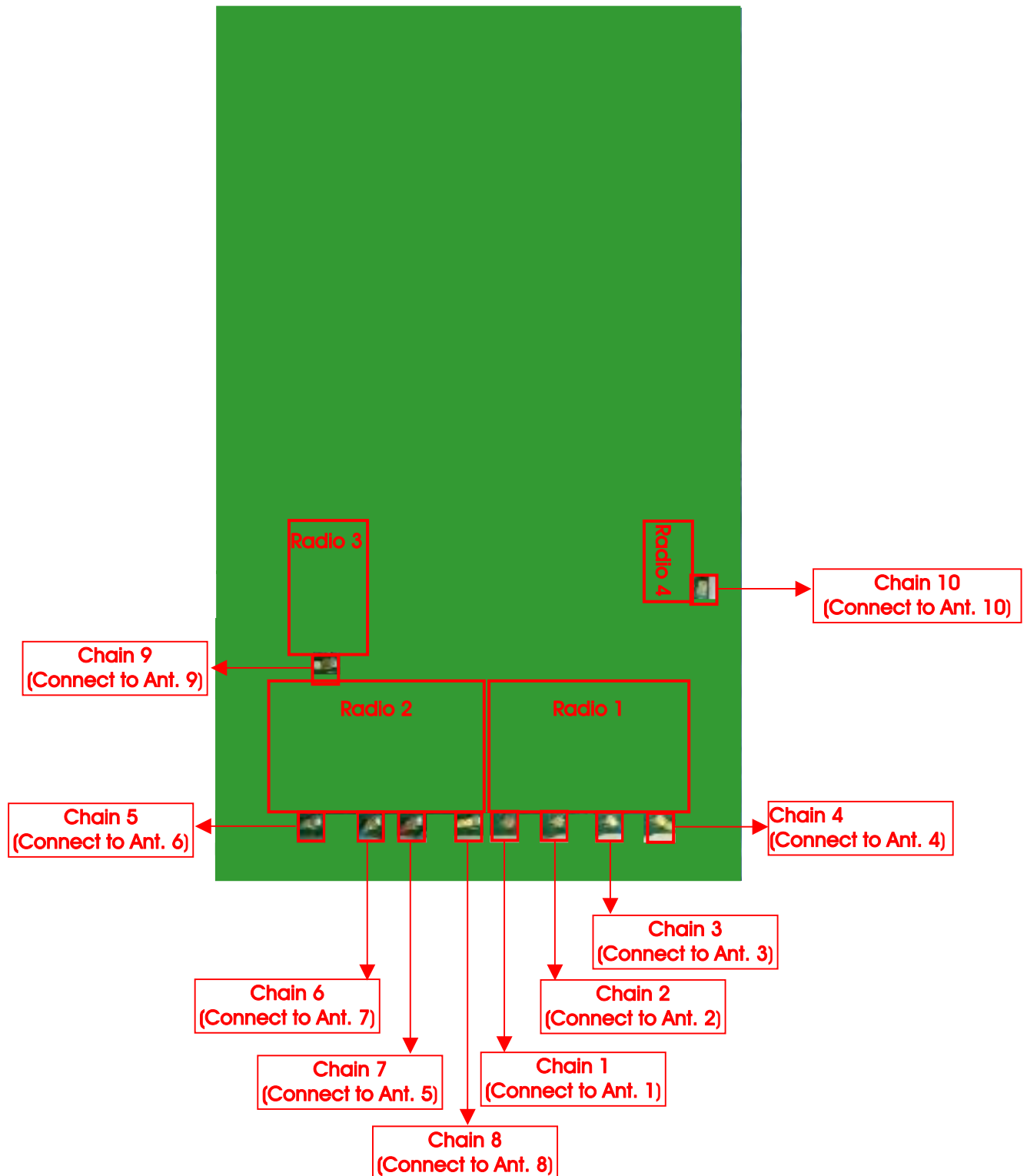

### 3.4. Table for Carrier Frequencies

There are three bandwidth systems.

For 20MHz bandwidth systems, use Channel 36, 40, 44, 48, 149, 153, 157, 161, 165.

For 40MHz bandwidth systems, use Channel 38, 46, 151, 159.

For 80MHz bandwidth systems, use Channel 42, 155.

Frequency Band	Channel No.	Frequency	Channel No.	Frequency
5150~5250 MHz Band 1	36	5180 MHz	44	5220 MHz
	38	5190 MHz	46	5230 MHz
	40	5200 MHz	48	5240 MHz
	42	5210 MHz	-	-
5725~5850 MHz Band 4	149	5745 MHz	157	5785 MHz
	151	5755 MHz	159	5795 MHz
	153	5765 MHz	161	5805 MHz
	155	5775 MHz	165	5825 MHz

### 3.5. Table for 80+80 MHz Mode

Type	Channel No.	Frequency
1	42+155	5210+5775 MHz

### 3.6. Table for Test Modes

Preliminary tests were performed in different data rate to find the worst radiated emission. The data rate shown in the table below is the worst-case rate with respect to the specific test item. Investigation has been done on all the possible configurations for searching the worst cases. The following table is a list of the test modes shown in this test report.

#### For Radio 2

Test Items	Mode		Data Rate	Channel	Chain
AC Power Conducted Emission	Normal Link		-	-	-
Max. Conducted Output Power	<b>For Non-Beamforming Mode</b>				
	11a/BPSK	Band 1&4	6Mbps	36/40/48/149/157/165	5+6+7+8
	11ac VHT20	Band 1&4	MCS0/Nss1	36/40/48/149/157/165	5+6+7+8
	11ac VHT40	Band 1&4	MCS0/Nss1	38/46/151/159	5+6+7+8
	11ac VHT80	Band 1&4	MCS0/Nss1	42/155	5+6+7+8
	11ac VHT20	Band 1&4	MCS0/Nss4	36/40/48/149/157/165	5+6+7+8
	11ac VHT40	Band 1&4	MCS0/Nss4	38/46/151/159	5+6+7+8
	11ac VHT80	Band 1&4	MCS0/Nss4	42/155	5+6+7+8
	<b>For Beamforming Mode</b>				
	11ac VHT20	Band 1&4	MCS0/Nss1	36/40/48/149/157/165	5+6+7+8
	11ac VHT40	Band 1&4	MCS0/Nss1	38/46/151/159	5+6+7+8
	11ac VHT80	Band 1&4	MCS0/Nss1	42/155	5+6+7+8
	11ac VHT20	Band 1&4	MCS0/Nss2	36/40/48/149/157/165	5+6+7+8
	11ac VHT40	Band 1&4	MCS0/Nss2	38/46/151/159	5+6+7+8
	11ac VHT80	Band 1&4	MCS0/Nss2	42/155	5+6+7+8
	11ac VHT20	Band 1&4	MCS0/Nss3	36/40/48/149/157/165	5+6+7+8
	11ac VHT40	Band 1&4	MCS0/Nss3	38/46/151/159	5+6+7+8
	11ac VHT80	Band 1&4	MCS0/Nss3	42/155	5+6+7+8



Power Spectral Density	<b>For Non-Beamforming Mode</b>				
	11a/BPSK	Band 1&4	6Mbps	36/40/48/149/157/165	5+6+7+8
	11ac VHT20	Band 1&4	MCS0/Nss1	36/40/48/149/157/165	5+6+7+8
	11ac VHT40	Band 1&4	MCS0/Nss1	38/46/151/159	5+6+7+8
	11ac VHT80	Band 1&4	MCS0/Nss1	42/155	5+6+7+8
	11ac VHT20	Band 1&4	MCS0/Nss4	36/40/48/149/157/165	5+6+7+8
	11ac VHT40	Band 1&4	MCS0/Nss4	38/46/151/159	5+6+7+8
	11ac VHT80	Band 1&4	MCS0/Nss4	42/155	5+6+7+8
	<b>For Beamforming Mode</b>				
	11ac VHT20	Band 1&4	MCS0/Nss1	36/40/48/149/157/165	5+6+7+8
	11ac VHT40	Band 1&4	MCS0/Nss1	38/46/151/159	5+6+7+8
	11ac VHT80	Band 1&4	MCS0/Nss1	42/155	5+6+7+8
	11ac VHT20	Band 1&4	MCS0/Nss2	36/40/48/149/157/165	5+6+7+8
	11ac VHT40	Band 1&4	MCS0/Nss2	38/46/151/159	5+6+7+8
	11ac VHT80	Band 1&4	MCS0/Nss2	42/155	5+6+7+8
	11ac VHT20	Band 1&4	MCS0/Nss3	36/40/48/149/157/165	5+6+7+8
	11ac VHT40	Band 1&4	MCS0/Nss3	38/46/151/159	5+6+7+8
	11ac VHT80	Band 1&4	MCS0/Nss3	42/155	5+6+7+8
	26dB Spectrum Bandwidth & 99% Occupied Bandwidth Measurement	<b>For Non-Beamforming Mode</b>			
11a/BPSK		Band 1&4	6Mbps	36/40/48/149/157/165	5/6/7/8
11ac VHT20		Band 1&4	MCS0/Nss1	36/40/48/149/157/165	5/6/7/8
11ac VHT40		Band 1&4	MCS0/Nss1	38/46/151/159	5/6/7/8
11ac VHT80		Band 1&4	MCS0/Nss1	42/155	5/6/7/8
11ac VHT20		Band 1&4	MCS0/Nss4	36/40/48/149/157/165	5/6/7/8
11ac VHT40		Band 1&4	MCS0/Nss4	38/46/151/159	5/6/7/8
11ac VHT80		Band 1&4	MCS0/Nss4	42/155	5/6/7/8
<b>For Beamforming Mode</b>					
11ac VHT20		Band 1&4	MCS0/Nss1	36/40/48/149/157/165	5/6/7/8
11ac VHT40		Band 1&4	MCS0/Nss1	38/46/151/159	5/6/7/8
11ac VHT80		Band 1&4	MCS0/Nss1	42/155	5/6/7/8
11ac VHT20		Band 1&4	MCS0/Nss2	36/40/48/149/157/165	5/6/7/8
11ac VHT40		Band 1&4	MCS0/Nss2	38/46/151/159	5/6/7/8
11ac VHT80		Band 1&4	MCS0/Nss2	42/155	5/6/7/8
11ac VHT20		Band 1&4	MCS0/Nss3	36/40/48/149/157/165	5/6/7/8
11ac VHT40		Band 1&4	MCS0/Nss3	38/46/151/159	5/6/7/8
11ac VHT80		Band 1&4	MCS0/Nss3	42/155	5/6/7/8

6dB Spectrum Bandwidth Measurement	<b>For Non-Beamforming Mode</b>				
	11a/BPSK	Band 4	6Mbps	149/157/165	5/6/7/8
	11ac VHT20	Band 4	MCS0/Nss1	149/157/165	5/6/7/8
	11ac VHT40	Band 4	MCS0/Nss1	151/159	5/6/7/8
	11ac VHT80	Band 4	MCS0/Nss1	155	5/6/7/8
	11ac VHT20	Band 4	MCS0/Nss4	149/157/165	5/6/7/8
	11ac VHT40	Band 4	MCS0/Nss4	151/159	5/6/7/8
	11ac VHT80	Band 4	MCS0/Nss4	155	5/6/7/8
	<b>For Beamforming Mode</b>				
	11ac VHT20	Band 4	MCS0/Nss1	149/157/165	5+6+7+8
	11ac VHT40	Band 4	MCS0/Nss1	151/159	5+6+7+8
	11ac VHT80	Band 4	MCS0/Nss1	155	5+6+7+8
	11ac VHT20	Band 4	MCS0/Nss2	149/157/165	5+6+7+8
	11ac VHT40	Band 4	MCS0/Nss2	151/159	5+6+7+8
	11ac VHT80	Band 4	MCS0/Nss2	155	5+6+7+8
	11ac VHT20	Band 4	MCS0/Nss3	149/157/165	5+6+7+8
	11ac VHT40	Band 4	MCS0/Nss3	151/159	5+6+7+8
	11ac VHT80	Band 4	MCS0/Nss3	155	5+6+7+8

Radiated Emission Below 1GHz	Normal Link	-	-	-	
Radiated Emission Above 1GHz	<b>For Non-Beamforming Mode</b>				
	11a/BPSK	Band 1&4	6Mbps	36/40/48/149/157/165	5+6+7+8
	11ac VHT20	Band 1&4	MCS0/Nss1	36/40/48/149/157/165	5+6+7+8
	11ac VHT40	Band 1&4	MCS0/Nss1	38/46/151/159	5+6+7+8
	11ac VHT80	Band 1&4	MCS0/Nss1	42/155	5+6+7+8
	11ac VHT20	Band 1&4	MCS0/Nss4	36/40/48/149/157/165	5+6+7+8
	11ac VHT40	Band 1&4	MCS0/Nss4	38/46/151/159	5+6+7+8
	11ac VHT80	Band 1&4	MCS0/Nss4	42/155	5+6+7+8
	<b>For Beamforming Mode</b>				
	11ac VHT20	Band 1&4	MCS0/Nss1	36/40/48/149/157/165	5+6+7+8
	11ac VHT40	Band 1&4	MCS0/Nss1	38/46/151/159	5+6+7+8
	11ac VHT80	Band 1&4	MCS0/Nss1	42/155	5+6+7+8
	11ac VHT20	Band 1&4	MCS0/Nss2	36/40/48/149/157/165	5+6+7+8
	11ac VHT40	Band 1&4	MCS0/Nss2	38/46/151/159	5+6+7+8
	11ac VHT80	Band 1&4	MCS0/Nss2	42/155	5+6+7+8
	11ac VHT20	Band 1&4	MCS0/Nss3	36/40/48/149/157/165	5+6+7+8
11ac VHT40	Band 1&4	MCS0/Nss3	38/46/151/159	5+6+7+8	
11ac VHT80	Band 1&4	MCS0/Nss3	42/155	5+6+7+8	

Band Edge Emission	<b>For Non-Beamforming Mode</b>				
	11a/BPSK	Band 1&4	6Mbps	36/40/48/149/157/165	5+6+7+8
	11ac VHT20	Band 1&4	MCS0/Nss1	36/40/48/149/157/165	5+6+7+8
	11ac VHT40	Band 1&4	MCS0/Nss1	38/46/151/159	5+6+7+8
	11ac VHT80	Band 1&4	MCS0/Nss1	42/155	5+6+7+8
	11ac VHT20	Band 1&4	MCS0/Nss4	36/40/48/149/157/165	5+6+7+8
	11ac VHT40	Band 1&4	MCS0/Nss4	38/46/151/159	5+6+7+8
	11ac VHT80	Band 1&4	MCS0/Nss4	42/155	5+6+7+8
	<b>For Beamforming Mode</b>				
	11ac VHT20	Band 1&4	MCS0/Nss1	36/40/48/149/157/165	5+6+7+8
	11ac VHT40	Band 1&4	MCS0/Nss1	38/46/151/159	5+6+7+8
	11ac VHT80	Band 1&4	MCS0/Nss1	42/155	5+6+7+8
	11ac VHT20	Band 1&4	MCS0/Nss2	36/40/48/149/157/165	5+6+7+8
	11ac VHT40	Band 1&4	MCS0/Nss2	38/46/151/159	5+6+7+8
	11ac VHT80	Band 1&4	MCS0/Nss2	42/155	5+6+7+8
	11ac VHT20	Band 1&4	MCS0/Nss3	36/40/48/149/157/165	5+6+7+8
	11ac VHT40	Band 1&4	MCS0/Nss3	38/46/151/159	5+6+7+8
	11ac VHT80	Band 1&4	MCS0/Nss3	42/155	5+6+7+8
	Frequency Stability	20 MHz	Band 1&4	-	40/157
40 MHz		Band 1&4	-	38/151	6
80 MHz		Band 1&4	-	42/155	6

**For 802.11ac MCS0/Nss2 VHT80+80 (Non-Beamforming and Beamforming) Mode**

Test Items	Mode		Data Rate	Type	Channel	Chain
Max. Conducted Output Power Power Spectral Density 26dB Spectrum Bandwidth & 99% Occupied Bandwidth Measurement Radiated Emission Above 1GHz Band Edge Emission	11ac VHT80+80	Band 1&4	MCS0/Nss2	1	42	5+6
					155	7+8
26dB Spectrum Bandwidth & 99% Occupied Bandwidth	11ac VHT80+80	Band 1&4	MCS0/Nss2	1	42	5/6
					155	7/8
6dB Spectrum Bandwidth Measurement	11ac VHT80+80	Band 1&4	MCS0/Nss2	1	42	-
					155	7/8

## For Radio 3

Test Items	Mode		Data Rate	Channel	Chain
AC Power Conducted Emission	Normal Link		-	-	-
Max. Conducted Output Power	11a/BPSK	Band 1&4	6Mbps	36/40/48/149/157/165	9
	11ac VHT20	Band 1&4	MCS0/Nss1	36/40/48/149/157/165	9
	11ac VHT40	Band 1&4	MCS0/Nss1	38/46/151/159	9
	11ac VHT80	Band 1&4	MCS0/Nss1	42/155	9
Power Spectral Density	11a/BPSK	Band 1&4	6Mbps	36/40/48/149/157/165	9
	11ac VHT20	Band 1&4	MCS0/Nss1	36/40/48/149/157/165	9
	11ac VHT40	Band 1&4	MCS0/Nss1	38/46/151/159	9
	11ac VHT80	Band 1&4	MCS0/Nss1	42/155	9
26dB Spectrum Bandwidth & 99% Occupied Bandwidth Measurement	11a/BPSK	Band 1&4	6Mbps	36/40/48/149/157/165	9
	11ac VHT20	Band 1&4	MCS0/Nss1	36/40/48/149/157/165	9
	11ac VHT40	Band 1&4	MCS0/Nss1	38/46/151/159	9
	11ac VHT80	Band 1&4	MCS0/Nss1	42/155	9
6dB Spectrum Bandwidth Measurement	11a/BPSK	Band 4	6Mbps	149/157/165	9
	11ac VHT20	Band 4	MCS0/Nss1	149/157/165	9
	11ac VHT40	Band 4	MCS0/Nss1	151/159	9
	11ac VHT80	Band 4	MCS0/Nss1	155	9
Radiated Emission Below 1GHz	Normal Link		-	-	-
Radiated Emission Above 1GHz	11a/BPSK	Band 1&4	6Mbps	36/40/48/149/157/165	9
	11ac VHT20	Band 1&4	MCS0/Nss1	36/40/48/149/157/165	9
	11ac VHT40	Band 1&4	MCS0/Nss1	38/46/151/159	9
	11ac VHT80	Band 1&4	MCS0/Nss1	42/155	9
Band Edge Emission	11a/BPSK	Band 1&4	6Mbps	36/40/48/149/157/165	9
	11ac VHT20	Band 1&4	MCS0/Nss1	36/40/48/149/157/165	9
	11ac VHT40	Band 1&4	MCS0/Nss1	38/46/151/159	9
	11ac VHT80	Band 1&4	MCS0/Nss1	42/155	9
Frequency Stability	20 MHz	Band 1&4	-	40/157	9
	40 MHz	Band 1&4	-	38/151	9
	80 MHz	Band 1&4	-	42/155	9

Note 1: VHT20/VHT40 covers HT20/HT40, due to same modulation. The power setting for 802.11n HT20 and HT40 are the same or lower than 802.11ac VHT20 and VHT40.

Note 2: There are two modes of EUT, one is beamforming mode, and the other is non-beamforming mode for 802.11n/ac. All test results were recorded in the report.

Note 3: Adapter and PoE information as below, and the Adapter and PoE are for measurement only, would not be marketed.

Power	Brand	Model
Adapter	ITE	MU30-5120250-A1
PoE	Motorola	PD-7001G

The following test modes were performed for all tests:

Conducted Emission test	
Mode	Description
1	Radio 1 (2.4GHz WLAN function) + Radio 2 (5GHz WLAN function) + Radio 3 (2.4GHz WLAN function) + Bluetooth with Adapter
2	Radio 1 (2.4GHz WLAN function) + Radio 2 (5GHz WLAN function) + Radio 3 (5GHz WLAN function) + Bluetooth with Adapter
Mode 1 generated the worst test result, so it was recorded in this report.	

Radiated Emission test <Below 1GHz>	
Mode	Description
1	Radio 1 (2.4GHz WLAN function) + Radio 2 (5GHz WLAN function) + Radio 3 (2.4GHz WLAN function) + Bluetooth with Adapter - Z axis
2	Radio 1 (2.4GHz WLAN function) + Radio 2 (5GHz WLAN function) + Radio 3 (2.4GHz WLAN function) + Bluetooth with Adapter - Y axis
Mode 2 has been evaluated to be the worst case between Mode 1~2, thus measurement for Mode 3 will follow this same test mode.	
3	Radio 1 (2.4GHz WLAN function) + Radio 2 (5GHz WLAN function) + Radio 3 (2.4GHz WLAN function) + Bluetooth with PoE - Y axis
Mode 3 has been evaluated to be the worst case among Mode 1~3, thus measurement for Mode 4 will follow this same test mode.	
4	Radio 1 (2.4GHz WLAN function) + Radio 2 (5GHz WLAN function) + Radio 3 (5GHz WLAN function) + Bluetooth with PoE - Y axis
Mode 3 generated the worst test result, so it was recorded in this report.	

Radiated Emission test<Above 1GHz>	
The EUT was performed at X axis, Y axis and Z axis position for Radiated emission above 1GHz test, and the worst case was found at Y axis. So the measurement will follow this same test configuration.	
Mode	Description
1	CTX - Y axis

Co-location MPE and Radiated Emission Co-location Test	
Mode	Description
1	Radio 1 (2.4GHz WLAN function) + Radio 2 (5GHz WLAN function) + Radio 3 (2.4GHz WLAN function) + Bluetooth
2	Radio 1 (2.4GHz WLAN function) + Radio 2 (5GHz WLAN function) + Radio 3 (5GHz WLAN function) + Bluetooth
Therefore Co-location Maximum Permissible Exposure (Please refer to FA590419) and Radiated Emission Co-location (please refer to Appendix B) tests are added for simultaneously transmit.	

### 3.7. Table for Testing Locations

Test Site Location					
Address:	No.8, Lane 724, Bo-ai St., Jhubei City, Hsinchu County 302, Taiwan, R.O.C.				
TEL:	886-3-656-9065				
FAX:	886-3-656-9085				
Test Site No.	Site Category	Location	FCC Reg. No.	IC File No.	VCCI Reg. No
03CH01-CB	SAC	Hsin Chu	262045	IC 4086D	-
CO01-CB	Conduction	Hsin Chu	262045	IC 4086D	-
TH01-CB	OVEN Room	Hsin Chu	-	-	-

Open Area Test Site (OATS); Semi Anechoic Chamber (SAC).



### 3.8. Table for Supporting Units

For Test Site No: 03CH01-CB (Below 1GHz)

Support Unit	Brand	Model	FCC ID
NB*5	DELL	E4300	DoC
NB	Apple	Mac Book	DoC
PoE	Motorola	PD-7001G	DoC
Bluetooth dongle	WPI	CC2540	DoC

For Test Site No: 03CH01-CB (Above 1GHz)

<For Non-beamforming Mode>

Support Unit	Brand	Model	FCC ID
NB	DELL	E4300	DoC
PoE	Motorola	PD-7001G	DoC

<For Beamforming Mode>

Support Unit	Brand	Model	FCC ID
NB*2	DELL	E4300	DoC
PoE	Motorola	PD-7001G	DoC
RX Device	CISCO	MR52-HW	UDX-60041010

For Test Site No: CO01-CB

Support Unit	Brand	Model	FCC ID
NB*6	DELL	E6430	DoC
Bluetooth dongle	WPI	CC2540	DoC
Adapter	ITE	MU30-5120250-A1	N/A

For Test Site No: TH01-CB

Support Unit	Brand	Model	FCC ID
NB	DELL	E4300	DoC
Adapter	ITE	MU30-5120250-A1	N/A

### 3.9. Table for Parameters of Test Software Setting

During testing, Channel and Power Controlling Software provided by the customer was used to control the operating channel as well as the output power level. The RF output power selection is for the setting of RF output power expected by the customer and is going to be fixed on the firmware of the final end product.

<For Radio 2 Non-beamforming Mode>

Test Software Version	QCAQML-QLIB V6190,QPHONEMS					
Mode	Test Frequency (MHz)					
	NCB: 20MHz					
	5180 MHz	5200 MHz	5240 MHz	5745 MHz	5785 MHz	5825 MHz
802.11a	20	22.5	22.5	20	23.5	20.5
802.11ac MCS0/Nss1 VHT20	20	22	22.5	20	23.5	20.5
802.11ac MCS0/Nss4 VHT20	18.5	19.5	21	17	21	18
Mode	NCB: 40MHz					
	5190 MHz		5230 MHz		5755 MHz	
802.11ac MCS0/Nss1 VHT40	18		20		17	
802.11ac MCS0/Nss4 VHT40	16.5		18.5		16.5	
Mode	NCB: 80MHz					
	5210 MHz			5775 MHz		
802.11ac MCS0/Nss1 VHT80	14.5			11		
802.11ac MCS0/Nss4 VHT80	14			14		

Test Software Version	QCAQML-QLIB V6190,QPHONEMS	
Mode	NCB: 80MHz+80MHz	
	Type 1	
	5210+5775 MHz	
802.11ac MCS0/Nss2 VHT80+80	13.5	

## &lt;For Radio 2 Beamforming Mode&gt;:

Test Software Version	QCAQML-QLIB V6190,QPHONEMS					
Mode	Test Frequency (MHz)					
	NCB: 20MHz					
	5180 MHz	5200 MHz	5240 MHz	5745 MHz	5785 MHz	5825 MHz
802.11ac MCS0/Nss1 VHT20	30	30	30	26	30	30
802.11ac MCS0/Nss2 VHT20	30	30	30	27	30	30
802.11ac MCS0/Nss3 VHT20	30	30	30	20	30	23
Mode	NCB: 40MHz					
	5190 MHz		5230 MHz		5755 MHz	
	5795 MHz					
802.11ac MCS0/Nss1 VHT40	23		30		23	
802.11ac MCS0/Nss2 VHT40	22		30		23	
802.11ac MCS0/Nss3 VHT40	20		30		22	
Mode	NCB: 80MHz					
	5210 MHz			5775 MHz		
802.11ac MCS0/Nss1 VHT80	20			17		
802.11ac MCS0/Nss2 VHT80	21			20		
802.11ac MCS0/Nss3 VHT80	21			21		

Test Software Version	QCAQML-QLIB V6190,QPHONEMS
Mode	NCB: 80MHz+80MHz
	Type 1
	5210+5775 MHz
802.11ac MCS0/Nss2 VHT80+80	23

**<For Radio 3 Mode>:**

Test Software Version	QCAQML-QLIB V6190,QPHONEMS					
Mode	Test Frequency (MHz)					
	NCB: 20MHz					
	5180 MHz	5200 MHz	5240 MHz	5745 MHz	5785 MHz	5825 MHz
802.11a	22.5	28.5	17	17	29.5	24.5
802.11ac MCS0/Nss1 VHT20	21.5	29	16.5	17	29.5	20.5
Mode	NCB: 40MHz					
	5190 MHz		5230 MHz		5755 MHz	
	5795 MHz		5795 MHz			
802.11ac MCS0/Nss1 VHT40	15.5		19		14.5	
Mode	NCB: 80MHz					
	5210 MHz			5775 MHz		
	5775 MHz					
802.11ac MCS0/Nss1 VHT80	13.5			13		

### 3.10. EUT Operation during Test

**<For Non-beamforming Mode>**

The EUT was programmed to be in continuously transmitting mode.

**<For Beamforming Mode>**

For Conducted Mode:

The EUT was programmed to be in continuously transmitting mode.

For Radiated Mode:

During the test, the following programs under WIN XP were executed.

The program was executed as follows:

1. During the test, the EUT operation to normal function.
2. Executed command fixed test channel under DOS.
3. Executed "Lantest.exe " to link with the remote workstation to receive and transmit packet by RX Device and transmit duty cycle no less 98%

### 3.11. Duty Cycle

<For Non-beamforming Mode>

Mode	On Time (ms)	On+Off Time (ms)	Duty Cycle (%)	Duty Factor (dB)	1/T Minimum VBW (kHz)
802.11a	2.058	2.120	97.08%	0.13	0.49
802.11ac MCS0/Nss1 VHT20	4.980	5.070	98.22%	0.08	0.01
802.11ac MCS0/Nss1 VHT40	2.394	2.483	96.39%	0.16	0.42
802.11ac MCS0/Nss1 VHT80	1.132	1.199	94.44%	0.25	0.88
802.11ac MCS0/Nss4 VHT20	4.960	5.040	98.41%	0.07	0.01
802.11ac MCS0/Nss4 VHT40	2.383	2.486	95.83%	0.18	0.42
802.11ac MCS0/Nss4 VHT80	1.152	1.216	94.74%	0.23	0.87
802.11ac MCS0/Nss2 VHT80+80	1.140	1.200	95.00%	0.22	0.88

<For Beamforming Mode>

Mode	On Time (ms)	On+Off Time (ms)	Duty Cycle (%)	Duty Factor (dB)	1/T Minimum VBW (kHz)
802.11ac MCS0/Nss1 VHT20	8.820	9.592	91.95%	0.36	0.11
802.11ac MCS0/Nss1 VHT40	8.210	8.520	96.36%	0.16	0.12
802.11ac MCS0/Nss1 VHT80	7.772	8.530	91.11%	0.40	0.13
802.11ac MCS0/Nss2 VHT20	8.800	8.832	99.64%	0.02	0.01
802.11ac MCS0/Nss2 VHT40	6.640	8.080	82.18%	0.85	0.15
802.11ac MCS0/Nss2 VHT80	6.912	8.060	85.76%	0.67	0.14
802.11ac MCS0/Nss3 VHT20	1.600	2.120	75.47%	1.22	0.63
802.11ac MCS0/Nss3 VHT40	7.515	8.280	90.76%	0.42	0.13
802.11ac MCS0/Nss3 VHT80	7.240	8.120	89.16%	0.50	0.14
802.11ac MCS0/Nss2 VHT80+80	6.608	8.184	80.74%	0.93	0.15

### 3.12. Test Configurations

#### 3.12.1. AC Power Line Conduction Emissions Test Configuration

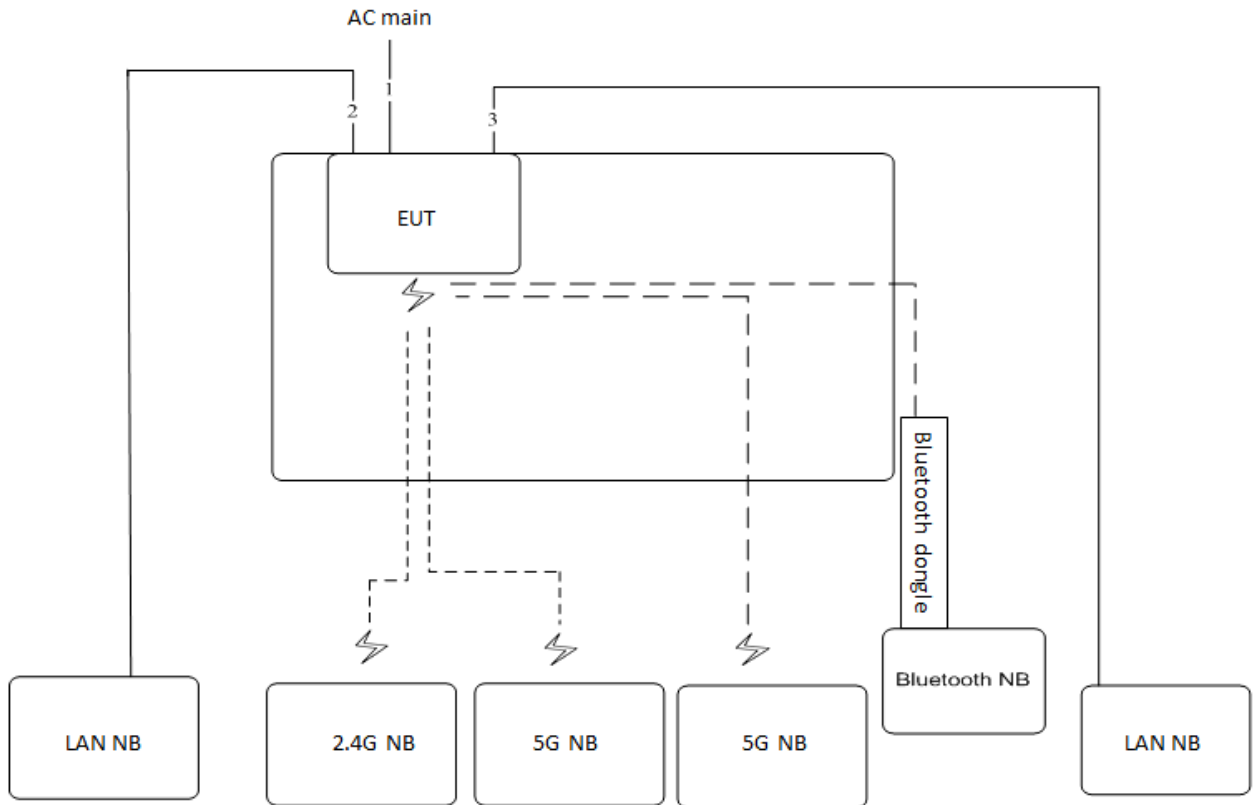

Item	Connection	Shielded	Length
1	Power cable	No	1.5m
2	RJ-45 cable	No	100m
3	RJ-45 cable	No	50m

### 3.12.2. Radiation Emissions Test Configuration

Test Configuration: 30MHz ~1GHz

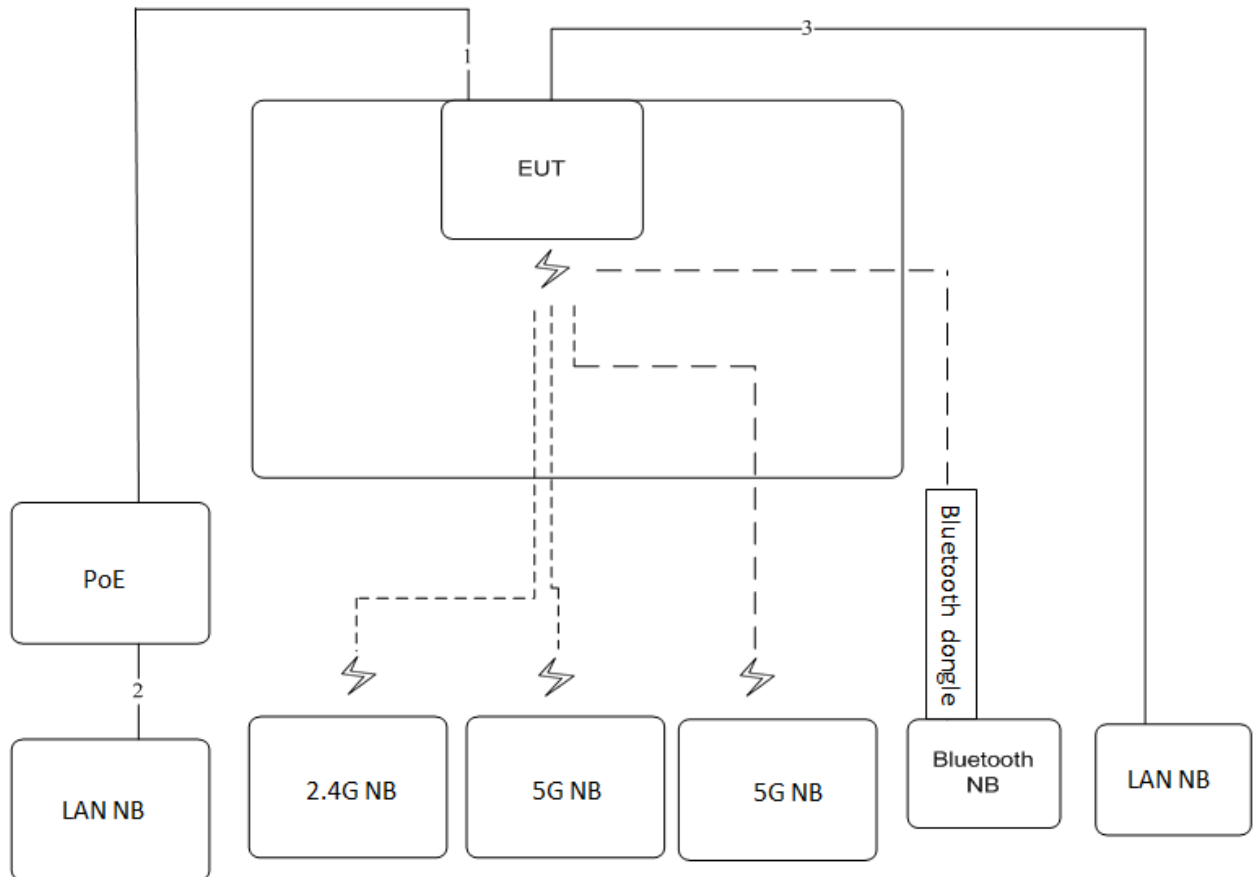

Item	Connection	Shielded	Length
1	RJ-45 cable	No	10m
2	RJ-45 cable	No	1.5m
3	RJ-45 cable	No	10m

Test Configuration: above 1GHz  
 <For Non-Beamforming Mode>

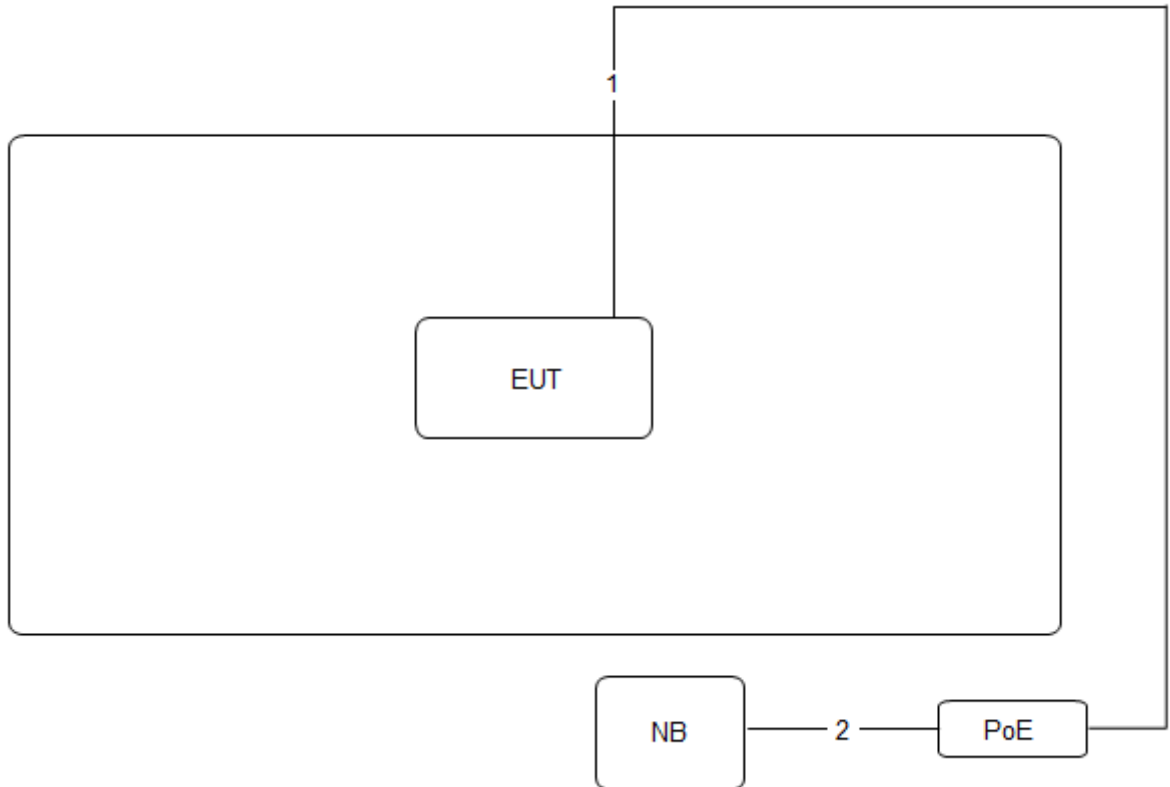

Item	Connection	Shielded	Length
1	RJ-45 cable	No	10m
2	RJ-45 cable	No	1.5m



<For Beamforming Mode>

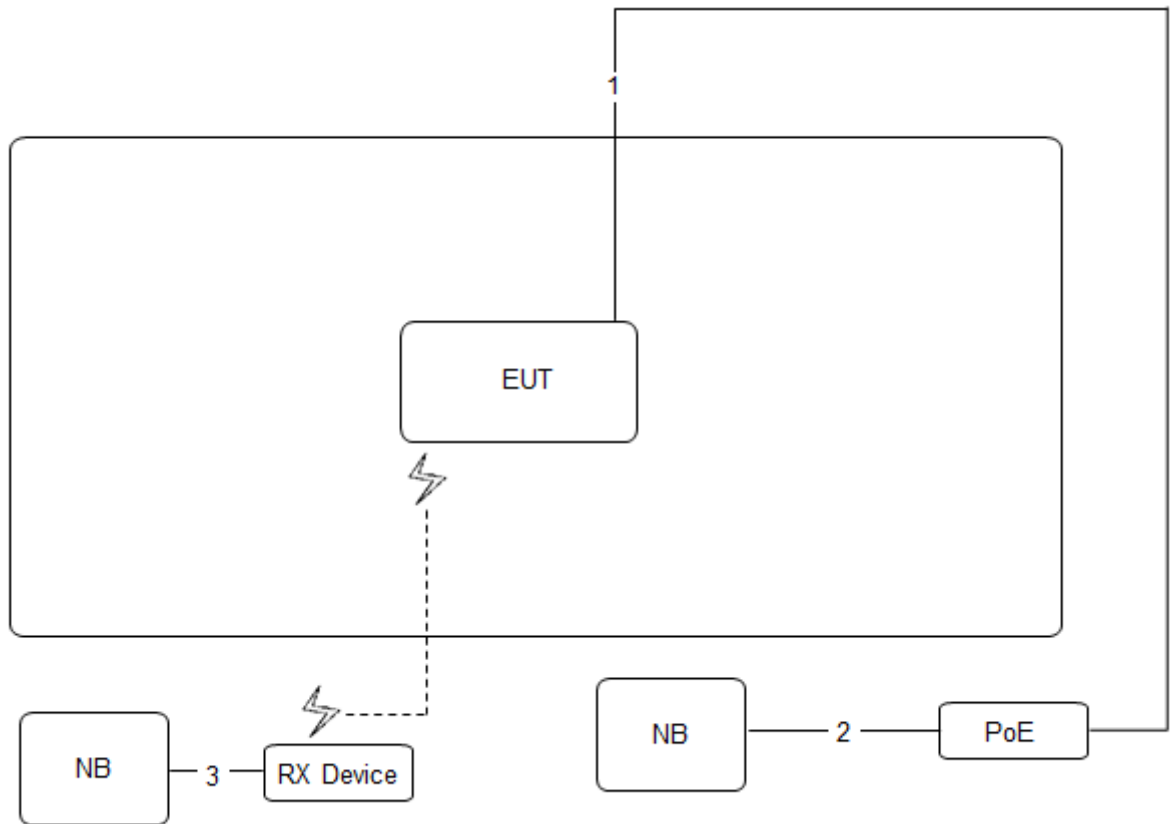

Item	Connection	Shielded	Length
1	RJ-45 cable	No	10m
2	RJ-45 cable	No	1.5m
3	RF-45 cable	No	1.5m

## 4. TEST RESULT

### 4.1. AC Power Line Conducted Emissions Measurement

#### 4.1.1. Limit

For this product that is designed to connect to the AC power line, the radio frequency voltage that is conducted back onto the AC power line on any frequency or frequencies within the band 150 kHz to 30 MHz shall not exceed below limits table.

Frequency (MHz)	QP Limit (dBuV)	AV Limit (dBuV)
0.15~0.5	66~56	56~46
0.5~5	56	46
5~30	60	50

#### 4.1.2. Measuring Instruments and Setting

Please refer to section 5 of equipments list in this report. The following table is the setting of the receiver.

Receiver Parameters	Setting
Attenuation	10 dB
Start Frequency	0.15 MHz
Stop Frequency	30 MHz
IF Bandwidth	9 kHz

#### 4.1.3. Test Procedures

1. Configure the EUT according to ANSI C63.10. The EUT or host of EUT has to be placed 0.4 meter far from the conducting wall of the shielding room and at least 80 centimeters from any other grounded conducting surface.
2. Connect EUT or host of EUT to the power mains through a line impedance stabilization network (LISN).
3. All the support units are connected to the other LISNs. The LISN should provide 50uH/50ohms coupling impedance.
4. The frequency range from 150 kHz to 30 MHz was searched.
5. Set the test-receiver system to Peak Detect Function and Specified Bandwidth with Maximum Hold Mode.
6. The measurement has to be done between each power line and ground at the power terminal.

#### 4.1.4. Test Setup Layout

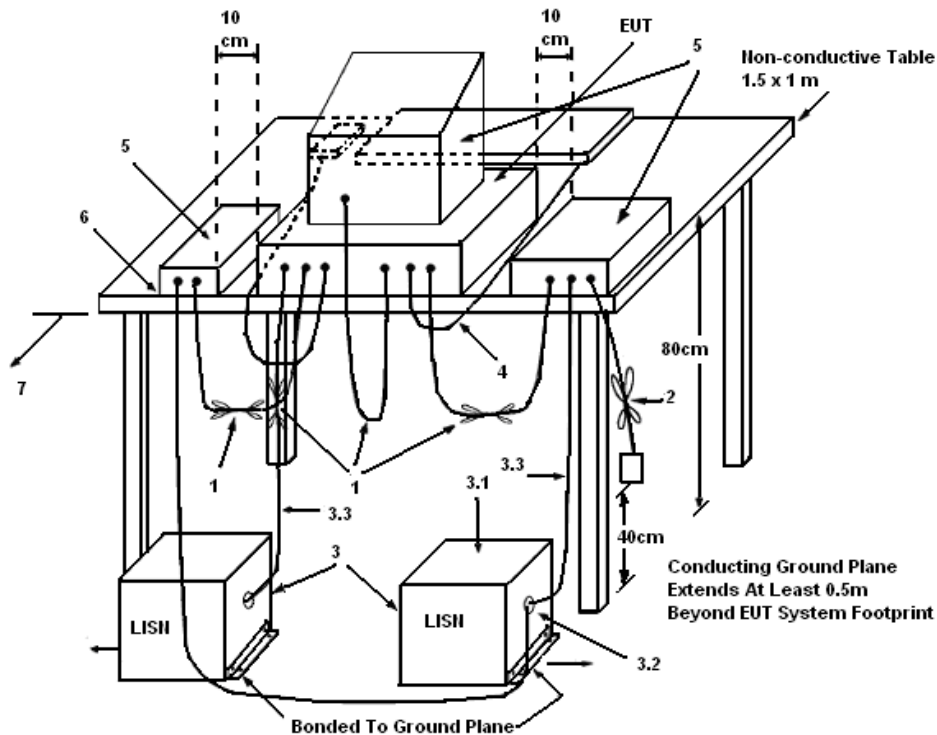

#### LEGEND:

- (1) Interconnecting cables that hang closer than 40 cm to the ground plane shall be folded back and forth in the center forming a bundle 30 to 40 cm long.
- (2) I/O cables that are not connected to a peripheral shall be bundled in the center. The end of the cable may be terminated, if required, using the correct terminating impedance. The overall length shall not exceed 1 m.
- (3) EUT connected to one LISN. Unused LISN measuring port connectors shall be terminated in 50  $\Omega$ . LISN can be placed on top of, or immediately beneath, reference ground plane.
  - (3.1) All other equipment powered from additional LISN(s).
  - (3.2) Multiple outlet strip can be used for multiple power cords of non-EUT equipment.
  - (3.3) LISN at least 80 cm from nearest part of EUT chassis.
- (4) Cables of hand-operated devices, such as keyboards, mice, etc., shall be placed as for normal use.
- (5) Non-EUT components of EUT system being tested.
- (6) Rear of EUT, including peripherals, shall all be aligned and flush with rear of tabletop.
- (7) Rear of tabletop shall be 40 cm removed from a vertical conducting plane that is bonded to the ground plane.

#### 4.1.5. Test Deviation

There is no deviation with the original standard.

#### 4.1.6. EUT Operation during Test

The EUT was placed on the test table and programmed in normal function.

4.1.7. Results of AC Power Line Conducted Emissions Measurement

Temperature	23°C	Humidity	63%
Test Engineer	Parody Lin	Phase	Line
Configuration	Normal Link / Mode 1		

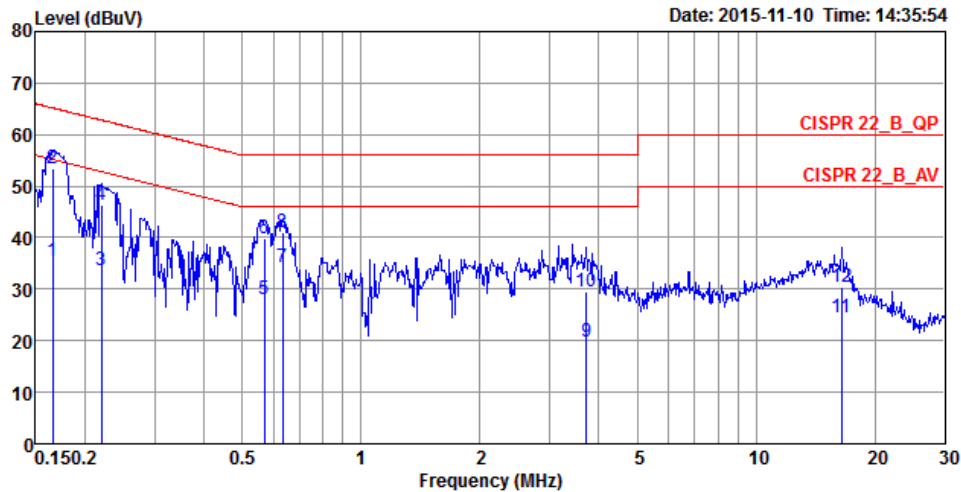

	Freq	Level	Over Limit	Limit Line	Read Level	LISN Factor	Cable Loss	Pol/Phase	Remark
	MHz	dBuV	dB	dBuV	dBuV	dB	dB		
1	0.1659	35.57	-19.59	55.16	25.62	9.93	0.02	LINE	Average
2	0.1659	53.42	-11.74	65.16	43.47	9.93	0.02	LINE	QP
3	0.2197	33.58	-19.25	52.83	23.63	9.93	0.02	LINE	Average
4	0.2197	46.27	-16.56	62.83	36.32	9.93	0.02	LINE	QP
5	0.5701	28.16	-17.84	46.00	18.18	9.94	0.04	LINE	Average
6	0.5701	39.87	-16.13	56.00	29.89	9.94	0.04	LINE	QP
7	0.6338	34.28	-11.72	46.00	24.30	9.94	0.04	LINE	Average
8	0.6338	40.93	-15.07	56.00	30.95	9.94	0.04	LINE	QP
9	3.7198	19.74	-26.26	46.00	9.66	10.02	0.06	LINE	Average
10	3.7198	29.40	-26.60	56.00	19.32	10.02	0.06	LINE	QP
11	16.4856	24.45	-25.55	50.00	13.82	10.37	0.26	LINE	Average
12	16.4856	30.43	-29.57	60.00	19.80	10.37	0.26	LINE	QP

Temperature	23°C	Humidity	63%
Test Engineer	Parody Lin	Phase	Neutral
Configuration	Normal Link / Mode 1		

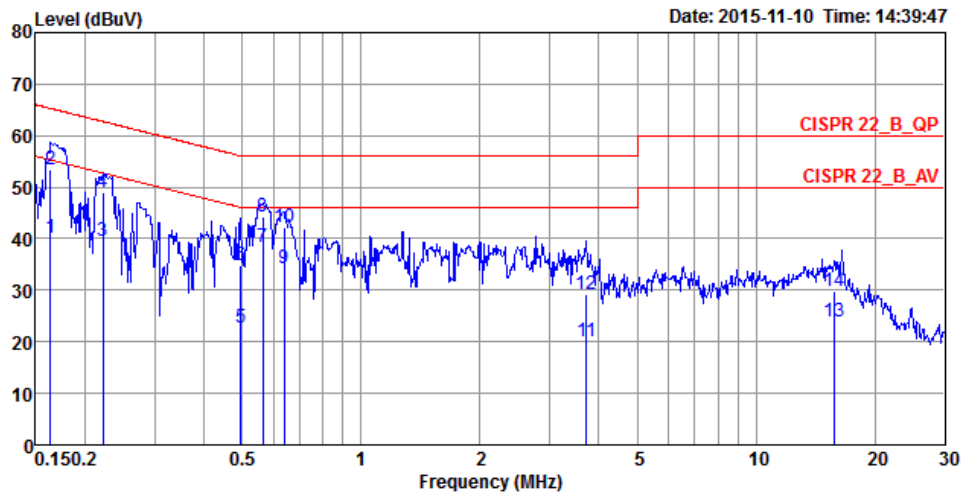

	Freq	Level	Over Limit	Limit Line	Read Level	LISN Factor	Cable Loss	Pol/Phase	Remark
	MHz	dBuV	dB	dBuV	dBuV	dB	dB		
1	0.1633	40.17	-15.13	55.30	30.37	9.78	0.02	NEUTRAL	Average
2	0.1633	53.57	-11.73	65.30	43.77	9.78	0.02	NEUTRAL	QP
3	0.2220	39.47	-13.27	52.74	29.65	9.79	0.03	NEUTRAL	Average
4	0.2220	49.15	-13.59	62.74	39.33	9.79	0.03	NEUTRAL	QP
5	0.4967	22.71	-23.34	46.05	12.88	9.79	0.04	NEUTRAL	Average
6	0.4967	34.82	-21.23	56.05	24.99	9.79	0.04	NEUTRAL	QP
7	0.5641	38.33	-7.67	46.00	28.49	9.80	0.04	NEUTRAL	Average
8	0.5641	44.40	-11.60	56.00	34.56	9.80	0.04	NEUTRAL	QP
9	0.6372	34.21	-11.79	46.00	24.37	9.80	0.04	NEUTRAL	Average
10	0.6372	42.12	-13.88	56.00	32.28	9.80	0.04	NEUTRAL	QP
11	3.7198	19.93	-26.07	46.00	10.00	9.87	0.06	NEUTRAL	Average
12	3.7198	29.21	-26.79	56.00	19.28	9.87	0.06	NEUTRAL	QP
13	15.8014	23.91	-26.09	50.00	13.53	10.12	0.26	NEUTRAL	Average
14	15.8014	29.86	-30.14	60.00	19.48	10.12	0.26	NEUTRAL	QP

Note:

Level = Read Level + LISN Factor + Cable Loss.

## 4.2. 26dB Bandwidth and 99% Occupied Bandwidth Measurement

### 4.2.1. Limit

No restriction limits.

### 4.2.2. Measuring Instruments and Setting

Please refer to section 5 of equipments list in this report. The following table is the setting of the spectrum analyzer.

26dB Bandwidth	
Spectrum Parameters	Setting
Attenuation	Auto
Span Frequency	> 26dB Bandwidth
RBW	Approximately 1% of the emission bandwidth
VBW	VBW > RBW
Detector	Peak
Trace	Max Hold
Sweep Time	Auto
99% Occupied Bandwidth	
Spectrum Parameters	Setting
Span	1.5 times to 5.0 times the OBW
RBW	1 % to 5 % of the OBW
VBW	$\geq 3 \times \text{RBW}$
Detector	Peak
Trace	Max Hold

### 4.2.3. Test Procedures

1. The transmitter was conducted to the spectrum analyzer in peak hold mode.
2. Measure the maximum width of the emission that is 26 dB down from the peak of the emission.
3. Compare this with the RBW setting of the analyzer. Readjust RBW and repeat measurement as needed until the RBW/EBW ratio is approximately 1%.
4. Measurement perform conducted of each port.

### 4.2.4. Test Setup Layout

This test setup layout is the same as that shown in section 4.5.4.

### 4.2.5. Test Deviation

There is no deviation with the original standard.

### 4.2.6. EUT Operation during Test

The EUT was programmed to be in continuously transmitting mode.

## 4.2.7. Test Result of 26dB Bandwidth and 99% Occupied Bandwidth

Temperature	25°C	Humidity	45%
Test Engineer	Mars Lin		

&lt;For Radio 2 Non-beamforming Mode&gt;

Mode	Frequency	26dB Bandwidth (MHz)				99% Occupied Bandwidth (MHz)			
		Chain 5	Chain 6	Chain 7	Chain 8	Chain 5	Chain 6	Chain 7	Chain 8
802.11a	5180 MHz	19.74	20.26	19.74	19.91	16.41	16.58	16.41	16.50
	5200 MHz	22.52	22.52	23.57	28.17	16.58	16.67	16.67	16.76
	5240 MHz	30.87	31.91	25.22	34.09	16.76	16.93	16.85	17.19
	5745 MHz	20.26	20.35	20.17	20.26	16.41	16.50	16.58	16.50
	5785 MHz	34.26	35.39	41.39	38.96	17.19	18.15	26.74	23.44
	5825 MHz	19.30	20.52	21.57	20.78	16.50	16.58	16.58	16.58
802.11ac MCS0/Nss1 VHT20	5180 MHz	20.52	20.78	20.43	20.70	17.63	17.63	17.63	17.63
	5200 MHz	21.91	21.91	22.09	27.13	17.71	17.80	17.71	17.80
	5240 MHz	27.65	27.74	23.39	32.00	17.80	17.80	17.80	18.06
	5745 MHz	20.78	20.52	20.87	20.61	17.71	17.71	17.63	17.63
	5785 MHz	30.70	35.91	42.78	38.96	18.06	19.02	27.26	21.79
	5825 MHz	20.78	20.78	21.57	21.22	17.71	17.71	17.71	17.71
802.11ac MCS0/Nss1 VHT40	5190 MHz	40.43	40.72	40.43	40.15	36.32	36.18	36.32	36.18
	5230 MHz	40.58	40.72	40.58	40.00	36.32	36.32	36.32	36.18
	5755 MHz	40.43	40.87	41.16	40.87	36.32	36.32	36.32	36.32
	5795 MHz	40.72	41.01	40.87	40.58	36.47	36.32	36.32	36.32
802.11ac MCS0/Nss1 VHT80	5210 MHz	80.00	80.00	80.29	79.71	75.83	75.83	75.83	75.83
	5775 MHz	80.29	80.29	80.29	80.00	75.83	75.83	75.83	75.83
802.11ac MCS0/Nss4 VHT20	5180 MHz	23.13	22.78	22.61	24.96	17.89	17.89	17.89	17.97
	5200 MHz	23.30	23.48	23.30	25.83	18.06	17.89	17.97	18.15
	5240 MHz	30.70	30.26	28.00	29.74	18.32	18.23	18.15	18.41
	5745 MHz	22.96	22.52	22.35	22.61	17.97	17.89	17.89	17.97
	5785 MHz	24.70	30.52	35.48	33.48	18.15	18.15	18.84	18.49
	5825 MHz	23.22	22.35	23.13	24.87	17.97	17.89	17.97	17.97
802.11ac MCS0/Nss4 VHT40	5190 MHz	44.93	45.07	44.35	45.36	36.76	36.90	37.05	37.05
	5230 MHz	44.20	44.93	44.64	45.22	36.76	37.05	37.05	37.19
	5755 MHz	44.64	45.07	44.93	45.36	36.90	37.19	37.34	37.05
	5795 MHz	44.06	44.64	45.65	45.65	37.05	37.19	37.34	37.19
802.11ac MCS0/Nss4 VHT80	5210 MHz	86.38	87.83	88.41	86.67	76.41	76.41	76.41	76.12
	5775 MHz	88.12	88.70	88.70	86.96	76.41	76.41	76.70	76.41

Mode	Frequency	26dB Bandwidth (MHz)				99% Occupied Bandwidth (MHz)			
		Chain 5	Chain 6	Chain 7	Chain 8	Chain 5	Chain 6	Chain 7	Chain 8
802.11ac MCS0/Nss2 VHT80+80	5210 MHz	80.00	80.00	-	-	75.83	75.83	-	-
	5775 MHz	-	-	80.00	80.29	-	-	75.54	75.83

Mode	Frequency	26dB Total BW (MHz)
802.11ac MCS0/Nss2 VHT80+80	5210+5775 MHz	160.29



## &lt;For Radio 2 Beamforming Mode&gt;

Mode	Frequency	26dB Bandwidth (MHz)				99% Occupied Bandwidth (MHz)			
		Chain 5	Chain 6	Chain 7	Chain 8	Chain 5	Chain 6	Chain 7	Chain 8
802.11ac MCSO/Nss1 VHT20	5180 MHz	20.09	20.35	20.00	20.00	17.71	17.80	17.63	17.80
	5200 MHz	20.09	20.00	20.00	20.17	17.63	17.80	17.71	17.80
	5240 MHz	20.26	20.09	20.26	20.09	17.63	17.80	17.71	17.71
	5745 MHz	22.78	22.43	22.35	22.61	17.97	17.89	17.89	17.89
	5785 MHz	20.35	20.00	20.26	20.17	17.80	17.80	17.80	17.80
	5825 MHz	20.35	20.35	20.17	20.26	17.80	17.80	17.80	17.80
802.11ac MCSO/Nss1 VHT40	5190 MHz	40.29	40.58	40.29	40.29	36.32	36.32	36.32	36.32
	5230 MHz	40.43	40.58	40.14	40.43	36.32	36.32	36.32	36.32
	5755 MHz	40.43	40.72	40.43	40.58	36.32	36.32	36.32	36.32
	5795 MHz	40.58	41.01	40.87	40.43	36.32	36.32	36.32	36.32
802.11ac MCSO/Nss1 VHT80	5210 MHz	80.00	80.29	80.29	80.29	75.83	75.83	75.83	75.83
	5775 MHz	80.29	80.58	80.29	80.58	75.83	76.12	76.12	75.83
802.11ac MCSO/Nss2 VHT20	5180 MHz	20.26	20.26	20.09	20.09	17.80	17.80	17.63	17.71
	5200 MHz	19.83	20.35	20.26	20.17	17.71	17.80	17.71	17.80
	5240 MHz	20.09	20.09	20.26	20.17	17.80	17.80	17.71	17.63
	5745 MHz	20.00	20.35	20.26	20.35	17.71	17.71	17.71	17.80
	5785 MHz	20.26	20.26	20.09	20.43	17.80	17.80	17.71	17.80
	5825 MHz	20.09	20.78	20.26	20.00	17.71	17.80	17.80	17.71
802.11ac MCSO/Nss2 VHT40	5190 MHz	40.14	40.72	40.43	40.58	36.32	36.32	36.32	36.32
	5230 MHz	40.43	40.43	40.29	40.29	36.32	36.32	36.32	36.47
	5755 MHz	40.58	40.58	40.29	40.14	36.32	36.47	36.32	36.32
	5795 MHz	40.72	40.72	40.43	40.14	36.32	36.32	36.32	36.18
802.11ac MCSO/Nss2 VHT80	5210 MHz	80.29	79.71	80.00	79.71	75.83	75.83	75.83	75.83
	5775 MHz	80.29	80.29	80.29	80.29	75.83	75.83	75.83	75.83

Mode	Frequency	26dB Bandwidth (MHz)				99% Occupied Bandwidth (MHz)			
		Chain 5	Chain 6	Chain 7	Chain 8	Chain 5	Chain 6	Chain 7	Chain 8
802.11ac MCSO/Nss3 VHT20	5180 MHz	22.52	22.87	22.17	21.65	17.89	17.89	17.80	18.06
	5200 MHz	22.96	22.87	21.30	22.78	17.89	17.97	17.89	18.06
	5240 MHz	23.04	22.78	21.57	21.74	17.80	17.89	17.89	17.97
	5745 MHz	23.13	22.78	21.22	21.65	17.97	17.97	17.80	18.06
	5785 MHz	22.87	22.96	21.48	22.17	17.97	17.97	17.89	18.06
	5825 MHz	22.52	22.61	22.00	21.57	17.89	17.97	17.97	18.06
802.11ac MCSO/Nss3 VHT40	5190 MHz	44.78	45.65	45.51	44.93	37.05	37.05	36.90	37.19
	5230 MHz	45.07	45.22	44.64	44.78	37.05	37.05	36.90	37.05
	5755 MHz	45.65	45.36	45.07	45.22	37.19	37.34	37.05	37.19
	5795 MHz	45.51	46.09	45.22	45.07	37.19	37.19	37.05	37.19
802.11ac MCSO/Nss3 VHT80	5210 MHz	86.09	87.54	86.96	86.09	76.12	76.41	76.41	76.12
	5775 MHz	86.09	86.09	87.83	88.12	76.70	76.12	76.41	76.12

Mode	Frequency	26dB Bandwidth (MHz)				99% Occupied Bandwidth (MHz)			
		Chain 5	Chain 6	Chain 7	Chain 8	Chain 5	Chain 6	Chain 7	Chain 8
802.11ac MCSO/Nss2 VHT80+80	5210 MHz	80.29	80.29	-	-	75.83	75.83	-	-
	5775 MHz	-	-	80.00	80.29	-	-	75.25	75.83

Mode	Frequency	26dB Total BW (MHz)
802.11ac MCSO/Nss2 VHT80+80	5210+5775 MHz	160.58

## &lt;For Radio 3 Mode&gt;

Mode	Frequency	26dB Bandwidth (MHz)	99% Occupied Bandwidth (MHz)
802.11a	5180 MHz	39.47	24.83
	5200 MHz	50.69	34.90
	5240 MHz	28.86	17.80
	5745 MHz	29.21	17.71
	5785 MHz	56.60	38.20
	5825 MHz	42.95	28.21
802.11ac MCS0/Nss1 VHT20	5180 MHz	41.73	25.18
	5200 MHz	55.21	38.03
	5240 MHz	28.69	18.49
	5745 MHz	30.26	18.66
	5785 MHz	57.65	40.28
	5825 MHz	39.82	23.44
802.11ac MCS0/Nss1 VHT40	5190 MHz	52.90	37.77
	5230 MHz	69.57	38.49
	5755 MHz	51.01	37.48
	5795 MHz	93.33	55.57
802.11ac MCS0/Nss1 VHT80	5210 MHz	104.35	76.70
	5775 MHz	100.58	76.70

<For Radio 2 Non-beamforming Mode>

26dB Bandwidth and 99% Occupied Bandwidth Plot on Configuration IEEE 802.11a / Chain 5 / 5180 MHz

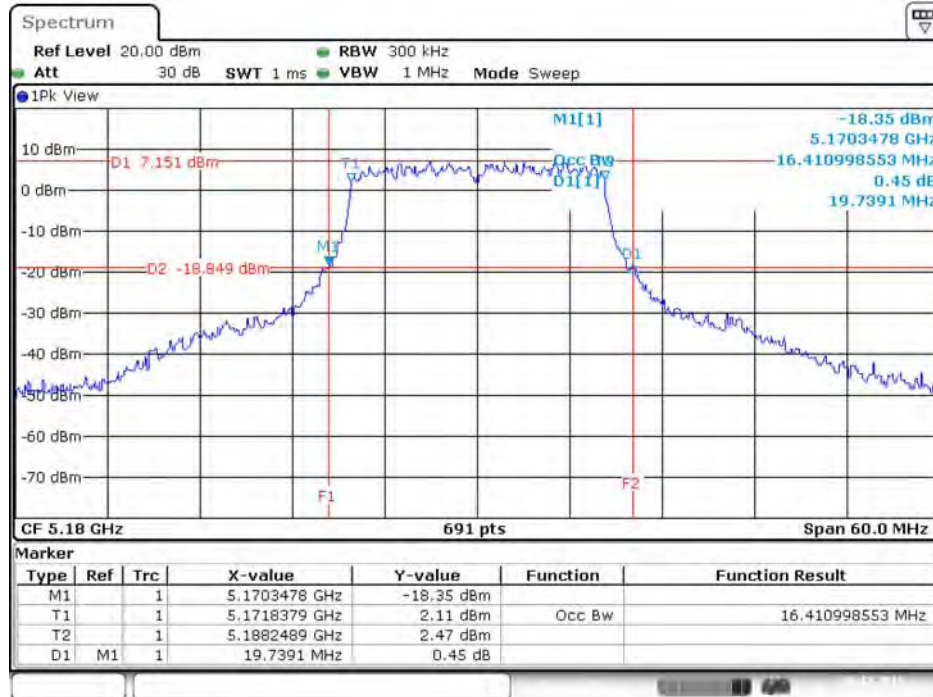

Date: 20.DEC.2015 09:45:08

26dB Bandwidth and 99% Occupied Bandwidth Plot on Configuration IEEE 802.11a / Chain 6 / 5180 MHz

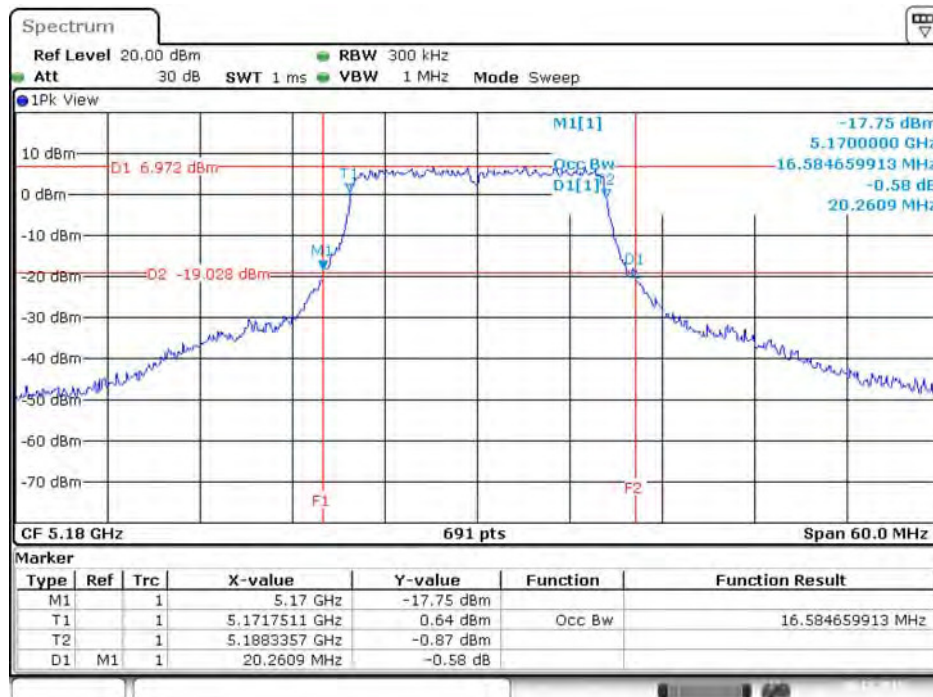

Date: 20.DEC.2015 09:45:38

26dB Bandwidth and 99% Occupied Bandwidth Plot on Configuration IEEE 802.11a / Chain 7 / 5180 MHz

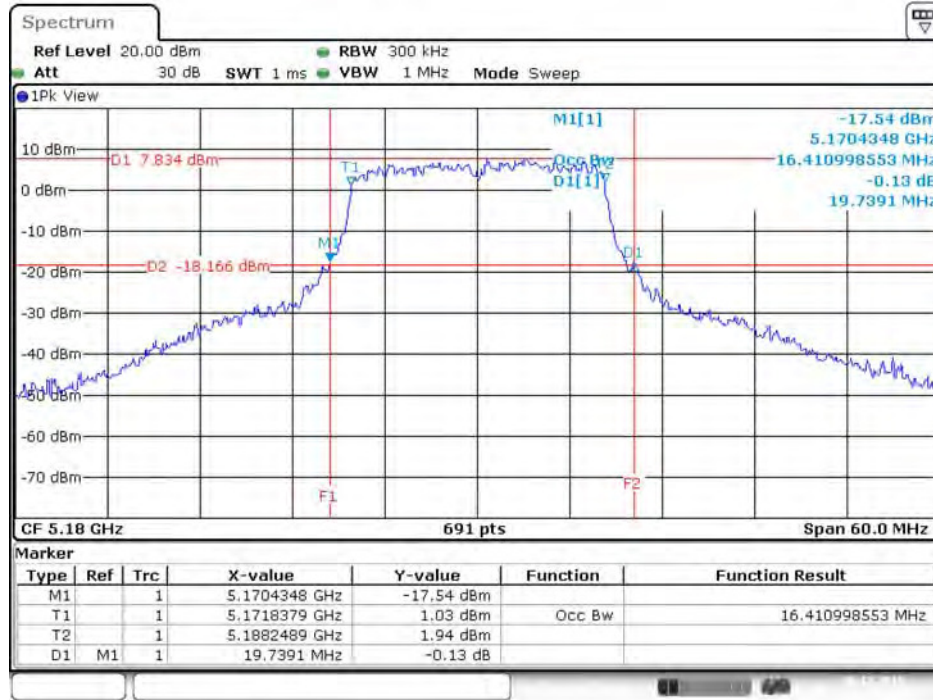

Date: 20.DEC.2015 09:46:01

26dB Bandwidth and 99% Occupied Bandwidth Plot on Configuration IEEE 802.11a / Chain 8 / 5180 MHz

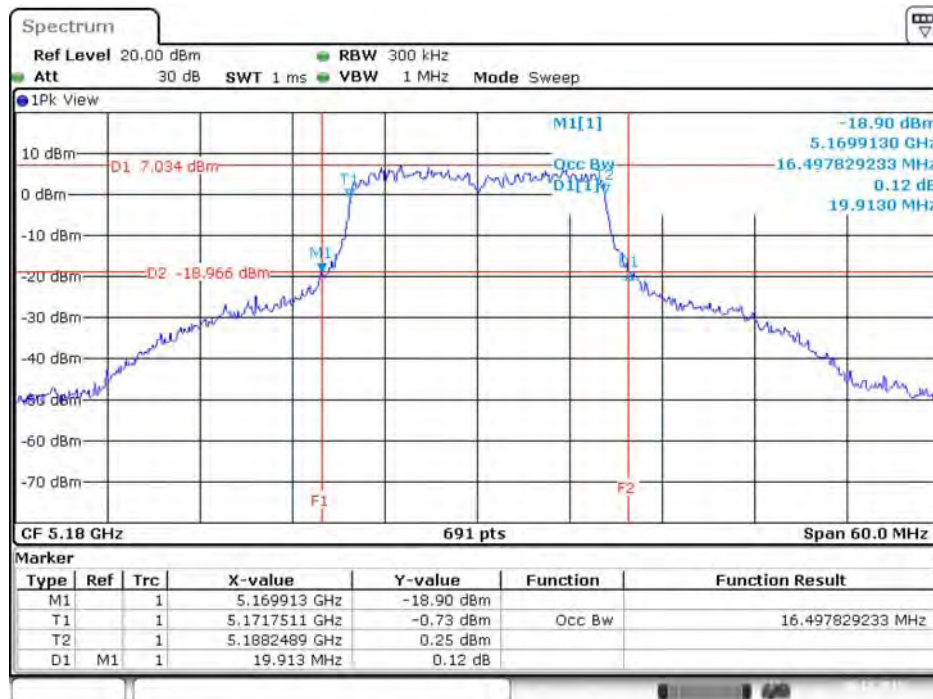

Date: 20.DEC.2015 09:46:25

26dB Bandwidth and 99% Occupied Bandwidth Plot on Configuration IEEE 802.11a / Chain 5 / 5200 MHz

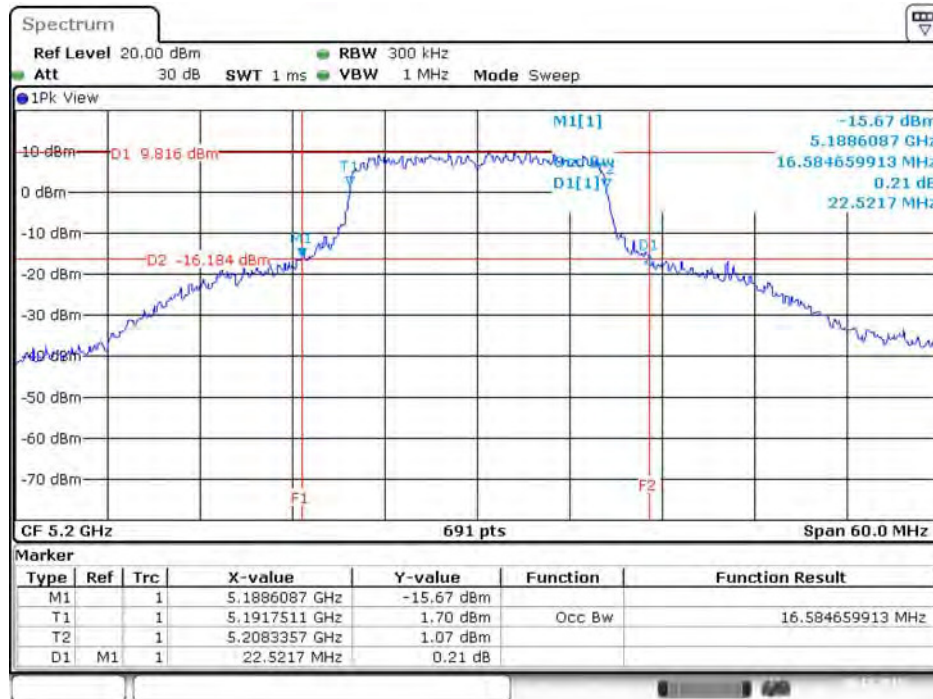

Date: 20.DEC.2015 09:49:01

26dB Bandwidth and 99% Occupied Bandwidth Plot on Configuration IEEE 802.11a / Chain 6 / 5200 MHz

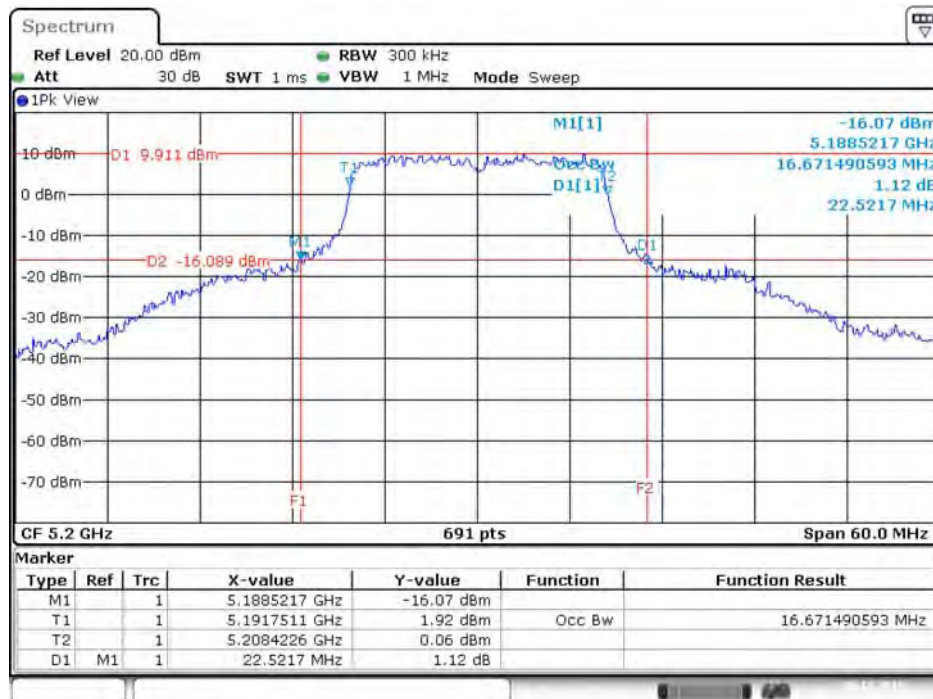

Date: 20.DEC.2015 09:48:33

26dB Bandwidth and 99% Occupied Bandwidth Plot on Configuration IEEE 802.11a / Chain 7 / 5200 MHz

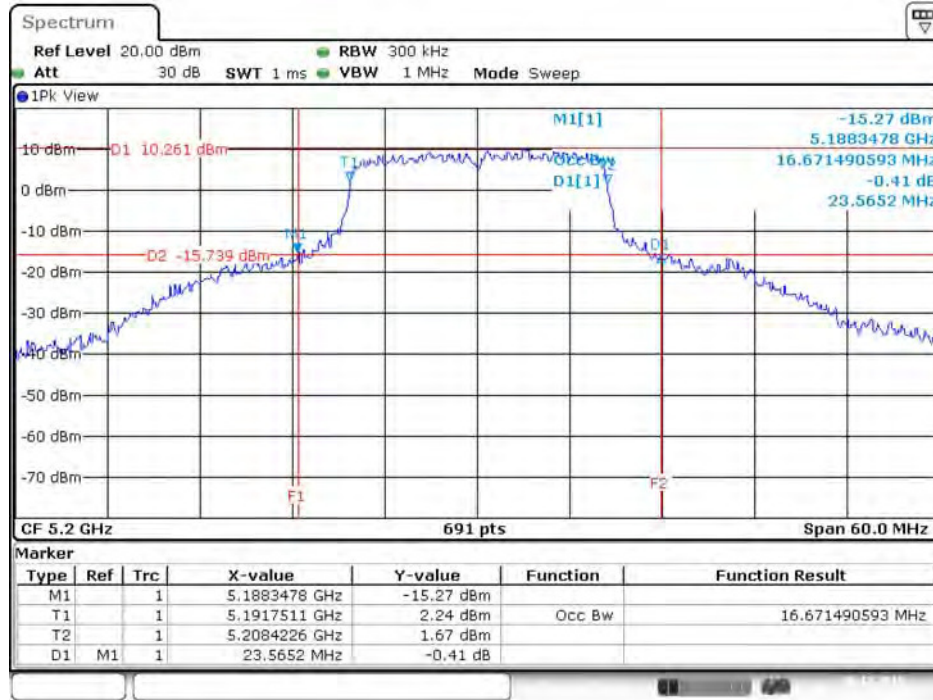

Date: 20.DEC.2015 09:48:08

26dB Bandwidth and 99% Occupied Bandwidth Plot on Configuration IEEE 802.11a / Chain 8 / 5200 MHz

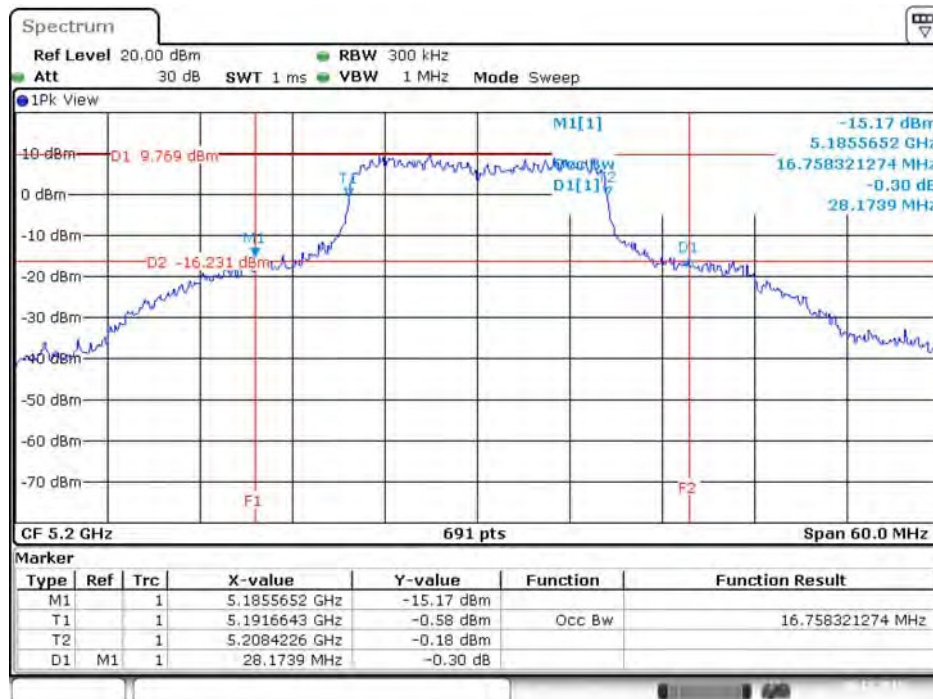

Date: 20.DEC.2015 09:50:03

26dB Bandwidth and 99% Occupied Bandwidth Plot on Configuration IEEE 802.11a / Chain 5 / 5240 MHz

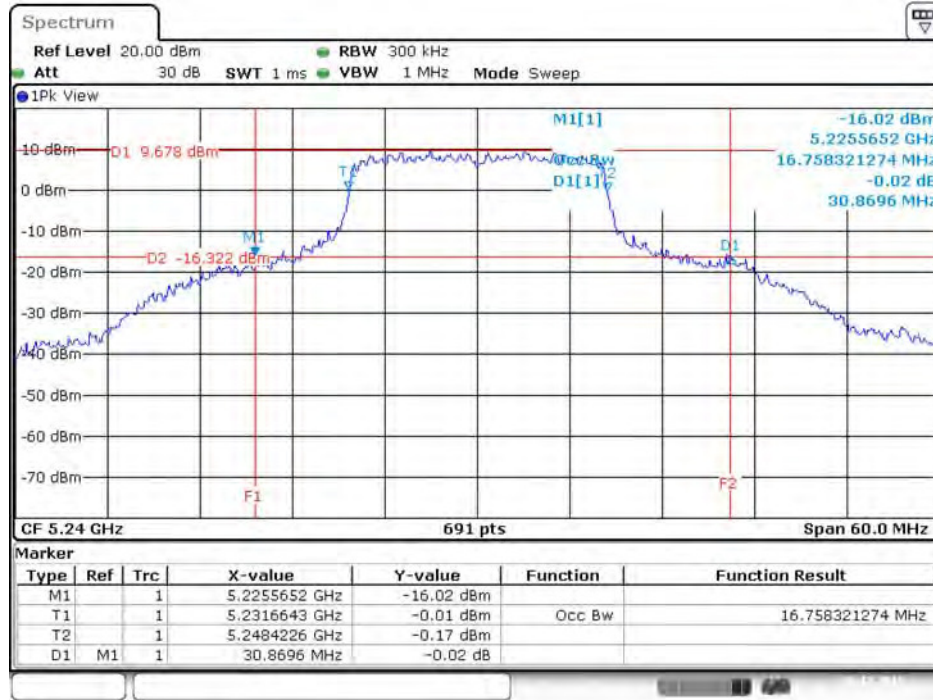

Date: 20.DEC.2015 09:53:11

26dB Bandwidth and 99% Occupied Bandwidth Plot on Configuration IEEE 802.11a / Chain 6 / 5240 MHz

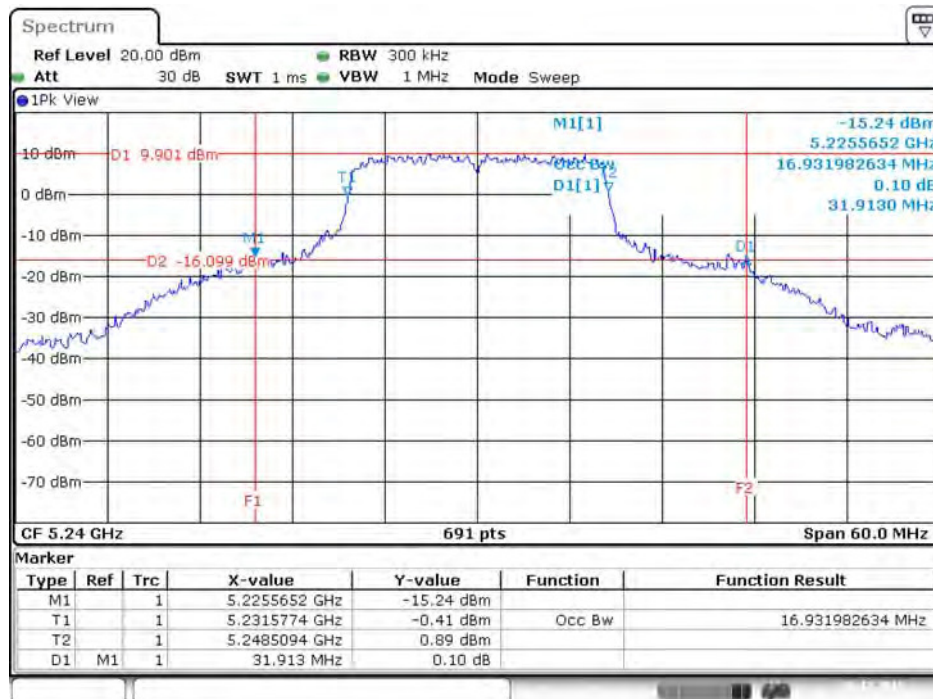

Date: 20.DEC.2015 09:52:47



26dB Bandwidth and 99% Occupied Bandwidth Plot on Configuration IEEE 802.11a / Chain 7 / 5240 MHz

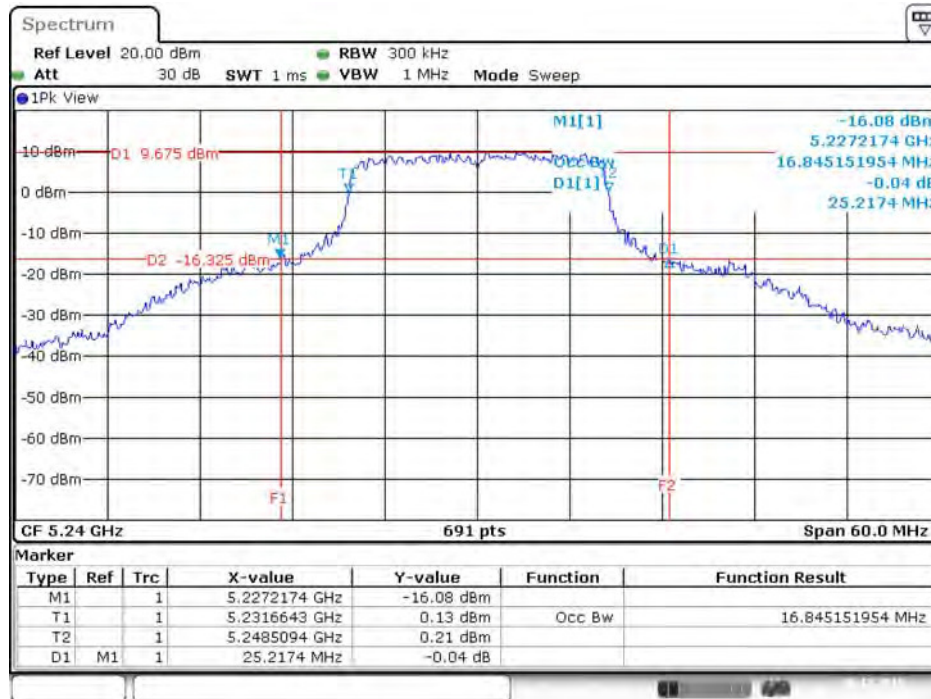

Date: 20.DEC.2015 09:52:03

26dB Bandwidth and 99% Occupied Bandwidth Plot on Configuration IEEE 802.11a / Chain 8 / 5240 MHz

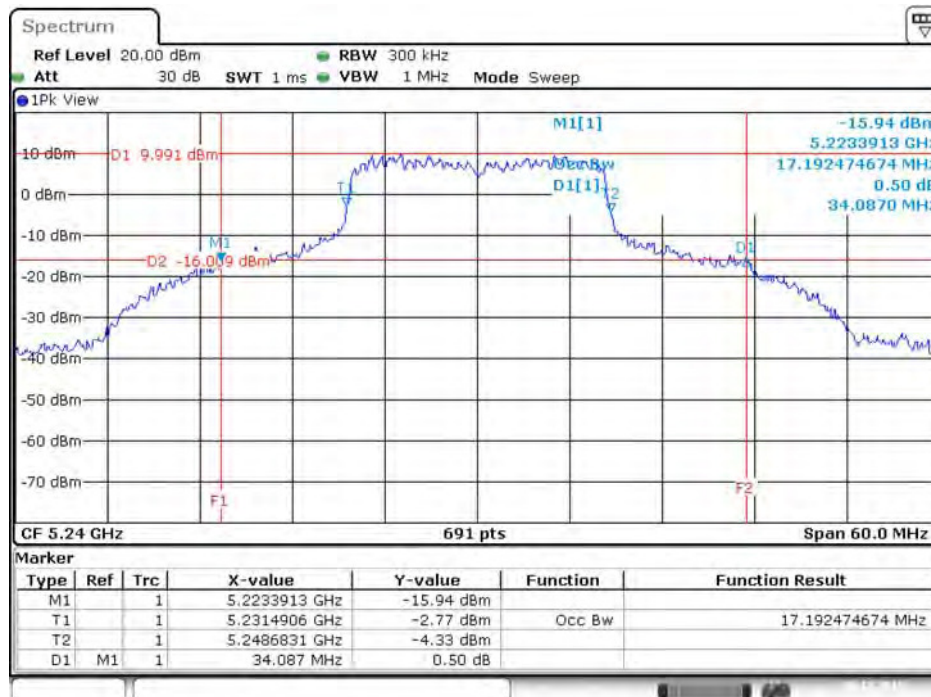

Date: 20.DEC.2015 09:51:19

26dB Bandwidth and 99% Occupied Bandwidth Plot on Configuration IEEE 802.11a / Chain 5 / 5745 MHz

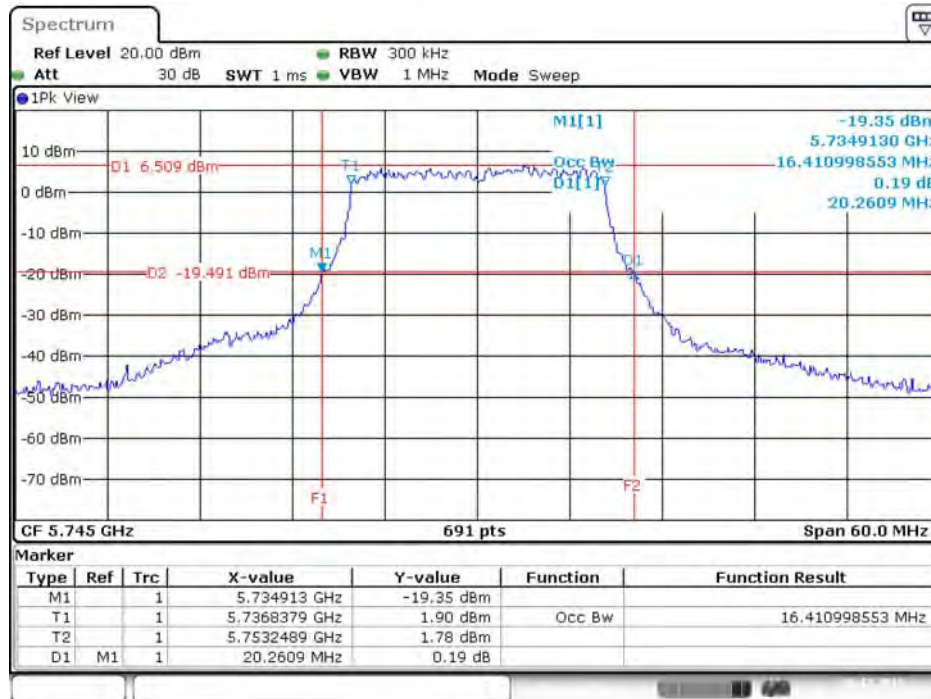

Date: 20.DEC.2015 10:31:01

26dB Bandwidth and 99% Occupied Bandwidth Plot on Configuration IEEE 802.11a / Chain 6 / 5745 MHz



Date: 20.DEC.2015 10:31:29

26dB Bandwidth and 99% Occupied Bandwidth Plot on Configuration IEEE 802.11a / Chain 7 / 5745 MHz

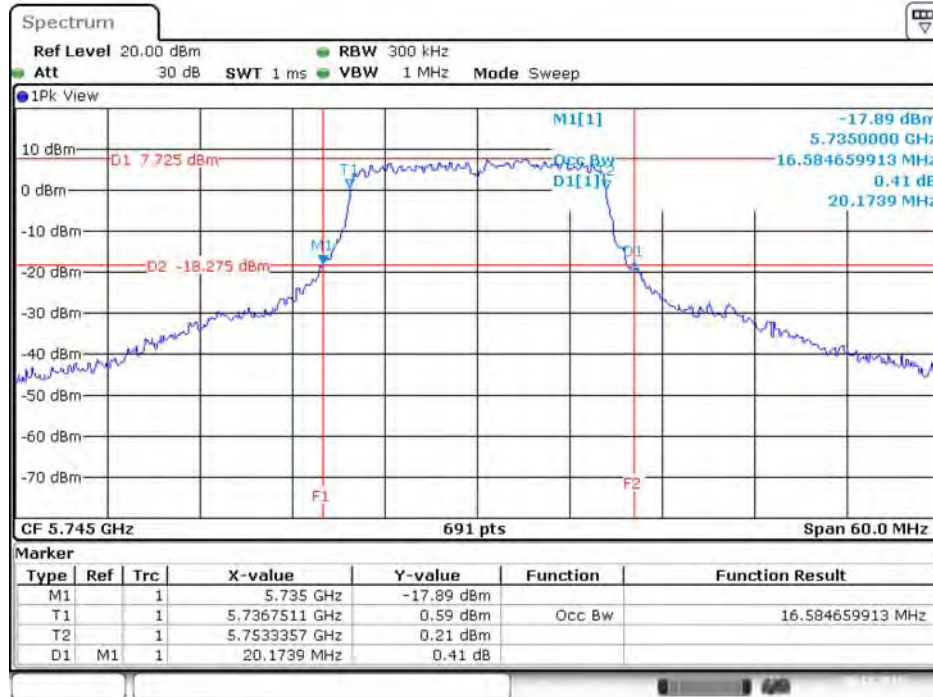

Date: 20.DEC.2015 10:33:24

26dB Bandwidth and 99% Occupied Bandwidth Plot on Configuration IEEE 802.11a / Chain 8 / 5745 MHz

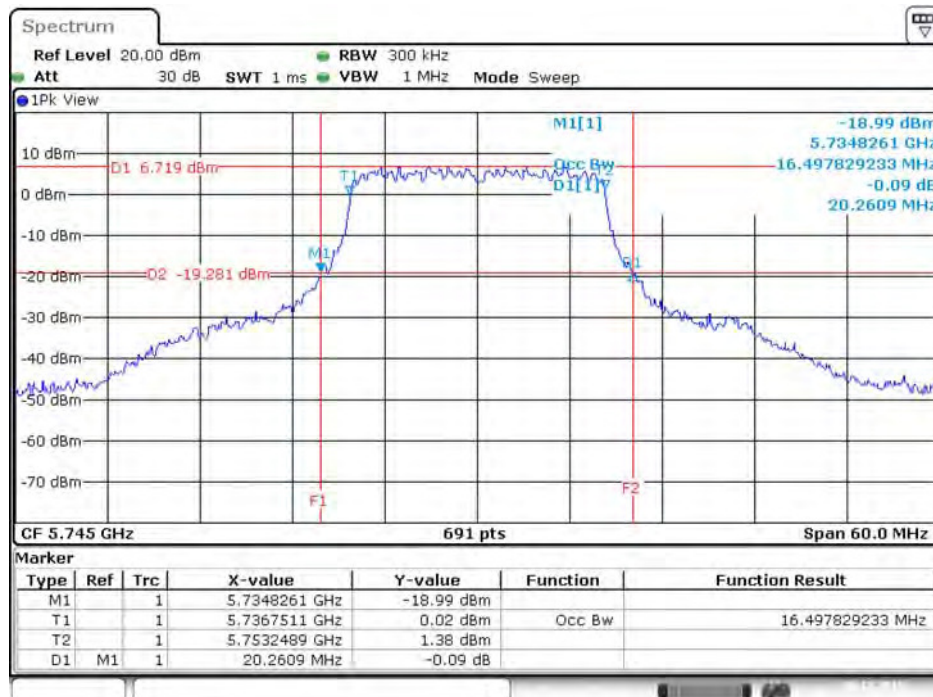

Date: 20.DEC.2015 10:33:55

26dB Bandwidth and 99% Occupied Bandwidth Plot on Configuration IEEE 802.11a / Chain 5 / 5785 MHz

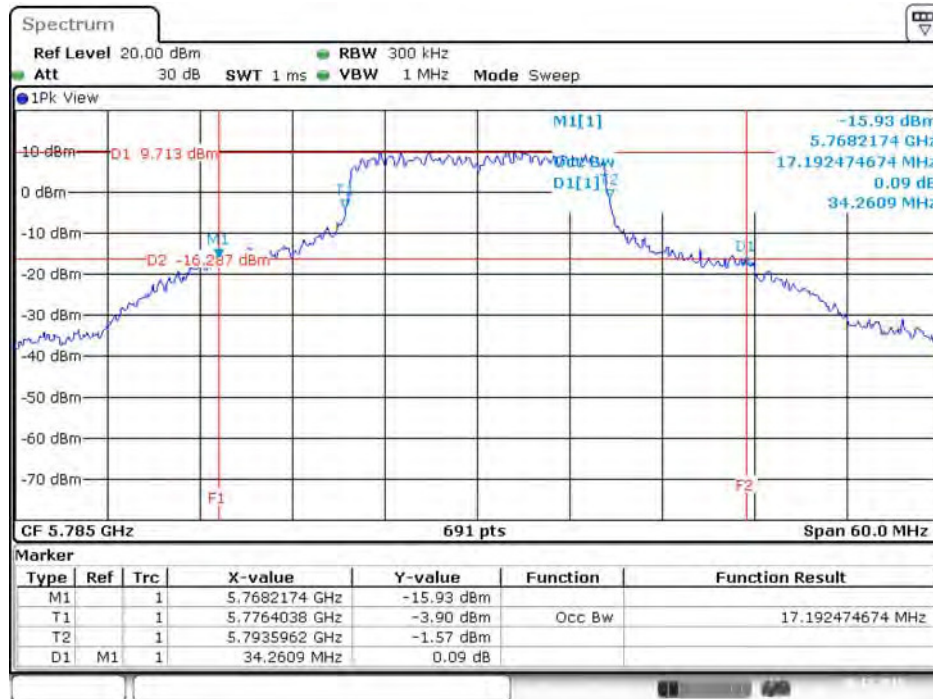

Date: 20.DEC.2015 10:37:03

26dB Bandwidth and 99% Occupied Bandwidth Plot on Configuration IEEE 802.11a / Chain 6 / 5785 MHz

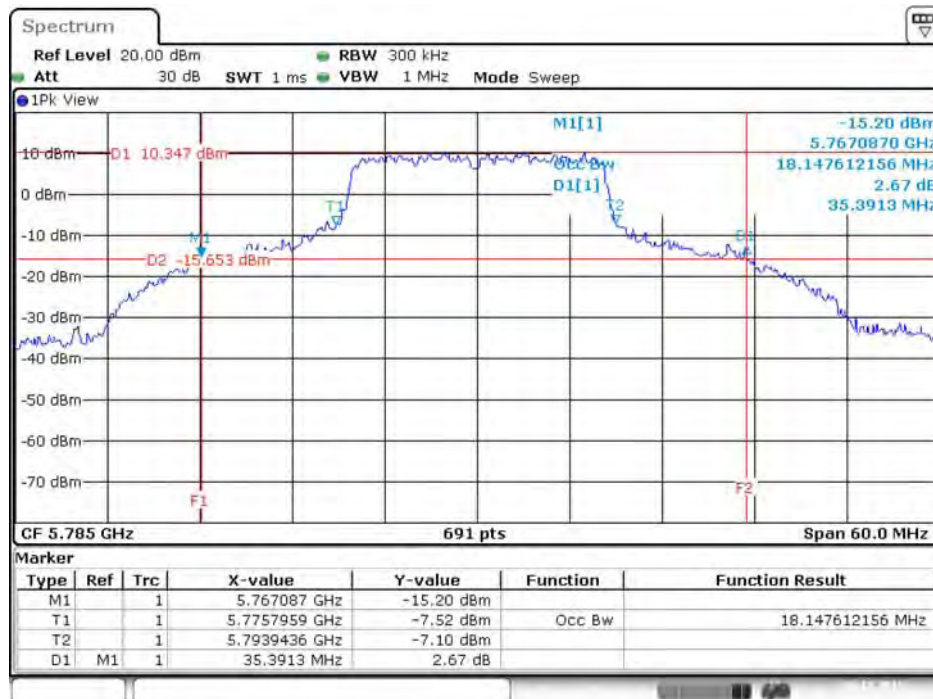

Date: 20.DEC.2015 10:36:25

26dB Bandwidth and 99% Occupied Bandwidth Plot on Configuration IEEE 802.11a / Chain 7 / 5785 MHz

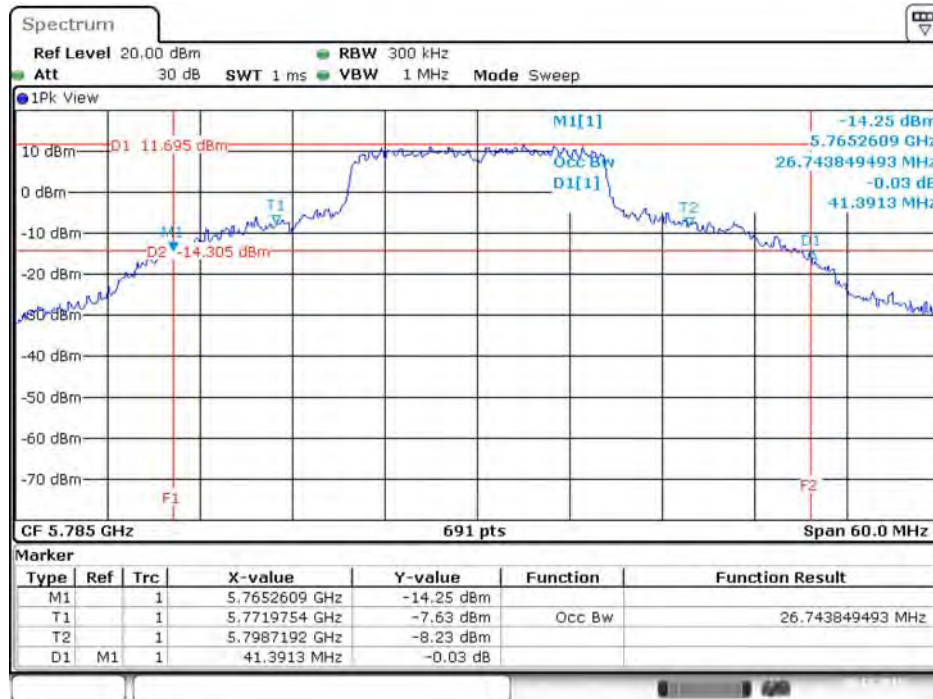

Date: 20.DEC.2015 10:35:50

26dB Bandwidth and 99% Occupied Bandwidth Plot on Configuration IEEE 802.11a / Chain 8 / 5785 MHz

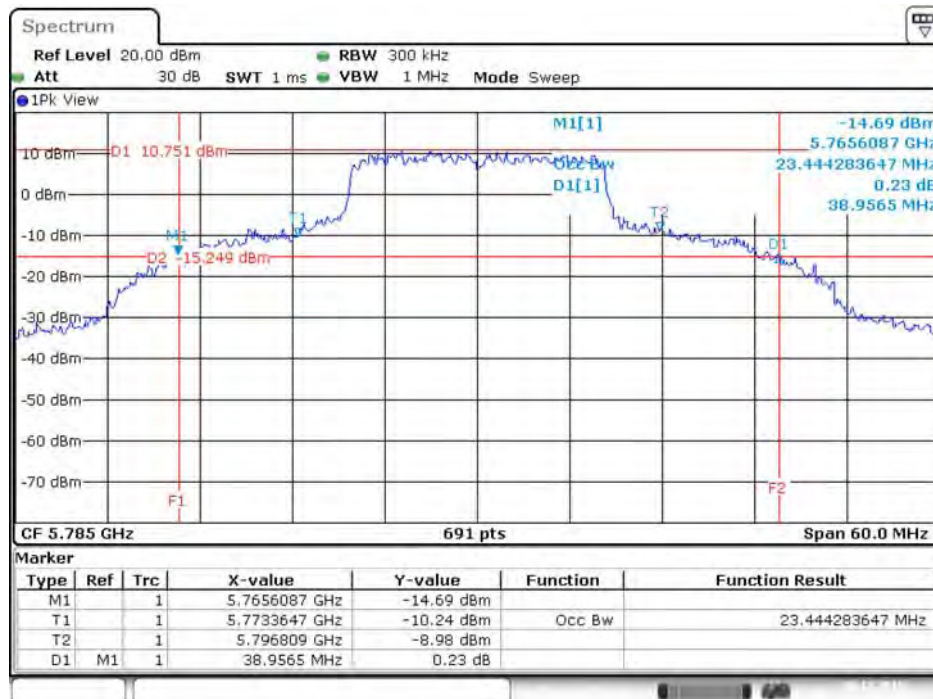

Date: 20.DEC.2015 10:35:08

26dB Bandwidth and 99% Occupied Bandwidth Plot on Configuration IEEE 802.11a / Chain 5 / 5825 MHz

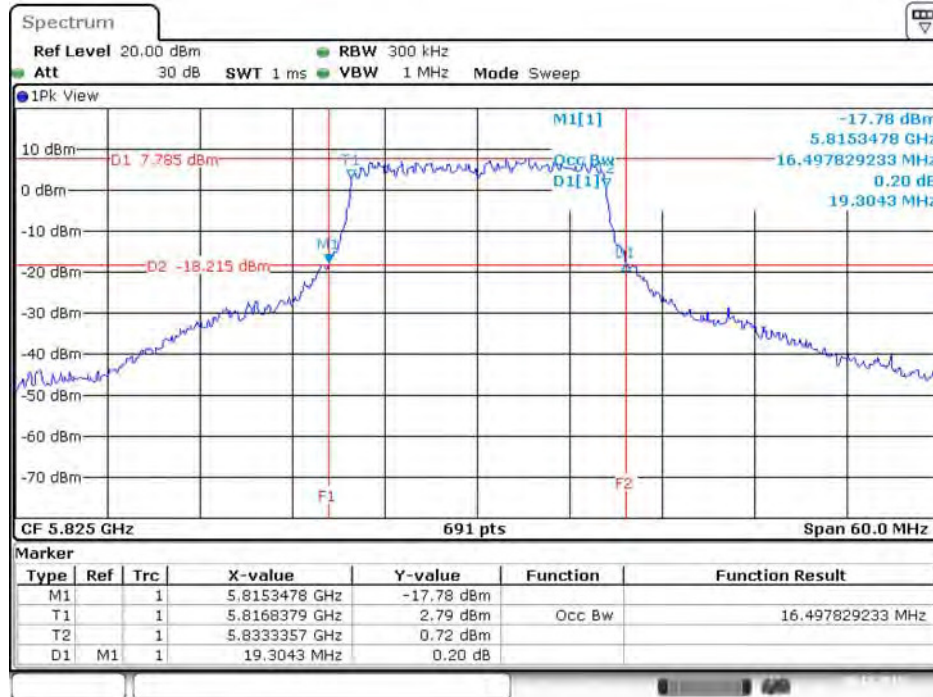

Date: 20.DEC.2015 10:37:53

26dB Bandwidth and 99% Occupied Bandwidth Plot on Configuration IEEE 802.11a / Chain 6 / 5825 MHz

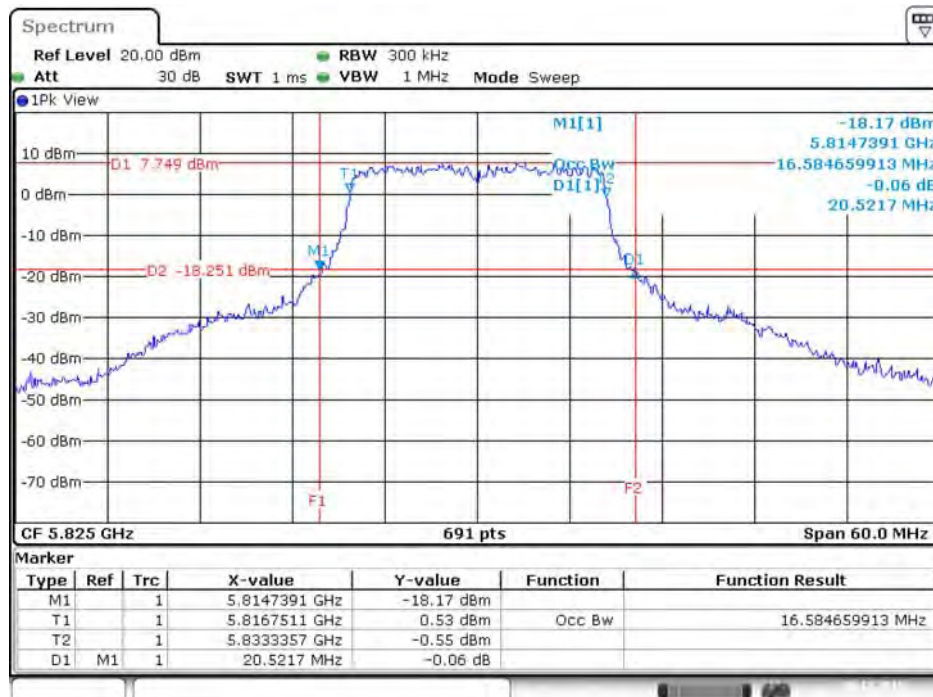

Date: 20.DEC.2015 10:38:17

26dB Bandwidth and 99% Occupied Bandwidth Plot on Configuration IEEE 802.11a / Chain 7 / 5825 MHz

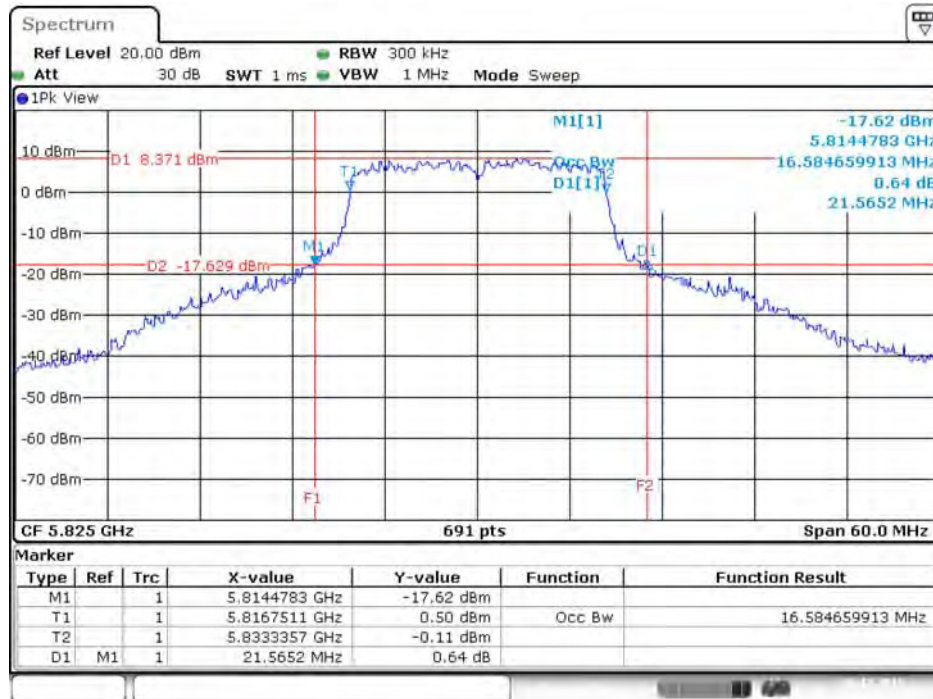

Date: 20.DEC.2015 10:38:45

26dB Bandwidth and 99% Occupied Bandwidth Plot on Configuration IEEE 802.11a / Chain 8 / 5825 MHz



Date: 20.DEC.2015 10:39:13

26dB Bandwidth and 99% Occupied Bandwidth Plot on Configuration IEEE 802.11ac MCS0/Nss1 VHT20 / Chain 5 / 5180 MHz

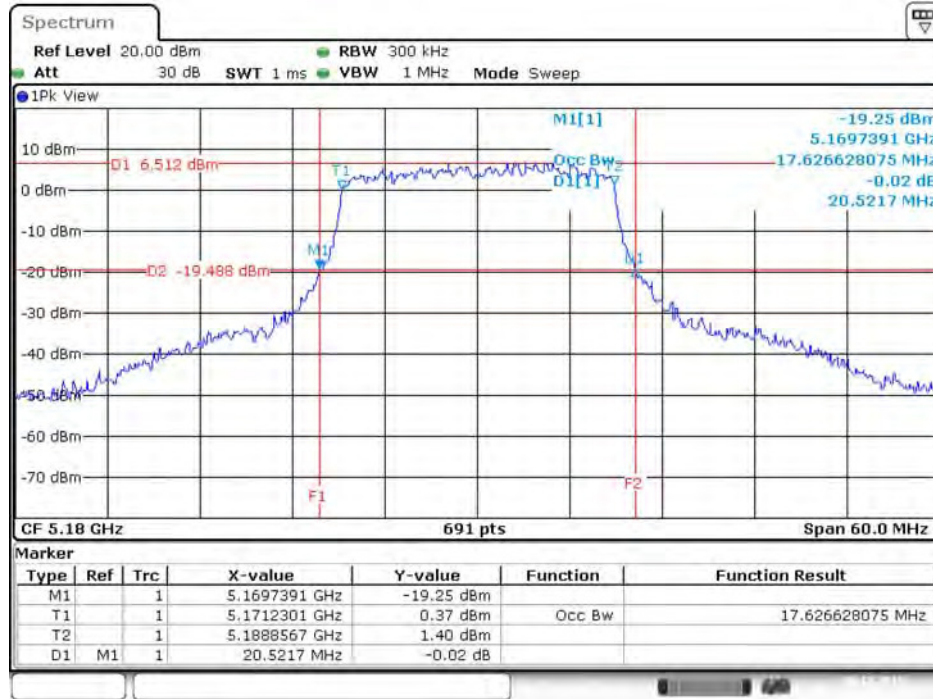

Date: 20.DEC.2015 10:58:53

26dB Bandwidth and 99% Occupied Bandwidth Plot on Configuration IEEE 802.11ac MCS0/Nss1 VHT20 / Chain 6 / 5180 MHz

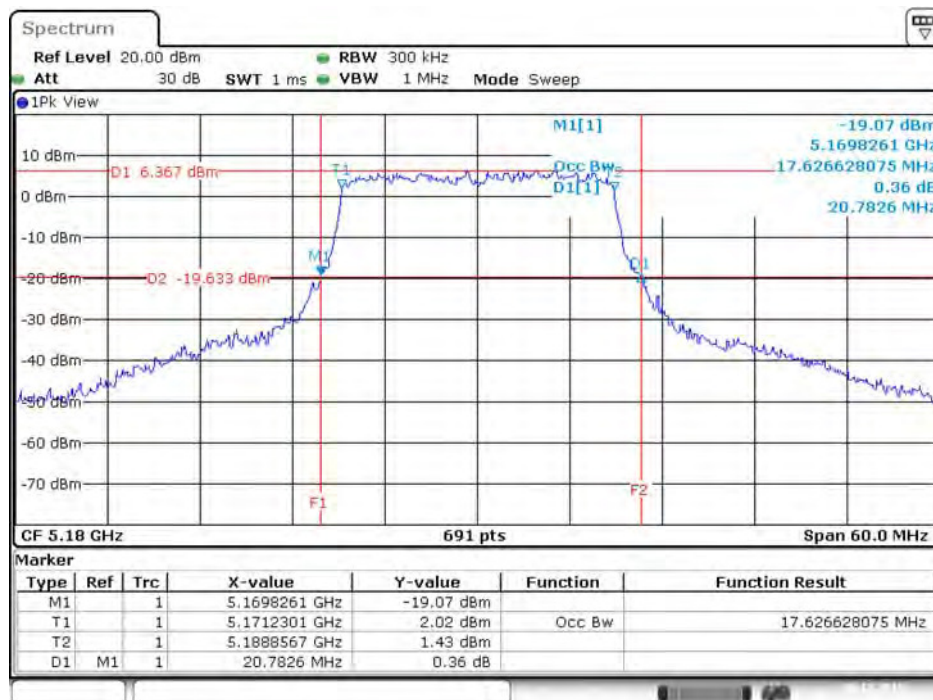

Date: 20.DEC.2015 10:59:31



26dB Bandwidth and 99% Occupied Bandwidth Plot on Configuration IEEE 802.11ac MCS0/Nss1 VHT20 / Chain 7 / 5180 MHz

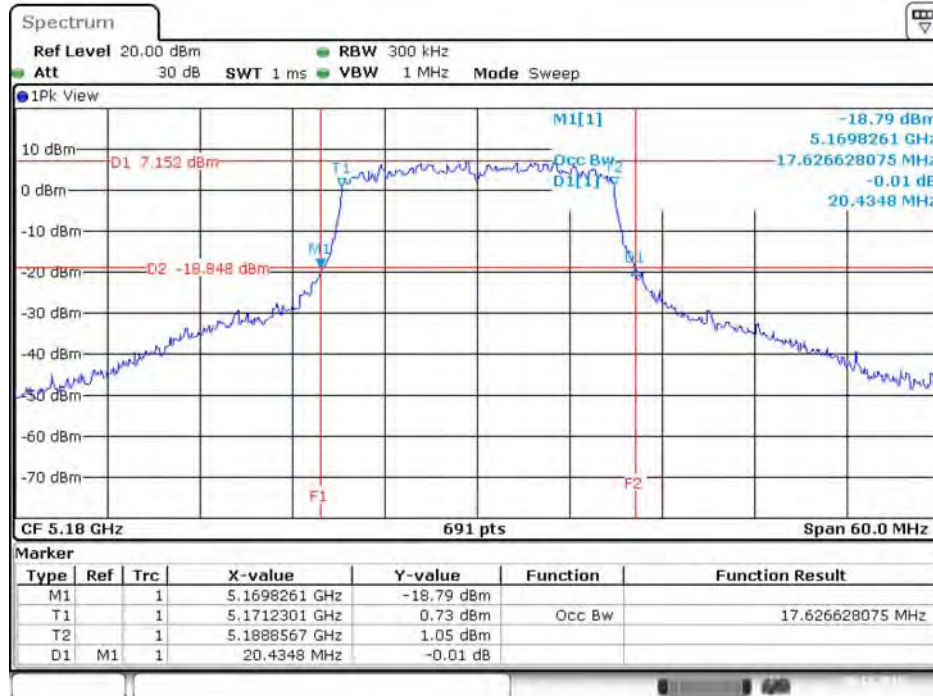

Date: 20.DEC.2015 11:00:21

26dB Bandwidth and 99% Occupied Bandwidth Plot on Configuration IEEE 802.11ac MCS0/Nss1 VHT20 / Chain 8 / 5180 MHz

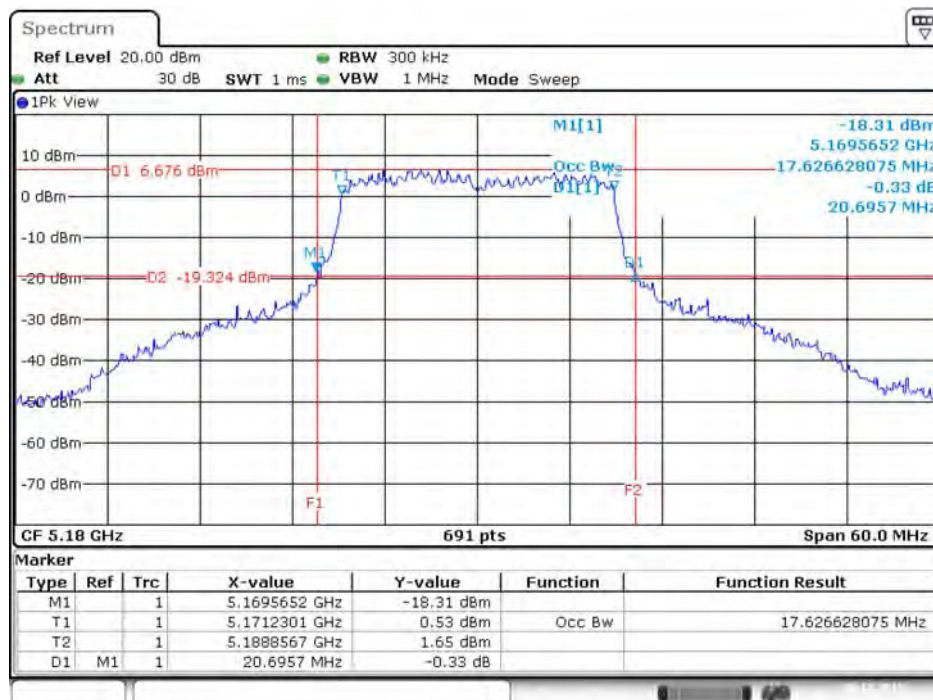

Date: 20.DEC.2015 11:00:54

26dB Bandwidth and 99% Occupied Bandwidth Plot on Configuration IEEE 802.11ac MCS0/Nss1 VHT20 / Chain 5 / 5200 MHz

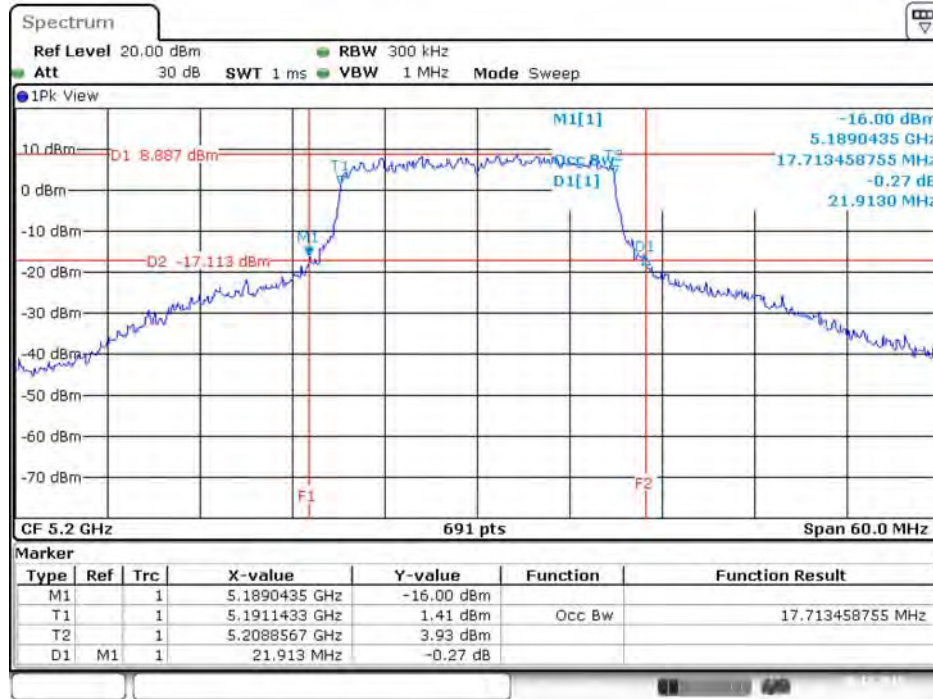

Date: 20.DEC.2015 11:03:19

26dB Bandwidth and 99% Occupied Bandwidth Plot on Configuration IEEE 802.11ac MCS0/Nss1 VHT20 / Chain 6 / 5200 MHz



Date: 20.DEC.2015 11:02:58

26dB Bandwidth and 99% Occupied Bandwidth Plot on Configuration IEEE 802.11ac MCS0/Nss1 VHT20 / Chain 7 / 5200 MHz

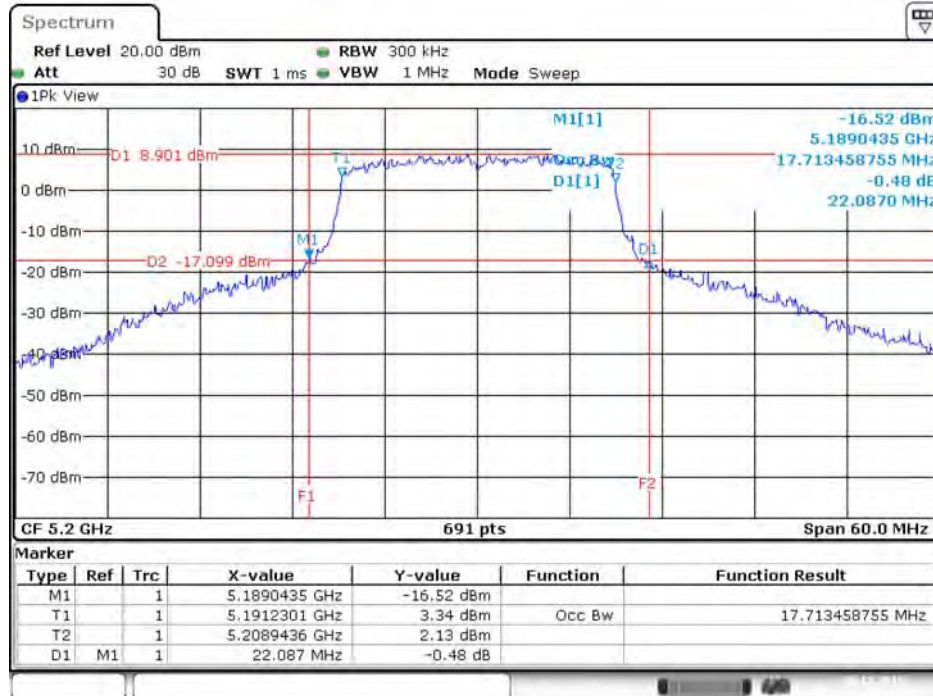

26dB Bandwidth and 99% Occupied Bandwidth Plot on Configuration IEEE 802.11ac MCS0/Nss1 VHT20 / Chain 8 / 5200 MHz

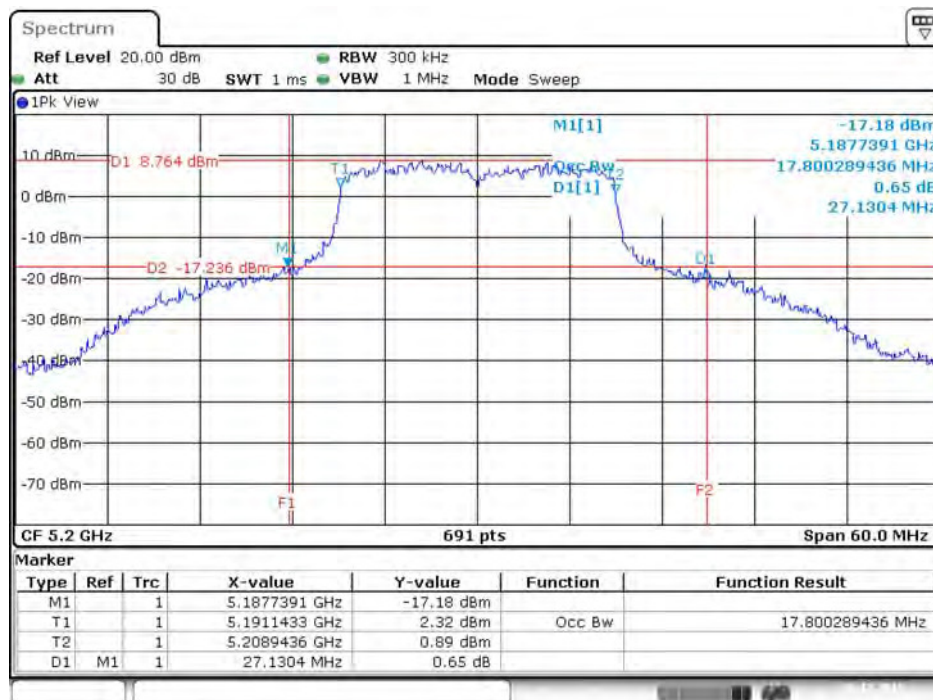

26dB Bandwidth and 99% Occupied Bandwidth Plot on Configuration IEEE 802.11ac MCS0/Nss1 VHT20 / Chain 5 / 5240 MHz

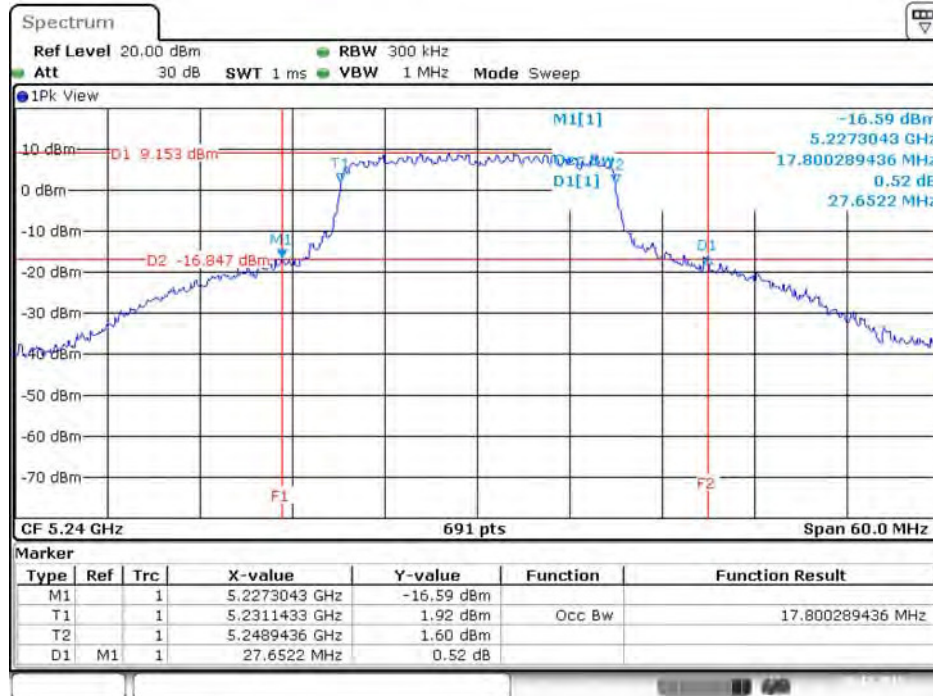

Date: 20.DEC.2015 11:04:25

26dB Bandwidth and 99% Occupied Bandwidth Plot on Configuration IEEE 802.11ac MCS0/Nss1 VHT20 / Chain 6 / 5240 MHz

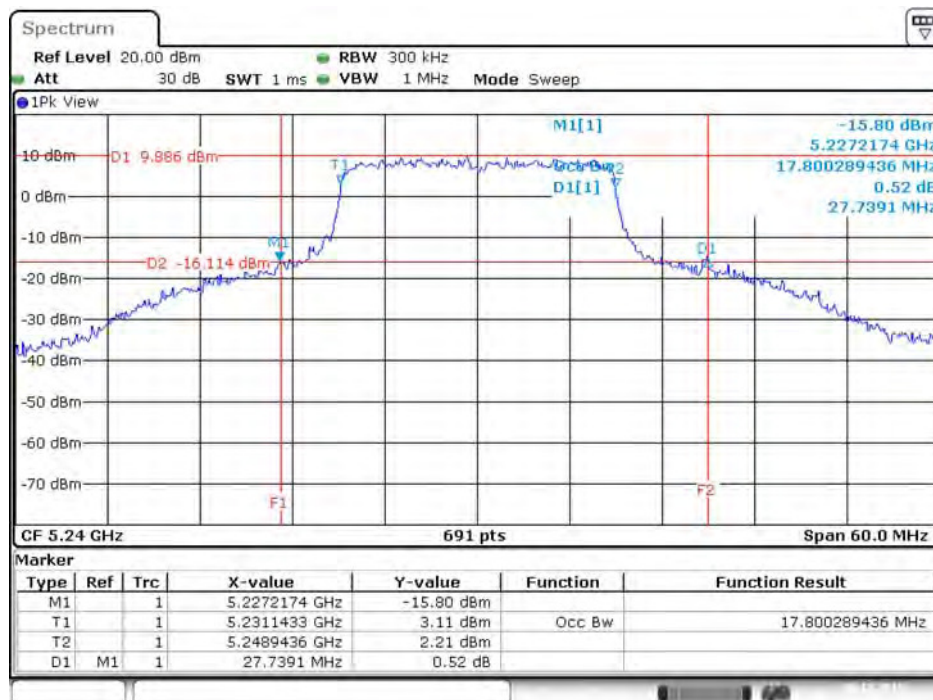

Date: 20.DEC.2015 11:05:35

26dB Bandwidth and 99% Occupied Bandwidth Plot on Configuration IEEE 802.11ac MCS0/Nss1 VHT20 / Chain 7 / 5240 MHz

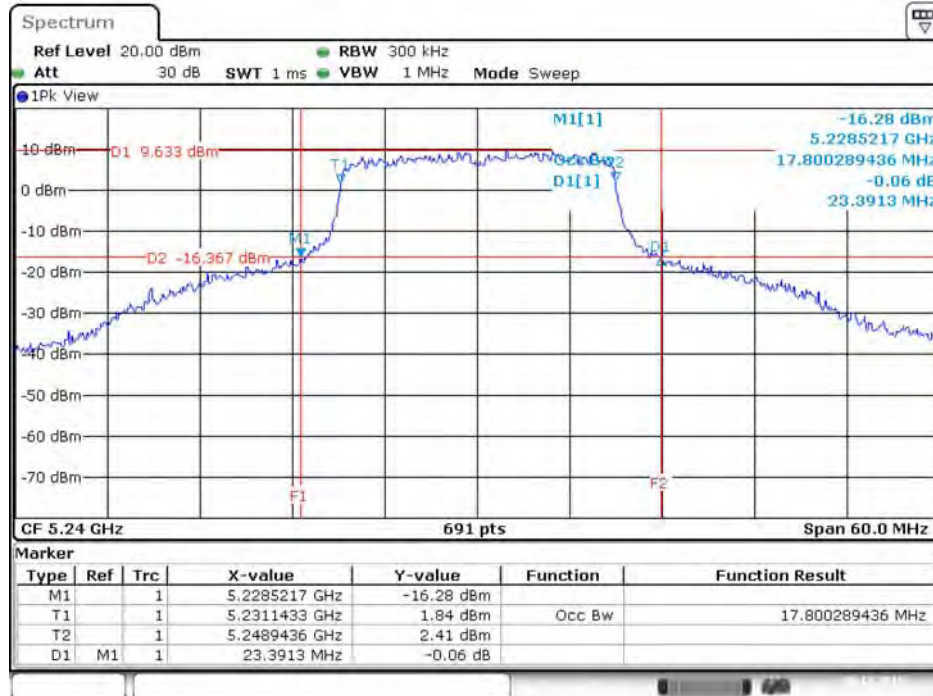

26dB Bandwidth and 99% Occupied Bandwidth Plot on Configuration IEEE 802.11ac MCS0/Nss1 VHT20 / Chain 8 / 5240 MHz

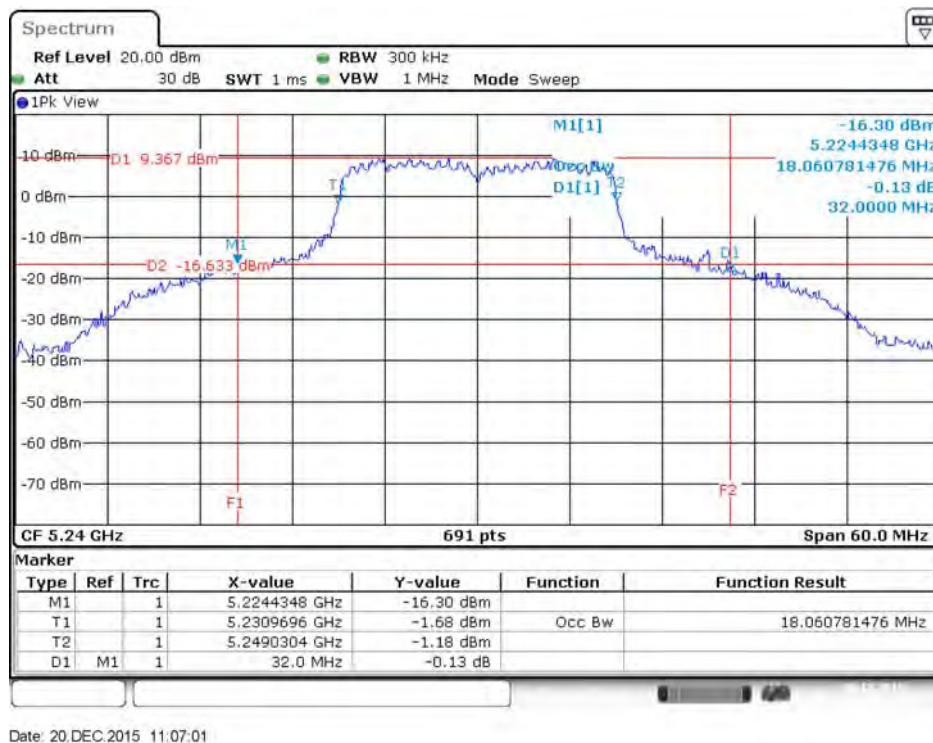

26dB Bandwidth and 99% Occupied Bandwidth Plot on Configuration IEEE 802.11ac MCS0/Nss1 VHT20 / Chain 5 / 5745 MHz

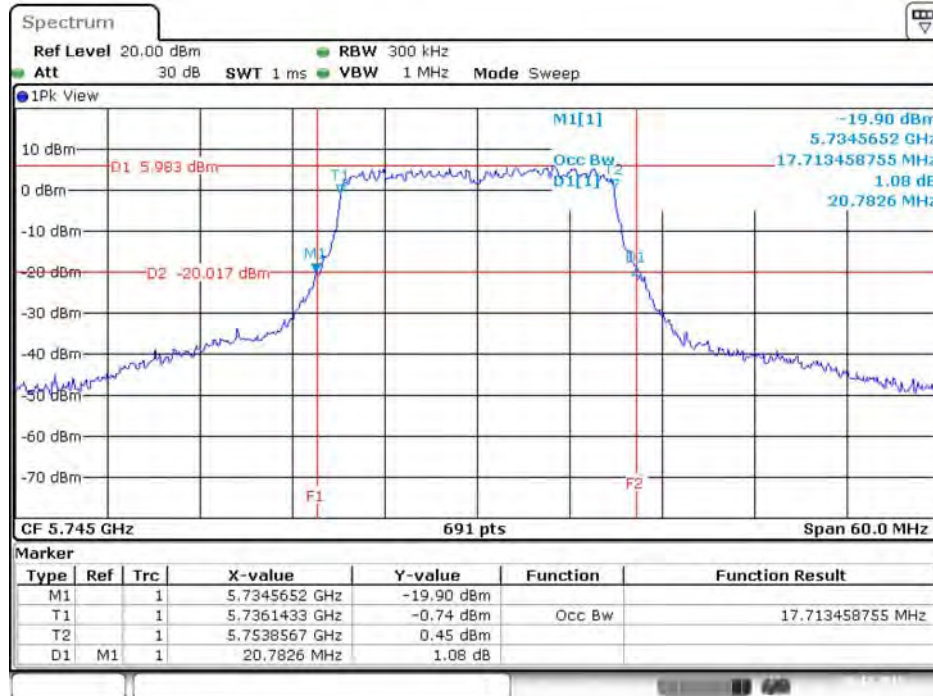

Date: 20.DEC.2015 10:57:28

26dB Bandwidth and 99% Occupied Bandwidth Plot on Configuration IEEE 802.11ac MCS0/Nss1 VHT20 / Chain 6 / 5745 MHz

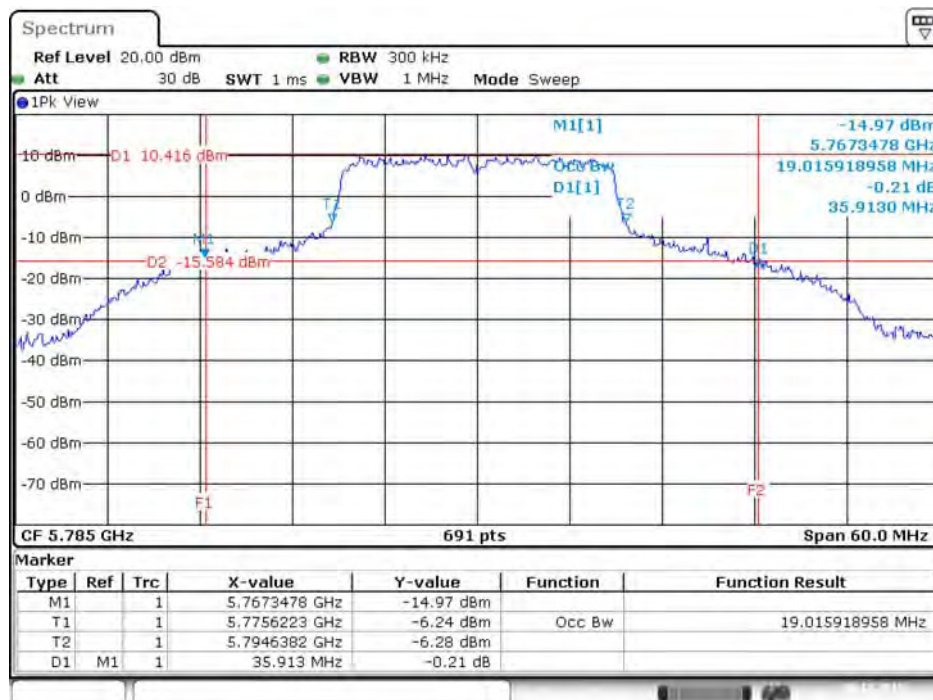

Date: 20.DEC.2015 10:52:20

26dB Bandwidth and 99% Occupied Bandwidth Plot on Configuration IEEE 802.11ac MCS0/Nss1 VHT20 / Chain 7 / 5745 MHz

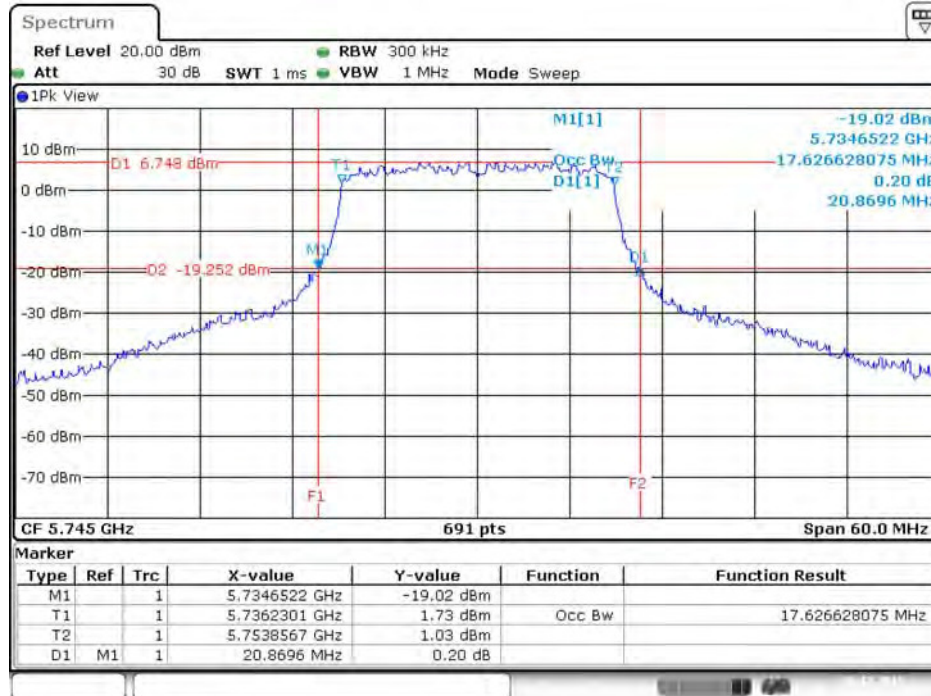

Date: 20.DEC.2015 10:56:34

26dB Bandwidth and 99% Occupied Bandwidth Plot on Configuration IEEE 802.11ac MCS0/Nss1 VHT20 / Chain 8 / 5745 MHz

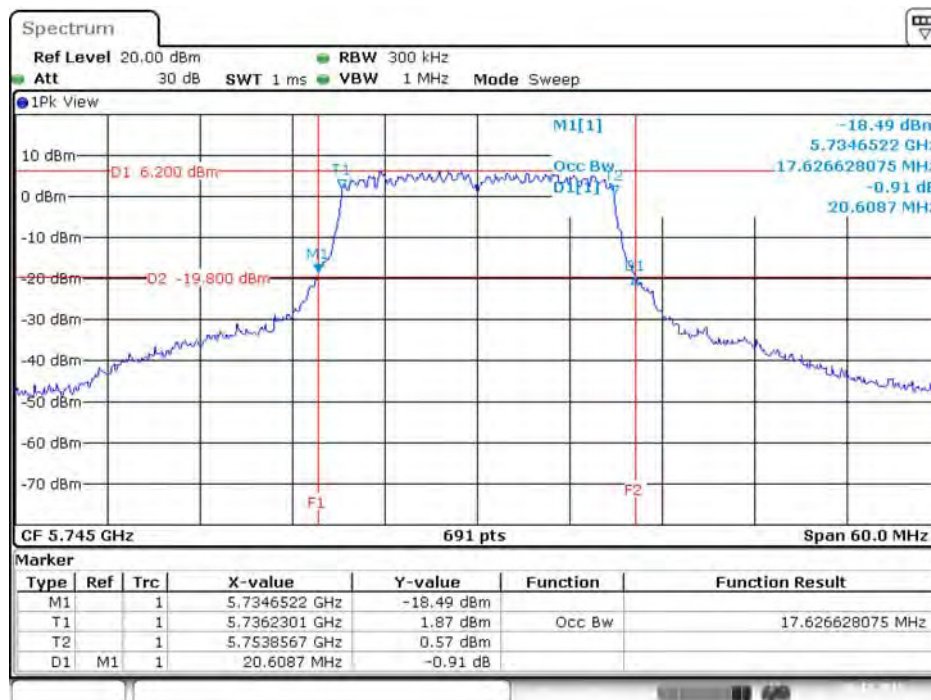

Date: 20.DEC.2015 10:55:55

26dB Bandwidth and 99% Occupied Bandwidth Plot on Configuration IEEE 802.11ac MCS0/Nss1 VHT20 / Chain 5 / 5785 MHz

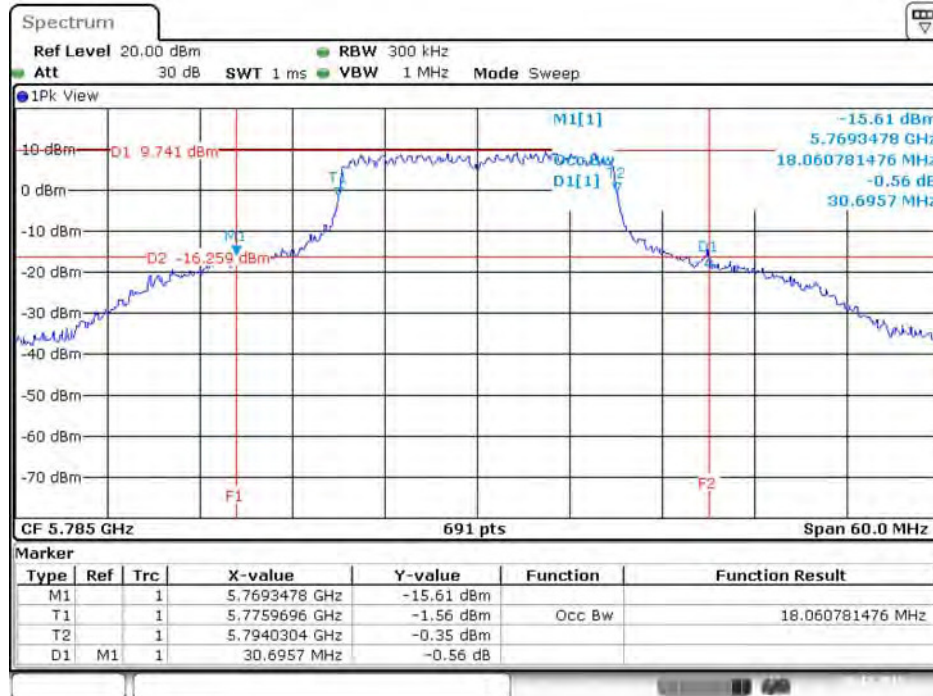

Date: 20.DEC.2015 10:49:16

26dB Bandwidth and 99% Occupied Bandwidth Plot on Configuration IEEE 802.11ac MCS0/Nss1 VHT20 / Chain 6 / 5785 MHz

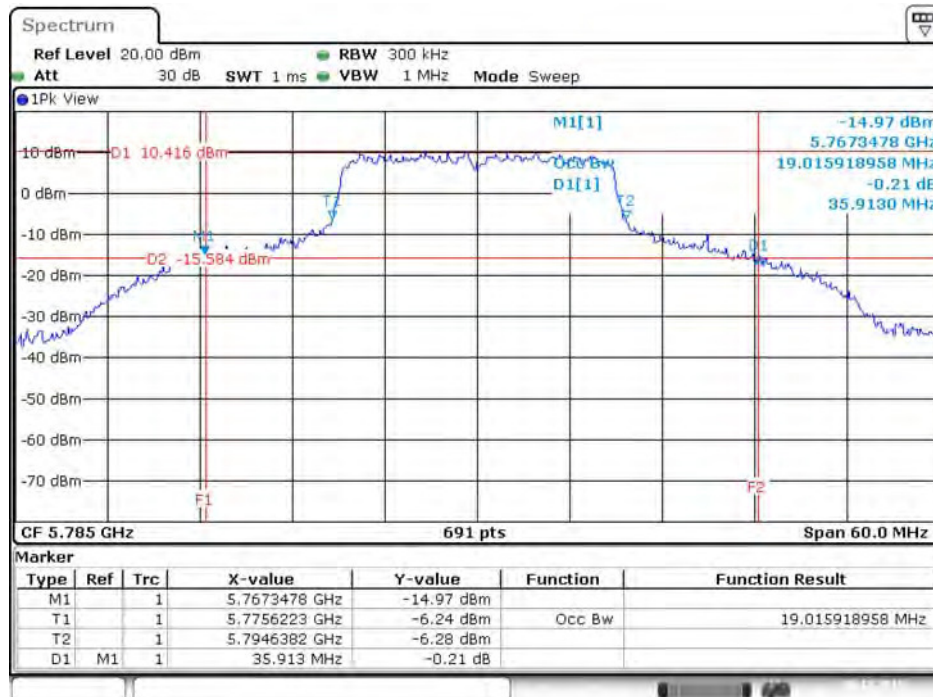

Date: 20.DEC.2015 10:52:20



26dB Bandwidth and 99% Occupied Bandwidth Plot on Configuration IEEE 802.11ac MCS0/Nss1 VHT20 / Chain 7 / 5785 MHz

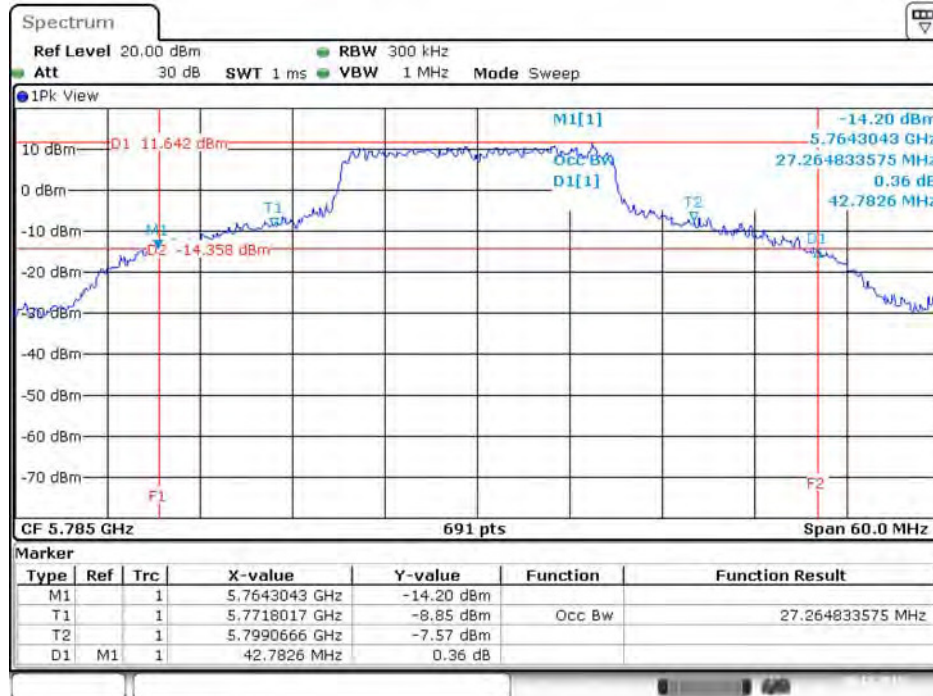

Date: 20.DEC.2015 10:54:33

26dB Bandwidth and 99% Occupied Bandwidth Plot on Configuration IEEE 802.11ac MCS0/Nss1 VHT20 / Chain 8 / 5785 MHz

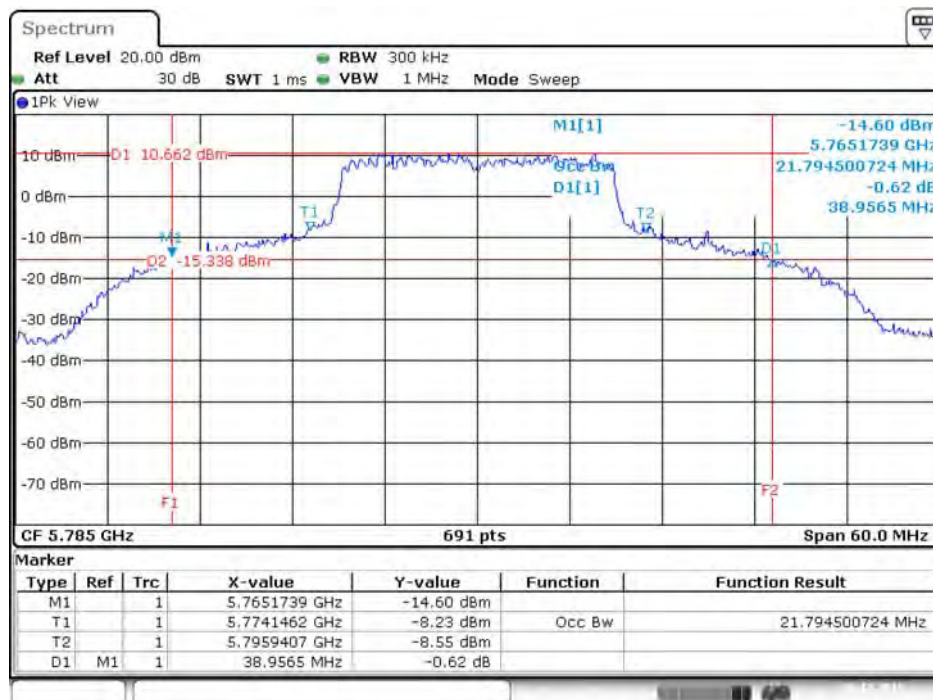

Date: 20.DEC.2015 10:54:58

26dB Bandwidth and 99% Occupied Bandwidth Plot on Configuration IEEE 802.11ac MCS0/Nss1 VHT20 / Chain 5 / 5825 MHz

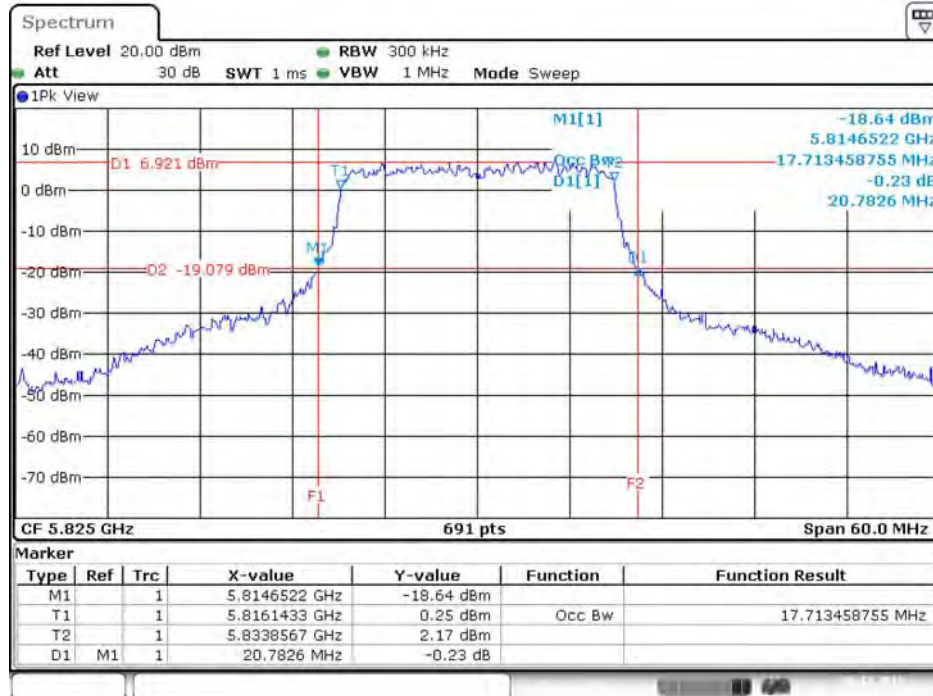

Date: 20.DEC.2015 10:47:28

26dB Bandwidth and 99% Occupied Bandwidth Plot on Configuration IEEE 802.11ac MCS0/Nss1 VHT20 / Chain 6 / 5825 MHz

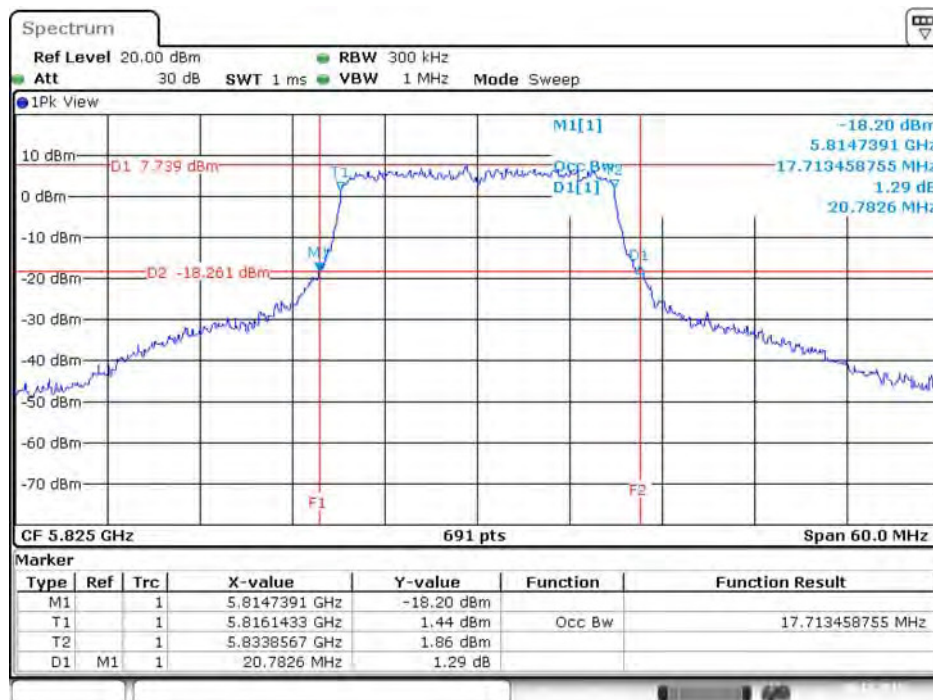

Date: 20.DEC.2015 10:46:13

26dB Bandwidth and 99% Occupied Bandwidth Plot on Configuration IEEE 802.11ac MCS0/Nss1 VHT20 / Chain 7 / 5825 MHz

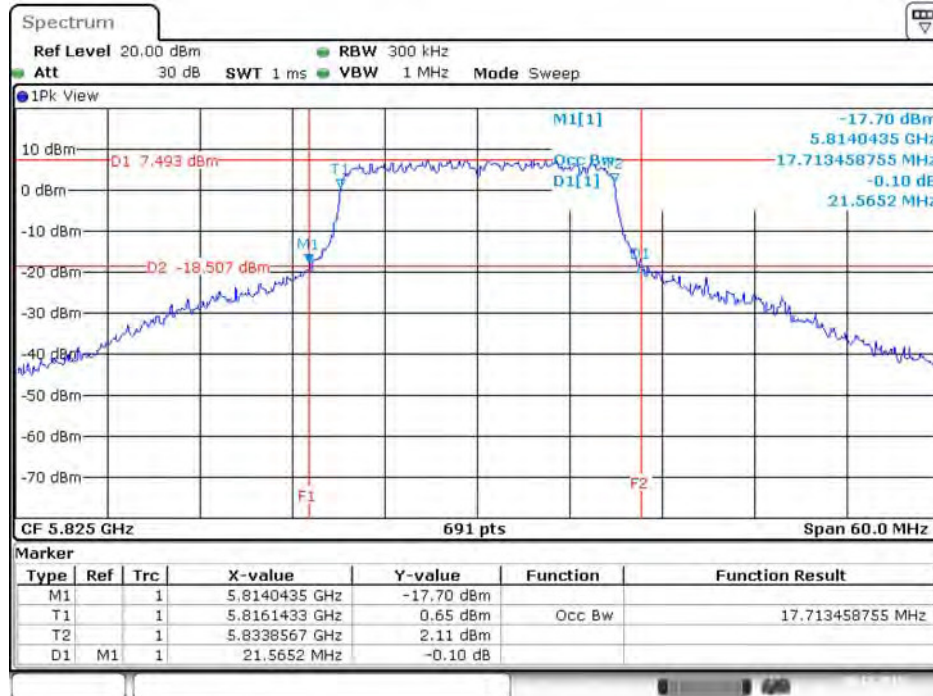

Date: 20.DEC.2015 10:45:28

26dB Bandwidth and 99% Occupied Bandwidth Plot on Configuration IEEE 802.11ac MCS0/Nss1 VHT20 / Chain 8 / 5825 MHz

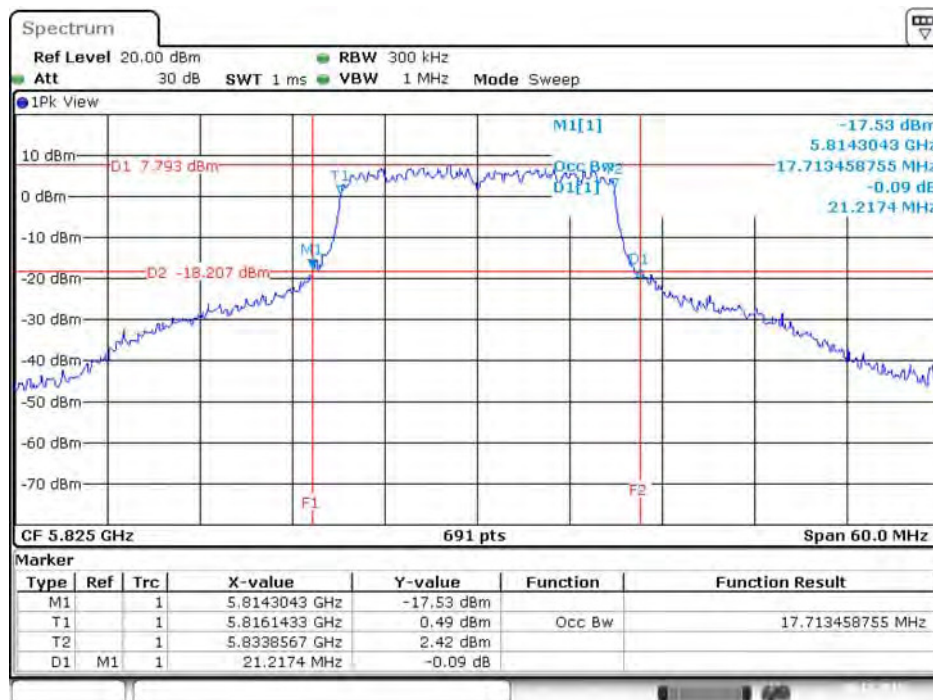

Date: 20.DEC.2015 10:44:39

26dB Bandwidth and 99% Occupied Bandwidth Plot on Configuration IEEE 802.11ac MCS0/Nss1 VHT40 / Chain 5 / 5190 MHz

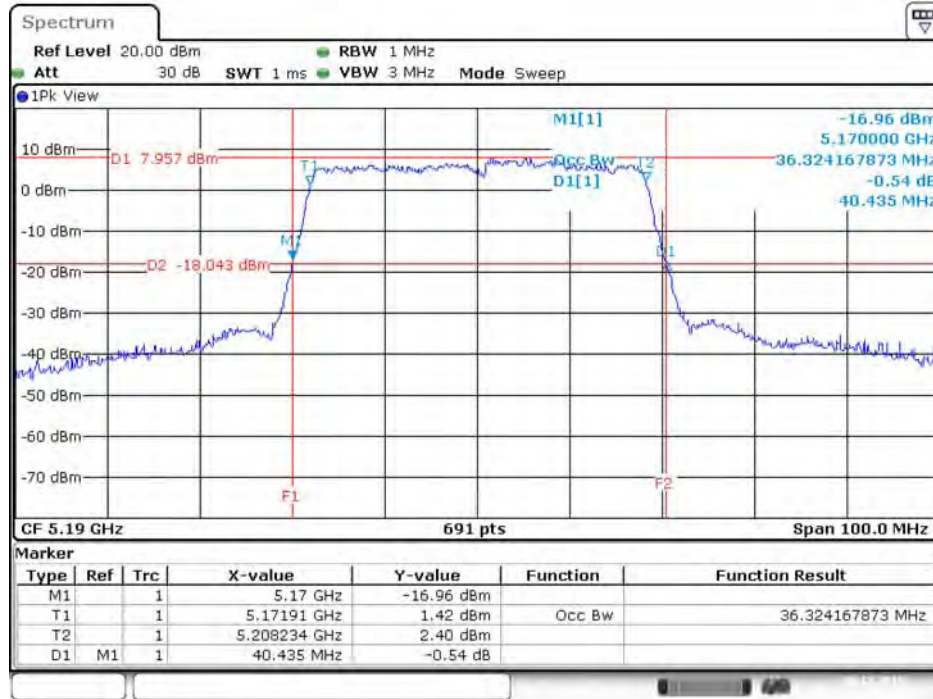

Date: 20.DEC.2015 11:29:07

26dB Bandwidth and 99% Occupied Bandwidth Plot on Configuration IEEE 802.11ac MCS0/Nss1 VHT40 / Chain 6 / 5190 MHz

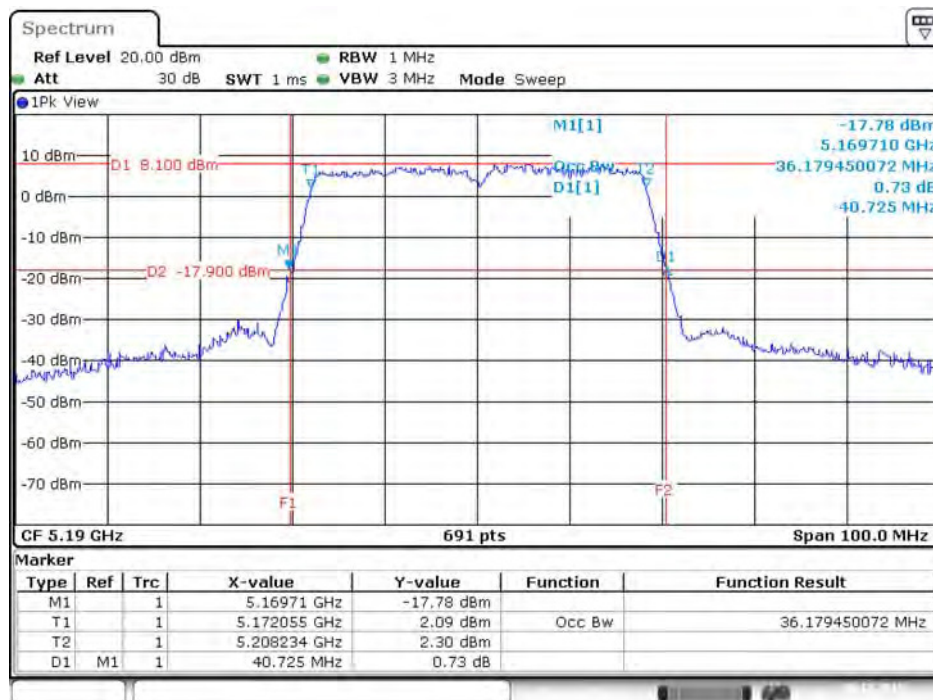

Date: 20.DEC.2015 11:28:34

26dB Bandwidth and 99% Occupied Bandwidth Plot on Configuration IEEE 802.11ac MCS0/Nss1 VHT40 / Chain 7 / 5190 MHz

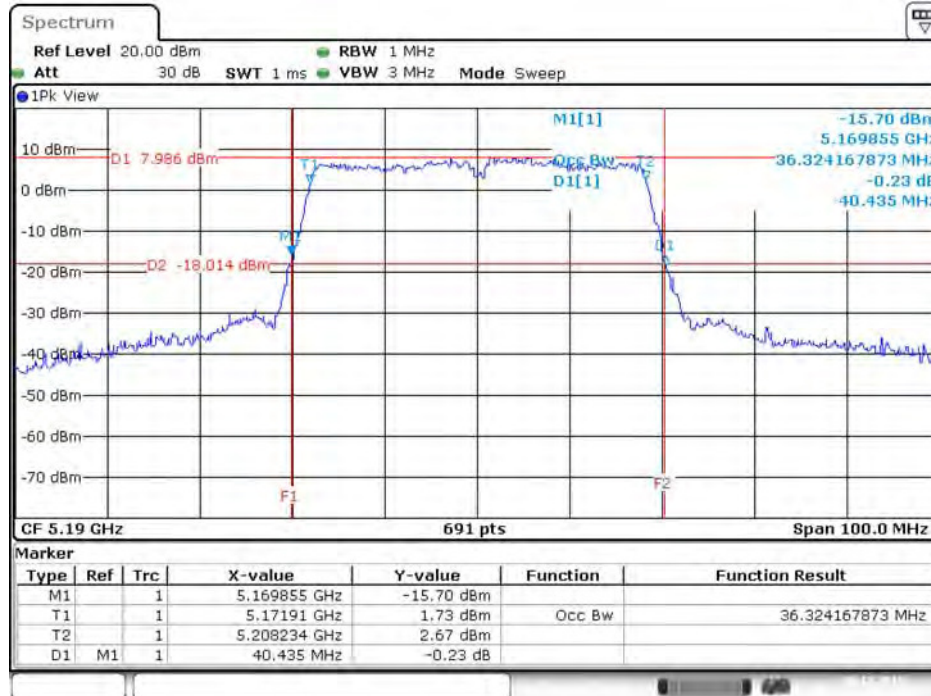

Date: 20.DEC.2015 11:27:31

26dB Bandwidth and 99% Occupied Bandwidth Plot on Configuration IEEE 802.11ac MCS0/Nss1 VHT40 / Chain 8 / 5190 MHz

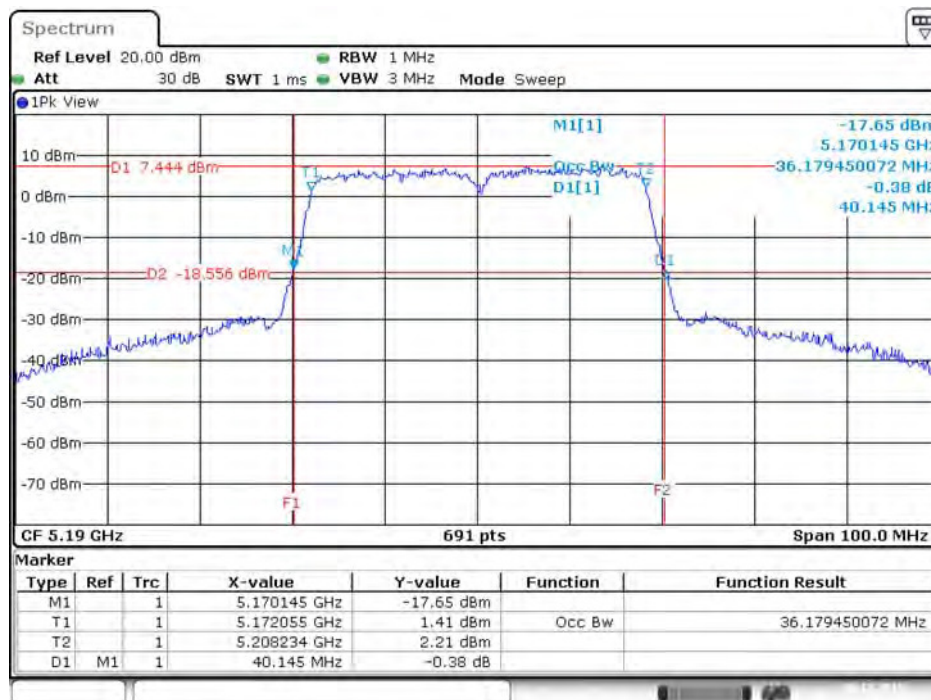

Date: 20.DEC.2015 11:25:36

26dB Bandwidth and 99% Occupied Bandwidth Plot on Configuration IEEE 802.11ac MCS0/Nss1 VHT40 / Chain 5 / 5230 MHz

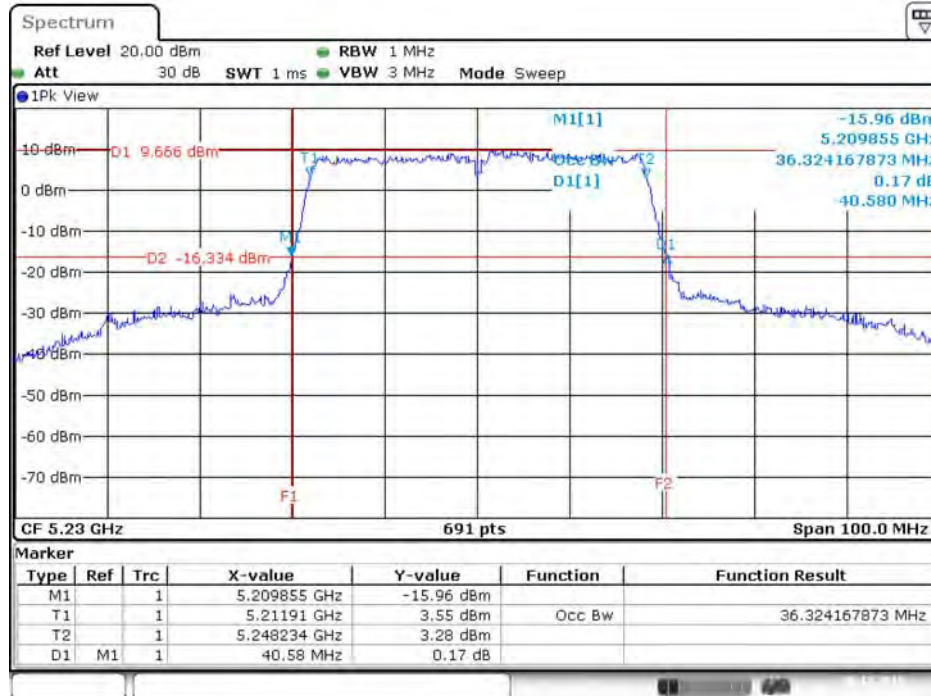

Date: 20.DEC.2015 11:30:57

26dB Bandwidth and 99% Occupied Bandwidth Plot on Configuration IEEE 802.11ac MCS0/Nss1 VHT40 / Chain 6 / 5230 MHz

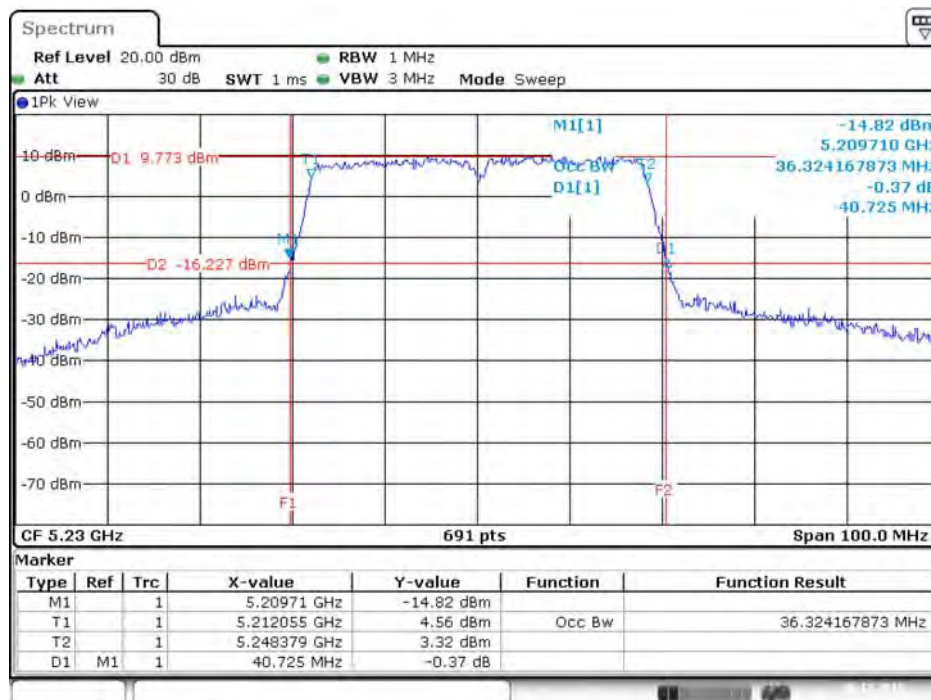

Date: 20.DEC.2015 11:31:20

26dB Bandwidth and 99% Occupied Bandwidth Plot on Configuration IEEE 802.11ac MCS0/Nss1 VHT40 / Chain 7 / 5230 MHz

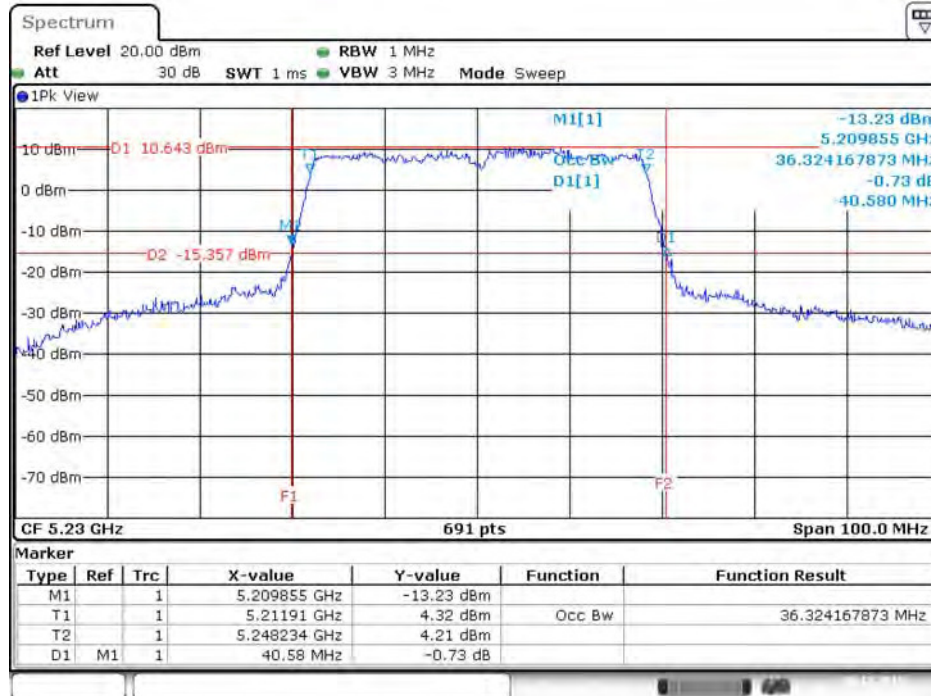

Date: 20.DEC.2015 11:31:54

26dB Bandwidth and 99% Occupied Bandwidth Plot on Configuration IEEE 802.11ac MCS0/Nss1 VHT40 / Chain 8 / 5230 MHz

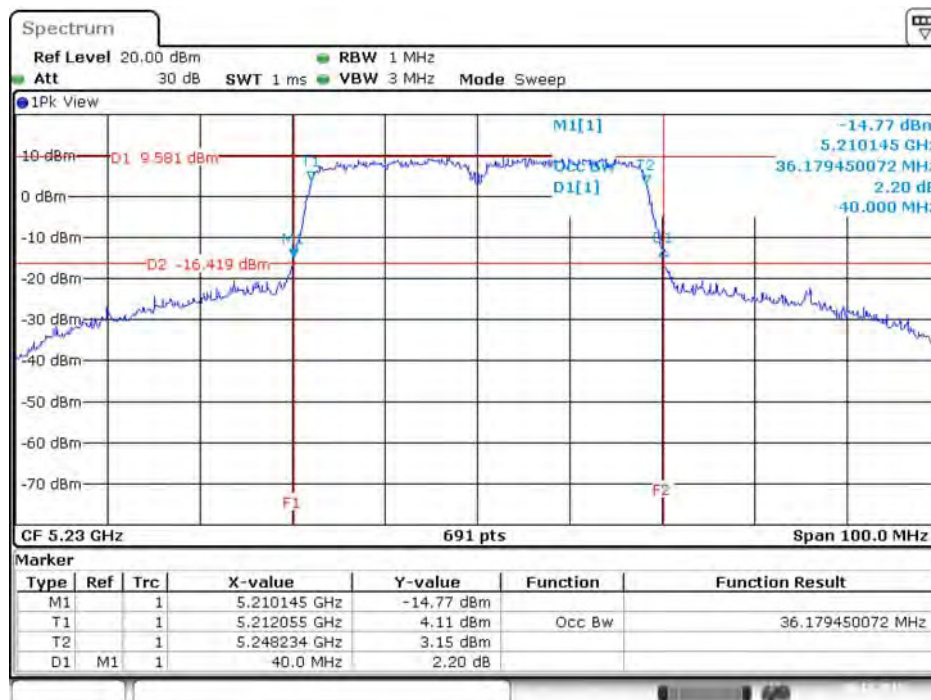

Date: 20.DEC.2015 11:32:15

26dB Bandwidth and 99% Occupied Bandwidth Plot on Configuration IEEE 802.11ac MCS0/Nss1 VHT40 / Chain 5 / 5755 MHz

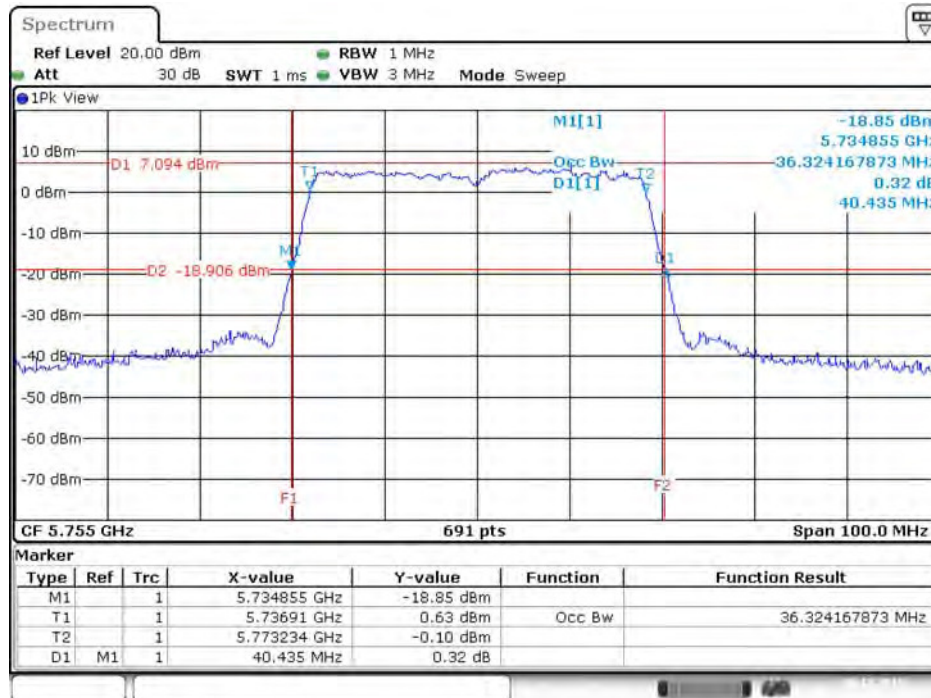

Date: 20.DEC.2015 12:01:07

26dB Bandwidth and 99% Occupied Bandwidth Plot on Configuration IEEE 802.11ac MCS0/Nss1 VHT40 / Chain 6 / 5755 MHz

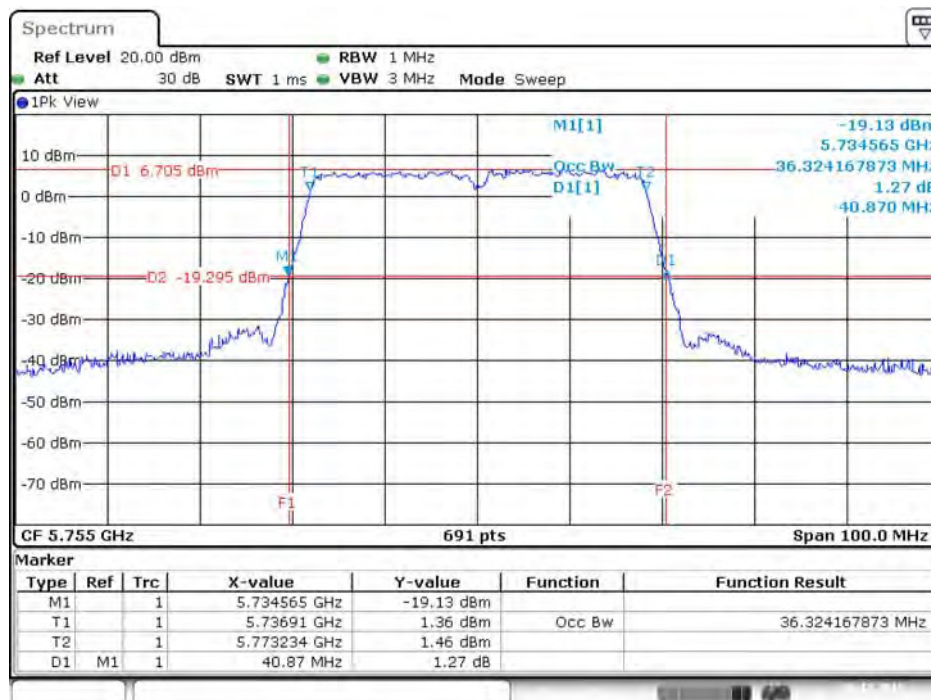

Date: 20.DEC.2015 12:03:19



26dB Bandwidth and 99% Occupied Bandwidth Plot on Configuration IEEE 802.11ac MCS0/Nss1 VHT40 / Chain 7 / 5755 MHz

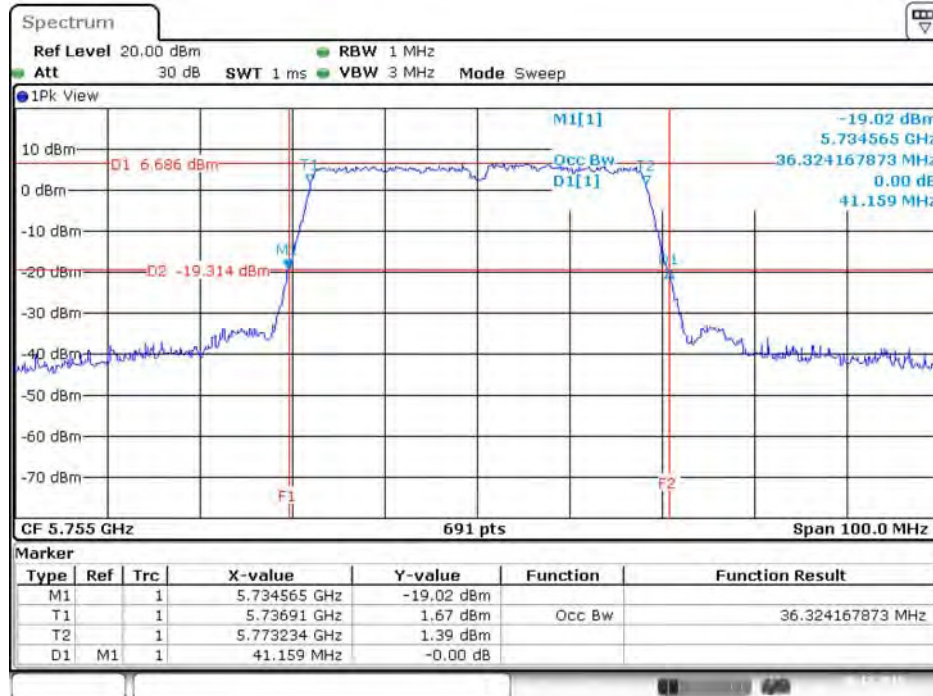

26dB Bandwidth and 99% Occupied Bandwidth Plot on Configuration IEEE 802.11ac MCS0/Nss1 VHT40 / Chain 8 / 5755 MHz

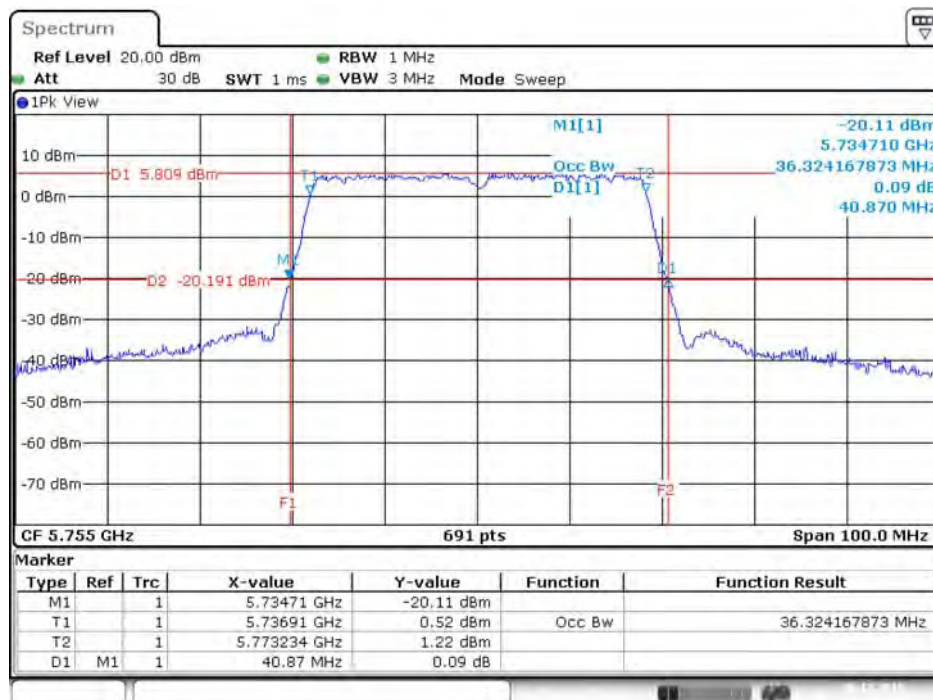

26dB Bandwidth and 99% Occupied Bandwidth Plot on Configuration IEEE 802.11ac MCS0/Nss1 VHT40 / Chain 5 / 5795 MHz

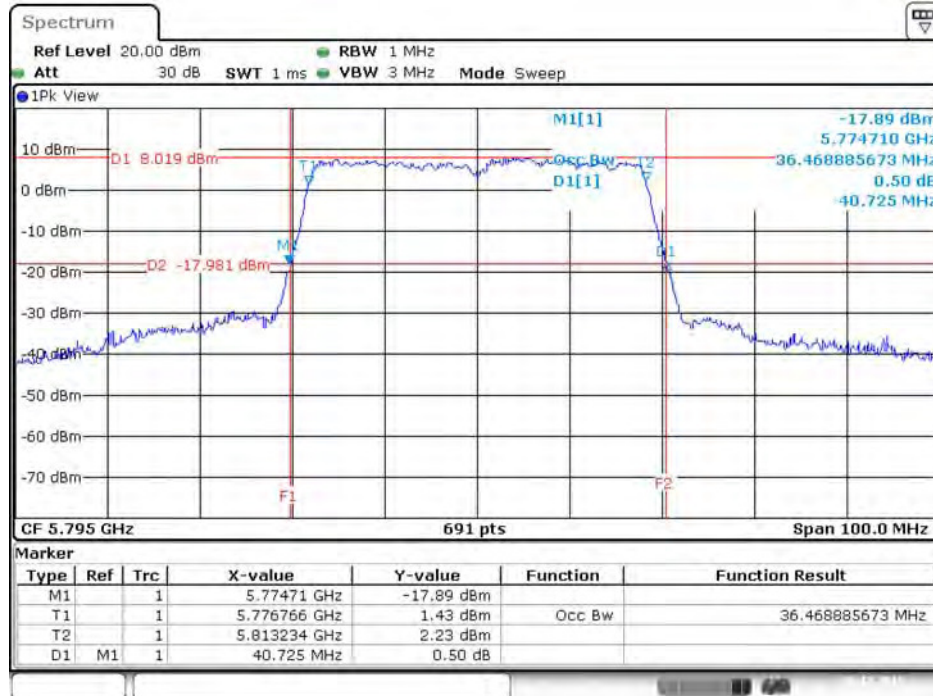

26dB Bandwidth and 99% Occupied Bandwidth Plot on Configuration IEEE 802.11ac MCS0/Nss1 VHT40 / Chain 6 / 5795 MHz

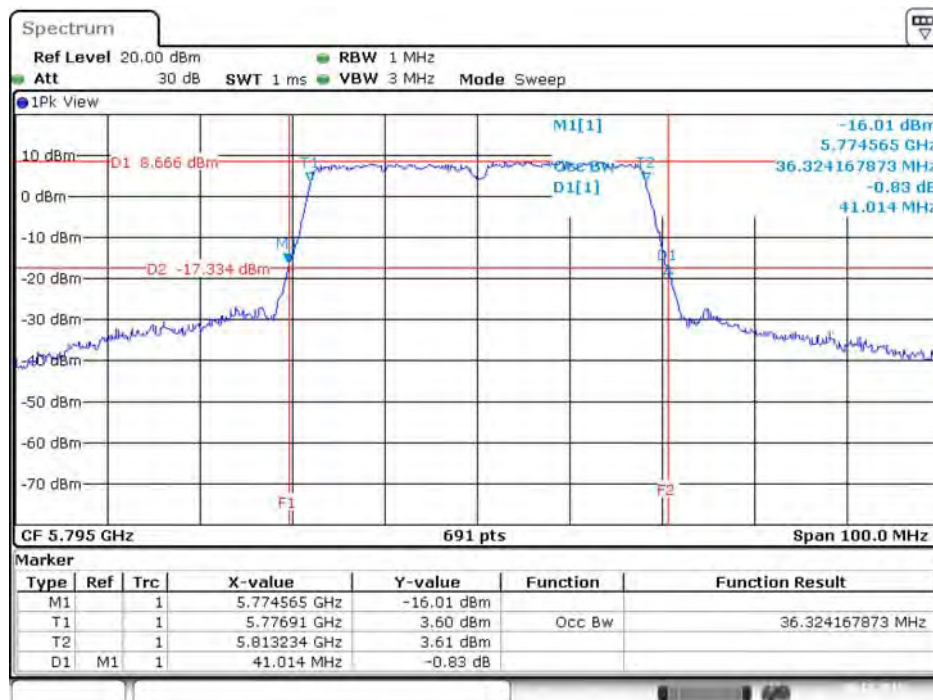

26dB Bandwidth and 99% Occupied Bandwidth Plot on Configuration IEEE 802.11ac MCS0/Nss1 VHT40 / Chain 7 / 5795 MHz

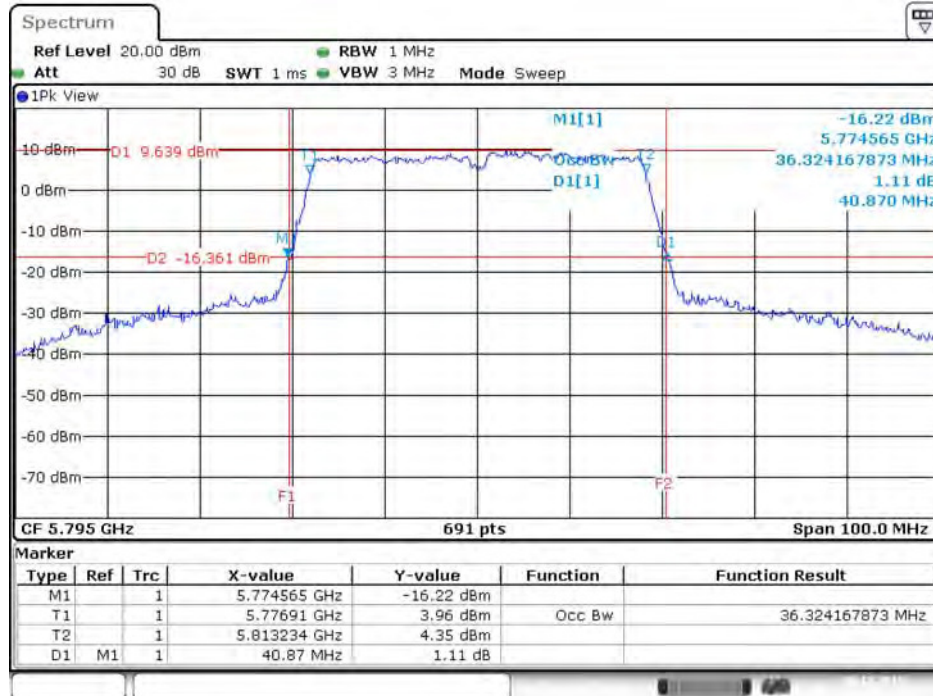

Date: 20.DEC.2015 12:05:35

26dB Bandwidth and 99% Occupied Bandwidth Plot on Configuration IEEE 802.11ac MCS0/Nss1 VHT40 / Chain 8 / 5795 MHz

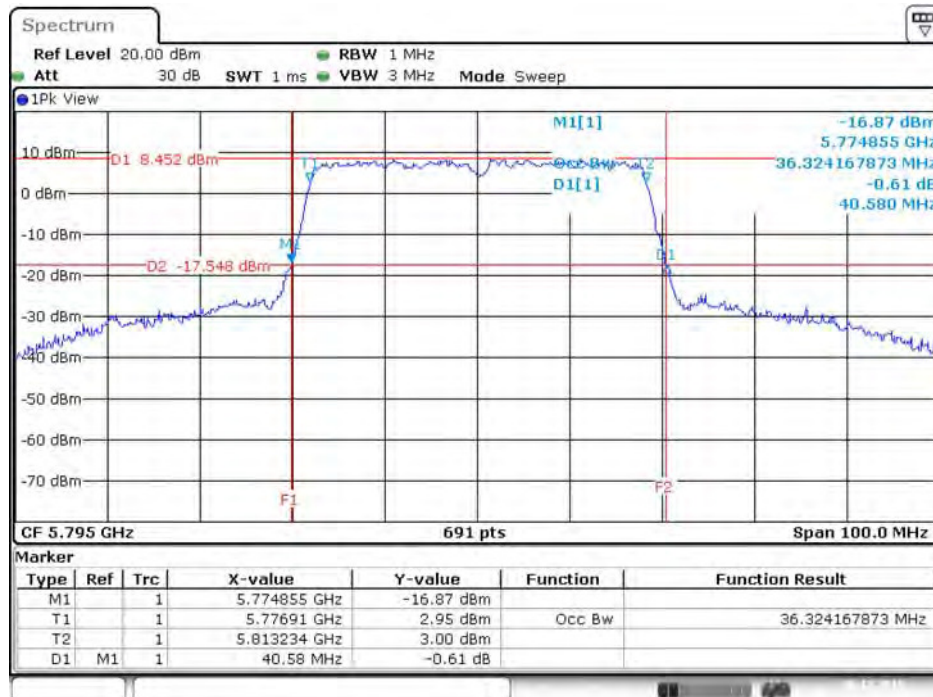

Date: 20.DEC.2015 12:05:05

**26dB Bandwidth and 99% Occupied Bandwidth Plot on Configuration IEEE 802.11ac MCS0/Nss1 VHT80 / Chain 5 / 5210 MHz**

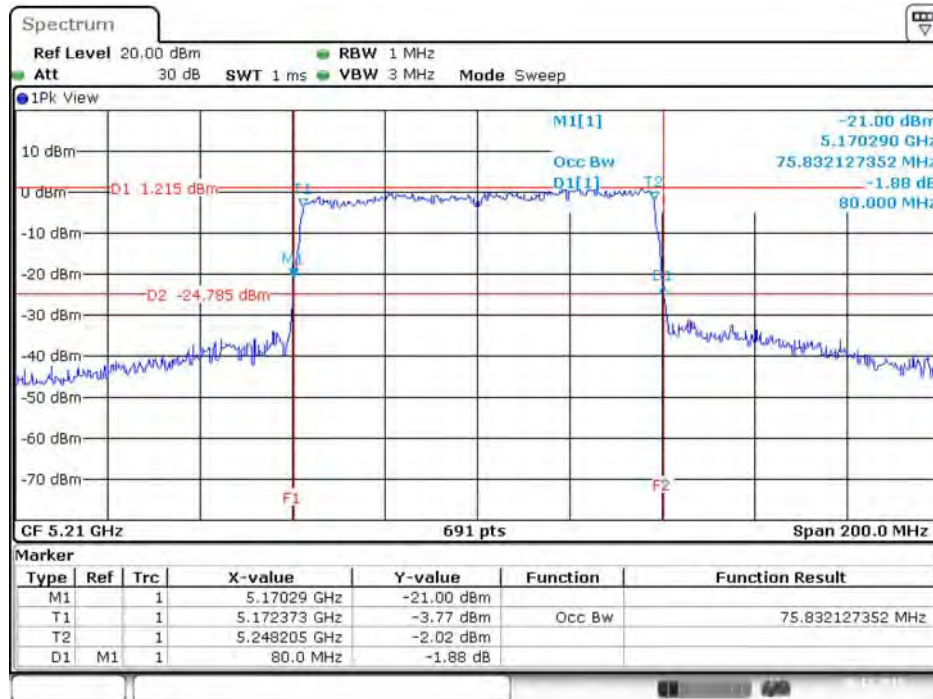

Date: 20.DEC.2015 12:07:25

**26dB Bandwidth and 99% Occupied Bandwidth Plot on Configuration IEEE 802.11ac MCS0/Nss1 VHT80 / Chain 6 / 5210 MHz**

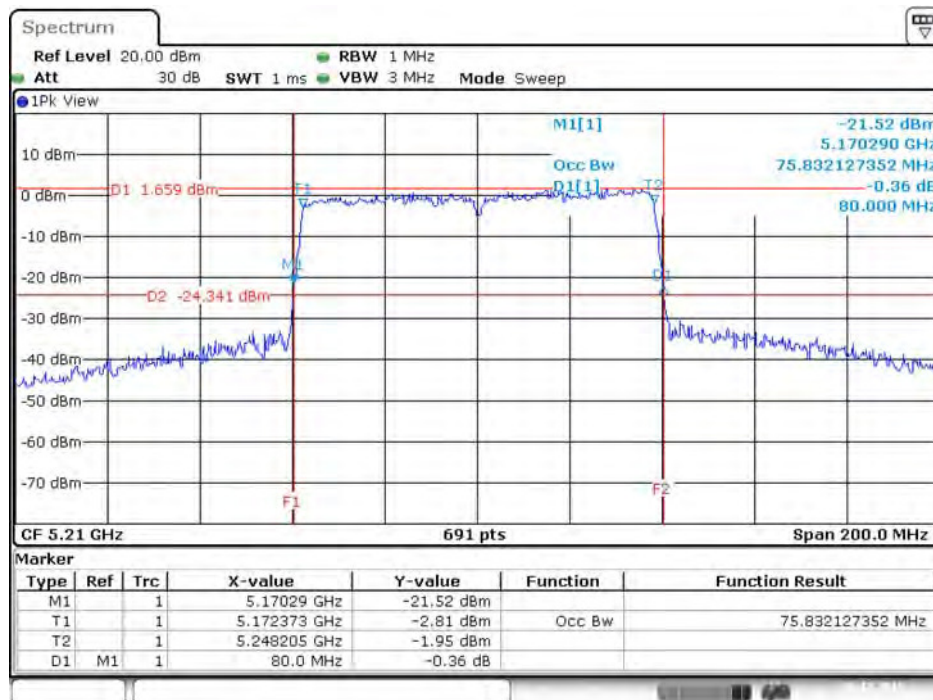

Date: 20.DEC.2015 12:08:10

26dB Bandwidth and 99% Occupied Bandwidth Plot on Configuration IEEE 802.11ac MCS0/Nss1 VHT80 / Chain 7 / 5210 MHz

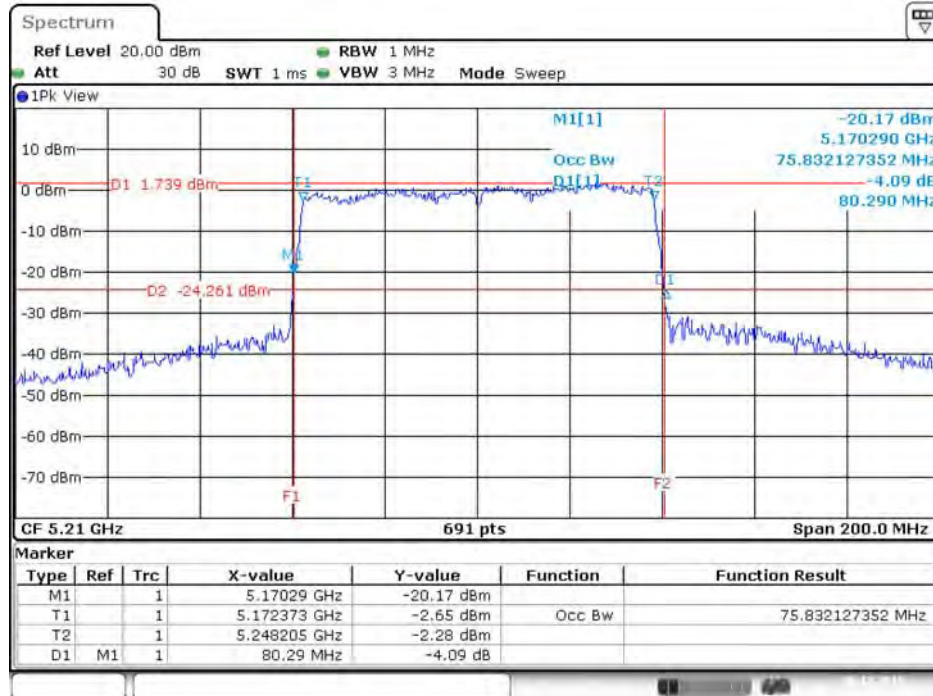

Date: 20.DEC.2015 12:09:05

26dB Bandwidth and 99% Occupied Bandwidth Plot on Configuration IEEE 802.11ac MCS0/Nss1 VHT80 / Chain 8 / 5210 MHz

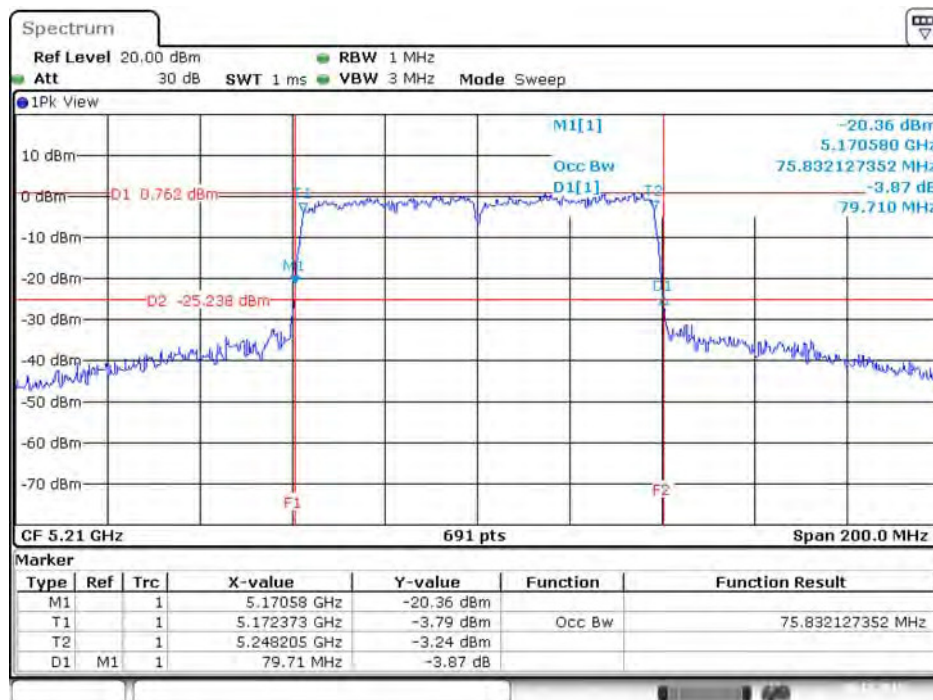

Date: 20.DEC.2015 12:09:24

**26dB Bandwidth and 99% Occupied Bandwidth Plot on Configuration IEEE 802.11ac MCS0/Nss1 VHT80 / Chain 5 / 5775 MHz**

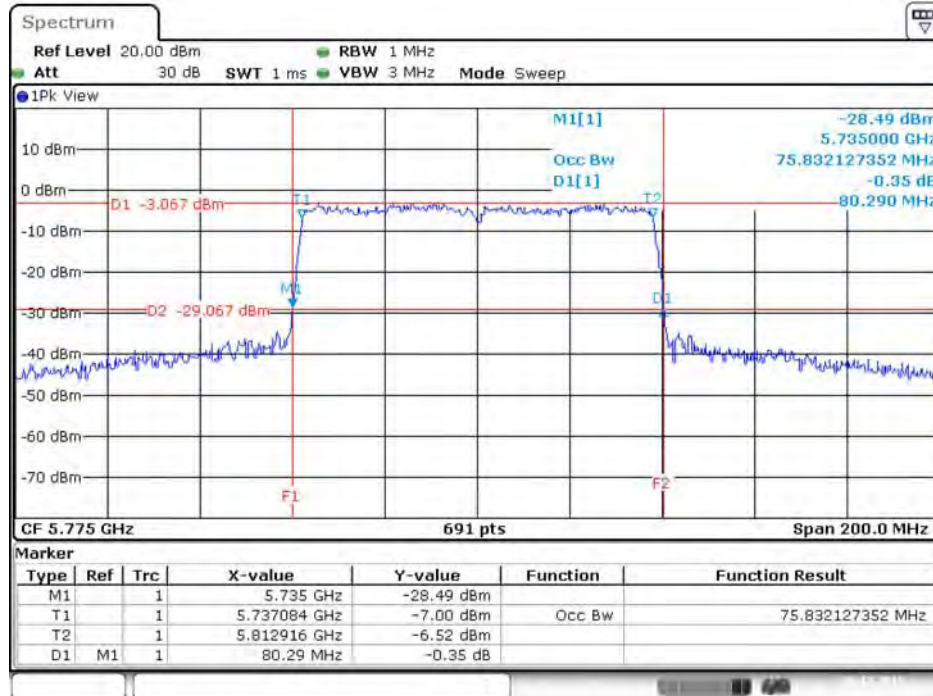

Date: 20.DEC.2015 12:59:15

**26dB Bandwidth and 99% Occupied Bandwidth Plot on Configuration IEEE 802.11ac MCS0/Nss1 VHT80 / Chain 6 / 5775 MHz**

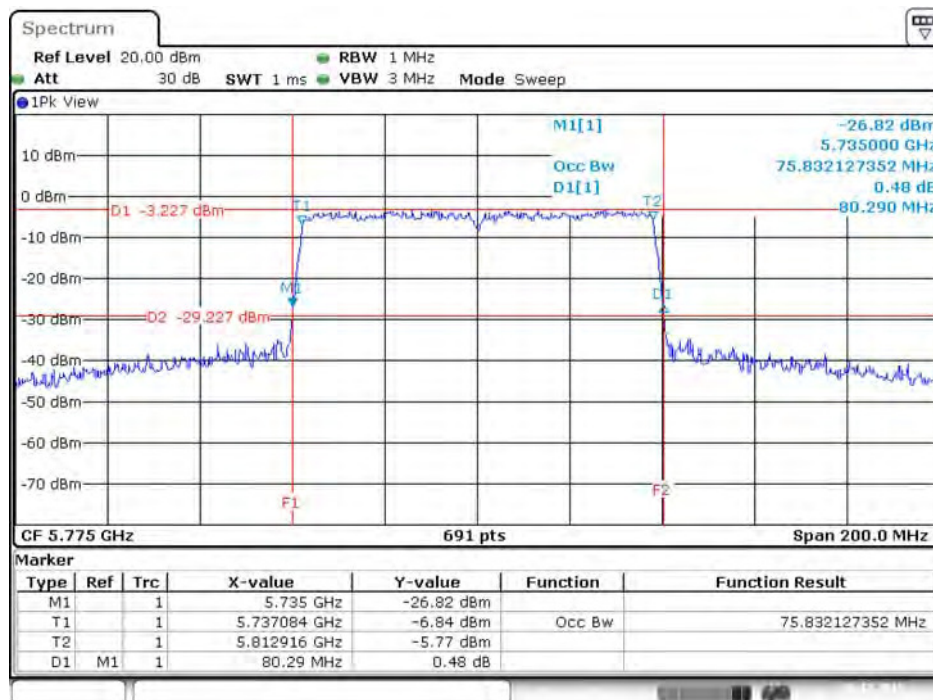

Date: 20.DEC.2015 13:00:24

**26dB Bandwidth and 99% Occupied Bandwidth Plot on Configuration IEEE 802.11ac MCS0/Nss1 VHT80 / Chain 7 / 5775 MHz**

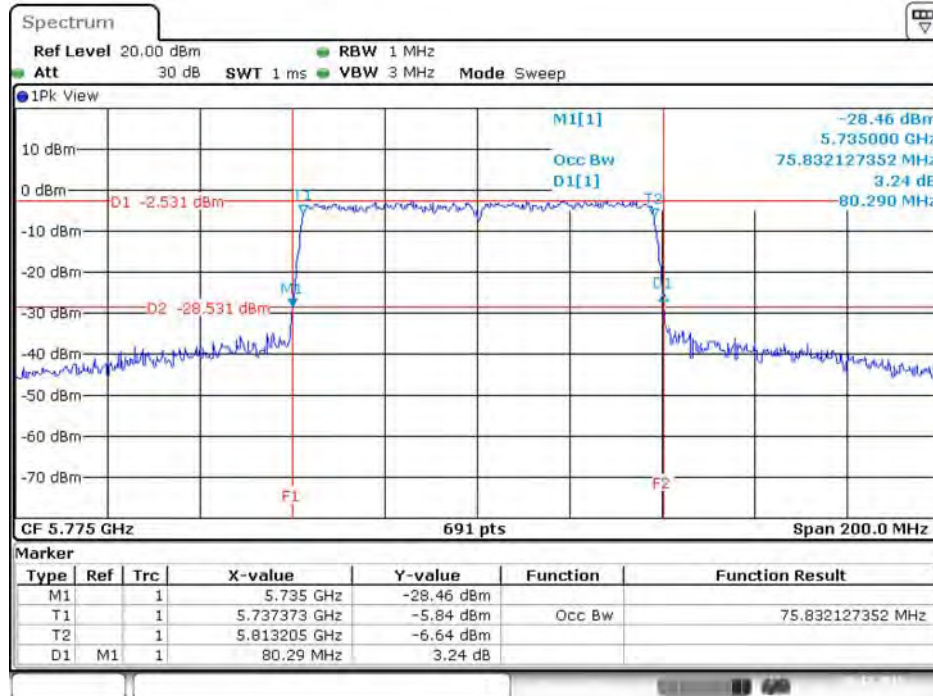

Date: 20.DEC.2015 13:00:51

**26dB Bandwidth and 99% Occupied Bandwidth Plot on Configuration IEEE 802.11ac MCS0/Nss1 VHT80 / Chain 8 / 5775 MHz**

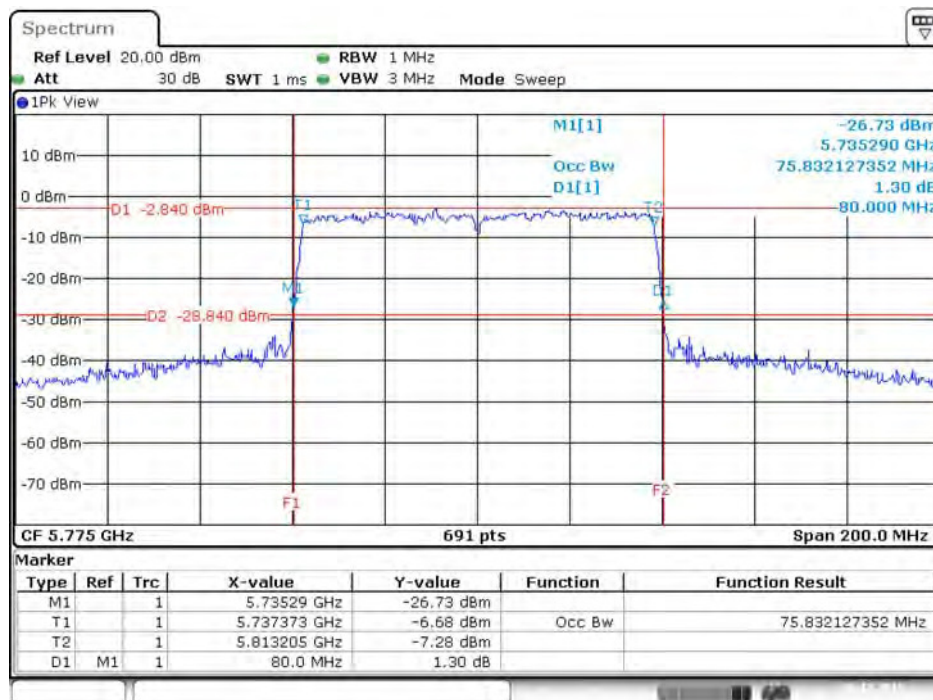

Date: 20.DEC.2015 13:01:15

26dB Bandwidth and 99% Occupied Bandwidth Plot on Configuration IEEE 802.11ac MCS0/Nss4 VHT20 / Chain 5 / 5180 MHz

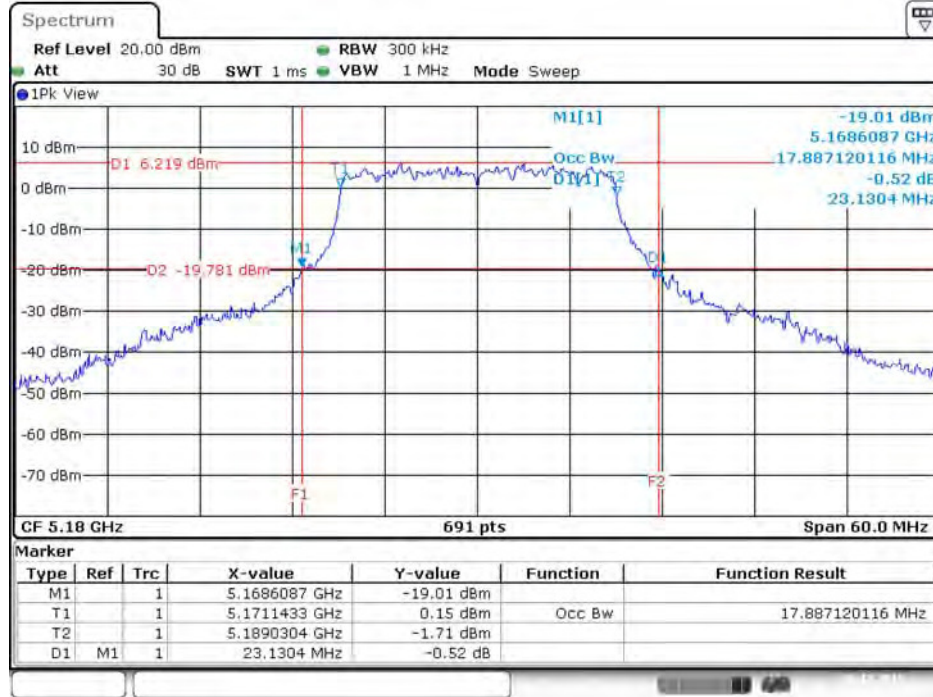

Date: 20.DEC.2015 14:10:45

26dB Bandwidth and 99% Occupied Bandwidth Plot on Configuration IEEE 802.11ac MCS0/Nss4 VHT20 / Chain 6 / 5180 MHz

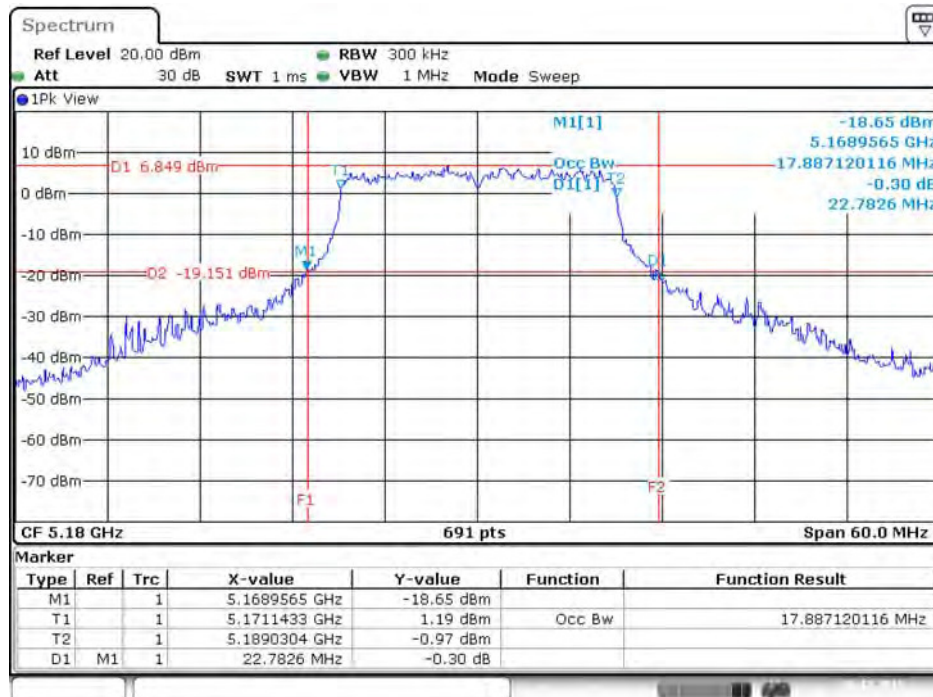

Date: 20.DEC.2015 14:10:02



26dB Bandwidth and 99% Occupied Bandwidth Plot on Configuration IEEE 802.11ac MCS0/Nss4 VHT20 / Chain 7 / 5180 MHz

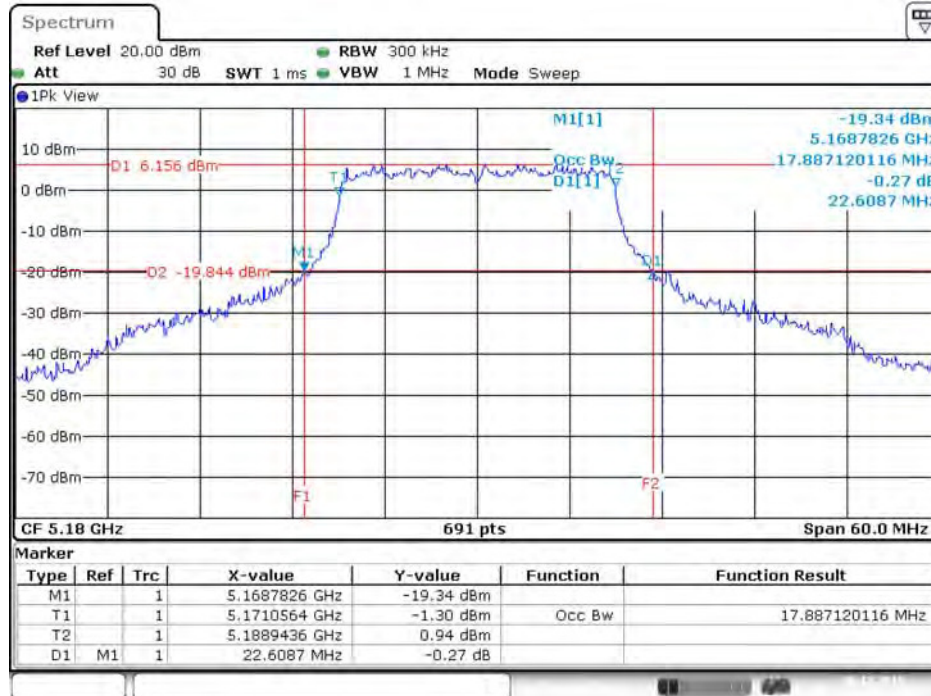

Date: 20.DEC.2015 13:57:39

26dB Bandwidth and 99% Occupied Bandwidth Plot on Configuration IEEE 802.11ac MCS0/Nss4 VHT20 / Chain 8 / 5180 MHz

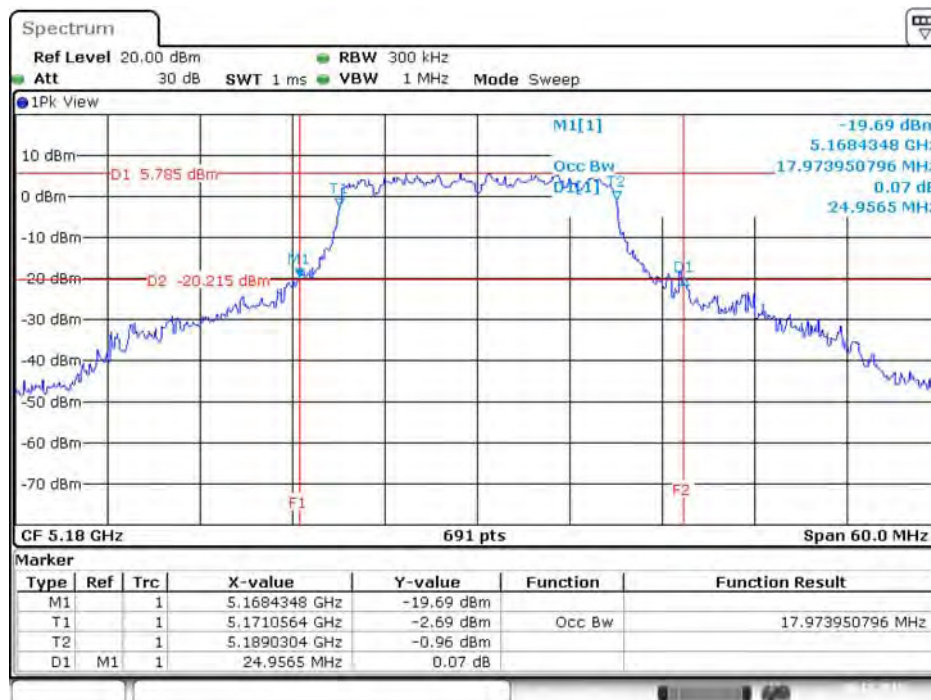

Date: 20.DEC.2015 13:58:50

26dB Bandwidth and 99% Occupied Bandwidth Plot on Configuration IEEE 802.11ac MCS0/Nss4 VHT20 / Chain 5 / 5200 MHz

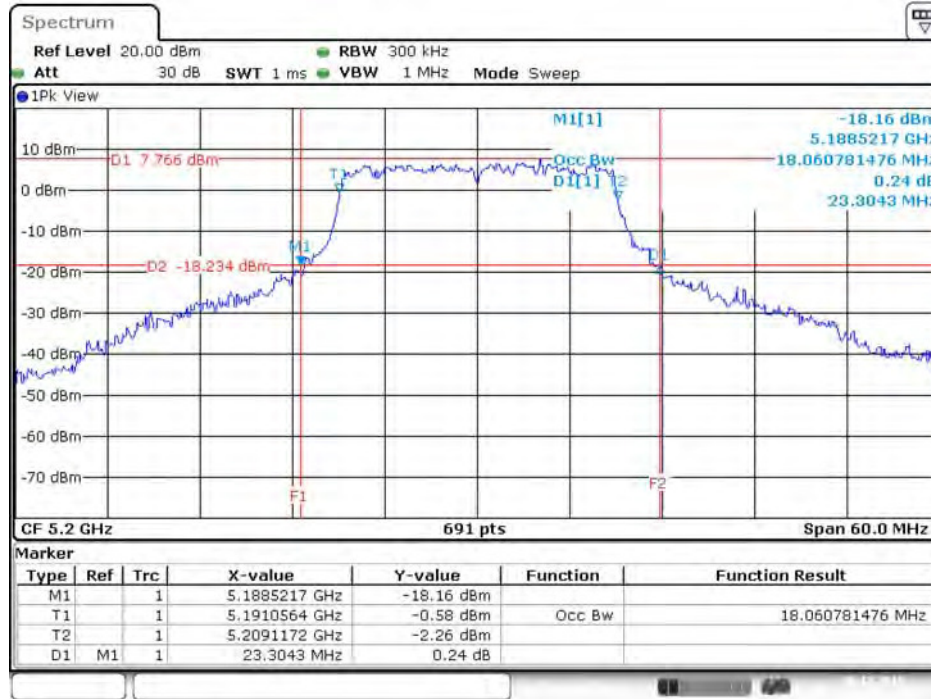

Date: 20.DEC.2015 14:11:43

26dB Bandwidth and 99% Occupied Bandwidth Plot on Configuration IEEE 802.11ac MCS0/Nss4 VHT20 / Chain 6 / 5200 MHz

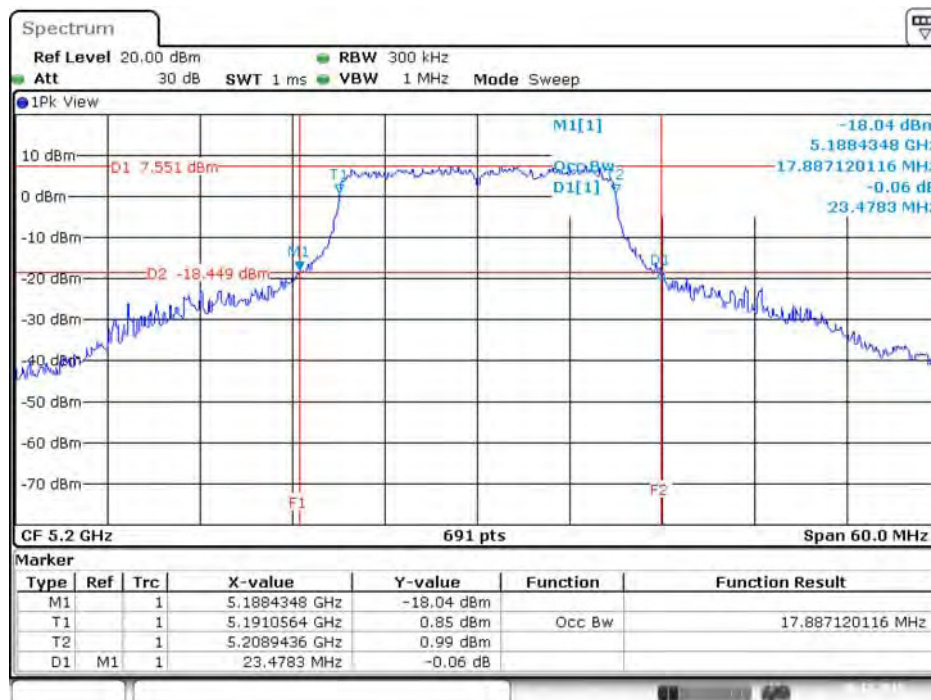

Date: 20.DEC.2015 14:12:24

26dB Bandwidth and 99% Occupied Bandwidth Plot on Configuration IEEE 802.11ac MCS0/Nss4 VHT20 / Chain 7 / 5200 MHz

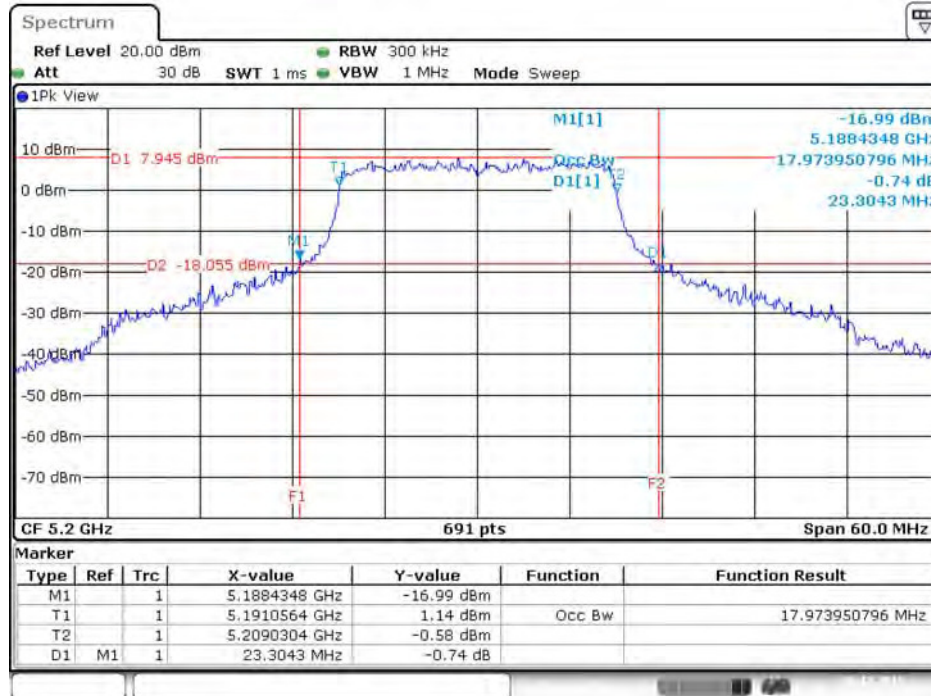

Date: 20.DEC.2015 14:12:46

26dB Bandwidth and 99% Occupied Bandwidth Plot on Configuration IEEE 802.11ac MCS0/Nss4 VHT20 / Chain 8 / 5200 MHz

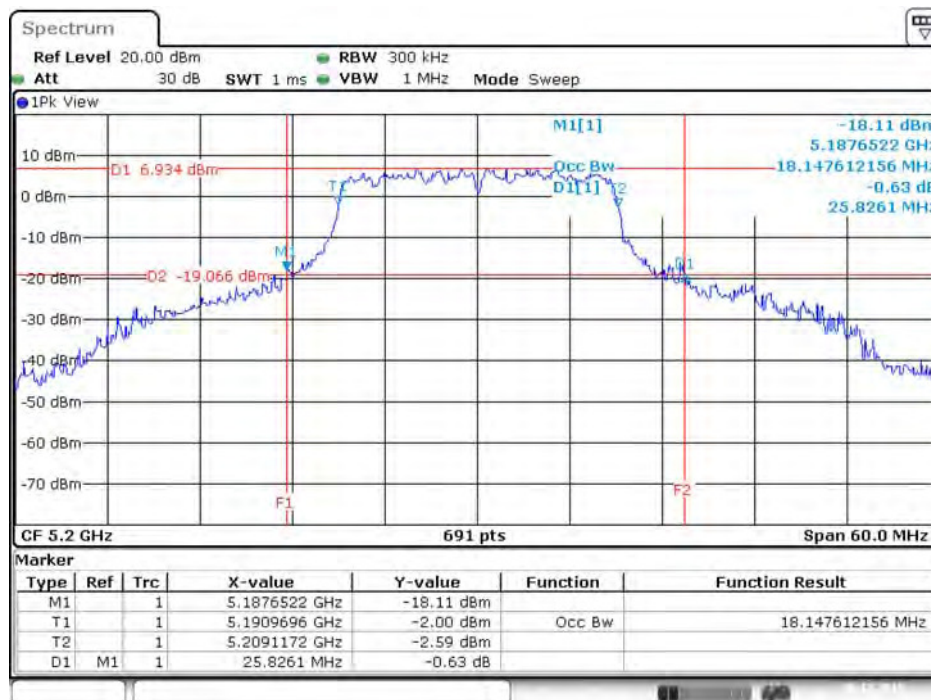

Date: 20.DEC.2015 14:13:11

26dB Bandwidth and 99% Occupied Bandwidth Plot on Configuration IEEE 802.11ac MCS0/Nss4 VHT20 / Chain 5 / 5240 MHz

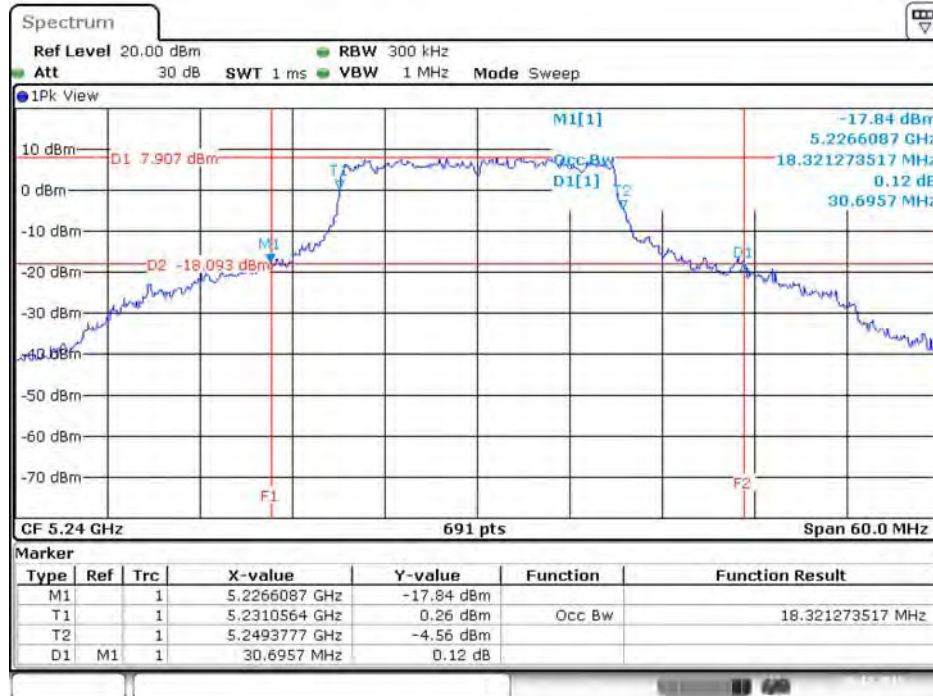

Date: 20.DEC.2015 14:16:46

26dB Bandwidth and 99% Occupied Bandwidth Plot on Configuration IEEE 802.11ac MCS0/Nss4 VHT20 / Chain 6 / 5240 MHz

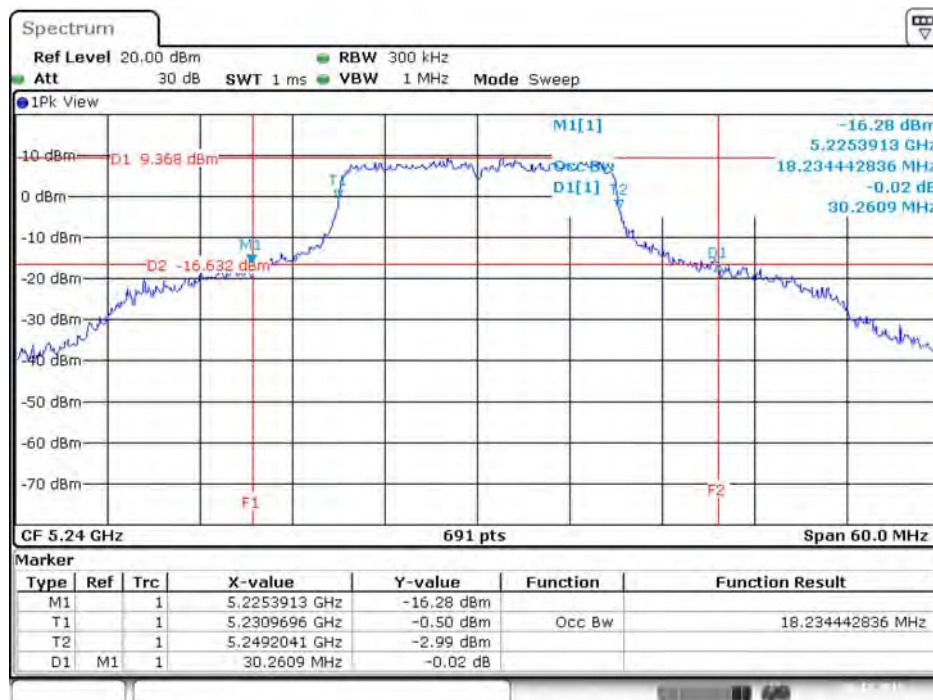

Date: 20.DEC.2015 14:16:25

26dB Bandwidth and 99% Occupied Bandwidth Plot on Configuration IEEE 802.11ac MCS0/Nss4 VHT20 / Chain 7 / 5240 MHz

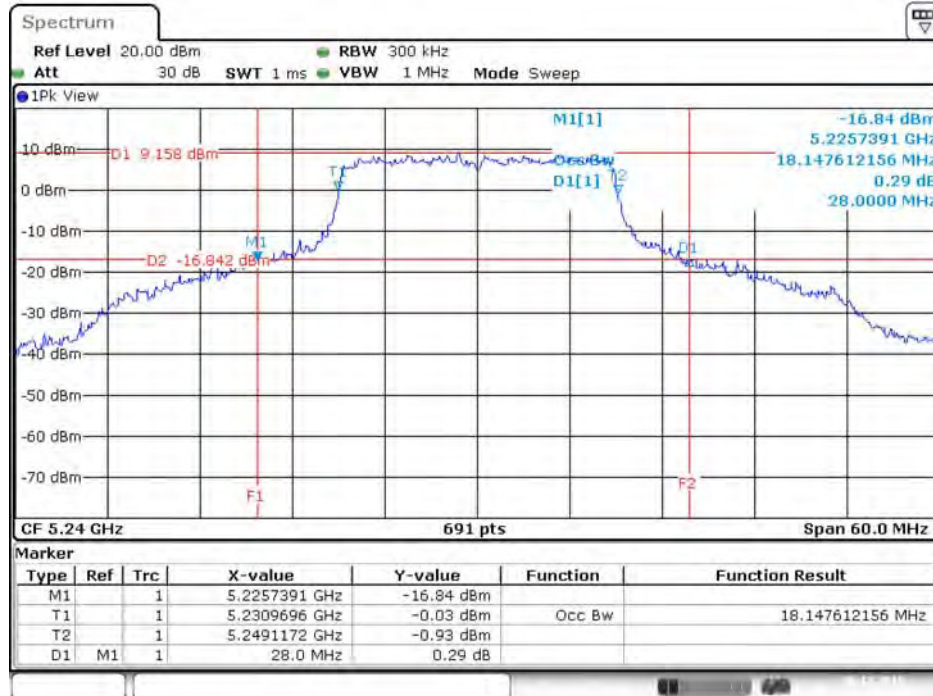

Date: 20.DEC.2015 14:15:57

26dB Bandwidth and 99% Occupied Bandwidth Plot on Configuration IEEE 802.11ac MCS0/Nss4 VHT20 / Chain 8 / 5240 MHz

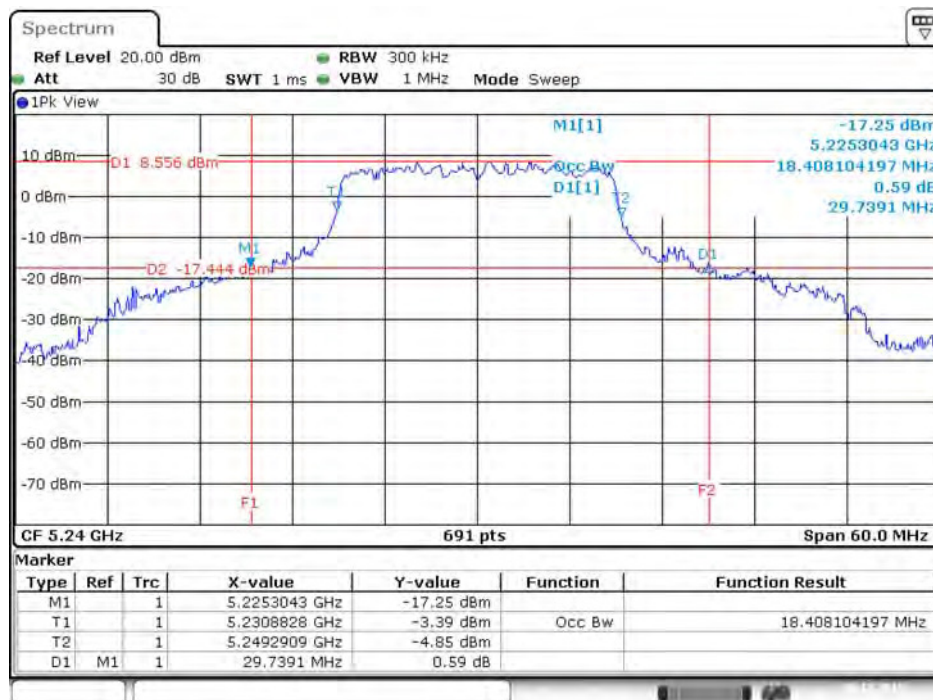

Date: 20.DEC.2015 14:15:35

26dB Bandwidth and 99% Occupied Bandwidth Plot on Configuration IEEE 802.11ac MCS0/Nss4 VHT20 / Chain 5 / 5745 MHz

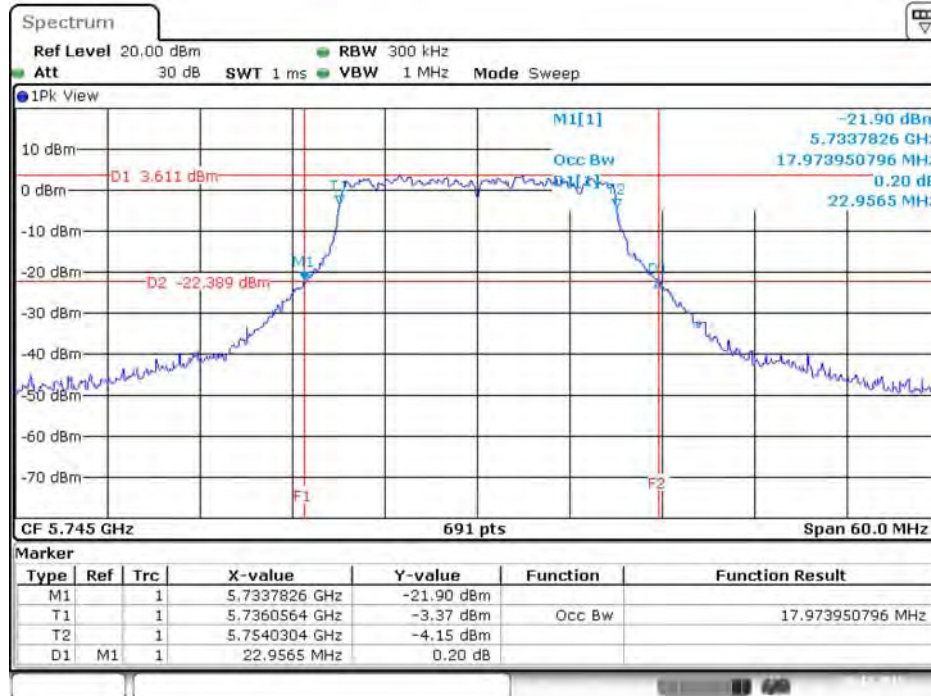

Date: 20.DEC.2015 14:35:20

26dB Bandwidth and 99% Occupied Bandwidth Plot on Configuration IEEE 802.11ac MCS0/Nss4 VHT20 / Chain 6 / 5745 MHz

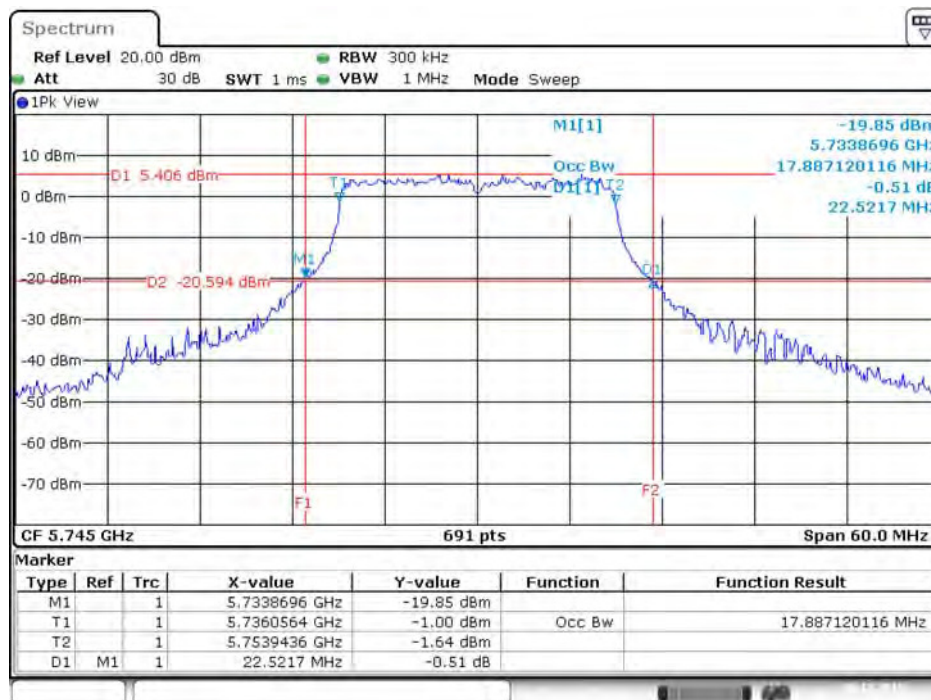

Date: 20.DEC.2015 14:35:40

26dB Bandwidth and 99% Occupied Bandwidth Plot on Configuration IEEE 802.11ac MCS0/Nss4 VHT20 / Chain 7 / 5745 MHz

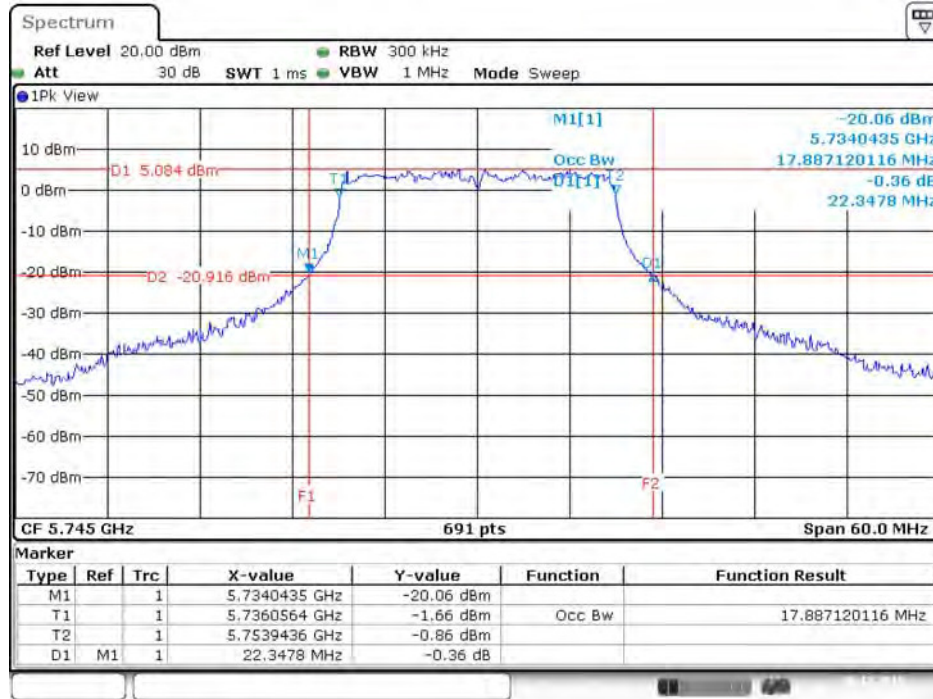

Date: 20.DEC.2015 14:36:03

26dB Bandwidth and 99% Occupied Bandwidth Plot on Configuration IEEE 802.11ac MCS0/Nss4 VHT20 / Chain 8 / 5745 MHz

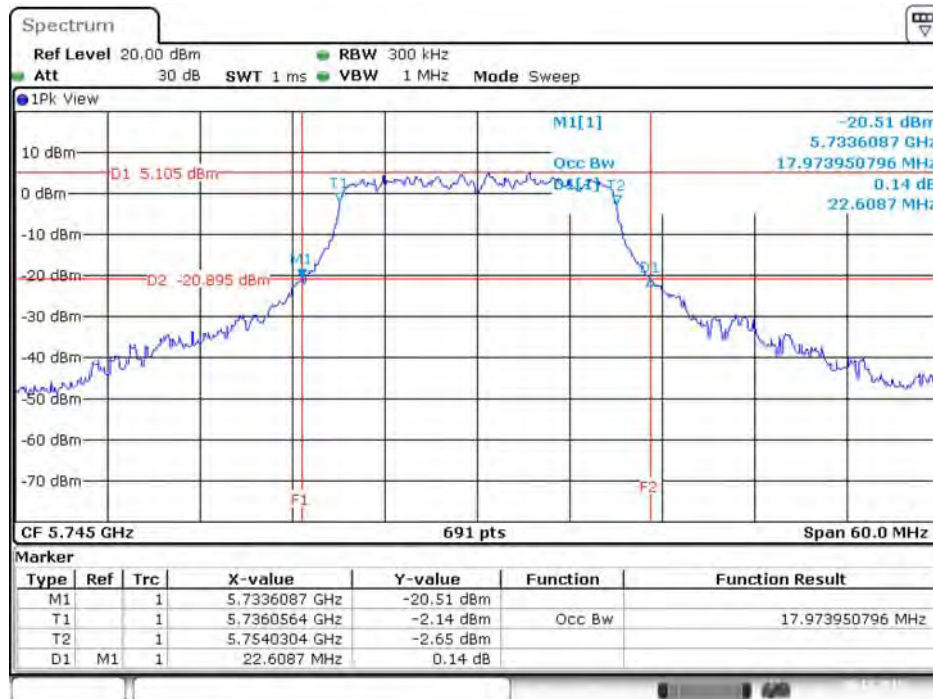

Date: 20.DEC.2015 14:36:23

26dB Bandwidth and 99% Occupied Bandwidth Plot on Configuration IEEE 802.11ac MCS0/Nss4 VHT20 / Chain 5 / 5785 MHz

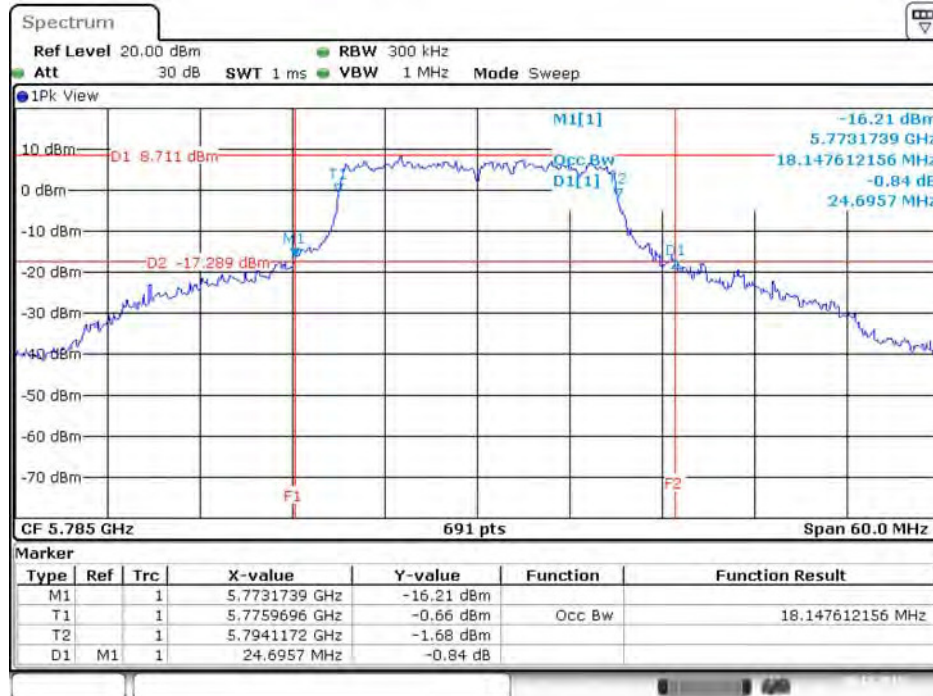

Date: 20.DEC.2015 14:38:37

26dB Bandwidth and 99% Occupied Bandwidth Plot on Configuration IEEE 802.11ac MCS0/Nss4 VHT20 / Chain 6 / 5785 MHz

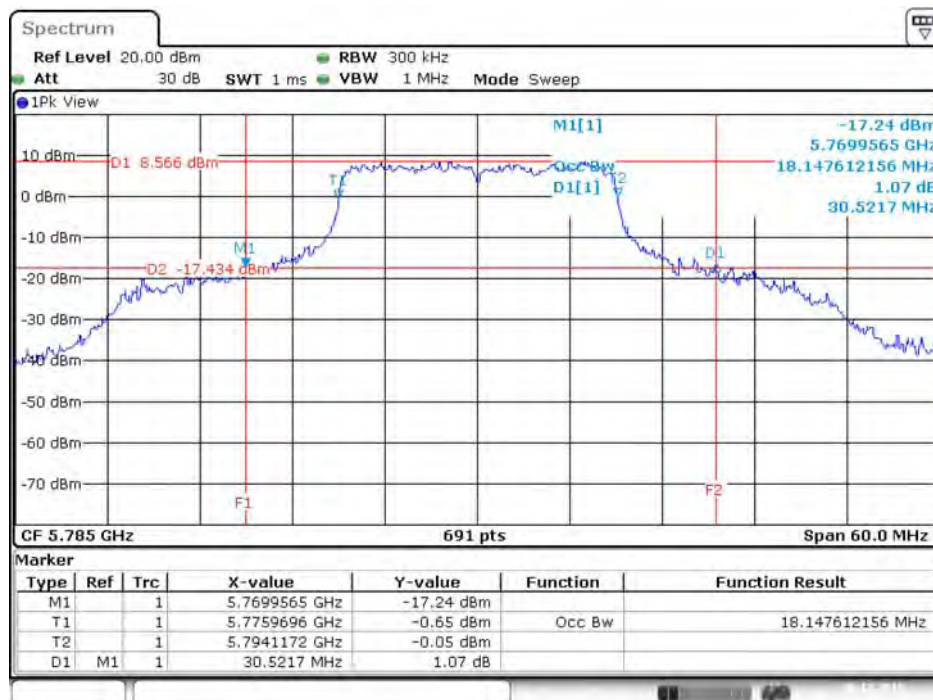

Date: 20.DEC.2015 14:38:17



26dB Bandwidth and 99% Occupied Bandwidth Plot on Configuration IEEE 802.11ac MCS0/Nss4 VHT20 / Chain 7 / 5785 MHz

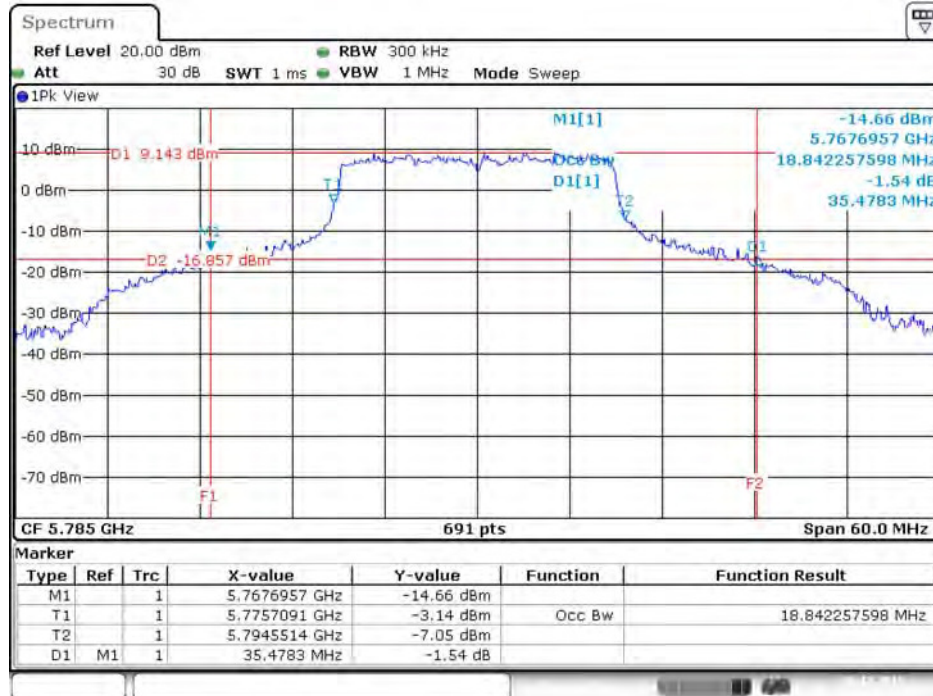

Date: 20.DEC.2015 14:37:58

26dB Bandwidth and 99% Occupied Bandwidth Plot on Configuration IEEE 802.11ac MCS0/Nss4 VHT20 / Chain 8 / 5785 MHz

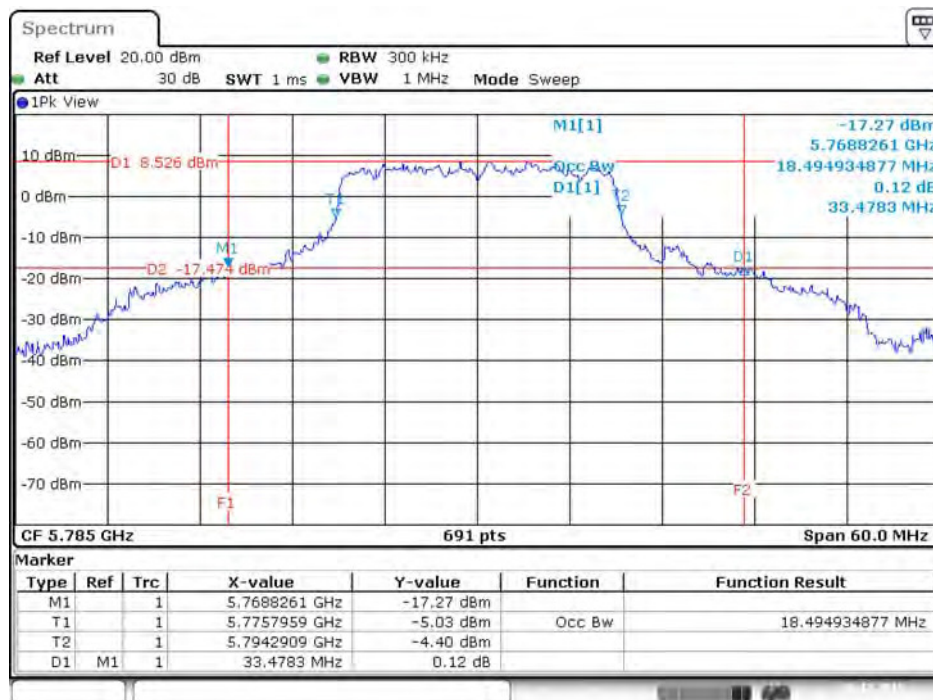

Date: 20.DEC.2015 14:37:28

26dB Bandwidth and 99% Occupied Bandwidth Plot on Configuration IEEE 802.11ac MCS0/Nss4 VHT20 / Chain 5 / 5825 MHz

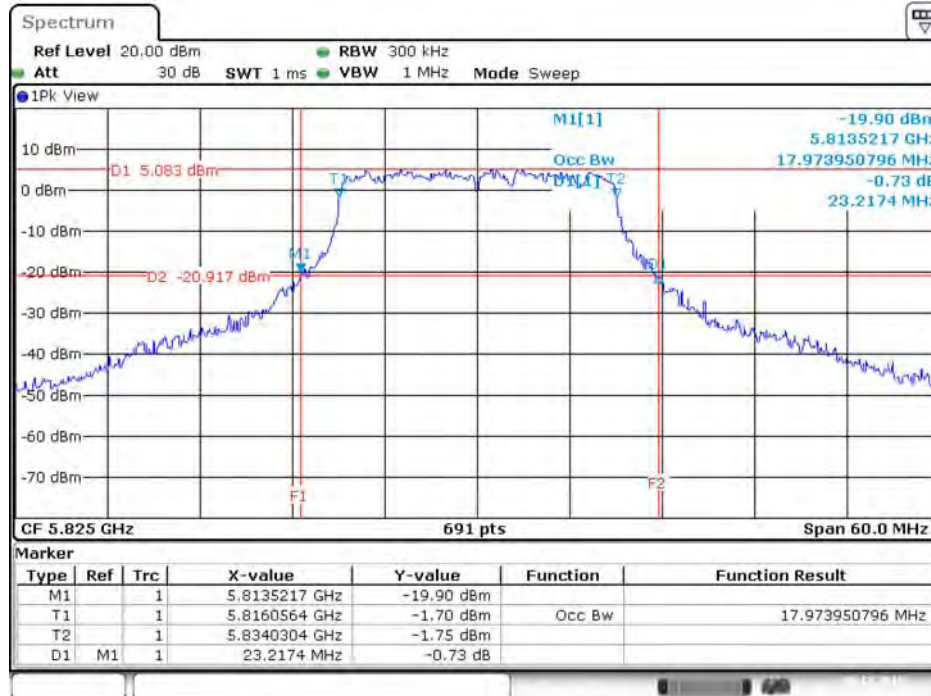

Date: 20.DEC.2015 14:39:43

26dB Bandwidth and 99% Occupied Bandwidth Plot on Configuration IEEE 802.11ac MCS0/Nss4 VHT20 / Chain 6 / 5825 MHz

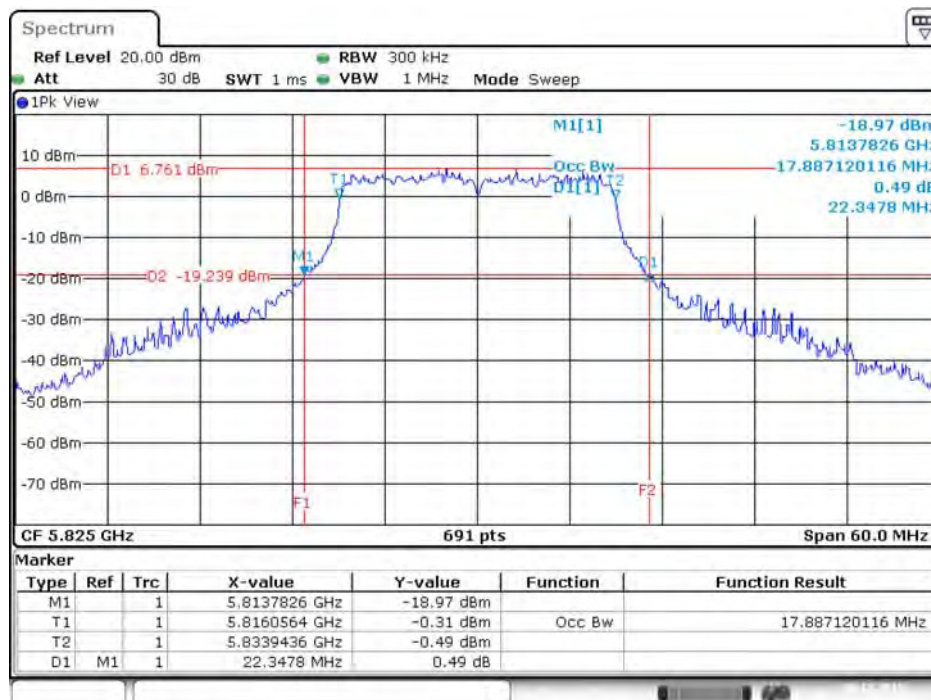

Date: 20.DEC.2015 14:40:05

26dB Bandwidth and 99% Occupied Bandwidth Plot on Configuration IEEE 802.11ac MCS0/Nss4 VHT20 / Chain 7 / 5825 MHz

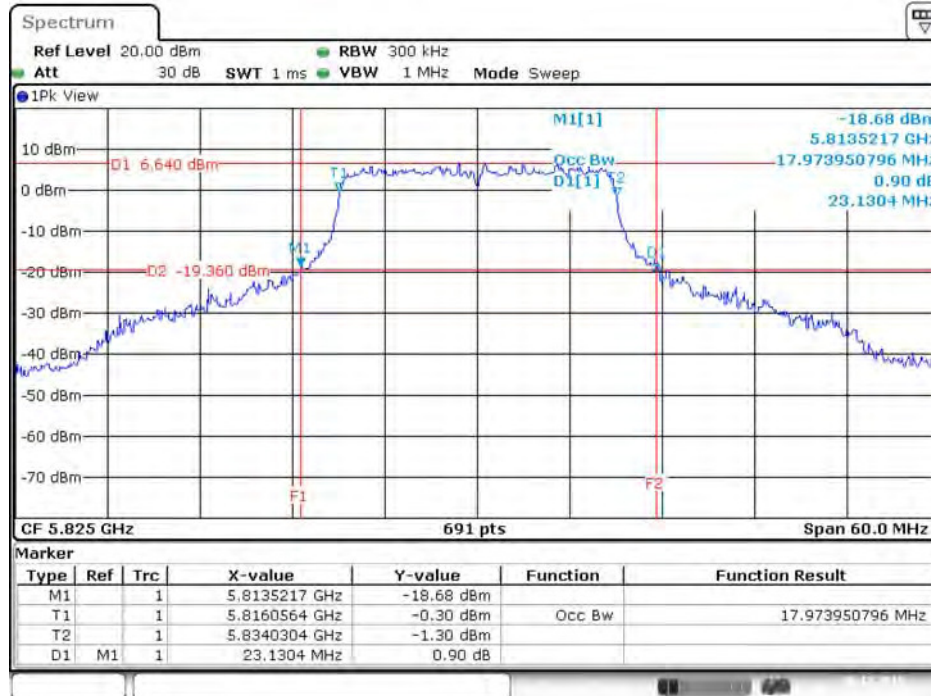

Date: 20.DEC.2015 14:40:28

26dB Bandwidth and 99% Occupied Bandwidth Plot on Configuration IEEE 802.11ac MCS0/Nss4 VHT20 / Chain 8 / 5825 MHz

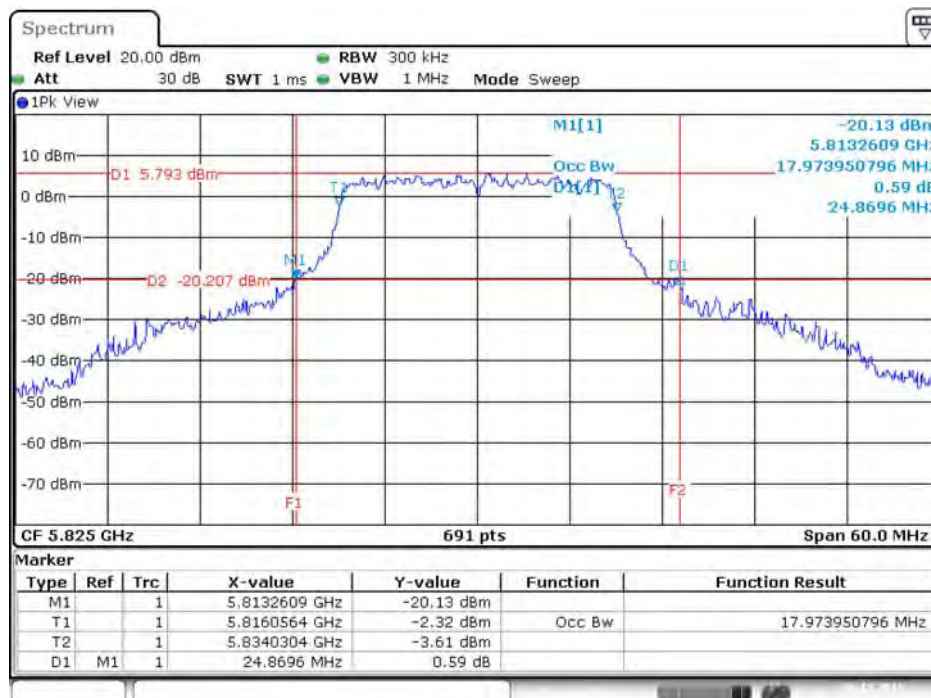

Date: 20.DEC.2015 14:40:51

26dB Bandwidth and 99% Occupied Bandwidth Plot on Configuration IEEE 802.11ac MCS0/Nss4 VHT40 / Chain 5 / 5190 MHz

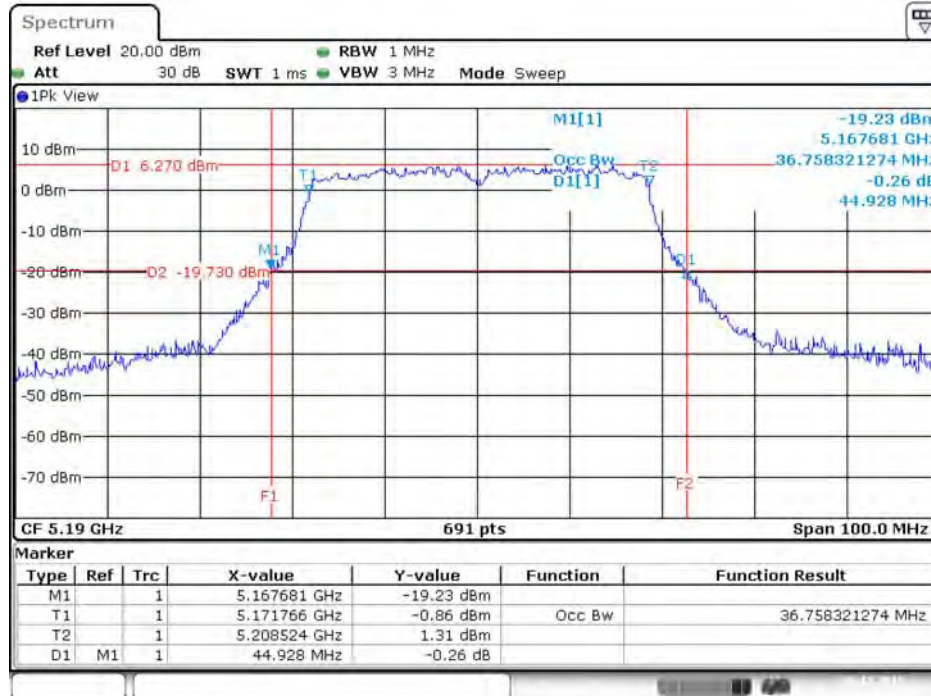

Date: 20.DEC.2015 13:22:12

26dB Bandwidth and 99% Occupied Bandwidth Plot on Configuration IEEE 802.11ac MCS0/Nss4 VHT40 / Chain 6 / 5190 MHz

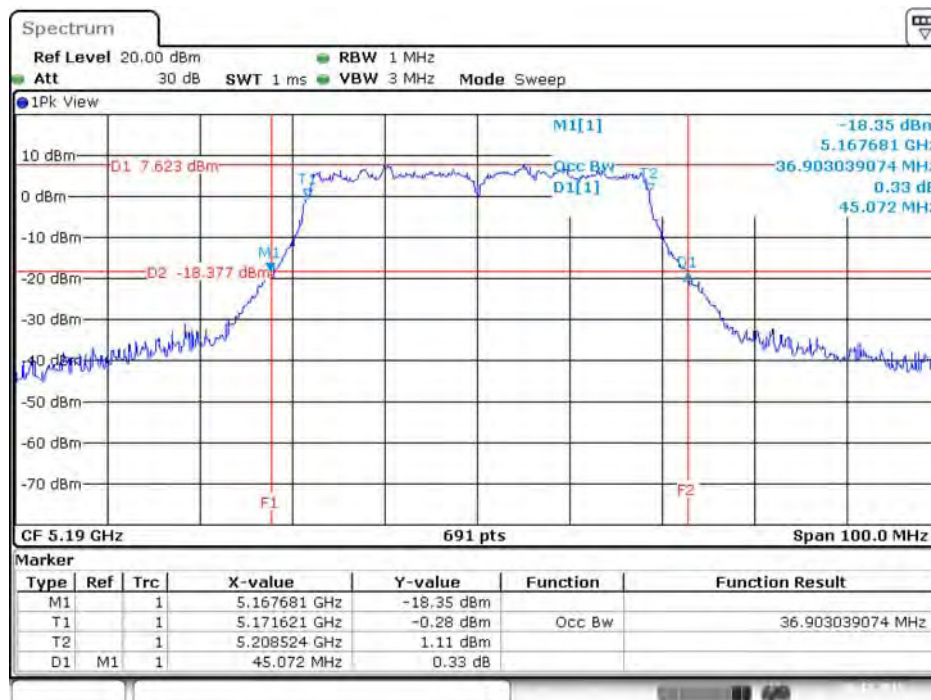

Date: 20.DEC.2015 13:22:46

26dB Bandwidth and 99% Occupied Bandwidth Plot on Configuration IEEE 802.11ac MCS0/Nss4 VHT40 / Chain 7 / 5190 MHz

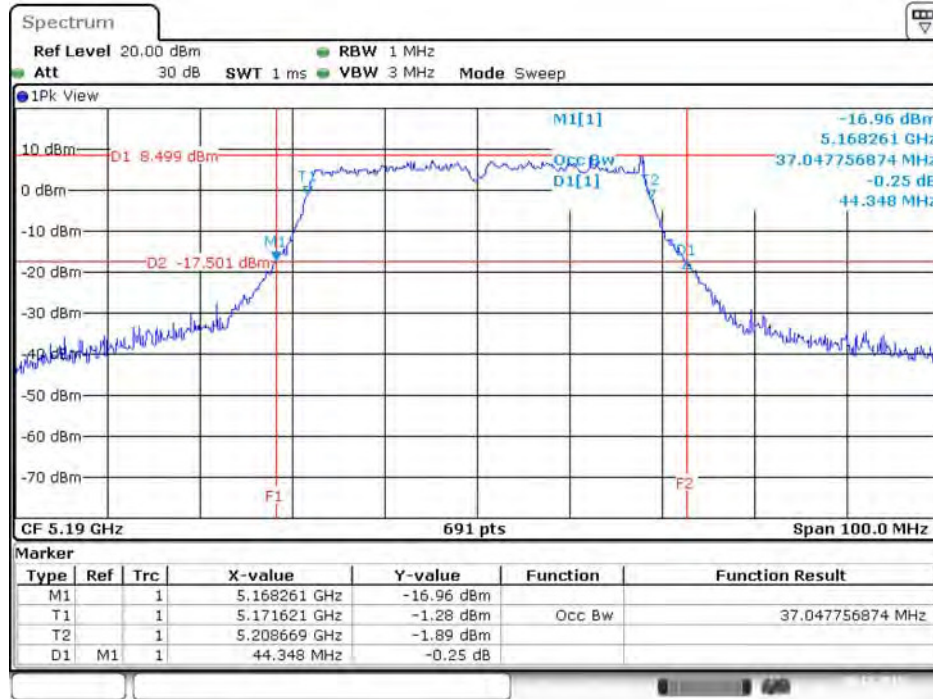

Date: 20.DEC.2015 13:24:48

26dB Bandwidth and 99% Occupied Bandwidth Plot on Configuration IEEE 802.11ac MCS0/Nss4 VHT40 / Chain 8 / 5190 MHz

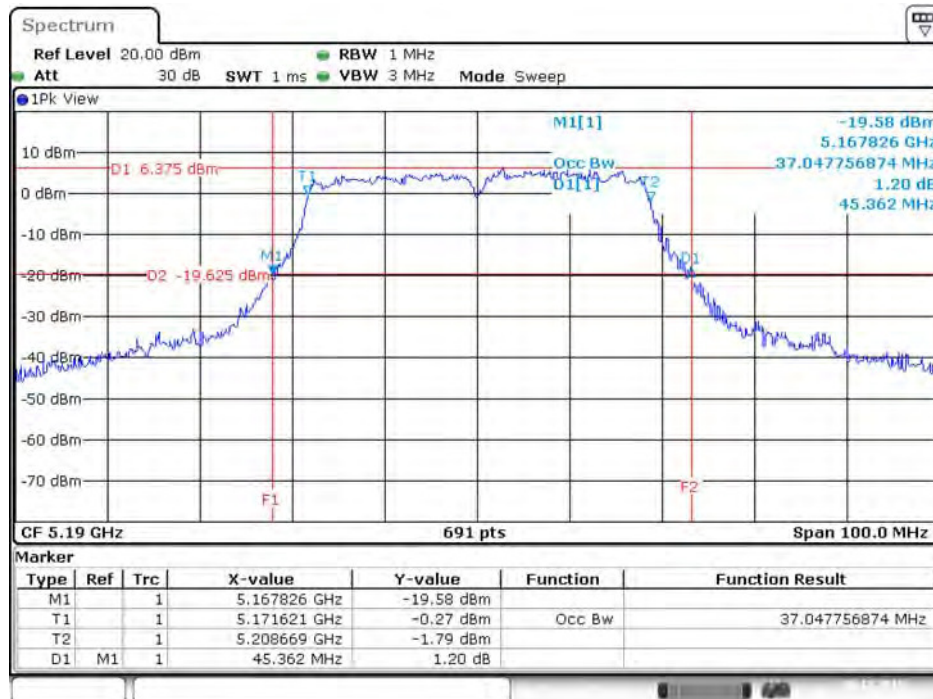

Date: 20.DEC.2015 13:25:09

**26dB Bandwidth and 99% Occupied Bandwidth Plot on Configuration IEEE 802.11ac MCS0/Nss4 VHT40 / Chain 5 / 5230 MHz**

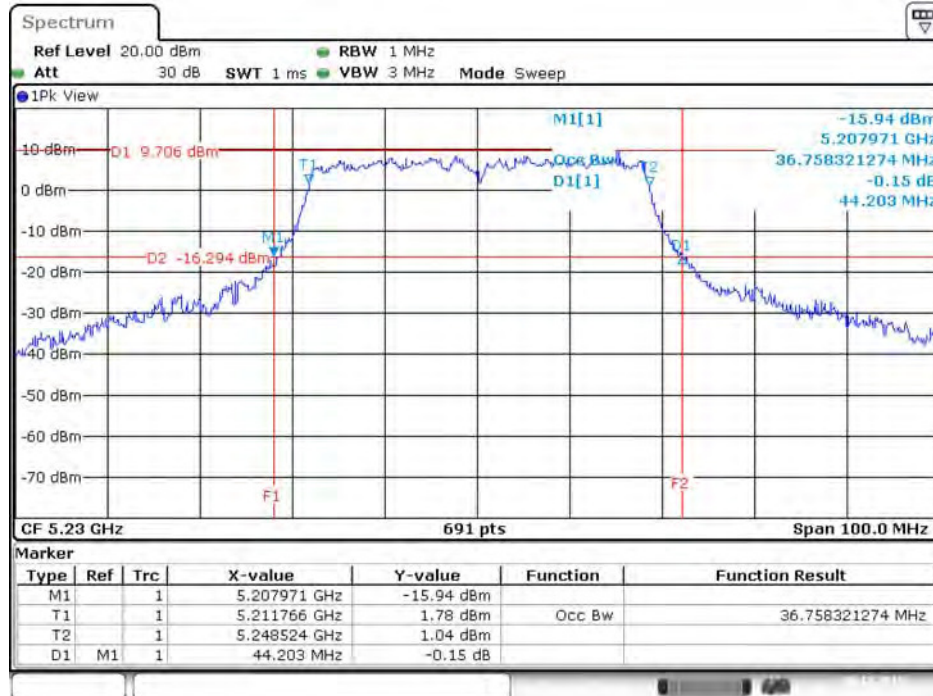

Date: 20.DEC.2015 13:27:35

**26dB Bandwidth and 99% Occupied Bandwidth Plot on Configuration IEEE 802.11ac MCS0/Nss4 VHT40 / Chain 6 / 5230 MHz**

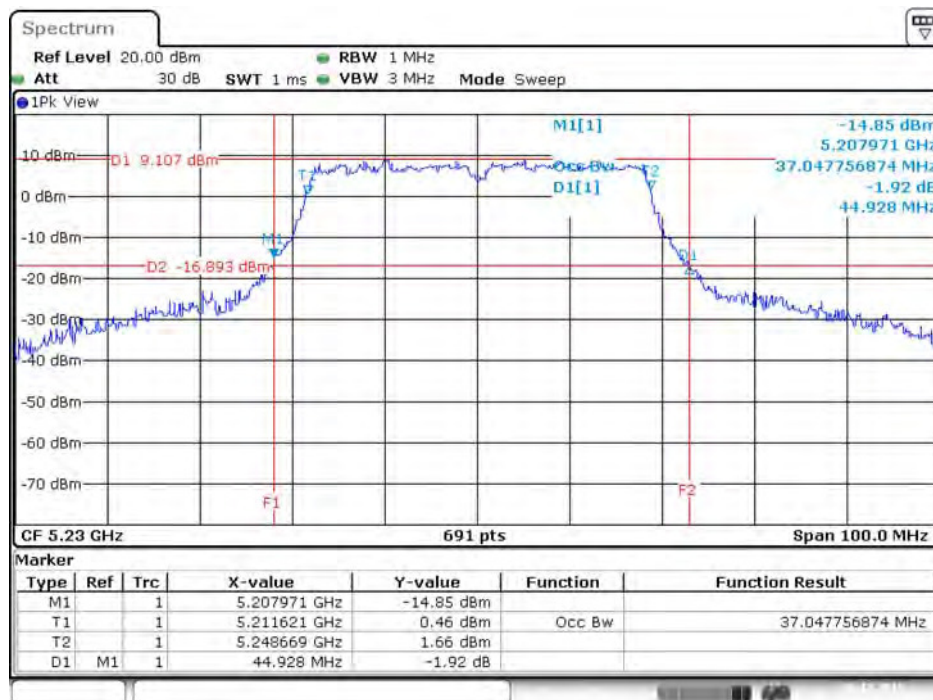

Date: 20.DEC.2015 13:27:11

26dB Bandwidth and 99% Occupied Bandwidth Plot on Configuration IEEE 802.11ac MCS0/Nss4 VHT40 / Chain 7 / 5230 MHz

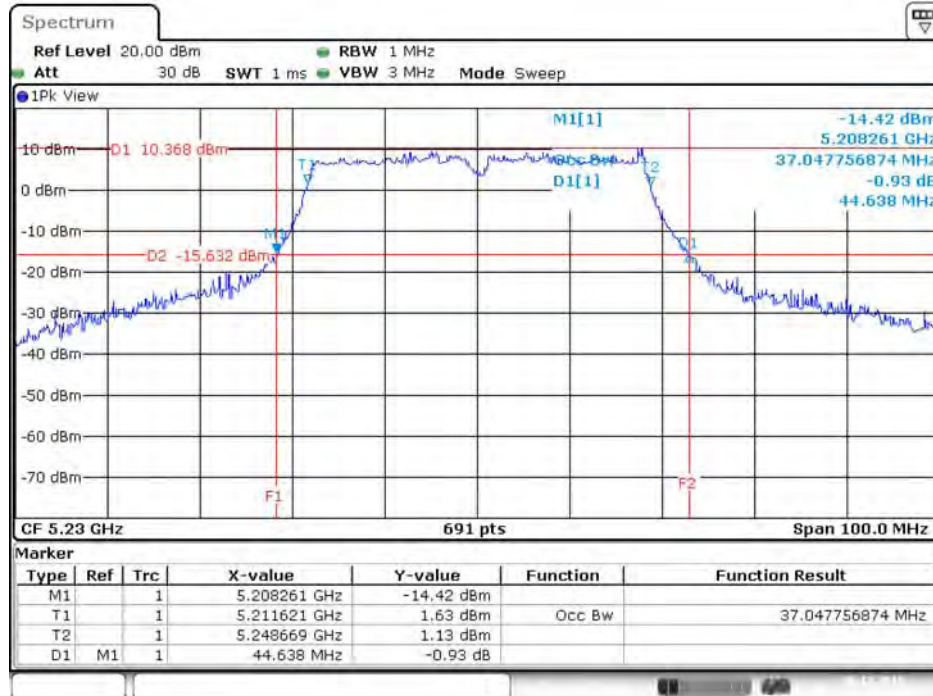

Date: 20.DEC.2015 13:26:49

26dB Bandwidth and 99% Occupied Bandwidth Plot on Configuration IEEE 802.11ac MCS0/Nss4 VHT40 / Chain 8 / 5230 MHz

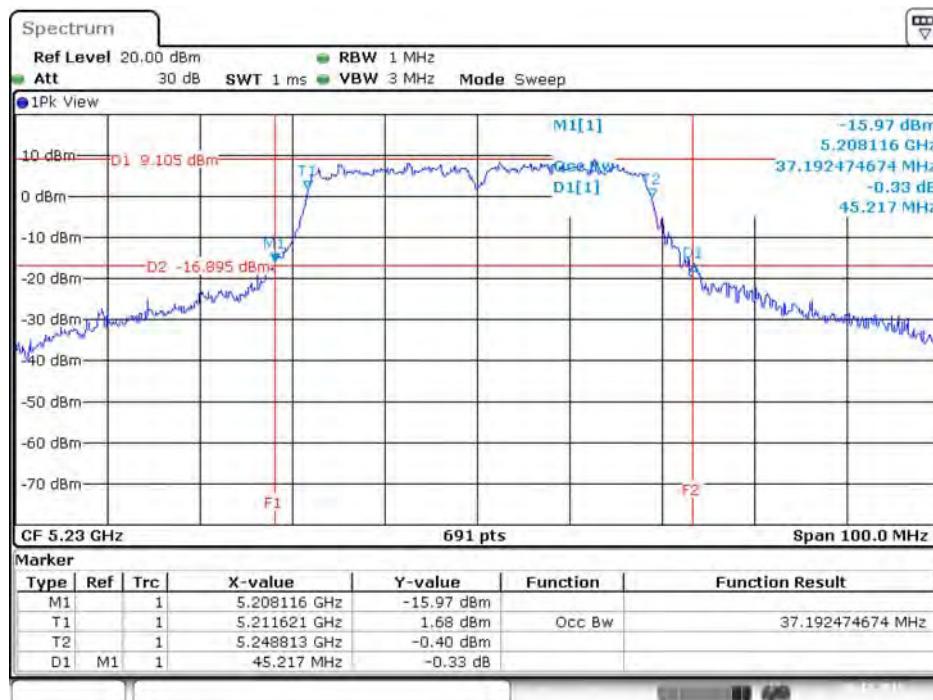

Date: 20.DEC.2015 13:26:04

26dB Bandwidth and 99% Occupied Bandwidth Plot on Configuration IEEE 802.11ac MCS0/Nss4 VHT40 / Chain 5 / 5755 MHz

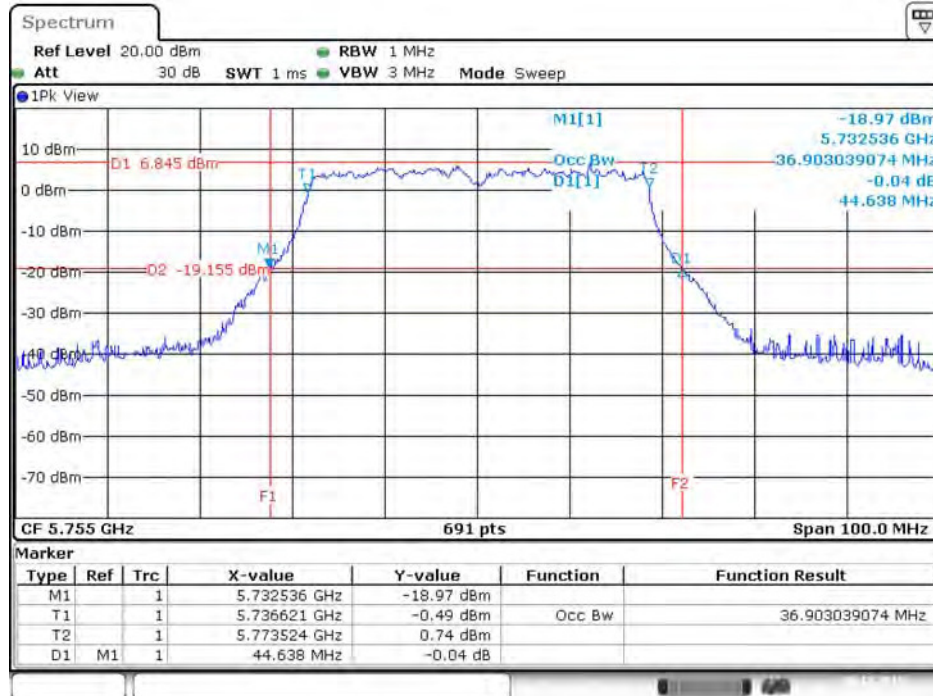

Date: 20.DEC.2015 13:48:54

26dB Bandwidth and 99% Occupied Bandwidth Plot on Configuration IEEE 802.11ac MCS0/Nss4 VHT40 / Chain 6 / 5755 MHz

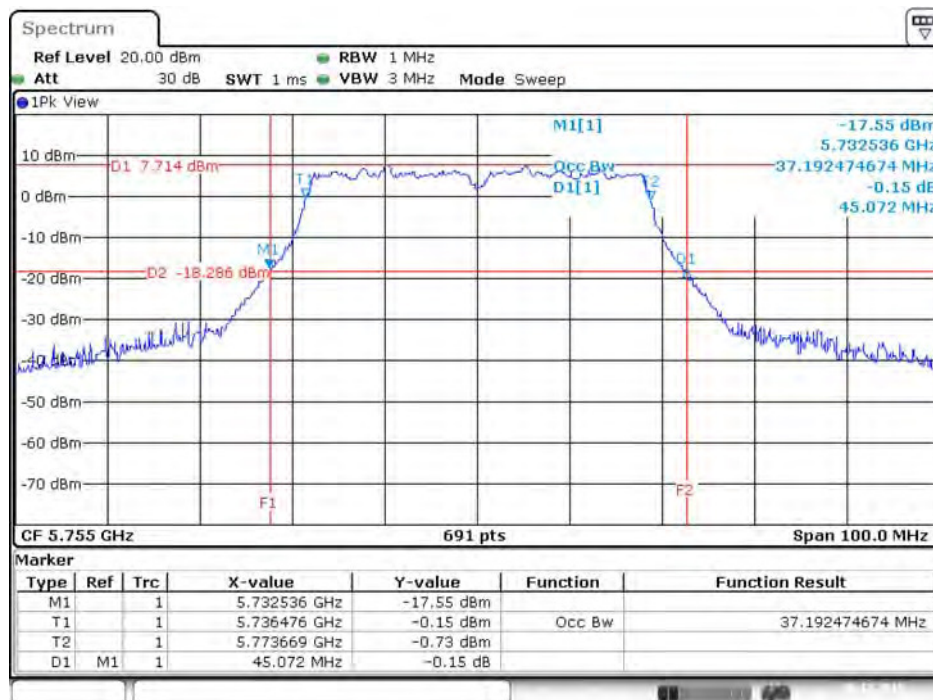

Date: 20.DEC.2015 13:48:19



26dB Bandwidth and 99% Occupied Bandwidth Plot on Configuration IEEE 802.11ac MCS0/Nss4 VHT40 / Chain 7 / 5755 MHz

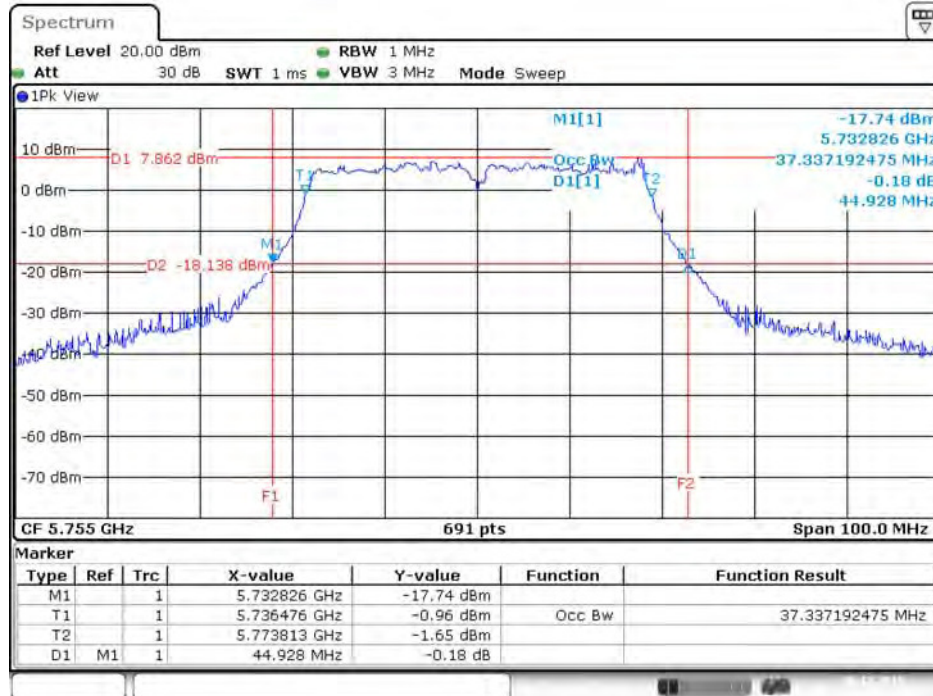

Date: 20.DEC.2015 13:47:23

26dB Bandwidth and 99% Occupied Bandwidth Plot on Configuration IEEE 802.11ac MCS0/Nss4 VHT40 / Chain 8 / 5755 MHz

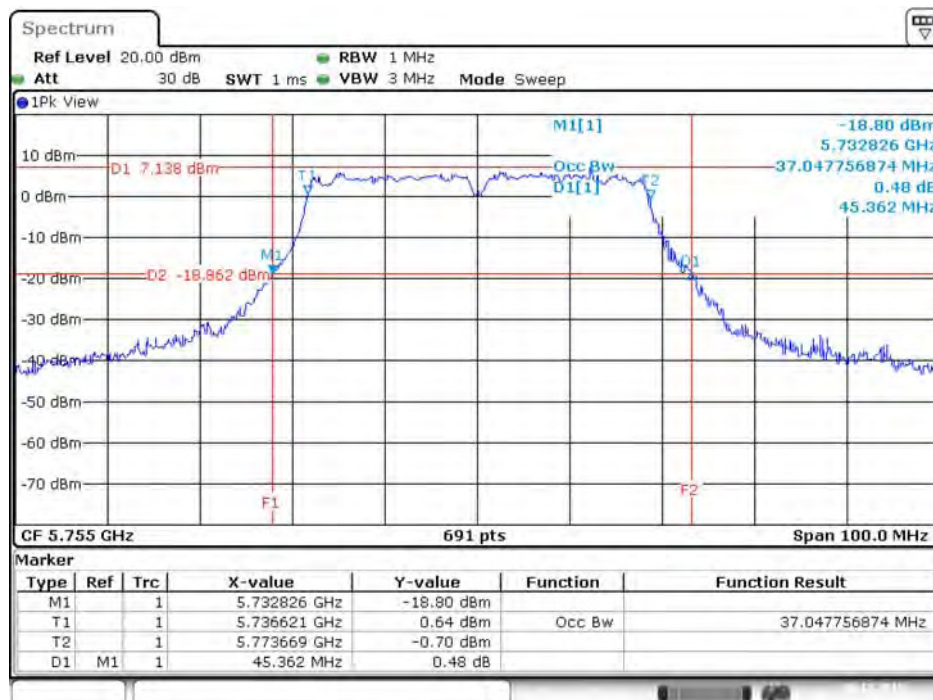

Date: 20.DEC.2015 13:46:20

26dB Bandwidth and 99% Occupied Bandwidth Plot on Configuration IEEE 802.11ac MCS0/Nss4 VHT40 / Chain 5 / 5795 MHz

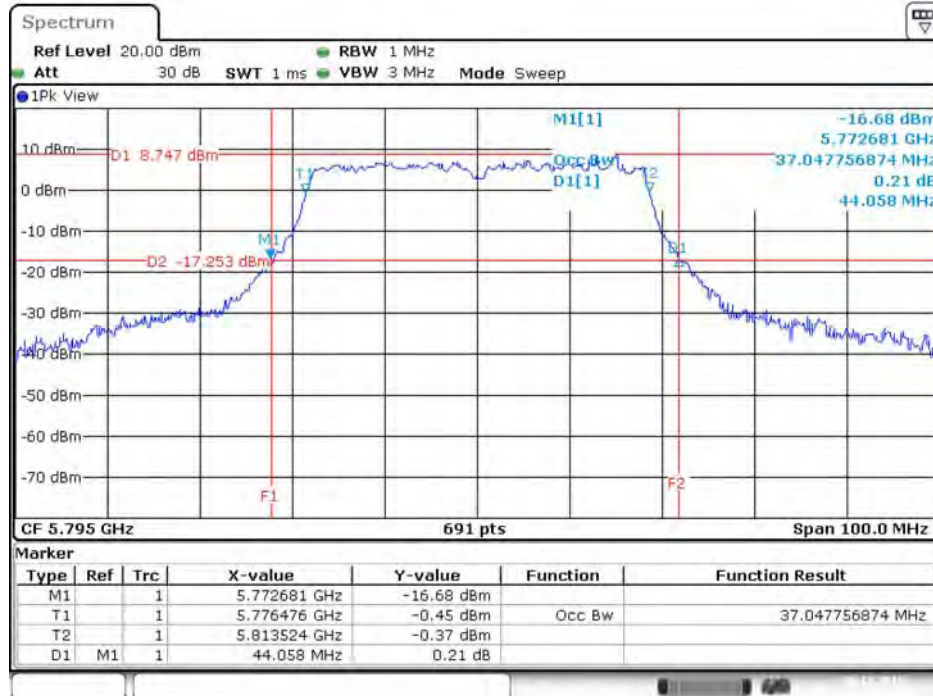

26dB Bandwidth and 99% Occupied Bandwidth Plot on Configuration IEEE 802.11ac MCS0/Nss4 VHT40 / Chain 6 / 5795 MHz

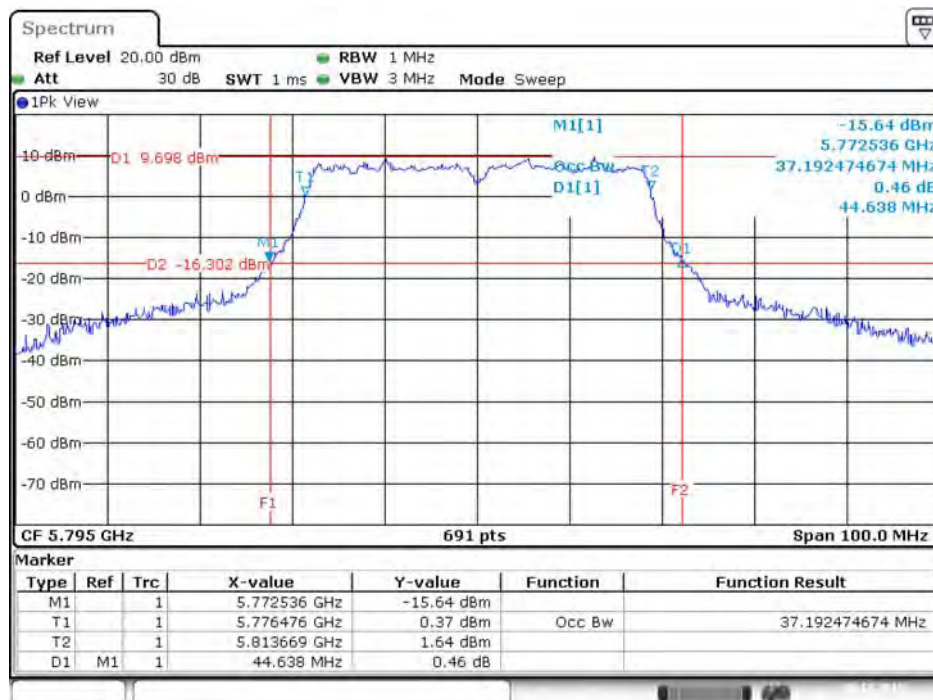

26dB Bandwidth and 99% Occupied Bandwidth Plot on Configuration IEEE 802.11ac MCS0/Nss4 VHT40 / Chain 7 / 5795 MHz

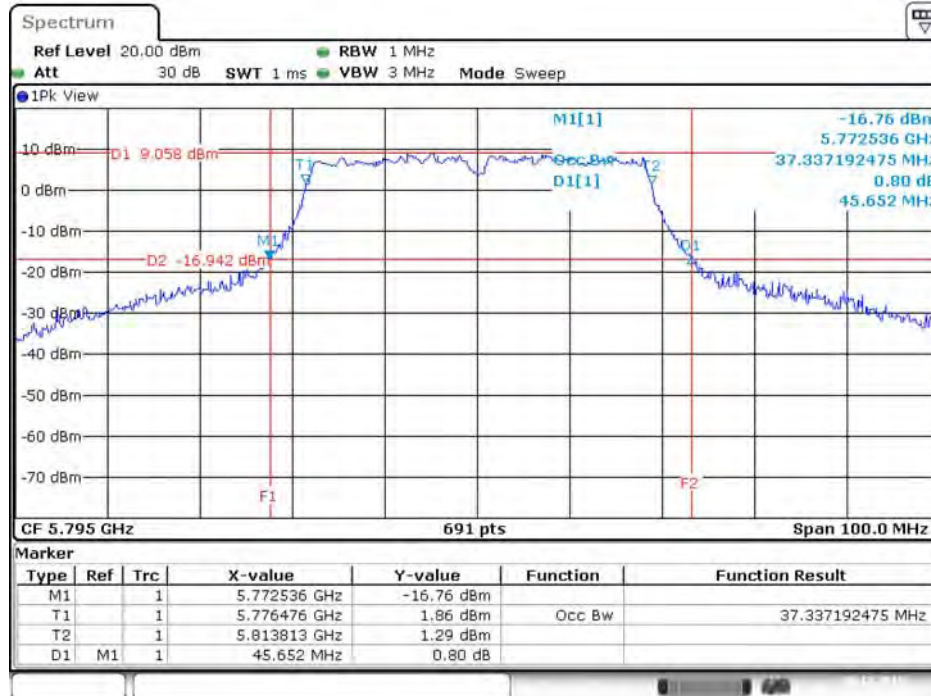

Date: 20.DEC.2015 13:54:01

26dB Bandwidth and 99% Occupied Bandwidth Plot on Configuration IEEE 802.11ac MCS0/Nss4 VHT40 / Chain 8 / 5795 MHz

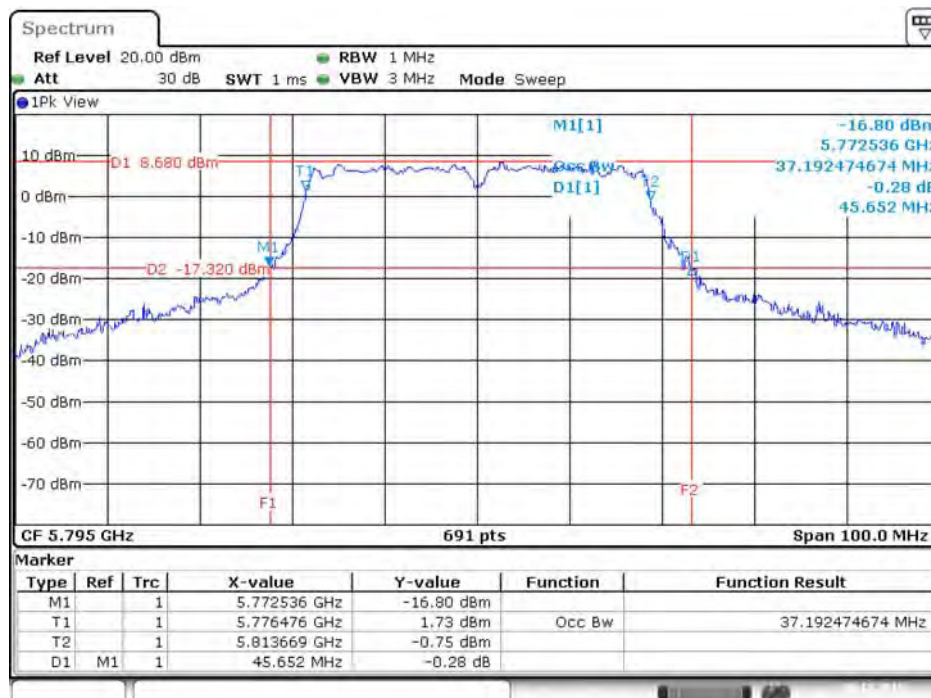

Date: 20.DEC.2015 13:54:32

**26dB Bandwidth and 99% Occupied Bandwidth Plot on Configuration IEEE 802.11ac MCS0/Nss4 VHT80 / Chain 5 / 5210 MHz**

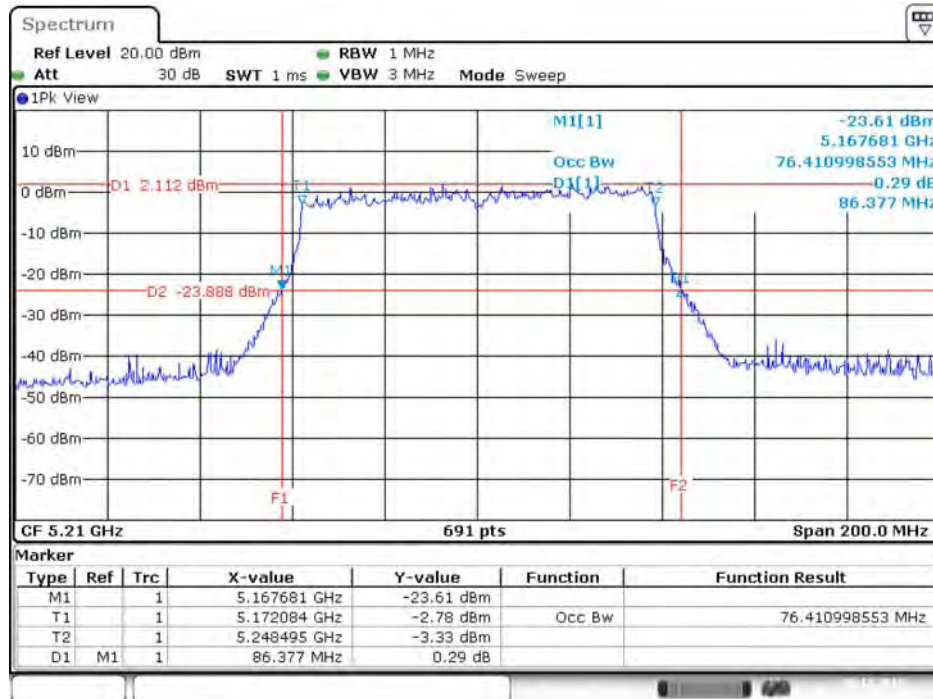

Date: 20.DEC.2015 13:20:41

**26dB Bandwidth and 99% Occupied Bandwidth Plot on Configuration IEEE 802.11ac MCS0/Nss4 VHT80 / Chain 6 / 5210 MHz**

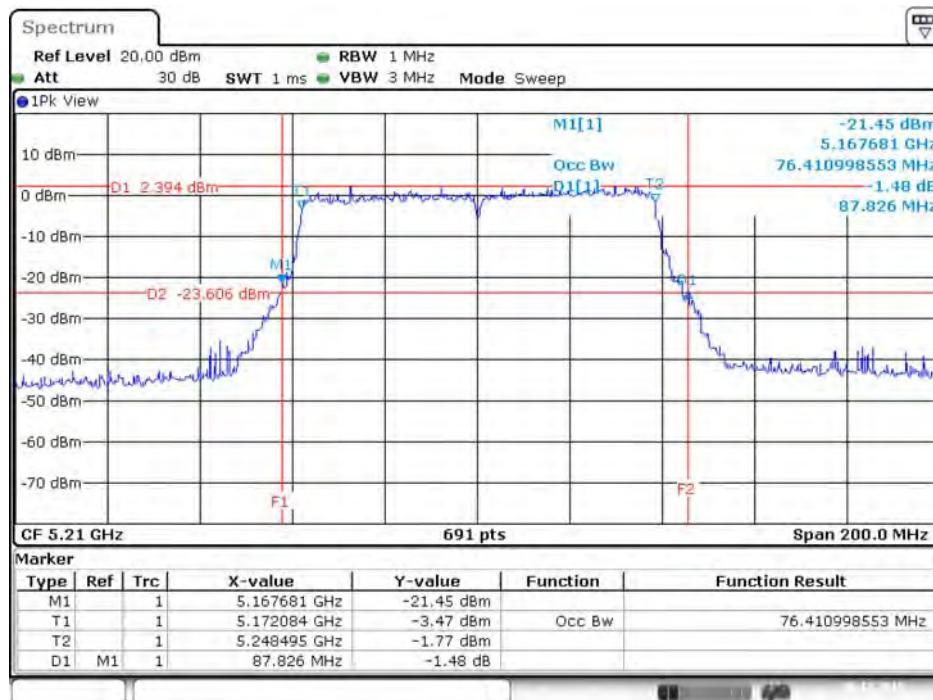

Date: 20.DEC.2015 13:20:11