

FCC Test Report

Report No.: RF151111C06A

FCC ID: UDX-60034010

Test Model: MC74-HW

Received Date: Nov. 26, 2015

Test Date: Nov. 26, 2015 ~ Jan. 12, 2016

Issued Date: Jan. 22, 2016

Applicant: Cisco Systems, Inc.

Address: 170 West Tasman Drive, San Jose, CA 95134 USA

Issued By: Bureau Veritas Consumer Products Services (H.K.) Ltd., Taoyuan Branch

Lab Address: No. 47-2, 14th Ling, Chia Pau Vil., Lin Kou Dist., New Taipei City, Taiwan (R.O.C)

Test Location (1): No. 19, Hwa Ya 2nd Rd, Wen Hwa Tsuen, Kwei Shan Hsiang, Taoyuan Hsien 333, Taiwan, R.O.C.

Test Location (2): No.215, Sec. 3, Beixin Rd., Xindian Dist., New Taipei City 231, Taiwan, R.O.C



This report is for your exclusive use. Any copying or replication of this report to or for any other person or entity, or use of our name or trademark, is permitted only with our prior written permission. This report sets forth our findings solely with respect to the test samples identified herein. The results set forth in this report are not indicative or representative of the quality or characteristics of the lot from which a test sample was taken or any similar or identical product unless specifically and expressly noted. Our report includes all of the tests requested by you and the results thereof based upon the information that you provided to us. You have 60 days from date of issuance of this report to notify us of any material error or omission caused by our negligence, provided, however, that such notice shall be in writing and shall specifically address the issue you wish to raise. A failure to raise such issue within the prescribed time shall constitute your unqualified acceptance of the completeness of this report, the tests conducted and the correctness of the report contents. Unless specific mention, the uncertainty of measurement has been explicitly taken into account to declare the compliance or non-compliance to the specification. The report must not be used by the client to claim product certification, approval, or endorsement by TAF or any government agencies.

Table of Contents

Release Control Record	4
1 Certificate of Conformity	5
2 Summary of Test Results.....	6
2.1 Measurement Uncertainty.....	6
2.2 Modification Record	6
3 General Information	7
3.1 General Description of EUT	7
3.2 Description of Test Modes.....	9
3.2.1 Test Mode Applicability and Tested Channel Detail.....	11
3.3 Duty Cycle of Test Signal	13
3.4 Description of Support Units	17
3.4.1 Configuration of System under Test	17
3.5 General Description of Applied Standards.....	18
4 Test Types and Results	19
4.1 Radiated Emission and Bandedge Measurement	19
4.1.1 Limits of Radiated Emission and Bandedge Measurement	19
4.1.2 Limits of Unwanted Emission Out of the Restricted Bands	19
4.1.3 Test Instruments	20
4.1.4 Test Procedures.....	21
4.1.5 Deviation from Test Standard	21
4.1.6 Test Set Up	22
4.1.7 EUT Operating Conditions.....	22
4.1.8 Test Results	23
4.2 Conducted Emission Measurement.....	69
4.2.1 Limits of Conducted Emission Measurement	69
4.2.2 Test Instruments	69
4.2.3 Test Procedures.....	70
4.2.4 Deviation from Test Standard	70
4.2.5 Test Setup.....	70
4.2.6 EUT Operating Conditions.....	70
4.2.7 Test Results	71
4.3 Transmit Power Measurement.....	75
4.3.1 Limits of Transmit Power Measurement	75
4.3.2 Test Setup.....	75
4.3.3 Test Instruments	76
4.3.4 Test Procedure	76
4.3.5 Deviation from Test Standard	76
4.3.6 EUT Operating Conditions.....	76
4.3.7 Test Result	77
4.4 Peak Power Spectral Density Measurement	82
4.4.1 Limits of Peak Power Spectral Density Measurement	82
4.4.2 Test Setup.....	82
4.4.3 Test Instruments	82
4.4.4 Test Procedures.....	83
4.4.5 Deviation from Test Standard	83
4.4.6 EUT Operating Conditions.....	83
4.4.7 Test Results	84
4.5 Frequency Stability	89
4.5.1 Limit of Frequency Stability Measurement	89
4.5.2 Test Setup.....	89
4.5.3 Test Instruments	89
4.5.4 Test Procedure	89
4.5.5 Deviation from Test Standard	89



4.5.6 EUT Operating Condition	89
4.5.7 Test Results	90
4.6 6 dB Bandwidth Measurement.....	91
4.6.1 Limits of 6 dB Bandwidth Measurement.....	91
4.6.2 Test Setup.....	91
4.6.3 Test Instruments	91
4.6.4 Test Procedure	91
4.6.5 Deviation from Test Standard	91
4.6.6 EUT Operating Condition	91
4.6.7 Test Results	92
5 Pictures of Test Arrangements.....	94
Appendix – Information on the Testing Laboratories	95



A D T

Release Control Record

Issue No.	Description	Date Issued
RF151111C06A	Original Release	Jan. 22, 2016

1 Certificate of Conformity

Product: VoIP Phone

Brand: Cisco

Test Model: MC74-HW

Sample Status: Engineering sample

Applicant: Cisco Systems, Inc.

Test Date: Nov. 26, 2015 ~ Jan. 12, 2016

Standards: 47 CFR FCC Part 15, Subpart E (Section 15.407)
ANSI C63.10:2013

The above equipment has been tested by **Bureau Veritas Consumer Products Services (H.K.) Ltd., Taoyuan Branch**, and found compliance with the requirement of the above standards. The test record, data evaluation & Equipment Under Test (EUT) configurations represented herein are true and accurate accounts of the measurements of the sample's EMC characteristics under the conditions specified in this report.

Prepared by : _____



Date: _____

Jan. 22, 2016

Vera Huang / Specialist

Approved by : _____

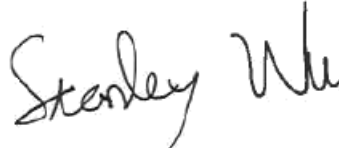

Date: _____

Jan. 22, 2016

Stanley Wu / Assistant Manager

2 Summary of Test Results

47 CFR FCC Part 15, Subpart E (Section 15.407)			
FCC Clause	Test Item	Result	Remarks
15.407(b)(6)	AC Power Conducted Emissions	Pass	Meet the requirement of limit. Minimum passing margin is -5.76 dB at 0.42782 MHz.
15.407(b) (1/2/3/4/6)	Radiated Emissions & Band Edge Measurement	Pass	Meet the requirement of limit. Minimum passing margin is -0.29 dB at 32.43 MHz.
15.407(a)(1/2 /3)	Max Average Transmit Power	Pass	Meet the requirement of limit.
15.407(a)(1/2 /3)	Peak Power Spectral Density	Pass	Meet the requirement of limit.
15.407(e)	6 dB Bandwidth	Pass	Meet the requirement of limit. (U-NII-3 Band only)
15.407(g)	Frequency Stability	Pass	Meet the requirement of limit.
15.203	Antenna Requirement	Pass	No antenna connector is used.

2.1 Measurement Uncertainty

Where relevant, the following measurement uncertainty levels have been estimated for tests performed on the EUT as specified in CISPR 16-4-2:

Measurement	Frequency	Expanded Uncertainty (k=2) (±)
Conducted Emissions at mains ports	150 kHz ~ 30 MHz	2.44 dB
Radiated Emissions up to 1 GHz	30 MHz ~ 200 MHz	2.0153 dB
	200 MHz ~ 1000 MHz	2.0224 dB
Radiated Emissions above 1 GHz	1 GHz ~ 18 GHz	1.0121 dB
	18 GHz ~ 40 GHz	1.1508 dB

2.2 Modification Record

There were no modifications required for compliance.

3 General Information

3.1 General Description of EUT

Product	VoIP Phone
Brand	Cisco
Test Model	MC74-HW
Power Supply Rating	12 Vdc (adapter) 54 Vdc (POE)
Modulation Type	256QAM, 64QAM, 16QAM, QPSK, BPSK
Modulation Technology	OFDM
Transfer Rate	802.11a: 54.0/ 48.0/ 36.0/ 24.0/ 18.0/ 12.0/ 9.0/ 6.0 Mbps 802.11n: up to MCS7 802.11ac: up to V9
Operating Frequency	5180 ~ 5240 MHz, 5260 ~ 5320 MHz, 5500 ~ 5700 MHz, 5745 ~ 5825 MHz
Number of Channel	5180 ~ 5240 MHz: 4 for 802.11a, 802.11n (HT20) 2 for 802.11n (HT40) 1 for 802.11ac (VHT80) 5260 ~ 5320 MHz: 4 for 802.11a, 802.11n (HT20) 2 for 802.11n (HT40) 1 for 802.11ac (VHT80) 5500 ~ 5700 MHz: 11 for 802.11a, 802.11n (HT20) 5 for 802.11n (HT40) 2 for 802.11ac (VHT80) 5745 ~ 5825 MHz: 5 for 802.11a, 802.11n (HT20) 2 for 802.11n (HT40) 1 for 802.11ac (VHT80)
Output Power	73.28 mW for 5180 ~ 5240 MHz 72.95 mW for 5260 ~ 5320 MHz 74.99 mW for 5500 ~ 5700 MHz 77.27 mW for 5745 ~ 5825 MHz
Antenna Type	PCB antenna with 2.81 dBi gain (5180 ~ 5240 MHz) PCB antenna with 3.10 dBi gain (5260 ~ 5320 MHz) PCB antenna with 2.56 dBi gain (5500 ~ 5700 MHz) PCB antenna with 2.78 dBi gain (5745 ~ 5825 MHz)
Antenna Connector	N/A
Accessory Device	Refer to Note as below
Data Cable Supplied	Refer to Note as below

Note:

1. The EUT provides one completed transmitter and one receiver.

Modulation Mode	Tx Function
802.11a	1TX
802.11n (HT20)	1TX
802.11n (HT40)	1TX
802.11ac (VHT80)	1TX

* The modulation and bandwidth are similar for 802.11n mode for HT20 / HT40 and 802.11ac mode for HT20 / HT40, therefore investigated worst case to representative mode in test report. (Final test mode refer section 3.2.1)

2. The EUT contains following accessory devices.

Product	Brand	Model	Description
Adapter	CUI INC	6A-181WP12	I/P: 100-240 Vac, 50/60 Hz, 0.6 A O/P: 12 Vdc, 1.5 A 1.5m cable with 1 core

3. The above EUT information is declared by manufacturer and for more detailed features description, please refer to the manufacturer's specifications or user's manual.

3.2 Description of Test Modes

FOR 5180 ~ 5240 MHz

4 channels are provided for 802.11a, 802.11n (HT20):

Channel	Frequency (MHz)	Channel	Frequency (MHz)
36	5180	44	5220
40	5200	48	5240

2 channels are provided for 802.11n (HT40):

Channel	Frequency (MHz)	Channel	Frequency (MHz)
38	5190	46	5230

1 channel is provided for 802.11ac (VHT80):

Channel	Frequency (MHz)
42	5210

FOR 5260 ~ 5320 MHz

4 channels are provided for 802.11a, 802.11n (HT20):

Channel	Frequency (MHz)	Channel	Frequency (MHz)
52	5260	60	5300
56	5280	64	5320

2 channels are provided for 802.11n (HT40):

Channel	Frequency (MHz)	Channel	Frequency (MHz)
54	5270	62	5310

1 channel is provided for 802.11ac (VHT80):

Channel	Frequency (MHz)
58	5290

FOR 5500 ~ 5700 MHz

11 channels are provided for 802.11a, 802.11n (HT20):

Channel	Frequency (MHz)	Channel	Frequency (MHz)
100	5500	124	5620
104	5520	128	5640
108	5540	132	5660
112	5560	136	5680
116	5580	140	5700
120	5600		

5 channels are provided for 802.11n (HT40):

Channel	Frequency (MHz)	Channel	Frequency (MHz)
102	5510	126	5630
110	5550	134	5670
118	5590		

2 channels are provided for 802.11ac (VHT80):

Channel	Frequency (MHz)	Channel	Frequency (MHz)
106	5530	122	5610

FOR 5745 ~ 5825 MHz:

5 channels are provided for 802.11a, 802.11n (HT20):

Channel	Frequency (MHz)	Channel	Frequency (MHz)
149	5745	161	5805
153	5765	165	5825
157	5785		

2 channels are provided for 802.11n (HT40):

Channel	Frequency (MHz)	Channel	Frequency (MHz)
151	5755	159	5795

1 channel is provided for 802.11ac (VHT80):

Channel	Frequency (MHz)
155	5775

3.2.1 Test Mode Applicability and Tested Channel Detail

EUT Configure Mode	Applicable To				Description
	RE \geq 1G	RE $<$ 1G	PLC	APCM	
A	√	√	√	√	Adapter Mode
B	-	√	√	-	POE Mode

Where **RE \geq 1G**: Radiated Emission above 1 GHz

RE $<$ 1G: Radiated Emission below 1 GHz

PLC: Power Line Conducted Emission

APCM: Antenna Port Conducted Measurement

NOTE: "-" means no effect.

Radiated Emission Test (Above 1 GHz):

Pre-Scan has been conducted to determine the worst-case mode from all possible combinations between available modulations, data rates and antenna ports (if EUT with antenna diversity architecture).

Following channel(s) was (were) selected for the final test as listed below.

EUT Configure Mode	Mode	Frequency Band (MHz)	Available Channel	Tested Channel	Modulation Technology	Modulation Type	Data Rate (Mbps)
A	802.11a	5180-5240	36 to 48	36, 44, 48	OFDM	BPSK	6.0
	802.11n (HT20)		36 to 48	36, 44, 48	OFDM	BPSK	MCS0
	802.11n (HT40)		38 to 46	38, 46	OFDM	BPSK	MCS0
	802.11ac (VHT80)		42	42	OFDM	BPSK	V0
	802.11a	5260-5320	52 to 64	52, 60, 64	OFDM	BPSK	6.0
	802.11n (HT20)		52 to 64	52, 60, 64	OFDM	BPSK	MCS0
	802.11n (HT40)		54 to 62	54, 62	OFDM	BPSK	MCS0
	802.11ac (VHT80)		58	58	OFDM	BPSK	V0
	802.11a	5500-5700	100 to 140	100, 116, 140	OFDM	BPSK	6.0
	802.11n (HT20)		100 to 140	100, 116, 140	OFDM	BPSK	MCS0
	802.11n (HT40)		102 to 134	102, 110, 134	OFDM	BPSK	MCS0
	802.11ac (VHT80)		106 to 122	106, 122	OFDM	BPSK	V0
	802.11a	5745-5825	149 to 165	149, 157, 165	OFDM	BPSK	6.0
	802.11n (HT20)		149 to 165	149, 157, 165	OFDM	BPSK	MCS0
	802.11n (HT40)		151 to 159	151, 159	OFDM	BPSK	MCS0
	802.11ac (VHT80)		155	155	OFDM	BPSK	V0

Radiated Emission Test (Below 1 GHz):

Pre-Scan has been conducted to determine the worst-case mode from all possible combinations between available modulations, data rates and antenna ports (if EUT with antenna diversity architecture).

Following channel(s) was (were) selected for the final test as listed below.

EUT Configure Mode	Mode	Frequency Band (MHz)	Available Channel	Tested Channel	Modulation Technology	Modulation Type	Data Rate (Mbps)
A, B	802.11ac (VHT80)	5180-5240	42	42	OFDM	BPSK	V0
A, B	802.11a	5260-5320	52 to 64	64	OFDM	BPSK	6.0
A, B	802.11a	5500-5700	100 to 140	100	OFDM	BPSK	6.0
A, B	802.11n (HT40)	5745-5825	151 to 159	151	OFDM	BPSK	MCS0

Power Line Conducted Emission Test:

- Pre-Scan has been conducted to determine the worst-case mode from all possible combinations between available modulations, data rates and antenna ports (if EUT with antenna diversity architecture).
- Following channel(s) was (were) selected for the final test as listed below.

EUT Configure Mode	Mode	Frequency Band (MHz)	Available Channel	Tested Channel	Modulation Technology	Modulation Type	Data Rate (Mbps)
A, B	802.11a	5500-5700	100 to 140	100	OFDM	BPSK	6.0

Antenna Port Conducted Measurement:

- This item includes all test value of each mode, but only includes spectrum plot of worst value of each mode.
- Pre-Scan has been conducted to determine the worst-case mode from all possible combinations between available modulations, data rates and antenna ports (if EUT with antenna diversity architecture).
- Following channel(s) was (were) selected for the final test as listed below.

EUT Configure Mode	Mode	Frequency Band (MHz)	Available Channel	Tested Channel	Modulation Technology	Modulation Type	Data Rate (Mbps)
A	802.11a	5180-5240	36 to 48	36, 44, 48	OFDM	BPSK	6.0
	802.11n (HT20)		36 to 48	36, 44, 48	OFDM	BPSK	MCS0
	802.11n (HT40)		38 to 46	38, 46	OFDM	BPSK	MCS0
	802.11ac (VHT80)		42	42	OFDM	BPSK	V0
	802.11a	5260-5320	52 to 64	52, 60, 64	OFDM	BPSK	6.0
	802.11n (HT20)		52 to 64	52, 60, 64	OFDM	BPSK	MCS0
	802.11n (HT40)		54 to 62	54, 62	OFDM	BPSK	MCS0
	802.11ac (VHT80)		58	58	OFDM	BPSK	V0
	802.11a	5500-5700	100 to 140	100, 116, 140	OFDM	BPSK	6.0
	802.11n (HT20)		100 to 140	100, 116, 140	OFDM	BPSK	MCS0
	802.11n (HT40)		102 to 134	102, 110, 134	OFDM	BPSK	MCS0
	802.11ac (VHT80)		106 to 122	106, 122	OFDM	BPSK	V0
	802.11a	5745-5825	149 to 165	149, 157, 165	OFDM	BPSK	6.0
	802.11n (HT20)		149 to 165	149, 157, 165	OFDM	BPSK	MCS0
	802.11n (HT40)		151 to 159	151, 159	OFDM	BPSK	MCS0
	802.11ac (VHT80)		155	155	OFDM	BPSK	V0

Test Condition:

Applicable To	Environmental Conditions	Input Power	Tested by
RE≥1G	25 deg. C, 65 % RH	120 Vac, 60 Hz	Karl Lee
RE<1G	25 deg. C, 65 % RH	120 Vac, 60 Hz	Karl Lee
PLC	25 deg. C, 65 % RH	120 Vac, 60 Hz	Toby Tian
APCM	25 deg. C, 65 % RH	120 Vac, 60 Hz	Luke Chen

3.3 Duty Cycle of Test Signal

MODULATION TYPE: BPSK

Duty cycle of test signal is < 98 %, duty factor is required.

802.11a: Duty cycle = 1.415/1.445 = 0.979, Duty factor = $10 * \log(1/0.979) = 0.09$

802.11n (HT20): Duty cycle = 1.325/1.360 = 0.974, Duty factor = $10 * \log(1/0.974) = 0.11$

802.11n (HT40): Duty cycle = 655/685 = 0.956, Duty factor = $10 * \log(1/0.956) = 0.20$

802.11ac (VHT80): Duty cycle = 290/345 = 0.841, Duty factor = $10 * \log(1/0.841) = 0.75$

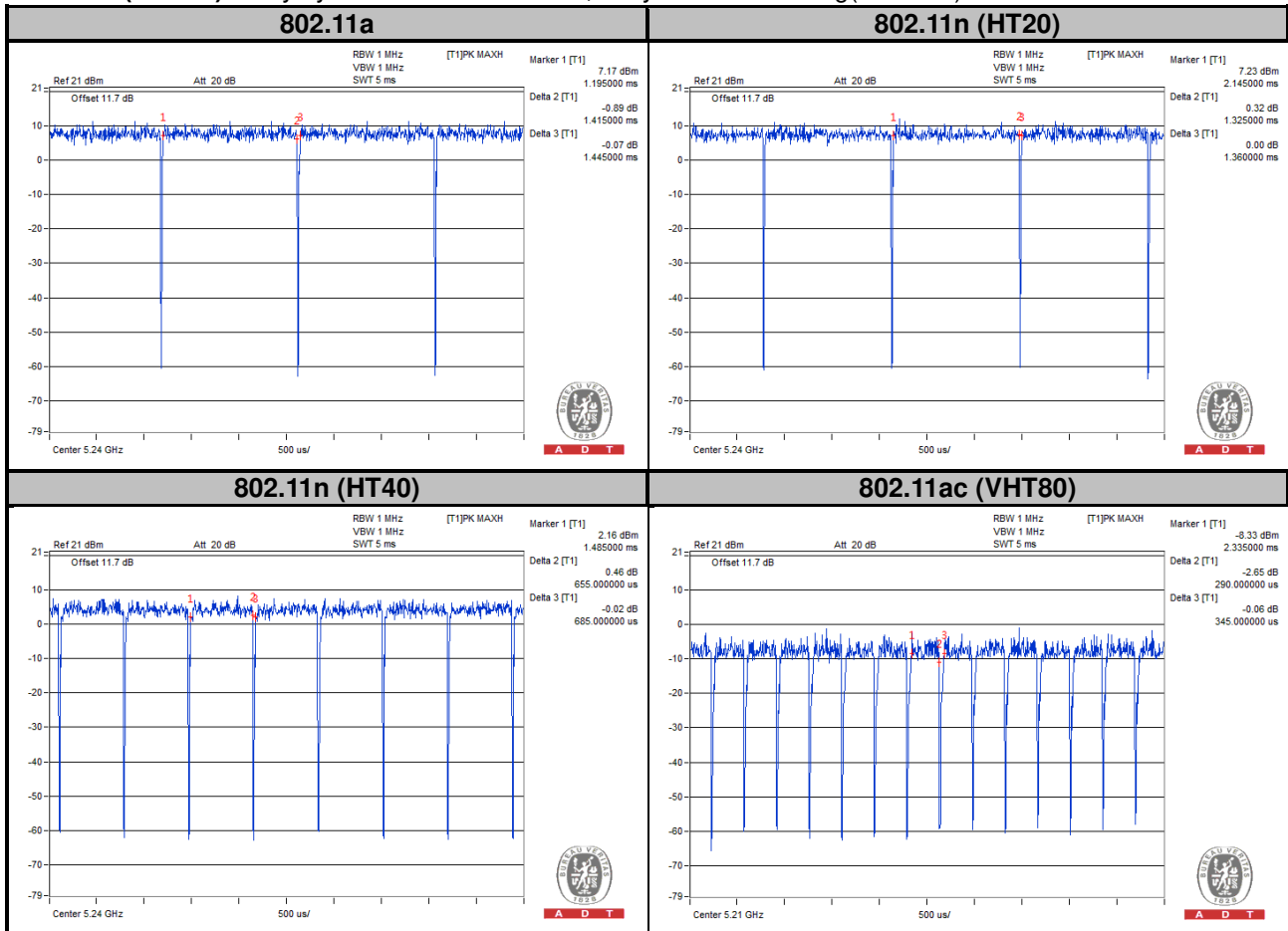

MODULATION TYPE: QPSK

Duty cycle of test signal is < 98 %, duty factor is required.

802.11a: Duty cycle = 715/745 = 0.960, Duty factor = $10 * \log(1/0.960) = 0.18$

802.11n (HT20): Duty cycle = 675/710 = 0.951, Duty factor = $10 * \log(1/0.951) = 0.22$

802.11n (HT40): Duty cycle = 343/373 = 0.92, Duty factor = $10 * \log(1/0.92) = 0.36$

802.11ac (VHT80): Duty cycle = 146/204 = 0.716, Duty factor = $10 * \log(1/0.716) = 1.45$

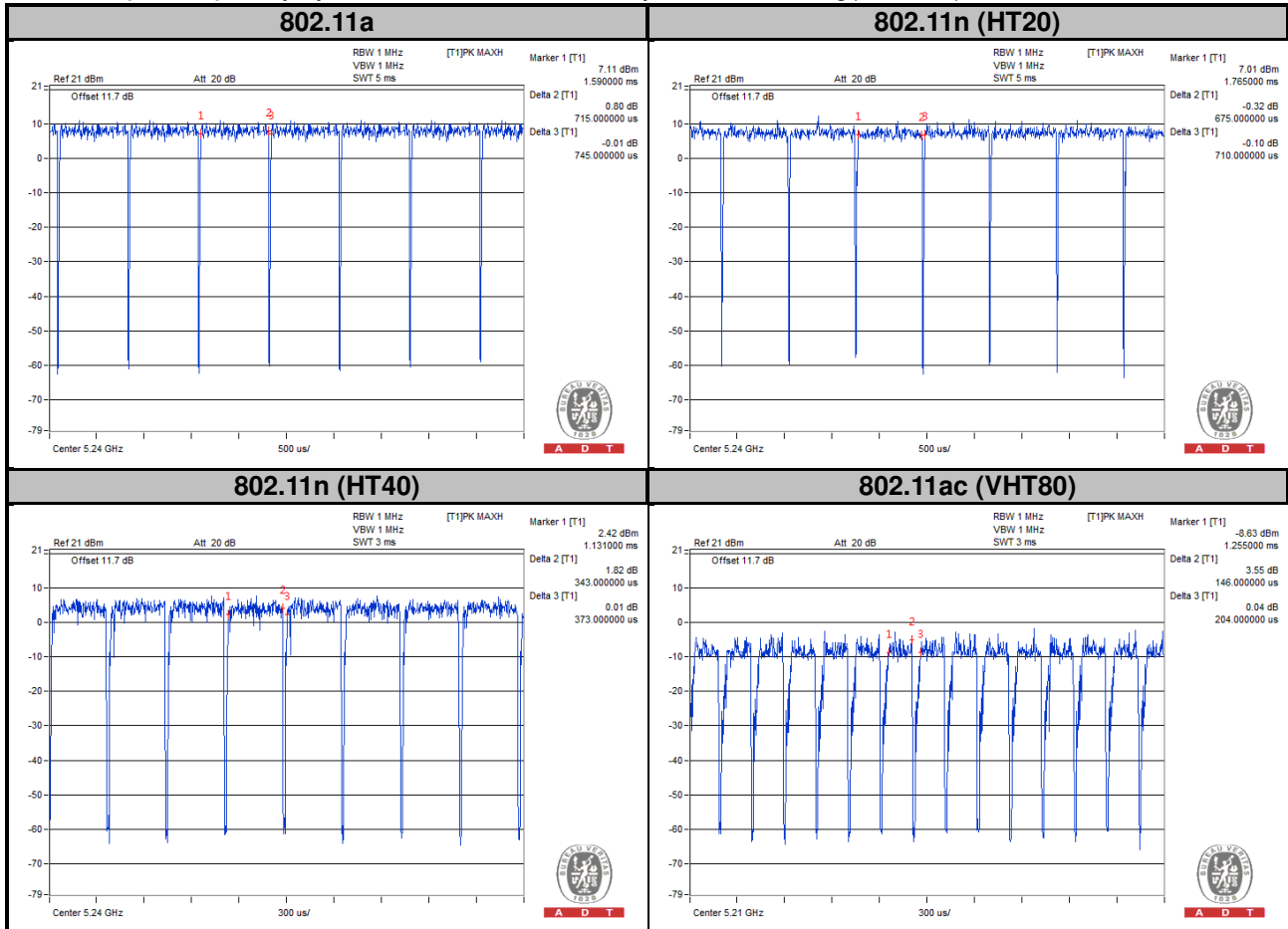

MODULATION TYPE: 16QAM

Duty cycle of test signal is < 98 %, duty factor is required.

802.11a: Duty cycle = 364/394 = 0.924, Duty factor = $10 * \log(1/0.924) = 0.34$

802.11n (HT20): Duty cycle = 354/386 = 0.917, Duty factor = $10 * \log(1/0.917) = 0.38$

802.11n (HT40): Duty cycle = 187/217 = 0.862, Duty factor = $10 * \log(1/0.862) = 0.64$

802.11ac (VHT80): Duty cycle = 78/134 = 0.582, Duty factor = $10 * \log(1/0.582) = 2.35$

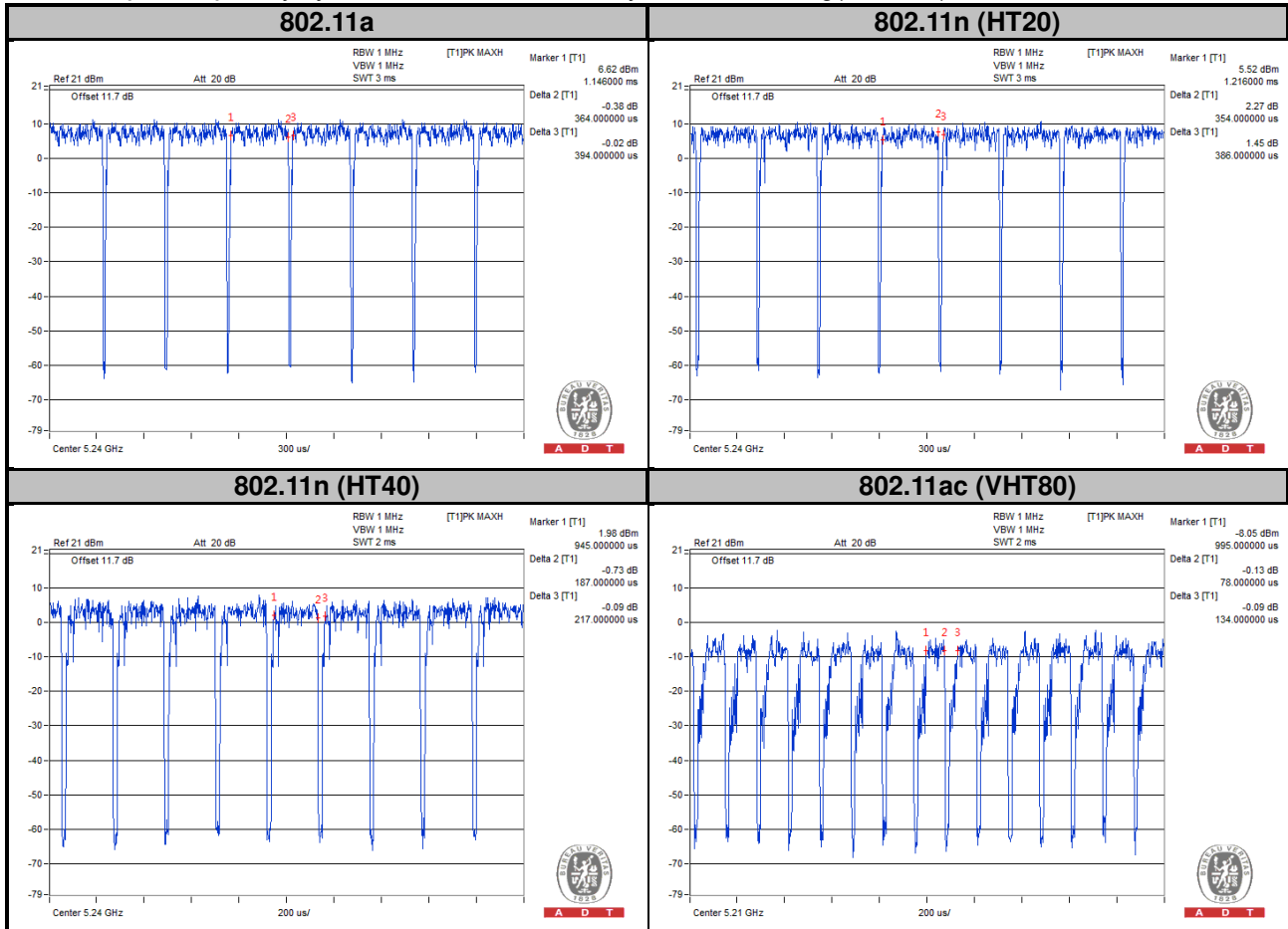

MODULATION TYPE: 64QAM

Duty cycle of test signal is < 98 %, duty factor is required.

802.11a: Duty cycle = 188/216 = 0.87, Duty factor = $10 * \log(1/0.87) = 0.60$

802.11n (HT20): Duty cycle = 192/222 = 0.865, Duty factor = $10 * \log(1/0.865) = 0.63$

802.11n (HT40): Duty cycle = 107/137 = 0.781, Duty factor = $10 * \log(1/0.781) = 1.07$

802.11ac (VHT80): Duty cycle = 42/98 = 0.429, Duty factor = $10 * \log(1/0.429) = 3.68$

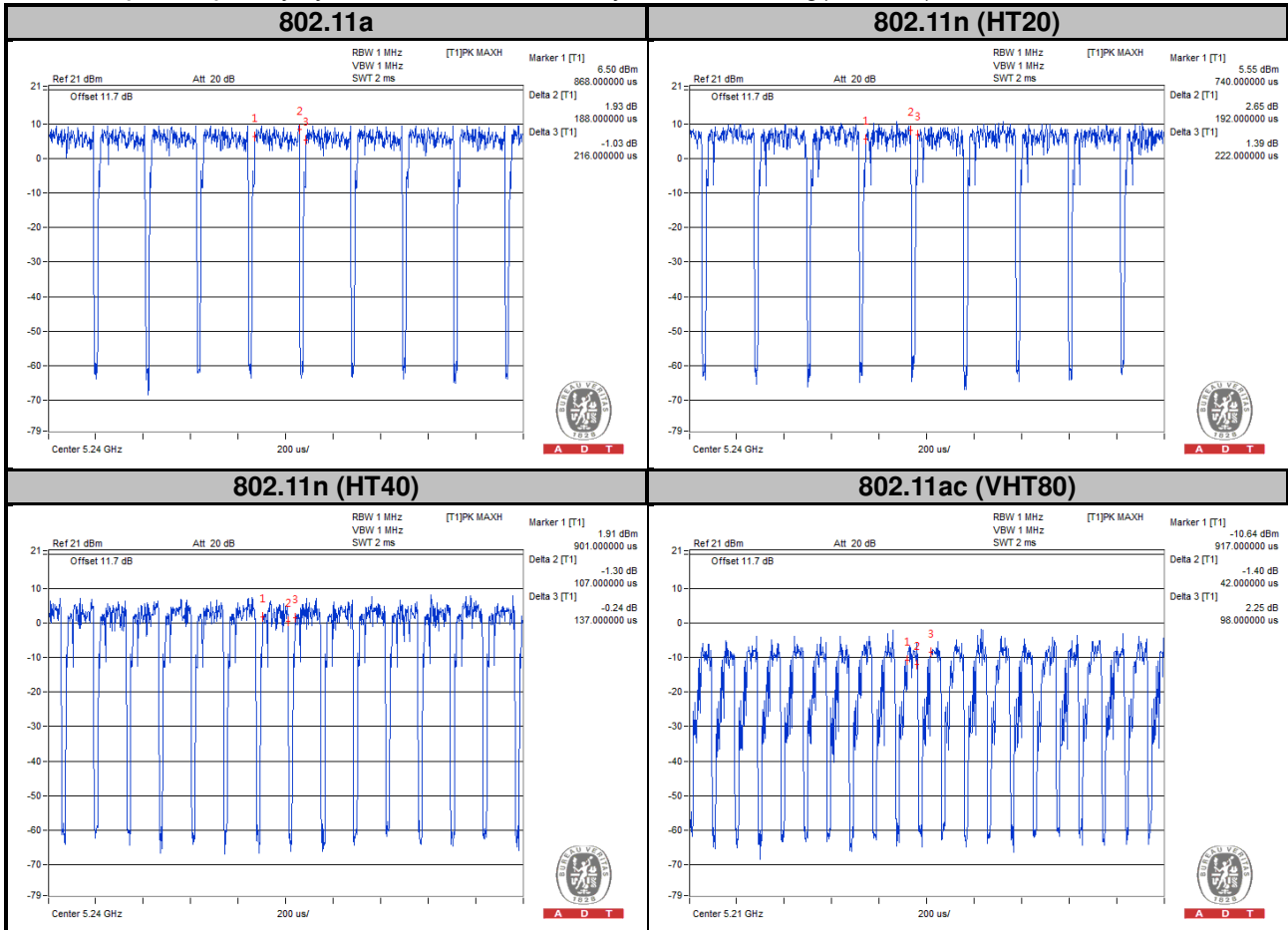

MODULATION TYPE: 256QAM

Duty cycle of test signal is < 98 %, duty factor is required.

802.11ac (VHT80): Duty cycle = 28/86 = 0.326, Duty factor = $10 * \log(1/0.326) = 4.87$

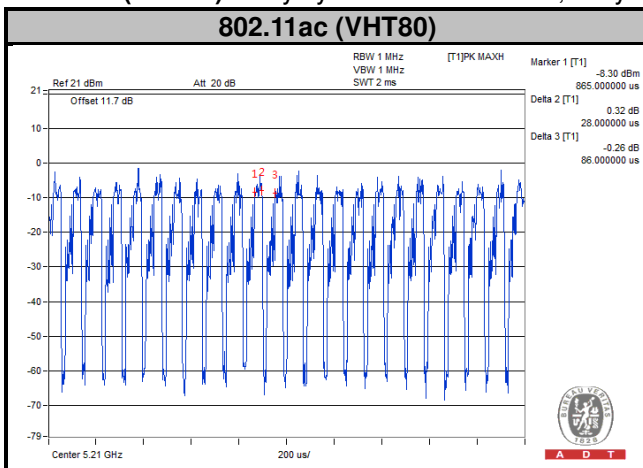

3.4 Description of Support Units

The EUT has been tested as an independent unit together with other necessary accessories or support units. The following support units or accessories were used to form a representative test configuration during the tests.

No.	Product	Brand	Model No.	Serial No.	FCC ID
1.	POE Switch	CISCO	SG300-10MPP	N/A	N/A

No.	Signal Cable Description Of The Above Support Units
1.	N/A

Note:

1. All power cords of the above support units are non-shielded (1.8m).
2. Item 1 was provided by client.

3.4.1 Configuration of System under Test

Mode A

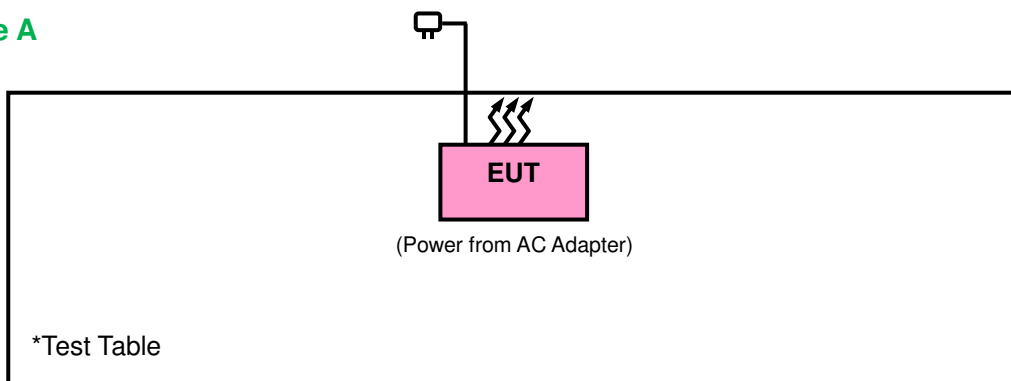

Mode B

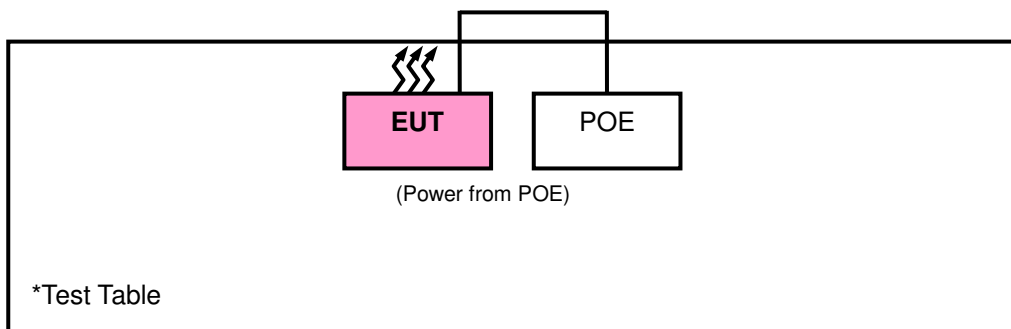

3.5 General Description of Applied Standards

The EUT is a RF Product. According to the specifications of the manufacturer, it must comply with the requirements of the following standards:

FCC Part 15, Subpart E (15.407)

789033 D02 General UNII Test Procedures New Rules v01r01

644545 D03 Guidance for IEEE 802 11ac v01

ANSI C63.10-2013

All test items have been performed and recorded as per the above standards.

NOTE: The EUT has been verified to comply with the requirements of FCC Part 15, Subpart B, Class B (DoC).
The test report has been issued separately.

4 Test Types and Results

4.1 Radiated Emission and Bandedge Measurement

4.1.1 Limits of Radiated Emission and Bandedge Measurement

Radiated emissions which fall in the restricted bands must comply with the radiated emission limits specified as below table. Other emissions shall be at least 20 dB below the highest level of the desired power:

Frequencies (MHz)	Field Strength (microvolts/meter)	Measurement Distance (meters)
0.009 ~ 0.490	2400/F (kHz)	300
0.490 ~ 1.705	24000/F (kHz)	30
1.705 ~ 30.0	30	30
30 ~ 88	100	3
88 ~ 216	150	3
216 ~ 960	200	3
Above 960	500	3

NOTE:

1. The lower limit shall apply at the transition frequencies.
2. Emission level (dBuV/m) = 20 log Emission level (uV/m).
3. For frequencies above 1000 MHz, the field strength limits are based on average detector, however, the peak field strength of any emission shall not exceed the maximum permitted average limits, specified above by more than 20 dB under any condition of modulation.

4.1.2 Limits of Unwanted Emission Out of the Restricted Bands

Applicable To	Limit	
789033 D02 General UNII Test Procedures New Rules v01	Field Strength at 3 m	
	PK: 74 (dBμV/m)	AV: 54 (dBμV/m)
Applicable To	EIRP Limit	Equivalent Field Strength at 3 m
15.407(b)(1)	PK: -27 (dBm/MHz)	PK: 68.2 (dBμV/m)
15.407(b)(2)		
15.407(b)(3)		
15.407(b)(4)	PK: -27 (dBm/MHz) ^{*1} PK: -17 (dBm/MHz) ^{*2}	PK: 68.2 (dBμV/m) ^{*1} PK: 78.2 (dBμV/m) ^{*2}

NOTE: ^{*1} beyond 10 MHz of the band edge ^{*2} within 10 MHz of band edge

The following formula is used to convert the equipment isotropic radiated power (eirp) to field strength:

$$E = \frac{1000000\sqrt{30P}}{3} \mu\text{V/m, where } P \text{ is the eirp (Watts).}$$

4.1.3 Test Instruments

Description & Manufacturer	Model No.	Serial No.	Date of Calibration	Due Date of Calibration
Test Receiver Agilent Technologies	N9038A	MY52260177	May 19, 2015	May 18, 2016
Spectrum Analyzer ROHDE & SCHWARZ	FSU43	101261	Dec. 10, 2014	Dec. 09, 2015
			Dec. 17, 2015	Dec. 16, 2016
BILOG Antenna SCHWARZBECK	VULB9168	9168-472	Feb. 04, 2015	Feb. 04, 2016
HORN Antenna ETS-Lindgren	3117	00143293	Feb. 06, 2015	Feb. 05, 2016
HORN Antenna SCHWARZBECK	BBHA 9170	9170-480	Feb. 04, 2015	Feb. 04, 2016
Agilent Communications Tester-Wireless	8960 Series 10	MY53201073	Jul. 03, 2015	Jul. 02, 2017
Preamplifier Agilent	310N	187226	Jun. 29, 2015	Jun. 28, 2016
Preamplifier Agilent	83017A	MY39501357	Jun. 29, 2015	Jun. 28, 2016
Power Meter Anritsu	ML2495A	1232002	Sep. 21, 2015	Sep. 20, 2016
Power Sensor Anritsu	MA2411B	1207325	Sep. 21, 2015	Sep. 20, 2016
RF signal cable ETS-LINDGREN	5D-FB	Cable-CH1-01(R FC-SMS-100-SM S-120+RFC-SMS -100-SMS-400)	Jun. 27, 2015	Jun. 26, 2016
RF signal cable ETS-LINDGREN	8D-FB	Cable-CH1-02(R FC-SMS-100-SM S-24)	Jun. 27, 2015	Jun. 26, 2016
Software BV ADT	E3 8.130425b	NA	NA	NA
Antenna Tower MF	NA	NA	NA	NA
Turn Table MF	NA	NA	NA	NA
Antenna Tower & Turn Table Controller MF	MF-7802	NA	NA	NA

Note: 1. The calibration interval of the above test instruments is 12 months and the calibrations are traceable to NML/ROC and NIST/USA.

2. The test was performed in HsinTien Chamber 1.
3. The horn antenna and preamplifier (model: 83017A) are used only for the measurement of emission frequency above 1 GHz if tested.
4. The FCC Site Registration No. is 149147.
5. The IC Site Registration No. is IC7450I-1.

4.1.4 Test Procedures

- a. The EUT was placed on the top of a rotating table 0.8 meters (for below 1 GHz) / 1.5 meters (for above 1 GHz) above the ground at 3 meter chamber room for test. The table was rotated 360 degrees to determine the position of the highest radiation.
- b. The EUT was set 3 meters away from the interference-receiving antenna, which was mounted on the top of a variable-height antenna tower.
- c. The height of antenna is varied from one meter to four meters above the ground to determine the maximum value of the field strength. Both horizontal and vertical polarizations of the antenna are set to make the measurement.
- d. For each suspected emission, the EUT was arranged to its worst case and then the antenna was tuned to heights from 1 meter to 4 meters and the rotatable table was turned from 0 degrees to 360 degrees to find the maximum reading.
- e. The test-receiver system was set to quasi-peak detect function and specified bandwidth with maximum hold mode when the test frequency is below 1 GHz.
- f. The test-receiver system was set to peak and average detected function and specified bandwidth with maximum hold mode when the test frequency is above 1 GHz. If the peak reading value also meets average limit, measurement with the average detector is unnecessary.

Note:

1. The resolution bandwidth and video bandwidth of test receiver/spectrum analyzer is 120 kHz for Quasi-peak detection (QP) at frequency below 1 GHz.
2. The resolution bandwidth of test receiver/spectrum analyzer is 1 MHz and the video bandwidth is 3 MHz for Peak detection (PK) at frequency above 1 GHz.
3. The resolution bandwidth of test receiver/spectrum analyzer is 1 MHz and the video bandwidth is 3 MHz for RMS Average (Duty cycle < 98 %) for Average detection (AV) at frequency above 1 GHz, then the measurement results was added to a correction factor ($10 \log(1/\text{duty cycle})$).
4. The resolution bandwidth of test receiver/spectrum analyzer is 1 MHz and the video bandwidth is 10 Hz (Duty cycle ≥ 98 %) for Average detection (AV) at frequency above 1 GHz.
5. All modes of operation were investigated and the worst-case emissions are reported.

4.1.5 Deviation from Test Standard

No deviation.

4.1.6 Test Set Up

<Frequency Range below 1 GHz>

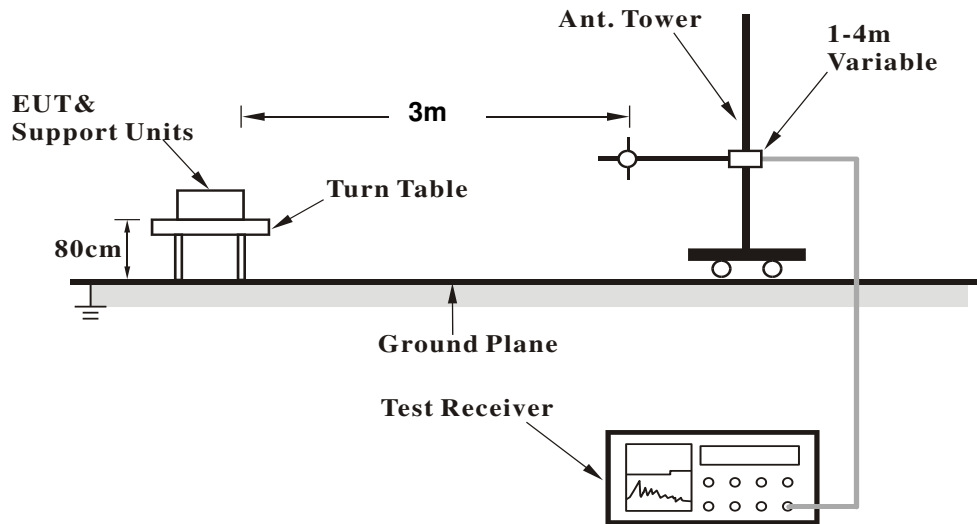

<Frequency Range above 1 GHz>

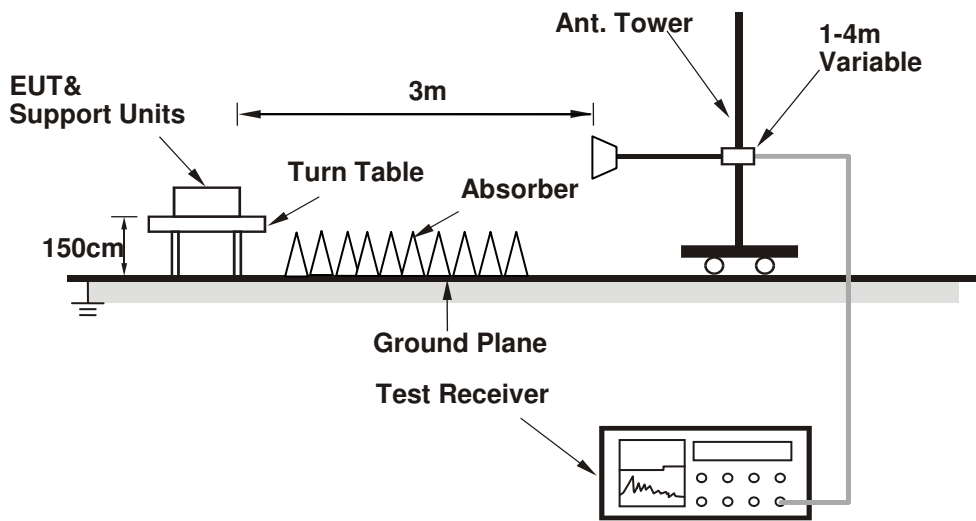

For the actual test configuration, please refer to the attached file (Test Setup Photo).

4.1.7 EUT Operating Conditions

- Placed the EUT on a testing table.
- Use the software to control the EUT under transmission condition continuously at specific channel frequency.

4.1.8 Test Results
ABOVE 1 GHz DATA :
802.11a

EUT Test Condition		Measurement Detail	
Channel	Channel 36	Frequency Range	1 GHz ~ 40 GHz
Input Power	120 Vac, 60 Hz	Detector Function	Peak (PK) Average (AV)
Environmental Conditions	25 deg. C, 65 % RH	Tested By	Karl Lee

Antenna Polarity & Test Distance: Horizontal at 3 m

Frequency (MHz)	Emission Level (dBuV/m)	Read Level (dBuV)	Limit (dBuV/m)	Margin (dB)	Antenna Factor (dB/m)	Cable Loss (dB)	Preamp Factor (dB)	Antenna Height (cm)	Table Angle (Degree)	Remark
5150	47.46	39.21	54	-6.54	34.12	8.13	34	100	331	Average
5150	58.87	50.62	74	-15.13	34.12	8.13	34	100	331	Peak
5180	97.15	88.84			34.15	8.16	34	100	331	Average
5180	104.22	95.91			34.15	8.16	34	100	331	Peak
5404	46.36	37.64	54	-7.64	34.32	8.44	34.04	100	331	Average
5404	57.48	48.76	74	-16.52	34.32	8.44	34.04	100	331	Peak

Antenna Polarity & Test Distance: Vertical at 3 m

Frequency (MHz)	Emission Level (dBuV/m)	Read Level (dBuV)	Limit (dBuV/m)	Margin (dB)	Antenna Factor (dB/m)	Cable Loss (dB)	Preamp Factor (dB)	Antenna Height (cm)	Table Angle (Degree)	Remark
5150	52.34	44.09	54	-1.66	34.12	8.13	34	130	332	Average
5150	64.31	56.06	74	-9.69	34.12	8.13	34	130	332	Peak
5180	100.87	92.56			34.15	8.16	34	130	332	Average
5180	108.21	99.9			34.15	8.16	34	130	332	Peak
5452	44.53	35.71	54	-9.47	34.36	8.51	34.05	130	332	Average
5452	58.24	49.42	74	-15.76	34.36	8.51	34.05	130	332	Peak

Remarks:

- Emission Level = Read Level + Antenna Factor + Cable Loss - Preamp Factor
Margin value = Emission level – Limit value
- 5180 MHz: Fundamental frequency.



A D T

EUT Test Condition		Measurement Detail	
Channel	Channel 44	Frequency Range	1 GHz ~ 40 GHz
Input Power	120 Vac, 60 Hz	Detector Function	Peak (PK) Average (AV)
Environmental Conditions	25 deg. C, 65 % RH	Tested By	Karl Lee

Antenna Polarity & Test Distance: Horizontal at 3 m										
Frequency (MHz)	Emission Level (dBuV/m)	Read Level (dBuV)	Limit (dBuV/m)	Margin (dB)	Antenna Factor (dB/m)	Cable Loss (dB)	Preamp Factor (dB)	Antenna Height (cm)	Table Angle (Degree)	Remark
5112	44.2	36	54	-9.8	34.09	8.1	33.99	112	332	Average
5112	56.47	48.27	74	-17.53	34.09	8.1	33.99	112	332	Peak
5220	100.74	92.35			34.17	8.22	34	112	332	Average
5220	107.56	99.17			34.17	8.22	34	112	332	Peak
5440	44.47	35.68	54	-9.53	34.35	8.48	34.04	112	332	Average
5440	56.62	47.83	74	-17.38	34.35	8.48	34.04	112	332	Peak

Antenna Polarity & Test Distance: Vertical at 3 m										
Frequency (MHz)	Emission Level (dBuV/m)	Read Level (dBuV)	Limit (dBuV/m)	Margin (dB)	Antenna Factor (dB/m)	Cable Loss (dB)	Preamp Factor (dB)	Antenna Height (cm)	Table Angle (Degree)	Remark
5150	46.05	37.8	54	-7.95	34.12	8.13	34	114	335	Average
5150	59.15	50.9	74	-14.85	34.12	8.13	34	114	335	Peak
5220	104.71	96.32			34.17	8.22	34	114	335	Average
5220	111.97	103.58			34.17	8.22	34	114	335	Peak
5434	44.49	35.7	54	-9.51	34.35	8.48	34.04	114	335	Average
5434	58.48	49.69	74	-15.52	34.35	8.48	34.04	114	335	Peak

Remarks:

- Emission Level = Read Level + Antenna Factor + Cable Loss - Preamp Factor
Margin value = Emission level – Limit value
- 5220 MHz: Fundamental frequency.



A D T

EUT Test Condition		Measurement Detail	
Channel	Channel 48	Frequency Range	1 GHz ~ 40 GHz
Input Power	120 Vac, 60 Hz	Detector Function	Peak (PK) Average (AV)
Environmental Conditions	25 deg. C, 65 % RH	Tested By	Karl Lee

Antenna Polarity & Test Distance: Horizontal at 3 m										
Frequency (MHz)	Emission Level (dBuV/m)	Read Level (dBuV)	Limit (dBuV/m)	Margin (dB)	Antenna Factor (dB/m)	Cable Loss (dB)	Preamp Factor (dB)	Antenna Height (cm)	Table Angle (Degree)	Remark
5118	42.86	34.66	54	-11.14	34.09	8.1	33.99	105	332	Average
5118	57.45	49.25	74	-16.55	34.09	8.1	33.99	105	332	Peak
5240	100.71	92.27			34.19	8.26	34.01	105	332	Average
5240	107.77	99.33			34.19	8.26	34.01	105	332	Peak
5392	44.33	35.65	54	-9.67	34.31	8.41	34.04	105	332	Average
5392	57.68	49	74	-16.32	34.31	8.41	34.04	105	332	Peak

Antenna Polarity & Test Distance: Vertical at 3 m										
Frequency (MHz)	Emission Level (dBuV/m)	Read Level (dBuV)	Limit (dBuV/m)	Margin (dB)	Antenna Factor (dB/m)	Cable Loss (dB)	Preamp Factor (dB)	Antenna Height (cm)	Table Angle (Degree)	Remark
5130	43.71	35.49	54	-10.29	34.11	8.1	33.99	101	331	Average
5130	57.92	49.7	74	-16.08	34.11	8.1	33.99	101	331	Peak
5240	104.93	96.49			34.19	8.26	34.01	101	331	Average
5240	111.14	102.7			34.19	8.26	34.01	101	331	Peak
5382	44.04	35.36	54	-9.96	34.31	8.41	34.04	101	331	Average
5382	58.28	49.6	74	-15.72	34.31	8.41	34.04	101	331	Peak

Remarks:

1. Emission Level = Read Level + Antenna Factor + Cable Loss - Preamp Factor
Margin value = Emission level – Limit value
2. 5240 MHz: Fundamental frequency.

EUT Test Condition		Measurement Detail	
Channel	Channel 52	Frequency Range	1 GHz ~ 40 GHz
Input Power	120 Vac, 60 Hz	Detector Function	Peak (PK) Average (AV)
Environmental Conditions	25 deg. C, 65 % RH	Tested By	Karl Lee

Antenna Polarity & Test Distance: Horizontal at 3 m										
Frequency (MHz)	Emission Level (dBuV/m)	Read Level (dBuV)	Limit (dBuV/m)	Margin (dB)	Antenna Factor (dB/m)	Cable Loss (dB)	Preamp Factor (dB)	Antenna Height (cm)	Table Angle (Degree)	Remark
5090	43.31	35.14	54	-10.69	34.08	8.07	33.98	174	16	Average
5090	57.77	49.6	74	-16.23	34.08	8.07	33.98	174	16	Peak
5260	99.65	91.19			34.21	8.26	34.01	174	16	Average
5260	107.25	98.79			34.21	8.26	34.01	174	16	Peak
5456	43.76	34.94	54	-10.24	34.36	8.51	34.05	174	16	Average
5456	58.41	49.59	74	-15.59	34.36	8.51	34.05	174	16	Peak
Antenna Polarity & Test Distance: Vertical at 3 m										
Frequency (MHz)	Emission Level (dBuV/m)	Read Level (dBuV)	Limit (dBuV/m)	Margin (dB)	Antenna Factor (dB/m)	Cable Loss (dB)	Preamp Factor (dB)	Antenna Height (cm)	Table Angle (Degree)	Remark
5138	43.48	35.23	54	-10.52	34.11	8.13	33.99	145	330	Average
5138	57.68	49.43	74	-16.32	34.11	8.13	33.99	145	330	Peak
5260	104.38	95.92			34.21	8.26	34.01	145	330	Average
5260	111.55	103.09			34.21	8.26	34.01	145	330	Peak
5430	43.52	34.73	54	-10.48	34.35	8.48	34.04	145	330	Average
5430	58.07	49.28	74	-15.93	34.35	8.48	34.04	145	330	Peak

Remarks:

- Emission Level = Read Level + Antenna Factor + Cable Loss - Preamp Factor
Margin value = Emission level – Limit value
- 5260 MHz: Fundamental frequency.

EUT Test Condition		Measurement Detail	
Channel	Channel 60	Frequency Range	1 GHz ~ 40 GHz
Input Power	120 Vac, 60 Hz	Detector Function	Peak (PK) Average (AV)
Environmental Conditions	25 deg. C, 65 % RH	Tested By	Karl Lee

Antenna Polarity & Test Distance: Horizontal at 3 m										
Frequency (MHz)	Emission Level (dBuV/m)	Read Level (dBuV)	Limit (dBuV/m)	Margin (dB)	Antenna Factor (dB/m)	Cable Loss (dB)	Preamp Factor (dB)	Antenna Height (cm)	Table Angle (Degree)	Remark
5126	43.2	34.98	54	-10.8	34.11	8.1	33.99	192	16	Average
5126	57.15	48.93	74	-16.85	34.11	8.1	33.99	192	16	Peak
5300	99.52	90.98			34.24	8.32	34.02	192	16	Average
5300	106.62	98.08			34.24	8.32	34.02	192	16	Peak
5356	48.9	40.27	54	-5.1	34.28	8.38	34.03	192	16	Average
5356	61.85	53.22	74	-12.15	34.28	8.38	34.03	192	16	Peak
Antenna Polarity & Test Distance: Vertical at 3 m										
Frequency (MHz)	Emission Level (dBuV/m)	Read Level (dBuV)	Limit (dBuV/m)	Margin (dB)	Antenna Factor (dB/m)	Cable Loss (dB)	Preamp Factor (dB)	Antenna Height (cm)	Table Angle (Degree)	Remark
5080	42.7	34.58	54	-11.3	34.07	8.03	33.98	101	342	Average
5080	56.6	48.48	74	-17.4	34.07	8.03	33.98	101	342	Peak
5300	103.29	94.75			34.24	8.32	34.02	101	342	Average
5300	110.25	101.71			34.24	8.32	34.02	101	342	Peak
5350	50.79	42.16	54	-3.21	34.28	8.38	34.03	101	342	Average
5350	63.26	54.63	74	-10.74	34.28	8.38	34.03	101	342	Peak

Remarks:

- Emission Level = Read Level + Antenna Factor + Cable Loss - Preamp Factor
Margin value = Emission level – Limit value
- 5300 MHz: Fundamental frequency.



EUT Test Condition		Measurement Detail	
Channel	Channel 64	Frequency Range	1 GHz ~ 40 GHz
Input Power	120 Vac, 60 Hz	Detector Function	Peak (PK) Average (AV)
Environmental Conditions	25 deg. C, 65 % RH	Tested By	Karl Lee

Antenna Polarity & Test Distance: Horizontal at 3 m										
Frequency (MHz)	Emission Level (dBuV/m)	Read Level (dBuV)	Limit (dBuV/m)	Margin (dB)	Antenna Factor (dB/m)	Cable Loss (dB)	Preamp Factor (dB)	Antenna Height (cm)	Table Angle (Degree)	Remark
5108	42.79	34.59	54	-11.21	34.09	8.1	33.99	188	17	Average
5108	58.24	50.04	74	-15.76	34.09	8.1	33.99	188	17	Peak
5320	96.81	88.23			34.25	8.35	34.02	188	17	Average
5320	104.2	95.62			34.25	8.35	34.02	188	17	Peak
5350	49.83	41.2	54	-4.17	34.28	8.38	34.03	188	17	Average
5350	63.16	54.53	74	-10.84	34.28	8.38	34.03	188	17	Peak

Antenna Polarity & Test Distance: Vertical at 3 m										
Frequency (MHz)	Emission Level (dBuV/m)	Read Level (dBuV)	Limit (dBuV/m)	Margin (dB)	Antenna Factor (dB/m)	Cable Loss (dB)	Preamp Factor (dB)	Antenna Height (cm)	Table Angle (Degree)	Remark
5100	42.76	34.6	54	-11.24	34.08	8.07	33.99	101	334	Average
5100	57.33	49.17	74	-16.67	34.08	8.07	33.99	101	334	Peak
5320	100.19	91.61			34.25	8.35	34.02	101	334	Average
5320	108.43	99.85			34.25	8.35	34.02	101	334	Peak
5352	52.93	44.3	54	-1.07	34.28	8.38	34.03	101	334	Average
5352	67.08	58.45	74	-6.92	34.28	8.38	34.03	101	334	Peak

Remarks:

- Emission Level = Read Level + Antenna Factor + Cable Loss - Preamp Factor
Margin value = Emission level – Limit value
- 5320 MHz: Fundamental frequency.

EUT Test Condition		Measurement Detail	
Channel	Channel 100	Frequency Range	1 GHz ~ 40 GHz
Input Power	120 Vac, 60 Hz	Detector Function	Peak (PK) Average (AV)
Environmental Conditions	25 deg. C, 65 % RH	Tested By	Karl Lee

Antenna Polarity & Test Distance: Horizontal at 3 m										
Frequency (MHz)	Emission Level (dBuV/m)	Read Level (dBuV)	Limit (dBuV/m)	Margin (dB)	Antenna Factor (dB/m)	Cable Loss (dB)	Preamp Factor (dB)	Antenna Height (cm)	Table Angle (Degree)	Remark
5454	50.37	41.55	54	-3.63	34.36	8.51	34.05	102	205	Average
5454	62.64	53.82	74	-11.36	34.36	8.51	34.05	102	205	Peak
5470	65.4	56.57	68.2	-2.8	34.37	8.51	34.05	102	205	Peak
5500	96.87	87.95			34.4	8.57	34.05	102	205	Average
5500	104.08	95.16			34.4	8.57	34.05	102	205	Peak
5725	57.01	47.85	68.2	-11.19	34.62	8.65	34.11	102	205	Peak
Antenna Polarity & Test Distance: Vertical at 3 m										
Frequency (MHz)	Emission Level (dBuV/m)	Read Level (dBuV)	Limit (dBuV/m)	Margin (dB)	Antenna Factor (dB/m)	Cable Loss (dB)	Preamp Factor (dB)	Antenna Height (cm)	Table Angle (Degree)	Remark
5460	51.65	42.83	54	-2.35	34.36	8.51	34.05	234	0	Average
5460	61.74	52.92	74	-12.26	34.36	8.51	34.05	234	0	Peak
5470	67.25	58.42	68.2	-0.95	34.37	8.51	34.05	234	0	Peak
5500	100.05	91.13			34.4	8.57	34.05	234	0	Average
5500	107.63	98.71			34.4	8.57	34.05	234	0	Peak
5725	56.14	46.98	68.2	-12.06	34.62	8.65	34.11	234	0	Peak

Remarks:

- Emission Level = Read Level + Antenna Factor + Cable Loss - Preamp Factor
Margin value = Emission level – Limit value
- 5500 MHz: Fundamental frequency.
- 5470 MHz & 5725 MHz: Out of restricted band

EUT Test Condition		Measurement Detail	
Channel	Channel 116	Frequency Range	1 GHz ~ 40 GHz
Input Power	120 Vac, 60 Hz	Detector Function	Peak (PK) Average (AV)
Environmental Conditions	25 deg. C, 65 % RH	Tested By	Karl Lee

Antenna Polarity & Test Distance: Horizontal at 3 m										
Frequency (MHz)	Emission Level (dBuV/m)	Read Level (dBuV)	Limit (dBuV/m)	Margin (dB)	Antenna Factor (dB/m)	Cable Loss (dB)	Preamp Factor (dB)	Antenna Height (cm)	Table Angle (Degree)	Remark
5352	43.15	34.52	54	-10.85	34.28	8.38	34.03	188	27	Average
5352	58.24	49.61	74	-15.76	34.28	8.38	34.03	188	27	Peak
5470	55.27	46.44	68.2	-12.93	34.37	8.51	34.05	188	27	Peak
5580	99.43	90.44			34.47	8.6	34.08	188	27	Average
5580	106.53	97.54			34.47	8.6	34.08	188	27	Peak
5725	55.83	46.67	68.2	-12.37	34.62	8.65	34.11	188	27	Peak
11160	51.78	36.7	54	-2.22	37.7	12.83	35.45	151	219	Average
11160	63.73	48.65	74	-10.27	37.7	12.83	35.45	151	219	Peak

Antenna Polarity & Test Distance: Vertical at 3 m										
Frequency (MHz)	Emission Level (dBuV/m)	Read Level (dBuV)	Limit (dBuV/m)	Margin (dB)	Antenna Factor (dB/m)	Cable Loss (dB)	Preamp Factor (dB)	Antenna Height (cm)	Table Angle (Degree)	Remark
5416	43.49	34.76	54	-10.51	34.33	8.44	34.04	238	0	Average
5416	57.74	49.01	74	-16.26	34.33	8.44	34.04	238	0	Peak
5470	57.3	48.47	68.2	-10.9	34.37	8.51	34.05	238	0	Peak
5580	101.6	92.61			34.47	8.6	34.08	238	0	Average
5580	109.66	100.67			34.47	8.6	34.08	238	0	Peak
5725	58.66	49.5	68.2	-9.54	34.62	8.65	34.11	238	0	Peak
11160	50.54	35.46	54	-3.46	37.7	12.83	35.45	100	243	Average
11160	63.79	48.71	74	-10.21	37.7	12.83	35.45	100	243	Peak

Remarks:

- Emission Level = Read Level + Antenna Factor + Cable Loss - Preamp Factor
Margin value = Emission level – Limit value
- 5580 MHz: Fundamental frequency.
- 5470 MHz & 5725 MHz: Out of restricted band

EUT Test Condition		Measurement Detail	
Channel	Channel 140	Frequency Range	1 GHz ~ 40 GHz
Input Power	120 Vac, 60 Hz	Detector Function	Peak (PK) Average (AV)
Environmental Conditions	25 deg. C, 65 % RH	Tested By	Karl Lee

Antenna Polarity & Test Distance: Horizontal at 3 m										
Frequency (MHz)	Emission Level (dBuV/m)	Read Level (dBuV)	Limit (dBuV/m)	Margin (dB)	Antenna Factor (dB/m)	Cable Loss (dB)	Preamp Factor (dB)	Antenna Height (cm)	Table Angle (Degree)	Remark
5452	42.87	34.05	54	-11.13	34.36	8.51	34.05	250	27	Average
5452	57.18	48.36	74	-16.82	34.36	8.51	34.05	250	27	Peak
5470	56.35	47.52	68.2	-11.85	34.37	8.51	34.05	250	27	Peak
5700	94.23	85.1			34.59	8.64	34.1	250	27	Average
5700	102.3	93.17			34.59	8.64	34.1	250	27	Peak
5725	67	57.84	68.2	-1.2	34.62	8.65	34.11	250	27	Peak
Antenna Polarity & Test Distance: Vertical at 3 m										
Frequency (MHz)	Emission Level (dBuV/m)	Read Level (dBuV)	Limit (dBuV/m)	Margin (dB)	Antenna Factor (dB/m)	Cable Loss (dB)	Preamp Factor (dB)	Antenna Height (cm)	Table Angle (Degree)	Remark
5438	43.1	34.31	54	-10.9	34.35	8.48	34.04	100	0	Average
5438	56.59	47.8	74	-17.41	34.35	8.48	34.04	100	0	Peak
5470	53.96	45.13	68.2	-14.24	34.37	8.51	34.05	100	0	Peak
5700	97.86	88.73			34.59	8.64	34.1	100	0	Average
5700	105.02	95.89			34.59	8.64	34.1	100	0	Peak
5725	67.16	58	68.2	-1.04	34.62	8.65	34.11	100	0	Peak

Remarks:

- Emission Level = Read Level + Antenna Factor + Cable Loss - Preamp Factor
Margin value = Emission level – Limit value
- 5700 MHz: Fundamental frequency.
- 5470 MHz & 5725 MHz: Out of restricted band



A D T

EUT Test Condition		Measurement Detail	
Channel	Channel 149	Frequency Range	1 GHz ~ 40 GHz
Input Power	120 Vac, 60 Hz	Detector Function	Peak (PK) Average (AV)
Environmental Conditions	25 deg. C, 65 % RH	Tested By	Karl Lee

Antenna Polarity & Test Distance: Horizontal at 3 m										
Frequency (MHz)	Emission Level (dBuV/m)	Read Level (dBuV)	Limit (dBuV/m)	Margin (dB)	Antenna Factor (dB/m)	Cable Loss (dB)	Preamp Factor (dB)	Antenna Height (cm)	Table Angle (Degree)	Remark
*5714	64.84	55.69	68.2	-3.36	34.61	8.65	34.11	114	330	Peak
*5724	71.88	62.72	78.2	-6.32	34.62	8.65	34.11	114	330	Peak
5745	98.3	89.11			34.64	8.66	34.11	114	330	Average
5745	106.5	97.31			34.64	8.66	34.11	114	330	Peak
*5860	63.31	53.99	78.2	-14.89	34.76	8.7	34.14	114	330	Peak
*5864	63.18	53.85	68.2	-5.02	34.76	8.71	34.14	114	330	Peak
Antenna Polarity & Test Distance: Vertical at 3 m										
Frequency (MHz)	Emission Level (dBuV/m)	Read Level (dBuV)	Limit (dBuV/m)	Margin (dB)	Antenna Factor (dB/m)	Cable Loss (dB)	Preamp Factor (dB)	Antenna Height (cm)	Table Angle (Degree)	Remark
*5714	67.08	57.93	68.2	-1.12	34.61	8.65	34.11	149	327	Peak
*5722	75.38	66.22	78.2	-2.82	34.62	8.65	34.11	149	327	Peak
5745	101.1	91.91			34.64	8.66	34.11	149	327	Average
5745	109.19	100			34.64	8.66	34.11	149	327	Peak
*5852	63.38	54.08	78.2	-14.82	34.74	8.7	34.14	149	327	Peak
*5870	62.61	53.28	68.2	-5.59	34.76	8.71	34.14	149	327	Peak

Remarks:

1. Emission Level = Read Level + Antenna Factor + Cable Loss - Preamp Factor
Margin value = Emission level – Limit value
2. 5745 MHz: Fundamental frequency.
3. *: Out of restricted band

EUT Test Condition		Measurement Detail	
Channel	Channel 157	Frequency Range	1 GHz ~ 40 GHz
Input Power	120 Vac, 60 Hz	Detector Function	Peak (PK) Average (AV)
Environmental Conditions	25 deg. C, 65 % RH	Tested By	Karl Lee

Antenna Polarity & Test Distance: Horizontal at 3 m										
Frequency (MHz)	Emission Level (dBuV/m)	Read Level (dBuV)	Limit (dBuV/m)	Margin (dB)	Antenna Factor (dB/m)	Cable Loss (dB)	Preamp Factor (dB)	Antenna Height (cm)	Table Angle (Degree)	Remark
*5712	59.5	50.35	68.2	-8.7	34.61	8.65	34.11	101	330	Peak
*5716	64.82	55.67	78.2	-13.38	34.61	8.65	34.11	101	330	Peak
5785	101.96	92.73			34.68	8.68	34.13	101	330	Average
5785	109.41	100.18			34.68	8.68	34.13	101	330	Peak
*5852	63.53	54.23	78.2	-14.67	34.74	8.7	34.14	101	330	Peak
*5870	62.66	53.33	68.2	-5.54	34.76	8.71	34.14	101	330	Peak
11570	51.9	36.59	54	-2.1	38	12.68	35.37	151	223	Average
11570	62.32	47.01	74	-11.68	38	12.68	35.37	151	223	Peak

Antenna Polarity & Test Distance: Vertical at 3 m										
Frequency (MHz)	Emission Level (dBuV/m)	Read Level (dBuV)	Limit (dBuV/m)	Margin (dB)	Antenna Factor (dB/m)	Cable Loss (dB)	Preamp Factor (dB)	Antenna Height (cm)	Table Angle (Degree)	Remark
*5710	63.23	54.08	68.2	-4.97	34.61	8.65	34.11	147	327	Peak
*5724	63.5	54.34	78.2	-14.7	34.62	8.65	34.11	147	327	Peak
5785	104.46	95.23			34.68	8.68	34.13	147	327	Average
5785	112.4	103.17			34.68	8.68	34.13	147	327	Peak
*5856	64.32	55	78.2	-13.88	34.76	8.7	34.14	147	327	Peak
*5862	62.9	53.57	68.2	-5.3	34.76	8.71	34.14	147	327	Peak
11570	49.6	34.29	54	-4.4	38	12.68	35.37	100	249	Average
11570	61.06	45.75	74	-12.94	38	12.68	35.37	100	249	Peak

Remarks:

- Emission Level = Read Level + Antenna Factor + Cable Loss - Preamp Factor
Margin value = Emission level – Limit value
- 5785 MHz: Fundamental frequency.
- *: Out of restricted band

EUT Test Condition		Measurement Detail	
Channel	Channel 165	Frequency Range	1 GHz ~ 40 GHz
Input Power	120 Vac, 60 Hz	Detector Function	Peak (PK) Average (AV)
Environmental Conditions	25 deg. C, 65 % RH	Tested By	Karl Lee

Antenna Polarity & Test Distance: Horizontal at 3 m										
Frequency (MHz)	Emission Level (dBuV/m)	Read Level (dBuV)	Limit (dBuV/m)	Margin (dB)	Antenna Factor (dB/m)	Cable Loss (dB)	Preamp Factor (dB)	Antenna Height (cm)	Table Angle (Degree)	Remark
*5714	63.31	54.16	68.2	-4.89	34.61	8.65	34.11	113	330	Peak
*5722	62.23	53.07	78.2	-15.97	34.62	8.65	34.11	113	330	Peak
5825	98.42	89.13			34.73	8.69	34.13	113	330	Average
5825	106.05	96.76			34.73	8.69	34.13	113	330	Peak
*5852	71.6	62.3	78.2	-6.6	34.74	8.7	34.14	113	330	Peak
*5864	63.76	54.43	68.2	-4.44	34.76	8.71	34.14	113	330	Peak
Antenna Polarity & Test Distance: Vertical at 3 m										
Frequency (MHz)	Emission Level (dBuV/m)	Read Level (dBuV)	Limit (dBuV/m)	Margin (dB)	Antenna Factor (dB/m)	Cable Loss (dB)	Preamp Factor (dB)	Antenna Height (cm)	Table Angle (Degree)	Remark
*5710	64.69	55.54	68.2	-3.51	34.61	8.65	34.11	159	327	Peak
*5720	64.09	54.93	78.2	-14.11	34.62	8.65	34.11	159	327	Peak
5825	101.52	92.23			34.73	8.69	34.13	159	327	Average
5825	109.03	99.74			34.73	8.69	34.13	159	327	Peak
*5852	74.89	65.59	78.2	-3.31	34.74	8.7	34.14	159	327	Peak
*5864	67.07	57.74	68.2	-1.13	34.76	8.71	34.14	159	327	Peak

Remarks:

- Emission Level = Read Level + Antenna Factor + Cable Loss - Preamp Factor
Margin value = Emission level – Limit value
- 5825 MHz: Fundamental frequency.
- *: Out of restricted band

802.11n (HT20)

EUT Test Condition		Measurement Detail	
Channel	Channel 36	Frequency Range	1 GHz ~ 40 GHz
Input Power	120 Vac, 60 Hz	Detector Function	Peak (PK) Average (AV)
Environmental Conditions	25 deg. C, 65 % RH	Tested By	Karl Lee

Antenna Polarity & Test Distance: Horizontal at 3 m

Frequency (MHz)	Emission Level (dBuV/m)	Read Level (dBuV)	Limit (dBuV/m)	Margin (dB)	Antenna Factor (dB/m)	Cable Loss (dB)	Preamp Factor (dB)	Antenna Height (cm)	Table Angle (Degree)	Remark
5148	48.38	40.13	54	-5.62	34.12	8.13	34	100	331	Average
5148	60.66	52.41	74	-13.34	34.12	8.13	34	100	331	Peak
5180	96.05	87.74			34.15	8.16	34	100	331	Average
5180	104.96	96.65			34.15	8.16	34	100	331	Peak
5460	43.68	34.86	54	-10.32	34.36	8.51	34.05	100	331	Average
5460	58.99	50.17	74	-15.01	34.36	8.51	34.05	100	331	Peak

Antenna Polarity & Test Distance: Vertical at 3 m

Frequency (MHz)	Emission Level (dBuV/m)	Read Level (dBuV)	Limit (dBuV/m)	Margin (dB)	Antenna Factor (dB/m)	Cable Loss (dB)	Preamp Factor (dB)	Antenna Height (cm)	Table Angle (Degree)	Remark
5150	52.35	44.1	54	-1.65	34.12	8.13	34	130	332	Average
5150	64.19	55.94	74	-9.81	34.12	8.13	34	130	332	Peak
5180	100.8	92.49			34.15	8.16	34	130	332	Average
5180	108.23	99.92			34.15	8.16	34	130	332	Peak
5446	44.51	35.68	54	-9.49	34.36	8.51	34.04	130	332	Average
5446	59.23	50.4	74	-14.77	34.36	8.51	34.04	130	332	Peak

Remarks:

- Emission Level = Read Level + Antenna Factor + Cable Loss - Preamp Factor
Margin value = Emission level – Limit value
- 5180 MHz: Fundamental frequency.

EUT Test Condition		Measurement Detail	
Channel	Channel 44	Frequency Range	1 GHz ~ 40 GHz
Input Power	120 Vac, 60 Hz	Detector Function	Peak (PK) Average (AV)
Environmental Conditions	25 deg. C, 65 % RH	Tested By	Karl Lee

Antenna Polarity & Test Distance: Horizontal at 3 m										
Frequency (MHz)	Emission Level (dBuV/m)	Read Level (dBuV)	Limit (dBuV/m)	Margin (dB)	Antenna Factor (dB/m)	Cable Loss (dB)	Preamp Factor (dB)	Antenna Height (cm)	Table Angle (Degree)	Remark
5106	44.66	36.49	54	-9.34	34.09	8.07	33.99	112	331	Average
5106	57.65	49.48	74	-16.35	34.09	8.07	33.99	112	331	Peak
5220	99.47	91.08			34.17	8.22	34	112	331	Average
5220	106.65	98.26			34.17	8.22	34	112	331	Peak
5440	44.03	35.24	54	-9.97	34.35	8.48	34.04	112	331	Average
5440	57.88	49.09	74	-16.12	34.35	8.48	34.04	112	331	Peak
Antenna Polarity & Test Distance: Vertical at 3 m										
Frequency (MHz)	Emission Level (dBuV/m)	Read Level (dBuV)	Limit (dBuV/m)	Margin (dB)	Antenna Factor (dB/m)	Cable Loss (dB)	Preamp Factor (dB)	Antenna Height (cm)	Table Angle (Degree)	Remark
5140	46.18	37.92	54	-7.82	34.12	8.13	33.99	114	331	Average
5140	57.21	48.95	74	-16.79	34.12	8.13	33.99	114	331	Peak
5220	103.63	95.24			34.17	8.22	34	114	331	Average
5220	110.38	101.99			34.17	8.22	34	114	331	Peak
5434	44.27	35.48	54	-9.73	34.35	8.48	34.04	114	331	Average
5434	58.12	49.33	74	-15.88	34.35	8.48	34.04	114	331	Peak

Remarks:

- Emission Level = Read Level + Antenna Factor + Cable Loss - Preamp Factor
Margin value = Emission level – Limit value
- 5220 MHz: Fundamental frequency.

EUT Test Condition		Measurement Detail	
Channel	Channel 48	Frequency Range	1 GHz ~ 40 GHz
Input Power	120 Vac, 60 Hz	Detector Function	Peak (PK) Average (AV)
Environmental Conditions	25 deg. C, 65 % RH	Tested By	Karl Lee

Antenna Polarity & Test Distance: Horizontal at 3 m										
Frequency (MHz)	Emission Level (dBuV/m)	Read Level (dBuV)	Limit (dBuV/m)	Margin (dB)	Antenna Factor (dB/m)	Cable Loss (dB)	Preamp Factor (dB)	Antenna Height (cm)	Table Angle (Degree)	Remark
5026	42.77	34.74	54	-11.23	34.03	7.97	33.97	105	331	Average
5026	56.98	48.95	74	-17.02	34.03	7.97	33.97	105	331	Peak
5240	99.24	90.8			34.19	8.26	34.01	105	331	Average
5240	106.51	98.07			34.19	8.26	34.01	105	331	Peak
5450	43.98	35.16	54	-10.02	34.36	8.51	34.05	105	331	Average
5450	58.82	50	74	-15.18	34.36	8.51	34.05	105	331	Peak
Antenna Polarity & Test Distance: Vertical at 3 m										
Frequency (MHz)	Emission Level (dBuV/m)	Read Level (dBuV)	Limit (dBuV/m)	Margin (dB)	Antenna Factor (dB/m)	Cable Loss (dB)	Preamp Factor (dB)	Antenna Height (cm)	Table Angle (Degree)	Remark
5112	43.88	35.68	54	-10.12	34.09	8.1	33.99	101	331	Average
5112	57.73	49.53	74	-16.27	34.09	8.1	33.99	101	331	Peak
5240	103.77	95.33			34.19	8.26	34.01	101	331	Average
5240	110.67	102.23			34.19	8.26	34.01	101	331	Peak
5454	44.01	35.19	54	-9.99	34.36	8.51	34.05	101	331	Average
5454	57.93	49.11	74	-16.07	34.36	8.51	34.05	101	331	Peak

Remarks:

- Emission Level = Read Level + Antenna Factor + Cable Loss - Preamp Factor
Margin value = Emission level – Limit value
- 5240 MHz: Fundamental frequency.



EUT Test Condition		Measurement Detail	
Channel	Channel 52	Frequency Range	1 GHz ~ 40 GHz
Input Power	120 Vac, 60 Hz	Detector Function	Peak (PK) Average (AV)
Environmental Conditions	25 deg. C, 65 % RH	Tested By	Karl Lee

Antenna Polarity & Test Distance: Horizontal at 3 m										
Frequency (MHz)	Emission Level (dBuV/m)	Read Level (dBuV)	Limit (dBuV/m)	Margin (dB)	Antenna Factor (dB/m)	Cable Loss (dB)	Preamp Factor (dB)	Antenna Height (cm)	Table Angle (Degree)	Remark
5136	43.25	35	54	-10.75	34.11	8.13	33.99	174	16	Average
5136	57.63	49.38	74	-16.37	34.11	8.13	33.99	174	16	Peak
5260	98.56	90.1			34.21	8.26	34.01	174	16	Average
5260	106.48	98.02			34.21	8.26	34.01	174	16	Peak
5452	43.82	35	54	-10.18	34.36	8.51	34.05	174	16	Average
5452	58.35	49.53	74	-15.65	34.36	8.51	34.05	174	16	Peak
Antenna Polarity & Test Distance: Vertical at 3 m										
Frequency (MHz)	Emission Level (dBuV/m)	Read Level (dBuV)	Limit (dBuV/m)	Margin (dB)	Antenna Factor (dB/m)	Cable Loss (dB)	Preamp Factor (dB)	Antenna Height (cm)	Table Angle (Degree)	Remark
5050	43.14	35.08	54	-10.86	34.04	8	33.98	145	329	Average
5050	56.77	48.71	74	-17.23	34.04	8	33.98	145	329	Peak
5260	103.24	94.78			34.21	8.26	34.01	145	329	Average
5260	110.69	102.23			34.21	8.26	34.01	145	329	Peak
5424	43.43	34.66	54	-10.57	34.33	8.48	34.04	145	329	Average
5424	57.42	48.65	74	-16.58	34.33	8.48	34.04	145	329	Peak

Remarks:

- Emission Level = Read Level + Antenna Factor + Cable Loss - Preamp Factor
Margin value = Emission level – Limit value
- 5260 MHz: Fundamental frequency.



EUT Test Condition		Measurement Detail	
Channel	Channel 60	Frequency Range	1 GHz ~ 40 GHz
Input Power	120 Vac, 60 Hz	Detector Function	Peak (PK) Average (AV)
Environmental Conditions	25 deg. C, 65 % RH	Tested By	Karl Lee

Antenna Polarity & Test Distance: Horizontal at 3 m										
Frequency (MHz)	Emission Level (dBuV/m)	Read Level (dBuV)	Limit (dBuV/m)	Margin (dB)	Antenna Factor (dB/m)	Cable Loss (dB)	Preamp Factor (dB)	Antenna Height (cm)	Table Angle (Degree)	Remark
5058	43.14	35.04	54	-10.86	34.05	8.03	33.98	192	16	Average
5058	57.96	49.86	74	-16.04	34.05	8.03	33.98	192	16	Peak
5300	98.41	89.87			34.24	8.32	34.02	192	16	Average
5300	106.18	97.64			34.24	8.32	34.02	192	16	Peak
5356	49.42	40.79	54	-4.58	34.28	8.38	34.03	192	16	Average
5356	61.79	53.16	74	-12.21	34.28	8.38	34.03	192	16	Peak
Antenna Polarity & Test Distance: Vertical at 3 m										
Frequency (MHz)	Emission Level (dBuV/m)	Read Level (dBuV)	Limit (dBuV/m)	Margin (dB)	Antenna Factor (dB/m)	Cable Loss (dB)	Preamp Factor (dB)	Antenna Height (cm)	Table Angle (Degree)	Remark
5076	42.88	34.76	54	-11.12	34.07	8.03	33.98	101	342	Average
5076	57.49	49.37	74	-16.51	34.07	8.03	33.98	101	342	Peak
5300	103.09	94.55			34.24	8.32	34.02	101	342	Average
5300	110.85	102.31			34.24	8.32	34.02	101	342	Peak
5350	51.68	43.05	54	-2.32	34.28	8.38	34.03	101	342	Average
5350	63.62	54.99	74	-10.38	34.28	8.38	34.03	101	342	Peak

Remarks:

- Emission Level = Read Level + Antenna Factor + Cable Loss - Preamp Factor
Margin value = Emission level – Limit value
- 5300 MHz: Fundamental frequency.



A D T

EUT Test Condition		Measurement Detail	
Channel	Channel 64	Frequency Range	1 GHz ~ 40 GHz
Input Power	120 Vac, 60 Hz	Detector Function	Peak (PK) Average (AV)
Environmental Conditions	25 deg. C, 65 % RH	Tested By	Karl Lee

Antenna Polarity & Test Distance: Horizontal at 3 m										
Frequency (MHz)	Emission Level (dBuV/m)	Read Level (dBuV)	Limit (dBuV/m)	Margin (dB)	Antenna Factor (dB/m)	Cable Loss (dB)	Preamp Factor (dB)	Antenna Height (cm)	Table Angle (Degree)	Remark
5114	42.7	34.5	54	-11.3	34.09	8.1	33.99	188	17	Average
5114	57.09	48.89	74	-16.91	34.09	8.1	33.99	188	17	Peak
5320	95.78	87.2			34.25	8.35	34.02	188	17	Average
5320	103.61	95.03			34.25	8.35	34.02	188	17	Peak
5350	47.79	39.16	54	-6.21	34.28	8.38	34.03	188	17	Average
5350	60.14	51.51	74	-13.86	34.28	8.38	34.03	188	17	Peak

Antenna Polarity & Test Distance: Vertical at 3 m										
Frequency (MHz)	Emission Level (dBuV/m)	Read Level (dBuV)	Limit (dBuV/m)	Margin (dB)	Antenna Factor (dB/m)	Cable Loss (dB)	Preamp Factor (dB)	Antenna Height (cm)	Table Angle (Degree)	Remark
5086	42.56	34.4	54	-11.44	34.07	8.07	33.98	101	334	Average
5086	57.43	49.27	74	-16.57	34.07	8.07	33.98	101	334	Peak
5320	100.08	91.5			34.25	8.35	34.02	101	334	Average
5320	107.12	98.54			34.25	8.35	34.02	101	334	Peak
5352	52.15	43.52	54	-1.85	34.28	8.38	34.03	101	334	Average
5352	62.76	54.13	74	-11.24	34.28	8.38	34.03	101	334	Peak

Remarks:

- Emission Level = Read Level + Antenna Factor + Cable Loss - Preamp Factor
Margin value = Emission level – Limit value
- 5320 MHz: Fundamental frequency.

EUT Test Condition		Measurement Detail	
Channel	Channel 100	Frequency Range	1 GHz ~ 40 GHz
Input Power	120 Vac, 60 Hz	Detector Function	Peak (PK) Average (AV)
Environmental Conditions	25 deg. C, 65 % RH	Tested By	Karl Lee

Antenna Polarity & Test Distance: Horizontal at 3 m										
Frequency (MHz)	Emission Level (dBuV/m)	Read Level (dBuV)	Limit (dBuV/m)	Margin (dB)	Antenna Factor (dB/m)	Cable Loss (dB)	Preamp Factor (dB)	Antenna Height (cm)	Table Angle (Degree)	Remark
5454	47.35	38.53	54	-6.65	34.36	8.51	34.05	102	205	Average
5454	60.19	51.37	74	-13.81	34.36	8.51	34.05	102	205	Peak
5470	61.66	52.83	68.2	-6.54	34.37	8.51	34.05	102	205	Peak
5500	96.3	87.38			34.4	8.57	34.05	102	205	Average
5500	104.14	95.22			34.4	8.57	34.05	102	205	Peak
5725	55.75	46.59	68.2	-12.45	34.62	8.65	34.11	102	205	Peak
Antenna Polarity & Test Distance: Vertical at 3 m										
Frequency (MHz)	Emission Level (dBuV/m)	Read Level (dBuV)	Limit (dBuV/m)	Margin (dB)	Antenna Factor (dB/m)	Cable Loss (dB)	Preamp Factor (dB)	Antenna Height (cm)	Table Angle (Degree)	Remark
5460	48.49	39.67	54	-5.51	34.36	8.51	34.05	234	0	Average
5460	60.57	51.75	74	-13.43	34.36	8.51	34.05	234	0	Peak
5470	66.76	57.93	68.2	-1.44	34.37	8.51	34.05	234	0	Peak
5500	99.35	90.43			34.4	8.57	34.05	234	0	Average
5500	107.08	98.16			34.4	8.57	34.05	234	0	Peak
5725	56.99	47.83	68.2	-11.21	34.62	8.65	34.11	234	0	Peak

Remarks:

- Emission Level = Read Level + Antenna Factor + Cable Loss - Preamp Factor
Margin value = Emission level – Limit value
- 5500 MHz: Fundamental frequency.
- 5470 MHz & 5725 MHz: Out of restricted band

EUT Test Condition		Measurement Detail	
Channel	Channel 116	Frequency Range	1 GHz ~ 40 GHz
Input Power	120 Vac, 60 Hz	Detector Function	Peak (PK) Average (AV)
Environmental Conditions	25 deg. C, 65 % RH	Tested By	Karl Lee

Antenna Polarity & Test Distance: Horizontal at 3 m										
Frequency (MHz)	Emission Level (dBuV/m)	Read Level (dBuV)	Limit (dBuV/m)	Margin (dB)	Antenna Factor (dB/m)	Cable Loss (dB)	Preamp Factor (dB)	Antenna Height (cm)	Table Angle (Degree)	Remark
5458	43.6	34.78	54	-10.4	34.36	8.51	34.05	188	27	Average
5458	58.11	49.29	74	-15.89	34.36	8.51	34.05	188	27	Peak
5470	56.84	48.01	68.2	-11.36	34.37	8.51	34.05	188	27	Peak
5580	100.31	91.32			34.47	8.6	34.08	188	27	Average
5580	107.59	98.6			34.47	8.6	34.08	188	27	Peak
5725	56.19	47.03	68.2	-12.01	34.62	8.65	34.11	188	27	Peak
11160	51.49	36.41	54	-2.51	37.7	12.83	35.45	151	219	Average
11160	63.18	48.1	74	-10.82	37.7	12.83	35.45	151	219	Peak

Antenna Polarity & Test Distance: Vertical at 3 m										
Frequency (MHz)	Emission Level (dBuV/m)	Read Level (dBuV)	Limit (dBuV/m)	Margin (dB)	Antenna Factor (dB/m)	Cable Loss (dB)	Preamp Factor (dB)	Antenna Height (cm)	Table Angle (Degree)	Remark
5408	43.42	34.7	54	-10.58	34.32	8.44	34.04	238	0	Average
5408	57.25	48.53	74	-16.75	34.32	8.44	34.04	238	0	Peak
5470	56.27	47.44	68.2	-11.93	34.37	8.51	34.05	238	0	Peak
5580	102.51	93.52			34.47	8.6	34.08	238	0	Average
5580	110.16	101.17			34.47	8.6	34.08	238	0	Peak
5725	56.06	46.9	68.2	-12.14	34.62	8.65	34.11	238	0	Peak
11160	50.19	35.11	54	-3.81	37.7	12.83	35.45	100	243	Average
11160	63.24	48.16	74	-10.76	37.7	12.83	35.45	100	243	Peak

Remarks:

- Emission Level = Read Level + Antenna Factor + Cable Loss - Preamp Factor
Margin value = Emission level – Limit value
- 5580 MHz: Fundamental frequency.
- 5470 MHz & 5725 MHz: Out of restricted band

EUT Test Condition		Measurement Detail	
Channel	Channel 140	Frequency Range	1 GHz ~ 40 GHz
Input Power	120 Vac, 60 Hz	Detector Function	Peak (PK) Average (AV)
Environmental Conditions	25 deg. C, 65 % RH	Tested By	Karl Lee

Antenna Polarity & Test Distance: Horizontal at 3 m										
Frequency (MHz)	Emission Level (dBuV/m)	Read Level (dBuV)	Limit (dBuV/m)	Margin (dB)	Antenna Factor (dB/m)	Cable Loss (dB)	Preamp Factor (dB)	Antenna Height (cm)	Table Angle (Degree)	Remark
5460	42.87	34.05	54	-11.13	34.36	8.51	34.05	250	27	Average
5460	57.8	48.98	74	-16.2	34.36	8.51	34.05	250	27	Peak
5470	56.13	47.3	68.2	-12.07	34.37	8.51	34.05	250	27	Peak
5700	94.06	84.93			34.59	8.64	34.1	250	27	Average
5700	102.28	93.15			34.59	8.64	34.1	250	27	Peak
5725	66.51	57.35	68.2	-1.69	34.62	8.65	34.11	250	27	Peak

Antenna Polarity & Test Distance: Vertical at 3 m										
Frequency (MHz)	Emission Level (dBuV/m)	Read Level (dBuV)	Limit (dBuV/m)	Margin (dB)	Antenna Factor (dB/m)	Cable Loss (dB)	Preamp Factor (dB)	Antenna Height (cm)	Table Angle (Degree)	Remark
5364	42.87	34.23	54	-11.13	34.29	8.38	34.03	100	0	Average
5364	56.92	48.28	74	-17.08	34.29	8.38	34.03	100	0	Peak
5470	55.88	47.05	68.2	-12.32	34.37	8.51	34.05	100	0	Peak
5700	97.83	88.7			34.59	8.64	34.1	100	0	Average
5700	105.16	96.03			34.59	8.64	34.1	100	0	Peak
5725	67.14	57.98	68.2	-1.06	34.62	8.65	34.11	100	0	Peak

Remarks:

- Emission Level = Read Level + Antenna Factor + Cable Loss - Preamp Factor
Margin value = Emission level – Limit value
- 5700 MHz: Fundamental frequency.
- 5470 MHz & 5725 MHz: Out of restricted band

EUT Test Condition		Measurement Detail	
Channel	Channel 149	Frequency Range	1 GHz ~ 40 GHz
Input Power	120 Vac, 60 Hz	Detector Function	Peak (PK) Average (AV)
Environmental Conditions	25 deg. C, 65 % RH	Tested By	Karl Lee

Antenna Polarity & Test Distance: Horizontal at 3 m										
Frequency (MHz)	Emission Level (dBuV/m)	Read Level (dBuV)	Limit (dBuV/m)	Margin (dB)	Antenna Factor (dB/m)	Cable Loss (dB)	Preamp Factor (dB)	Antenna Height (cm)	Table Angle (Degree)	Remark
*5714	62.3	53.15	68.2	-5.9	34.61	8.65	34.11	114	330	Peak
*5724	70.66	61.5	78.2	-7.54	34.62	8.65	34.11	114	330	Peak
5745	98.3	89.11			34.64	8.66	34.11	114	330	Average
5745	105.73	96.54			34.64	8.66	34.11	114	330	Peak
*5852	62.55	53.25	78.2	-15.65	34.74	8.7	34.14	114	330	Peak
*5862	63.16	53.83	68.2	-5.04	34.76	8.71	34.14	114	330	Peak
Antenna Polarity & Test Distance: Vertical at 3 m										
Frequency (MHz)	Emission Level (dBuV/m)	Read Level (dBuV)	Limit (dBuV/m)	Margin (dB)	Antenna Factor (dB/m)	Cable Loss (dB)	Preamp Factor (dB)	Antenna Height (cm)	Table Angle (Degree)	Remark
*5710	66.85	57.7	68.2	-1.35	34.61	8.65	34.11	149	327	Peak
*5722	73.73	64.57	78.2	-4.47	34.62	8.65	34.11	149	327	Peak
5745	100.3	91.11			34.64	8.66	34.11	149	327	Average
5745	108.67	99.48			34.64	8.66	34.11	149	327	Peak
*5856	63.3	53.98	78.2	-14.9	34.76	8.7	34.14	149	327	Peak
*5866	63.81	54.48	68.2	-4.39	34.76	8.71	34.14	149	327	Peak

Remarks:

- Emission Level = Read Level + Antenna Factor + Cable Loss - Preamp Factor
Margin value = Emission level – Limit value
- 5745 MHz: Fundamental frequency.
- *: Out of restricted band

EUT Test Condition		Measurement Detail	
Channel	Channel 157	Frequency Range	1 GHz ~ 40 GHz
Input Power	120 Vac, 60 Hz	Detector Function	Peak (PK) Average (AV)
Environmental Conditions	25 deg. C, 65 % RH	Tested By	Karl Lee

Antenna Polarity & Test Distance: Horizontal at 3 m										
Frequency (MHz)	Emission Level (dBuV/m)	Read Level (dBuV)	Limit (dBuV/m)	Margin (dB)	Antenna Factor (dB/m)	Cable Loss (dB)	Preamp Factor (dB)	Antenna Height (cm)	Table Angle (Degree)	Remark
*5710	64.26	55.11	68.2	-3.94	34.61	8.65	34.11	101	330	Peak
*5724	65.5	56.34	78.2	-12.7	34.62	8.65	34.11	101	330	Peak
5785	102.36	93.13			34.68	8.68	34.13	101	330	Average
5785	109.41	100.18			34.68	8.68	34.13	101	330	Peak
*5860	63.35	54.03	78.2	-14.85	34.76	8.7	34.14	101	330	Peak
*5866	64.06	54.73	68.2	-4.14	34.76	8.71	34.14	101	330	Peak
11570	51.6	36.29	54	-2.4	38	12.68	35.37	151	223	Average
11570	61.63	46.32	74	-12.37	38	12.68	35.37	151	223	Peak

Antenna Polarity & Test Distance: Vertical at 3 m										
Frequency (MHz)	Emission Level (dBuV/m)	Read Level (dBuV)	Limit (dBuV/m)	Margin (dB)	Antenna Factor (dB/m)	Cable Loss (dB)	Preamp Factor (dB)	Antenna Height (cm)	Table Angle (Degree)	Remark
*5712	63.74	54.59	68.2	-4.46	34.61	8.65	34.11	147	327	Peak
*5718	64.51	55.35	78.2	-13.69	34.62	8.65	34.11	147	327	Peak
5785	104.86	95.63			34.68	8.68	34.13	147	327	Average
5785	112.15	102.92			34.68	8.68	34.13	147	327	Peak
*5854	63.88	54.56	78.2	-14.32	34.76	8.7	34.14	147	327	Peak
*5864	62.64	53.31	68.2	-5.56	34.76	8.71	34.14	147	327	Peak
11570	49.7	34.39	54	-4.3	38	12.68	35.37	100	249	Average
11570	58.99	43.68	74	-15.01	38	12.68	35.37	100	249	Peak

Remarks:

- Emission Level = Read Level + Antenna Factor + Cable Loss - Preamp Factor
Margin value = Emission level – Limit value
- 5785 MHz: Fundamental frequency.
- *: Out of restricted band



A D T

EUT Test Condition		Measurement Detail	
Channel	Channel 165	Frequency Range	1 GHz ~ 40 GHz
Input Power	120 Vac, 60 Hz	Detector Function	Peak (PK) Average (AV)
Environmental Conditions	25 deg. C, 65 % RH	Tested By	Karl Lee

Antenna Polarity & Test Distance: Horizontal at 3 m										
Frequency (MHz)	Emission Level (dBuV/m)	Read Level (dBuV)	Limit (dBuV/m)	Margin (dB)	Antenna Factor (dB/m)	Cable Loss (dB)	Preamp Factor (dB)	Antenna Height (cm)	Table Angle (Degree)	Remark
*5706	63.27	54.12	68.2	-4.93	34.61	8.65	34.11	113	330	Peak
*5720	63.61	54.45	78.2	-14.59	34.62	8.65	34.11	113	330	Peak
5825	97.42	88.13			34.73	8.69	34.13	113	330	Average
5825	104.9	95.61			34.73	8.69	34.13	113	330	Peak
*5852	67.88	58.58	78.2	-10.32	34.74	8.7	34.14	113	330	Peak
*5868	63.22	53.89	68.2	-4.98	34.76	8.71	34.14	113	330	Peak

Antenna Polarity & Test Distance: Vertical at 3 m										
Frequency (MHz)	Emission Level (dBuV/m)	Read Level (dBuV)	Limit (dBuV/m)	Margin (dB)	Antenna Factor (dB/m)	Cable Loss (dB)	Preamp Factor (dB)	Antenna Height (cm)	Table Angle (Degree)	Remark
*5708	64.34	55.19	68.2	-3.86	34.61	8.65	34.11	159	327	Peak
*5724	63.64	54.48	78.2	-14.56	34.62	8.65	34.11	159	327	Peak
5825	100.42	91.13			34.73	8.69	34.13	159	327	Average
5825	107.85	98.56			34.73	8.69	34.13	159	327	Peak
*5854	72.93	63.61	78.2	-5.27	34.76	8.7	34.14	159	327	Peak
*5868	66.17	56.84	68.2	-2.03	34.76	8.71	34.14	159	327	Peak

Remarks:

- Emission Level = Read Level + Antenna Factor + Cable Loss - Preamp Factor
Margin value = Emission level – Limit value
- 5825 MHz: Fundamental frequency.
- *: Out of restricted band

802.11n (HT40)

EUT Test Condition		Measurement Detail	
Channel	Channel 38	Frequency Range	1 GHz ~ 40 GHz
Input Power	120 Vac, 60 Hz	Detector Function	Peak (PK) Average (AV)
Environmental Conditions	25 deg. C, 65 % RH	Tested By	Karl Lee

Antenna Polarity & Test Distance: Horizontal at 3 m

Frequency (MHz)	Emission Level (dBuV/m)	Read Level (dBuV)	Limit (dBuV/m)	Margin (dB)	Antenna Factor (dB/m)	Cable Loss (dB)	Preamp Factor (dB)	Antenna Height (cm)	Table Angle (Degree)	Remark
5142	48.45	40.19	54	-5.55	34.12	8.13	33.99	100	331	Average
5142	60	51.74	74	-14	34.12	8.13	33.99	100	331	Peak
5190	91.17	82.83			34.15	8.19	34	100	331	Average
5190	99.2	90.86			34.15	8.19	34	100	331	Peak
5444	43.48	34.69	54	-10.52	34.35	8.48	34.04	100	331	Average
5444	57.7	48.91	74	-16.3	34.35	8.48	34.04	100	331	Peak

Antenna Polarity & Test Distance: Vertical at 3 m

Frequency (MHz)	Emission Level (dBuV/m)	Read Level (dBuV)	Limit (dBuV/m)	Margin (dB)	Antenna Factor (dB/m)	Cable Loss (dB)	Preamp Factor (dB)	Antenna Height (cm)	Table Angle (Degree)	Remark
5146	52.56	44.31	54	-1.44	34.12	8.13	34	122	331	Average
5146	64.05	55.8	74	-9.95	34.12	8.13	34	122	331	Peak
5190	96.65	88.31			34.15	8.19	34	122	331	Average
5190	103.89	95.55			34.15	8.19	34	122	331	Peak
5394	43.29	34.58	54	-10.71	34.31	8.44	34.04	122	331	Average
5394	57.5	48.79	74	-16.5	34.31	8.44	34.04	122	331	Peak

Remarks:

- Emission Level = Read Level + Antenna Factor + Cable Loss - Preamp Factor
Margin value = Emission level – Limit value
- 5190 MHz: Fundamental frequency.



EUT Test Condition		Measurement Detail	
Channel	Channel 46	Frequency Range	1 GHz ~ 40 GHz
Input Power	120 Vac, 60 Hz	Detector Function	Peak (PK) Average (AV)
Environmental Conditions	25 deg. C, 65 % RH	Tested By	Karl Lee

Antenna Polarity & Test Distance: Horizontal at 3 m										
Frequency (MHz)	Emission Level (dBuV/m)	Read Level (dBuV)	Limit (dBuV/m)	Margin (dB)	Antenna Factor (dB/m)	Cable Loss (dB)	Preamp Factor (dB)	Antenna Height (cm)	Table Angle (Degree)	Remark
5148	46.81	38.56	54	-7.19	34.12	8.13	34	105	332	Average
5148	58.44	50.19	74	-15.56	34.12	8.13	34	105	332	Peak
5230	96.84	88.44			34.19	8.22	34.01	105	332	Average
5230	103.99	95.59			34.19	8.22	34.01	105	332	Peak
5434	43.59	34.8	54	-10.41	34.35	8.48	34.04	105	332	Average
5434	58.11	49.32	74	-15.89	34.35	8.48	34.04	105	332	Peak

Antenna Polarity & Test Distance: Vertical at 3 m										
Frequency (MHz)	Emission Level (dBuV/m)	Read Level (dBuV)	Limit (dBuV/m)	Margin (dB)	Antenna Factor (dB/m)	Cable Loss (dB)	Preamp Factor (dB)	Antenna Height (cm)	Table Angle (Degree)	Remark
5150	52.5	44.25	54	-1.5	34.12	8.13	34	115	331	Average
5150	62.6	54.35	74	-11.4	34.12	8.13	34	115	331	Peak
5230	101.58	93.18			34.19	8.22	34.01	115	331	Average
5230	108.83	100.43			34.19	8.22	34.01	115	331	Peak
5418	44.67	35.94	54	-9.33	34.33	8.44	34.04	115	331	Average
5418	58.86	50.13	74	-15.14	34.33	8.44	34.04	115	331	Peak

Remarks:

- Emission Level = Read Level + Antenna Factor + Cable Loss - Preamp Factor
Margin value = Emission level – Limit value
- 5230 MHz: Fundamental frequency.



EUT Test Condition		Measurement Detail	
Channel	Channel 54	Frequency Range	1 GHz ~ 40 GHz
Input Power	120 Vac, 60 Hz	Detector Function	Peak (PK) Average (AV)
Environmental Conditions	25 deg. C, 65 % RH	Tested By	Karl Lee

Antenna Polarity & Test Distance: Horizontal at 3 m										
Frequency (MHz)	Emission Level (dBuV/m)	Read Level (dBuV)	Limit (dBuV/m)	Margin (dB)	Antenna Factor (dB/m)	Cable Loss (dB)	Preamp Factor (dB)	Antenna Height (cm)	Table Angle (Degree)	Remark
5144	47.28	39.03	54	-6.72	34.12	8.13	34	174	16	Average
5144	58.77	50.52	74	-15.23	34.12	8.13	34	174	16	Peak
5270	96.64	88.15			34.21	8.29	34.01	174	16	Average
5270	104.83	96.34			34.21	8.29	34.01	174	16	Peak
5350	52	43.37	54	-2	34.28	8.38	34.03	174	16	Average
5350	65.02	56.39	74	-8.98	34.28	8.38	34.03	174	16	Peak

Antenna Polarity & Test Distance: Vertical at 3 m										
Frequency (MHz)	Emission Level (dBuV/m)	Read Level (dBuV)	Limit (dBuV/m)	Margin (dB)	Antenna Factor (dB/m)	Cable Loss (dB)	Preamp Factor (dB)	Antenna Height (cm)	Table Angle (Degree)	Remark
5146	46.18	37.93	54	-7.82	34.12	8.13	34	145	329	Average
5146	57.53	49.28	74	-16.47	34.12	8.13	34	145	329	Peak
5270	101.58	93.09			34.21	8.29	34.01	145	329	Average
5270	108.69	100.2			34.21	8.29	34.01	145	329	Peak
5350	51.4	42.77	54	-2.6	34.28	8.38	34.03	145	329	Average
5350	61.47	52.84	74	-12.53	34.28	8.38	34.03	145	329	Peak

Remarks:

- Emission Level = Read Level + Antenna Factor + Cable Loss - Preamp Factor
Margin value = Emission level – Limit value
- 5270 MHz: Fundamental frequency.

EUT Test Condition		Measurement Detail	
Channel	Channel 62	Frequency Range	1 GHz ~ 40 GHz
Input Power	120 Vac, 60 Hz	Detector Function	Peak (PK) Average (AV)
Environmental Conditions	25 deg. C, 65 % RH	Tested By	Karl Lee

Antenna Polarity & Test Distance: Horizontal at 3 m										
Frequency (MHz)	Emission Level (dBuV/m)	Read Level (dBuV)	Limit (dBuV/m)	Margin (dB)	Antenna Factor (dB/m)	Cable Loss (dB)	Preamp Factor (dB)	Antenna Height (cm)	Table Angle (Degree)	Remark
5016	43.06	35.05	54	-10.94	34.01	7.97	33.97	188	17	Average
5016	58.19	50.18	74	-15.81	34.01	7.97	33.97	188	17	Peak
5310	92.12	83.57			34.25	8.32	34.02	188	17	Average
5310	99.67	91.12			34.25	8.32	34.02	188	17	Peak
5354	48.94	40.31	54	-5.06	34.28	8.38	34.03	188	17	Average
5354	60.98	52.35	74	-13.02	34.28	8.38	34.03	188	17	Peak
Antenna Polarity & Test Distance: Vertical at 3 m										
Frequency (MHz)	Emission Level (dBuV/m)	Read Level (dBuV)	Limit (dBuV/m)	Margin (dB)	Antenna Factor (dB/m)	Cable Loss (dB)	Preamp Factor (dB)	Antenna Height (cm)	Table Angle (Degree)	Remark
5144	43.09	34.84	54	-10.91	34.12	8.13	34	101	334	Average
5144	57.19	48.94	74	-16.81	34.12	8.13	34	101	334	Peak
5310	95.7	87.15			34.25	8.32	34.02	101	334	Average
5310	103.07	94.52			34.25	8.32	34.02	101	334	Peak
5352	52.48	43.85	54	-1.52	34.28	8.38	34.03	101	334	Average
5352	64.63	56	74	-9.37	34.28	8.38	34.03	101	334	Peak

Remarks:

- Emission Level = Read Level + Antenna Factor + Cable Loss - Preamp Factor
Margin value = Emission level – Limit value
- 5310 MHz: Fundamental frequency.



EUT Test Condition		Measurement Detail	
Channel	Channel 102	Frequency Range	1 GHz ~ 40 GHz
Input Power	120 Vac, 60 Hz	Detector Function	Peak (PK) Average (AV)
Environmental Conditions	25 deg. C, 65 % RH	Tested By	Karl Lee

Antenna Polarity & Test Distance: Horizontal at 3 m										
Frequency (MHz)	Emission Level (dBuV/m)	Read Level (dBuV)	Limit (dBuV/m)	Margin (dB)	Antenna Factor (dB/m)	Cable Loss (dB)	Preamp Factor (dB)	Antenna Height (cm)	Table Angle (Degree)	Remark
5452	50.37	41.55	54	-3.63	34.36	8.51	34.05	102	205	Average
5452	61.71	52.89	74	-12.29	34.36	8.51	34.05	102	205	Peak
5470	64.56	55.73	68.2	-3.64	34.37	8.51	34.05	102	205	Peak
5510	91.82	82.91			34.4	8.57	34.06	102	205	Average
5510	99.92	91.01			34.4	8.57	34.06	102	205	Peak
5725	56.05	46.89	68.2	-12.15	34.62	8.65	34.11	102	205	Peak
Antenna Polarity & Test Distance: Vertical at 3 m										
Frequency (MHz)	Emission Level (dBuV/m)	Read Level (dBuV)	Limit (dBuV/m)	Margin (dB)	Antenna Factor (dB/m)	Cable Loss (dB)	Preamp Factor (dB)	Antenna Height (cm)	Table Angle (Degree)	Remark
5460	51.35	42.53	54	-2.65	34.36	8.51	34.05	234	0	Average
5460	63.7	54.88	74	-10.3	34.36	8.51	34.05	234	0	Peak
5470	66.86	58.03	68.2	-1.34	34.37	8.51	34.05	234	0	Peak
5510	94.69	85.78			34.4	8.57	34.06	234	0	Average
5510	102.21	93.3			34.4	8.57	34.06	234	0	Peak
5725	57.47	48.31	68.2	-10.73	34.62	8.65	34.11	234	0	Peak

Remarks:

- Emission Level = Read Level + Antenna Factor + Cable Loss - Preamp Factor
Margin value = Emission level – Limit value
- 5510 MHz: Fundamental frequency.
- 5470 MHz & 5725 MHz: Out of restricted band

EUT Test Condition		Measurement Detail	
Channel	Channel 110	Frequency Range	1 GHz ~ 40 GHz
Input Power	120 Vac, 60 Hz	Detector Function	Peak (PK) Average (AV)
Environmental Conditions	25 deg. C, 65 % RH	Tested By	Karl Lee

Antenna Polarity & Test Distance: Horizontal at 3 m										
Frequency (MHz)	Emission Level (dBuV/m)	Read Level (dBuV)	Limit (dBuV/m)	Margin (dB)	Antenna Factor (dB/m)	Cable Loss (dB)	Preamp Factor (dB)	Antenna Height (cm)	Table Angle (Degree)	Remark
5450	50.8	41.98	54	-3.2	34.36	8.51	34.05	188	27	Average
5450	61.68	52.86	74	-12.32	34.36	8.51	34.05	188	27	Peak
5470	60.56	51.73	68.2	-7.64	34.37	8.51	34.05	188	27	Peak
5550	97.04	88.07			34.45	8.59	34.07	188	27	Average
5550	104.39	95.42			34.45	8.59	34.07	188	27	Peak
5725	55.76	46.6	68.2	-12.44	34.62	8.65	34.11	188	27	Peak
Antenna Polarity & Test Distance: Vertical at 3 m										
Frequency (MHz)	Emission Level (dBuV/m)	Read Level (dBuV)	Limit (dBuV/m)	Margin (dB)	Antenna Factor (dB/m)	Cable Loss (dB)	Preamp Factor (dB)	Antenna Height (cm)	Table Angle (Degree)	Remark
5460	51.72	42.9	54	-2.28	34.36	8.51	34.05	104	0	Average
5460	62.82	54	74	-11.18	34.36	8.51	34.05	104	0	Peak
5470	64.2	55.37	68.2	-4	34.37	8.51	34.05	104	0	Peak
5550	99.56	90.59			34.45	8.59	34.07	104	0	Average
5550	107.11	98.14			34.45	8.59	34.07	104	0	Peak
5725	56.04	46.88	68.2	-12.16	34.62	8.65	34.11	104	0	Peak

Remarks:

- Emission Level = Read Level + Antenna Factor + Cable Loss - Preamp Factor
Margin value = Emission level – Limit value
- 5550 MHz: Fundamental frequency.
- 5470 MHz & 5725 MHz: Out of restricted band

EUT Test Condition		Measurement Detail	
Channel	Channel 134	Frequency Range	1 GHz ~ 40 GHz
Input Power	120 Vac, 60 Hz	Detector Function	Peak (PK) Average (AV)
Environmental Conditions	25 deg. C, 65 % RH	Tested By	Karl Lee

Antenna Polarity & Test Distance: Horizontal at 3 m										
Frequency (MHz)	Emission Level (dBuV/m)	Read Level (dBuV)	Limit (dBuV/m)	Margin (dB)	Antenna Factor (dB/m)	Cable Loss (dB)	Preamp Factor (dB)	Antenna Height (cm)	Table Angle (Degree)	Remark
5408	43.26	34.54	54	-10.74	34.32	8.44	34.04	242	27	Average
5408	58.12	49.4	74	-15.88	34.32	8.44	34.04	242	27	Peak
5470	54.86	46.03	68.2	-13.34	34.37	8.51	34.05	242	27	Peak
5670	93.91	84.81			34.57	8.63	34.1	242	27	Average
5670	100.52	91.42			34.57	8.63	34.1	242	27	Peak
5725	64.47	55.31	68.2	-3.73	34.62	8.65	34.11	242	27	Peak
Antenna Polarity & Test Distance: Vertical at 3 m										
Frequency (MHz)	Emission Level (dBuV/m)	Read Level (dBuV)	Limit (dBuV/m)	Margin (dB)	Antenna Factor (dB/m)	Cable Loss (dB)	Preamp Factor (dB)	Antenna Height (cm)	Table Angle (Degree)	Remark
5448	43.44	34.61	54	-10.56	34.36	8.51	34.04	100	0	Average
5448	57.61	48.78	74	-16.39	34.36	8.51	34.04	100	0	Peak
5470	54.78	45.95	68.2	-13.42	34.37	8.51	34.05	100	0	Peak
5670	96.44	87.34			34.57	8.63	34.1	100	0	Average
5670	103.24	94.14			34.57	8.63	34.1	100	0	Peak
5725	67.11	57.95	68.2	-1.09	34.62	8.65	34.11	100	0	Peak

Remarks:

- Emission Level = Read Level + Antenna Factor + Cable Loss - Preamp Factor
Margin value = Emission level – Limit value
- 5670 MHz: Fundamental frequency.
- 5470 MHz & 5725 MHz: Out of restricted band



A D T

EUT Test Condition		Measurement Detail	
Channel	Channel 151	Frequency Range	1 GHz ~ 40 GHz
Input Power	120 Vac, 60 Hz	Detector Function	Peak (PK) Average (AV)
Environmental Conditions	25 deg. C, 65 % RH	Tested By	Karl Lee

Antenna Polarity & Test Distance: Horizontal at 3 m										
Frequency (MHz)	Emission Level (dBuV/m)	Read Level (dBuV)	Limit (dBuV/m)	Margin (dB)	Antenna Factor (dB/m)	Cable Loss (dB)	Preamp Factor (dB)	Antenna Height (cm)	Table Angle (Degree)	Remark
*5712	66.5	57.35	68.2	-1.7	34.61	8.65	34.11	101	330	Peak
*5716	69.03	59.88	78.2	-9.17	34.61	8.65	34.11	101	330	Peak
5755	93.32	84.11			34.66	8.66	34.11	101	330	Average
5755	100.24	91.03			34.66	8.66	34.11	101	330	Peak
*5852	64.15	54.85	78.2	-14.05	34.74	8.7	34.14	101	330	Peak
*5868	62.71	53.38	68.2	-5.49	34.76	8.71	34.14	101	330	Peak
Antenna Polarity & Test Distance: Vertical at 3 m										
Frequency (MHz)	Emission Level (dBuV/m)	Read Level (dBuV)	Limit (dBuV/m)	Margin (dB)	Antenna Factor (dB/m)	Cable Loss (dB)	Preamp Factor (dB)	Antenna Height (cm)	Table Angle (Degree)	Remark
*5708	67.18	58.03	68.2	-1.02	34.61	8.65	34.11	148	327	Peak
*5724	69.58	60.42	78.2	-8.62	34.62	8.65	34.11	148	327	Peak
5755	97.12	87.91			34.66	8.66	34.11	148	327	Average
5755	103.16	93.95			34.66	8.66	34.11	148	327	Peak
*5858	63.32	54	78.2	-14.88	34.76	8.7	34.14	148	327	Peak
*5870	63.07	53.74	68.2	-5.13	34.76	8.71	34.14	148	327	Peak

Remarks:

- Emission Level = Read Level + Antenna Factor + Cable Loss - Preamp Factor
Margin value = Emission level – Limit value
- 5755 MHz: Fundamental frequency.
- *: Out of restricted band



A D T

EUT Test Condition		Measurement Detail	
Channel	Channel 159	Frequency Range	1 GHz ~ 40 GHz
Input Power	120 Vac, 60 Hz	Detector Function	Peak (PK) Average (AV)
Environmental Conditions	25 deg. C, 65 % RH	Tested By	Karl Lee

Antenna Polarity & Test Distance: Horizontal at 3 m										
Frequency (MHz)	Emission Level (dBuV/m)	Read Level (dBuV)	Limit (dBuV/m)	Margin (dB)	Antenna Factor (dB/m)	Cable Loss (dB)	Preamp Factor (dB)	Antenna Height (cm)	Table Angle (Degree)	Remark
*5714	63.85	54.7	68.2	-4.35	34.61	8.65	34.11	101	330	Peak
*5718	65.05	55.89	78.2	-13.15	34.62	8.65	34.11	101	330	Peak
5795	97.27	88.03			34.69	8.68	34.13	101	330	Average
5795	104.36	95.12			34.69	8.68	34.13	101	330	Peak
*5856	63.17	53.85	78.2	-15.03	34.76	8.7	34.14	101	330	Peak
*5868	61.2	51.87	68.2	-7	34.76	8.71	34.14	101	330	Peak

Antenna Polarity & Test Distance: Vertical at 3 m										
Frequency (MHz)	Emission Level (dBuV/m)	Read Level (dBuV)	Limit (dBuV/m)	Margin (dB)	Antenna Factor (dB/m)	Cable Loss (dB)	Preamp Factor (dB)	Antenna Height (cm)	Table Angle (Degree)	Remark
*5708	64.46	55.31	68.2	-3.74	34.61	8.65	34.11	146	327	Peak
*5722	65.7	56.54	78.2	-12.5	34.62	8.65	34.11	146	327	Peak
5795	100.47	91.23			34.69	8.68	34.13	146	327	Average
5795	107.45	98.21			34.69	8.68	34.13	146	327	Peak
*5852	67.44	58.14	78.2	-10.76	34.74	8.7	34.14	146	327	Peak
*5862	66.72	57.39	68.2	-1.48	34.76	8.71	34.14	146	327	Peak

Remarks:

- Emission Level = Read Level + Antenna Factor + Cable Loss - Preamp Factor
Margin value = Emission level – Limit value
- 5795 MHz: Fundamental frequency.
- *: Out of restricted band

802.11ac (VHT80)

EUT Test Condition		Measurement Detail	
Channel	Channel 42	Frequency Range	1 GHz ~ 40 GHz
Input Power	120 Vac, 60 Hz	Detector Function	Peak (PK) Average (AV)
Environmental Conditions	25 deg. C, 65 % RH	Tested By	Karl Lee

Antenna Polarity & Test Distance: Horizontal at 3 m										
Frequency (MHz)	Emission Level (dBuV/m)	Read Level (dBuV)	Limit (dBuV/m)	Margin (dB)	Antenna Factor (dB/m)	Cable Loss (dB)	Preamp Factor (dB)	Antenna Height (cm)	Table Angle (Degree)	Remark
5148	46.75	38.5	54	-7.25	34.12	8.13	34	149	334	Average
5148	59.04	50.79	74	-14.96	34.12	8.13	34	149	334	Peak
5210	89.97	81.61			34.17	8.19	34	149	334	Average
5210	97.95	89.59			34.17	8.19	34	149	334	Peak
5452	43.87	35.05	54	-10.13	34.36	8.51	34.05	149	334	Average
5452	57.02	48.2	74	-16.98	34.36	8.51	34.05	149	334	Peak

Antenna Polarity & Test Distance: Vertical at 3 m										
Frequency (MHz)	Emission Level (dBuV/m)	Read Level (dBuV)	Limit (dBuV/m)	Margin (dB)	Antenna Factor (dB/m)	Cable Loss (dB)	Preamp Factor (dB)	Antenna Height (cm)	Table Angle (Degree)	Remark
5116	52.65	44.45	54	-1.35	34.09	8.1	33.99	169	334	Average
5116	62.28	54.08	74	-11.72	34.09	8.1	33.99	169	334	Peak
5210	93.97	85.61			34.17	8.19	34	169	334	Average
5210	101.31	92.95			34.17	8.19	34	169	334	Peak
5410	44.38	35.66	54	-9.62	34.32	8.44	34.04	169	334	Average
5410	56.91	48.19	74	-17.09	34.32	8.44	34.04	169	334	Peak

Remarks:

- Emission Level = Read Level + Antenna Factor + Cable Loss - Preamp Factor
Margin value = Emission level – Limit value
- 5210 MHz: Fundamental frequency.

EUT Test Condition		Measurement Detail	
Channel	Channel 58	Frequency Range	1 GHz ~ 40 GHz
Input Power	120 Vac, 60 Hz	Detector Function	Peak (PK) Average (AV)
Environmental Conditions	25 deg. C, 65 % RH	Tested By	Karl Lee

Antenna Polarity & Test Distance: Horizontal at 3 m										
Frequency (MHz)	Emission Level (dBuV/m)	Read Level (dBuV)	Limit (dBuV/m)	Margin (dB)	Antenna Factor (dB/m)	Cable Loss (dB)	Preamp Factor (dB)	Antenna Height (cm)	Table Angle (Degree)	Remark
5016	44.52	36.51	54	-9.48	34.01	7.97	33.97	192	16	Average
5016	58.31	50.3	74	-15.69	34.01	7.97	33.97	192	16	Peak
5290	90.27	81.74			34.23	8.32	34.02	192	16	Average
5290	97.95	89.42			34.23	8.32	34.02	192	16	Peak
5358	48.7	40.07	54	-5.3	34.28	8.38	34.03	192	16	Average
5358	60.36	51.73	74	-13.64	34.28	8.38	34.03	192	16	Peak
Antenna Polarity & Test Distance: Vertical at 3 m										
Frequency (MHz)	Emission Level (dBuV/m)	Read Level (dBuV)	Limit (dBuV/m)	Margin (dB)	Antenna Factor (dB/m)	Cable Loss (dB)	Preamp Factor (dB)	Antenna Height (cm)	Table Angle (Degree)	Remark
5040	43.5	35.43	54	-10.5	34.04	8	33.97	115	335	Average
5040	57.44	49.37	74	-16.56	34.04	8	33.97	115	335	Peak
5290	94.11	85.58			34.23	8.32	34.02	115	335	Average
5290	101.7	93.17			34.23	8.32	34.02	115	335	Peak
5352	52.12	43.49	54	-1.88	34.28	8.38	34.03	115	335	Average
5352	63.01	54.38	74	-10.99	34.28	8.38	34.03	115	335	Peak

Remarks:

- Emission Level = Read Level + Antenna Factor + Cable Loss - Preamp Factor
Margin value = Emission level – Limit value
- 5290 MHz: Fundamental frequency.



A D T

EUT Test Condition		Measurement Detail	
Channel	Channel 106	Frequency Range	1 GHz ~ 40 GHz
Input Power	120 Vac, 60 Hz	Detector Function	Peak (PK) Average (AV)
Environmental Conditions	25 deg. C, 65 % RH	Tested By	Karl Lee

Antenna Polarity & Test Distance: Horizontal at 3 m										
Frequency (MHz)	Emission Level (dBuV/m)	Read Level (dBuV)	Limit (dBuV/m)	Margin (dB)	Antenna Factor (dB/m)	Cable Loss (dB)	Preamp Factor (dB)	Antenna Height (cm)	Table Angle (Degree)	Remark
5442	49.84	41.05	54	-4.16	34.35	8.48	34.04	101	205	Average
5442	60.37	51.58	74	-13.63	34.35	8.48	34.04	101	205	Peak
5470	59.5	50.67	68.2	-8.7	34.37	8.51	34.05	101	205	Peak
5530	89.54	80.61			34.42	8.58	34.07	101	205	Average
5530	96.56	87.63			34.42	8.58	34.07	101	205	Peak
5725	55.53	46.37	68.2	-12.67	34.62	8.65	34.11	101	205	Peak

Antenna Polarity & Test Distance: Vertical at 3 m										
Frequency (MHz)	Emission Level (dBuV/m)	Read Level (dBuV)	Limit (dBuV/m)	Margin (dB)	Antenna Factor (dB/m)	Cable Loss (dB)	Preamp Factor (dB)	Antenna Height (cm)	Table Angle (Degree)	Remark
5452	52.28	43.46	54	-1.72	34.36	8.51	34.05	104	360	Average
5452	63.08	54.26	74	-10.92	34.36	8.51	34.05	104	360	Peak
5470	65.31	56.48	68.2	-2.89	34.37	8.51	34.05	104	360	Peak
5530	92.68	83.75			34.42	8.58	34.07	104	360	Average
5530	99.7	90.77			34.42	8.58	34.07	104	360	Peak
5725	56.53	47.37	68.2	-11.67	34.62	8.65	34.11	104	360	Peak

Remarks:

- Emission Level = Read Level + Antenna Factor + Cable Loss - Preamp Factor
Margin value = Emission level – Limit value
- 5530 MHz: Fundamental frequency.
- 5470 MHz & 5725 MHz: Out of restricted band

EUT Test Condition		Measurement Detail	
Channel	Channel 122	Frequency Range	1 GHz ~ 40 GHz
Input Power	120 Vac, 60 Hz	Detector Function	Peak (PK) Average (AV)
Environmental Conditions	25 deg. C, 65 % RH	Tested By	Karl Lee

Antenna Polarity & Test Distance: Horizontal at 3 m										
Frequency (MHz)	Emission Level (dBuV/m)	Read Level (dBuV)	Limit (dBuV/m)	Margin (dB)	Antenna Factor (dB/m)	Cable Loss (dB)	Preamp Factor (dB)	Antenna Height (cm)	Table Angle (Degree)	Remark
5450	49.37	40.55	54	-4.63	34.36	8.51	34.05	166	27	Average
5450	60.45	51.63	74	-13.55	34.36	8.51	34.05	166	27	Peak
5470	62.13	53.3	68.2	-6.07	34.37	8.51	34.05	166	27	Peak
5610	93.01	83.98			34.5	8.61	34.08	166	27	Average
5610	101.95	92.92			34.5	8.61	34.08	166	27	Peak
5725	64.86	55.7	68.2	-3.34	34.62	8.65	34.11	166	27	Peak
Antenna Polarity & Test Distance: Vertical at 3 m										
Frequency (MHz)	Emission Level (dBuV/m)	Read Level (dBuV)	Limit (dBuV/m)	Margin (dB)	Antenna Factor (dB/m)	Cable Loss (dB)	Preamp Factor (dB)	Antenna Height (cm)	Table Angle (Degree)	Remark
5460	49.01	40.19	54	-4.99	34.36	8.51	34.05	102	0	Average
5460	59.68	50.86	74	-14.32	34.36	8.51	34.05	102	0	Peak
5470	59.37	50.54	68.2	-8.83	34.37	8.51	34.05	102	0	Peak
5610	96.26	87.23			34.5	8.61	34.08	102	0	Average
5610	104.58	95.55			34.5	8.61	34.08	102	0	Peak
5725	62.65	53.49	68.2	-5.55	34.62	8.65	34.11	102	0	Peak

Remarks:

- Emission Level = Read Level + Antenna Factor + Cable Loss - Preamp Factor
Margin value = Emission level – Limit value
- 5610 MHz: Fundamental frequency.
- 5470 MHz & 5725 MHz: Out of restricted band

EUT Test Condition		Measurement Detail	
Channel	Channel 155	Frequency Range	1 GHz ~ 40 GHz
Input Power	120 Vac, 60 Hz	Detector Function	Peak (PK) Average (AV)
Environmental Conditions	25 deg. C, 65 % RH	Tested By	Karl Lee

Antenna Polarity & Test Distance: Horizontal at 3 m										
Frequency (MHz)	Emission Level (dBuV/m)	Read Level (dBuV)	Limit (dBuV/m)	Margin (dB)	Antenna Factor (dB/m)	Cable Loss (dB)	Preamp Factor (dB)	Antenna Height (cm)	Table Angle (Degree)	Remark
*5710	66.42	57.27	68.2	-1.78	34.61	8.65	34.11	164	348	Peak
*5716	66.88	57.73	78.2	-11.32	34.61	8.65	34.11	164	348	Peak
5775	90.35	81.12			34.68	8.67	34.12	164	348	Average
5775	98.01	88.78			34.68	8.67	34.12	164	348	Peak
*5860	58.89	49.57	78.2	-19.31	34.76	8.7	34.14	164	348	Peak
*5868	59.89	50.56	68.2	-8.31	34.76	8.71	34.14	164	348	Peak
Antenna Polarity & Test Distance: Vertical at 3 m										
Frequency (MHz)	Emission Level (dBuV/m)	Read Level (dBuV)	Limit (dBuV/m)	Margin (dB)	Antenna Factor (dB/m)	Cable Loss (dB)	Preamp Factor (dB)	Antenna Height (cm)	Table Angle (Degree)	Remark
*5710	67.1	57.95	68.2	-1.1	34.61	8.65	34.11	185	327	Peak
*5720	67.76	58.6	78.2	-10.44	34.62	8.65	34.11	185	327	Peak
5775	93.45	84.22			34.68	8.67	34.12	185	327	Average
5775	101.7	92.47			34.68	8.67	34.12	185	327	Peak
*5852	60.04	50.74	78.2	-18.16	34.74	8.7	34.14	185	327	Peak
*5862	59.44	50.11	68.2	-8.76	34.76	8.71	34.14	185	327	Peak

Remarks:

- Emission Level = Read Level + Antenna Factor + Cable Loss - Preamp Factor
Margin value = Emission level – Limit value
- 5775 MHz: Fundamental frequency.
- *: Out of restricted band



9 kHz ~ 30 MHz DATA:

The amplitude of spurious emissions attenuated more than 20 dB below the permissible value is not required to be report.

30 MHz ~ 1 GHz WORST-CASE DATA:

Mode A

802.11ac (VHT80)

EUT Test Condition		Measurement Detail	
Channel	Channel 42	Frequency Range	30 MHz ~ 1 GHz
Input Power	120 Vac, 60 Hz	Detector Function	Peak (PK) Quasi-peak (QP)
Environmental Conditions	25 deg. C, 65 % RH	Tested By	Karl Lee

Antenna Polarity & Test Distance: Horizontal at 3 m										
Frequency (MHz)	Emission Level (dBuV/m)	Read Level (dBuV)	Limit (dBuV/m)	Margin (dB)	Antenna Factor (dB/m)	Cable Loss (dB)	Preamp Factor (dB)	Antenna Height (cm)	Table Angle (Degree)	Remark
91.02	29.04	49.01	43.5	-14.46	10.69	1.11	31.77	190	10	Peak
143.94	28.05	50.55	43.5	-15.45	8.39	1.38	32.27	100	20	Peak
208.2	25.46	44.92	43.5	-18.04	11.15	1.65	32.26	111	114	Peak
381.2	25.2	40.42	46	-20.8	14.61	2.34	32.17	181	20	Peak
565.3	31.07	43.07	46	-14.93	17.38	2.82	32.2	153	64	Peak
739.6	29.39	38.65	46	-16.61	19.71	3.16	32.13	197	316	Peak

Antenna Polarity & Test Distance: Vertical at 3 m										
Frequency (MHz)	Emission Level (dBuV/m)	Read Level (dBuV)	Limit (dBuV/m)	Margin (dB)	Antenna Factor (dB/m)	Cable Loss (dB)	Preamp Factor (dB)	Antenna Height (cm)	Table Angle (Degree)	Remark
52.14	32.75	49.7	40	-7.25	14.38	0.9	32.23	152	144	Peak
90.21	23.04	43.18	43.5	-20.46	10.46	1.11	31.71	190	210	Peak
192.27	15.77	35.67	43.5	-27.73	10.75	1.61	32.26	127	139	Peak
565.3	27.08	39.08	46	-18.92	17.38	2.82	32.2	156	27	Peak
626.2	33.87	44.93	46	-12.13	18.18	2.93	32.17	162	33	Peak
745.2	27.66	36.82	46	-18.34	19.76	3.22	32.14	197	322	Peak

Remarks:

1. Emission Level = Read Level + Antenna Factor + Cable Loss - Preamp Factor

Margin value = Emission level – Limit value



802.11a

EUT Test Condition		Measurement Detail	
Channel	Channel 64	Frequency Range	30 MHz ~ 1 GHz
Input Power	120 Vac, 60 Hz	Detector Function	Peak (PK) Quasi-peak (QP)
Environmental Conditions	25 deg. C, 65 % RH	Tested By	Karl Lee

Antenna Polarity & Test Distance: Horizontal at 3 m										
Frequency (MHz)	Emission Level (dBuV/m)	Read Level (dBuV)	Limit (dBuV/m)	Margin (dB)	Antenna Factor (dB/m)	Cable Loss (dB)	Preamp Factor (dB)	Antenna Height (cm)	Table Angle (Degree)	Remark
93.18	26.07	45.68	43.5	-17.43	11.16	1.11	31.88	115	116	Peak
131.79	25.99	47.99	43.5	-17.51	8.86	1.38	32.24	131	78	Peak
192	25.37	45.27	43.5	-18.13	10.75	1.61	32.26	107	48	Peak
335.7	27.42	43.38	46	-18.58	13.94	2.19	32.09	157	274	Peak
624.8	28.07	39.14	46	-17.93	18.17	2.93	32.17	139	336	Peak
780.9	28.79	37.47	46	-17.21	20.14	3.27	32.09	120	139	Peak

Antenna Polarity & Test Distance: Vertical at 3 m										
Frequency (MHz)	Emission Level (dBuV/m)	Read Level (dBuV)	Limit (dBuV/m)	Margin (dB)	Antenna Factor (dB/m)	Cable Loss (dB)	Preamp Factor (dB)	Antenna Height (cm)	Table Angle (Degree)	Remark
33.78	24.85	44.52	40	-15.15	11.83	0.74	32.24	133	69	Peak
103.17	18.1	36.72	43.5	-25.4	12.36	1.28	32.26	128	258	Peak
143.94	19.24	41.74	43.5	-24.26	8.39	1.38	32.27	192	208	Peak
433.7	22.5	36.82	46	-23.5	15.36	2.49	32.17	144	224	Peak
471.5	24.1	37.74	46	-21.9	15.92	2.56	32.12	159	157	Peak
666.8	31.07	41.44	46	-14.93	18.71	3.05	32.13	181	305	Peak

Remarks:

- Emission Level = Read Level + Antenna Factor + Cable Loss - Preamp Factor
Margin value = Emission level – Limit value

802.11a

EUT Test Condition		Measurement Detail	
Channel	Channel 100	Frequency Range	30 MHz ~ 1 GHz
Input Power	120 Vac, 60 Hz	Detector Function	Peak (PK) Quasi-peak (QP)
Environmental Conditions	25 deg. C, 65 % RH	Tested By	Karl Lee

Antenna Polarity & Test Distance: Horizontal at 3 m

Frequency (MHz)	Emission Level (dBuV/m)	Read Level (dBuV)	Limit (dBuV/m)	Margin (dB)	Antenna Factor (dB/m)	Cable Loss (dB)	Preamp Factor (dB)	Antenna Height (cm)	Table Angle (Degree)	Remark
91.83	28.1	47.89	43.5	-15.4	10.92	1.11	31.82	188	103	Peak
143.94	27.07	49.57	43.5	-16.43	8.39	1.38	32.27	200	1	Peak
233.31	30.73	49.15	46	-15.27	11.89	1.85	32.16	130	228	Peak
330.1	27.24	43.36	46	-18.76	13.78	2.19	32.09	133	301	Peak
573.7	23.48	35.32	46	-22.52	17.54	2.82	32.2	154	186	Peak
769	29.33	38.21	46	-16.67	20.01	3.22	32.11	169	229	Peak

Antenna Polarity & Test Distance: Vertical at 3 m

Frequency (MHz)	Emission Level (dBuV/m)	Read Level (dBuV)	Limit (dBuV/m)	Margin (dB)	Antenna Factor (dB/m)	Cable Loss (dB)	Preamp Factor (dB)	Antenna Height (cm)	Table Angle (Degree)	Remark
48.63	23.59	40.35	40	-16.41	14.56	0.9	32.22	186	90	Peak
88.59	22.42	43.17	43.5	-21.08	9.95	1.11	31.81	111	135	Peak
208.2	17.93	37.39	43.5	-25.57	11.15	1.65	32.26	114	165	Peak
437.9	21.93	36.2	46	-24.07	15.4	2.49	32.16	190	214	Peak
624.8	25.15	36.22	46	-20.85	18.17	2.93	32.17	126	226	Peak
817.3	24.64	32.67	46	-21.36	20.61	3.32	31.96	117	81	Peak

Remarks:

- Emission Level = Read Level + Antenna Factor + Cable Loss - Preamp Factor
Margin value = Emission level – Limit value

802.11n (HT40)

EUT Test Condition		Measurement Detail	
Channel	Channel 151	Frequency Range	30 MHz ~ 1 GHz
Input Power	120 Vac, 60 Hz	Detector Function	Peak (PK) Quasi-peak (QP)
Environmental Conditions	25 deg. C, 65 % RH	Tested By	Karl Lee

Antenna Polarity & Test Distance: Horizontal at 3 m

Frequency (MHz)	Emission Level (dBuV/m)	Read Level (dBuV)	Limit (dBuV/m)	Margin (dB)	Antenna Factor (dB/m)	Cable Loss (dB)	Preamp Factor (dB)	Antenna Height (cm)	Table Angle (Degree)	Remark
88.59	29.34	50.09	43.5	-14.16	9.95	1.11	31.81	188	248	Peak
131.79	27.78	49.78	43.5	-15.72	8.86	1.38	32.24	175	95	Peak
208.2	25.62	45.08	43.5	-17.88	11.15	1.65	32.26	200	235	Peak
359.5	26.49	41.98	46	-19.51	14.35	2.26	32.1	159	359	Peak
556.2	22.66	34.9	46	-23.34	17.2	2.76	32.2	129	199	Peak
793.5	29.54	38.08	46	-16.46	20.26	3.27	32.07	178	335	Peak

Antenna Polarity & Test Distance: Vertical at 3 m

Frequency (MHz)	Emission Level (dBuV/m)	Read Level (dBuV)	Limit (dBuV/m)	Margin (dB)	Antenna Factor (dB/m)	Cable Loss (dB)	Preamp Factor (dB)	Antenna Height (cm)	Table Angle (Degree)	Remark
32.97	24.92	44.69	40	-15.08	11.74	0.74	32.25	132	197	Peak
89.4	22.78	43.22	43.5	-20.72	10.21	1.11	31.76	122	18	Peak
132.06	20.45	42.45	43.5	-23.05	8.86	1.38	32.24	130	60	Peak
419.7	22.99	37.54	46	-23.01	15.23	2.41	32.19	149	174	Peak
565.3	26.67	38.67	46	-19.33	17.38	2.82	32.2	171	10	Peak
743.8	24.61	33.84	46	-21.39	19.75	3.16	32.14	176	336	Peak

Remarks:

- Emission Level = Read Level + Antenna Factor + Cable Loss - Preamp Factor
Margin value = Emission level – Limit value

Mode B
802.11ac (VHT80)

EUT Test Condition		Measurement Detail	
Channel	Channel 42	Frequency Range	30 MHz ~ 1 GHz
Input Power	120 Vac, 60 Hz	Detector Function	Peak (PK) Quasi-peak (QP)
Environmental Conditions	25 deg. C, 65 % RH	Tested By	Karl Lee

Antenna Polarity & Test Distance: Horizontal at 3 m

Frequency (MHz)	Emission Level (dBuV/m)	Read Level (dBuV)	Limit (dBuV/m)	Margin (dB)	Antenna Factor (dB/m)	Cable Loss (dB)	Preamp Factor (dB)	Antenna Height (cm)	Table Angle (Degree)	Remark
86.43	38.81	60.17	40	-1.19	9.44	1.11	31.91	186	41	QP
102.36	38.46	57.08	43.5	-5.04	12.36	1.28	32.26	120	360	QP
194.7	39.77	59.5	43.5	-3.73	10.94	1.61	32.28	194	77	QP
366.5	40.67	56.1	46	-5.33	14.43	2.26	32.12	200	263	Peak
687.8	37.1	47.1	46	-8.9	19.05	3.05	32.1	167	158	Peak
750.1	42.79	51.91	46	-3.21	19.81	3.22	32.15	175	101	Peak

Antenna Polarity & Test Distance: Vertical at 3 m

Frequency (MHz)	Emission Level (dBuV/m)	Read Level (dBuV)	Limit (dBuV/m)	Margin (dB)	Antenna Factor (dB/m)	Cable Loss (dB)	Preamp Factor (dB)	Antenna Height (cm)	Table Angle (Degree)	Remark
32.7	38.29	58.06	40	-1.71	11.74	0.74	32.25	103	240	QP
49.17	36.07	52.84	40	-3.93	14.55	0.9	32.22	149	30	QP
187.95	39.37	59.56	43.5	-4.13	10.45	1.61	32.25	187	22	Peak
381.9	33.6	48.8	46	-12.4	14.63	2.34	32.17	169	168	Peak
687.8	35.54	45.54	46	-10.46	19.05	3.05	32.1	168	39	Peak
750.1	38.64	47.76	46	-7.36	19.81	3.22	32.15	175	119	Peak

Remarks:

- Emission Level = Read Level + Antenna Factor + Cable Loss - Preamp Factor
Margin value = Emission level – Limit value

802.11a

EUT Test Condition		Measurement Detail	
Channel	Channel 64	Frequency Range	30 MHz ~ 1 GHz
Input Power	120 Vac, 60 Hz	Detector Function	Peak (PK) Quasi-peak (QP)
Environmental Conditions	25 deg. C, 65 % RH	Tested By	Karl Lee

Antenna Polarity & Test Distance: Horizontal at 3 m										
Frequency (MHz)	Emission Level (dBuV/m)	Read Level (dBuV)	Limit (dBuV/m)	Margin (dB)	Antenna Factor (dB/m)	Cable Loss (dB)	Preamp Factor (dB)	Antenna Height (cm)	Table Angle (Degree)	Remark
84	38.41	60.31	40	-1.59	9	1.11	32.01	185	40	QP
105.87	37.72	56.36	43.5	-5.78	12.34	1.28	32.26	125	356	QP
196.05	39.77	59.47	43.5	-3.73	10.97	1.61	32.28	190	78	QP
327.3	40.24	56.53	46	-5.76	13.7	2.11	32.1	140	236	Peak
565.3	29.9	41.9	46	-16.1	17.38	2.82	32.2	129	89	Peak
812.4	32.96	41.1	46	-13.04	20.53	3.32	31.99	120	332	Peak

Antenna Polarity & Test Distance: Vertical at 3 m										
Frequency (MHz)	Emission Level (dBuV/m)	Read Level (dBuV)	Limit (dBuV/m)	Margin (dB)	Antenna Factor (dB/m)	Cable Loss (dB)	Preamp Factor (dB)	Antenna Height (cm)	Table Angle (Degree)	Remark
33.24	38.95	58.72	40	-1.05	11.74	0.74	32.25	100	249	QP
50.52	35.31	52.09	40	-4.69	14.54	0.9	32.22	150	26	QP
193.35	38.2	58.05	43.5	-5.3	10.81	1.61	32.27	188	20	Peak
391.7	32.35	47.38	46	-13.65	14.83	2.34	32.2	117	190	Peak
499.5	29.89	43.01	46	-16.11	16.35	2.63	32.1	163	263	Peak
812.4	30.61	38.75	46	-15.39	20.53	3.32	31.99	120	53	Peak

Remarks:

1. Emission Level = Read Level + Antenna Factor + Cable Loss - Preamp Factor
Margin value = Emission level – Limit value

802.11a

EUT Test Condition		Measurement Detail	
Channel	Channel 100	Frequency Range	30 MHz ~ 1 GHz
Input Power	120 Vac, 60 Hz	Detector Function	Peak (PK) Quasi-peak (QP)
Environmental Conditions	25 deg. C, 65 % RH	Tested By	Karl Lee

Antenna Polarity & Test Distance: Horizontal at 3 m

Frequency (MHz)	Emission Level (dBuV/m)	Read Level (dBuV)	Limit (dBuV/m)	Margin (dB)	Antenna Factor (dB/m)	Cable Loss (dB)	Preamp Factor (dB)	Antenna Height (cm)	Table Angle (Degree)	Remark
85.89	37.45	58.81	40	-2.55	9.44	1.11	31.91	190	136	QP
110.73	36.12	55.18	43.5	-7.38	11.91	1.28	32.25	101	110	QP
196.86	40.63	60.3	43.5	-2.87	11	1.61	32.28	200	26	QP
330.8	38.81	54.9	46	-7.19	13.81	2.19	32.09	133	8	Peak
380.5	40.03	55.34	46	-5.97	14.59	2.26	32.16	140	290	Peak
780.2	32.26	40.95	46	-13.74	20.13	3.27	32.09	192	294	Peak

Antenna Polarity & Test Distance: Vertical at 3 m

Frequency (MHz)	Emission Level (dBuV/m)	Read Level (dBuV)	Limit (dBuV/m)	Margin (dB)	Antenna Factor (dB/m)	Cable Loss (dB)	Preamp Factor (dB)	Antenna Height (cm)	Table Angle (Degree)	Remark
32.7	39.15	58.92	40	-0.85	11.74	0.74	32.25	130	250	QP
52.41	35.71	52.66	40	-4.29	14.38	0.9	32.23	145	180	QP
83.46	32.22	54.37	40	-7.78	8.8	1.11	32.06	195	8	QP
390.3	32.51	47.57	46	-13.49	14.79	2.34	32.19	190	33	Peak
654.2	29.13	39.76	46	-16.87	18.52	2.99	32.14	185	225	Peak
812.4	31.05	39.19	46	-14.95	20.53	3.32	31.99	131	350	Peak

Remarks:

- Emission Level = Read Level + Antenna Factor + Cable Loss - Preamp Factor
Margin value = Emission level – Limit value

802.11n (HT40)

EUT Test Condition		Measurement Detail	
Channel	Channel 151	Frequency Range	30 MHz ~ 1 GHz
Input Power	120 Vac, 60 Hz	Detector Function	Peak (PK) Quasi-peak (QP)
Environmental Conditions	25 deg. C, 65 % RH	Tested By	Karl Lee

Antenna Polarity & Test Distance: Horizontal at 3 m

Frequency (MHz)	Emission Level (dBuV/m)	Read Level (dBuV)	Limit (dBuV/m)	Margin (dB)	Antenna Factor (dB/m)	Cable Loss (dB)	Preamp Factor (dB)	Antenna Height (cm)	Table Angle (Degree)	Remark
83.46	37.94	60.09	40	-2.06	8.8	1.11	32.06	186	140	QP
106.14	36.79	55.43	43.5	-6.71	12.34	1.28	32.26	106	114	QP
194.16	40.11	59.89	43.5	-3.39	10.88	1.61	32.27	194	14	QP
328	39.71	55.97	46	-6.29	13.73	2.11	32.1	132	71	Peak
372.8	41.3	56.68	46	-4.7	14.5	2.26	32.14	144	104	Peak
687.8	38.34	48.34	46	-7.66	19.05	3.05	32.1	187	77	Peak

Antenna Polarity & Test Distance: Vertical at 3 m

Frequency (MHz)	Emission Level (dBuV/m)	Read Level (dBuV)	Limit (dBuV/m)	Margin (dB)	Antenna Factor (dB/m)	Cable Loss (dB)	Preamp Factor (dB)	Antenna Height (cm)	Table Angle (Degree)	Remark
32.43	39.71	59.48	40	-0.29	11.74	0.74	32.25	132	248	QP
49.98	35.74	52.52	40	-4.26	14.54	0.9	32.22	140	174	QP
82.11	32.92	55.31	40	-7.08	8.61	1.11	32.11	198	11	QP
381.9	33.33	48.53	46	-12.67	14.63	2.34	32.17	133	34	Peak
687.8	35.84	45.84	46	-10.16	19.05	3.05	32.1	109	90	Peak
750.1	38.98	48.1	46	-7.02	19.81	3.22	32.15	175	11	Peak

Remarks:

- Emission Level = Read Level + Antenna Factor + Cable Loss - Preamp Factor
Margin value = Emission level – Limit value

4.2 Conducted Emission Measurement

4.2.1 Limits of Conducted Emission Measurement

Frequency (MHz)	Conducted Limit (dBuV)	
	Quasi-peak	Average
0.15 - 0.5	66 - 56	56 - 46
0.50 - 5.0	56	46
5.0 - 30.0	60	50

Note: 1. The lower limit shall apply at the transition frequencies.

2. The limit decreases in line with the logarithm of the frequency in the range of 0.15 to 0.50 MHz.

4.2.2 Test Instruments

Description & Manufacturer	Model No.	Serial No.	Date Of Calibration	Due Date Of Calibration
Test Receiver ROHDE & SCHWARZ	ESCI	100613	Nov. 16, 2015	Nov. 15, 2016
RF signal cable (with 10dB PAD) Woken	5D-FB	Cable-cond1-01	Dec. 26, 2015	Dec. 25, 2016
LISN ROHDE & SCHWARZ (EUT)	ESH3-Z5	835239/001	Feb. 26, 2015	Feb. 25, 2016
LISN ROHDE & SCHWARZ (Peripheral)	ESH3-Z5	100311	Jul. 24, 2015	Jul. 23, 2016
Software ADT	BV ADT_Cond_ V7.3.7.3	NA	NA	NA

- Note:**
1. The calibration interval of the above test instruments is 12 months and the calibrations are traceable to NML/ROC and NIST/USA.
 2. The test was performed in HwaYa Shielded Room 1.
 3. The VCCI Site Registration No. is C-2040.
 4. Test Date: 2015/12/29

4.2.3 Test Procedures

- a. The EUT was placed 0.4 meters from the conducting wall of the shielded room with EUT being connected to the power mains through a line impedance stabilization network (LISN). Other support units were connected to the power mains through another LISN. The two LISNs provide 50 ohm/ 50uH of coupling impedance for the measuring instrument.
- b. Both lines of the power mains connected to the EUT were checked for maximum conducted interference.
- c. The frequency range from 150 kHz to 30 MHz was searched. Emission levels under (Limit -20 dB) was not recorded.

NOTE: All modes of operation were investigated and the worst-case emissions are reported.

4.2.4 Deviation from Test Standard

No deviation.

4.2.5 Test Setup

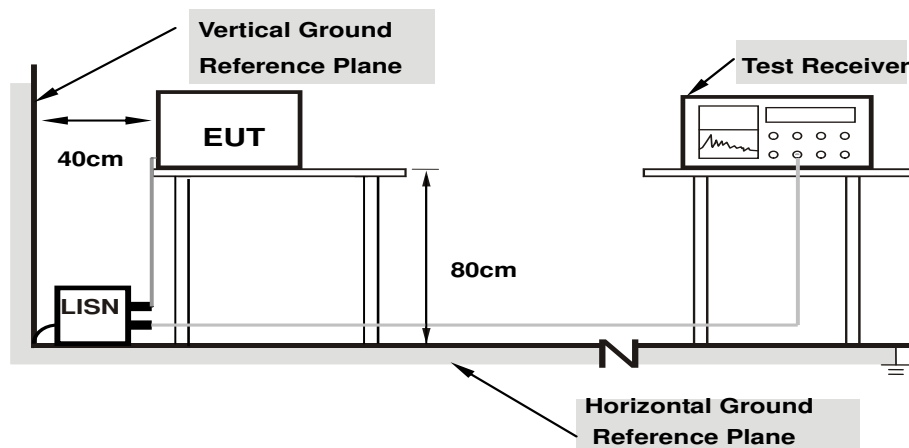

- Note: 1.Support units were connected to second LISN.**
2.Both of LISNs (AMN) are 80 cm from EUT and at least 80 from other units and other metal planes

For the actual test configuration, please refer to the attached file (Test Setup Photo).

4.2.6 EUT Operating Conditions

- a. Placed the EUT on a testing table.
- b. Use the software to control the EUT under transmission condition continuously at specific channel frequency.

4.2.7 Test Results

Mode A

Frequency Range	150kHz ~ 30MHz	Detector Function & Resolution Bandwidth	Quasi-Peak (QP) / Average (AV), 9kHz
Input Power	120Vac, 60Hz	Environmental Conditions	25°C, 65%RH
Tested by	Toby Tian	Test Date	2015/12/29

Phase Of Power : Line (L)										
No	Frequency (MHz)	Correction Factor (dB)	Reading Value (dBuV)		Emission Level (dBuV)		Limit (dBuV)		Margin (dB)	
			Q.P.	AV.	Q.P.	AV.	Q.P.	AV.	Q.P.	AV.
1	0.16569	9.83	39.92	23.44	49.75	33.27	65.17	55.17	-15.43	-21.91
2	0.17737	9.83	38.32	22.33	48.15	32.16	64.61	54.61	-16.46	-22.45
3	0.20474	9.84	34.54	20.88	44.38	30.72	63.42	53.42	-19.04	-22.70
4	0.24775	9.85	29.25	15.13	39.10	24.98	61.83	51.83	-22.73	-26.85
5	0.36114	9.87	31.55	20.96	41.42	30.83	58.70	48.70	-17.28	-17.87
6	0.50581	9.89	19.14	13.01	29.03	22.90	56.00	46.00	-26.97	-23.10

Remarks:

1. Q.P. and AV. are abbreviations of quasi-peak and average individually.
2. The emission levels of other frequencies were very low against the limit.
3. Margin value = Emission level – Limit value
4. Correction factor = Insertion loss + Cable loss
5. Emission Level = Correction Factor + Reading Value

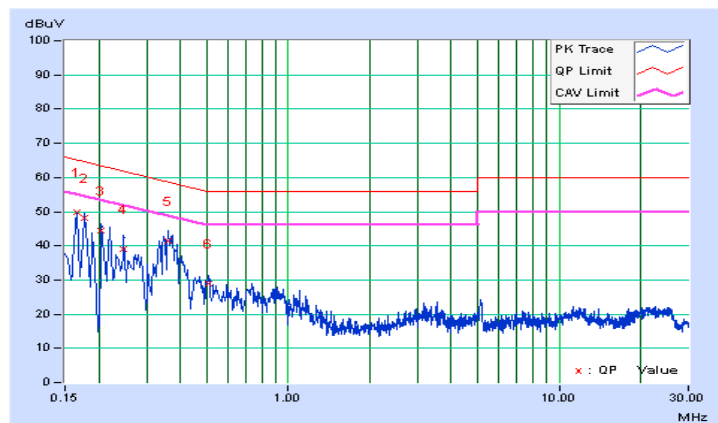

Frequency Range	150kHz ~ 30MHz	Detector Function & Resolution Bandwidth	Quasi-Peak (QP) / Average (AV), 9kHz
Input Power	120Vac, 60Hz	Environmental Conditions	25°C, 65%RH
Tested by	Toby Tian	Test Date	2015/12/29

Phase Of Power : Neutral (N)										
No	Frequency (MHz)	Correction Factor (dB)	Reading Value (dBuV)		Emission Level (dBuV)		Limit (dBuV)		Margin (dB)	
			Q.P.	AV.	Q.P.	AV.	Q.P.	AV.	Q.P.	AV.
1	0.15391	9.82	37.27	26.30	47.09	36.12	65.79	55.79	-18.70	-19.67
2	0.17932	9.83	37.74	20.33	47.57	30.16	64.52	54.52	-16.95	-24.36
3	0.19692	9.83	29.43	12.50	39.26	22.33	63.74	53.74	-24.48	-31.41
4	0.22429	9.84	30.07	16.71	39.91	26.55	62.66	52.66	-22.75	-26.11
5	0.25166	9.84	27.48	12.30	37.32	22.14	61.70	51.70	-24.38	-29.56
6	0.34941	9.87	26.50	13.16	36.37	23.03	58.98	48.98	-22.61	-25.95

Remarks:

1. Q.P. and AV. are abbreviations of quasi-peak and average individually.
2. The emission levels of other frequencies were very low against the limit.
3. Margin value = Emission level – Limit value
4. Correction factor = Insertion loss + Cable loss
5. Emission Level = Correction Factor + Reading Value

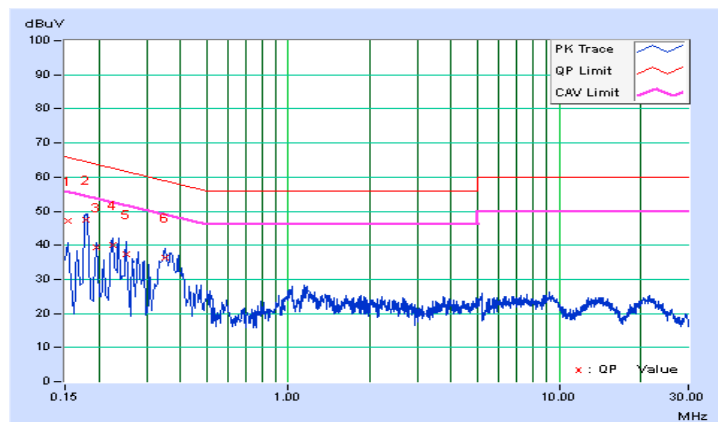

Mode B

Frequency Range	150kHz ~ 30MHz	Detector Function & Resolution Bandwidth	Quasi-Peak (QP) / Average (AV), 9kHz
Input Power	120Vac, 60Hz	Environmental Conditions	25°C, 65%RH
Tested by	Toby Tian	Test Date	2015/12/29

Phase Of Power : Line (L)										
No	Frequency (MHz)	Correction Factor (dB)	Reading Value (dBuV)		Emission Level (dBuV)		Limit (dBuV)		Margin (dB)	
			Q.P.	AV.	Q.P.	AV.	Q.P.	AV.	Q.P.	AV.
1	0.16181	9.82	39.85	25.13	49.67	34.95	65.37	55.37	-15.70	-20.42
2	0.17737	9.83	39.04	25.55	48.87	35.38	64.61	54.61	-15.74	-19.23
3	0.19301	9.84	36.29	22.41	46.13	32.25	63.91	53.91	-17.78	-21.66
4	0.23216	9.85	31.17	20.80	41.02	30.65	62.37	52.37	-21.36	-21.73
5	0.42670	9.88	36.40	31.09	46.28	40.97	57.32	47.32	-11.03	-6.34
6	0.69740	9.90	22.25	17.88	32.15	27.78	56.00	46.00	-23.85	-18.22

Remarks:

1. Q.P. and AV. are abbreviations of quasi-peak and average individually.
2. The emission levels of other frequencies were very low against the limit.
3. Margin value = Emission level – Limit value
4. Correction factor = Insertion loss + Cable loss
5. Emission Level = Correction Factor + Reading Value

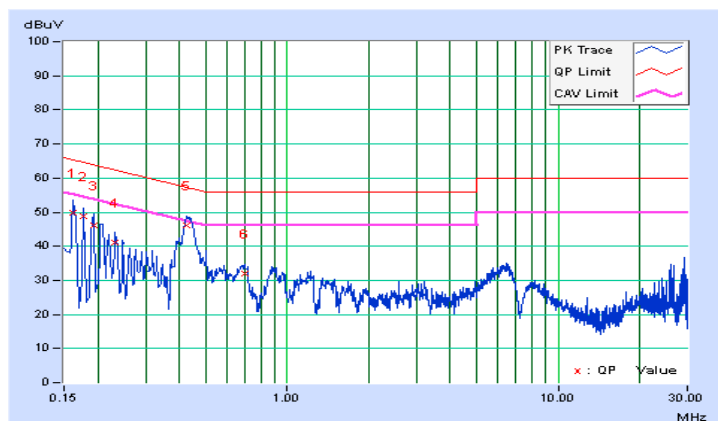

Frequency Range	150kHz ~ 30MHz	Detector Function & Resolution Bandwidth	Quasi-Peak (QP) / Average (AV), 9kHz
Input Power	120Vac, 60Hz	Environmental Conditions	25°C, 65%RH
Tested by	Toby Tian	Test Date	2015/12/29

Phase Of Power : Neutral (N)										
No	Frequency (MHz)	Correction Factor (dB)	Reading Value (dBuV)		Emission Level (dBuV)		Limit (dBuV)		Margin (dB)	
			Q.P.	AV.	Q.P.	AV.	Q.P.	AV.	Q.P.	AV.
1	0.15391	9.82	43.42	31.98	53.24	41.80	65.79	55.79	-12.55	-13.99
2	0.18075	9.83	38.49	24.87	48.32	34.70	64.45	54.45	-16.13	-19.75
3	0.19561	9.83	35.92	22.49	45.75	32.32	63.79	53.79	-18.05	-21.48
4	0.22434	9.84	31.98	21.17	41.82	31.01	62.66	52.66	-20.84	-21.65
5	0.42782	9.88	35.93	31.65	45.81	41.53	57.29	47.29	-11.48	-5.76
6	0.67311	9.90	22.13	17.94	32.03	27.84	56.00	46.00	-23.97	-18.16

Remarks:

1. Q.P. and AV. are abbreviations of quasi-peak and average individually.
2. The emission levels of other frequencies were very low against the limit.
3. Margin value = Emission level – Limit value
4. Correction factor = Insertion loss + Cable loss
5. Emission Level = Correction Factor + Reading Value

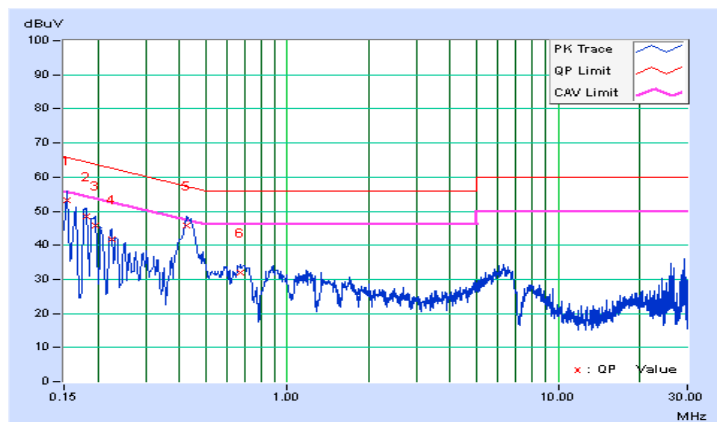

4.3 Transmit Power Measurement

4.3.1 Limits of Transmit Power Measurement

Operation Band	EUT Category	Limit
U-NII-1	Outdoor Access Point	1 Watt (30 dBm) (Max. e.i.r.p \leq 125 mW (21 dBm) at any elevation angle above 30 degrees as measured from the horizon)
	Fixed point-to-point Access Point	1 Watt (30 dBm)
	Indoor Access Point	1 Watt (30 dBm)
	√ Mobile and Portable client device	250 mW (24 dBm)
U-NII-2A	√	250 mW (24 dBm) or 11 dBm+10 log B*
U-NII-2C	√	250 mW (24 dBm) or 11 dBm+10 log B*
U-NII-3	√	1 Watt (30 dBm)

*B is the 26 dB emission bandwidth in megahertz

Per KDB 662911 Method of conducted output power measurement on IEEE 802.11 devices,

Array Gain = 0 dB (i.e., no array gain) for $N_{ANT} \leq 4$;

Array Gain = 0 dB (i.e., no array gain) for channel widths ≥ 40 MHz for any N_{ANT} ;

Array Gain = $5 \log(N_{ANT}/N_{SS})$ dB or 3 dB, whichever is less for 20 MHz channel widths with $N_{ANT} \geq 5$.

For power measurements on all other devices: Array Gain = $10 \log(N_{ANT}/N_{SS})$ dB.

4.3.2 Test Setup

<Power Output Measurement>

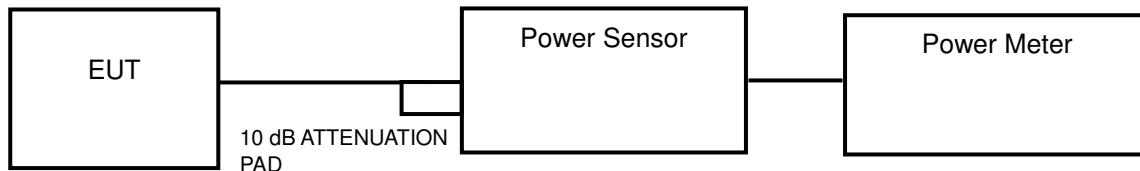

or

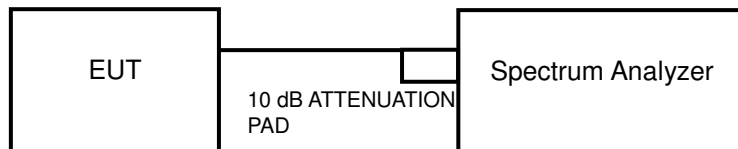

<26 dB Bandwidth>

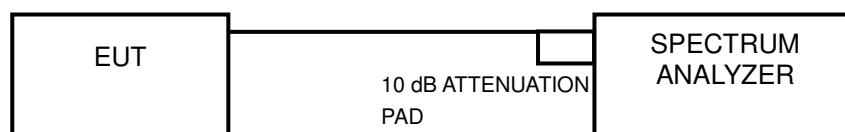

4.3.3 Test Instruments

Refer to section 4.1.2 to get information of above instrument.

4.3.4 Test Procedure

Average Power Measurement

<802.11a, 802.11n (HT20), 802.11n (HT40)>

Method PM is used to perform output power measurement, trigger and gating function of wide band power meter is enabled to measure max output power of TX on burst. Duty factor is not added to measured value.

<802.11ac (VHT80)>

Method SA-1 is used to perform output power measurement, trigger and gating function of spectrum analyzer is enabled to measure max output power of TX on burst. Duty factor is not added to measured value.

26 dB Bandwidth

- 1) Set RBW = approximately 1 % of the emission bandwidth.
- 2) Set the VBW > RBW.
- 3) Detector = Peak.
- 4) Trace mode = max hold.
- 5) Measure the maximum width of the emission that is 26 dB down from the peak of the emission. Compare this with the RBW setting of the analyzer. Readjust RBW and repeat measurement as needed until the RBW/EBW ratio is approximately 1 %.

4.3.5 Deviation from Test Standard

No deviation.

4.3.6 EUT Operating Conditions

The software provided by client to enable the EUT under transmission condition continuously at lowest, middle and highest channel frequencies individually.

4.3.7 Test Result

Power Output:

802.11a

Channel	Frequency (MHz)	Maximum Conducted Power (mW)	Maximum Conducted Power (dBm)	Power Limit (dBm)	Pass / Fail
36	5180	27.73	14.43	24	Pass
44	5220	67.14	18.27	24	Pass
48	5240	71.78	18.56	24	Pass
52	5260	70.96	18.51	24	Pass
60	5300	71.61	18.55	24	Pass
64	5320	37.84	15.78	24	Pass
100	5500	47.32	16.75	24	Pass
116	5580	73.11	18.64	24	Pass
140	5700	32.96	15.18	24	Pass
149	5745	38.11	15.81	30	Pass
157	5785	76.56	18.84	30	Pass
165	5825	40.09	16.03	30	Pass

NOTE:

For U-NII-2A, U-NII-2C Band:

1. $11 \text{ dBm} + 10\log(39.16) = 26.93 \text{ dBm} > 24 \text{ dBm}$.
2. $11 \text{ dBm} + 10\log(38.72) = 26.88 \text{ dBm} > 24 \text{ dBm}$.
3. $11 \text{ dBm} + 10\log(21.83) = 24.39 \text{ dBm} > 24 \text{ dBm}$.
4. $11 \text{ dBm} + 10\log(22.06) = 24.44 \text{ dBm} > 24 \text{ dBm}$.
5. $11 \text{ dBm} + 10\log(38.04) = 26.80 \text{ dBm} > 24 \text{ dBm}$.
6. $11 \text{ dBm} + 10\log(21.72) = 24.37 \text{ dBm} > 24 \text{ dBm}$.

802.11n (HT20)

Channel	Frequency (MHz)	Maximum Conducted Power (mW)	Maximum Conducted Power (dBm)	Power Limit (dBm)	Pass / Fail
36	5180	27.23	14.35	24	Pass
44	5220	68.55	18.36	24	Pass
48	5240	73.28	18.65	24	Pass
52	5260	72.95	18.63	24	Pass
60	5300	72.11	18.58	24	Pass
64	5320	32.81	15.16	24	Pass
100	5500	36.73	15.65	24	Pass
116	5580	74.99	18.75	24	Pass
140	5700	32.28	15.09	24	Pass
149	5745	29.31	14.67	30	Pass
157	5785	77.27	18.88	30	Pass
165	5825	31.62	15.00	30	Pass

NOTE:
For U-NII-2A, U-NII-2C Band:

1. $11 \text{ dBm} + 10\log(47.37) = 27.76 \text{ dBm} > 24 \text{ dBm}$.
2. $11 \text{ dBm} + 10\log(46.79) = 27.70 \text{ dBm} > 24 \text{ dBm}$.
3. $11 \text{ dBm} + 10\log(22.13) = 24.45 \text{ dBm} > 24 \text{ dBm}$.
4. $11 \text{ dBm} + 10\log(22.09) = 24.44 \text{ dBm} > 24 \text{ dBm}$.
5. $11 \text{ dBm} + 10\log(47.41) = 27.76 \text{ dBm} > 24 \text{ dBm}$.
6. $11 \text{ dBm} + 10\log(22.20) = 24.46 \text{ dBm} > 24 \text{ dBm}$.

802.11n (HT40)

Channel	Frequency (MHz)	Maximum Conducted Power (mW)	Maximum Conducted Power (dBm)	Power Limit (dBm)	Pass / Fail
38	5190	19.59	12.92	24	Pass
46	5230	58.61	17.68	24	Pass
54	5270	55.34	17.43	24	Pass
62	5310	22.03	13.43	24	Pass
102	5510	26.42	14.22	24	Pass
110	5550	74.47	18.72	24	Pass
134	5670	50.47	17.03	24	Pass
151	5755	15.17	11.81	30	Pass
159	5795	52.00	17.16	30	Pass

NOTE:

For U-NII-2A, U-NII-2C Band:

1. $11 \text{ dBm} + 10\log(73.30) = 29.65 \text{ dBm} > 24 \text{ dBm}$.
2. $11 \text{ dBm} + 10\log(41.72) = 27.20 \text{ dBm} > 24 \text{ dBm}$.
3. $11 \text{ dBm} + 10\log(41.48) = 27.18 \text{ dBm} > 24 \text{ dBm}$.
4. $11 \text{ dBm} + 10\log(93.67) = 30.72 \text{ dBm} > 24 \text{ dBm}$.
5. $11 \text{ dBm} + 10\log(68.62) = 29.36 \text{ dBm} > 24 \text{ dBm}$.

802.11ac (VHT80)

Channel	Frequency (MHz)	Maximum Conducted Power (mW)	Maximum Conducted Power (dBm)	Power Limit (dBm)	Pass / Fail
42	5210	15.21	11.82	24	Pass
58	5290	21.68	13.36	24	Pass
106	5530	30.97	14.91	24	Pass
122	5610	64.86	18.12	24	Pass
155	5775	14.19	11.52	30	Pass

NOTE:

For U-NII-2A, U-NII-2C Band:

1. $11 \text{ dBm} + 10\log(82.53) = 30.17 \text{ dBm} > 24 \text{ dBm}$.
2. $11 \text{ dBm} + 10\log(82.74) = 30.18 \text{ dBm} > 24 \text{ dBm}$.
3. $11 \text{ dBm} + 10\log(139.85) = 32.46 \text{ dBm} > 24 \text{ dBm}$.

26 dB Bandwidth:
802.11a

Channel	Frequency (MHz)	26 dBc Bandwidth (MHz)	Pass / Fail
36	5180	22.01	Pass
44	5220	38.60	Pass
48	5240	40.20	Pass
52	5260	39.16	Pass
60	5300	38.72	Pass
64	5320	21.83	Pass
100	5500	22.06	Pass
116	5580	38.04	Pass
140	5700	21.72	Pass

802.11n (HT20)

Channel	Frequency (MHz)	26 dBc Bandwidth (MHz)	Pass / Fail
36	5180	22.14	Pass
44	5220	44.97	Pass
48	5240	40.32	Pass
52	5260	47.37	Pass
60	5300	46.79	Pass
64	5320	22.13	Pass
100	5500	22.09	Pass
116	5580	47.41	Pass
140	5700	22.20	Pass

802.11n (HT40)

Channel	Frequency (MHz)	26 dBc Bandwidth (MHz)	Pass / Fail
38	5190	41.22	Pass
46	5230	84.95	Pass
54	5270	73.30	Pass
62	5310	41.72	Pass
102	5510	41.48	Pass
110	5550	93.67	Pass
134	5670	68.62	Pass

802.11ac (VHT80)

Channel	Frequency (MHz)	26 dBc Bandwidth (MHz)	Pass / Fail
42	5210	82.35	Pass
58	5290	82.53	Pass
106	5530	82.74	Pass
122	5610	139.85	Pass

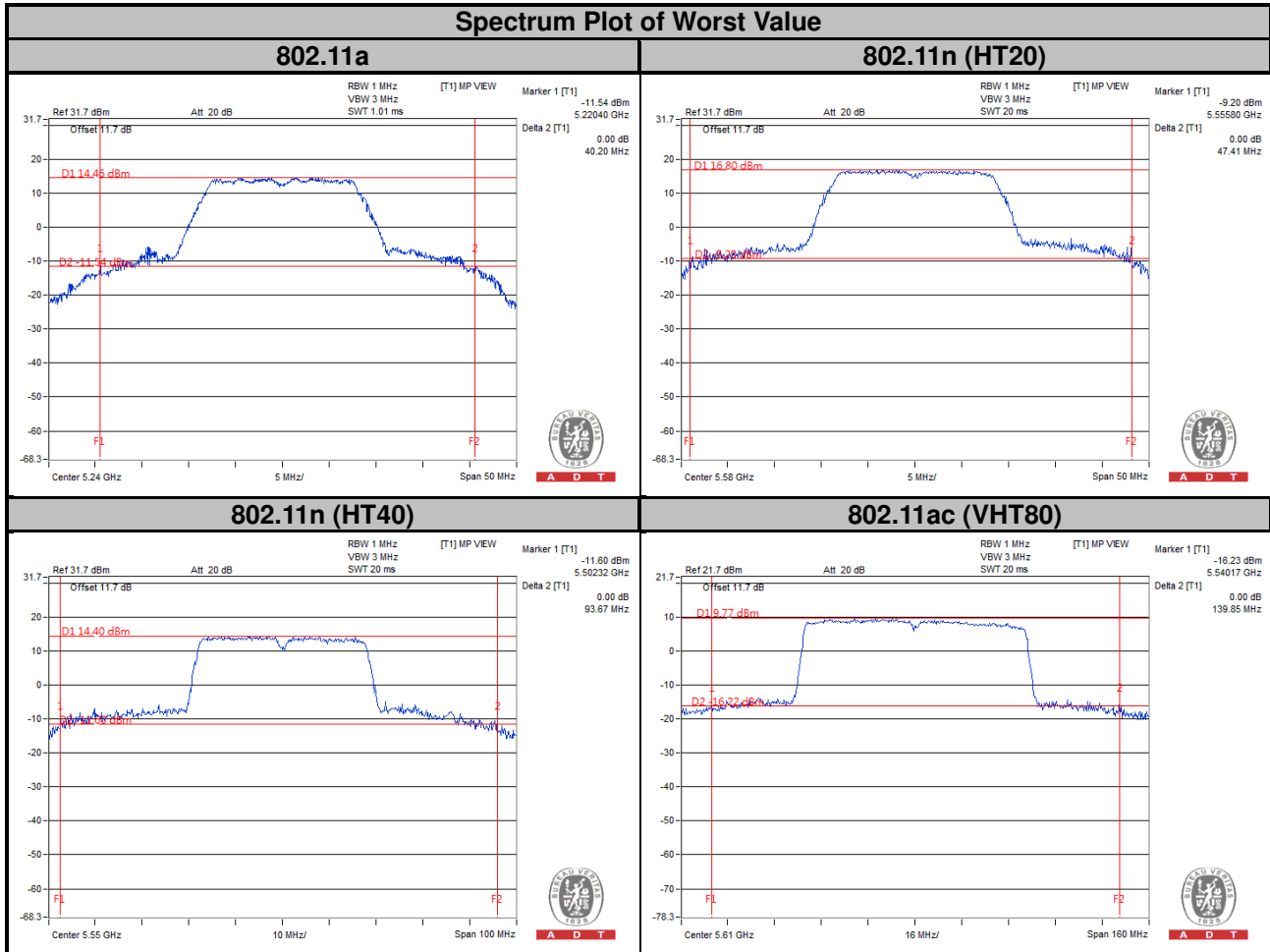

4.4 Peak Power Spectral Density Measurement

4.4.1 Limits of Peak Power Spectral Density Measurement

Operation Band	EUT Category		Limit
U-NII-1		Outdoor Access Point	17 dBm/MHz
		Fixed point-to-point Access Point	
		Indoor Access Point	
	√	Mobile and Portable client device	11 dBm/MHz
U-NII-2A		√	11 dBm/MHz
U-NII-2C		√	11 dBm/MHz
U-NII-3		√	30 dBm/500 kHz

4.4.2 Test Setup

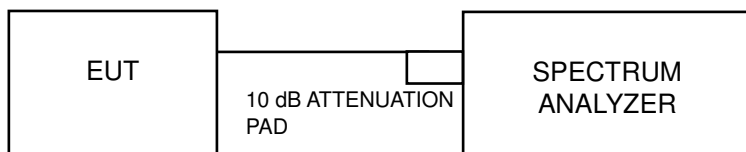

4.4.3 Test Instruments

Refer to section 4.1.3 to get information of above instrument.

4.4.4 Test Procedures

For U-NII-1, U-NII-2A, U-NII-2C band:

Using method SA-2

1. Set span to encompass the entire emission bandwidth (EBW) of the signal.
2. Set RBW = 1 MHz, Set VBW \geq 3 MHz, Detector = RMS
3. Sweep time = auto, trigger set to "free run".
4. Trace average at least 100 traces in power averaging mode.
5. Record the max value and add $10 \log (1/\text{duty cycle})$

※For U-NII-3:

1. Set span to encompass the entire emission bandwidth (EBW) of the signal.
2. Set RBW = 300 kHz, Set VBW \geq 1 MHz, Detector = RMS
3. Use the peak marker function to determine the maximum power level in any 300 kHz band segment within the fundamental EBW.
4. Scale the observed power level to an equivalent value in 500 kHz by adjusting (reducing) the measured power by a bandwidth correction factor (BWCF) where $\text{BWCF} = 10\log(500 \text{ kHz}/300 \text{ kHz})$
5. Sweep time = auto, trigger set to "free run".
6. Trace average at least 100 traces in power averaging mode.
7. Record the max value and add $10 \log (1/\text{duty cycle})$

4.4.5 Deviation from Test Standard

No deviation.

4.4.6 EUT Operating Conditions

The software provided by client to enable the EUT under transmission condition continuously at lowest, middle and highest channel frequencies individually.

4.4.7 Test Results

802.11a

Channel	Frequency (MHz)	PSD w/o Duty Factor (dBm)	Duty Factor	PSD with Duty Factor (dBm)	Maximum Limit (dBm)	Pass / Fail
36	5180	2.16	0.09	2.25	11	Pass
44	5220	5.39	0.09	5.48	11	Pass
48	5240	5.96	0.09	6.05	11	Pass
52	5260	6.81	0.09	6.90	11	Pass
60	5300	7.33	0.09	7.42	11	Pass
64	5320	4.82	0.09	4.91	11	Pass
100	5500	6.43	0.09	6.52	11	Pass
116	5580	8.00	0.09	8.09	11	Pass
140	5700	3.34	0.09	3.43	11	Pass

NOTE: Refer to section 3.3 for duty cycle spectrum plot.

802.11n (HT20)

Channel	Frequency (MHz)	PSD w/o Duty Factor (dBm)	Duty Factor	PSD with Duty Factor (dBm)	Maximum Limit (dBm)	Pass / Fail
36	5180	1.97	0.11	2.08	11	Pass
44	5220	4.99	0.11	5.10	11	Pass
48	5240	5.44	0.11	5.55	11	Pass
52	5260	6.55	0.11	6.66	11	Pass
60	5300	7.06	0.11	7.17	11	Pass
64	5320	3.51	0.11	3.62	11	Pass
100	5500	4.84	0.11	4.95	11	Pass
116	5580	7.44	0.11	7.55	11	Pass
140	5700	3.24	0.11	3.35	11	Pass

NOTE: Refer to section 3.3 for duty cycle spectrum plot.

802.11n (HT40)

Channel	Frequency (MHz)	PSD w/o Duty Factor (dBm)	Duty Factor	PSD with Duty Factor (dBm)	Maximum Limit (dBm)	Pass / Fail
38	5190	-3.34	0.19	-3.15	11	Pass
46	5230	1.75	0.19	1.94	11	Pass
54	5270	2.34	0.19	2.53	11	Pass
62	5310	-1.41	0.19	-1.22	11	Pass
102	5510	0.14	0.19	0.33	11	Pass
110	5550	4.86	0.19	5.05	11	Pass
134	5670	2.09	0.19	2.28	11	Pass

NOTE: Refer to section 3.3 for duty cycle spectrum plot.

802.11ac (VHT80)

Channel	Frequency (MHz)	PSD w/o Duty Factor (dBm)	Duty Factor	PSD with Duty Factor (dBm)	Maximum Limit (dBm)	Pass / Fail
42	5210	-5.10	0.75	-4.35	11	Pass
58	5290	-6.25	0.75	-5.50	11	Pass
106	5530	-4.65	0.75	-3.90	11	Pass
122	5610	-1.32	0.75	-0.57	11	Pass

NOTE: Refer to section 3.3 for duty cycle spectrum plot.

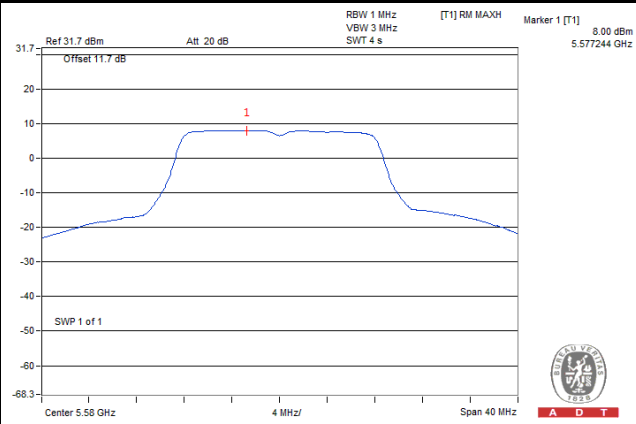
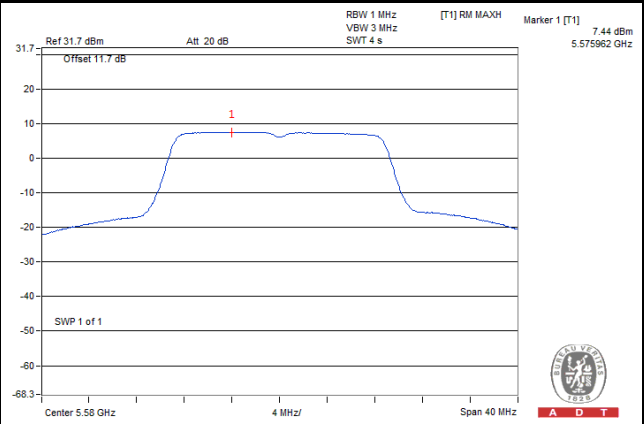
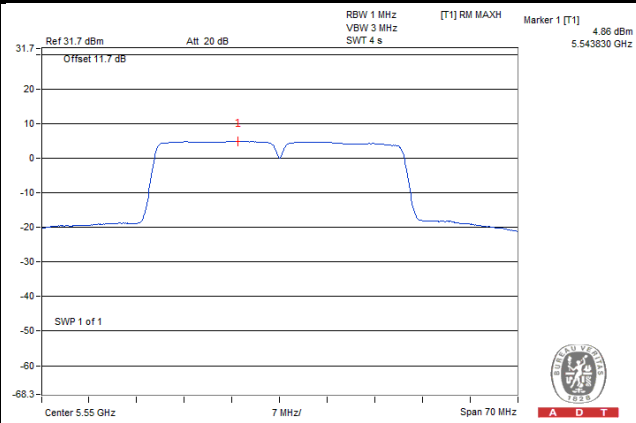
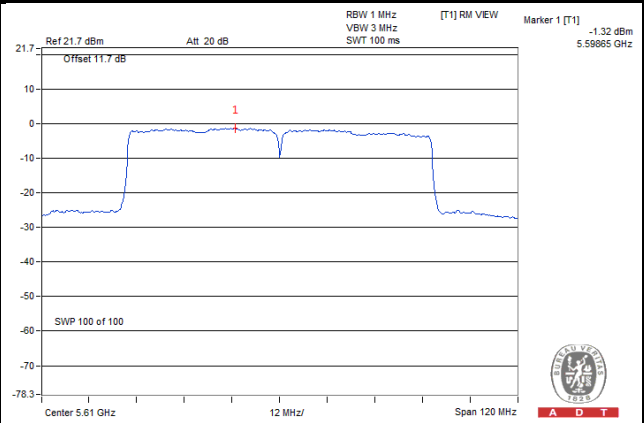
Spectrum Plot of Worst Value**802.11a****802.11n (HT20)****802.11n (HT40)****802.11ac (VHT80)**

For U-NII-3 Band

802.11a

Channel	Frequency (MHz)	PSD w/o Duty Factor (dBm)	Duty Factor	PSD with Duty Factor (dBm)	Limit (dBm/500 kHz)	Pass / Fail
149	5745	0.31	0.09	0.40	30	Pass
157	5785	3.57	0.09	3.66	30	Pass
165	5825	1.34	0.09	1.43	30	Pass

NOTE: Refer to section 3.3 for duty cycle spectrum plot.

802.11n (HT20)

Channel	Frequency (MHz)	PSD w/o Duty Factor (dBm)	Duty Factor	PSD with Duty Factor (dBm)	Limit (dBm/500 kHz)	Pass / Fail
149	5745	-1.20	0.11	-1.09	30	Pass
157	5785	3.09	0.11	3.20	30	Pass
165	5825	-0.12	0.11	-0.01	30	Pass

NOTE: Refer to section 3.3 for duty cycle spectrum plot.

802.11n (HT40)

Channel	Frequency (MHz)	PSD w/o Duty Factor (dBm)	Duty Factor	PSD with Duty Factor (dBm)	Limit (dBm/500 kHz)	Pass / Fail
151	5755	-6.25	0.19	-6.06	30	Pass
159	5795	-1.17	0.19	-0.98	30	Pass

NOTE: Refer to section 3.3 for duty cycle spectrum plot.

802.11ac (VHT80)

Channel	Frequency (MHz)	PSD w/o Duty Factor (dBm)	Duty Factor	PSD with Duty Factor (dBm)	Limit (dBm/500 kHz)	Pass / Fail
155	5775	-8.59	0.75	-7.84	30	Pass

NOTE: Refer to section 3.3 for duty cycle spectrum plot.

Spectrum Plot of Worst Value

802.11a

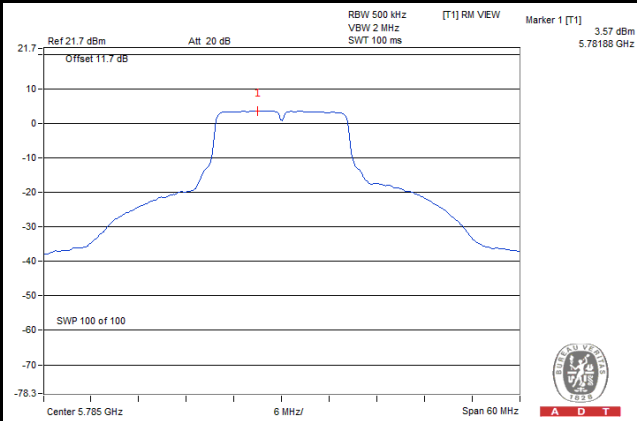

802.11n (HT20)

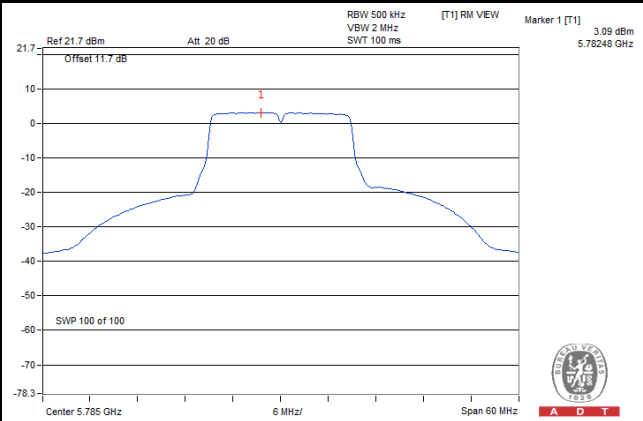

802.11n (HT40)

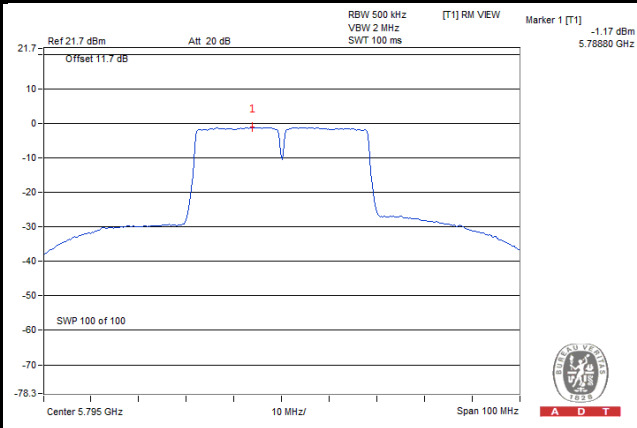

802.11ac (VHT80)

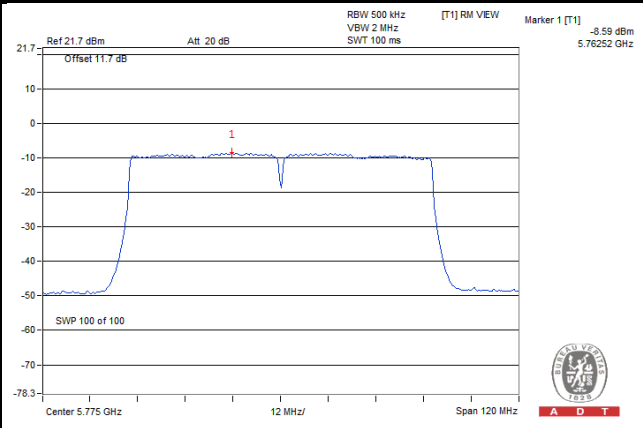

4.5 Frequency Stability

4.5.1 Limit of Frequency Stability Measurement

The frequency of the carrier signal shall be maintained within band of operation

4.5.2 Test Setup

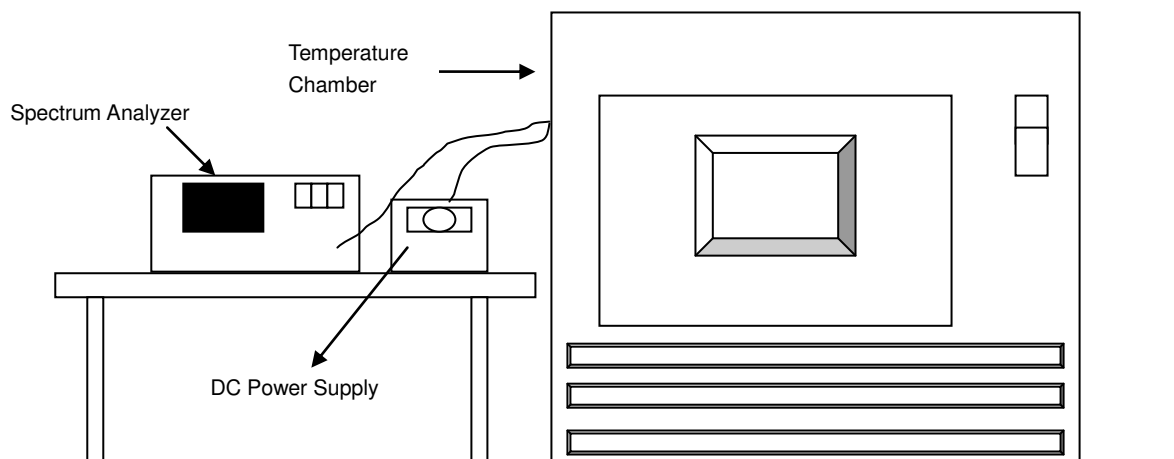

4.5.3 Test Instruments

Refer to section 4.1.3 to get information of above instrument.

4.5.4 Test Procedure

- To ensure emission at the band edge is maintained within the authorized band, those values shall be measured by radiation emissions at upper and lower frequency points, and finally compensated by frequency deviation as procedures below.
- The EUT was operated at the maximum output power, and connected to the spectrum analyzer, which is set to maximum hold function and peak detector. The peak value of the power envelope was measured and noted. The upper and lower frequency points were respectively measured relatively 10 dB lower than the measured peak value.
- The frequency deviation was calculated by adding the upper frequency point and the lower frequency point divided by two. Those detailed values of frequency deviation are provided in table below.

4.5.5 Deviation from Test Standard

No deviation.

4.5.6 EUT Operating Condition

Set the EUT transmit at un-modulation mode to test frequency stability.

4.5.7 Test Results

Frequency Stability Versus Temp.									
Operating Frequency: 5180 MHz									
Temp. (°C)	Power Supply (Vac)	0 Minute		2 Minute		5 Minute		10 Minute	
		Measured Frequency (MHz)	Frequency Drift (ppm)	Measured Frequency (MHz)	Frequency Drift (ppm)	Measured Frequency (MHz)	Frequency Drift (ppm)	Measured Frequency (MHz)	Frequency Drift (ppm)
50	120	5180.016563	3.197	5180.016989	3.280	5180.016648	3.214	5180.017009	3.284
40	120	5180.016373	3.161	5180.016402	3.166	5180.016726	3.229	5180.016949	3.272
30	120	5180.017079	3.297	5180.017153	3.311	5180.017351	3.350	5180.017054	3.292
20	120	5180.018074	3.489	5180.018425	3.557	5180.018429	3.558	5180.018016	3.478
10	120	5180.020004	3.862	5180.020109	3.882	5180.019774	3.817	5180.020182	3.896
0	120	5180.017974	3.470	5180.018374	3.547	5180.018084	3.491	5180.018327	3.538
-10	120	5180.016700	3.224	5180.017234	3.327	5180.017010	3.284	5180.017185	3.318
-20	120	5180.016474	3.180	5180.016500	3.185	5180.016589	3.203	5180.016427	3.171
-30	120	5180.014711	2.840	5180.014567	2.812	5180.014545	2.808	5180.014898	2.876

Frequency Stability Versus Temp.									
Operating Frequency: 5180 MHz									
Temp. (°C)	Power Supply (Vac)	0 Minute		2 Minute		5 Minute		10 Minute	
		Measured Frequency (MHz)	Frequency Drift (ppm)	Measured Frequency (MHz)	Frequency Drift (ppm)	Measured Frequency (MHz)	Frequency Drift (ppm)	Measured Frequency (MHz)	Frequency Drift (ppm)
20	102	5180.017660	3.409	5180.017824	3.441	5180.017649	3.407	5180.017573	3.392
	120	5180.018074	3.489	5180.018425	3.557	5180.018429	3.558	5180.018016	3.478
	138	5180.019340	3.734	5180.019540	3.772	5180.019786	3.820	5180.019754	3.814

4.6 6 dB Bandwidth Measurement

4.6.1 Limits of 6 dB Bandwidth Measurement

The minimum of 6 dB Bandwidth Measurement is 0.5 MHz.

4.6.2 Test Setup

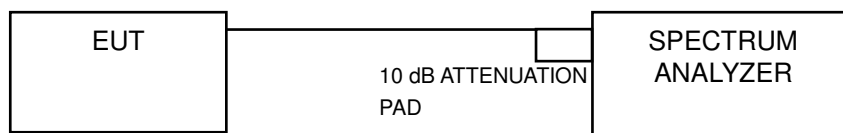

4.6.3 Test Instruments

Refer to section 4.1.3 to get information of above instrument.

4.6.4 Test Procedure

MEASUREMENT PROCEDURE REF

- Set resolution bandwidth (RBW) = 100 kHz
- Set the video bandwidth (VBW) $\geq 3 \times$ RBW, Detector = Peak.
- Trace mode = max hold.
- Sweep = auto couple.
- Measure the maximum width of the emission that is constrained by the frequencies associated with the two amplitude points (upper and lower) that are attenuated by 6 dB relative to the maximum level measured in the fundamental emission

4.6.5 Deviation from Test Standard

No deviation.

4.6.6 EUT Operating Condition

The software provided by client to enable the EUT under transmission condition continuously at lowest, middle and highest channel frequencies individually.

4.6.7 Test Results

802.11a

Channel	Frequency (MHz)	6 dB Bandwidth (MHz)	Minimum Limit (MHz)	Pass / Fail
149	5745	16.38	0.5	Pass
157	5785	16.39	0.5	Pass
165	5825	16.38	0.5	Pass

802.11n (HT20)

Channel	Frequency (MHz)	6 dB Bandwidth (MHz)	Minimum Limit (MHz)	Pass / Fail
149	5745	17.65	0.5	Pass
157	5785	17.61	0.5	Pass
165	5825	17.63	0.5	Pass

802.11n (HT40)

Channel	Frequency (MHz)	6 dB Bandwidth (MHz)	Minimum Limit (MHz)	Pass / Fail
151	5755	36.44	0.5	Pass
159	5795	36.41	0.5	Pass

802.11ac (VHT80)

Channel	Frequency (MHz)	6 dB Bandwidth (MHz)	Minimum Limit (MHz)	Pass / Fail
155	5775	76.34	0.5	Pass

Spectrum Plot of Worst Value

802.11a

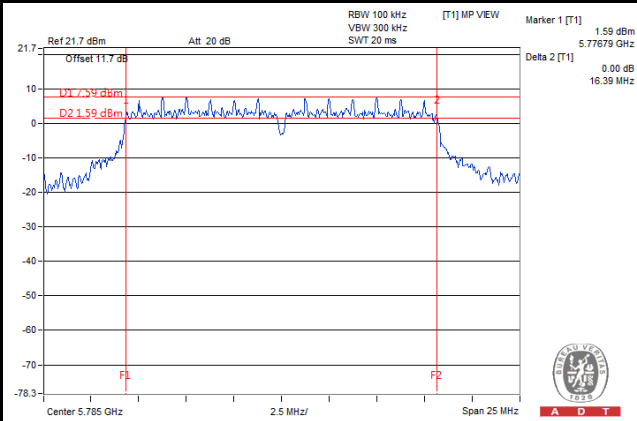

802.11n (HT20)

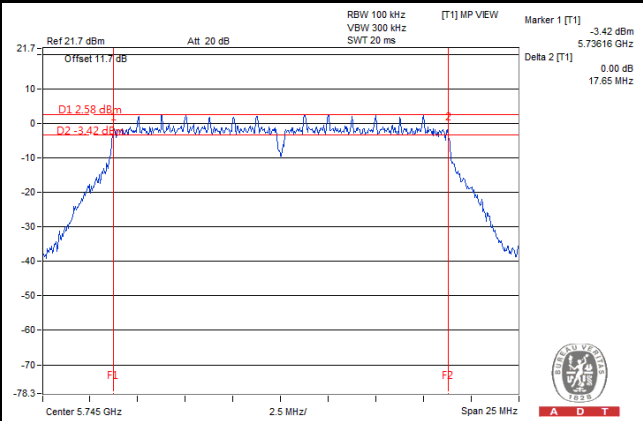

802.11n (HT40)

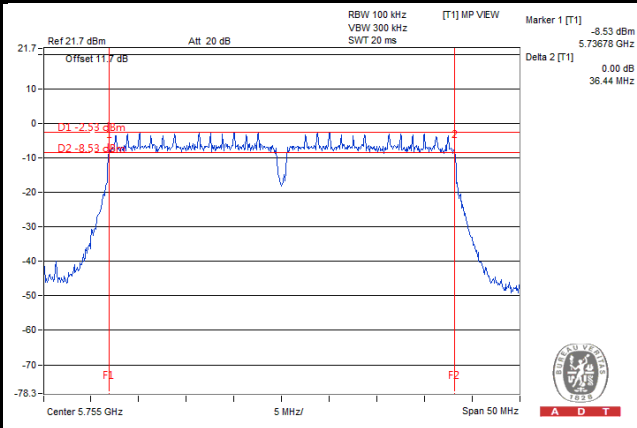

802.11ac (VHT80)

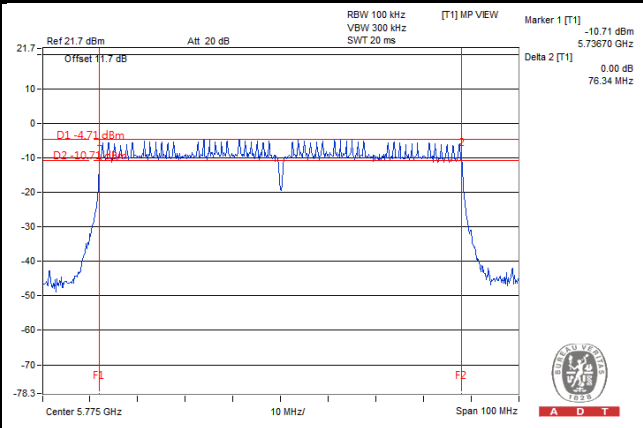



5 Pictures of Test Arrangements

Please refer to the attached file (Test Setup Photo).



A D T

Appendix – Information on the Testing Laboratories

We, Bureau Veritas Consumer Products Services (H.K.) Ltd., Taoyuan Branch, were founded in 1988 to provide our best service in EMC, Radio, Telecom and Safety consultation. Our laboratories are accredited and approved according to ISO/IEC 17025.

If you have any comments, please feel free to contact us at the following:

Linko EMC/RF Lab

Tel: 886-2-26052180

Fax: 886-2-26051924

Hsin Chu EMC/RF/Telecom Lab

Tel: 886-3-6668565

Fax: 886-3-6668323

Hwa Ya EMC/RF/Safety

Tel: 886-3-3183232

Fax: 886-3-3270892

Email: service.adt@tw.bureauveritas.com

Web Site: www.bureauveritas-adt.com

The address and road map of all our labs can be found in our web site also.

--- END ---