

FCC Test Report

Report No.: RF151111C06

FCC ID: UDX-60034010

Test Model: MC74-HW

Received Date: Nov. 11, 2015

Test Date: Nov. 26, 2015 ~ Dec. 29, 2015

Issued Date: Jan. 06, 2016

Applicant: Cisco Systems, Inc.

Address: 170 West Tasman Drive, San Jose, CA 95134 USA

Issued By: Bureau Veritas Consumer Products Services (H.K.) Ltd., Taoyuan Branch

Lab Address: No. 47-2, 14th Ling, Chia Pau Vil., Lin Kou Dist., New Taipei City, Taiwan (R.O.C)

Test Location (1): No. 19, Hwa Ya 2nd Rd, Wen Hwa Tsuen, Kwei Shan Hsiang, Taoyuan Hsien 333, Taiwan, R.O.C.

Test Location (2): No.215, Sec. 3, Beixin Rd., Xindian Dist., New Taipei City 231, Taiwan, R.O.C



This report is for your exclusive use. Any copying or replication of this report to or for any other person or entity, or use of our name or trademark, is permitted only with our prior written permission. This report sets forth our findings solely with respect to the test samples identified herein. The results set forth in this report are not indicative or representative of the quality or characteristics of the lot from which a test sample was taken or any similar or identical product unless specifically and expressly noted. Our report includes all of the tests requested by you and the results thereof based upon the information that you provided to us. You have 60 days from date of issuance of this report to notify us of any material error or omission caused by our negligence, provided, however, that such notice shall be in writing and shall specifically address the issue you wish to raise. A failure to raise such issue within the prescribed time shall constitute your unqualified acceptance of the completeness of this report, the tests conducted and the correctness of the report contents. Unless specific mention, the uncertainty of measurement has been explicitly taken into account to declare the compliance or non-compliance to the specification.

Table of Contents

Release Control Record	4
1 Certificate of Conformity	5
2 Summary of Test Results	6
2.1 Measurement Uncertainty	6
2.2 Modification Record	6
3 General Information	7
3.1 General Description of EUT	7
3.2 Description of Test Modes	8
3.2.1 Test Mode Applicability and Tested Channel Detail	9
3.3 Duty Cycle of Test Signal	11
3.4 Description of Support Units	12
3.4.1 Configuration of System under Test	12
3.5 General Description of Applied Standards	13
4 Test Types and Results	14
4.1 Radiated Emission and Bandedge Measurement	14
4.1.1 Limits of Radiated Emission and Bandedge Measurement	14
4.1.2 Test Instruments	15
4.1.3 Test Procedures	16
4.1.4 Deviation from Test Standard	16
4.1.5 Test Set Up	17
4.1.6 EUT Operating Conditions	17
4.1.7 Test Results	18
4.2 Conducted Emission Measurement	32
4.2.1 Limits of Conducted Emission Measurement	32
4.2.2 Test Instruments	32
4.2.3 Test Procedures	33
4.2.4 Deviation from Test Standard	33
4.2.5 Test Setup	33
4.2.6 EUT Operating Conditions	33
4.2.7 Test Results	34
4.3 6 dB Bandwidth Measurement	38
4.3.1 Limits of 6 dB Bandwidth Measurement	38
4.3.2 Test Setup	38
4.3.3 Test Instruments	38
4.3.4 Test Procedure	38
4.3.5 Deviation from Test Standard	38
4.3.6 EUT Operating Conditions	38
4.3.7 Test Result	39
4.4 Conducted Output Power Measurement	41
4.4.1 Limits of Conducted Output Power Measurement	41
4.4.2 Test Setup	41
4.4.3 Test Instruments	41
4.4.4 Test Procedures	41
4.4.5 Deviation from Test Standard	41
4.4.6 EUT Operating Conditions	41
4.4.7 Test Results	42
4.5 Power Spectral Density Measurement	43
4.5.1 Limits of Power Spectral Density Measurement	43
4.5.2 Test Setup	43
4.5.3 Test Instruments	43
4.5.4 Test Procedure	43
4.5.5 Deviation from Test Standard	43
4.5.6 EUT Operating Condition	43



4.5.7 Test Results	44
4.6 Conducted Out of Band Emission Measurement	46
4.6.1 Limits of Conducted Out of Band Emission Measurement.....	46
4.6.2 Test Setup.....	46
4.6.3 Test Instruments	46
4.6.4 Test Procedure	46
4.6.5 Deviation from Test Standard	46
4.6.6 EUT Operating Condition	46
4.6.7 Test Results	47
5 Pictures of Test Arrangements.....	55
Appendix – Information on the Testing Laboratories	56



A D T

Release Control Record

Issue No.	Description	Date Issued
RF151111C06	Original Release	Jan. 06, 2016



1 Certificate of Conformity

Product: VoIP Phone

Brand: Cisco

Test Model: MC74-HW

Sample Status: Engineering sample

Applicant: Cisco Systems, Inc.

Test Date: Nov. 26, 2015 ~ Dec. 29, 2015

Standards: 47 CFR FCC Part 15, Subpart C (Section 15.247)
ANSI C63.10:2013

The above equipment has been tested by **Bureau Veritas Consumer Products Services (H.K.) Ltd., Taoyuan Branch**, and found compliance with the requirement of the above standards. The test record, data evaluation & Equipment Under Test (EUT) configurations represented herein are true and accurate accounts of the measurements of the sample's EMC characteristics under the conditions specified in this report.

Prepared by : *Vera Huang* , **Date:** Jan. 06, 2016
Vera Huang / Specialist

Approved by : *Stanley Wu* , **Date:** Jan. 06, 2016
Stanley Wu / Assistant Manager

2 Summary of Test Results

47 CFR FCC Part 15, Subpart C (Section 15.247)			
FCC Clause	Test Item	Result	Remarks
15.207	AC Power Conducted Emission	Pass	Meet the requirement of limit. Minimum passing margin is -5.42 dB at 0.42782 MHz.
15.205 / 15.209 / 15.247(d)	Radiated Emissions and Band Edge Measurement	Pass	Meet the requirement of limit. Minimum passing margin is -0.4 dB at 32.43 MHz.
15.247(d)	Antenna Port Emission	Pass	Meet the requirement of limit.
15.247(a)(2)	6 dB Bandwidth	Pass	Meet the requirement of limit.
15.247(b)	Conducted power	Pass	Meet the requirement of limit.
15.247(e)	Power Spectral Density	Pass	Meet the requirement of limit.
15.203	Antenna Requirement	Pass	No antenna connector is used.

2.1 Measurement Uncertainty

Where relevant, the following measurement uncertainty levels have been estimated for tests performed on the EUT:

The listed uncertainties are the worst case uncertainty for the entire range of measurement. Please note that the uncertainty values are provided for informational purposes only and are not used in determining the PASS/FAIL results.

Measurement	Frequency	Expanded Uncertainty (k=2) (±)
Conducted Emissions at mains ports	150 kHz ~ 30 MHz	2.44 dB
Radiated Emissions up to 1 GHz	30 MHz ~ 200 MHz	2.0153 dB
	200 MHz ~ 1000 MHz	2.0224 dB
Radiated Emissions above 1 GHz	1 GHz ~ 18 GHz	1.0121 dB
	18 GHz ~ 40 GHz	1.1508 dB

2.2 Modification Record

There were no modifications required for compliance.

3 General Information

3.1 General Description of EUT

Product	VoIP Phone
Brand	Cisco
Test Model	MC74-HW
Power Supply Rating	12 Vdc (adapter) 54 Vdc (POE)
Modulation Type	CCK, DQPSK, DBPSK for DSSS 64QAM, 16QAM, QPSK, BPSK for OFDM
Modulation Technology	DSSS, OFDM
Transfer Rate	802.11b: 11.0 / 5.5 / 2.0 / 1.0 Mbps 802.11g: 54.0 / 48.0 / 36.0 / 24.0 / 18.0 / 12.0 / 9.0 / 6.0 Mbps 802.11n: up to MCS7
Operating Frequency	2412 ~ 2462 MHz
Number of Channel	11 for 802.11b, 802.11g, 802.11n (HT20) 7 for 802.11n (HT40)
Output Power	226.46 mW
Antenna Type	PCB antenna with 4.14 dBi gain
Antenna Connector	N/A
Accessory Device	Refer to Note as below
Data Cable Supplied	Refer to Note as below

Note:

- The EUT provides one completed transmitter and one receiver.

Modulation Mode	TX Function
802.11b	1TX
802.11g	1TX
802.11n (HT20)	1TX
802.11n (HT40)	1TX

- The EUT contains following accessory devices.

Product	Brand	Model	Description
Adapter	CUI INC	6A-181WP12	I/P: 100-240 Vac, 50/60 Hz, 0.6 A O/P: 12 Vdc, 1.5 A 1.5m cable with 1 core

- The above EUT information is declared by manufacturer and for more detailed features description, please refer to the manufacturer's specifications or user's manual.

3.2 Description of Test Modes

11 channels are provided for 802.11b, 802.11g and 802.11n (HT20):

Channel	Frequency (MHz)	Channel	Frequency (MHz)
1	2412	7	2442
2	2417	8	2447
3	2422	9	2452
4	2427	10	2457
5	2432	11	2462
6	2437		

7 channels are provided for 802.11n (HT40):

Channel	Frequency (MHz)	Channel	Frequency (MHz)
3	2422	7	2442
4	2427	8	2447
5	2432	9	2452
6	2437		

3.2.1 Test Mode Applicability and Tested Channel Detail

EUT Configure Mode	Applicable To				Description
	RE \geq 1G	RE<1G	PLC	APCM	
A	√	√	√	√	Adapter Mode
B	-	√	√	-	POE Mode

Where **RE \geq 1G**: Radiated Emission above 1 GHz

RE<1G: Radiated Emission below 1 GHz

PLC: Power Line Conducted Emission

APCM: Antenna Port Conducted Measurement

NOTE: “-” means no effect.

Radiated Emission Test (Above 1 GHz):

- Pre-Scan has been conducted to determine the worst-case mode from all possible combinations between available modulations, data rates and antenna ports (if EUT with antenna diversity architecture).
- Following channel(s) was (were) selected for the final test as listed below.

EUT Configure Mode	Mode	Available Channel	Tested Channel	Modulation Technology	Modulation Type	Data Rate (Mbps)
A	802.11b	1 to 11	1, 6, 11	DSSS	DBPSK	1.0
	802.11g	1 to 11	1, 6, 11	OFDM	BPSK	6.0
	802.11n (HT20)	1 to 11	1, 6, 11	OFDM	BPSK	MCS0
	802.11n (HT40)	3 to 9	3, 6, 9	OFDM	BPSK	MCS0

Radiated Emission Test (Below 1 GHz):

- Pre-Scan has been conducted to determine the worst-case mode from all possible combinations between available modulations, data rates and antenna ports (if EUT with antenna diversity architecture).
- Following channel(s) was (were) selected for the final test as listed below.

EUT Configure Mode	Mode	Available Channel	Tested Channel	Modulation Technology	Modulation Type	Data Rate (Mbps)
A, B	802.11b	1 to 11	1	DSSS	DBPSK	1.0

Power Line Conducted Emission Test:

- Pre-Scan has been conducted to determine the worst-case mode from all possible combinations between available modulations, data rates and antenna ports (if EUT with antenna diversity architecture).
- Following channel(s) was (were) selected for the final test as listed below.

EUT Configure Mode	Mode	Available Channel	Tested Channel	Modulation Technology	Modulation Type	Data Rate (Mbps)
A, B	802.11b	1 to 11	1	DSSS	DBPSK	1.0

Bandedge Measurement:

- Pre-Scan has been conducted to determine the worst-case mode from all possible combinations between available modulations, data rates and antenna ports (if EUT with antenna diversity architecture).
- Following channel(s) was (were) selected for the final test as listed below.

EUT Configure Mode	Mode	Available Channel	Tested Channel	Modulation Technology	Modulation Type	Data Rate (Mbps)
A	802.11b	1 to 11	1, 11	DSSS	DBPSK	1.0
	802.11g	1 to 11	1, 11	OFDM	BPSK	6.0
	802.11n (HT20)	1 to 11	1, 11	OFDM	BPSK	MCS0
	802.11n (HT40)	3 to 9	3, 9	OFDM	BPSK	MCS0

Antenna Port Conducted Measurement:

- This item includes all test value of each mode, but only includes spectrum plot of worst value of each mode.
- Pre-Scan has been conducted to determine the worst-case mode from all possible combinations between available modulations, data rates and antenna ports (if EUT with antenna diversity architecture).
- Following channel(s) was (were) selected for the final test as listed below.

EUT Configure Mode	Mode	Available Channel	Tested Channel	Modulation Technology	Modulation Type	Data Rate (Mbps)
A	802.11b	1 to 11	1, 6, 11	DSSS	DBPSK	1.0
	802.11g	1 to 11	1, 6, 11	OFDM	BPSK	6.0
	802.11n (HT20)	1 to 11	1, 6, 11	OFDM	BPSK	MCS0
	802.11n (HT40)	3 to 9	3, 6, 9	OFDM	BPSK	MCS0

Test Condition:

Applicable To	Environmental Conditions	Input Power	Tested by
RE≥1G	25 deg. C, 65 % RH	120 Vac, 60 Hz	Karl Lee
RE<1G	25 deg. C, 65 % RH	120 Vac, 60 Hz	Karl Lee
PLC	25 deg. C, 65 % RH	120 Vac, 60 Hz	Toby Tian
APCM	25 deg. C, 65 % RH	120 Vac, 60 Hz	Luke Chen

3.3 Duty Cycle of Test Signal

802.11b: Duty cycle of test signal is 100 %

802.11g: Duty cycle = $1.418/1.458 = 0.973$, Duty factor = $10 * \log(1/0.973) = 0.12$

802.11n (HT20): Duty cycle = $1.322/1.362 = 0.971$, Duty factor = $10 * \log(1/0.971) = 0.13$

802.11n (HT40): Duty cycle = $636.217/774.038 = 0.822$, Duty factor = $10 * \log(1/0.822) = 0.85$

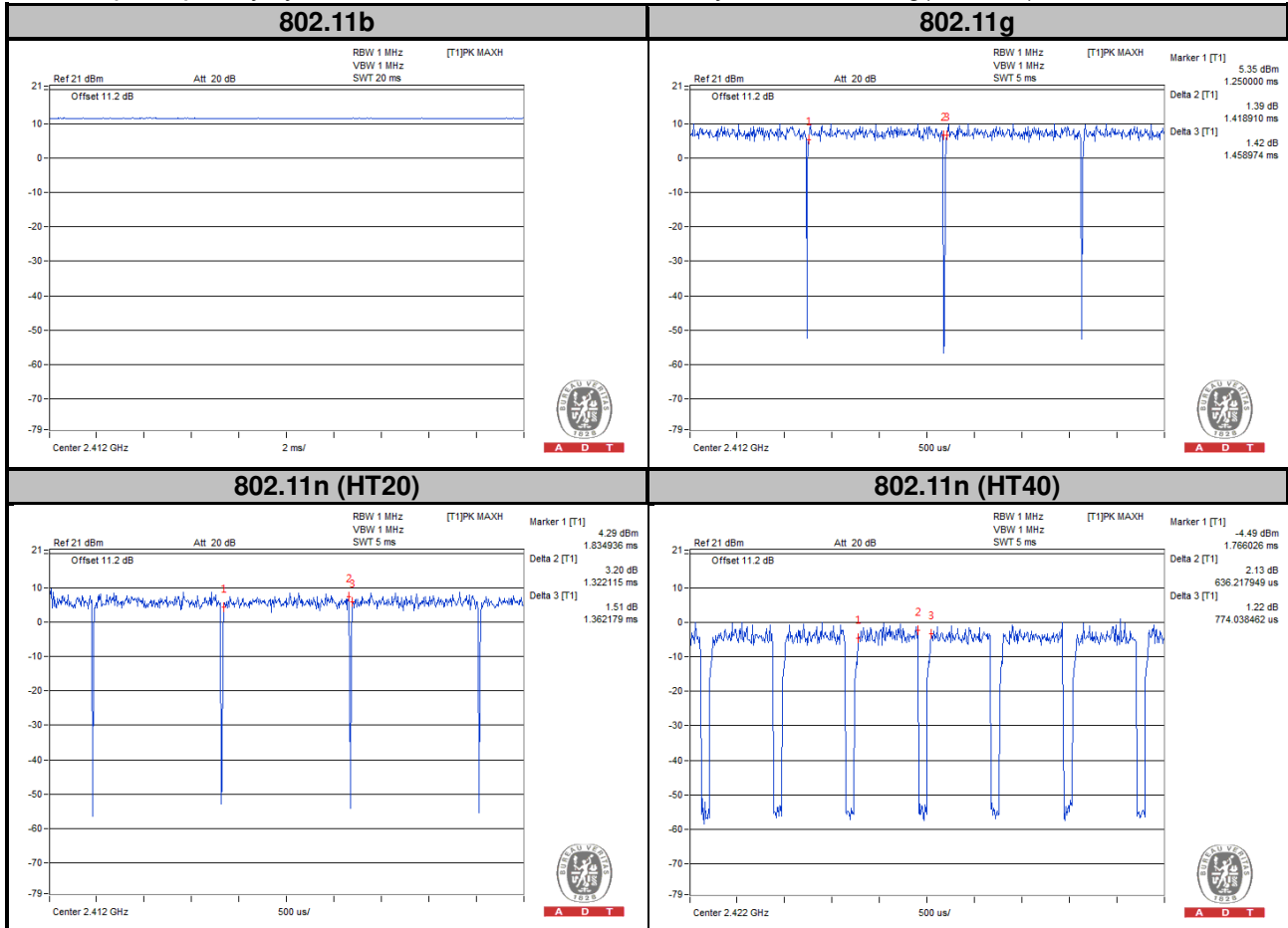

3.4 Description of Support Units

The EUT has been tested as an independent unit together with other necessary accessories or support units. The following support units or accessories were used to form a representative test configuration during the tests.

No.	Product	Brand	Model No.	Serial No.	FCC ID
1.	POE Switch	CISCO	SG300-10MPP	N/A	N/A

No.	Signal Cable Description Of The Above Support Units
1.	N/A

Note:

1. All power cords of the above support units are non-shielded (1.8m).
2. Item 1 was provided by client.

3.4.1 Configuration of System under Test

Mode A

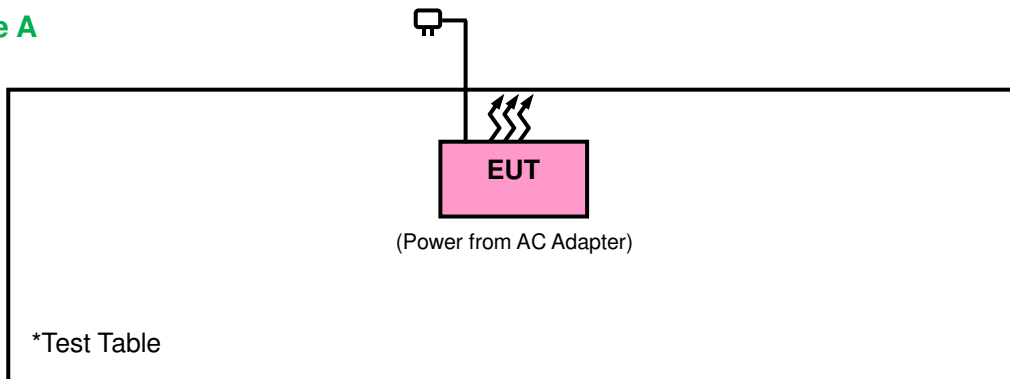

Mode B

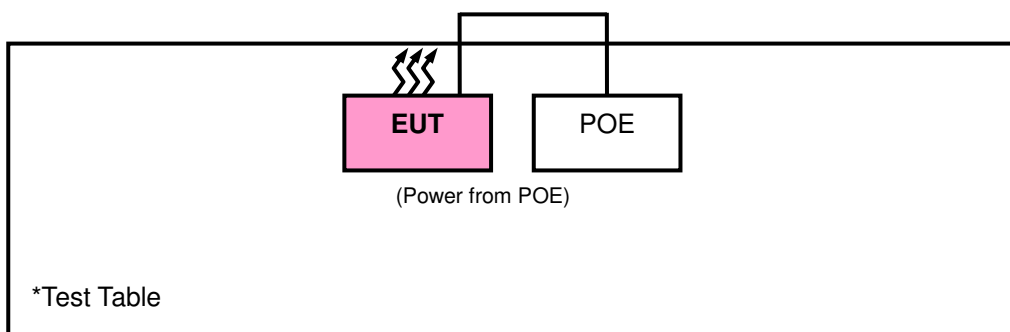

3.5 General Description of Applied Standards

The EUT is a RF Product. According to the specifications of the manufacturer, it must comply with the requirements of the following standards:

FCC Part 15, Subpart C (15.247)

558074 D01 DTS Meas Guidance v03r04

ANSI C63.10-2013

All test items have been performed and recorded as per the above standards.

NOTE: The EUT has been verified to comply with the requirements of FCC Part 15, Subpart B, Class B (DoC).
The test report has been issued separately.

4 Test Types and Results

4.1 Radiated Emission and Bandedge Measurement

4.1.1 Limits of Radiated Emission and Bandedge Measurement

Radiated emissions which fall in the restricted bands must comply with the radiated emission limits specified as below table. Other emissions shall be at least 20 dB below the highest level of the desired power:

Frequencies (MHz)	Field Strength (microvolts/meter)	Measurement Distance (meters)
0.009 ~ 0.490	2400/F (kHz)	300
0.490 ~ 1.705	24000/F (kHz)	30
1.705 ~ 30.0	30	30
30 ~ 88	100	3
88 ~ 216	150	3
216 ~ 960	200	3
Above 960	500	3

NOTE:

1. The lower limit shall apply at the transition frequencies.
2. Emission level (dBuV/m) = 20 log Emission level (uV/m).
3. For frequencies above 1000 MHz, the field strength limits are based on average detector, however, the peak field strength of any emission shall not exceed the maximum permitted average limits, specified above by more than 20 dB under any condition of modulation.

4.1.2 Test Instruments

Description & Manufacturer	Model No.	Serial No.	Date of Calibration	Due Date of Calibration
Test Receiver Agilent Technologies	N9038A	MY52260177	May 19, 2015	May 18, 2016
Spectrum Analyzer ROHDE & SCHWARZ	FSU43	101261	Dec. 10, 2014	Dec. 09, 2015
			Dec. 17, 2015	Dec. 16, 2016
BILOG Antenna SCHWARZBECK	VULB9168	9168-472	Feb. 04, 2015	Feb. 04, 2016
HORN Antenna ETS-Lindgren	3117	00143293	Jan. 05, 2015	Jan. 04, 2016
HORN Antenna SCHWARZBECK	BBHA 9170	9170-480	Feb. 04, 2015	Feb. 04, 2016
Agilent Communications Tester-Wireless	8960 Series 10	MY53201073	Jul. 03, 2015	Jul. 02, 2017
Preamplifier Agilent	310N	187226	Jun. 29, 2015	Jun. 28, 2016
Preamplifier Agilent	83017A	MY39501357	Jun. 29, 2015	Jun. 28, 2016
Power Meter Anritsu	ML2495A	1232002	Sep. 21, 2015	Sep. 20, 2016
Power Sensor Anritsu	MA2411B	1207325	Sep. 21, 2015	Sep. 20, 2016
RF signal cable ETS-LINDGREN	5D-FB	Cable-CH1-01(R FC-SMS-100-SM S-120+RFC-SMS -100-SMS-400)	Jun. 27, 2015	Jun. 26, 2016
RF signal cable ETS-LINDGREN	8D-FB	Cable-CH1-02(R FC-SMS-100-SM S-24)	Jun. 27, 2015	Jun. 26, 2016
Software BV ADT	E3 8.130425b	NA	NA	NA
Antenna Tower MF	NA	NA	NA	NA
Turn Table MF	NA	NA	NA	NA
Antenna Tower & Turn Table Controller MF	MF-7802	NA	NA	NA

- Note: 1. The calibration interval of the above test instruments is 12 months and the calibrations are traceable to NML/ROC and NIST/USA.
2. The test was performed in HsinTien Chamber 1.
3. The horn antenna and preamplifier (model: 83017A) are used only for the measurement of emission frequency above 1 GHz if tested.
4. The FCC Site Registration No. is 149147.
5. The IC Site Registration No. is IC7450I-1.

4.1.3 Test Procedures

- a. The EUT was placed on the top of a rotating table 0.8 meters (for below 1 GHz) / 1.5 meters (for above 1 GHz) above the ground at 3 meter chamber room for test. The table was rotated 360 degrees to determine the position of the highest radiation.
- b. The EUT was set 3 meters away from the interference-receiving antenna, which was mounted on the top of a variable-height antenna tower.
- c. The height of antenna is varied from one meter to four meters above the ground to determine the maximum value of the field strength. Both horizontal and vertical polarizations of the antenna are set to make the measurement.
- d. For each suspected emission, the EUT was arranged to its worst case and then the antenna was tuned to heights from 1 meter to 4 meters and the rotatable table was turned from 0 degrees to 360 degrees to find the maximum reading.
- e. The test-receiver system was set to quasi-peak detect function and specified bandwidth with maximum hold mode when the test frequency is below 1 GHz.
- f. The test-receiver system was set to peak and average detected function and specified bandwidth with maximum hold mode when the test frequency is above 1 GHz. If the peak reading value also meets average limit, measurement with the average detector is unnecessary.

Note:

1. The resolution bandwidth and video bandwidth of test receiver/spectrum analyzer is 120 kHz for Quasi-peak detection (QP) at frequency below 1 GHz.
2. The resolution bandwidth of test receiver/spectrum analyzer is 1 MHz and the video bandwidth is 3 MHz for Peak detection (PK) at frequency above 1 GHz.
3. The resolution bandwidth of test receiver/spectrum analyzer is 1 MHz and the video bandwidth is 3 MHz for RMS Average (Duty cycle < 98 %) for Average detection (AV) at frequency above 1 GHz, then the measurement results was added to a correction factor ($10 \log(1/\text{duty cycle})$).
4. The resolution bandwidth of test receiver/spectrum analyzer is 1MHz and the video bandwidth is 10 Hz (Duty cycle ≥ 98 %) for Average detection (AV) at frequency above 1 GHz.
5. All modes of operation were investigated and the worst-case emissions are reported.

4.1.4 Deviation from Test Standard

No deviation.

4.1.5 Test Set Up

<Frequency Range below 1 GHz>

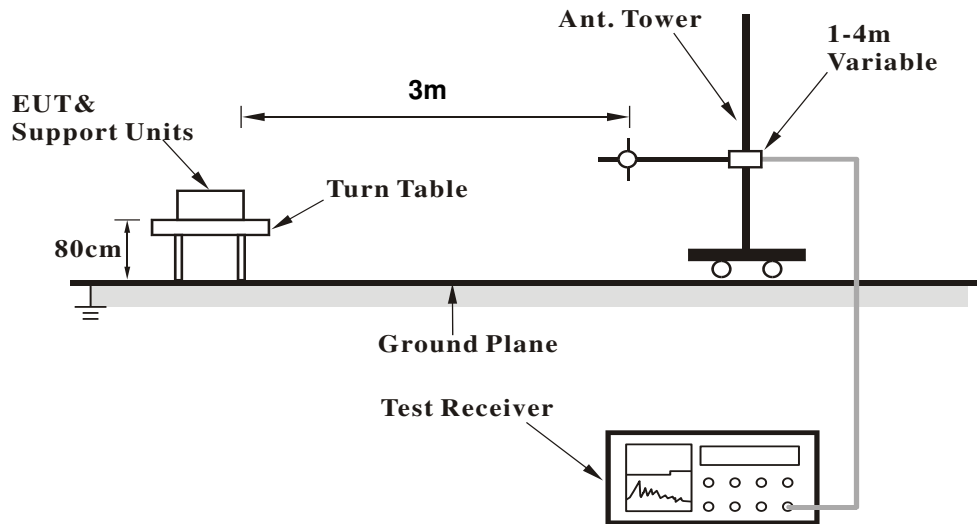

<Frequency Range above 1 GHz>

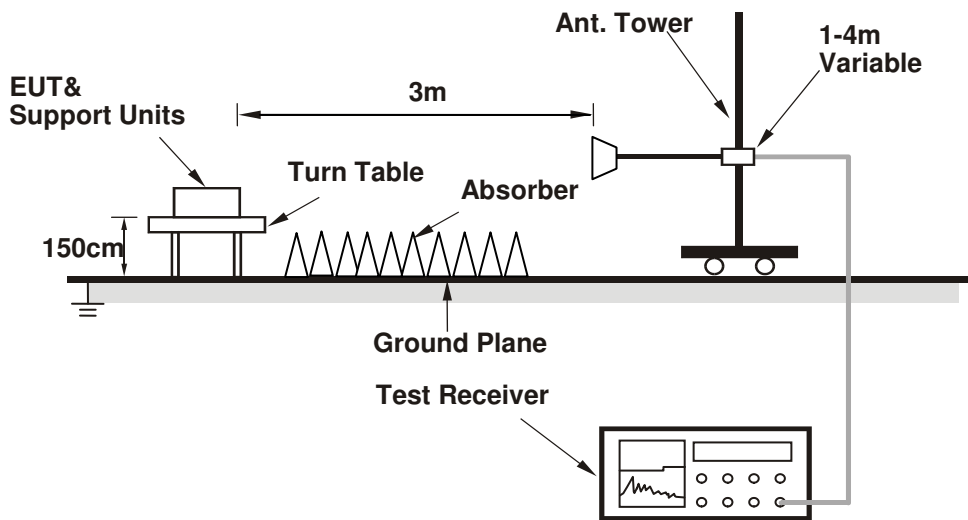

For the actual test configuration, please refer to the attached file (Test Setup Photo).

4.1.6 EUT Operating Conditions

- Placed the EUT on a testing table.
- Use the software to control the EUT under transmission condition continuously at specific channel frequency.

4.1.7 Test Results
Above 1 GHz Data :
802.11b

EUT Test Condition		Measurement Detail	
Channel	Channel 1	Frequency Range	1 GHz ~ 25 GHz
Input Power	120 Vac, 60 Hz	Detector Function	Peak (PK) Average (AV)
Environmental Conditions	25 deg. C, 65 % RH	Tested By	Karl Lee

Antennal Polarity & Test Distance: Horizontal at 3 m

Frequency (MHz)	Emission Level (dBuV/m)	Read Level (dBuV)	Limit (dBuV/m)	Margin (dB)	Antenna Factor (dB/m)	Cable Loss (dB)	Preamp Factor (dB)	Antenna Height (cm)	Table Angle (Degree)	Remark
2388	47.81	46.1	54	-6.19	31.8	5.4	35.49	104	35	Average
2388	57.22	55.51	74	-16.78	31.8	5.4	35.49	104	35	Peak
2412	101.66	99.89			31.81	5.43	35.47	104	35	Average
2412	104.42	102.65			31.81	5.43	35.47	104	35	Peak
2490	40.45	38.44	54	-13.55	31.9	5.53	35.42	104	35	Average
2490	55.83	53.82	74	-18.17	31.9	5.53	35.42	104	35	Peak

Antennal Polarity & Test Distance: Vertical at 3 m

Frequency (MHz)	Emission Level (dBuV/m)	Read Level (dBuV)	Limit (dBuV/m)	Margin (dB)	Antenna Factor (dB/m)	Cable Loss (dB)	Preamp Factor (dB)	Antenna Height (cm)	Table Angle (Degree)	Remark
2390	52.98	51.25	54	-1.02	31.8	5.4	35.47	100	345	Average
2390	60.79	59.06	74	-13.21	31.8	5.4	35.47	100	345	Peak
2412	102.37	100.6			31.81	5.43	35.47	100	345	Average
2412	105.02	103.25			31.81	5.43	35.47	100	345	Peak
2492	40.98	38.96	54	-13.02	31.9	5.53	35.41	100	345	Average
2492	55.97	53.95	74	-18.03	31.9	5.53	35.41	100	345	Peak

Remarks:

- Emission Level = Read Level + Antenna Factor + Cable Loss - Preamp Factor
Margin value = Emission level – Limit value
- 2412 MHz: Fundamental frequency.



A D T

EUT Test Condition		Measurement Detail	
Channel	Channel 6	Frequency Range	1 GHz ~ 25 GHz
Input Power	120 Vac, 60 Hz	Detector Function	Peak (PK) Average (AV)
Environmental Conditions	25 deg. C, 65 % RH	Tested By	Karl Lee

Antennal Polarity & Test Distance: Horizontal at 3 m										
Frequency (MHz)	Emission Level (dBuV/m)	Read Level (dBuV)	Limit (dBuV/m)	Margin (dB)	Antenna Factor (dB/m)	Cable Loss (dB)	Preamp Factor (dB)	Antenna Height (cm)	Table Angle (Degree)	Remark
2380	40.04	38.38	54	-13.96	31.78	5.37	35.49	104	37	Average
2380	56.54	54.88	74	-17.46	31.78	5.37	35.49	104	37	Peak
2437	103.81	101.96			31.85	5.46	35.46	104	37	Average
2437	106.86	105.01			31.85	5.46	35.46	104	37	Peak
2500	40.77	38.75	54	-13.23	31.9	5.53	35.41	104	37	Average
2500	56.74	54.72	74	-17.26	31.9	5.53	35.41	104	37	Peak

Antennal Polarity & Test Distance: Vertical at 3 m										
Frequency (MHz)	Emission Level (dBuV/m)	Read Level (dBuV)	Limit (dBuV/m)	Margin (dB)	Antenna Factor (dB/m)	Cable Loss (dB)	Preamp Factor (dB)	Antenna Height (cm)	Table Angle (Degree)	Remark
2390	40.81	39.08	54	-13.19	31.8	5.4	35.47	132	118	Average
2390	55.41	53.68	74	-18.59	31.8	5.4	35.47	132	118	Peak
2437	104.7	102.85			31.85	5.46	35.46	132	118	Average
2437	107.32	105.47			31.85	5.46	35.46	132	118	Peak
2500	41.58	39.56	54	-12.42	31.9	5.53	35.41	132	118	Average
2500	56.7	54.68	74	-17.3	31.9	5.53	35.41	132	118	Peak

Remarks:

- Emission Level = Read Level + Antenna Factor + Cable Loss - Preamp Factor
Margin value = Emission level – Limit value
- 2437 MHz: Fundamental frequency.



A D T

EUT Test Condition		Measurement Detail	
Channel	Channel 11	Frequency Range	1 GHz ~ 25 GHz
Input Power	120 Vac, 60 Hz	Detector Function	Peak (PK) Average (AV)
Environmental Conditions	25 deg. C, 65 % RH	Tested By	Karl Lee

Antennal Polarity & Test Distance: Horizontal at 3 m										
Frequency (MHz)	Emission Level (dBuV/m)	Read Level (dBuV)	Limit (dBuV/m)	Margin (dB)	Antenna Factor (dB/m)	Cable Loss (dB)	Preamp Factor (dB)	Antenna Height (cm)	Table Angle (Degree)	Remark
2384	39.77	38.08	54	-14.23	31.78	5.4	35.49	102	38	Average
2384	56.02	54.33	74	-17.98	31.78	5.4	35.49	102	38	Peak
2462	101.33	99.4			31.87	5.5	35.44	102	38	Average
2462	104.16	102.23			31.87	5.5	35.44	102	38	Peak
2490	50.37	48.36	54	-3.63	31.9	5.53	35.42	102	38	Average
2490	59.58	57.57	74	-14.42	31.9	5.53	35.42	102	38	Peak

Antennal Polarity & Test Distance: Vertical at 3 m										
Frequency (MHz)	Emission Level (dBuV/m)	Read Level (dBuV)	Limit (dBuV/m)	Margin (dB)	Antenna Factor (dB/m)	Cable Loss (dB)	Preamp Factor (dB)	Antenna Height (cm)	Table Angle (Degree)	Remark
2372	40.69	39.03	54	-13.31	31.78	5.37	35.49	147	118	Average
2372	56.18	54.52	74	-17.82	31.78	5.37	35.49	147	118	Peak
2462	102.95	101.02			31.87	5.5	35.44	147	118	Average
2462	105.46	103.53			31.87	5.5	35.44	147	118	Peak
2484	51.61	49.65	54	-2.39	31.88	5.5	35.42	147	118	Average
2484	60.96	59	74	-13.04	31.88	5.5	35.42	147	118	Peak

Remarks:

- Emission Level = Read Level + Antenna Factor + Cable Loss - Preamp Factor
Margin value = Emission level – Limit value
- 2462 MHz: Fundamental frequency.

802.11g

EUT Test Condition		Measurement Detail	
Channel	Channel 1	Frequency Range	1 GHz ~ 25 GHz
Input Power	120 Vac, 60 Hz	Detector Function	Peak (PK) Average (AV)
Environmental Conditions	25 deg. C, 65 % RH	Tested By	Karl Lee

Antennal Polarity & Test Distance: Horizontal at 3 m

Frequency (MHz)	Emission Level (dBuV/m)	Read Level (dBuV)	Limit (dBuV/m)	Margin (dB)	Antenna Factor (dB/m)	Cable Loss (dB)	Preamp Factor (dB)	Antenna Height (cm)	Table Angle (Degree)	Remark
2390	45.73	44	54	-8.27	31.8	5.4	35.47	104	35	Average
2390	58.67	56.94	74	-15.33	31.8	5.4	35.47	104	35	Peak
2412	95.88	94.11			31.81	5.43	35.47	104	35	Average
2412	103.34	101.57			31.81	5.43	35.47	104	35	Peak
2494	41.28	39.26	54	-12.72	31.9	5.53	35.41	104	35	Average
2494	55.24	53.22	74	-18.76	31.9	5.53	35.41	104	35	Peak

Antennal Polarity & Test Distance: Vertical at 3 m

Frequency (MHz)	Emission Level (dBuV/m)	Read Level (dBuV)	Limit (dBuV/m)	Margin (dB)	Antenna Factor (dB/m)	Cable Loss (dB)	Preamp Factor (dB)	Antenna Height (cm)	Table Angle (Degree)	Remark
2390	51.25	49.52	54	-2.75	31.8	5.4	35.47	100	345	Average
2390	64.57	62.84	74	-9.43	31.8	5.4	35.47	100	345	Peak
2412	96.97	95.2			31.81	5.43	35.47	100	345	Average
2412	104.31	102.54			31.81	5.43	35.47	100	345	Peak
2492	41.74	39.72	54	-12.26	31.9	5.53	35.41	100	345	Average
2492	56.28	54.26	74	-17.72	31.9	5.53	35.41	100	345	Peak

Remarks:

- Emission Level = Read Level + Antenna Factor + Cable Loss - Preamp Factor
Margin value = Emission level – Limit value
- 2412 MHz: Fundamental frequency.



A D T

EUT Test Condition		Measurement Detail	
Channel	Channel 6	Frequency Range	1 GHz ~ 25 GHz
Input Power	120 Vac, 60 Hz	Detector Function	Peak (PK) Average (AV)
Environmental Conditions	25 deg. C, 65 % RH	Tested By	Karl Lee

Antennal Polarity & Test Distance: Horizontal at 3 m										
Frequency (MHz)	Emission Level (dBuV/m)	Read Level (dBuV)	Limit (dBuV/m)	Margin (dB)	Antenna Factor (dB/m)	Cable Loss (dB)	Preamp Factor (dB)	Antenna Height (cm)	Table Angle (Degree)	Remark
2382	44.89	43.2	54	-9.11	31.78	5.4	35.49	104	37	Average
2382	57.58	55.89	74	-16.42	31.78	5.4	35.49	104	37	Peak
2437	99.03	97.18			31.85	5.46	35.46	104	37	Average
2437	107.52	105.67			31.85	5.46	35.46	104	37	Peak
2484	46.26	44.3	54	-7.74	31.88	5.5	35.42	104	37	Average
2484	58.43	56.47	74	-15.57	31.88	5.5	35.42	104	37	Peak

Antennal Polarity & Test Distance: Vertical at 3 m										
Frequency (MHz)	Emission Level (dBuV/m)	Read Level (dBuV)	Limit (dBuV/m)	Margin (dB)	Antenna Factor (dB/m)	Cable Loss (dB)	Preamp Factor (dB)	Antenna Height (cm)	Table Angle (Degree)	Remark
2390	48.18	46.45	54	-5.82	31.8	5.4	35.47	132	118	Average
2390	59.79	58.06	74	-14.21	31.8	5.4	35.47	132	118	Peak
2437	100.64	98.79			31.85	5.46	35.46	132	118	Average
2437	108.15	106.3			31.85	5.46	35.46	132	118	Peak
2484	48.87	46.91	54	-5.13	31.88	5.5	35.42	132	118	Average
2484	62.22	60.26	74	-11.78	31.88	5.5	35.42	132	118	Peak

Remarks:

- Emission Level = Read Level + Antenna Factor + Cable Loss - Preamp Factor
Margin value = Emission level – Limit value
- 2437 MHz: Fundamental frequency.



EUT Test Condition		Measurement Detail	
Channel	Channel 11	Frequency Range	1 GHz ~ 25 GHz
Input Power	120 Vac, 60 Hz	Detector Function	Peak (PK) Average (AV)
Environmental Conditions	25 deg. C, 65 % RH	Tested By	Karl Lee

Antennal Polarity & Test Distance: Horizontal at 3 m

Frequency (MHz)	Emission Level (dBuV/m)	Read Level (dBuV)	Limit (dBuV/m)	Margin (dB)	Antenna Factor (dB/m)	Cable Loss (dB)	Preamp Factor (dB)	Antenna Height (cm)	Table Angle (Degree)	Remark
2366	40.49	38.85	54	-13.51	31.76	5.37	35.49	102	38	Average
2366	55.92	54.28	74	-18.08	31.76	5.37	35.49	102	38	Peak
2462	96.92	94.99			31.87	5.5	35.44	102	38	Average
2462	103.51	101.58			31.87	5.5	35.44	102	38	Peak
2488	47.87	45.86	54	-6.13	31.9	5.53	35.42	102	38	Average
2488	60.94	58.93	74	-13.06	31.9	5.53	35.42	102	38	Peak

Antennal Polarity & Test Distance: Vertical at 3 m

Frequency (MHz)	Emission Level (dBuV/m)	Read Level (dBuV)	Limit (dBuV/m)	Margin (dB)	Antenna Factor (dB/m)	Cable Loss (dB)	Preamp Factor (dB)	Antenna Height (cm)	Table Angle (Degree)	Remark
2390	40.84	39.11	54	-13.16	31.8	5.4	35.47	147	122	Average
2390	56.66	54.93	74	-17.34	31.8	5.4	35.47	147	122	Peak
2462	96.14	94.21			31.87	5.5	35.44	147	122	Average
2462	104.51	102.58			31.87	5.5	35.44	147	122	Peak
2484	50.65	48.69	54	-3.35	31.88	5.5	35.42	147	122	Average
2484	61.49	59.53	74	-12.51	31.88	5.5	35.42	147	122	Peak

Remarks:

- Emission Level = Read Level + Antenna Factor + Cable Loss - Preamp Factor
Margin value = Emission level – Limit value
- 2462 MHz: Fundamental frequency.

802.11n (HT20)

EUT Test Condition		Measurement Detail	
Channel	Channel 1	Frequency Range	1 GHz ~ 25 GHz
Input Power	120 Vac, 60 Hz	Detector Function	Peak (PK) Average (AV)
Environmental Conditions	25 deg. C, 65 % RH	Tested By	Karl Lee

Antennal Polarity & Test Distance: Horizontal at 3 m

Frequency (MHz)	Emission Level (dBuV/m)	Read Level (dBuV)	Limit (dBuV/m)	Margin (dB)	Antenna Factor (dB/m)	Cable Loss (dB)	Preamp Factor (dB)	Antenna Height (cm)	Table Angle (Degree)	Remark
2390	46.66	44.93	54	-7.34	31.8	5.4	35.47	104	34	Average
2390	62.23	60.5	74	-11.77	31.8	5.4	35.47	104	34	Peak
2412	94.43	92.66			31.81	5.43	35.47	104	34	Average
2412	102.89	101.12			31.81	5.43	35.47	104	34	Peak
2492	41.12	39.1	54	-12.88	31.9	5.53	35.41	104	34	Average
2492	55.36	53.34	74	-18.64	31.9	5.53	35.41	104	34	Peak

Antennal Polarity & Test Distance: Vertical at 3 m

Frequency (MHz)	Emission Level (dBuV/m)	Read Level (dBuV)	Limit (dBuV/m)	Margin (dB)	Antenna Factor (dB/m)	Cable Loss (dB)	Preamp Factor (dB)	Antenna Height (cm)	Table Angle (Degree)	Remark
2390	52.18	50.45	54	-1.82	31.8	5.4	35.47	100	345	Average
2390	66.27	64.54	74	-7.73	31.8	5.4	35.47	100	345	Peak
2412	94.61	92.84			31.81	5.43	35.47	100	345	Average
2412	103.82	102.05			31.81	5.43	35.47	100	345	Peak
2490	41.53	39.52	54	-12.47	31.9	5.53	35.42	100	345	Average
2490	55.69	53.68	74	-18.31	31.9	5.53	35.42	100	345	Peak

Remarks:

- Emission Level = Read Level + Antenna Factor + Cable Loss - Preamp Factor
Margin value = Emission level – Limit value
- 2412 MHz: Fundamental frequency.

EUT Test Condition		Measurement Detail	
Channel	Channel 6	Frequency Range	1 GHz ~ 25 GHz
Input Power	120 Vac, 60 Hz	Detector Function	Peak (PK) Average (AV)
Environmental Conditions	25 deg. C, 65 % RH	Tested By	Karl Lee

Antennal Polarity & Test Distance: Horizontal at 3 m										
Frequency (MHz)	Emission Level (dBuV/m)	Read Level (dBuV)	Limit (dBuV/m)	Margin (dB)	Antenna Factor (dB/m)	Cable Loss (dB)	Preamp Factor (dB)	Antenna Height (cm)	Table Angle (Degree)	Remark
2388	44.84	43.13	54	-9.16	31.8	5.4	35.49	104	37	Average
2388	59.13	57.42	74	-14.87	31.8	5.4	35.49	104	37	Peak
2437	99	97.15			31.85	5.46	35.46	104	37	Average
2437	107.68	105.83			31.85	5.46	35.46	104	37	Peak
2484	46.72	44.76	54	-7.28	31.88	5.5	35.42	104	37	Average
2484	58.89	56.93	74	-15.11	31.88	5.5	35.42	104	37	Peak
Antennal Polarity & Test Distance: Vertical at 3 m										
Frequency (MHz)	Emission Level (dBuV/m)	Read Level (dBuV)	Limit (dBuV/m)	Margin (dB)	Antenna Factor (dB/m)	Cable Loss (dB)	Preamp Factor (dB)	Antenna Height (cm)	Table Angle (Degree)	Remark
2390	48.26	46.53	54	-5.74	31.8	5.4	35.47	132	118	Average
2390	60.15	58.42	74	-13.85	31.8	5.4	35.47	132	118	Peak
2437	100.51	98.66			31.85	5.46	35.46	132	118	Average
2437	108.09	106.24			31.85	5.46	35.46	132	118	Peak
2484	49.48	47.52	54	-4.52	31.88	5.5	35.42	132	118	Average
2484	62.52	60.56	74	-11.48	31.88	5.5	35.42	132	118	Peak

Remarks:

- Emission Level = Read Level + Antenna Factor + Cable Loss - Preamp Factor
Margin value = Emission level – Limit value
- 2437 MHz: Fundamental frequency.



EUT Test Condition		Measurement Detail	
Channel	Channel 11	Frequency Range	1 GHz ~ 25 GHz
Input Power	120 Vac, 60 Hz	Detector Function	Peak (PK) Average (AV)
Environmental Conditions	25 deg. C, 65 % RH	Tested By	Karl Lee

Antennal Polarity & Test Distance: Horizontal at 3 m										
Frequency (MHz)	Emission Level (dBuV/m)	Read Level (dBuV)	Limit (dBuV/m)	Margin (dB)	Antenna Factor (dB/m)	Cable Loss (dB)	Preamp Factor (dB)	Antenna Height (cm)	Table Angle (Degree)	Remark
2366	40.45	38.81	54	-13.55	31.76	5.37	35.49	102	38	Average
2366	56.2	54.56	74	-17.8	31.76	5.37	35.49	102	38	Peak
2462	95.97	94.04			31.87	5.5	35.44	102	38	Average
2462	103.92	101.99			31.87	5.5	35.44	102	38	Peak
2484	47.49	45.53	54	-6.51	31.88	5.5	35.42	102	38	Average
2484	59.57	57.61	74	-14.43	31.88	5.5	35.42	102	38	Peak

Antennal Polarity & Test Distance: Vertical at 3 m										
Frequency (MHz)	Emission Level (dBuV/m)	Read Level (dBuV)	Limit (dBuV/m)	Margin (dB)	Antenna Factor (dB/m)	Cable Loss (dB)	Preamp Factor (dB)	Antenna Height (cm)	Table Angle (Degree)	Remark
2370	40.7	39.04	54	-13.3	31.78	5.37	35.49	147	122	Average
2370	55.58	53.92	74	-18.42	31.78	5.37	35.49	147	122	Peak
2462	97.17	95.24			31.87	5.5	35.44	147	122	Average
2462	105.53	103.6			31.87	5.5	35.44	147	122	Peak
2484	50.26	48.3	54	-3.74	31.88	5.5	35.42	147	122	Average
2484	61.9	59.94	74	-12.1	31.88	5.5	35.42	147	122	Peak

Remarks:

- Emission Level = Read Level + Antenna Factor + Cable Loss - Preamp Factor
Margin value = Emission level – Limit value
- 2462 MHz: Fundamental frequency.

802.11n (HT40)

EUT Test Condition		Measurement Detail	
Channel	Channel 3	Frequency Range	1 GHz ~ 25 GHz
Input Power	120 Vac, 60 Hz	Detector Function	Peak (PK) Average (AV)
Environmental Conditions	25 deg. C, 65 % RH	Tested By	Karl Lee

Antennal Polarity & Test Distance: Horizontal at 3 m

Frequency (MHz)	Emission Level (dBuV/m)	Read Level (dBuV)	Limit (dBuV/m)	Margin (dB)	Antenna Factor (dB/m)	Cable Loss (dB)	Preamp Factor (dB)	Antenna Height (cm)	Table Angle (Degree)	Remark
2390	47.2	45.47	54	-6.8	31.8	5.4	35.47	104	34	Average
2390	58.38	56.65	74	-15.62	31.8	5.4	35.47	104	34	Peak
2422	88.76	86.96			31.83	5.43	35.46	104	34	Average
2422	96.73	94.93			31.83	5.43	35.46	104	34	Peak
2494	41.53	39.51	54	-12.47	31.9	5.53	35.41	104	34	Average
2494	56.19	54.17	74	-17.81	31.9	5.53	35.41	104	34	Peak

Antennal Polarity & Test Distance: Vertical at 3 m

Frequency (MHz)	Emission Level (dBuV/m)	Read Level (dBuV)	Limit (dBuV/m)	Margin (dB)	Antenna Factor (dB/m)	Cable Loss (dB)	Preamp Factor (dB)	Antenna Height (cm)	Table Angle (Degree)	Remark
2390	52.9	51.17	54	-1.1	31.8	5.4	35.47	100	345	Average
2390	64.6	62.87	74	-9.4	31.8	5.4	35.47	100	345	Peak
2422	89.56	87.76			31.83	5.43	35.46	100	345	Average
2422	97.74	95.94			31.83	5.43	35.46	100	345	Peak
2498	41.93	39.91	54	-12.07	31.9	5.53	35.41	100	345	Average
2498	55.88	53.86	74	-18.12	31.9	5.53	35.41	100	345	Peak

Remarks:

- Emission Level = Read Level + Antenna Factor + Cable Loss - Preamp Factor
Margin value = Emission level – Limit value
- 2422 MHz: Fundamental frequency.



A D T

EUT Test Condition		Measurement Detail	
Channel	Channel 6	Frequency Range	1 GHz ~ 25 GHz
Input Power	120 Vac, 60 Hz	Detector Function	Peak (PK) Average (AV)
Environmental Conditions	25 deg. C, 65 % RH	Tested By	Karl Lee

Antennal Polarity & Test Distance: Horizontal at 3 m										
Frequency (MHz)	Emission Level (dBuV/m)	Read Level (dBuV)	Limit (dBuV/m)	Margin (dB)	Antenna Factor (dB/m)	Cable Loss (dB)	Preamp Factor (dB)	Antenna Height (cm)	Table Angle (Degree)	Remark
2390	48	46.27	54	-6	31.8	5.4	35.47	104	37	Average
2390	60.7	58.97	74	-13.3	31.8	5.4	35.47	104	37	Peak
2437	91.51	89.66			31.85	5.46	35.46	104	37	Average
2437	99.21	97.36			31.85	5.46	35.46	104	37	Peak
2484	45.88	43.92	54	-8.12	31.88	5.5	35.42	104	37	Average
2484	59.73	57.77	74	-14.27	31.88	5.5	35.42	104	37	Peak

Antennal Polarity & Test Distance: Vertical at 3 m										
Frequency (MHz)	Emission Level (dBuV/m)	Read Level (dBuV)	Limit (dBuV/m)	Margin (dB)	Antenna Factor (dB/m)	Cable Loss (dB)	Preamp Factor (dB)	Antenna Height (cm)	Table Angle (Degree)	Remark
2390	52.3	50.57	54	-1.7	31.8	5.4	35.47	133	118	Average
2390	64.09	62.36	74	-9.91	31.8	5.4	35.47	133	118	Peak
2437	92.31	90.46			31.85	5.46	35.46	133	118	Average
2437	100.49	98.64			31.85	5.46	35.46	133	118	Peak
2484	47.87	45.91	54	-6.13	31.88	5.5	35.42	133	118	Average
2484	60.98	59.02	74	-13.02	31.88	5.5	35.42	133	118	Peak

Remarks:

- Emission Level = Read Level + Antenna Factor + Cable Loss - Preamp Factor
Margin value = Emission level – Limit value
- 2437 MHz: Fundamental frequency.



A D T

EUT Test Condition		Measurement Detail	
Channel	Channel 9	Frequency Range	1 GHz ~ 25 GHz
Input Power	120 Vac, 60 Hz	Detector Function	Peak (PK) Average (AV)
Environmental Conditions	25 deg. C, 65 % RH	Tested By	Karl Lee

Antennal Polarity & Test Distance: Horizontal at 3 m										
Frequency (MHz)	Emission Level (dBuV/m)	Read Level (dBuV)	Limit (dBuV/m)	Margin (dB)	Antenna Factor (dB/m)	Cable Loss (dB)	Preamp Factor (dB)	Antenna Height (cm)	Table Angle (Degree)	Remark
2344	42.58	41.01	54	-11.42	31.74	5.33	35.5	102	38	Average
2344	55.79	54.22	74	-18.21	31.74	5.33	35.5	102	38	Peak
2452	91.81	89.94			31.85	5.46	35.44	102	38	Average
2452	99.53	97.66			31.85	5.46	35.44	102	38	Peak
2498	47.93	45.91	54	-6.07	31.9	5.53	35.41	102	38	Average
2498	59.97	57.95	74	-14.03	31.9	5.53	35.41	102	38	Peak

Antennal Polarity & Test Distance: Vertical at 3 m										
Frequency (MHz)	Emission Level (dBuV/m)	Read Level (dBuV)	Limit (dBuV/m)	Margin (dB)	Antenna Factor (dB/m)	Cable Loss (dB)	Preamp Factor (dB)	Antenna Height (cm)	Table Angle (Degree)	Remark
2388	44.41	42.7	54	-9.59	31.8	5.4	35.49	131	116	Average
2388	55.34	53.63	74	-18.66	31.8	5.4	35.49	131	116	Peak
2452	92.11	90.24			31.85	5.46	35.44	131	116	Average
2452	100.74	98.87			31.85	5.46	35.44	131	116	Peak
2486	52.41	50.42	54	-1.59	31.88	5.53	35.42	131	116	Average
2486	64.05	62.06	74	-9.95	31.88	5.53	35.42	131	116	Peak

Remarks:

- Emission Level = Read Level + Antenna Factor + Cable Loss - Preamp Factor
Margin value = Emission level – Limit value
- 2452 MHz: Fundamental frequency.

9 kHz ~ 30 MHz DATA:

The amplitude of spurious emissions attenuated more than 20 dB below the permissible value is not required to be report.

30 MHz ~ 1 GHz WORST-CASE DATA:
Mode A
802.11b

EUT Test Condition		Measurement Detail	
Channel	Channel 1	Frequency Range	30 MHz ~ 1 GHz
Input Power	120 Vac, 60 Hz	Detector Function	Peak (PK) Quasi-peak (QP)
Environmental Conditions	25 deg. C, 65 % RH	Tested By	Karl Lee

Antennal Polarity & Test Distance: Horizontal at 3 m

Frequency (MHz)	Emission Level (dBuV/m)	Read Level (dBuV)	Limit (dBuV/m)	Margin (dB)	Antenna Factor (dB/m)	Cable Loss (dB)	Preamp Factor (dB)	Antenna Height (cm)	Table Angle (Degree)	Remark
90.21	28.93	49.07	43.5	-14.57	10.46	1.11	31.71	190	100	Peak
143.94	27.53	50.03	43.5	-15.97	8.39	1.38	32.27	143	299	Peak
233.04	31.85	50.31	46	-14.15	11.86	1.85	32.17	131	50	Peak
308.4	34.22	50.98	46	-11.78	13.25	2.11	32.12	120	40	Peak
565.3	31.59	43.59	46	-14.41	17.38	2.82	32.2	173	187	Peak
768.3	29.88	38.77	46	-16.12	20	3.22	32.11	129	194	Peak

Antennal Polarity & Test Distance: Vertical at 3 m

Frequency (MHz)	Emission Level (dBuV/m)	Read Level (dBuV)	Limit (dBuV/m)	Margin (dB)	Antenna Factor (dB/m)	Cable Loss (dB)	Preamp Factor (dB)	Antenna Height (cm)	Table Angle (Degree)	Remark
33.24	25.21	44.98	40	-14.79	11.74	0.74	32.25	133	24	Peak
77.25	28.64	51.42	40	-11.36	8.33	1.11	32.22	183	111	Peak
193.62	23.02	42.8	43.5	-20.48	10.88	1.61	32.27	162	230	Peak
419.7	24.06	38.61	46	-21.94	15.23	2.41	32.19	149	97	Peak
565.3	26.3	38.3	46	-19.7	17.38	2.82	32.2	173	184	Peak
801.2	24.9	33.28	46	-21.1	20.35	3.32	32.05	181	101	Peak

Remarks:

- Emission Level = Read Level + Antenna Factor + Cable Loss - Preamp Factor
Margin value = Emission level – Limit value

Mode B
802.11b

EUT Test Condition		Measurement Detail	
Channel	Channel 1	Frequency Range	30 MHz ~ 1 GHz
Input Power	120 Vac, 60 Hz	Detector Function	Peak (PK) Quasi-peak (QP)
Environmental Conditions	25 deg. C, 65 % RH	Tested By	Karl Lee

Antennal Polarity & Test Distance: Horizontal at 3 m										
Frequency (MHz)	Emission Level (dBuV/m)	Read Level (dBuV)	Limit (dBuV/m)	Margin (dB)	Antenna Factor (dB/m)	Cable Loss (dB)	Preamp Factor (dB)	Antenna Height (cm)	Table Angle (Degree)	Remark
88.32	38.01	58.76	43.5	-5.49	9.95	1.11	31.81	101	345	QP
193.89	41.43	61.21	43.5	-2.07	10.88	1.61	32.27	193	89	QP
264.09	40.42	58.04	46	-5.58	12.55	1.94	32.11	106	36	QP
360.9	41.26	56.74	46	-4.74	14.36	2.26	32.1	160	360	Peak
386.8	40.66	55.77	46	-5.34	14.73	2.34	32.18	168	290	Peak
750.1	42.83	51.95	46	-3.17	19.81	3.22	32.15	191	187	Peak
Antennal Polarity & Test Distance: Vertical at 3 m										
Frequency (MHz)	Emission Level (dBuV/m)	Read Level (dBuV)	Limit (dBuV/m)	Margin (dB)	Antenna Factor (dB/m)	Cable Loss (dB)	Preamp Factor (dB)	Antenna Height (cm)	Table Angle (Degree)	Remark
32.43	39.6	59.37	40	-0.4	11.74	0.74	32.25	100	246	QP
53.76	35.79	52.82	40	-4.21	14.3	0.9	32.23	153	76	QP
187.95	38.84	59.03	43.5	-4.66	10.45	1.61	32.25	187	95	Peak
386.8	33.27	48.38	46	-12.73	14.73	2.34	32.18	186	66	Peak
687.8	35.54	45.54	46	-10.46	19.05	3.05	32.1	167	305	Peak
750.1	39.25	48.37	46	-6.75	19.81	3.22	32.15	175	11	Peak

Remarks:

- Emission Level = Read Level + Antenna Factor + Cable Loss - Preamp Factor
Margin value = Emission level – Limit value

4.2 Conducted Emission Measurement

4.2.1 Limits of Conducted Emission Measurement

Frequency (MHz)	Conducted Limit (dBuV)	
	Quasi-peak	Average
0.15 - 0.5	66 - 56	56 - 46
0.50 - 5.0	56	46
5.0 - 30.0	60	50

Note: 1. The lower limit shall apply at the transition frequencies.

2. The limit decreases in line with the logarithm of the frequency in the range of 0.15 to 0.50 MHz.

4.2.2 Test Instruments

Description & Manufacturer	Model No.	Serial No.	Date of Calibration	Due Date of Calibration
Test Receiver ROHDE & SCHWARZ	ESCI	100613	Nov. 16, 2015	Nov. 15, 2016
RF signal cable (with 10dB PAD) Woken	5D-FB	Cable-cond1-01	Dec. 26, 2015	Dec. 25, 2016
LISN ROHDE & SCHWARZ (EUT)	ESH3-Z5	835239/001	Feb. 26, 2015	Feb. 25, 2016
LISN ROHDE & SCHWARZ (Peripheral)	ESH3-Z5	100311	Jul. 24, 2015	Jul. 23, 2016
Software ADT	BV ADT_Cond_ V7.3.7.3	NA	NA	NA

Note: 1. The calibration interval of the above test instruments is 12 months and the calibrations are traceable to NML/ROC and NIST/USA.

2. The test was performed in HwaYa Shielded Room 1.
3. The VCCI Site Registration No. is C-2040.
4. Test Date: 2015/12/29

4.2.3 Test Procedures

- The EUT was placed 0.4 meters from the conducting wall of the shielded room with EUT being connected to the power mains through a line impedance stabilization network (LISN). Other support units were connected to the power mains through another LISN. The two LISNs provide 50 ohm/50 uH of coupling impedance for the measuring instrument.
- Both lines of the power mains connected to the EUT were checked for maximum conducted interference.
- The frequency range from 150 kHz to 30 MHz was searched. Emission levels under (Limit – 20 dB) was not recorded.

NOTE: All modes of operation were investigated and the worst-case emissions are reported.

4.2.4 Deviation from Test Standard

No deviation.

4.2.5 Test Setup

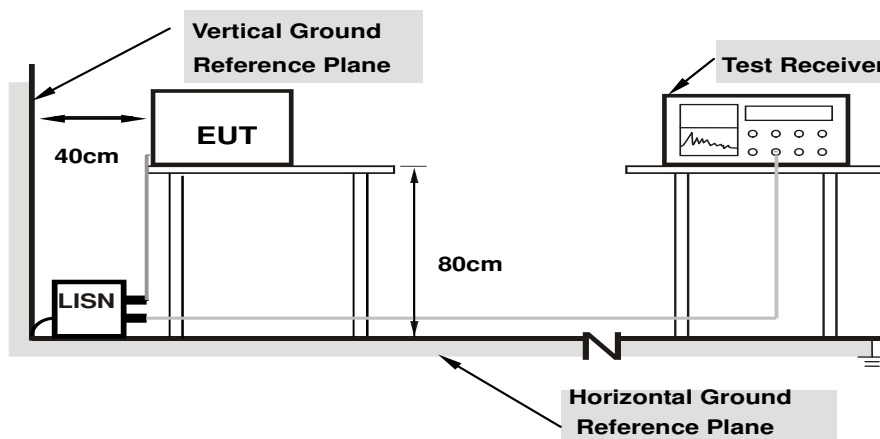

Note: 1. Support units were connected to second LISN.

For the actual test configuration, please refer to the attached file (Test Setup Photo).

4.2.6 EUT Operating Conditions

- Placed the EUT on a testing table.
- Use the software to control the EUT under transmission condition continuously at specific channel frequency.

4.2.7 Test Results

Mode A

Frequency Range	150kHz ~ 30MHz	Detector Function & Resolution Bandwidth	Quasi-Peak (QP) / Average (AV), 9kHz
Input Power	120Vac, 60Hz	Environmental Conditions	25°C, 65%RH
Tested by	Toby Tian	Test Date	2015/12/29

Phase Of Power : Line (L)										
No	Frequency (MHz)	Correction Factor (dB)	Reading Value (dBuV)		Emission Level (dBuV)		Limit (dBuV)		Margin (dB)	
			Q.P.	AV.	Q.P.	AV.	Q.P.	AV.	Q.P.	AV.
1	0.15000	9.82	43.67	28.10	53.49	37.92	66.00	56.00	-12.51	-18.08
2	0.16955	9.83	41.16	26.66	50.99	36.49	64.98	54.98	-13.99	-18.49
3	0.18508	9.83	37.70	19.91	47.53	29.74	64.25	54.25	-16.72	-24.51
4	0.24384	9.85	29.08	15.19	38.93	25.04	61.96	51.96	-23.04	-26.93
5	0.35723	9.87	31.54	18.71	41.41	28.58	58.79	48.79	-17.38	-20.21
6	0.46280	9.89	20.05	9.78	29.94	19.67	56.64	46.64	-26.71	-26.98

Remarks:

1. Q.P. and AV. are abbreviations of quasi-peak and average individually.
2. The emission levels of other frequencies were very low against the limit.
3. Margin value = Emission level – Limit value
4. Correction factor = Insertion loss + Cable loss
5. Emission Level = Correction Factor + Reading Value

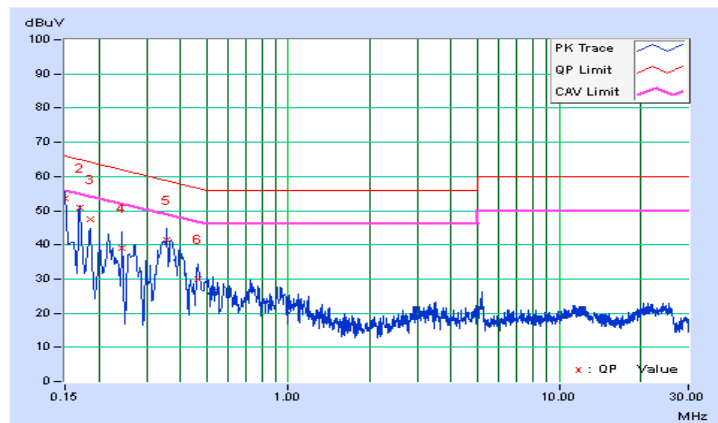

Frequency Range	150kHz ~ 30MHz	Detector Function & Resolution Bandwidth	Quasi-Peak (QP) / Average (AV), 9kHz
Input Power	120Vac, 60Hz	Environmental Conditions	25°C, 65%RH
Tested by	Toby Tian	Test Date	2015/12/29

Phase Of Power : Neutral (N)										
No	Frequency (MHz)	Correction Factor (dB)	Reading Value (dBuV)		Emission Level (dBuV)		Limit (dBuV)		Margin (dB)	
			Q.P.	AV.	Q.P.	AV.	Q.P.	AV.	Q.P.	AV.
1	0.15391	9.82	37.57	26.36	47.39	36.18	65.79	55.79	-18.40	-19.61
2	0.17346	9.82	38.90	22.88	48.72	32.70	64.79	54.79	-16.07	-22.09
3	0.18519	9.83	37.34	17.79	47.17	27.62	64.25	54.25	-17.08	-26.63
4	0.21256	9.83	31.96	14.48	41.79	24.31	63.10	53.10	-21.31	-28.79
5	0.25166	9.84	27.72	12.30	37.56	22.14	61.70	51.70	-24.14	-29.56
6	0.37304	9.87	25.75	20.26	35.62	30.13	58.43	48.43	-22.81	-18.30

Remarks:

1. Q.P. and AV. are abbreviations of quasi-peak and average individually.
2. The emission levels of other frequencies were very low against the limit.
3. Margin value = Emission level – Limit value
4. Correction factor = Insertion loss + Cable loss
5. Emission Level = Correction Factor + Reading Value

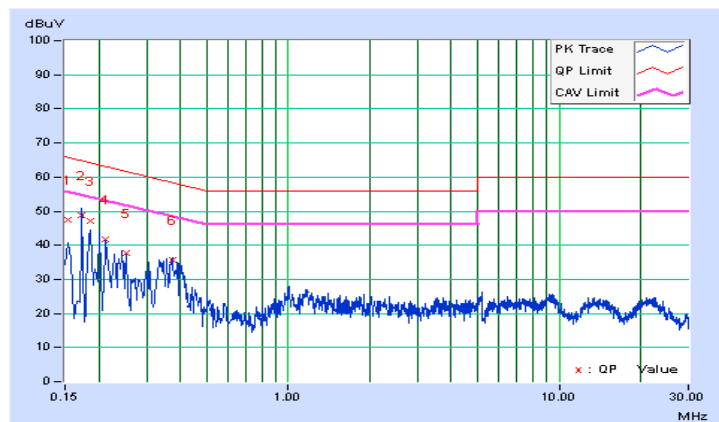

Mode B

Frequency Range	150kHz ~ 30MHz	Detector Function & Resolution Bandwidth	Quasi-Peak (QP) / Average (AV), 9kHz
Input Power	120Vac, 60Hz	Environmental Conditions	25°C, 65%RH
Tested by	Toby Tian	Test Date	2015/12/29

Phase Of Power : Line (L)										
No	Frequency (MHz)	Correction Factor (dB)	Reading Value (dBuV)		Emission Level (dBuV)		Limit (dBuV)		Margin (dB)	
			Q.P.	AV.	Q.P.	AV.	Q.P.	AV.	Q.P.	AV.
1	0.15000	9.82	44.22	32.55	54.04	42.37	66.00	56.00	-11.96	-13.63
2	0.16955	9.83	40.56	26.00	50.39	35.83	64.98	54.98	-14.59	-19.15
3	0.18519	9.83	38.15	23.71	47.98	33.54	64.25	54.25	-16.27	-20.71
4	0.23602	9.85	30.98	19.48	40.83	29.33	62.24	52.24	-21.41	-22.91
5	0.43924	9.88	35.39	30.98	45.27	40.86	57.08	47.08	-11.80	-6.21
6	0.68926	9.90	22.41	18.28	32.31	28.18	56.00	46.00	-23.69	-17.82

Remarks:

1. Q.P. and AV. are abbreviations of quasi-peak and average individually.
2. The emission levels of other frequencies were very low against the limit.
3. Margin value = Emission level – Limit value
4. Correction factor = Insertion loss + Cable loss
5. Emission Level = Correction Factor + Reading Value

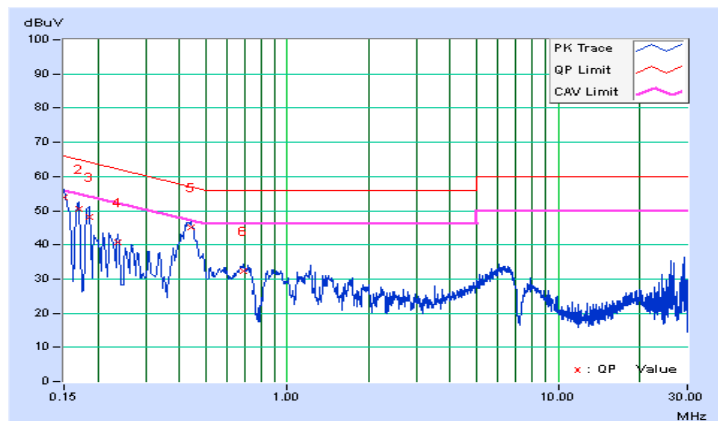

Frequency Range	150kHz ~ 30MHz	Detector Function & Resolution Bandwidth	Quasi-Peak (QP) / Average (AV), 9kHz
Input Power	120Vac, 60Hz	Environmental Conditions	25°C, 65%RH
Tested by	Toby Tian	Test Date	2015/12/29

Phase Of Power : Neutral (N)										
No	Frequency (MHz)	Correction Factor (dB)	Reading Value (dBuV)		Emission Level (dBuV)		Limit (dBuV)		Margin (dB)	
			Q.P.	AV.	Q.P.	AV.	Q.P.	AV.	Q.P.	AV.
1	0.15391	9.82	43.66	32.34	53.48	42.16	65.79	55.79	-12.31	-13.63
2	0.16181	9.82	39.74	25.41	49.56	35.23	65.37	55.37	-15.81	-20.14
3	0.18128	9.83	38.77	24.81	48.60	34.64	64.43	54.43	-15.83	-19.79
4	0.23586	9.84	30.87	19.34	40.71	29.18	62.24	52.24	-21.53	-23.06
5	0.42782	9.88	36.31	31.99	46.19	41.87	57.29	47.29	-11.10	-5.42
6	0.68204	9.90	22.21	17.95	32.11	27.85	56.00	46.00	-23.89	-18.15

Remarks:

1. Q.P. and AV. are abbreviations of quasi-peak and average individually.
2. The emission levels of other frequencies were very low against the limit.
3. Margin value = Emission level – Limit value
4. Correction factor = Insertion loss + Cable loss
5. Emission Level = Correction Factor + Reading Value

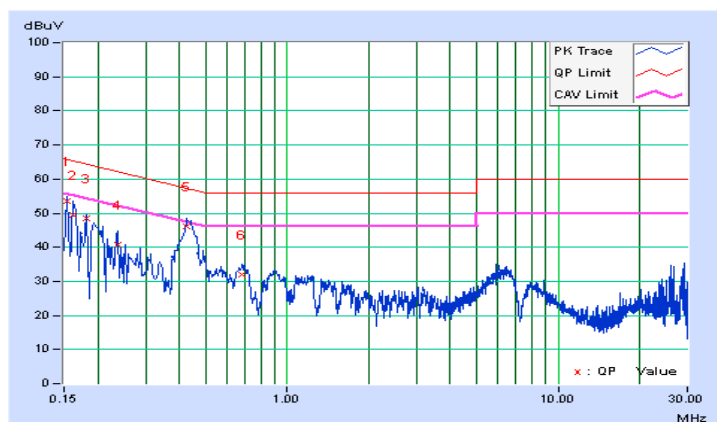

4.3 6 dB Bandwidth Measurement

4.3.1 Limits of 6 dB Bandwidth Measurement

The minimum of 6 dB Bandwidth Measurement is 0.5 MHz.

4.3.2 Test Setup

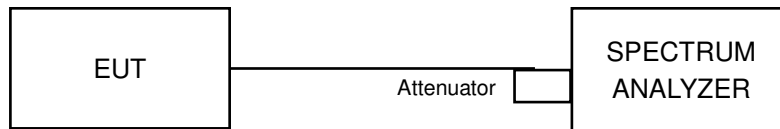

4.3.3 Test Instruments

Refer to section 4.1.2 to get information of above instrument.

4.3.4 Test Procedure

- a. Set resolution bandwidth (RBW) = 100 kHz
- b. Set the video bandwidth (VBW) $\geq 3 \times$ RBW, Detector = Peak.
- c. Trace mode = max hold.
- d. Sweep = auto couple.
- e. Measure the maximum width of the emission that is constrained by the frequencies associated with the two amplitude points (upper and lower) that are attenuated by 6 dB relative to the maximum level measured in the fundamental emission

4.3.5 Deviation from Test Standard

No deviation.

4.3.6 EUT Operating Conditions

The software provided by client to enable the EUT under transmission condition continuously at lowest, middle and highest channel frequencies individually.

4.3.7 Test Result

802.11b

Channel	Frequency (MHz)	6 dB Bandwidth (MHz)	Minimum Limit (MHz)	Pass / Fail
1	2412	8.08	0.5	Pass
6	2437	8.08	0.5	Pass
11	2462	8.10	0.5	Pass

802.11g

Channel	Frequency (MHz)	6 dB Bandwidth (MHz)	Minimum Limit (MHz)	Pass / Fail
1	2412	16.40	0.5	Pass
6	2437	16.39	0.5	Pass
11	2462	16.42	0.5	Pass

802.11n (HT20)

Channel	Frequency (MHz)	6 dB Bandwidth (MHz)	Minimum Limit (MHz)	Pass / Fail
1	2412	17.63	0.5	Pass
6	2437	17.63	0.5	Pass
11	2462	17.64	0.5	Pass

802.11n (HT40)

Channel	Frequency (MHz)	6 dB Bandwidth (MHz)	Minimum Limit (MHz)	Pass / Fail
3	2422	36.41	0.5	Pass
6	2437	36.39	0.5	Pass
9	2452	36.41	0.5	Pass

Spectrum Plot of Worst Value

802.11b

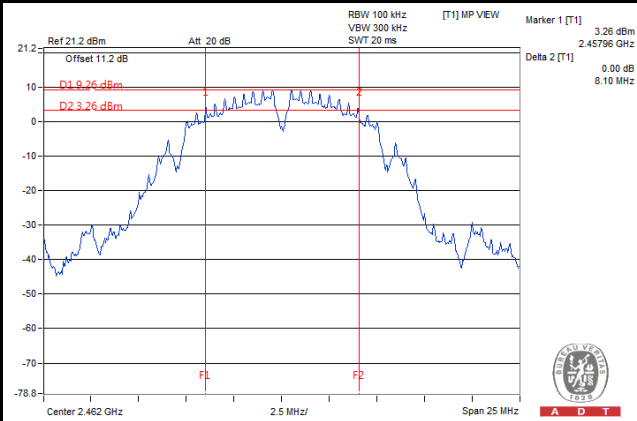

802.11g

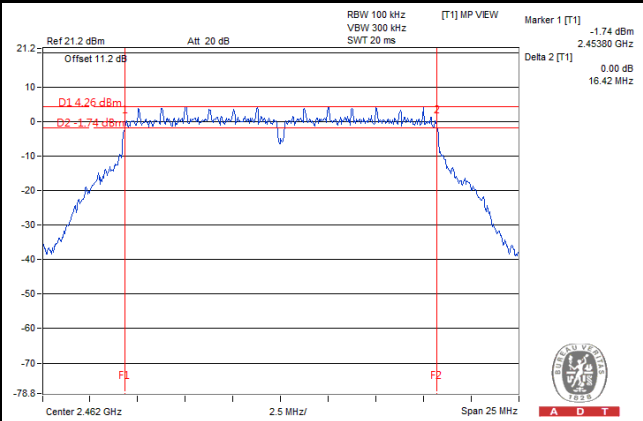

802.11n (HT20)

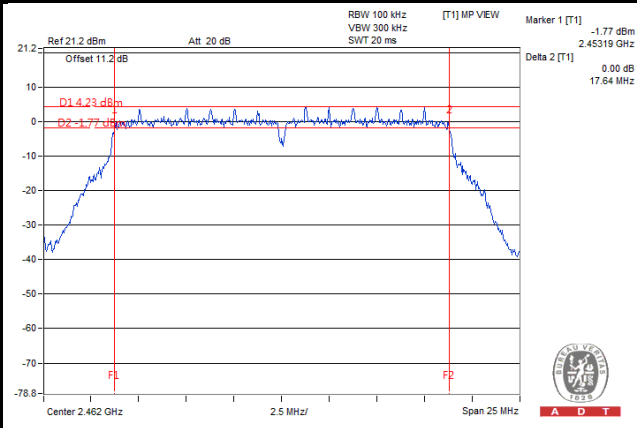

802.11n (HT40)

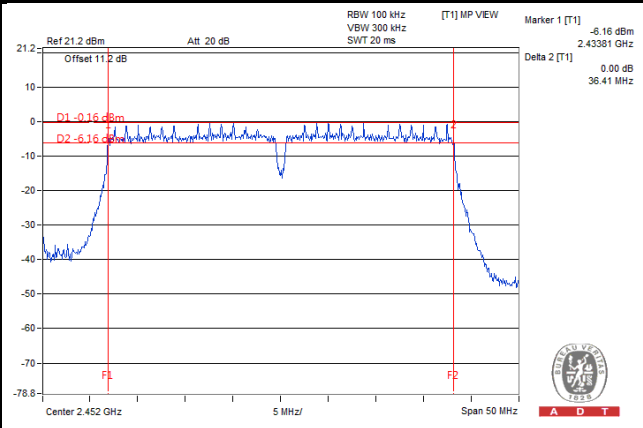

4.4 Conducted Output Power Measurement

4.4.1 Limits of Conducted Output Power Measurement

For systems using digital modulation in the 2400–2483.5 MHz bands: 1 Watt (30 dBm)

4.4.2 Test Setup

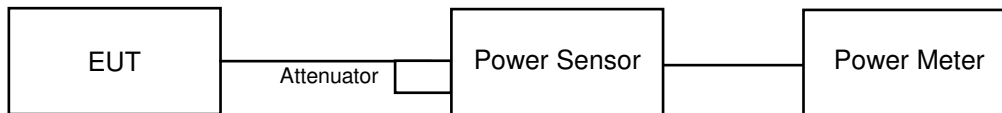

4.4.3 Test Instruments

Refer to section 4.1.2 to get information of above instrument.

4.4.4 Test Procedures

A peak power sensor was used on the output port of the EUT. A power meter was used to read the response of the peak power sensor. Record the power level.

4.4.5 Deviation from Test Standard

No deviation.

4.4.6 EUT Operating Conditions

The software provided by client to enable the EUT under transmission condition continuously at lowest, middle and highest channel frequencies individually.

4.4.7 Test Results

802.11b

Channel	Frequency (MHz)	Peak Power (mW)	Peak Power (dBm)	Limit (dBm)	Pass / Fail
1	2412	94.41	19.75	30	Pass
6	2437	129.42	21.12	30	Pass
11	2462	100.46	20.02	30	Pass

802.11g

Channel	Frequency (MHz)	Peak Power (mW)	Peak Power (dBm)	Limit (dBm)	Pass / Fail
1	2412	157.04	21.96	30	Pass
6	2437	224.91	23.52	30	Pass
11	2462	151.71	21.81	30	Pass

802.11n (HT20)

Channel	Frequency (MHz)	Peak Power (mW)	Peak Power (dBm)	Limit (dBm)	Pass / Fail
1	2412	129.42	21.12	30	Pass
6	2437	226.46	23.55	30	Pass
11	2462	149.97	21.76	30	Pass

802.11n (HT40)

Channel	Frequency (MHz)	Peak Power (mW)	Peak Power (dBm)	Limit (dBm)	Pass / Fail
3	2422	62.66	17.97	30	Pass
6	2437	153.11	21.85	30	Pass
9	2452	126.18	21.01	30	Pass

4.5 Power Spectral Density Measurement

4.5.1 Limits of Power Spectral Density Measurement

The Maximum of Power Spectral Density Measurement is 8 dBm.

4.5.2 Test Setup

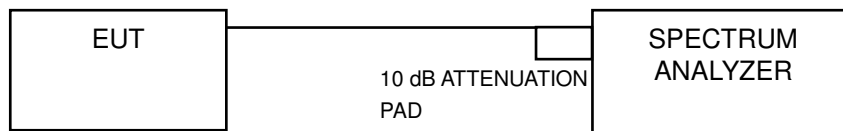

4.5.3 Test Instruments

Refer to section 4.1.2 to get information of above instrument.

4.5.4 Test Procedure

- Set analyzer center frequency to DTS channel center frequency.
- Set the span to 1.5 times the DTS bandwidth.
- Set the RBW to: $3 \text{ kHz} \leq \text{RBW} \leq 100 \text{ kHz}$.
- Set the VBW $\geq 3 \times \text{RBW}$.
- Detector = peak.
- Sweep time = auto couple.
- Trace mode = max hold.
- Allow trace to fully stabilize.
- Use the peak marker function to determine the maximum amplitude level within the RBW.

4.5.5 Deviation from Test Standard

No deviation.

4.5.6 EUT Operating Condition

The software provided by client to enable the EUT under transmission condition continuously at lowest, middle and highest channel frequencies individually.

4.5.7 Test Results

802.11b

Channel	Frequency (MHz)	PSD (dBm)	Limit (dBm)	Pass / Fail
1	2412	-4.67	8	Pass
6	2437	-2.34	8	Pass
11	2462	-4.84	8	Pass

802.11g

Channel	Frequency (MHz)	PSD (dBm)	Limit (dBm)	Pass / Fail
1	2412	-11.83	8	Pass
6	2437	-6.60	8	Pass
11	2462	-11.57	8	Pass

802.11n (HT20)

Channel	Frequency (MHz)	PSD (dBm)	Limit (dBm)	Pass / Fail
1	2412	-11.68	8	Pass
6	2437	-6.22	8	Pass
11	2462	-10.43	8	Pass

802.11n (HT40)

Channel	Frequency (MHz)	PSD (dBm)	Limit (dBm)	Pass / Fail
3	2422	-17.72	8	Pass
6	2437	-13.67	8	Pass
9	2452	-14.80	8	Pass

Spectrum Plot of Worst Value

802.11b

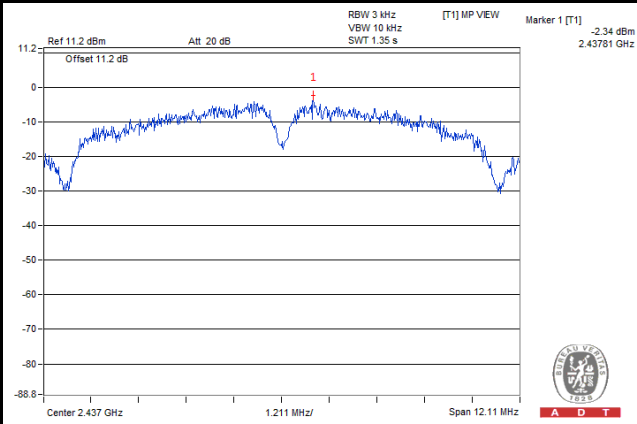

802.11g

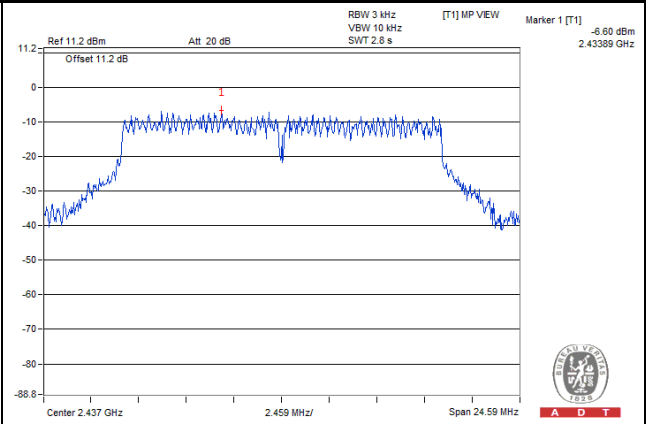

802.11n (HT20)

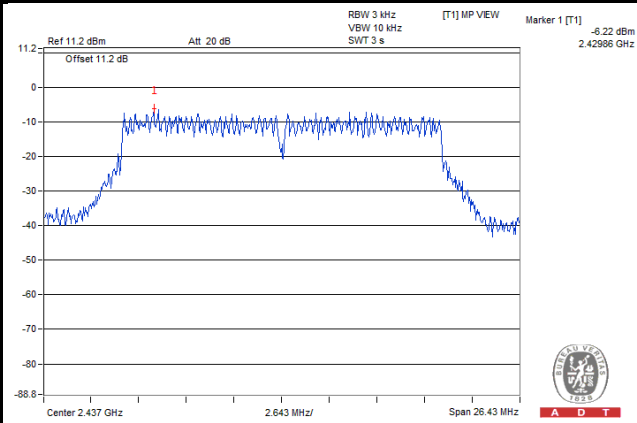

802.11n (HT40)

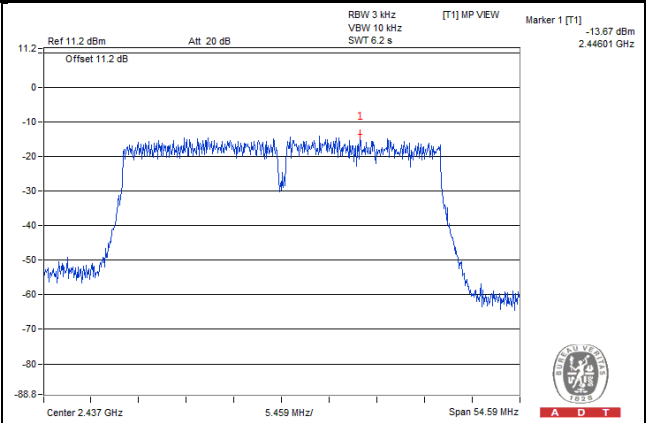

4.6 Conducted Out of Band Emission Measurement

4.6.1 Limits of Conducted Out of Band Emission Measurement

Below 20 dB of the highest emission level of operating band (in 100 kHz Resolution Bandwidth).

4.6.2 Test Setup

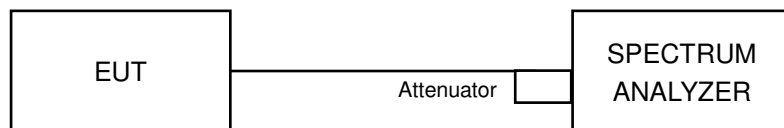

4.6.3 Test Instruments

Refer to section 4.1.2 to get information of above instrument.

4.6.4 Test Procedure

MEASUREMENT PROCEDURE REF

1. Set the RBW = 100 kHz.
2. Set the VBW \geq 300 kHz.
3. Detector = peak.
4. Sweep time = auto couple.
5. Trace mode = max hold.
6. Allow trace to fully stabilize.
7. Use the peak marker function to determine the maximum power level in any 100 kHz band segment within the fundamental EBW.

MEASUREMENT PROCEDURE OOB

1. Set RBW = 100 kHz.
2. Set VBW \geq 300 kHz.
3. Detector = peak.
4. Sweep = auto couple.
5. Trace Mode = max hold.
6. Allow trace to fully stabilize.
7. Use the peak marker function to determine the maximum amplitude level.

4.6.5 Deviation from Test Standard

No deviation.

4.6.6 EUT Operating Condition

The software provided by client to enable the EUT under transmission condition continuously at lowest, middle and highest channel frequencies individually.

4.6.7 Test Results

802.11b

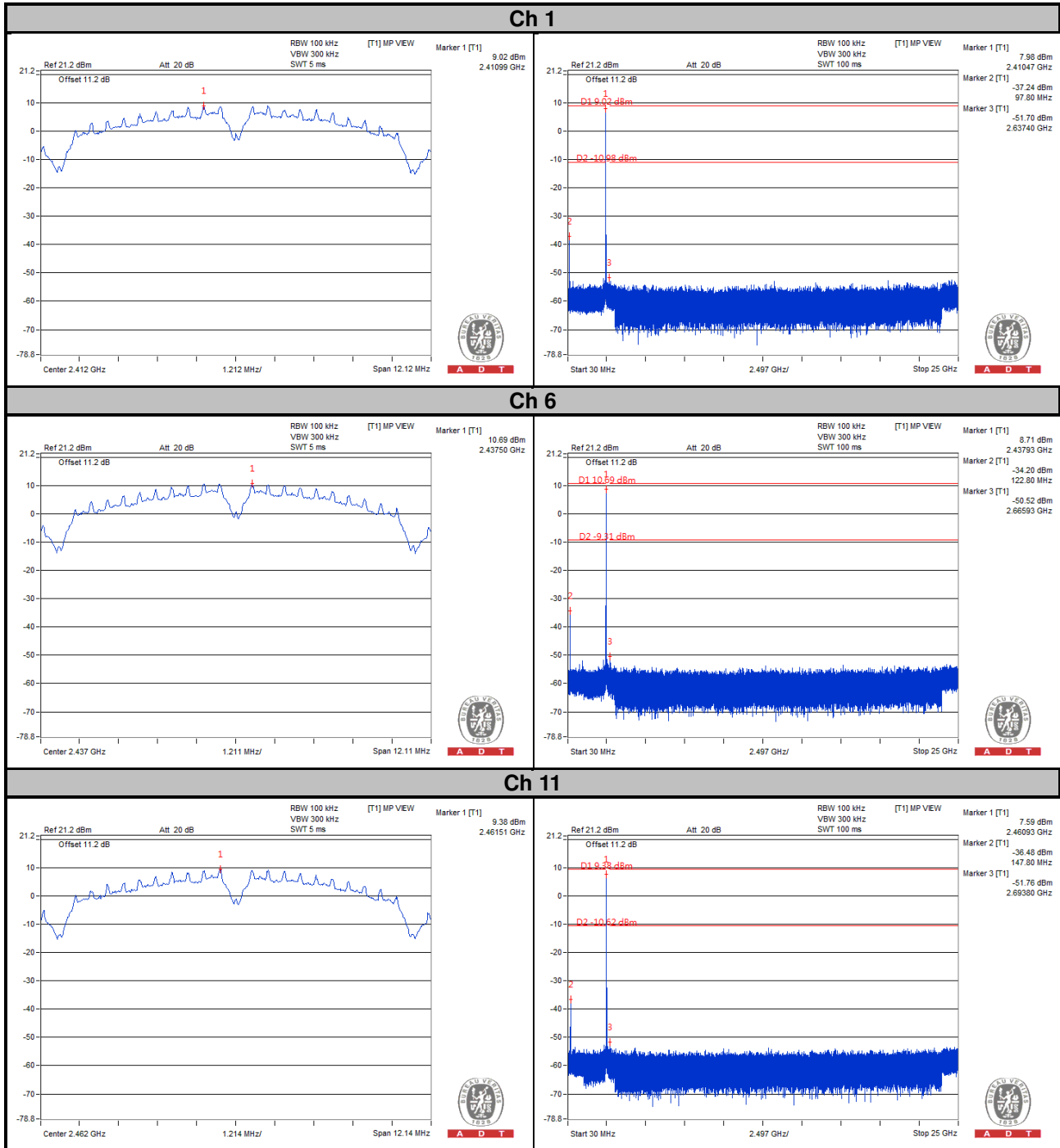

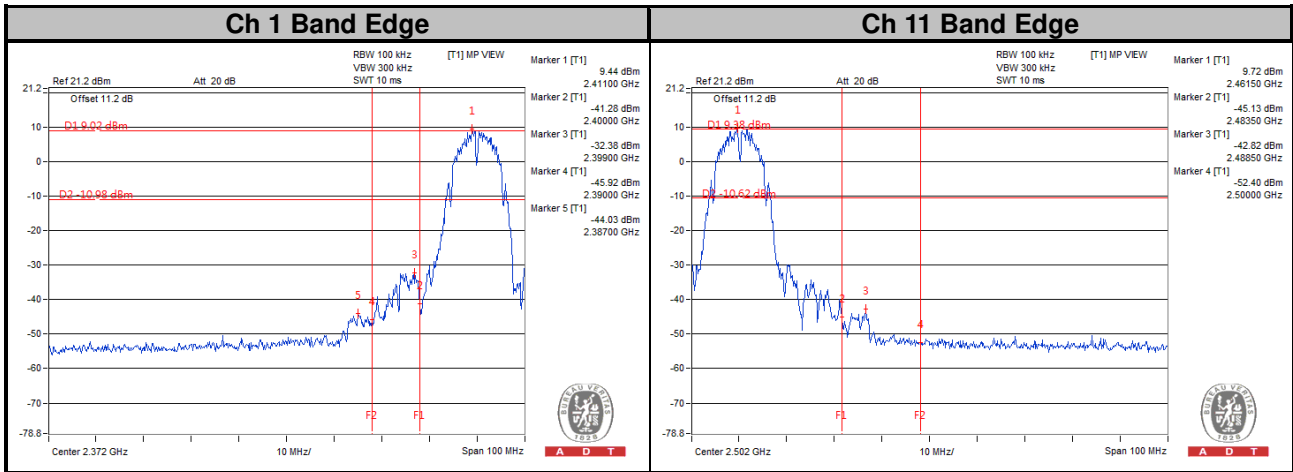

802.11g

Ch 1

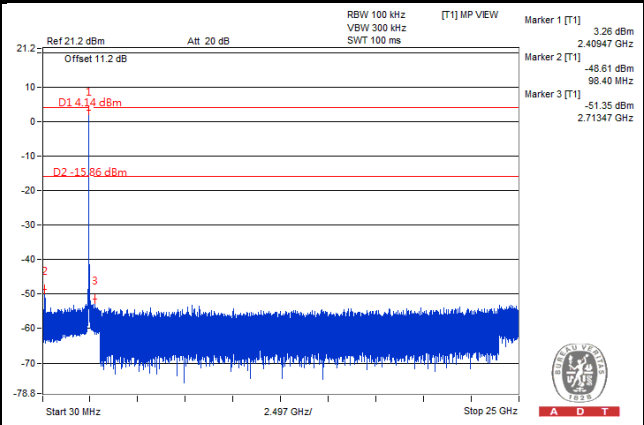
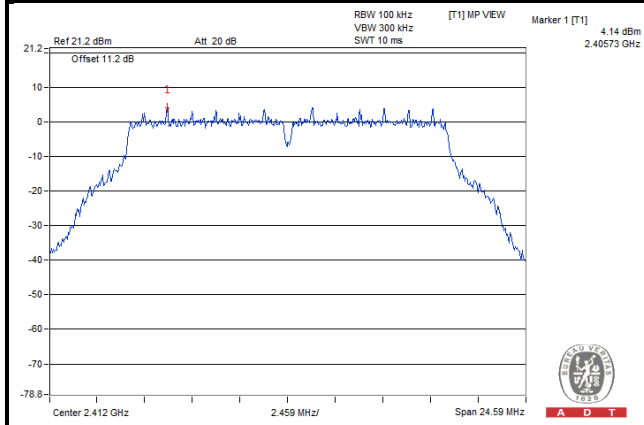

Ch 6

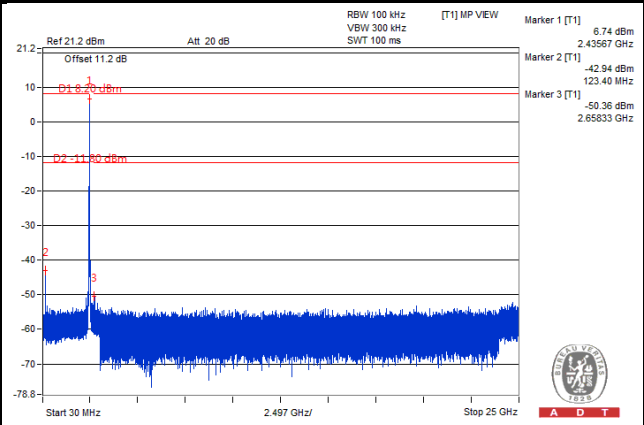
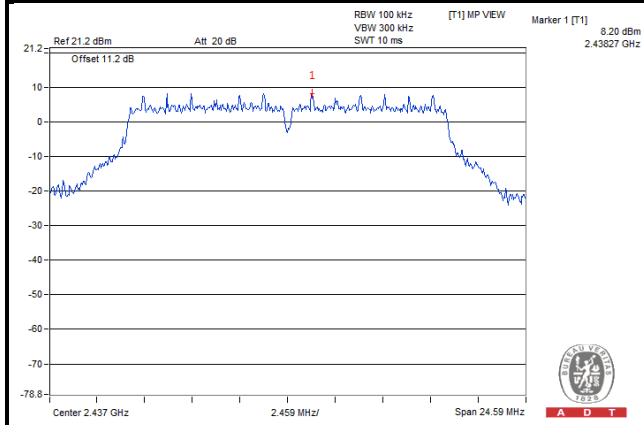

Ch 11

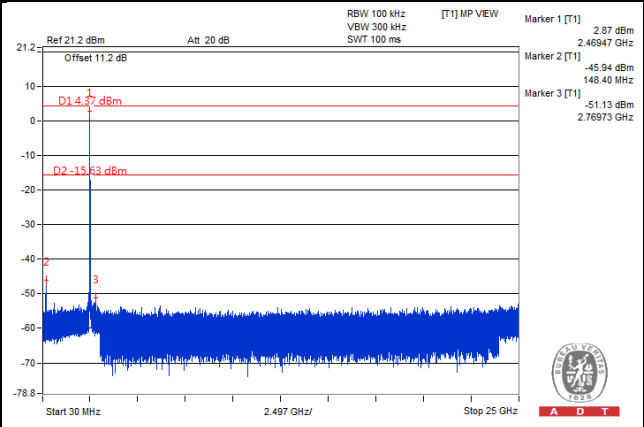
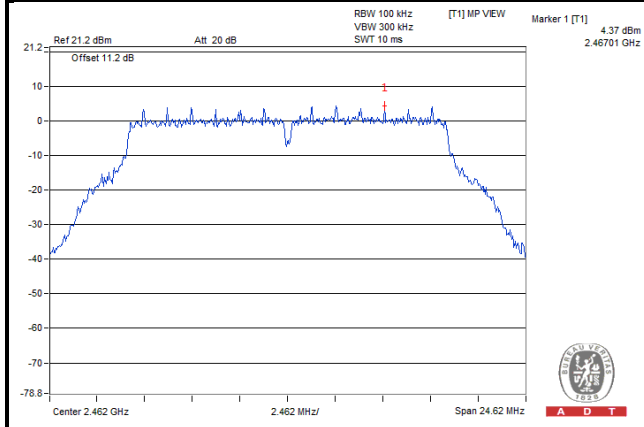

Ch 1 Band Edge

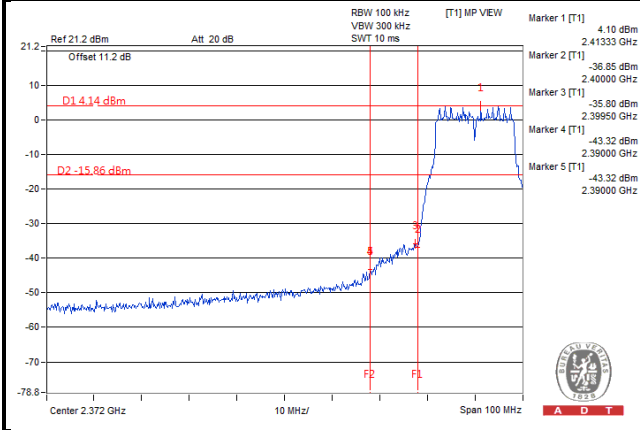

Ch 11 Band Edge

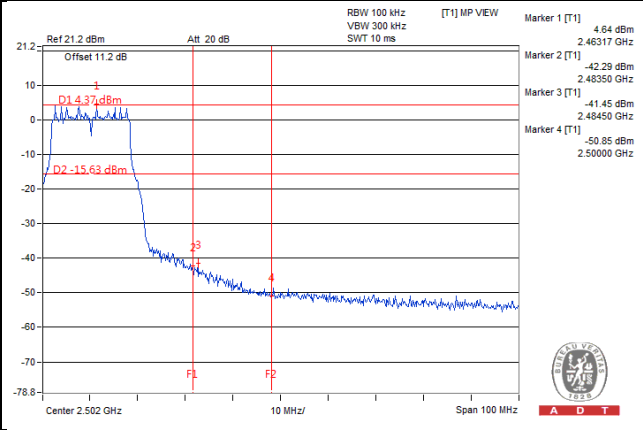

802.11n (HT20)

Ch 1

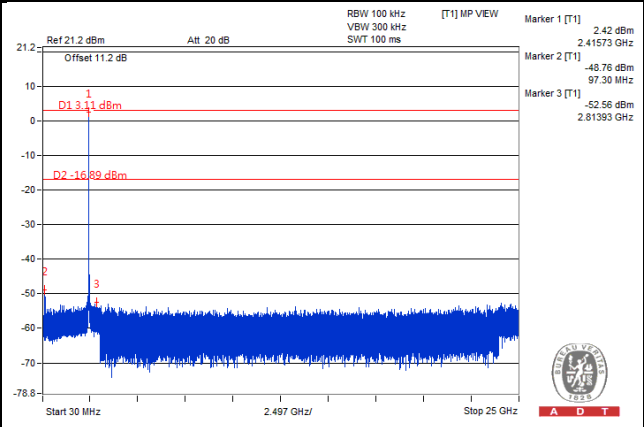
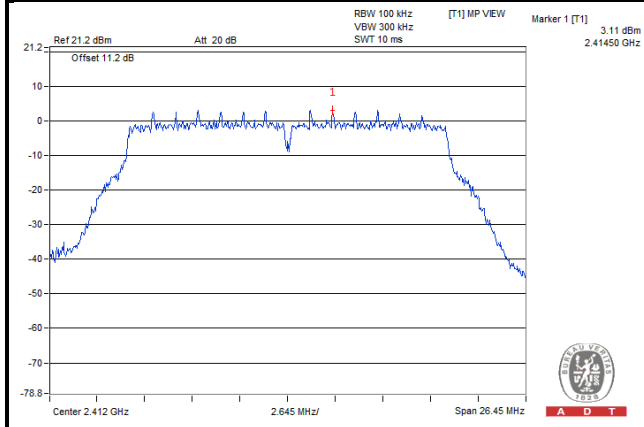

Ch 6

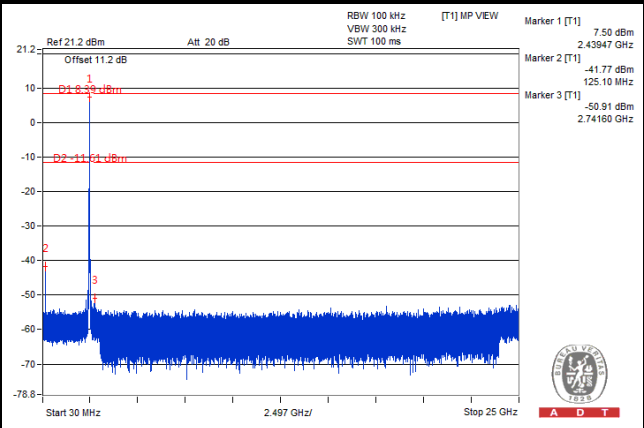
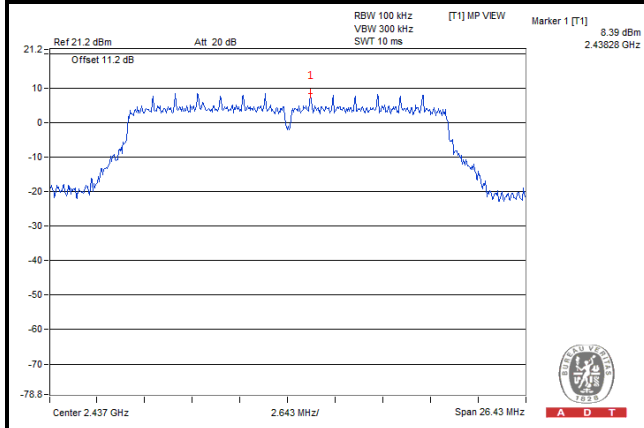

Ch 11

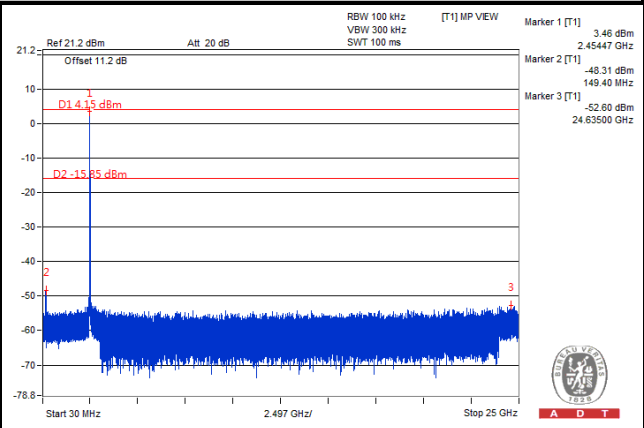
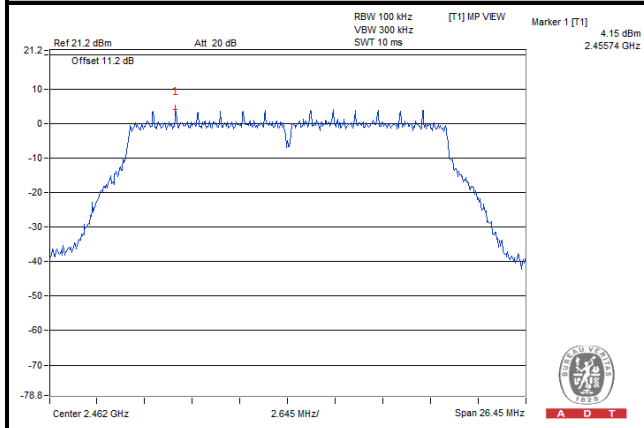

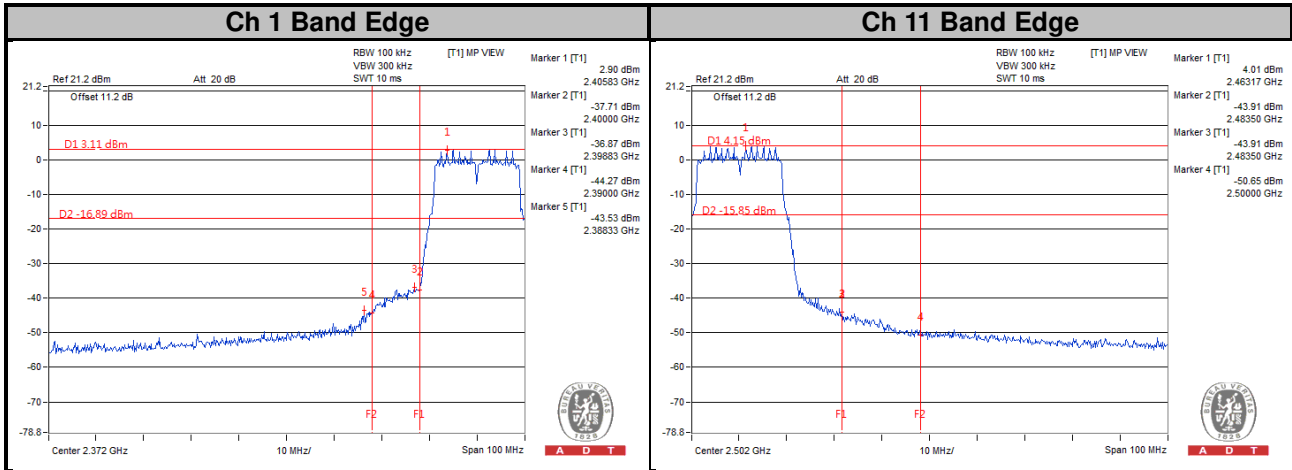

802.11n (HT40)

Ch 3

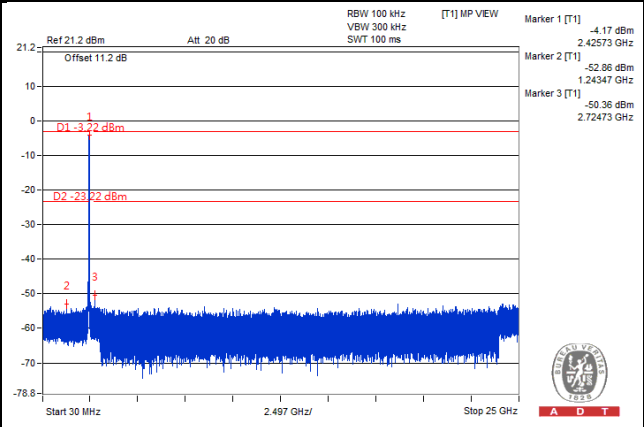
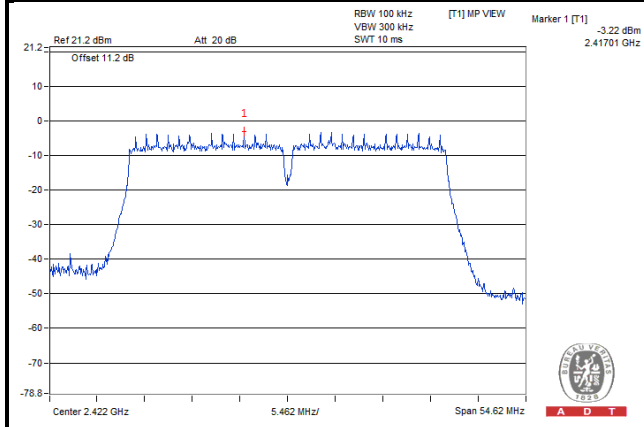

Ch 6

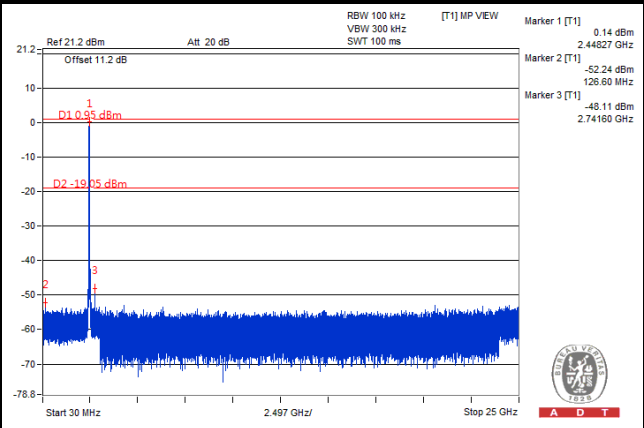
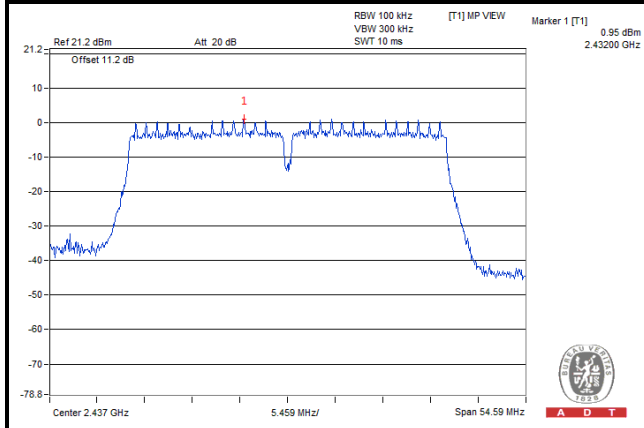

Ch 9

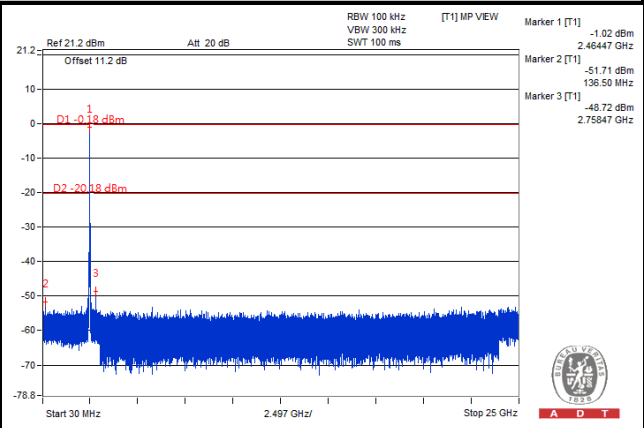
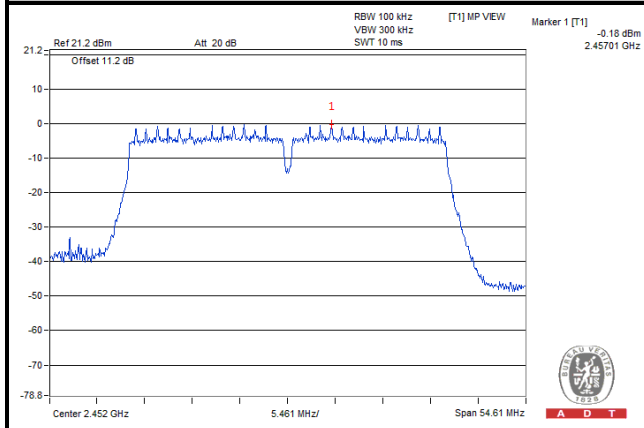

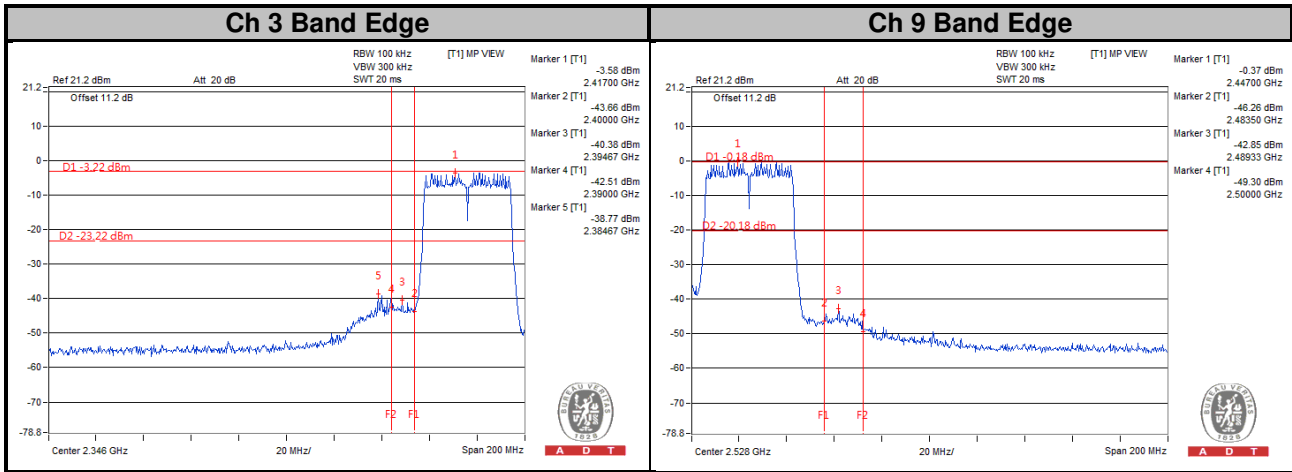



5 Pictures of Test Arrangements

Please refer to the attached file (Test Setup Photo).



A D T

Appendix – Information on the Testing Laboratories

We, Bureau Veritas Consumer Products Services (H.K.) Ltd., Taoyuan Branch, were founded in 1988 to provide our best service in EMC, Radio, Telecom and Safety consultation. Our laboratories are accredited and approved according to ISO/IEC 17025.

If you have any comments, please feel free to contact us at the following:

Linko EMC/RF Lab

Tel: 886-2-26052180

Fax: 886-2-26051924

Hsin Chu EMC/RF/Telecom Lab

Tel: 886-3-6668565

Fax: 886-3-6668323

Hwa Ya EMC/RF/Safety Lab

Tel: 886-3-3183232

Fax: 886-3-3270892

Email: service.adt@tw.bureauveritas.com

Web Site: www.bureauveritas-adt.com

The address and road map of all our labs can be found in our web site also.

--- END ---