



FCC TEST REPORT

REPORT NO.: RF141029C03

MODEL NO.: MR72-HW

FCC ID: UDX-60033010

RECEIVED: Oct. 07, 2014

TESTED: Oct. 07 ~ Dec. 10, 2014

ISSUED: Dec. 22, 2014

APPLICANT: Cisco Systems, Inc.

ADDRESS: 170 West Tasman Drive, San Jose, CA 95134

ISSUED BY: Bureau Veritas Consumer Products Services
(H.K.) Ltd., Taoyuan Branch

LAB ADDRESS: No. 47-2, 14th Ling, Chia Pau Vil., Lin Kou Dist.,
New Taipei City, Taiwan, R.O.C.

TEST LOCATION: No. 19, Hwa Ya 2nd Rd, Wen Hwa Tsuen, Kwei
Shan Hsiang, Taoyuan Hsien 333, Taiwan, R.O.C.

This report should not be used by the client to claim product certification, approval, or endorsement by TAF or any government agencies.



This report is for your exclusive use. Any copying or replication of this report to or for any other person or entity, or use of our name or trademark, is permitted only with our prior written permission. This report sets forth our findings solely with respect to the test samples identified herein. The results set forth in this report are not indicative or representative of the quality or characteristics of the lot from which a test sample was taken or any similar or identical product unless specifically and expressly noted. Our report includes all of the tests requested by you and the results thereof based upon the information that you provided to us. You have 60 days from date of issuance of this report to notify us of any material error or omission caused by our negligence, provided, however, that such notice shall be in writing and shall specifically address the issue you wish to raise. A failure to raise such issue within the prescribed time shall constitute your unqualified acceptance of the completeness of this report, the tests conducted and the correctness of the report contents. Unless specific mention, the uncertainty of measurement has been explicitly taken into account to declare the compliance or non-compliance to the specification.



A D T

TABLE OF CONTENTS

RELEASE CONTROL RECORD.....	4
1. CERTIFICATION	5
2. SUMMARY OF TEST RESULTS	6
2.1 MEASUREMENT UNCERTAINTY.....	6
3. GENERAL INFORMATION.....	7
3.1 GENERAL DESCRIPTION OF EUT	7
3.2 DESCRIPTION OF TEST MODES.....	9
3.2.1 TEST MODE APPLICABILITY AND TESTED CHANNEL DETAIL.....	10
3.3 DUTY CYCLE OF TEST SIGNAL.....	13
3.4 DESCRIPTION OF SUPPORT UNITS	17
3.4.1 CONFIGURATION OF SYSTEM UNDER TEST	17
3.5 GENERAL DESCRIPTION OF APPLIED STANDARDS	18
4. TEST TYPES AND RESULTS	19
4.1 RADIATED EMISSION AND BANDEDGE MEASUREMENT.....	19
4.1.1 LIMITS OF RADIATED EMISSION AND BANDEDGE MEASUREMENT	19
4.1.2 TEST INSTRUMENTS.....	20
4.1.3 TEST PROCEDURES	21
4.1.4 DEVIATION FROM TEST STANDARD	21
4.1.5 TEST SETUP.....	22
4.1.6 EUT OPERATING CONDITIONS	23
4.1.7 TEST RESULTS	24
4.2 CONDUCTED EMISSION MEASUREMENT	64
4.2.1 LIMITS OF CONDUCTED EMISSION MEASUREMENT.....	64
4.2.2 TEST INSTRUMENTS.....	64
4.2.3 TEST PROCEDURES	65
4.2.4 DEVIATION FROM TEST STANDARD	65
4.2.5 TEST SETUP.....	65
4.2.6 EUT OPERATING CONDITIONS	65
4.2.7 TEST RESULTS	66
4.3 6dB BANDWIDTH MEASUREMENT.....	74
4.3.1 LIMITS OF 6dB BANDWIDTH MEASUREMENT	74
4.3.2 TEST SETUP.....	74
4.3.3 TEST INSTRUMENTS.....	74
4.3.4 TEST PROCEDURE.....	74
4.3.5 DEVIATION FROM TEST STANDARD	74
4.3.6 EUT OPERATING CONDITIONS	74
4.3.7 TEST RESULTS	75
4.4 CONDUCTED OUTPUT POWER	83
4.4.1 LIMITS OF CONDUCTED OUTPUT POWER MEASUREMENT	83
4.4.2 TEST SETUP.....	83
4.4.3 TEST INSTRUMENTS.....	83
4.4.4 TEST PROCEDURES	83
4.4.5 DEVIATION FROM TEST STANDARD	84
4.4.6 EUT OPERATING CONDITIONS	84
4.4.7 TEST RESULTS	85
4.5 POWER SPECTRAL DENSITY MEASUREMENT.....	89
4.5.1 LIMITS OF POWER SPECTRAL DENSITY MEASUREMENT	89
4.5.2 TEST SETUP.....	89
4.5.3 TEST INSTRUMENTS.....	89
4.5.4 TEST PROCEDURE.....	89



A D T

4.5.5	DEVIATION FROM TEST STANDARD	89
4.5.6	EUT OPERATING CONDITION	89
4.5.7	TEST RESULTS	90
4.6	CONDUCTED OUT OF BAND EMISSION MEASUREMENT.....	98
4.6.1	LIMITS OF CONDUCTED OUT OF BAND EMISSION MEASUREMENT	98
4.6.2	TEST SETUP.....	98
4.6.3	TEST INSTRUMENTS.....	98
4.6.4	TEST PROCEDURE.....	99
4.6.5	DEVIATION FROM TEST STANDARD	99
4.6.6	EUT OPERATING CONDITION	99
4.6.7	TEST RESULTS	100
5.	PHOTOGRAPHS OF THE TEST CONFIGURATION.....	122
6.	INFORMATION ON THE TESTING LABORATORIES	123
7.	APPENDIX A – MODIFICATIONS RECORDERS FOR ENGINEERING CHANGES TO THE EUT BY THE LAB.....	124



A D T

RELEASE CONTROL RECORD

ISSUE NO.	REASON FOR CHANGE	DATE ISSUED
RF141029C03	Original release	Dec. 22, 2014



1. CERTIFICATION

PRODUCT: 802.11 abgn/ac device
MODEL NO.: MR72-HW
BRAND: Cisco
APPLICANT: Cisco Systems, Inc.
TESTED: Oct. 07 ~ Dec. 10, 2014
TEST SAMPLE: ENGINEERING SAMPLE
STANDARDS: FCC Part 15, Subpart C (Section 15.247)

The above equipment (model: MR72-HW) has been tested by **Bureau Veritas Consumer Products Services (H.K.) Ltd., Taoyuan Branch**, and found compliance with the requirement of the above standards. The test record, data evaluation & Equipment Under Test (EUT) configurations represented herein are true and accurate accounts of the measurements of the sample's EMC characteristics under the conditions specified in this report.

PREPARED BY :  , **DATE** : Dec. 22, 2014
Pettie Chen / Senior Specialist

APPROVED BY :  , **DATE** : Dec. 22, 2014
Ken Liu / Senior Manager

2. SUMMARY OF TEST RESULTS

The EUT has been tested according to the following specifications:

APPLIED STANDARD: FCC PART 15, SUBPART C (SECTION 15.247)			
STANDARD SECTION	TEST TYPE	RESULT	REMARK
15.207	AC Power Conducted Emission	PASS	Meet the requirement of limit. Minimum passing margin is -10.15dB at 23.14453MHz.
15.205 & 209	Radiated Emissions	PASS	Meet the requirement of limit. Minimum passing margin is -1.0dB at 163.89, 2390.0, 2483.50MHz.
15.247(d)	Band Edge Measurement	PASS	Meet the requirement of limit. Minimum passing margin is -1.0dB at 2483.50MHz.
15.247(d)	Antenna Port Emission	PASS	Meet the requirement of limit.
15.247(a)(2)	6dB bandwidth	PASS	Meet the requirement of limit.
15.247(b)	Conducted power	PASS	Meet the requirement of limit.
15.247(e)	Power Spectral Density	PASS	Meet the requirement of limit.
15.203	Antenna Requirement	PASS	For Dipole, Patch, Sector antenna: Antenna connector is N-Type. (The device is professionally installed). For PIFA antenna: No antenna connector is used.

2.1 MEASUREMENT UNCERTAINTY

Where relevant, the following measurement uncertainty levels have been estimated for tests performed on the EUT as specified in CISPR 16-4-2:

MEASUREMENT	FREQUENCY	UNCERTAINTY
Conducted emissions	150kHz~30MHz	2.44 dB
Radiated emissions	30MHz ~ 200MHz	3.86 dB
	200MHz ~1000MHz	3.87 dB
	1GHz ~ 18GHz	2.29 dB
	18GHz ~ 40GHz	2.29 dB

This uncertainty represents an expanded uncertainty expressed at approximately the 95% confidence level using a coverage factor of $k = 2$.



A D T

3. GENERAL INFORMATION

3.1 GENERAL DESCRIPTION OF EUT

EUT	802.11 abgn/ac device
MODEL NO.	MR72-HW
POWER SUPPLY	55Vdc (POE)
MODULATION TYPE	CCK, DQPSK, DBPSK for DSSS 64QAM, 16QAM, QPSK, BPSK for OFDM
MODULATION TECHNOLOGY	DSSS, OFDM
TRANSFER RATE	802.11b:11.0/ 5.5/ 2.0/ 1.0Mbps 802.11g: 54.0/ 48.0/ 36.0/ 24.0/ 18.0/ 12.0/ 9.0/ 6.0Mbps 802.11n: up to 300.0Mbps
OPERATING FREQUENCY	2412 ~ 2462MHz
NUMBER OF CHANNEL	11
OUTPUT POWER	Dipole Antenna: Radio 1: 627.191mW Patch Antenna: Radio 1: 604.913mW Sector Antenna: Radio 1: 315.606mW PIFA Antenna: Radio 3: 92.045mW
ANTENNA TYPE	Refer to note
ANTENNA CONNECTOR	Refer to note
DATA CABLE	NA
I/O PORTS	Refer to user's manual
ACCESSORY DEVICES	NA



NOTE:

- The EUT incorporates a MIMO function. Physically, the EUT provides two completed transmitters and two receivers.

MODULATION MODE	TX FUNCTION	REMARK
2.4GHz Band		
802.11b	1TX	Radio 3
	2TX	Radio 1
802.11g	1TX	Radio 3
	2TX	Radio 1
802.11n (20MHz)	1TX	Radio 3
	2TX	Radio 1
5GHz Band		
802.11a	1TX	Radio 3
	2TX	Radio 2
802.11n (20MHz)	1TX	Radio 3
	2TX	Radio 2
802.11n (40MHz)	1TX	Radio 3
	2TX	Radio 2
802.11ac (80MHz)	2TX	Radio 2

* The modulation and bandwidth are similar for 802.11n mode for 20MHz / 40MHz and 802.11ac mode for 20MHz / 40MHz, therefore investigated worst case to representative mode in test report. (Final test mode refer section 3.2.1)

- The EUT with follow antennas gain is listed as table below.

No.	Type	Connector	Gain(dBi)									Remark
			2400 MHz	2450 MHz	2500 MHz	4900 MHz	5150 MHz	5350 MHz	5475 MHz	5725 MHz	5875 MHz	
1	Dipole	N-Type	4			-						Radio 1 (WLAN)
			-			7						Radio 2 (WLAN)
	Patch	N-Type	8.1			-						Radio 1 (WLAN)
			-			7.1						Radio 2 (WLAN)
	Sector	N-Type	11			-						Radio 1 (WLAN)
			-			13						Radio 2 (WLAN)
2	PIFA	NA	5.4	5.7	4.7	6.0	6.1	5.7	6.2	5.8	6.5	Radio 3 (WLAN)
3	PIFA	NA	4.2			-						Radio 4 (BT LE)

* Antenna 1 of the EUT can choose dipole, patch or sector antenna.

- The EUT consumes power from the following POE. (for supply unit only)

POE	
BRAND	CISCO
MODEL	PD-9001GR/AT/AC
INPUT POWER	100-240Vac~0.67A, 50/60Hz
OUTPUT POWER	55Vdc, 0.6A

- The above EUT information is declared by manufacturer and for more detailed features description, please refer to the manufacturer's specifications or user's manual.



A D T

3.2 DESCRIPTION OF TEST MODES

11 channels are provided for 802.11b, 802.11g and 802.11n (20MHz):

CHANNEL	FREQUENCY	CHANNEL	FREQUENCY
1	2412MHz	7	2442MHz
2	2417MHz	8	2447MHz
3	2422MHz	9	2452MHz
4	2427MHz	10	2457MHz
5	2432MHz	11	2462MHz
6	2437MHz		

3.2.1 TEST MODE APPLICABILITY AND TESTED CHANNEL DETAIL

EUT CONFIGURE MODE	APPLICABLE TO				DESCRIPTION
	RE \geq 1G	RE<1G	PLC	APCM	
-	√	√	√	√	-

Where **RE \geq 1G**: Radiated Emission above 1GHz **RE<1G**: Radiated Emission below 1GHz
PLC: Power Line Conducted Emission **APCM**: Antenna Port Conducted Measurement

NOTE:

- The EUT had been pre-tested on the positioned of each 3 axis. The worst case was found when positioned on **X-plane (Dipole Antenna & Patch Antenna), Z-plane (PIFA Antenna & Sector Antenna)**.

RADIATED EMISSION TEST (ABOVE 1GHz):

- Pre-Scan has been conducted to determine the worst-case mode from all possible combinations between available modulations, data rates and antenna ports (if EUT with antenna diversity architecture).
- Following channel(s) was (were) selected for the final test as listed below.

EUT CONFIGURE MODE	MODE	AVAILABLE CHANNEL	TESTED CHANNEL	MODULATION TECHNOLOGY	MODULATION TYPE	DATA RATE (Mbps)	REMARK
-	802.11b	1 to 11	1, 6, 11	DSSS	DBPSK	1.0	2TX (Radio 1) (Dipole, Patch & Sector Antenna)
		1 to 11	1, 6, 11	DSSS	DBPSK	1.0	1TX (Radio 3) (PIFA Antenna)
	802.11g	1 to 11	1, 6, 11	OFDM	BPSK	6.0	2TX (Radio 1) (Dipole, Patch & Sector Antenna)
		1 to 11	1, 6, 11	OFDM	BPSK	6.0	1TX (Radio 3) (PIFA Antenna)
	802.11n (20MHz)	1 to 11	1, 6, 11	OFDM	BPSK	14.4	2TX (Radio 1) (Dipole, Patch & Sector Antenna)
		1 to 11	1, 6, 11	OFDM	BPSK	7.2	1TX (Radio 3) (PIFA Antenna)

RADIATED EMISSION TEST (BELOW 1GHz):

- Pre-Scan has been conducted to determine the worst-case mode from all possible combinations between available modulations, data rates and antenna ports (if EUT with antenna diversity architecture).
- Following channel(s) was (were) selected for the final test as listed below.

EUT CONFIGURE MODE	MODE	AVAILABLE CHANNEL	TESTED CHANNEL	MODULATION TECHNOLOGY	MODULATION TYPE	DATA RATE (Mbps)	REMARK
-	802.11b	1 to 11	1	DSSS	DBPSK	1.0	2TX (Radio 1) (Dipole Antenna)
	802.11b	1 to 11	6	DSSS	DBPSK	1.0	2TX (Radio 1) (Patch & Sector Antenna)
	802.11g	1 to 11	1	OFDM	BPSK	6.0	1TX (Radio 3) (PIFA Antenna)

POWER LINE CONDUCTED EMISSION TEST:

- Pre-Scan has been conducted to determine the worst-case mode from all possible combinations between available modulations, data rates and antenna ports (if EUT with antenna diversity architecture).
- Following channel(s) was (were) selected for the final test as listed below.

EUT CONFIGURE MODE	MODE	AVAILABLE CHANNEL	TESTED CHANNEL	MODULATION TECHNOLOGY	MODULATION TYPE	DATA RATE (Mbps)	REMARK
-	802.11b	1 to 11	1	DSSS	DBPSK	1.0	2TX (Radio 1) (Dipole Antenna)
	802.11b	1 to 11	6	DSSS	DBPSK	1.0	2TX (Radio 1) (Patch & Sector Antenna)
	802.11g	1 to 11	1	OFDM	BPSK	6.0	1TX (Radio 3) (PIFA Antenna)



BANDEDGE MEASUREMENT:

- Pre-Scan has been conducted to determine the worst-case mode from all possible combinations between available modulations, data rates and antenna ports (if EUT with antenna diversity architecture).
- Following channel(s) was (were) selected for the final test as listed below.

EUT CONFIGURE MODE	MODE	AVAILABLE CHANNEL	TESTED CHANNEL	MODULATION TECHNOLOGY	MODULATION TYPE	DATA RATE (Mbps)	REMARK
	802.11b	1 to 11	1, 11	DSSS	DBPSK	1.0	2TX (Radio 1) (Dipole, Patch & Sector Antenna)
		1 to 11	1, 11	DSSS	DBPSK	1.0	1TX (Radio 3) (PIFA Antenna)
	802.11g	1 to 11	1, 11	OFDM	BPSK	6.0	2TX (Radio 1) (Dipole, Patch & Sector Antenna)
		1 to 11	1, 11	OFDM	BPSK	6.0	1TX (Radio 3) (PIFA Antenna)
	802.11n (20MHz)	1 to 11	1, 11	OFDM	BPSK	14.4	2TX (Radio 1) (Dipole, Patch & Sector Antenna)
		1 to 11	1, 11	OFDM	BPSK	7.2	1TX (Radio 3) (PIFA Antenna)

ANTENNA PORT CONDUCTED MEASUREMENT:

- This item includes all test value of each mode, but only includes spectrum plot of worst value of each mode.
- Pre-Scan has been conducted to determine the worst-case mode from all possible combinations between available modulations, data rates and antenna ports (if EUT with antenna diversity architecture).
- Following channel(s) was (were) selected for the final test as listed below.

EUT CONFIGURE MODE	MODE	AVAILABLE CHANNEL	TESTED CHANNEL	MODULATION TECHNOLOGY	MODULATION TYPE	DATA RATE (Mbps)	REMARK
	802.11b	1 to 11	1, 6, 11	DSSS	DBPSK	1.0	2TX (Radio 1) (Dipole, Patch & Sector Antenna)
		1 to 11	1, 6, 11	DSSS	DBPSK	1.0	1TX (Radio 3) (PIFA Antenna)
	802.11g	1 to 11	1, 6, 11	OFDM	BPSK	6.0	2TX (Radio 1) (Dipole, Patch & Sector Antenna)
		1 to 11	1, 6, 11	OFDM	BPSK	6.0	1TX (Radio 3) (PIFA Antenna)
	802.11n (20MHz)	1 to 11	1, 6, 11	OFDM	BPSK	14.4	2TX (Radio 1) (Dipole, Patch & Sector Antenna)
		1 to 11	1, 6, 11	OFDM	BPSK	7.2	1TX (Radio 3) (PIFA Antenna)



A D T

TEST CONDITION:

APPLICABLE TO	ENVIRONMENTAL CONDITIONS	INPUT POWER	TESTED BY
RE≥1G	22deg. C, 72%RH 22deg. C, 70%RH	55Vdc	Nick Hsu Jones Chang
RE<1G	22deg. C, 65%RH	55Vdc	Jones Chang
PLC	22deg. C, 72%RH, 25deg. C, 70%RH	55Vdc	Nick Hsu Jones Chang
APCM	25deg. C, 60%RH	55Vdc	Nick Hsu

3.3 DUTY CYCLE OF TEST SIGNAL

Radio 1: Dipole antenna

802.11b: Duty cycle of test signal is 100 %, duty factor is not required.

802.11g, 802.11n (20MHz): Duty cycle is > 98%, duty factor is not required.

802.11g: Duty cycle = 2.06/2.08 = 0.99 > 98%, duty factor is not required.

802.11n (20MHz): Duty cycle = 1.918/1.946 = 0.986 > 98%, duty factor is not required.

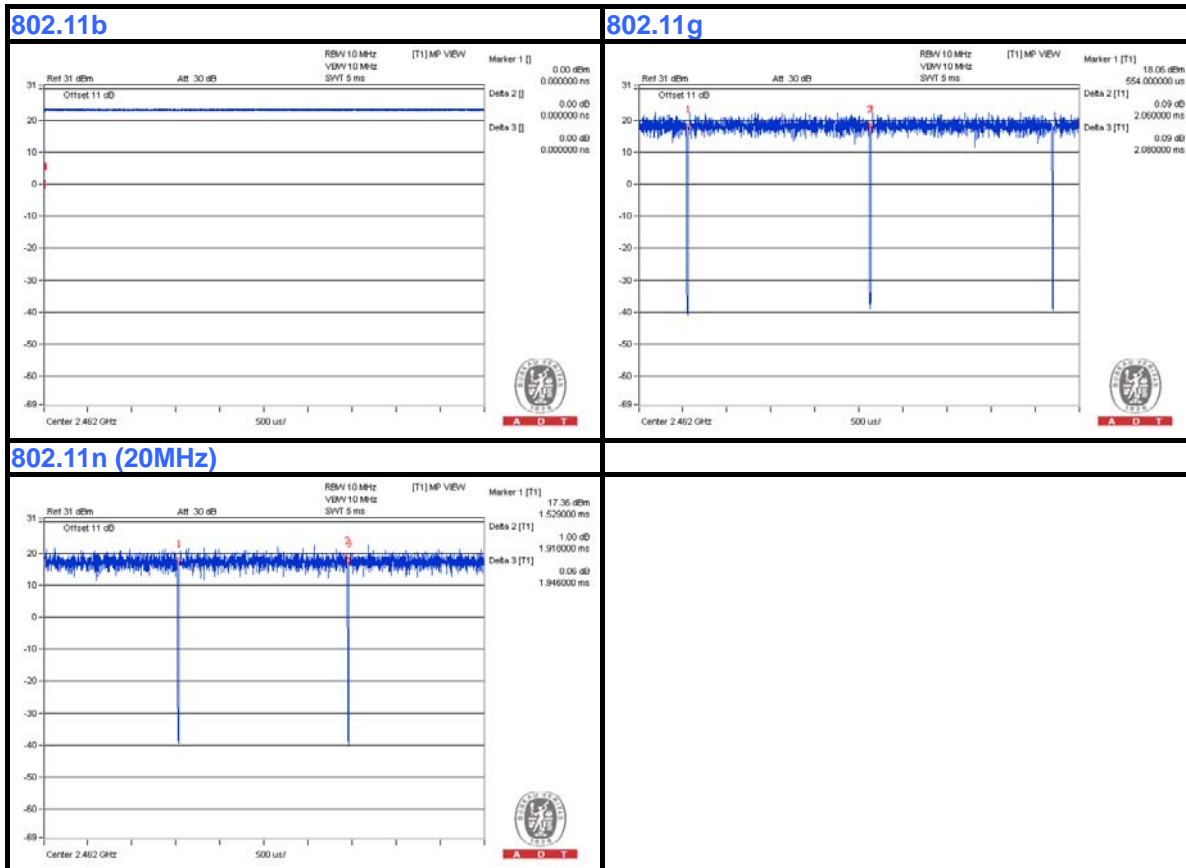



A D T

Radio 1: Patch antenna

802.11b: Duty cycle of test signal is 100 %, duty factor is not required.

802.11g, 802.11n (20MHz): Duty cycle is > 98%, duty factor is not required.

802.11g: Duty cycle = $2.063/2.085 = 0.989 > 98\%$, duty factor is not required.

802.11n (20MHz): Duty cycle = $1.919/1.939 = 0.999 > 98\%$, duty factor is not required.

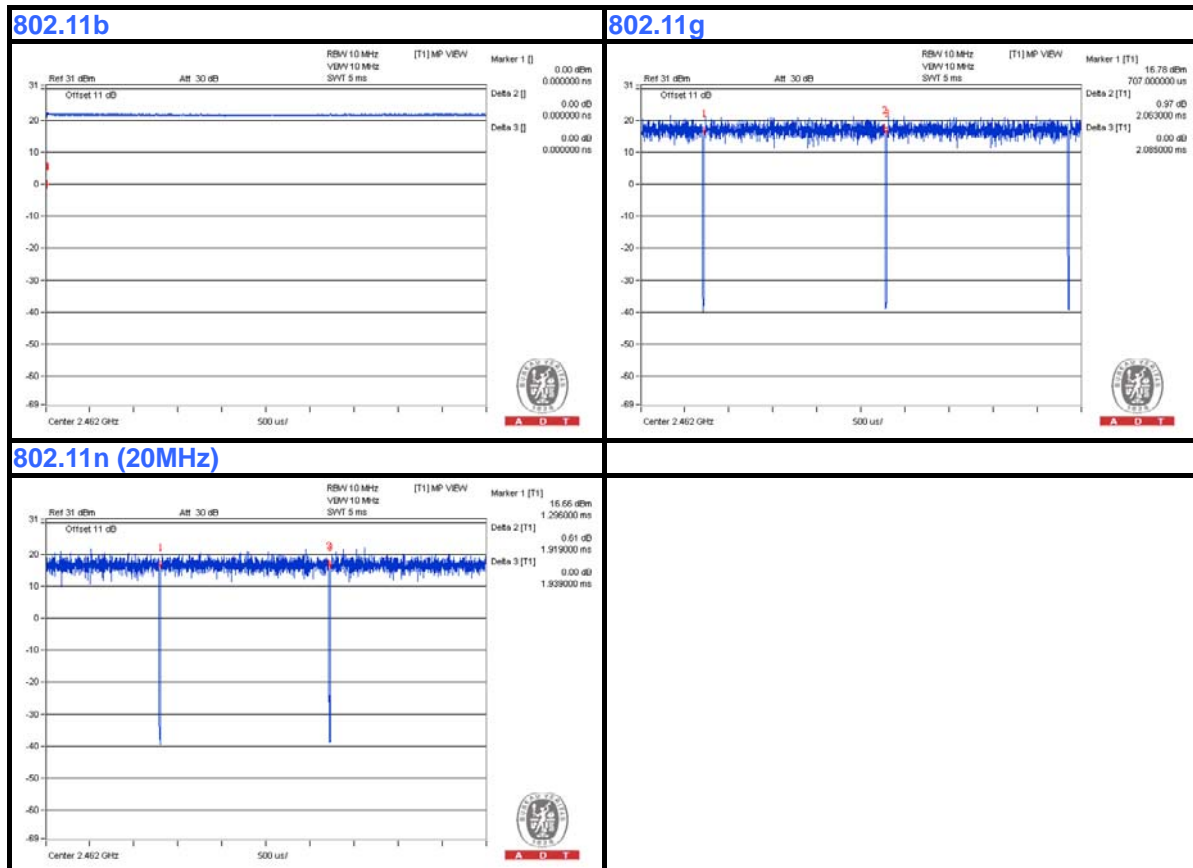

Radio 1: Sector antenna

802.11b: Duty cycle of test signal is 100 %, duty factor is not required.

802.11g, 802.11n (20MHz): Duty cycle is > 98%, duty factor is not required.

802.11g: Duty cycle = $2.063/2.085 = 0.989 > 98\%$, duty factor is not required.

802.11n (20MHz): Duty cycle = $1.918/1.946 = 0.987$, duty factor is not required.

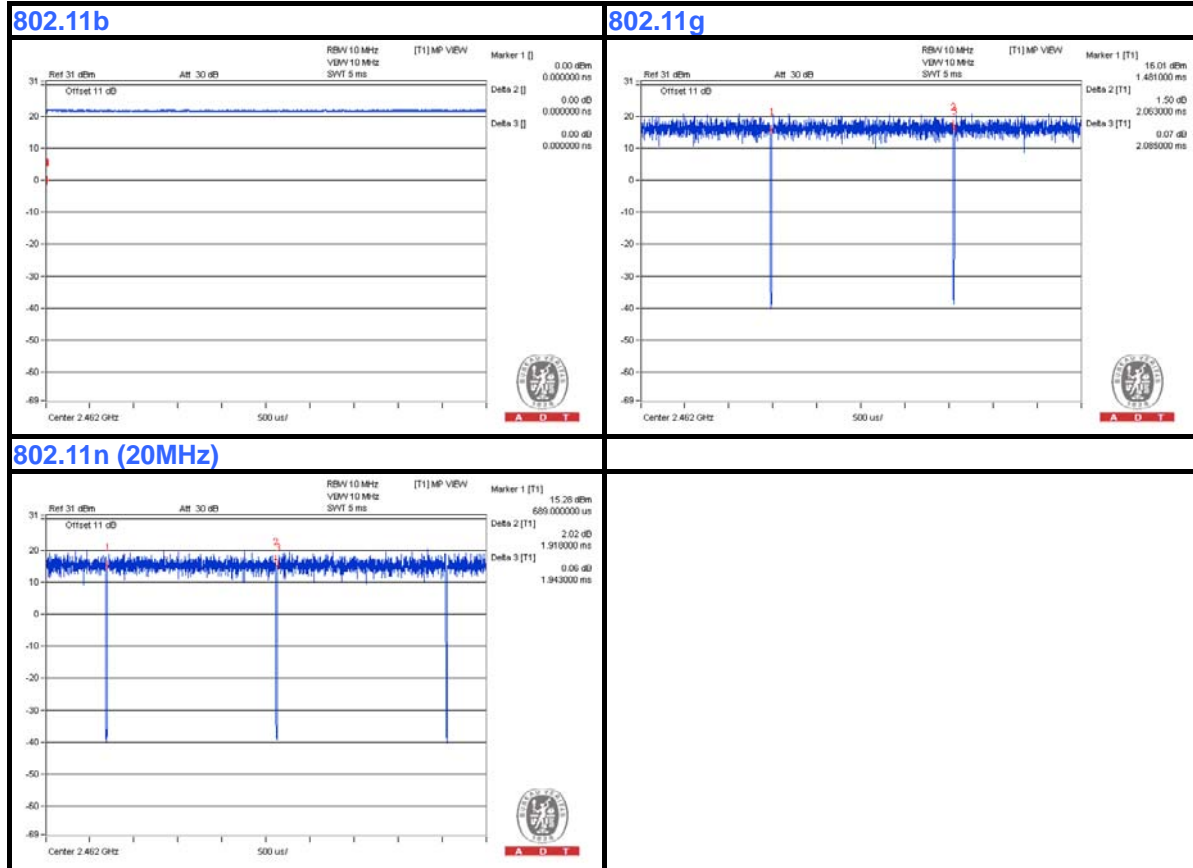



A D T

Radio 3: PIFA antenna

Duty cycle is > 98%, duty factor is not required.

802.11b: Duty cycle = $0.398/0.406 = 0.98 > 98\%$, duty factor is not required.

802.11g: Duty cycle = $2.062/2.093 = 0.985 > 98\%$, duty factor is not required.

802.11n (20MHz): Duty cycle = $1.906/1.943 = 0.981 > 98\%$, duty factor is not required.

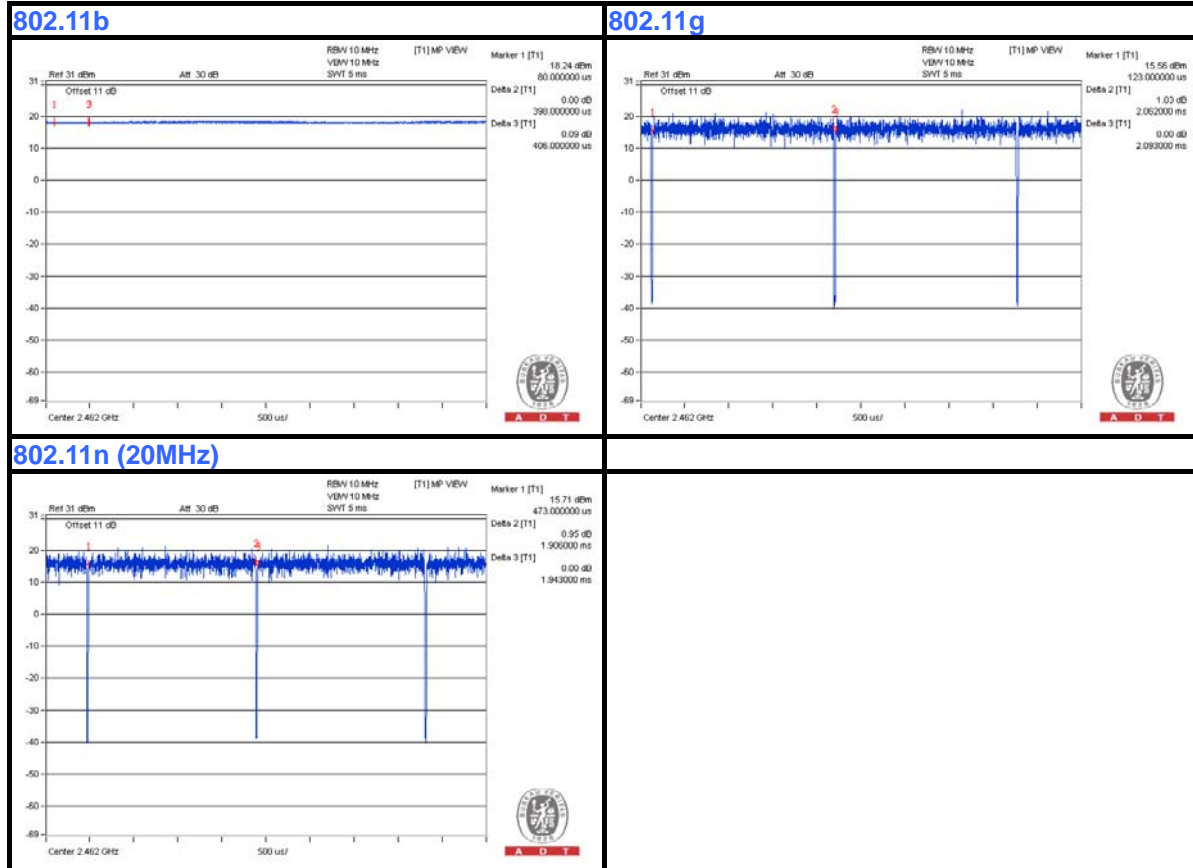

3.4 DESCRIPTION OF SUPPORT UNITS

The EUT has been tested as an independent unit together with other necessary accessories or support units. The following support units or accessories were used to form a representative test configuration during the tests.

NO.	PRODUCT	BRAND	MODEL NO.	SERIAL NO.	FCC ID
1	NOTEBOOK	DELL	D531	CN-0XM006-48643 -81U-2973	QDS-BRCM1020
2	POE	CISCO	PD-9001GR/AT/AC	NA	NA

NO.	SIGNAL CABLE DESCRIPTION OF THE ABOVE SUPPORT UNITS
1	1.8m LAN cable
2	10m LAN cable

NOTE:

1. All power cords of the above support units are non-shielded (1.8 m).
2. Item 1 acted as a communication partner to transfer data.
3. Item 2 was provided by the manufacturer.

3.4.1 CONFIGURATION OF SYSTEM UNDER TEST

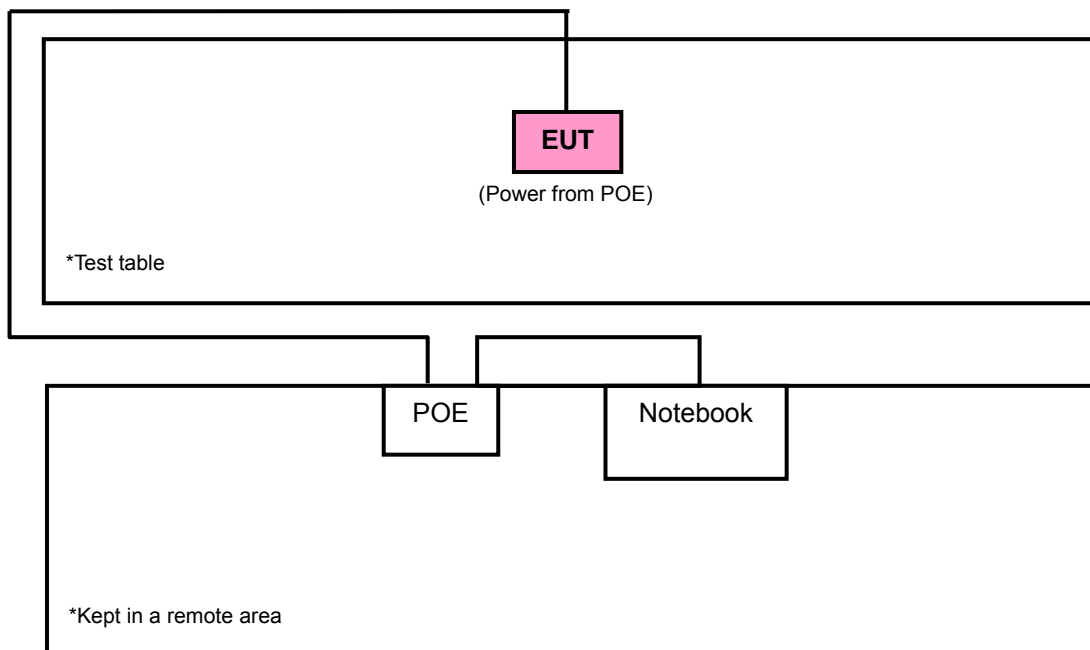

3.5 GENERAL DESCRIPTION OF APPLIED STANDARDS

The EUT is a RF Product. According to the specifications of the manufacturer, it must comply with the requirements of the following standards:

FCC Part 15, Subpart C (15.247)

558074 D01 DTS Meas Guidance v03r02

662911 D01 Multiple Transmitter Output v02r01

ANSI C63.10-2009

All test items have been performed and recorded as per the above standards.

NOTE: The EUT is also considered as a kind of computer peripheral, because the connection to computer is necessary for typical use. It has been verified to comply with the requirements of FCC Part 15, Subpart B, Class B (DoC). The test report has been issued separately.

4. TEST TYPES AND RESULTS

4.1 RADIATED EMISSION AND BANDEDGE MEASUREMENT

4.1.1 LIMITS OF RADIATED EMISSION AND BANDEDGE MEASUREMENT

Radiated emissions which fall in the restricted bands must comply with the radiated emission limits specified as below table. Other emissions shall be at least 30dB below the highest level of the desired power:

FREQUENCIES (MHz)	FIELD STRENGTH (microvolts/meter)	MEASUREMENT DISTANCE (meters)
0.009 ~ 0.490	2400/F(kHz)	300
0.490 ~ 1.705	24000/F(kHz)	30
1.705 ~ 30.0	30	30
30 ~ 88	100	3
88 ~ 216	150	3
216 ~ 960	200	3
Above 960	500	3

NOTE:

1. The lower limit shall apply at the transition frequencies.
2. Emission level (dBuV/m) = 20 log Emission level (uV/m).
3. For frequencies above 1000MHz, the field strength limits are based on average detector, however, the peak field strength of any emission shall not exceed the maximum permitted average limits, specified above by more than 30dB under any condition of modulation.



A D T

4.1.2 TEST INSTRUMENTS

DESCRIPTION & MANUFACTURER	MODEL NO.	SERIAL NO.	DATE OF CALIBRATION	DUE DATE OF CALIBRATION
Test Receiver ROHDE & SCHWARZ	ESIB7	100187	Jan. 02, 2014	Jan. 01, 2015
Spectrum Analyzer ROHDE & SCHWARZ	FSP40	100039	Mar. 03, 2014	Mar. 02, 2015
BILOG Antenna SCHWARZBECK	VULB9168	9168-160	Feb. 26, 2014	Feb. 25, 2015
HORN Antenna SCHWARZBECK	9120D	209	Aug. 25, 2014	Aug. 24, 2015
HORN Antenna SCHWARZBECK	BBHA 9170	BBHA9170241	Feb. 17, 2014	Feb. 16, 2015
Preamplifier Agilent	8447D	2944A10738	Oct.18, 2014	Oct. 17, 2015
Preamplifier Agilent	8449B	3008A01964	Aug. 22, 2014	Aug. 21, 2015
RF signal cable HUBER+SUHNNER	SUCOFLEX 104	214378/4	Aug. 22, 2014	Aug. 21, 2015
RF signal cable HUBER+SUHNNER	SUCOFLEX 106	12738/6 +309224/4	Aug. 22, 2014	Aug. 21, 2015
Software BV ADT	ADT_Radiated_ V7.6.15.9.4	NA	NA	NA
Antenna Tower inn-co GmbH	MA 4000	013303	NA	NA
Antenna Tower Controller inn-co GmbH	CO2000	017303	NA	NA
Turn Table BV ADT	TT100	TT93021703	NA	NA
Turn Table Controller BV ADT	SC100	SC93021703	NA	NA
High Speed Peak Power Meter	ML2495A	0824011	Jul. 26, 2014	Jul. 25, 2015
Power Sensor	MA2411B	0738171	Jul. 26, 2014	Jul. 25, 2015

- NOTE:**
1. The calibration interval of the above test instruments is 12 months and the calibrations are traceable to NML/ROC and NIST/USA.
 2. The test was performed in HwaYa Chamber 3.
 3. The horn antenna and HP preamplifier (model: 8449B) are used only for the measurement of emission frequency above 1GHz if tested.
 4. The FCC Site Registration No. is 988962.
 5. The IC Site Registration No. is IC 7450F-3.

4.1.3 TEST PROCEDURES

- a. The EUT was placed on the top of a rotating table 0.8 meters above the ground at a 3 meters semi-anechoic chamber. The table was rotated 360 degrees to determine the position of the highest radiation.
- b. The EUT was set 3 meters away from the interference-receiving antenna, which was mounted on the top of a variable-height antenna tower.
- c. Height of receiving antenna is varied from one meter to four meters above the ground to determine the maximum value of the field strength. Both horizontal and vertical polarizations of the antenna are set to make the measurement.
- d. For each suspected emission, the EUT was arranged to its worst case and then the antenna was tuned to heights from 1 meter to 4 meters and the rotatable table was turned from 0 degrees to 360 degrees to find the maximum reading.
- e. The test-receiver system was set to Peak Detect Function and Specified Bandwidth with Maximum Hold Mode.
- f. If the emission level of the EUT in peak mode was lower than the limit specified, then testing could be stopped and the peak values of the EUT would be reported. Otherwise the emissions would be re-tested one by one using peak, quasi-peak or average method as specified and then reported in a data sheet.

NOTE:

1. The resolution bandwidth and video bandwidth of test receiver/spectrum analyzer is 120kHz for Quasi-peak detection at frequency below 1GHz.
2. The resolution bandwidth of test receiver/spectrum analyzer is 1MHz and video bandwidth is 3MHz for Peak detection at frequency above 1GHz.
3. The resolution bandwidth of test receiver/spectrum analyzer is 1MHz and the video bandwidth is $\geq 1/T$ (Duty cycle < 98%) or 10Hz(Duty cycle > 98%) for Average detection (AV) at frequency above 1GHz.
4. All modes of operation were investigated and the worst-case emissions are reported.

4.1.4 DEVIATION FROM TEST STANDARD

No deviation.

4.1.5 TEST SETUP

Frequency range 30MHz~1GHz

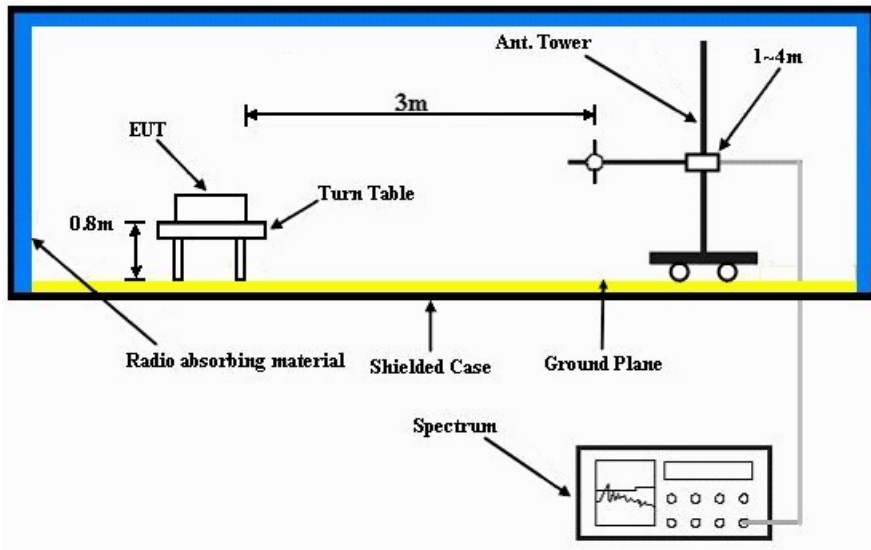

Frequency range above 1GHz

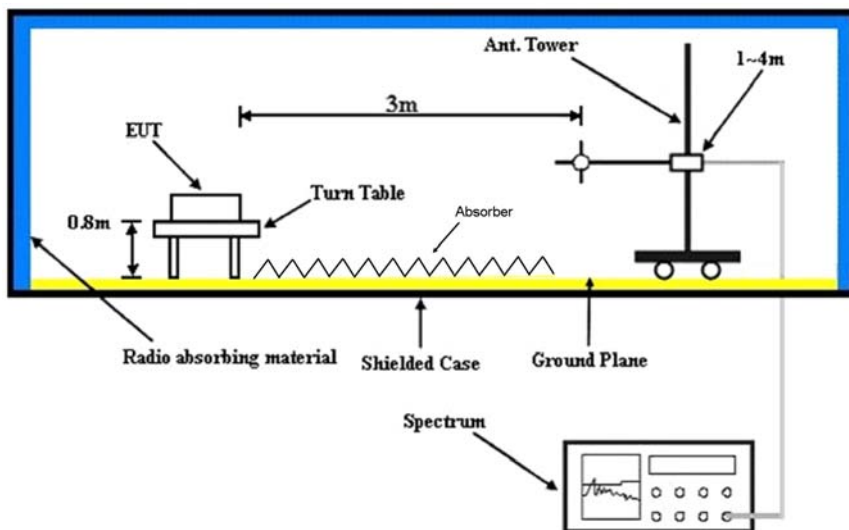

For the actual test configuration, please refer to the attached file (Test Setup Photo).

4.1.6 EUT OPERATING CONDITIONS

- a. Placed the EUT on the testing table.
- b. Prepared a notebook to act as communication partner and placed it outside of testing area.
- c. The communication partner connected with EUT via a RJ45 cable and run a test program (provided by manufacturer) to enable EUT under transmission condition continuously at specific channel frequency.
- d. The communication partner sent data to EUT by command "PING".



A D T

4.1.7 TEST RESULTS

ABOVE 1GHz DATA :

Radio 1: Dipole antenna

802.11b

CHANNEL	TX Channel 1	DETECTOR FUNCTION	Peak (PK)
FREQUENCY RANGE	1GHz ~ 25GHz		Average (AV)

ANTENNA POLARITY & TEST DISTANCE: HORIZONTAL AT 3 M

NO.	FREQ. (MHz)	EMISSION LEVEL (dBuV/m)	LIMIT (dBuV/m)	MARGIN (dB)	ANTENNA HEIGHT (m)	TABLE ANGLE (Degree)	RAW VALUE (dBuV)	CORRECTION FACTOR (dB/m)
1	2390.00	62.7 PK	74.0	-11.3	1.29 H	275	29.50	33.20
2	2390.00	52.3 AV	54.0	-1.7	1.29 H	275	19.10	33.20
3	*2412.00	120.9 PK			1.35 H	282	87.60	33.30
4	*2412.00	117.0 AV			1.35 H	282	83.70	33.30
5	4824.00	48.2 PK	74.0	-25.8	1.22 H	83	42.10	6.10
6	4824.00	36.0 AV	54.0	-18.0	1.22 H	83	29.90	6.10
7	5000.00	53.9 PK	74.0	-20.1	1.69 H	120	47.30	6.60
8	5000.00	48.9 AV	54.0	-5.1	1.69 H	120	42.30	6.60

ANTENNA POLARITY & TEST DISTANCE: VERTICAL AT 3 M

NO.	FREQ. (MHz)	EMISSION LEVEL (dBuV/m)	LIMIT (dBuV/m)	MARGIN (dB)	ANTENNA HEIGHT (m)	TABLE ANGLE (Degree)	RAW VALUE (dBuV)	CORRECTION FACTOR (dB/m)
1	2390.00	57.3 PK	74.0	-16.7	1.12 V	152	24.10	33.20
2	2390.00	46.1 AV	54.0	-7.9	1.12 V	152	12.90	33.20
3	*2412.00	107.4 PK			1.00 V	304	74.10	33.30
4	*2412.00	103.4 AV			1.00 V	304	70.10	33.30
5	4824.00	49.3 PK	74.0	-24.7	1.56 V	133	43.20	6.10
6	4824.00	36.7 AV	54.0	-17.3	1.56 V	133	30.60	6.10
7	5000.00	55.5 PK	74.0	-18.5	1.13 V	22	48.90	6.60
8	5000.00	50.6 AV	54.0	-3.4	1.13 V	22	44.00	6.60

REMARKS:

1. Emission Level(dBuV/m) = Raw Value(dBuV) + Correction Factor(dB/m)
2. Correction Factor(dB/m) = Antenna Factor(dB/m) + Cable Factor(dB)
3. The other emission levels were very low against the limit.
4. Margin value = Emission Level – Limit value
5. " * ": Fundamental frequency.



A D T

CHANNEL	TX Channel 6	DETECTOR FUNCTION	Peak (PK)
FREQUENCY RANGE	1GHz ~ 25GHz		Average (AV)

ANTENNA POLARITY & TEST DISTANCE: HORIZONTAL AT 3 M

NO.	FREQ. (MHz)	EMISSION LEVEL (dBuV/m)	LIMIT (dBuV/m)	MARGIN (dB)	ANTENNA HEIGHT (m)	TABLE ANGLE (Degree)	RAW VALUE (dBuV)	CORRECTION FACTOR (dB/m)
1	*2437.00	125.1 PK			1.30 H	278	91.70	33.40
2	*2437.00	121.3 AV			1.30 H	278	87.90	33.40
3	2483.50	63.9 PK	74.0	-10.1	1.28 H	282	30.50	33.40
4	2483.50	52.3 AV	54.0	-1.7	1.28 H	282	18.90	33.40
5	4874.00	49.4 PK	74.0	-24.6	1.00 H	115	43.20	6.20
6	4874.00	37.2 AV	54.0	-16.8	1.00 H	115	31.00	6.20
7	5000.00	54.4 PK	74.0	-19.6	1.57 H	111	47.80	6.60
8	5000.00	49.4 AV	54.0	-4.6	1.57 H	111	42.80	6.60

ANTENNA POLARITY & TEST DISTANCE: VERTICAL AT 3 M

NO.	FREQ. (MHz)	EMISSION LEVEL (dBuV/m)	LIMIT (dBuV/m)	MARGIN (dB)	ANTENNA HEIGHT (m)	TABLE ANGLE (Degree)	RAW VALUE (dBuV)	CORRECTION FACTOR (dB/m)
1	*2437.00	111.7 PK			1.00 V	305	78.30	33.40
2	*2437.00	108.4 AV			1.00 V	305	75.00	33.40
3	2483.50	57.8 PK	74.0	-16.2	1.08 V	173	24.40	33.40
4	2483.50	46.6 AV	54.0	-7.4	1.08 V	173	13.20	33.40
5	4874.00	51.0 PK	74.0	-23.0	1.59 V	107	44.80	6.20
6	4874.00	40.1 AV	54.0	-13.9	1.59 V	107	33.90	6.20
7	5000.00	55.5 PK	74.0	-18.5	1.14 V	24	48.90	6.60
8	5000.00	50.8 AV	54.0	-3.2	1.14 V	24	44.20	6.60

REMARKS:

1. Emission Level(dBuV/m) = Raw Value(dBuV) + Correction Factor(dB/m)
2. Correction Factor(dB/m) = Antenna Factor(dB/m) + Cable Factor(dB)
3. The other emission levels were very low against the limit.
4. Margin value = Emission Level – Limit value
5. " * ": Fundamental frequency.



CHANNEL	TX Channel 11	DETECTOR FUNCTION	Peak (PK)
FREQUENCY RANGE	1GHz ~ 25GHz		Average (AV)

ANTENNA POLARITY & TEST DISTANCE: HORIZONTAL AT 3 M

NO.	FREQ. (MHz)	EMISSION LEVEL (dBuV/m)	LIMIT (dBuV/m)	MARGIN (dB)	ANTENNA HEIGHT (m)	TABLE ANGLE (Degree)	RAW VALUE (dBuV)	CORRECTION FACTOR (dB/m)
1	*2462.00	120.0 PK			1.30 H	273	86.70	33.30
2	*2462.00	116.3 AV			1.30 H	273	83.00	33.30
3	2483.50	63.0 PK	74.0	-11.0	1.30 H	281	29.60	33.40
4	2483.50	52.8 AV	54.0	-1.2	1.30 H	281	19.40	33.40
5	4924.00	49.1 PK	74.0	-24.9	1.46 H	126	42.80	6.30
6	4924.00	36.8 AV	54.0	-17.2	1.46 H	126	30.50	6.30
7	5000.00	54.9 PK	74.0	-19.1	1.78 H	113	48.30	6.60
8	5000.00	49.7 AV	54.0	-4.3	1.78 H	113	43.10	6.60

ANTENNA POLARITY & TEST DISTANCE: VERTICAL AT 3 M

NO.	FREQ. (MHz)	EMISSION LEVEL (dBuV/m)	LIMIT (dBuV/m)	MARGIN (dB)	ANTENNA HEIGHT (m)	TABLE ANGLE (Degree)	RAW VALUE (dBuV)	CORRECTION FACTOR (dB/m)
1	*2462.00	107.7 PK			1.00 V	304	74.40	33.30
2	*2462.00	104.2 AV			1.00 V	304	70.90	33.30
3	2483.50	57.7 PK	74.0	-16.3	1.06 V	146	24.30	33.40
4	2483.50	46.7 AV	54.0	-7.3	1.06 V	146	13.30	33.40
5	4924.00	50.5 PK	74.0	-23.5	1.25 V	139	44.20	6.30
6	4924.00	38.0 AV	54.0	-16.0	1.25 V	139	31.70	6.30
7	5000.00	55.2 PK	74.0	-18.8	1.13 V	24	48.60	6.60
8	5000.00	50.8 AV	54.0	-3.2	1.13 V	24	44.20	6.60

REMARKS:

1. Emission Level(dBuV/m) = Raw Value(dBuV) + Correction Factor(dB/m)
2. Correction Factor(dB/m) = Antenna Factor(dB/m) + Cable Factor(dB)
3. The other emission levels were very low against the limit.
4. Margin value = Emission Level – Limit value
5. " * ": Fundamental frequency.



A D T

802.11g

CHANNEL	TX Channel 1	DETECTOR FUNCTION	Peak (PK)
FREQUENCY RANGE	1GHz ~ 25GHz		Average (AV)

ANTENNA POLARITY & TEST DISTANCE: HORIZONTAL AT 3 M

NO.	FREQ. (MHz)	EMISSION LEVEL (dBuV/m)	LIMIT (dBuV/m)	MARGIN (dB)	ANTENNA HEIGHT (m)	TABLE ANGLE (Degree)	RAW VALUE (dBuV)	CORRECTION FACTOR (dB/m)
1	2390.00	67.4 PK	74.0	-6.6	1.36 H	63	34.20	33.20
2	2390.00	52.8 AV	54.0	-1.2	1.36 H	63	19.60	33.20
3	*2412.00	115.2 PK			1.31 H	67	81.90	33.30
4	*2412.00	105.7 AV			1.31 H	67	72.40	33.30
5	4824.00	48.5 PK	74.0	-25.5	1.19 H	178	42.40	6.10
6	4824.00	35.1 AV	54.0	-18.9	1.19 H	178	29.00	6.10
7	5000.00	54.1 PK	74.0	-19.9	1.70 H	119	47.50	6.60
8	5000.00	49.2 AV	54.0	-4.8	1.70 H	119	42.60	6.60

ANTENNA POLARITY & TEST DISTANCE: VERTICAL AT 3 M

NO.	FREQ. (MHz)	EMISSION LEVEL (dBuV/m)	LIMIT (dBuV/m)	MARGIN (dB)	ANTENNA HEIGHT (m)	TABLE ANGLE (Degree)	RAW VALUE (dBuV)	CORRECTION FACTOR (dB/m)
1	2390.00	57.3 PK	74.0	-16.7	1.20 V	255	24.10	33.20
2	2390.00	46.4 AV	54.0	-7.6	1.20 V	255	13.20	33.20
3	*2412.00	101.8 PK			1.00 V	140	68.50	33.30
4	*2412.00	93.0 AV			1.00 V	140	59.70	33.30
5	4824.00	48.3 PK	74.0	-25.7	1.06 V	64	42.20	6.10
6	4824.00	35.1 AV	54.0	-18.9	1.06 V	64	29.00	6.10
7	5000.00	54.5 PK	74.0	-19.5	1.13 V	25	47.90	6.60
8	5000.00	50.4 AV	54.0	-3.6	1.13 V	25	43.80	6.60

REMARKS:

1. Emission Level(dBuV/m) = Raw Value(dBuV) + Correction Factor(dB/m)
2. Correction Factor(dB/m) = Antenna Factor(dB/m) + Cable Factor(dB)
3. The other emission levels were very low against the limit.
4. Margin value = Emission Level – Limit value
5. " * ": Fundamental frequency.



A D T

CHANNEL	TX Channel 6	DETECTOR FUNCTION	Peak (PK)
FREQUENCY RANGE	1GHz ~ 25GHz		Average (AV)

ANTENNA POLARITY & TEST DISTANCE: HORIZONTAL AT 3 M

NO.	FREQ. (MHz)	EMISSION LEVEL (dBuV/m)	LIMIT (dBuV/m)	MARGIN (dB)	ANTENNA HEIGHT (m)	TABLE ANGLE (Degree)	RAW VALUE (dBuV)	CORRECTION FACTOR (dB/m)
1	2390.00	68.9 PK	74.0	-5.1	1.32 H	69	35.70	33.20
2	2390.00	52.5 AV	54.0	-1.5	1.32 H	69	19.30	33.20
3	*2437.00	121.7 PK			1.30 H	60	88.30	33.40
4	*2437.00	112.4 AV			1.30 H	60	79.00	33.40
5	2483.50	69.4 PK	74.0	-4.6	1.34 H	87	36.00	33.40
6	2483.50	52.9 AV	54.0	-1.1	1.34 H	87	19.50	33.40
7	4874.00	47.8 PK	74.0	-26.2	1.22 H	133	41.60	6.20
8	4874.00	35.3 AV	54.0	-18.7	1.22 H	133	29.10	6.20
9	5000.00	54.2 PK	74.0	-19.8	1.57 H	112	47.60	6.60
10	5000.00	49.1 AV	54.0	-4.9	1.57 H	112	42.50	6.60

ANTENNA POLARITY & TEST DISTANCE: VERTICAL AT 3 M

NO.	FREQ. (MHz)	EMISSION LEVEL (dBuV/m)	LIMIT (dBuV/m)	MARGIN (dB)	ANTENNA HEIGHT (m)	TABLE ANGLE (Degree)	RAW VALUE (dBuV)	CORRECTION FACTOR (dB/m)
1	2390.00	57.0 PK	74.0	-17.0	1.05 V	301	23.80	33.20
2	2390.00	46.1 AV	54.0	-7.9	1.05 V	301	12.90	33.20
3	*2437.00	109.1 PK			1.00 V	305	75.70	33.40
4	*2437.00	99.9 AV			1.00 V	305	66.50	33.40
5	2483.50	58.2 PK	74.0	-15.8	1.14 V	275	24.80	33.40
6	2483.50	46.3 AV	54.0	-7.7	1.14 V	275	12.90	33.40
7	4874.00	48.2 PK	74.0	-25.8	1.02 V	84	42.00	6.20
8	4874.00	35.3 AV	54.0	-18.7	1.02 V	84	29.10	6.20
9	5000.00	54.7 PK	74.0	-19.3	1.13 V	22	48.10	6.60
10	5000.00	50.3 AV	54.0	-3.7	1.13 V	22	43.70	6.60

REMARKS:

1. Emission Level(dBuV/m) = Raw Value(dBuV) + Correction Factor(dB/m)
2. Correction Factor(dB/m) = Antenna Factor(dB/m) + Cable Factor(dB)
3. The other emission levels were very low against the limit.
4. Margin value = Emission Level – Limit value
5. " * ": Fundamental frequency.



A D T

CHANNEL	TX Channel 11	DETECTOR FUNCTION	Peak (PK)
FREQUENCY RANGE	1GHz ~ 25GHz		Average (AV)

ANTENNA POLARITY & TEST DISTANCE: HORIZONTAL AT 3 M

NO.	FREQ. (MHz)	EMISSION LEVEL (dBuV/m)	LIMIT (dBuV/m)	MARGIN (dB)	ANTENNA HEIGHT (m)	TABLE ANGLE (Degree)	RAW VALUE (dBuV)	CORRECTION FACTOR (dB/m)
1	*2462.00	117.0 PK			1.28 H	66	83.70	33.30
2	*2462.00	107.3 AV			1.28 H	66	74.00	33.30
3	2483.50	71.5 PK	74.0	-2.5	2.03 H	86	38.10	33.40
4	2483.50	52.2 AV	54.0	-1.8	2.03 H	86	18.80	33.40
5	4924.00	48.7 PK	74.0	-25.3	1.15 H	57	42.40	6.30
6	4924.00	35.9 AV	54.0	-18.1	1.15 H	57	29.60	6.30
7	5000.00	53.9 PK	74.0	-20.1	1.69 H	120	47.30	6.60
8	5000.00	48.8 AV	54.0	-5.2	1.69 H	120	42.20	6.60

ANTENNA POLARITY & TEST DISTANCE: VERTICAL AT 3 M

NO.	FREQ. (MHz)	EMISSION LEVEL (dBuV/m)	LIMIT (dBuV/m)	MARGIN (dB)	ANTENNA HEIGHT (m)	TABLE ANGLE (Degree)	RAW VALUE (dBuV)	CORRECTION FACTOR (dB/m)
1	*2462.00	105.4 PK			1.00 V	304	72.10	33.30
2	*2462.00	96.2 AV			1.00 V	304	62.90	33.30
3	2483.50	59.6 PK	74.0	-14.4	1.00 V	301	26.20	33.40
4	2483.50	46.9 AV	54.0	-7.1	1.00 V	301	13.50	33.40
5	4924.00	48.9 PK	74.0	-25.1	1.57 V	49	42.60	6.30
6	4924.00	35.8 AV	54.0	-18.2	1.57 V	49	29.50	6.30
7	5000.00	55.1 PK	74.0	-18.9	1.67 V	126	48.50	6.60
8	5000.00	50.8 AV	54.0	-3.2	1.67 V	126	44.20	6.60

REMARKS:

1. Emission Level(dBuV/m) = Raw Value(dBuV) + Correction Factor(dB/m)
2. Correction Factor(dB/m) = Antenna Factor(dB/m) + Cable Factor(dB)
3. The other emission levels were very low against the limit.
4. Margin value = Emission Level – Limit value
5. " * ": Fundamental frequency.



A D T

802.11n (20MHz)

CHANNEL	TX Channel 1	DETECTOR FUNCTION	Peak (PK)
FREQUENCY RANGE	1GHz ~ 25GHz		Average (AV)

ANTENNA POLARITY & TEST DISTANCE: HORIZONTAL AT 3 M

NO.	FREQ. (MHz)	EMISSION LEVEL (dBuV/m)	LIMIT (dBuV/m)	MARGIN (dB)	ANTENNA HEIGHT (m)	TABLE ANGLE (Degree)	RAW VALUE (dBuV)	CORRECTION FACTOR (dB/m)
1	2390.00	66.5 PK	74.0	-7.5	1.33 H	68	33.30	33.20
2	2390.00	52.6 AV	54.0	-1.4	1.33 H	68	19.40	33.20
3	*2412.00	112.6 PK			1.31 H	279	79.30	33.30
4	*2412.00	101.9 AV			1.31 H	279	68.60	33.30
5	4824.00	49.0 PK	74.0	-25.0	1.18 H	236	42.90	6.10
6	4824.00	35.2 AV	54.0	-18.8	1.18 H	236	29.10	6.10
7	5000.00	54.5 PK	74.0	-19.5	1.67 H	114	47.90	6.60
8	5000.00	49.6 AV	54.0	-4.4	1.67 H	114	43.00	6.60

ANTENNA POLARITY & TEST DISTANCE: VERTICAL AT 3 M

NO.	FREQ. (MHz)	EMISSION LEVEL (dBuV/m)	LIMIT (dBuV/m)	MARGIN (dB)	ANTENNA HEIGHT (m)	TABLE ANGLE (Degree)	RAW VALUE (dBuV)	CORRECTION FACTOR (dB/m)
1	2390.00	57.1 PK	74.0	-16.9	1.21 V	152	23.90	33.20
2	2390.00	46.4 AV	54.0	-7.6	1.21 V	152	13.20	33.20
3	*2412.00	100.6 PK			1.01 V	142	67.30	33.30
4	*2412.00	90.2 AV			1.01 V	142	56.90	33.30
5	4824.00	48.6 PK	74.0	-25.4	1.67 V	54	42.50	6.10
6	4824.00	35.0 AV	54.0	-19.0	1.67 V	54	28.90	6.10
7	5000.00	55.9 PK	74.0	-18.1	2.04 V	128	49.30	6.60
8	5000.00	50.6 AV	54.0	-3.4	2.04 V	128	44.00	6.60

REMARKS:

1. Emission Level(dBuV/m) = Raw Value(dBuV) + Correction Factor(dB/m)
2. Correction Factor(dB/m) = Antenna Factor(dB/m) + Cable Factor(dB)
3. The other emission levels were very low against the limit.
4. Margin value = Emission Level – Limit value
5. " * ": Fundamental frequency.



A D T

CHANNEL	TX Channel 6	DETECTOR FUNCTION	Peak (PK)
FREQUENCY RANGE	1GHz ~ 25GHz		Average (AV)

ANTENNA POLARITY & TEST DISTANCE: HORIZONTAL AT 3 M

NO.	FREQ. (MHz)	EMISSION LEVEL (dBuV/m)	LIMIT (dBuV/m)	MARGIN (dB)	ANTENNA HEIGHT (m)	TABLE ANGLE (Degree)	RAW VALUE (dBuV)	CORRECTION FACTOR (dB/m)
1	*2437.00	121.1 PK			1.34 H	282	87.70	33.40
2	*2437.00	109.6 AV			1.34 H	282	76.20	33.40
3	2483.50	66.8 PK	74.0	-7.2	1.25 H	67	33.40	33.40
4	2483.50	52.6 AV	54.0	-1.4	1.25 H	67	19.20	33.40
5	4874.00	48.3 PK	74.0	-25.7	1.18 H	185	42.10	6.20
6	4874.00	35.5 AV	54.0	-18.5	1.18 H	185	29.30	6.20
7	5000.00	54.8 PK	74.0	-19.2	1.66 H	115	48.20	6.60
8	5000.00	49.8 AV	54.0	-4.2	1.66 H	115	43.20	6.60

ANTENNA POLARITY & TEST DISTANCE: VERTICAL AT 3 M

NO.	FREQ. (MHz)	EMISSION LEVEL (dBuV/m)	LIMIT (dBuV/m)	MARGIN (dB)	ANTENNA HEIGHT (m)	TABLE ANGLE (Degree)	RAW VALUE (dBuV)	CORRECTION FACTOR (dB/m)
1	*2437.00	109.0 PK			1.00 V	305	75.60	33.40
2	*2437.00	98.2 AV			1.00 V	305	64.80	33.40
3	2483.50	58.3 PK	74.0	-15.7	1.00 V	302	24.90	33.40
4	2483.50	47.0 AV	54.0	-7.0	1.00 V	302	13.60	33.40
5	4874.00	48.6 PK	74.0	-25.4	1.19 V	175	42.40	6.20
6	4874.00	35.6 AV	54.0	-18.4	1.19 V	175	29.40	6.20
7	5000.00	55.3 PK	74.0	-18.7	2.00 V	125	48.70	6.60
8	5000.00	51.0 AV	54.0	-3.0	2.00 V	125	44.40	6.60

REMARKS:

1. Emission Level(dBuV/m) = Raw Value(dBuV) + Correction Factor(dB/m)
2. Correction Factor(dB/m) = Antenna Factor(dB/m) + Cable Factor(dB)
3. The other emission levels were very low against the limit.
4. Margin value = Emission Level – Limit value
5. " * ": Fundamental frequency.



A D T

CHANNEL	TX Channel 11	DETECTOR FUNCTION	Peak (PK)
FREQUENCY RANGE	1GHz ~ 25GHz		Average (AV)

ANTENNA POLARITY & TEST DISTANCE: HORIZONTAL AT 3 M

NO.	FREQ. (MHz)	EMISSION LEVEL (dBuV/m)	LIMIT (dBuV/m)	MARGIN (dB)	ANTENNA HEIGHT (m)	TABLE ANGLE (Degree)	RAW VALUE (dBuV)	CORRECTION FACTOR (dB/m)
1	*2462.00	115.1 PK			1.26 H	273	81.80	33.30
2	*2462.00	103.4 AV			1.26 H	273	70.10	33.30
3	2483.50	67.2 PK	74.0	-6.8	1.27 H	280	33.80	33.40
4	2483.50	52.2 AV	54.0	-1.8	1.27 H	280	18.80	33.40
5	4924.00	48.7 PK	74.0	-25.3	1.10 H	184	42.40	6.30
6	4924.00	35.8 AV	54.0	-18.2	1.10 H	184	29.50	6.30
7	5000.00	54.5 PK	74.0	-19.5	1.84 H	112	47.90	6.60
8	5000.00	49.2 AV	54.0	-4.8	1.84 H	112	42.60	6.60

ANTENNA POLARITY & TEST DISTANCE: VERTICAL AT 3 M

NO.	FREQ. (MHz)	EMISSION LEVEL (dBuV/m)	LIMIT (dBuV/m)	MARGIN (dB)	ANTENNA HEIGHT (m)	TABLE ANGLE (Degree)	RAW VALUE (dBuV)	CORRECTION FACTOR (dB/m)
1	*2462.00	103.7 PK			1.00 V	303	70.40	33.30
2	*2462.00	92.4 AV			1.00 V	303	59.10	33.30
3	2483.50	57.9 PK	74.0	-16.1	1.00 V	300	24.50	33.40
4	2483.50	47.1 AV	54.0	-6.9	1.00 V	300	13.70	33.40
5	4924.00	48.8 PK	74.0	-25.2	1.32 V	62	42.50	6.30
6	4924.00	36.1 AV	54.0	-17.9	1.32 V	62	29.80	6.30
7	5000.00	55.9 PK	74.0	-18.1	2.00 V	126	49.30	6.60
8	5000.00	51.2 AV	54.0	-2.8	2.00 V	126	44.60	6.60

REMARKS:

1. Emission Level(dBuV/m) = Raw Value(dBuV) + Correction Factor(dB/m)
2. Correction Factor(dB/m) = Antenna Factor(dB/m) + Cable Factor(dB)
3. The other emission levels were very low against the limit.
4. Margin value = Emission Level – Limit value
5. " * ": Fundamental frequency.



A D T

Radio 1: Patch antenna

802.11b

CHANNEL	TX Channel 1	DETECTOR FUNCTION	Peak (PK)
FREQUENCY RANGE	1GHz ~ 25GHz		Average (AV)

ANTENNA POLARITY & TEST DISTANCE: HORIZONTAL AT 3 M

NO.	FREQ. (MHz)	EMISSION LEVEL (dBuV/m)	LIMIT (dBuV/m)	MARGIN (dB)	ANTENNA HEIGHT (m)	TABLE ANGLE (Degree)	RAW VALUE (dBuV)	CORRECTION FACTOR (dB/m)
1	2390.00	63.3 PK	74.0	-10.7	1.00 H	0	30.10	33.20
2	2390.00	52.3 AV	54.0	-1.7	1.00 H	0	19.10	33.20
3	*2412.00	120.5 PK			1.19 H	0	87.20	33.30
4	*2412.00	116.4 AV			1.19 H	0	83.10	33.30
5	2487.00	61.4 PK	74.0	-12.6	1.15 H	0	28.00	33.40
6	2487.00	51.6 AV	54.0	-2.4	1.15 H	0	18.20	33.40
7	4824.00	50.0 PK	74.0	-24.0	1.00 H	159	43.90	6.10
8	4824.00	43.0 AV	54.0	-11.0	1.00 H	159	36.90	6.10

ANTENNA POLARITY & TEST DISTANCE: VERTICAL AT 3 M

NO.	FREQ. (MHz)	EMISSION LEVEL (dBuV/m)	LIMIT (dBuV/m)	MARGIN (dB)	ANTENNA HEIGHT (m)	TABLE ANGLE (Degree)	RAW VALUE (dBuV)	CORRECTION FACTOR (dB/m)
1	2390.00	61.7 PK	74.0	-12.3	1.05 V	6	28.50	33.20
2	2390.00	51.2 AV	54.0	-2.8	1.05 V	6	18.00	33.20
3	*2412.00	117.3 PK			1.29 V	7	84.00	33.30
4	*2412.00	113.4 AV			1.29 V	7	80.10	33.30
5	2487.00	60.4 PK	74.0	-13.6	1.00 V	0	27.00	33.40
6	2487.00	49.0 AV	54.0	-5.0	1.00 V	0	15.60	33.40
7	4824.00	51.9 PK	74.0	-22.1	1.00 V	188	45.80	6.10
8	4824.00	44.5 AV	54.0	-9.5	1.00 V	188	38.40	6.10

REMARKS:

1. Emission Level(dBuV/m) = Raw Value(dBuV) + Correction Factor(dB/m)
2. Correction Factor(dB/m) = Antenna Factor(dB/m) + Cable Factor(dB)
3. The other emission levels were very low against the limit.
4. Margin value = Emission Level – Limit value
5. " * ": Fundamental frequency.



A D T

CHANNEL	TX Channel 6	DETECTOR FUNCTION	Peak (PK)
FREQUENCY RANGE	1GHz ~ 25GHz		Average (AV)

ANTENNA POLARITY & TEST DISTANCE: HORIZONTAL AT 3 M

NO.	FREQ. (MHz)	EMISSION LEVEL (dBuV/m)	LIMIT (dBuV/m)	MARGIN (dB)	ANTENNA HEIGHT (m)	TABLE ANGLE (Degree)	RAW VALUE (dBuV)	CORRECTION FACTOR (dB/m)
1	2390.00	62.0 PK	74.0	-12.0	1.20 H	0	28.80	33.20
2	2390.00	50.9 AV	54.0	-3.1	1.20 H	0	17.70	33.20
3	*2437.00	124.3 PK			1.20 H	353	90.90	33.40
4	*2437.00	120.4 AV			1.20 H	353	87.00	33.40
5	2483.50	64.0 PK	74.0	-10.0	1.14 H	3	30.60	33.40
6	2483.50	52.5 AV	54.0	-1.5	1.14 H	3	19.10	33.40
7	4874.00	51.5 PK	74.0	-22.5	1.77 H	165	45.30	6.20
8	4874.00	43.4 AV	54.0	-10.6	1.77 H	165	37.20	6.20
9	7311.00	58.8 PK	74.0	-15.2	1.30 H	207	46.60	12.20
10	7311.00	51.2 AV	54.0	-2.8	1.30 H	207	39.00	12.20

ANTENNA POLARITY & TEST DISTANCE: VERTICAL AT 3 M

NO.	FREQ. (MHz)	EMISSION LEVEL (dBuV/m)	LIMIT (dBuV/m)	MARGIN (dB)	ANTENNA HEIGHT (m)	TABLE ANGLE (Degree)	RAW VALUE (dBuV)	CORRECTION FACTOR (dB/m)
1	2390.00	61.1 PK	74.0	-12.9	1.06 V	7	27.90	33.20
2	2390.00	49.4 AV	54.0	-4.6	1.06 V	7	16.20	33.20
3	*2437.00	121.6 PK			1.04 V	0	88.20	33.40
4	*2437.00	117.9 AV			1.04 V	0	84.50	33.40
5	2483.50	64.3 PK	74.0	-9.7	1.03 V	349	30.90	33.40
6	2483.50	51.8 AV	54.0	-2.2	1.03 V	349	18.40	33.40
7	4874.00	52.8 PK	74.0	-21.2	1.27 V	212	46.60	6.20
8	4874.00	47.2 AV	54.0	-6.8	1.27 V	212	41.00	6.20
9	7311.00	57.9 PK	74.0	-16.1	1.00 V	203	45.70	12.20
10	7311.00	50.8 AV	54.0	-3.2	1.00 V	203	38.60	12.20

REMARKS:

1. Emission Level(dBuV/m) = Raw Value(dBuV) + Correction Factor(dB/m)
2. Correction Factor(dB/m) = Antenna Factor(dB/m) + Cable Factor(dB)
3. The other emission levels were very low against the limit.
4. Margin value = Emission Level – Limit value
5. " * ": Fundamental frequency.



A D T

CHANNEL	TX Channel 11	DETECTOR FUNCTION	Peak (PK)
FREQUENCY RANGE	1GHz ~ 25GHz		Average (AV)

ANTENNA POLARITY & TEST DISTANCE: HORIZONTAL AT 3 M

NO.	FREQ. (MHz)	EMISSION LEVEL (dBuV/m)	LIMIT (dBuV/m)	MARGIN (dB)	ANTENNA HEIGHT (m)	TABLE ANGLE (Degree)	RAW VALUE (dBuV)	CORRECTION FACTOR (dB/m)
1	*2462.00	119.2 PK			1.17 H	356	85.90	33.30
2	*2462.00	115.5 AV			1.17 H	356	82.20	33.30
3	2483.50	62.3 PK	74.0	-11.7	1.16 H	0	28.90	33.40
4	2483.50	52.7 AV	54.0	-1.3	1.16 H	0	19.30	33.40
5	4924.00	54.1 PK	74.0	-19.9	1.07 H	148	47.80	6.30
6	4924.00	47.9 AV	54.0	-6.1	1.07 H	148	41.60	6.30

ANTENNA POLARITY & TEST DISTANCE: VERTICAL AT 3 M

NO.	FREQ. (MHz)	EMISSION LEVEL (dBuV/m)	LIMIT (dBuV/m)	MARGIN (dB)	ANTENNA HEIGHT (m)	TABLE ANGLE (Degree)	RAW VALUE (dBuV)	CORRECTION FACTOR (dB/m)
1	*2462.00	116.0 PK			1.02 V	6	82.70	33.30
2	*2462.00	112.4 AV			1.02 V	6	79.10	33.30
3	2483.50	60.9 PK	74.0	-13.1	1.00 V	0	27.50	33.40
4	2483.50	50.5 AV	54.0	-3.5	1.00 V	0	17.10	33.40
5	4924.00	54.9 PK	74.0	-19.1	1.09 V	106	48.60	6.30
6	4924.00	50.2 AV	54.0	-3.8	1.09 V	106	43.90	6.30

REMARKS:

1. Emission Level(dBuV/m) = Raw Value(dBuV) + Correction Factor(dB/m)
2. Correction Factor(dB/m) = Antenna Factor(dB/m) + Cable Factor(dB)
3. The other emission levels were very low against the limit.
4. Margin value = Emission Level – Limit value
5. " * ": Fundamental frequency.



A D T

802.11g

CHANNEL	TX Channel 1	DETECTOR FUNCTION	Peak (PK)
FREQUENCY RANGE	1GHz ~ 25GHz		Average (AV)

ANTENNA POLARITY & TEST DISTANCE: HORIZONTAL AT 3 M								
NO.	FREQ. (MHz)	EMISSION LEVEL (dBuV/m)	LIMIT (dBuV/m)	MARGIN (dB)	ANTENNA HEIGHT (m)	TABLE ANGLE (Degree)	RAW VALUE (dBuV)	CORRECTION FACTOR (dB/m)
1	2390.00	68.8 PK	74.0	-5.2	1.00 H	0	35.60	33.20
2	2390.00	51.9 AV	54.0	-2.1	1.00 H	0	18.70	33.20
3	*2412.00	115.8 PK			1.00 H	357	82.50	33.30
4	*2412.00	104.9 AV			1.00 H	357	71.60	33.30
5	2487.00	61.1 PK	74.0	-12.9	1.17 H	0	27.70	33.40
6	2487.00	52.4 AV	54.0	-1.6	1.17 H	0	19.00	33.40
7	4824.00	51.2 PK	74.0	-22.8	1.10 H	60	45.10	6.10
8	4824.00	41.5 AV	54.0	-12.5	1.10 H	60	35.40	6.10
ANTENNA POLARITY & TEST DISTANCE: VERTICAL AT 3 M								
NO.	FREQ. (MHz)	EMISSION LEVEL (dBuV/m)	LIMIT (dBuV/m)	MARGIN (dB)	ANTENNA HEIGHT (m)	TABLE ANGLE (Degree)	RAW VALUE (dBuV)	CORRECTION FACTOR (dB/m)
1	2390.00	66.9 PK	74.0	-7.1	1.09 V	349	33.70	33.20
2	2390.00	52.6 AV	54.0	-1.4	1.09 V	349	19.40	33.20
3	*2412.00	114.7 PK			1.09 V	345	81.40	33.30
4	*2412.00	104.8 AV			1.09 V	345	71.50	33.30
5	2487.00	62.3 PK	74.0	-11.7	1.26 V	341	28.90	33.40
6	2487.00	51.7 AV	54.0	-2.3	1.26 V	341	18.30	33.40
7	4824.00	53.1 PK	74.0	-20.9	1.09 V	203	47.00	6.10
8	4824.00	46.0 AV	54.0	-8.0	1.09 V	203	39.90	6.10

REMARKS:

1. Emission Level(dBuV/m) = Raw Value(dBuV) + Correction Factor(dB/m)
2. Correction Factor(dB/m) = Antenna Factor(dB/m) + Cable Factor(dB)
3. The other emission levels were very low against the limit.
4. Margin value = Emission Level – Limit value
5. " * ": Fundamental frequency.



A D T

CHANNEL	TX Channel 6	DETECTOR FUNCTION	Peak (PK)
FREQUENCY RANGE	1GHz ~ 25GHz		Average (AV)

ANTENNA POLARITY & TEST DISTANCE: HORIZONTAL AT 3 M

NO.	FREQ. (MHz)	EMISSION LEVEL (dBuV/m)	LIMIT (dBuV/m)	MARGIN (dB)	ANTENNA HEIGHT (m)	TABLE ANGLE (Degree)	RAW VALUE (dBuV)	CORRECTION FACTOR (dB/m)
1	2390.00	70.2 PK	74.0	-3.8	1.00 H	349	37.00	33.20
2	2390.00	52.7 AV	54.0	-1.3	1.00 H	349	19.50	33.20
3	*2437.00	123.0 PK			1.17 H	338	89.60	33.40
4	*2437.00	112.7 AV			1.17 H	338	79.30	33.40
5	2483.50	69.7 PK	74.0	-4.3	1.18 H	6	36.30	33.40
6	2483.50	52.8 AV	54.0	-1.2	1.18 H	6	19.40	33.40
7	4874.00	52.5 PK	74.0	-21.5	1.15 H	149	46.30	6.20
8	4874.00	45.4 AV	54.0	-8.6	1.15 H	149	39.20	6.20

ANTENNA POLARITY & TEST DISTANCE: VERTICAL AT 3 M

NO.	FREQ. (MHz)	EMISSION LEVEL (dBuV/m)	LIMIT (dBuV/m)	MARGIN (dB)	ANTENNA HEIGHT (m)	TABLE ANGLE (Degree)	RAW VALUE (dBuV)	CORRECTION FACTOR (dB/m)
1	2390.00	68.7 PK	74.0	-5.3	1.09 V	343	35.50	33.20
2	2390.00	51.5 AV	54.0	-2.5	1.09 V	343	18.30	33.20
3	*2437.00	121.2 PK			1.06 V	351	87.80	33.40
4	*2437.00	112.1 AV			1.06 V	351	78.70	33.40
5	2483.50	69.3 PK	74.0	-4.7	1.04 V	345	35.90	33.40
6	2483.50	52.7 AV	54.0	-1.3	1.04 V	345	19.30	33.40
7	4874.00	52.7 PK	74.0	-21.3	1.22 V	114	46.50	6.20
8	4874.00	46.0 AV	54.0	-8.0	1.22 V	114	39.80	6.20

REMARKS:

1. Emission Level(dBuV/m) = Raw Value(dBuV) + Correction Factor(dB/m)
2. Correction Factor(dB/m) = Antenna Factor(dB/m) + Cable Factor(dB)
3. The other emission levels were very low against the limit.
4. Margin value = Emission Level – Limit value
5. " * ": Fundamental frequency.



A D T

CHANNEL	TX Channel 11	DETECTOR FUNCTION	Peak (PK)
FREQUENCY RANGE	1GHz ~ 25GHz		Average (AV)

ANTENNA POLARITY & TEST DISTANCE: HORIZONTAL AT 3 M

NO.	FREQ. (MHz)	EMISSION LEVEL (dBuV/m)	LIMIT (dBuV/m)	MARGIN (dB)	ANTENNA HEIGHT (m)	TABLE ANGLE (Degree)	RAW VALUE (dBuV)	CORRECTION FACTOR (dB/m)
1	*2462.00	116.4 PK			1.18 H	347	83.10	33.30
2	*2462.00	105.9 AV			1.18 H	347	72.60	33.30
3	2483.50	67.3 PK	74.0	-6.7	1.17 H	351	33.90	33.40
4	2483.50	52.6 AV	54.0	-1.4	1.17 H	351	19.20	33.40
5	4924.00	53.1 PK	74.0	-20.9	1.19 H	150	46.80	6.30
6	4924.00	45.0 AV	54.0	-9.0	1.19 H	150	38.70	6.30

ANTENNA POLARITY & TEST DISTANCE: VERTICAL AT 3 M

NO.	FREQ. (MHz)	EMISSION LEVEL (dBuV/m)	LIMIT (dBuV/m)	MARGIN (dB)	ANTENNA HEIGHT (m)	TABLE ANGLE (Degree)	RAW VALUE (dBuV)	CORRECTION FACTOR (dB/m)
1	*2462.00	115.1 PK			1.06 V	353	81.80	33.30
2	*2462.00	105.0 AV			1.06 V	353	71.70	33.30
3	2483.50	65.6 PK	74.0	-8.4	1.06 V	0	32.20	33.40
4	2483.50	50.2 AV	54.0	-3.8	1.06 V	0	16.80	33.40
5	4924.00	53.6 PK	74.0	-20.4	1.34 V	201	47.30	6.30
6	4924.00	46.6 AV	54.0	-7.4	1.34 V	201	40.30	6.30

REMARKS:

1. Emission Level(dBuV/m) = Raw Value(dBuV) + Correction Factor(dB/m)
2. Correction Factor(dB/m) = Antenna Factor(dB/m) + Cable Factor(dB)
3. The other emission levels were very low against the limit.
4. Margin value = Emission Level – Limit value
5. " * ": Fundamental frequency.



A D T

802.11n (20MHz)

CHANNEL	TX Channel 1	DETECTOR FUNCTION	Peak (PK)
FREQUENCY RANGE	1GHz ~ 25GHz		Average (AV)

ANTENNA POLARITY & TEST DISTANCE: HORIZONTAL AT 3 M

NO.	FREQ. (MHz)	EMISSION LEVEL (dBuV/m)	LIMIT (dBuV/m)	MARGIN (dB)	ANTENNA HEIGHT (m)	TABLE ANGLE (Degree)	RAW VALUE (dBuV)	CORRECTION FACTOR (dB/m)
1	2390.00	68.3 PK	74.0	-5.7	1.00 H	0	35.10	33.20
2	2390.00	52.8 AV	54.0	-1.2	1.00 H	0	19.60	33.20
3	*2412.00	115.3 PK			1.17 H	0	82.00	33.30
4	*2412.00	104.2 AV			1.17 H	0	70.90	33.30
5	2487.00	60.7 PK	74.0	-13.3	1.16 H	352	27.30	33.40
6	2487.00	51.9 AV	54.0	-2.1	1.16 H	352	18.50	33.40
7	4824.00	48.9 PK	74.0	-25.1	1.04 H	84	42.80	6.10
8	4824.00	34.2 AV	54.0	-19.8	1.04 H	84	28.10	6.10

ANTENNA POLARITY & TEST DISTANCE: VERTICAL AT 3 M

NO.	FREQ. (MHz)	EMISSION LEVEL (dBuV/m)	LIMIT (dBuV/m)	MARGIN (dB)	ANTENNA HEIGHT (m)	TABLE ANGLE (Degree)	RAW VALUE (dBuV)	CORRECTION FACTOR (dB/m)
1	2390.00	69.6 PK	74.0	-4.4	1.09 V	355	36.40	33.20
2	2390.00	52.4 AV	54.0	-1.6	1.09 V	355	19.20	33.20
3	*2412.00	113.3 PK			1.29 V	7	80.00	33.30
4	*2412.00	104.1 AV			1.29 V	7	70.80	33.30
5	2487.00	59.1 PK	74.0	-14.9	1.00 V	3	25.70	33.40
6	2487.00	47.6 AV	54.0	-6.4	1.00 V	3	14.20	33.40
7	4824.00	47.8 PK	74.0	-26.2	1.00 V	305	41.70	6.10
8	4824.00	34.8 AV	54.0	-19.2	1.00 V	305	28.70	6.10

REMARKS:

1. Emission Level(dBuV/m) = Raw Value(dBuV) + Correction Factor(dB/m)
2. Correction Factor(dB/m) = Antenna Factor(dB/m) + Cable Factor(dB)
3. The other emission levels were very low against the limit.
4. Margin value = Emission Level – Limit value
5. " * ": Fundamental frequency.



A D T

CHANNEL	TX Channel 6	DETECTOR FUNCTION	Peak (PK)
FREQUENCY RANGE	1GHz ~ 25GHz		Average (AV)

ANTENNA POLARITY & TEST DISTANCE: HORIZONTAL AT 3 M

NO.	FREQ. (MHz)	EMISSION LEVEL (dBuV/m)	LIMIT (dBuV/m)	MARGIN (dB)	ANTENNA HEIGHT (m)	TABLE ANGLE (Degree)	RAW VALUE (dBuV)	CORRECTION FACTOR (dB/m)
1	2390.00	70.8 PK	74.0	-3.2	1.20 H	0	37.60	33.20
2	2390.00	52.8 AV	54.0	-1.2	1.20 H	0	19.60	33.20
3	*2437.00	122.5 PK			1.19 H	0	89.10	33.40
4	*2437.00	111.9 AV			1.19 H	0	78.50	33.40
5	2483.50	68.1 PK	74.0	-5.9	1.16 H	0	34.70	33.40
6	2483.50	52.4 AV	54.0	-1.6	1.16 H	0	19.00	33.40
7	4874.00	50.1 PK	74.0	-23.9	1.27 H	86	43.90	6.20
8	4874.00	36.5 AV	54.0	-17.5	1.27 H	86	30.30	6.20

ANTENNA POLARITY & TEST DISTANCE: VERTICAL AT 3 M

NO.	FREQ. (MHz)	EMISSION LEVEL (dBuV/m)	LIMIT (dBuV/m)	MARGIN (dB)	ANTENNA HEIGHT (m)	TABLE ANGLE (Degree)	RAW VALUE (dBuV)	CORRECTION FACTOR (dB/m)
1	2390.00	65.3 PK	74.0	-8.7	1.25 V	19	32.10	33.20
2	2390.00	49.7 AV	54.0	-4.3	1.25 V	19	16.50	33.20
3	*2437.00	120.7 PK			1.25 V	3	87.30	33.40
4	*2437.00	111.0 AV			1.25 V	3	77.60	33.40
5	2483.50	68.0 PK	74.0	-6.0	1.25 V	354	34.60	33.40
6	2483.50	52.6 AV	54.0	-1.4	1.25 V	354	19.20	33.40
7	4874.00	49.8 PK	74.0	-24.2	1.00 V	282	43.60	6.20
8	4874.00	36.5 AV	54.0	-17.5	1.00 V	282	30.30	6.20

REMARKS:

1. Emission Level(dBuV/m) = Raw Value(dBuV) + Correction Factor(dB/m)
2. Correction Factor(dB/m) = Antenna Factor(dB/m) + Cable Factor(dB)
3. The other emission levels were very low against the limit.
4. Margin value = Emission Level – Limit value
5. " * ": Fundamental frequency.



A D T

CHANNEL	TX Channel 11	DETECTOR FUNCTION	Peak (PK)
FREQUENCY RANGE	1GHz ~ 25GHz		Average (AV)

ANTENNA POLARITY & TEST DISTANCE: HORIZONTAL AT 3 M

NO.	FREQ. (MHz)	EMISSION LEVEL (dBuV/m)	LIMIT (dBuV/m)	MARGIN (dB)	ANTENNA HEIGHT (m)	TABLE ANGLE (Degree)	RAW VALUE (dBuV)	CORRECTION FACTOR (dB/m)
1	*2462.00	115.4 PK			1.13 H	0	82.10	33.30
2	*2462.00	104.8 AV			1.13 H	0	71.50	33.30
3	2483.50	68.0 PK	74.0	-6.0	1.14 H	6	34.60	33.40
4	2483.50	52.8 AV	54.0	-1.2	1.14 H	6	19.40	33.40
5	4924.00	48.9 PK	74.0	-25.1	1.15 H	243	42.60	6.30
6	4924.00	35.8 AV	54.0	-18.2	1.15 H	243	29.50	6.30

ANTENNA POLARITY & TEST DISTANCE: VERTICAL AT 3 M

NO.	FREQ. (MHz)	EMISSION LEVEL (dBuV/m)	LIMIT (dBuV/m)	MARGIN (dB)	ANTENNA HEIGHT (m)	TABLE ANGLE (Degree)	RAW VALUE (dBuV)	CORRECTION FACTOR (dB/m)
1	*2462.00	114.4 PK			1.27 V	356	81.10	33.30
2	*2462.00	105.0 AV			1.27 V	356	71.70	33.30
3	2483.50	67.8 PK	74.0	-6.2	1.25 V	353	34.40	33.40
4	2483.50	52.7 AV	54.0	-1.3	1.25 V	353	19.30	33.40
5	4924.00	49.0 PK	74.0	-25.0	1.00 V	106	42.70	6.30
6	4924.00	36.2 AV	54.0	-17.8	1.00 V	106	29.90	6.30

REMARKS:

1. Emission Level(dBuV/m) = Raw Value(dBuV) + Correction Factor(dB/m)
2. Correction Factor(dB/m) = Antenna Factor(dB/m) + Cable Factor(dB)
3. The other emission levels were very low against the limit.
4. Margin value = Emission Level – Limit value
5. " * ": Fundamental frequency.



A D T

Radio 1: Sector antenna**802.11b**

CHANNEL	TX Channel 1	DETECTOR FUNCTION	Peak (PK)
FREQUENCY RANGE	1GHz ~ 25GHz		Average (AV)

ANTENNA POLARITY & TEST DISTANCE: HORIZONTAL AT 3 M								
NO.	FREQ. (MHz)	EMISSION LEVEL (dBuV/m)	LIMIT (dBuV/m)	MARGIN (dB)	ANTENNA HEIGHT (m)	TABLE ANGLE (Degree)	RAW VALUE (dBuV)	CORRECTION FACTOR (dB/m)
1	2390.00	62.9 PK	74.0	-11.1	1.00 H	3	29.70	33.20
2	2390.00	52.2 AV	54.0	-1.8	1.00 H	3	19.00	33.20
3	*2412.00	119.2 PK			1.17 H	6	85.90	33.30
4	*2412.00	115.5 AV			1.17 H	6	82.20	33.30
5	2487.00	60.8 PK	74.0	-13.2	1.13 H	3	27.40	33.40
6	2487.00	51.7 AV	54.0	-2.3	1.13 H	3	18.30	33.40
7	4824.00	49.5 PK	74.0	-24.5	1.04 H	348	43.40	6.10
8	4824.00	40.9 AV	54.0	-13.1	1.04 H	348	34.80	6.10
ANTENNA POLARITY & TEST DISTANCE: VERTICAL AT 3 M								
NO.	FREQ. (MHz)	EMISSION LEVEL (dBuV/m)	LIMIT (dBuV/m)	MARGIN (dB)	ANTENNA HEIGHT (m)	TABLE ANGLE (Degree)	RAW VALUE (dBuV)	CORRECTION FACTOR (dB/m)
1	2390.00	60.3 PK	74.0	-13.7	1.01 V	4	27.10	33.20
2	2390.00	50.1 AV	54.0	-3.9	1.01 V	4	16.90	33.20
3	*2412.00	118.4 PK			1.00 V	7	85.10	33.30
4	*2412.00	114.5 AV			1.00 V	7	81.20	33.30
5	2487.00	60.9 PK	74.0	-13.1	1.00 V	2	27.50	33.40
6	2487.00	49.9 AV	54.0	-4.1	1.00 V	2	16.50	33.40
7	4824.00	50.6 PK	74.0	-23.4	1.10 V	169	44.50	6.10
8	4824.00	42.2 AV	54.0	-11.8	1.10 V	169	36.10	6.10

REMARKS:

1. Emission Level(dBuV/m) = Raw Value(dBuV) + Correction Factor(dB/m)
2. Correction Factor(dB/m) = Antenna Factor(dB/m) + Cable Factor(dB)
3. The other emission levels were very low against the limit.
4. Margin value = Emission Level – Limit value
5. " * ": Fundamental frequency.



A D T

CHANNEL	TX Channel 6	DETECTOR FUNCTION	Peak (PK)
FREQUENCY RANGE	1GHz ~ 25GHz		Average (AV)

ANTENNA POLARITY & TEST DISTANCE: HORIZONTAL AT 3 M

NO.	FREQ. (MHz)	EMISSION LEVEL (dBuV/m)	LIMIT (dBuV/m)	MARGIN (dB)	ANTENNA HEIGHT (m)	TABLE ANGLE (Degree)	RAW VALUE (dBuV)	CORRECTION FACTOR (dB/m)
1	*2437.00	120.9 PK			1.00 H	0	87.50	33.40
2	*2437.00	117.3 AV			1.00 H	0	83.90	33.40
3	4874.00	50.8 PK	74.0	-23.2	1.00 H	307	44.60	6.20
4	4874.00	42.2 AV	54.0	-11.8	1.00 H	307	36.00	6.20

ANTENNA POLARITY & TEST DISTANCE: VERTICAL AT 3 M

NO.	FREQ. (MHz)	EMISSION LEVEL (dBuV/m)	LIMIT (dBuV/m)	MARGIN (dB)	ANTENNA HEIGHT (m)	TABLE ANGLE (Degree)	RAW VALUE (dBuV)	CORRECTION FACTOR (dB/m)
1	*2437.00	119.9 PK			1.00 V	12	86.50	33.40
2	*2437.00	116.3 AV			1.00 V	12	82.90	33.40
3	4874.00	52.6 PK	74.0	-21.4	1.35 V	198	46.40	6.20
4	4874.00	46.3 AV	54.0	-7.7	1.35 V	198	40.10	6.20

REMARKS:

1. Emission Level(dBuV/m) = Raw Value(dBuV) + Correction Factor(dB/m)
2. Correction Factor(dB/m) = Antenna Factor(dB/m) + Cable Factor(dB)
3. The other emission levels were very low against the limit.
4. Margin value = Emission Level – Limit value
5. " * ": Fundamental frequency.



A D T

CHANNEL	TX Channel 11	DETECTOR FUNCTION	Peak (PK)
FREQUENCY RANGE	1GHz ~ 25GHz		Average (AV)

ANTENNA POLARITY & TEST DISTANCE: HORIZONTAL AT 3 M

NO.	FREQ. (MHz)	EMISSION LEVEL (dBuV/m)	LIMIT (dBuV/m)	MARGIN (dB)	ANTENNA HEIGHT (m)	TABLE ANGLE (Degree)	RAW VALUE (dBuV)	CORRECTION FACTOR (dB/m)
1	*2462.00	118.5 PK			1.16 H	0	85.20	33.30
2	*2462.00	114.5 AV			1.16 H	0	81.20	33.30
3	2483.50	62.3 PK	74.0	-11.7	1.12 H	0	28.90	33.40
4	2483.50	52.6 AV	54.0	-1.4	1.12 H	0	19.20	33.40
5	4924.00	52.8 PK	74.0	-21.2	1.00 H	320	46.50	6.30
6	4924.00	46.7 AV	54.0	-7.3	1.00 H	320	40.40	6.30

ANTENNA POLARITY & TEST DISTANCE: VERTICAL AT 3 M

NO.	FREQ. (MHz)	EMISSION LEVEL (dBuV/m)	LIMIT (dBuV/m)	MARGIN (dB)	ANTENNA HEIGHT (m)	TABLE ANGLE (Degree)	RAW VALUE (dBuV)	CORRECTION FACTOR (dB/m)
1	*2462.00	117.5 PK			1.00 V	0	84.20	33.30
2	*2462.00	114.0 AV			1.00 V	0	80.70	33.30
3	2483.50	63.0 PK	74.0	-11.0	1.00 V	358	29.60	33.40
4	2483.50	53.0 AV	54.0	-1.0	1.00 V	358	19.60	33.40
5	4924.00	53.5 PK	74.0	-20.5	1.01 V	220	47.20	6.30
6	4924.00	47.3 AV	54.0	-6.7	1.01 V	220	41.00	6.30

REMARKS:

1. Emission Level(dBuV/m) = Raw Value(dBuV) + Correction Factor(dB/m)
2. Correction Factor(dB/m) = Antenna Factor(dB/m) + Cable Factor(dB)
3. The other emission levels were very low against the limit.
4. Margin value = Emission Level – Limit value
5. " * ": Fundamental frequency.



802.11g

CHANNEL	TX Channel 1	DETECTOR FUNCTION	Peak (PK)
FREQUENCY RANGE	1GHz ~ 25GHz		Average (AV)

ANTENNA POLARITY & TEST DISTANCE: HORIZONTAL AT 3 M								
NO.	FREQ. (MHz)	EMISSION LEVEL (dBuV/m)	LIMIT (dBuV/m)	MARGIN (dB)	ANTENNA HEIGHT (m)	TABLE ANGLE (Degree)	RAW VALUE (dBuV)	CORRECTION FACTOR (dB/m)
1	2390.00	70.4 PK	74.0	-3.6	1.00 H	0	37.20	33.20
2	2390.00	52.4 AV	54.0	-1.6	1.00 H	0	19.20	33.20
3	*2412.00	116.2 PK			1.13 H	10	82.90	33.30
4	*2412.00	105.7 AV			1.13 H	10	72.40	33.30
5	2487.00	61.6 PK	74.0	-12.4	1.36 H	4	28.20	33.40
6	2487.00	52.8 AV	54.0	-1.2	1.36 H	4	19.40	33.40
7	4824.00	48.0 PK	74.0	-26.0	1.24 H	213	41.90	6.10
8	4824.00	34.7 AV	54.0	-19.3	1.24 H	213	28.60	6.10
ANTENNA POLARITY & TEST DISTANCE: VERTICAL AT 3 M								
NO.	FREQ. (MHz)	EMISSION LEVEL (dBuV/m)	LIMIT (dBuV/m)	MARGIN (dB)	ANTENNA HEIGHT (m)	TABLE ANGLE (Degree)	RAW VALUE (dBuV)	CORRECTION FACTOR (dB/m)
1	2390.00	65.4 PK	74.0	-8.6	1.00 V	0	32.20	33.20
2	2390.00	52.1 AV	54.0	-1.9	1.00 V	0	18.90	33.20
3	*2412.00	114.3 PK			1.00 V	2	81.00	33.30
4	*2412.00	104.9 AV			1.00 V	2	71.60	33.30
5	2487.00	59.1 PK	74.0	-14.9	1.00 V	0	25.70	33.40
6	2487.00	49.2 AV	54.0	-4.8	1.00 V	0	15.80	33.40
7	4824.00	48.0 PK	74.0	-26.0	1.00 V	106	41.90	6.10
8	4824.00	35.0 AV	54.0	-19.0	1.00 V	106	28.90	6.10

REMARKS:

1. Emission Level(dBuV/m) = Raw Value(dBuV) + Correction Factor(dB/m)
2. Correction Factor(dB/m) = Antenna Factor(dB/m) + Cable Factor(dB)
3. The other emission levels were very low against the limit.
4. Margin value = Emission Level – Limit value
5. " * ": Fundamental frequency.



A D T

CHANNEL	TX Channel 6	DETECTOR FUNCTION	Peak (PK)
FREQUENCY RANGE	1GHz ~ 25GHz		Average (AV)

ANTENNA POLARITY & TEST DISTANCE: HORIZONTAL AT 3 M

NO.	FREQ. (MHz)	EMISSION LEVEL (dBuV/m)	LIMIT (dBuV/m)	MARGIN (dB)	ANTENNA HEIGHT (m)	TABLE ANGLE (Degree)	RAW VALUE (dBuV)	CORRECTION FACTOR (dB/m)
1	2390.00	69.5 PK	74.0	-4.5	1.00 H	345	36.30	33.20
2	2390.00	52.6 AV	54.0	-1.4	1.00 H	345	19.40	33.20
3	*2437.00	122.5 PK			1.17 H	356	89.10	33.40
4	*2437.00	112.2 AV			1.17 H	356	78.80	33.40
5	2483.50	68.7 PK	74.0	-5.3	1.14 H	357	35.30	33.40
6	2483.50	53.0 AV	54.0	-1.0	1.14 H	357	19.60	33.40
7	4874.00	52.6 PK	74.0	-21.4	1.27 H	186	46.40	6.20
8	4874.00	46.0 AV	54.0	-8.0	1.27 H	186	39.80	6.20

ANTENNA POLARITY & TEST DISTANCE: VERTICAL AT 3 M

NO.	FREQ. (MHz)	EMISSION LEVEL (dBuV/m)	LIMIT (dBuV/m)	MARGIN (dB)	ANTENNA HEIGHT (m)	TABLE ANGLE (Degree)	RAW VALUE (dBuV)	CORRECTION FACTOR (dB/m)
1	2390.00	68.8 PK	74.0	-5.2	1.08 V	356	35.60	33.20
2	2390.00	51.9 AV	54.0	-2.1	1.08 V	356	18.70	33.20
3	*2437.00	122.3 PK			1.04 V	350	88.90	33.40
4	*2437.00	112.6 AV			1.04 V	350	79.20	33.40
5	2483.50	68.2 PK	74.0	-5.8	1.02 V	344	34.80	33.40
6	2483.50	52.3 AV	54.0	-1.7	1.02 V	344	18.90	33.40
7	4874.00	53.7 PK	74.0	-20.3	1.06 V	191	47.50	6.20
8	4874.00	47.2 AV	54.0	-6.8	1.06 V	191	41.00	6.20

REMARKS:

1. Emission Level(dBuV/m) = Raw Value(dBuV) + Correction Factor(dB/m)
2. Correction Factor(dB/m) = Antenna Factor(dB/m) + Cable Factor(dB)
3. The other emission levels were very low against the limit.
4. Margin value = Emission Level – Limit value
5. " * ": Fundamental frequency.



A D T

CHANNEL	TX Channel 11	DETECTOR FUNCTION	Peak (PK)
FREQUENCY RANGE	1GHz ~ 25GHz		Average (AV)

ANTENNA POLARITY & TEST DISTANCE: HORIZONTAL AT 3 M

NO.	FREQ. (MHz)	EMISSION LEVEL (dBuV/m)	LIMIT (dBuV/m)	MARGIN (dB)	ANTENNA HEIGHT (m)	TABLE ANGLE (Degree)	RAW VALUE (dBuV)	CORRECTION FACTOR (dB/m)
1	*2462.00	118.8 PK			1.13 H	0	85.50	33.30
2	*2462.00	108.0 AV			1.13 H	0	74.70	33.30
3	2483.50	70.4 PK	74.0	-3.6	1.13 H	359	37.00	33.40
4	2483.50	53.0 AV	54.0	-1.0	1.13 H	359	19.60	33.40
5	4924.00	54.2 PK	74.0	-19.8	1.15 H	187	47.90	6.30
6	4924.00	45.9 AV	54.0	-8.1	1.15 H	187	39.60	6.30

ANTENNA POLARITY & TEST DISTANCE: VERTICAL AT 3 M

NO.	FREQ. (MHz)	EMISSION LEVEL (dBuV/m)	LIMIT (dBuV/m)	MARGIN (dB)	ANTENNA HEIGHT (m)	TABLE ANGLE (Degree)	RAW VALUE (dBuV)	CORRECTION FACTOR (dB/m)
1	*2462.00	114.8 PK			1.00 V	354	81.50	33.30
2	*2462.00	105.1 AV			1.00 V	354	71.80	33.30
3	2483.50	66.3 PK	74.0	-7.7	1.00 V	359	32.90	33.40
4	2483.50	52.2 AV	54.0	-1.8	1.00 V	359	18.80	33.40
5	4924.00	54.9 PK	74.0	-19.1	1.07 V	191	48.60	6.30
6	4924.00	47.9 AV	54.0	-6.1	1.07 V	191	41.60	6.30

REMARKS:

1. Emission Level(dBuV/m) = Raw Value(dBuV) + Correction Factor(dB/m)
2. Correction Factor(dB/m) = Antenna Factor(dB/m) + Cable Factor(dB)
3. The other emission levels were very low against the limit.
4. Margin value = Emission Level – Limit value
5. " * ": Fundamental frequency.



A D T

802.11n (20MHz)

CHANNEL	TX Channel 1	DETECTOR FUNCTION	Peak (PK)
FREQUENCY RANGE	1GHz ~ 25GHz		Average (AV)

ANTENNA POLARITY & TEST DISTANCE: HORIZONTAL AT 3 M

NO.	FREQ. (MHz)	EMISSION LEVEL (dBuV/m)	LIMIT (dBuV/m)	MARGIN (dB)	ANTENNA HEIGHT (m)	TABLE ANGLE (Degree)	RAW VALUE (dBuV)	CORRECTION FACTOR (dB/m)
1	2390.00	69.6 PK	74.0	-4.4	1.16 H	354	36.40	33.20
2	2390.00	52.6 AV	54.0	-1.4	1.16 H	354	19.40	33.20
3	*2412.00	113.9 PK			1.00 H	350	80.60	33.30
4	*2412.00	103.5 AV			1.00 H	350	70.20	33.30
5	2487.00	60.3 PK	74.0	-13.7	1.34 H	5	26.90	33.40
6	2487.00	51.2 AV	54.0	-2.8	1.34 H	5	17.80	33.40
7	4824.00	47.6 PK	74.0	-26.4	1.14 H	284	41.50	6.10
8	4824.00	34.8 AV	54.0	-19.2	1.14 H	284	28.70	6.10

ANTENNA POLARITY & TEST DISTANCE: VERTICAL AT 3 M

NO.	FREQ. (MHz)	EMISSION LEVEL (dBuV/m)	LIMIT (dBuV/m)	MARGIN (dB)	ANTENNA HEIGHT (m)	TABLE ANGLE (Degree)	RAW VALUE (dBuV)	CORRECTION FACTOR (dB/m)
1	2390.00	67.0 PK	74.0	-7.0	1.06 V	0	33.80	33.20
2	2390.00	51.0 AV	54.0	-3.0	1.06 V	0	17.80	33.20
3	*2412.00	112.3 PK			1.00 V	0	79.00	33.30
4	*2412.00	103.2 AV			1.00 V	0	69.90	33.30
5	2487.00	59.5 PK	74.0	-14.5	1.00 V	1	26.10	33.40
6	2487.00	48.5 AV	54.0	-5.5	1.00 V	1	15.10	33.40
7	4824.00	48.4 PK	74.0	-25.6	1.00 V	216	42.30	6.10
8	4824.00	34.8 AV	54.0	-19.2	1.00 V	216	28.70	6.10

REMARKS:

1. Emission Level(dBuV/m) = Raw Value(dBuV) + Correction Factor(dB/m)
2. Correction Factor(dB/m) = Antenna Factor(dB/m) + Cable Factor(dB)
3. The other emission levels were very low against the limit.
4. Margin value = Emission Level – Limit value
5. " * ": Fundamental frequency.



A D T

CHANNEL	TX Channel 6	DETECTOR FUNCTION	Peak (PK)
FREQUENCY RANGE	1GHz ~ 25GHz		Average (AV)

ANTENNA POLARITY & TEST DISTANCE: HORIZONTAL AT 3 M

NO.	FREQ. (MHz)	EMISSION LEVEL (dBuV/m)	LIMIT (dBuV/m)	MARGIN (dB)	ANTENNA HEIGHT (m)	TABLE ANGLE (Degree)	RAW VALUE (dBuV)	CORRECTION FACTOR (dB/m)
1	2390.00	72.5 PK	74.0	-1.5	1.00 H	351	39.30	33.20
2	2390.00	52.9 AV	54.0	-1.1	1.00 H	351	19.70	33.20
3	*2437.00	123.0 PK			1.18 H	353	89.60	33.40
4	*2437.00	111.7 AV			1.18 H	353	78.30	33.40
5	2483.50	70.1 PK	74.0	-3.9	1.16 H	355	36.70	33.40
6	2483.50	52.6 AV	54.0	-1.4	1.16 H	355	19.20	33.40
7	4874.00	51.5 PK	74.0	-22.5	1.25 H	186	45.30	6.20
8	4874.00	44.8 AV	54.0	-9.2	1.25 H	186	38.60	6.20

ANTENNA POLARITY & TEST DISTANCE: VERTICAL AT 3 M

NO.	FREQ. (MHz)	EMISSION LEVEL (dBuV/m)	LIMIT (dBuV/m)	MARGIN (dB)	ANTENNA HEIGHT (m)	TABLE ANGLE (Degree)	RAW VALUE (dBuV)	CORRECTION FACTOR (dB/m)
1	2390.00	72.9 PK	74.0	-1.1	1.09 V	352	39.70	33.20
2	2390.00	52.4 AV	54.0	-1.6	1.09 V	352	19.20	33.20
3	*2437.00	122.2 PK			1.03 V	346	88.80	33.40
4	*2437.00	112.6 AV			1.03 V	346	79.20	33.40
5	2483.50	68.8 PK	74.0	-5.2	1.05 V	343	35.40	33.40
6	2483.50	52.8 AV	54.0	-1.2	1.05 V	343	19.40	33.40
7	4874.00	52.4 PK	74.0	-21.6	1.06 V	191	46.20	6.20
8	4874.00	46.1 AV	54.0	-7.9	1.06 V	191	39.90	6.20

REMARKS:

1. Emission Level(dBuV/m) = Raw Value(dBuV) + Correction Factor(dB/m)
2. Correction Factor(dB/m) = Antenna Factor(dB/m) + Cable Factor(dB)
3. The other emission levels were very low against the limit.
4. Margin value = Emission Level – Limit value
5. " * ": Fundamental frequency.



A D T

CHANNEL	TX Channel 11	DETECTOR FUNCTION	Peak (PK)
FREQUENCY RANGE	1GHz ~ 25GHz		Average (AV)

ANTENNA POLARITY & TEST DISTANCE: HORIZONTAL AT 3 M

NO.	FREQ. (MHz)	EMISSION LEVEL (dBuV/m)	LIMIT (dBuV/m)	MARGIN (dB)	ANTENNA HEIGHT (m)	TABLE ANGLE (Degree)	RAW VALUE (dBuV)	CORRECTION FACTOR (dB/m)
1	*2462.00	116.6 PK			1.16 H	357	83.30	33.30
2	*2462.00	105.3 AV			1.16 H	357	72.00	33.30
3	2483.50	69.6 PK	74.0	-4.4	1.15 H	333	36.20	33.40
4	2483.50	52.4 AV	54.0	-1.6	1.15 H	333	19.00	33.40
5	4924.00	51.8 PK	74.0	-22.2	1.16 H	188	45.50	6.30
6	4924.00	45.5 AV	54.0	-8.5	1.16 H	188	39.20	6.30

ANTENNA POLARITY & TEST DISTANCE: VERTICAL AT 3 M

NO.	FREQ. (MHz)	EMISSION LEVEL (dBuV/m)	LIMIT (dBuV/m)	MARGIN (dB)	ANTENNA HEIGHT (m)	TABLE ANGLE (Degree)	RAW VALUE (dBuV)	CORRECTION FACTOR (dB/m)
1	*2462.00	113.7 PK			1.00 V	353	80.40	33.30
2	*2462.00	104.5 AV			1.00 V	353	71.20	33.30
3	2483.50	68.3 PK	74.0	-5.7	1.02 V	345	34.90	33.40
4	2483.50	52.9 AV	54.0	-1.1	1.02 V	345	19.50	33.40
5	4924.00	52.8 PK	74.0	-21.2	1.09 V	218	46.50	6.30
6	4924.00	46.9 AV	54.0	-7.1	1.09 V	218	40.60	6.30

REMARKS:

1. Emission Level(dBuV/m) = Raw Value(dBuV) + Correction Factor(dB/m)
2. Correction Factor(dB/m) = Antenna Factor(dB/m) + Cable Factor(dB)
3. The other emission levels were very low against the limit.
4. Margin value = Emission Level – Limit value
5. " * ": Fundamental frequency.



A D T

Radio 3: PIFA antenna

802.11b

CHANNEL	TX Channel 1	DETECTOR FUNCTION	Peak (PK)
FREQUENCY RANGE	1GHz ~ 25GHz		Average (AV)

ANTENNA POLARITY & TEST DISTANCE: HORIZONTAL AT 3 M

NO.	FREQ. (MHz)	EMISSION LEVEL (dBuV/m)	LIMIT (dBuV/m)	MARGIN (dB)	ANTENNA HEIGHT (m)	TABLE ANGLE (Degree)	RAW VALUE (dBuV)	CORRECTION FACTOR (dB/m)
1	2390.00	62.9 PK	74.0	-11.1	1.40 H	320	29.70	33.20
2	2390.00	52.8 AV	54.0	-1.2	1.40 H	320	19.60	33.20
3	*2412.00	111.5 PK			1.38 H	319	78.20	33.30
4	*2412.00	107.8 AV			1.38 H	319	74.50	33.30
5	4824.00	52.9 PK	74.0	-21.1	1.26 H	13	46.80	6.10
6	4824.00	48.0 AV	54.0	-6.0	1.26 H	13	41.90	6.10
7	5000.00	50.4 PK	74.0	-23.6	1.15 H	9	43.80	6.60
8	5000.00	42.4 AV	54.0	-11.6	1.15 H	9	35.80	6.60

ANTENNA POLARITY & TEST DISTANCE: VERTICAL AT 3 M

NO.	FREQ. (MHz)	EMISSION LEVEL (dBuV/m)	LIMIT (dBuV/m)	MARGIN (dB)	ANTENNA HEIGHT (m)	TABLE ANGLE (Degree)	RAW VALUE (dBuV)	CORRECTION FACTOR (dB/m)
1	2390.00	59.7 PK	74.0	-14.3	1.05 V	37	26.50	33.20
2	2390.00	49.7 AV	54.0	-4.3	1.05 V	37	16.50	33.20
3	*2412.00	104.7 PK			1.29 V	36	71.40	33.30
4	*2412.00	101.1 AV			1.29 V	36	67.80	33.30
5	4824.00	54.9 PK	74.0	-19.1	1.06 V	35	48.80	6.10
6	4824.00	50.8 AV	54.0	-3.2	1.06 V	35	44.70	6.10
7	5000.00	52.8 PK	74.0	-21.2	1.09 V	31	46.20	6.60
8	5000.00	46.8 AV	54.0	-7.2	1.09 V	31	40.20	6.60

REMARKS:

1. Emission Level(dBuV/m) = Raw Value(dBuV) + Correction Factor(dB/m)
2. Correction Factor(dB/m) = Antenna Factor(dB/m) + Cable Factor(dB)
3. The other emission levels were very low against the limit.
4. Margin value = Emission Level – Limit value
5. " * ": Fundamental frequency.



A D T

CHANNEL	TX Channel 6	DETECTOR FUNCTION	Peak (PK)
FREQUENCY RANGE	1GHz ~ 25GHz		Average (AV)

ANTENNA POLARITY & TEST DISTANCE: HORIZONTAL AT 3 M

NO.	FREQ. (MHz)	EMISSION LEVEL (dBuV/m)	LIMIT (dBuV/m)	MARGIN (dB)	ANTENNA HEIGHT (m)	TABLE ANGLE (Degree)	RAW VALUE (dBuV)	CORRECTION FACTOR (dB/m)
1	*2437.00	109.8 PK			1.40 H	324	76.40	33.40
2	*2437.00	106.2 AV			1.40 H	324	72.80	33.40
3	4874.00	53.3 PK	74.0	-20.7	1.26 H	17	47.10	6.20
4	4874.00	47.6 AV	54.0	-6.4	1.26 H	17	41.40	6.20
5	7311.00	58.7 PK	74.0	-15.3	1.31 H	282	46.50	12.20
6	7311.00	51.8 AV	54.0	-2.2	1.31 H	282	39.60	12.20

ANTENNA POLARITY & TEST DISTANCE: VERTICAL AT 3 M

NO.	FREQ. (MHz)	EMISSION LEVEL (dBuV/m)	LIMIT (dBuV/m)	MARGIN (dB)	ANTENNA HEIGHT (m)	TABLE ANGLE (Degree)	RAW VALUE (dBuV)	CORRECTION FACTOR (dB/m)
1	*2437.00	103.1 PK			1.00 V	43	69.70	33.40
2	*2437.00	99.3 AV			1.00 V	43	65.90	33.40
3	4874.00	54.0 PK	74.0	-20.0	1.34 V	324	47.80	6.20
4	4874.00	50.2 AV	54.0	-3.8	1.34 V	324	44.00	6.20
5	7311.00	59.2 PK	74.0	-14.8	1.06 V	8	47.00	12.20
6	7311.00	52.5 AV	54.0	-1.5	1.06 V	8	40.30	12.20

REMARKS:

1. Emission Level(dBuV/m) = Raw Value(dBuV) + Correction Factor(dB/m)
2. Correction Factor(dB/m) = Antenna Factor(dB/m) + Cable Factor(dB)
3. The other emission levels were very low against the limit.
4. Margin value = Emission Level – Limit value
5. " * ": Fundamental frequency.



A D T

CHANNEL	TX Channel 11	DETECTOR FUNCTION	Peak (PK)
FREQUENCY RANGE	1GHz ~ 25GHz		Average (AV)

ANTENNA POLARITY & TEST DISTANCE: HORIZONTAL AT 3 M

NO.	FREQ. (MHz)	EMISSION LEVEL (dBuV/m)	LIMIT (dBuV/m)	MARGIN (dB)	ANTENNA HEIGHT (m)	TABLE ANGLE (Degree)	RAW VALUE (dBuV)	CORRECTION FACTOR (dB/m)
1	*2462.00	108.8 PK			1.62 H	326	75.50	33.30
2	*2462.00	105.2 AV			1.62 H	326	71.90	33.30
3	2483.50	60.2 PK	74.0	-13.8	1.07 H	285	26.80	33.40
4	2483.50	49.8 AV	54.0	-4.2	1.07 H	285	16.40	33.40
5	4924.00	54.2 PK	74.0	-19.8	1.12 H	13	47.90	6.30
6	4924.00	49.9 AV	54.0	-4.1	1.12 H	13	43.60	6.30
7	7386.00	58.9 PK	74.0	-15.1	1.78 H	287	46.60	12.30
8	7386.00	51.5 AV	54.0	-2.5	1.78 H	287	39.20	12.30

ANTENNA POLARITY & TEST DISTANCE: VERTICAL AT 3 M

NO.	FREQ. (MHz)	EMISSION LEVEL (dBuV/m)	LIMIT (dBuV/m)	MARGIN (dB)	ANTENNA HEIGHT (m)	TABLE ANGLE (Degree)	RAW VALUE (dBuV)	CORRECTION FACTOR (dB/m)
1	*2462.00	101.8 PK			1.02 V	40	68.50	33.30
2	*2462.00	97.9 AV			1.02 V	40	64.60	33.30
3	2483.50	57.6 PK	74.0	-16.4	1.00 V	40	24.20	33.40
4	2483.50	46.7 AV	54.0	-7.3	1.00 V	40	13.30	33.40
5	4924.00	55.9 PK	74.0	-18.1	1.05 V	37	49.60	6.30
6	4924.00	52.5 AV	54.0	-1.5	1.05 V	37	46.20	6.30
7	7386.00	59.4 PK	74.0	-14.6	1.13 V	10	47.10	12.30
8	7386.00	52.7 AV	54.0	-1.3	1.13 V	10	40.40	12.30

REMARKS:

1. Emission Level(dBuV/m) = Raw Value(dBuV) + Correction Factor(dB/m)
2. Correction Factor(dB/m) = Antenna Factor(dB/m) + Cable Factor(dB)
3. The other emission levels were very low against the limit.
4. Margin value = Emission Level – Limit value
5. " * ": Fundamental frequency.



A D T

802.11g

CHANNEL	TX Channel 1	DETECTOR FUNCTION	Peak (PK)
FREQUENCY RANGE	1GHz ~ 25GHz		Average (AV)

ANTENNA POLARITY & TEST DISTANCE: HORIZONTAL AT 3 M

NO.	FREQ. (MHz)	EMISSION LEVEL (dBuV/m)	LIMIT (dBuV/m)	MARGIN (dB)	ANTENNA HEIGHT (m)	TABLE ANGLE (Degree)	RAW VALUE (dBuV)	CORRECTION FACTOR (dB/m)
1	2390.00	66.4 PK	74.0	-7.6	1.39 H	320	33.20	33.20
2	2390.00	53.0 AV	54.0	-1.0	1.39 H	320	19.80	33.20
3	*2412.00	107.8 PK			1.38 H	320	74.50	33.30
4	*2412.00	98.2 AV			1.38 H	320	64.90	33.30
5	4824.00	48.4 PK	74.0	-25.6	1.40 H	9	42.30	6.10
6	4824.00	35.7 AV	54.0	-18.3	1.40 H	9	29.60	6.10
7	5000.00	50.8 PK	74.0	-23.2	1.38 H	9	44.20	6.60
8	5000.00	42.1 AV	54.0	-11.9	1.38 H	9	35.50	6.60

ANTENNA POLARITY & TEST DISTANCE: VERTICAL AT 3 M

NO.	FREQ. (MHz)	EMISSION LEVEL (dBuV/m)	LIMIT (dBuV/m)	MARGIN (dB)	ANTENNA HEIGHT (m)	TABLE ANGLE (Degree)	RAW VALUE (dBuV)	CORRECTION FACTOR (dB/m)
1	2390.00	66.4 PK	74.0	-7.6	1.05 V	37	33.20	33.20
2	2390.00	51.0 AV	54.0	-3.0	1.05 V	37	17.80	33.20
3	*2412.00	103.3 PK			1.29 V	37	70.00	33.30
4	*2412.00	91.4 AV			1.29 V	37	58.10	33.30
5	4824.00	51.2 PK	74.0	-22.8	1.07 V	35	45.10	6.10
6	4824.00	37.7 AV	54.0	-16.3	1.07 V	35	31.60	6.10
7	5000.00	53.1 PK	74.0	-20.9	1.09 V	30	46.50	6.60
8	5000.00	47.2 AV	54.0	-6.8	1.09 V	30	40.60	6.60

REMARKS:

1. Emission Level(dBuV/m) = Raw Value(dBuV) + Correction Factor(dB/m)
2. Correction Factor(dB/m) = Antenna Factor(dB/m) + Cable Factor(dB)
3. The other emission levels were very low against the limit.
4. Margin value = Emission Level – Limit value
5. " * ": Fundamental frequency.



A D T

CHANNEL	TX Channel 6	DETECTOR FUNCTION	Peak (PK)
FREQUENCY RANGE	1GHz ~ 25GHz		Average (AV)

ANTENNA POLARITY & TEST DISTANCE: HORIZONTAL AT 3 M

NO.	FREQ. (MHz)	EMISSION LEVEL (dBuV/m)	LIMIT (dBuV/m)	MARGIN (dB)	ANTENNA HEIGHT (m)	TABLE ANGLE (Degree)	RAW VALUE (dBuV)	CORRECTION FACTOR (dB/m)
1	2390.00	72.8 PK	74.0	-1.2	1.38 H	322	39.60	33.20
2	2390.00	52.5 AV	54.0	-1.5	1.38 H	322	19.30	33.20
3	*2437.00	117.4 PK			1.40 H	325	84.00	33.40
4	*2437.00	107.0 AV			1.40 H	325	73.60	33.40
5	4874.00	54.1 PK	74.0	-19.9	1.12 H	13	47.90	6.20
6	4874.00	39.9 AV	54.0	-14.1	1.12 H	13	33.70	6.20
7	5000.00	50.6 PK	74.0	-23.4	1.39 H	11	44.00	6.60
8	5000.00	41.6 AV	54.0	-12.4	1.39 H	11	35.00	6.60
9	7311.00	67.5 PK	74.0	-6.5	1.32 H	284	55.30	12.20
10	7311.00	51.8 AV	54.0	-2.2	1.32 H	284	39.60	12.20

ANTENNA POLARITY & TEST DISTANCE: VERTICAL AT 3 M

NO.	FREQ. (MHz)	EMISSION LEVEL (dBuV/m)	LIMIT (dBuV/m)	MARGIN (dB)	ANTENNA HEIGHT (m)	TABLE ANGLE (Degree)	RAW VALUE (dBuV)	CORRECTION FACTOR (dB/m)
1	2390.00	68.6 PK	74.0	-5.4	1.03 V	37	35.40	33.20
2	2390.00	50.5 AV	54.0	-3.5	1.03 V	37	17.30	33.20
3	*2437.00	110.2 PK			1.04 V	40	76.80	33.40
4	*2437.00	99.6 AV			1.04 V	40	66.20	33.40
5	4874.00	53.1 PK	74.0	-20.9	1.28 V	41	46.90	6.20
6	4874.00	40.9 AV	54.0	-13.1	1.28 V	41	34.70	6.20
7	5000.00	52.4 PK	74.0	-21.6	1.10 V	27	45.80	6.60
8	5000.00	46.2 AV	54.0	-7.8	1.10 V	27	39.60	6.60
9	7311.00	67.7 PK	74.0	-6.3	1.15 V	8	55.50	12.20
10	7311.00	52.9 AV	54.0	-1.1	1.15 V	8	40.70	12.20

REMARKS:

1. Emission Level(dBuV/m) = Raw Value(dBuV) + Correction Factor(dB/m)
2. Correction Factor(dB/m) = Antenna Factor(dB/m) + Cable Factor(dB)
3. The other emission levels were very low against the limit.
4. Margin value = Emission Level – Limit value
5. " * ": Fundamental frequency.



A D T

CHANNEL	TX Channel 11	DETECTOR FUNCTION	Peak (PK)
FREQUENCY RANGE	1GHz ~ 25GHz		Average (AV)

ANTENNA POLARITY & TEST DISTANCE: HORIZONTAL AT 3 M

NO.	FREQ. (MHz)	EMISSION LEVEL (dBuV/m)	LIMIT (dBuV/m)	MARGIN (dB)	ANTENNA HEIGHT (m)	TABLE ANGLE (Degree)	RAW VALUE (dBuV)	CORRECTION FACTOR (dB/m)
1	*2462.00	109.2 PK			1.39 H	323	75.90	33.30
2	*2462.00	99.9 AV			1.39 H	323	66.60	33.30
3	2483.50	70.6 PK	74.0	-3.4	1.35 H	322	37.20	33.40
4	2483.50	53.0 AV	54.0	-1.0	1.35 H	322	19.60	33.40
5	4924.00	51.8 PK	74.0	-22.2	1.12 H	4	45.50	6.30
6	4924.00	38.5 AV	54.0	-15.5	1.12 H	4	32.20	6.30
7	5000.00	50.7 PK	74.0	-23.3	1.38 H	9	44.10	6.60
8	5000.00	41.8 AV	54.0	-12.2	1.38 H	9	35.20	6.60

ANTENNA POLARITY & TEST DISTANCE: VERTICAL AT 3 M

NO.	FREQ. (MHz)	EMISSION LEVEL (dBuV/m)	LIMIT (dBuV/m)	MARGIN (dB)	ANTENNA HEIGHT (m)	TABLE ANGLE (Degree)	RAW VALUE (dBuV)	CORRECTION FACTOR (dB/m)
1	*2462.00	105.1 PK			1.04 V	38	71.80	33.30
2	*2462.00	93.9 AV			1.04 V	38	60.60	33.30
3	2483.50	62.5 PK	74.0	-11.5	1.00 V	40	29.10	33.40
4	2483.50	49.2 AV	54.0	-4.8	1.00 V	40	15.80	33.40
5	4924.00	50.4 PK	74.0	-23.6	1.30 V	43	44.10	6.30
6	4924.00	38.8 AV	54.0	-15.2	1.30 V	43	32.50	6.30
7	5000.00	51.8 PK	74.0	-22.2	1.12 V	22	45.20	6.60
8	5000.00	45.6 AV	54.0	-8.4	1.12 V	22	39.00	6.60

REMARKS:

1. Emission Level(dBuV/m) = Raw Value(dBuV) + Correction Factor(dB/m)
2. Correction Factor(dB/m) = Antenna Factor(dB/m) + Cable Factor(dB)
3. The other emission levels were very low against the limit.
4. Margin value = Emission Level – Limit value
5. " * ": Fundamental frequency.



A D T

802.11n (20MHz)

CHANNEL	TX Channel 1	DETECTOR FUNCTION	Peak (PK)
FREQUENCY RANGE	1GHz ~ 25GHz		Average (AV)

ANTENNA POLARITY & TEST DISTANCE: HORIZONTAL AT 3 M

NO.	FREQ. (MHz)	EMISSION LEVEL (dBuV/m)	LIMIT (dBuV/m)	MARGIN (dB)	ANTENNA HEIGHT (m)	TABLE ANGLE (Degree)	RAW VALUE (dBuV)	CORRECTION FACTOR (dB/m)
1	2390.00	66.7 PK	74.0	-7.3	1.39 H	322	33.50	33.20
2	2390.00	52.2 AV	54.0	-1.8	1.39 H	322	19.00	33.20
3	*2412.00	107.1 PK			1.39 H	320	73.80	33.30
4	*2412.00	97.4 AV			1.39 H	320	64.10	33.30
5	4824.00	48.5 PK	74.0	-25.5	1.23 H	13	42.40	6.10
6	4824.00	35.7 AV	54.0	-18.3	1.23 H	13	29.60	6.10
7	5000.00	50.7 PK	74.0	-23.3	1.33 H	11	44.10	6.60
8	5000.00	42.0 AV	54.0	-12.0	1.33 H	11	35.40	6.60

ANTENNA POLARITY & TEST DISTANCE: VERTICAL AT 3 M

NO.	FREQ. (MHz)	EMISSION LEVEL (dBuV/m)	LIMIT (dBuV/m)	MARGIN (dB)	ANTENNA HEIGHT (m)	TABLE ANGLE (Degree)	RAW VALUE (dBuV)	CORRECTION FACTOR (dB/m)
1	2390.00	62.3 PK	74.0	-11.7	1.07 V	40	29.10	33.20
2	2390.00	49.9 AV	54.0	-4.1	1.07 V	40	16.70	33.20
3	*2412.00	100.7 PK			1.31 V	38	67.40	33.30
4	*2412.00	90.9 AV			1.31 V	38	57.60	33.30
5	4824.00	48.4 PK	74.0	-25.6	1.06 V	15	42.30	6.10
6	4824.00	35.1 AV	54.0	-18.9	1.06 V	15	29.00	6.10
7	5000.00	51.7 PK	74.0	-22.3	1.10 V	39	45.10	6.60
8	5000.00	45.5 AV	54.0	-8.5	1.10 V	39	38.90	6.60

REMARKS:

1. Emission Level(dBuV/m) = Raw Value(dBuV) + Correction Factor(dB/m)
2. Correction Factor(dB/m) = Antenna Factor(dB/m) + Cable Factor(dB)
3. The other emission levels were very low against the limit.
4. Margin value = Emission Level – Limit value
5. " * ": Fundamental frequency.



A D T

CHANNEL	TX Channel 6	DETECTOR FUNCTION	Peak (PK)
FREQUENCY RANGE	1GHz ~ 25GHz		Average (AV)

ANTENNA POLARITY & TEST DISTANCE: HORIZONTAL AT 3 M

NO.	FREQ. (MHz)	EMISSION LEVEL (dBuV/m)	LIMIT (dBuV/m)	MARGIN (dB)	ANTENNA HEIGHT (m)	TABLE ANGLE (Degree)	RAW VALUE (dBuV)	CORRECTION FACTOR (dB/m)
1	2390.00	71.5 PK	74.0	-2.5	1.38 H	317	38.30	33.20
2	2390.00	52.8 AV	54.0	-1.2	1.38 H	317	19.60	33.20
3	*2437.00	117.3 PK			1.40 H	326	83.90	33.40
4	*2437.00	107.2 AV			1.40 H	326	73.80	33.40
5	4874.00	53.5 PK	74.0	-20.5	1.13 H	15	47.30	6.20
6	4874.00	39.5 AV	54.0	-14.5	1.13 H	15	33.30	6.20
7	5000.00	51.7 PK	74.0	-22.3	1.39 H	10	45.10	6.60
8	5000.00	42.1 AV	54.0	-11.9	1.39 H	10	35.50	6.60
9	7311.00	65.3 PK	74.0	-8.7	1.30 H	280	53.10	12.20
10	7311.00	51.2 AV	54.0	-2.8	1.30 H	280	39.00	12.20

ANTENNA POLARITY & TEST DISTANCE: VERTICAL AT 3 M

NO.	FREQ. (MHz)	EMISSION LEVEL (dBuV/m)	LIMIT (dBuV/m)	MARGIN (dB)	ANTENNA HEIGHT (m)	TABLE ANGLE (Degree)	RAW VALUE (dBuV)	CORRECTION FACTOR (dB/m)
1	2390.00	69.2 PK	74.0	-4.8	1.06 V	35	36.00	33.20
2	2390.00	50.2 AV	54.0	-3.8	1.06 V	35	17.00	33.20
3	*2437.00	109.1 PK			1.03 V	41	75.70	33.40
4	*2437.00	99.1 AV			1.03 V	41	65.70	33.40
5	4874.00	52.7 PK	74.0	-21.3	1.28 V	44	46.50	6.20
6	4874.00	40.5 AV	54.0	-13.5	1.28 V	44	34.30	6.20
7	5000.00	52.0 PK	74.0	-22.0	1.11 V	30	45.40	6.60
8	5000.00	46.1 AV	54.0	-7.9	1.11 V	30	39.50	6.60
9	7311.00	67.3 PK	74.0	-6.7	1.16 V	9	55.10	12.20
10	7311.00	52.5 AV	54.0	-1.5	1.16 V	9	40.30	12.20

REMARKS:

1. Emission Level(dBuV/m) = Raw Value(dBuV) + Correction Factor(dB/m)
2. Correction Factor(dB/m) = Antenna Factor(dB/m) + Cable Factor(dB)
3. The other emission levels were very low against the limit.
4. Margin value = Emission Level – Limit value
5. " * ": Fundamental frequency.



A D T

CHANNEL	TX Channel 11	DETECTOR FUNCTION	Peak (PK)
FREQUENCY RANGE	1GHz ~ 25GHz		Average (AV)

ANTENNA POLARITY & TEST DISTANCE: HORIZONTAL AT 3 M

NO.	FREQ. (MHz)	EMISSION LEVEL (dBuV/m)	LIMIT (dBuV/m)	MARGIN (dB)	ANTENNA HEIGHT (m)	TABLE ANGLE (Degree)	RAW VALUE (dBuV)	CORRECTION FACTOR (dB/m)
1	*2462.00	110.1 PK			1.38 H	324	76.80	33.30
2	*2462.00	100.5 AV			1.38 H	324	67.20	33.30
3	2483.50	70.0 PK	74.0	-4.0	1.34 H	323	36.60	33.40
4	2483.50	53.0 AV	54.0	-1.0	1.34 H	323	19.60	33.40
5	4924.00	51.1 PK	74.0	-22.9	1.10 H	6	44.80	6.30
6	4924.00	38.3 AV	54.0	-15.7	1.10 H	6	32.00	6.30
7	5000.00	50.4 PK	74.0	-23.6	1.39 H	11	43.80	6.60
8	5000.00	41.4 AV	54.0	-12.6	1.39 H	11	34.80	6.60

ANTENNA POLARITY & TEST DISTANCE: VERTICAL AT 3 M

NO.	FREQ. (MHz)	EMISSION LEVEL (dBuV/m)	LIMIT (dBuV/m)	MARGIN (dB)	ANTENNA HEIGHT (m)	TABLE ANGLE (Degree)	RAW VALUE (dBuV)	CORRECTION FACTOR (dB/m)
1	#2437.00	65.7 PK	83.5	-17.8	1.25 V	45	32.30	33.40
2	#2437.00	50.0 AV	73.9	-23.9	1.25 V	45	16.60	33.40
3	*2462.00	103.5 PK			1.03 V	37	70.20	33.30
4	*2462.00	93.9 AV			1.03 V	37	60.60	33.30
5	4924.00	51.4 PK	74.0	-22.6	1.27 V	41	45.10	6.30
6	4924.00	38.6 AV	54.0	-15.4	1.27 V	41	32.30	6.30
7	5000.00	51.9 PK	74.0	-22.1	1.08 V	31	45.30	6.60
8	5000.00	45.9 AV	54.0	-8.1	1.08 V	31	39.30	6.60

REMARKS:

1. Emission Level(dBuV/m) = Raw Value(dBuV) + Correction Factor(dB/m)
2. Correction Factor(dB/m) = Antenna Factor(dB/m) + Cable Factor(dB)
3. The other emission levels were very low against the limit.
4. Margin value = Emission Level – Limit value



BELOW 1GHz WORST-CASE DATA

Radio 1: Dipole antenna

802.11b

CHANNEL	TX Channel 1	DETECTOR FUNCTION	Quasi-Peak (QP)
FREQUENCY RANGE	30MHz ~ 1GHz		

ANTENNA POLARITY & TEST DISTANCE: HORIZONTAL AT 3 M

NO.	FREQ. (MHz)	EMISSION LEVEL (dBuV/m)	LIMIT (dBuV/m)	MARGIN (dB)	ANTENNA HEIGHT (m)	TABLE ANGLE (Degree)	RAW VALUE (dBuV)	CORRECTION FACTOR (dB/m)
1	57.12	32.6 QP	40.0	-7.4	2.00 H	304	47.10	-14.50
2	156.28	41.1 QP	43.5	-2.4	1.50 H	276	54.70	-13.60
3	162.11	40.4 QP	43.5	-3.1	1.50 H	287	54.10	-13.70
4	204.89	34.3 QP	43.5	-9.2	1.50 H	121	50.80	-16.50
5	414.87	32.1 QP	46.0	-13.9	2.00 H	157	42.00	-9.90
6	799.84	37.4 QP	46.0	-8.6	1.01 H	136	39.20	-1.80

ANTENNA POLARITY & TEST DISTANCE: VERTICAL AT 3 M

NO.	FREQ. (MHz)	EMISSION LEVEL (dBuV/m)	LIMIT (dBuV/m)	MARGIN (dB)	ANTENNA HEIGHT (m)	TABLE ANGLE (Degree)	RAW VALUE (dBuV)	CORRECTION FACTOR (dB/m)
1	51.29	36.4 QP	40.0	-3.6	1.00 V	8	50.80	-14.40
2	66.84	35.2 QP	40.0	-4.8	1.00 V	8	50.80	-15.60
3	146.56	38.8 QP	43.5	-4.7	1.00 V	82	52.70	-13.90
4	204.89	39.8 QP	43.5	-3.7	1.00 V	43	56.30	-16.50
5	325.43	31.7 QP	46.0	-14.3	1.49 V	14	43.10	-11.40
6	799.84	36.9 QP	46.0	-9.1	1.49 V	14	38.70	-1.80

REMARKS:

1. Emission Level(dBuV/m) = Raw Value(dBuV) + Correction Factor(dB/m)
2. Correction Factor(dB/m) = Antenna Factor(dB/m) + Cable Factor(dB)
3. The other emission levels were very low against the limit.
4. Margin value = Emission Level – Limit value



A D T

Radio 1: Patch antenna**802.11b**

CHANNEL	TX Channel 6	DETECTOR FUNCTION	Quasi-Peak (QP)
FREQUENCY RANGE	30MHz ~ 1GHz		

ANTENNA POLARITY & TEST DISTANCE: HORIZONTAL AT 3 M

NO.	FREQ. (MHz)	EMISSION LEVEL (dBuV/m)	LIMIT (dBuV/m)	MARGIN (dB)	ANTENNA HEIGHT (m)	TABLE ANGLE (Degree)	RAW VALUE (dBuV)	CORRECTION FACTOR (dB/m)
1	35.73	36.6 QP	40.0	-3.4	1.00 H	333	52.20	-15.60
2	155.15	42.1 QP	43.5	-1.4	2.00 H	252	55.80	-13.70
3	195.16	40.1 QP	43.5	-3.4	1.99 H	93	56.50	-16.40
4	237.94	33.4 QP	46.0	-12.6	1.50 H	293	48.10	-14.70
5	300.16	32.7 QP	46.0	-13.3	1.00 H	233	44.70	-12.00
6	799.84	37.2 QP	46.0	-8.8	1.00 H	131	39.00	-1.80

ANTENNA POLARITY & TEST DISTANCE: VERTICAL AT 3 M

NO.	FREQ. (MHz)	EMISSION LEVEL (dBuV/m)	LIMIT (dBuV/m)	MARGIN (dB)	ANTENNA HEIGHT (m)	TABLE ANGLE (Degree)	RAW VALUE (dBuV)	CORRECTION FACTOR (dB/m)
1	51.29	38.1 QP	40.0	-1.9	1.01 V	12	52.50	-14.40
2	156.28	41.6 QP	43.5	-1.9	1.01 V	132	55.20	-13.60
3	191.28	39.2 QP	43.5	-4.3	1.01 V	35	55.40	-16.20
4	459.59	34.7 QP	46.0	-11.3	1.01 V	230	43.40	-8.70
5	799.84	36.3 QP	46.0	-9.7	1.50 V	120	38.10	-1.80
6	1000.00	36.9 QP	54.0	-17.1	1.50 V	241	35.50	1.40

REMARKS:

1. Emission Level(dBuV/m) = Raw Value(dBuV) + Correction Factor(dB/m)
2. Correction Factor(dB/m) = Antenna Factor(dB/m) + Cable Factor(dB)
3. The other emission levels were very low against the limit.
4. Margin value = Emission Level – Limit value



A D T

Radio 1: Sector antenna**802.11b**

CHANNEL	TX Channel 6	DETECTOR FUNCTION	Quasi-Peak (QP)
FREQUENCY RANGE	30MHz ~ 1GHz		

ANTENNA POLARITY & TEST DISTANCE: HORIZONTAL AT 3 M

NO.	FREQ. (MHz)	EMISSION LEVEL (dBuV/m)	LIMIT (dBuV/m)	MARGIN (dB)	ANTENNA HEIGHT (m)	TABLE ANGLE (Degree)	RAW VALUE (dBuV)	CORRECTION FACTOR (dB/m)
1	57.12	33.3 QP	40.0	-6.7	1.99 H	60	47.80	-14.50
2	107.67	42.2 QP	43.5	-1.3	1.49 H	165	59.70	-17.50
3	140.69	42.1 QP	43.5	-1.4	1.99 H	279	56.40	-14.30
4	163.89	42.5 QP	43.5	-1.0	1.48 H	267	56.20	-13.70
5	199.05	34.5 QP	43.5	-9.0	1.00 H	290	51.00	-16.50
6	426.53	34.0 QP	46.0	-12.0	1.99 H	108	43.40	-9.40

ANTENNA POLARITY & TEST DISTANCE: VERTICAL AT 3 M

NO.	FREQ. (MHz)	EMISSION LEVEL (dBuV/m)	LIMIT (dBuV/m)	MARGIN (dB)	ANTENNA HEIGHT (m)	TABLE ANGLE (Degree)	RAW VALUE (dBuV)	CORRECTION FACTOR (dB/m)
1	31.81	34.7 QP	40.0	-5.3	1.00 V	258	50.60	-15.90
2	48.76	35.5 QP	40.0	-4.5	1.00 V	42	49.90	-14.40
3	59.02	35.9 QP	40.0	-4.1	1.00 V	348	50.50	-14.60
4	109.62	38.9 QP	43.5	-4.6	1.00 V	152	56.10	-17.20
5	175.72	41.9 QP	43.5	-1.6	1.00 V	6	56.40	-14.50
6	198.73	42.1 QP	43.5	-1.4	1.00 V	37	58.60	-16.50

REMARKS:

1. Emission Level(dBuV/m) = Raw Value(dBuV) + Correction Factor(dB/m)
2. Correction Factor(dB/m) = Antenna Factor(dB/m) + Cable Factor(dB)
3. The other emission levels were very low against the limit.
4. Margin value = Emission Level – Limit value



A D T

Radio 3: PIFA antenna

802.11g

CHANNEL	TX Channel 1	DETECTOR FUNCTION	Quasi-Peak (QP)
FREQUENCY RANGE	30MHz ~ 1GHz		

ANTENNA POLARITY & TEST DISTANCE: HORIZONTAL AT 3 M

NO.	FREQ. (MHz)	EMISSION LEVEL (dBuV/m)	LIMIT (dBuV/m)	MARGIN (dB)	ANTENNA HEIGHT (m)	TABLE ANGLE (Degree)	RAW VALUE (dBuV)	CORRECTION FACTOR (dB/m)
1	62.95	33.5 QP	40.0	-6.5	1.50 H	22	48.60	-15.10
2	142.67	42.2 QP	43.5	-1.3	2.00 H	261	56.40	-14.20
3	162.11	40.0 QP	43.5	-3.5	2.00 H	244	53.70	-13.70
4	204.89	37.4 QP	43.5	-6.1	1.50 H	98	53.90	-16.50
5	358.48	32.0 QP	46.0	-14.0	1.50 H	6	43.10	-11.10
6	1000.00	39.2 QP	54.0	-14.8	1.50 H	7	37.80	1.40

ANTENNA POLARITY & TEST DISTANCE: VERTICAL AT 3 M

NO.	FREQ. (MHz)	EMISSION LEVEL (dBuV/m)	LIMIT (dBuV/m)	MARGIN (dB)	ANTENNA HEIGHT (m)	TABLE ANGLE (Degree)	RAW VALUE (dBuV)	CORRECTION FACTOR (dB/m)
1	29.90	38.9 QP	40.0	-1.1	1.99 V	120	54.80	-15.90
2	55.18	37.5 QP	40.0	-2.5	1.00 V	301	51.90	-14.40
3	66.84	35.9 QP	40.0	-4.1	1.00 V	7	51.50	-15.60
4	144.61	40.3 QP	43.5	-3.2	1.00 V	140	54.30	-14.00
5	204.89	38.9 QP	43.5	-4.6	1.00 V	26	55.40	-16.50
6	799.84	38.5 QP	46.0	-7.5	1.99 V	3	40.30	-1.80

REMARKS:

1. Emission Level(dBuV/m) = Raw Value(dBuV) + Correction Factor(dB/m)
2. Correction Factor(dB/m) = Antenna Factor(dB/m) + Cable Factor(dB)
3. The other emission levels were very low against the limit.
4. Margin value = Emission Level – Limit value

4.2 CONDUCTED EMISSION MEASUREMENT

4.2.1 LIMITS OF CONDUCTED EMISSION MEASUREMENT

FREQUENCY OF EMISSION (MHz)	CONDUCTED LIMIT (dB μ V)	
	Quasi-peak	Average
0.15 ~ 0.5	66 to 56	56 to 46
0.5 ~ 5	56	46
5 ~ 30	60	50

- NOTE:**
1. The lower limit shall apply at the transition frequencies.
 2. The limit decreases in line with the logarithm of the frequency in the range of 0.15 to 0.50MHz.
 3. All emanations from a class A/B digital device or system, including any network of conductors and apparatus connected thereto, shall not exceed the level of field strengths specified above.

4.2.2 TEST INSTRUMENTS

DESCRIPTION & MANUFACTURER	MODEL NO.	SERIAL NO.	DATE OF CALIBRATION	DUE DATE OF CALIBRATION
Test Receiver ROHDE & SCHWARZ	ESCS30	100288	Apr. 24, 2014	Apr. 23, 2015
RF signal cable Woken	5D-FB	Cable-HYCO2-01	Dec. 27, 2013	Dec. 26, 2014
LISN ROHDE & SCHWARZ (EUT)	ESH2-Z5	100100	Dec. 23, 2013	Dec. 22, 2014
LISN ROHDE & SCHWARZ (Peripheral)	ESH3-Z5	100312	Jul. 10, 2014	Jul. 09, 2015
Software ADT	BV ADT_Cond_ V7.3.7.3	NA	NA	NA

- NOTE:**
1. The calibration interval of the above test instruments is 12 months and the calibrations are traceable to NML/ROC and NIST/USA.
 2. The test was performed in HwaYa Shielded Room 2.
 3. The VCCI Site Registration No. is C-2047.

4.2.3 TEST PROCEDURES

- The EUT was placed 0.4 meters from the conducting wall of the shielded room with EUT being connected to the power mains through a line impedance stabilization network (LISN). Other support units were connected to the power mains through another LISN. The two LISNs provide 50 ohm/ 50uH of coupling impedance for the measuring instrument.
- Both lines of the power mains connected to the EUT were checked for maximum conducted interference.
- The frequency range from 150kHz to 30MHz was searched. Emission levels under (Limit - 20dB) was not recorded.

NOTE: All modes of operation were investigated and the worst-case emissions are reported.

4.2.4 DEVIATION FROM TEST STANDARD

No deviation.

4.2.5 TEST SETUP

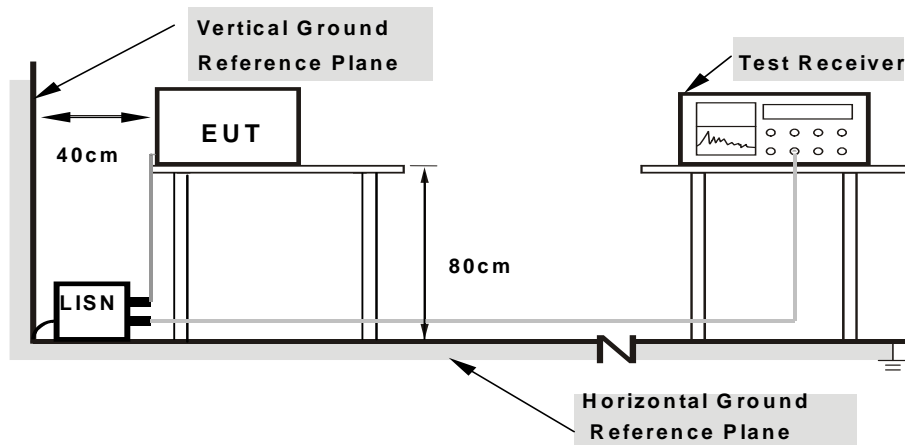

- Note:**
- Support units were connected to second LISN.
 - Both of LISNs (AMN) are 80 cm from EUT and at least 80 cm from other units and other metal planes

For the actual test configuration, please refer to the attached file (Test Setup Photo).

4.2.6 EUT OPERATING CONDITIONS

Same as 4.1.6.

4.2.7 TEST RESULTS

CONDUCTED WORST-CASE DATA :

Radio 1: Dipole antenna
802.11b

PHASE	Line 1	6dB BANDWIDTH	9kHz
-------	--------	---------------	------

No	Freq. [MHz]	Corr. Factor (dB)	Reading Value		Emission Level		Limit		Margin	
			[dB (uV)]		[dB (uV)]		[dB (uV)]		(dB)	
			Q.P.	AV.	Q.P.	AV.	Q.P.	AV.	Q.P.	AV.
1	0.16953	0.27	48.03	37.63	48.30	37.90	64.98	54.98	-16.68	-17.08
2	0.21250	0.28	42.01	32.86	42.29	33.14	63.11	53.11	-20.82	-19.97
3	0.39400	0.30	37.21	31.75	37.51	32.05	57.98	47.98	-20.47	-15.93
4	0.68516	0.32	30.43	24.51	30.75	24.83	56.00	46.00	-25.25	-21.17
5	12.53516	0.52	33.22	32.47	33.74	32.99	60.00	50.00	-26.26	-17.01
6	25.14063	0.53	32.63	27.13	33.16	27.66	60.00	50.00	-26.84	-22.34

REMARKS:

1. Q.P. and AV. are abbreviations of quasi-peak and average individually.
2. The emission levels of other frequencies were very low against the limit.
3. Margin value = Emission level - Limit value
4. Correction factor = Insertion loss + Cable loss
5. Emission Level = Correction Factor + Reading Value

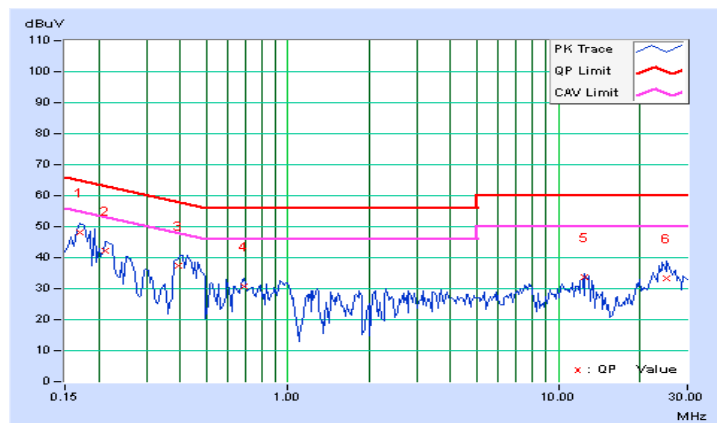

PHASE	Line 2	6dB BANDWIDTH	9kHz
-------	--------	---------------	------

No	Freq. [MHz]	Corr. Factor (dB)	Reading Value		Emission Level		Limit		Margin	
			[dB (uV)]		[dB (uV)]		[dB (uV)]		(dB)	
			Q.P.	AV.	Q.P.	AV.	Q.P.	AV.	Q.P.	AV.
1	0.15000	0.26	43.01	19.67	43.27	19.93	66.00	56.00	-22.73	-36.07
2	0.16953	0.27	48.10	37.45	48.37	37.72	64.98	54.98	-16.61	-17.26
3	0.20078	0.28	36.52	15.50	36.80	15.78	63.58	53.58	-26.78	-37.80
4	0.42344	0.30	37.00	29.45	37.30	29.75	57.38	47.38	-20.08	-17.63
5	0.68125	0.32	29.76	22.75	30.08	23.07	56.00	46.00	-25.92	-22.93
6	24.45703	0.57	32.51	27.13	33.08	27.70	60.00	50.00	-26.92	-22.30

REMARKS:

1. Q.P. and AV. are abbreviations of quasi-peak and average individually.
2. The emission levels of other frequencies were very low against the limit.
3. Margin value = Emission level - Limit value
4. Correction factor = Insertion loss + Cable loss
5. Emission Level = Correction Factor + Reading Value

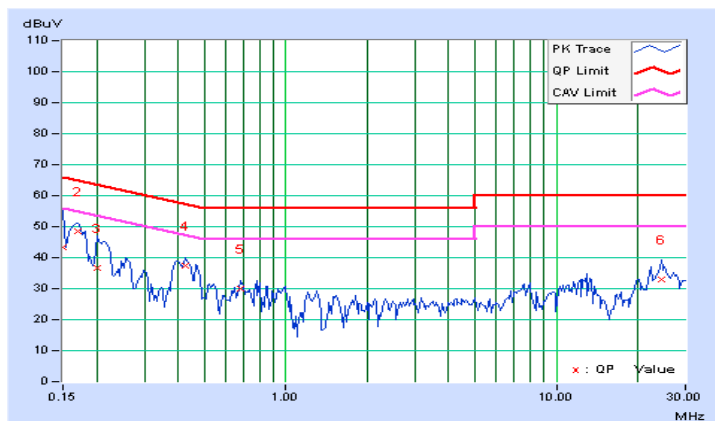



A D T

Radio 1: Patch antenna

802.11b

PHASE	Line 1	6dB BANDWIDTH	9kHz
-------	--------	---------------	------

No	Freq. [MHz]	Corr. Factor (dB)	Reading Value		Emission Level		Limit		Margin	
			[dB (uV)]		[dB (uV)]		[dB (uV)]		(dB)	
			Q.P.	AV.	Q.P.	AV.	Q.P.	AV.	Q.P.	AV.
1	0.16172	0.27	44.92	31.37	45.19	31.64	65.38	55.38	-20.19	-23.74
2	0.20078	0.28	37.49	27.89	37.77	28.17	63.58	53.58	-25.81	-25.41
3	0.23984	0.28	35.78	25.63	36.06	25.91	62.10	52.10	-26.04	-26.19
4	0.41563	0.30	39.05	35.44	39.35	35.74	57.54	47.54	-18.18	-11.79
5	19.32813	0.58	38.17	37.75	38.75	38.33	60.00	50.00	-21.25	-11.67
6	21.61719	0.57	39.82	38.87	40.39	39.44	60.00	50.00	-19.61	-10.56

REMARKS:

1. Q.P. and AV. are abbreviations of quasi-peak and average individually.
2. The emission levels of other frequencies were very low against the limit.
3. Margin value = Emission level - Limit value
4. Correction factor = Insertion loss + Cable loss
5. Emission Level = Correction Factor + Reading Value

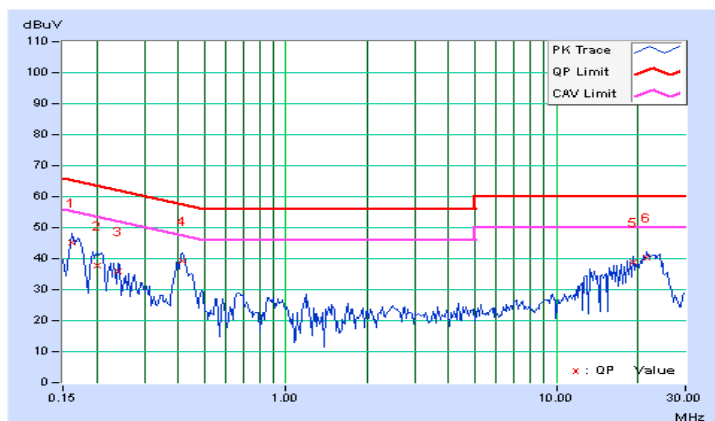

PHASE	Line 2	6dB BANDWIDTH	9kHz
-------	--------	---------------	------

No	Freq. [MHz]	Corr. Factor (dB)	Reading Value		Emission Level		Limit		Margin	
			[dB (uV)]		[dB (uV)]		[dB (uV)]		(dB)	
			Q.P.	AV.	Q.P.	AV.	Q.P.	AV.	Q.P.	AV.
1	0.16681	0.27	43.89	33.37	44.16	33.64	65.12	55.12	-20.96	-21.48
2	0.19687	0.28	40.50	29.45	40.78	29.73	63.74	53.74	-22.96	-24.01
3	0.22829	0.28	37.14	27.09	37.42	27.37	62.51	52.51	-25.09	-25.14
4	0.41172	0.30	40.40	34.73	40.70	35.03	57.61	47.61	-16.91	-12.58
5	0.65781	0.32	28.55	25.61	28.87	25.93	56.00	46.00	-27.13	-20.07
6	23.14453	0.59	41.05	39.26	41.64	39.85	60.00	50.00	-18.36	-10.15

REMARKS:

1. Q.P. and AV. are abbreviations of quasi-peak and average individually.
2. The emission levels of other frequencies were very low against the limit.
3. Margin value = Emission level - Limit value
4. Correction factor = Insertion loss + Cable loss
5. Emission Level = Correction Factor + Reading Value



Radio 1: Sector antenna
802.11b

PHASE	Line 1	6dB BANDWIDTH	9kHz
-------	--------	---------------	------

No	Freq. [MHz]	Corr. Factor (dB)	Reading Value		Emission Level		Limit		Margin	
			[dB (uV)]		[dB (uV)]		[dB (uV)]		(dB)	
			Q.P.	AV.	Q.P.	AV.	Q.P.	AV.	Q.P.	AV.
1	0.15508	0.27	49.63	39.79	49.90	40.06	65.72	55.72	-15.83	-15.67
2	0.19552	0.28	44.08	36.30	44.36	36.58	63.80	53.80	-19.44	-17.22
3	0.23456	0.28	38.86	30.72	39.14	31.00	62.29	52.29	-23.14	-21.28
4	0.39609	0.30	38.73	32.84	39.03	33.14	57.93	47.93	-18.91	-14.80
5	0.84141	0.33	28.26	21.54	28.59	21.87	56.00	46.00	-27.41	-24.13
6	23.47537	0.55	33.38	29.85	33.93	30.40	60.00	50.00	-26.07	-19.60

REMARKS:

1. Q.P. and AV. are abbreviations of quasi-peak and average individually.
2. The emission levels of other frequencies were very low against the limit.
3. Margin value = Emission level - Limit value
4. Correction factor = Insertion loss + Cable loss
5. Emission Level = Correction Factor + Reading Value

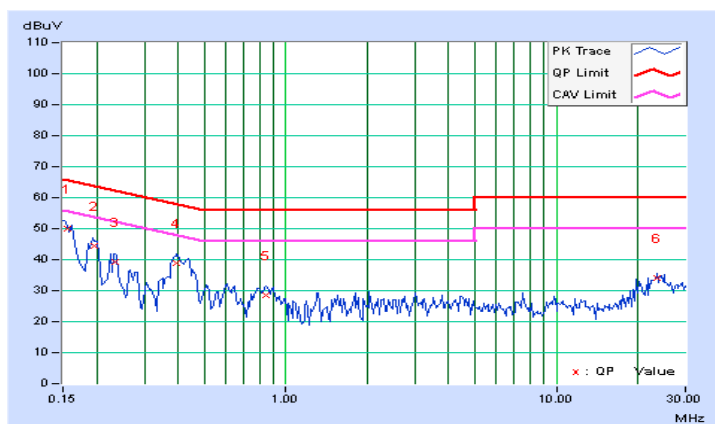

PHASE	Line 2	6dB BANDWIDTH	9kHz
-------	--------	---------------	------

No	Freq. [MHz]	Corr. Factor (dB)	Reading Value		Emission Level		Limit		Margin	
			[dB (uV)]		[dB (uV)]		[dB (uV)]		(dB)	
			Q.P.	AV.	Q.P.	AV.	Q.P.	AV.	Q.P.	AV.
1	0.15305	0.27	49.13	37.61	49.40	37.88	65.83	55.83	-16.44	-17.96
2	0.19297	0.28	43.16	34.10	43.44	34.38	63.91	53.91	-20.47	-19.53
3	0.23203	0.28	37.69	28.57	37.97	28.85	62.38	52.38	-24.40	-23.52
4	0.39609	0.30	37.56	33.09	37.86	33.39	57.93	47.93	-20.08	-14.55
5	0.84531	0.33	25.13	15.56	25.46	15.89	56.00	46.00	-30.54	-30.11
6	22.46484	0.60	31.97	30.03	32.57	30.63	60.00	50.00	-27.43	-19.37

REMARKS:

1. Q.P. and AV. are abbreviations of quasi-peak and average individually.
2. The emission levels of other frequencies were very low against the limit.
3. Margin value = Emission level - Limit value
4. Correction factor = Insertion loss + Cable loss
5. Emission Level = Correction Factor + Reading Value

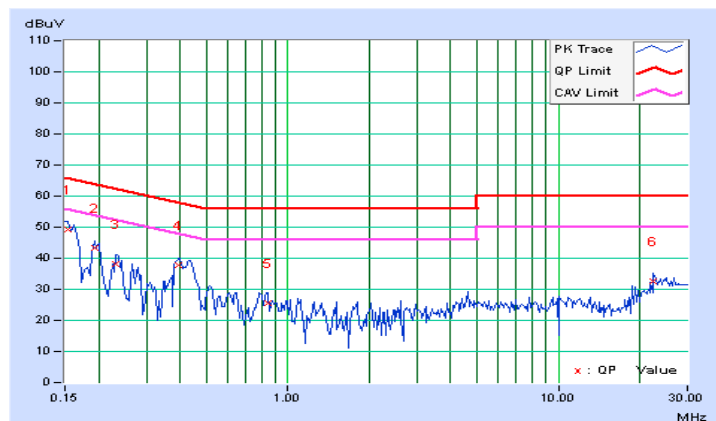

Radio 3: PIFA antenna
802.11g

PHASE	Line 1	6dB BANDWIDTH	9kHz
-------	--------	---------------	------

No	Freq. [MHz]	Corr. Factor (dB)	Reading Value		Emission Level		Limit		Margin	
			[dB (uV)]		[dB (uV)]		[dB (uV)]		(dB)	
			Q.P.	AV.	Q.P.	AV.	Q.P.	AV.	Q.P.	AV.
1	0.15000	0.26	37.91	18.03	38.17	18.29	66.00	56.00	-27.83	-37.71
2	0.16680	0.27	45.89	35.39	46.16	35.66	65.12	55.12	-18.96	-19.46
3	0.20967	0.28	40.48	31.35	40.76	31.63	63.22	53.22	-22.46	-21.59
4	0.42716	0.30	39.57	36.09	39.87	36.39	57.31	47.31	-17.44	-10.92
5	0.68388	0.32	30.94	26.38	31.26	26.70	56.00	46.00	-24.74	-19.30
6	24.99609	0.54	31.73	26.98	32.27	27.52	60.00	50.00	-27.73	-22.48

REMARKS:

1. Q.P. and AV. are abbreviations of quasi-peak and average individually.
2. The emission levels of other frequencies were very low against the limit.
3. Margin value = Emission level - Limit value
4. Correction factor = Insertion loss + Cable loss
5. Emission Level = Correction Factor + Reading Value

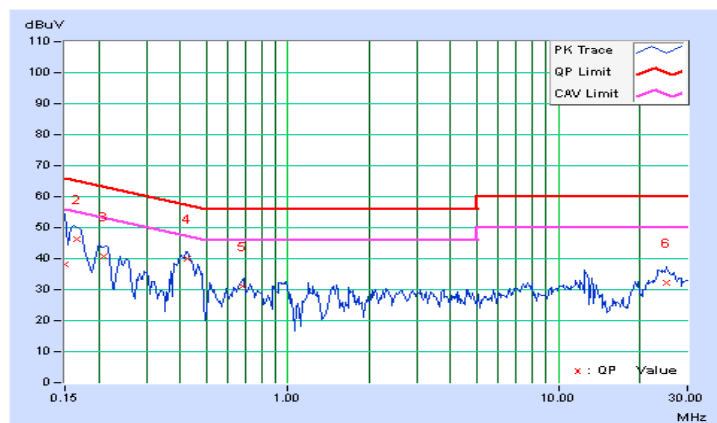

PHASE	Line 2	6dB BANDWIDTH	9kHz
-------	--------	---------------	------

No	Freq. [MHz]	Corr. Factor (dB)	Reading Value		Emission Level		Limit		Margin	
			[dB (uV)]		[dB (uV)]		[dB (uV)]		(dB)	
			Q.P.	AV.	Q.P.	AV.	Q.P.	AV.	Q.P.	AV.
1	0.16757	0.27	45.99	35.52	46.26	35.79	65.08	55.08	-18.82	-19.29
2	0.20968	0.28	39.74	30.47	40.02	30.75	63.22	53.22	-23.20	-22.47
3	0.42589	0.30	38.78	35.33	39.08	35.63	57.33	47.33	-18.25	-11.70
4	0.68125	0.32	29.77	25.61	30.09	25.93	56.00	46.00	-25.91	-20.07
5	12.29297	0.54	31.93	30.64	32.47	31.18	60.00	50.00	-27.53	-18.82
6	24.59766	0.57	31.30	26.36	31.87	26.93	60.00	50.00	-28.13	-23.07

REMARKS:

1. Q.P. and AV. are abbreviations of quasi-peak and average individually.
2. The emission levels of other frequencies were very low against the limit.
3. Margin value = Emission level - Limit value
4. Correction factor = Insertion loss + Cable loss
5. Emission Level = Correction Factor + Reading Value

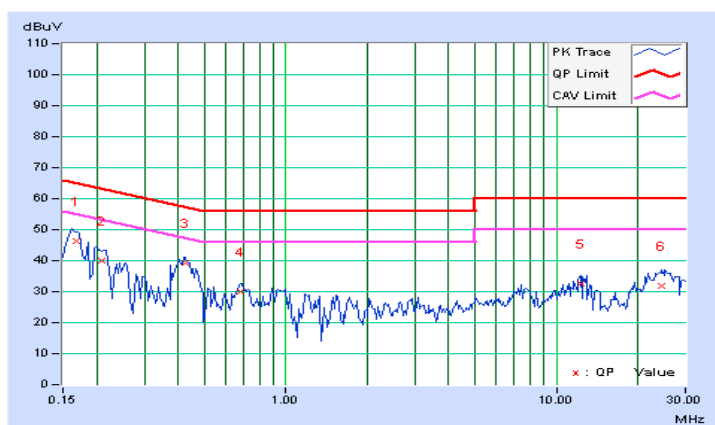

4.3 6dB BANDWIDTH MEASUREMENT

4.3.1 LIMITS OF 6dB BANDWIDTH MEASUREMENT

The minimum of 6dB Bandwidth Measurement is 0.5 MHz.

4.3.2 TEST SETUP

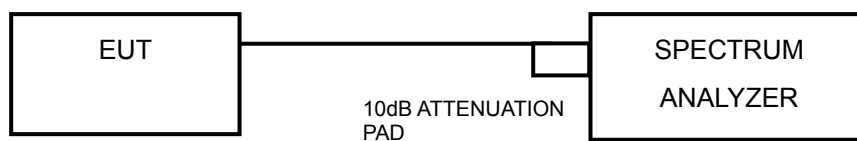

4.3.3 TEST INSTRUMENTS

Refer to section 4.1.2 to get information of above instrument.

4.3.4 TEST PROCEDURE

- a. Set resolution bandwidth (RBW) = 100kHz
- b. Set the video bandwidth (VBW) $\geq 3 \times$ RBW, Detector = Peak.
- c. Trace mode = max hold.
- d. Sweep = auto couple.
- e. Measure the maximum width of the emission that is constrained by the frequencies associated with the two amplitude points (upper and lower) that are attenuated by 6 dB relative to the maximum level measured in the fundamental emission

4.3.5 DEVIATION FROM TEST STANDARD

No deviation.

4.3.6 EUT OPERATING CONDITIONS

The software provided by client to enable the EUT under transmission condition continuously at lowest, middle and highest channel frequencies individually.

4.3.7 TEST RESULTS

Radio 1: Dipole antenna

802.11b

CHANNEL	FREQUENCY (MHz)	6dB BANDWIDTH (MHz)		MINIMUM LIMIT (MHz)	PASS / FAIL
		CHAIN 0	CHAIN 1		
1	2412	8.58	9.06	0.5	PASS
6	2437	9.09	9.10	0.5	PASS
11	2462	8.57	8.59	0.5	PASS

802.11g

CHANNEL	FREQUENCY (MHz)	6dB BANDWIDTH (MHz)		MINIMUM LIMIT (MHz)	PASS / FAIL
		CHAIN 0	CHAIN 1		
1	2412	16.40	16.45	0.5	PASS
6	2437	16.36	16.40	0.5	PASS
11	2462	16.37	16.41	0.5	PASS

802.11n (20MHz)

CHANNEL	FREQUENCY (MHz)	6dB BANDWIDTH (MHz)		MINIMUM LIMIT (MHz)	PASS / FAIL
		CHAIN 0	CHAIN 1		
1	2412	17.62	17.65	0.5	PASS
6	2437	17.61	17.64	0.5	PASS
11	2462	17.60	17.64	0.5	PASS



A D T

SPECTRUM PLOT OF WORST VALUE

802.11b

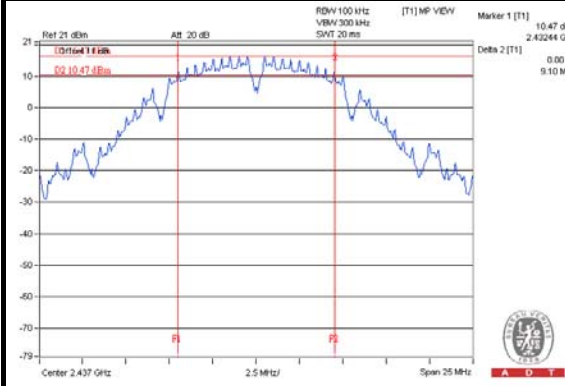

802.11g

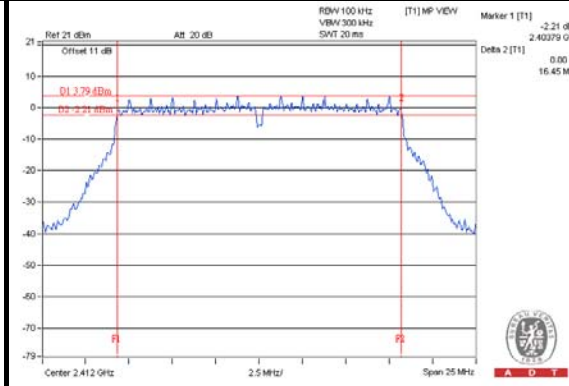

802.11n (20MHz)

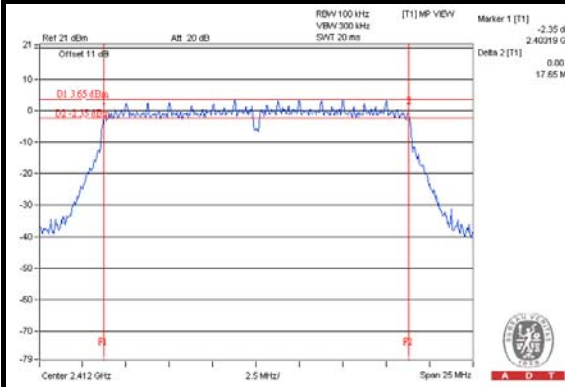



Radio 1: Patch antenna

802.11b

CHANNEL	FREQUENCY (MHz)	6dB BANDWIDTH (MHz)		MINIMUM LIMIT (MHz)	PASS / FAIL
		CHAIN 0	CHAIN 1		
1	2412	8.59	8.60	0.5	PASS
6	2437	9.06	9.07	0.5	PASS
11	2462	8.14	8.57	0.5	PASS

802.11g

CHANNEL	FREQUENCY (MHz)	6dB BANDWIDTH (MHz)		MINIMUM LIMIT (MHz)	PASS / FAIL
		CHAIN 0	CHAIN 1		
1	2412	16.41	16.43	0.5	PASS
6	2437	16.37	16.41	0.5	PASS
11	2462	16.38	16.42	0.5	PASS

802.11n (20MHz)

CHANNEL	FREQUENCY (MHz)	6dB BANDWIDTH (MHz)		MINIMUM LIMIT (MHz)	PASS / FAIL
		CHAIN 0	CHAIN 1		
1	2412	17.64	17.66	0.5	PASS
6	2437	17.62	17.66	0.5	PASS
11	2462	17.60	17.65	0.5	PASS

SPECTRUM PLOT OF WORST VALUE

802.11b

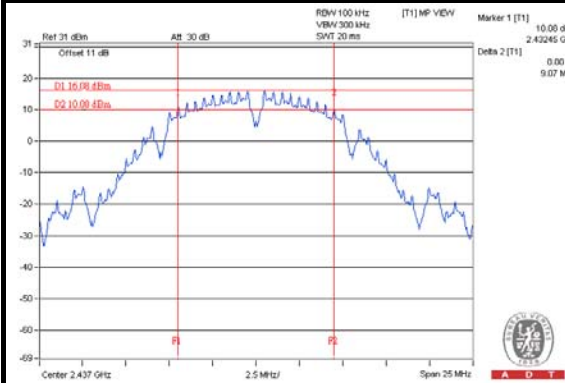

802.11g

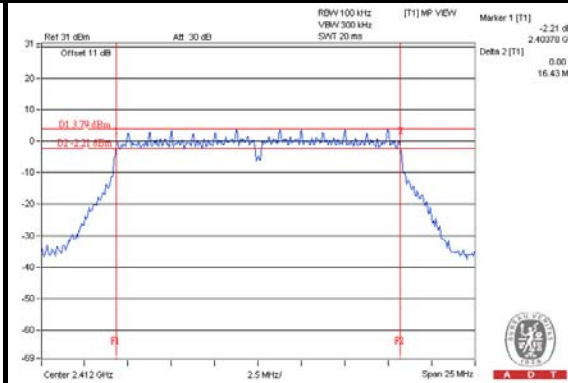

802.11n (20MHz)

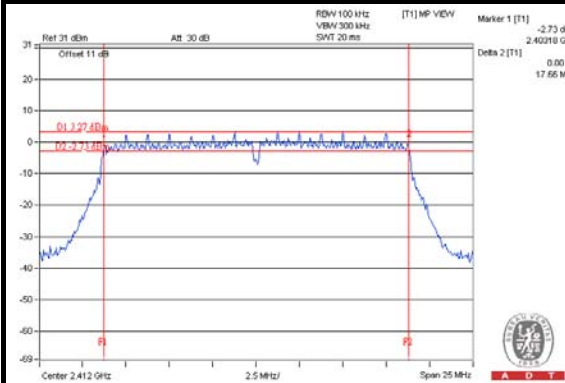



Radio 1: Sector antenna

802.11b

CHANNEL	FREQUENCY (MHz)	6dB BANDWIDTH (MHz)		MINIMUM LIMIT (MHz)	PASS / FAIL
		CHAIN 0	CHAIN 1		
1	2412	8.58	8.59	0.5	PASS
6	2437	8.56	9.09	0.5	PASS
11	2462	9.06	8.12	0.5	PASS

802.11g

CHANNEL	FREQUENCY (MHz)	6dB BANDWIDTH (MHz)		MINIMUM LIMIT (MHz)	PASS / FAIL
		CHAIN 0	CHAIN 1		
1	2412	16.39	16.41	0.5	PASS
6	2437	16.36	16.39	0.5	PASS
11	2462	16.38	16.40	0.5	PASS

802.11n (20MHz)

CHANNEL	FREQUENCY (MHz)	6dB BANDWIDTH (MHz)		MINIMUM LIMIT (MHz)	PASS / FAIL
		CHAIN 0	CHAIN 1		
1	2412	17.62	17.66	0.5	PASS
6	2437	17.61	17.67	0.5	PASS
11	2462	17.62	17.64	0.5	PASS

SPECTRUM PLOT OF WORST VALUE

802.11b

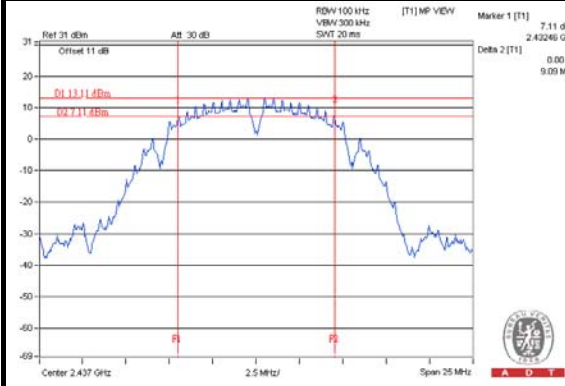

802.11g

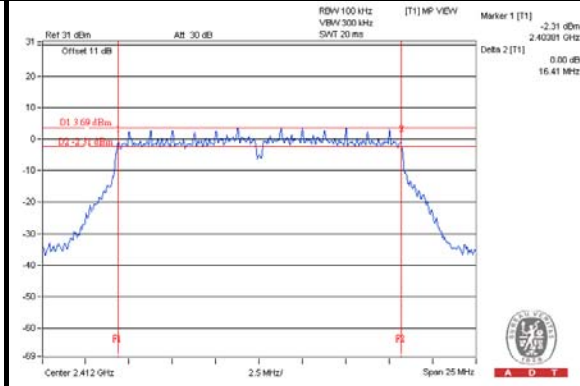

802.11n (20MHz)

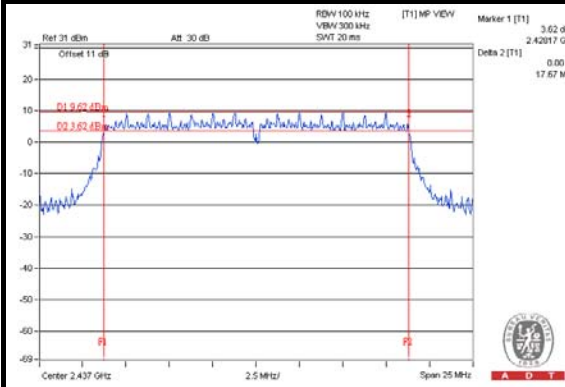



A D T

Radio 3: PIFA antenna

802.11b

CHANNEL	FREQUENCY (MHz)	6dB BANDWIDTH (MHz)	MINIMUM LIMIT (MHz)	PASS / FAIL
1	2412	8.09	0.5	PASS
6	2437	8.11	0.5	PASS
11	2462	8.10	0.5	PASS

802.11g

CHANNEL	FREQUENCY (MHz)	6dB BANDWIDTH (MHz)	MINIMUM LIMIT (MHz)	PASS / FAIL
1	2412	15.19	0.5	PASS
6	2437	15.12	0.5	PASS
11	2462	15.14	0.5	PASS

802.11n (20MHz)

CHANNEL	FREQUENCY (MHz)	6dB BANDWIDTH (MHz)	MINIMUM LIMIT (MHz)	PASS / FAIL
1	2412	15.17	0.5	PASS
6	2437	15.15	0.5	PASS
11	2462	15.15	0.5	PASS

SPECTRUM PLOT OF WORST VALUE

802.11b

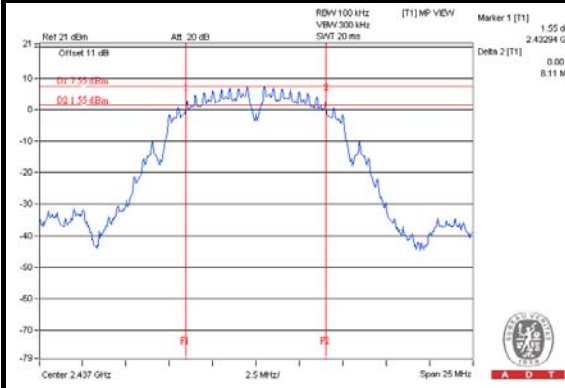

802.11g

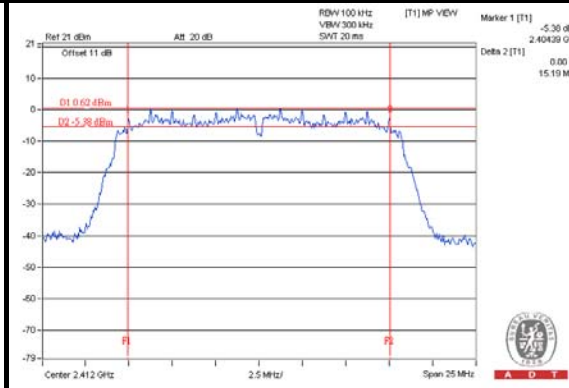

802.11n (20MHz)

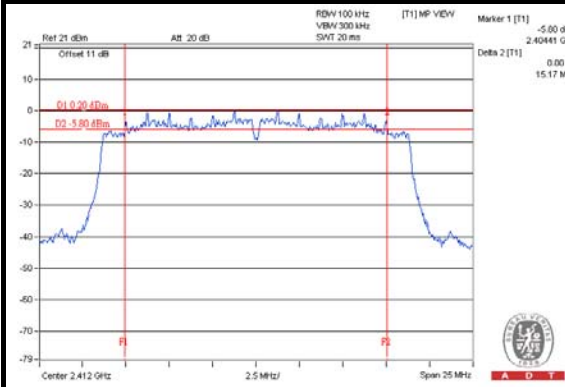

4.4 CONDUCTED OUTPUT POWER

4.4.1 LIMITS OF CONDUCTED OUTPUT POWER MEASUREMENT

For systems using digital modulation in the 2400–2483.5 MHz bands: 1 Watt (30dBm)

Per KDB 662911 D01 Multiple Transmitter Output v02r01 Method of conducted output power measurement on IEEE 802.11 devices,

Array Gain = 0 dB (i.e., no array gain) for $NANT \leq 4$;

Array Gain = 0 dB (i.e., no array gain) for channel widths ≥ 40 MHz for any NANT;

Array Gain = $5 \log(NANT/NSS)$ dB or 3 dB, whichever is less for 20-MHz channel widths with $NANT \geq 5$.

For power measurements on all other devices: Array Gain = $10 \log(NANT/NSS)$ dB.

4.4.2 TEST SETUP

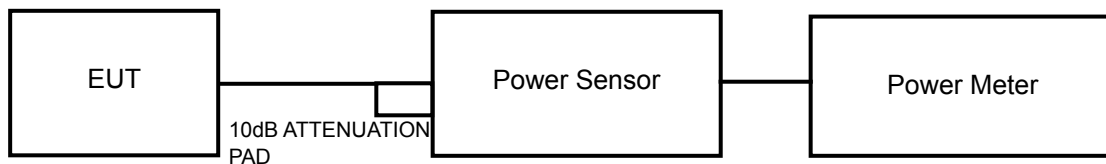

4.4.3 TEST INSTRUMENTS

Refer to section 4.1.2 to get information of above instrument.

4.4.4 TEST PROCEDURES

An average power sensor was used on the output port of the EUT. A power meter was used to read the response of the average power sensor. Record the power level.



A D T

4.4.5 DEVIATION FROM TEST STANDARD

No deviation.

4.4.6 EUT OPERATING CONDITIONS

Same as Item 4.3.6.

4.4.7 TEST RESULTS

Radio 1: Dipole antenna

802.11b

CHAN.	FREQ. (MHz)	AVG. POWER (dBm)		TOTAL POWER (mW)	TOTAL POWER (dBm)	LIMIT (dBm)	PASS / FAIL
		CHAIN 0	CHAIN 1				
1	2412	21.46	21.36	276.732	24.42	30	PASS
6	2437	24.68	25.23	627.191	27.97	30	PASS
11	2462	20.75	20.74	237.427	23.76	30	PASS

802.11g

CHAN.	FREQ. (MHz)	AVG. POWER (dBm)		TOTAL POWER (mW)	TOTAL POWER (dBm)	LIMIT (dBm)	PASS / FAIL
		CHAIN 0	CHAIN 1				
1	2412	15.34	15.31	68.161	18.34	30	PASS
6	2437	22.22	22.12	329.655	25.18	30	PASS
11	2462	16.49	16.40	88.218	19.46	30	PASS

802.11n (20MHz)

CHAN.	FREQ. (MHz)	AVG. POWER (dBm)		TOTAL POWER (mW)	TOTAL POWER (dBm)	LIMIT (dBm)	PASS / FAIL
		CHAIN 0	CHAIN 1				
1	2412	14.81	14.65	59.443	17.74	30	PASS
6	2437	21.60	21.47	284.825	24.55	30	PASS
11	2462	16.00	15.97	79.348	19.00	30	PASS



Radio 1: Patch antenna

802.11b

CHAN.	FREQ. (MHz)	AVG. POWER (dBm)		TOTAL POWER (mW)	TOTAL POWER (dBm)	LIMIT (dBm)	PASS / FAIL
		CHAIN 0	CHAIN 1				
1	2412	21.31	21.59	279.419	24.46	27.90	PASS
6	2437	24.56	25.04	604.913	27.82	27.90	PASS
11	2462	19.41	20.01	187.528	22.73	27.90	PASS

Gain = 8.1 > 6dBi, so the conducted power limit shall be reduced to 30-(8.1-6) = 27.90dBm.

802.11g

CHAN.	FREQ. (MHz)	AVG. POWER (dBm)		TOTAL POWER (mW)	TOTAL POWER (dBm)	LIMIT (dBm)	PASS / FAIL
		CHAIN 0	CHAIN 1				
1	2412	15.53	15.68	72.710	18.62	27.90	PASS
6	2437	22.01	22.33	329.857	25.18	27.90	PASS
11	2462	15.71	15.86	75.787	18.80	27.90	PASS

Gain = 8.1 > 6dBi, so the conducted power limit shall be reduced to 30-(8.1-6) = 27.90dBm.

802.11n (20MHz)

CHAN.	FREQ. (MHz)	AVG. POWER (dBm)		TOTAL POWER (mW)	TOTAL POWER (dBm)	LIMIT (dBm)	PASS / FAIL
		CHAIN 0	CHAIN 1				
1	2412	14.71	14.81	59.849	17.77	27.90	PASS
6	2437	21.54	22.00	301.05	24.79	27.90	PASS
11	2462	15.55	15.87	74.529	18.72	27.90	PASS

Gain = 8.1 > 6dBi, so the conducted power limit shall be reduced to 30-(8.1-6) = 27.90dBm.

**Radio 1: Sector antenna****802.11b**

CHAN.	FREQ. (MHz)	AVG. POWER (dBm)		TOTAL POWER (mW)	TOTAL POWER (dBm)	LIMIT (dBm)	PASS / FAIL
		CHAIN 0	CHAIN 1				
1	2412	20.25	20.65	222.070	23.46	25.00	PASS
6	2437	21.88	22.08	315.606	24.99	25.00	PASS
11	2462	20.34	20.45	219.060	23.41	25.00	PASS

Gain = 11 > 6dBi, so the conducted power limit shall be reduced to $30-(11-6) = 25.00$ dBm.

802.11g

CHAN.	FREQ. (MHz)	AVG. POWER (dBm)		TOTAL POWER (mW)	TOTAL POWER (dBm)	LIMIT (dBm)	PASS / FAIL
		CHAIN 0	CHAIN 1				
1	2412	15.18	15.21	66.150	18.21	25.00	PASS
6	2437	21.03	21.15	257.082	24.10	25.00	PASS
11	2462	15.69	15.70	74.222	18.71	25.00	PASS

Gain = 11 > 6dBi, so the conducted power limit shall be reduced to $30-(11-6) = 25.00$ dBm.

802.11n (20MHz)

CHAN.	FREQ. (MHz)	AVG. POWER (dBm)		TOTAL POWER (mW)	TOTAL POWER (dBm)	LIMIT (dBm)	PASS / FAIL
		CHAIN 0	CHAIN 1				
1	2412	13.61	13.70	46.403	16.67	25.00	PASS
6	2437	21.13	21.23	262.457	24.19	25.00	PASS
11	2462	14.72	14.88	60.409	17.81	25.00	PASS

Gain = 11 > 6dBi, so the conducted power limit shall be reduced to $30-(11-6) = 25.00$ dBm.

**Radio 3: PIFA antenna****802.11b**

CHANNEL	FREQUENCY (MHz)	AVG. POWER (mW)	AVG. POWER (dBm)	LIMIT (dBm)	PASS/FAIL
1	2412	57.016	17.56	30	PASS
6	2437	38.371	15.84	30	PASS
11	2462	34.356	15.36	30	PASS

802.11g

CHANNEL	FREQUENCY (MHz)	AVG. POWER (mW)	AVG. POWER (dBm)	LIMIT (dBm)	PASS/FAIL
1	2412	13.868	11.42	30	PASS
6	2437	92.045	19.64	30	PASS
11	2462	25.527	14.07	30	PASS

802.11n (20MHz)

CHANNEL	FREQUENCY (MHz)	AVG. POWER (mW)	AVG. POWER (dBm)	LIMIT (dBm)	PASS/FAIL
1	2412	11.858	10.74	30	PASS
6	2437	83.753	19.23	30	PASS
11	2462	25.586	14.08	30	PASS

4.5 POWER SPECTRAL DENSITY MEASUREMENT

4.5.1 LIMITS OF POWER SPECTRAL DENSITY MEASUREMENT

The Maximum of Power Spectral Density Measurement is 8dBm.

4.5.2 TEST SETUP

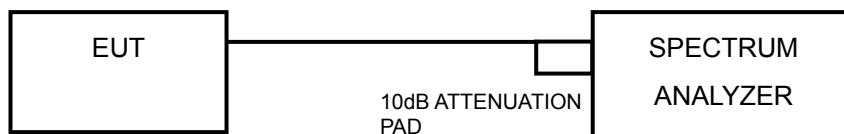

4.5.3 TEST INSTRUMENTS

Refer to section 4.1.2 to get information of above instrument.

4.5.4 TEST PROCEDURE

- a) Set instrument center frequency to DTS channel center frequency.
- b) Set span to at least 1.5 times the OBW.
- c) Set RBW to: $3 \text{ kHz} \leq \text{RBW} \leq 100 \text{ kHz}$.
- d) Set VBW $\geq 3 \times \text{RBW}$.
- e) Detector = power averaging (RMS) or sample detector (when RMS not available).
- f) Ensure that the number of measurement points in the sweep $\geq 2 \times \text{span}/\text{RBW}$.
- g) Sweep time = auto couple.
- h) Employ trace averaging (RMS) mode over a minimum of 100 traces.
- i) Use the peak marker function to determine the maximum amplitude level.

4.5.5 DEVIATION FROM TEST STANDARD

No deviation.

4.5.6 EUT OPERATING CONDITION

Same as Item 4.3.6

4.5.7 TEST RESULTS

Radio 1: Dipole antenna

802.11b

TX chain	Channel	Freq. (MHz)	PSD (dBm)	10 log (N=2) dB	Total PSD (dBm)	Limit (dBm)	PASS /FAIL
0	1	2412	-6.11	3.01	-3.10	6.99	PASS
	6	2437	-3.72	3.01	-0.71	6.99	PASS
	11	2462	-6.90	3.01	-3.89	6.99	PASS
1	1	2412	-6.36	3.01	-3.35	6.99	PASS
	6	2437	-2.74	3.01	0.27	6.99	PASS
	11	2462	-7.01	3.01	-4.00	6.99	PASS

NOTE: Directional gain = $4\text{dBi} + 10\log(2) = 7.01\text{dBi} > 6\text{dBi}$, so the power density limit shall be reduced to $8-(7.01-6) = 6.99\text{dBm}$.

802.11g

TX chain	Channel	Freq. (MHz)	PSD (dBm)	10 log (N=2) dB	Total PSD (dBm)	Limit (dBm)	PASS /FAIL
0	1	2412	-13.71	3.01	-10.70	6.99	PASS
	6	2437	-7.59	3.01	-4.58	6.99	PASS
	11	2462	-12.80	3.01	-9.79	6.99	PASS
1	1	2412	-14.09	3.01	-11.08	6.99	PASS
	6	2437	-7.07	3.01	-4.06	6.99	PASS
	11	2462	-12.51	3.01	-9.50	6.99	PASS

NOTE: Directional gain = $4\text{dBi} + 10\log(2) = 7.01\text{dBi} > 6\text{dBi}$, so the power density limit shall be reduced to $8-(7.01-6) = 6.99\text{dBm}$.

802.11n (20MHz)

TX chain	Channel	Freq. (MHz)	PSD (dBm)	10 log (N=2) dB	Total PSD (dBm)	Limit (dBm)	PASS /FAIL
0	1	2412	-15.92	3.01	-12.91	6.99	PASS
	6	2437	-8.97	3.01	-5.96	6.99	PASS
	11	2462	-14.05	3.01	-11.04	6.99	PASS
1	1	2412	-15.11	3.01	-12.10	6.99	PASS
	6	2437	-8.58	3.01	-5.57	6.99	PASS
	11	2462	-14.45	3.01	-11.44	6.99	PASS

NOTE: Directional gain = $4\text{dBi} + 10\log(2) = 7.01\text{dBi} > 6\text{dBi}$, so the power density limit shall be reduced to $8-(7.01-6) = 6.99\text{dBm}$.



A D T

SPECTRUM PLOT OF WORST VALUE

802.11b

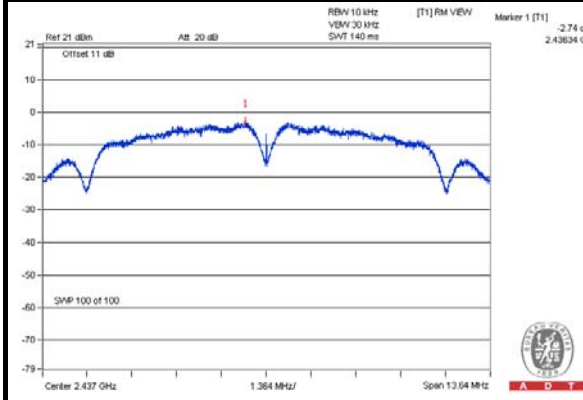

802.11g

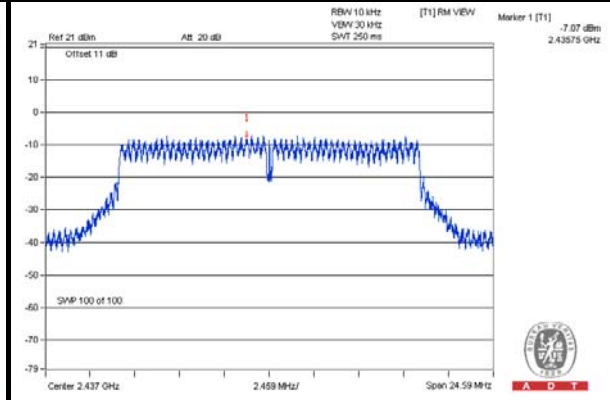

802.11n (20MHz)

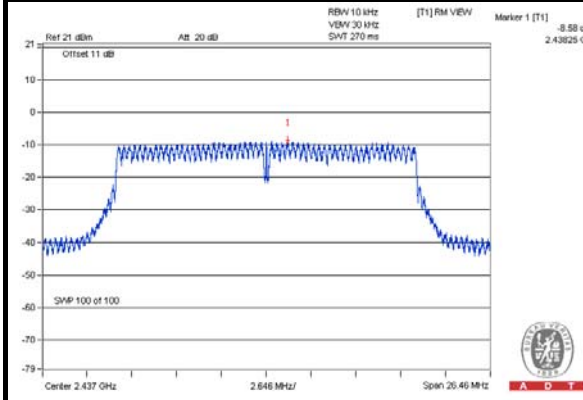



Radio 1: Patch antenna

802.11b

TX chain	Channel	Freq. (MHz)	PSD (dBm)	10 log (N=2) dB	Total PSD (dBm)	Limit (dBm)	PASS /FAIL
0	1	2412	-7.20	3.01	-4.19	2.89	PASS
	6	2437	-4.00	3.01	-0.99	2.89	PASS
	11	2462	-8.90	3.01	-5.89	2.89	PASS
1	1	2412	-6.93	3.01	-3.92	2.89	PASS
	6	2437	-3.77	3.01	-0.76	2.89	PASS
	11	2462	-8.49	3.01	-5.48	2.89	PASS

NOTE: Directional gain = 8.1dBi + 10log(2) = 11.11dBi > 6dBi , so the power density limit shall be reduced to 8-(11.11-6) = 2.89dBm.

802.11g

TX chain	Channel	Freq. (MHz)	PSD (dBm)	10 log (N=2) dB	Total PSD (dBm)	Limit (dBm)	PASS /FAIL
0	1	2412	-14.14	3.01	-11.13	2.89	PASS
	6	2437	-7.32	3.01	-4.31	2.89	PASS
	11	2462	-14.06	3.01	-11.05	2.89	PASS
1	1	2412	-13.46	3.01	-10.45	2.89	PASS
	6	2437	-6.58	3.01	-3.57	2.89	PASS
	11	2462	-13.42	3.01	-10.41	2.89	PASS

NOTE: Directional gain = 8.1dBi + 10log(2) = 11.11dBi > 6dBi , so the power density limit shall be reduced to 8-(11.11-6) = 2.89dBm.

802.11n (20MHz)

TX chain	Channel	Freq. (MHz)	PSD (dBm)	10 log (N=2) dB	Total PSD (dBm)	Limit (dBm)	PASS /FAIL
0	1	2412	-16.12	3.01	-13.11	2.89	PASS
	6	2437	-9.15	3.01	-6.14	2.89	PASS
	11	2462	-15.46	3.01	-12.45	2.89	PASS
1	1	2412	-15.44	3.01	-12.43	2.89	PASS
	6	2437	-8.98	3.01	-5.97	2.89	PASS
	11	2462	-15.21	3.01	-12.20	2.89	PASS

NOTE: Directional gain = 8.1dBi + 10log(2) = 11.11dBi > 6dBi , so the power density limit shall be reduced to 8-(11.11-6) = 2.89dBm.



A D T

SPECTRUM PLOT OF WORST VALUE

802.11b

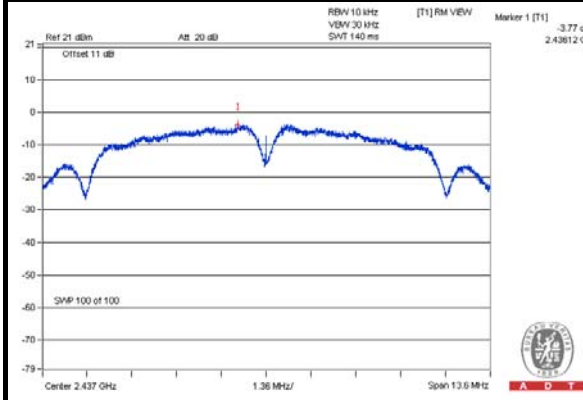

802.11g

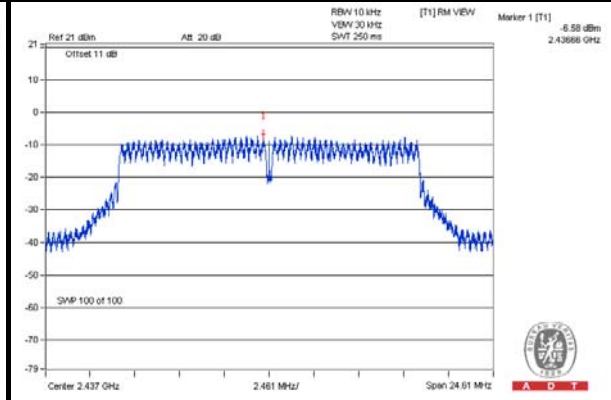

802.11n (20MHz)

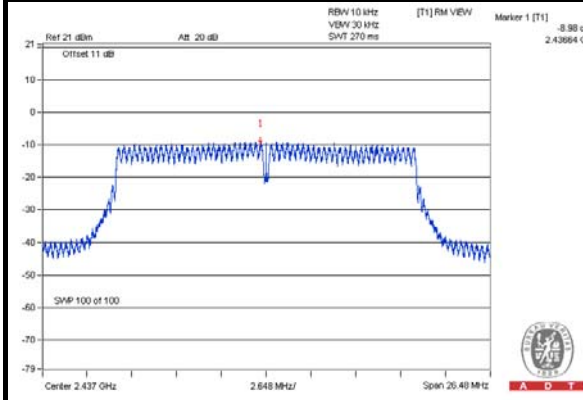

Radio 1: Sector antenna

802.11b

TX chain	Channel	Freq. (MHz)	PSD (dBm)	10 log (N=2) dB	Total PSD (dBm)	Limit (dBm)	PASS /FAIL
0	1	2412	-8.39	3.01	-5.38	-0.01	PASS
	6	2437	-6.47	3.01	-3.46	-0.01	PASS
	11	2462	-8.59	3.01	-5.58	-0.01	PASS
1	1	2412	-8.14	3.01	-5.13	-0.01	PASS
	6	2437	-6.58	3.01	-3.57	-0.01	PASS
	11	2462	-7.58	3.01	-4.57	-0.01	PASS

NOTE: Directional gain = 11dBi + 10log(2) = 14.01dBi > 6dBi , so the power density limit shall be reduced to 8-(14.01-6) = -0.01dBm.

802.11g

TX chain	Channel	Freq. (MHz)	PSD (dBm)	10 log (N=2) dB	Total PSD (dBm)	Limit (dBm)	PASS /FAIL
0	1	2412	-14.39	3.01	-11.38	-0.01	PASS
	6	2437	-8.87	3.01	-5.86	-0.01	PASS
	11	2462	-14.37	3.01	-11.36	-0.01	PASS
1	1	2412	-14.53	3.01	-11.52	-0.01	PASS
	6	2437	-8.65	3.01	-5.64	-0.01	PASS
	11	2462	-13.93	3.01	-10.92	-0.01	PASS

NOTE: Directional gain = 11dBi + 10log(2) = 14.01dBi > 6dBi , so the power density limit shall be reduced to 8-(14.01-6) = -0.01dBm.

802.11n (20MHz)

TX chain	Channel	Freq. (MHz)	PSD (dBm)	10 log (N=2) dB	Total PSD (dBm)	Limit (dBm)	PASS /FAIL
0	1	2412	-17.37	3.01	-14.36	-0.01	PASS
	6	2437	-9.56	3.01	-6.55	-0.01	PASS
	11	2462	-16.48	3.01	-13.47	-0.01	PASS
1	1	2412	-16.35	3.01	-13.34	-0.01	PASS
	6	2437	-9.79	3.01	-6.78	-0.01	PASS
	11	2462	-16.07	3.01	-13.06	-0.01	PASS

NOTE: Directional gain = 11dBi + 10log(2) = 14.01dBi > 6dBi , so the power density limit shall be reduced to 8-(14.01-6) = -0.01dBm.



A D T

SPECTRUM PLOT OF WORST VALUE

802.11b

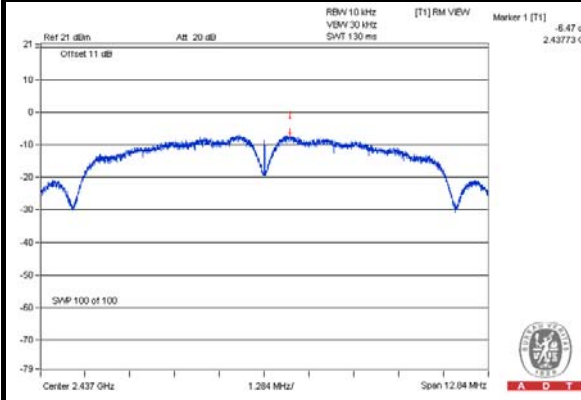

802.11g

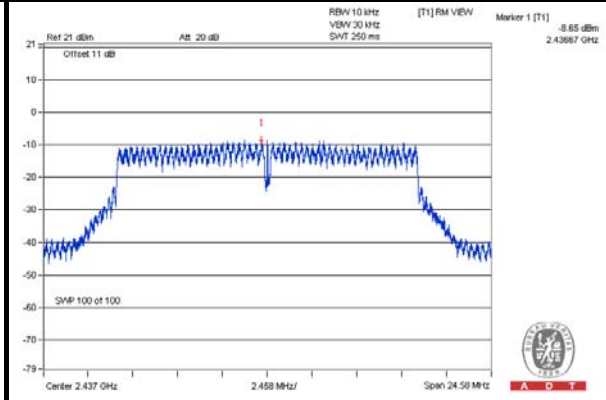

802.11n (20MHz)

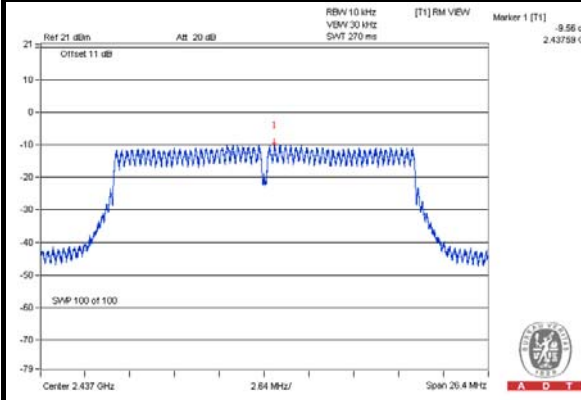



Radio 3: PIFA antenna

802.11b

CHANNEL	FREQUENCY (MHz)	PSD (dBm)	LIMIT (dBm)	PASS /FAIL
1	2412	-9.13	8	PASS
6	2437	-12.00	8	PASS
11	2462	-12.35	8	PASS

802.11g

CHANNEL	FREQUENCY (MHz)	PSD (dBm)	LIMIT (dBm)	PASS /FAIL
1	2412	-17.60	8	PASS
6	2437	-9.43	8	PASS
11	2462	-15.59	8	PASS

802.11n (20MHz)

CHANNEL	FREQUENCY (MHz)	PSD (dBm)	LIMIT (dBm)	PASS /FAIL
1	2412	-18.62	8	PASS
6	2437	-9.82	8	PASS
11	2462	-15.41	8	PASS

SPECTRUM PLOT OF WORST VALUE

802.11b

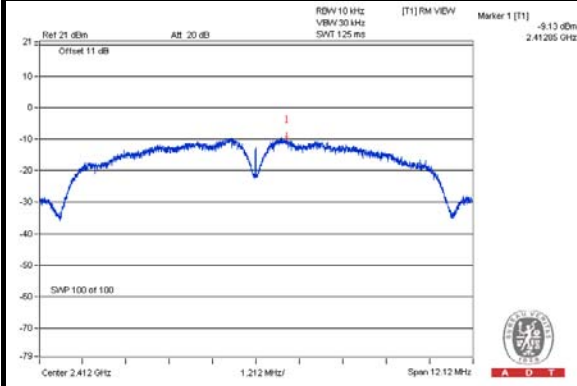

802.11g

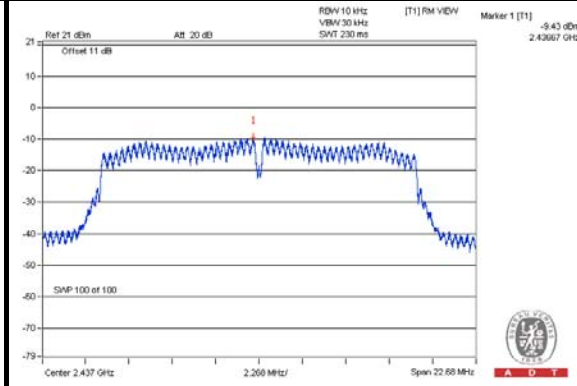

802.11n (20MHz)

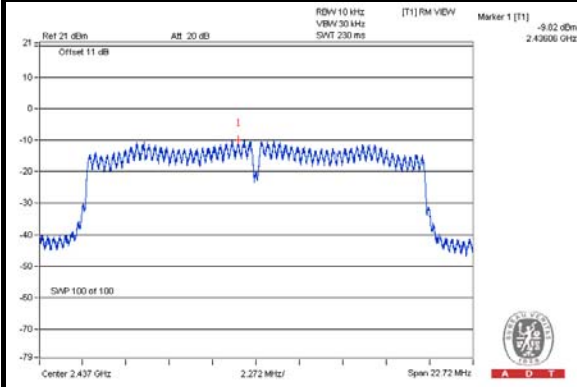

4.6 CONDUCTED OUT OF BAND EMISSION MEASUREMENT

4.6.1 LIMITS OF CONDUCTED OUT OF BAND EMISSION MEASUREMENT

Below -30dB of the highest emission level of operating band (in 100kHz Resolution Bandwidth).

4.6.2 TEST SETUP

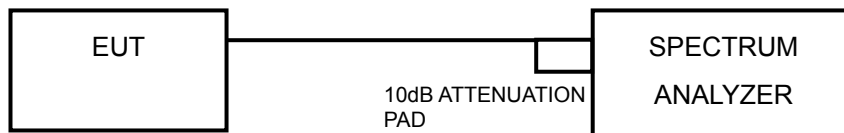

4.6.3 TEST INSTRUMENTS

Refer to section 4.1.2 to get information of above instrument.

4.6.4 TEST PROCEDURE

MEASUREMENT PROCEDURE REF

1. Set the RBW = 100 kHz.
2. Set the VBW \geq 300 kHz.
3. Detector = average.
4. Sweep time = auto couple.
5. Trace mode = max hold.
6. Allow trace to fully stabilize.
7. Use the peak marker function to determine the maximum power level in any 100 kHz band segment within the fundamental EBW.

MEASUREMENT PROCEDURE OOB

1. Set RBW = 100 kHz.
2. Set VBW \geq 300 kHz.
3. Detector = peak.
4. Sweep = auto couple.
5. Trace Mode = max hold.
6. Allow trace to fully stabilize.
7. Use the peak marker function to determine the maximum amplitude level.

4.6.5 DEVIATION FROM TEST STANDARD

No deviation.

4.6.6 EUT OPERATING CONDITION

Same as Item 4.3.6

4.6.7 TEST RESULTS

The conducted emission test is performed on each TX port of operating mode without summing or adding $10\log(N)$ since the limit is relative emission limit. Only worst data of each operating mode is presented.

The spectrum plots are attached on the following pages. D1 line indicates the highest level, and D2 line indicates the 30dB offset below D1. It shows compliance with the requirement.

Radio 1: Dipole antenna

802.11b

CHAIN 0

CH 1

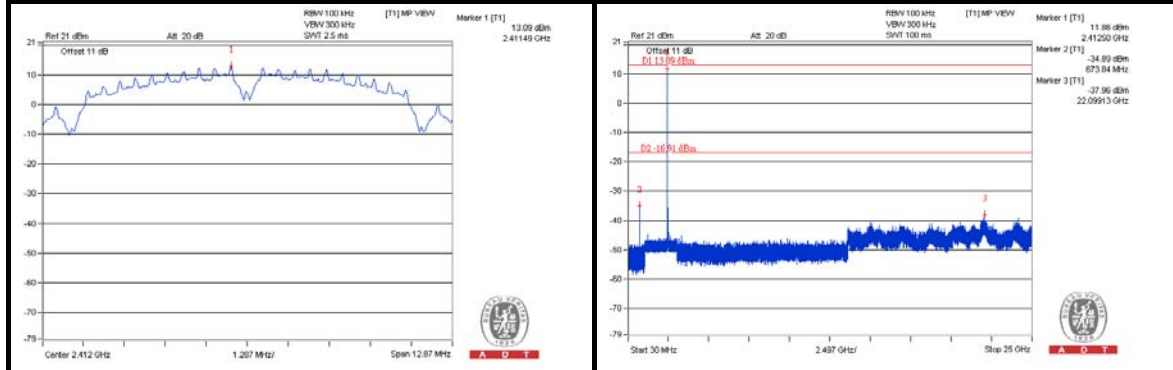

CH 6

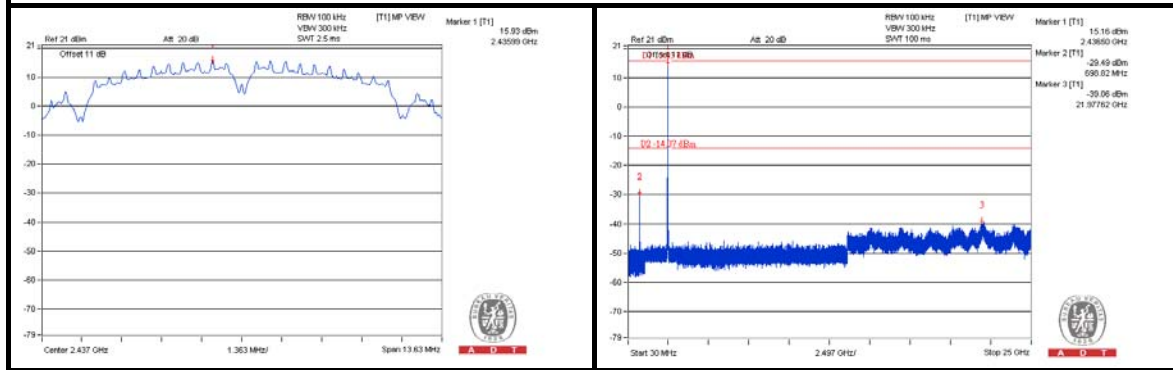

CH 11

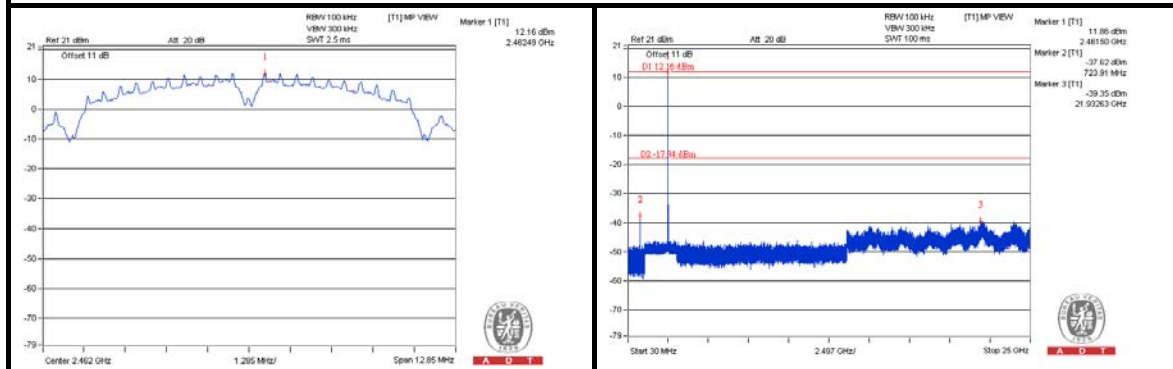

CH 1 Band edge

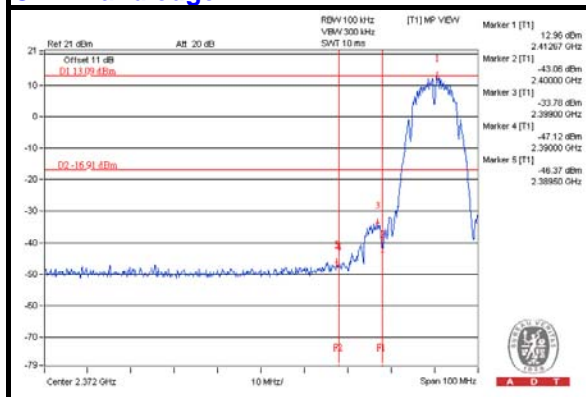

CH 11 Band edge

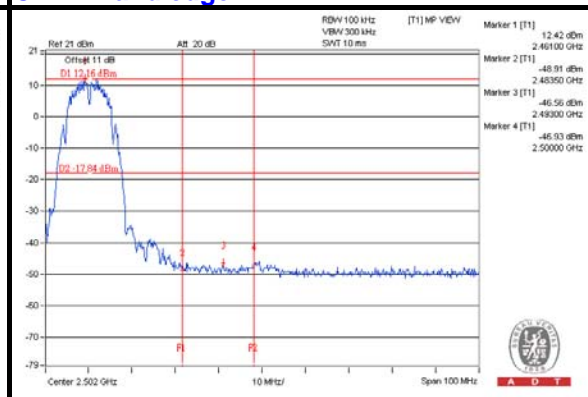

CHAIN 1

CH 1

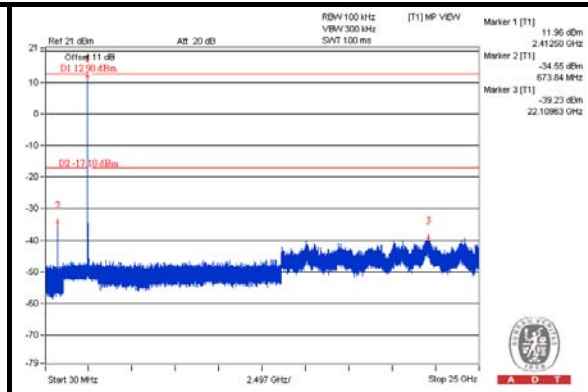
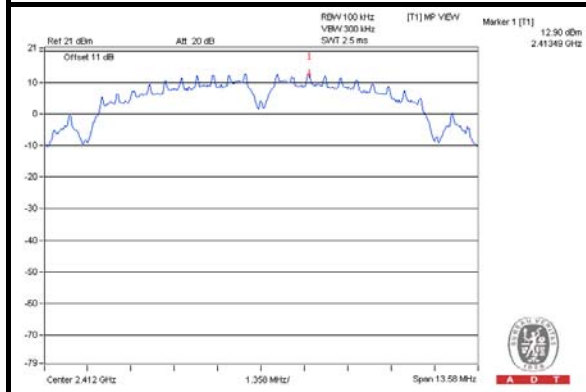

CH 6

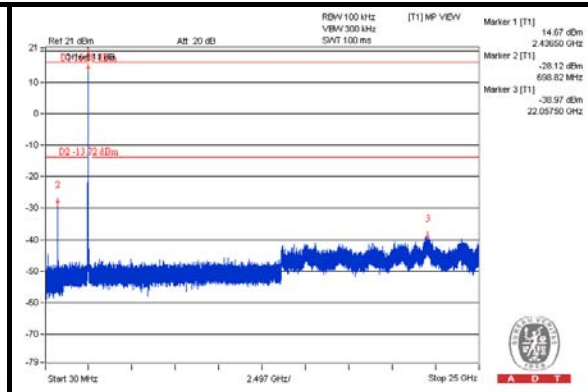
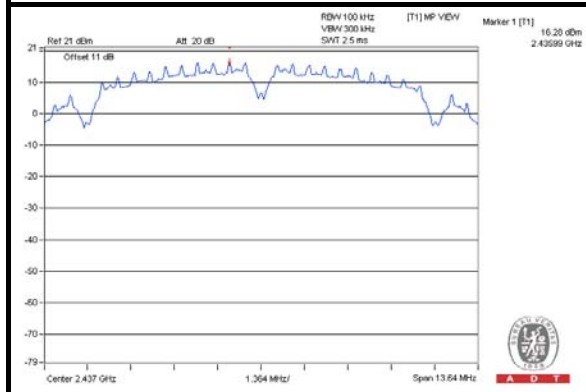

CH 11

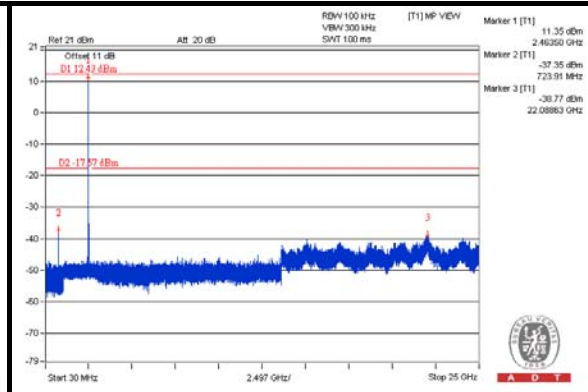
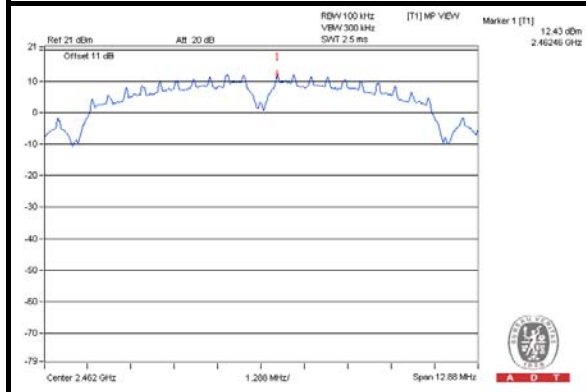

CH 1 Band edge

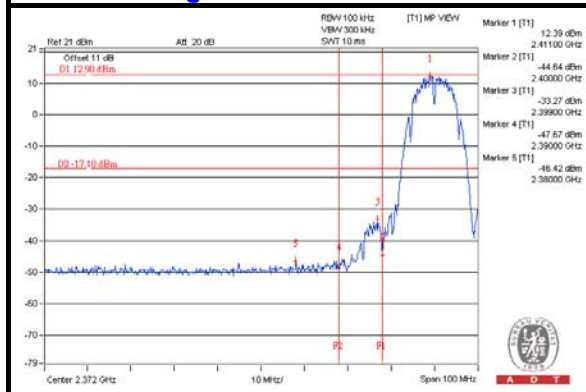

CH 11 Band edge

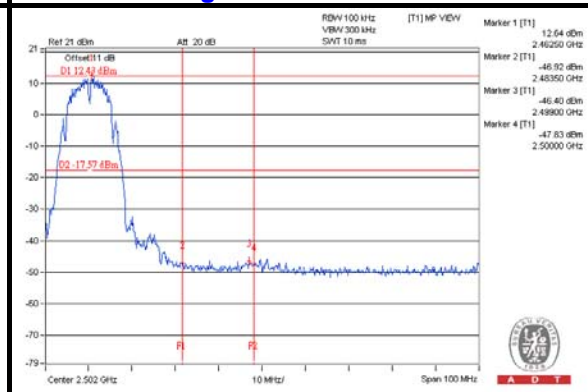



A D T

802.11g CHAIN 0

CH 1

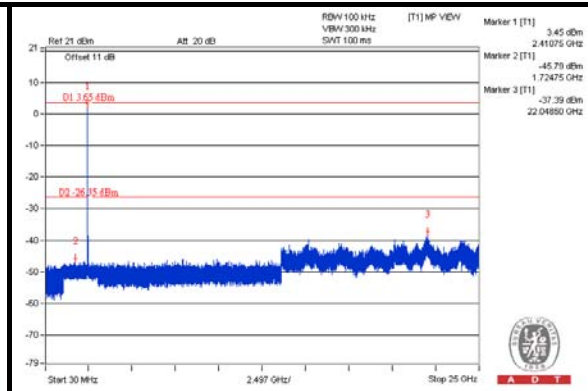
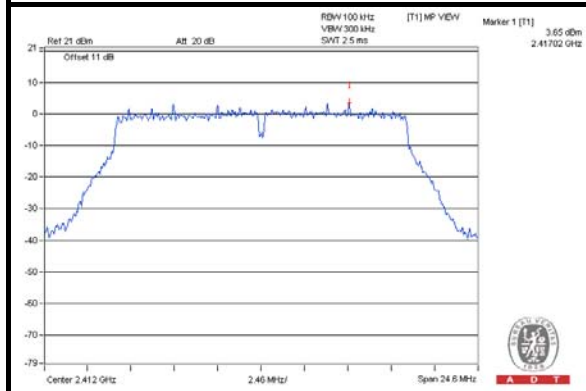

CH 6

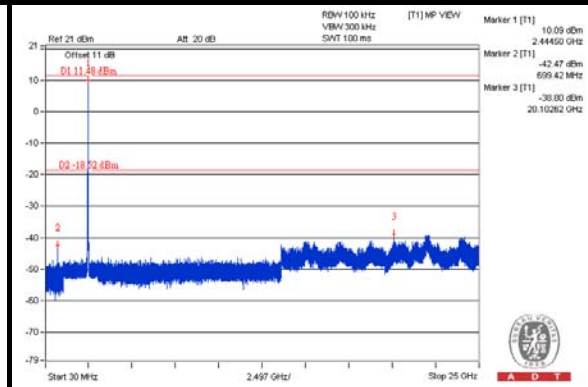
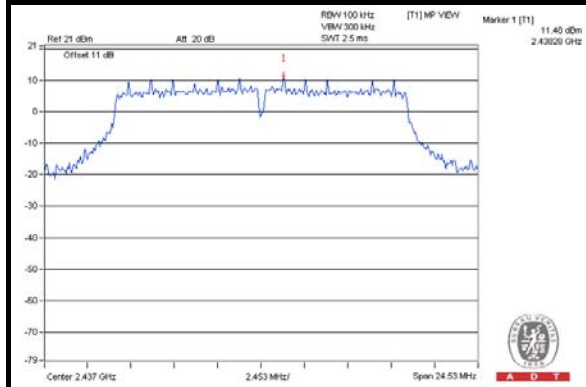

CH 11

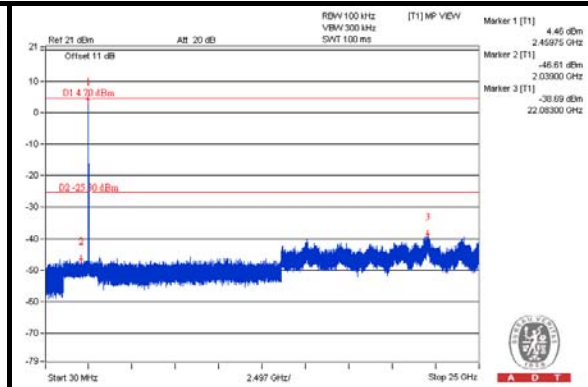
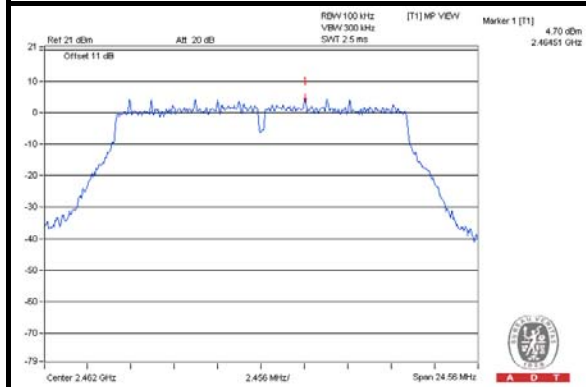

CH 1 Band edge

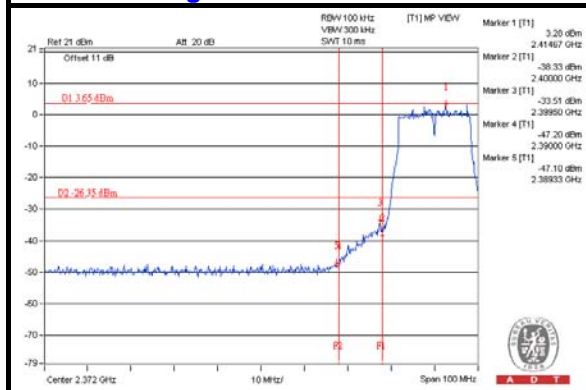

CH 11 Band edge

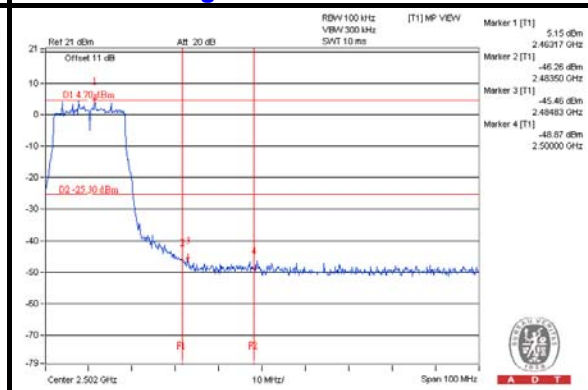

CHAIN 1

CH 1

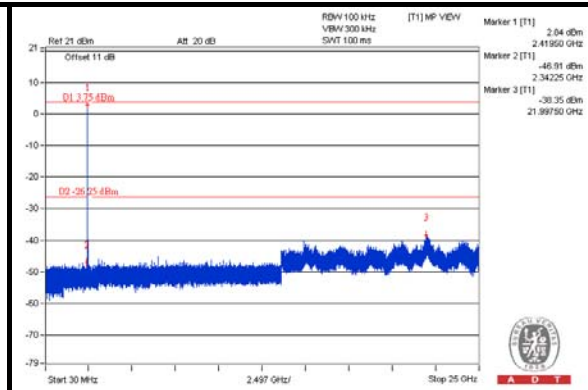
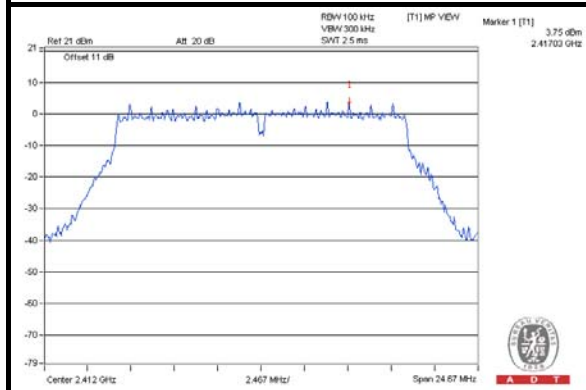

CH 6

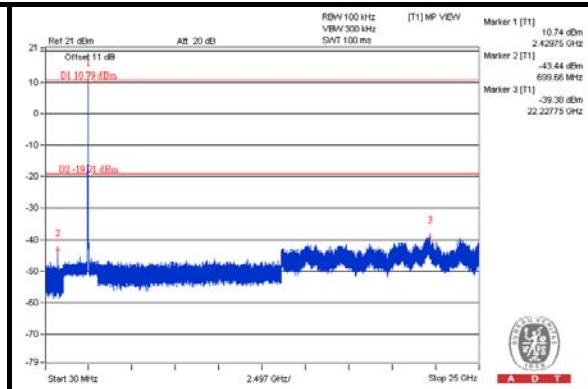
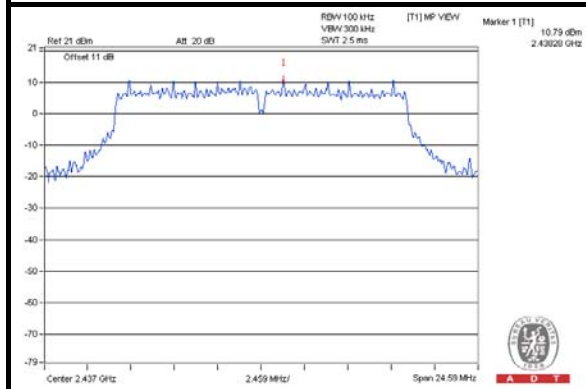

CH 11

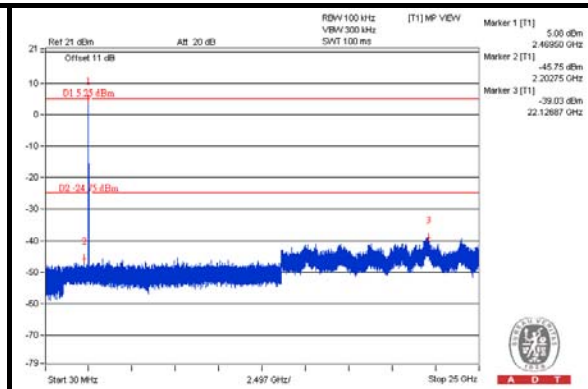
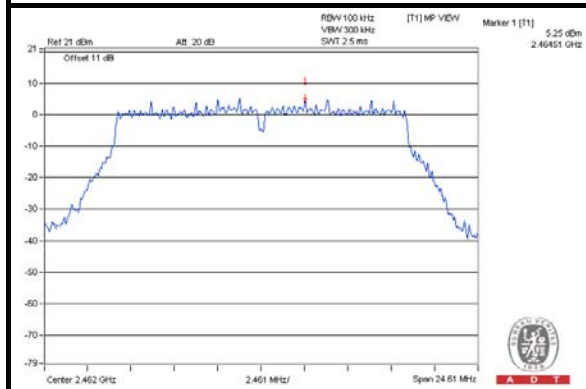

CH 1 Band edge

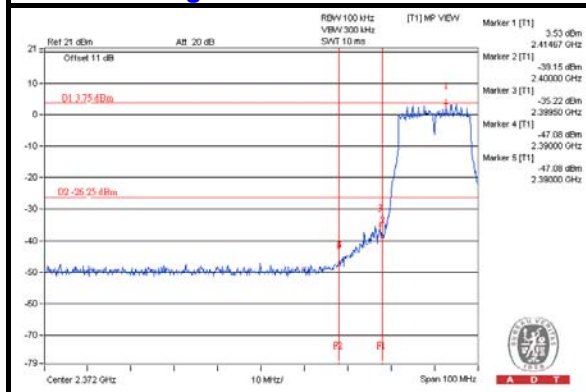

CH 11 Band edge

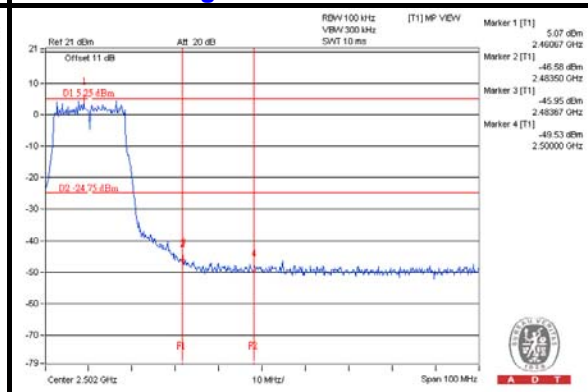



A D T

802.11n (20MHz) CHAIN 0

CH 1

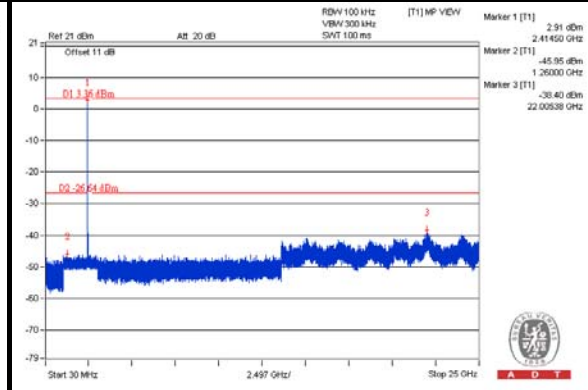
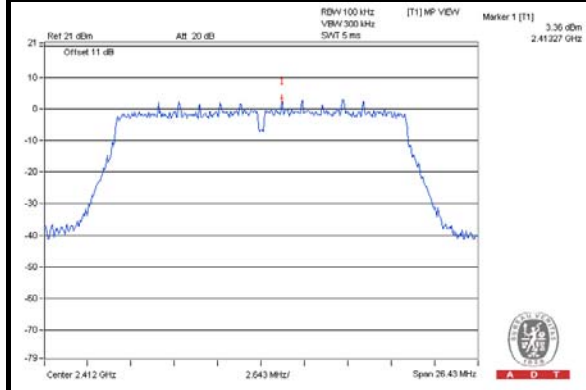

CH 6

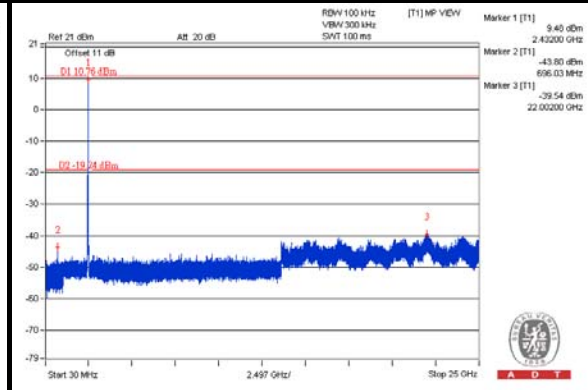
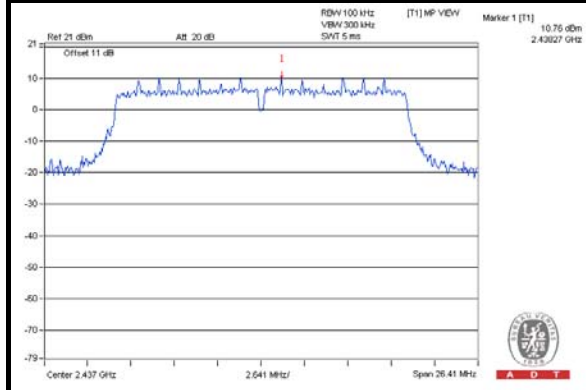

CH 11

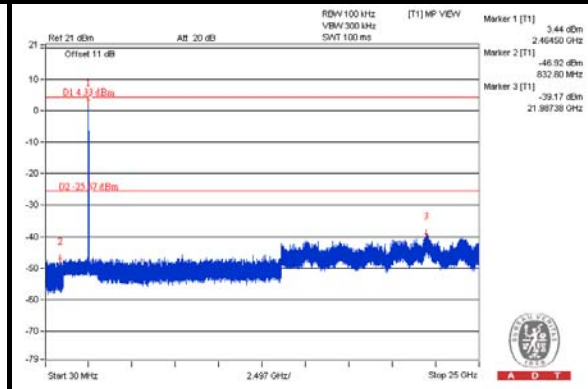
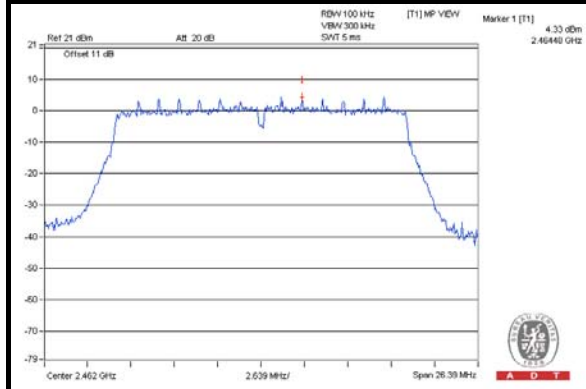

CH 1 Band edge

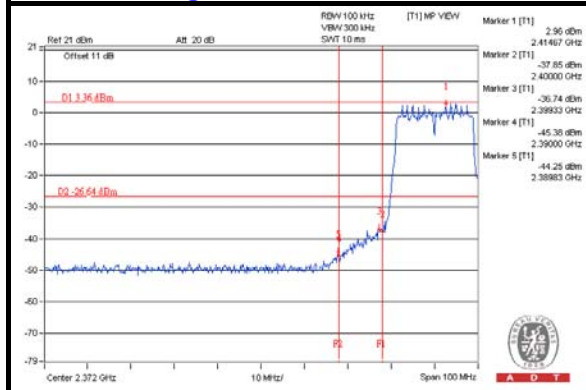

CH 11 Band edge

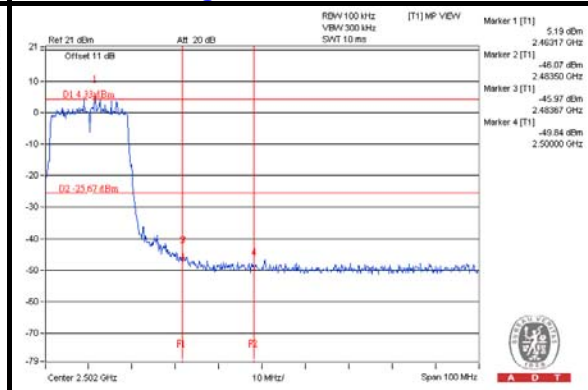

CHAIN 1

CH 1

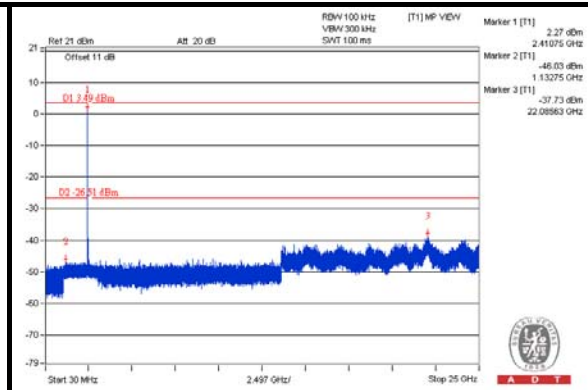
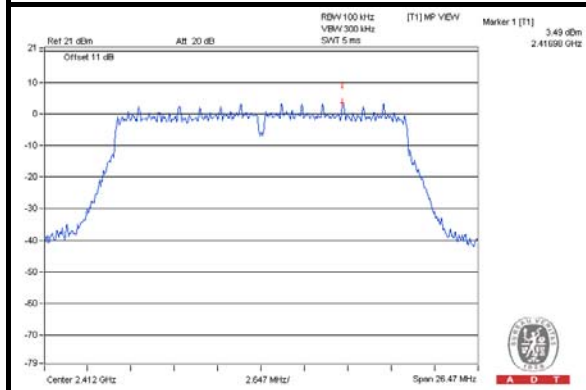

CH 6

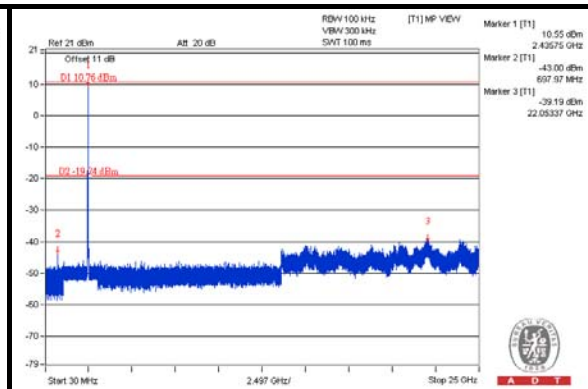
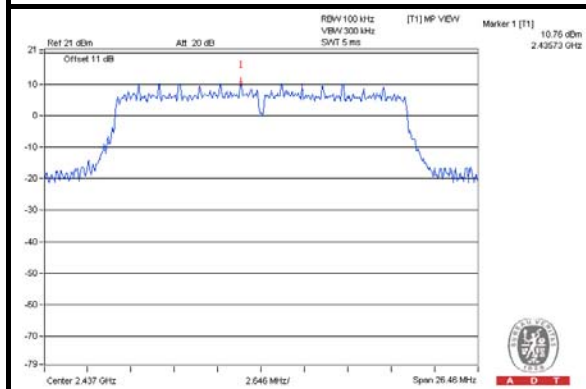

CH 11

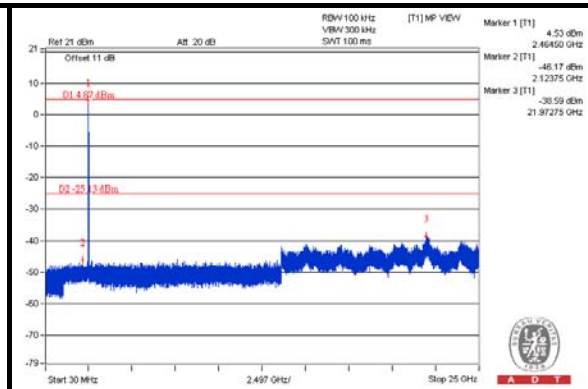
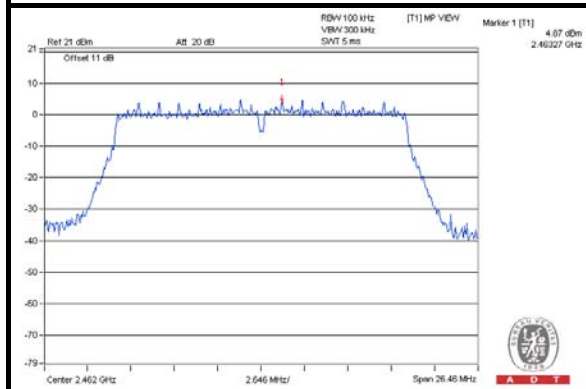

CH 1 Band edge

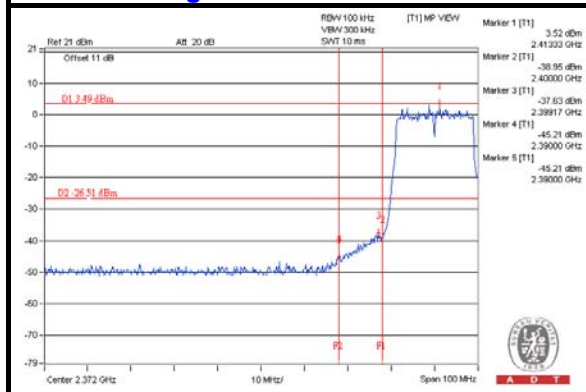

CH 11 Band edge

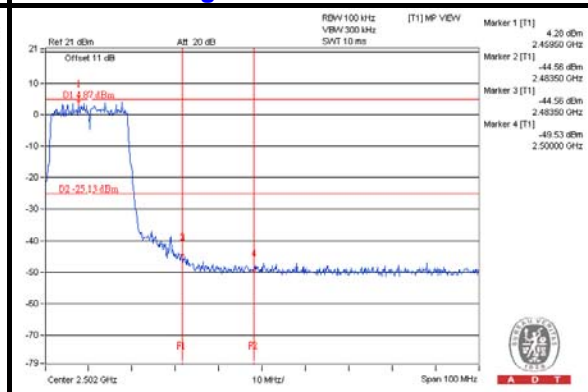



A D T

Radio 1: Patch antenna

802.11b

CHAIN 0

CH 1

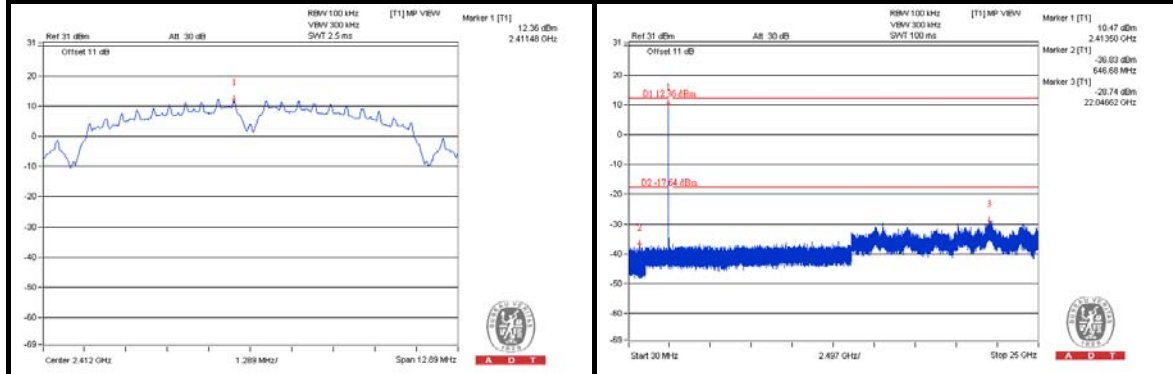

CH 6

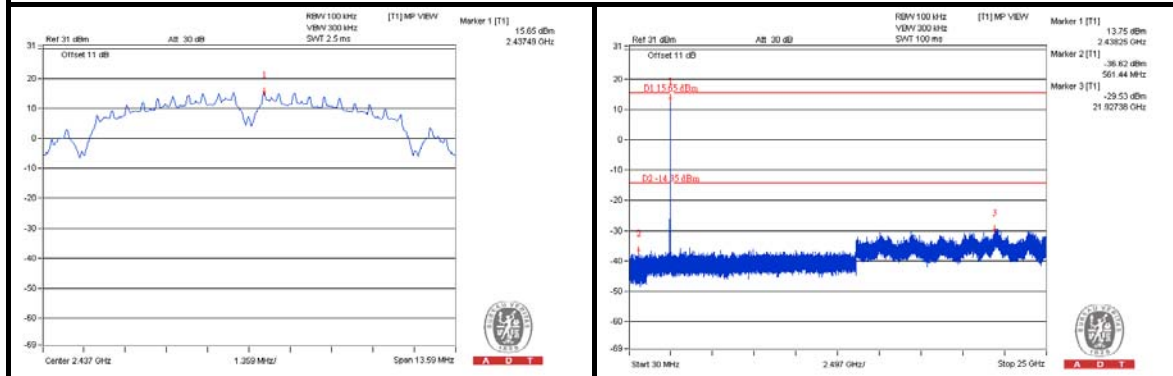

CH 11

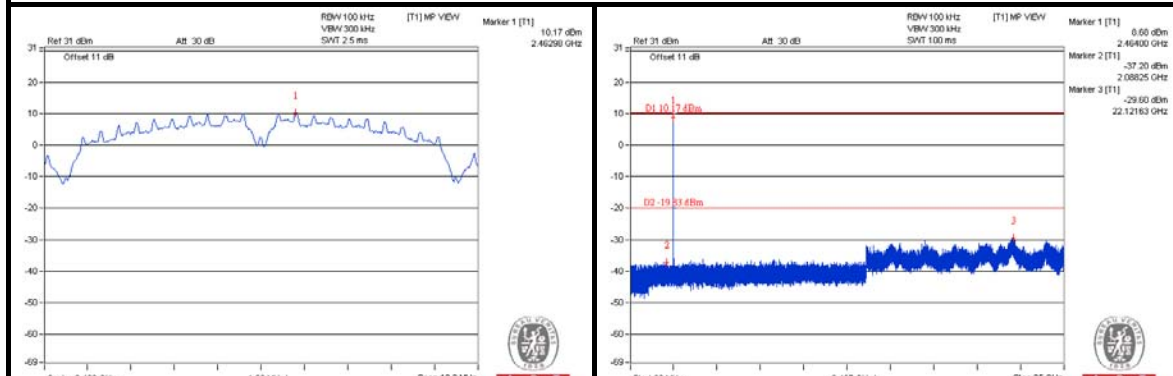

CH 1 Band edge

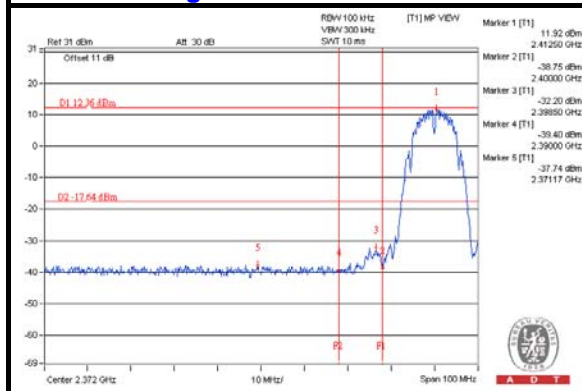

CH 11 Band edge

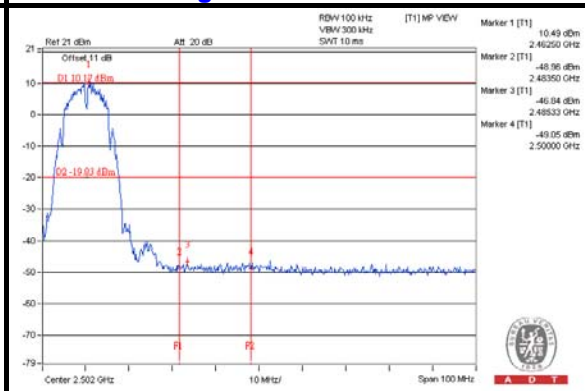

CHAIN 1

CH 1

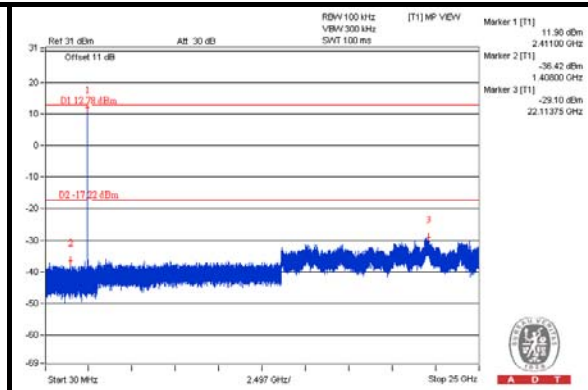
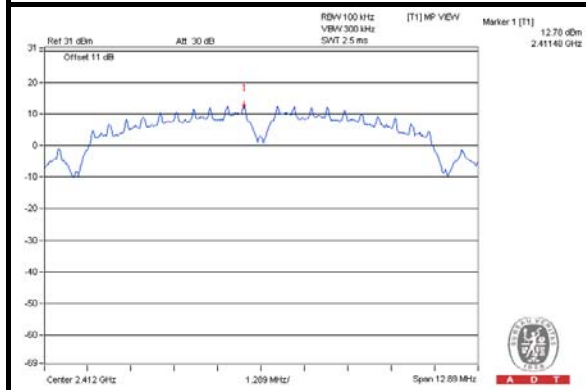

CH 6

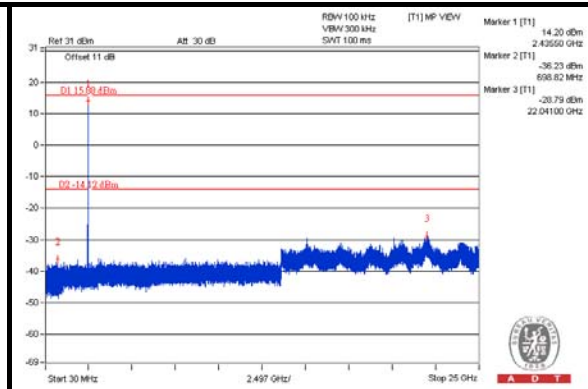
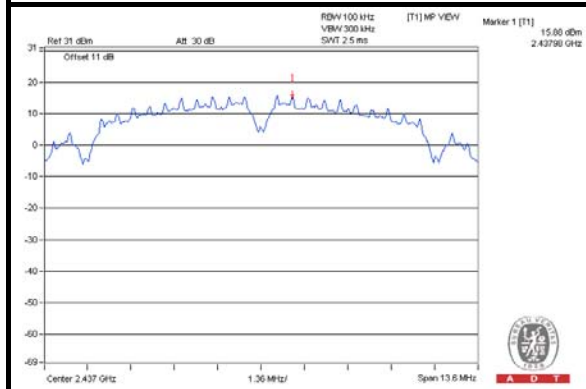

CH 11

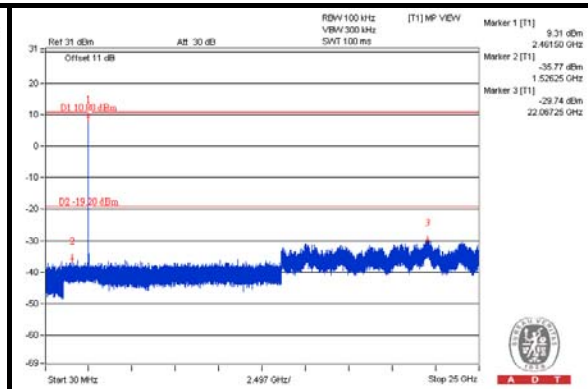
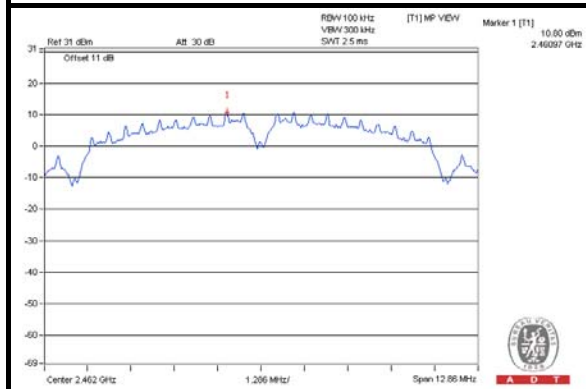

CH 1 Band edge

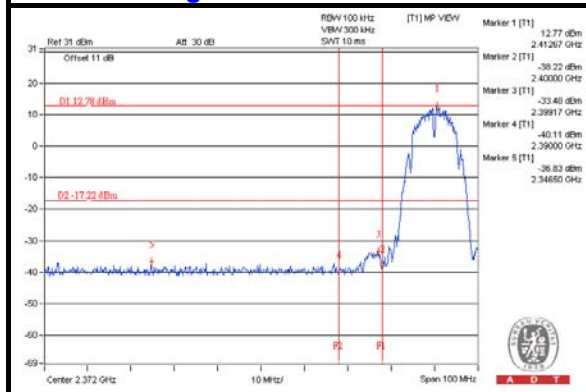

CH 11 Band edge

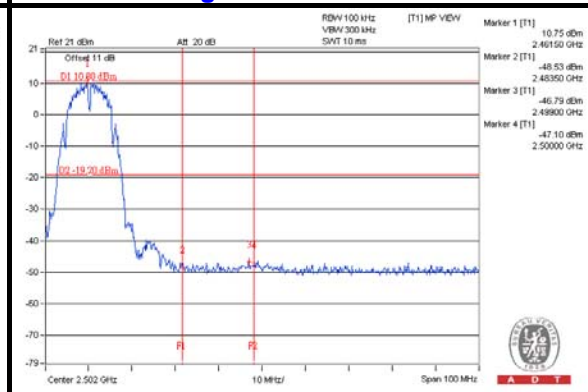



A D T

802.11g CHAIN 0

CH 1

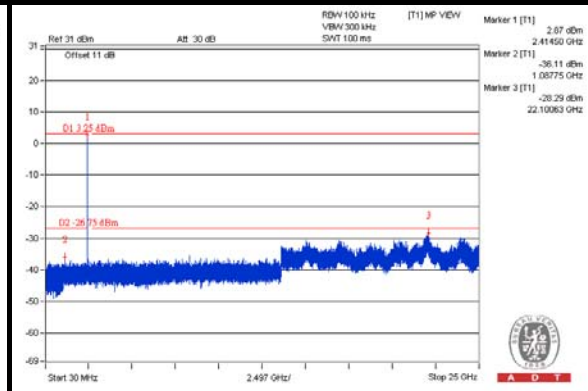
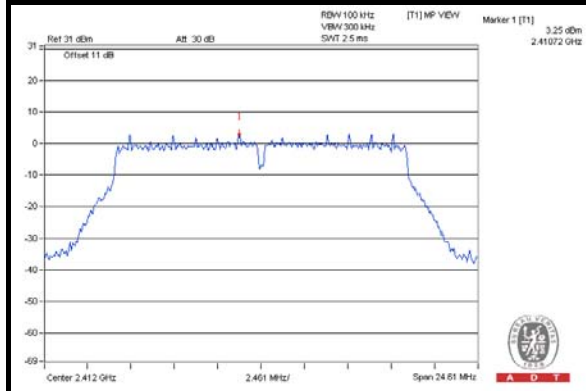

CH 6

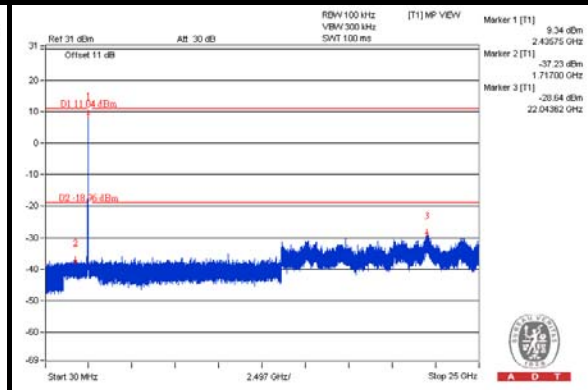
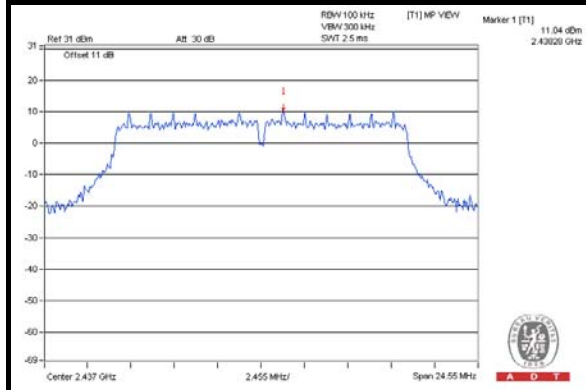

CH 11

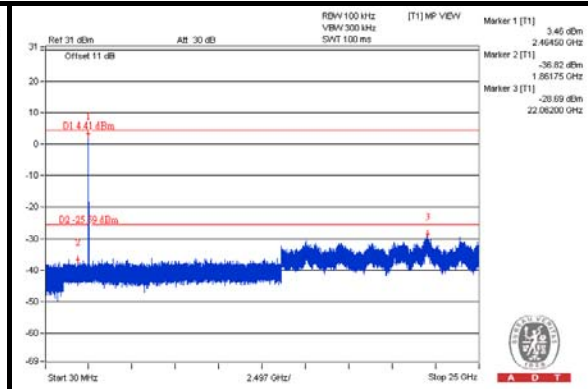
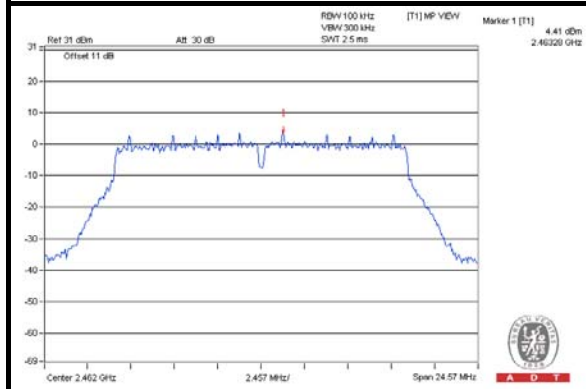

CH 1 Band edge

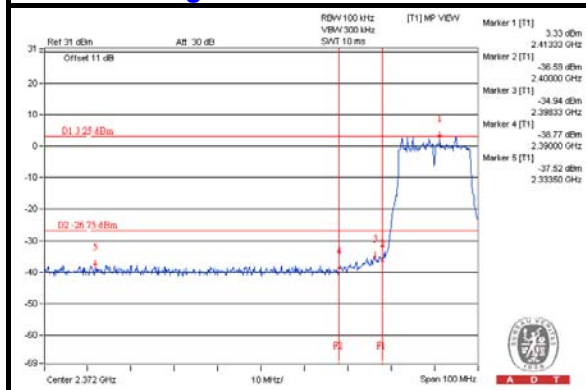

CH 11 Band edge

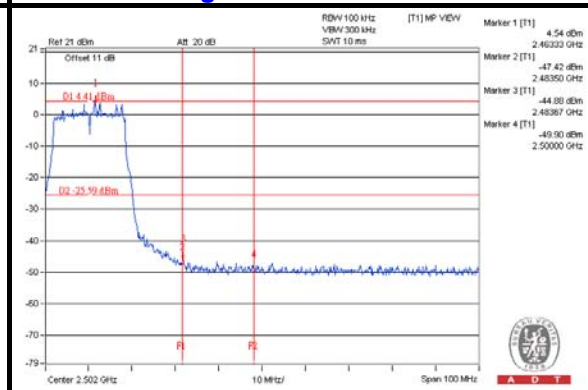



A D T

CHAIN 1

CH 1

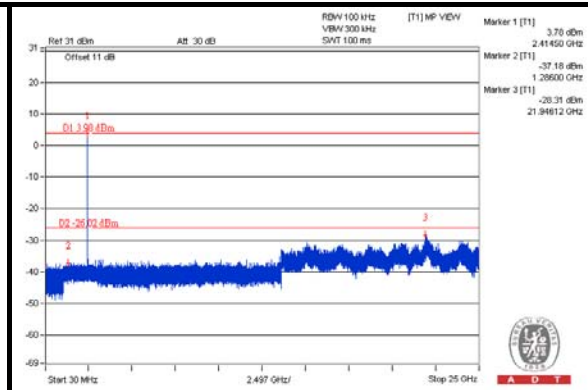
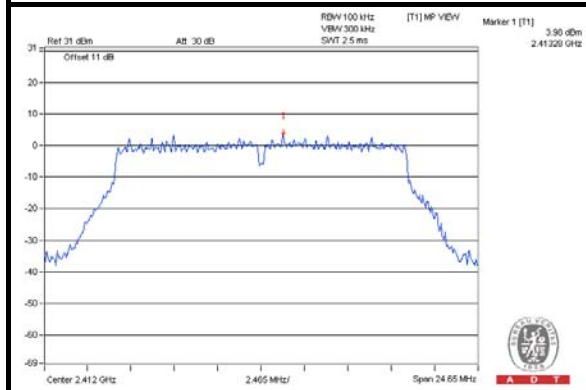

CH 6

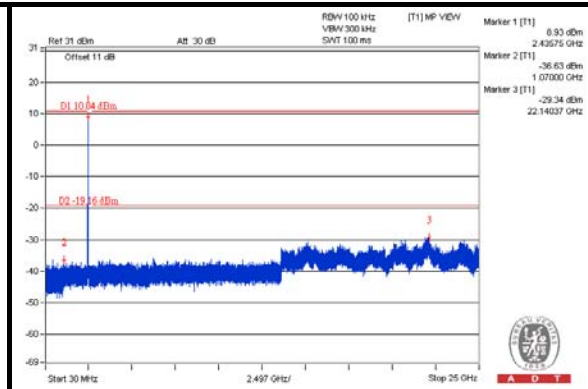
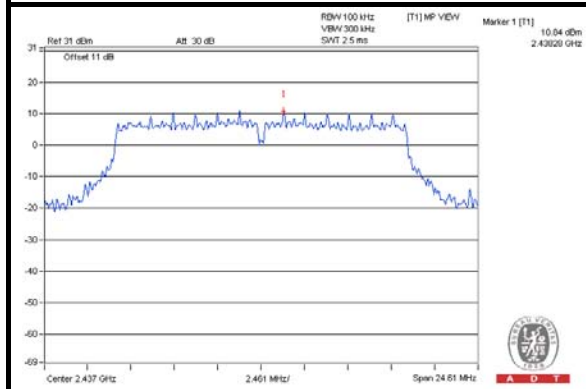

CH 11

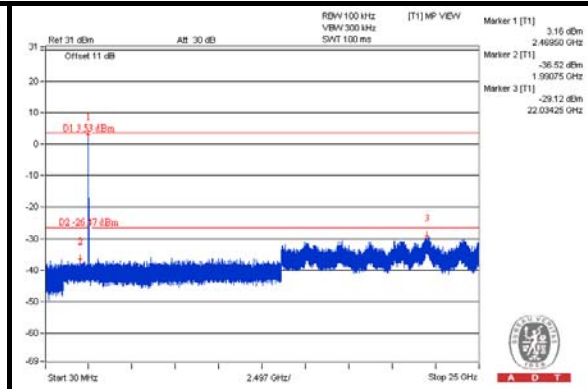
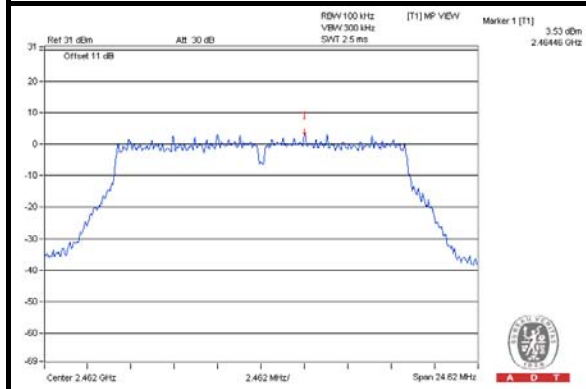

CH 1 Band edge

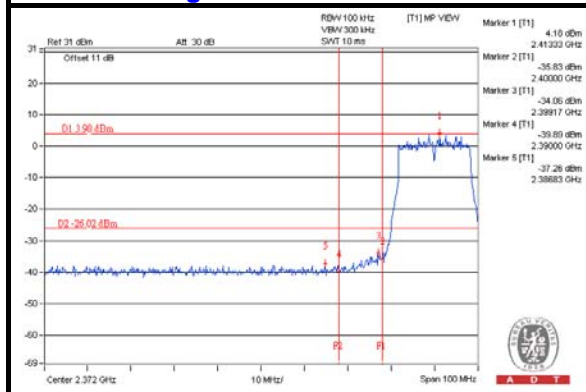

CH 11 Band edge

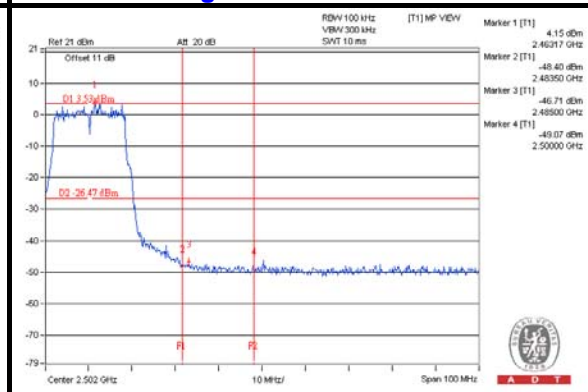



A D T

802.11n (20MHz) CHAIN 0

CH 1

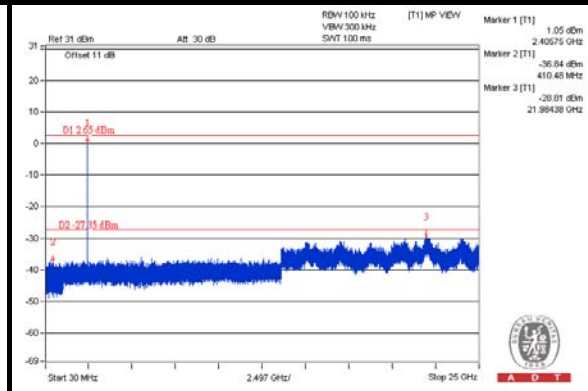
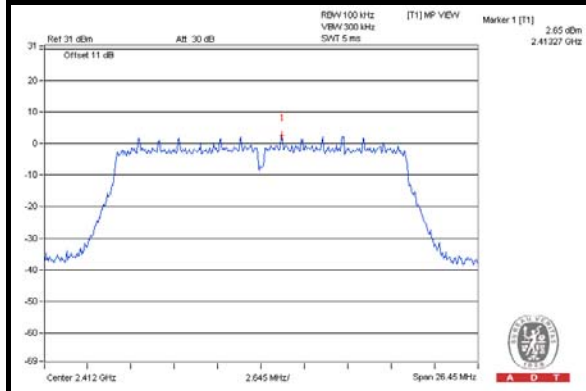

CH 6

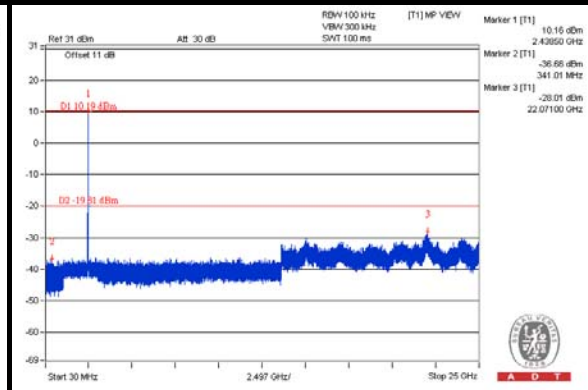
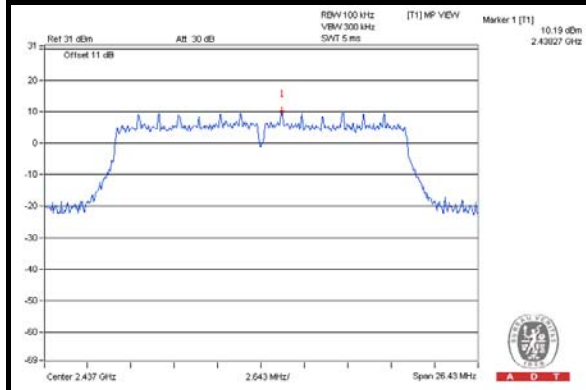

CH 11

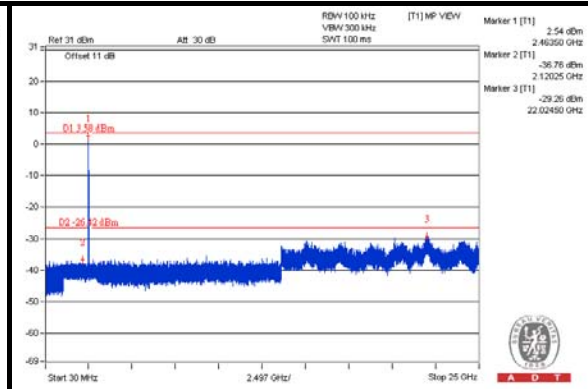
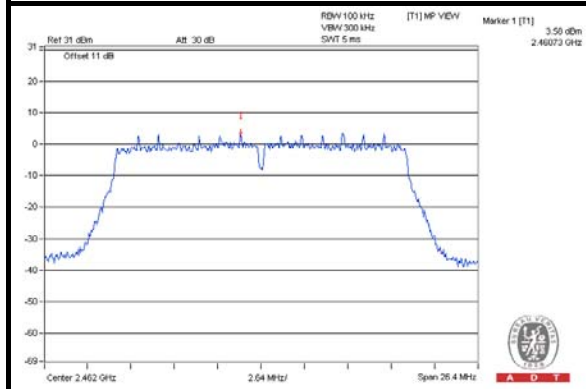

CH 1 Band edge

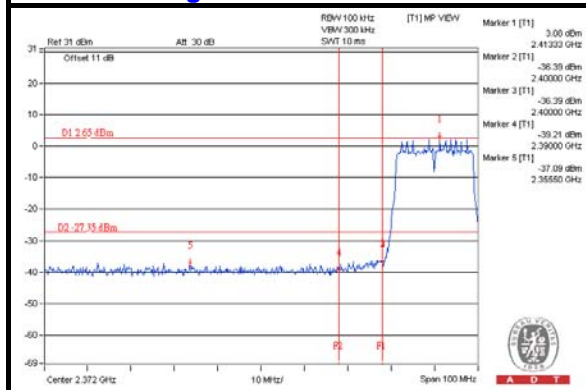

CH 11 Band edge

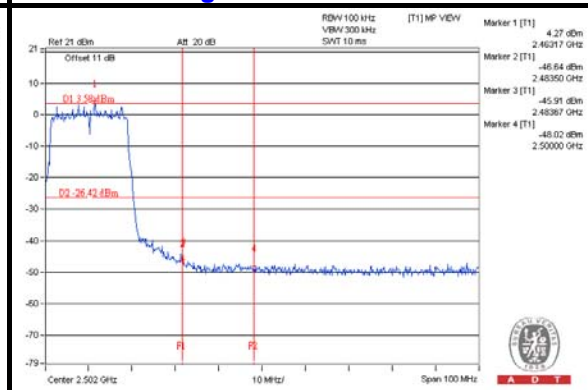

CHAIN 1

CH 1

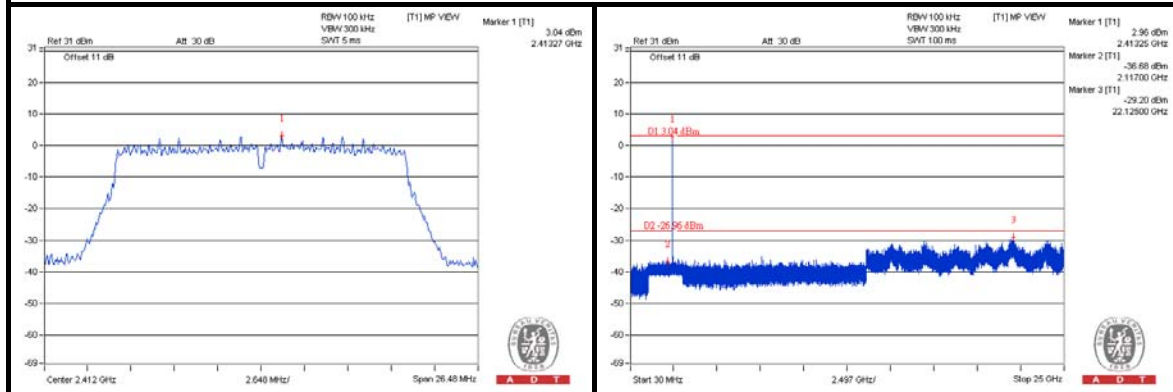

CH 6

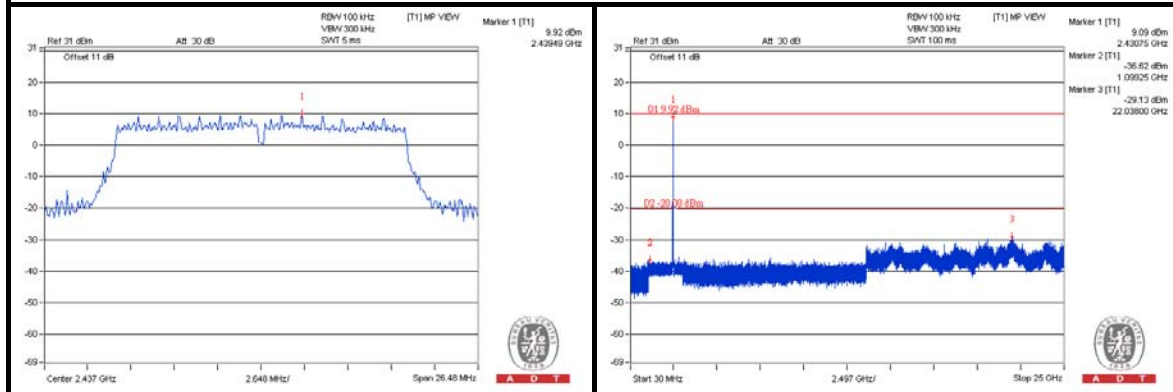

CH 11

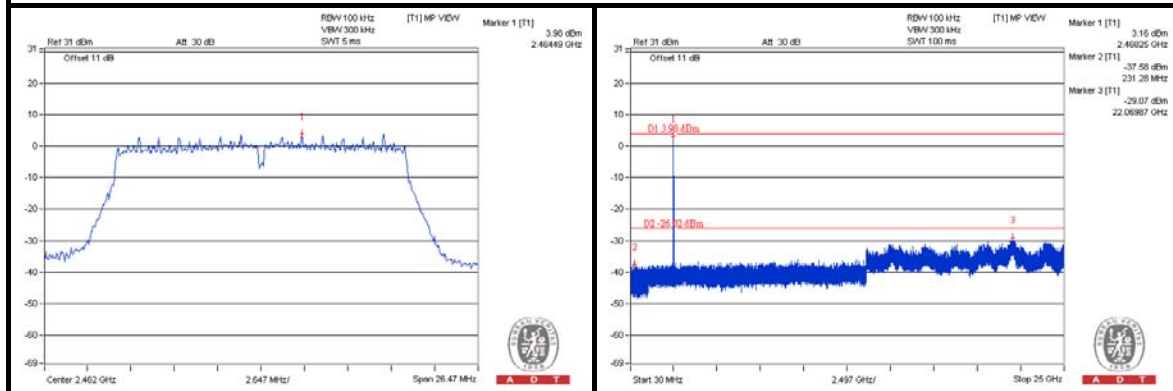

CH 1 Band edge

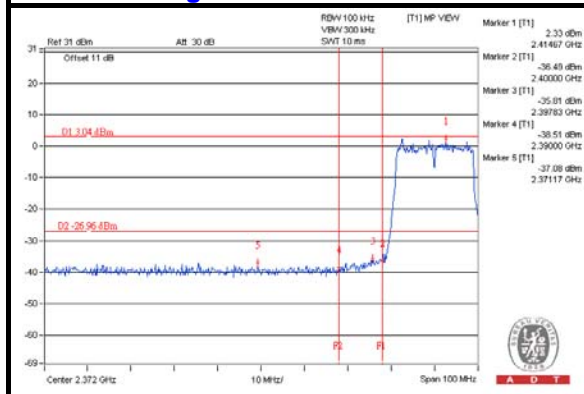

CH 11 Band edge

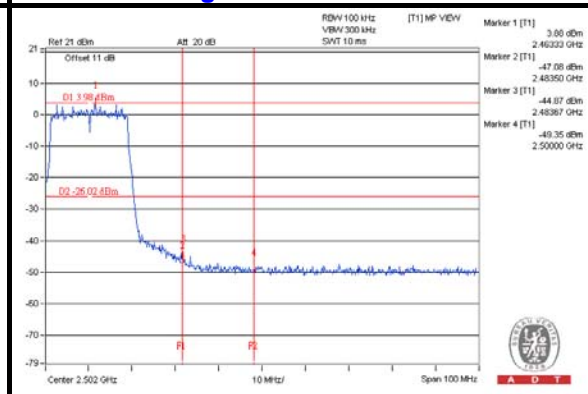



A D T

Radio 1: Sector antenna

802.11b

CHAIN 0

CH 1

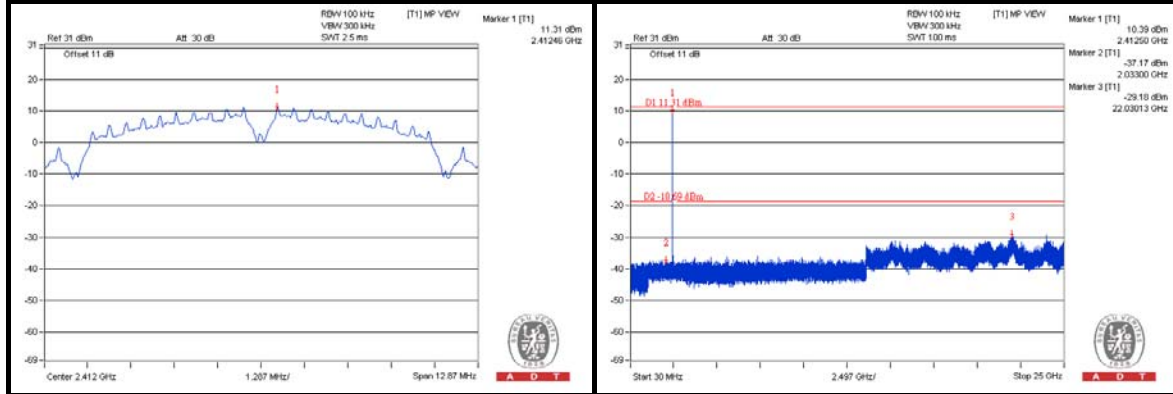

CH 6

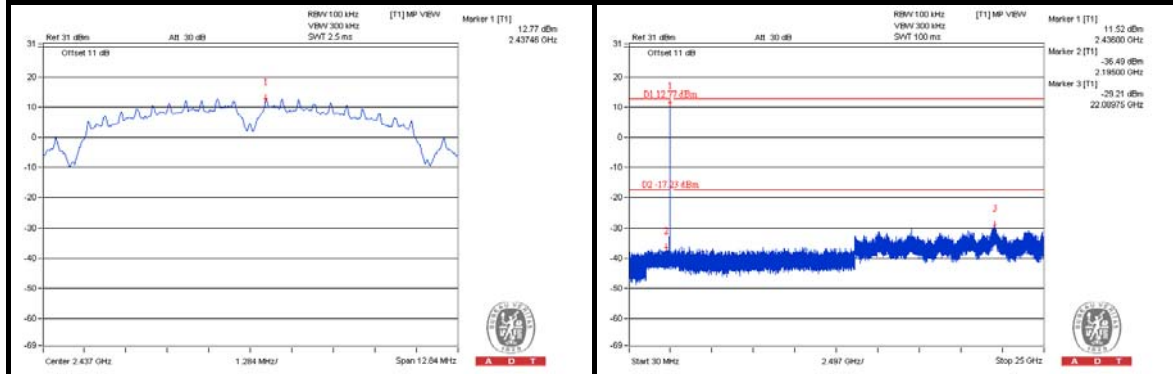

CH 11

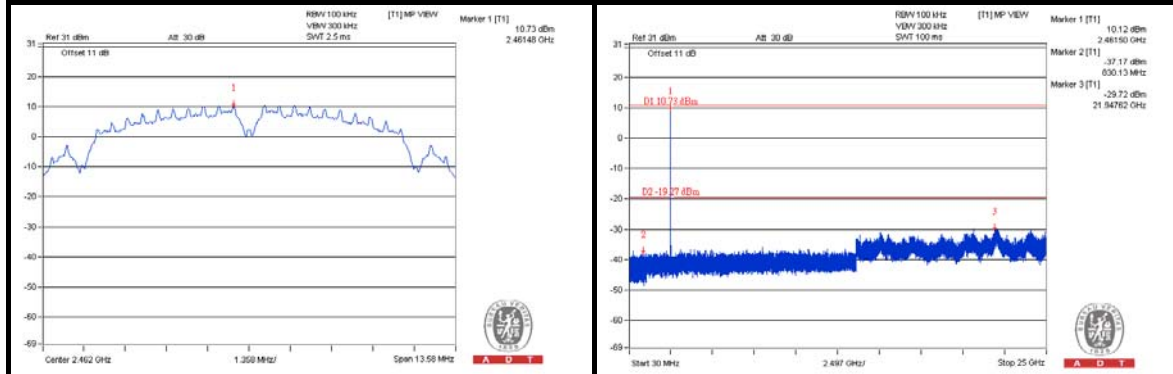

CH 1 Band edge

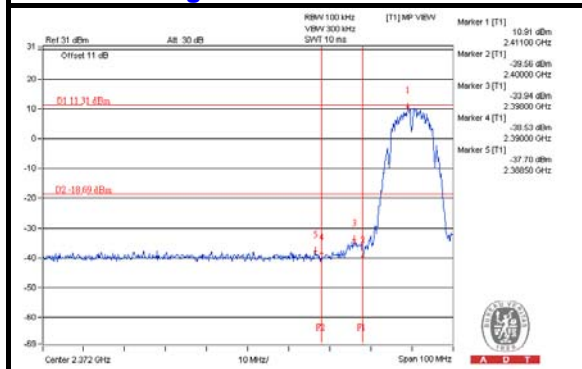

CH 11 Band edge

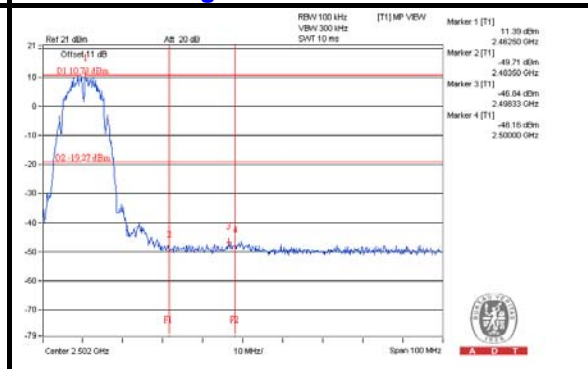

CHAIN 1

CH 1

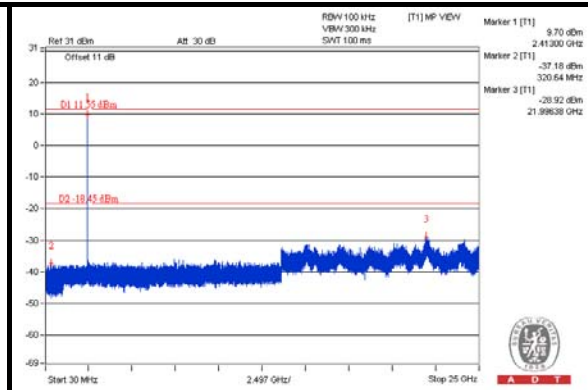
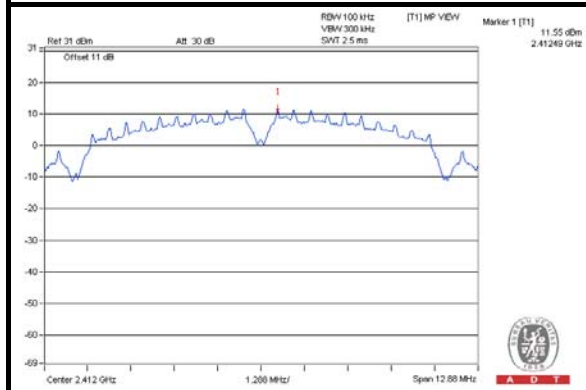

CH 6

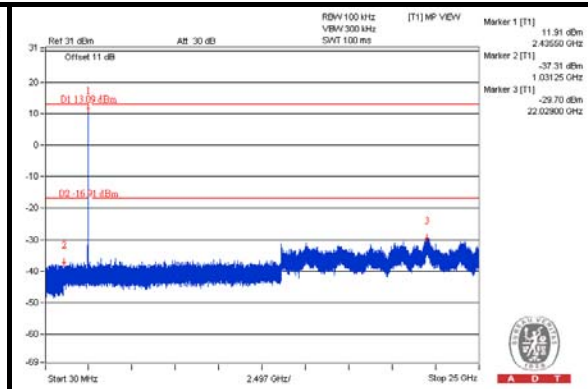
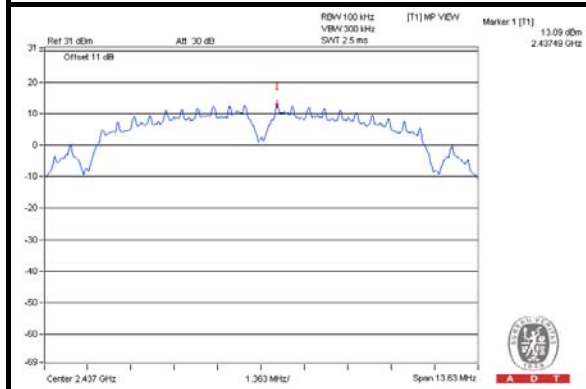

CH 11

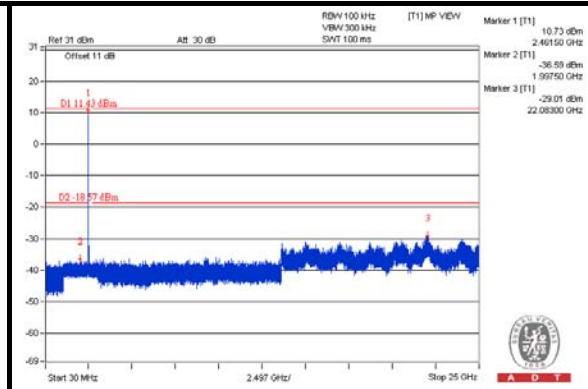
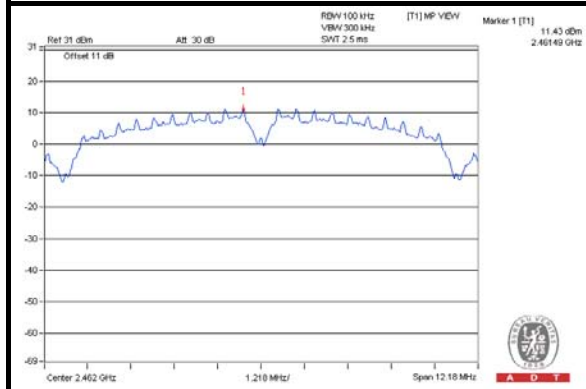

CH 1 Band edge

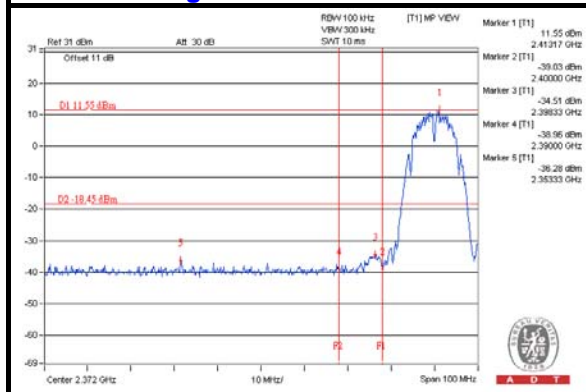

CH 11 Band edge

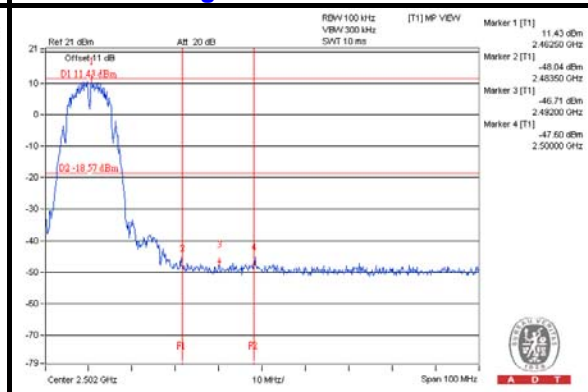



A D T

802.11g CHAIN 0

CH 1

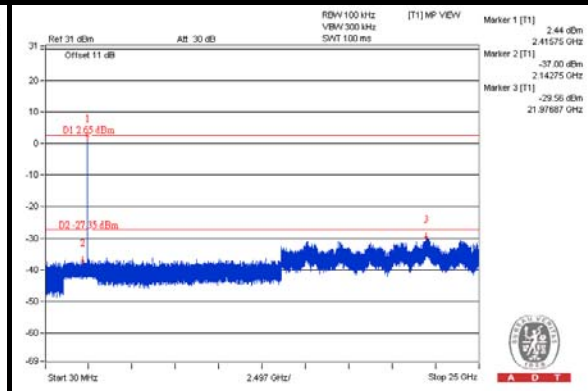
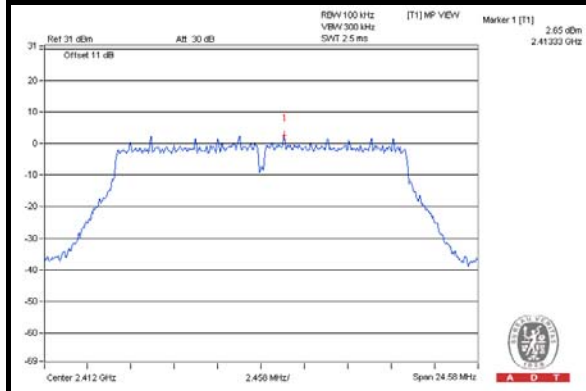

CH 6

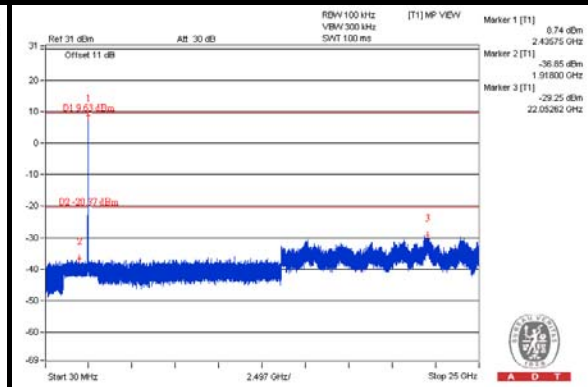
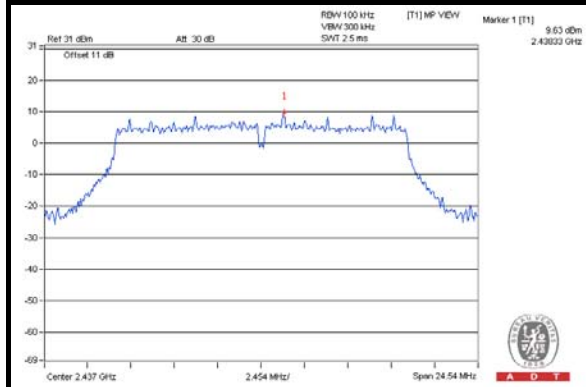

CH 11

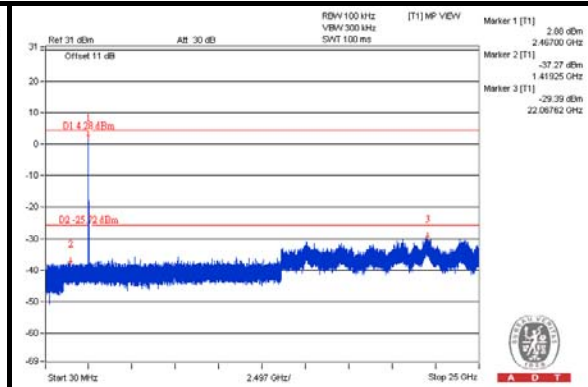
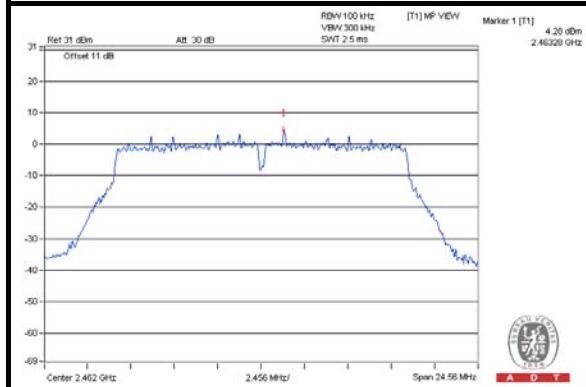

CH 1 Band edge

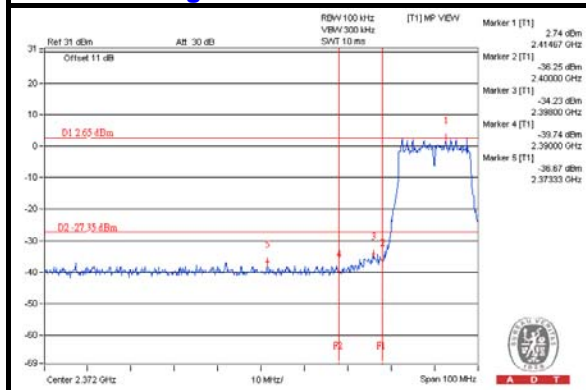

CH 11 Band edge

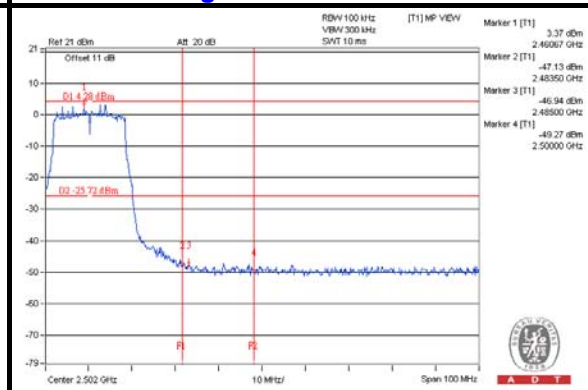

CHAIN 1

CH 1

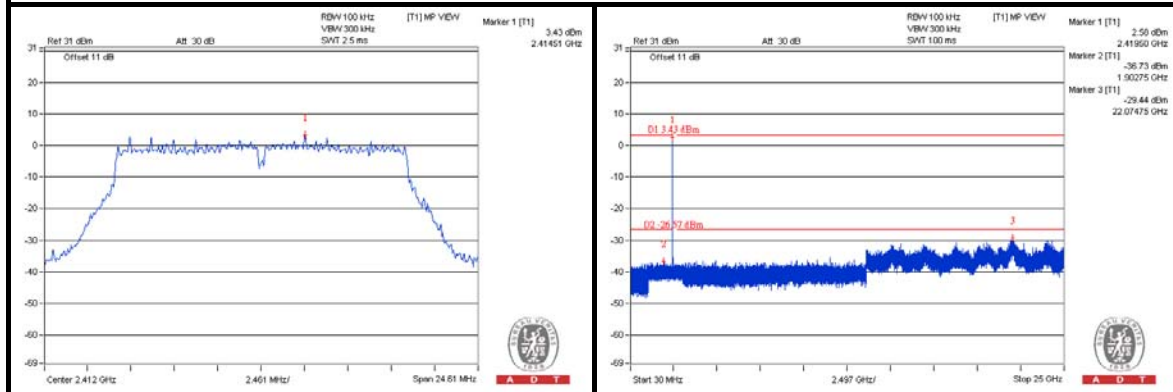

CH 6

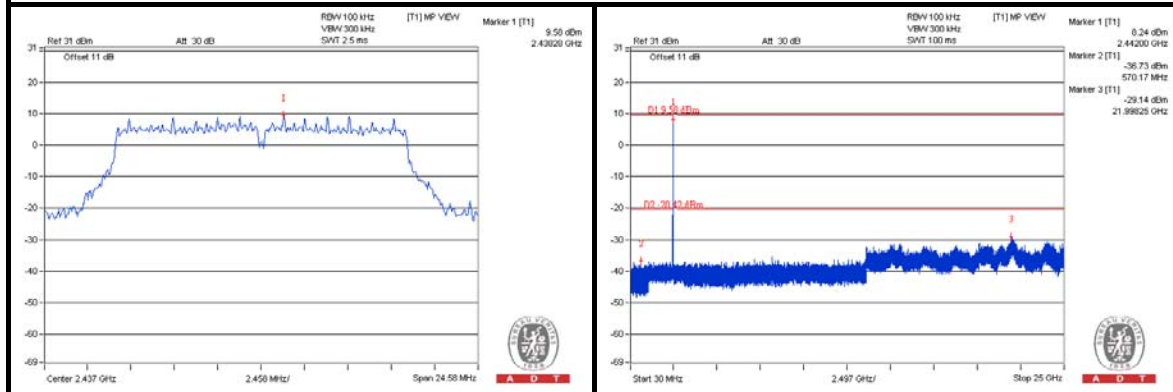

CH 11

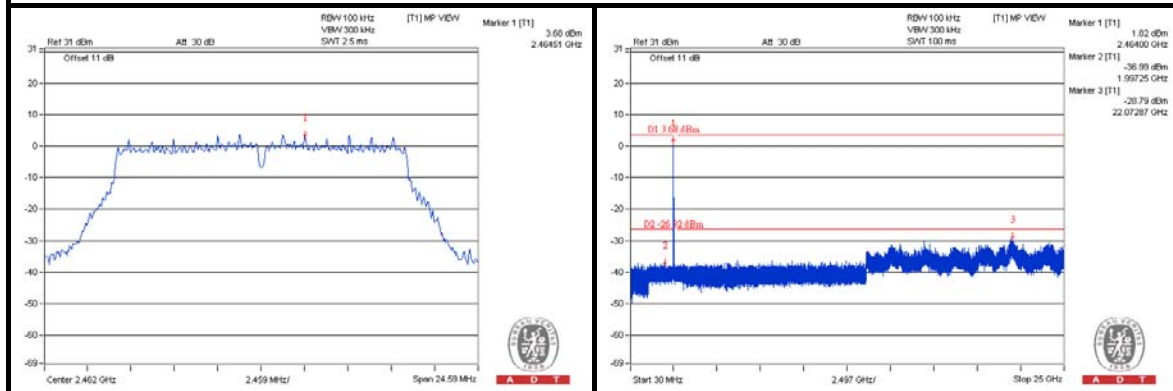

CH 1 Band edge

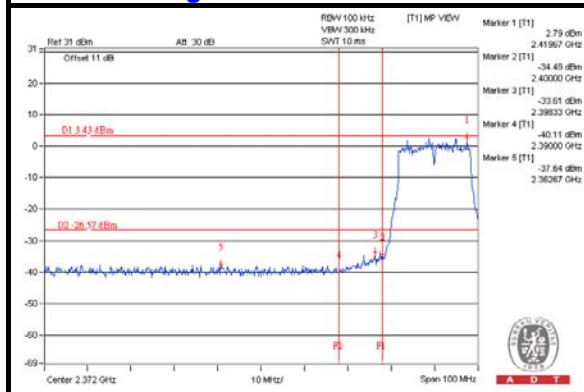

CH 11 Band edge

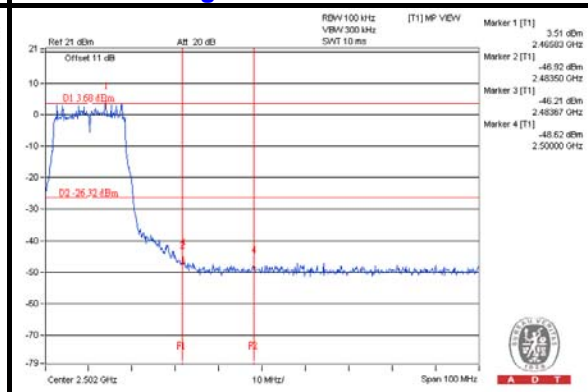



A D T

802.11n (20MHz) CHAIN 0

CH 1

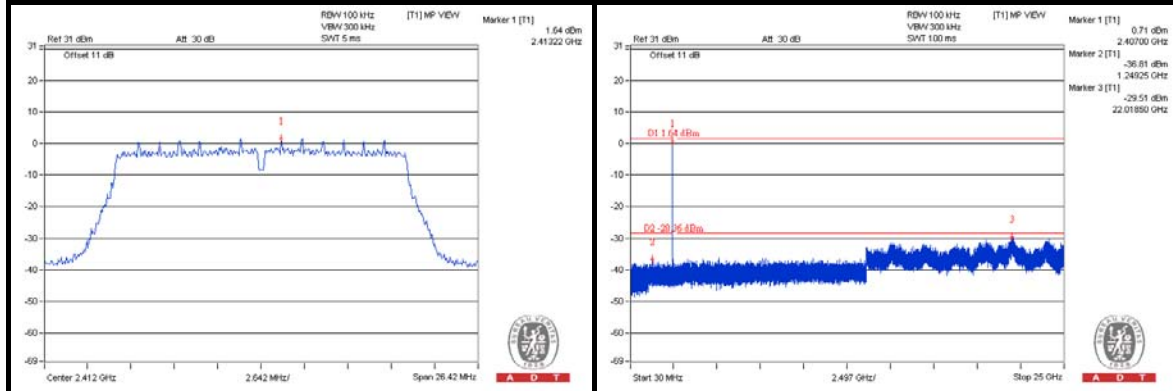

CH 6

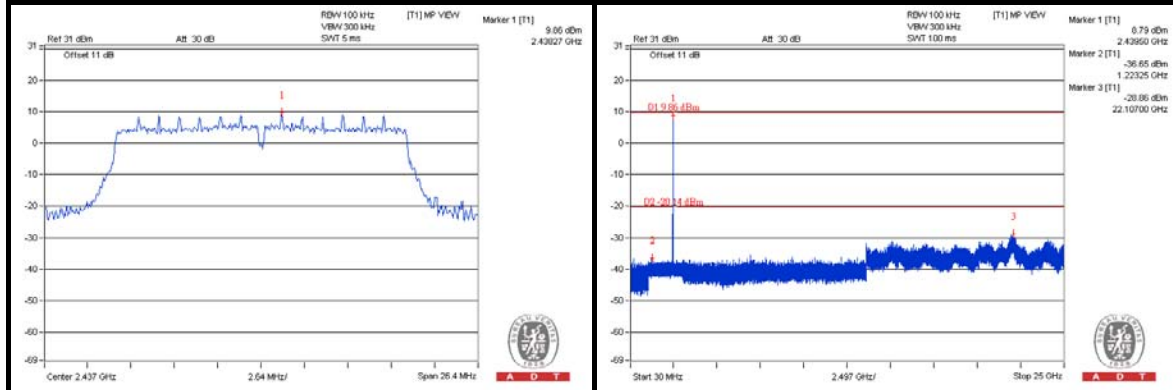

CH 11

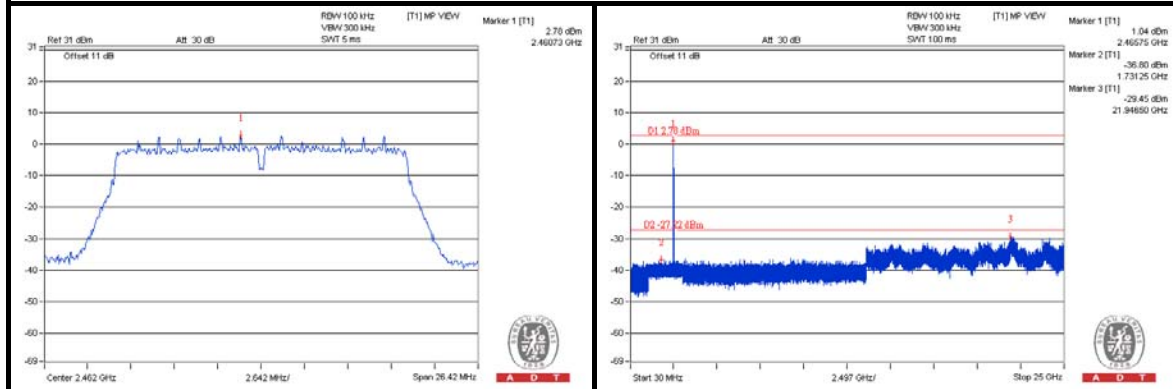

CH 11 Band edge

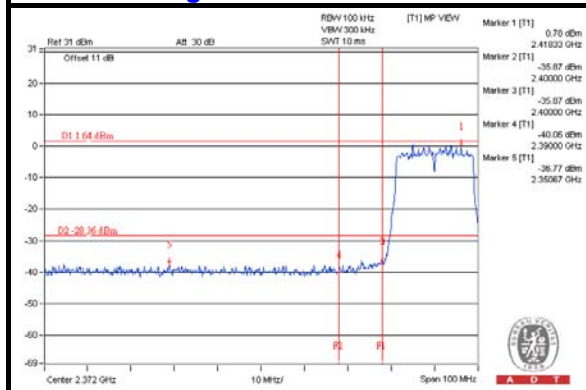

CH 11 Band edge

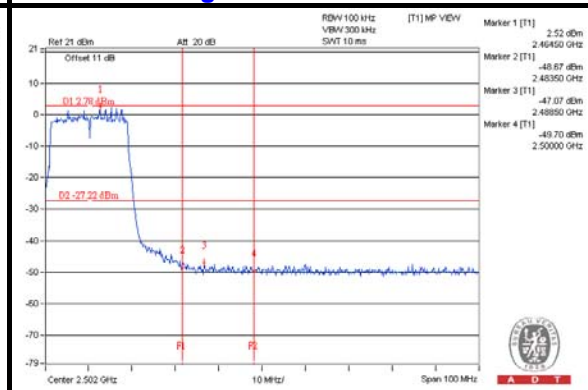

CHAIN 1

CH 1

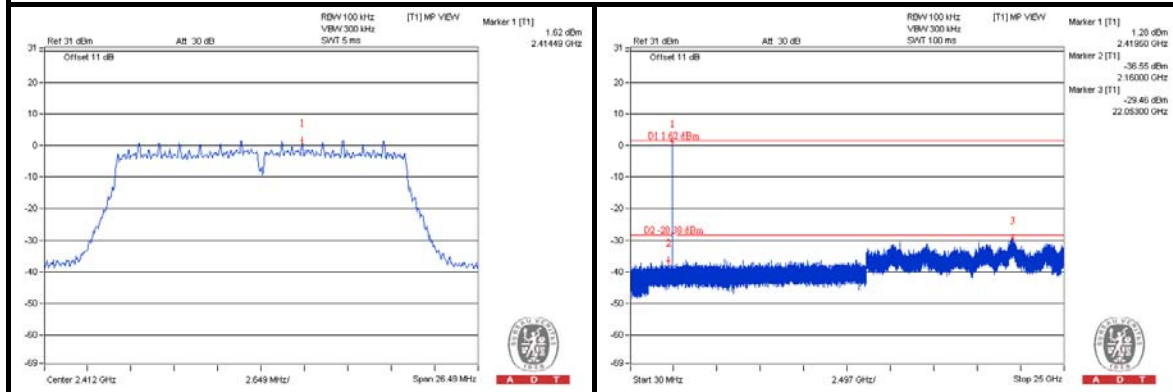

CH 6

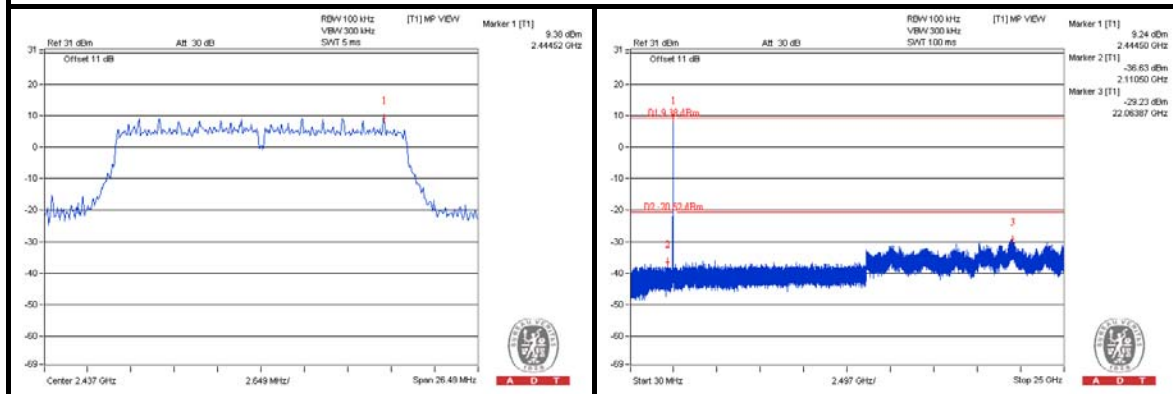

CH 11

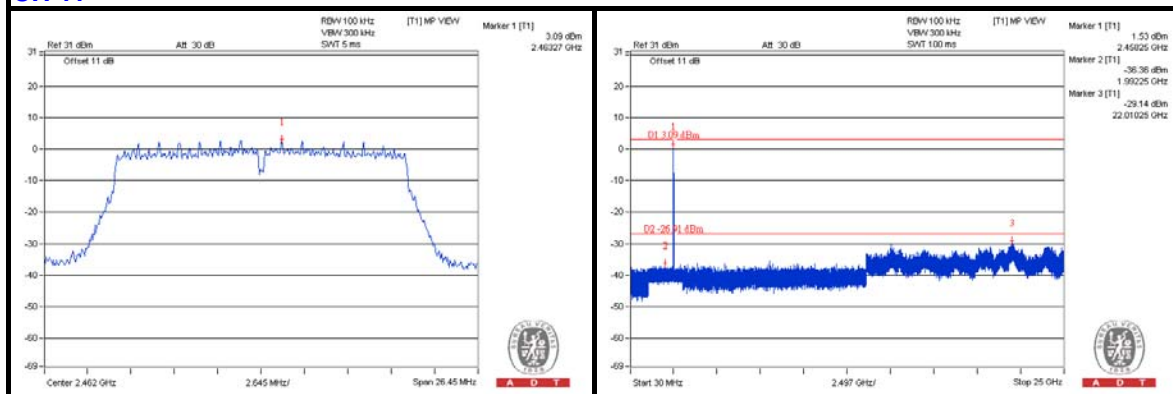

CH 1 Band edge

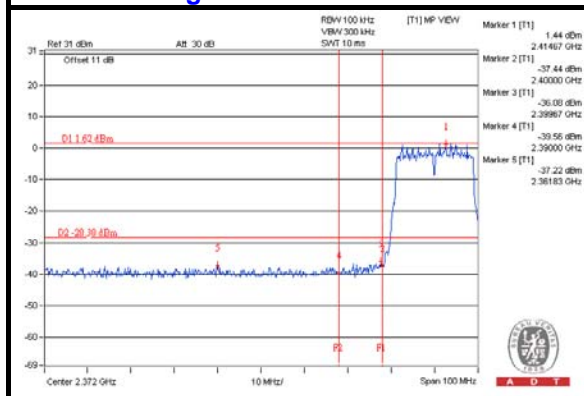

CH 11 Band edge

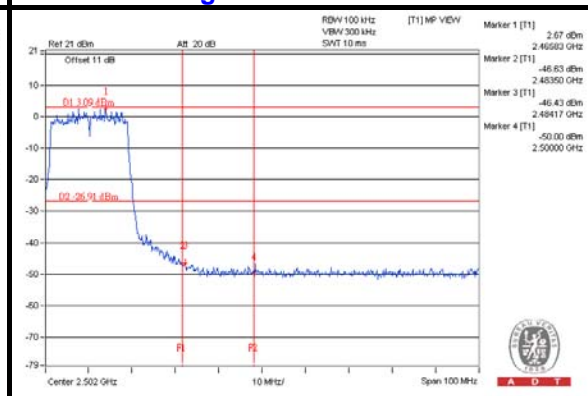

Radio 3: PIFA antenna
802.11b

CH 1

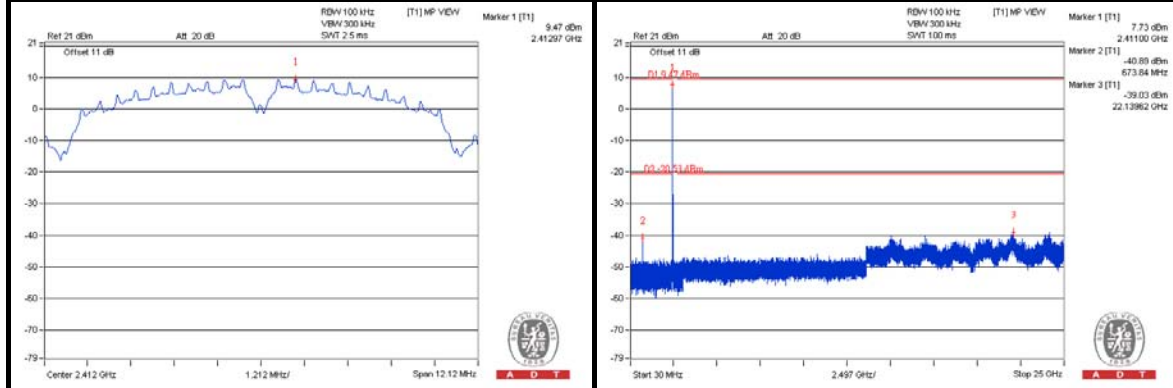

CH 6

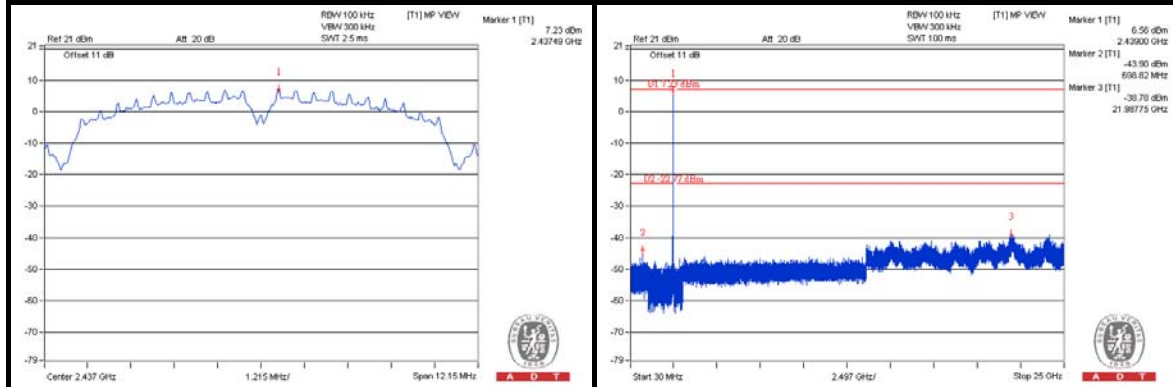

CH 11

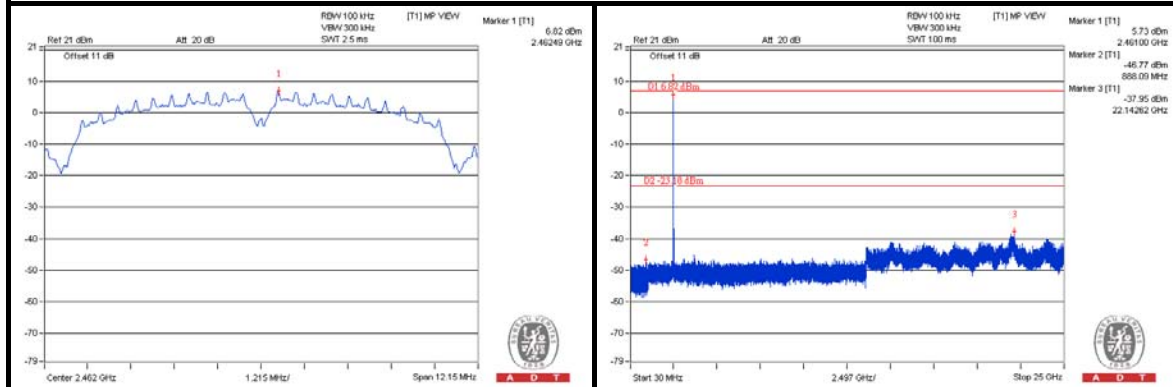

CH 1 Band edge

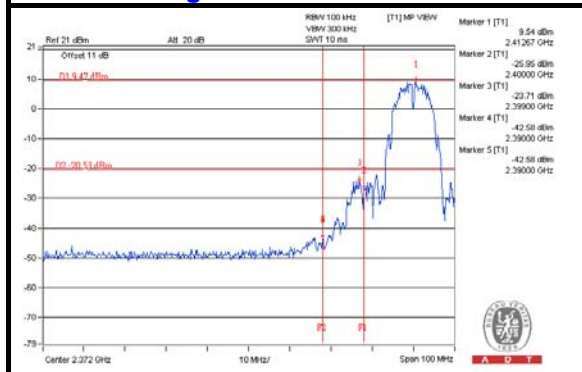

CH 11 Band edge

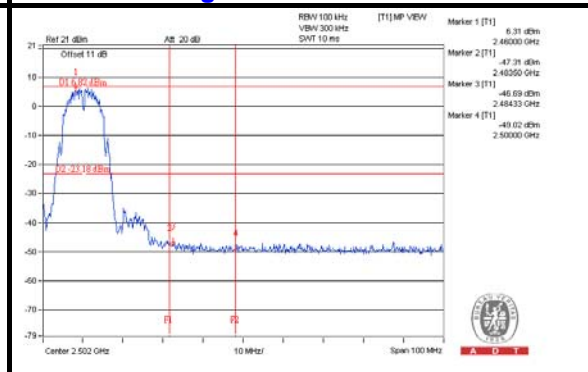

802.11g

CH 1

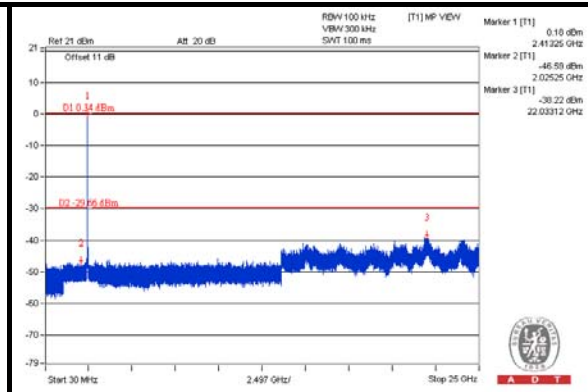
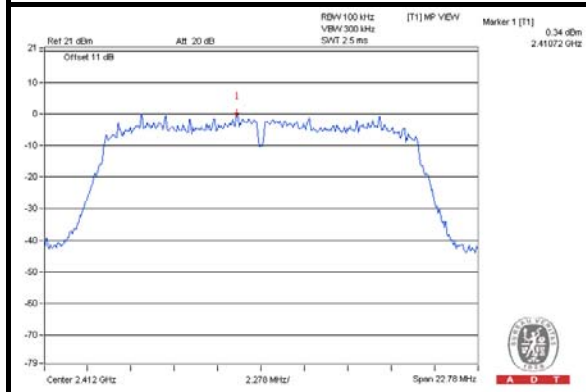

CH 6

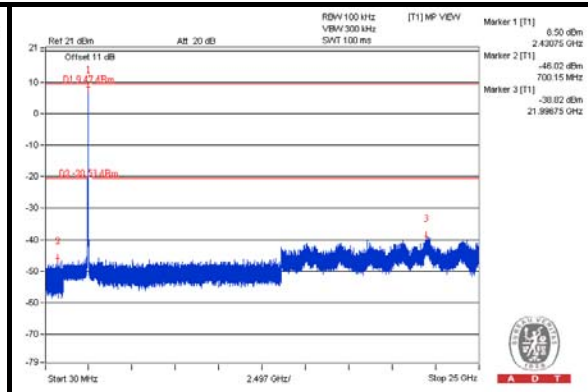
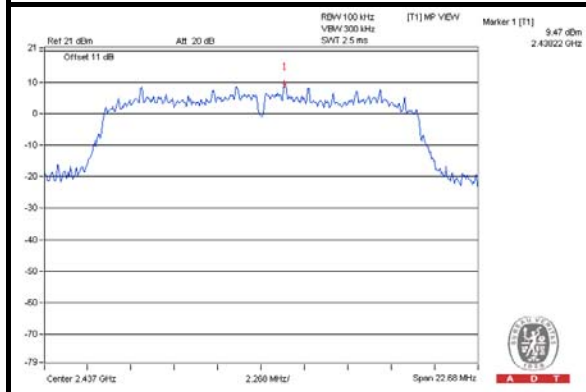

CH 11

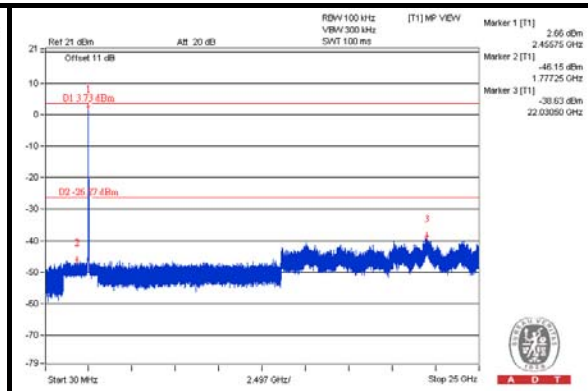
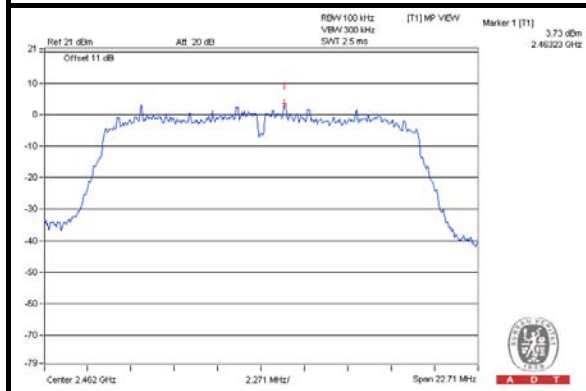

CH 1 Band edge

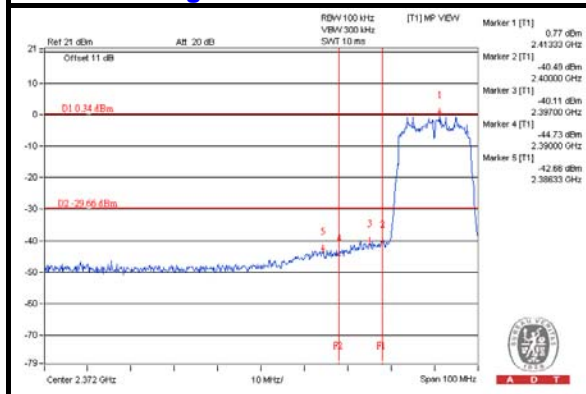

CH 11 Band edge

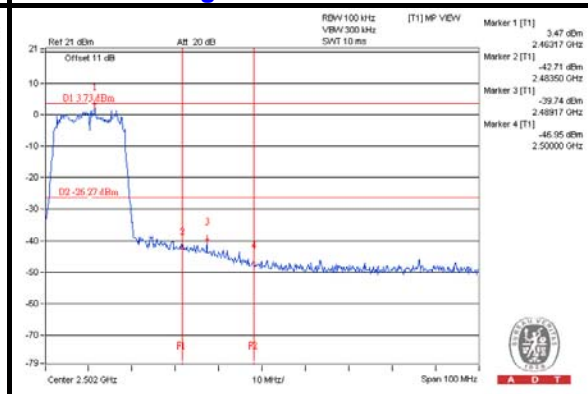

802.11n (20MHz)

CH 1

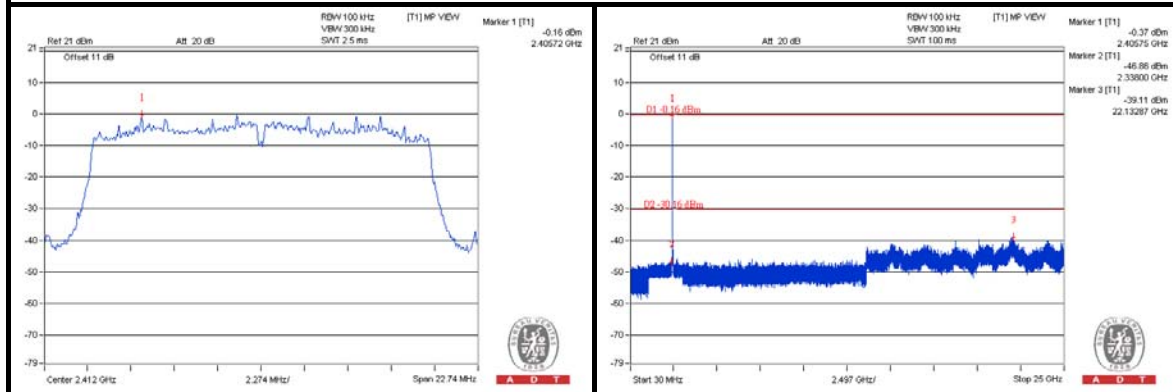

CH 6

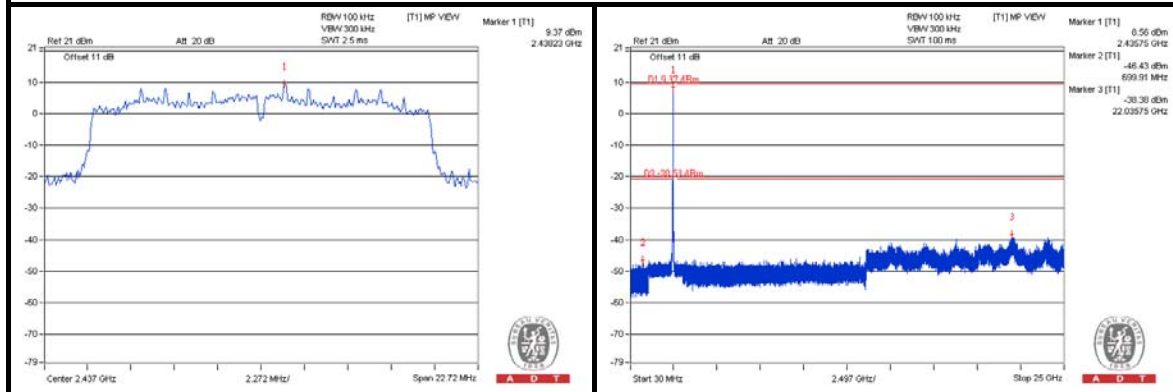

CH 11

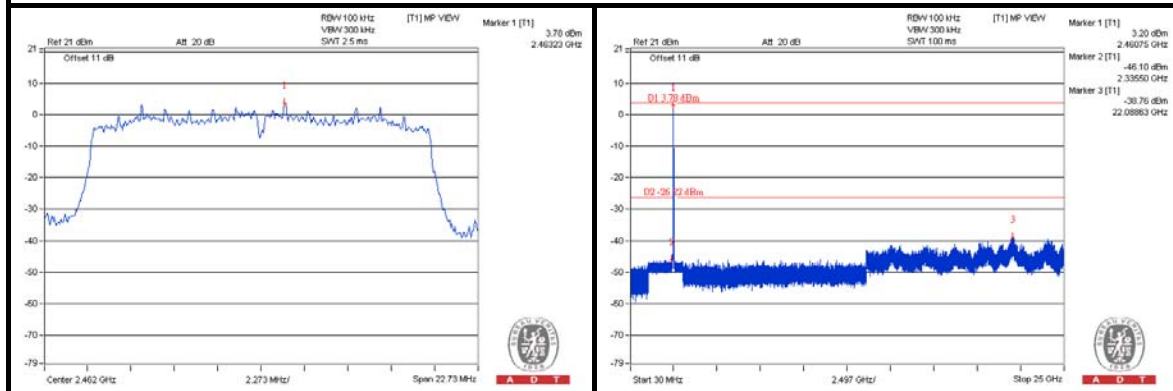

CH 1 Band edge

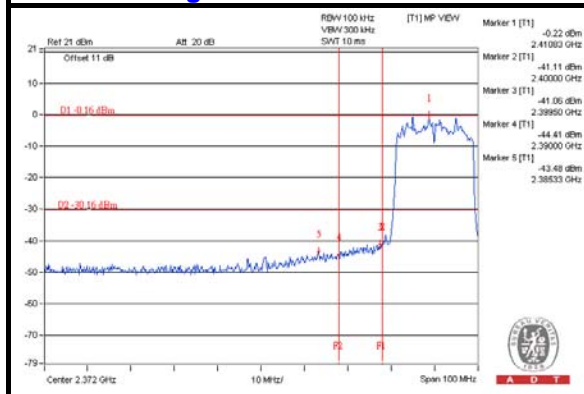

CH 11 Band edge

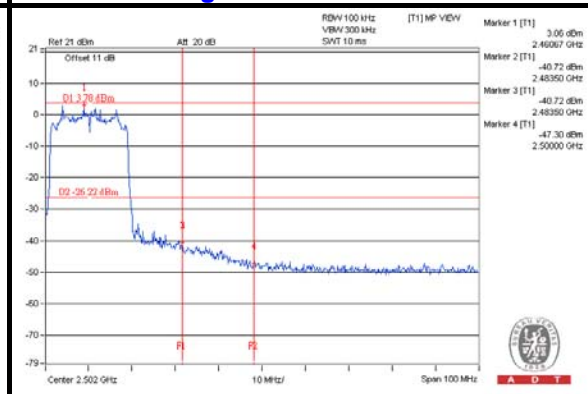

5. PHOTOGRAPHS OF THE TEST CONFIGURATION

Please refer to the attached file (Test Setup Photo).



6. INFORMATION ON THE TESTING LABORATORIES

We, Bureau Veritas Consumer Products Services (H.K.) Ltd., Taoyuan Branch, were founded in 1988 to provide our best service in EMC, Radio, Telecom and Safety consultation. Our laboratories are accredited and approved according to ISO/IEC 17025.

If you have any comments, please feel free to contact us at the following:

Linko EMC/RF Lab:

Tel: 886-2-26052180

Fax: 886-2-26051924

Hsin Chu EMC/RF/ Telecom Lab:

Tel: 886-3-5935343

Fax: 886-3-5935342

Hwa Ya EMC/RF/Safety Lab:

Tel: 886-3-3183232

Fax: 886-3-3270892

Email: service.adt@tw.bureauveritas.com

Web Site: www.bureauveritas-adt.com

The address and road map of all our labs can be found in our web site also.



A D T

7. APPENDIX A – MODIFICATIONS RECORDERS FOR ENGINEERING CHANGES TO THE EUT BY THE LAB

No any modifications were made to the EUT by the lab during the test.

---END---