



RADIO TEST REPORT

FCC ID : UDX-600191010
Equipment : Catalyst Wireless 9163E Series Wi-Fi 6E Access Point
Brand Name : CISCO
Model Name : CW9163E-B, CW9163E-MR
Applicant : Cisco Systems, Inc.
170 West Tasman Drive, San Jose, CA 95134 USA
Manufacturer : Cisco Systems, Inc.
170 West Tasman Drive, San Jose, CA 95134 USA
Standard : 47 CFR FCC Part 15.407

The product was received on Oct. 12, 2023, and testing was started from Oct. 17, 2023 and completed on Mar. 14, 2024. We, Sporton International Inc. Hsinchu Laboratory, would like to declare that the tested sample has been evaluated in accordance with the procedures given in ANSI C63.10-2013 and shown compliance with the applicable technical standards.

The test results in this variant report apply exclusively to the tested model / sample. Without written approval of Sporton International Inc. Hsinchu Laboratory, the test report shall not be reproduced except in full.

Approved by: Sam Chen

Sporton International Inc. Hsinchu Laboratory

No.8, Ln. 724, Bo'ai St., Zhubei City, Hsinchu County 302010, Taiwan (R.O.C.)



Table of Contents

History of this test report.....3

Summary of Test Result.....4

1 General Description5

1.1 Information.....5

1.2 Applicable Standards14

1.3 Testing Location Information.....14

1.4 Measurement Uncertainty14

2 Test Configuration of EUT15

2.1 Test Channel Mode15

2.2 The Worst Case Measurement Configuration17

2.3 EUT Operation during Test20

2.4 Accessories20

2.5 Support Equipment.....20

2.6 Test Setup Diagram21

3 Transmitter Test Result24

3.1 AC Power-line Conducted Emissions24

3.2 Emission Bandwidth26

3.3 Maximum Output Power27

3.4 Power Spectral Density29

3.5 Unwanted Emissions.....32

4 Test Equipment and Calibration Data36

Appendix A. Test Results of AC Power-line Conducted Emissions

Appendix B. Test Results of Emission Bandwidth

Appendix C. Test Results of Maximum Output Power

Appendix D. Test Results of Power Spectral Density

Appendix E. Test Results of Unwanted Emissions

Appendix F. Test Photos

Photographs of EUT v01



Summary of Test Result

Report Clause	Ref Std. Clause	Test Items	Result (PASS/FAIL)	Remark
1.1.2	15.203	Antenna Requirement	PASS	-
3.1	15.207	AC Power-line Conducted Emissions	PASS	-
3.2	15.407(a)	Emission Bandwidth	PASS	-
3.3	15.407(a)	Maximum Output Power	PASS	-
3.4	15.407(a)	Power Spectral Density	PASS	-
3.5	15.407(b)	Unwanted Emissions	PASS	-

Conformity Assessment Condition:

1. The test results (PASS/FAIL) with all measurement uncertainty excluded are presented against the regulation limits or in accordance with the requirements stipulated by the applicant/manufacturer who shall bear all the risks of non-compliance that may potentially occur if measurement uncertainty is taken into account.
2. The measurement uncertainty please refer to each test result in the chapter "Measurement Uncertainty".

Disclaimer:

The product specifications of the EUT presented in the test report that may affect the test assessments are declared by the manufacturer who shall take full responsibility for the authenticity.

Reviewed by: Sam Chen
Report Producer: Wendy Pan



1 General Description

1.1 Information

1.1.1 RF General Information

Frequency Range (MHz)	IEEE Std. 802.11	Ch. Frequency (MHz)	Channel Number
5150-5250	a, n (HT20), ac (VHT20), ax (HEW20)	5180-5240	36-48 [4]
5150-5250	n (HT40), ac (VHT40), ax (HEW40)	5190-5230	38-46 [2]
5150-5250	ac (VHT80), ax (HEW80)	5210	42 [1]

For Radio 1

Band	Mode	BWch (MHz)	Nant
5.15-5.25GHz	802.11a	20	1TX/2TX
5.15-5.25GHz	802.11n HT20	20	1TX/2TX
5.15-5.25GHz	802.11n HT20-BF	20	2TX
5.15-5.25GHz	802.11ac VHT20	20	1TX/2TX
5.15-5.25GHz	802.11ac VHT20-BF	20	2TX
5.15-5.25GHz	802.11ax HEW20	20	1TX/2TX
5.15-5.25GHz	802.11ax HEW20-BF	20	2TX
5.15-5.25GHz	802.11n HT40	40	1TX/2TX
5.15-5.25GHz	802.11n HT40-BF	40	2TX
5.15-5.25GHz	802.11ac VHT40	40	1TX/2TX
5.15-5.25GHz	802.11ac VHT40-BF	40	2TX
5.15-5.25GHz	802.11ax HEW40	40	1TX/2TX
5.15-5.25GHz	802.11ax HEW40-BF	40	2TX
5.15-5.25GHz	802.11ac VHT80	80	1TX/2TX
5.15-5.25GHz	802.11ac VHT80-BF	80	2TX
5.15-5.25GHz	802.11ax HEW80	80	1TX/2TX
5.15-5.25GHz	802.11ax HEW80-BF	80	2TX



For Scanning Radio 2

Band	Mode	BWch (MHz)	Nant
5.15-5.25GHz	802.11a	20	1TX
5.15-5.25GHz	802.11n HT20	20	1TX
5.15-5.25GHz	802.11ac VHT20	20	1TX
5.15-5.25GHz	802.11ax HEW20	20	1TX
5.15-5.25GHz	802.11n HT40	40	1TX
5.15-5.25GHz	802.11ac VHT40	40	1TX
5.15-5.25GHz	802.11ax HEW40	40	1TX
5.15-5.25GHz	802.11ac VHT80	80	1TX
5.15-5.25GHz	802.11ax HEW80	80	1TX

Note:

- ♦ 11a, HT20 and HT40 use a combination of OFDM-BPSK, QPSK, 16QAM, 64QAM modulation.
- ♦ VHT20, VHT40, VHT80 use a combination of OFDM-BPSK, QPSK, 16QAM, 64QAM, 256QAM modulation.
- ♦ HEW20, HEW40, HEW80 use a combination of OFDMA-BPSK, QPSK, 16QAM, 64QAM, 256QAM, 1024QAM modulation.
- ♦ BWch is the nominal channel bandwidth.



1.1.2 Antenna Information

Set	Ant.	2.4GHz Port	5GHz Port	6GHz Port	Bluetooth/ Zigbee	GPS	Brand	Model Name	Antenna Type	Connector	Remark	Gain (dBi)
1	1	2	2	-	-	-	CISCO	CW-ANT-O1-NS-00	Dipole	N-Type	External Antenna	Note 1
	2	1	1	-	-	-	CISCO	CW-ANT-O1-NS-00	Dipole	N-Type	External Antenna	
	3	-	-	1	-	-	CISCO	CW-ANT-O1-NS-00	Dipole	N-Type	External Antenna	
	4	-	-	2	-	-	CISCO	CW-ANT-O1-NS-00	Dipole	N-Type	External Antenna	
2	5	1	1	1	-	-	AWAN	A8M6P-100005	PIFA	N-Type	Internal Antenna	
3	6	-	-	-	1	-	AWAN	A8M6P-100003	PIFA	N-Type	Internal Antenna	
4	7	-	-	-	-	1	AWAN	A8M6P-100004	PIFA	N-Type	Internal Antenna	
5	8	-	-	-	-	2	CISCO	CW-ANT-GPS2-S-00	Patch	SMA	External Antenna	
6	9	2	2	-	-	-	CISCO	CW-ANT-D1-NS-00	Patch	N-Type	External Antenna	
	10	1	1	-	-	-	CISCO	CW-ANT-D1-NS-00	Patch	N-Type	External Antenna	
	11	-	-	1	-	-	CISCO	CW-ANT-D1-NS-00	Patch	N-Type	External Antenna	
	12	-	-	2	-	-	CISCO	CW-ANT-D1-NS-00	Patch	N-Type	External Antenna	



Note1:

Ant.	Gain (dBi)								
	2.4GHz	5GHz UNII 1	5GHz UNII 2A	5GHz UNII 2C	5GHz UNII 3	6GHz UNII 5	6GHz UNII 7	Bluetooth / Zigbee	GPS
1	4	8	8	8	8	-	-	-	-
2	4	8	8	8	8	-	-	-	-
3	-	-	-	-	-	8	8	-	-
4	-	-	-	-	-	8	8	-	-
5	4.9	3	3	3.1	3	2.8	3.2	-	-
6	-	-	-	-	-	-	-	5.7	-
7	-	-	-	-	-	-	-	-	3.7
8	-	-	-	-	-	-	-	-	3.18
9	8	9	9	9	9	-	-	-	-
10	8	9	9	9	9	-	-	-	-
11	-	-	-	-	-	9	9	-	-
12	-	-	-	-	-	9	9	-	-

Note2: The above information was declared by manufacturer.

Note3: The antenna 9~ 10 is the cross-polarized antenna; it doesn't need to evaluate array gain.

Note4: For radio 1: The EUT can be equipped with antenna set 1 or set 6 for radio 1.



Note5: Directional gain information

Type	Maximum Output Power	Power Spectral Density
Non-BF	Directional gain = Max.gain + array gain. For power measurements on IEEE 802.11 devices Array Gain = 0 dB (i.e., no array gain) for N ANT ≤ 4	$DirectionalGain = 10 \cdot \log \left[\frac{\sum_{j=1}^{N_{ANT}} \left[\sum_{k=1}^{N_{ANT}} g_{j,k} \right]^2}{N_{ANT}} \right]$
BF	$DirectionalGain = 10 \cdot \log \left[\frac{\sum_{j=1}^{N_{ANT}} \left[\sum_{k=1}^{N_{ANT}} g_{j,k} \right]^2}{N_{ANT}} \right]$	$DirectionalGain = 10 \cdot \log \left[\frac{\sum_{j=1}^{N_{ANT}} \left[\sum_{k=1}^{N_{ANT}} g_{j,k} \right]^2}{N_{ANT}} \right]$

Ex.

Directional Gain (NSS1) formula :

$$DirectionalGain = 10 \cdot \log \left[\frac{\sum_{j=1}^{N_{ANT}} \left[\sum_{k=1}^{N_{ANT}} g_{j,k} \right]^2}{N_{ANT}} \right]$$

$$NSS1(g1,1) = 10^{G1/20} ; NSS1(g1,2) = 10^{G2/20} ; NSS1(g1,3) = 10^{G3/20} ; NSS1(g1,4) = 10^{G4/20}$$

$$g_{j,k} = (NSS1(g1,1) + NSS1(g1,2) + NSS1(g1,3) + NSS1(g1,4))^2$$

$$DG = 10 \log[(NSS1(g1,1) + NSS1(g1,2) + NSS1(g1,3) + NSS1(g1,4))^2 / N_{ANT}] => 10$$

$$\log[(10^{G1/20} + 10^{G2/20} + 10^{G3/20} + 10^{G4/20})^2 / N_{ANT}]$$

Where ;

Set 1 Ant. Dipole

2.4G G1= 4 dBi ; G2= 4 dBi ;DG= 7.01dBi

5G G1= 8 dBi ; G2= 8 dBi ;DG= 11.01dBi

6G G1= 8 dBi ; G2= 8 dBi ;DG= 11.01dBi

Set 6 Ant. Patch Patch (Cross-Polarized Antenna)

2.4G G1= 8.00 dBi ;G2= 8.00 dBi ;

5G UNII-1 G1 = 9.00 dBi; G2 = 9.00 dBi;

5G UNII-2A G1 = 9.00 dBi; G2 = 9.00 dBi;

5G UNII-2C G1 = 9.00 dBi; G2 = 9.00 dBi;

5G UNII-3 G1 = 9.00 dBi; G2 = 9.00 dBi;

2.4G DG = 8.00 dBi

5G UNII-1 DG = 9.00 dBi

5G UNII-2A DG = 9.00 dBi

5G UNII-2C DG = 9.00 dBi

5G UNII-3 DG = 9.00 dBi

Set 6 Ant. Patch

6G G1= 9 dBi ; G2= 9 dBi ;DG= 12.01dBi



<For Radio 1 (2.4GHz/5GHz/6GHz Functions)>

IEEE 802.11a/b/g/n/VHT/ax

For 1TX/2RX:

The EUT supports the antenna with TX diversity functions.

Both Port 1 and Port 2 support transmit and receive functions, but only one of them will be used to transmit at one time.

For 2TX/2RX:

Port 1 and Port 2 can be used as transmitting/receiving antenna.

Port 1 and Port 2 could transmit/receive simultaneously.

<For Scanning Radio 2 (2.4GHz/5GHz/6GHz Functions)>

IEEE 802.11a/b/g/n/VHT/ax

For 1TX/1RX:

Only Port 1 can be use as transmitting/receiving antenna.

<For Radio 3 / Bluetooth/Zigbee Functions>

For 1TX/1RX:

Only Port 1 can be use as transmitting/receiving antenna.

<For Radio 4 / GPS Functions>

For 1RX:

The EUT supports the antenna with RX diversity functions.

Both Port 1 and Port 2 support receive functions, but only one of them will be used to receive at one time.

**1.1.3 Mode Test Duty Cycle****For Radio 1 + Set 6 Ant.****For 1TX/Port 1**

Mode	DC	DCF(dB)	T(s)	VBW(Hz) $\geq 1/T$
802.11a	1,(6D)	0	n/a (DC \geq 0.98)	n/a (DC \geq 0.98)
802.11ax HEW20	1,(M0)	0	n/a (DC \geq 0.98)	n/a (DC \geq 0.98)
802.11ax HEW40	1,(M0)	0	n/a (DC \geq 0.98)	n/a (DC \geq 0.98)
802.11ax HEW80	1,(M0)	0	n/a (DC \geq 0.98)	n/a (DC \geq 0.98)

For 1TX/Port 2

Mode	DC	DCF(dB)	T(s)	VBW(Hz) $\geq 1/T$
802.11a	1,(6D)	0	n/a (DC \geq 0.98)	n/a (DC \geq 0.98)
802.11ax HEW20	1,(M0)	0	n/a (DC \geq 0.98)	n/a (DC \geq 0.98)
802.11ax HEW40	1,(M0)	0	n/a (DC \geq 0.98)	n/a (DC \geq 0.98)
802.11ax HEW80	1,(M0)	0	n/a (DC \geq 0.98)	n/a (DC \geq 0.98)

For 2TX

Mode	DC	DCF(dB)	T(s)	VBW(Hz) $\geq 1/T$
802.11a	0.942	0.26	1.977m	1k
802.11ax HEW20	0.801	0.96	5.453m	300
802.11ax HEW20-BF	0.801	0.96	5.452m	300
802.11ax HEW40	0.799	0.97	5.453m	300
802.11ax HEW40-BF	0.802	0.96	5.453m	300
802.11ax HEW80	0.801	0.96	5.452m	300
802.11ax HEW80-BF	0.799	0.97	5.453m	300

Note:

- ◆ DC is Duty Cycle.
- ◆ DCF is Duty Cycle Factor.



1.1.4 EUT Operational Condition

EUT Power Type	From PoE			
Beamforming Function	<input checked="" type="checkbox"/>	With beamforming	<input type="checkbox"/>	Without beamforming
	The product has beamforming function for 11n/VHT/11ax in 2.4GHz and 11n/11ac/11ax in 5GHz.			
Function	<input checked="" type="checkbox"/>	Outdoor P2M	<input type="checkbox"/>	Indoor P2M
	<input type="checkbox"/>	Fixed P2P	<input type="checkbox"/>	Client
	<input checked="" type="checkbox"/>	Point-to-multipoint	<input type="checkbox"/>	Point-to-point
Channel Puncturing Function	<input type="checkbox"/>	Supported	<input checked="" type="checkbox"/>	Unsupported
Support RU	<input checked="" type="checkbox"/>	Full RU	<input type="checkbox"/>	Partial RU
Test Software Version	QSPR Version 5.0-00202			

Note: The above information was declared by manufacturer.

1.1.5 Table for Multiple Listing

The model names in the following table are all refer to the identical product.

Model Name	SW
CW9163E-B	Cisco
CW9163E-MR	Meraki

Note1: From the above models, model: CW9163E-B was selected as representative model for the test and its data was recorded in this report.

Note2: The above information was declared by manufacturer.

1.1.6 Table of Serial Number

Test items	Serial Number
1. AC Power-line Conducted Emissions 2. Radiated Emission Co-location (As below for Non Beamforming mode) 3. Emission Bandwidth 4. Maximum Output Power 5. Power Spectral Density 6. Unwanted Emissions below 1GHz 7. Unwanted Emissions above 1GHz	DSM2711000W
(As below for Beamforming mode) 8. Maximum Output Power	DSM2711001S

Note: The above information was declared by manufacturer.



1.1.7 Table for Radio Function

Radio	Support Band
1	2.4GHz / 5GHz UNII 1~UNII 3 / 6GHz UNII5 , UNII 7
2	Scanning 2.4GHz / 5GHz UNII 1~UNII 3 / 6GHz UNII5 , UNII 7
3	Bluetooth / Zigbee
4	GPS

Note1: The above information was declared by manufacturer.
 Note2: The Radio 1 and Radio 2 can't be operated simultaneously.

1.1.8 Table for EUT Information

EUT	RJ-45 Connector	Console Connector
1	Brand Name: UDE Model Name: R66-MK-3001	Brand Name: UDE Model Name: R66-MK-2001
2	Brand Name: ODS Model Name: CMK-RJ45-CAP	Brand Name: ODS Model Name: CMK-RJ45-CG

Note1: From the above EUTs, EUT 1 was selected as representative EUT for all the tests and its data was recorded in this report.
 Note2: The above information was declared by manufacturer.

1.1.9 Table for Permissive Change

This product is an extension of original one reported under Sporton project number: FR340101AB
 Below is the table for the change of the product with respect to the original one.

Modifications	Performance Checking
1. Adding one set antenna (antenna set 6) with different antenna type and higher gain for Radio 1 use only.	All test items (Except Radiated Emission Co-location)
2. Adding a bracket of antenna and used for antenna set 6. 3. Revise the typo in antenna model names to "CW-ANT-O1-NS-00" from "CW-ANT-O1-NS" and to "CW-ANT-GPS2-S-00" from "CW-ANT-GPS2".	After evaluating, it is not necessary to re-test all test items.



1.2 Applicable Standards

According to the specifications of the manufacturer, the EUT must comply with the requirements of the following standards:

- ♦ 47 CFR FCC Part 15
- ♦ ANSI C63.10-2013
- ♦ FCC KDB 789033 D02 v02r01

The following reference test guidance is not within the scope of accreditation of TAF.

- ♦ FCC KDB 662911 D01 v02r01
- ♦ FCC KDB 412172 D01 v01r01
- ♦ FCC KDB 414788 D01 v01r01

1.3 Testing Location Information

Testing Location Information	
Test Lab. : Sporton International Inc. Hsinchu Laboratory	
Hsinchu (TAF: 3787)	ADD: No.8, Ln. 724, Bo'ai St., Zhubei City, Hsinchu County 302010, Taiwan (R.O.C.) TEL: 886-3-656-9065 FAX: 886-3-656-9085 Test site Designation No. TW3787 with FCC. Conformity Assessment Body Identifier (CABID) TW3787 with ISED.

Test Condition	Test Site No.	Test Engineer	Test Environment (°C / %)	Test Date
RF Conducted	TH01-CB	Ken Yeh	20.5~21.3 / 63~67	Oct. 17, 2023~Oct. 31, 2023
	TH01-CB	Ken Yeh	20.5~21.3 / 63~67	Mar. 13, 2024~Mar. 14, 2024
Radiated below 1GHz	03CH01-CB	Jackson Peng	21.2-22.3 / 56-59	Oct. 17, 2023~Nov.17, 2023
Radiated above 1GHz	03CH03-CB	Jackson Peng	22.7-23.8 / 56-59	Oct. 17, 2023~Nov.17, 2023
AC Conduction	CO01-CB	Joe Chu	22~23 / 54~55	Nov. 23, 2023

1.4 Measurement Uncertainty

ISO/IEC 17025 requires that an estimate of the measurement uncertainties associated with the emissions test results be included in the report. The measurement uncertainties given below are based on a 95% confidence level (based on a coverage factor (k=2))

Test Items	Uncertainty	Remark
Conducted Emission (150kHz ~ 30MHz)	3.4 dB	Confidence levels of 95%
Radiated Emission (9kHz ~ 30MHz)	3.7 dB	Confidence levels of 95%
Radiated Emission (30MHz ~ 1,000MHz)	5.1 dB	Confidence levels of 95%
Radiated Emission (1GHz ~ 18GHz)	4.1 dB	Confidence levels of 95%
Radiated Emission (18GHz ~ 40GHz)	4.2 dB	Confidence levels of 95%
Conducted Emission	3.1 dB	Confidence levels of 95%
Output Power Measurement	0.8 dB	Confidence levels of 95%
Power Density Measurement	3.1 dB	Confidence levels of 95%
Bandwidth Measurement	2.2%	Confidence levels of 95%



2 Test Configuration of EUT

2.1 Test Channel Mode

For Radio 1 + Set 6 Ant.

For 1TX/Port 1:

Mode	Power Setting
802.11a_Nss1,(6Mbps)_1TX	-
5180MHz	20.5
5200MHz	21.5
5240MHz	21
802.11ax HEW20_Nss1,(MCS0)_1TX	-
5180MHz	20
5200MHz	22
5240MHz	21.5
802.11ax HEW40_Nss1,(MCS0)_1TX	-
5190MHz	19
5230MHz	21
802.11ax HEW80_Nss1,(MCS0)_1TX	-
5210MHz	18

For 1TX/Port 2:

Mode	Power Setting
802.11a_Nss1,(6Mbps)_1TX	-
5180MHz	21
5200MHz	22
5240MHz	22
802.11ax HEW20_Nss1,(MCS0)_1TX	-
5180MHz	21
5200MHz	22.5
5240MHz	22.5
802.11ax HEW40_Nss1,(MCS0)_1TX	-
5190MHz	20
5230MHz	22
802.11ax HEW80_Nss1,(MCS0)_1TX	-
5210MHz	19



For 2TX:

Mode	Power Setting
802.11a_Nss1,(6Mbps)_2TX	-
5180MHz	18.5
5200MHz	18.5
5240MHz	18.5
802.11ax HEW20_Nss1,(MCS0)_2TX	-
5180MHz	19.5
5200MHz	19
5240MHz	19
802.11ax HEW40_Nss1,(MCS0)_2TX	-
5190MHz	18
5230MHz	18.5
802.11ax HEW80_Nss1,(MCS0)_2TX	-
5210MHz	17
802.11ax HEW20-BF_Nss1,(MCS0)_2TX	-
5180MHz	19.5
5200MHz	19
5240MHz	19
802.11ax HEW40-BF_Nss1,(MCS0)_2TX	-
5190MHz	18
5230MHz	18.5
802.11ax HEW80-BF_Nss1,(MCS0)_2TX	-
5210MHz	17

Note:

- ♦ Evaluated HEW20/HEW40/HEW80 mode only, due to similar modulation. The power setting of HT20/HT40/VHT20/VHT40/VHT80 mode are the same or lower than HEW20/HEW40/HEW80.
- ♦ The EUT supports beamforming and CDD modes, and the CDD mode is the worst case. Therefore, all test items are evaluated in the report. The beamforming mode only evaluates the output power.



2.2 The Worst Case Measurement Configuration

The Worst Case Mode for Following Conformance Tests	
Tests Item	AC power-line conducted emissions
Condition	AC power-line conducted measurement for line and neutral Test Voltage: 120Vac / 60Hz
Operating Mode	CTX
1. The EUT powered by PoE 1~5, and "PoE 3" has been evaluated to be the worst case. Thus, the measurement will follow this same test mode. 2. There are EUT 1 and EUT 2, and "EUT 1" has been evaluated to be the worst case. Thus, the measurement will follow this same test mode.	
1	EUT 1 + Radio 1 (2.4GHz) + PoE 3 + Set 6 Ant.
2	EUT 1 + Radio 1 (5GHz) + PoE 3 + Set 6 Ant.
3	EUT 1 + Radio 1 (6GHz) + PoE 3 + Set 6 Ant.
For operating mode 1 is the worst case and it was record in this test report.	

The Worst Case Mode for Following Conformance Tests	
Tests Item	Emission Bandwidth Maximum Output Power Power Spectral Density
Test Condition	Conducted measurement at transmit chains
1	EUT 1 + Radio 1 + Set 6 Ant.



The Worst Case Mode for Following Conformance Tests	
Tests Item	Unwanted Emissions
Test Condition	Radiated measurement If EUT consist of multiple antenna assembly (multiple antenna are used in EUT regardless of spatial multiplexing MIMO configuration), the radiated test should be performed with highest antenna gain of each antenna type.
Operating Mode < 1GHz	CTX
1. After evaluating, the worst case was found at Y axis. So the measurement will follow this same test configuration. 2. The EUT powered by PoE 1~5, and "PoE 5" has been evaluated to be the worst case. Thus, the measurement will follow this same test mode. 3. There are EUT 1 and EUT 2, and "EUT 1" has been evaluated to be the worst case. Thus, the measurement will follow this same test mode.	
1	EUT 1 in Y axis + Radio 1 (2.4GHz) + PoE 5 + Set 6 Ant.
2	EUT 1 in Y axis + Radio 1 (5GHz) + PoE 5 + Set 6 Ant.
3	EUT 1 in Y axis + Radio 1 (6GHz) + PoE 5 + Set 6 Ant.
For operating mode 3 is the worst case and it was record in this test report.	
Operating Mode > 1GHz	CTX
	After evaluating, the worst case was found at Y axis. So the measurement will follow this same test configuration.
1	EUT 1 in Y axis + Radio 1 + Set 6 Ant.



The Worst Case Mode for Following Conformance Tests	
Tests Item	Simultaneous Transmission Analysis - Co-location RF Exposure Evaluation
Operating Mode	
1	Radio 1 + Set 1 Ant. (WLAN 2.4GHz+5GHz+6GHz) + Scanning Radio 2 Set 2 Ant. (WLAN 2.4GHz) + Radio 3 (Bluetooth) + Set 3 Ant.
2	Radio 1 + Set 1 Ant. (WLAN 2.4GHz+5GHz+6GHz) + Scanning Radio 2 Set 2 Ant. (WLAN 5GHz) + Radio 3 (Bluetooth) + Set 3 Ant.
3	Radio 1 + Set 1 Ant. (WLAN 2.4GHz+5GHz+6GHz) + Scanning Radio 2 Set 2 Ant. (WLAN 6Hz) + Radio 3 (Bluetooth) + Set 3 Ant.
4	Radio 1 + Set 1 Ant. (WLAN 2.4GHz+5GHz+6GHz) + Scanning Radio 2 Set 2 Ant. (WLAN 2.4GHz) + Radio 3 (Zigbee) + Set 3 Ant.
5	Radio 1 + Set 1 Ant. (WLAN 2.4GHz+5GHz+6GHz) + Scanning Radio 2 Set 2 Ant. (WLAN 5GHz) + Radio 3 (Zigbee) + Set 3 Ant.
6	Radio 1 + Set 1 Ant. (WLAN 2.4GHz+5GHz+6GHz) + Scanning Radio 2 Set 2 Ant. (WLAN 6Hz) + Radio 3 (Zigbee) + Set 3 Ant.
7	Radio 1 + Set 6 Ant. (WLAN 2.4GHz+5GHz+6GHz) + Scanning Radio 2 Set 2 Ant. (WLAN 2.4GHz) + Radio 3 (Bluetooth) + Set 3 Ant.
8	Radio 1 + Set 6 Ant. (WLAN 2.4GHz+5GHz+6GHz) + Scanning Radio 2 Set 2 Ant. (WLAN 5GHz) + Radio 3 (Bluetooth) + Set 3 Ant.
9	Radio 1 + Set 6 Ant. (WLAN 2.4GHz+5GHz+6GHz) + Scanning Radio 2 Set 2 Ant. (WLAN 6Hz) + Radio 3 (Bluetooth) + Set 3 Ant.
10	Radio 1 + Set 6 Ant. (WLAN 2.4GHz+5GHz+6GHz) + Scanning Radio 2 Set 2 Ant. (WLAN 2.4GHz) + Radio 3 (Zigbee) + Set 3 Ant.
11	Radio 1 + Set 6 Ant. (WLAN 2.4GHz+5GHz+6GHz) + Scanning Radio 2 Set 2 Ant. (WLAN 5GHz) + Radio 3 (Zigbee) + Set 3 Ant.
12	Radio 1 + Set 6 Ant. (WLAN 2.4GHz+5GHz+6GHz) + Scanning Radio 2 Set 2 Ant. (WLAN 6Hz) + Radio 3 (Zigbee) + Set 3 Ant.
Refer to Sporton Test Report No.: FA340101-03 for Co-location RF Exposure Evaluation.	

Note: The PoEs are for measurement only, would not be marketed.

PoE information as below:

Power	Brand Name	Model Name
PoE 1	PHIHONG	POEA33U-1ATE
PoE 2	PHIHONG	POE60U-1BT-X
PoE 3	PHIHONG	POE29U-1AT(PL)
PoE 4	Delta	ADH-65AR B
PoE 5	Cisco	POEO75U-1BT



2.3 EUT Operation during Test

The EUT was programmed to be in continuously transmitting mode.

2.4 Accessories

Equipment	Brand Name	Model Name	Remark
Mount bracket 1*1	Meraki	MA-MNT-MR-16	Used for CW9163E-MR
Mount bracket 2*1	Cisco	AIR-MNT-VERT1	Used for CW9163E-B
Waterproof Covering (Cap) 1*1	UDE	R66-MK-3001	Used for EUT 1
Waterproof Covering (Cap) 2*1	ODS	CMK-RJ45-CAP	Used for EUT 2
Waterproof Covering (Cable Gland) 1*1	UDE	R66-MK-2001	Used for EUT 1
Waterproof Covering (Cable Gland) 2*1	ODS	CMK-RJ45-CG	Used for EUT 2
Bracket of antenna	Cisco	CW-WNT-ART2	Used for Ant.9~12

2.5 Support Equipment

For AC Conduction:

Support Equipment				
No.	Equipment	Brand Name	Model Name	FCC ID
A	LAN NB	DELL	E6430	N/A
B	PoE 3	PHIHONG	POE29U-1AT(PL)	N/A

For Radiated:

Support Equipment				
No.	Equipment	Brand Name	Model Name	FCC ID
A	PoE 5	Cisco	POEO75U-1BT	N/A
B	Notebook	DELL	E6430	N/A

For RF Conducted:

Support Equipment				
No.	Equipment	Brand Name	Model Name	FCC ID
A	Notebook	DELL	E4300	N/A
B	PoE 4	Delta	ADH-65AR B	N/A

2.6 Test Setup Diagram

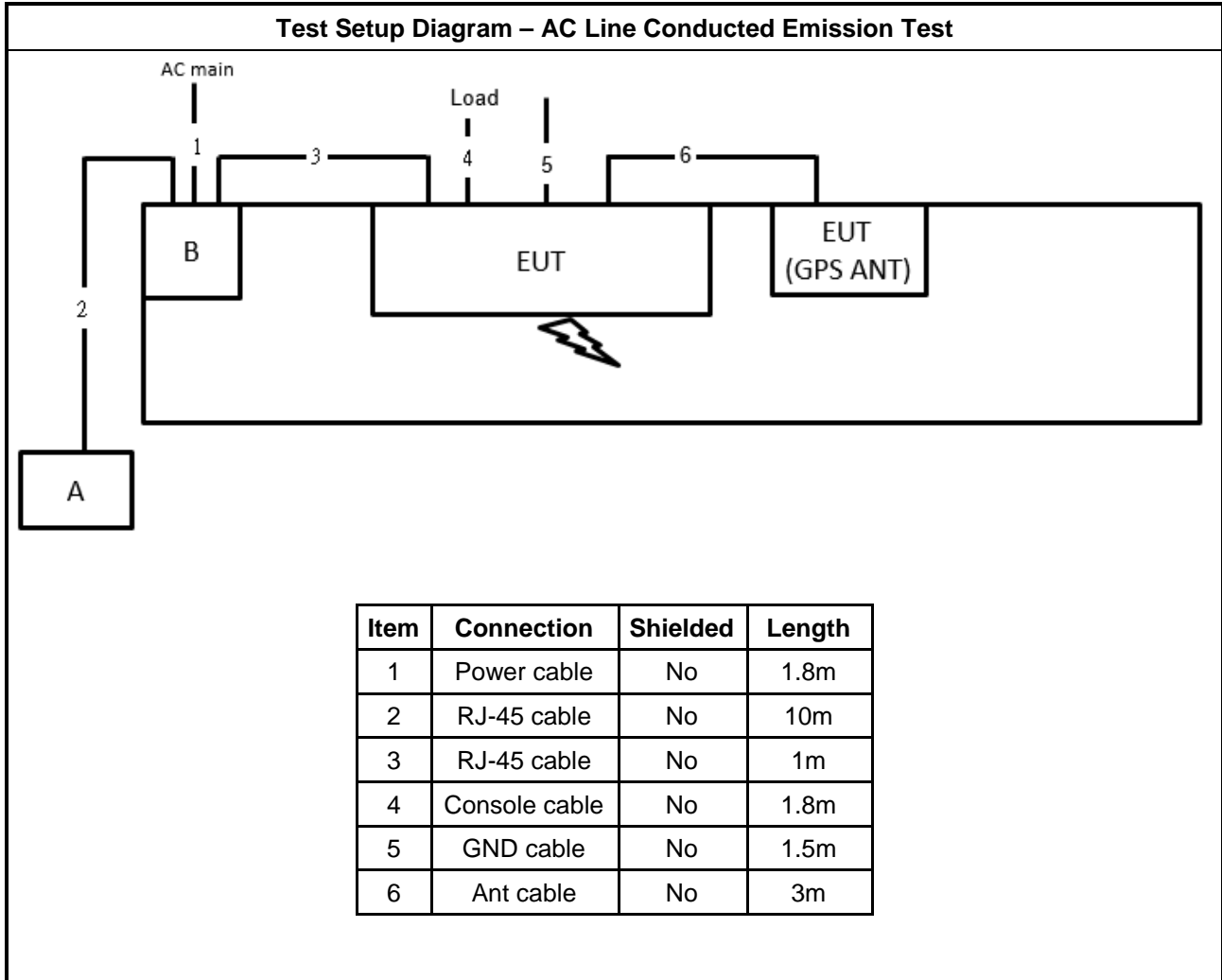



Test Setup Diagram - Radiated Test < 1GHz

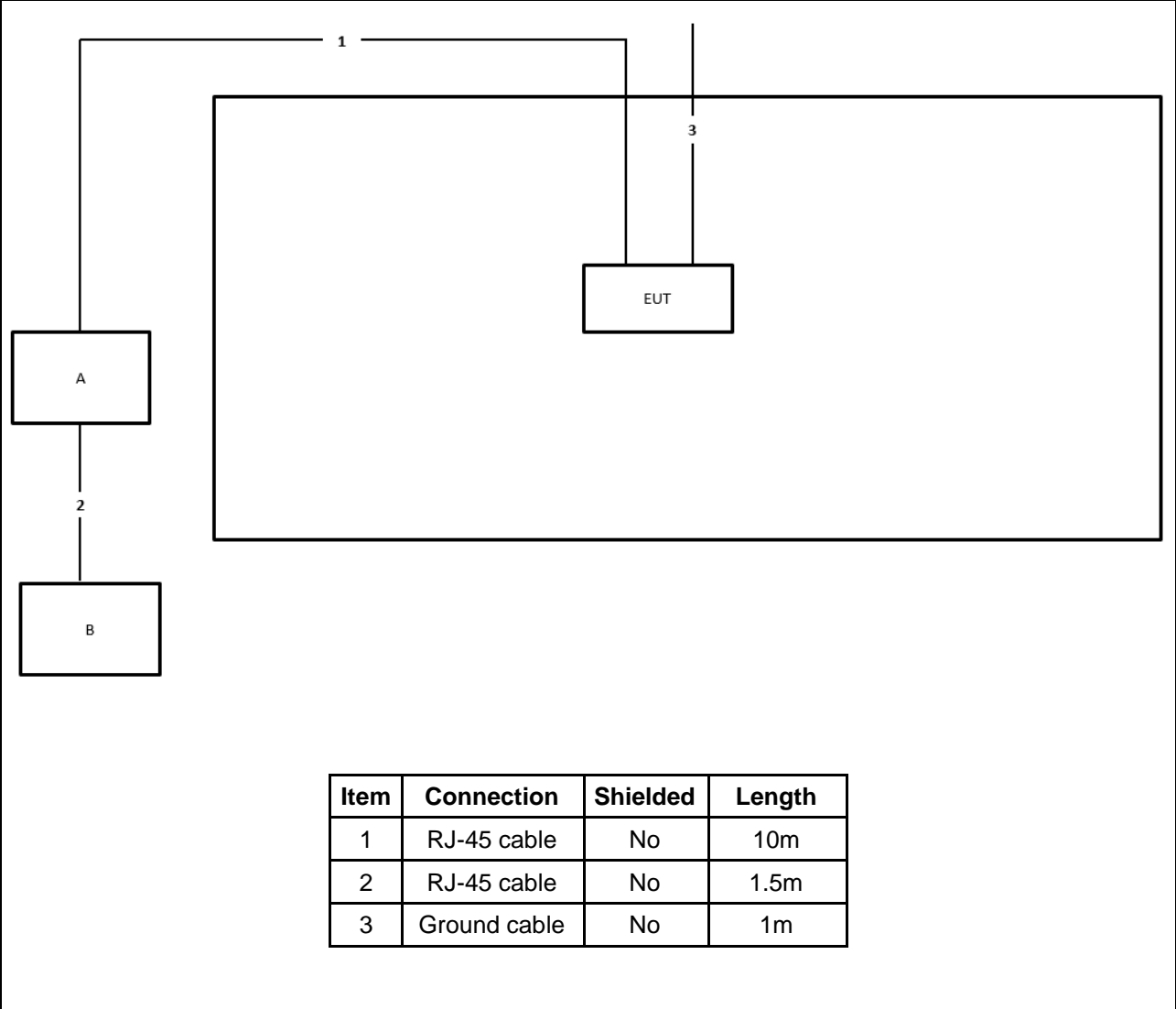



Test Setup Diagram - Radiated Test > 1GHz

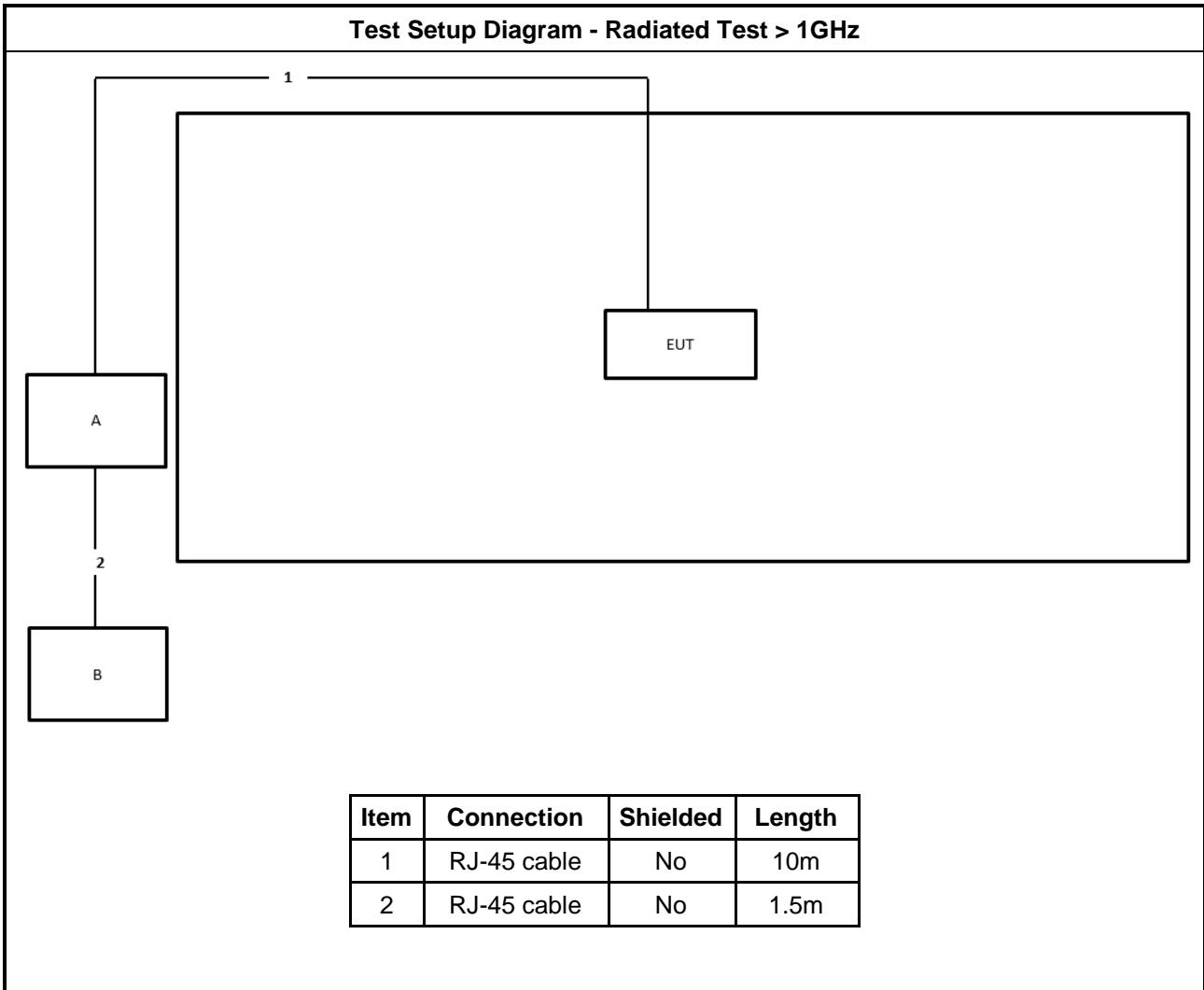

Item	Connection	Shielded	Length
1	RJ-45 cable	No	10m
2	RJ-45 cable	No	1.5m



3 Transmitter Test Result

3.1 AC Power-line Conducted Emissions

3.1.1 AC Power-line Conducted Emissions Limit

AC Power-line Conducted Emissions Limit		
Frequency Emission (MHz)	Quasi-Peak	Average
0.15-0.5	66 - 56 *	56 - 46 *
0.5-5	56	46
5-30	60	50

Note 1: * Decreases with the logarithm of the frequency.

3.1.2 Measuring Instruments

Refer a test equipment and calibration data table in this test report.

3.1.3 Test Procedures

Test Method
<input checked="" type="checkbox"/> Refer as ANSI C63.10-2013, clause 6.2 for AC power-line conducted emissions.

3.1.4 Test Setup

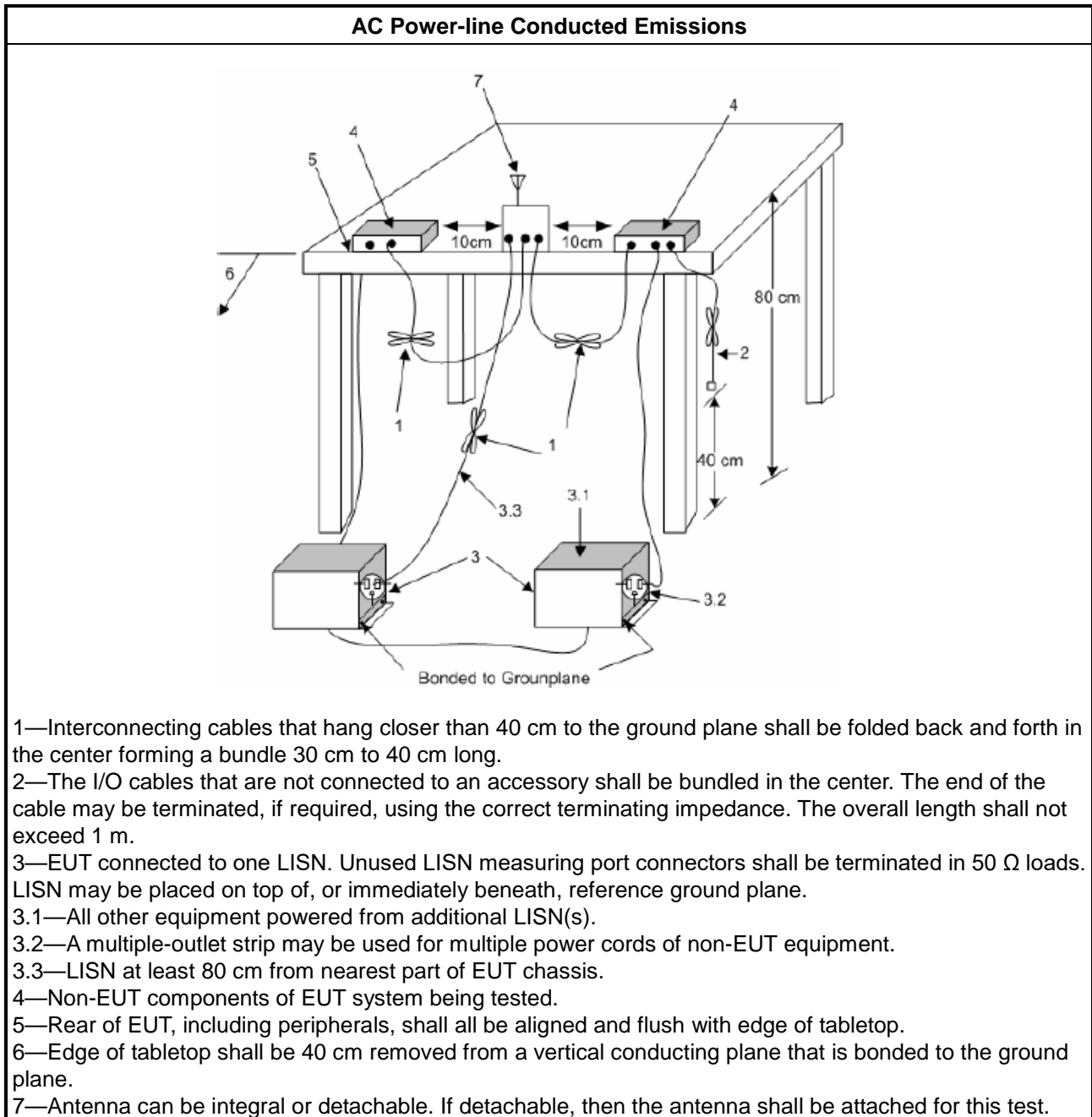

3.1.5 Measurement Results Calculation

The measured Level is calculated using:

- a. Corrected Reading: LISN Factor (LISN) + Attenuator (AT/AUX) + Cable Loss (CL) + Read Level (Raw) = Level
- b. Margin = -Limit + Level

3.1.6 Test Result of AC Power-line Conducted Emissions

Refer as Appendix A

3.2 Emission Bandwidth

3.2.1 Emission Bandwidth Limit

Emission Bandwidth Limit	
UNII Devices	
<input checked="" type="checkbox"/>	For the 5.15-5.25 GHz band, N/A
<input type="checkbox"/>	For the 5.25-5.35 GHz band, the maximum conducted output power shall not exceed the lesser of 250 mW or 11 dBm + 10 log B, where B is the 26 dB emission bandwidth in MHz.
<input type="checkbox"/>	For the 5.47-5.725 GHz band, the maximum conducted output power shall not exceed the lesser of 250 mW or 11 dBm + 10 log B, where B is the 26 dB emission bandwidth in MHz.
<input type="checkbox"/>	For the 5.725-5.85 GHz band, 26 dB emission bandwidth ,N/A. 6 dB emission bandwidth ≥ 500kHz.
LE-LAN Devices	
<input type="checkbox"/>	For the band 5.15-5.25 GHz, the maximum e.i.r.p. shall not exceed 200 mW or 10 + 10 log B, dBm, whichever power is less. B is the 99% emission bandwidth in MHz.
<input type="checkbox"/>	For the 5.25-5.35 GHz band, the maximum e.i.r.p. shall not exceed 1.0 W or 17 + 10 log B, dBm, whichever power is less. B is the 99% emission bandwidth in MHz
<input type="checkbox"/>	For the 5.47-5.6 GHz band and 5.65-5.725 GHz band, the maximum e.i.r.p. shall not exceed 1.0 W or 17 + 10 log B, dBm, whichever power is less. B is the 99% emission bandwidth in MHz
<input type="checkbox"/>	For the 5.725-5.85 GHz band, 6 dB emission bandwidth ≥ 500kHz.

3.2.2 Measuring Instruments

Refer a test equipment and calibration data table in this test report.

3.2.3 Test Procedures

Test Method							
<ul style="list-style-type: none"> ▪ For the emission bandwidth shall be measured using one of the options below: <table border="1" style="width: 100%; border-collapse: collapse;"> <tr> <td style="width: 30px;"><input checked="" type="checkbox"/></td> <td>Refer as FCC KDB 789033 D02, clause C for EBW and clause D for OBW measurement.</td> </tr> <tr> <td><input type="checkbox"/></td> <td>Refer as ANSI C63.10, clause 6.9.1 for occupied bandwidth testing.</td> </tr> <tr> <td><input type="checkbox"/></td> <td>Refer as IC RSS-Gen, clause 4.6 for bandwidth testing.</td> </tr> </table> 		<input checked="" type="checkbox"/>	Refer as FCC KDB 789033 D02, clause C for EBW and clause D for OBW measurement.	<input type="checkbox"/>	Refer as ANSI C63.10, clause 6.9.1 for occupied bandwidth testing.	<input type="checkbox"/>	Refer as IC RSS-Gen, clause 4.6 for bandwidth testing.
<input checked="" type="checkbox"/>	Refer as FCC KDB 789033 D02, clause C for EBW and clause D for OBW measurement.						
<input type="checkbox"/>	Refer as ANSI C63.10, clause 6.9.1 for occupied bandwidth testing.						
<input type="checkbox"/>	Refer as IC RSS-Gen, clause 4.6 for bandwidth testing.						

3.2.4 Test Setup

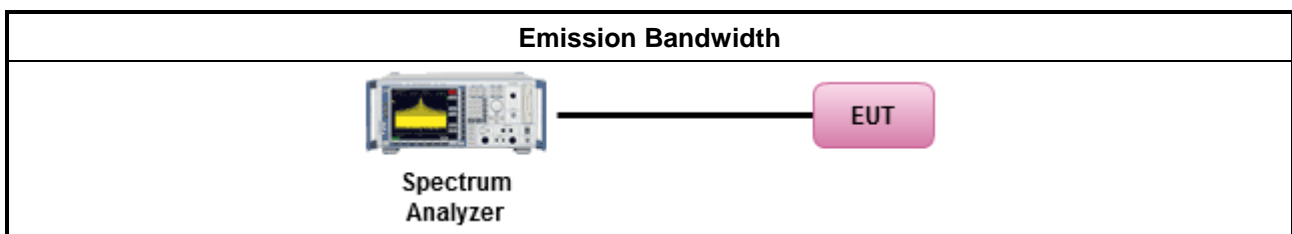

3.2.5 Test Result of Emission Bandwidth

Refer as Appendix B



3.3 Maximum Output Power

3.3.1 Limit

Maximum Output Power Limit	
UNII Devices	
<input checked="" type="checkbox"/> For the 5.15-5.25 GHz band:	
<input type="checkbox"/>	<ul style="list-style-type: none"> ▪ Outdoor AP: the maximum conducted output power (P_{Out}) shall not exceed the lesser of 1 W. If $G_{TX} > 6$ dBi, then $P_{Out} = 30 - (G_{TX} - 6)$. e.i.r.p. at any elevation angle above 30 degrees $\leq 125mW$ [21dBm] ▪ Indoor AP: the maximum conducted output power (P_{Out}) shall not exceed the lesser of 1 W. If $G_{TX} > 6$ dBi, then $P_{Out} = 30 - (G_{TX} - 6)$ ▪ Point-to-point AP: the maximum conducted output power (P_{Out}) shall not exceed the lesser of 1 W. If $G_{TX} > 23$ dBi, then $P_{Out} = 30 - (G_{TX} - 23)$. ▪ Mobile or Portable Client: the maximum conducted output power (P_{Out}) shall not exceed the lesser of 250 mW. If $G_{TX} > 6$ dBi, then $P_{Out} = 24 - (G_{TX} - 6)$.
<input type="checkbox"/>	For the 5.25-5.35 GHz band, the maximum conducted output power (P_{Out}) shall not exceed the lesser of 250 mW or $11 \text{ dBm} + 10 \log B$, where B is the 26 dB emission bandwidth in MHz. If $G_{TX} > 6$ dBi, then $P_{Out} = 24 - (G_{TX} - 6)$.
<input type="checkbox"/>	For the 5.47-5.725 GHz band, the maximum conducted output power (P_{Out}) shall not exceed the lesser of 250 mW or $11 \text{ dBm} + 10 \log B$, where B is the 26 dB emission bandwidth in MHz. If $G_{TX} > 6$ dBi, then $P_{Out} = 24 - (G_{TX} - 6)$.
<input type="checkbox"/> For the 5.725-5.85 GHz band:	
<input type="checkbox"/>	<ul style="list-style-type: none"> ▪ Point-to-multipoint systems (P2M): the maximum conducted output power (P_{Out}) shall not exceed the lesser of 1 W. If $G_{TX} > 6$ dBi, then $P_{Out} = 30 - (G_{TX} - 6)$. ▪ Point-to-point systems (P2P): the maximum conducted output power (P_{Out}) shall not exceed the lesser of 1 W.
LE-LAN Devices	
<input type="checkbox"/>	For the 5.15-5.25 GHz band, the maximum e.i.r.p. shall not exceed 200 mW or $10 + 10 \log B$, dBm, whichever power is less. B is the 99% emission bandwidth in MHz.
<input type="checkbox"/>	For the 5.25-5.35 GHz band, the maximum e.i.r.p. shall not exceed 1.0 W or $17 + 10 \log B$, dBm, whichever power is less. B is the 99% emission bandwidth in MHz
<input type="checkbox"/>	For the 5.47-5.6 GHz band and 5.65-5.725 GHz band, the maximum e.i.r.p. shall not exceed 1.0 W or $17 + 10 \log B$, dBm, whichever power is less. B is the 99% emission bandwidth in MHz
<input type="checkbox"/> For the 5.725-5.85 GHz band:	
<input type="checkbox"/>	<ul style="list-style-type: none"> ▪ Point-to-multipoint systems (P2M): the maximum conducted output power (P_{Out}) shall not exceed the lesser of 1 W. If $G_{TX} > 6$ dBi, then $P_{Out} = 30 - (G_{TX} - 6)$. ▪ Point-to-point systems (P2P): the maximum conducted output power (P_{Out}) shall not exceed the lesser of 1 W.
P_{Out} = maximum conducted output power in dBm, G_{TX} = the maximum transmitting antenna directional gain in dBi.	

3.3.2 Measuring Instruments

Refer a test equipment and calibration data table in this test report.

3.3.3 Test Procedures

Test Method	
	Average over on/off periods with duty factor
<input type="checkbox"/>	Refer as FCC KDB 789033 D02, clause E Method SA-2 (spectral trace averaging).
<input type="checkbox"/>	Refer as FCC KDB 789033 D02, clause E Method SA-2 Alt. (RMS detection with slow sweep speed)
	Wideband RF power meter and average over on/off periods with duty factor
<input checked="" type="checkbox"/>	Refer as FCC KDB 789033 D02, clause E Method PM-G (using an RF average power meter).
<input checked="" type="checkbox"/>	For conducted measurement.
	<ul style="list-style-type: none"> If the EUT supports multiple transmit chains using options given below: Refer as FCC KDB 662911, In-band power measurements. Using the measure-and-sum approach, measured all transmit ports individually. Sum the power (in linear power units e.g., mW) of all ports for each individual sample and save them.
	<ul style="list-style-type: none"> If multiple transmit chains, EIRP calculation could be following as methods: $P_{total} = P_1 + P_2 + \dots + P_n$ (calculated in linear unit [mW] and transfer to log unit [dBm]) $EIRP_{total} = P_{total} + DG$
<input type="checkbox"/>	For radiated measurement.
	<ul style="list-style-type: none"> Refer as FCC KDB 789033 D02 clause II A.1.F "Antenna-port Conducted versus Radiated Testing" Refer as ANSI C63.10, clause 6.6 for radiated emissions above 1GHz. Refer as FCC KDB 412172 D01 clause 2.2 for EIRP calculation.

3.3.4 Test Setup

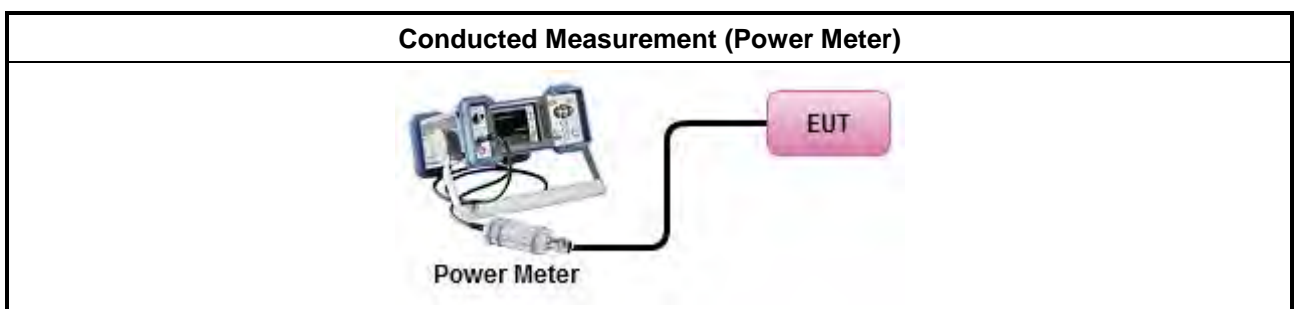

3.3.5 Test Result of Maximum Output Power

Refer as Appendix C



3.4 Power Spectral Density

3.4.1 Limit

Peak Power Spectral Density Limit	
UNII Devices	
<input checked="" type="checkbox"/> For the 5.15-5.25 GHz band:	
<input type="checkbox"/>	<ul style="list-style-type: none"> ▪ Outdoor AP: the peak power spectral density (PPSD) shall not exceed the lesser of 17dBm/MHz. If $G_{TX} > 6$ dBi, then $P_{Out} = 17 - (G_{TX} - 6)$. ▪ Indoor AP: the peak power spectral density (PPSD) shall not exceed the lesser of 17dBm/MHz. If $G_{TX} > 6$ dBi, then $P_{Out} = 17 - (G_{TX} - 6)$. ▪ Point-to-point AP: the peak power spectral density (PPSD) shall not exceed the lesser of 17dBm/MHz. If $G_{TX} > 23$ dBi, then $P_{Out} = 17 - (G_{TX} - 23)$. ▪ Mobile or Portable Client: the peak power spectral density (PPSD) ≤ 11 dBm/MHz. If $G_{TX} > 6$ dBi, then $PPSD = 11 - (G_{TX} - 6)$.
<input type="checkbox"/> For the 5.25-5.35 GHz band, the peak power spectral density (PPSD) ≤ 11 dBm/MHz. If $G_{TX} > 6$ dBi, then $PPSD = 11 - (G_{TX} - 6)$.	
<input type="checkbox"/> For the 5.47-5.725 GHz band, the peak power spectral density (PPSD) ≤ 11 dBm/MHz. If $G_{TX} > 6$ dBi, then $PPSD = 11 - (G_{TX} - 6)$.	
<input type="checkbox"/> For the 5.725-5.85 GHz band:	
<input type="checkbox"/>	<ul style="list-style-type: none"> ▪ Point-to-multipoint systems (P2M): the peak power spectral density (PPSD) ≤ 30 dBm/500kHz. If $G_{TX} > 6$ dBi, then $PPSD = 30 - (G_{TX} - 6)$. ▪ Point-to-point systems (P2P): the peak power spectral density (PPSD) ≤ 30 dBm/500kHz.
LE-LAN Devices	
<input type="checkbox"/> For the 5.15-5.25 GHz band, the e.i.r.p. peak power spectral density (PPSD) ≤ 10 dBm/MHz.	
<input type="checkbox"/> For the 5.25-5.35 GHz band, the peak power spectral density (PPSD) ≤ 11 dBm/MHz.	
<input type="checkbox"/>	<ul style="list-style-type: none"> ▪ e.i.r.p. greater than 200 mW shall comply with the following e.i.r.p. at different elevations, where θ is the angle above the local horizontal plane (of the Earth) as shown below: -13 dBW/MHz for $0^\circ \leq \theta < 8^\circ$; -13 - 0.716 ($\theta-8$) dBW/MHz for $8^\circ \leq \theta < 40^\circ$ -35.9 - 1.22 ($\theta-40$) dBW/MHz for $40^\circ \leq \theta \leq 45^\circ$; -42 dBW/MHz for $\theta > 45^\circ$
<input type="checkbox"/> For the 5.47-5.6 GHz band and 5.65-5.725 GHz band, the peak power spectral density (PPSD) ≤ 11 dBm/MHz.	
<input type="checkbox"/> For the 5.725-5.85 GHz band:	
<input type="checkbox"/>	<ul style="list-style-type: none"> ▪ Point-to-multipoint systems (P2M): the peak power spectral density (PPSD) ≤ 30 dBm/500kHz. If $G_{TX} > 6$ dBi, then $PPSD = 30 - (G_{TX} - 6)$. ▪ Point-to-point systems (P2P): the peak power spectral density (PPSD) ≤ 30 dBm/500kHz.
<p>PPSD = peak power spectral density that he same method as used to determine the conducted output power shall be used to determine the power spectral density. And power spectral density in dBm/MHz G_{TX} = the maximum transmitting antenna directional gain in dBi.</p>	

3.4.2 Measuring Instruments

Refer a test equipment and calibration data table in this test report.



3.4.3 Test Procedures

Test Method	
<ul style="list-style-type: none"> ▪ Peak power spectral density procedures that the same method as used to determine the conducted output power shall be used to determine the peak power spectral density and use the peak search function on the spectrum analyzer to find the peak of the spectrum. For the peak power spectral density shall be measured using below options: 	
<input type="checkbox"/>	Refer as FCC KDB 789033 D02, F)5) power spectral density can be measured using resolution bandwidths < 1 MHz provided that the results are integrated over 1 MHz bandwidth
[duty cycle ≥ 98% or external video / power trigger]	
<input checked="" type="checkbox"/>	Refer as FCC KDB 789033 D02, clause E Method SA-1 (spectral trace averaging).
<input type="checkbox"/>	Refer as FCC KDB 789033 D02, clause E Method SA-1 Alt. (RMS detection with slow sweep speed)
duty cycle < 98% and average over on/off periods with duty factor	
<input checked="" type="checkbox"/>	Refer as FCC KDB 789033 D02, clause E Method SA-2 (spectral trace averaging).
<input type="checkbox"/>	Refer as FCC KDB 789033 D02, clause E Method SA-2 Alt. (RMS detection with slow sweep speed)
<input checked="" type="checkbox"/> For conducted measurement.	
<ul style="list-style-type: none"> ▪ If the EUT supports multiple transmit chains using options given below: 	
<input checked="" type="checkbox"/>	Option 1: Measure and sum the spectra across the outputs. Refer as FCC KDB 662911, In-band power spectral density (PSD). Sample all transmit ports simultaneously using a spectrum analyzer for each transmit port. Where the trace bin-by-bin of each transmit port summing can be performed. (i.e., in the first spectral bin of output 1 is summed with that in the first spectral bin of output 2 and that from the first spectral bin of output 3, and so on up to the NTX output to obtain the value for the first frequency bin of the summed spectrum.). Add up the amplitude (power) values for the different transmit chains and use this as the new data trace.
<input type="checkbox"/>	Option 2: Measure and sum spectral maxima across the outputs. With this technique, spectra are measured at each output of the device at the required resolution bandwidth. The maximum value (peak) of each spectrum is determined. These maximum values are then summed mathematically in linear power units across the outputs. These operations shall be performed separately over frequency spans that have different out-of-band or spurious emission limits,
<input type="checkbox"/>	Option 3: Measure and add 10 log(N) dB, where N is the number of transmit chains. Refer as FCC KDB 662911, In-band power spectral density (PSD). Performed at each transmit chains and each transmit chains shall be compared with the limit have been reduced with 10 log(N). Or each transmit chains shall be add 10 log(N) to compared with the limit.
<ul style="list-style-type: none"> ▪ If multiple transmit chains, EIRP PPSD calculation could be following as methods: $PPSD_{total} = PPSD_1 + PPSD_2 + \dots + PPSD_n$ (calculated in linear unit [mW] and transfer to log unit [dBm]) $EIRP_{total} = PPSD_{total} + DG$ 	
<input type="checkbox"/> For radiated measurement.	
<ul style="list-style-type: none"> ▪ Refer as FCC KDB 789033 D02 clause II A.1.F "Antenna-port Conducted versus Radiated Testing" ▪ Refer as ANSI C63.10, clause 6.6 for radiated emissions above 1GHz. 	

Test Method	
	Refer as FCC KDB 412172 D01 clause 2.2 for EIRP calculation.

3.4.4 Test Setup

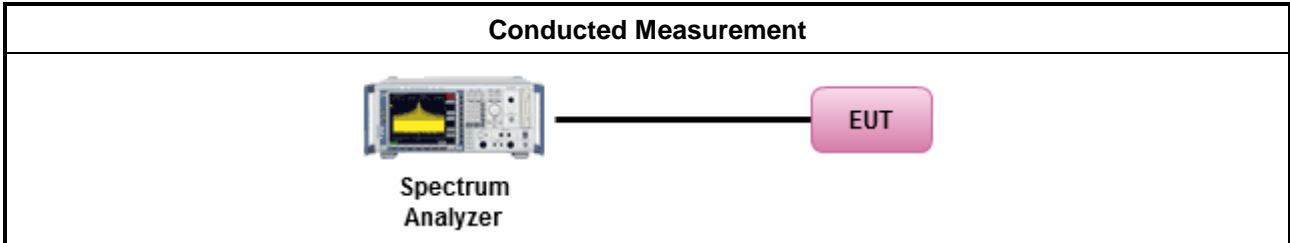

3.4.5 Test Result of Power Spectral Density

Refer as Appendix D



3.5 Unwanted Emissions

3.5.1 Transmitter Unwanted Emissions Limit

Unwanted emissions below 1 GHz and restricted band emissions above 1GHz limit			
Frequency Range (MHz)	Field Strength (uV/m)	Field Strength (dBuV/m)	Measure Distance (m)
0.009~0.490	2400/F(kHz)	48.5 - 13.8	300
0.490~1.705	24000/F(kHz)	33.8 - 23	30
1.705~30.0	30	29	30
30~88	100	40	3
88~216	150	43.5	3
216~960	200	46	3
Above 960	500	54	3

Note 1: Test distance for frequencies at or above 30 MHz, measurements may be performed at a distance other than the limit distance provided they are not performed in the near field and the emissions to be measured can be detected by the measurement equipment. When performing measurements at a distance other than that specified, the results shall be extrapolated to the specified distance using an extrapolation factor of 20 dB/decade (inverse of linear distance for field-strength measurements, inverse of linear distance-squared for power-density measurements).

Note 2: Test distance for frequencies at below 30 MHz, measurements may be performed at a distance closer than the EUT limit distance; however, an attempt should be made to avoid making measurements in the near field. When performing measurements below 30 MHz at a closer distance than the limit distance, the results shall be extrapolated to the specified distance by either making measurements at a minimum of two or more distances on at least one radial to determine the proper extrapolation factor or by using the square of an inverse linear distance extrapolation factor (40 dB/decade). The test report shall specify the extrapolation method used to determine compliance of the EUT.

Note 3: Using the distance of 1m during the test for above 18 GHz, and the test value to correct for the distance factor at 3m.

Un-restricted band emissions above 1GHz Limit	
Operating Band	Limit
<input checked="" type="checkbox"/> 5.15 - 5.25 GHz	e.i.r.p. -27 dBm [68.2 dBuV/m @3m]
<input type="checkbox"/> 5.25 - 5.35 GHz	e.i.r.p. -27 dBm [68.2 dBuV/m @3m]
<input type="checkbox"/> 5.47 - 5.725 GHz	e.i.r.p. -27 dBm [68.2 dBuV/m @3m]
<input type="checkbox"/> 5.725 - 5.85 GHz	all emissions shall be limited to a level of -27 dBm/MHz at 75 MHz or more above or below the band edge increasing linearly to 10 dBm/MHz at 25 MHz above or below the band edge, and from 25 MHz above or below the band edge increasing linearly to a level of 15.6 dBm/MHz at 5 MHz above or below the band edge, and from 5 MHz above or below the band edge increasing linearly to a level of 27 dBm/MHz at the band edge.

Note 1: Measurements may be performed at a distance other than the limit distance provided they are not performed in the near field and the emissions to be measured can be detected by the measurement equipment. When performing measurements at a distance other than that specified, the results shall be extrapolated to the specified distance using an extrapolation factor of 20 dB/decade (inverse of



linear distance for field-strength measurements, inverse of linear distance-squared for power-density measurements).

3.5.2 Measuring Instruments

Refer a test equipment and calibration data table in this test report.

3.5.3 Test Procedures

Test Method	
<ul style="list-style-type: none"> ▪ Measurements may be performed at a distance other than the limit distance provided they are not performed in the near field and the emissions to be measured can be detected by the measurement equipment. Measurements shall not be performed at a distance greater than 30 m for frequencies above 30 MHz, unless it can be further demonstrated that measurements at a distance of 30 m or less are impractical. When performing measurements at a distance other than that specified, the results shall be extrapolated to the specified distance using an extrapolation factor of 20 dB/decade (inverse of linear distance for field-strength measurements, inverse of linear distance-squared for power-density measurements). 	
<ul style="list-style-type: none"> ▪ The average emission levels shall be measured in [duty cycle ≥ 98 or duty factor]. 	
<ul style="list-style-type: none"> ▪ For the transmitter unwanted emissions shall be measured using following options below: 	
	<ul style="list-style-type: none"> ▪ Refer as FCC KDB 789033 D02, clause G)2) for unwanted emissions into non-restricted bands.
	<ul style="list-style-type: none"> ▪ Refer as FCC KDB 789033 D02, clause G)1) for unwanted emissions into restricted bands.
<input type="checkbox"/>	Refer as FCC KDB 789033 D02, G)6) Method AD (Trace Averaging).
<input checked="" type="checkbox"/>	Refer as FCC KDB 789033 D02, G)6) Method VB (Reduced VBW).
<input type="checkbox"/>	Refer as ANSI C63.10, clause 11.12.2.5.3 (Reduced VBW). VBW ≥ 1/T, where T is pulse time.
<input type="checkbox"/>	Refer as ANSI C63.10, clause 7.5 average value of pulsed emissions.
<input checked="" type="checkbox"/>	Refer as FCC KDB 789033 D02, clause G)5) measurement procedure peak limit.
<input type="checkbox"/>	Refer as ANSI C63.10, clause 4.1.4.2.2 measurement procedure peak limit.
<ul style="list-style-type: none"> ▪ For radiated measurement. 	
	<ul style="list-style-type: none"> ▪ Refer as ANSI C63.10, clause 6.4 for radiated emissions below 30 MHz and test distance is 3m.
	<ul style="list-style-type: none"> ▪ Refer as ANSI C63.10, clause 6.5 for radiated emissions 30 MHz to 1 GHz and test distance is 3m.
	<ul style="list-style-type: none"> ▪ Refer as ANSI C63.10, clause 6.6 for radiated emissions above 1GHz.
<ul style="list-style-type: none"> ▪ The any unwanted emissions level shall not exceed the fundamental emission level. 	
<ul style="list-style-type: none"> ▪ All amplitude of spurious emissions that are attenuated by more than 20 dB below the permissible value has no need to be reported. 	

3.5.4 Test Setup

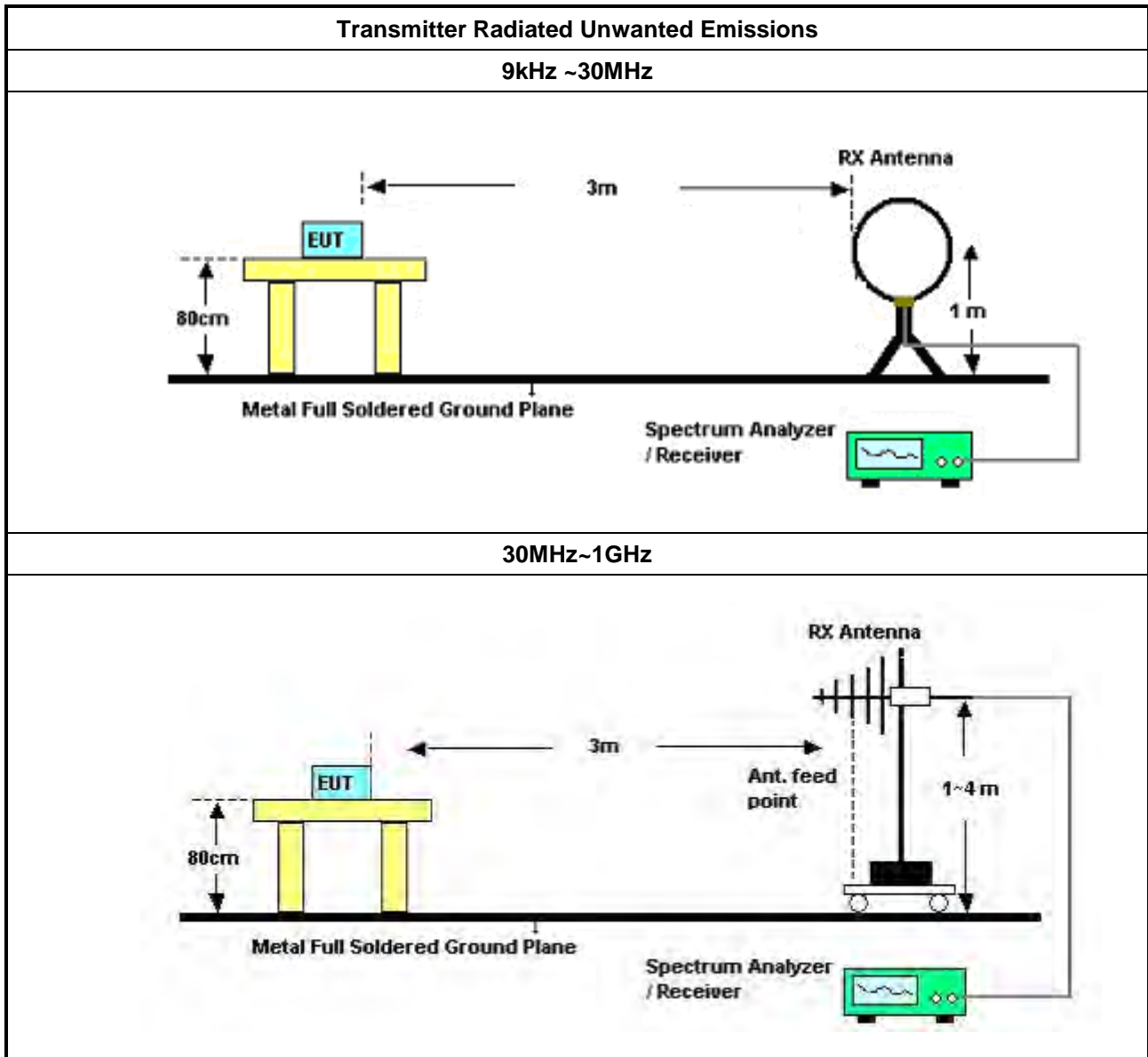

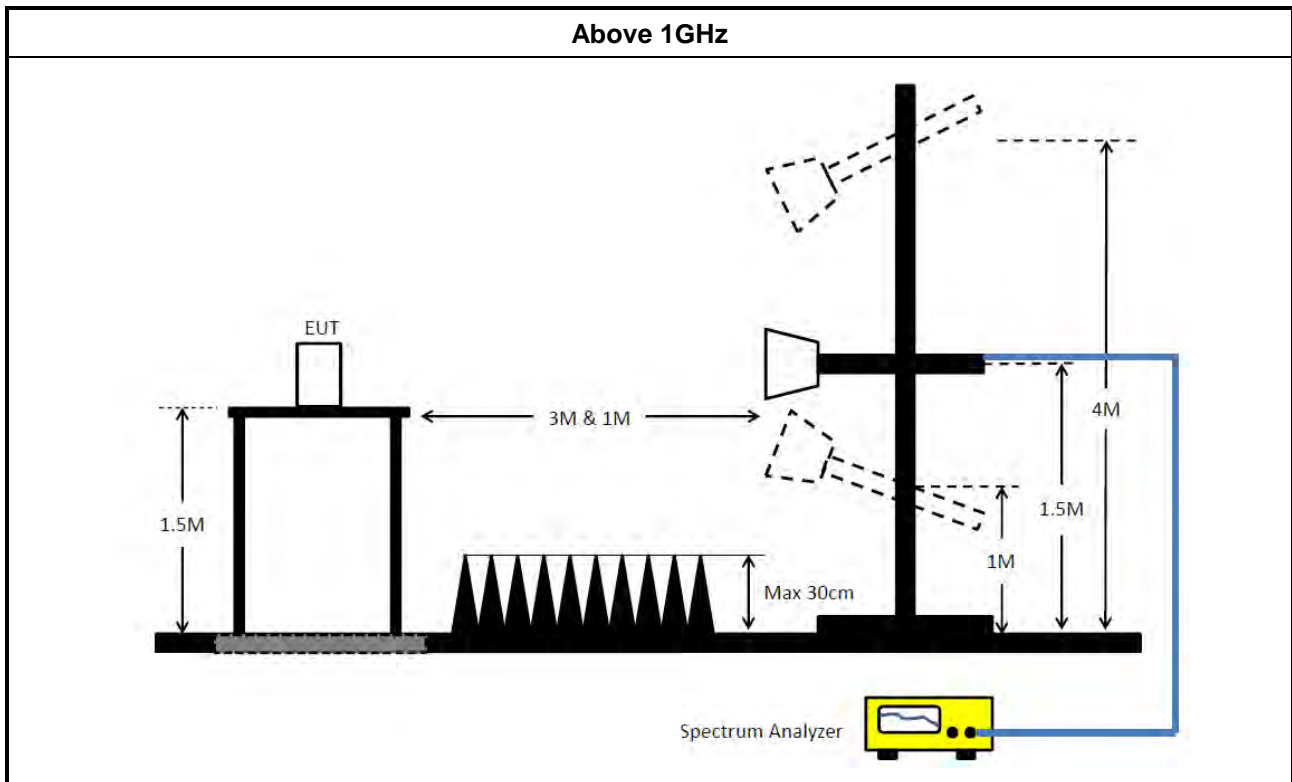

3.5.5 Measurement Results Calculation

The measured Level is calculated using:

Corrected Reading: $\text{Antenna factor (AF)} + \text{Cable loss (CL)} + \text{Read level (Raw)} - \text{Preamp factor (PA)} (\text{if applicable}) = \text{Level}$.

3.5.6 Transmitter Unwanted Emissions (Below 30MHz)

There is a comparison data of both open-field test site and alternative test site - semi-Anechoic chamber according to KDB414788 Radiated Test Site, and the result came out very similar.

All amplitude of spurious emissions that are attenuated by more than 20 dB below the permissible value has no need to be reported.

The radiated emissions were investigated from 9 kHz or the lowest frequency generated within the device, up to the 10th harmonic or 40 GHz, whichever is appropriate.

3.5.7 Test Result of Transmitter Unwanted Emissions

Refer as Appendix E



4 Test Equipment and Calibration Data

Instrument	Brand	Model No.	Serial No.	Characteristics	Calibration Date	Calibration Due Date	Remark
EMI Receiver	Agilent	N9038A	My52260123	9kHz ~ 8.4GHz	Feb. 20, 2023	Feb. 19, 2024	Conduction (CO01-CB)
LISN	F.C.C.	FCC-LISN-50-16-2	04083	150kHz ~ 100MHz	Feb. 16, 2023	Feb. 15, 2024	Conduction (CO01-CB)
LISN	Schwarzbeck	NSLK 8127	8127647	9kHz ~ 30MHz	Apr. 27, 2023	Apr. 26, 2024	Conduction (CO01-CB)
Pulse Limiter	Rohde&Schwarz	ESH3-Z2	100430	9kHz ~ 30MHz	Feb. 09, 2023	Feb. 08, 2024	Conduction (CO01-CB)
COND Cable	Woken	Cable	Low cable-CO01	9kHz ~ 30MHz	Oct. 17, 2023	Oct. 16, 2024	Conduction (CO01-CB)
Software	SPORTON	SENSE	V5.10	-	N.C.R.	N.C.R.	Conduction (CO01-CB)
Loop Antenna	Teseq	HLA 6121	65417	9kHz - 30 MHz	Oct. 13, 2023	Oct. 12, 2024	Radiation (03CH01-CB)
3m Semi Anechoic Chamber NSA	TDK	SAC-3M	03CH01-CB	30 MHz ~ 1 GHz	Jan. 16, 2023	Jan. 15, 2024	Radiation (03CH01-CB)
BILOG ANTENNA with 6dB Attenuator	TESEQ & EMCI	CBL6112D N-6-06	37880 & AT-N0609	20MHz ~ 2GHz	Feb. 19, 2023	Feb. 18, 2024	Radiation (03CH01-CB)
Pre-Amplifier	SGH	SGH0301	20230109-2	10M~1GHz	Jun. 23, 2023	Jun. 22, 2024	Radiation (03CH01-CB)
Signal Analyzer	R&S	FSV3044	101437	10kHz ~ 44GHz	Nov. 29, 2022	Nov. 29, 2023	Radiation (03CH01-CB)
EMI Test Receiver	R&S	ESCS	826547/017	9kHz ~ 2.75GHz	Jun. 13, 2023	Jun. 12, 2024	Radiation (03CH01-CB)
RF Cable-low	Woken	RG402	Low Cable-16+17	30 MHz ~ 1 GHz	Oct. 02, 2023	Oct. 01, 2024	Radiation (03CH01-CB)
RF Cable-low	Woken	RG402	Low Cable-31+32	30 MHz ~ 1 GHz	Nov. 06, 2023	Nov. 05, 2024	Radiation (03CH01-CB)
Test Software	SPORTON	SENSE	V5.10	-	N.C.R.	N.C.R.	Radiation (03CH01-CB)
3m Semi Anechoic Chamber VSWR	TDK	SAC-3M	03CH03-CB	1GHz ~18GHz 3m	May 04, 2023	May 03, 2024	Radiation (03CH03-CB)
Horn Antenna	ETS-Lindgren	3115	6821	750MHz~18GHz	Feb. 03, 2023	Feb. 02, 2024	Radiation (03CH03-CB)
Horn Antenna	Schwarzbeck	BBHA 9170	BBHA9170252	15GHz ~ 40GHz	Sep. 04, 2023	Sep. 03, 2024	Radiation (03CH03-CB)
Pre-Amplifier	Agilent	8449B	3008A02097	1GHz ~ 26.5GHz	Jun. 30, 2023	Jun. 29, 2024	Radiation (03CH03-CB)
Pre-Amplifier	SGH	SGH184	20221107-3	18GHz ~ 40GHz	Nov. 16, 2022	Nov. 15, 2023	Radiation (03CH03-CB)
Pre-Amplifier	SGH	SGH184	20230109-3	18~40GHz	Jan. 13, 2023	Jan. 12, 2024	Radiation (03CH03-CB)
Spectrum Analyzer	R&S	FSP40	100019	9kHz ~ 40GHz	Jun. 12, 2023	Jun. 11, 2024	Radiation (03CH03-CB)



Instrument	Brand	Model No.	Serial No.	Characteristics	Calibration Date	Calibration Due Date	Remark
RF Cable-high	Woken	RG402	High Cable-20+29	1GHz ~ 18GHz	Oct. 02, 2023	Oct. 01, 2024	Radiation (03CH03-CB)
RF Cable-high	Woken	RG402	High Cable-29	1GHz ~ 18GHz	Oct. 02, 2023	Oct. 01, 2024	Radiation (03CH03-CB)
High Cable	Woken	WCA0929M	40G#5+6	1GHz ~ 40 GHz	Oct. 02, 2023	Oct. 01, 2024	Radiation (03CH03-CB)
High Cable	Woken	WCA0929M	40G#5	1GHz ~ 40 GHz	Oct. 02, 2023	Oct. 01, 2024	Radiation (03CH03-CB)
High Cable	Woken	WCA0929M	40G#6	1GHz ~ 40 GHz	Oct. 02, 2023	Oct. 01, 2024	Radiation (03CH03-CB)
Test Software	SPORTON	SENSE	V5.10	-	N.C.R.	N.C.R.	Radiation (03CH03-CB)
Signal Analyzer	R&S	FSV40	101904	9kHz ~ 40GHz	Apr. 21, 2023	Apr. 20, 2024	Conducted (TH01-CB)
Spectrum analyzer	R&S	FSV40	100979	9kHz~40GHz	May 29, 2023	May 28, 2024	Conducted (TH01-CB)
Switch	SPTCB	SP-SWI	SWI-01	1~26.5 GHz	Oct. 03, 2023	Oct. 02, 2024	Conducted (TH01-CB)
RF Cable-high	Woken	RG402	High Cable-06	1 GHz – 18 GHz	Oct. 02, 2023	Oct. 01, 2024	Conducted (TH01-CB)
RF Cable-high	Woken	RG402	High Cable-07	1 GHz – 18 GHz	Oct. 02, 2023	Oct. 01, 2024	Conducted (TH01-CB)
RF Cable-high	Woken	RG402	High Cable-08	1 GHz – 18 GHz	Oct. 02, 2023	Oct. 01, 2024	Conducted (TH01-CB)
RF Cable-high	Woken	RG402	High Cable-09	1 GHz – 18 GHz	Oct. 02, 2023	Oct. 01, 2024	Conducted (TH01-CB)
RF Cable-high	Woken	RG402	High Cable-10	1 GHz – 18 GHz	Oct. 02, 2023	Oct. 01, 2024	Conducted (TH01-CB)
RF Cable-high	Woken	RG402	High Cable-30	1 GHz – 18 GHz	Oct. 02, 2023	Oct. 01, 2024	Conducted (TH01-CB)
Power Sensor	Agilent	E9327A	US40442088	50MHz~18GHz	Feb. 22, 2023	Feb. 21, 2024	Conducted (TH01-CB)
Power Sensor	Agilent	E9327A	US40442088	50MHz~18GHz	Mar. 01, 2024	Feb. 28, 2025	Conducted (TH01-CB)
Power Meter	Agilent	E4416A	GB41291199	50MHz~18GHz	Feb. 22, 2023	Feb. 21, 2024	Conducted (TH01-CB)
Power Meter	Agilent	E4416A	GB41291199	50MHz~18GHz	Mar. 04, 2024	Mar. 03, 2025	Conducted (TH01-CB)
Test Software	SPORTON	SENSE	V5.10	-	N.C.R.	N.C.R.	Conducted (TH01-CB)

Note: Calibration Interval of instruments listed above is one year.

N.C.R. means Non-Calibration required.



Summary

Mode	Result	Type	Freq (Hz)	Level (dBuV)	Limit (dBuV)	Margin (dB)	Condition
Mode 1	Pass	QP	150k	59.21	66.00	-6.79	Line

Mode 1

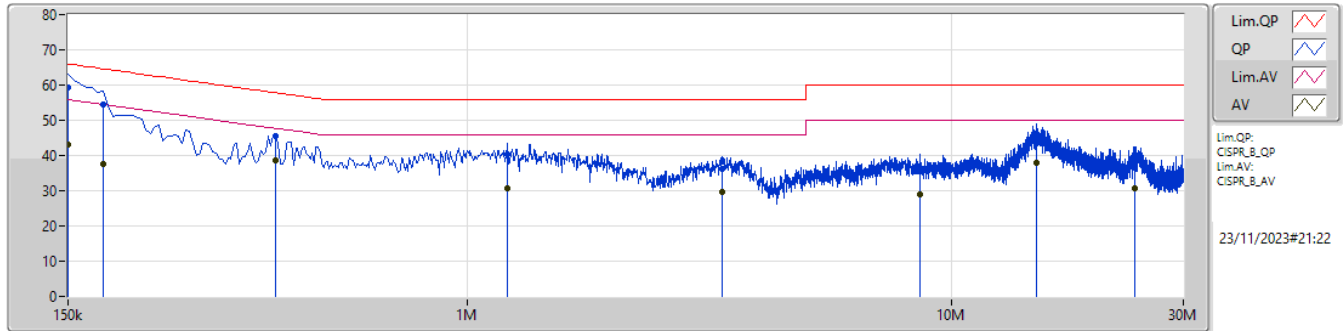

Type	Freq (Hz)	Level (dBuV)	Limit (dBuV)	Margin (dB)	Factor (dB)	Condition	Comment	Raw (dBuV)	LISN (dB)	CL (dB)	AT (dB)
QP	150k	59.21	66.00	-6.79	9.98	Line	"Worst"	49.23	0.09	0.02	9.87
AV	150k	43.24	56.00	-12.76	9.98	Line	-	33.26	0.09	0.02	9.87
QP	177k	54.36	64.62	-10.26	9.97	Line	-	44.39	0.08	0.02	9.87
AV	177k	37.60	54.62	-17.02	9.97	Line	-	27.63	0.08	0.02	9.87
QP	402k	45.36	57.82	-12.46	10.01	Line	-	35.35	0.09	0.02	9.90
AV	402k	38.56	47.82	-9.26	10.01	Line	-	28.55	0.09	0.02	9.90
QP	1.208M	40.40	56.00	-15.60	10.05	Line	-	30.35	0.12	0.03	9.90
AV	1.208M	30.82	46.00	-15.18	10.05	Line	-	20.77	0.12	0.03	9.90
QP	3.363M	36.25	56.00	-19.75	10.19	Line	-	26.06	0.16	0.12	9.91
AV	3.363M	29.73	46.00	-16.27	10.19	Line	-	19.54	0.16	0.12	9.91
QP	8.61M	35.40	60.00	-24.60	10.32	Line	-	25.08	0.24	0.14	9.94
AV	8.61M	28.86	50.00	-21.14	10.32	Line	-	18.54	0.24	0.14	9.94
QP	14.951M	44.85	60.00	-15.15	10.44	Line	-	34.41	0.28	0.18	9.98
AV	14.951M	38.09	50.00	-11.91	10.44	Line	-	27.65	0.28	0.18	9.98
QP	23.888M	37.51	60.00	-22.49	10.59	Line	-	26.92	0.31	0.24	10.04
AV	23.888M	30.82	50.00	-19.18	10.59	Line	-	20.23	0.31	0.24	10.04

Mode 1

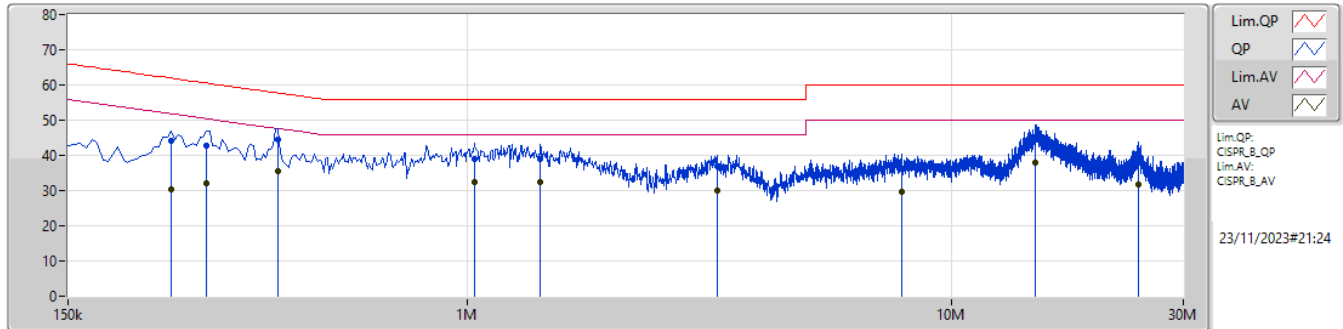

Type	Freq (Hz)	Level (dBuV)	Limit (dBuV)	Margin (dB)	Factor (dB)	Condition	Comment	Raw (dBuV)	LISN (dB)	CL (dB)	AT (dB)
QP	244.5k	44.25	61.95	-17.70	9.96	Neutral	-	34.29	0.07	0.02	9.87
AV	244.5k	30.29	51.95	-21.66	9.96	Neutral	-	20.33	0.07	0.02	9.87
QP	289.5k	42.69	60.53	-17.84	9.97	Neutral	-	32.72	0.07	0.02	9.88
AV	289.5k	31.98	50.53	-18.55	9.97	Neutral	-	22.01	0.07	0.02	9.88
QP	406.5k	44.46	57.72	-13.26	9.99	Neutral	-	34.47	0.07	0.02	9.90
AV	406.5k	35.66	47.72	-12.06	9.99	Neutral	"Worst"	25.67	0.07	0.02	9.90
QP	1.032M	38.88	56.00	-17.12	9.99	Neutral	-	28.89	0.08	0.01	9.90
AV	1.032M	32.39	46.00	-13.61	9.99	Neutral	-	22.40	0.08	0.01	9.90
QP	1.415M	38.86	56.00	-17.14	10.03	Neutral	-	28.83	0.09	0.04	9.90
AV	1.415M	32.55	46.00	-13.45	10.03	Neutral	-	22.52	0.09	0.04	9.90
QP	3.273M	36.93	56.00	-19.07	10.15	Neutral	-	26.78	0.12	0.12	9.91
AV	3.273M	29.89	46.00	-16.11	10.15	Neutral	-	19.74	0.12	0.12	9.91
QP	7.881M	36.15	60.00	-23.85	10.27	Neutral	-	25.88	0.20	0.14	9.93
AV	7.881M	29.82	50.00	-20.18	10.27	Neutral	-	19.55	0.20	0.14	9.93
QP	14.838M	44.70	60.00	-15.30	10.42	Neutral	-	34.28	0.26	0.18	9.98
AV	14.838M	37.93	50.00	-12.07	10.42	Neutral	-	27.51	0.26	0.18	9.98
QP	24.212M	38.43	60.00	-21.57	10.62	Neutral	-	27.81	0.34	0.24	10.04
AV	24.212M	31.61	50.00	-18.39	10.62	Neutral	-	20.99	0.34	0.24	10.04

Summary

Mode	Max-N dB (Hz)	Max-OBW (Hz)	ITU-Code	Min-N dB (Hz)	Min-OBW (Hz)
5.15-5.25GHz	-	-	-	-	-
802.11a_Nss1,(6Mbps)_1TX	26.125M	16.623M	16M6D1D	20.02M	16.42M
802.11ax HEW20_Nss1,(MCS0)_1TX	22.385M	19.032M	19M0D1D	20.625M	18.874M
802.11ax HEW40_Nss1,(MCS0)_1TX	45.21M	37.801M	37M8D1D	40.59M	37.737M
802.11ax HEW80_Nss1,(MCS0)_1TX	80.3M	77.507M	77M5D1D	80.3M	77.507M

Max-N dB = Maximum 6dB down bandwidth for 5.725-5.85GHz band / Maximum 26dB down bandwidth for other band;
 Max-OBW = Maximum 99% occupied bandwidth;
 Min-N dB = Minimum 6dB down bandwidth for 5.725-5.85GHz band / Maximum 26dB down bandwidth for other band;
 Min-OBW = Minimum 99% occupied bandwidth

Result

Mode	Result	Limit (Hz)	Port 1-N dB (Hz)	Port 1-OBW (Hz)
802.11a_Nss1,(6Mbps)_1TX	-	-	-	-
5180MHz	Pass	Inf	20.02M	16.42M
5200MHz	Pass	Inf	26.125M	16.623M
5240MHz	Pass	Inf	23.155M	16.586M
802.11ax HEW20_Nss1,(MCS0)_1TX	-	-	-	-
5180MHz	Pass	Inf	20.625M	18.874M
5200MHz	Pass	Inf	22.385M	19.008M
5240MHz	Pass	Inf	21.78M	19.032M
802.11ax HEW40_Nss1,(MCS0)_1TX	-	-	-	-
5190MHz	Pass	Inf	40.59M	37.737M
5230MHz	Pass	Inf	45.21M	37.801M
802.11ax HEW80_Nss1,(MCS0)_1TX	-	-	-	-
5210MHz	Pass	Inf	80.3M	77.507M

Port X-N dB = Port X 6dB down bandwidth for 5.725-5.85GHz band / 26dB down bandwidth for other band
 Port X-OBW = Port X 99% occupied bandwidth

5.15-5.25GHz_802.11a_Nss1,(6Mbps)_1TX

EBW

5180MHz

20/10/2023

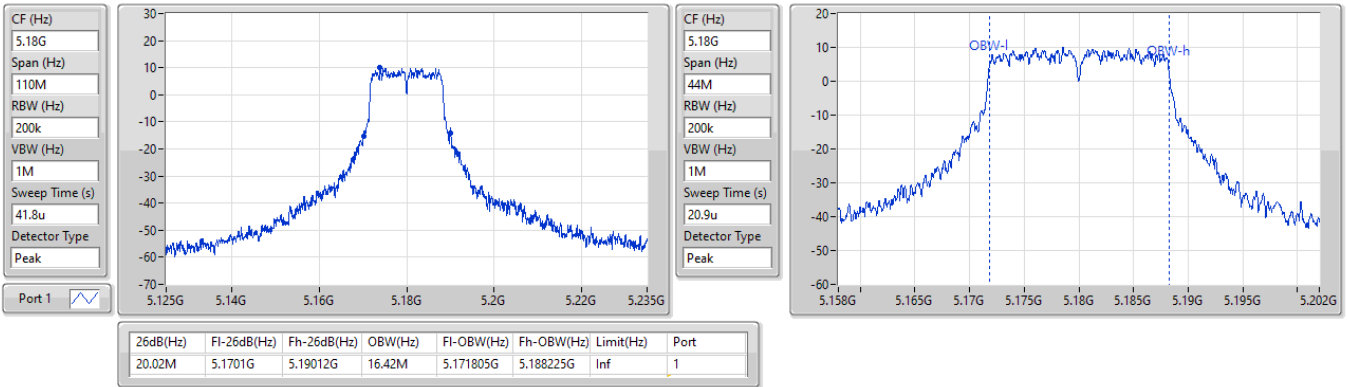

5.15-5.25GHz_802.11a_Nss1,(6Mbps)_1TX

EBW

5200MHz

20/10/2023

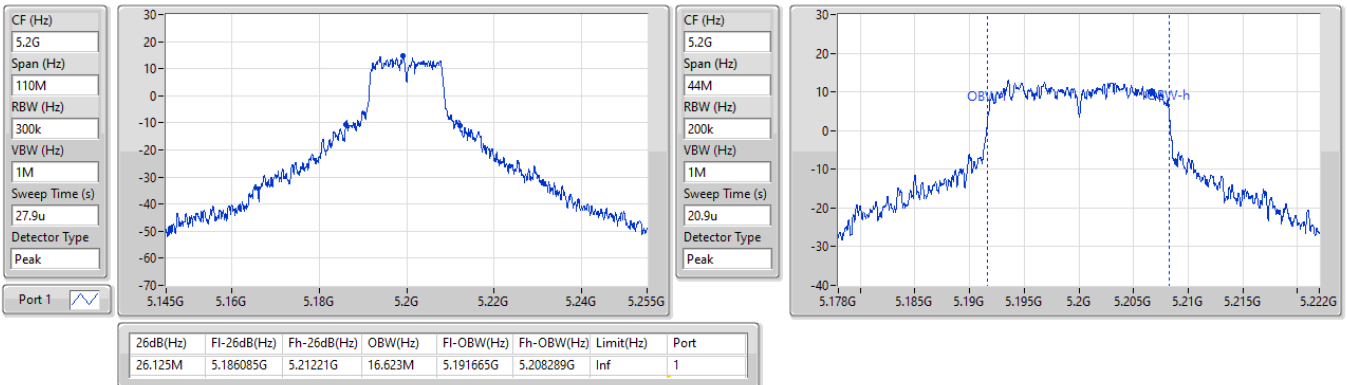

5.15-5.25GHz_802.11a_Nss1,(6Mbps)_1TX

EBW

5240MHz

20/10/2023

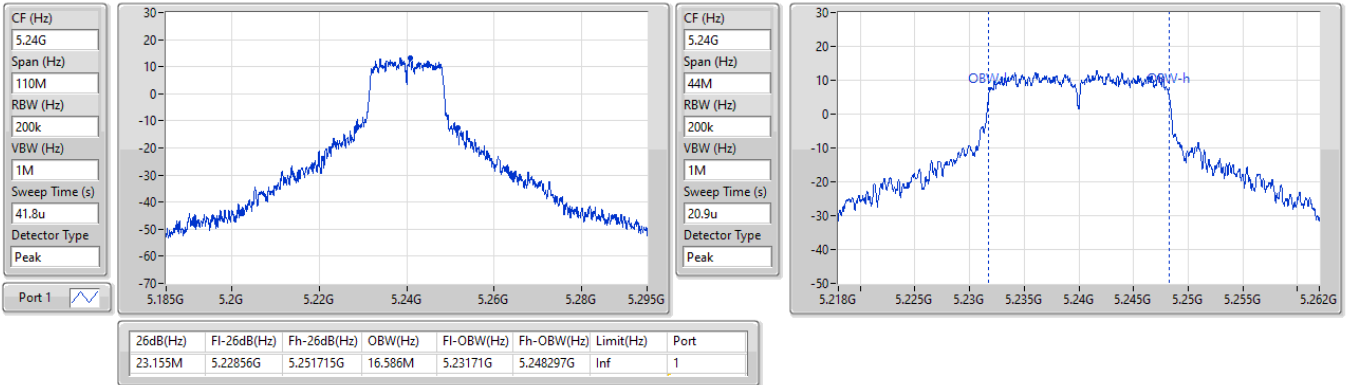

5.15-5.25GHz_802.11ax_HEW20_Nss1,(MCS0)_1TX

EBW

5180MHz

20/10/2023

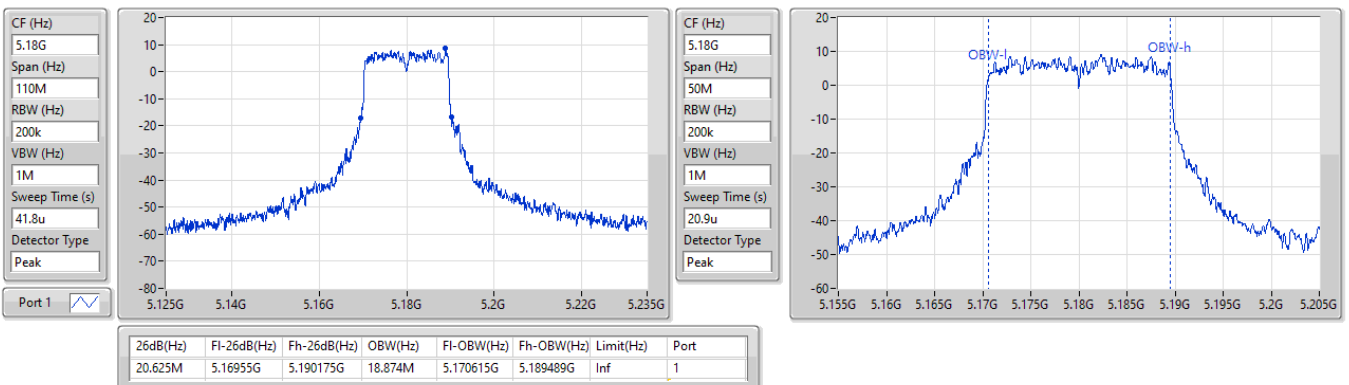

5.15-5.25GHz_802.11ax_HEW20_Nss1,(MCS0)_1TX

EBW

5200MHz

20/10/2023

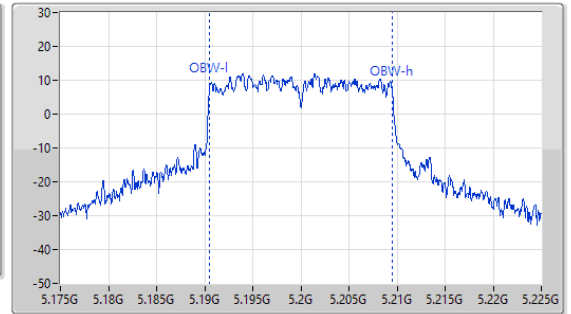
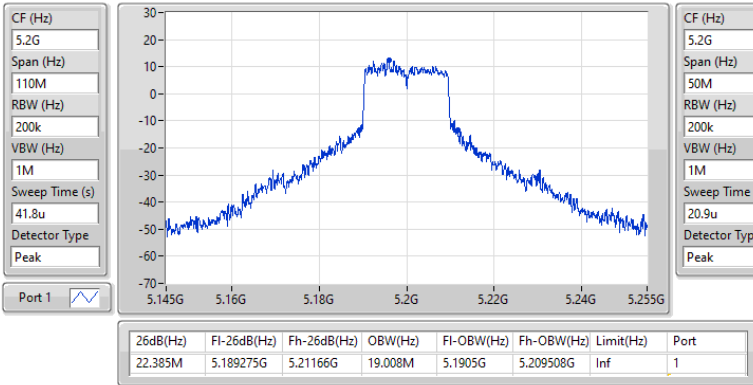

5.15-5.25GHz_802.11ax_HEW20_Nss1,(MCS0)_1TX

EBW

5240MHz

20/10/2023

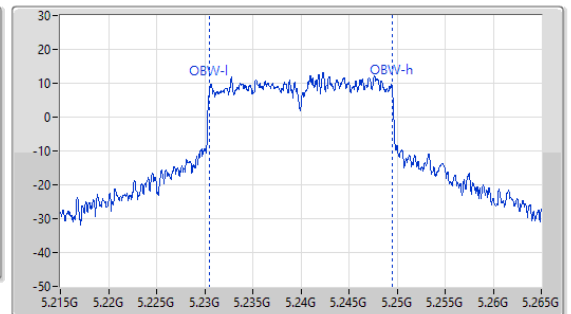
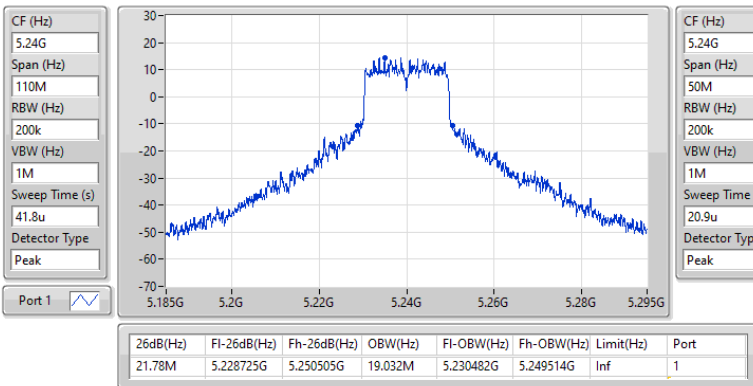

5.15-5.25GHz_802.11ax_HEW40_Nss1,(MCS0)_1TX

EBW

5190MHz

21/10/2023

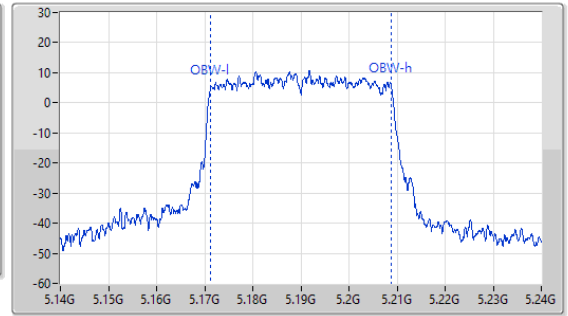
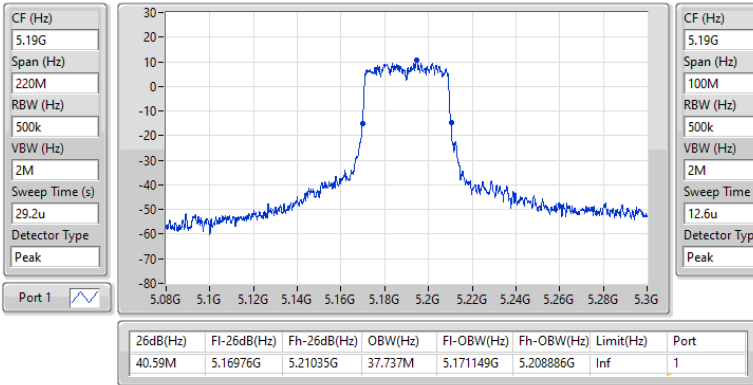

5.15-5.25GHz_802.11ax_HEW40_Nss1,(MCS0)_1TX

EBW

5230MHz

21/10/2023

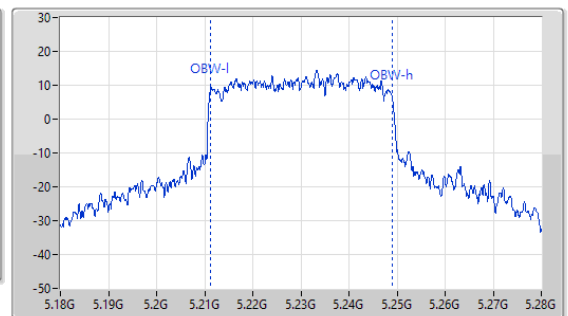
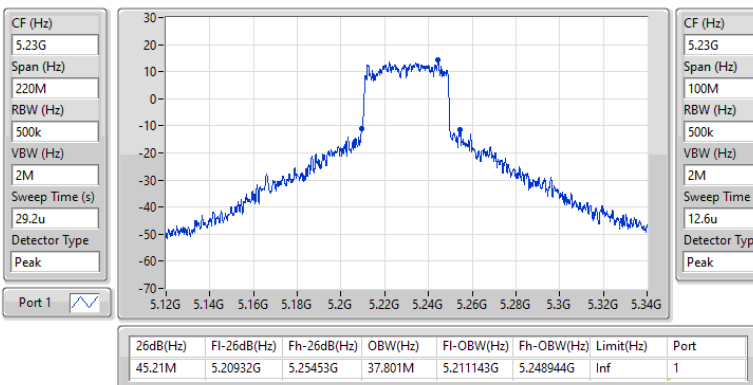

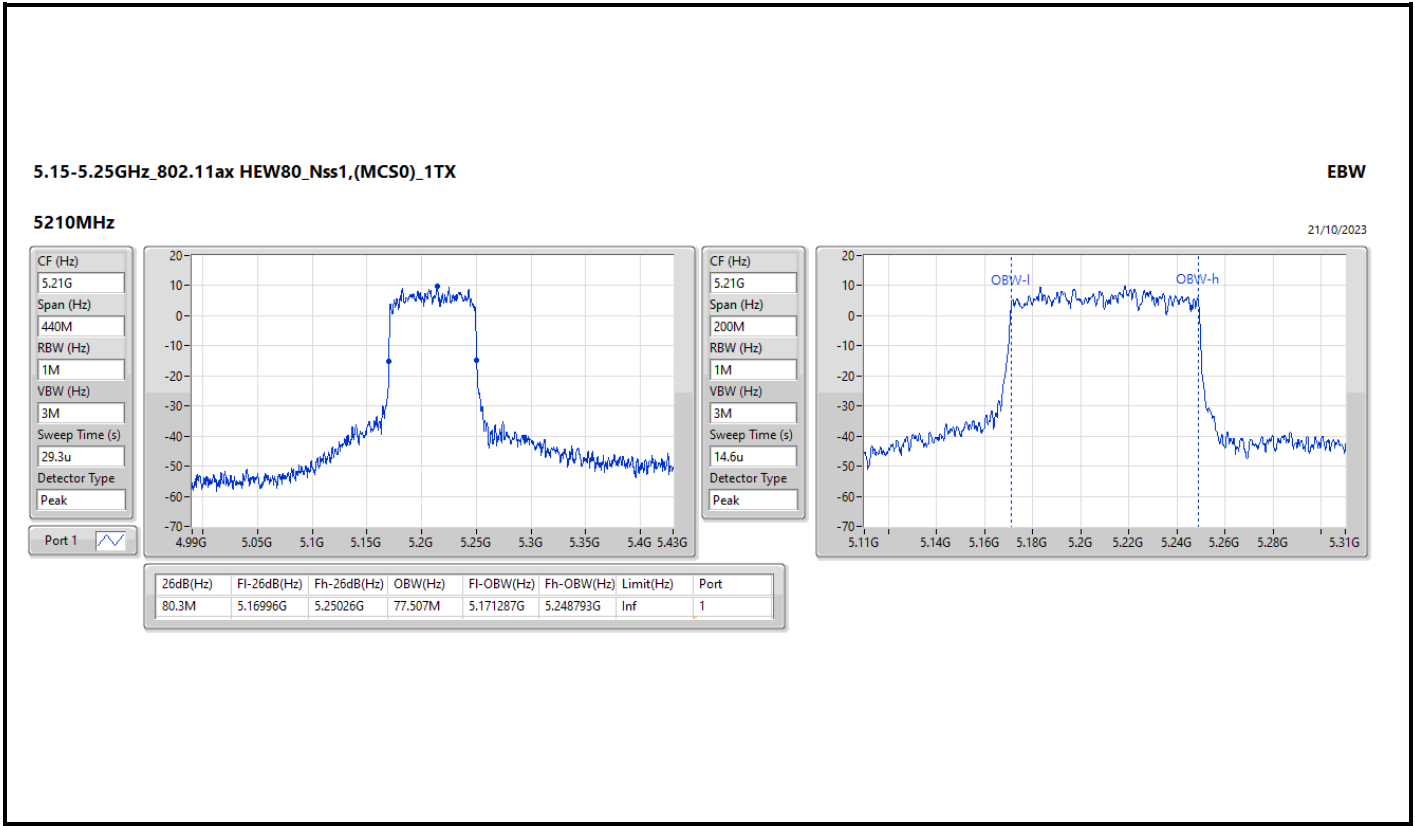

Summary

Mode	Max-N dB (Hz)	Max-OBW (Hz)	ITU-Code	Min-N dB (Hz)	Min-OBW (Hz)
5.15-5.25GHz	-	-	-	-	-
802.11a_Nss1,(6Mbps)_1TX	25.025M	16.695M	16M7D1D	20.46M	16.404M
802.11ax HEW20_Nss1,(MCS0)_1TX	24.035M	19.014M	19M0D1D	20.955M	18.918M
802.11ax HEW40_Nss1,(MCS0)_1TX	40.48M	37.768M	37M8D1D	40.37M	37.692M
802.11ax HEW80_Nss1,(MCS0)_1TX	80.96M	76.954M	77M0D1D	80.96M	76.954M

Max-N dB = Maximum 6dB down bandwidth for 5.725-5.85GHz band / Maximum 26dB down bandwidth for other band;
 Max-OBW = Maximum 99% occupied bandwidth;
 Min-N dB = Minimum 6dB down bandwidth for 5.725-5.85GHz band / Maximum 26dB down bandwidth for other band;
 Min-OBW = Minimum 99% occupied bandwidth

Result

Mode	Result	Limit (Hz)	Port 2-N dB (Hz)	Port 2-OBW (Hz)
802.11a_Nss1,(6Mbps)_1TX	-	-	-	-
5180MHz	Pass	Inf	20.46M	16.404M
5200MHz	Pass	Inf	25.025M	16.695M
5240MHz	Pass	Inf	22.77M	16.553M
802.11ax HEW20_Nss1,(MCS0)_1TX	-	-	-	-
5180MHz	Pass	Inf	20.955M	18.918M
5200MHz	Pass	Inf	24.035M	18.991M
5240MHz	Pass	Inf	20.955M	19.014M
802.11ax HEW40_Nss1,(MCS0)_1TX	-	-	-	-
5190MHz	Pass	Inf	40.48M	37.692M
5230MHz	Pass	Inf	40.37M	37.768M
802.11ax HEW80_Nss1,(MCS0)_1TX	-	-	-	-
5210MHz	Pass	Inf	80.96M	76.954M

Port X-N dB = Port X 6dB down bandwidth for 5.725-5.85GHz band / 26dB down bandwidth for other band
 Port X-OBW = Port X 99% occupied bandwidth

5.15-5.25GHz_802.11a_Nss1,(6Mbps)_1TX

EBW

5180MHz

21/10/2023

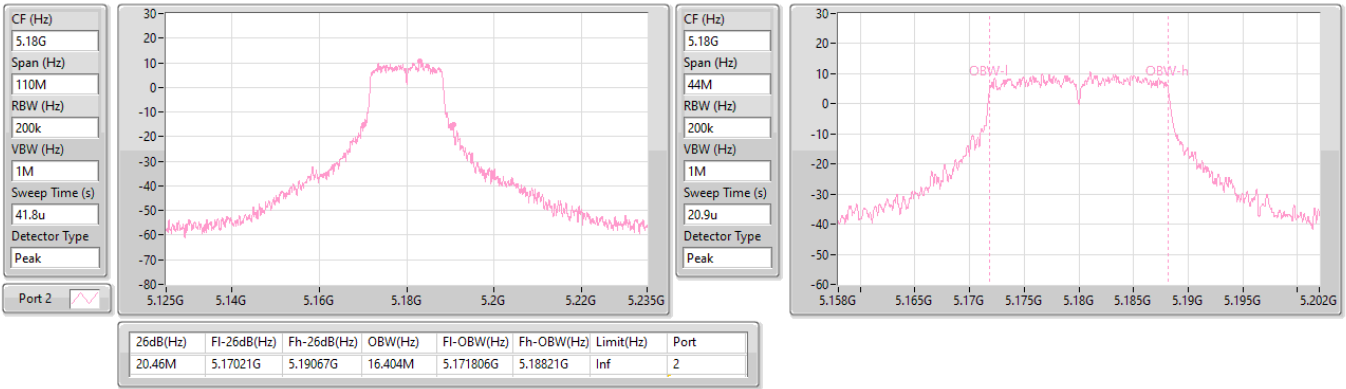

5.15-5.25GHz_802.11a_Nss1,(6Mbps)_1TX

EBW

5200MHz

23/10/2023

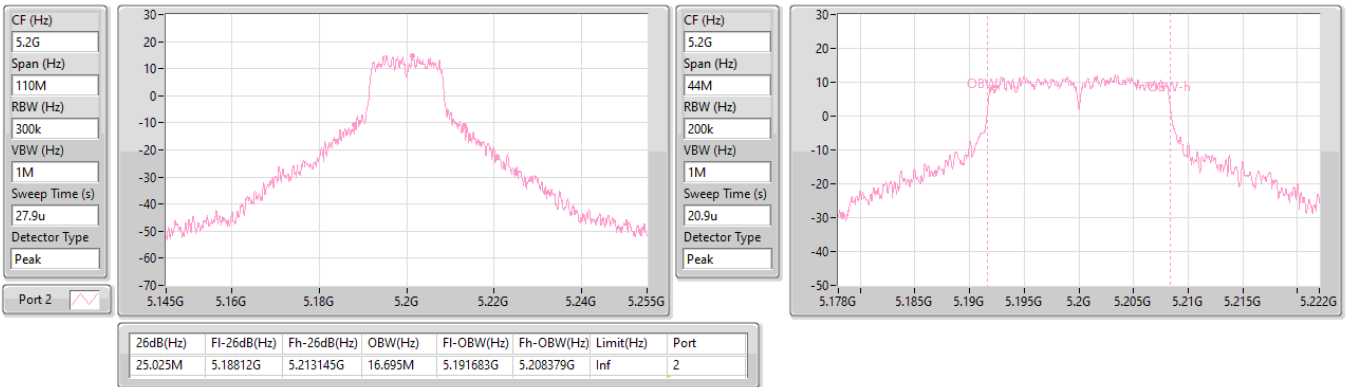

5.15-5.25GHz_802.11a_Nss1,(6Mbps)_1TX

EBW

5240MHz

21/10/2023

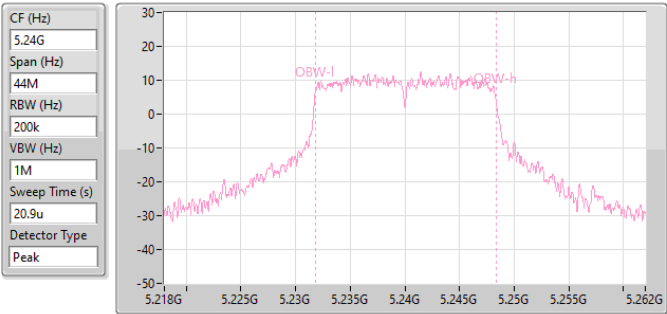
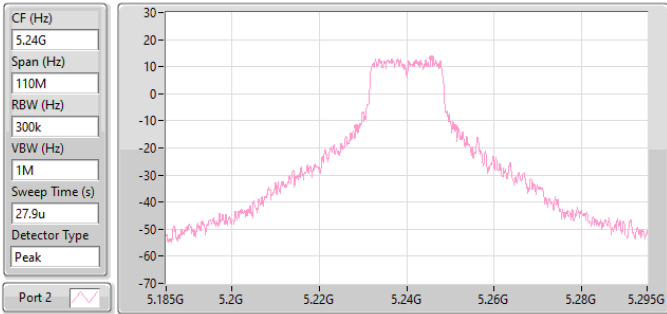

26dB(Hz)	Fl-26dB(Hz)	Fh-26dB(Hz)	OBW(Hz)	Fl-OBW(Hz)	Fh-OBW(Hz)	Limit(Hz)	Port
22.77M	5.228505G	5.251275G	16.553M	5.231787G	5.24834G	Inf	2

5.15-5.25GHz_802.11ax_HEW20_Nss1,(MCS0)_1TX

EBW

5180MHz

21/10/2023

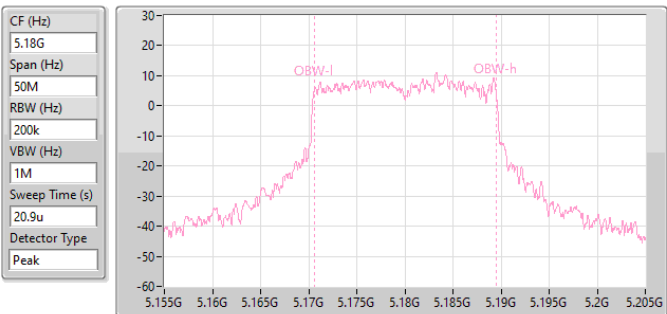
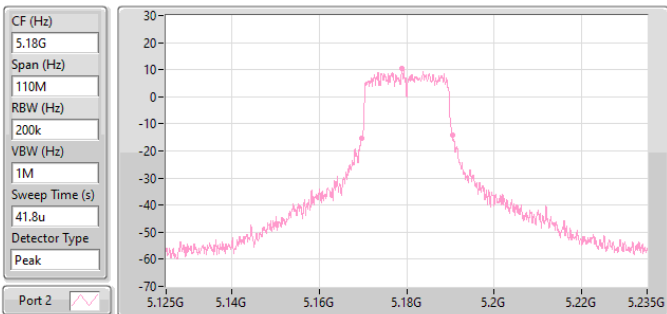

26dB(Hz)	Fl-26dB(Hz)	Fh-26dB(Hz)	OBW(Hz)	Fl-OBW(Hz)	Fh-OBW(Hz)	Limit(Hz)	Port
20.955M	5.169605G	5.19056G	18.918M	5.170552G	5.189471G	Inf	2

5.15-5.25GHz_802.11ax_HEW20_Nss1,(MCS0)_1TX

EBW

5200MHz

21/10/2023

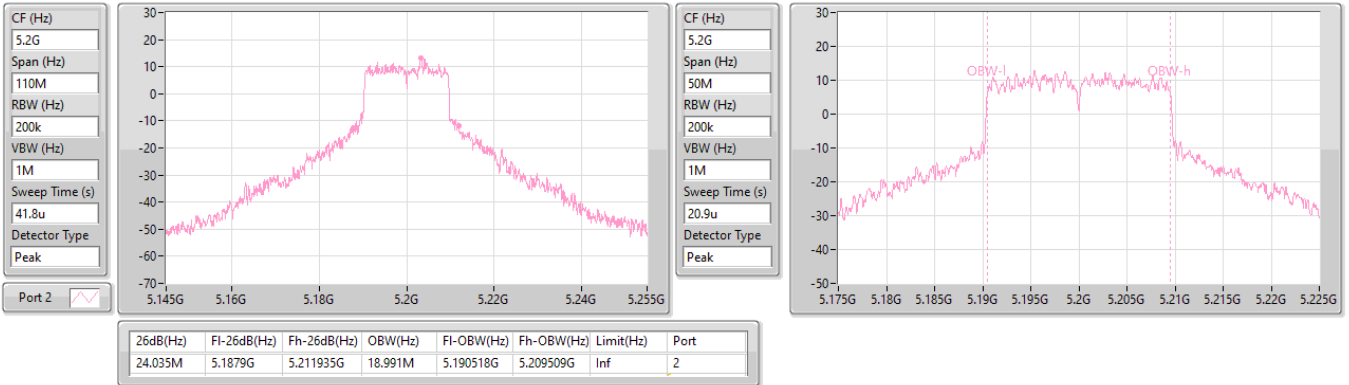

5.15-5.25GHz_802.11ax_HEW20_Nss1,(MCS0)_1TX

EBW

5240MHz

23/10/2023

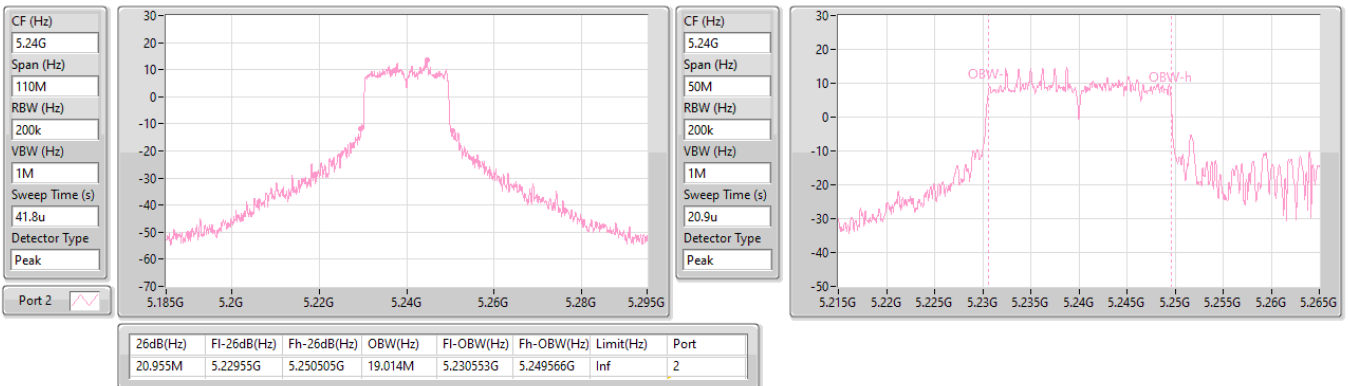

5.15-5.25GHz_802.11ax HEW40_Nss1,(MCS0)_1TX

EBW

5190MHz

21/10/2023

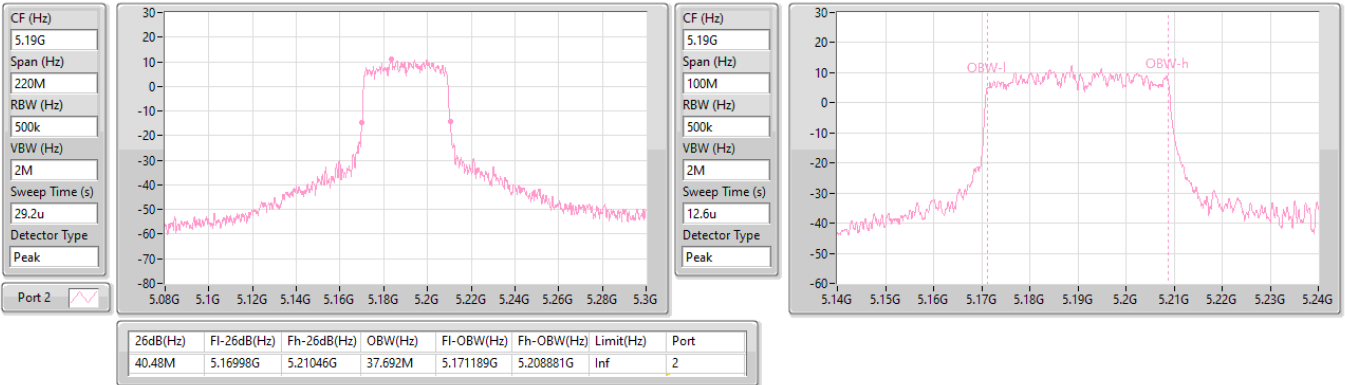

5.15-5.25GHz_802.11ax HEW40_Nss1,(MCS0)_1TX

EBW

5230MHz

21/10/2023

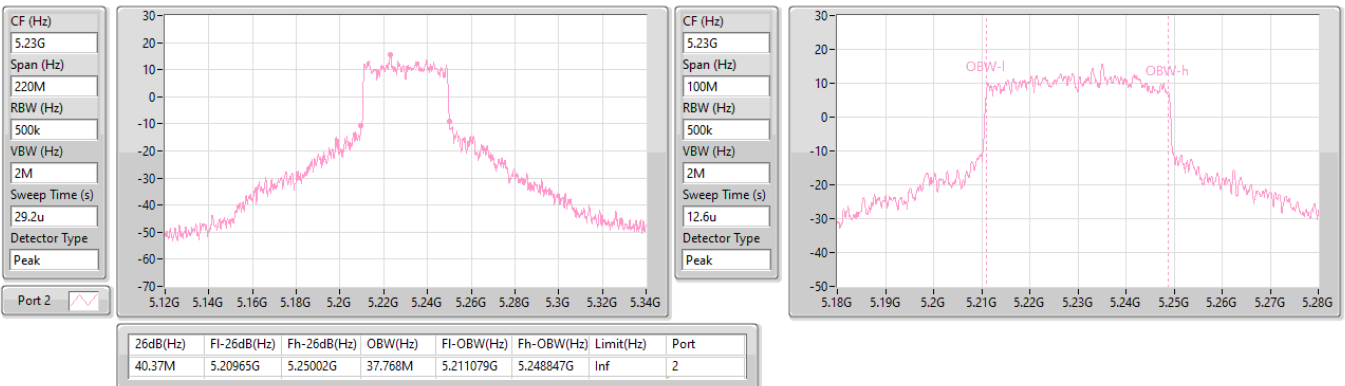

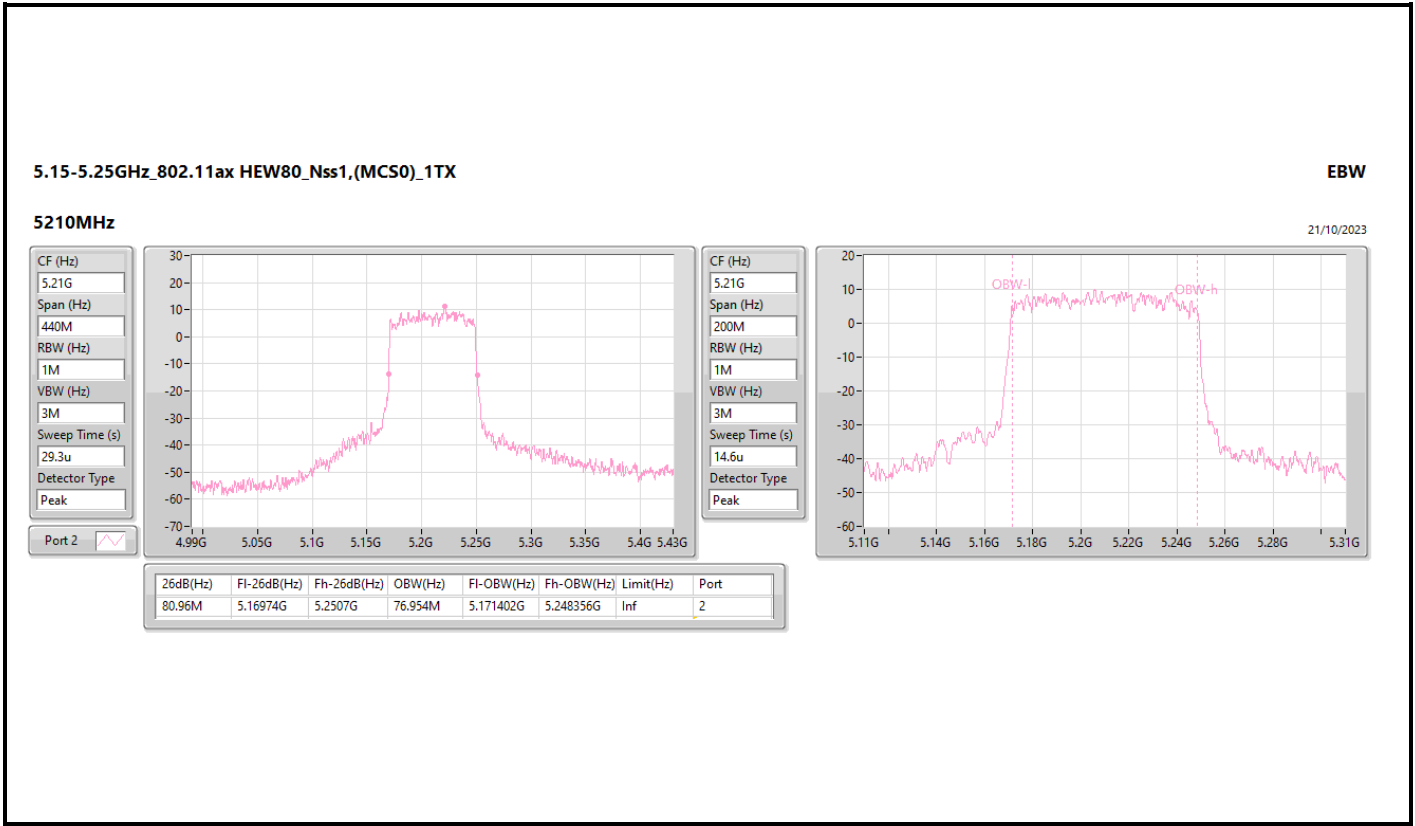



Summary

Mode	Max-N dB (Hz)	Max-OBW (Hz)	ITU-Code	Min-N dB (Hz)	Min-OBW (Hz)
5.15-5.25GHz	-	-	-	-	-
802.11a_Nss1,(6Mbps)_2TX	20.35M	16.462M	16M5D1D	18.645M	16.339M
802.11ax HEW20_Nss1,(MCS0)_2TX	21.56M	19.063M	19M1D1D	20.075M	18.783M
802.11ax HEW40_Nss1,(MCS0)_2TX	39.93M	37.793M	37M8D1D	39.38M	37.661M
802.11ax HEW80_Nss1,(MCS0)_2TX	80.74M	77.266M	77M3D1D	80.3M	77.033M

Max-N dB = Maximum 6dB down bandwidth for 5.725-5.85GHz band / Maximum 26dB down bandwidth for other band;
Max-OBW = Maximum 99% occupied bandwidth;
Min-N dB = Minimum 6dB down bandwidth for 5.725-5.85GHz band / Maximum 26dB down bandwidth for other band;
Min-OBW = Minimum 99% occupied bandwidth

Result

Mode	Result	Limit (Hz)	Port 1-N dB (Hz)	Port 1-OBW (Hz)	Port 2-N dB (Hz)	Port 2-OBW (Hz)
802.11a_Nss1,(6Mbps)_2TX	-	-	-	-	-	-
5180MHz	Pass	Inf	19.855M	16.399M	19.47M	16.462M
5200MHz	Pass	Inf	18.92M	16.386M	19.69M	16.378M
5240MHz	Pass	Inf	18.645M	16.339M	20.35M	16.444M
802.11ax HEW20_Nss1,(MCS0)_2TX	-	-	-	-	-	-
5180MHz	Pass	Inf	21.56M	18.857M	20.735M	19.063M
5200MHz	Pass	Inf	20.405M	18.853M	20.57M	18.783M
5240MHz	Pass	Inf	20.075M	18.939M	20.295M	18.975M
802.11ax HEW40_Nss1,(MCS0)_2TX	-	-	-	-	-	-
5190MHz	Pass	Inf	39.82M	37.661M	39.49M	37.793M
5230MHz	Pass	Inf	39.38M	37.679M	39.93M	37.695M
802.11ax HEW80_Nss1,(MCS0)_2TX	-	-	-	-	-	-
5210MHz	Pass	Inf	80.3M	77.266M	80.74M	77.033M

Port X-N dB = Port X 6dB down bandwidth for 5.725-5.85GHz band / 26dB down bandwidth for other band
Port X-OBW = Port X 99% occupied bandwidth

5.15-5.25GHz_802.11a_Nss1,(6Mbps)_2TX

EBW

5180MHz

25/10/2023

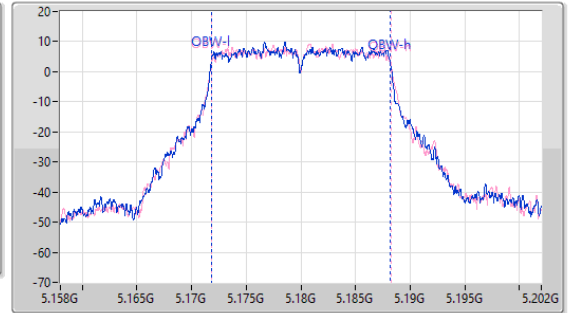
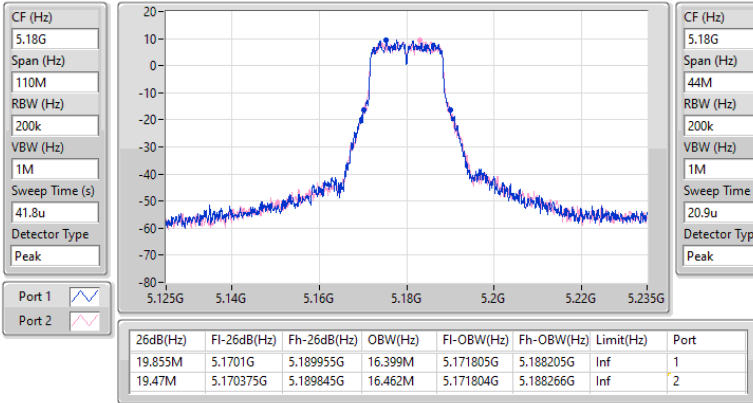

5.15-5.25GHz_802.11a_Nss1,(6Mbps)_2TX

EBW

5200MHz

25/10/2023

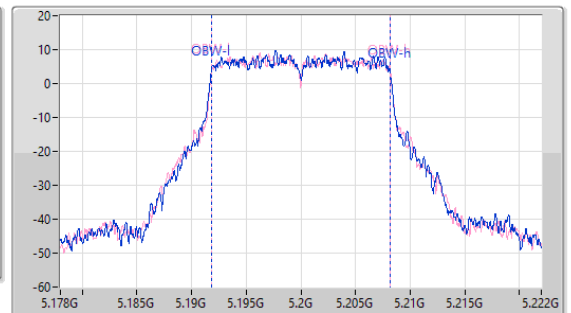
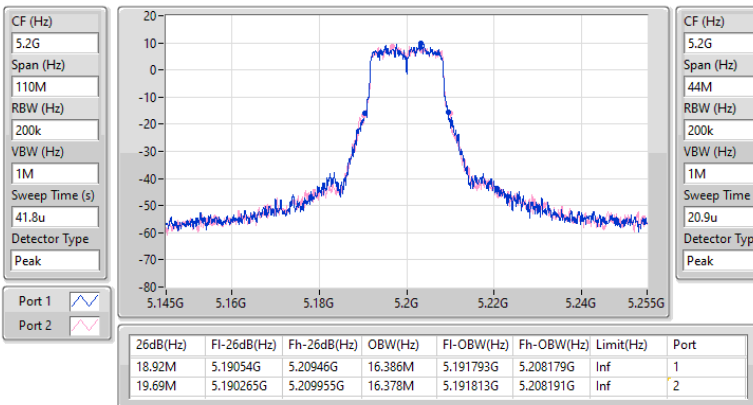

5.15-5.25GHz_802.11a_Nss1,(6Mbps)_2TX

EBW

5240MHz

25/10/2023

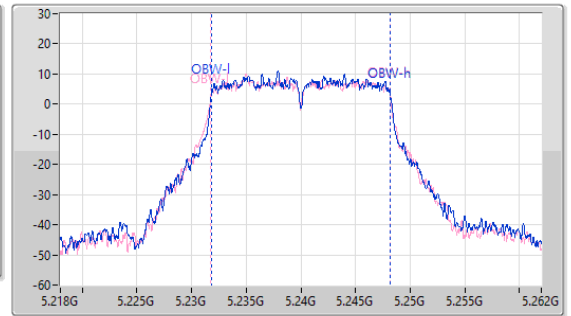
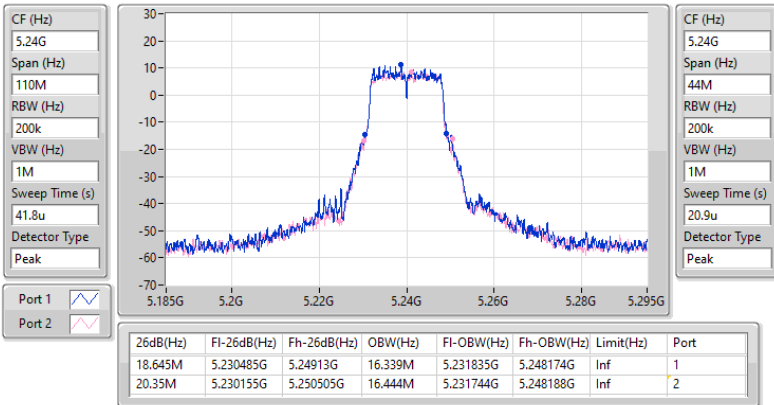

5.15-5.25GHz_802.11ax_HEW20_Nss1,(MCS0)_2TX

EBW

5180MHz

25/10/2023

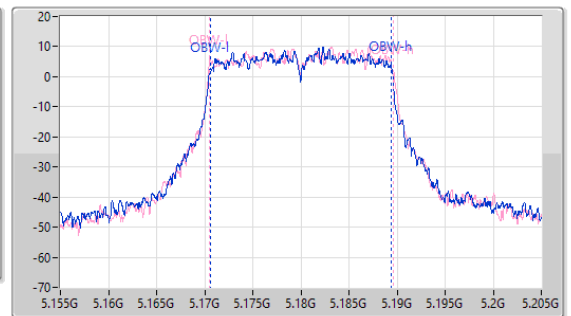
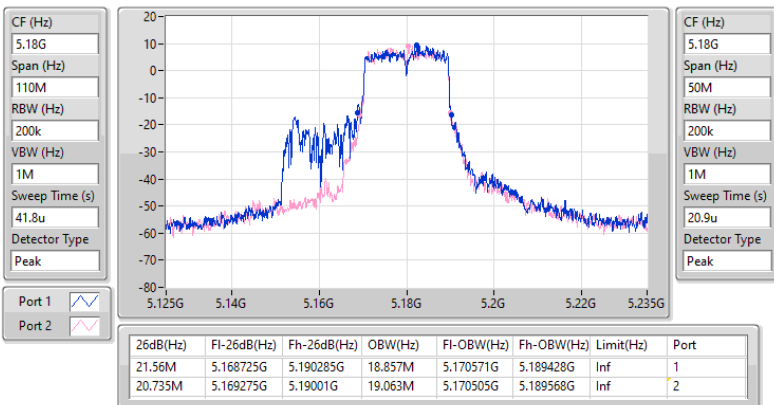

5.15-5.25GHz_802.11ax_HEW20_Nss1,(MCS0)_2TX

EBW

5200MHz

25/10/2023

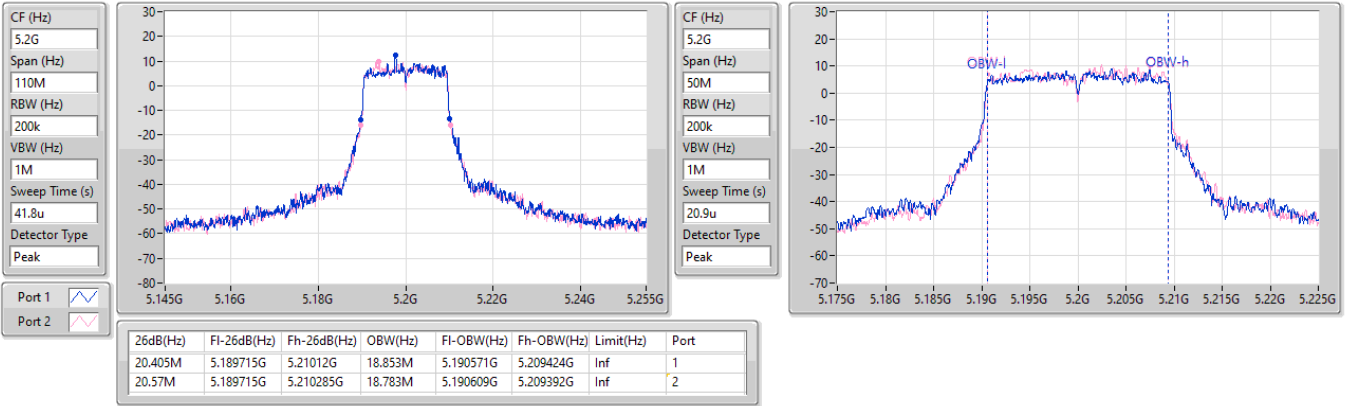

5.15-5.25GHz_802.11ax_HEW20_Nss1,(MCS0)_2TX

EBW

5240MHz

25/10/2023

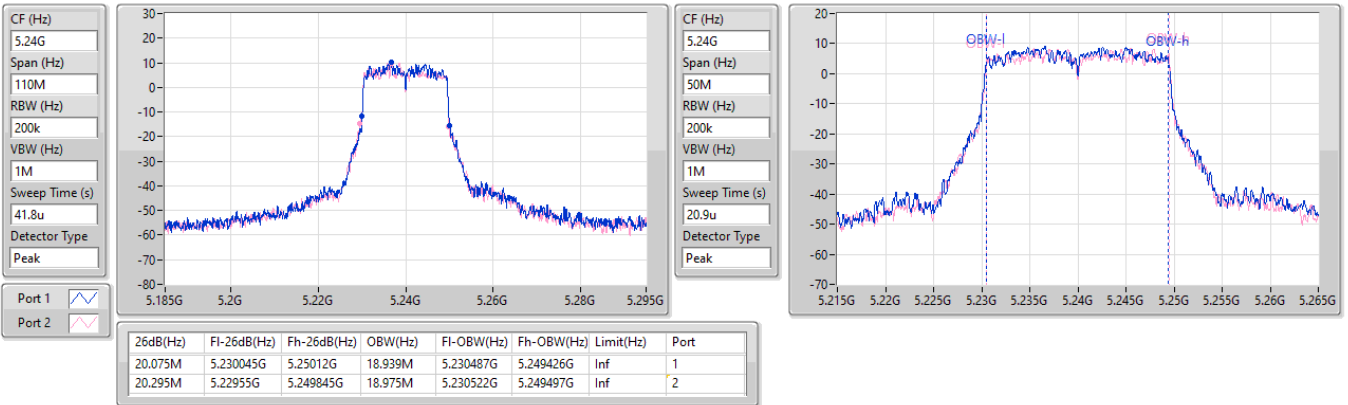

5.15-5.25GHz_802.11ax_HEW40_Nss1,(MCS0)_2TX

EBW

5190MHz

25/10/2023

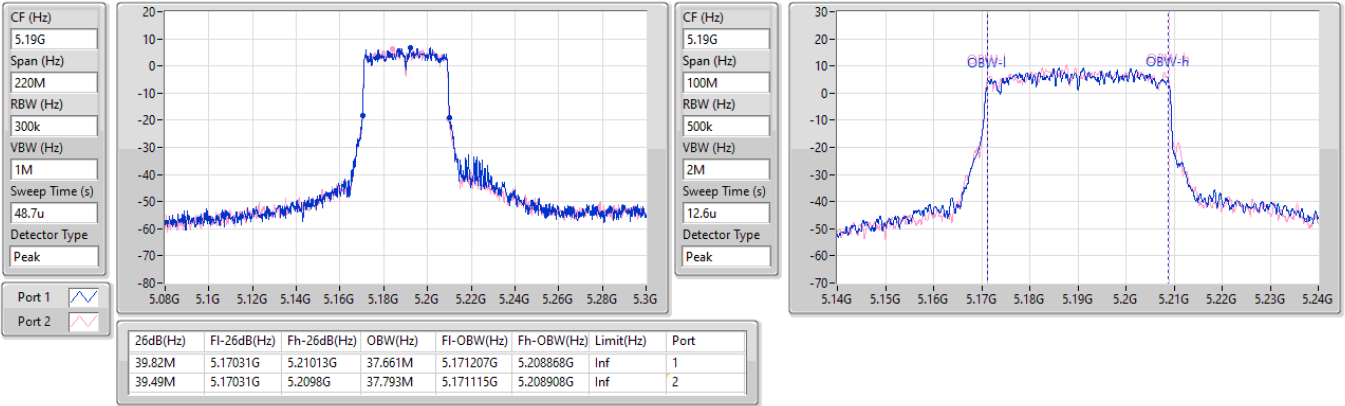

5.15-5.25GHz_802.11ax_HEW40_Nss1,(MCS0)_2TX

EBW

5230MHz

25/10/2023

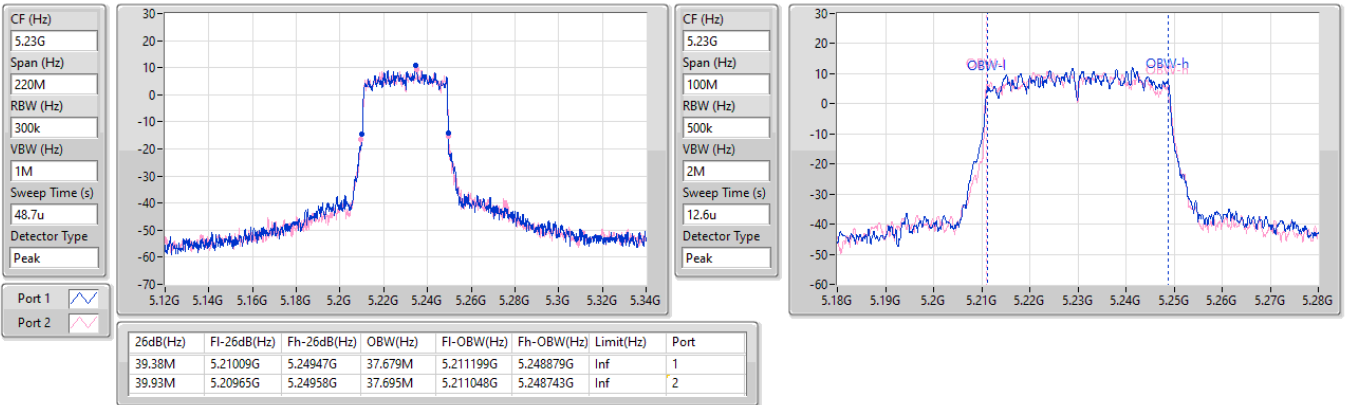

5.15-5.25GHz_802.11ax_HEW80_Nss1,(MCS0)_2TX

EBW

5210MHz

23/10/2023

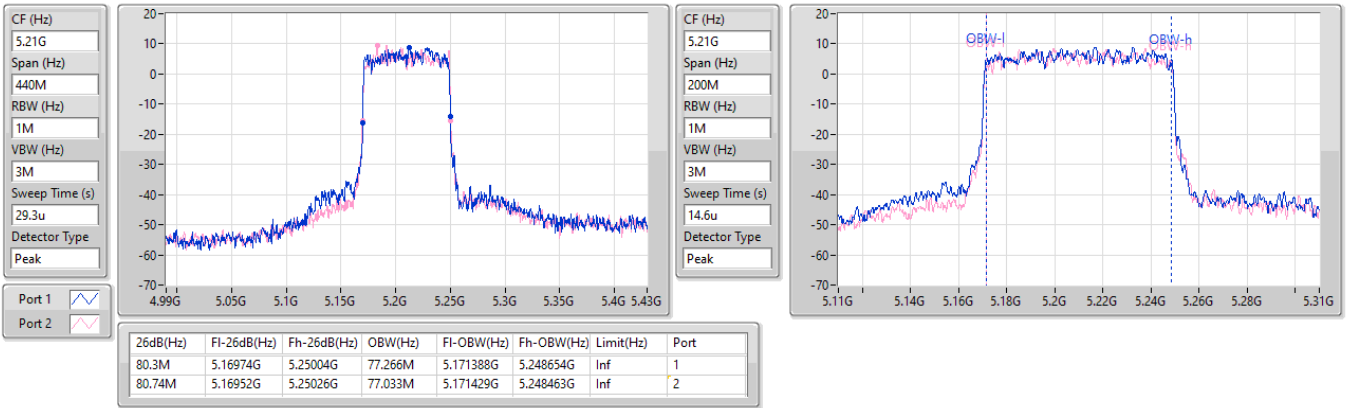



Summary

Mode	Total Power (dBm)	Total Power (W)	EIRP / EIRP [Phi 30°] (dBm)	EIRP / EIRP [Phi 30°] (W)
5.15-5.25GHz	-	-	-	-
802.11a_Nss1,(6Mbps)_1TX	22.72	0.18707	31.72/19.41	1.48594/0.087297
802.11ax HEW20_Nss1,(MCS0)_1TX	22.76	0.18880	31.76/19.45	1.49968/0.088105
802.11ax HEW40_Nss1,(MCS0)_1TX	22.67	0.18493	31.67/19.36	1.46893/0.086298
802.11ax HEW80_Nss1,(MCS0)_1TX	19.36	0.08630	28.36/16.05	0.68549/0.040272



Result

Mode	Result	DG (dBi)	Port 1 (dBm)	Total Power (dBm)	Power Limit (dBm)	EIRP / EIRP [Phi 30°] (dBm)	EIRP Limit / EIRP Limit [Phi 30°] (dBm)
802.11a_Nss1,(6Mbps)_1TX	-	-	-	-	-	-	-
5180MHz	Pass	9.00/-3.31	21.52	21.52	27.00	30.52/18.21	36.00/21.00
5200MHz	Pass	9.00/-3.31	22.69	22.69	27.00	31.69/19.38	36.00/21.00
5240MHz	Pass	9.00/-3.31	22.72	22.72	27.00	31.72/19.41	36.00/21.00
802.11ax HEW20_Nss1,(MCS0)_1TX	-	-	-	-	-	-	-
5180MHz	Pass	9.00/-3.31	20.26	20.26	27.00	29.26/16.95	36.00/21.00
5200MHz	Pass	9.00/-3.31	22.68	22.68	27.00	31.68/19.37	36.00/21.00
5240MHz	Pass	9.00/-3.31	22.76	22.76	27.00	31.76/19.45	36.00/21.00
802.11ax HEW40_Nss1,(MCS0)_1TX	-	-	-	-	-	-	-
5190MHz	Pass	9.00/-3.31	19.99	19.99	27.00	28.99/16.68	36.00/21.00
5230MHz	Pass	9.00/-3.31	22.67	22.67	27.00	31.67/19.36	36.00/21.00
802.11ax HEW80_Nss1,(MCS0)_1TX	-	-	-	-	-	-	-
5210MHz	Pass	9.00/-3.31	19.36	19.36	27.00	28.36/16.05	36.00/21.00

DG = Directional Gain; Port X = Port X output power



Summary

Mode	Total Power (dBm)	Total Power (W)	EIRP / EIRP [Phi 30°] (dBm)	EIRP Limit / EIRP Limit [Phi 30°] (W)
5.15-5.25GHz	-	-	-	-
802.11a_Nss1,(6Mbps)_1TX	22.93	0.19634	31.93/20.01	1.55955/0.100231
802.11ax HEW20_Nss1,(MCS0)_1TX	22.84	0.19231	31.84/19.92	1.52757/0.098175
802.11ax HEW40_Nss1,(MCS0)_1TX	22.66	0.18450	31.66/19.74	1.46555/0.094189
802.11ax HEW80_Nss1,(MCS0)_1TX	20.10	0.10233	29.10/17.18	0.81283/0.052240



Result

Mode	Result	DG (dBi)	Port 2 (dBm)	Total Power (dBm)	Power Limit (dBm)	EIRP / EIRP [Phi 30°] (dBm)	EIRP Limit / EIRP Limit [Phi 30°] (dBm)
802.11a_Nss1,(6Mbps)_1TX	-	-	-	-	-	-	-
5180MHz	Pass	9.00/-2.92	21.68	21.68	27.00	30.68/18.76	36.00/21.00
5200MHz	Pass	9.00/-2.92	22.93	22.93	27.00	31.93/20.01	36.00/21.00
5240MHz	Pass	9.00/-2.92	22.86	22.86	27.00	31.86/19.94	36.00/21.00
802.11ax HEW20_Nss1,(MCS0)_1TX	-	-	-	-	-	-	-
5180MHz	Pass	9.00/-2.92	21.26	21.26	27.00	30.26/18.34	36.00/21.00
5200MHz	Pass	9.00/-2.92	22.62	22.62	27.00	31.62/19.70	36.00/21.00
5240MHz	Pass	9.00/-2.92	22.84	22.84	27.00	31.84/19.92	36.00/21.00
802.11ax HEW40_Nss1,(MCS0)_1TX	-	-	-	-	-	-	-
5190MHz	Pass	9.00/-2.92	20.85	20.85	27.00	29.85/17.93	36.00/21.00
5230MHz	Pass	9.00/-2.92	22.66	22.66	27.00	31.66/19.74	36.00/21.00
802.11ax HEW80_Nss1,(MCS0)_1TX	-	-	-	-	-	-	-
5210MHz	Pass	9.00/-2.92	20.10	20.10	27.00	29.10/17.18	36.00/21.00

DG = Directional Gain; Port X = Port X output power



Summary

Mode	Total Power (dBm)	Total Power (W)	EIRP / EIRP [Phi 30°] (dBm)	EIRP / EIRP [Phi 30°] (W)
5.15-5.25GHz	-	-	-	-
802.11a_Nss1,(6Mbps)_2TX	22.85	0.19275	31.85/19.93	1.53109/0.098401
802.11ax HEW20_Nss1,(MCS0)_2TX	22.90	0.19498	31.90/19.98	1.54882/0.099541
802.11ax HEW20-BF_Nss1,(MCS0)_2TX	22.90	0.19498	31.90/19.98	1.54882/0.099541
802.11ax HEW40_Nss1,(MCS0)_2TX	22.69	0.18578	31.69/19.77	1.47571/0.094842
802.11ax HEW40-BF_Nss1,(MCS0)_2TX	22.69	0.18578	31.69/19.77	1.47571/0.094842
802.11ax HEW80_Nss1,(MCS0)_2TX	21.49	0.14093	30.49/18.57	1.11944/0.071945
802.11ax HEW80-BF_Nss1,(MCS0)_2TX	21.49	0.14093	30.49/18.57	1.11944/0.071945



Result

Mode	Result	DG (dBi)	Port 1 (dBm)	Port 2 (dBm)	Total Power (dBm)	Power Limit (dBm)	EIRP / EIRP [Phi 30°] (dBm)	EIRP Limit / EIRP Limit [Phi 30°] (dBm)
802.11a_Nss1,(6Mbps)_2TX	-	-	-	-	-	-	-	-
5180MHz	Pass	9.00/-2.92	19.82	19.82	22.83	27.00	31.83/19.91	36.00/21.00
5200MHz	Pass	9.00/-2.92	19.86	19.81	22.85	27.00	31.85/19.93	36.00/21.00
5240MHz	Pass	9.00/-2.92	19.88	19.56	22.73	27.00	31.73/19.81	36.00/21.00
802.11ax HEW20_Nss1,(MCS0)_2TX	-	-	-	-	-	-	-	-
5180MHz	Pass	9.00/-2.92	19.87	19.90	22.90	27.00	31.90/19.98	36.00/21.00
5200MHz	Pass	9.00/-2.92	19.74	19.52	22.64	27.00	31.64/19.72	36.00/21.00
5240MHz	Pass	9.00/-2.92	19.70	19.48	22.60	27.00	31.60/19.68	36.00/21.00
802.11ax HEW40_Nss1,(MCS0)_2TX	-	-	-	-	-	-	-	-
5190MHz	Pass	9.00/-2.92	19.33	19.18	22.27	27.00	31.27/19.35	36.00/21.00
5230MHz	Pass	9.00/-2.92	19.82	19.53	22.69	27.00	31.69/19.77	36.00/21.00
802.11ax HEW80_Nss1,(MCS0)_2TX	-	-	-	-	-	-	-	-
5210MHz	Pass	9.00/-2.92	18.67	18.28	21.49	27.00	30.49/18.57	36.00/21.00
802.11ax HEW20-BF_Nss1,(MCS0)_2TX	-	-	-	-	-	-	-	-
5180MHz	Pass	9.00/-2.92	19.87	19.90	22.90	27.00	31.90/19.98	36.00/21.00
5200MHz	Pass	9.00/-2.92	19.74	19.52	22.64	27.00	31.64/19.72	36.00/21.00
5240MHz	Pass	9.00/-2.92	19.70	19.48	22.60	27.00	31.60/19.68	36.00/21.00
802.11ax HEW40-BF_Nss1,(MCS0)_2TX	-	-	-	-	-	-	-	-
5190MHz	Pass	9.00/-2.92	19.33	19.18	22.27	27.00	31.27/19.35	36.00/21.00
5230MHz	Pass	9.00/-2.92	19.82	19.53	22.69	27.00	31.69/19.77	36.00/21.00
802.11ax HEW80-BF_Nss1,(MCS0)_2TX	-	-	-	-	-	-	-	-
5210MHz	Pass	9.00/-2.92	18.67	18.28	21.49	27.00	30.49/18.57	36.00/21.00

DG = Directional Gain; Port X = Port X output power



Summary

Mode	PD (dBm/RBW)
5.15-5.25GHz	-
802.11a_Nss1,(6Mbps)_1TX	9.94
802.11ax HEW20_Nss1,(MCS0)_1TX	9.15
802.11ax HEW40_Nss1,(MCS0)_1TX	6.24
802.11ax HEW80_Nss1,(MCS0)_1TX	-0.08

RBW = 500kHz for 5.725-5.85GHz band / 1MHz for other band:

Result

Mode	Result	DG (dBi)	Port 1 (dBm/RBW)	PD (dBm/RBW)	PD Limit (dBm/RBW)
802.11a_Nss1,(6Mbps)_1TX	-	-	-	-	-
5180MHz	Pass	9.00	9.10	9.10	14.00
5200MHz	Pass	9.00	9.80	9.80	14.00
5240MHz	Pass	9.00	9.94	9.94	14.00
802.11ax HEW20_Nss1,(MCS0)_1TX	-	-	-	-	-
5180MHz	Pass	9.00	7.02	7.02	14.00
5200MHz	Pass	9.00	9.12	9.12	14.00
5240MHz	Pass	9.00	9.15	9.15	14.00
802.11ax HEW40_Nss1,(MCS0)_1TX	-	-	-	-	-
5190MHz	Pass	9.00	3.87	3.87	14.00
5230MHz	Pass	9.00	6.24	6.24	14.00
802.11ax HEW80_Nss1,(MCS0)_1TX	-	-	-	-	-
5210MHz	Pass	9.00	-0.08	-0.08	14.00

DG = Directional Gain; RBW = 500kHz for 5.725-5.85GHz band / 1MHz for other band;
 PD = trace bin-by-bin of each transmits port summing can be performed maximum power density; Port X = Port X Power Density;

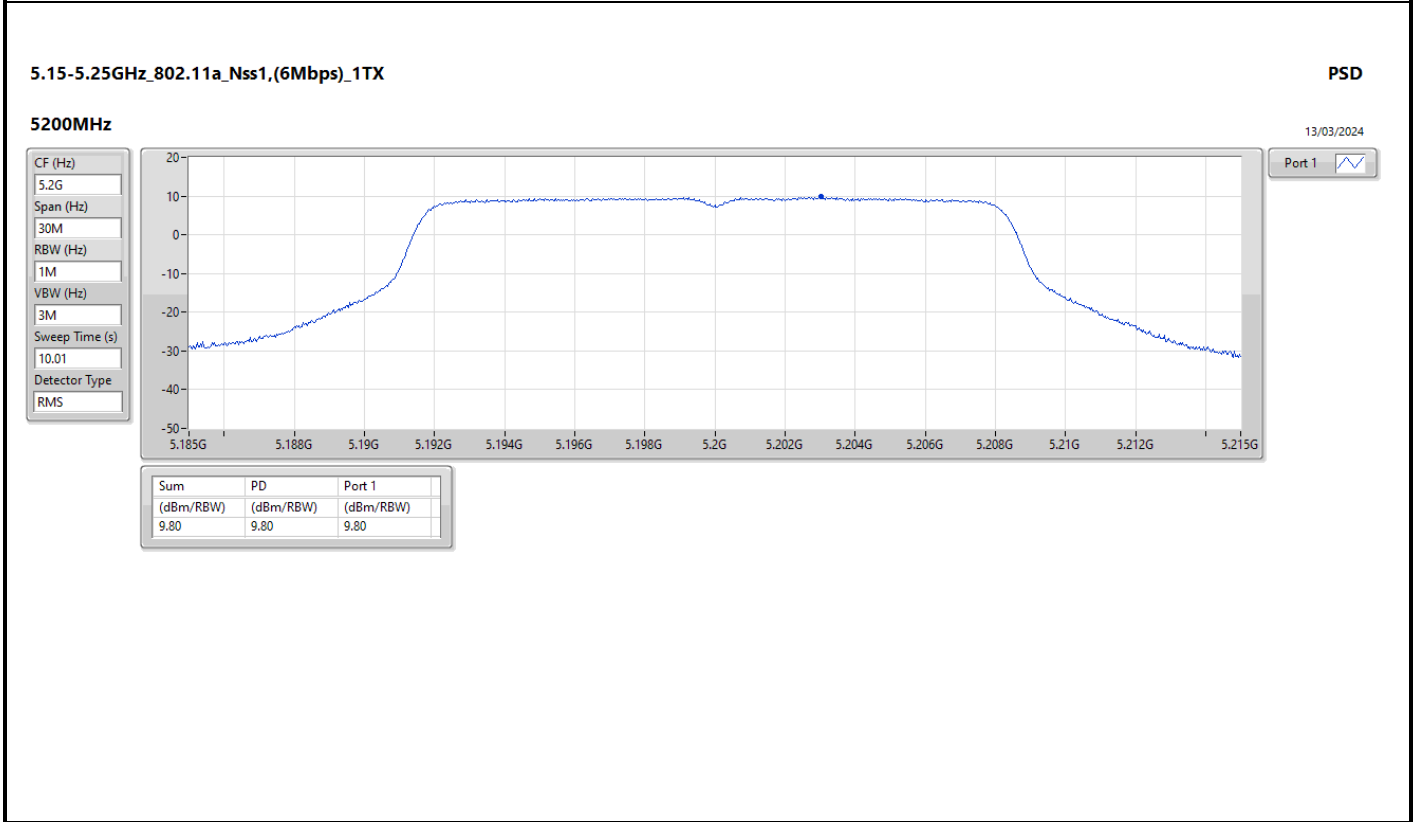
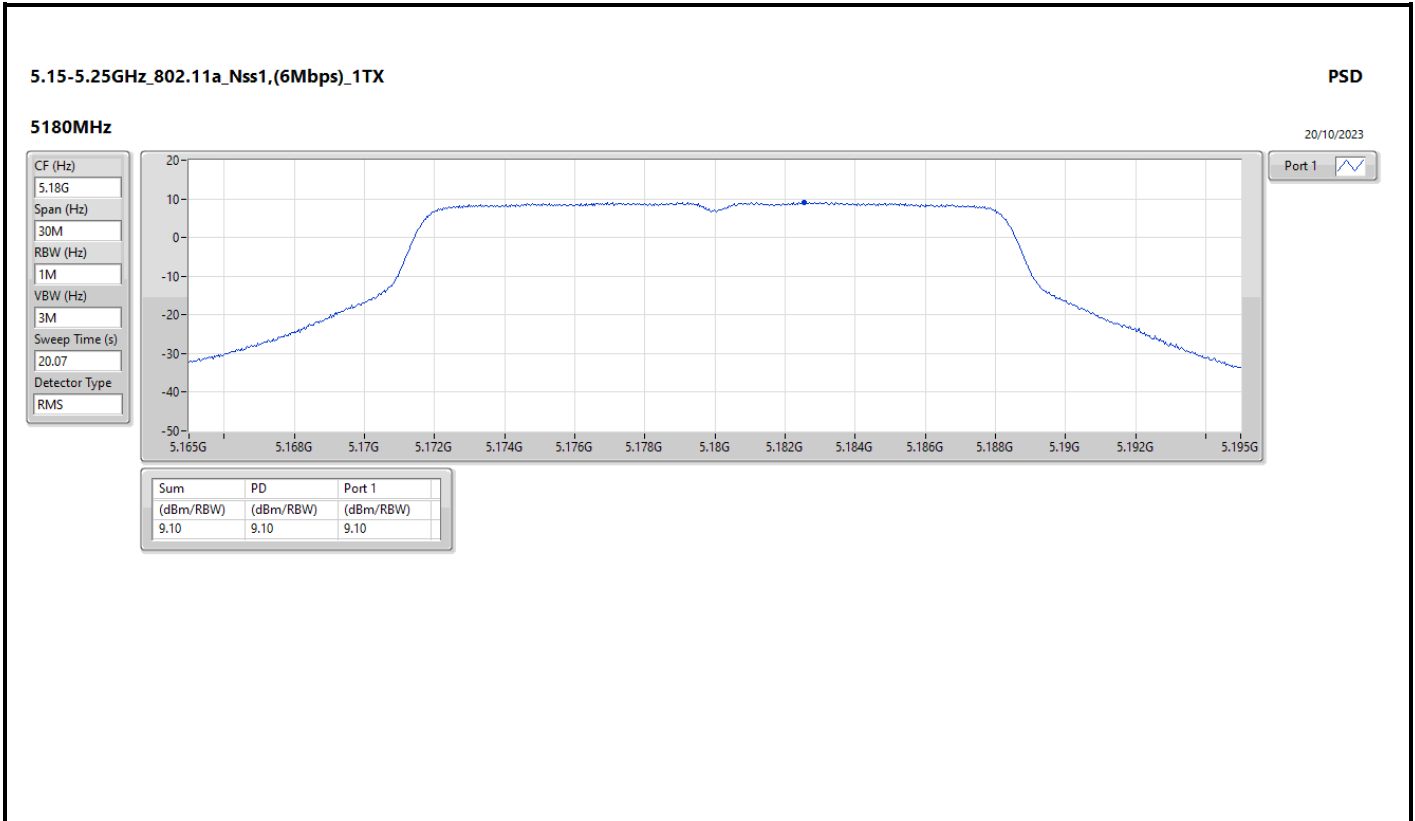

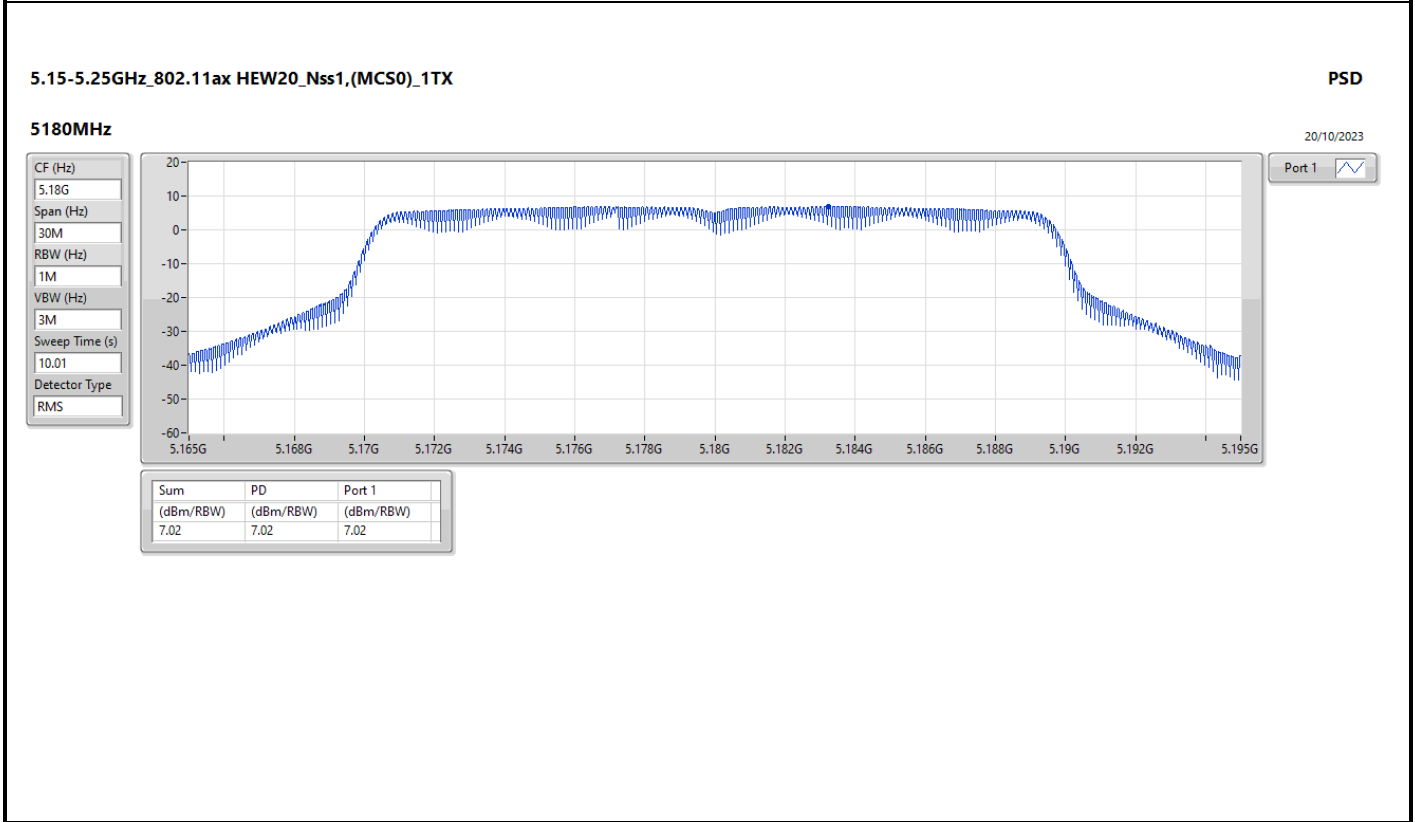
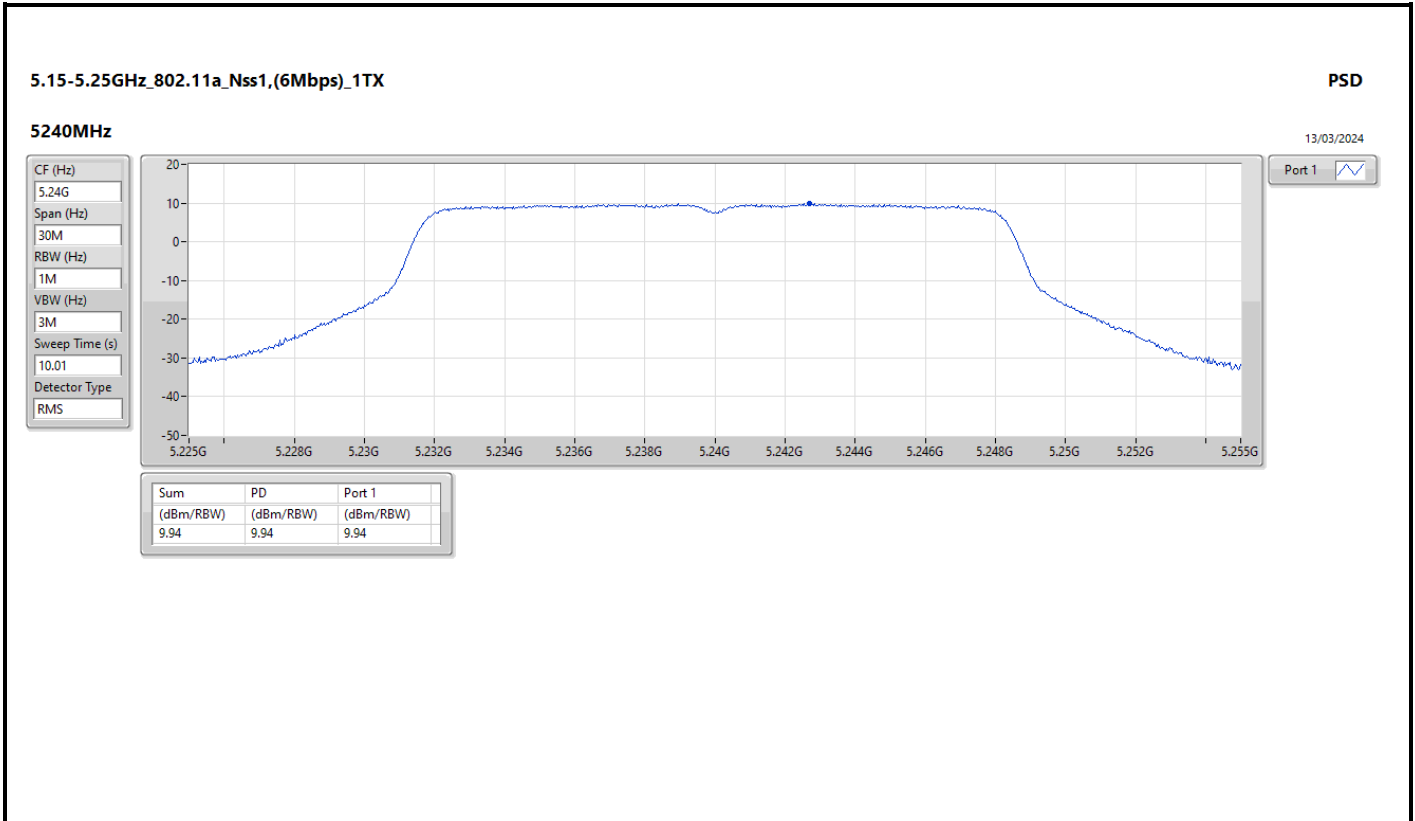

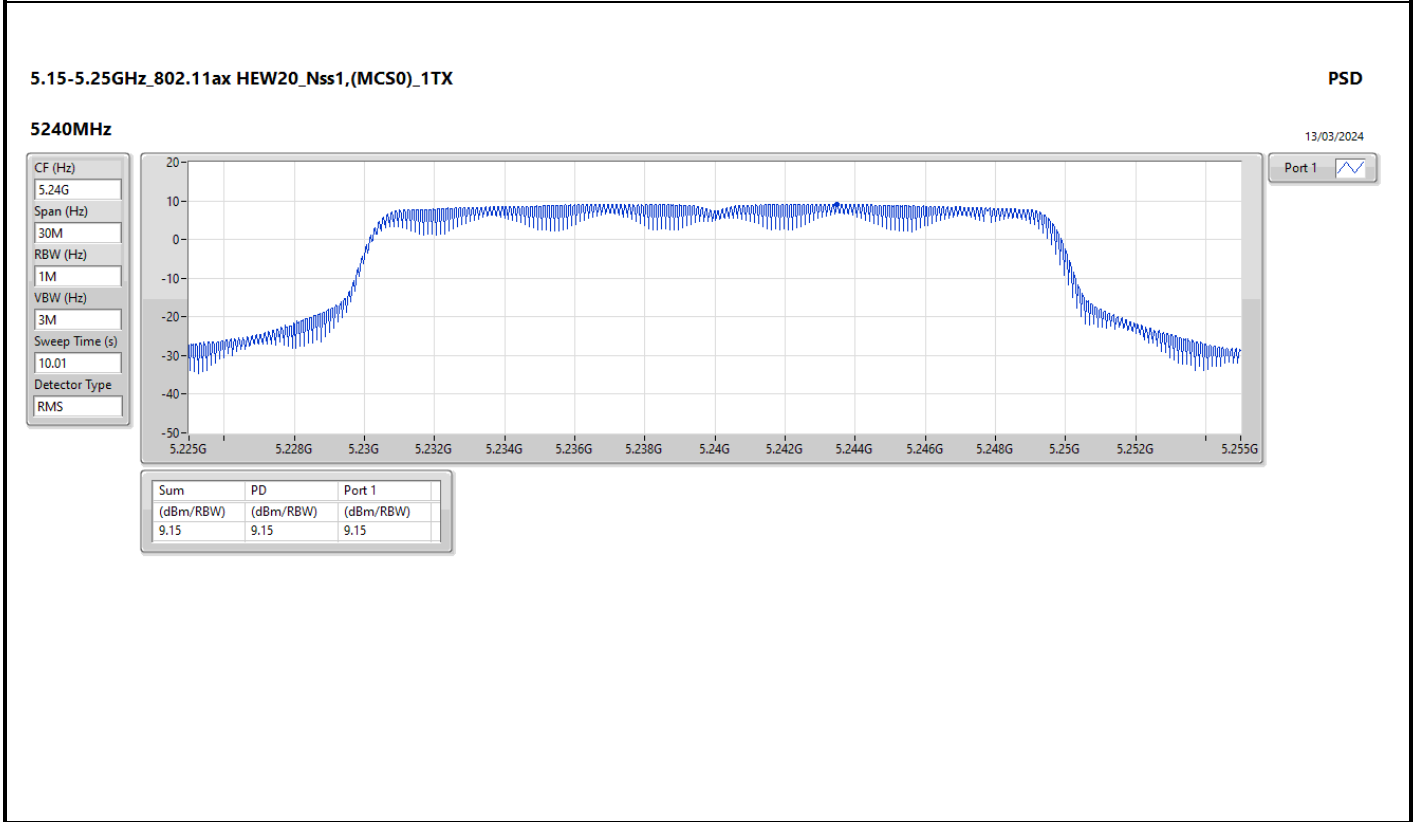
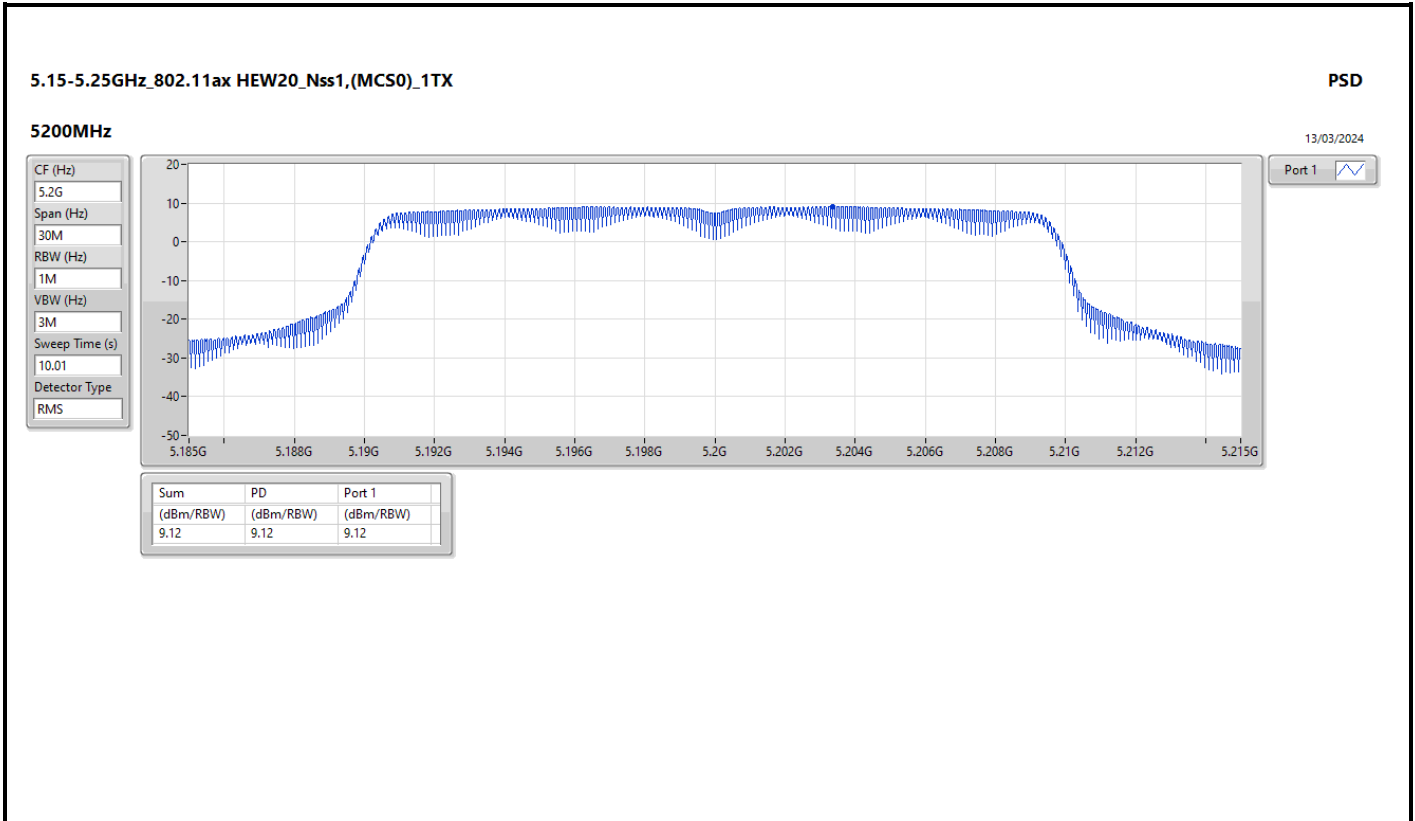

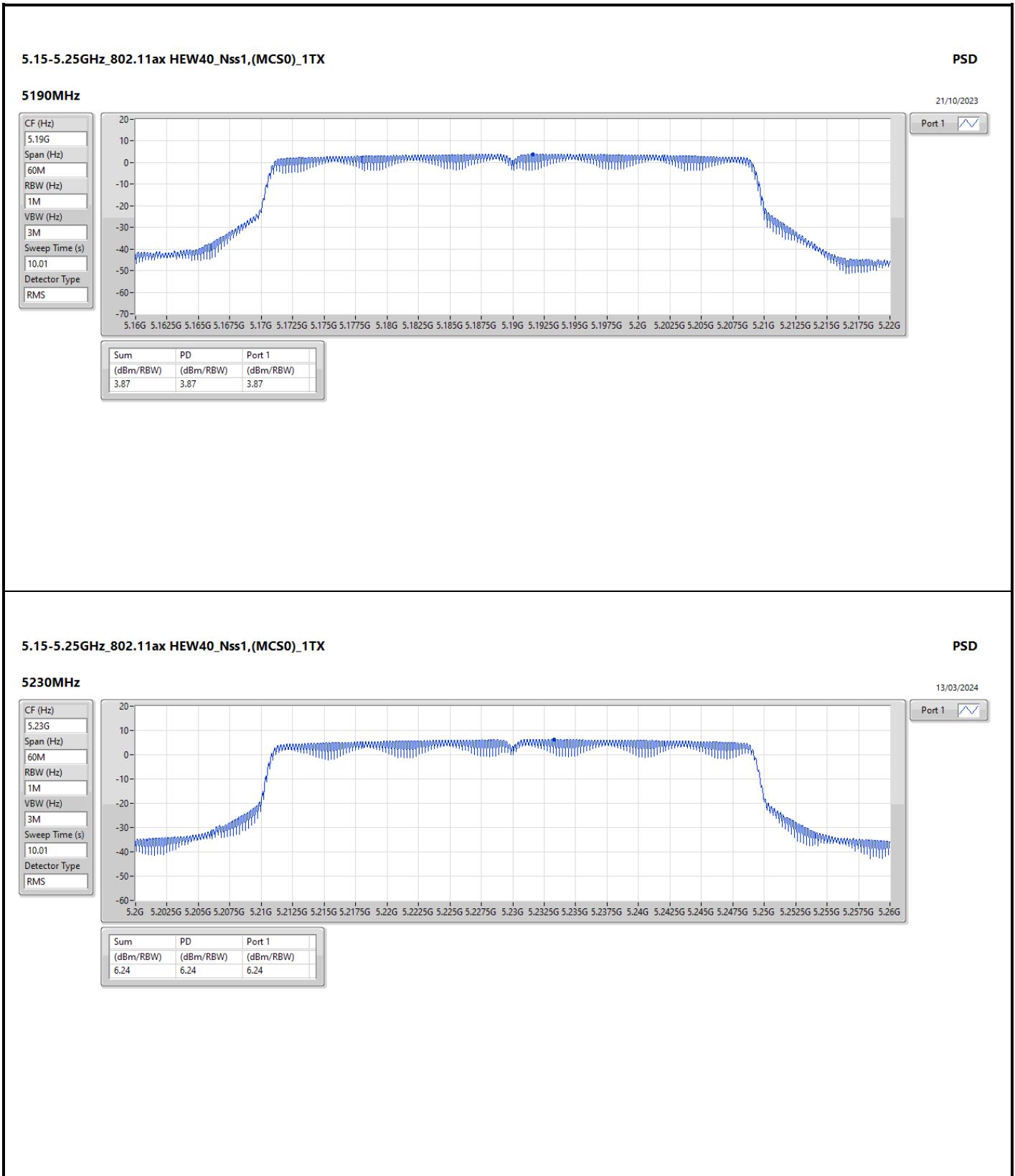

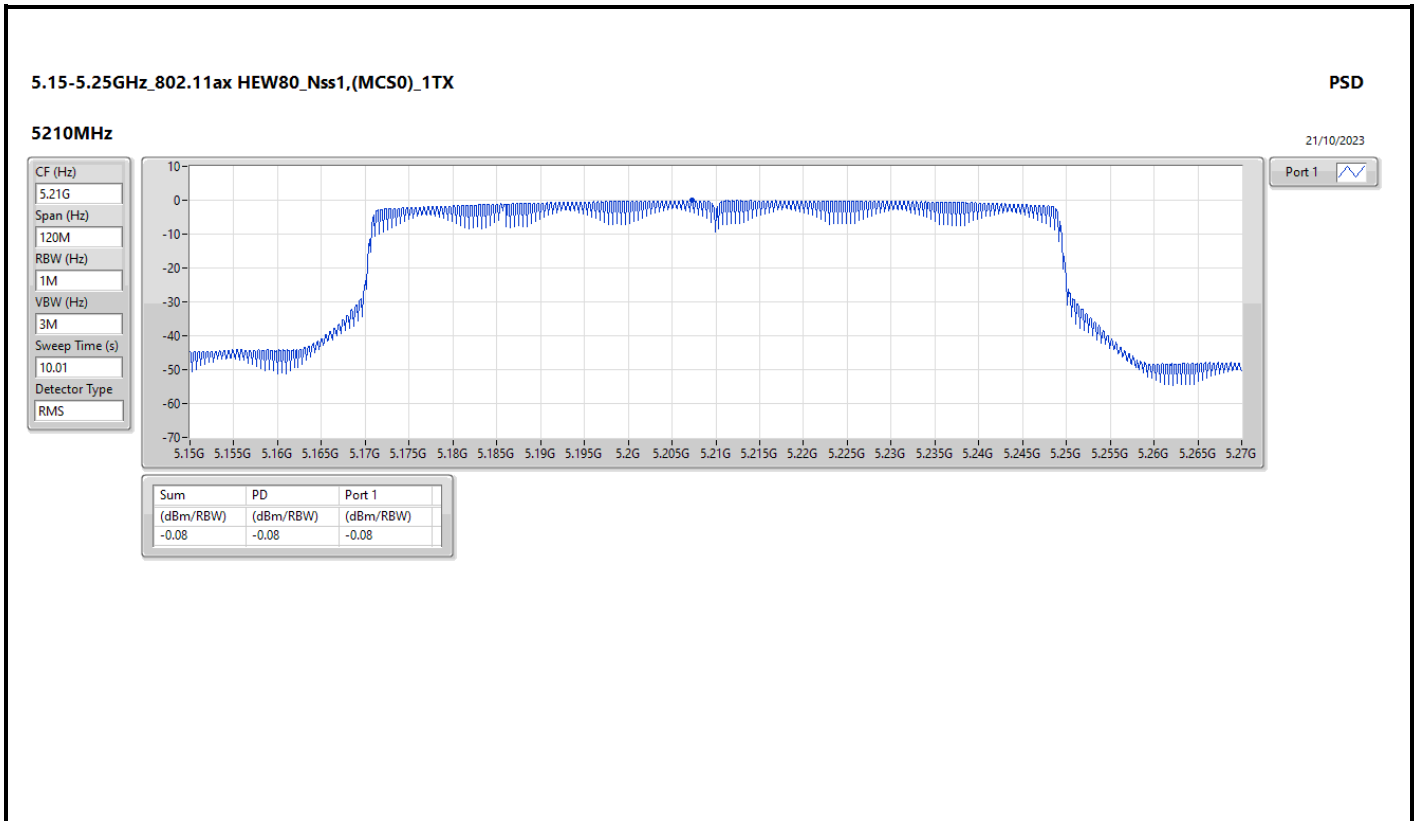



Summary

Mode	PD (dBm/RBW)
5.15-5.25GHz	-
802.11a_Nss1,(6Mbps)_1TX	10.05
802.11ax HEW20_Nss1,(MCS0)_1TX	9.21
802.11ax HEW40_Nss1,(MCS0)_1TX	6.29
802.11ax HEW80_Nss1,(MCS0)_1TX	0.84

RBW = 500kHz for 5.725-5.85GHz band / 1MHz for other band:

Result

Mode	Result	DG (dBi)	Port 2 (dBm/RBW)	PD (dBm/RBW)	PD Limit (dBm/RBW)
802.11a_Nss1,(6Mbps)_1TX	-	-	-	-	-
5180MHz	Pass	9.00	9.01	9.01	14.00
5200MHz	Pass	9.00	9.95	9.95	14.00
5240MHz	Pass	9.00	10.05	10.05	14.00
802.11ax HEW20_Nss1,(MCS0)_1TX	-	-	-	-	-
5180MHz	Pass	9.00	7.94	7.94	14.00
5200MHz	Pass	9.00	9.12	9.12	14.00
5240MHz	Pass	9.00	9.21	9.21	14.00
802.11ax HEW40_Nss1,(MCS0)_1TX	-	-	-	-	-
5190MHz	Pass	9.00	4.74	4.74	14.00
5230MHz	Pass	9.00	6.29	6.29	14.00
802.11ax HEW80_Nss1,(MCS0)_1TX	-	-	-	-	-
5210MHz	Pass	9.00	0.84	0.84	14.00

DG = Directional Gain; RBW = 500kHz for 5.725-5.85GHz band / 1MHz for other band;
 PD = trace bin-by-bin of each transmits port summing can be performed maximum power density; Port X = Port X Power Density;

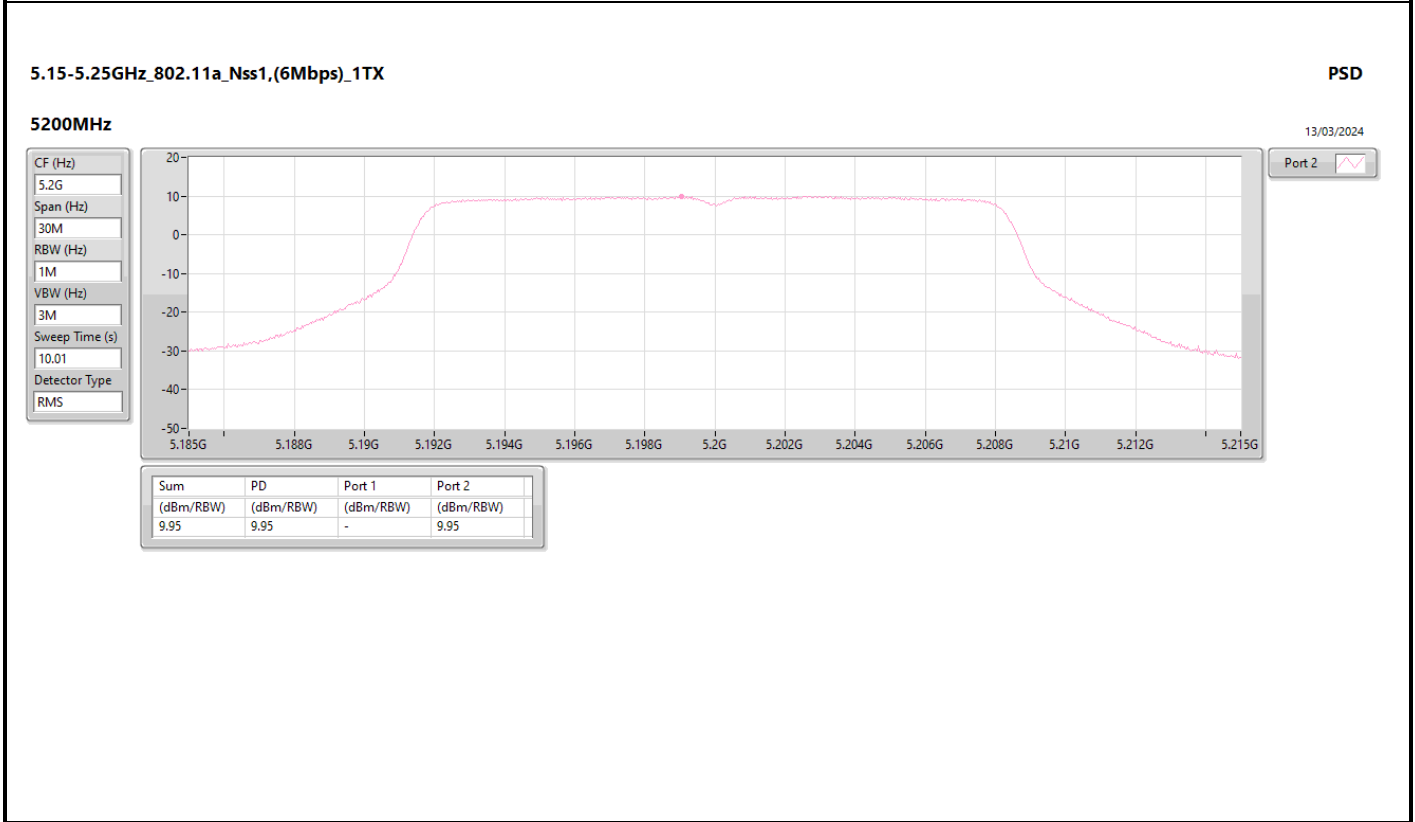
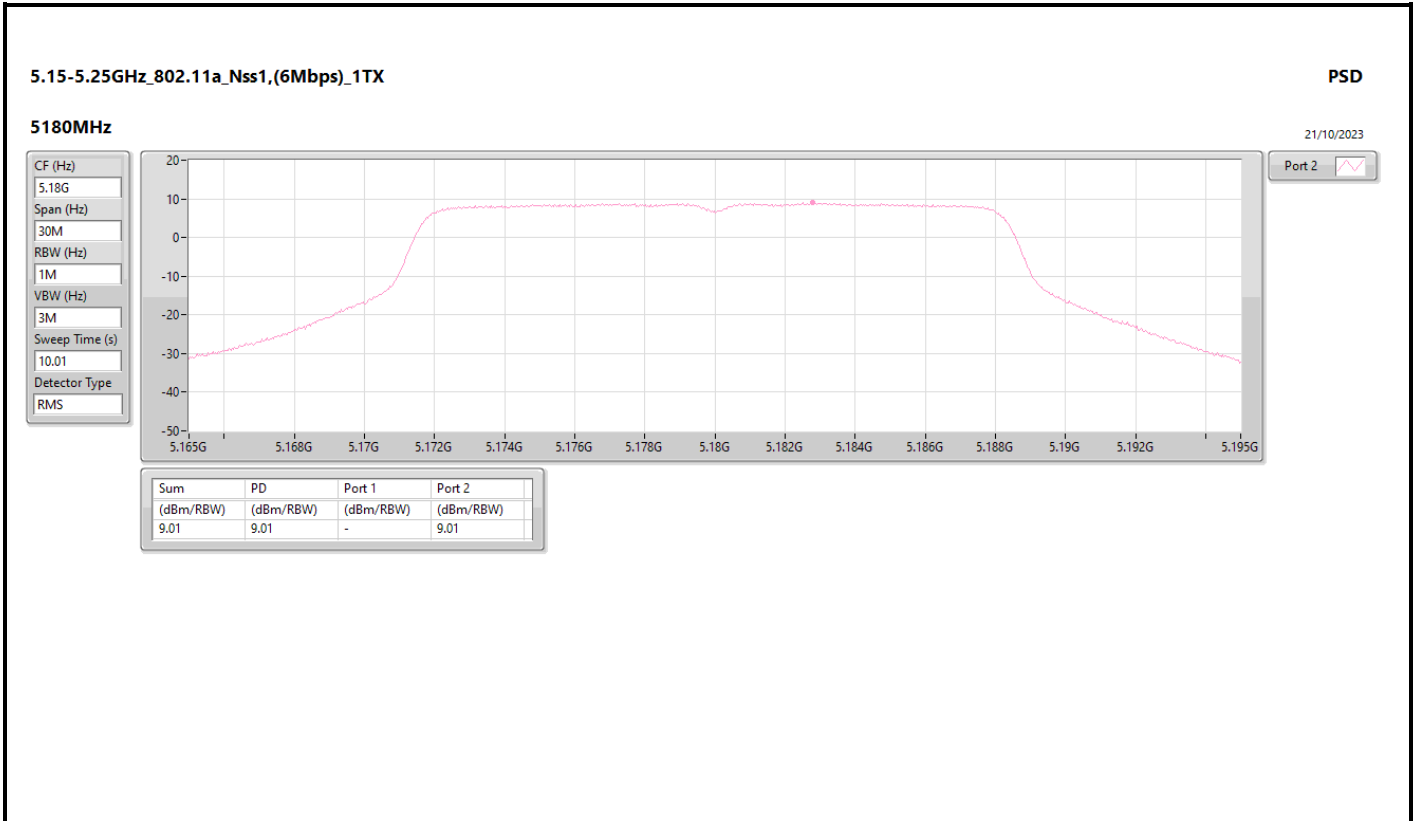

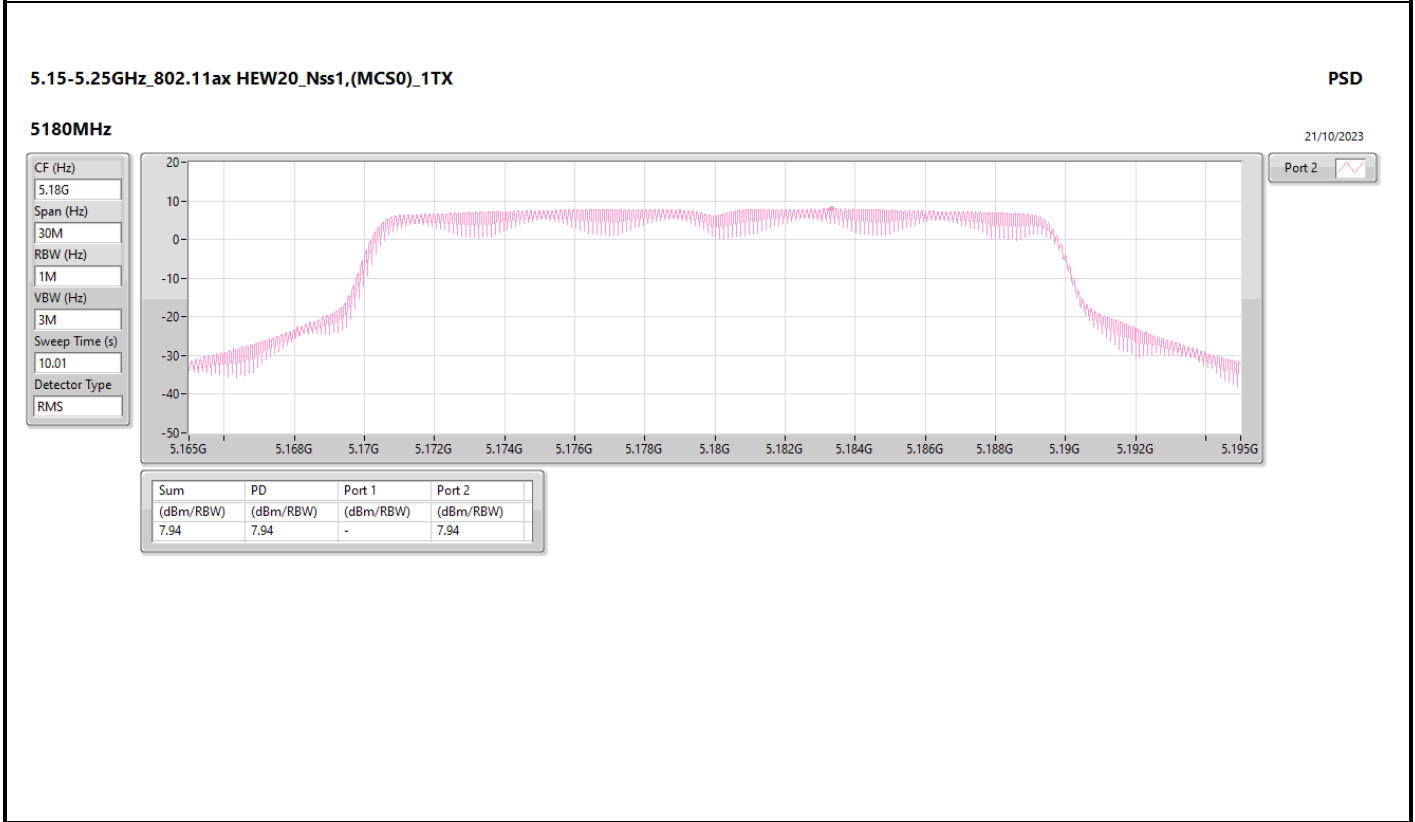
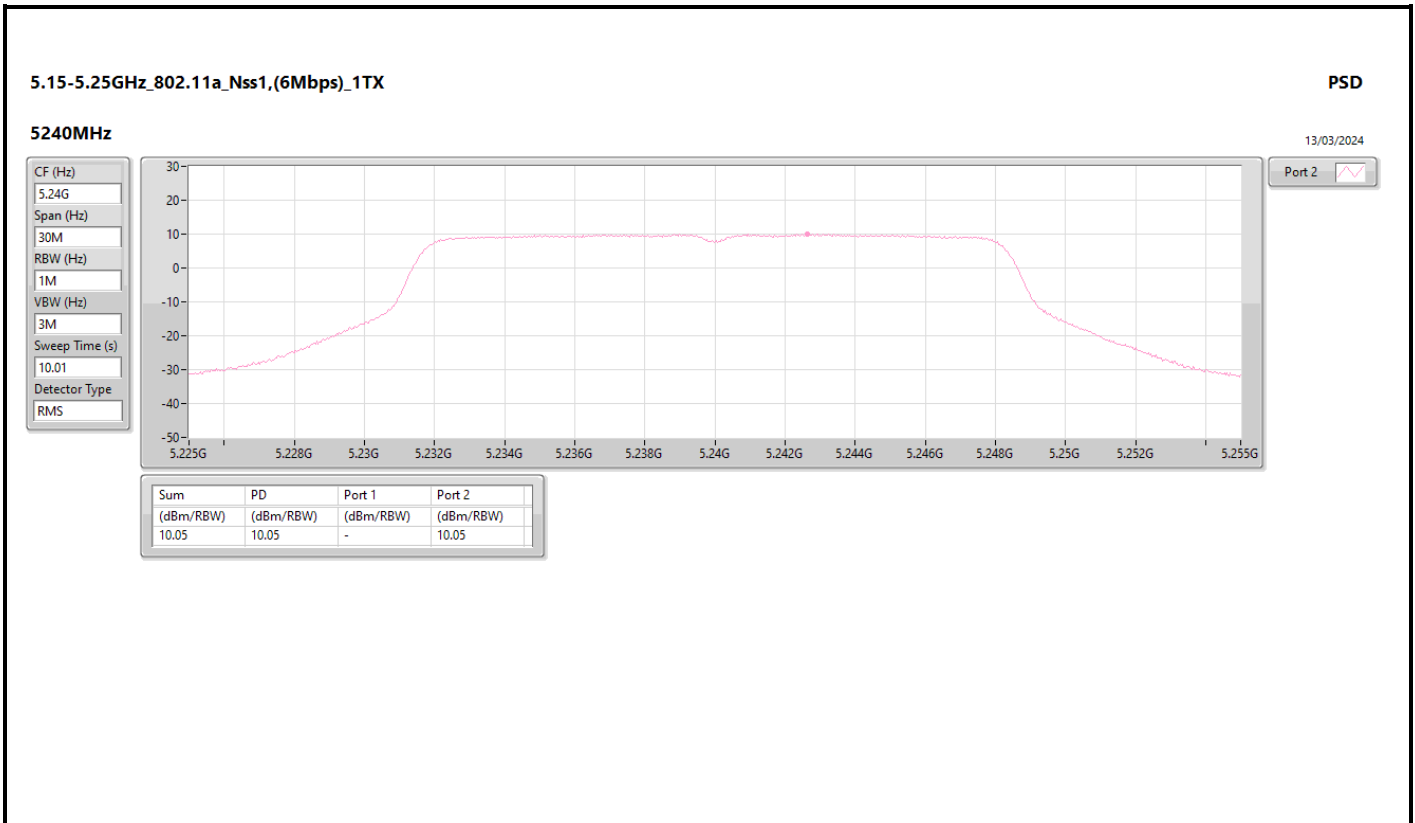

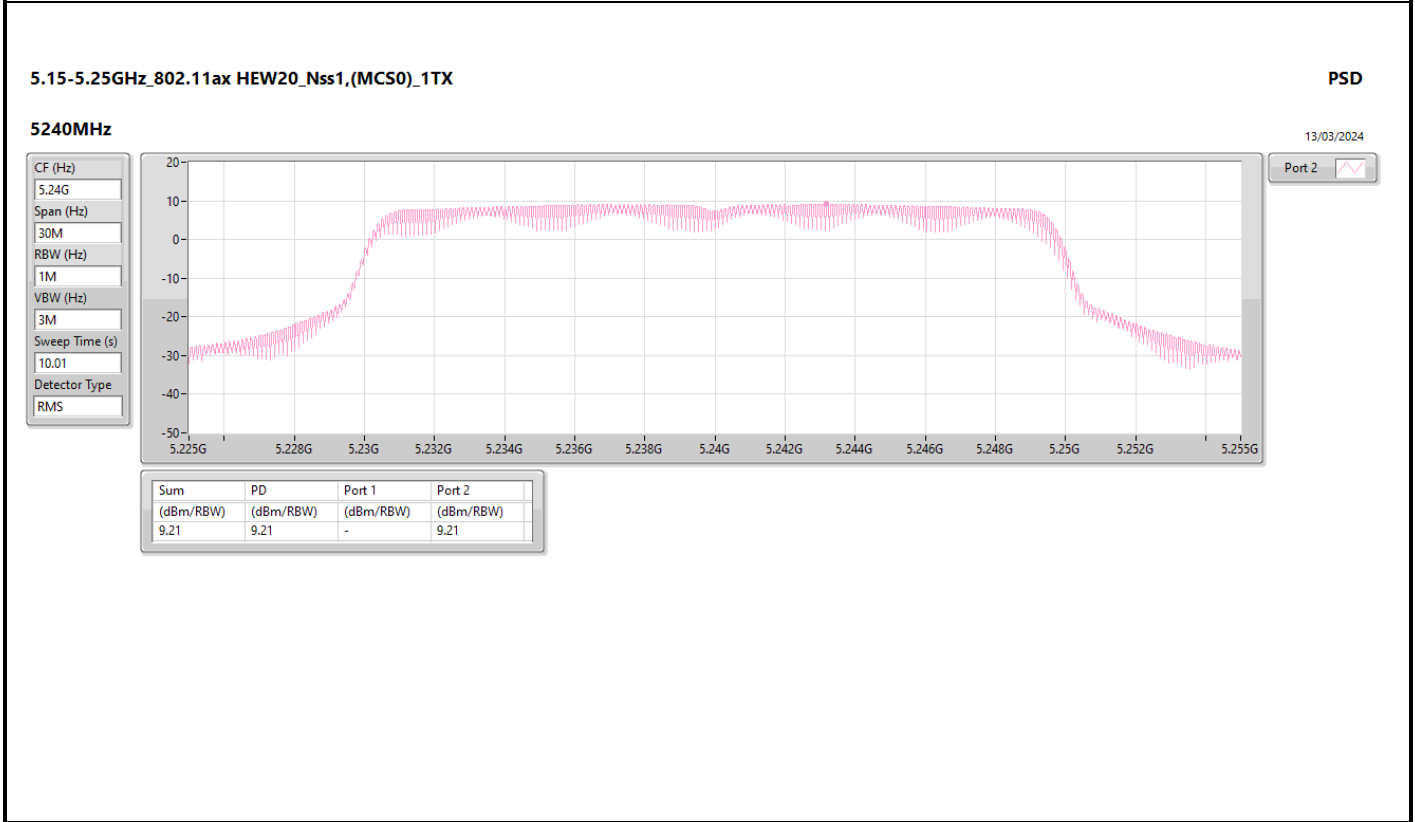
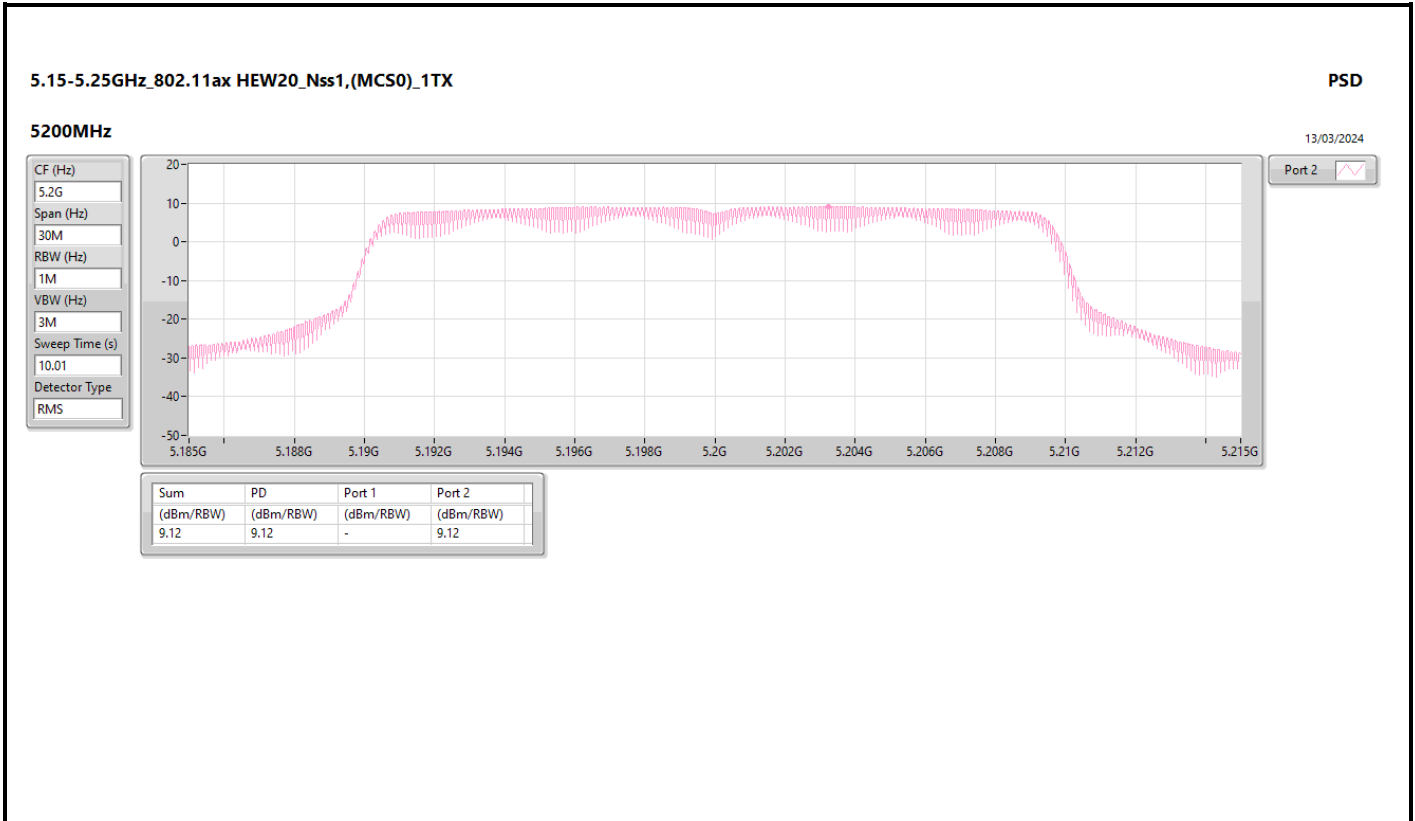

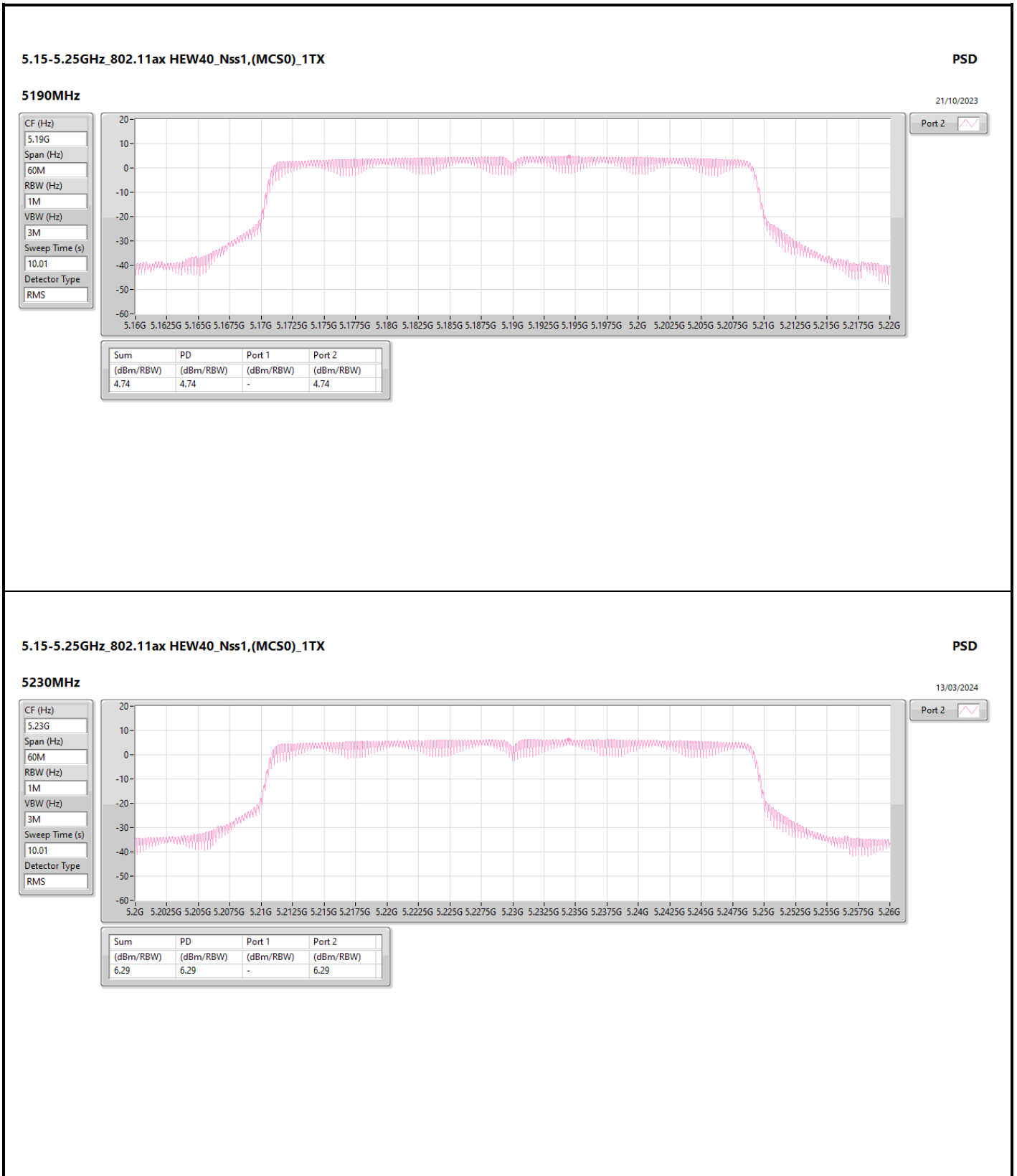

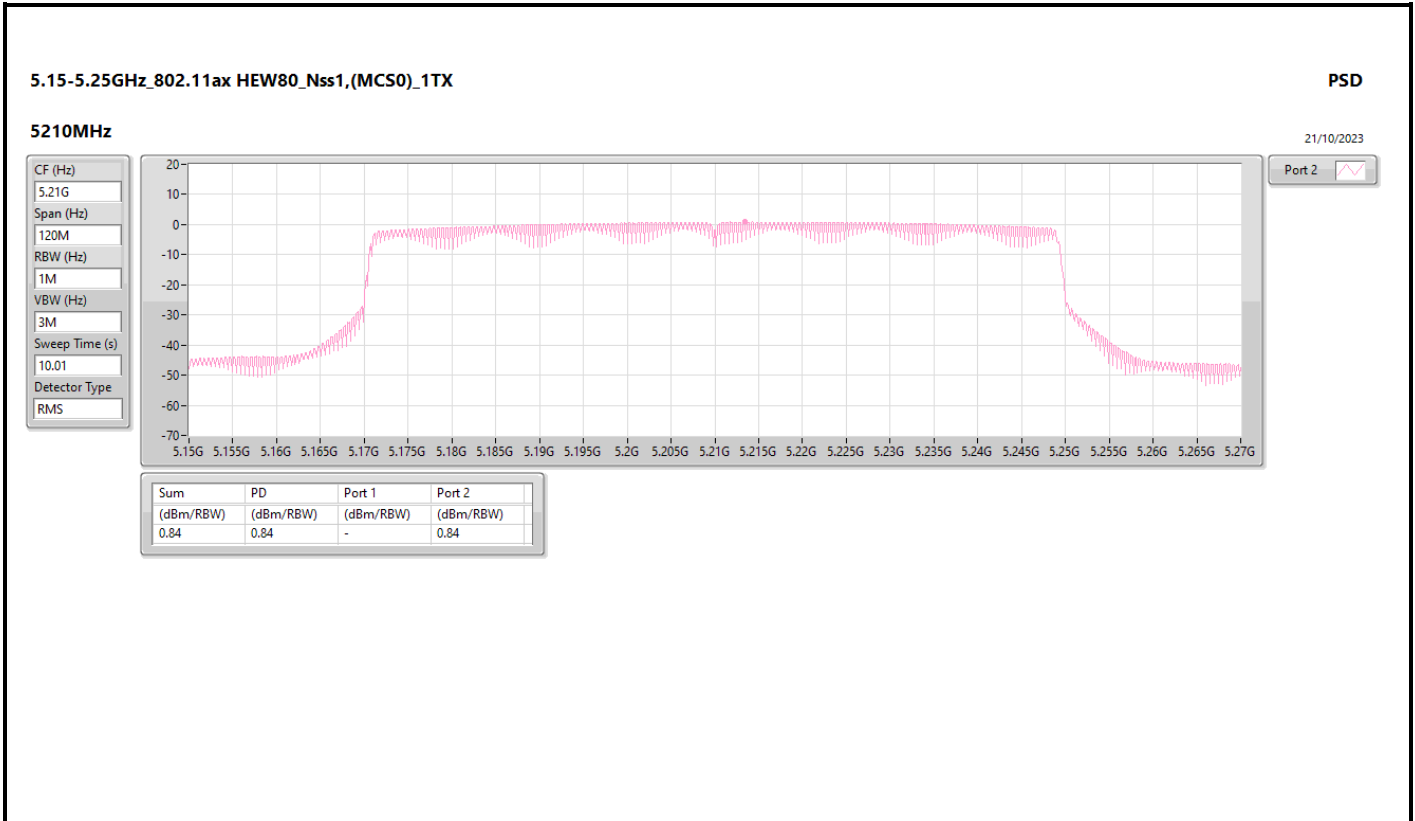



Summary

Mode	PD (dBm/RBW)
5.15-5.25GHz	-
802.11a_Nss1,(6Mbps)_2TX	10.11
802.11ax HEW20_Nss1,(MCS0)_2TX	10.10
802.11ax HEW40_Nss1,(MCS0)_2TX	7.26
802.11ax HEW80_Nss1,(MCS0)_2TX	2.31

RBW = 500kHz for 5.725-5.85GHz band / 1MHz for other band:

Result

Mode	Result	DG (dBi)	Port 1 (dBm/RBW)	Port 2 (dBm/RBW)	PD (dBm/RBW)	PD Limit (dBm/RBW)
802.11a_Nss1,(6Mbps)_2TX	-	-	-	-	-	-
5180MHz	Pass	9.00	7.24	7.23	10.06	14.00
5200MHz	Pass	9.00	7.30	7.25	10.11	14.00
5240MHz	Pass	9.00	7.23	7.13	10.00	14.00
802.11ax HEW20_Nss1,(MCS0)_2TX	-	-	-	-	-	-
5180MHz	Pass	9.00	6.96	6.92	9.84	14.00
5200MHz	Pass	9.00	7.19	7.16	10.10	14.00
5240MHz	Pass	9.00	7.26	7.02	9.93	14.00
802.11ax HEW40_Nss1,(MCS0)_2TX	-	-	-	-	-	-
5190MHz	Pass	9.00	3.44	3.42	6.31	14.00
5230MHz	Pass	9.00	4.44	4.24	7.26	14.00
802.11ax HEW80_Nss1,(MCS0)_2TX	-	-	-	-	-	-
5210MHz	Pass	9.00	-0.43	-0.72	2.31	14.00

DG = Directional Gain; RBW = 500kHz for 5.725-5.85GHz band / 1MHz for other band;
 PD = trace bin-by-bin of each transmits port summing can be performed maximum power density; Port X = Port X Power Density;

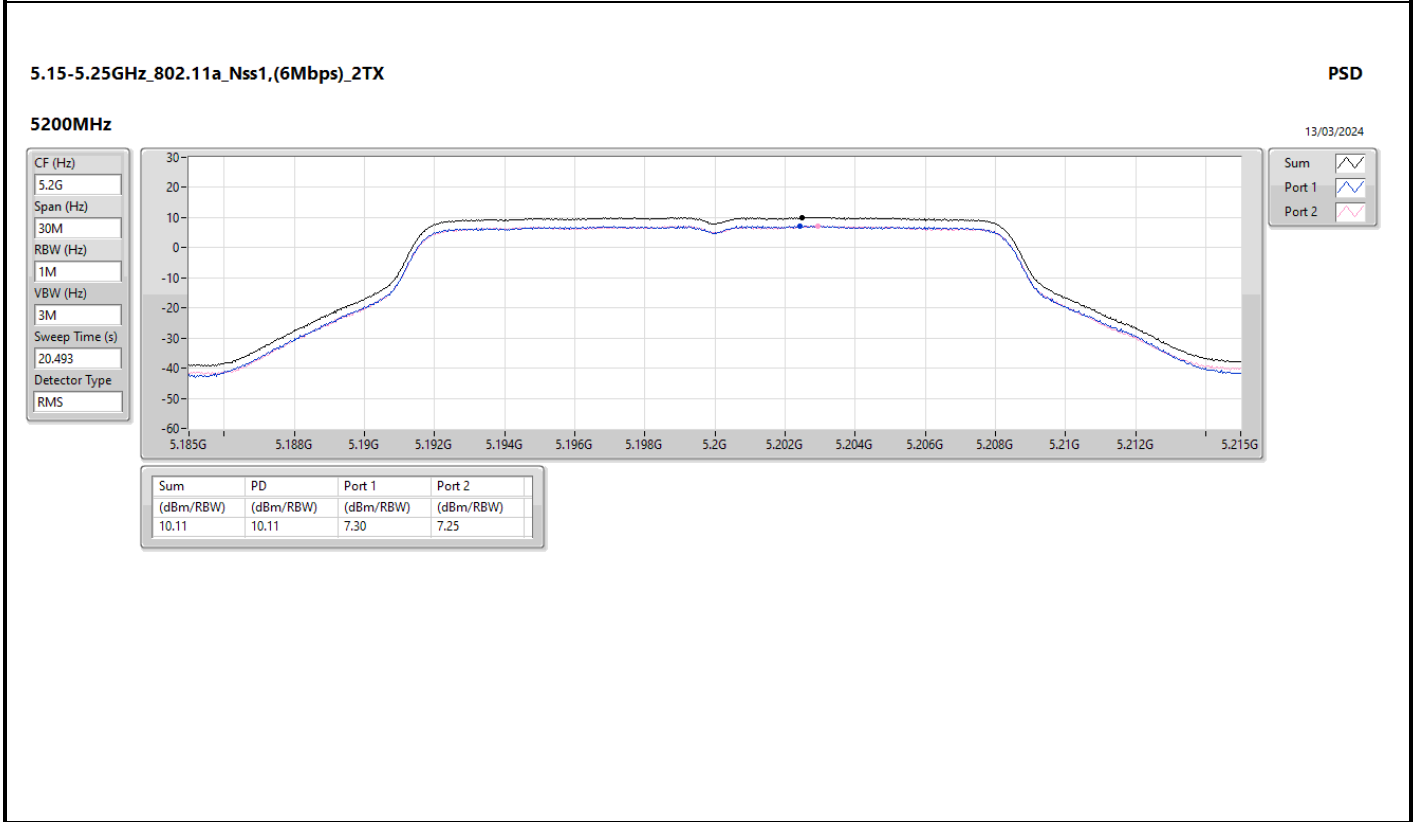
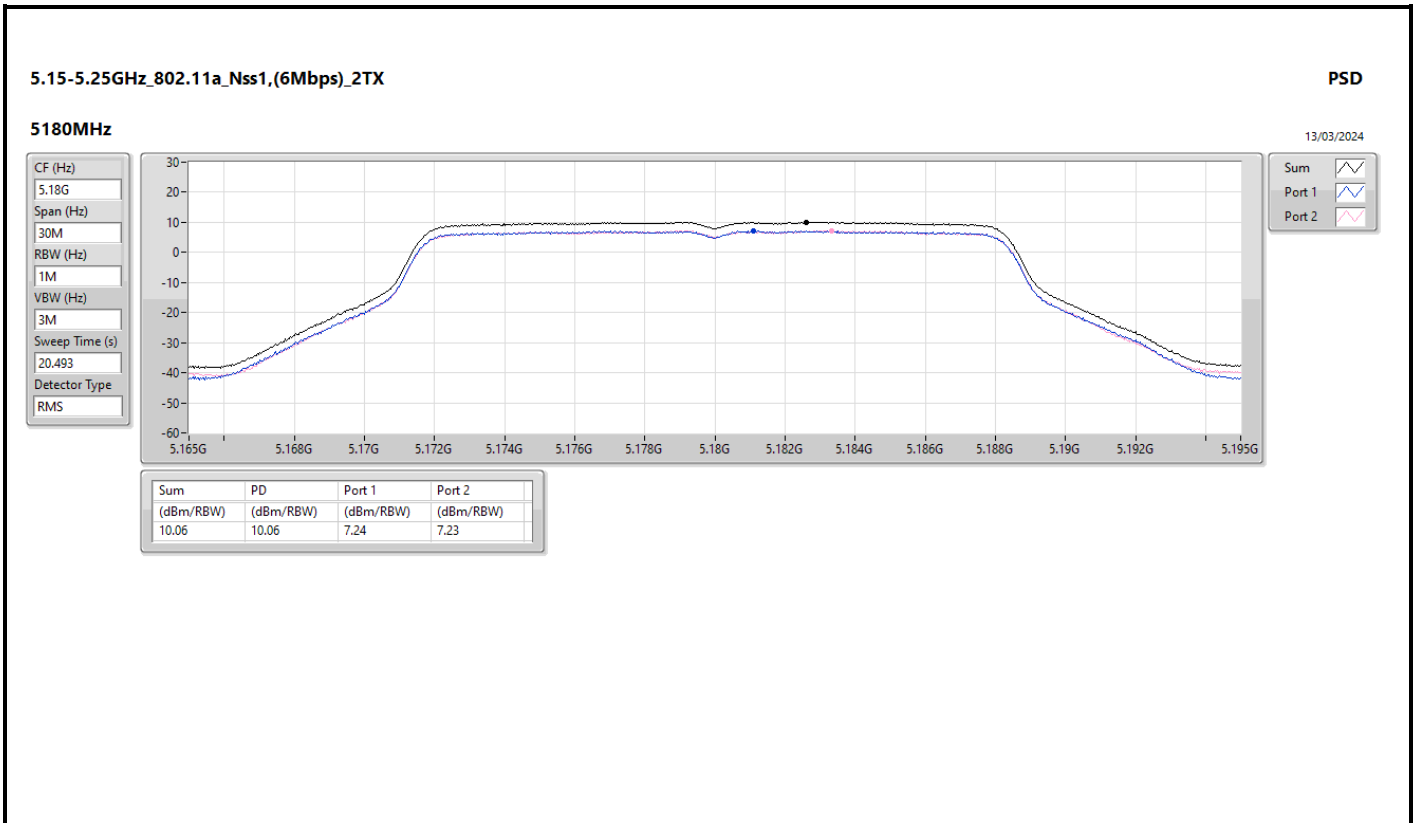

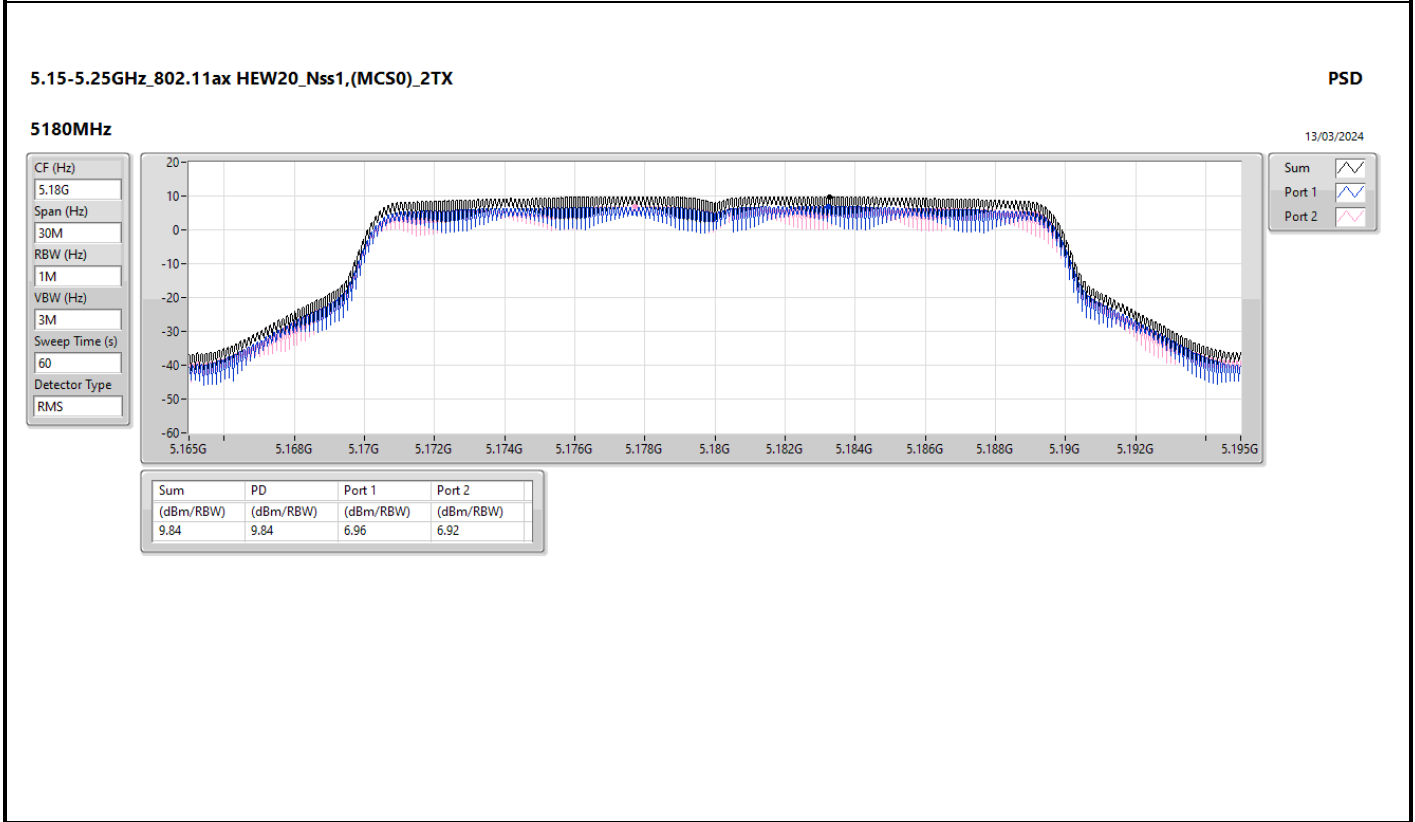
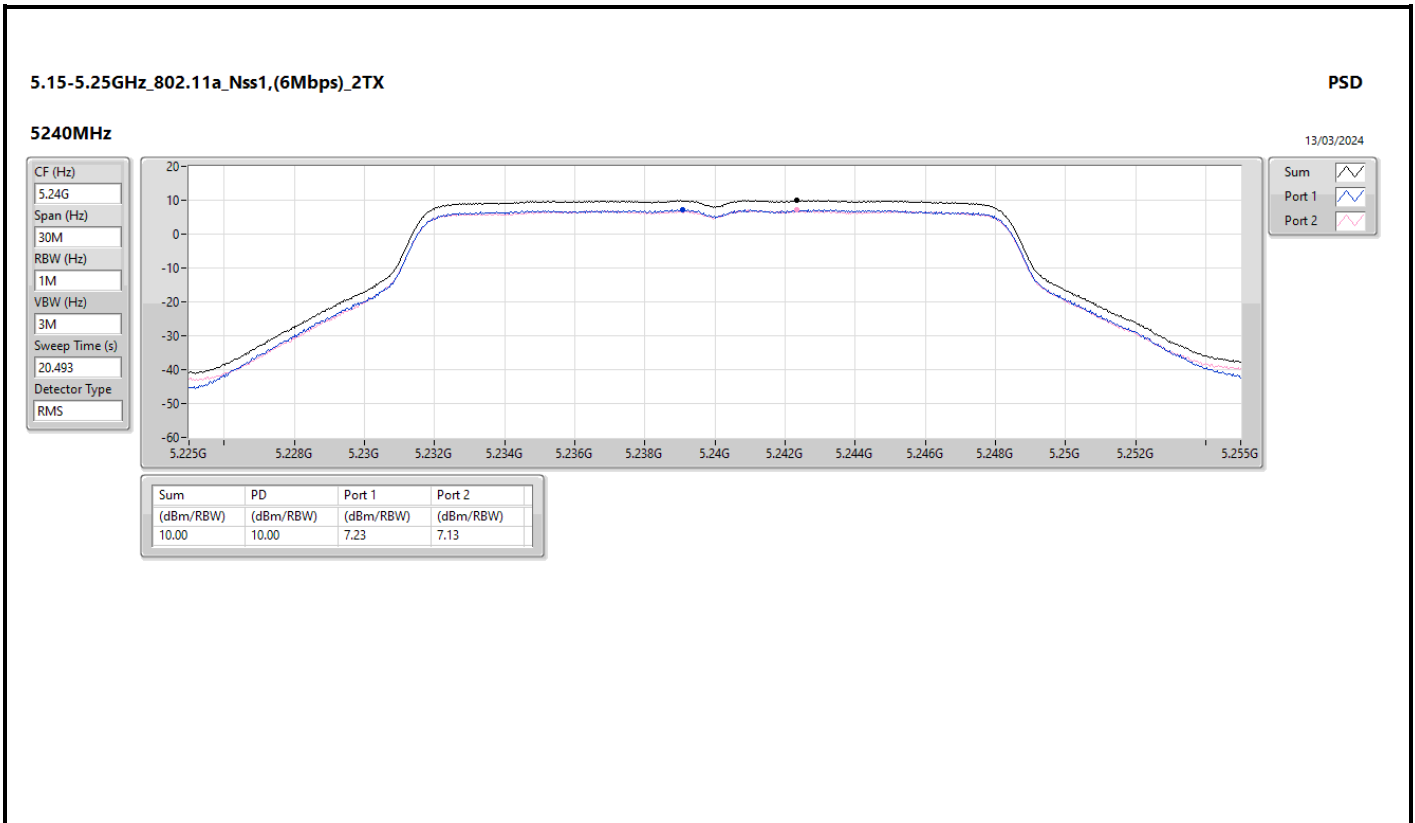

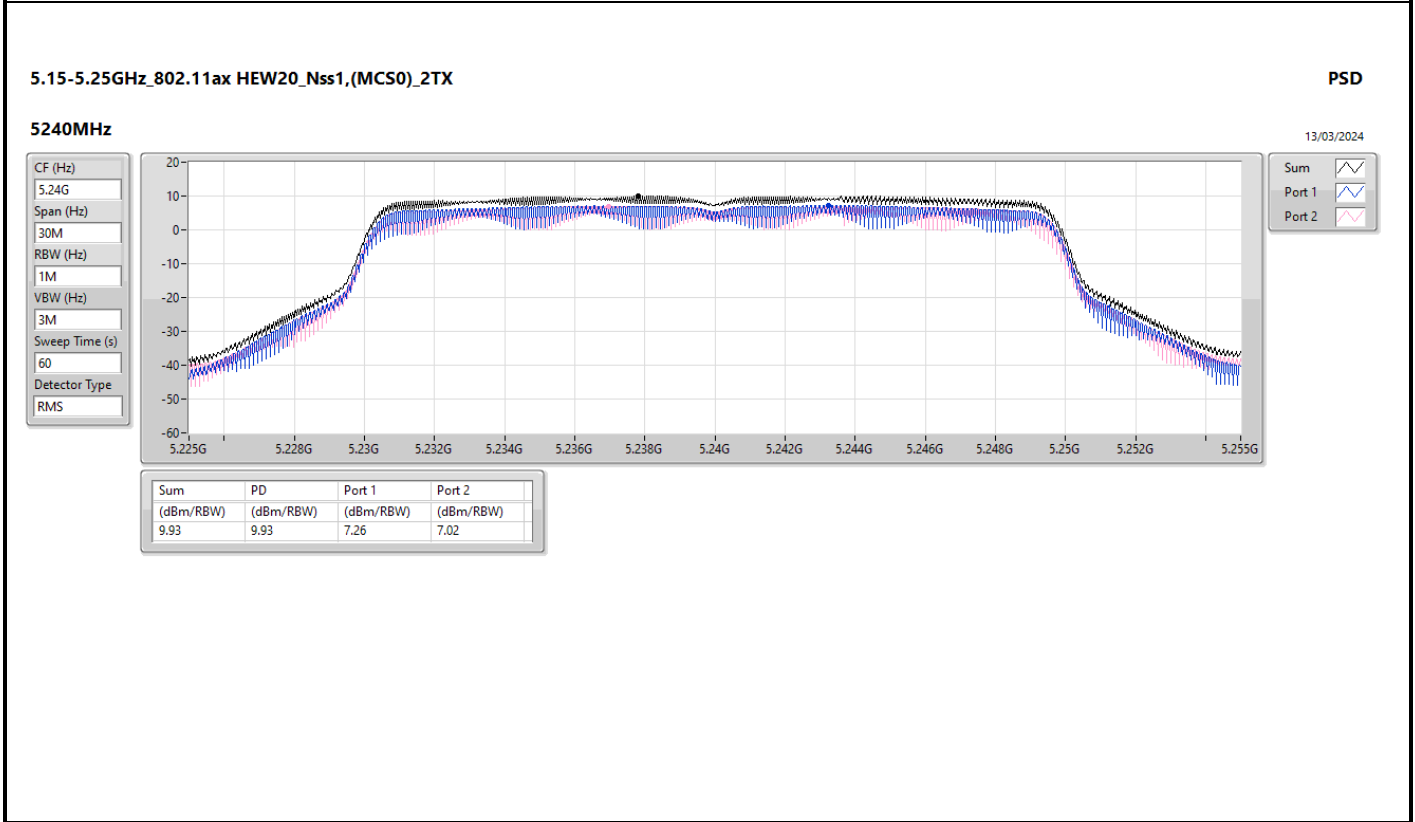
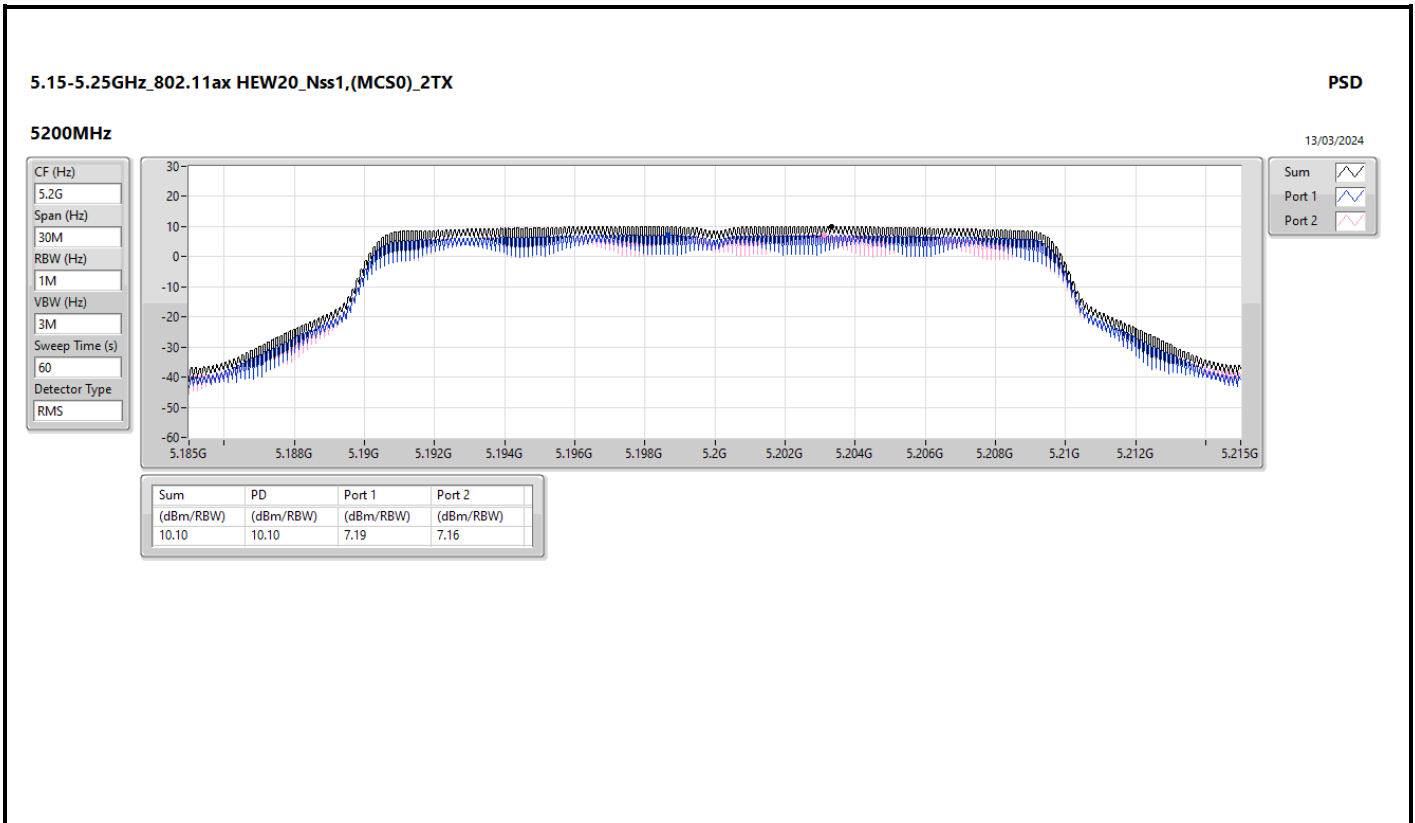

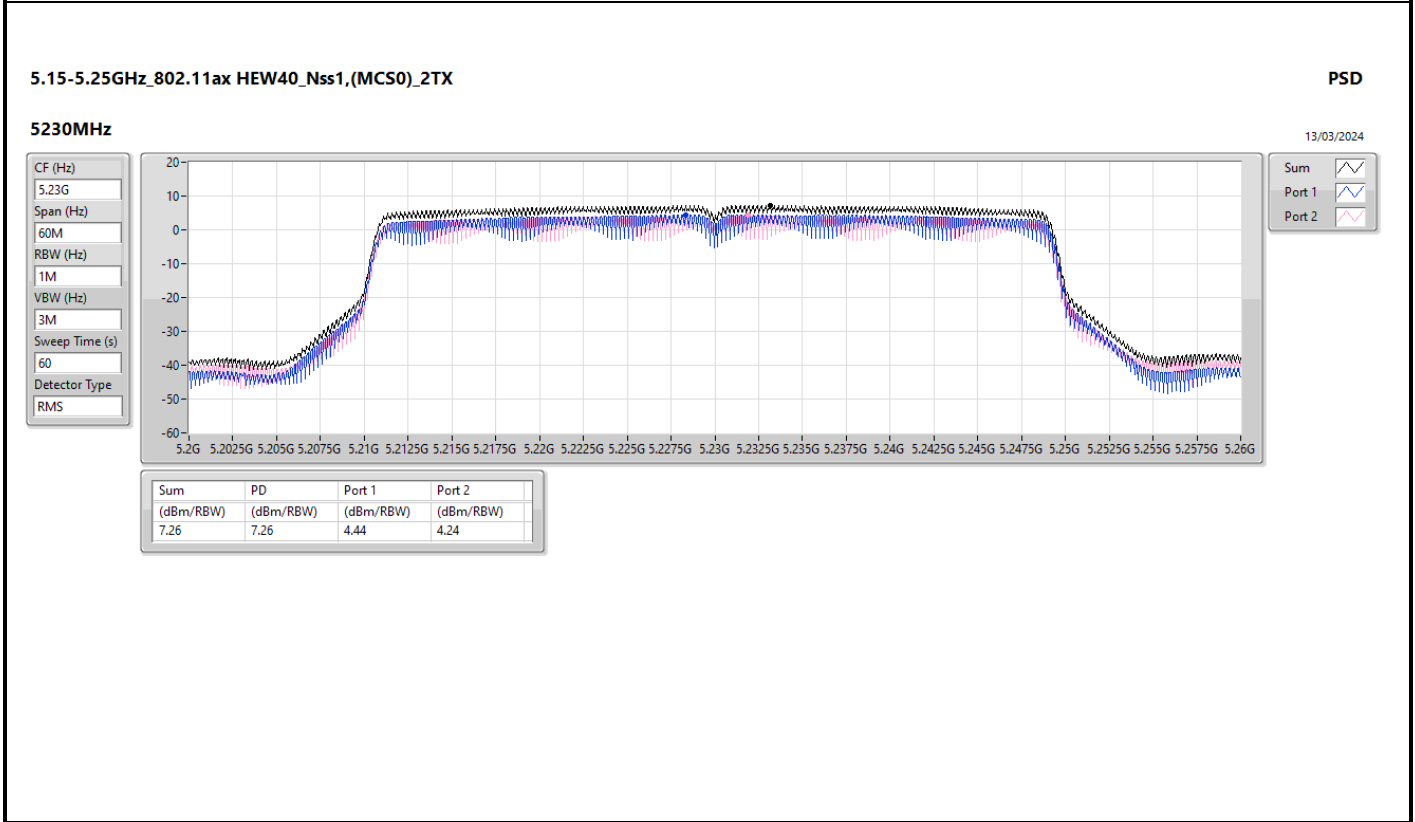
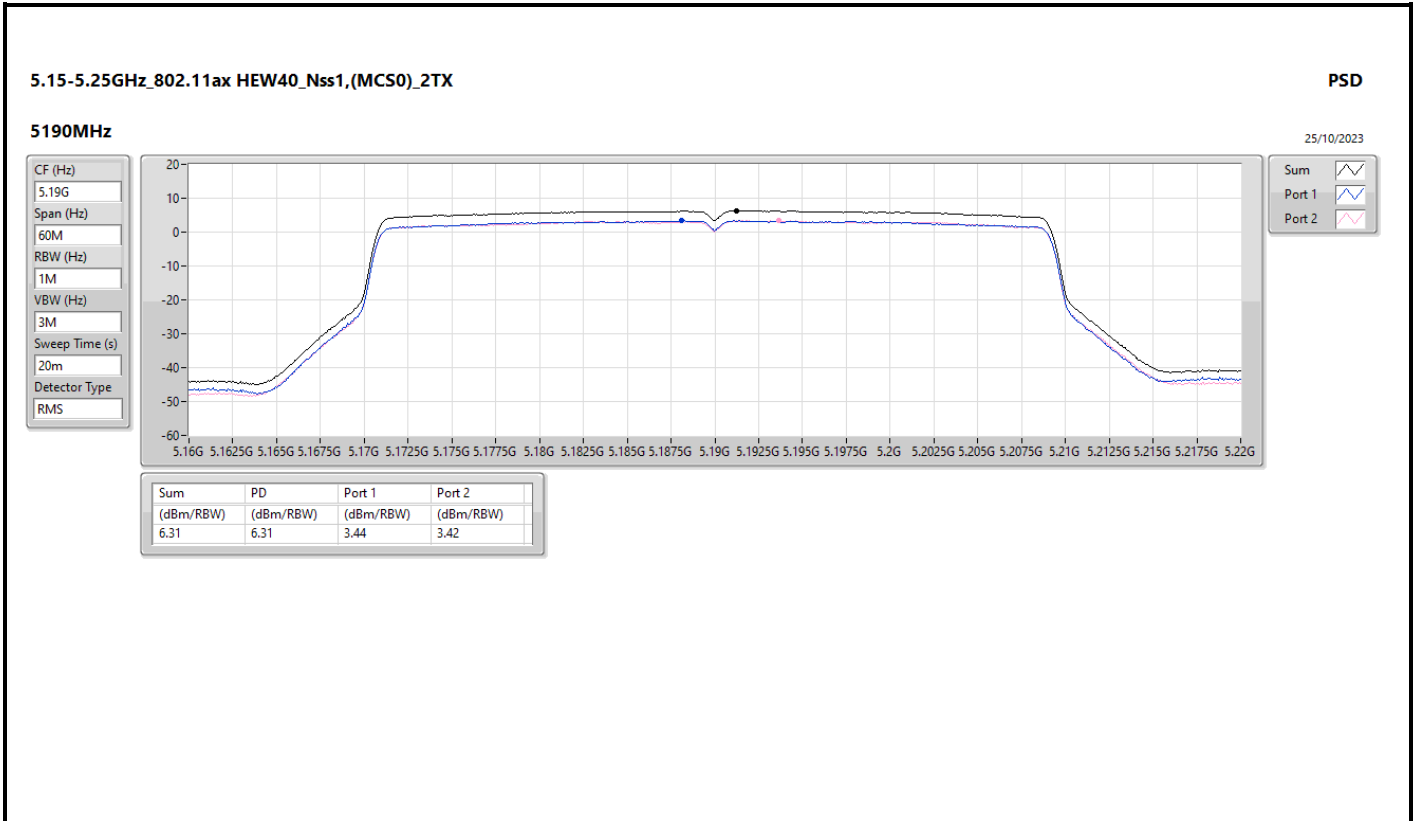

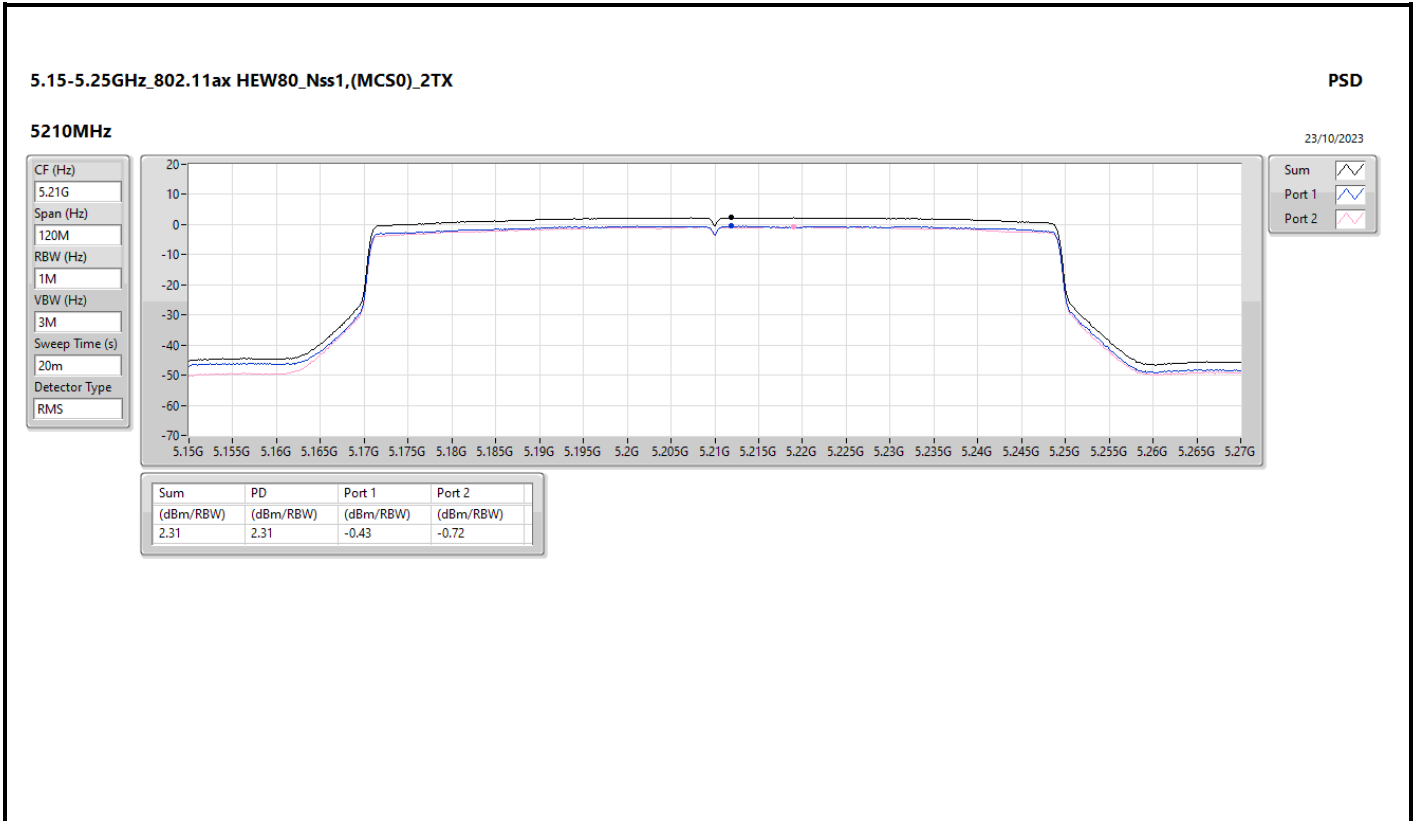



Summary

Mode	Result	Type	Freq (Hz)	Level (dBuV/m)	Limit (dBuV/m)	Margin (dB)	Condition
Mode 3	Pass	QP	41.64M	35.99	40.00	-4.01	Vertical

Mode 3

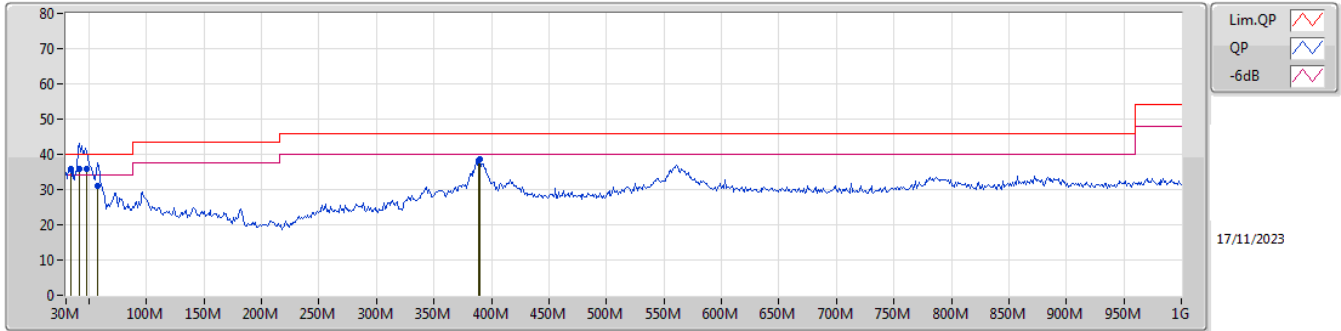

Type	Freq (Hz)	Level (dBuV/m)	Limit (dBuV/m)	Margin (dB)	Factor (dB/m)	Dist (m)	Condition	Azimuth (°)	Height (m)	Comment	Raw (dBuV/m)	AF (dB/m)	CL (dB)	PA (dB)
PK	33.88M	35.92	40.00	-4.08	-21.86	3	Vertical	124	1.00	-	57.78	21.76	0.70	44.32
QP	41.64M	35.99	40.00	-4.01	-26.19	3	Vertical	354	1.00	"Worst"	62.18	17.40	0.78	44.37
QP	48.43M	35.95	40.00	-4.05	-29.85	3	Vertical	360	1.00	-	65.80	13.88	0.84	44.57
QP	57.16M	31.09	40.00	-8.91	-31.91	3	Vertical	0	2.00	-	63.00	11.80	0.91	44.62
PK	388.9M	38.41	46.00	-7.59	-21.61	3	Vertical	360	1.50	-	60.02	20.35	2.19	44.15
PK	389.87M	38.62	46.00	-7.38	-21.56	3	Vertical	357	1.50	-	60.18	20.39	2.19	44.14

Mode 3

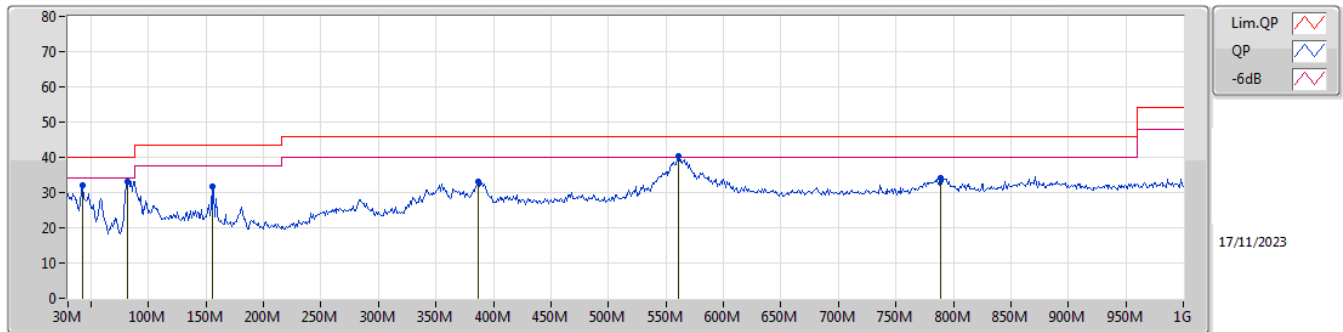

Type	Freq (Hz)	Level (dBuV/m)	Limit (dBuV/m)	Margin (dB)	Factor (dB/m)	Dist (m)	Condition	Azimuth (°)	Height (m)	Comment	Raw (dBuV/m)	AF (dB/m)	CL (dB)	PA (dB)
PK	42.61M	32.03	40.00	-7.97	-26.73	3	Horizontal	89	2.00	-	58.76	16.87	0.80	44.40
PK	81.41M	33.12	40.00	-6.88	-31.23	3	Horizontal	353	3.00	-	64.35	12.35	1.01	44.59
PK	155.13M	31.84	43.50	-11.66	-27.93	3	Horizontal	23	1.50	-	59.77	15.25	1.37	44.55
PK	386.96M	33.08	46.00	-12.92	-21.71	3	Horizontal	204	1.00	-	54.79	20.26	2.18	44.15
PK	560.59M	40.45	46.00	-5.55	-17.45	3	Horizontal	86	1.25	"Worst"	57.90	23.81	2.57	43.83
PK	788.54M	34.03	46.00	-11.97	-15.57	3	Horizontal	228	1.00	-	49.60	24.93	3.02	43.52



Summary

Mode	Result	Type	Freq (Hz)	Level (dBuV/m)	Limit (dBuV/m)	Margin (dB)	Dist (m)	Condition	Azimuth (°)	Height (m)	Comments
5.15-5.25GHz	-	-	-	-	-	-	-	-	-	-	-
802.11a_Nss1,(6Mbps)_1TX	Pass	AV	5.15G	53.95	54.00	-0.05	3	Horizontal	19	1.41	24

5.15-5.25GHz_802.11a_Nss1,(6Mbps)_2TX

5180MHz_TX

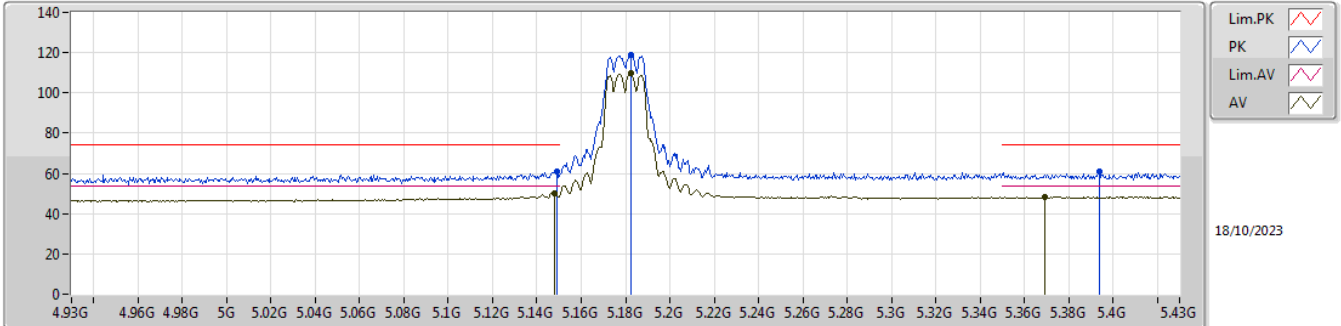

EUT Y_2TX
 SET 20
 20
 3.65

Type	Freq (Hz)	Level (dBuV/m)	Limit (dBuV/m)	Margin (dB)	Raw (dBuV)	Dist (m)	Condition	Azimuth (°)	Height (m)	Comment	AF (dB)	CL (dB)	PA (dB)
PK	5.149G	61.01	74.00	-12.99	53.65	3	Vertical	7	1.27	20	34.10	8.11	34.85
AV	5.148G	50.35	54.00	-3.65	43.00	3	Vertical	7	1.27	20	34.10	8.10	34.85
PK	5.1825G	118.78	Inf	-Inf	111.45	3	Vertical	7	1.27	20	34.03	8.16	34.86
AV	5.1825G	109.68	Inf	-Inf	102.35	3	Vertical	7	1.27	20	34.03	8.16	34.86
PK	5.394G	60.71	74.00	-13.29	52.67	3	Vertical	7	1.27	20	34.41	8.52	34.89
AV	5.369G	48.44	54.00	-5.56	40.38	3	Vertical	7	1.27	20	34.46	8.48	34.88

5.15-5.25GHz_802.11a_Nss1,(6Mbps)_2TX

5180MHz_TX

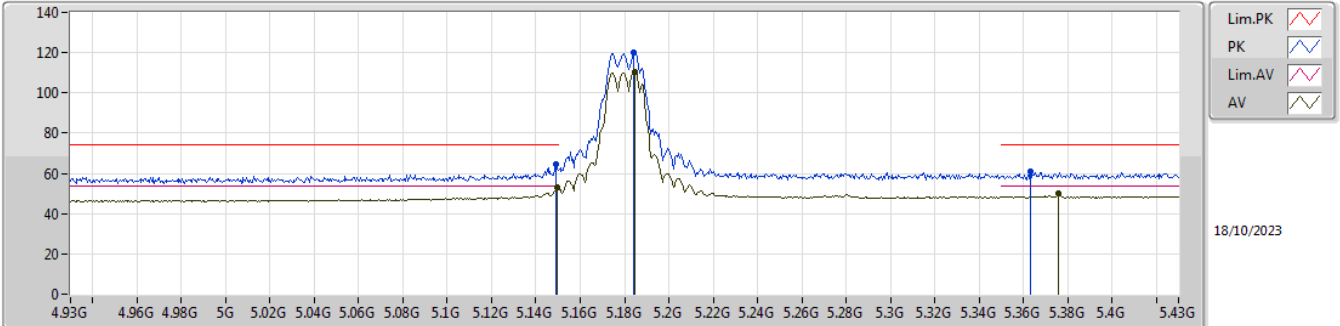

EUT_Y_2TX
 SET 20
 15\21\18\19.5\20\20.5\20
 5.37\ -3.39\4.26\2.78\1.40\ -0.82\1.18

Type	Freq (Hz)	Level (dBuV/m)	Limit (dBuV/m)	Margin (dB)	Raw (dBuV)	Dist (m)	Condition	Azimuth (°)	Height (m)	Comment	AF (dB)	CL (dB)	PA (dB)
PK	5.149G	64.37	74.00	-9.63	57.01	3	Horizontal	14	1.51	20	34.10	8.11	34.85
AV	5.1495G	52.82	54.00	-1.18	45.46	3	Horizontal	14	1.51	20	34.10	8.11	34.85
PK	5.184G	120.24	Inf	-Inf	112.91	3	Horizontal	14	1.51	20	34.03	8.16	34.86
AV	5.1845G	110.58	Inf	-Inf	103.25	3	Horizontal	14	1.51	20	34.03	8.16	34.86
PK	5.363G	60.85	74.00	-13.15	52.79	3	Horizontal	14	1.51	20	34.47	8.47	34.88
AV	5.376G	49.83	54.00	-4.17	41.77	3	Horizontal	14	1.51	20	34.45	8.49	34.88

5.15-5.25GHz_802.11a_Nss1,(6Mbps)_2TX

5180MHz_TX

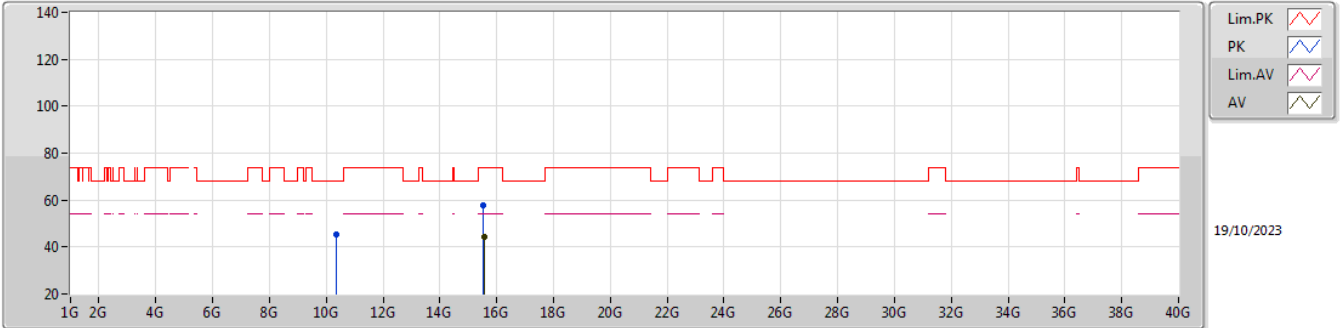

EUT_Y_2TX
SET 20

Type	Freq (Hz)	Level (dBuV/m)	Limit (dBuV/m)	Margin (dB)	Raw (dBuV)	Dist (m)	Condition	Azimuth (°)	Height (m)	Comment	AF (dB)	CL (dB)	PA (dB)
PK	10.35984G	45.21	68.20	-22.99	38.00	3	Vertical	30	1.82	20	37.86	12.37	43.02
PK	15.54128G	57.71	74.00	-16.29	41.75	3	Vertical	232	1.69	20	38.23	20.29	42.56
AV	15.55984G	44.31	54.00	-9.69	28.38	3	Vertical	232	1.69	20	38.16	20.31	42.54

5.15-5.25GHz_802.11a_Nss1,(6Mbps)_2TX

5180MHz_TX

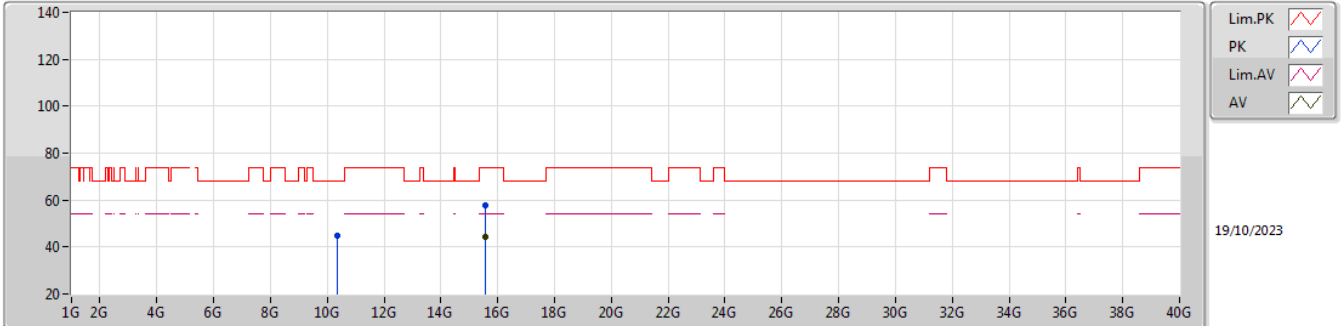

EUT_Y_2TX
SET 20

Type	Freq (Hz)	Level (dBuV/m)	Limit (dBuV/m)	Margin (dB)	Raw (dBuV)	Dist (m)	Condition	Azimuth (°)	Height (m)	Comment	AF (dB)	CL (dB)	PA (dB)
PK	10.3698G	44.98	68.20	-23.22	37.75	3	Horizontal	326	2.08	20	37.87	12.38	43.02
PK	15.551G	57.59	74.00	-16.41	41.64	3	Horizontal	115	1.37	20	38.20	20.30	42.55
AV	15.55856G	44.49	54.00	-9.51	28.55	3	Horizontal	115	1.37	20	38.17	20.31	42.54

5.15-5.25GHz_802.11a_Nss1,(6Mbps)_2TX

5200MHz_TX

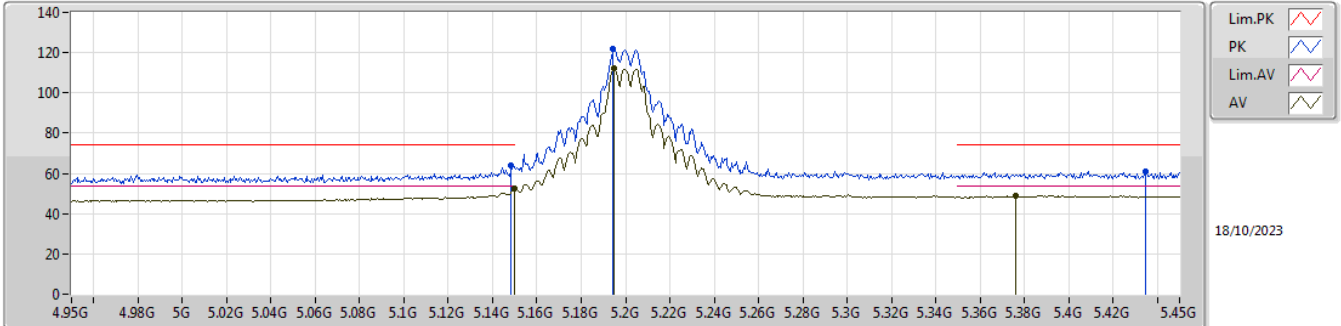

EUT_Y_2TX
 SET 23
 23.5\22.5\23
 -0.27\3.65\1.59

Type	Freq (Hz)	Level (dBuV/m)	Limit (dBuV/m)	Margin (dB)	Raw (dBuV)	Dist (m)	Condition	Azimuth (°)	Height (m)	Comment	AF (dB)	CL (dB)	PA (dB)
PK	5.1485G	64.19	74.00	-9.81	56.83	3	Vertical	12	1.41	23	34.10	8.11	34.85
AV	5.15G	52.41	54.00	-1.59	45.05	3	Vertical	12	1.41	23	34.10	8.11	34.85
PK	5.1945G	121.97	Inf	-Inf	114.64	3	Vertical	12	1.41	23	34.01	8.18	34.86
AV	5.195G	112.32	Inf	-Inf	104.99	3	Vertical	12	1.41	23	34.01	8.18	34.86
PK	5.4345G	60.77	74.00	-13.23	52.57	3	Vertical	12	1.41	23	34.54	8.55	34.89
AV	5.376G	49.07	54.00	-4.93	41.01	3	Vertical	12	1.41	23	34.45	8.49	34.88

5.15-5.25GHz_802.11a_Nss1,(6Mbps)_2TX

5200MHz_TX

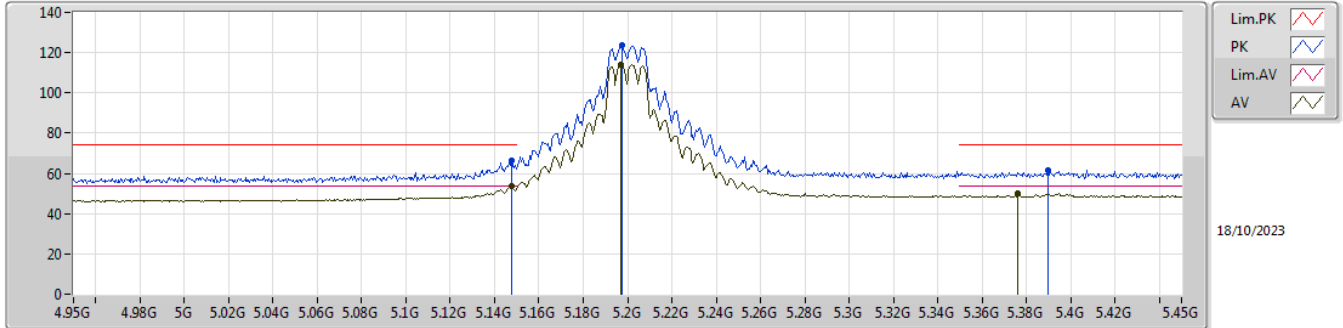

EUT Y_2TX
 SET 23.5
 15\21\24\22.5\23\23.5
 5.82\5.00\1.50\3.96\2.53\0.30

Type	Freq (Hz)	Level (dBuV/m)	Limit (dBuV/m)	Margin (dB)	Raw (dBuV)	Dist (m)	Condition	Azimuth (°)	Height (m)	Comment	AF (dB)	CL (dB)	PA (dB)
PK	5.1475G	66.12	74.00	-7.88	58.78	3	Horizontal	20	1.43	23.5	34.09	8.10	34.85
AV	5.1475G	53.70	54.00	-0.30	46.36	3	Horizontal	20	1.43	23.5	34.09	8.10	34.85
PK	5.1975G	123.86	Inf	-Inf	116.52	3	Horizontal	20	1.43	23.5	34.01	8.19	34.86
AV	5.197G	113.96	Inf	-Inf	106.62	3	Horizontal	20	1.43	23.5	34.01	8.19	34.86
PK	5.3895G	61.29	74.00	-12.71	53.24	3	Horizontal	20	1.43	23.5	34.42	8.51	34.88
AV	5.376G	50.05	54.00	-3.95	41.99	3	Horizontal	20	1.43	23.5	34.45	8.49	34.88

5.15-5.25GHz_802.11a_Nss1,(6Mbps)_2TX

5200MHz_TX

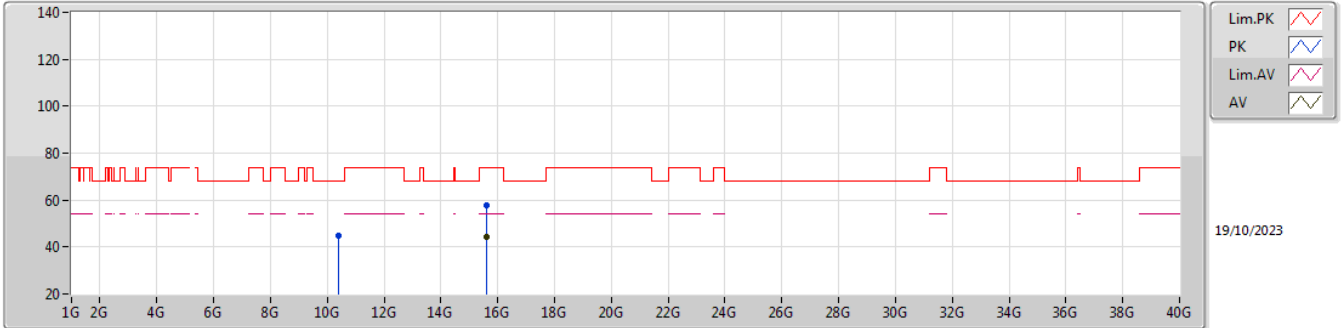

EUT_Y_2TX
SET 23

Type	Freq (Hz)	Level (dBuV/m)	Limit (dBuV/m)	Margin (dB)	Raw (dBuV)	Dist (m)	Condition	Azimuth (°)	Height (m)	Comment	AF (dB)	CL (dB)	PA (dB)
PK	10.3842G	44.72	68.20	-23.48	37.48	3	Vertical	25	1.80	23	37.88	12.39	43.03
PK	15.62G	57.99	74.00	-16.01	42.05	3	Vertical	39	1.77	23	38.02	20.39	42.47
AV	15.6026G	44.47	54.00	-9.53	28.59	3	Vertical	39	1.77	23	38.00	20.37	42.49

5.15-5.25GHz_802.11a_Nss1,(6Mbps)_2TX

5200MHz_TX

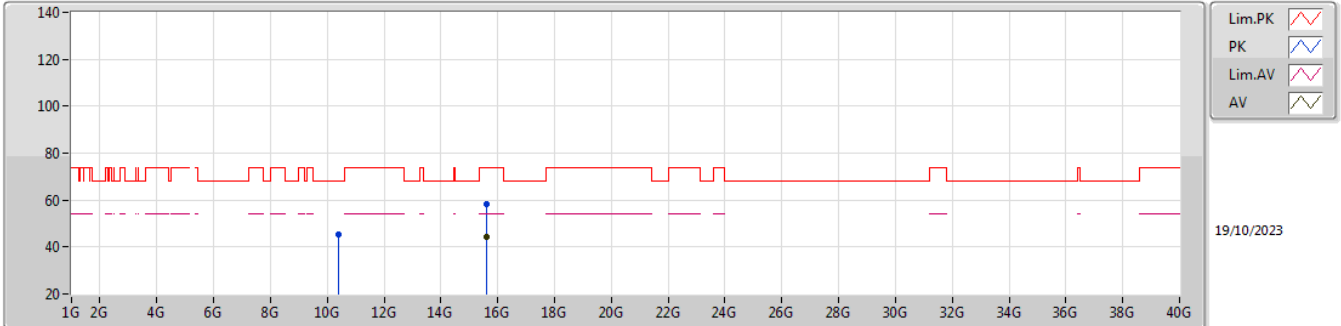

EUT_Y_2TX
SET 23

Type	Freq (Hz)	Level (dBuV/m)	Limit (dBuV/m)	Margin (dB)	Raw (dBuV)	Dist (m)	Condition	Azimuth (°)	Height (m)	Comment	AF (dB)	CL (dB)	PA (dB)
PK	10.40004G	45.31	68.20	-22.89	38.04	3	Horizontal	11	1.80	23	37.90	12.40	43.03
PK	15.59888G	58.06	74.00	-15.94	42.20	3	Horizontal	355	1.57	23	38.00	20.36	42.50
AV	15.58816G	44.53	54.00	-9.47	28.64	3	Horizontal	355	1.57	23	38.05	20.35	42.51

5.15-5.25GHz_802.11a_Nss1,(6Mbps)_2TX

5240MHz_TX

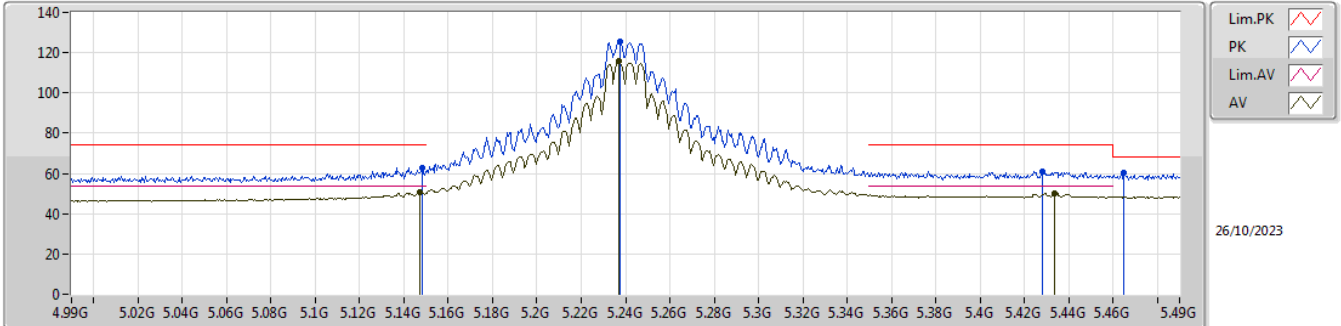

EUT_Y_2TX
SET 25

Type	Freq (Hz)	Level (dBuV/m)	Limit (dBuV/m)	Margin (dB)	Raw (dBuV)	Dist (m)	Condition	Azimuth (°)	Height (m)	Comment	AF (dB)	CL (dB)	PA (dB)
PK	5.1485G	63.05	74.00	-10.95	55.69	3	Vertical	10	1.50	-	34.10	8.11	34.85
AV	5.147G	50.75	54.00	-3.25	43.41	3	Vertical	10	1.50	-	34.09	8.10	34.85
PK	5.2375G	125.51	Inf	-Inf	118.12	3	Vertical	10	1.50	-	34.00	8.25	34.86
AV	5.237G	115.79	Inf	-Inf	108.40	3	Vertical	10	1.50	-	34.00	8.25	34.86
PK	5.428G	61.08	74.00	-12.92	52.91	3	Vertical	10	1.50	-	34.51	8.55	34.89
AV	5.4335G	50.15	54.00	-3.85	41.96	3	Vertical	10	1.50	-	34.53	8.55	34.89
PK	5.465G	60.21	68.20	-7.99	51.94	3	Vertical	10	1.50	-	34.60	8.57	34.90

5.15-5.25GHz_802.11a_Nss1,(6Mbps)_2TX

5240MHz_TX

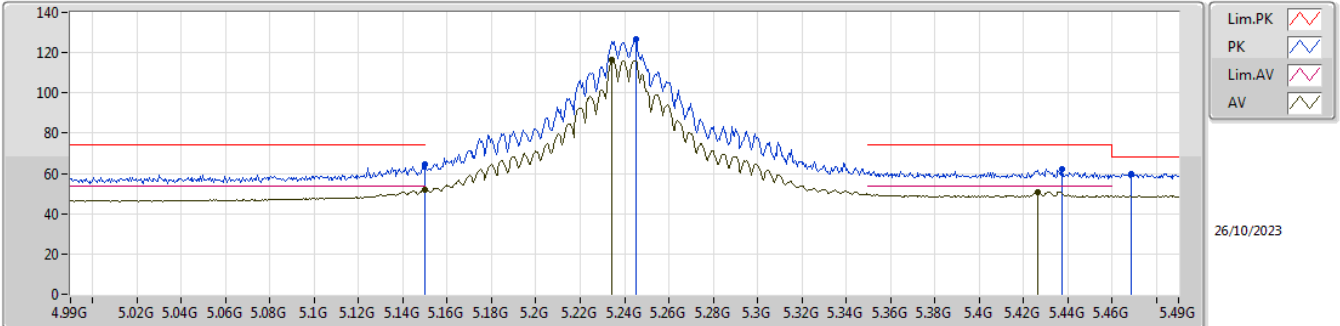

EUT_Y_2TX
 SET 25
 15\21\24\25
 5.77\5.25\4.31\2.31

Type	Freq (Hz)	Level (dBuV/m)	Limit (dBuV/m)	Margin (dB)	Raw (dBuV)	Dist (m)	Condition	Azimuth (°)	Height (m)	Comment	AF (dB)	CL (dB)	PA (dB)
PK	5.15G	64.61	74.00	-9.39	57.25	3	Horizontal	4	1.35	-	34.10	8.11	34.85
AV	5.15G	51.69	54.00	-2.31	44.33	3	Horizontal	4	1.35	-	34.10	8.11	34.85
PK	5.245G	126.46	Inf	-Inf	119.05	3	Horizontal	4	1.35	-	34.00	8.27	34.86
AV	5.2345G	116.18	Inf	-Inf	108.79	3	Horizontal	4	1.35	-	34.00	8.25	34.86
PK	5.4375G	62.26	74.00	-11.74	54.05	3	Horizontal	4	1.35	-	34.55	8.55	34.89
AV	5.4265G	50.85	54.00	-3.15	42.68	3	Horizontal	4	1.35	-	34.51	8.55	34.89
PK	5.4685G	60.01	68.20	-8.19	51.74	3	Horizontal	4	1.35	-	34.60	8.57	34.90

5.15-5.25GHz_802.11a_Nss1,(6Mbps)_2TX

5240MHz_TX

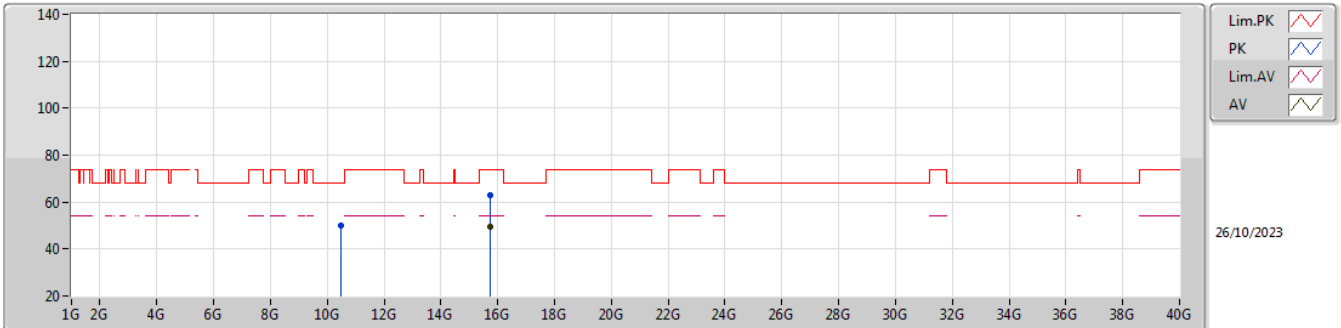

EUT_Y_2TX
SET 25

Type	Freq (Hz)	Level (dBuV/m)	Limit (dBuV/m)	Margin (dB)	Raw (dBuV)	Dist (m)	Condition	Azimuth (°)	Height (m)	Comment	AF (dB)	CL (dB)	PA (dB)
PK	10.47996G	50.03	68.20	-18.17	42.63	3	Vertical	335	1.61	-	37.98	12.46	43.04
PK	15.7206G	62.97	74.00	-11.03	46.81	3	Vertical	318	1.52	-	37.98	20.53	42.35
AV	15.72152G	49.68	54.00	-4.32	33.53	3	Vertical	318	1.52	-	37.97	20.53	42.35

5.15-5.25GHz_802.11a_Nss1,(6Mbps)_2TX

5240MHz_TX

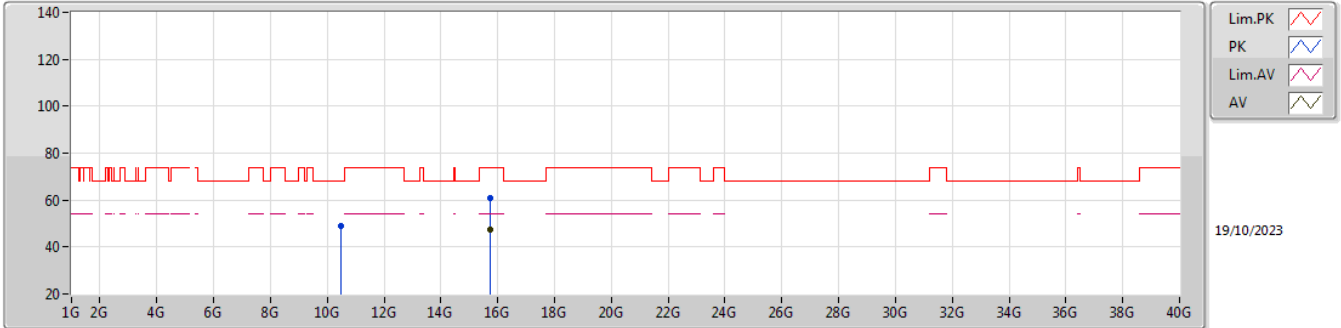

EUT_Y_2TX
SET 25

Type	Freq (Hz)	Level (dBuV/m)	Limit (dBuV/m)	Margin (dB)	Raw (dBuV)	Dist (m)	Condition	Azimuth (°)	Height (m)	Comment	AF (dB)	CL (dB)	PA (dB)
PK	10.48012G	48.88	68.20	-19.32	41.48	3	Horizontal	12	1.77	-	37.98	12.46	43.04
PK	15.7234G	60.95	74.00	-13.05	44.81	3	Horizontal	65	1.80	-	37.96	20.53	42.35
AV	15.72216G	47.31	54.00	-6.69	31.16	3	Horizontal	65	1.80	-	37.97	20.53	42.35

5.15-5.25GHz_802.11ax_HEW20_Nss1,(MCS0)_2TX

5180MHz_TX

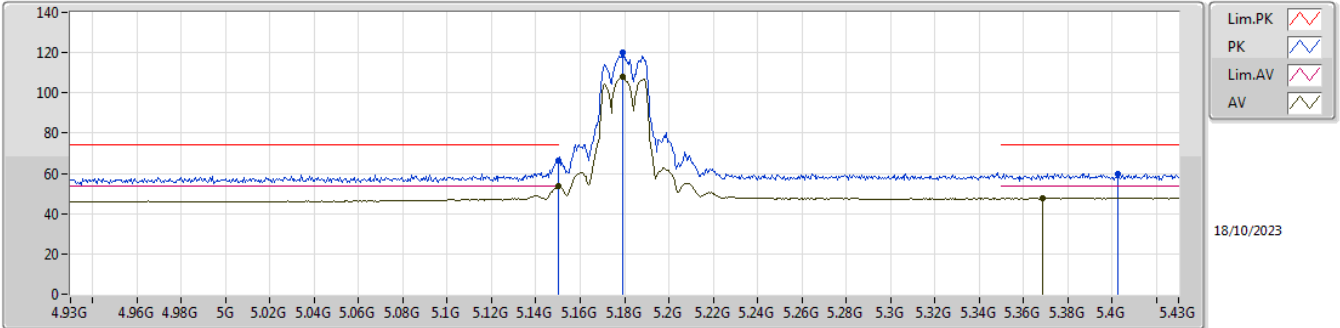

EUT_Y_2TX
 SET 20.5
 21\17\19\20\20.5
 -2.28\6.30\5.10\2.99\0.42

Type	Freq (Hz)	Level (dBuV/m)	Limit (dBuV/m)	Margin (dB)	Raw (dBuV)	Dist (m)	Condition	Azimuth (°)	Height (m)	Comment	AF (dB)	CL (dB)	PA (dB)
PK	5.15G	66.51	74.00	-7.49	59.15	3	Vertical	348	1.60	20.5	34.10	8.11	34.85
AV	5.15G	53.58	54.00	-0.42	46.22	3	Vertical	348	1.60	20.5	34.10	8.11	34.85
PK	5.179G	120.04	Inf	-Inf	112.70	3	Vertical	348	1.60	20.5	34.04	8.16	34.86
AV	5.179G	107.89	Inf	-Inf	100.55	3	Vertical	348	1.60	20.5	34.04	8.16	34.86
PK	5.4025G	59.91	74.00	-14.09	51.86	3	Vertical	348	1.60	20.5	34.41	8.53	34.89
AV	5.3685G	47.88	54.00	-6.12	39.82	3	Vertical	348	1.60	20.5	34.46	8.48	34.88

5.15-5.25GHz_802.11ax_HEW20_Nss1,(MCS0)_2TX

5180MHz_TX

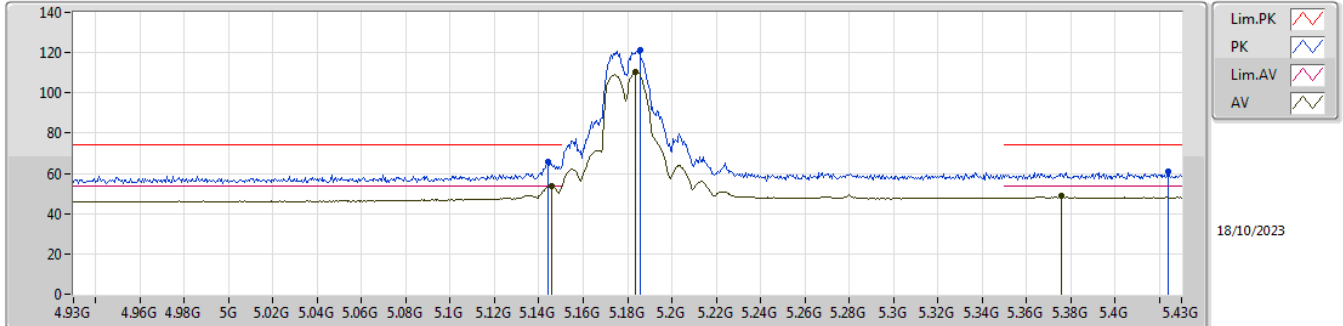

EUT Y_2TX
SET 21
15\21
5.94\0.40

Type	Freq (Hz)	Level (dBuV/m)	Limit (dBuV/m)	Margin (dB)	Raw (dBuV)	Dist (m)	Condition	Azimuth (°)	Height (m)	Comment	AF (dB)	CL (dB)	PA (dB)
PK	5.144G	65.96	74.00	-8.04	58.62	3	Horizontal	16	1.58	21	34.09	8.10	34.85
AV	5.146G	53.60	54.00	-0.40	46.26	3	Horizontal	16	1.58	21	34.09	8.10	34.85
PK	5.1855G	121.57	Inf	-Inf	114.23	3	Horizontal	16	1.58	21	34.03	8.17	34.86
AV	5.1835G	110.15	Inf	-Inf	102.82	3	Horizontal	16	1.58	21	34.03	8.16	34.86
PK	5.424G	60.75	74.00	-13.25	52.59	3	Horizontal	16	1.58	21	34.50	8.55	34.89
AV	5.376G	49.17	54.00	-4.83	41.11	3	Horizontal	16	1.58	21	34.45	8.49	34.88

5.15-5.25GHz_802.11ax_HEW20_Nss1,(MCS0)_2TX

5180MHz_TX

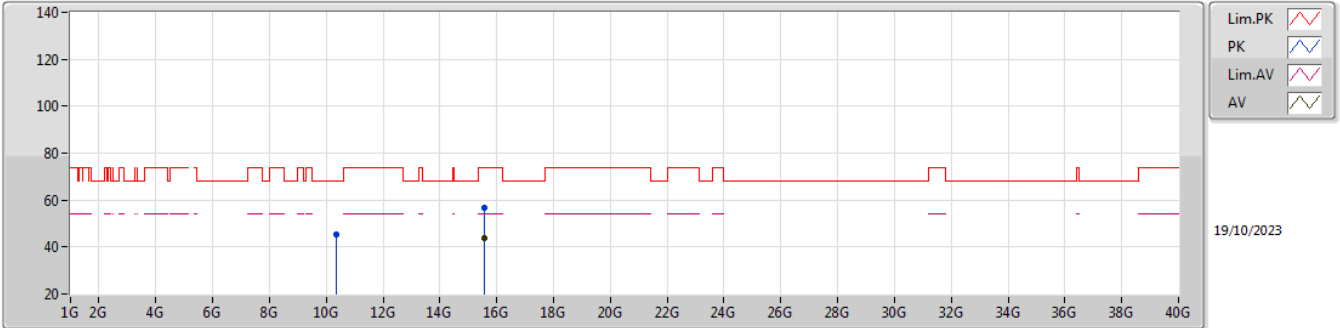

EUT_Y_2TX
SET 20.5

Type	Freq (Hz)	Level (dBuV/m)	Limit (dBuV/m)	Margin (dB)	Raw (dBuV)	Dist (m)	Condition	Azimuth (°)	Height (m)	Comment	AF (dB)	CL (dB)	PA (dB)
PK	10.36324G	45.21	68.20	-22.99	38.00	3	Vertical	28	2.53	20.5	37.86	12.37	43.02
PK	15.54724G	56.93	74.00	-17.07	40.98	3	Vertical	135	1.80	20.5	38.21	20.30	42.56
AV	15.56G	43.91	54.00	-10.09	27.98	3	Vertical	135	1.80	20.5	38.16	20.31	42.54

5.15-5.25GHz_802.11ax_HEW20_Nss1,(MCS0)_2TX

5180MHz_TX

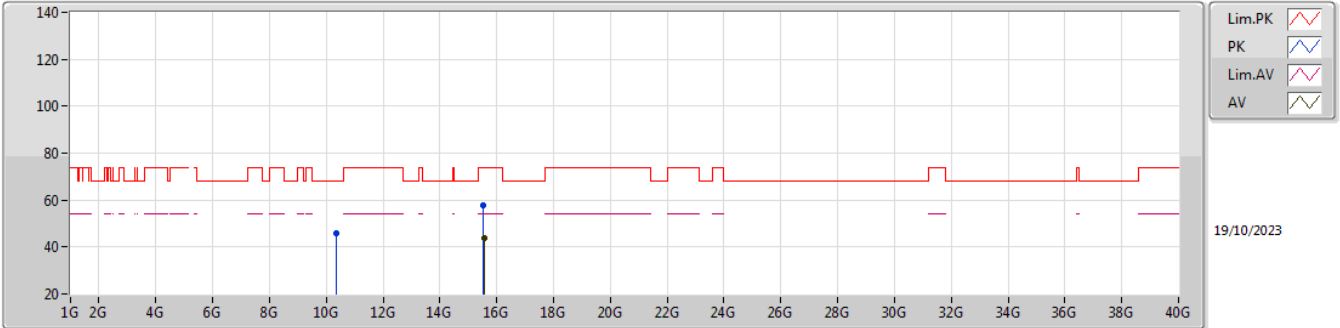

EUT_Y_2TX
SET 20.5

Type	Freq (Hz)	Level (dBuV/m)	Limit (dBuV/m)	Margin (dB)	Raw (dBuV)	Dist (m)	Condition	Azimuth (°)	Height (m)	Comment	AF (dB)	CL (dB)	PA (dB)
PK	10.36024G	45.62	68.20	-22.58	38.41	3	Horizontal	325	1.93	20.5	37.86	12.37	43.02
PK	15.54448G	57.63	74.00	-16.37	41.68	3	Horizontal	177	1.16	20.5	38.22	20.29	42.56
AV	15.55432G	43.85	54.00	-10.15	27.91	3	Horizontal	177	1.16	20.5	38.18	20.31	42.55

5.15-5.25GHz 802.11ax HEW20_Nss1,(MCS0)_2TX

5200MHz_TX

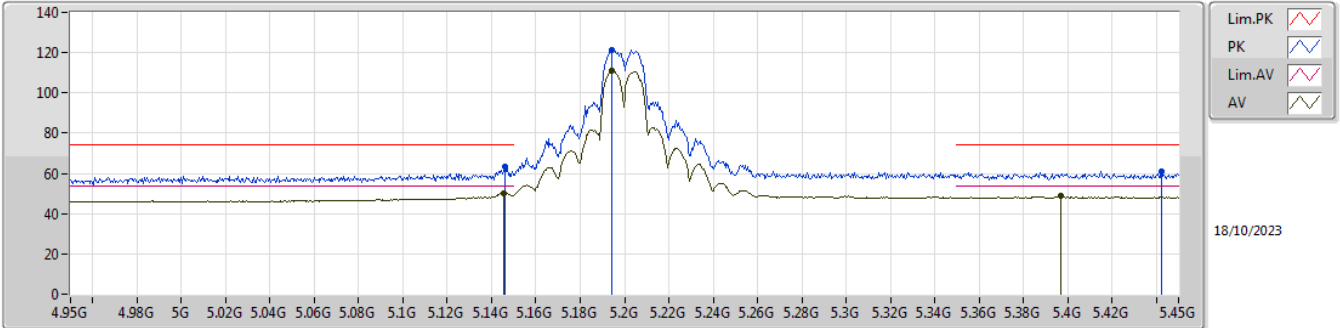

EUT Y_2TX
 SET 23
 23
 3.76

Type	Freq (Hz)	Level (dBuV/m)	Limit (dBuV/m)	Margin (dB)	Raw (dBuV)	Dist (m)	Condition	Azimuth (°)	Height (m)	Comment	AF (dB)	CL (dB)	PA (dB)
PK	5.146G	63.34	74.00	-10.66	56.00	3	Vertical	13	1.40	23	34.09	8.10	34.85
AV	5.1455G	50.24	54.00	-3.76	42.90	3	Vertical	13	1.40	23	34.09	8.10	34.85
PK	5.194G	121.48	Inf	-Inf	114.15	3	Vertical	13	1.40	23	34.01	8.18	34.86
AV	5.194G	111.07	Inf	-Inf	103.74	3	Vertical	13	1.40	23	34.01	8.18	34.86
PK	5.4425G	61.24	74.00	-12.76	53.00	3	Vertical	13	1.40	23	34.57	8.56	34.89
AV	5.397G	48.58	54.00	-5.42	40.54	3	Vertical	13	1.40	23	34.41	8.52	34.89

5.15-5.25GHz_802.11ax_HEW20_Nss1,(MCS0)_2TX

5200MHz_TX

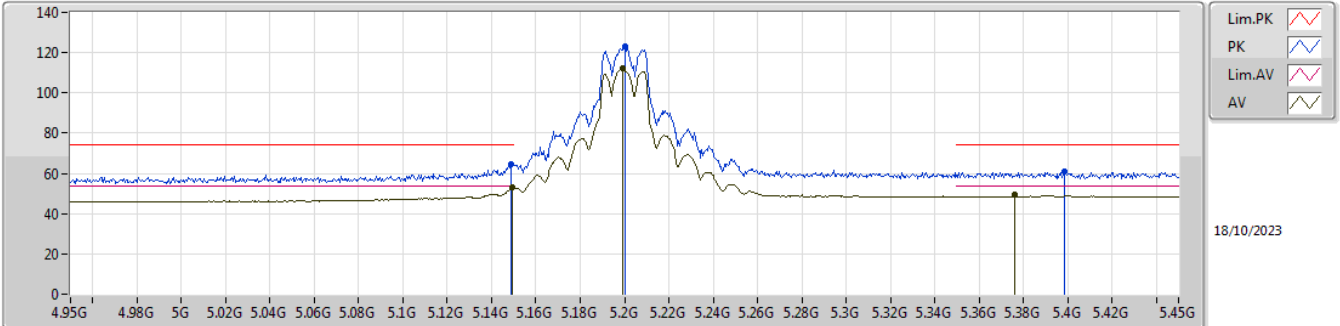

EUT_Y_2TX
 SET 23
 15\21\24\22.5\23\23.5\23
 6.27\5.36\4.30\3.25\1.21\1.00\1.16

Type	Freq (Hz)	Level (dBuV/m)	Limit (dBuV/m)	Margin (dB)	Raw (dBuV)	Dist (m)	Condition	Azimuth (°)	Height (m)	Comment	AF (dB)	CL (dB)	PA (dB)
PK	5.149G	64.38	74.00	-9.62	57.02	3	Horizontal	9	1.50	23	34.10	8.11	34.85
AV	5.1495G	52.84	54.00	-1.16	45.48	3	Horizontal	9	1.50	23	34.10	8.11	34.85
PK	5.2G	122.98	Inf	-Inf	115.65	3	Horizontal	9	1.50	23	34.00	8.19	34.86
AV	5.199G	112.01	Inf	-Inf	104.68	3	Horizontal	9	1.50	23	34.00	8.19	34.86
PK	5.3985G	61.13	74.00	-12.87	53.09	3	Horizontal	9	1.50	23	34.40	8.53	34.89
AV	5.376G	49.42	54.00	-4.58	41.36	3	Horizontal	9	1.50	23	34.45	8.49	34.88

5.15-5.25GHz_802.11ax_HEW20_Nss1,(MCS0)_2TX

5200MHz_TX

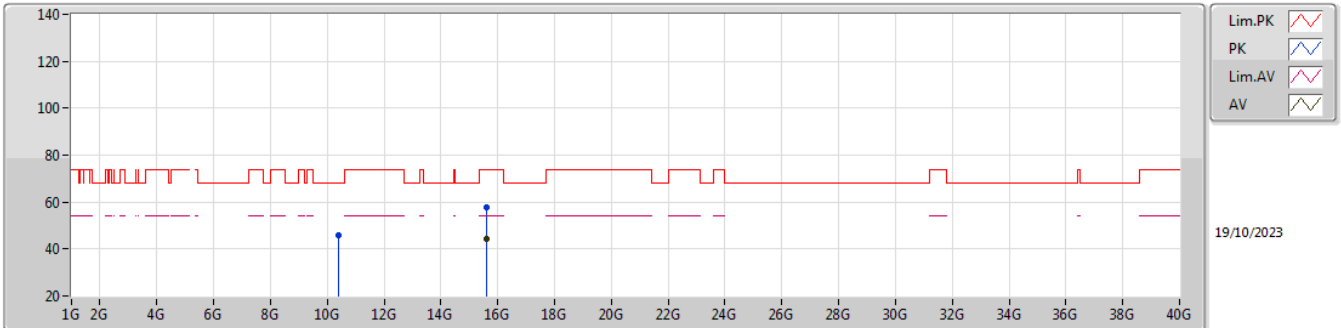

EUT_Y_2TX
SET 23

Type	Freq (Hz)	Level (dBuV/m)	Limit (dBuV/m)	Margin (dB)	Raw (dBuV)	Dist (m)	Condition	Azimuth (°)	Height (m)	Comment	AF (dB)	CL (dB)	PA (dB)
PK	10.39988G	45.78	68.20	-22.42	38.51	3	Vertical	24	1.80	23	37.90	12.40	43.03
PK	15.60108G	57.79	74.00	-16.21	41.91	3	Vertical	340	1.80	23	38.00	20.37	42.49
AV	15.593G	44.09	54.00	-9.91	28.20	3	Vertical	340	1.80	23	38.03	20.36	42.50

5.15-5.25GHz_802.11ax_HEW20_Nss1,(MCS0)_2TX

5200MHz_TX

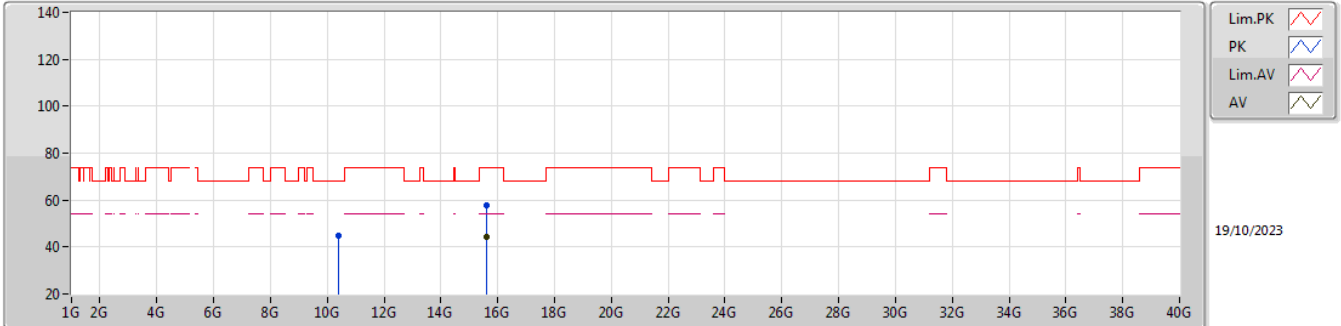

EUT Y_2TX
SET 23

Type	Freq (Hz)	Level (dBuV/m)	Limit (dBuV/m)	Margin (dB)	Raw (dBuV)	Dist (m)	Condition	Azimuth (°)	Height (m)	Comment	AF (dB)	CL (dB)	PA (dB)
PK	10.39968G	44.57	68.20	-23.63	37.30	3	Horizontal	14	1.80	23	37.90	12.40	43.03
PK	15.6168G	57.89	74.00	-16.11	41.95	3	Horizontal	279	1.80	23	38.02	20.39	42.47
AV	15.61672G	44.14	54.00	-9.86	28.20	3	Horizontal	279	1.80	23	38.02	20.39	42.47

5.15-5.25GHz_802.11ax_HEW20_Nss1,(MCS0)_2TX

5240MHz_TX

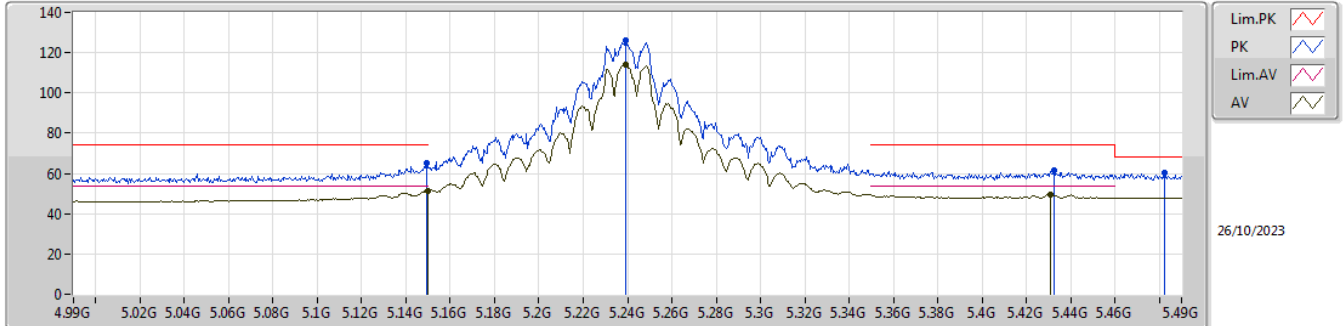

EUT Y_2TX
SET 25

Type	Freq (Hz)	Level (dBuV/m)	Limit (dBuV/m)	Margin (dB)	Raw (dBuV)	Dist (m)	Condition	Azimuth (°)	Height (m)	Comment	AF (dB)	CL (dB)	PA (dB)
PK	5.1495G	65.02	74.00	-8.98	57.66	3	Vertical	12	1.48	-	34.10	8.11	34.85
AV	5.15G	51.49	54.00	-2.51	44.13	3	Vertical	12	1.48	-	34.10	8.11	34.85
PK	5.239G	126.11	Inf	-Inf	118.71	3	Vertical	12	1.48	-	34.00	8.26	34.86
AV	5.239G	113.96	Inf	-Inf	106.56	3	Vertical	12	1.48	-	34.00	8.26	34.86
PK	5.4325G	61.39	74.00	-12.61	53.20	3	Vertical	12	1.48	-	34.53	8.55	34.89
AV	5.431G	49.61	54.00	-4.39	41.43	3	Vertical	12	1.48	-	34.52	8.55	34.89
PK	5.4825G	60.29	68.20	-7.91	52.01	3	Vertical	12	1.48	-	34.60	8.58	34.90

5.15-5.25GHz_802.11ax_HEW20_Nss1,(MCS0)_2TX

5240MHz_TX

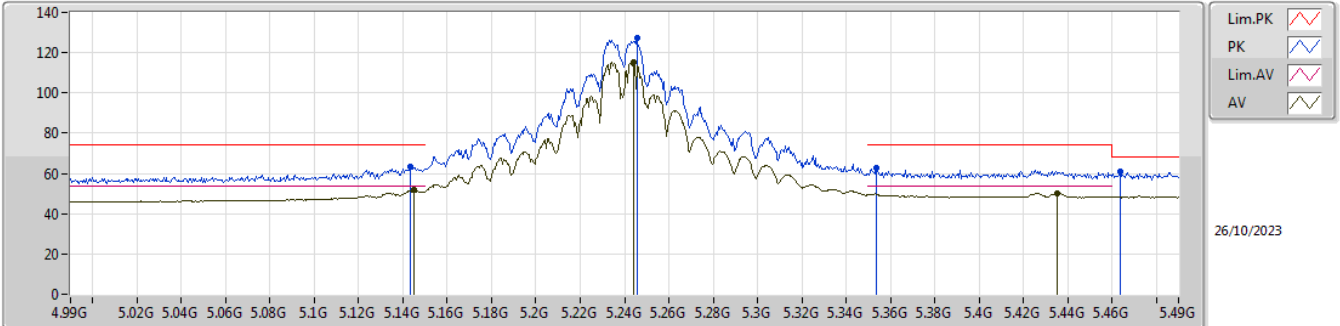

EUT_Y_2TX
 SET 25
 15\21\24\25
 6.09\5.37\4.86\2.39

Type	Freq (Hz)	Level (dBuV/m)	Limit (dBuV/m)	Margin (dB)	Raw (dBuV)	Dist (m)	Condition	Azimuth (°)	Height (m)	Comment	AF (dB)	CL (dB)	PA (dB)
PK	5.1435G	63.08	74.00	-10.92	55.74	3	Horizontal	6	1.43	-	34.09	8.10	34.85
AV	5.145G	51.61	54.00	-2.39	44.27	3	Horizontal	6	1.43	-	34.09	8.10	34.85
PK	5.2455G	127.21	Inf	-Inf	119.80	3	Horizontal	6	1.43	-	34.00	8.27	34.86
AV	5.244G	115.50	Inf	-Inf	108.10	3	Horizontal	6	1.43	-	34.00	8.26	34.86
PK	5.3535G	62.85	74.00	-11.15	54.79	3	Horizontal	6	1.43	-	34.49	8.45	34.88
PK	5.4635G	60.97	68.20	-7.23	52.69	3	Horizontal	6	1.43	-	34.60	8.57	34.89
AV	5.4355G	50.20	54.00	-3.80	42.00	3	Horizontal	6	1.43	-	34.54	8.55	34.89

5.15-5.25GHz_802.11ax_HEW20_Nss1,(MCS0)_2TX

5240MHz_TX

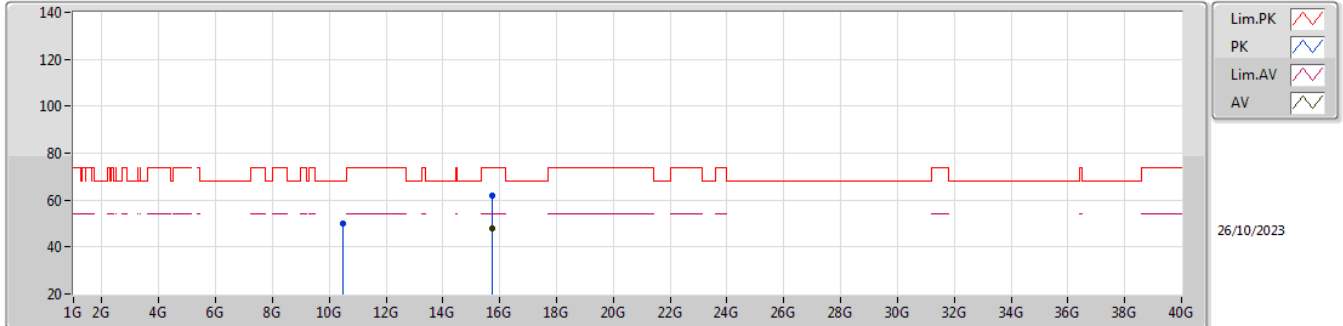

EUT_Y_2TX
SET 25

Type	Freq (Hz)	Level (dBuV/m)	Limit (dBuV/m)	Margin (dB)	Raw (dBuV)	Dist (m)	Condition	Azimuth (°)	Height (m)	Comment	AF (dB)	CL (dB)	PA (dB)
PK	10.47996G	50.10	68.20	-18.10	42.70	3	Vertical	334	1.60	-	37.98	12.46	43.04
PK	15.73184G	61.67	74.00	-12.33	45.56	3	Vertical	318	1.48	-	37.91	20.54	42.34
AV	15.72268G	48.05	54.00	-5.95	31.91	3	Vertical	318	1.48	-	37.96	20.53	42.35

5.15-5.25GHz_802.11ax_HEW20_Nss1,(MCS0)_2TX

5240MHz_TX

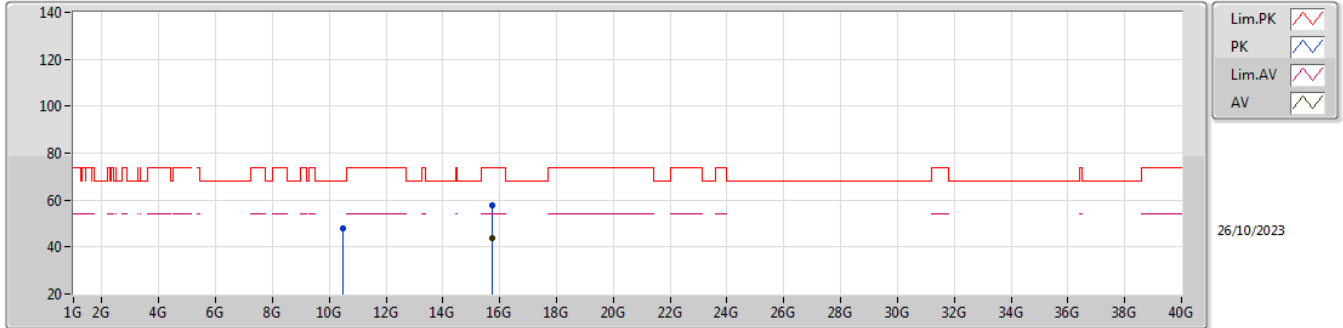

EUT_Y_2TX
SET 25

Type	Freq (Hz)	Level (dBuV/m)	Limit (dBuV/m)	Margin (dB)	Raw (dBuV)	Dist (m)	Condition	Azimuth (°)	Height (m)	Comment	AF (dB)	CL (dB)	PA (dB)
PK	10.47992G	47.74	68.20	-20.46	40.34	3	Horizontal	13	1.78	-	37.98	12.46	43.04
PK	15.71988G	57.57	74.00	-16.43	41.41	3	Horizontal	343	1.80	-	37.98	20.53	42.35
AV	15.72016G	43.92	54.00	-10.08	27.76	3	Horizontal	343	1.80	-	37.98	20.53	42.35

5.15-5.25GHz_802.11ax_HEW40_Nss1,(MCS0)_2TX

5190MHz_TX

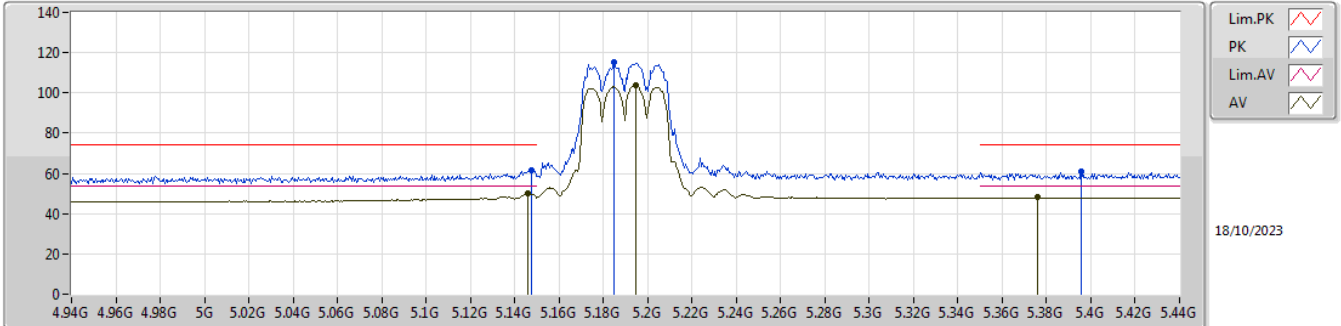

EUT Y_2TX
 SET 18
 18
 4.07

Type	Freq (Hz)	Level (dBuV/m)	Limit (dBuV/m)	Margin (dB)	Raw (dBuV)	Dist (m)	Condition	Azimuth (°)	Height (m)	Comment	AF (dB)	CL (dB)	PA (dB)
PK	5.1475G	61.28	74.00	-12.72	53.94	3	Vertical	14	1.56	18	34.09	8.10	34.85
AV	5.146G	49.93	54.00	-4.07	42.59	3	Vertical	14	1.56	18	34.09	8.10	34.85
PK	5.185G	115.25	Inf	-Inf	107.91	3	Vertical	14	1.56	18	34.03	8.17	34.86
AV	5.1945G	104.08	Inf	-Inf	96.75	3	Vertical	14	1.56	18	34.01	8.18	34.86
PK	5.3955G	60.67	74.00	-13.33	52.63	3	Vertical	14	1.56	18	34.41	8.52	34.89
AV	5.376G	48.05	54.00	-5.95	39.99	3	Vertical	14	1.56	18	34.45	8.49	34.88

5.15-5.25GHz_802.11ax_HEW40_Nss1,(MCS0)_2TX

5190MHz_TX

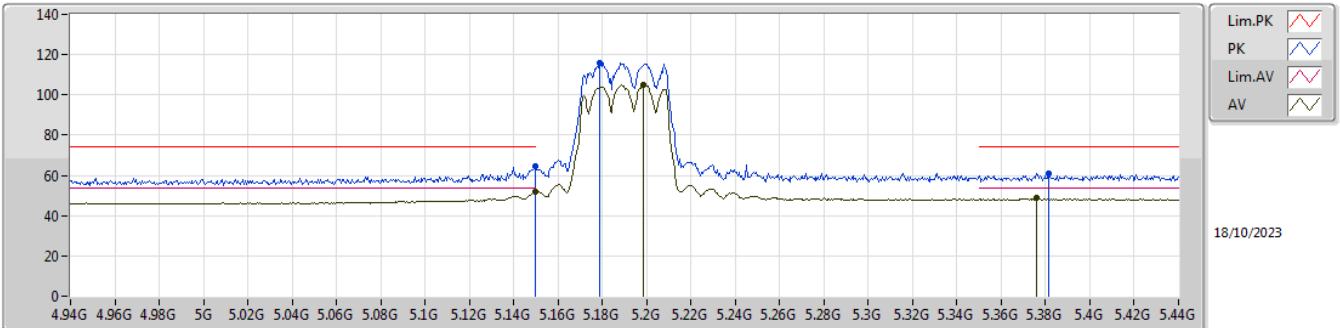

EUT_Y_2TX
 SET 18
 15\21\18\19.5\19\18.5\18
 5.22\13.26\1.92\4.45\1.40\0.10\1.94

Type	Freq (Hz)	Level (dBuV/m)	Limit (dBuV/m)	Margin (dB)	Raw (dBuV)	Dist (m)	Condition	Azimuth (°)	Height (m)	Comment	AF (dB)	CL (dB)	PA (dB)
PK	5.1495G	64.63	74.00	-9.37	57.27	3	Horizontal	12	1.35	18	34.10	8.11	34.85
AV	5.15G	52.06	54.00	-1.94	44.70	3	Horizontal	12	1.35	18	34.10	8.11	34.85
PK	5.179G	116.14	Inf	-Inf	108.80	3	Horizontal	12	1.35	18	34.04	8.16	34.86
AV	5.1985G	104.84	Inf	-Inf	97.51	3	Horizontal	12	1.35	18	34.00	8.19	34.86
PK	5.3815G	61.08	74.00	-12.92	53.02	3	Horizontal	12	1.35	18	34.44	8.50	34.88
AV	5.376G	49.16	54.00	-4.84	41.10	3	Horizontal	12	1.35	18	34.45	8.49	34.88

5.15-5.25GHz 802.11ax HEW40_Nss1,(MCS0)_2TX

5190MHz_TX

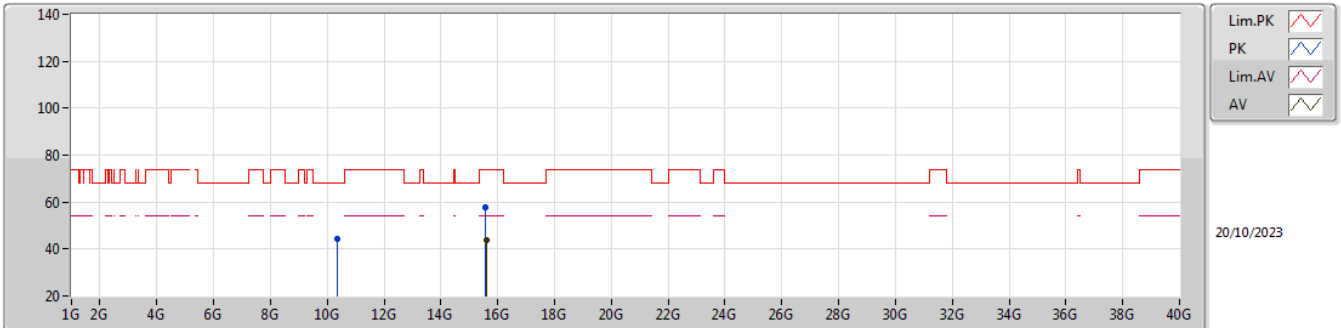

EUT_Y_2TX
SET 18

Type	Freq (Hz)	Level (dBuV/m)	Limit (dBuV/m)	Margin (dB)	Raw (dBuV)	Dist (m)	Condition	Azimuth (°)	Height (m)	Comment	AF (dB)	CL (dB)	PA (dB)
PK	10.35112G	44.37	68.20	-23.83	37.18	3	Vertical	26	2.52	18	37.85	12.36	43.02
PK	15.56384G	57.83	74.00	-16.17	41.91	3	Vertical	349	1.09	18	38.14	20.32	42.54
AV	15.59408G	44.05	54.00	-9.95	28.17	3	Vertical	349	1.09	18	38.02	20.36	42.50

5.15-5.25GHz 802.11ax HEW40_Nss1,(MCS0)_2TX

5190MHz_TX

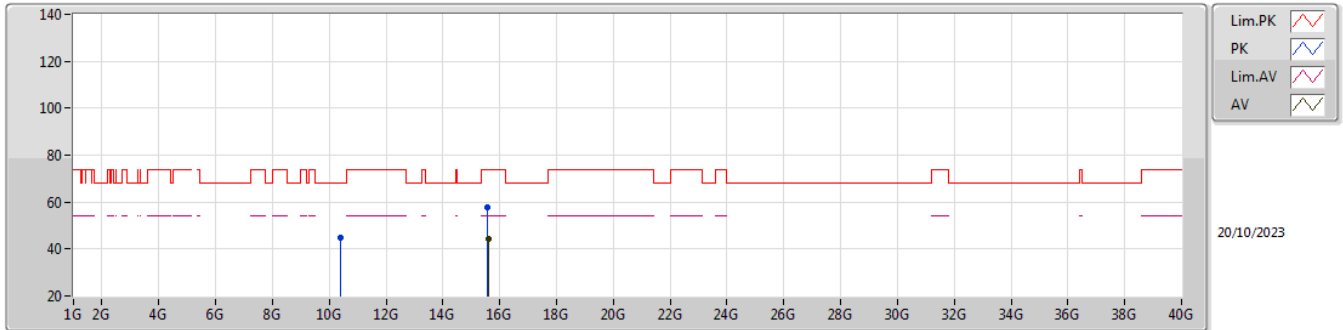

EUT Y_2TX
SET 18

Type	Freq (Hz)	Level (dBuV/m)	Limit (dBuV/m)	Margin (dB)	Raw (dBuV)	Dist (m)	Condition	Azimuth (°)	Height (m)	Comment	AF (dB)	CL (dB)	PA (dB)
PK	10.3924G	44.73	68.20	-23.47	37.48	3	Horizontal	323	2.07	18	37.89	12.39	43.03
PK	15.55808G	57.76	74.00	-16.24	41.82	3	Horizontal	237	1.80	18	38.17	20.31	42.54
AV	15.60168G	44.11	54.00	-9.89	28.23	3	Horizontal	237	1.80	18	38.00	20.37	42.49

5.15-5.25GHz_802.11ax_HEW40_Nss1,(MCS0)_2TX

5230MHz_TX

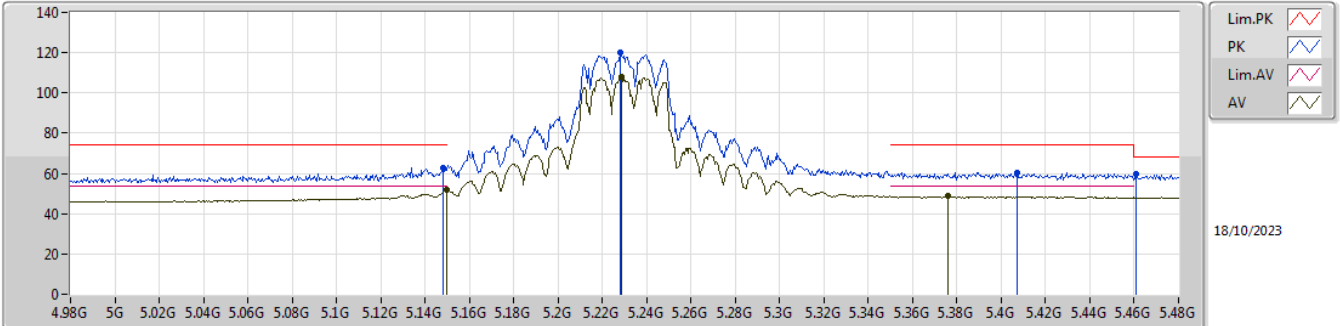

EUT_Y_2TX
 SET 22
 22.5\21.5\22
 -0.26\3.84\2.36

Type	Freq (Hz)	Level (dBuV/m)	Limit (dBuV/m)	Margin (dB)	Raw (dBuV)	Dist (m)	Condition	Azimuth (°)	Height (m)	Comment	AF (dB)	CL (dB)	PA (dB)
PK	5.148G	63.06	74.00	-10.94	55.71	3	Vertical	4	1.30	22	34.10	8.10	34.85
AV	5.15G	51.64	54.00	-2.36	44.28	3	Vertical	4	1.30	22	34.10	8.11	34.85
PK	5.228G	119.79	Inf	-Inf	112.41	3	Vertical	4	1.30	22	34.00	8.24	34.86
AV	5.2285G	107.88	Inf	-Inf	100.50	3	Vertical	4	1.30	22	34.00	8.24	34.86
PK	5.407G	60.49	74.00	-13.51	52.42	3	Vertical	4	1.30	22	34.43	8.53	34.89
AV	5.376G	48.60	54.00	-5.40	40.54	3	Vertical	4	1.30	22	34.45	8.49	34.88
PK	5.461G	59.65	68.20	-8.55	51.37	3	Vertical	4	1.30	22	34.60	8.57	34.89

5.15-5.25GHz_802.11ax_HEW40_Nss1,(MCS0)_2TX

5230MHz_TX

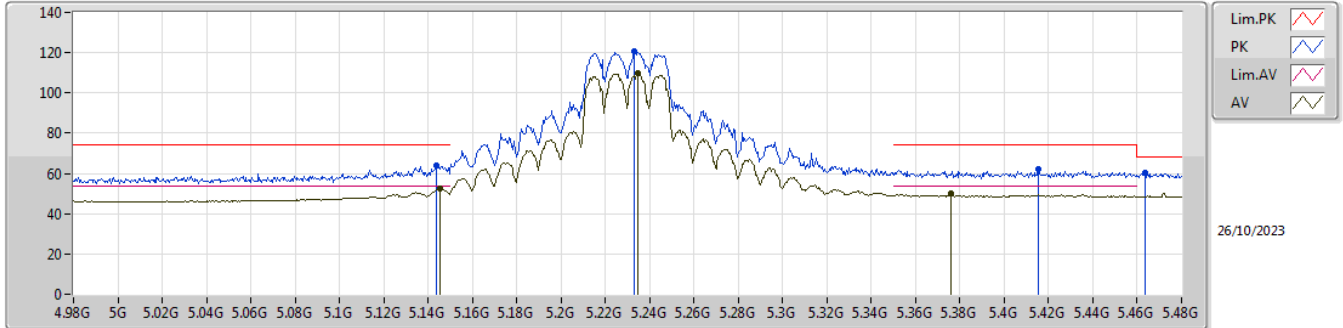

EUT_Y_2TX
 SET 22.5
 15\21\24\22.5\23\22.5
 6.07\5.18\8.05\1.56\0.66\1.50

Type	Freq (Hz)	Level (dBuV/m)	Limit (dBuV/m)	Margin (dB)	Raw (dBuV)	Dist (m)	Condition	Azimuth (°)	Height (m)	Comment	AF (dB)	CL (dB)	PA (dB)
PK	5.1435G	63.85	74.00	-10.15	56.51	3	Horizontal	0	1.58	22.5	34.09	8.10	34.85
AV	5.1455G	52.50	54.00	-1.50	45.16	3	Horizontal	0	1.58	22.5	34.09	8.10	34.85
PK	5.233G	120.57	Inf	-Inf	113.18	3	Horizontal	0	1.58	22.5	34.00	8.25	34.86
AV	5.2345G	109.70	Inf	-Inf	102.31	3	Horizontal	0	1.58	22.5	34.00	8.25	34.86
PK	5.4155G	61.92	74.00	-12.08	53.81	3	Horizontal	0	1.58	22.5	34.46	8.54	34.89
AV	5.376G	49.88	54.00	-4.12	41.82	3	Horizontal	0	1.58	22.5	34.45	8.49	34.88
PK	5.4635G	60.33	68.20	-7.87	52.05	3	Horizontal	0	1.58	22.5	34.60	8.57	34.89

5.15-5.25GHz_802.11ax_HEW40_Nss1,(MCS0)_2TX

5230MHz_TX

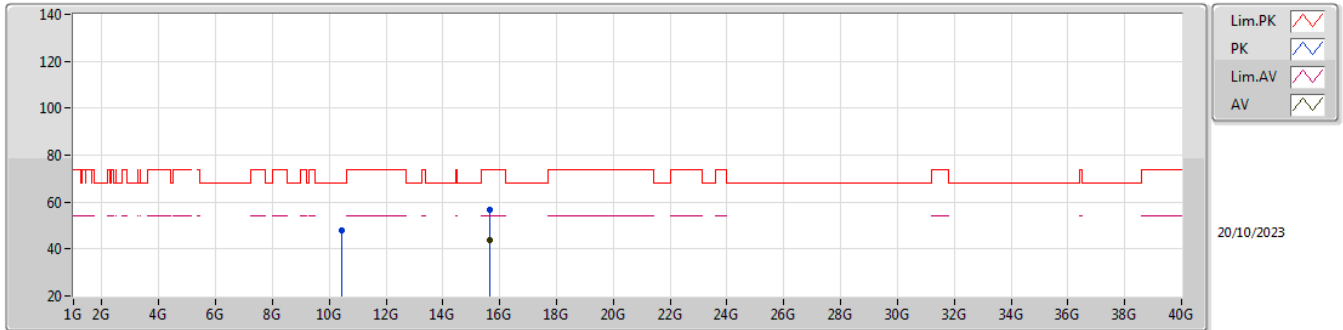

EUT_Y_2TX
SET 22

Type	Freq (Hz)	Level (dBuV/m)	Limit (dBuV/m)	Margin (dB)	Raw (dBuV)	Dist (m)	Condition	Azimuth (°)	Height (m)	Comment	AF (dB)	CL (dB)	PA (dB)
PK	10.45992G	47.89	68.20	-20.31	40.52	3	Vertical	318	1.05	22	37.96	12.45	43.04
PK	15.65184G	56.77	74.00	-17.23	40.71	3	Vertical	6	1.46	22	38.05	20.44	42.43
AV	15.65712G	43.94	54.00	-10.06	27.87	3	Vertical	6	1.46	22	38.06	20.44	42.43

5.15-5.25GHz_802.11ax_HEW40_Nss1,(MCS0)_2TX

5230MHz_TX

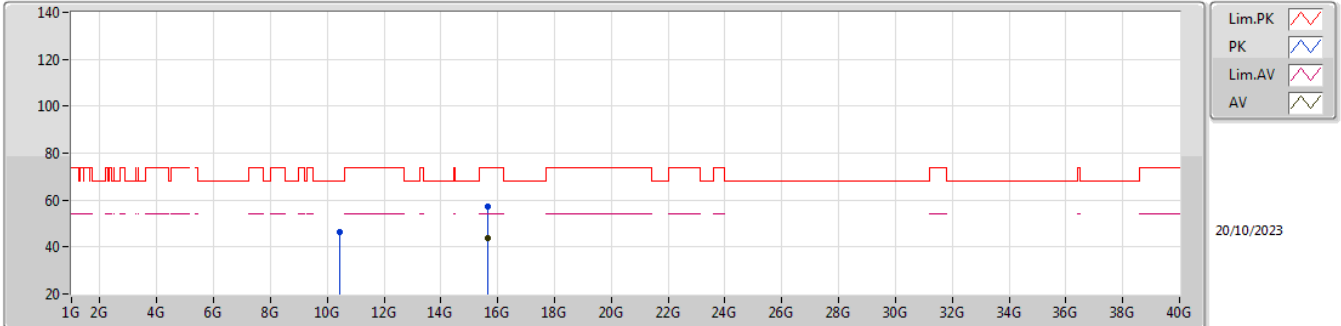

EUT_Y_2TX
SET 22

Type	Freq (Hz)	Level (dBuV/m)	Limit (dBuV/m)	Margin (dB)	Raw (dBuV)	Dist (m)	Condition	Azimuth (°)	Height (m)	Comment	AF (dB)	CL (dB)	PA (dB)
PK	10.46008G	46.56	68.20	-21.64	39.19	3	Horizontal	14	1.80	22	37.96	12.45	43.04
PK	15.65624G	57.07	74.00	-16.93	41.00	3	Horizontal	1	1.07	22	38.06	20.44	42.43
AV	15.65056G	43.98	54.00	-10.02	27.94	3	Horizontal	1	1.07	22	38.05	20.43	42.44

5.15-5.25GHz_802.11ax_HEW80_Nss1,(MCS0)_2TX

5210MHz_TX

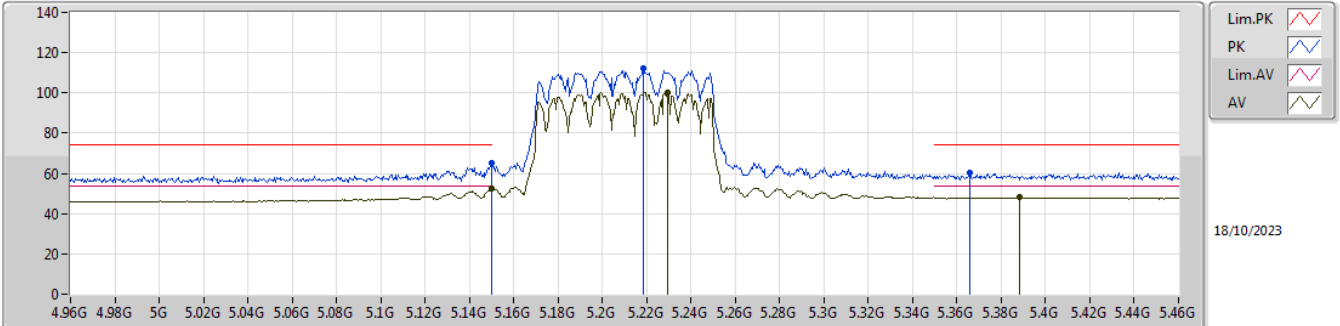

EUT Y_2TX
SET 17
17
1.77

Type	Freq (Hz)	Level (dBuV/m)	Limit (dBuV/m)	Margin (dB)	Raw (dBuV)	Dist (m)	Condition	Azimuth (°)	Height (m)	Comment	AF (dB)	CL (dB)	PA (dB)
PK	5.15G	65.22	74.00	-8.78	57.86	3	Vertical	10	1.20	17	34.10	8.11	34.85
AV	5.15G	52.23	54.00	-1.77	44.87	3	Vertical	10	1.20	17	34.10	8.11	34.85
PK	5.2185G	112.53	Inf	-Inf	105.17	3	Vertical	10	1.20	17	34.00	8.22	34.86
AV	5.2295G	100.24	Inf	-Inf	92.86	3	Vertical	10	1.20	17	34.00	8.24	34.86
PK	5.366G	60.16	74.00	-13.84	52.10	3	Vertical	10	1.20	17	34.47	8.47	34.88
AV	5.388G	48.02	54.00	-5.98	39.97	3	Vertical	10	1.20	17	34.42	8.51	34.88

5.15-5.25GHz_802.11ax_HEW80_Nss1,(MCS0)_2TX

5210MHz_TX

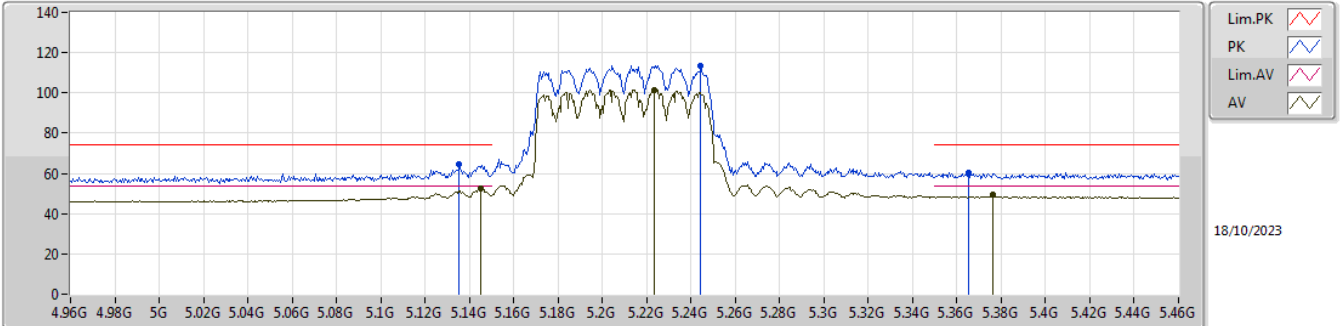

EUT_Y_2TX
 SET 17
 15\19\17\18\17.5\17
 4.23\4.52\1.53\0.87\0.00\1.49

Type	Freq (Hz)	Level (dBuV/m)	Limit (dBuV/m)	Margin (dB)	Raw (dBuV)	Dist (m)	Condition	Azimuth (°)	Height (m)	Comment	AF (dB)	CL (dB)	PA (dB)
PK	5.1355G	64.77	74.00	-9.23	57.47	3	Horizontal	18	1.46	17	34.07	8.08	34.85
AV	5.145G	52.51	54.00	-1.49	45.17	3	Horizontal	18	1.46	17	34.09	8.10	34.85
PK	5.2445G	113.49	Inf	-Inf	106.08	3	Horizontal	18	1.46	17	34.00	8.27	34.86
AV	5.2235G	101.59	Inf	-Inf	94.22	3	Horizontal	18	1.46	17	34.00	8.23	34.86
PK	5.3655G	60.64	74.00	-13.36	52.58	3	Horizontal	18	1.46	17	34.47	8.47	34.88
AV	5.376G	49.26	54.00	-4.74	41.20	3	Horizontal	18	1.46	17	34.45	8.49	34.88

5.15-5.25GHz_802.11ax_HEW80_Nss1,(MCS0)_2TX

5210MHz_TX

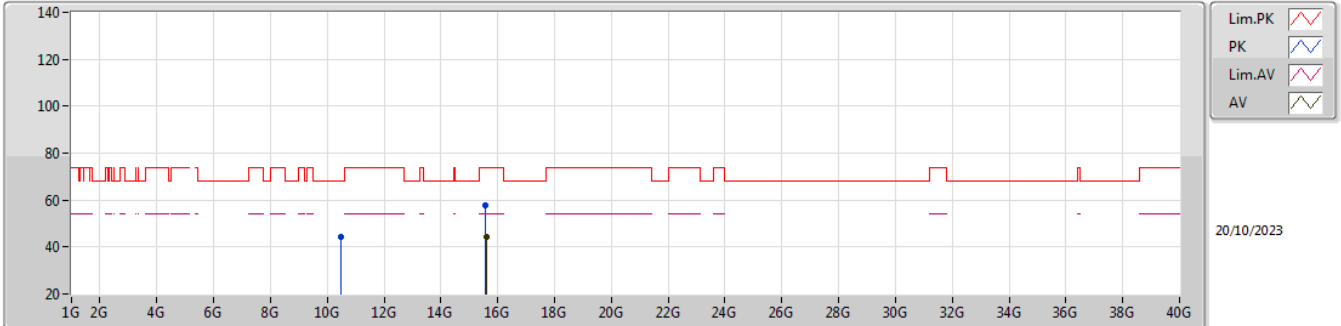

EUT_Y_2TX
SET 17

Type	Freq (Hz)	Level (dBuV/m)	Limit (dBuV/m)	Margin (dB)	Raw (dBuV)	Dist (m)	Condition	Azimuth (°)	Height (m)	Comment	AF (dB)	CL (dB)	PA (dB)
PK	10.4688G	44.28	68.20	-23.92	36.90	3	Vertical	22	2.63	17	37.97	12.45	43.04
PK	15.55032G	57.61	74.00	-16.39	41.66	3	Vertical	357	1.07	17	38.20	20.30	42.55
AV	15.59736G	44.18	54.00	-9.82	28.31	3	Vertical	357	1.07	17	38.01	20.36	42.50

5.15-5.25GHz_802.11ax_HEW80_Nss1,(MCS0)_2TX

5210MHz_TX

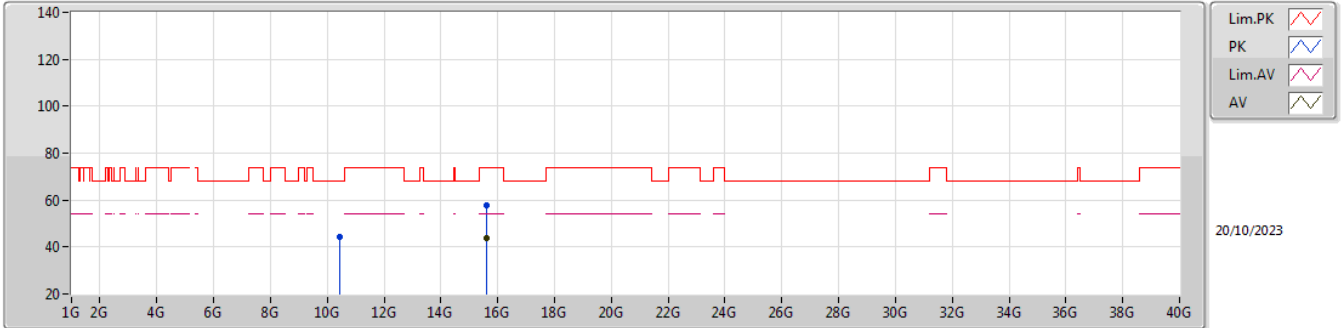

EUT_Y_2TX
SET 17

Type	Freq (Hz)	Level (dBuV/m)	Limit (dBuV/m)	Margin (dB)	Raw (dBuV)	Dist (m)	Condition	Azimuth (°)	Height (m)	Comment	AF (dB)	CL (dB)	PA (dB)
PK	10.41984G	44.37	68.20	-23.83	37.06	3	Horizontal	12	1.77	17	37.92	12.42	43.03
PK	15.59064G	57.64	74.00	-16.36	41.75	3	Horizontal	162	1.80	17	38.04	20.35	42.50
AV	15.60536G	43.99	54.00	-10.01	28.10	3	Horizontal	162	1.80	17	38.01	20.37	42.49