



RADIO TEST REPORT

FCC ID : UDX-600128010
Equipment : SMART Camera
Brand Name : CISCO
Model Name : MV33-HW
Applicant : Cisco Systems, Inc.
170 West Tasman Drive, San Jose, CA 95134 USA
Manufacturer : Cisco Systems, Inc.
170 West Tasman Drive, San Jose, CA 95134 USA
Standard : 47 CFR FCC Part 15.247

The product was received on Mar. 18, 2023, and testing was started from Mar. 22, 2023 and completed on Jul. 19, 2023. We, Sporton International Inc. Hsinchu Laboratory, would like to declare that the tested sample has been evaluated in accordance with the procedures given in ANSI C63.10-2013 and shown compliance with the applicable technical standards.

The test results in this report apply exclusively to the tested model / sample. Without written approval of Sporton International Inc. Hsinchu Laboratory, the test report shall not be reproduced except in full.

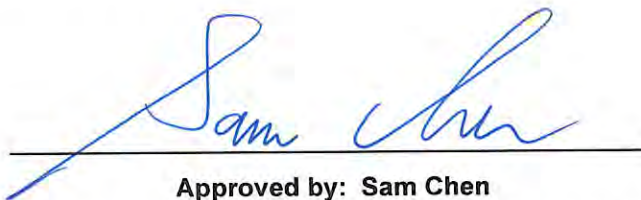

Approved by: Sam Chen

Sporton International Inc. Hsinchu Laboratory
No.8, Ln. 724, Bo'ai St., Zhubei City, Hsinchu County 302010, Taiwan (R.O.C.)



Table of Contents

History of this test report.....3

Summary of Test Result.....4

1 General Description5

1.1 Information.....5

1.2 Applicable Standards9

1.3 Testing Location Information9

1.4 Measurement Uncertainty10

2 Test Configuration of EUT11

2.1 Test Channel Mode11

2.2 The Worst Case Measurement Configuration12

2.3 EUT Operation during Test14

2.4 Accessories14

2.5 Support Equipment.....15

2.6 Test Setup Diagram16

3 Transmitter Test Result19

3.1 AC Power-line Conducted Emissions19

3.2 20dB Bandwidth and Carrier Frequency Separation.....21

3.3 Maximum Conducted Output Power22

3.4 Number of Hopping Frequencies and Hopping Bandedge23

3.5 Time of Occupancy (Dwell Time)24

3.6 Emissions in Non-restricted Frequency Bands25

3.7 Emissions in Restricted Frequency Bands.....26

4 Test Equipment and Calibration Data29

Appendix A. Test Results of AC Power-line Conducted Emissions

Appendix B. Test Results of 20dB Bandwidth and Carrier Frequency Separation

Appendix C. Test Results of Maximum Conducted Output Power

Appendix D. Test Results of Number of Hopping Frequencies and Hopping oppBandedge

Appendix E. Test Results of Time of Occupancy (Dwell Time)

Appendix F. Test Results of Emissions in Non-restricted Frequency Bands

Appendix G. Test Results of Emissions in Restricted Frequency Bands

Appendix H. Test Results of Radiated Emission Co-location

Appendix I. Test Photos

Photographs of EUT v01



Summary of Test Result

Report Clause	Ref Std. Clause	Test Items	Result (PASS/FAIL)	Remark
1.1.2	15.203	Antenna Requirement	PASS	-
3.1	15.207	AC Power-line Conducted Emissions	PASS	-
3.2	15.247(a)	20dB Bandwidth	PASS	-
3.2	15.247(a)	Carrier Frequency Separation	PASS	-
3.3	15.247(b)	Maximum Conducted Output Power	PASS	-
3.4	15.247(a)	Number of Hopping Frequencies and Hopping Band edge	PASS	-
3.5	15.247(a)	Time of Occupancy (Dwell Time)	PASS	-
3.6	15.247(d)	Emissions in Non-restricted Frequency Bands	PASS	-
3.7	15.247(d)	Emissions in Restricted Frequency Bands	PASS	-

Conformity Assessment Condition:

1. The test results (PASS/FAIL) with all measurement uncertainty excluded are presented against the regulation limits or in accordance with the requirements stipulated by the applicant/manufacturer who shall bear all the risks of non-compliance that may potentially occur if measurement uncertainty is taken into account.
2. The measurement uncertainty please refer to each test result in the chapter "Measurement Uncertainty".

Disclaimer:

The product specifications of the EUT presented in the test report that may affect the test assessments are declared by the manufacturer who shall take full responsibility for the authenticity.

Reviewed by: Sam Chen**Report Producer: Sandy Chuang**



1 General Description

1.1 Information

1.1.1 RF General Information

Frequency Range (MHz)	Bluetooth Version	Ch. Frequency (MHz)	Channel Number
2400-2483.5	BR / EDR	2402-2480	0-78 [79]

Band	Mode	BWch (MHz)	Nant
2.4-2.4835GHz	BT-BR(1Mbps)	1	1TX
2.4-2.4835GHz	BT-EDR(2Mbps)	1	1TX
2.4-2.4835GHz	BT-EDR(3Mbps)	1	1TX

Note:

- ◆ Bluetooth BR uses a GFSK (1Mbps).
- ◆ Bluetooth EDR uses a combination of $\pi/4$ -DQPSK (2Mbps) and 8DPSK (3Mbps).
- ◆ Bluetooth BR/EDR uses as a system using FHSS modulation.
- ◆ BWch is the nominal channel bandwidth.



1.1.2 Antenna Information

Ant.	Port		Brand	Model Name	Antenna Type	Connector	Gain (dBi)					
	WLAN	Bluetooth					WLAN 2.4GHz	WLAN 5GHz				Bluetooth
								UNII 1	UNII 2A	UNII 2C	UNII 3	
1	1	1	SERCOMM	Ant 1, Ant2	PIFA	I-PEX	2.40	3.31	3.31	3.76	3.05	2.40
2	2	2	SERCOMM	Ant 1, Ant2	PIFA	I-PEX	0.98	2.40	2.40	2.10	2.50	0.98

Note: The above information was declared by manufacturer.

For 2.4GHz function:

For IEEE 802.11b/g/n/VHT mode (1TX/1RX):

The EUT supports the antenna with TX and RX diversity functions.

Both Port 1 and Port 2 support transmit and receive functions, but only one of them will be used at one time.

The Port 1 generated the worst case, so it was selected to test and record in the report.

For 5GHz function:

For IEEE 802.11a/n/ac mode (1TX/1RX):

The EUT supports the antenna with TX and RX diversity functions.

Both Port 1 and Port 2 support transmit and receive functions, but only one of them will be used at one time.

The Port 1 generated the worst case, so it was selected to test and record in the report.

For Bluetooth function (1TX/1RX):

The EUT supports the antenna with TX and RX diversity functions.

Both Port 1 and Port 2 support transmit and receive functions, but only one of them will be used at one time.

The Port 1 generated the worst case, so it was selected to test and record in the report.



1.1.3 Mode Test Duty Cycle

Mode	DC	DCF(dB)	T(s)	VBW(Hz) ≥ 1/T
BT-BR(1Mbps)	0.784	1.06	2.888m	1k
BT-EDR(2Mbps)	0.774	1.11	2.89m	1k
BT-EDR(3Mbps)	0.755	1.22	2.893m	1k

Note:

- ◆ DC is Duty Cycle.
- ◆ DCF is Duty Cycle Factor.

1.1.4 EUT Operational Condition

EUT Power Type	From PoE
Test Software Version	QRCT_v4.0.00201.0



1.1.5 Multiple Sources

The EUT has second source verify for DDR4, UFS-3.1 256GB, PoE Transformer, LAN Transformer, ACT2, RF Connector, CMOS Coaxial Cable, LED Board Cable.

Note: The above information was declared by manufacturer.

1.1.6 EUT Combination Information

Item	Type	EUT 1	EUT 2
1	DDR4	Main Source	Second Source
2	UFS-3.1 256GB	Main Source	Second Source
3	PoE Transformer	Main Source	Second Source
4	LAN Transformer	Main Source	Second Source
5	ACT2	Main Source	Second Source
6	RF Connector	Main Source	Second Source
7	CMOS Coaxial Cable	Main Source	Second Source
8	LED Board Cable	Main Source	Second Source

Note 1: From the above, EUT 1 was selected to test all items and EUT 2 was selected to test AC Power-line Conducted Emissions and Emissions in Restricted Frequency Bands below 1GHz only, and their data was recorded in this report.

Note 2: The above information was declared by manufacturer.



1.2 Applicable Standards

According to the specifications of the manufacturer, the EUT must comply with the requirements of the following standards:

- ♦ 47 CFR FCC Part 15.247

The following reference test guidance is not within the scope of accreditation of TAF.

- ♦ FCC KDB 558074 D01 v05r02
- ♦ FCC KDB 414788 D01 v01r01

1.3 Testing Location Information

Testing Location Information	
Test Lab. : Sporton International Inc. Hsinchu Laboratory	
Hsinchu (TAF: 3787)	ADD: No.8, Ln. 724, Bo'ai St., Zhubei City, Hsinchu County 302010, Taiwan (R.O.C.) TEL: 886-3-656-9065 FAX: 886-3-656-9085 Test site Designation No. TW3787 with FCC. Conformity Assessment Body Identifier (CABID) TW3787 with ISED.

Test Condition	Test Site No.	Test Engineer	Test Environment (°C / %)	Test Date
RF Conducted	TH02-CB	Ken Yeh	22.6~24.3 / 60~62	Mar. 22, 2023~ May 18, 2023
Radiated <1GHz	03CH05-CB	Mark Hsu	21~22 / 55~58	Jul. 13, 2023
Radiated >1GHz	03CH01-CB	Paul Huang	22.4~23.9 / 59~60	May 17, 2023~ May 18, 2023
Radiated Co-location	03CH05-CB	Paul Huang	23~24.7 / 58~63	Jul. 13, 2023
AC Conduction	CO01-CB	Gray Lee	21~22 / 53~54	Jul. 19, 2023



1.4 Measurement Uncertainty

ISO/IEC 17025 requires that an estimate of the measurement uncertainties associated with the emissions test results be included in the report. The measurement uncertainties given below are based on a 95% confidence level (based on a coverage factor (k=2)

Test Date: Before Jun. 01, 2023

Test Items	Uncertainty	Remark
Radiated Emission (1GHz ~ 18GHz)	5.2 dB	Confidence levels of 95%
Radiated Emission (18GHz ~ 40GHz)	4.7 dB	Confidence levels of 95%
Conducted Emission	3.2 dB	Confidence levels of 95%
Output Power Measurement	0.8 dB	Confidence levels of 95%
Power Density Measurement	3.2 dB	Confidence levels of 95%
Bandwidth Measurement	2.0 %	Confidence levels of 95%

Test Date: After May 31, 2023

Test Items	Uncertainty	Remark
Conducted Emission (150kHz ~ 30MHz)	3.4 dB	Confidence levels of 95%
Radiated Emission (9kHz ~ 30MHz)	3.7 dB	Confidence levels of 95%
Radiated Emission (30MHz ~ 1,000MHz)	5.1 dB	Confidence levels of 95%
Radiated Emission (1GHz ~ 18GHz)	4.1 dB	Confidence levels of 95%
Radiated Emission (18GHz ~ 40GHz)	4.2 dB	Confidence levels of 95%



2 Test Configuration of EUT

2.1 Test Channel Mode

Mode	Power Setting
BT-BR(1Mbps)	-
2402MHz	9
2440MHz	9
2480MHz	9
BT-EDR(2Mbps)	-
2402MHz	9
2440MHz	9
2480MHz	9
BT-EDR(3Mbps)	-
2402MHz	9
2440MHz	9
2480MHz	9



2.2 The Worst Case Measurement Configuration

The Worst Case Mode for Following Conformance Tests	
Tests Item	AC power-line conducted emissions
Condition	AC power-line conducted measurement for line and neutral Test Voltage: 120Vac / 60Hz
Operating Mode	Normal Link
1	EUT 1 + LAN mode-Day mode + Bluetooth + PoE 1
2	EUT 1 + LAN mode-Night mode + Bluetooth + PoE 1
Mode 2 has been evaluated to be the worst case among Mode 1~2, thus measurement for Mode 3 ~ 6 will follow this same test mode.	
3	EUT 1 + WLAN 2.4GHz mode-Night mode + Bluetooth + PoE 1
4	EUT 1 + WLAN 2.4GHz mode-Night mode + Bluetooth + PoE 2
5	EUT 1 + WLAN 5GHz mode-Night mode + Bluetooth + PoE 1
6	EUT 1 + WLAN 5GHz mode-Night mode + Bluetooth + PoE 2
Mode 2 has been evaluated to be the worst case among Mode 1~6, thus measurement for Mode 7 will follow this same test mode.	
7	EUT 2 + LAN mode-Night mode + Bluetooth + PoE 1
For operating mode 2 is the worst case and it was record in this test report.	

The Worst Case Mode for Following Conformance Tests	
Tests Item	20dB Bandwidth Carrier Frequency Separation Maximum Conducted Output Power Number of Hopping Frequencies Hopping Bandedge Time of Occupancy (Dwell Time) Emissions in Non-restricted Frequency Bands
Test Condition	Conducted measurement at transmit chains
Test Mode	EUT 1



The Worst Case Mode for Following Conformance Tests	
Tests Item	Emissions in Restricted Frequency Bands
Test Condition	Radiated measurement If EUT consist of multiple antenna assembly (multiple antenna are used in EUT regardless of spatial multiplexing MIMO configuration), the radiated test should be performed with highest antenna gain of each antenna type.
Operating Mode < 1GHz	Normal Link
1	EUT 1 at Z axis + LAN mode-Day mode + Bluetooth + PoE 1
2	EUT 1 at Y axis + LAN mode-Day mode + Bluetooth + PoE 1
3	EUT 1 at X axis + LAN mode-Day mode + Bluetooth + PoE 1
Mode 1 has been evaluated to be the worst case among Mode 1~3, thus measurement for Mode 4 will follow this same test mode	
4	EUT 1 at Z axis + LAN mode-Night mode + Bluetooth + PoE 1
Mode 1 has been evaluated to be the worst case among Mode 1~4, thus measurement for Mode 5~ 8 will follow this same test mode.	
5	EUT 1 at Z axis + WLAN 2.4GHz mode-Day mode + Bluetooth + PoE 1
6	EUT 1 at Z axis + WLAN 2.4GHz mode-Day mode + Bluetooth + PoE 2
7	EUT 1 at Z axis + WLAN 5GHz mode-Day mode + Bluetooth + PoE 1
8	EUT 1 at Z axis + WLAN 5GHz mode-Day mode + Bluetooth + PoE 2
Mode 1 has been evaluated to be the worst case among Mode 1~8, thus measurement for Mode 9 will follow this same test mode.	
9	EUT 2 at Z axis + LAN mode-Day mode + Bluetooth + PoE 1
Mode 1 generated the worst test result, so it was recorded in this report.	
Operating Mode > 1GHz	CTX
	The EUT was performed at X axis, Y axis and Z axis position, and the worst case as below, Thus measurement will follow this same test configuration.
1	EUT 1 at Y axis



The Worst Case Mode for Following Conformance Tests	
Tests Item	Simultaneous Transmission Analysis - Radiated Emission Co-location
Test Condition	Radiated measurement
Operating Mode	Normal Link
The EUT was performed at X axis, Y axis and Z axis position for Radiated Emissions <Above 1GHz>, the worst case was found at Y axis position. Thus the measurement will follow.	
1	EUT 1 at Y axis + Bluetooth + WLAN 2.4GHz + PoE 1
2	EUT 1 at Y axis + Bluetooth + WLAN 5GHz + PoE 1
Mode 1 generated the worst test result, so it was recorded in this report.	
Refer to Appendix H for Radiated Emission Co-location.	

The Worst Case Mode for Following Conformance Tests	
Tests Item	Simultaneous Transmission Analysis - Co-location RF Exposure Evaluation
Operating Mode	
1	EUT 1 + Bluetooth + WLAN 2.4GHz
2	EUT 1 + Bluetooth + WLAN 5GHz
Refer to Sporton Test Report No.: FA282322-03 for Co-location RF Exposure Evaluation.	

Note: The PoEs are for measurement only, would not be marketed.

PoEs information as below:

Power	Brand	Model
PoE 1	PHIHONG	POEA33U-1ATE
PoE 2	CISCO	MA-PWR-MV-LV

2.3 EUT Operation during Test

For CTX Mode:

The EUT was programmed to be in continuously transmitting mode.

For Normal Link:

During the test, the EUT operation to normal function.

2.4 Accessories

Wall Bracket*3



2.5 Support Equipment

For AC Conduction:

Support Equipment				
No.	Equipment	Brand Name	Model Name	FCC ID
A	PoE 1	PHIHONG	POEA33U-1ATE	N/A
B	LAN NB	DELL	E6430	N/A
C	Smart phone	Samsung	Galaxy J2	N/A

For Radiated (below 1GHz):

Support Equipment				
No.	Equipment	Brand Name	Model Name	FCC ID
A	NB	DELL	E4300	N/A
B	PoE 1	PHIHONG	POEA33U-1ATE	N/A
C	Smart phone	Samsung	Galaxy J2	N/A

For Radiated (above 1GHz) and RF Conducted:

Support Equipment				
No.	Equipment	Brand Name	Model Name	FCC ID
A	NB	DELL	E4300	N/A
B	PoE 1	PHIHONG	PORA33U-1ATE	N/A

2.6 Test Setup Diagram

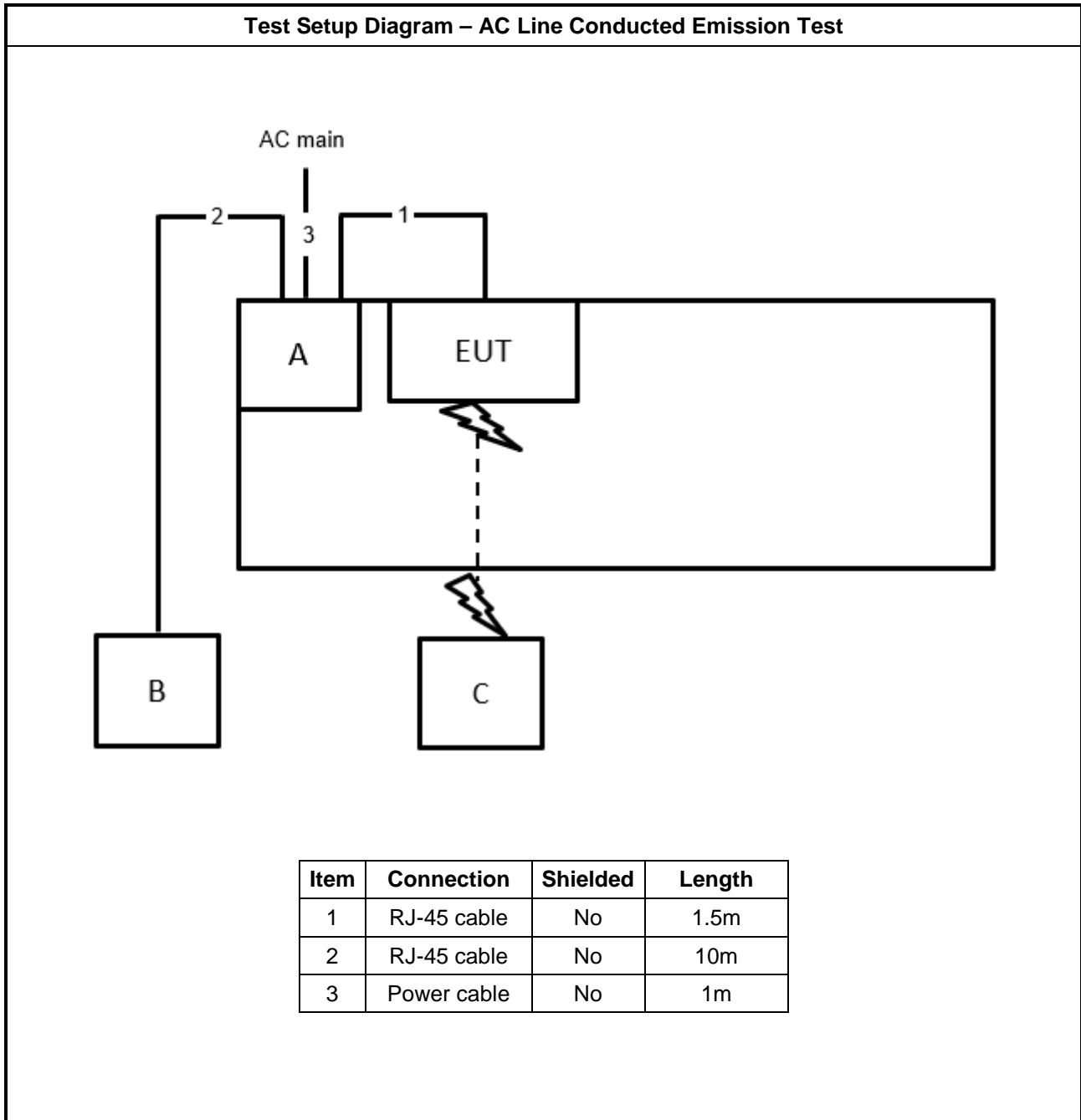

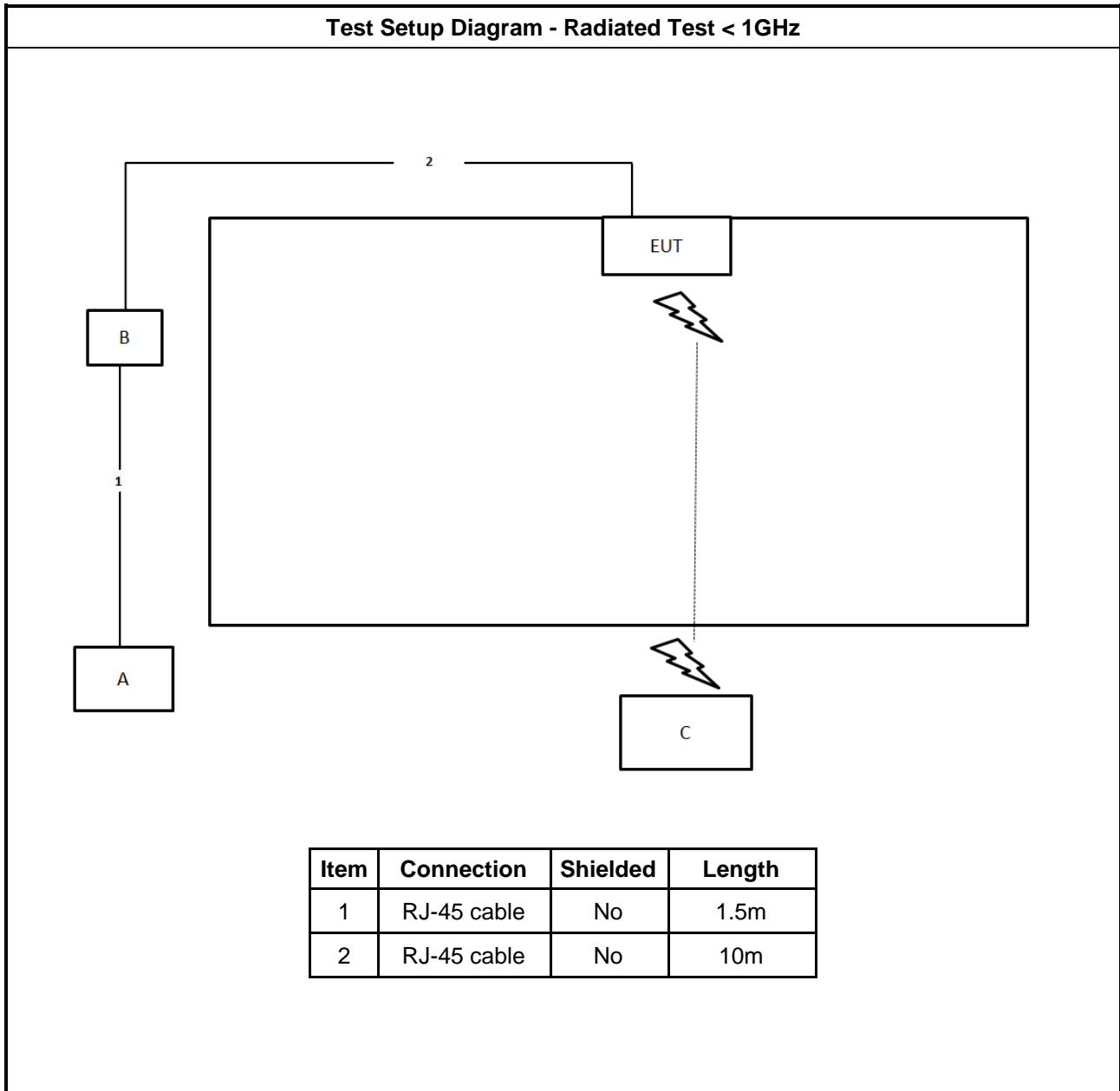



Test Setup Diagram - Radiated Test > 1GHz

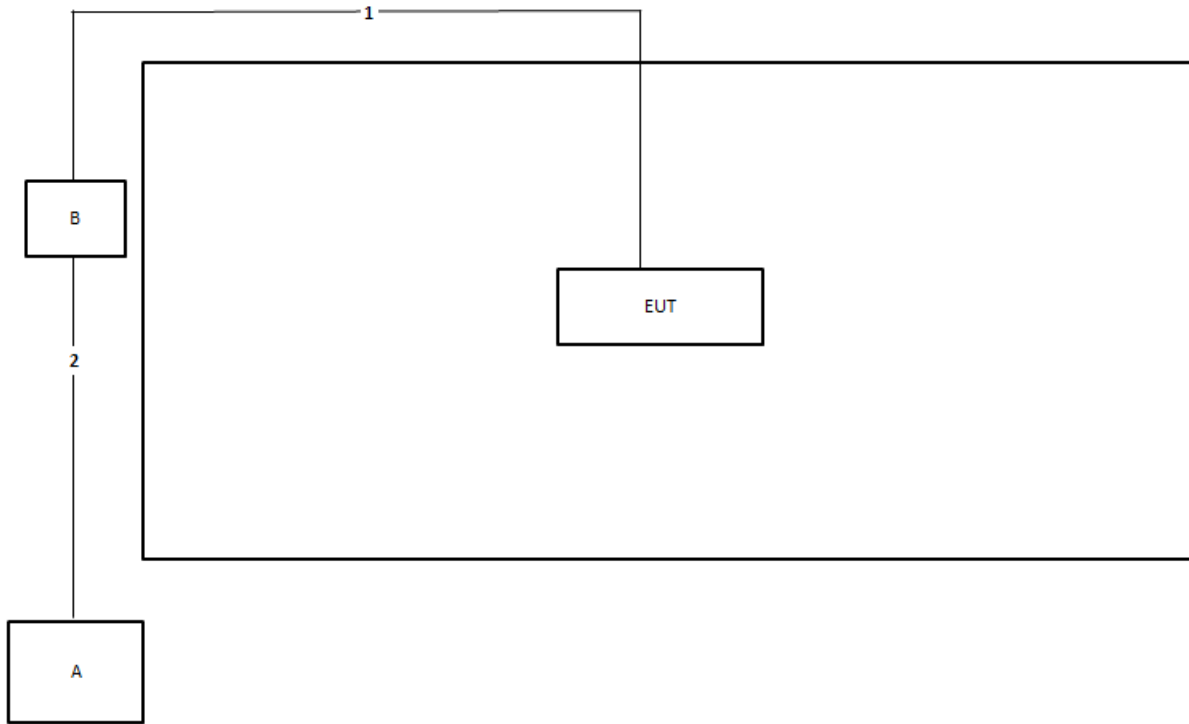

Item	Connection	Shielded	Length
1	RJ-45 cable	No	10m
2	RJ-45 cable	No	1.5m



3 Transmitter Test Result

3.1 AC Power-line Conducted Emissions

3.1.1 AC Power-line Conducted Emissions Limit

AC Power-line Conducted Emissions Limit		
Frequency Emission (MHz)	Quasi-Peak	Average
0.15-0.5	66 - 56 *	56 - 46 *
0.5-5	56	46
5-30	60	50

Note 1: * Decreases with the logarithm of the frequency.

3.1.2 Measuring Instruments

Refer a test equipment and calibration data table in this test report.

3.1.3 Test Procedures

Test Method
▪ Refer as ANSI C63.10-2013, clause 6.2 for AC power-line conducted emissions.

3.1.4 Test Setup

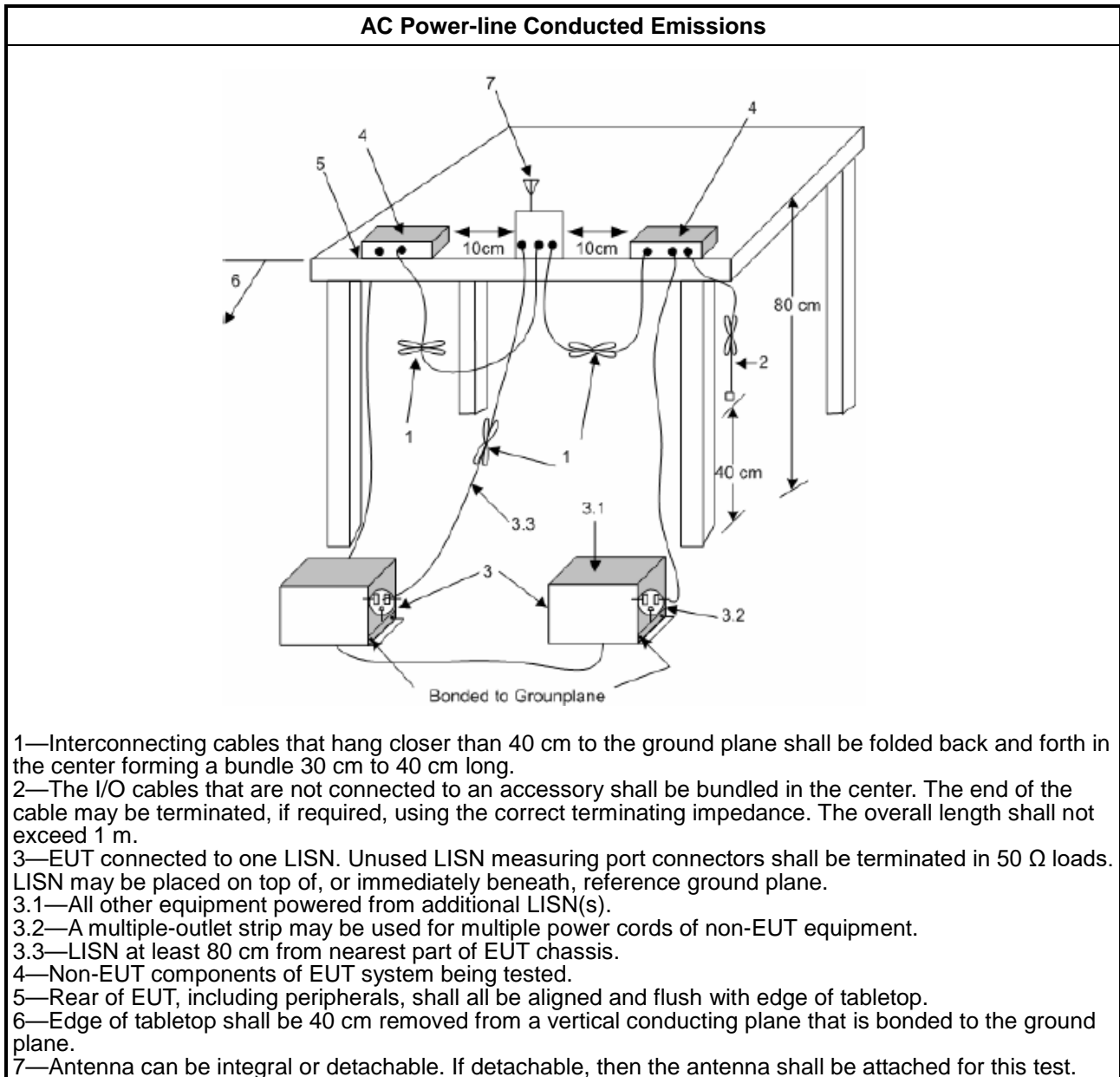

1.1.1. Measurement Results Calculation

The measured Level is calculated using:

- a. Corrected Reading: LISN Factor (LISN) + Attenuator (AT/AUX) + Cable Loss (CL) + Read Level (Raw) = Level
- b. Margin = -Limit + Level

3.1.5 Test Result of AC Power-line Conducted Emissions

Refer as Appendix A

3.2 20dB Bandwidth and Carrier Frequency Separation

3.2.1 20dB Bandwidth and Carrier Frequency Separation Limit

20dB Bandwidth and Carrier Frequency Separation Limit for Frequency Hopping Systems	
▪ 902-928 MHz Band:	
	▪ $N \geq 50$ and $ChS \geq MAX$ (20 dB bandwidth, 25 kHz); 20 dB bandwidth \leq 250 kHz.
	▪ $50 > N \geq 25$ and $ChS \geq MAX$ (20 dB bandwidth, 25 kHz); 20 dB bandwidth $>$ 250 kHz.
▪ 2400-2483.5 MHz Band:	
	▪ $N \geq 75$ and $ChS \geq MAX$ (20 dB bandwidth, 25 kHz).
	▪ $75 > N \geq 15$ and $ChS \geq MAX$ (20 dB bandwidth 2/3, 25 kHz).
▪ 5725-5850 MHz Band:	
	▪ $N \geq 75$ and $ChS \geq MAX$ (20 dB bandwidth, 25 kHz); 20 dB bandwidth \leq 1 MHz.
N: Number of Hopping Frequencies; ChS: Hopping Channel Separation	

3.2.2 Measuring Instruments

Refer a test equipment and calibration data table in this test report.

3.2.3 Test Procedures

Test Method
▪ Refer as ANSI C63.10-2013, clause 6.9.1 for 20 dB bandwidth measurement.
▪ Refer as ANSI C63.10-2013, clause 7.8.2 for carrier frequency separation measurement.

3.2.4 Test Setup

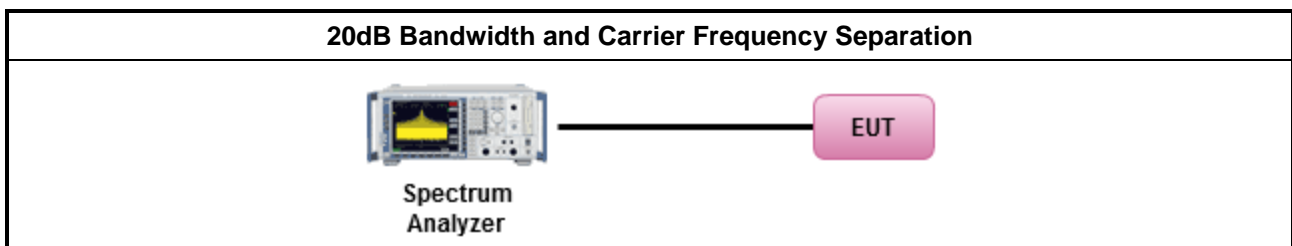

3.2.5 Test Result of 20dB Bandwidth

Refer as Appendix B

3.2.6 Test Result of Carrier Frequency Separation

Refer as Appendix B

3.3 Maximum Conducted Output Power

3.3.1 Maximum Conducted Output Power Limit

Maximum Conducted Output Power Limit	
<ul style="list-style-type: none"> ▪ 902-928 MHz Band: 	
	<ul style="list-style-type: none"> ▪ $N \geq 50$; Power 30dBm; EIRP 36dBm
	<ul style="list-style-type: none"> ▪ $50 > N \geq 25$; Power 23.98dBm; EIRP 29.98dBm
<ul style="list-style-type: none"> ▪ 2400-2483.5 MHz Band: 	
	<ul style="list-style-type: none"> ▪ $N \geq 75$; Power 30dBm; EIRP 36dBm
	<ul style="list-style-type: none"> ▪ $75 > N \geq 15$; Power 21dBm; EIRP 27dBm
<ul style="list-style-type: none"> ▪ 5725-5850 MHz Band: 	
	<ul style="list-style-type: none"> ▪ $N \geq 75$; Power 30dBm; EIRP 36dBm
N: Number of Hopping Frequencies	

3.3.2 Measuring Instruments

Refer a test equipment and calibration data table in this test report.

3.3.3 Test Procedures

Test Method
<ul style="list-style-type: none"> ▪ Refer as ANSI C63.10-2013, clause 7.8.5 for output power measurement.

3.3.4 Test Setup

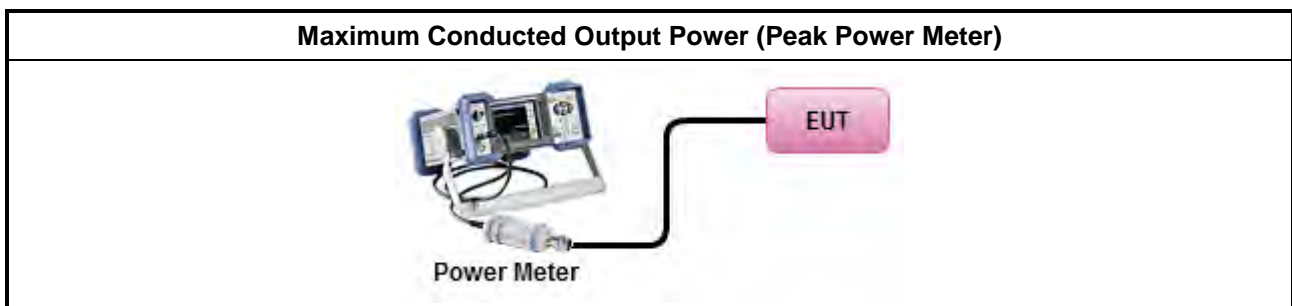

3.3.5 Test Result of Maximum Conducted Output Power

Refer as Appendix C

3.4 Number of Hopping Frequencies and Hopping Bandedge

3.4.1 Number of Hopping Frequencies Limit

Number of Hopping Frequencies Limit	
▪	902-928 MHz Band:
	▪ $N \geq 50$ and $ChS \geq MAX$ (20 dB bandwidth, 25 kHz); 20 dB bandwidth \leq 250 kHz.
	▪ $50 > N \geq 25$ and $ChS \geq MAX$ (20 dB bandwidth, 25 kHz); 20 dB bandwidth $>$ 250 kHz.
▪	2400-2483.5 MHz Band:
	▪ $N \geq 75$ and $ChS \geq MAX$ (20 dB bandwidth, 25 kHz).
	▪ $75 > N \geq 15$ and $ChS \geq MAX$ (20 dB bandwidth 2/3, 25 kHz).
▪	5725-5850 MHz Band:
	▪ $N \geq 75$ and $ChS \geq MAX$ (20 dB bandwidth, 25 kHz); 20 dB bandwidth \leq 1 MHz.
N: Number of Hopping Frequencies; ChS : Hopping Channel Separation	

3.4.2 Hopping Bandedge Limit

Refer clause 3.6.1 and clause 3.7.1

3.4.3 Measuring Instruments

Refer a test equipment and calibration data table in this test report.

3.4.4 Test Procedures

Test Method
▪ Refer as ANSI C63.10-2013, clause 7.8.3 for number of hopping frequencies measurement.
▪ Refer as ANSI C63.10-2013, clause 7.8.6 for hopping frequencies Bandedge measurement.

3.4.5 Test Setup

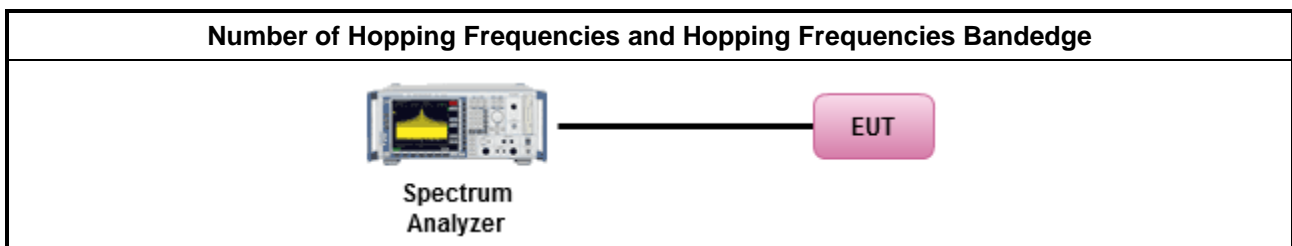

3.4.6 Test Result of Number of Hopping Frequencies

Refer as Appendix D

3.4.7 Test Result of Number of Hopping Frequencies Bandedge

Refer as Appendix D

3.5 Time of Occupancy (Dwell Time)

3.5.1 Time of Occupancy (Dwell Time) Limit

20dB Bandwidth and Carrier Frequency Separation Limit for Frequency Hopping Systems	
▪ 902-928 MHz Band:	
	▪ $N \geq 50$; 0.4s in 20s period
	▪ $50 > N \geq 25$; 0.4s in 10s period
▪ 2400-2483.5 MHz Band:	
	▪ $N \geq 75$; 0.4s in $N \times 0.4$ period
	▪ $75 > N \geq 15$; 0.4s in $N \times 0.4$ period
▪ 5725-5850 MHz Band:	
	▪ $N \geq 75$; 0.4s in 30s period
N: Number of Hopping Frequencies	

3.5.2 Measuring Instruments

Refer a test equipment and calibration data table in this test report.

3.5.3 Test Procedures

Test Method	
▪ Refer as ANSI C63.10-2013, clause 7.8.4 for dwell time measurement.	
▪ Bluetooth ACL packets can be 1, 3, or 5 time slots. Following as dwell time. Operate DH5 at maximum dwell time and maximum duty cycle.	
	▪ The DH5 packet can cover up to 5 time slots. Operate DH5 at maximum dwell time and maximum duty cycle. A maximum length packet has duration of 5 time slots. The hopping rate is 1600 hops/second so the maximum dwell time is $5/1600$ seconds, or 3.125ms. DH5 Packet permit maximum $1600 / 79 / 6 = 3.37$ hops per second in each channel.

3.5.4 Test Setup

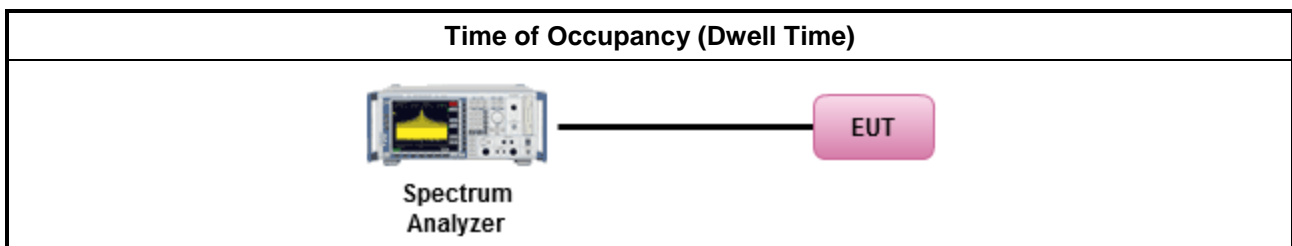

3.5.5 Test Result of Time of Occupancy (Dwell Time)

Refer as Appendix E

3.6 Emissions in Non-restricted Frequency Bands

3.6.1 Emissions in Non-restricted Frequency Bands Limit

Un-restricted Band Emissions Limit	
RF output power procedure	Limit (dBc)
Peak output power procedure	20
Note 1: If the peak output power procedure is used to measure the fundamental emission power to demonstrate compliance to requirements, then the peak conducted output power measured within any 100 kHz outside the authorized frequency band shall be attenuated by at least 20 dB relative to the maximum measured in-band peak PSD level.	

3.6.2 Measuring Instruments

Refer a test equipment and calibration data table in this test report.

3.6.3 Test Procedures

Test Method
<ul style="list-style-type: none"> Refer as ANSI C63.10-2013, clause 7.8.8 for unwanted emissions into non-restricted bands.

3.6.4 Test Setup

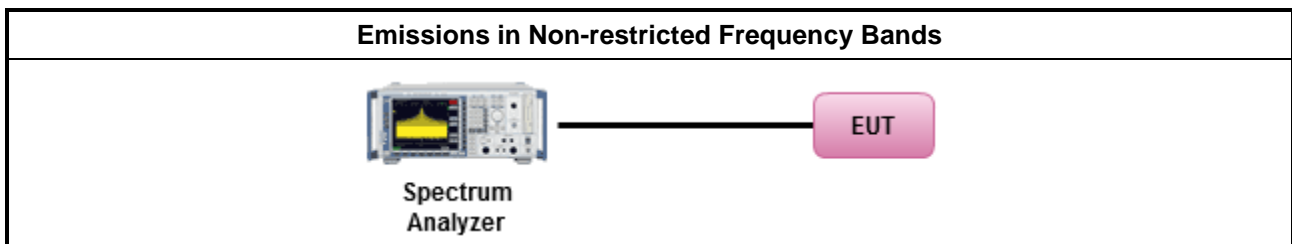

3.6.5 Test Result of Emissions in Non-restricted Frequency Bands

Refer as Appendix F



3.7 Emissions in Restricted Frequency Bands

3.7.1 Emissions in Restricted Frequency Bands Limit

Restricted Band Emissions Limit			
Frequency Range (MHz)	Field Strength (uV/m)	Field Strength (dBuV/m)	Measure Distance (m)
0.009~0.490	2400/F(kHz)	48.5 - 13.8	300
0.490~1.705	24000/F(kHz)	33.8 - 23	30
1.705~30.0	30	29	30
30~88	100	40	3
88~216	150	43.5	3
216~960	200	46	3
Above 960	500	54	3

Note 1: Test distance for frequencies at or above 30 MHz, measurements may be performed at a distance other than the limit distance provided they are not performed in the near field and the emissions to be measured can be detected by the measurement equipment. When performing measurements at a distance other than that specified, the results shall be extrapolated to the specified distance using an extrapolation factor of 20 dB/decade (inverse of linear distance for field-strength measurements, inverse of linear distance-squared for power-density measurements).

Note 2: Test distance for frequencies at below 30 MHz, measurements may be performed at a distance closer than the EUT limit distance; however, an attempt should be made to avoid making measurements in the near field. When performing measurements below 30 MHz at a closer distance than the limit distance, the results shall be extrapolated to the specified distance by either making measurements at a minimum of two or more distances on at least one radial to determine the proper extrapolation factor or by using the square of an inverse linear distance extrapolation factor (40 dB / decade). The test report shall specify the extrapolation method used to determine compliance of the EUT.

Note 3: Using the distance of 1m during the test for above 18 GHz, and the test value to correct for the distance factor at 3m.

3.7.2 Measuring Instruments

Refer a test equipment and calibration data table in this test report.

3.7.3 Test Procedures

Test Method				
<ul style="list-style-type: none"> The average emission levels shall be measured in [hopping duty factor]. 				
<ul style="list-style-type: none"> Refer as ANSI C63.10; clause 6.10.3 band-edge testing shall be performed at the lowest frequency channel and highest frequency channel within the allowed operating band. 				
<ul style="list-style-type: none"> For the transmitter unwanted emissions shall be measured using following options below: <table border="1" data-bbox="188 1776 1428 1912"> <tbody> <tr> <td> <ul style="list-style-type: none"> Refer as ANSI C63.10, clause 4.1.4.2.1 QP value. </td> </tr> <tr> <td> <ul style="list-style-type: none"> Refer as ANSI C63.10, clause 4.1.4.2.2 measurement procedure peak. </td> </tr> <tr> <td> <ul style="list-style-type: none"> Refer as ANSI C63.10, clause 4.1.4.2.4 average value of hopping pulsed emissions. </td> </tr> </tbody> </table> 		<ul style="list-style-type: none"> Refer as ANSI C63.10, clause 4.1.4.2.1 QP value. 	<ul style="list-style-type: none"> Refer as ANSI C63.10, clause 4.1.4.2.2 measurement procedure peak. 	<ul style="list-style-type: none"> Refer as ANSI C63.10, clause 4.1.4.2.4 average value of hopping pulsed emissions.
<ul style="list-style-type: none"> Refer as ANSI C63.10, clause 4.1.4.2.1 QP value. 				
<ul style="list-style-type: none"> Refer as ANSI C63.10, clause 4.1.4.2.2 measurement procedure peak. 				
<ul style="list-style-type: none"> Refer as ANSI C63.10, clause 4.1.4.2.4 average value of hopping pulsed emissions. 				

3.7.4 Test Setup

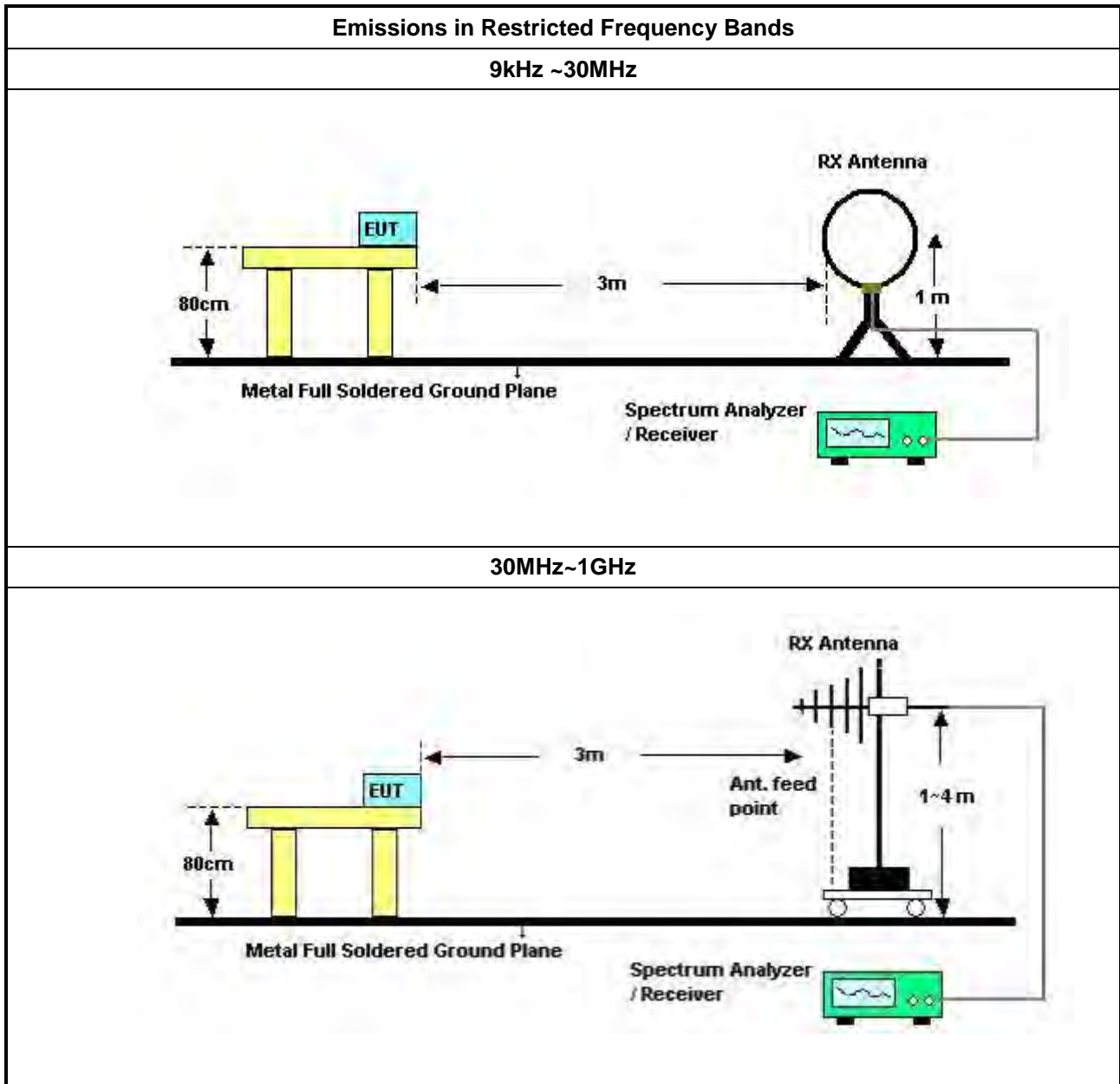

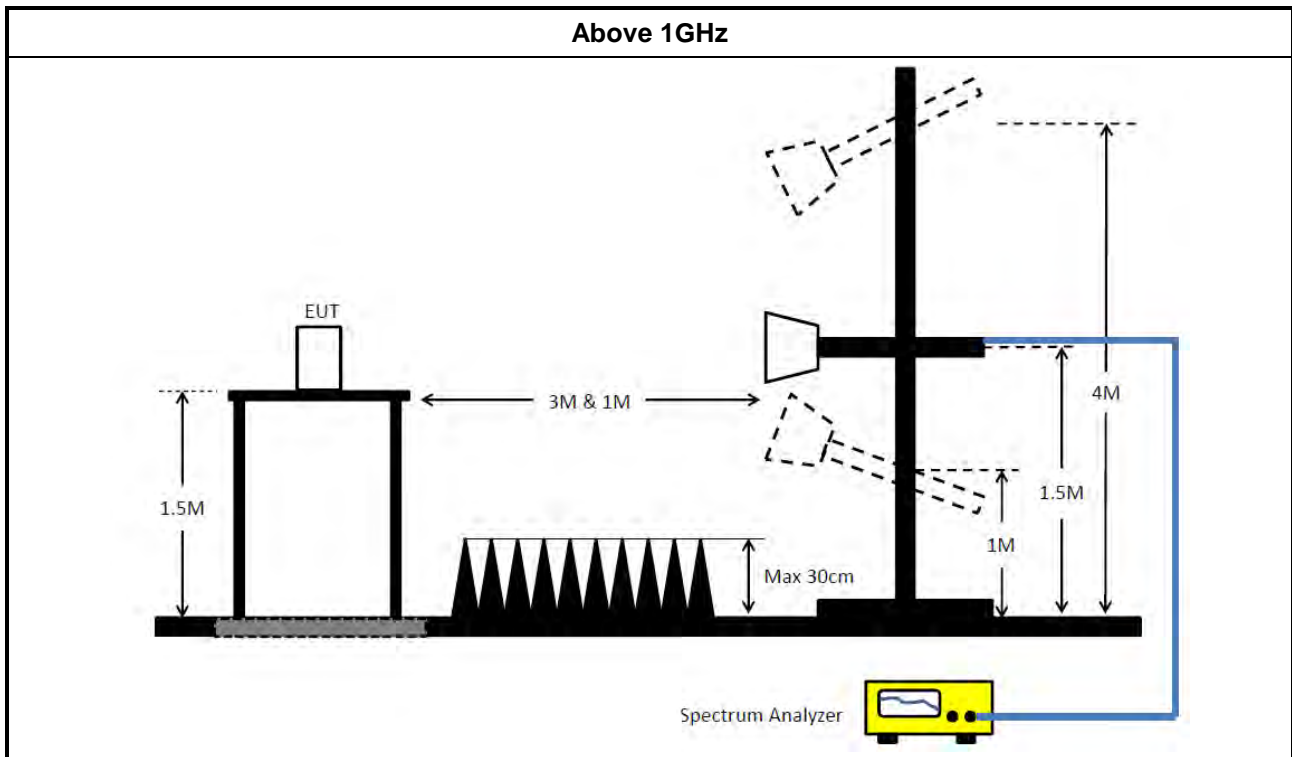

3.7.5 Measurement Results Calculation

The measured Level is calculated using:

Corrected Reading: Antenna factor (AF) + Cable loss (CL) + Read level (Raw) - Preamp factor (PA)(if applicable) = Level.

3.7.6 Emissions in Restricted Frequency Bands (Below 30MHz)

There is a comparison data of both open-field test site and alternative test site - semi-Anechoic chamber according to KDB414788 Radiated Test Site, and the result came out very similar.

All amplitude of spurious emissions that are attenuated by more than 20 dB below the permissible value has no need to be reported.

The radiated emissions were investigated from 9 kHz or the lowest frequency generated within the device, up to the 10th harmonic or 40 GHz, whichever is appropriate.

3.7.7 Test Result of Emissions in Restricted Frequency Bands

Refer as Appendix G



4 Test Equipment and Calibration Data

Instrument	Brand	Model No.	Serial No.	Characteristics	Calibration Date	Calibration Due Date	Remark
EMI Receiver	Agilent	N9038A	My52260123	9kHz ~ 8.4GHz	Feb. 20, 2023	Feb. 19, 2024	Conduction (CO01-CB)
LISN	F.C.C.	FCC-LISN-50-16-2	04083	150kHz ~ 100MHz	Feb. 16, 2023	Feb. 15, 2024	Conduction (CO01-CB)
LISN	Schwarzbeck	NSLK 8127	8127647	9kHz ~ 30MHz	Apr. 27, 2023	Apr. 26, 2024	Conduction (CO01-CB)
Pulse Limiter	Rohde&Schwarz	ESH3-Z2	100430	9kHz ~ 30MHz	Feb. 09, 2023	Feb. 08, 2024	Conduction (CO01-CB)
COND Cable	Woken	Cable	Low cable-CO01	9kHz ~ 30MHz	Oct. 18, 2022	Oct. 17, 2023	Conduction (CO01-CB)
Software	SPORTON	SENSE	V5.10	-	N.C.R.	N.C.R.	Conduction (CO01-CB)
Loop Antenna	Teseq	HLA 6120	31244	9kHz - 30 MHz	Mar. 23, 2023	Mar. 22, 2024	Radiation (03CH05-CB)
3m Semi Anechoic Chamber NSA	TDK	SAC-3M	03CH05-CB	30 MHz ~ 1 GHz	Aug. 03, 2022	Aug. 02, 2023	Radiation (03CH05-CB)
3m Semi Anechoic Chamber VSWR	TDK	SAC-3M	03CH05-CB	1GHz ~18GHz 3m	Nov. 06, 2022	Nov. 05, 2023	Radiation (03CH05-CB)
Bilog Antenna with 6dB Attenuator	TESEQ & EMCI	CBL 6112D & N-6-06	35236 & AT-N0610	30MHz ~ 2GHz	Mar. 24, 2023	Mar. 23, 2024	Radiation (03CH05-CB)
Horn Antenna	SCHWARZBECK	BBHA9120D	BBHA 9120 D-1291	1GHz~18GHz	Jun. 08, 2023	Jun. 07, 2024	Radiation (03CH05-CB)
Horn Antenna	Schwarzbeck	BBHA 9170	BBHA9170252	15GHz ~ 40GHz	Aug. 22, 2022	Aug. 21, 2023	Radiation (03CH05-CB)
Amplifier	EMCI	EMC330N	980331	20MHz ~ 3GHz	May 03, 2023	May 02, 2024	Radiation (03CH05-CB)
Pre-Amplifier	EMCI	EMC12630SE	980287	1GHz ~ 26.5GHz	Jun. 30, 2023	Jun. 29, 2024	Radiation (03CH05-CB)
Pre-Amplifier	SGH	SGH184	20221107-3	18GHz ~ 40GHz	Nov. 16, 2022	Nov. 15, 2023	Radiation (03CH05-CB)
Spectrum Analyzer	R&S	FSP40	100304	9kHz ~ 40GHz	Apr. 18, 2023	Apr. 17, 2024	Radiation (03CH05-CB)
EMI Test Receiver	R&S	ESCS	826547/017	9kHz ~ 2.75GHz	Jun. 13, 2023	Jun. 12, 2024	Radiation (03CH05-CB)
RF Cable-low	Woken	RG402	Low Cable-04+23	30MHz~1GHz	Oct. 03, 2022	Oct. 02, 2023	Radiation (03CH05-CB)
RF Cable-high	Woken	RG402	High Cable-28	1GHz~18GHz	Oct. 03, 2022	Oct. 02, 2023	Radiation (03CH05-CB)
RF Cable-high	Woken	RG402	High Cable-04+28	1GHz~18GHz	Oct. 03, 2022	Oct. 02, 2023	Radiation (03CH05-CB)
High Cable	Woken	WCA0929M	40G#5+6	1GHz ~ 40 GHz	Dec. 07, 2022	Dec. 06, 2023	Radiation (03CH05-CB)



Instrument	Brand	Model No.	Serial No.	Characteristics	Calibration Date	Calibration Due Date	Remark
High Cable	Woken	WCA0929M	40G#5	1GHz ~ 40 GHz	Dec. 07, 2022	Dec. 06, 2023	Radiation (03CH05-CB)
High Cable	Woken	WCA0929M	40G#6	1GHz ~ 40 GHz	Dec. 07, 2022	Dec. 06, 2023	Radiation (03CH05-CB)
Test Software	SPORTON	SENSE	V5.10	-	N.C.R.	N.C.R.	Radiation (03CH05-CB)
3m Semi Anechoic Chamber VSWR	TDK	SAC-3M	03CH01-CB	1GHz ~18GHz 3m	May 05, 2023	May 04, 2024	Radiation (03CH01-CB)
Horn Antenna	ETS-LINDGREN	3115	00075790	750MHz ~ 18GHz	Nov. 04, 2022	Nov. 03, 2023	Radiation (03CH01-CB)
Horn Antenna	Schwarzbeck	BBHA 9170	BBHA9170252	15GHz ~ 40GHz	Aug. 22, 2022	Aug. 21, 2023	Radiation (03CH01-CB)
Pre-Amplifier	Agilent	8449B	3008A02121	1GHz ~ 26.5GHz	May 19, 2022	May 18, 2023	Radiation (03CH01-CB)
Pre-Amplifier	SGH	SGH184	20221107-3	18GHz ~ 40GHz	Nov. 16, 2022	Nov. 15, 2023	Radiation (03CH01-CB)
Signal Analyzer	R&S	FSV3044	101437	10kHz ~ 44GHz	Nov 29, 2022	Nov 29, 2023	Radiation (03CH01-CB)
RF Cable-high	Woken	RG402	High Cable-16	1 GHz ~ 18 GHz	Oct. 03, 2022	Oct. 02, 2023	Radiation (03CH01-CB)
RF Cable-high	Woken	RG402	High Cable-16+17	1 GHz ~ 18 GHz	Oct. 03, 2022	Oct. 02, 2023	Radiation (03CH01-CB)
High Cable	Woken	WCA0929M	40G#5+6	1GHz ~ 40 GHz	Dec. 07, 2022	Dec. 06, 2023	Radiation (03CH01-CB)
High Cable	Woken	WCA0929M	40G#5	1GHz ~ 40 GHz	Dec. 07, 2022	Dec. 06, 2023	Radiation (03CH01-CB)
High Cable	Woken	WCA0929M	40G#6	1GHz ~ 40 GHz	Dec. 07, 2022	Dec. 06, 2023	Radiation (03CH01-CB)
Test Software	SPORTON	SENSE	V5.10	-	N.C.R.	N.C.R.	Radiation (03CH01-CB)
Spectrum analyzer	R&S	FSV40	101027	9kHz~40GHz	Aug. 15, 2022	Aug. 14, 2023	Conducted (TH02-CB)
Power Sensor	Anritsu	MA2411B	1126203	300MHz~40GHz	Oct. 17, 2022	Oct. 16, 2023	Conducted (TH02-CB)
Power Meter	Anritsu	ML2495A	1210004	300MHz~40GHz	Oct. 17, 2022	Oct. 16, 2023	Conducted (TH02-CB)
RF Cable-high	Woken	RG402	High Cable-01	1 GHz – 18 GHz	Oct. 03, 2022	Oct. 02, 2023	Conducted (TH02-CB)
RF Cable-high	Woken	RG402	High Cable-02	1 GHz – 18 GHz	Oct. 03, 2022	Oct. 02, 2023	Conducted (TH02-CB)
RF Cable-high	Woken	RG402	High Cable-03	1 GHz – 18 GHz	Oct. 03, 2022	Oct. 02, 2023	Conducted (TH02-CB)
RF Cable-high	Woken	RG402	High Cable-04	1 GHz – 18 GHz	Oct. 03, 2022	Oct. 02, 2023	Conducted (TH02-CB)
RF Cable-high	Woken	RG402	High Cable-05	1 GHz – 18 GHz	Oct. 03, 2022	Oct. 02, 2023	Conducted (TH02-CB)
Switch	SPTCB	SP-SWI	SWI-02	1 GHz ~26.5 GHz	Oct. 04, 2022	Oct. 03, 2023	Conducted (TH02-CB)



Instrument	Brand	Model No.	Serial No.	Characteristics	Calibration Date	Calibration Due Date	Remark
Test Software	SPORTON	SENSE	V5.10	-	N.C.R.	N.C.R.	Conducted (TH02-CB)

Note: Calibration Interval of instruments listed above is one year.

N.C.R. means Non-Calibration required.



Summary

Mode	Result	Type	Freq (Hz)	Level (dBuV)	Limit (dBuV)	Margin (dB)	Condition
Mode 2	Pass	AV	21.665M	44.89	50.00	-5.11	Neutral

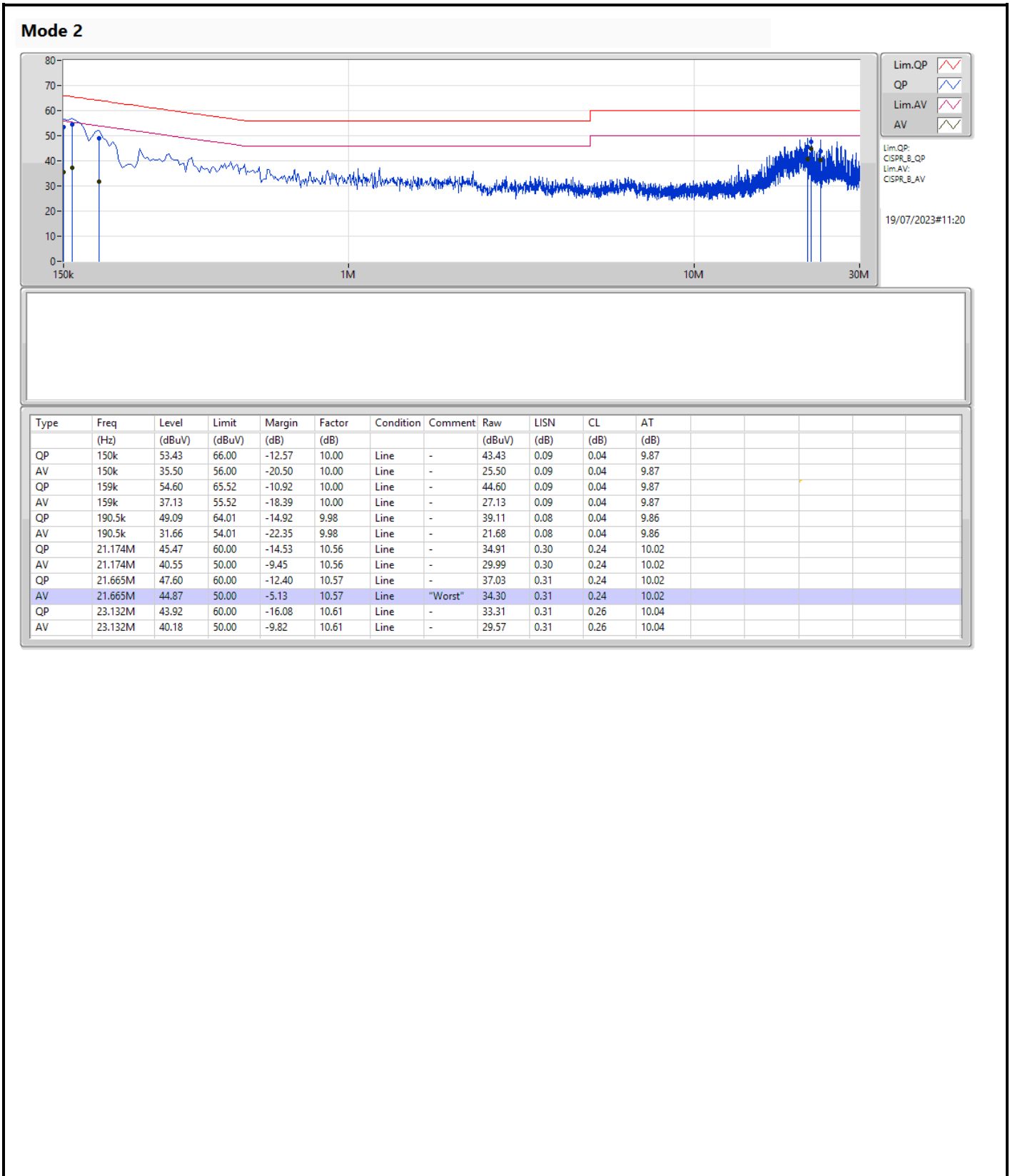

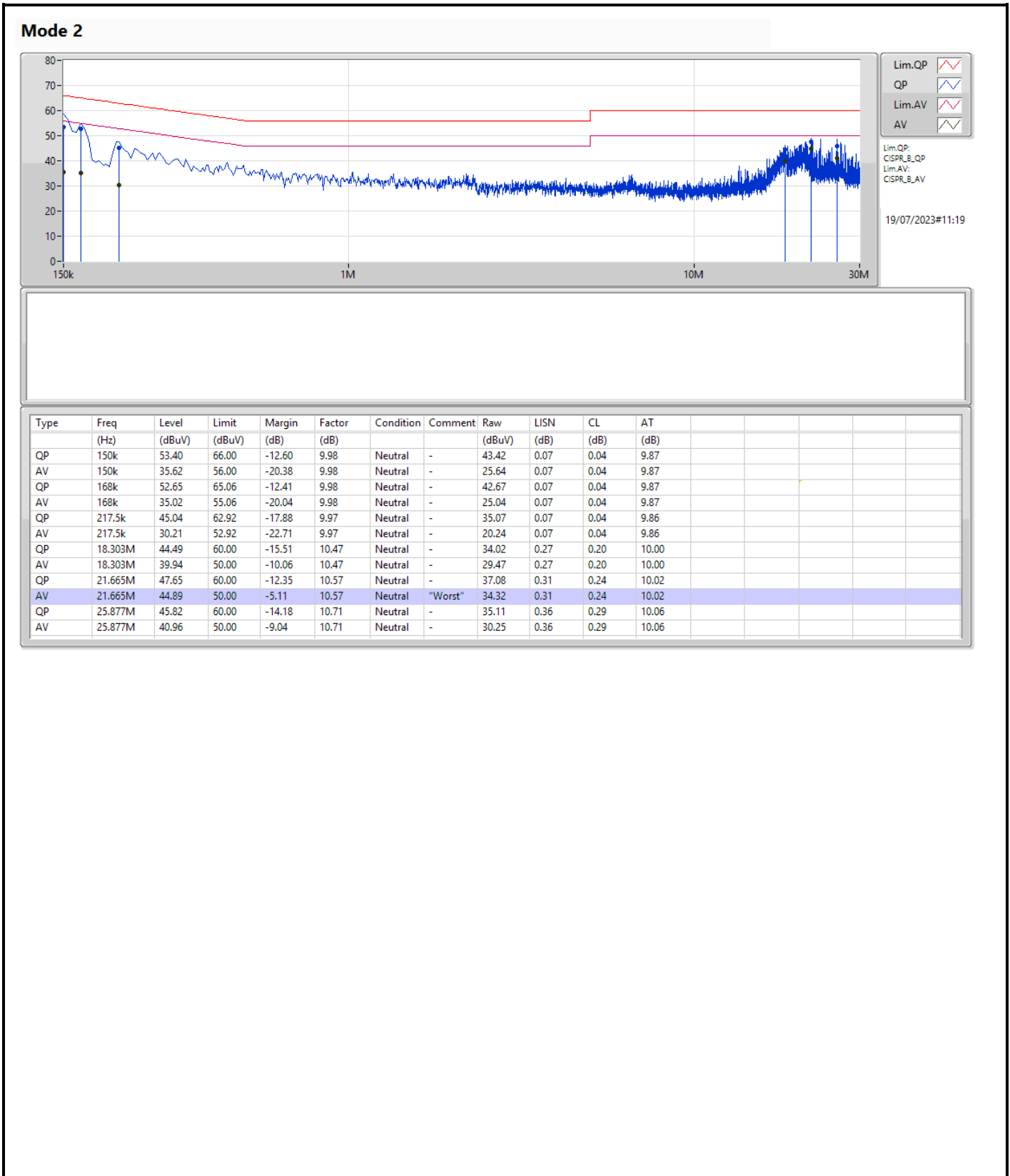



Summary

Mode	Max-N dB (Hz)	Max-OBW (Hz)	ITU-Code	Min-N dB (Hz)	Min-OBW (Hz)
2.4-2.4835GHz	-	-	-	-	-
BT-BR(1Mbps)	880k	844.578k	845KF1D	874.5k	839.58k
BT-EDR(2Mbps)	1.304M	1.192M	1M19G1D	1.254M	1.183M
BT-EDR(3Mbps)	1.257M	1.203M	1M20G1D	1.251M	1.191M

Max-N dB = Maximum 20dB down bandwidth; Max-OBW = Maximum 99% occupied bandwidth;
Min-N dB = Minimum 20dB down bandwidth; Min-OBW = Minimum 99% occupied bandwidth



Result

Mode	Result	Limit (Hz)	Port 1-N dB (Hz)	Port 1-OBW (Hz)
BT-BR(1Mbps)	-	-	-	-
2402MHz	Pass	Inf	874.5k	844.578k
2440MHz	Pass	Inf	877.25k	840.83k
2480MHz	Pass	Inf	880k	839.58k
BT-EDR(2Mbps)	-	-	-	-
2402MHz	Pass	Inf	1.254M	1.192M
2440MHz	Pass	Inf	1.257M	1.183M
2480MHz	Pass	Inf	1.304M	1.192M
BT-EDR(3Mbps)	-	-	-	-
2402MHz	Pass	Inf	1.251M	1.203M
2440MHz	Pass	Inf	1.257M	1.191M
2480MHz	Pass	Inf	1.257M	1.199M

Port X-N dB = Port X 20dB down bandwidth;
Port X-OBW = Port X 99% occupied bandwidth

2.4-2.4835GHz_BT-BR(1Mbps)

EBW-FS

2402MHz

18/05/2023

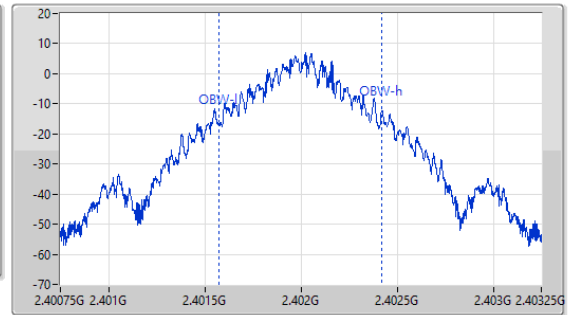
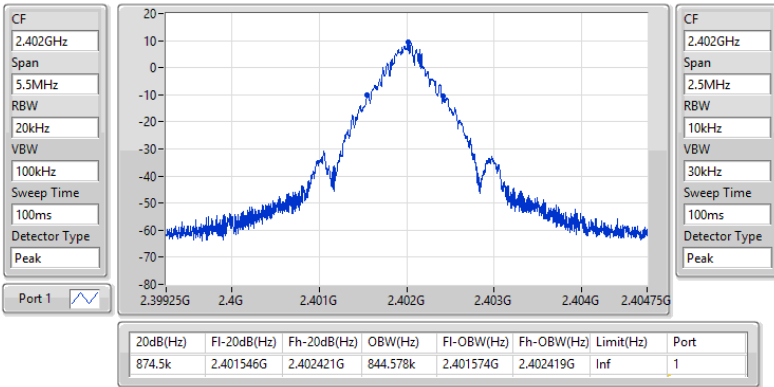

2.4-2.4835GHz_BT-BR(1Mbps)

EBW-FS

2440MHz

18/05/2023

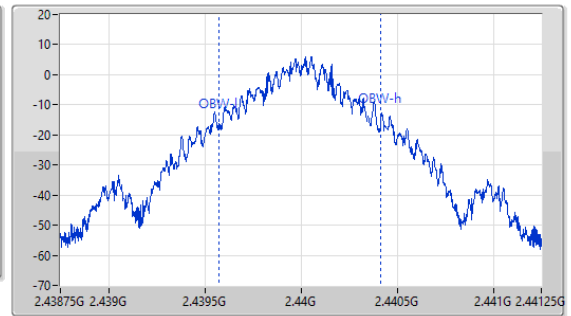
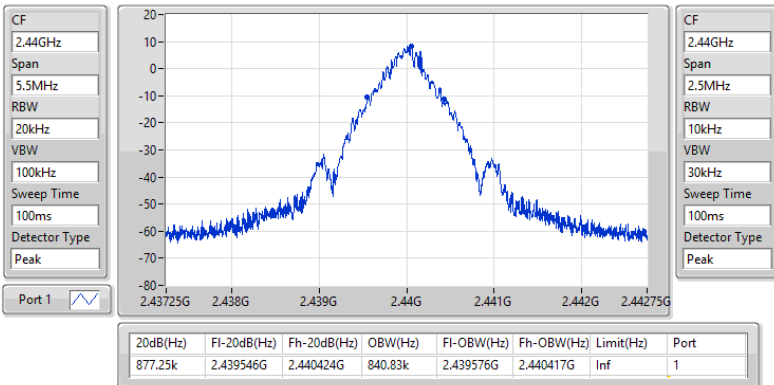

2.4-2.4835GHz_BT-BR(1Mbps)

EBW-FS

2480MHz

18/05/2023

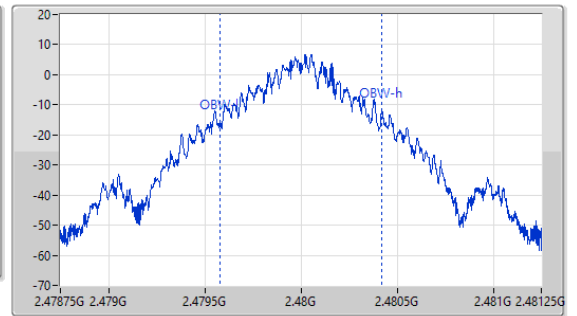
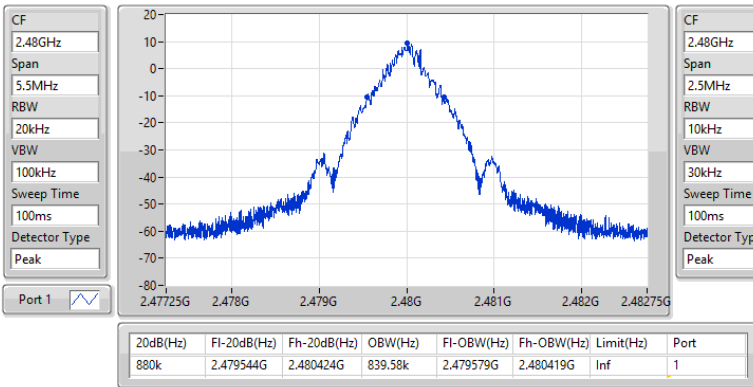

2.4-2.4835GHz_BT-EDR(2Mbps)

EBW-FS

2402MHz

18/05/2023

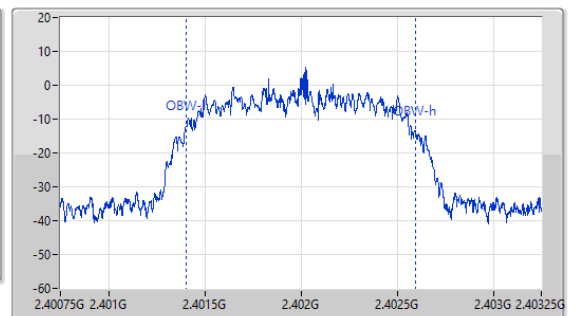
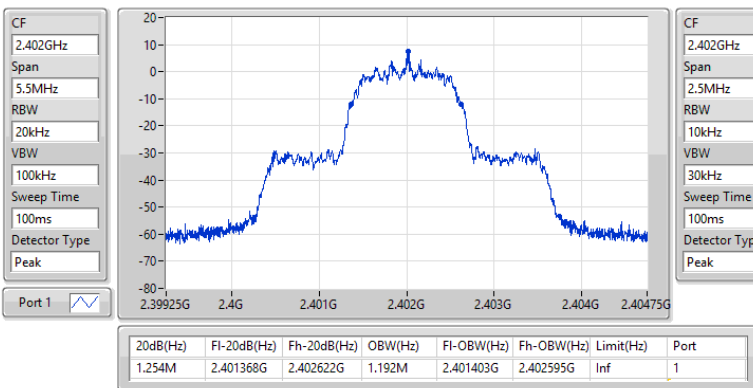

2.4-2.4835GHz_BT-EDR(2Mbps)

EBW-FS

2440MHz

18/05/2023

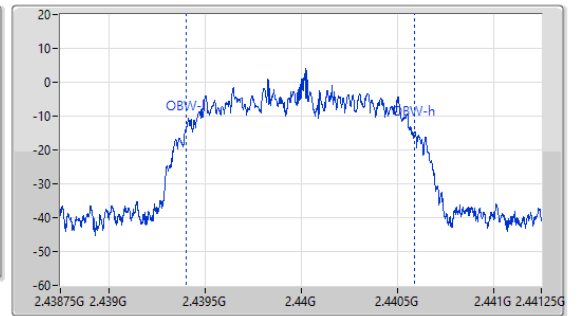
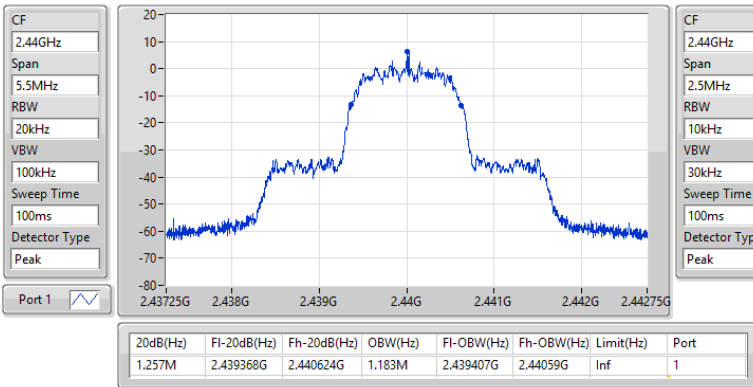

2.4-2.4835GHz_BT-EDR(2Mbps)

EBW-FS

2480MHz

18/05/2023

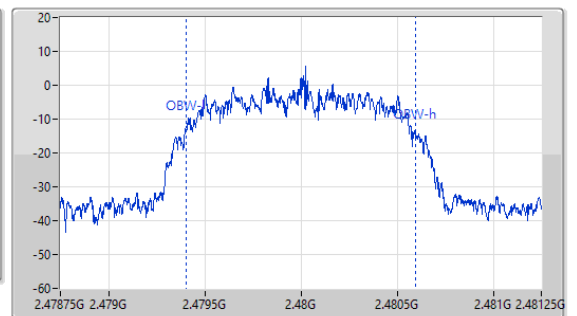
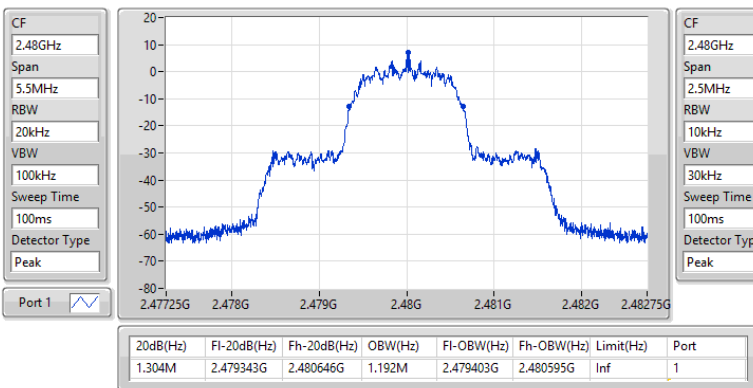

2.4-2.4835GHz_BT-EDR(3Mbps)

EBW-FS

2402MHz

18/05/2023

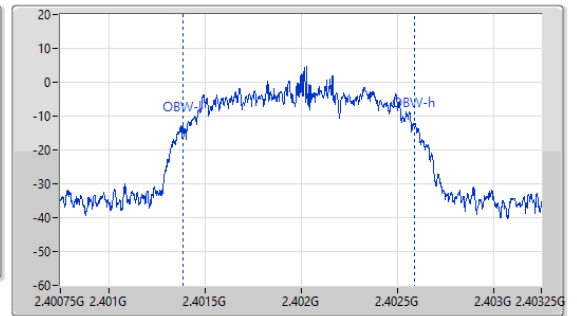
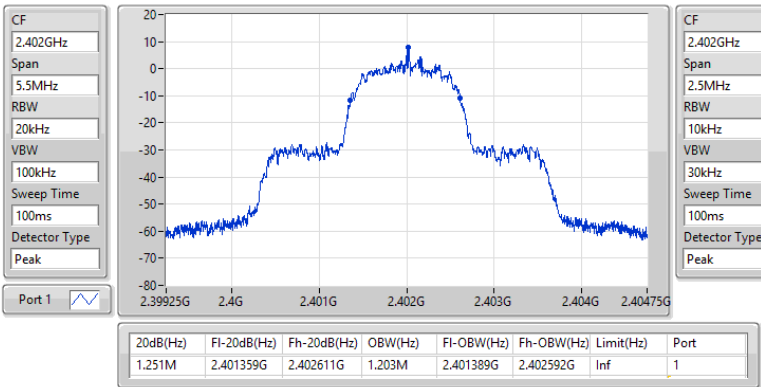

2.4-2.4835GHz_BT-EDR(3Mbps)

EBW-FS

2440MHz

18/05/2023

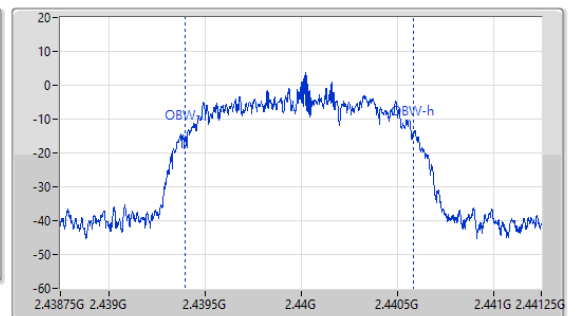
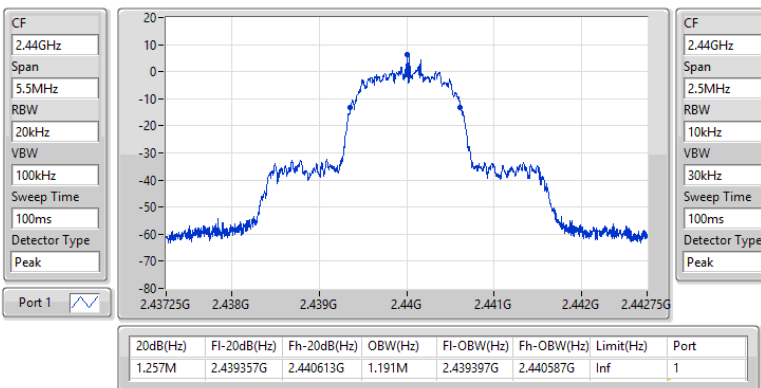

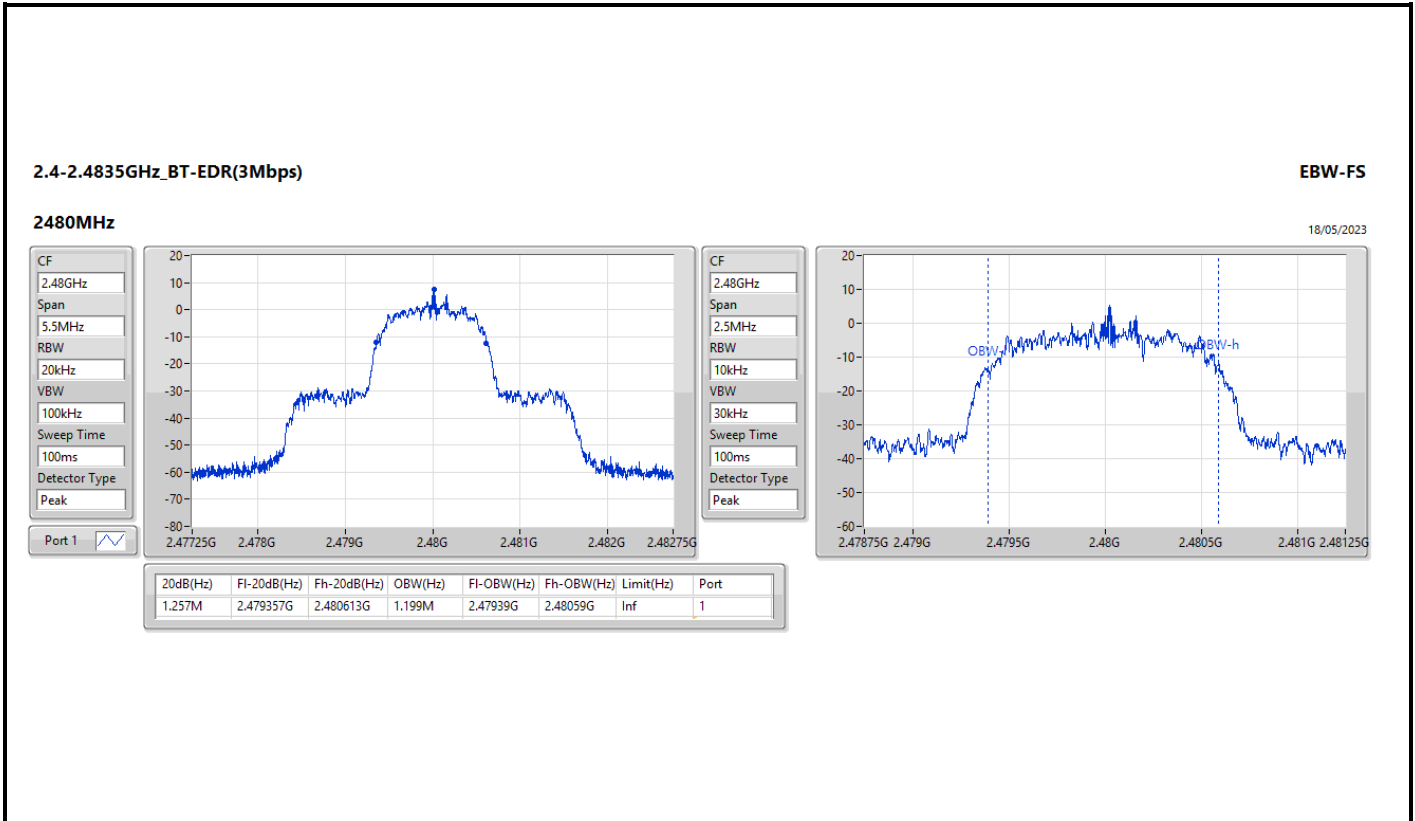



Summary

Mode	Max-Space (Hz)	Min-Space (Hz)
2.4-2.4835GHz	-	-
BT-BR(1Mbps)	1.002M	999k
BT-EDR(2Mbps)	1.002M	999k
BT-EDR(3Mbps)	1.002M	999k



Result

Mode	Result	Fl (Hz)	Fh (Hz)	Ch.Space (Hz)	Limit (Hz)
BT-BR(1Mbps)	-	-	-	-	-
2402MHz	Pass	2.40201G	2.403012G	1.002M	582.417k
2440MHz	Pass	2.44001G	2.441012G	1.002M	584.2485k
2480MHz	Pass	2.479011G	2.48001G	999k	586.08k
BT-EDR(2Mbps)	-	-	-	-	-
2402MHz	Pass	2.40201G	2.403012G	1.002M	835.164k
2440MHz	Pass	2.440011G	2.441012G	1.0005M	837.162k
2480MHz	Pass	2.479013G	2.480012G	999k	868.464k
BT-EDR(3Mbps)	-	-	-	-	-
2402MHz	Pass	2.402011G	2.403012G	1.0005M	833.166k
2440MHz	Pass	2.440011G	2.44101G	999k	837.162k
2480MHz	Pass	2.479011G	2.480013G	1.002M	837.162k

2.4-2.4835GHz_BT-BR(1Mbps)

Channel Separation-FS

2.402G/2.403GHz

18/05/2023

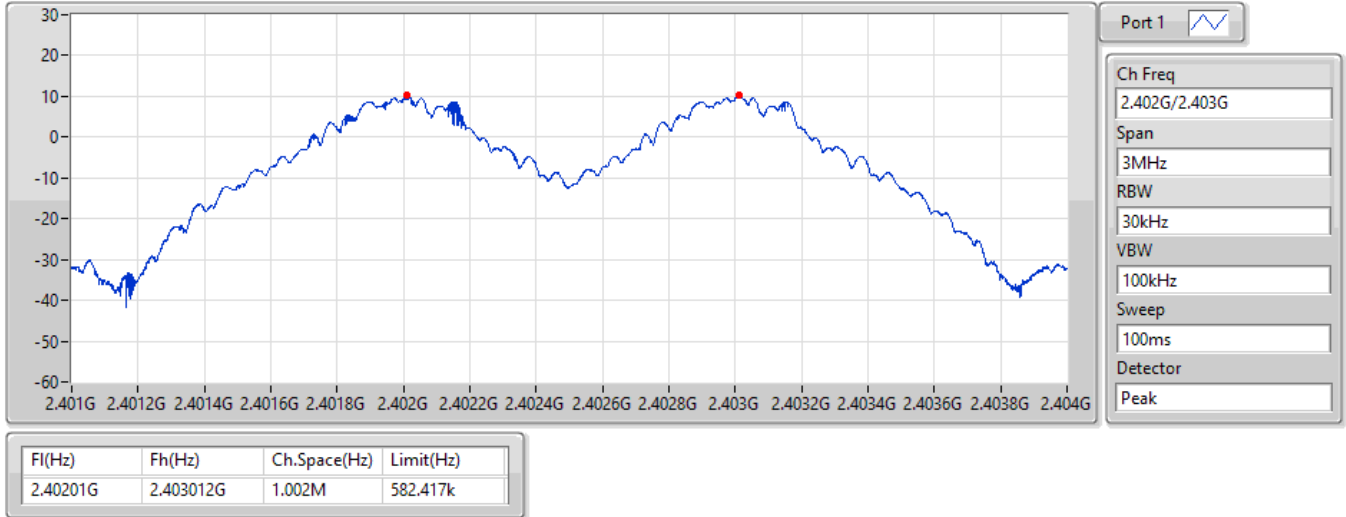

2.4-2.4835GHz_BT-BR(1Mbps)

Channel Separation-FS

2.44G/2.441GHz

18/05/2023

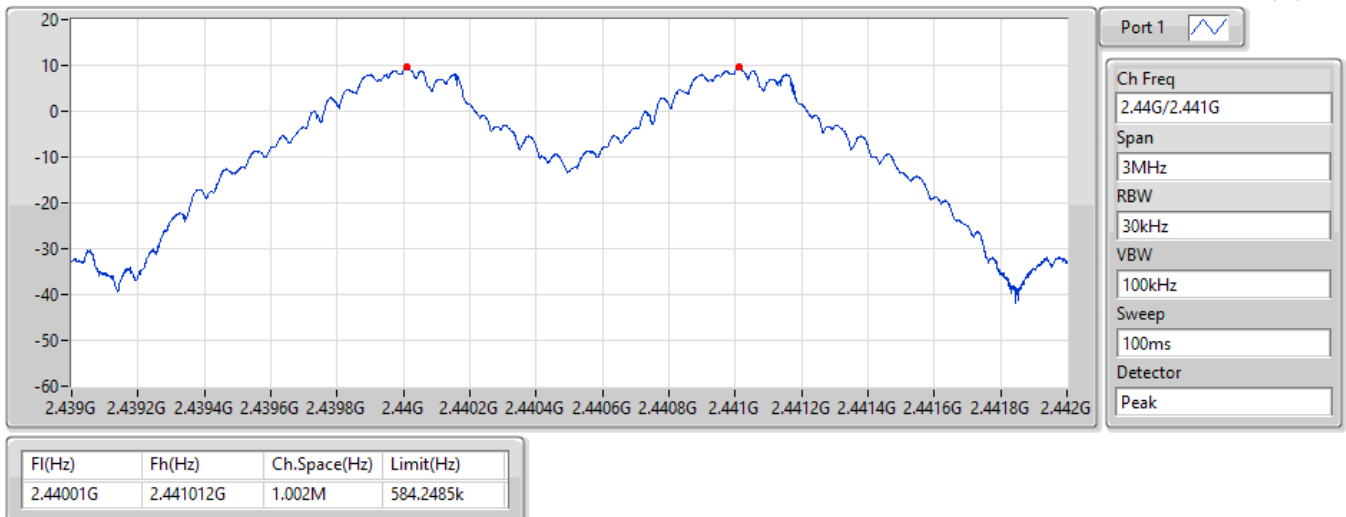

2.4-2.4835GHz_BT-BR(1Mbps)

Channel Separation-FS

2.48G/2.479GHz

18/05/2023

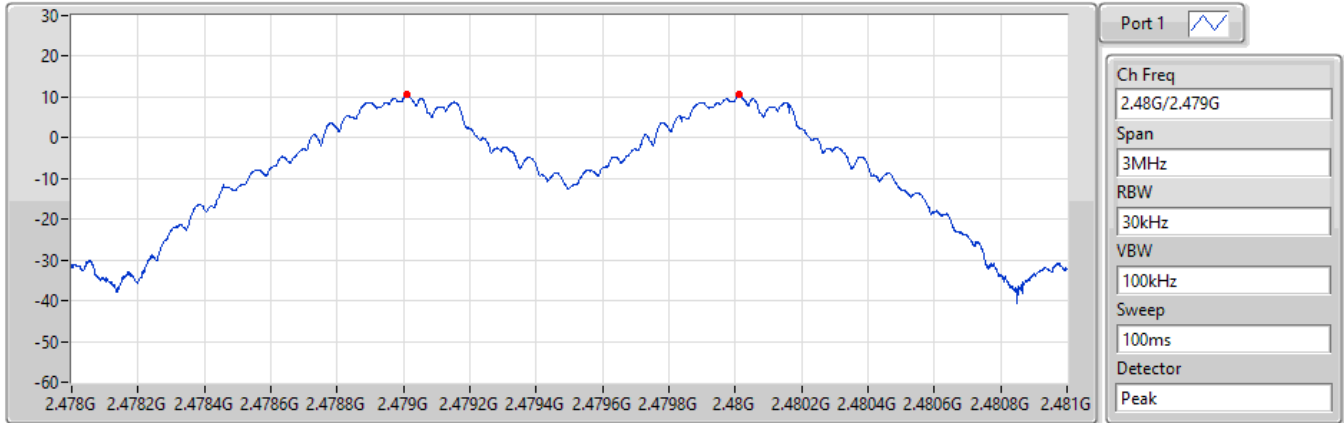

Fl(Hz)	Fh(Hz)	Ch.Space(Hz)	Limit(Hz)
2.479011G	2.48001G	999k	586.08k

2.4-2.4835GHz_BT-EDR(2Mbps)

Channel Separation-FS

2.402G/2.403GHz

18/05/2023

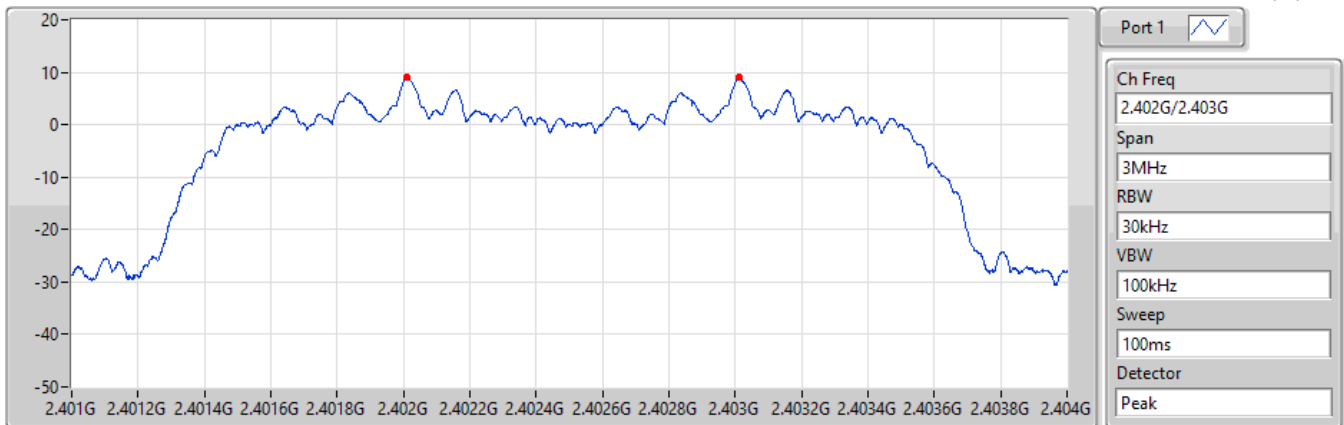

Fl(Hz)	Fh(Hz)	Ch.Space(Hz)	Limit(Hz)
2.40201G	2.403012G	1.002M	835.164k

2.4-2.4835GHz_BT-EDR(2Mbps)

Channel Separation-FS

2.44G/2.441GHz

18/05/2023

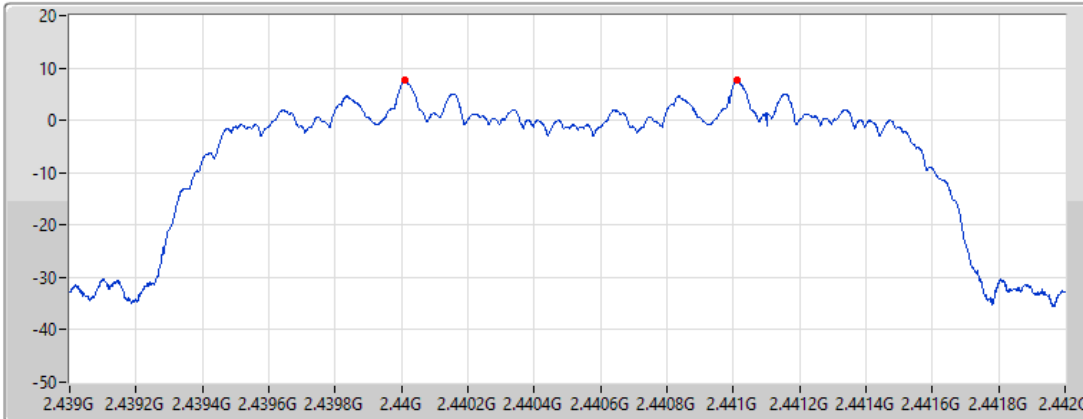

Port 1 

Ch Freq
2.44G/2.441G

Span
3MHz

RBW
30kHz

VBW
100kHz

Sweep
100ms

Detector
Peak

Fl(Hz)	Fh(Hz)	Ch.Space(Hz)	Limit(Hz)
2.440011G	2.441012G	1.0005M	837.162k

2.4-2.4835GHz_BT-EDR(2Mbps)

Channel Separation-FS

2.48G/2.479GHz

18/05/2023

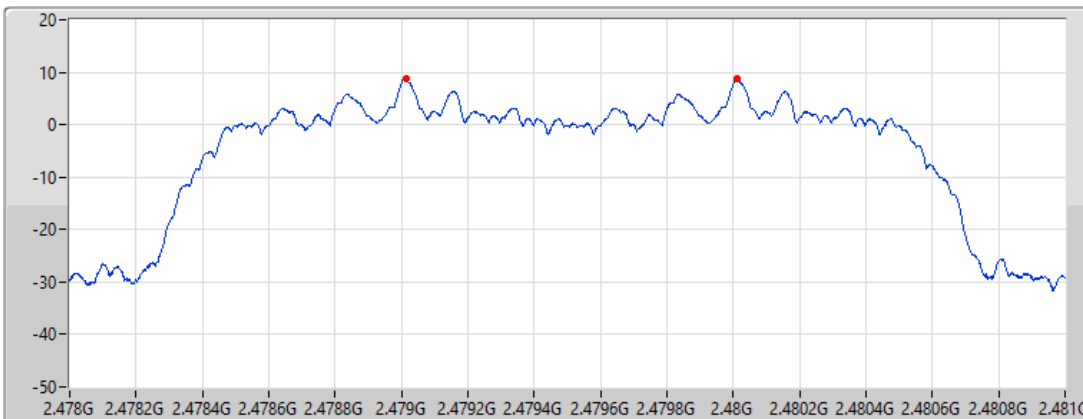

Port 1 

Ch Freq
2.48G/2.479G

Span
3MHz

RBW
30kHz

VBW
100kHz

Sweep
100ms

Detector
Peak

Fl(Hz)	Fh(Hz)	Ch.Space(Hz)	Limit(Hz)
2.479013G	2.480012G	999k	868.464k

2.4-2.4835GHz_BT-EDR(3Mbps)

Channel Separation-FS

2.402G/2.403GHz

18/05/2023

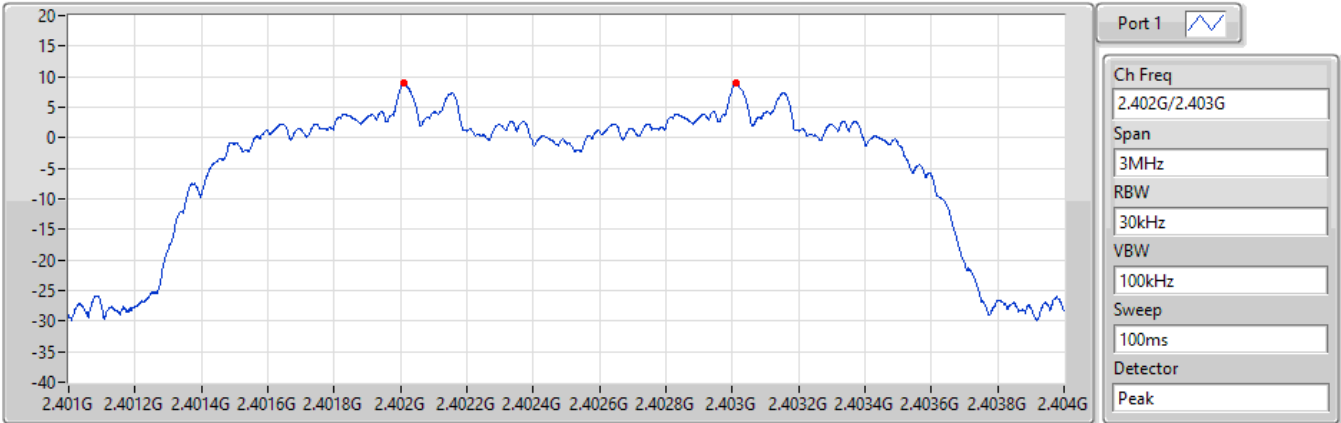

F1(Hz)	Fh(Hz)	Ch.Space(Hz)	Limit(Hz)
2.402011G	2.403012G	1.0005M	833.166k

2.4-2.4835GHz_BT-EDR(3Mbps)

Channel Separation-FS

2.44G/2.441GHz

18/05/2023

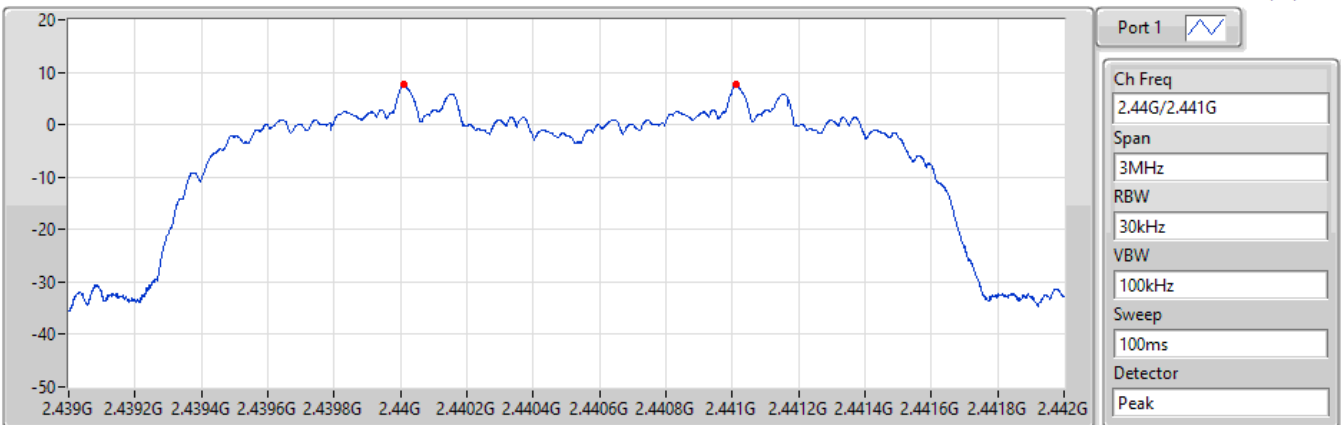

F1(Hz)	Fh(Hz)	Ch.Space(Hz)	Limit(Hz)
2.440011G	2.44101G	999k	837.162k

2.4-2.4835GHz_BT-EDR(3Mbps)

Channel Separation-FS

2.48G/2.479GHz

18/05/2023

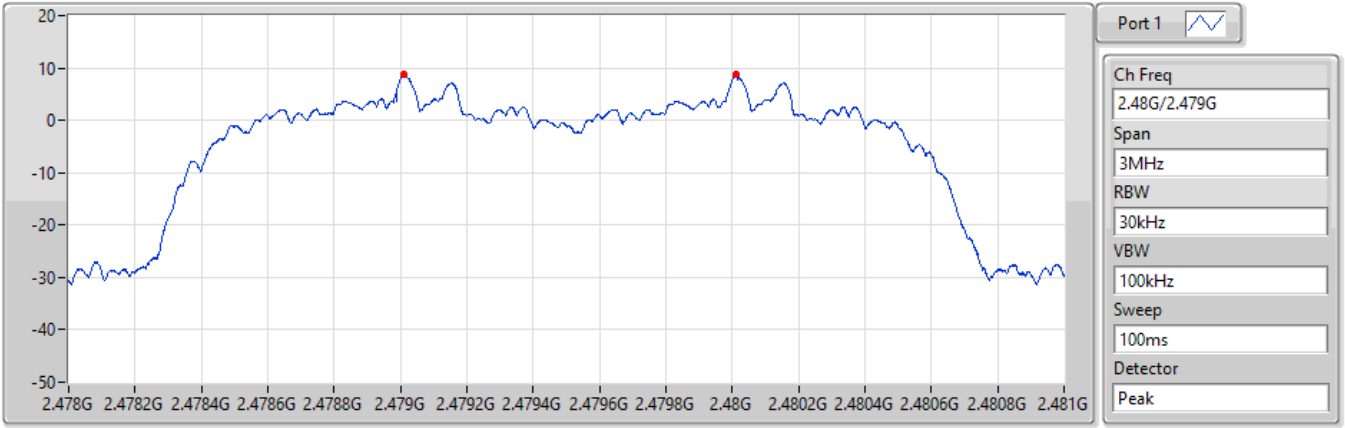

Fl(Hz)	Fh(Hz)	Ch.Space(Hz)	Limit(Hz)
2.479011G	2.480013G	1.002M	837.162k



Summary

Mode	Total Power (dBm)	Power (W)
2.4-2.4835GHz	-	-
BT-BR(1Mbps)	12.62	0.01828
BT-EDR(2Mbps)	10.45	0.01109
BT-EDR(3Mbps)	10.69	0.01172



Result

Mode	Result	DG (dBi)	Total Power (dBm)	Power Limit (dBm)
BT-BR(1Mbps)	-	-	-	-
2402MHz	Pass	2.40	12.62	21.00
2440MHz	Pass	2.40	11.75	21.00
2480MHz	Pass	2.40	12.51	21.00
BT-EDR(2Mbps)	-	-	-	-
2402MHz	Pass	2.40	10.30	21.00
2440MHz	Pass	2.40	9.31	21.00
2480MHz	Pass	2.40	10.45	21.00
BT-EDR(3Mbps)	-	-	-	-
2402MHz	Pass	2.40	10.69	21.00
2440MHz	Pass	2.40	9.34	21.00
2480MHz	Pass	2.40	10.30	21.00

DG = Directional Gain; Port X = Port X output power



Summary

Mode	Total Power (dBm)	Power (W)
2.4-2.4835GHz	-	-
BT-BR(1Mbps)	12.65	0.01841
BT-EDR(2Mbps)	12.12	0.01629
BT-EDR(3Mbps)	12.39	0.01734



Result

Mode	Result	DG (dBi)	Total Power (dBm)	Power Limit (dBm)
BT-BR(1Mbps)	-	-	-	-
2402MHz	Pass	2.40	12.65	21.00
2440MHz	Pass	2.40	11.80	21.00
2480MHz	Pass	2.40	12.53	21.00
BT-EDR(2Mbps)	-	-	-	-
2402MHz	Pass	2.40	12.11	21.00
2440MHz	Pass	2.40	11.27	21.00
2480MHz	Pass	2.40	12.12	21.00
BT-EDR(3Mbps)	-	-	-	-
2402MHz	Pass	2.40	12.39	21.00
2440MHz	Pass	2.40	11.50	21.00
2480MHz	Pass	2.40	12.29	21.00

DG = Directional Gain; Port X = Port X output power

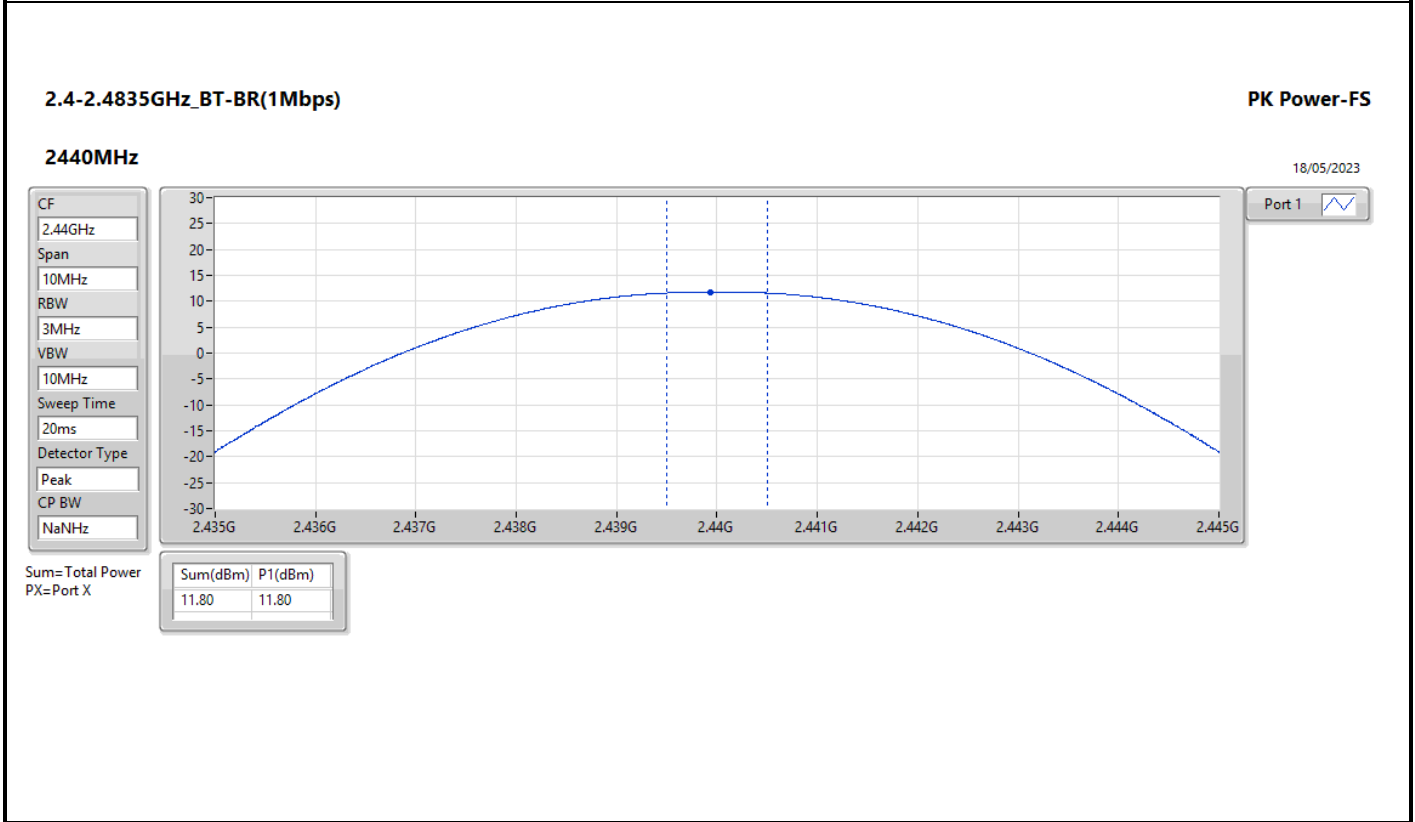
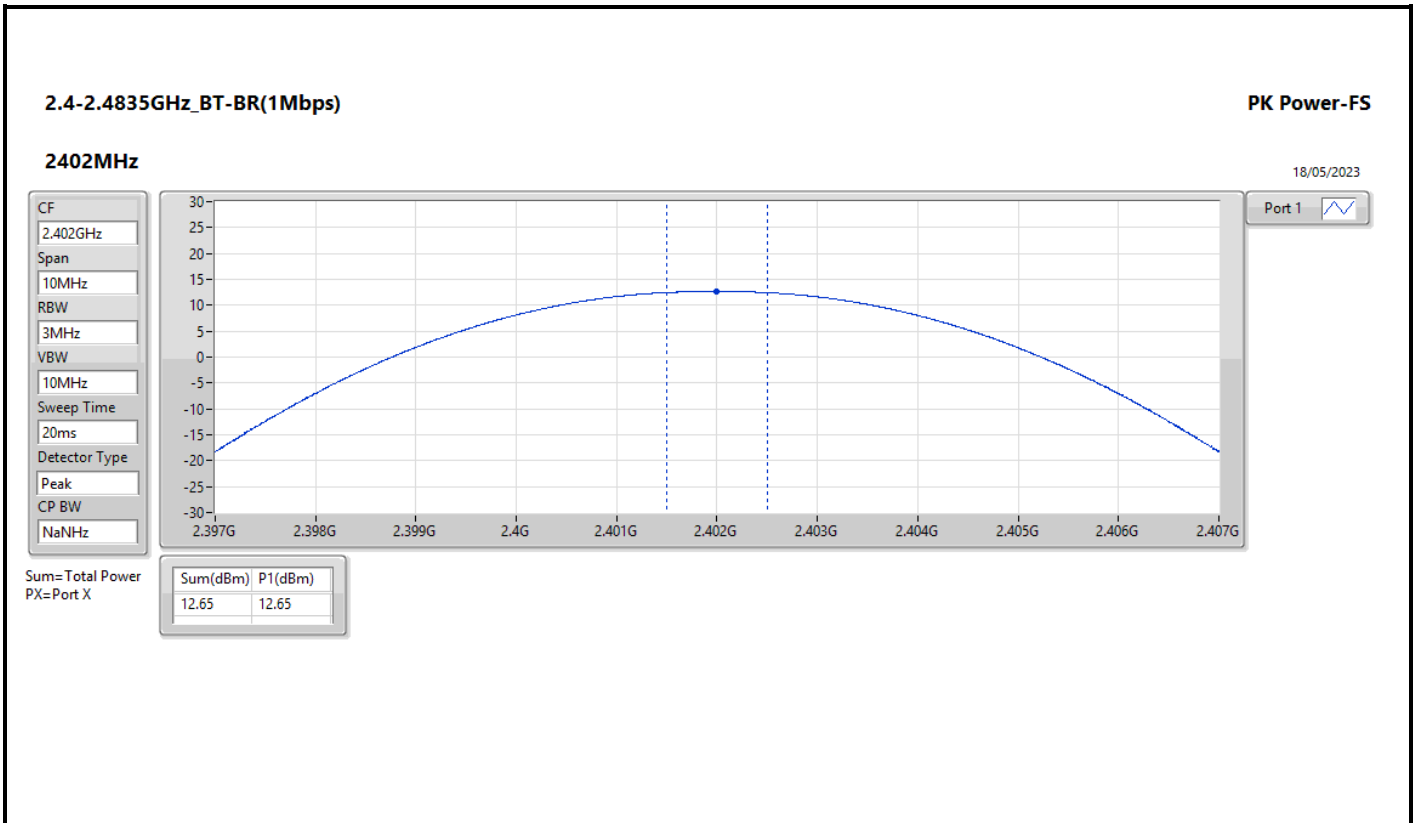

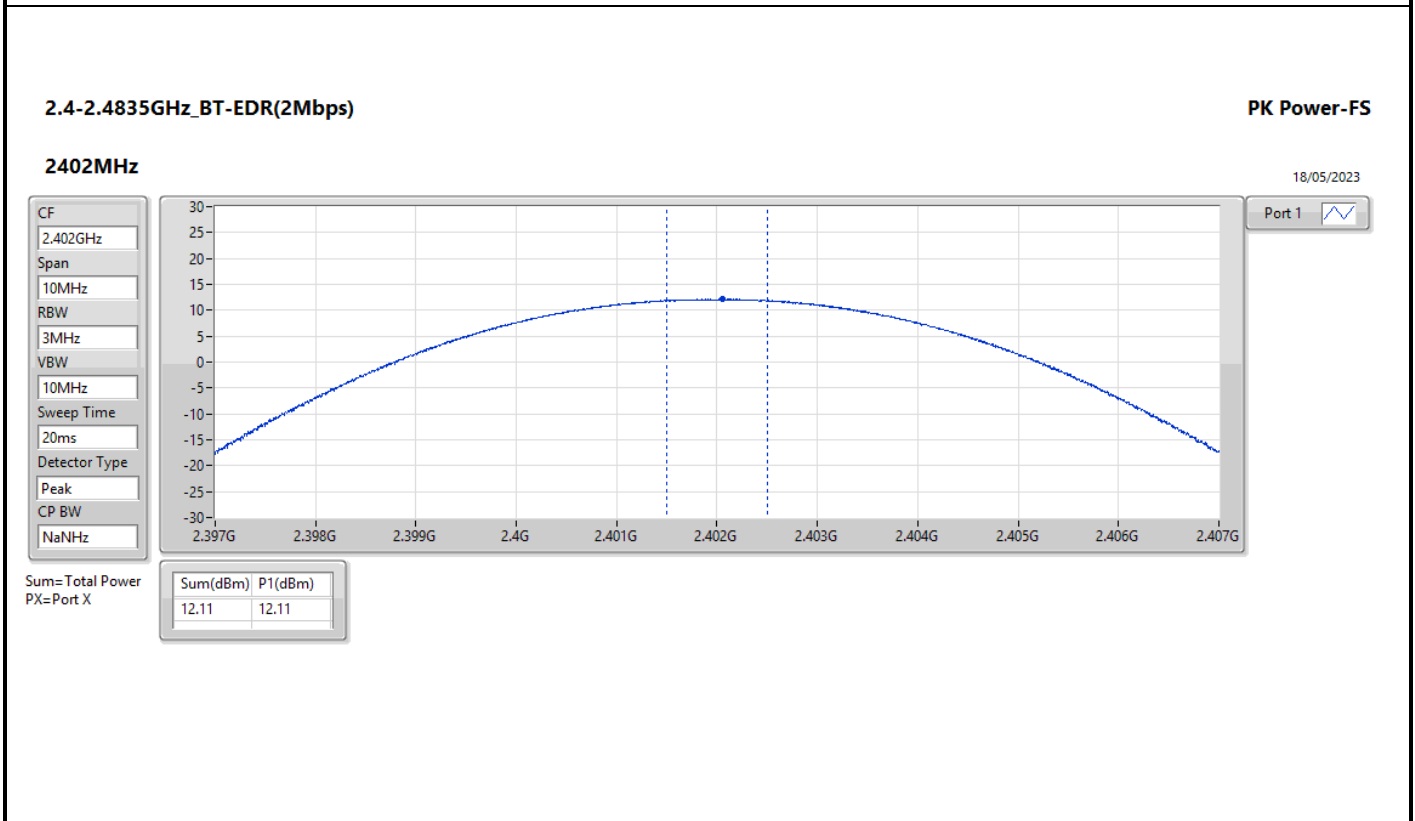
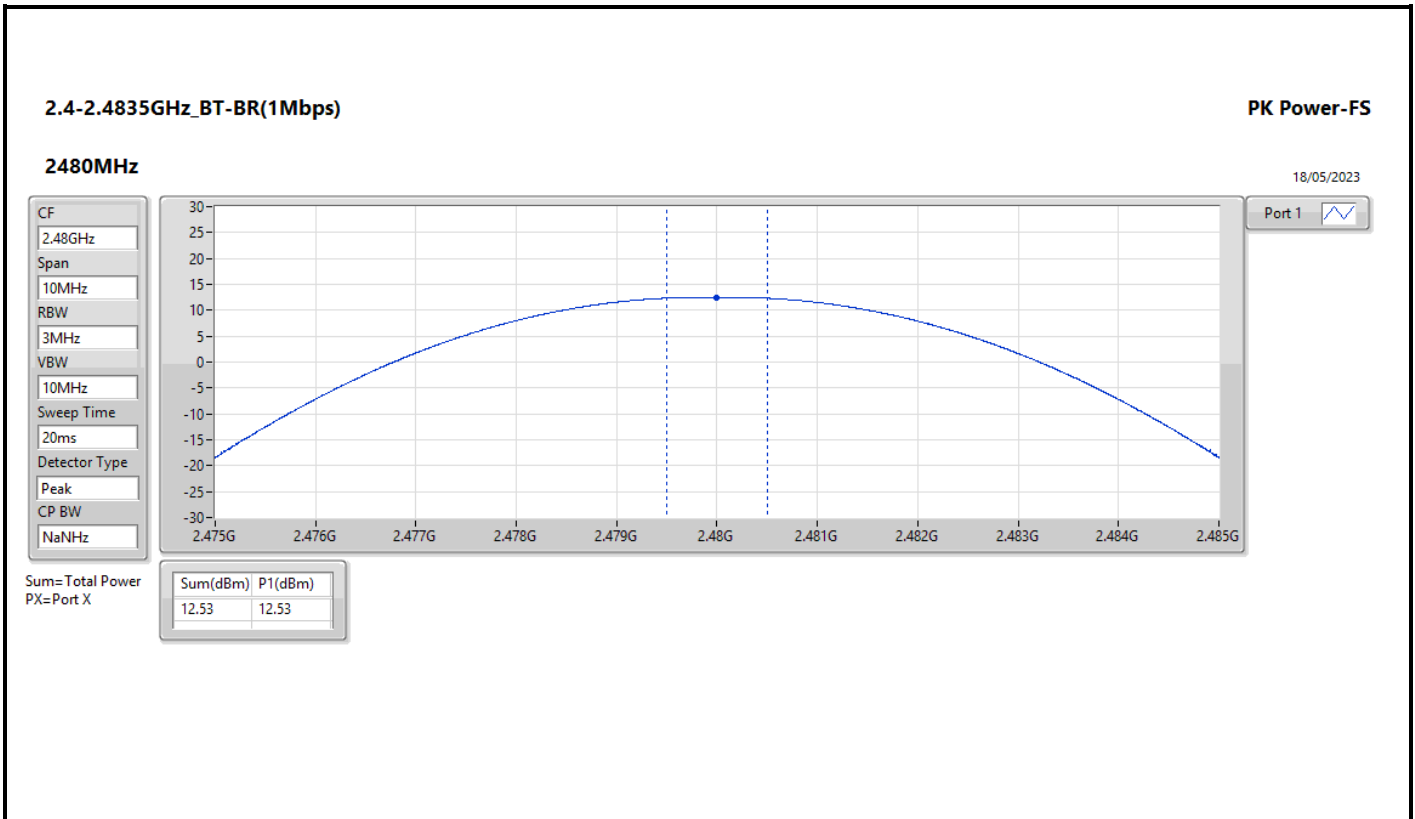

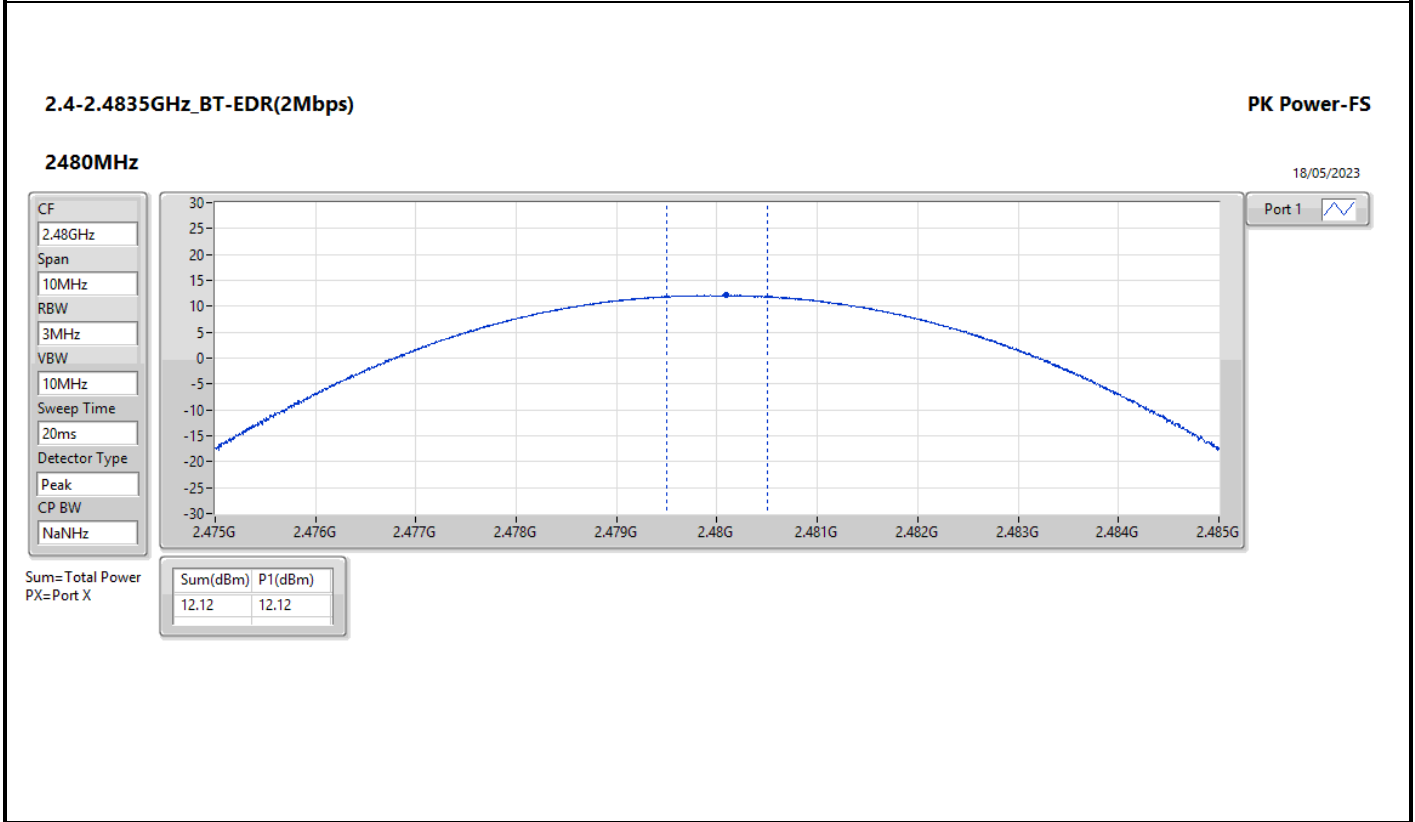
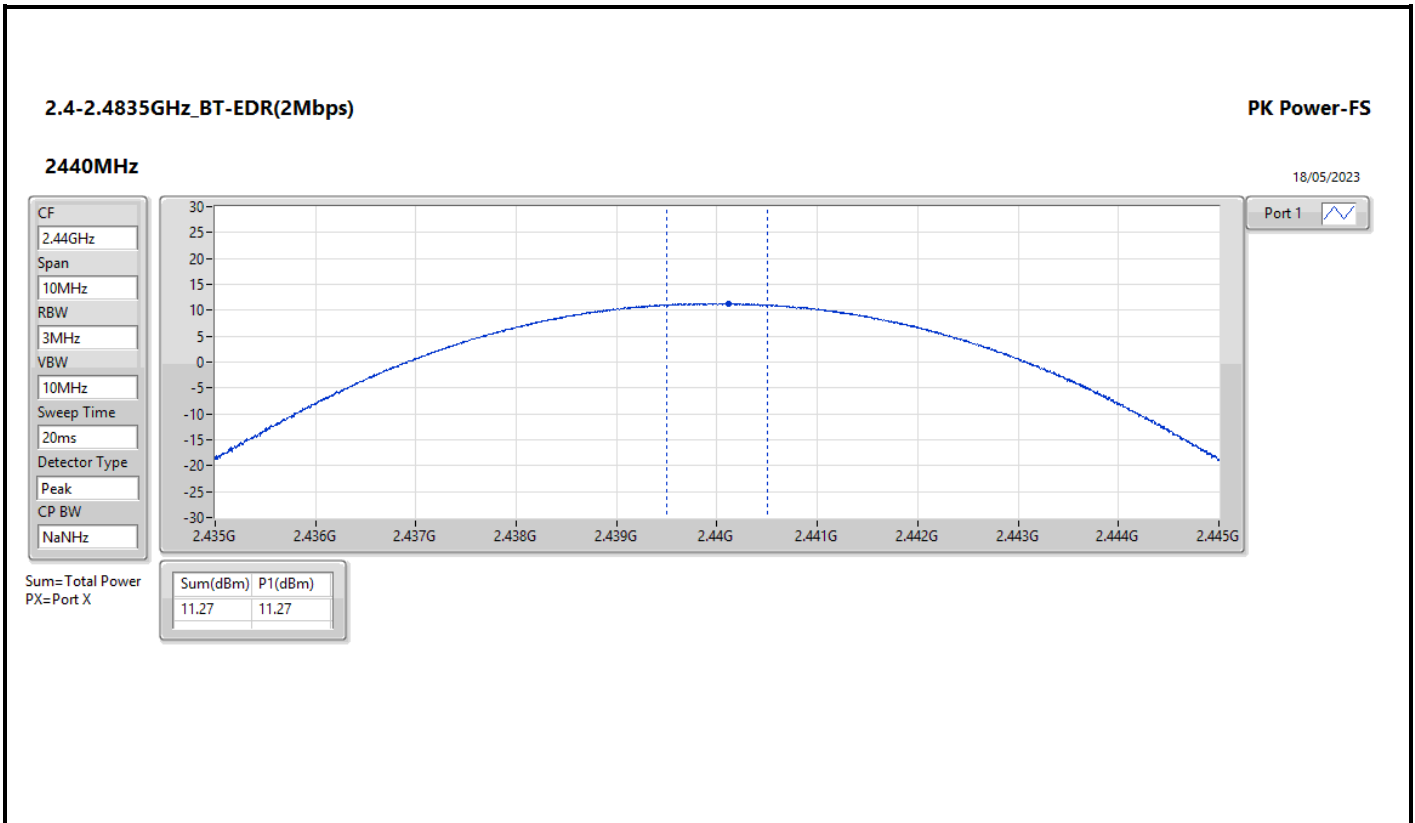

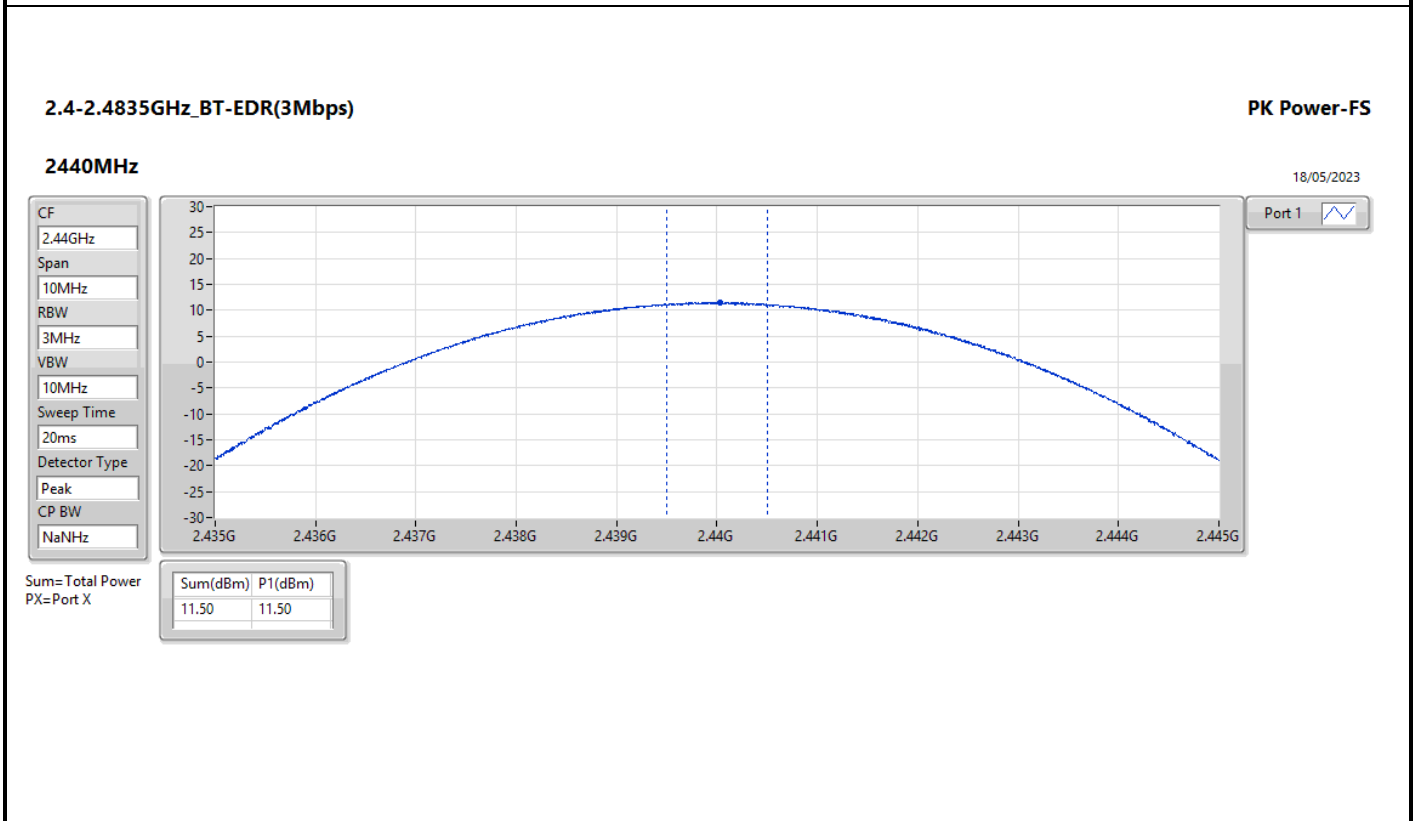
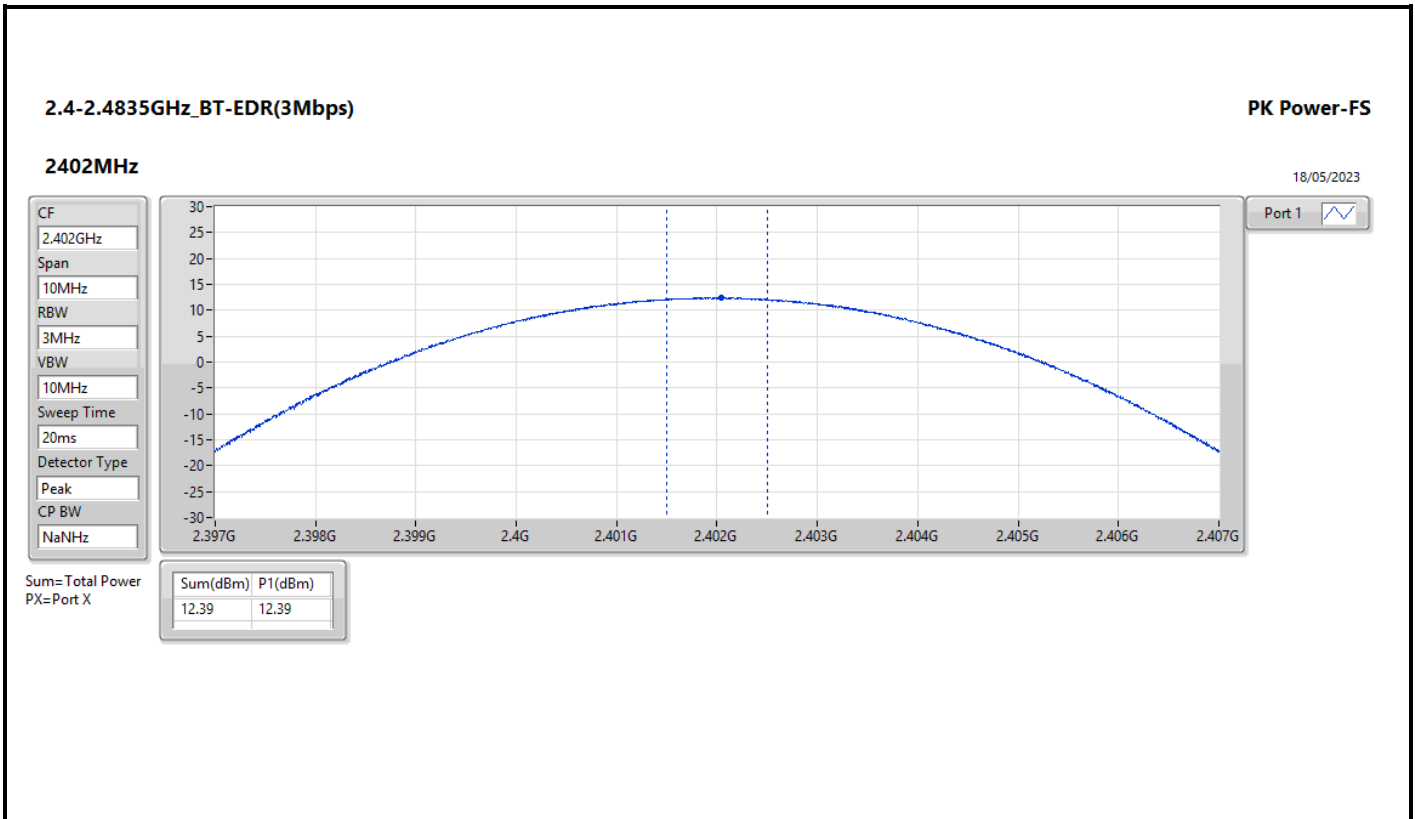

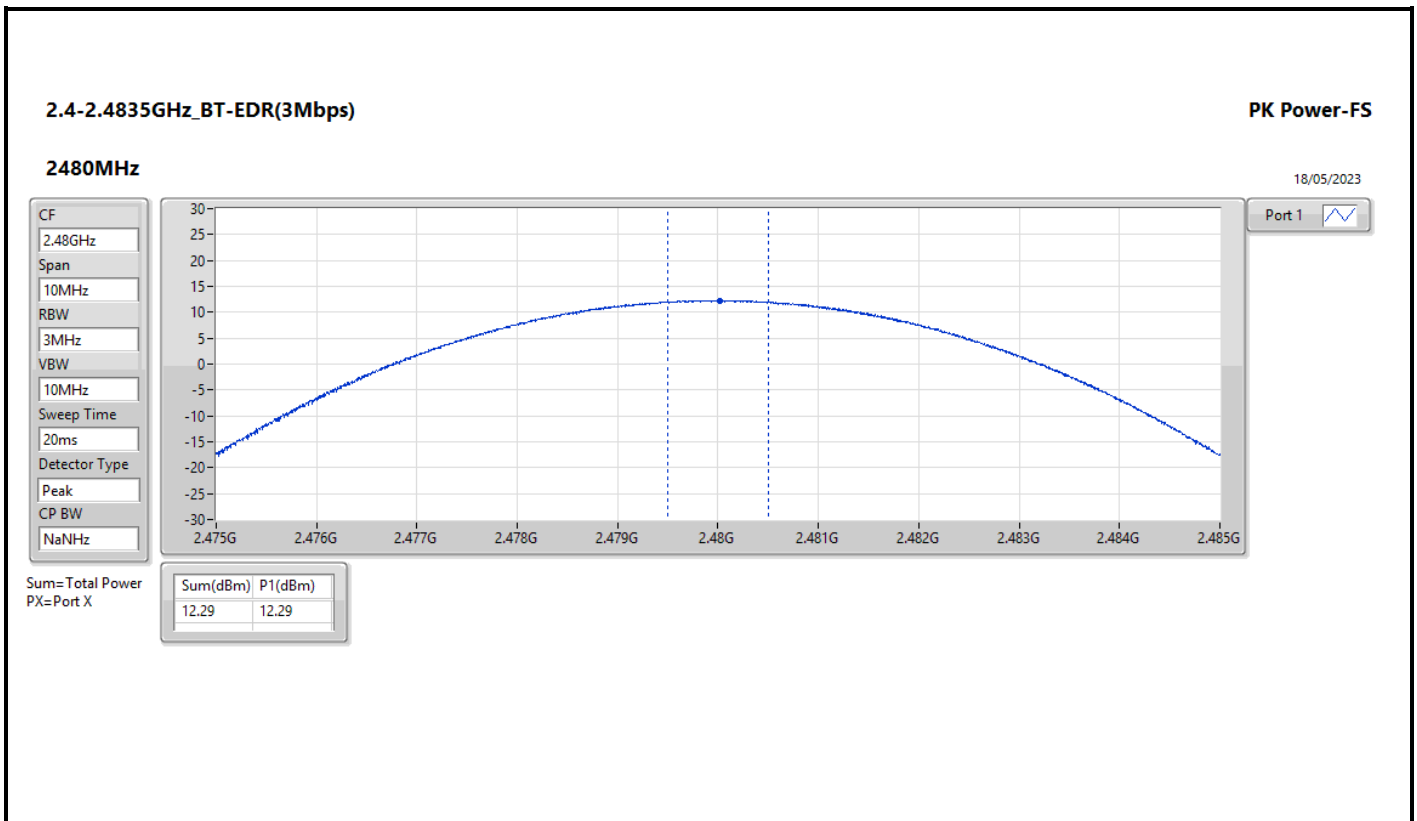



Summary

Mode	Max-Hop No
2.4-2.4835GHz	-
BT-BR(1Mbps)	79
BT-EDR(2Mbps)	79
BT-EDR(3Mbps)	79



Result

Mode	Result	Hopping No	Limit
BT-BR(1Mbps)	-	-	-
2440MHz	Pass	79	15
BT-EDR(2Mbps)	-	-	-
2440MHz	Pass	79	15
BT-EDR(3Mbps)	-	-	-
2440MHz	Pass	79	15

2.4-2.4835GHz_BT-BR(1Mbps)

Hopping-FS

2440MHz

18/05/2023

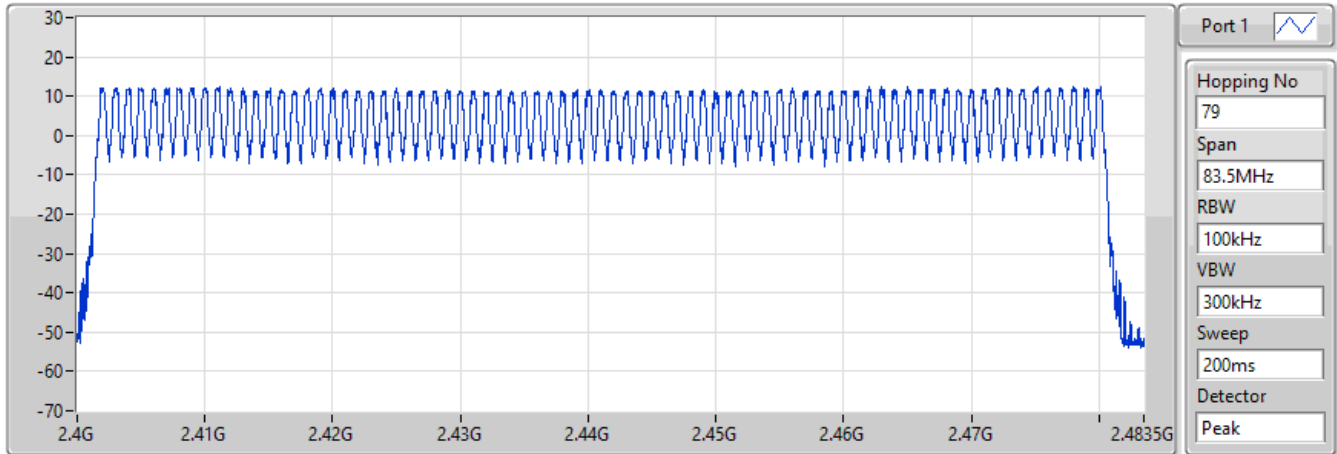

Port 1

Hopping No
79

Span
83.5MHz

RBW
100kHz

VBW
300kHz

Sweep
200ms

Detector
Peak

Hopping No	Limit
79	15

2.4-2.4835GHz_BT-BR(1Mbps)

2440MHz

Hopping Ch Bandedge (Non-restricted Band)

18/05/2023

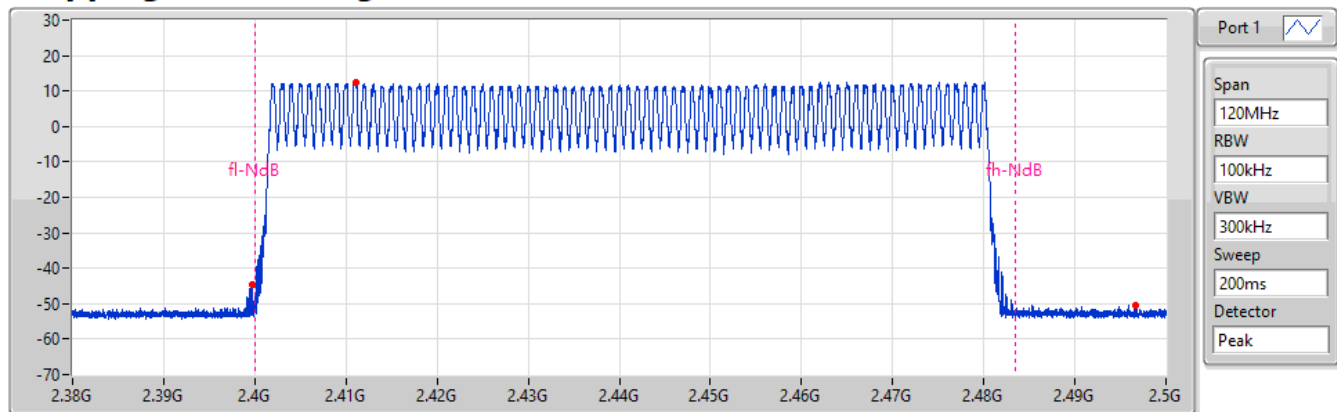

Port 1

Span
120MHz

RBW
100kHz

VBW
300kHz

Sweep
200ms

Detector
Peak

Limit(dBm)	Ref(Hz)	Ref(dBm)	BE-l(Hz)	BE-l(dBm)	BE-h(Hz)	BE-h(dBm)
-7.54	2.41114G	12.46	2.399785G	-44.71	2.496715G	-50.31

2.4-2.4835GHz_BT-BR(1Mbps)

2440MHz

Hopping Ch Bandedge (Restricted Band)

18/05/2023

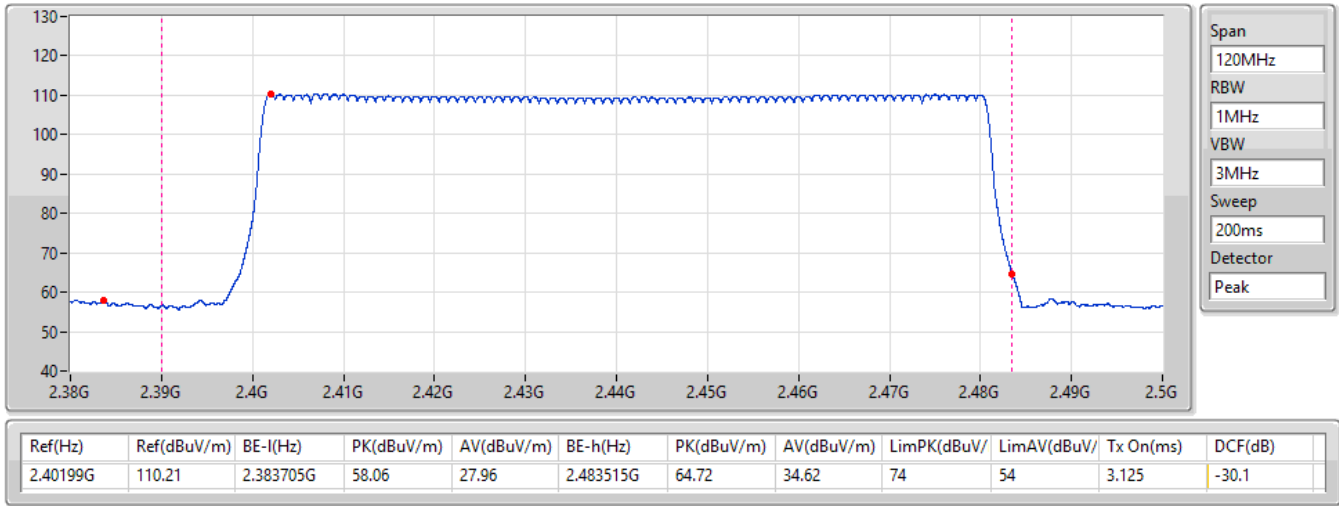

2.4-2.4835GHz_BT-EDR(2Mbps)

Hopping-FS

2440MHz

18/05/2023

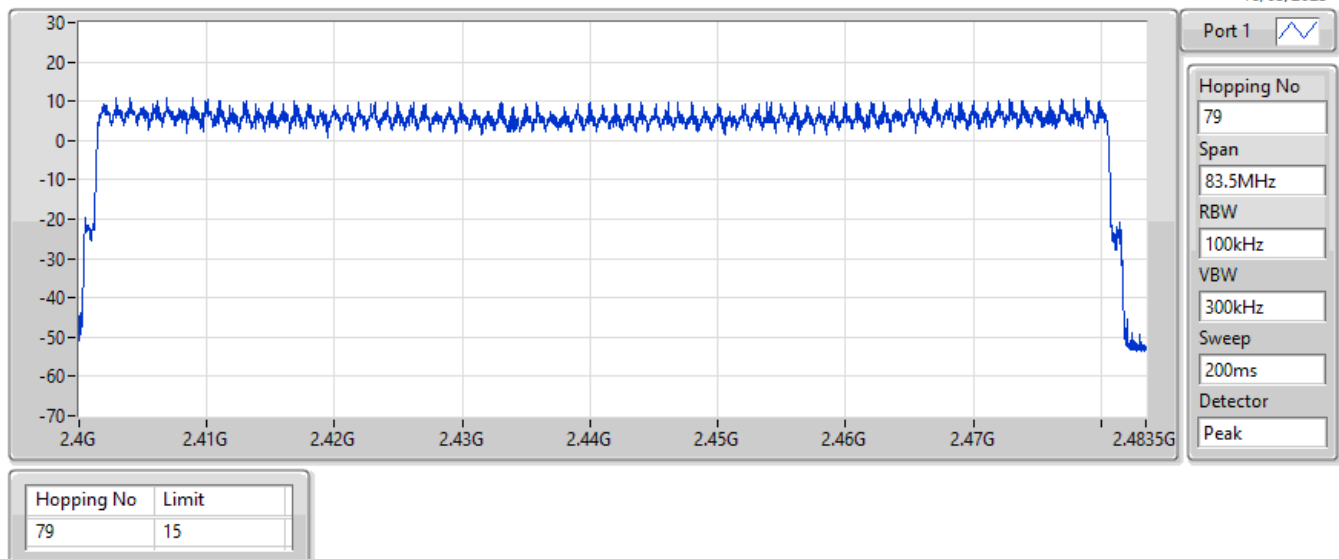

2.4-2.4835GHz_BT-EDR(2Mbps)

2440MHz

Hopping Ch Bandedge (Non-restricted Band)

18/05/2023

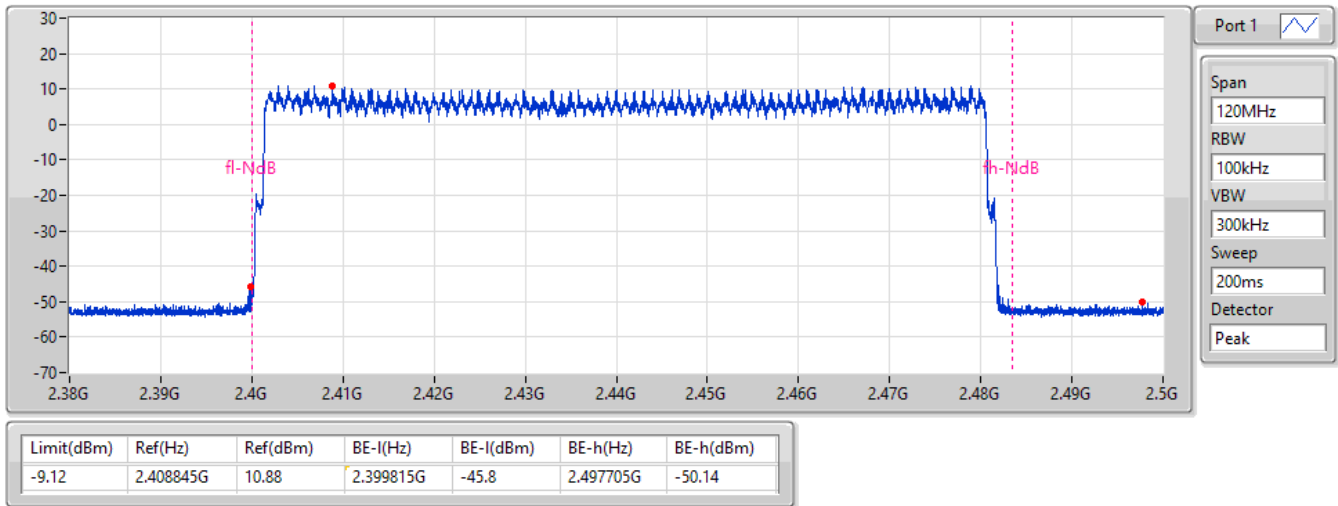

2.4-2.4835GHz_BT-EDR(2Mbps)

2440MHz

Hopping Ch Bandedge (Restricted Band)

18/05/2023

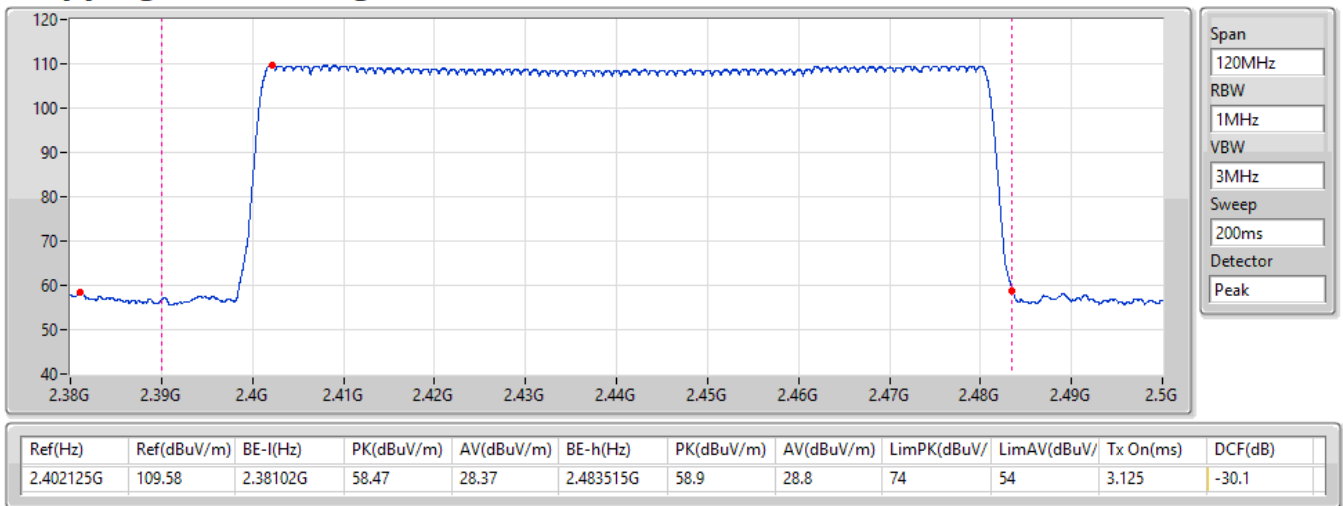

2.4-2.4835GHz_BT-EDR(3Mbps)
2440MHz

Hopping-FS

18/05/2023

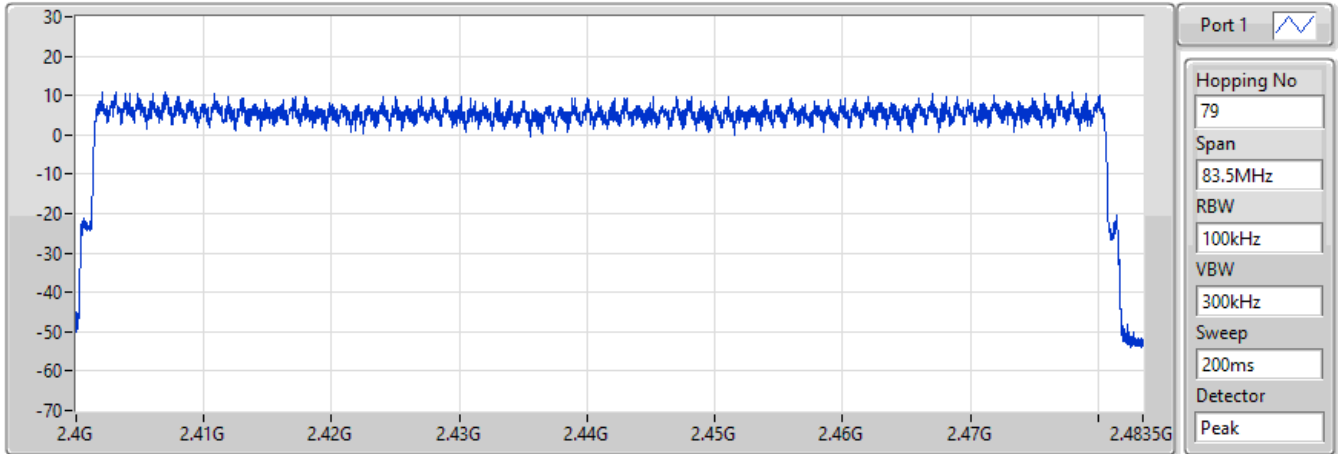

Port 1 

Hopping No
79

Span
83.5MHz

RBW
100kHz

VBW
300kHz

Sweep
200ms

Detector
Peak

Hopping No	Limit
79	15

2.4-2.4835GHz_BT-EDR(3Mbps)
2440MHz

Hopping Ch Bandedge (Non-restricted Band)

18/05/2023

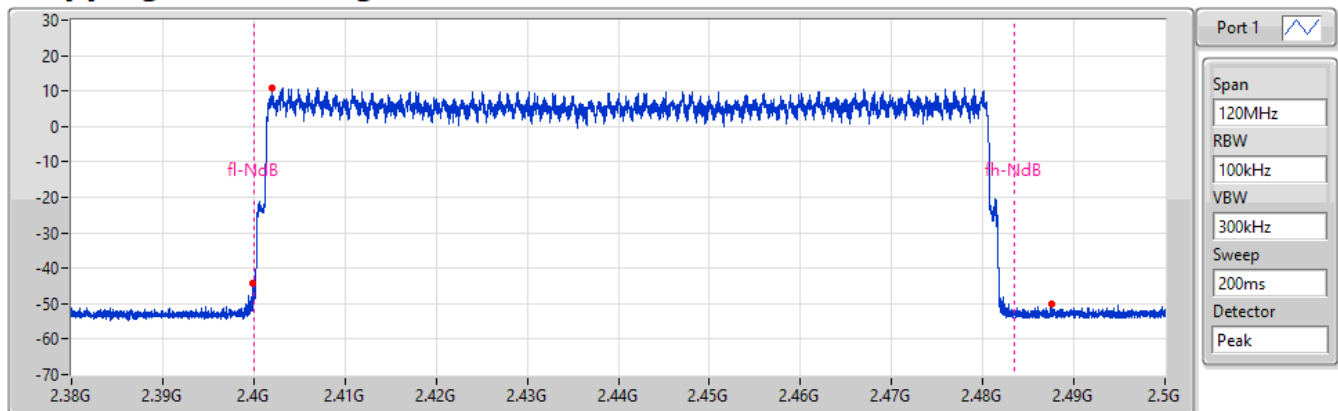

Port 1 

Span
120MHz

RBW
100kHz

VBW
300kHz

Sweep
200ms

Detector
Peak

Limit(dBm)	Ref(Hz)	Ref(dBm)	BE-l(Hz)	BE-l(dBm)	BE-h(Hz)	BE-h(dBm)
-9.12	2.402005G	10.88	2.39989G	-44.16	2.48749G	-49.96

2.4-2.4835GHz_BT-EDR(3Mbps)
2440MHz
Hopping Ch Bandedge (Restricted Band)

18/05/2023

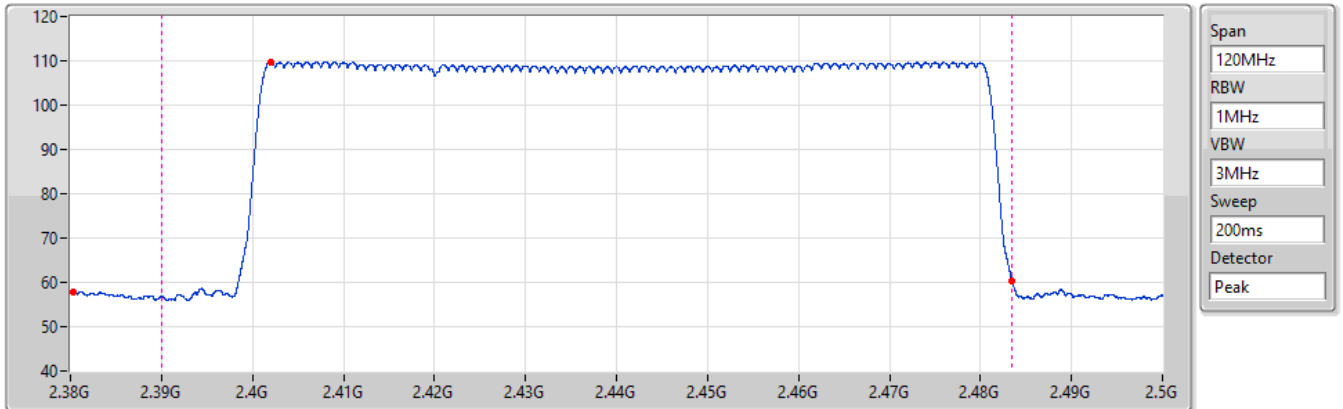

Ref(Hz)	Ref(dBuV/m)	BE-l(Hz)	PK(dBuV/m)	AV(dBuV/m)	BE-h(Hz)	PK(dBuV/m)	AV(dBuV/m)	LimPK(dBuV/	LimAV(dBuV/	Tx On(ms)	DCF(dB)
2.40199G	109.7	2.380375G	57.91	27.81	2.483515G	60.17	30.07	74	54	3.125	-30.1



Summary

Mode	Max-Dwell (s)
2.4-2.4835GHz	-
BT-BR(1Mbps)	308.31385m_DH5
BT-EDR(2Mbps)	308.95345m_DH5
BT-EDR(3Mbps)	309.06005m_DH5

Result

Mode	Result	Period (s)	Dwell (s)	Limit (s)	Tx On (s)
BT-BR(1Mbps)	-	-	-	-	-
2440MHz	Pass	31.6	308.31385m_DH5	400m	2.89225m
2440MHz	Pass	8	154.290175m_DH5-AFH	400m	2.89475m
BT-EDR(2Mbps)	-	-	-	-	-
2440MHz	Pass	31.6	308.95345m_DH5	400m	2.89825m
2440MHz	Pass	8	154.503375m_DH5-AFH	400m	2.89875m
BT-EDR(3Mbps)	-	-	-	-	-
2440MHz	Pass	31.6	309.06005m_DH5	400m	2.89925m
2440MHz	Pass	8	154.57m_DH5-AFH	400m	2.9m

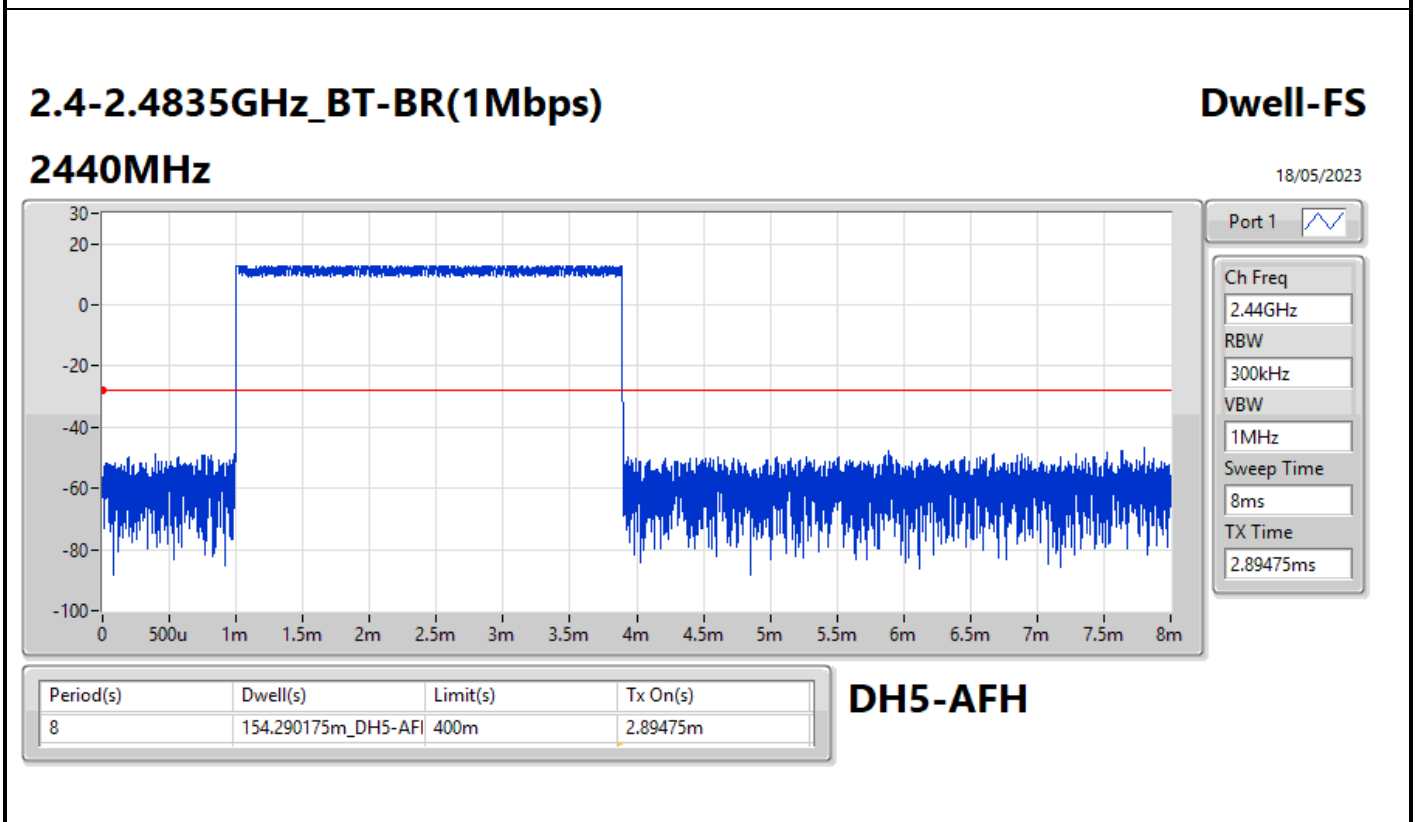
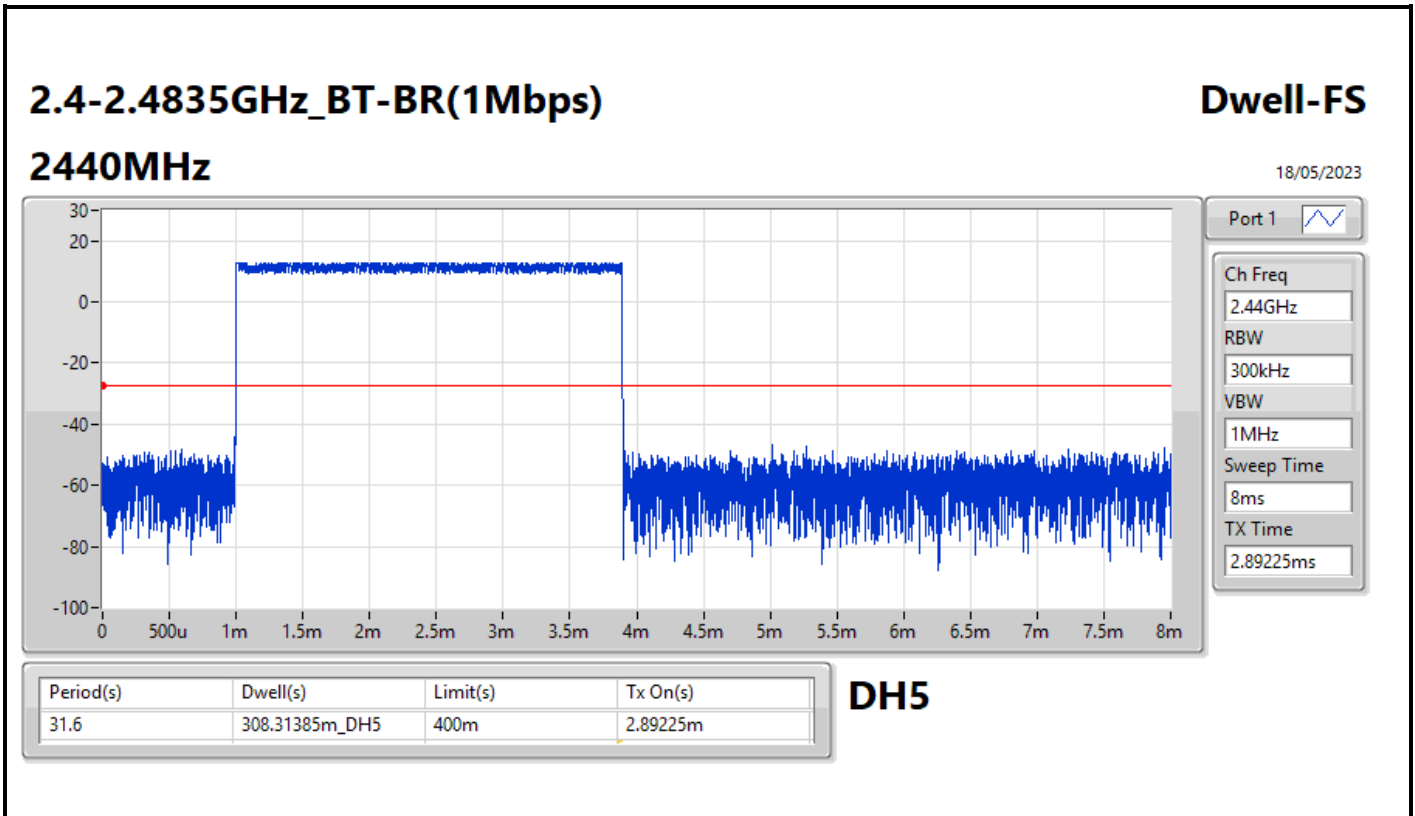



2.4-2.4835GHz_BT-EDR(2Mbps)

Dwell-FS

2440MHz

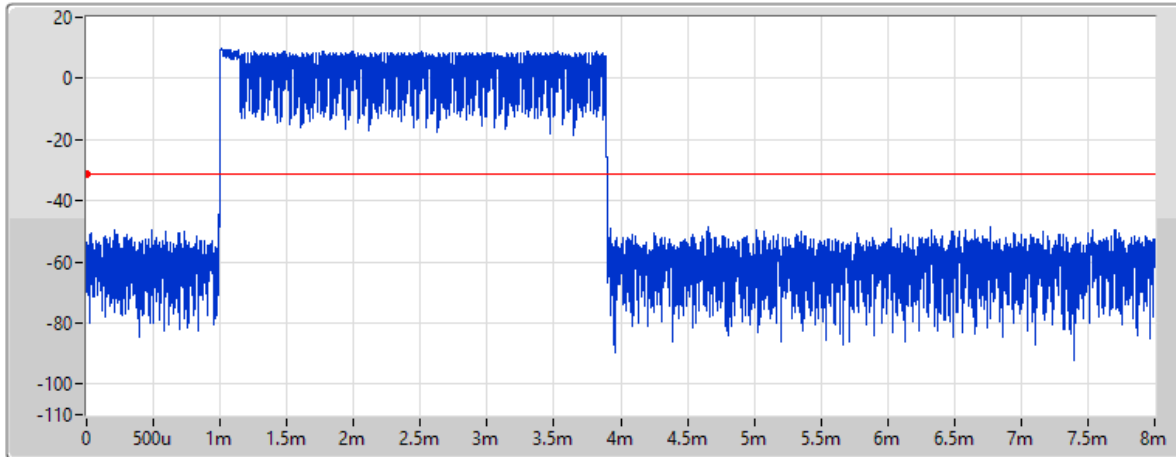
18/05/2023



Port 1 

Ch Freq
2.44GHz

RBW
300kHz

VBW
1MHz

Sweep Time
8ms

TX Time
2.89825ms

Period(s)	Dwell(s)	Limit(s)	Tx On(s)
31.6	308.95345m_DH5	400m	2.89825m

DH5

2.4-2.4835GHz_BT-EDR(2Mbps)

Dwell-FS

2440MHz

18/05/2023

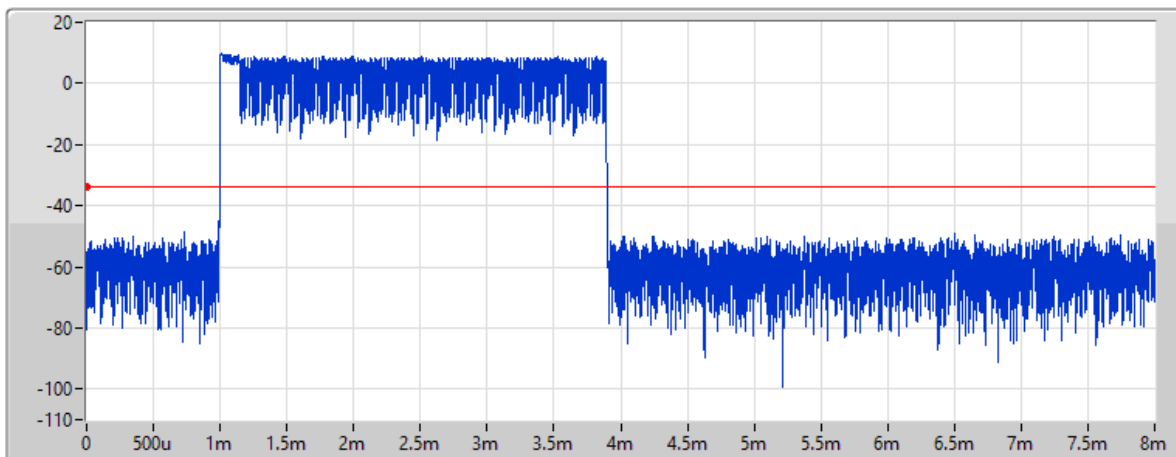

Port 1 

Ch Freq
2.44GHz

RBW
300kHz

VBW
1MHz

Sweep Time
8ms

TX Time
2.89875ms

Period(s)	Dwell(s)	Limit(s)	Tx On(s)
8	154.503375m_DH5-AF1	400m	2.89875m

DH5-AFH

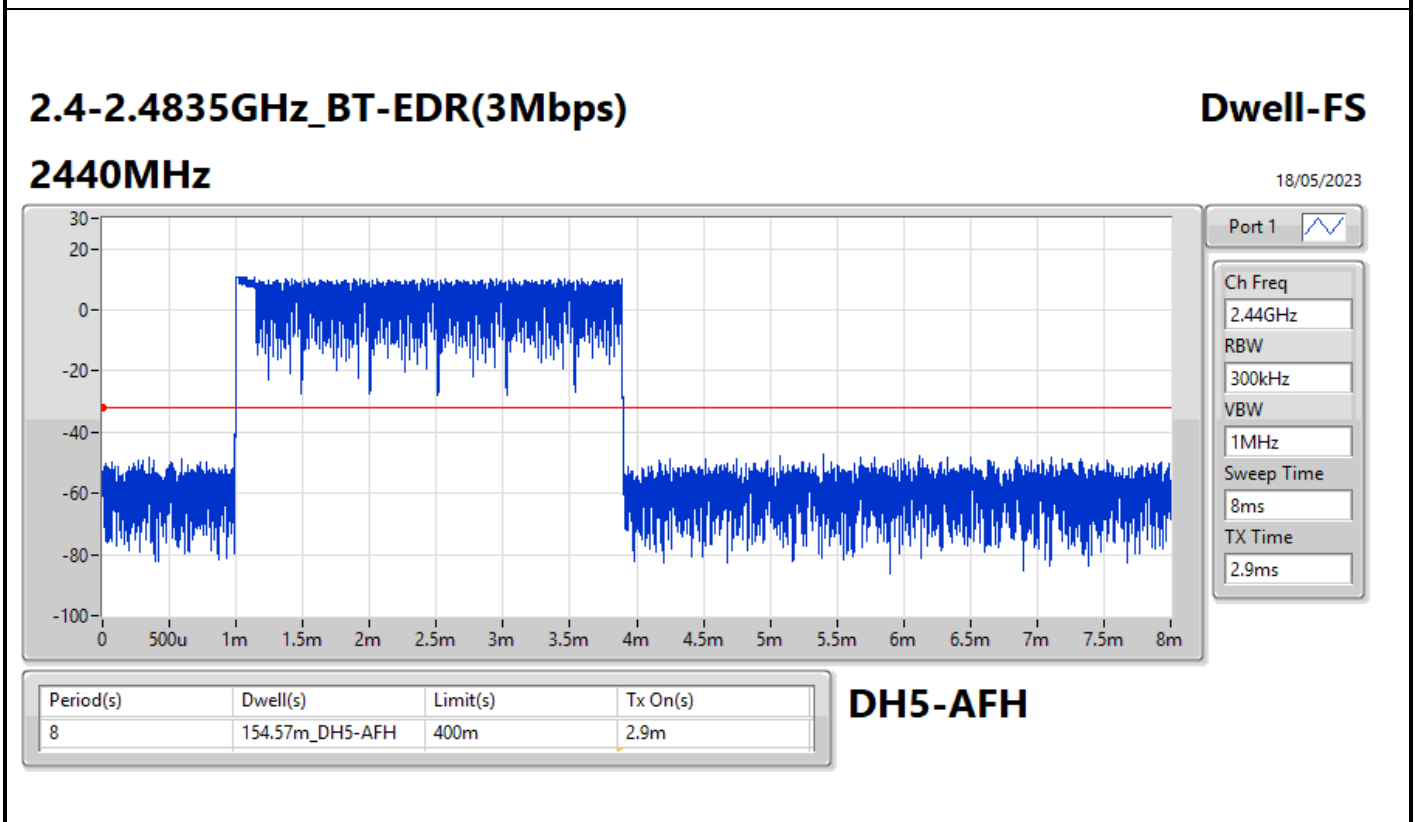
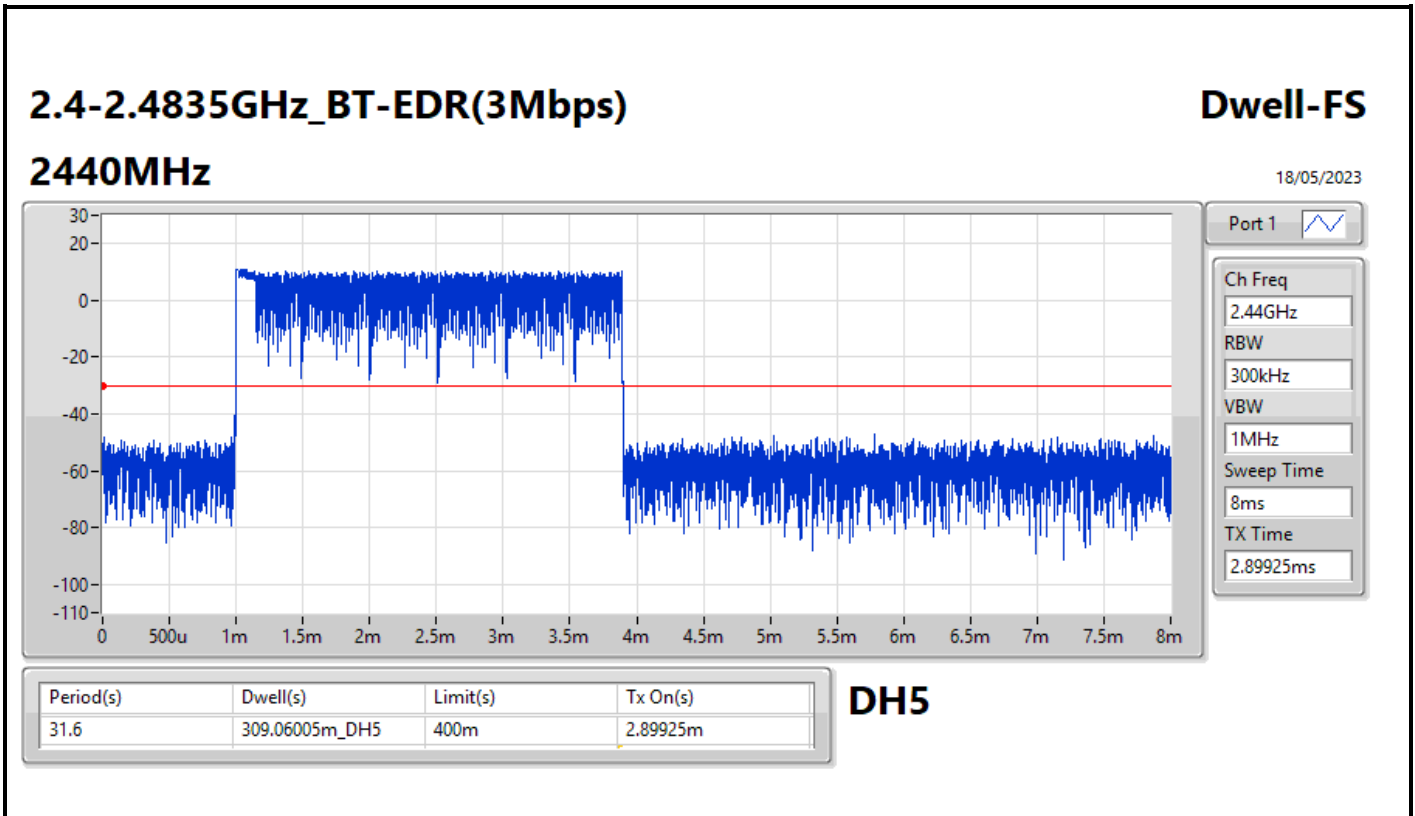



Summary

Mode	Result	Ref (Hz)	Ref (dBm)	Limit (dBm)	Freq (Hz)	Level (dBm)	Freq (Hz)	Level (dBm)	Freq (Hz)	Level (dBm)	Freq (Hz)	Level (dBm)	Freq (Hz)	Level (dBm)	Port
2.4-2.4835GHz	-	-	-	-	-	-	-	-	-	-	-	-	-	-	-
BT-BR(1Mbps)	Pass	2.402G	11.86	-8.14	1.64445G	-52.68	2.39988G	-42.82	2.4G	-49.40	2.50018G	-51.60	16.58912G	-47.33	1
BT-EDR(2Mbps)	Pass	2.40184G	10.92	-9.08	877.18M	-52.78	2.39996G	-44.28	2.4G	-43.49	2.5015G	-51.59	6.98593G	-48.09	1
BT-EDR(3Mbps)	Pass	2.40184G	10.55	-9.45	1.80778G	-52.41	2.4G	-43.82	2.4G	-42.76	2.50066G	-52.39	16.22355G	-46.58	1

Result

Mode	Result	Ref (Hz)	Ref (dBm)	Limit (dBm)	Freq (Hz)	Level (dBm)	Freq (Hz)	Level (dBm)	Freq (Hz)	Level (dBm)	Freq (Hz)	Level (dBm)	Freq (Hz)	Level (dBm)	Port
BT-BR(1Mbps)	-	-	-	-	-	-	-	-	-	-	-	-	-	-	-
2402MHz	Pass	2.402G	11.86	-8.14	1.64445G	-52.68	2.39988G	-42.82	2.4G	-49.40	2.50018G	-51.60	16.58912G	-47.33	1
2440MHz	Pass	2.44008G	11.61	-8.39	939.45M	-52.54	2.39412G	-51.33	2.4G	-54.24	2.50198G	-52.62	17.64083G	-46.90	1
2480MHz	Pass	2.47999G	12.47	-7.53	2.01458G	-52.78	2.39108G	-50.38	2.4G	-54.38	2.5035G	-51.77	24.45727G	-47.45	1
BT-EDR(2Mbps)	-	-	-	-	-	-	-	-	-	-	-	-	-	-	-
2402MHz	Pass	2.40184G	10.92	-9.08	877.18M	-52.78	2.39996G	-44.28	2.4G	-43.49	2.5015G	-51.59	6.98593G	-48.09	1
2440MHz	Pass	2.43991G	9.71	-10.29	527.03M	-52.53	2.3914G	-52.08	2.4G	-52.19	2.50346G	-52.09	17.66052G	-47.10	1
2480MHz	Pass	2.48016G	10.66	-9.34	793.75M	-52.55	2.39108G	-52.24	2.4G	-53.47	2.50266G	-51.97	17.68864G	-47.43	1
BT-EDR(3Mbps)	-	-	-	-	-	-	-	-	-	-	-	-	-	-	-
2402MHz	Pass	2.40184G	10.55	-9.45	1.80778G	-52.41	2.4G	-43.82	2.4G	-42.76	2.50066G	-52.39	16.22355G	-46.58	1
2440MHz	Pass	2.43991G	9.75	-10.25	1.9617G	-52.69	2.39756G	-52.01	2.4G	-54.71	2.50338G	-52.21	16.93219G	-47.17	1
2480MHz	Pass	2.48016G	10.82	-9.18	861.9M	-51.93	2.39268G	-52.20	2.4G	-53.79	2.50202G	-52.64	16.98562G	-47.09	1

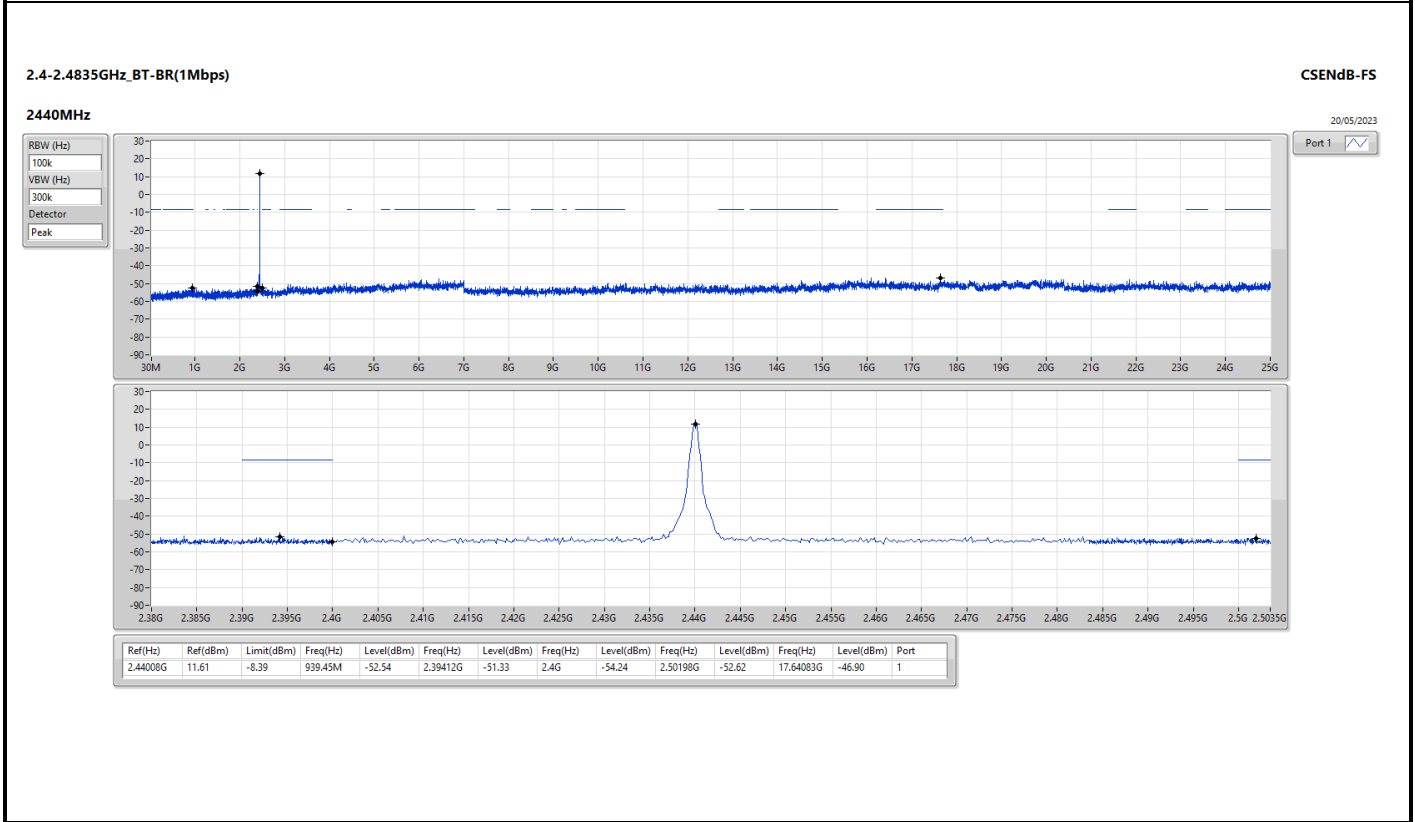
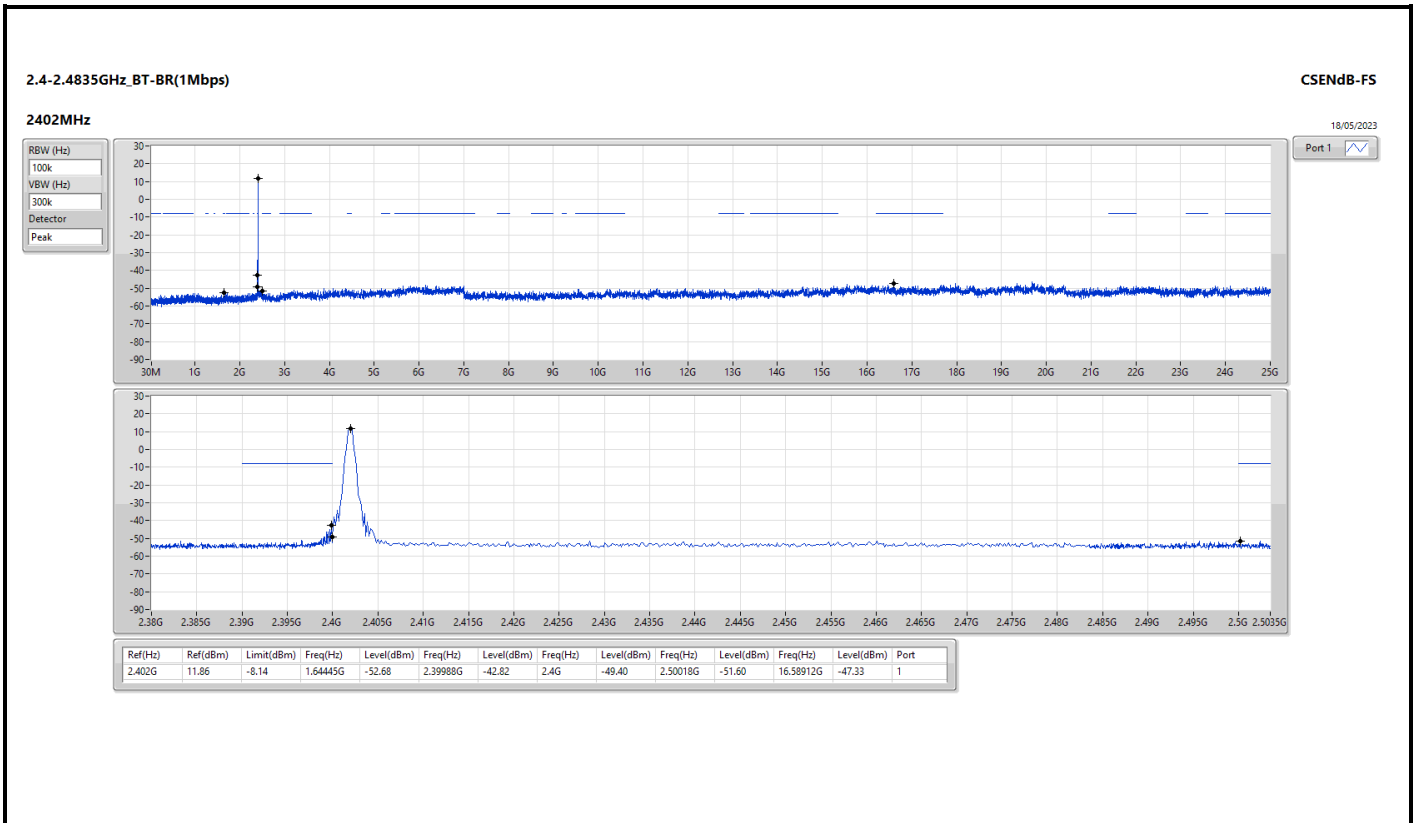

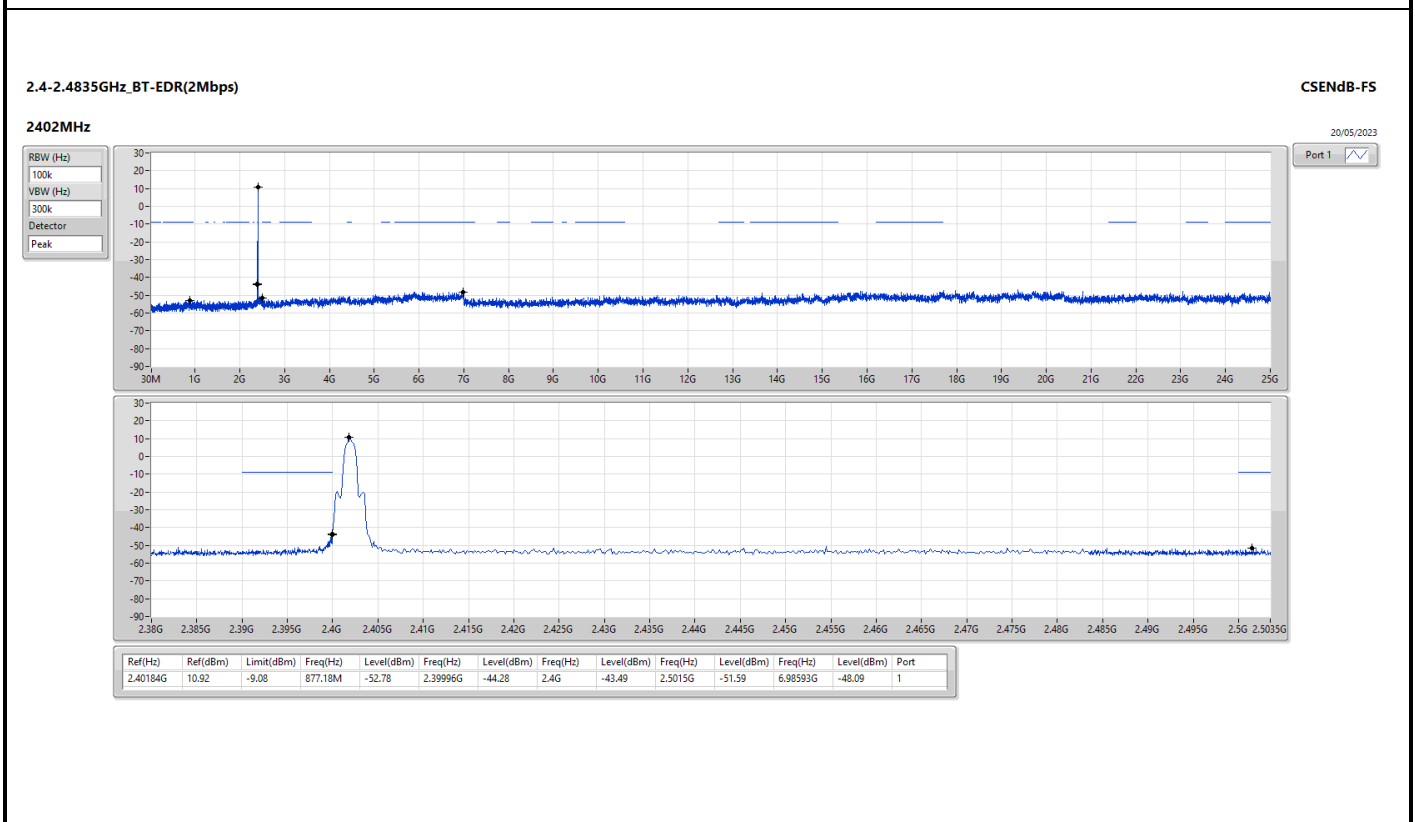
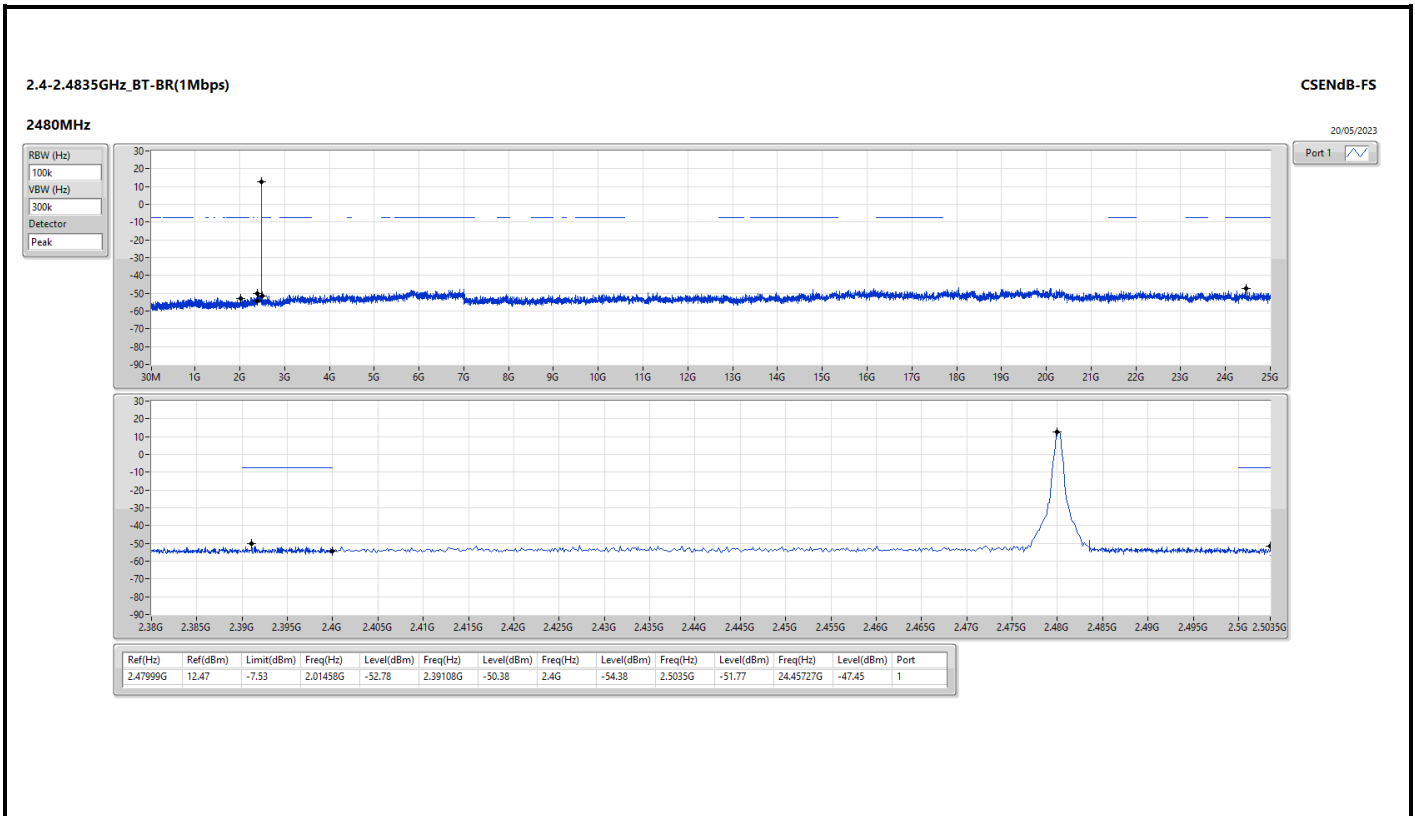

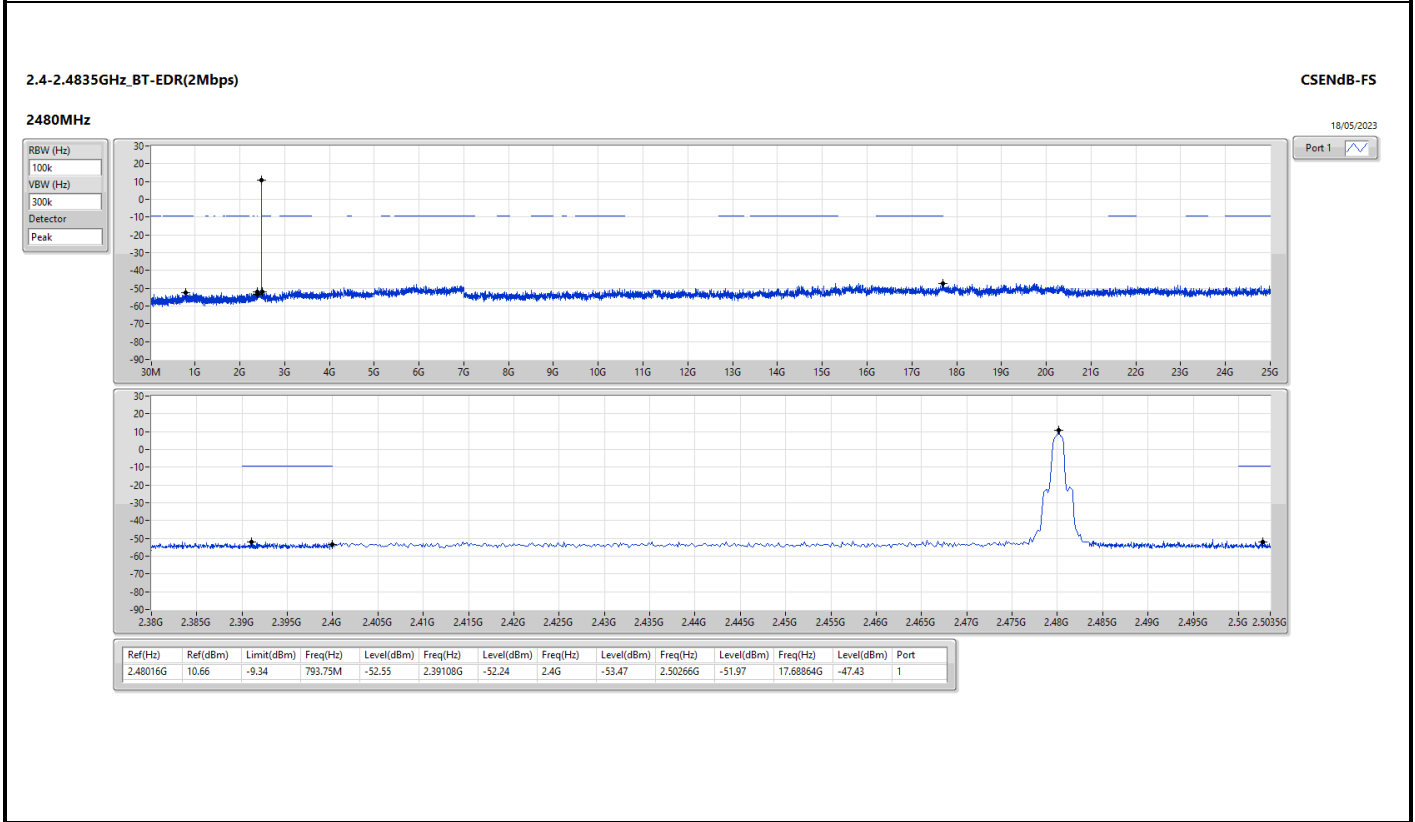
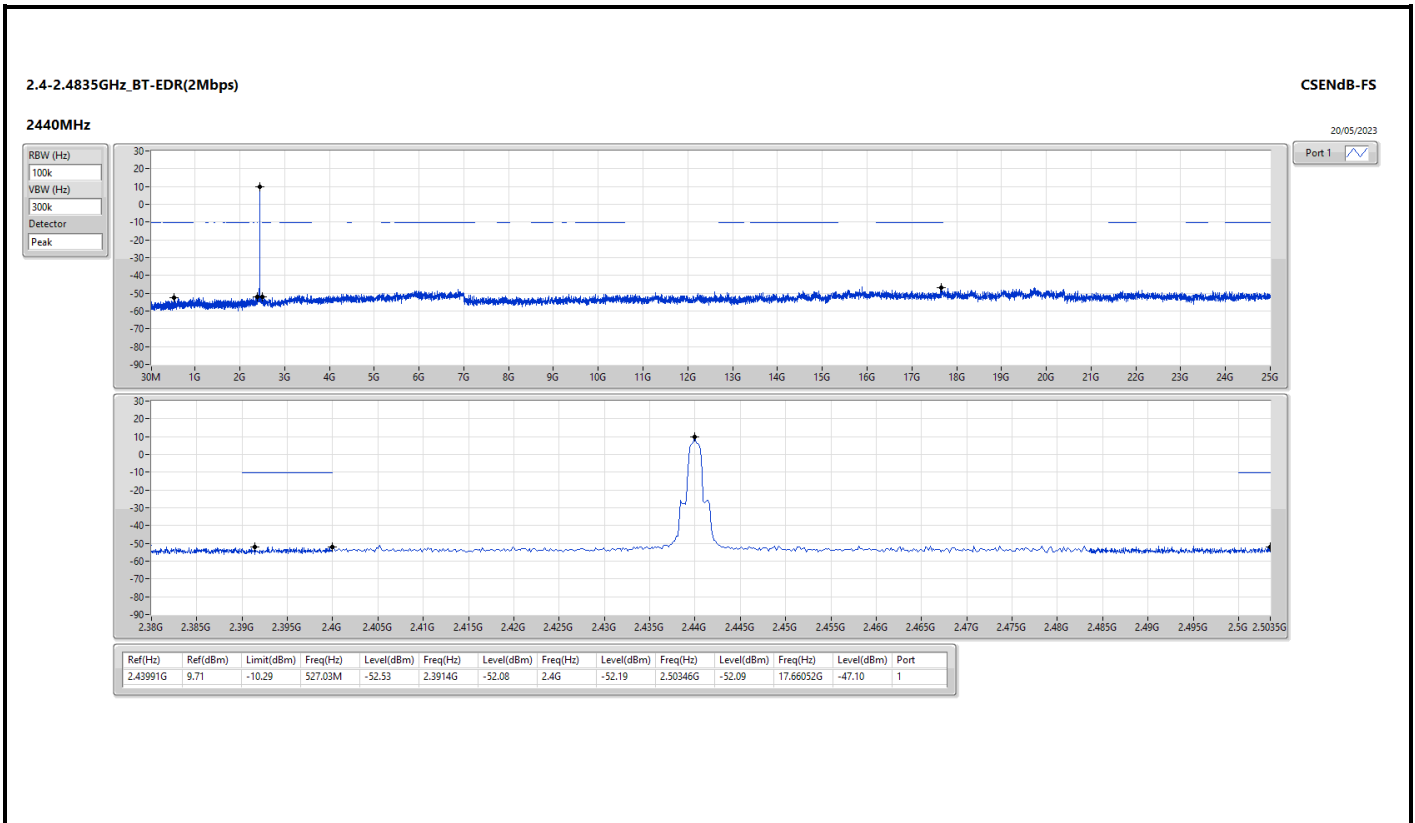

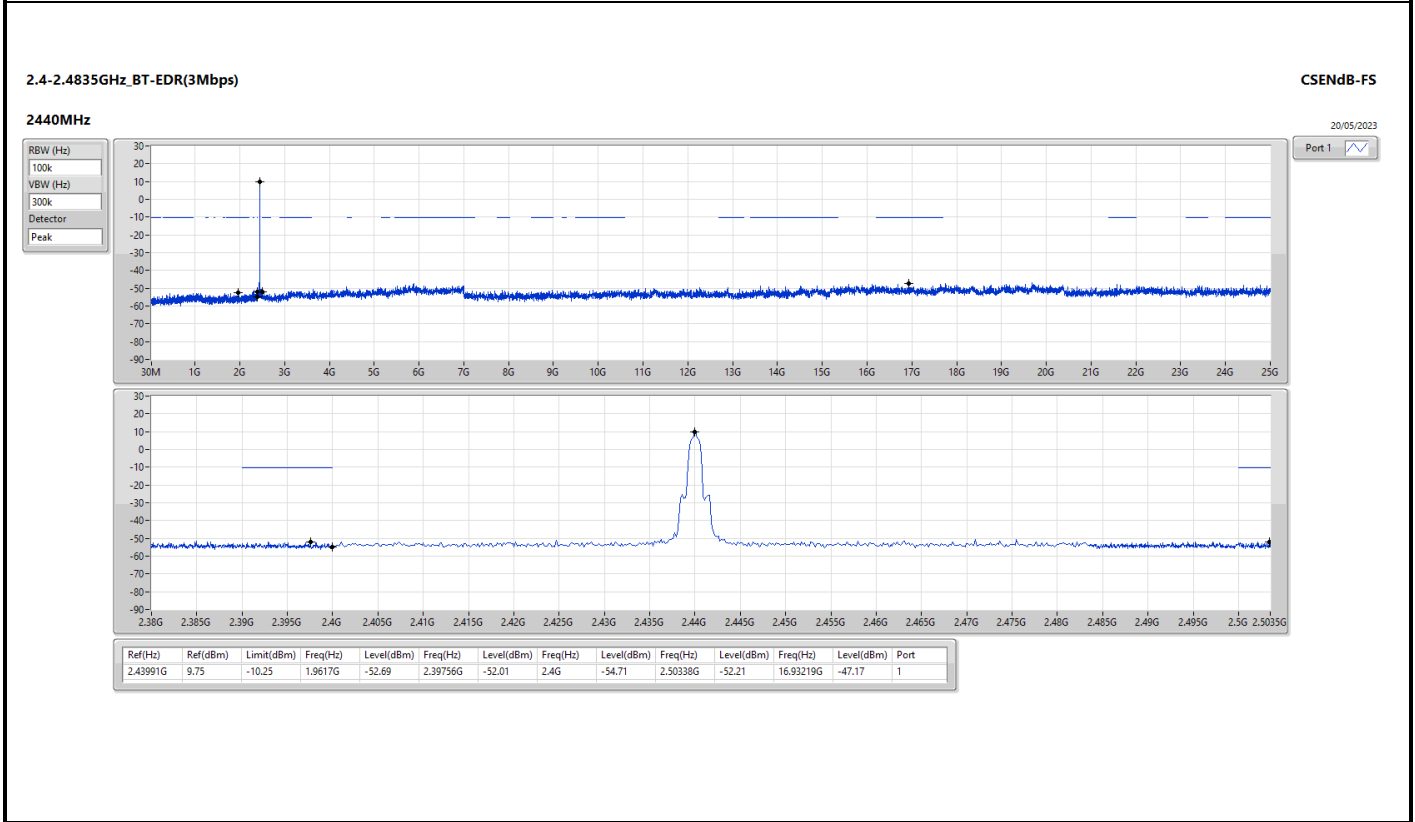
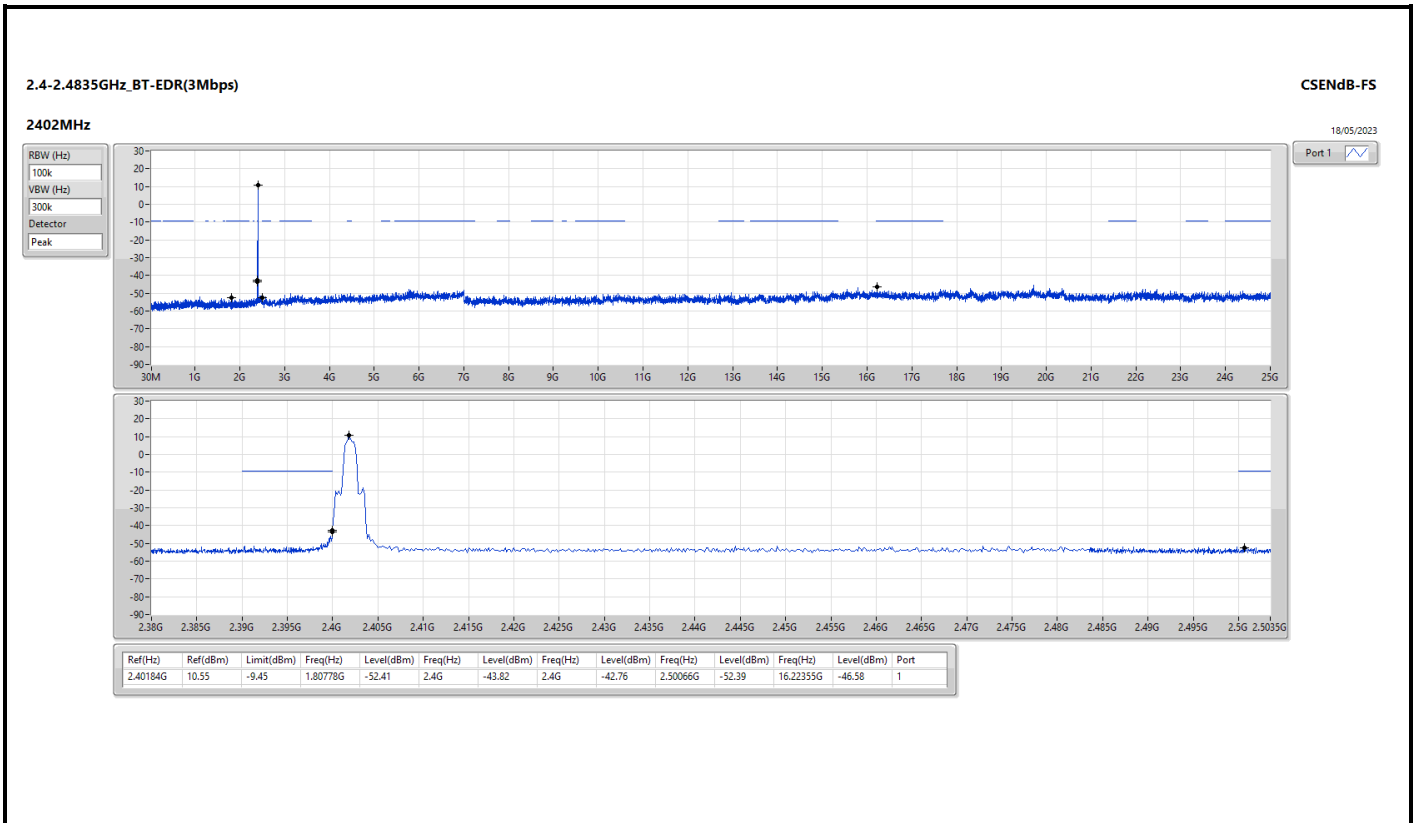

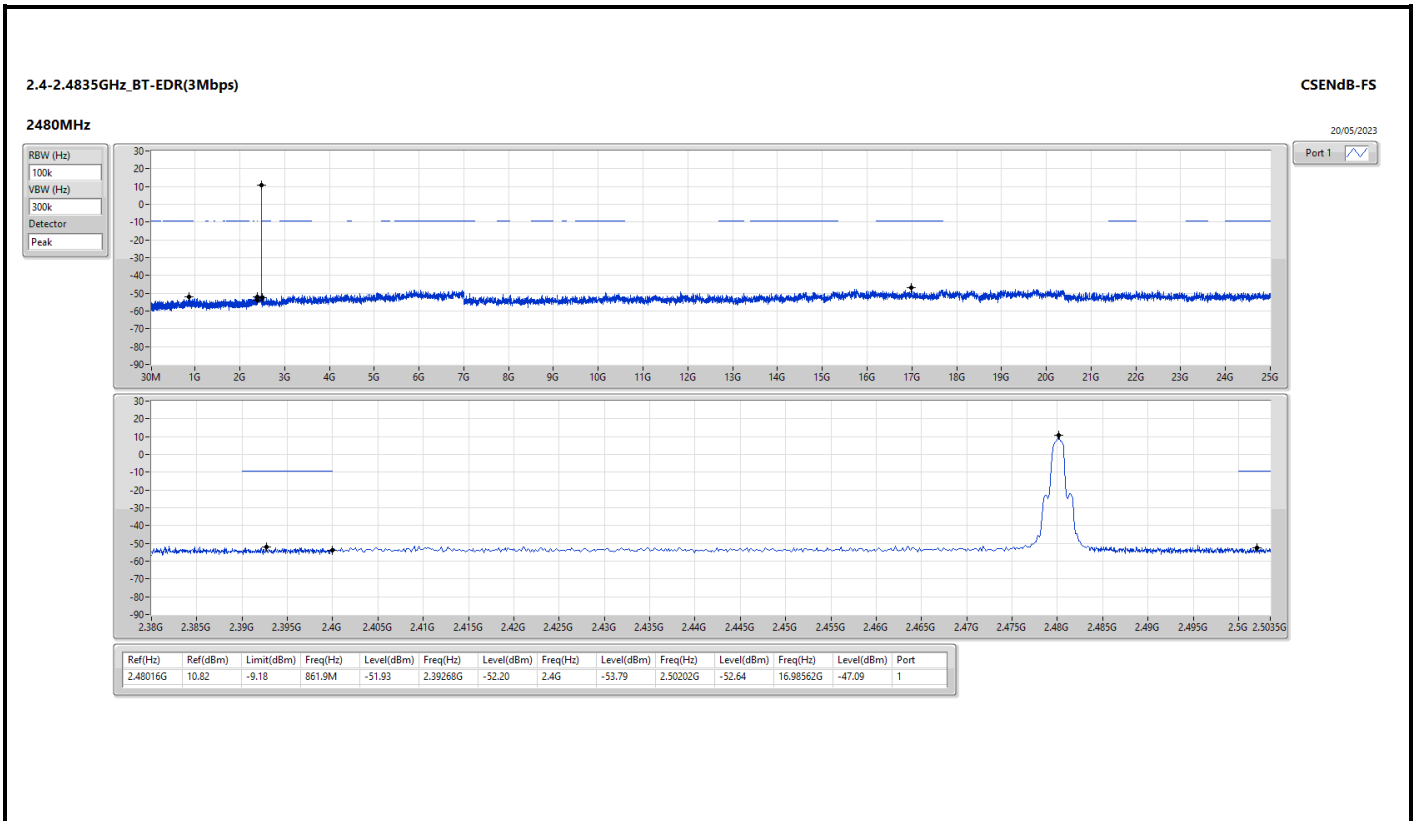



Summary

Mode	Result	Type	Freq (Hz)	Level (dBuV/m)	Limit (dBuV/m)	Margin (dB)	Condition
Mode 1	Pass	PK	250.19M	41.93	46.00	-4.07	Vertical

Mode 1

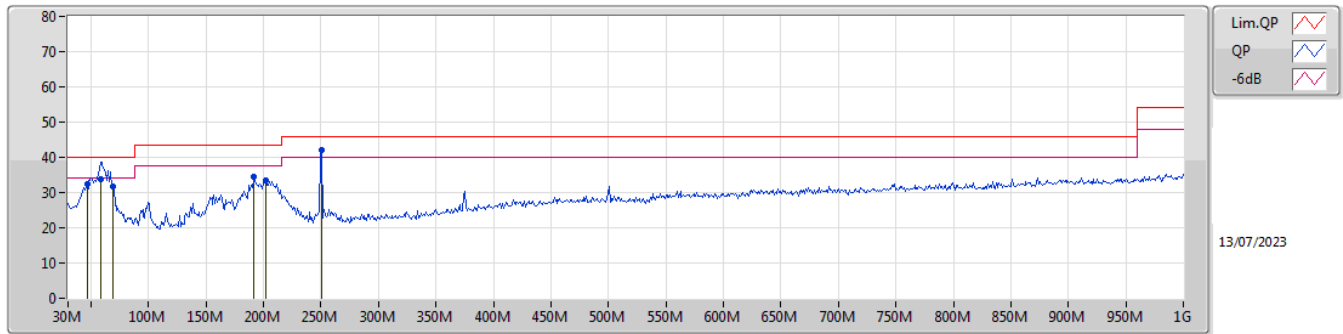

Type	Freq (Hz)	Level (dBuV/m)	Limit (dBuV/m)	Margin (dB)	Factor (dB)	Dist (m)	Condition	Azimuth (°)	Height (m)	Comment	Raw (dBuV)	AF (dB)	CL (dB)	PA (dB)
PK	46.49M	32.26	40.00	-7.74	-15.09	3	Vertical	359	1.00	-	47.35	15.52	1.22	31.83
QP	58.13M	33.63	40.00	-6.37	-18.11	3	Vertical	238	1.00	-	51.74	12.45	1.34	31.90
PK	68.8M	31.79	40.00	-8.21	-18.11	3	Vertical	316	1.50	-	49.90	12.35	1.44	31.90
PK	191.99M	34.63	43.50	-8.87	-14.52	3	Vertical	358	1.00	-	49.15	15.12	2.37	32.01
PK	201.69M	33.33	43.50	-10.17	-14.24	3	Vertical	0	1.50	-	47.57	15.34	2.43	32.01
PK	250.19M	41.93	46.00	-4.07	-11.04	3	Vertical	315	1.00	"Worst"	52.97	18.28	2.72	32.04

Mode 1

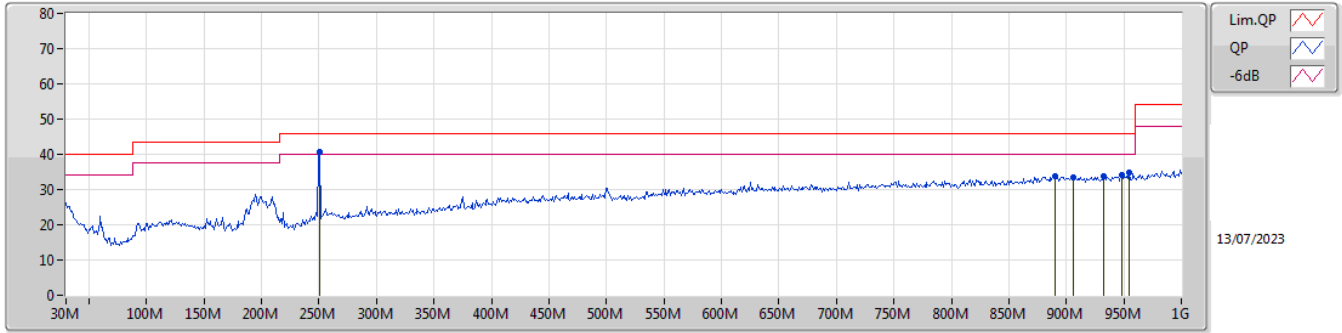

Type	Freq (Hz)	Level (dBuV/m)	Limit (dBuV/m)	Margin (dB)	Factor (dB)	Dist (m)	Condition	Azimuth (°)	Height (m)	Comment	Raw (dBuV)	AF (dB)	CL (dB)	PA (dB)
PK	250.19M	40.62	46.00	-5.38	-11.04	3	Horizontal	98	1.25	"Worst"	51.66	18.28	2.72	32.04
PK	890.39M	33.85	46.00	-12.15	-0.55	3	Horizontal	272	1.00	-	34.40	26.31	5.62	32.48
PK	905.91M	33.61	46.00	-12.39	-0.41	3	Horizontal	351	1.00	-	34.02	26.38	5.67	32.46
PK	932.1M	33.93	46.00	-12.07	-0.30	3	Horizontal	338	3.00	-	34.23	26.53	5.68	32.51
PK	948.59M	34.21	46.00	-11.79	-0.16	3	Horizontal	360	1.00	-	34.37	26.70	5.69	32.55
PK	954.41M	34.73	46.00	-11.27	-0.03	3	Horizontal	220	3.00	-	34.76	26.78	5.71	32.52



Summary

Mode	Result	Type	Freq (Hz)	Level (dBuV/m)	Limit (dBuV/m)	Margin (dB)	Dist (m)	Condition	Azimuth (°)	Height (m)	Comments
2.4-2.4835GHz	-	-	-	-	-	-	-	-	-	-	-
BT-BR(1Mbps)	Pass	AV	4.96004G	53.78	54.00	-0.22	3	Horizontal	351	1.74	-

2.4-2.4835GHz_BT-BR(1Mbps)

2402MHz_TX

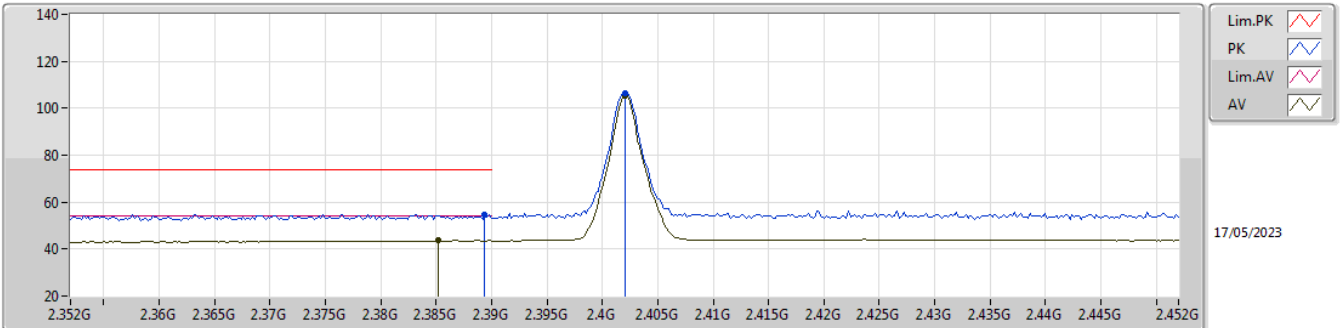

EUT Y_1TX
Setting 9
01-E-P-5

Type	Freq (Hz)	Level (dBuV/m)	Limit (dBuV/m)	Margin (dB)	Raw (dBuV)	Dist (m)	Condition	Azimuth (°)	Height (m)	Comment	AF (dB)	CL (dB)	PA (dB)
PK	2.3894G	54.79	74.00	-19.21	23.42	3	Vertical	11	1.23	-	27.78	3.59	-
AV	2.3852G	43.63	54.00	-10.37	12.27	3	Vertical	11	1.23	-	27.77	3.59	-
PK	2.402G	106.40	Inf	-Inf	75.00	3	Vertical	11	1.23	-	27.80	3.60	-
AV	2.402G	105.59	Inf	-Inf	74.19	3	Vertical	11	1.23	-	27.80	3.60	-

2.4-2.4835GHz_BT-BR(1Mbps)

2402MHz_TX

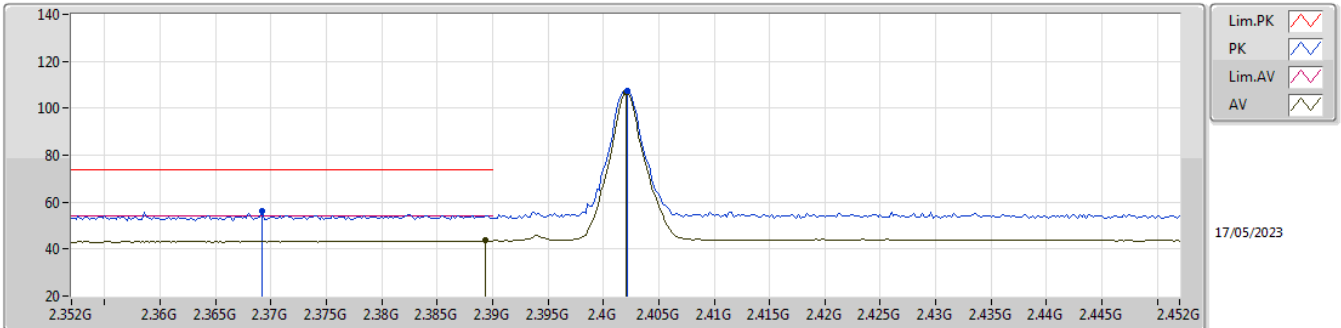

EUT Y_1TX
Setting 9
01-E-P-5

Type	Freq (Hz)	Level (dBuV/m)	Limit (dBuV/m)	Margin (dB)	Raw (dBuV)	Dist (m)	Condition	Azimuth (°)	Height (m)	Comment	AF (dB)	CL (dB)	PA (dB)
PK	2.3692G	56.04	74.00	-17.96	24.73	3	Horizontal	357	2.48	-	27.74	3.57	-
AV	2.3894G	43.56	54.00	-10.44	12.19	3	Horizontal	357	2.48	-	27.78	3.59	-
PK	2.4022G	107.48	Inf	-Inf	76.08	3	Horizontal	357	2.48	-	27.80	3.60	-
AV	2.402G	106.69	Inf	-Inf	75.29	3	Horizontal	357	2.48	-	27.80	3.60	-

2.4-2.4835GHz_BT-BR(1Mbps)

2402MHz_TX

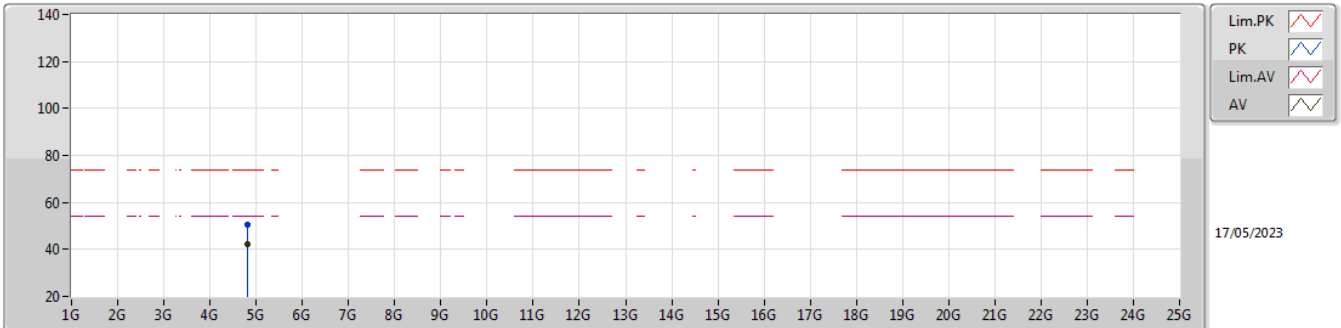

EUT Y_1TX
Setting 9
01-E-P-5

Type	Freq (Hz)	Level (dBuV/m)	Limit (dBuV/m)	Margin (dB)	Raw (dBuV)	Dist (m)	Condition	Azimuth (°)	Height (m)	Comment	AF (dB)	CL (dB)	PA (dB)
PK	4.80414G	50.46	74.00	-23.54	44.93	3	Vertical	50	1.78	-	32.72	5.70	32.89
AV	4.80402G	42.34	54.00	-11.66	36.81	3	Vertical	50	1.78	-	32.72	5.70	32.89

2.4-2.4835GHz_BT-BR(1Mbps)

2402MHz_TX

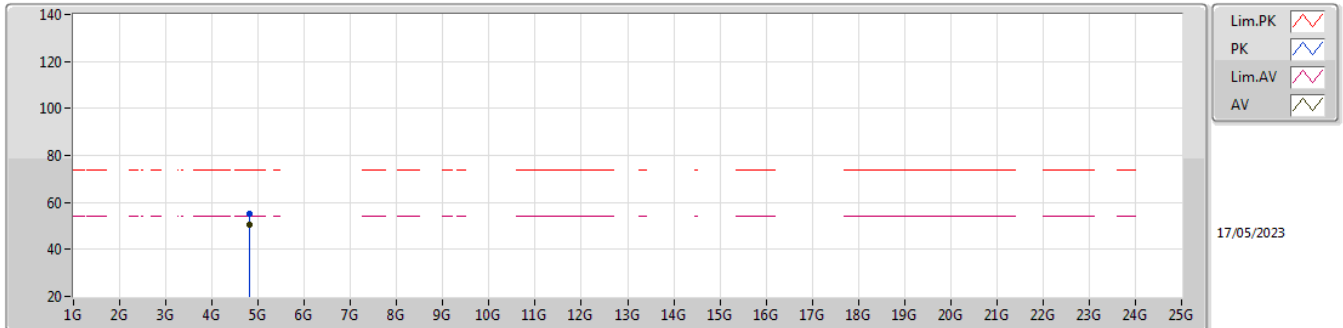

EUT Y_1TX
Setting 9
01-E-P-5

Type	Freq	Level	Limit	Margin	Raw	Dist	Condition	Azimuth	Height	Comment	AF	CL	PA			
	(Hz)	(dBuV/m)	(dBuV/m)	(dB)	(dBuV)	(m)		(°)	(m)		(dB)	(dB)	(dB)			
PK	4.8043G	55.42	74.00	-18.58	49.88	3	Horizontal	360	1.90	-	32.73	5.70	32.89			
AV	4.80405G	50.31	54.00	-3.69	44.78	3	Horizontal	360	1.90	-	32.72	5.70	32.89			

2.4-2.4835GHz_BT-BR(1Mbps)

2440MHz_TX

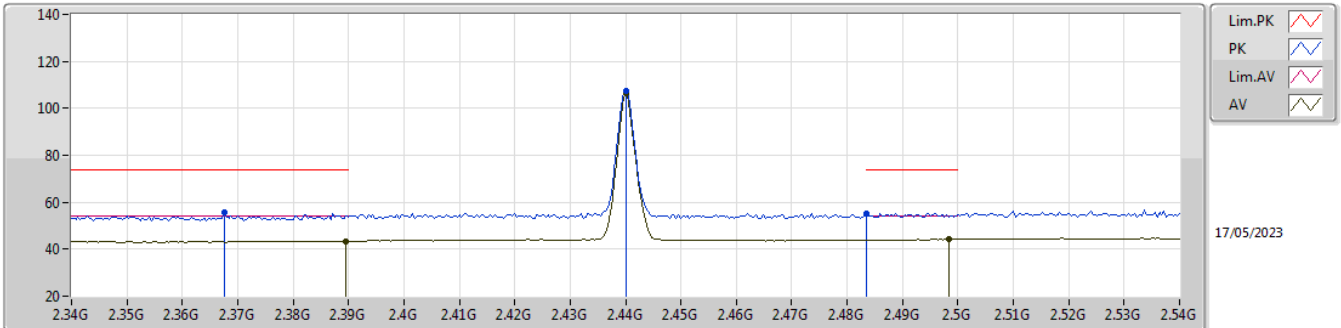

EUT_Y_1TX
Setting 9
01-E-P-5

Type	Freq (Hz)	Level (dBuV/m)	Limit (dBuV/m)	Margin (dB)	Raw (dBuV)	Dist (m)	Condition	Azimuth (°)	Height (m)	Comment	AF (dB)	CL (dB)	PA (dB)
PK	2.3676G	55.70	74.00	-18.30	24.39	3	Vertical	16	1.14	-	27.74	3.57	-
AV	2.3896G	43.53	54.00	-10.47	12.16	3	Vertical	16	1.14	-	27.78	3.59	-
PK	2.44G	107.32	Inf	-Inf	75.82	3	Vertical	16	1.14	-	27.88	3.62	-
AV	2.44G	106.49	Inf	-Inf	74.99	3	Vertical	16	1.14	-	27.88	3.62	-
PK	2.4835G	55.40	74.00	-18.60	23.66	3	Vertical	16	1.14	-	28.10	3.64	-
AV	2.4984G	44.23	54.00	-9.77	12.39	3	Vertical	16	1.14	-	28.19	3.65	-

2.4-2.4835GHz_BT-BR(1Mbps)

2440MHz_TX

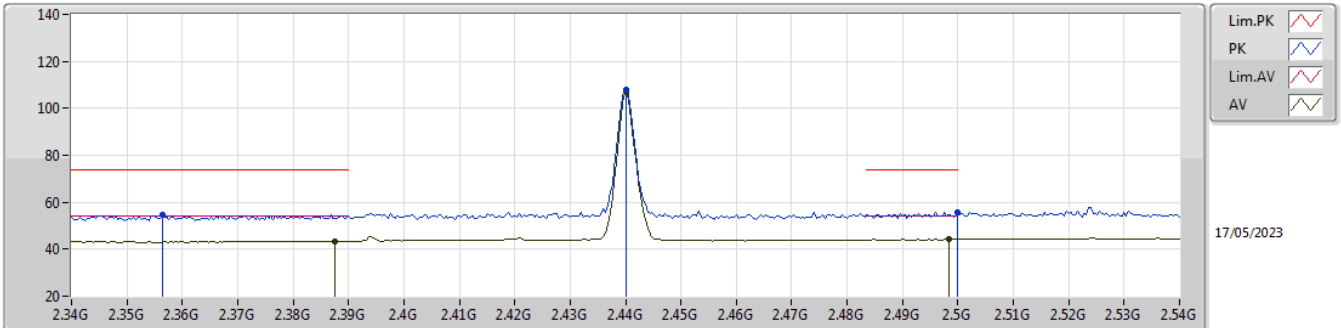

EUT_Y_1TX
Setting 9
01-E-P-5

Type	Freq (Hz)	Level (dBuV/m)	Limit (dBuV/m)	Margin (dB)	Raw (dBuV)	Dist (m)	Condition	Azimuth (°)	Height (m)	Comment	AF (dB)	CL (dB)	PA (dB)
PK	2.3564G	54.75	74.00	-19.25	23.48	3	Vertical	20	1.92	-	27.71	3.56	-
AV	2.3876G	43.41	54.00	-10.59	12.04	3	Vertical	20	1.92	-	27.78	3.59	-
PK	2.44G	107.68	Inf	-Inf	76.18	3	Vertical	20	1.92	-	27.88	3.62	-
AV	2.44G	106.90	Inf	-Inf	75.40	3	Vertical	20	1.92	-	27.88	3.62	-
PK	2.5G	55.89	74.00	-18.11	24.04	3	Vertical	20	1.92	-	28.20	3.65	-
AV	2.4984G	44.18	54.00	-9.82	12.34	3	Vertical	20	1.92	-	28.19	3.65	-

2.4-2.4835GHz_BT-BR(1Mbps)

2440MHz_TX

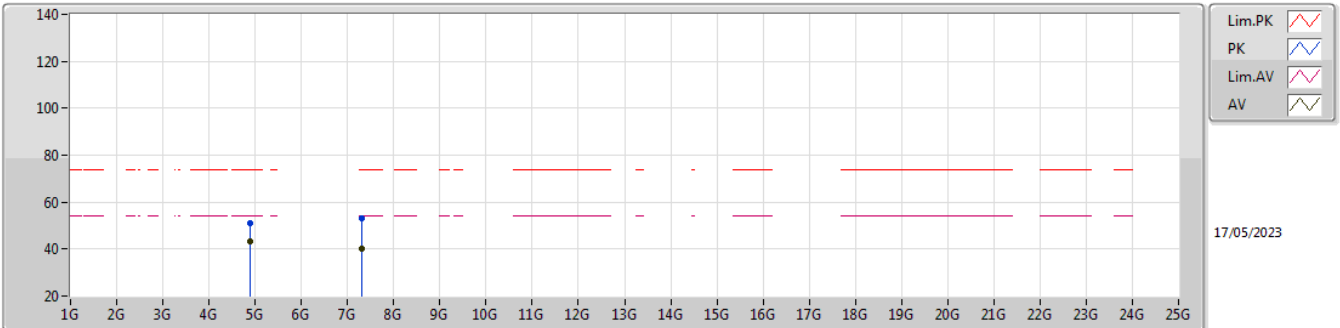

EUT Y_1TX
Setting 9
01-E-P-5

Type	Freq (Hz)	Level (dBuV/m)	Limit (dBuV/m)	Margin (dB)	Raw (dBuV)	Dist (m)	Condition	Azimuth (°)	Height (m)	Comment	AF (dB)	CL (dB)	PA (dB)
PK	4.87975G	51.25	74.00	-22.75	45.34	3	Vertical	50	1.31	-	33.00	5.78	32.87
AV	4.88G	43.28	54.00	-10.72	37.37	3	Vertical	50	1.31	-	33.00	5.78	32.87
PK	7.31828G	53.30	74.00	-20.70	41.73	3	Vertical	217	1.71	-	37.60	7.16	33.19
AV	7.31817G	40.15	54.00	-13.85	28.58	3	Vertical	217	1.71	-	37.60	7.16	33.19

2.4-2.4835GHz_BT-BR(1Mbps)

2440MHz_TX

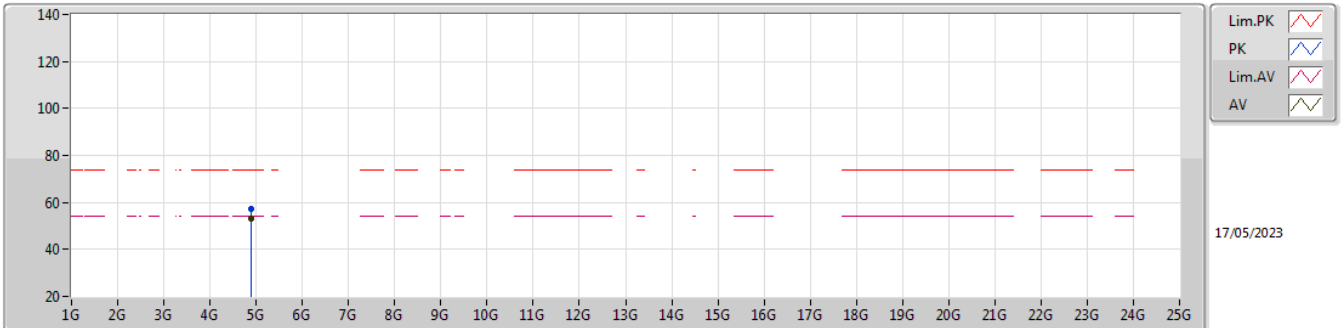

EUT_Y_1TX
Setting 9
01-E-P-5

Type	Freq (Hz)	Level (dBuV/m)	Limit (dBuV/m)	Margin (dB)	Raw (dBuV)	Dist (m)	Condition	Azimuth (°)	Height (m)	Comment	AF (dB)	CL (dB)	PA (dB)
PK	4.87977G	57.30	74.00	-16.70	51.39	3	Horizontal	353	1.90	-	33.00	5.78	32.87
AV	4.88003G	52.99	54.00	-1.01	47.08	3	Horizontal	353	1.90	-	33.00	5.78	32.87

2.4-2.4835GHz_BT-BR(1Mbps)

2480MHz_TX

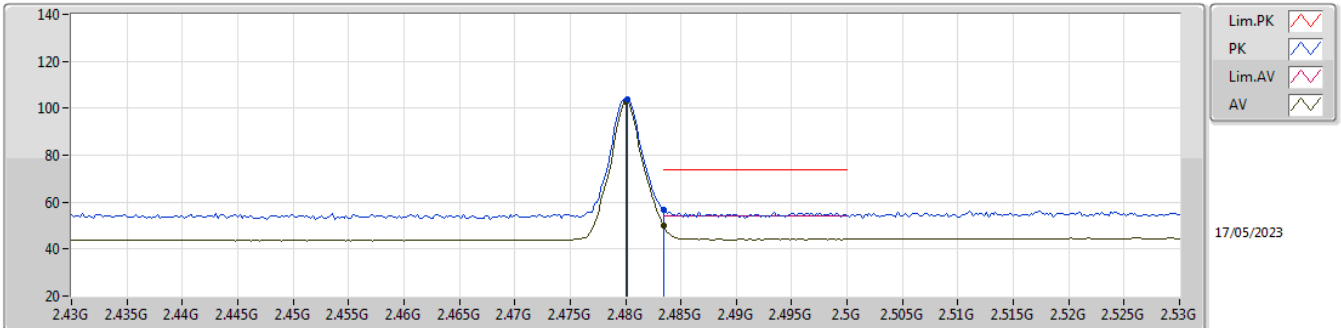

EUT Y_1TX
Setting 9
01-E-P-5

Type	Freq (Hz)	Level (dBuV/m)	Limit (dBuV/m)	Margin (dB)	Raw (dBuV)	Dist (m)	Condition	Azimuth (°)	Height (m)	Comment	AF (dB)	CL (dB)	PA (dB)
PK	2.4802G	103.76	Inf	-Inf	72.04	3	Vertical	12	1.76	-	28.08	3.64	-
AV	2.48G	102.95	Inf	-Inf	71.23	3	Vertical	12	1.76	-	28.08	3.64	-
PK	2.4835G	56.71	74.00	-17.29	24.97	3	Vertical	12	1.76	-	28.10	3.64	-
AV	2.4835G	50.24	54.00	-3.76	18.50	3	Vertical	12	1.76	-	28.10	3.64	-

2.4-2.4835GHz_BT-BR(1Mbps)

2480MHz_TX

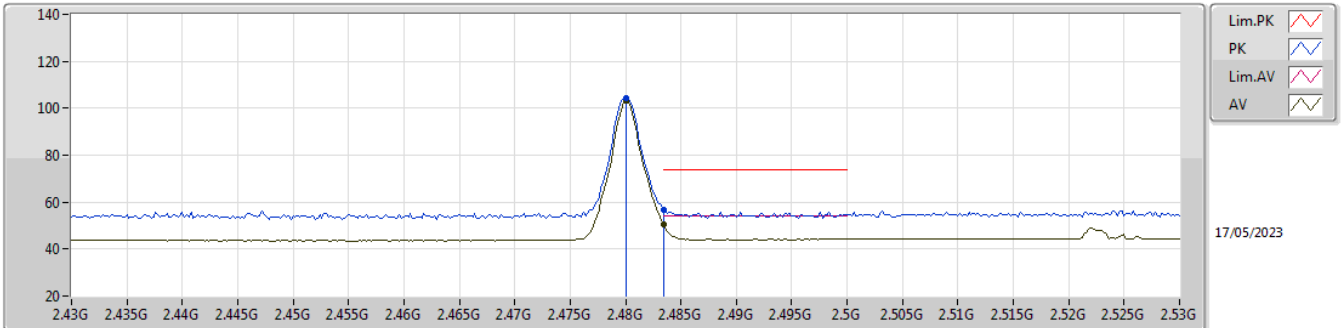

EUT Y_1TX
Setting 9
01-E-P-5

Type	Freq (Hz)	Level (dBuV/m)	Limit (dBuV/m)	Margin (dB)	Raw (dBuV)	Dist (m)	Condition	Azimuth (°)	Height (m)	Comment	AF (dB)	CL (dB)	PA (dB)
PK	2.48G	104.09	Inf	-Inf	72.37	3	Horizontal	299	2.17	-	28.08	3.64	-
AV	2.48G	103.23	Inf	-Inf	71.51	3	Horizontal	299	2.17	-	28.08	3.64	-
PK	2.4835G	56.84	74.00	-17.16	25.10	3	Horizontal	299	2.17	-	28.10	3.64	-
AV	2.4835G	50.52	54.00	-3.48	18.78	3	Horizontal	299	2.17	-	28.10	3.64	-

2.4-2.4835GHz_BT-BR(1Mbps)

2480MHz_TX

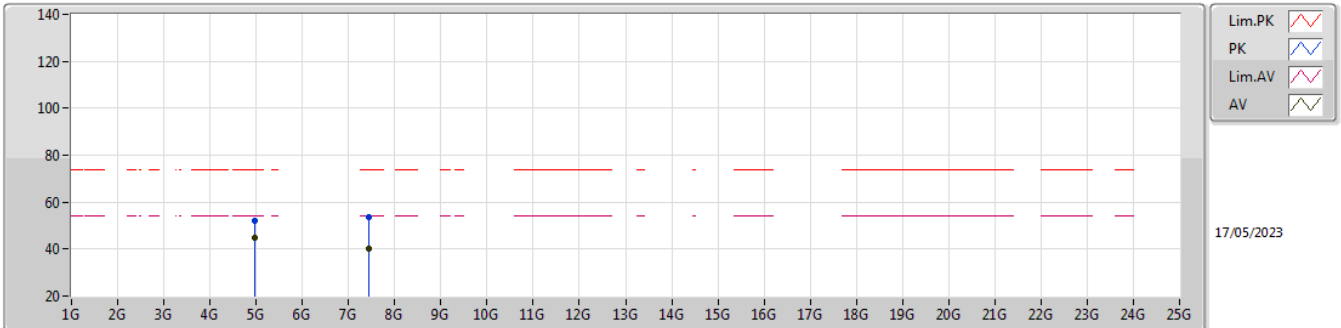

EUT Y_1TX
Setting 9
01-E-P-5

Type	Freq (Hz)	Level (dBuV/m)	Limit (dBuV/m)	Margin (dB)	Raw (dBuV)	Dist (m)	Condition	Azimuth (°)	Height (m)	Comment	AF (dB)	CL (dB)	PA (dB)
PK	4.96012G	52.11	74.00	-21.89	46.09	3	Vertical	316	2.09	-	33.02	5.86	32.86
AV	4.95997G	44.92	54.00	-9.08	38.90	3	Vertical	316	2.09	-	33.02	5.86	32.86
PK	7.43902G	53.50	74.00	-20.50	42.03	3	Vertical	37	1.47	-	37.50	7.22	33.25
AV	7.4388G	40.10	54.00	-13.90	28.63	3	Vertical	37	1.47	-	37.50	7.22	33.25

2.4-2.4835GHz_BT-BR(1Mbps)

2480MHz_TX

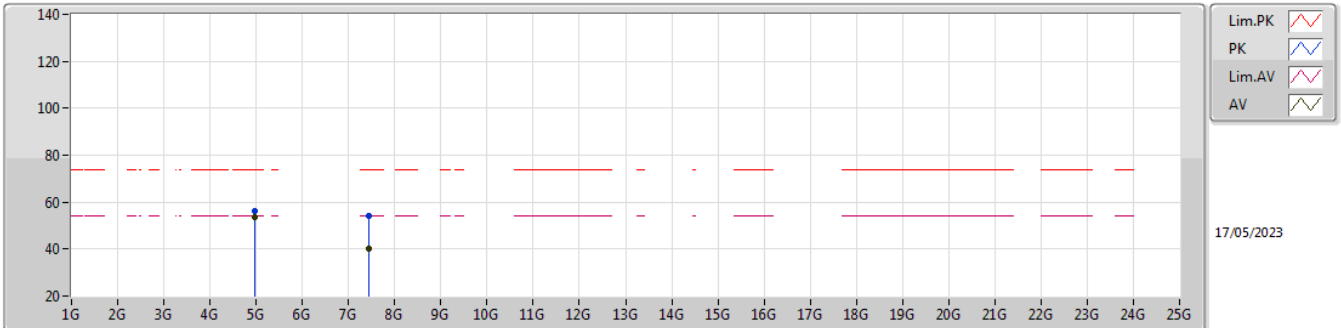

EUT Y_1TX
Setting 9
01-E-P-5

Type	Freq (Hz)	Level (dBuV/m)	Limit (dBuV/m)	Margin (dB)	Raw (dBuV)	Dist (m)	Condition	Azimuth (°)	Height (m)	Comment	AF (dB)	CL (dB)	PA (dB)
PK	4.95979G	56.34	74.00	-17.66	50.32	3	Horizontal	351	1.74	-	33.02	5.86	32.86
AV	4.96004G	53.78	54.00	-0.22	47.76	3	Horizontal	351	1.74	-	33.02	5.86	32.86
PK	7.43975G	53.89	74.00	-20.11	42.42	3	Horizontal	220	1.40	-	37.50	7.22	33.25
AV	7.44142G	40.11	54.00	-13.89	28.64	3	Horizontal	220	1.40	-	37.50	7.22	33.25

2.4-2.4835GHz_BT-EDR(3Mbps)

2402MHz_TX

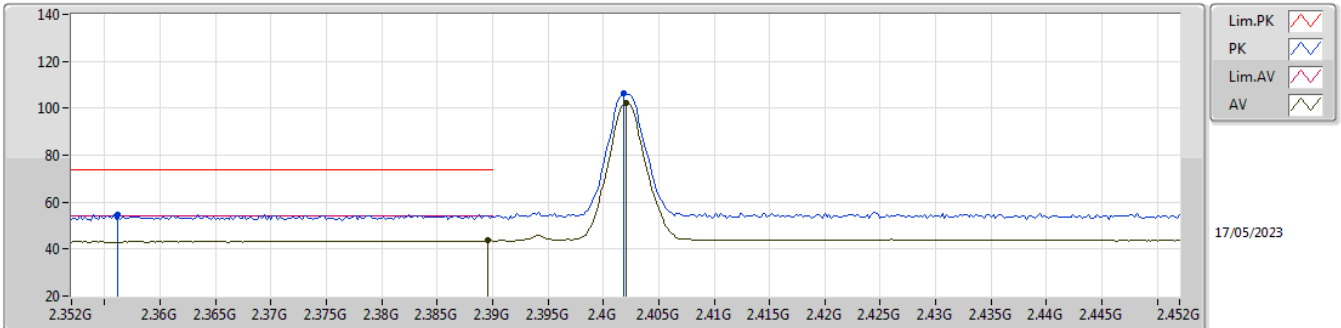

EUT Y_1TX
Setting 9
01-E-P-5

Type	Freq (Hz)	Level (dBuV/m)	Limit (dBuV/m)	Margin (dB)	Raw (dBuV)	Dist (m)	Condition	Azimuth (°)	Height (m)	Comment	AF (dB)	CL (dB)	PA (dB)
PK	2.3562G	54.66	74.00	-19.34	23.39	3	Vertical	17	1.80	-	27.71	3.56	-
AV	2.3896G	43.68	54.00	-10.32	12.31	3	Vertical	17	1.80	-	27.78	3.59	-
PK	2.4018G	106.16	Inf	-Inf	74.76	3	Vertical	17	1.80	-	27.80	3.60	-
AV	2.402G	102.23	Inf	-Inf	70.83	3	Vertical	17	1.80	-	27.80	3.60	-

2.4-2.4835GHz_BT-EDR(3Mbps)

2402MHz_TX

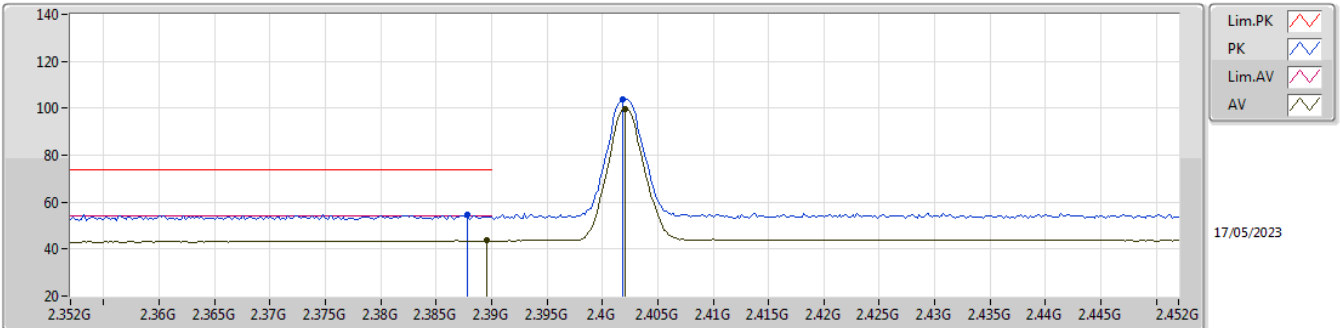

EUT Y_1TX
Setting 9
01-E-P-5

Type	Freq (Hz)	Level (dBuV/m)	Limit (dBuV/m)	Margin (dB)	Raw (dBuV)	Dist (m)	Condition	Azimuth (°)	Height (m)	Comment	AF (dB)	CL (dB)	PA (dB)
PK	2.3878G	54.71	74.00	-19.29	23.34	3	Horizontal	328	1.66	-	27.78	3.59	-
AV	2.3896G	43.67	54.00	-10.33	12.30	3	Horizontal	328	1.66	-	27.78	3.59	-
PK	2.4018G	103.58	Inf	-Inf	72.18	3	Horizontal	328	1.66	-	27.80	3.60	-
AV	2.402G	99.72	Inf	-Inf	68.32	3	Horizontal	328	1.66	-	27.80	3.60	-

2.4-2.4835GHz_BT-EDR(3Mbps)

2402MHz_TX

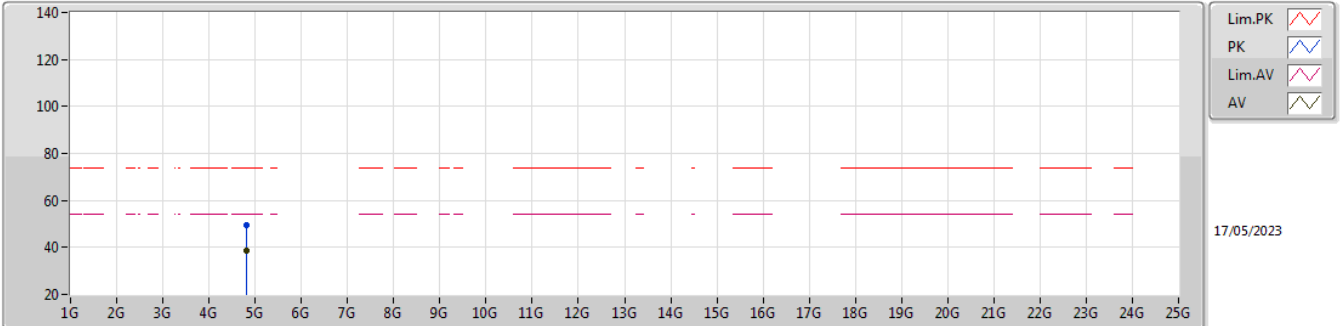

EUT Y_1TX
 Setting 9
 01-E-P-5

Type	Freq (Hz)	Level (dBuV/m)	Limit (dBuV/m)	Margin (dB)	Raw (dBuV)	Dist (m)	Condition	Azimuth (°)	Height (m)	Comment	AF (dB)	CL (dB)	PA (dB)
PK	4.80392G	49.51	74.00	-24.49	43.98	3	Vertical	40	1.77	-	32.72	5.70	32.89
AV	4.8041G	38.75	54.00	-15.25	33.22	3	Vertical	40	1.77	-	32.72	5.70	32.89

2.4-2.4835GHz_BT-EDR(3Mbps)

2402MHz_TX

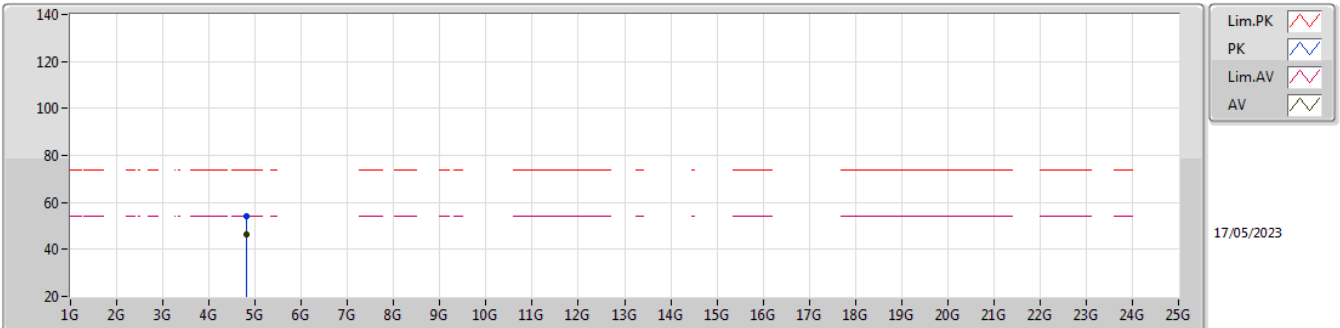

EUT Y_1TX
Setting 9
01-E-P-5

Type	Freq (Hz)	Level (dBuV/m)	Limit (dBuV/m)	Margin (dB)	Raw (dBuV)	Dist (m)	Condition	Azimuth (°)	Height (m)	Comment	AF (dB)	CL (dB)	PA (dB)
PK	4.80348G	54.30	74.00	-19.70	48.77	3	Horizontal	354	2.06	-	32.72	5.70	32.89
AV	4.80402G	46.16	54.00	-7.84	40.63	3	Horizontal	354	2.06	-	32.72	5.70	32.89

2.4-2.4835GHz_BT-EDR(3Mbps)

2440MHz_TX

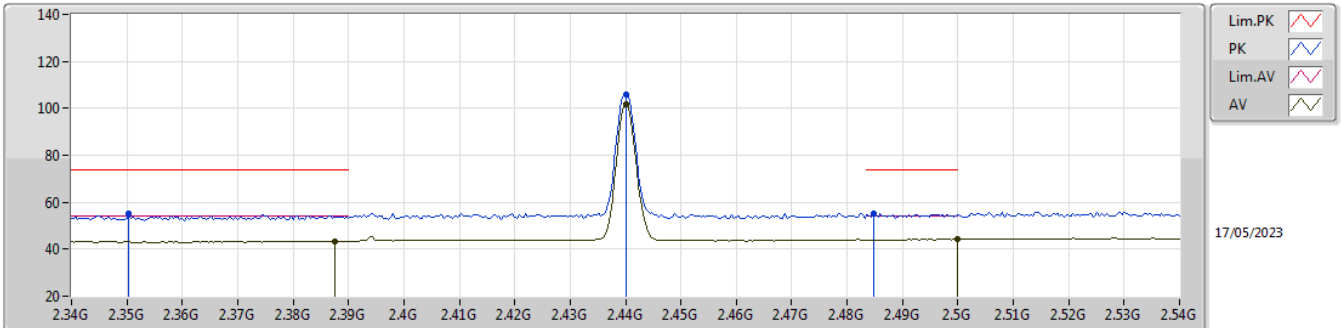

EUT_Y_1TX
Setting 9
01-E-P-5

Type	Freq (Hz)	Level (dBuV/m)	Limit (dBuV/m)	Margin (dB)	Raw (dBuV)	Dist (m)	Condition	Azimuth (°)	Height (m)	Comment	AF (dB)	CL (dB)	PA (dB)
PK	2.3504G	54.95	74.00	-19.05	23.70	3	Vertical	20	1.92	-	27.70	3.55	-
AV	2.3876G	43.41	54.00	-10.59	12.04	3	Vertical	20	1.92	-	27.78	3.59	-
PK	2.44G	105.92	Inf	-Inf	74.42	3	Vertical	20	1.92	-	27.88	3.62	-
AV	2.44G	101.96	Inf	-Inf	70.46	3	Vertical	20	1.92	-	27.88	3.62	-
PK	2.4848G	54.96	74.00	-19.04	23.21	3	Vertical	20	1.92	-	28.11	3.64	-
AV	2.5G	44.24	54.00	-9.76	12.39	3	Vertical	20	1.92	-	28.20	3.65	-

2.4-2.4835GHz_BT-EDR(3Mbps)

2440MHz_TX

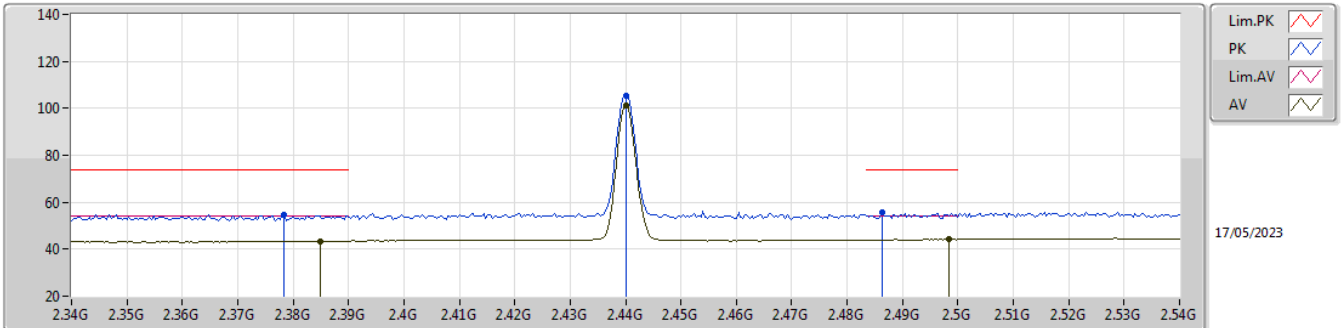

EUT_Y_1TX
Setting 9
01-E-P-5

Type	Freq (Hz)	Level (dBuV/m)	Limit (dBuV/m)	Margin (dB)	Raw (dBuV)	Dist (m)	Condition	Azimuth (°)	Height (m)	Comment	AF (dB)	CL (dB)	PA (dB)
PK	2.3784G	54.72	74.00	-19.28	23.38	3	Horizontal	312	2.29	-	27.76	3.58	-
AV	2.3848G	43.50	54.00	-10.50	12.15	3	Horizontal	312	2.29	-	27.77	3.58	-
PK	2.44G	105.46	Inf	-Inf	73.96	3	Horizontal	312	2.29	-	27.88	3.62	-
AV	2.44G	101.30	Inf	-Inf	69.80	3	Horizontal	312	2.29	-	27.88	3.62	-
PK	2.4864G	55.70	74.00	-18.30	23.94	3	Horizontal	312	2.29	-	28.12	3.64	-
AV	2.4984G	44.28	54.00	-9.72	12.44	3	Horizontal	312	2.29	-	28.19	3.65	-

2.4-2.4835GHz_BT-EDR(3Mbps)

2440MHz_TX

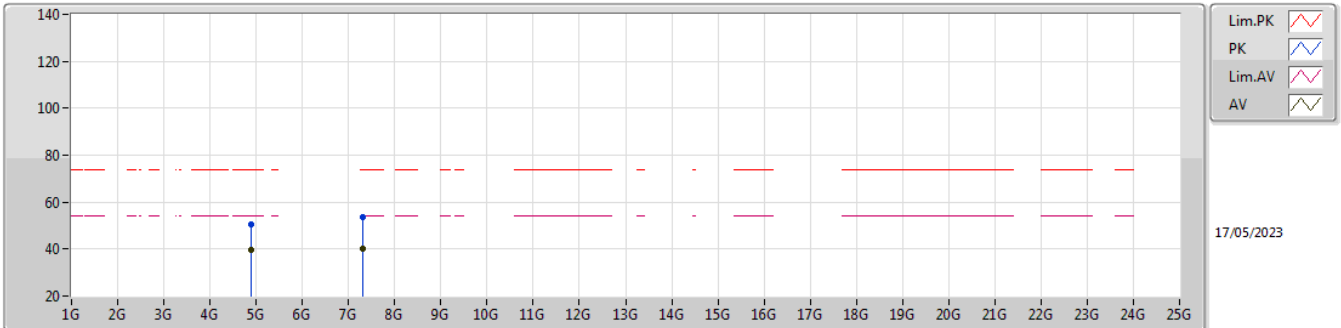

EUT Y_1TX
Setting 9
01-E-P-5

Type	Freq (Hz)	Level (dBuV/m)	Limit (dBuV/m)	Margin (dB)	Raw (dBuV)	Dist (m)	Condition	Azimuth (°)	Height (m)	Comment	AF (dB)	CL (dB)	PA (dB)
PK	4.8803G	50.71	74.00	-23.29	44.80	3	Vertical	46	1.75	-	33.00	5.78	32.87
AV	4.88014G	39.55	54.00	-14.45	33.64	3	Vertical	46	1.75	-	33.00	5.78	32.87
PK	7.31945G	53.53	74.00	-20.47	41.96	3	Vertical	221	2.90	-	37.60	7.16	33.19
AV	7.31819G	40.32	54.00	-13.68	28.75	3	Vertical	221	2.90	-	37.60	7.16	33.19

2.4-2.4835GHz_BT-EDR(3Mbps)

2440MHz_TX

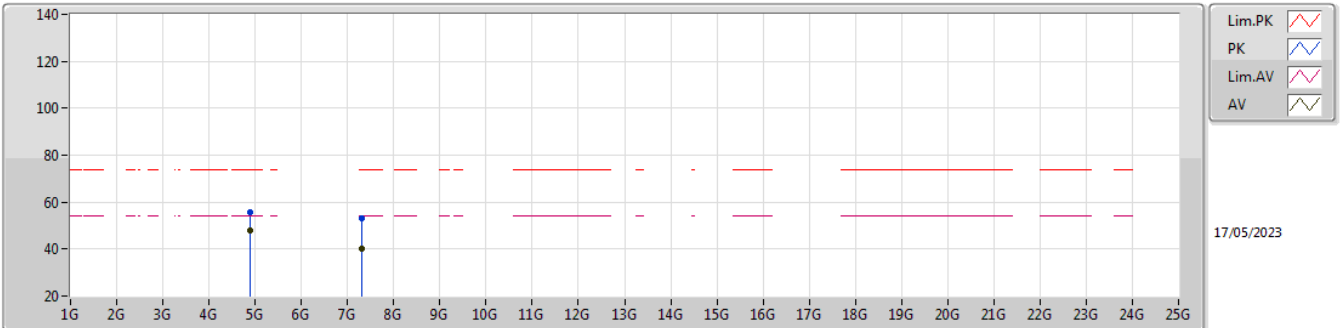

EUT Y_1TX
Setting 9
01-E-P-5

Type	Freq (Hz)	Level (dBuV/m)	Limit (dBuV/m)	Margin (dB)	Raw (dBuV)	Dist (m)	Condition	Azimuth (°)	Height (m)	Comment	AF (dB)	CL (dB)	PA (dB)
PK	4.88014G	55.59	74.00	-18.41	49.68	3	Horizontal	354	1.90	-	33.00	5.78	32.87
AV	4.87994G	47.73	54.00	-6.27	41.82	3	Horizontal	354	1.90	-	33.00	5.78	32.87
PK	7.31957G	53.13	74.00	-20.87	41.56	3	Horizontal	294	2.96	-	37.60	7.16	33.19
AV	7.31901G	40.26	54.00	-13.74	28.69	3	Horizontal	294	2.96	-	37.60	7.16	33.19

2.4-2.4835GHz_BT-EDR(3Mbps)

2480MHz_TX

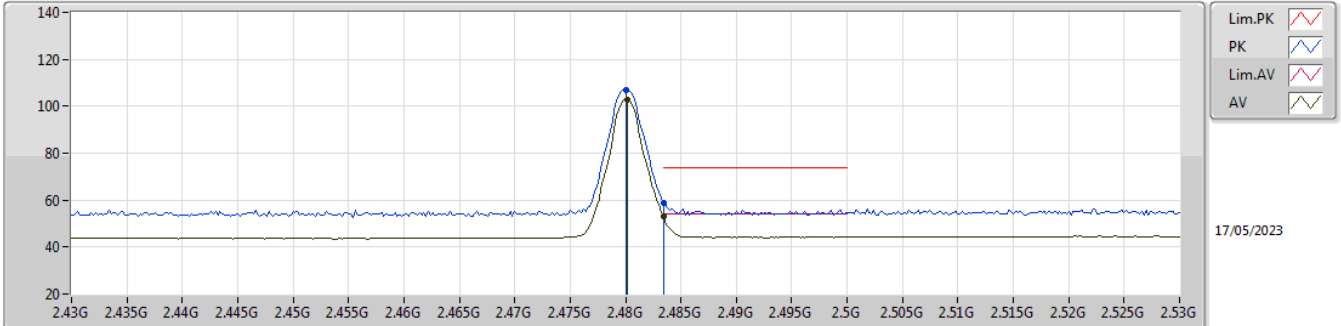

EUT Y_1TX
Setting 9
01-E-P-5

Type	Freq (Hz)	Level (dBuV/m)	Limit (dBuV/m)	Margin (dB)	Raw (dBuV)	Dist (m)	Condition	Azimuth (°)	Height (m)	Comment	AF (dB)	CL (dB)	PA (dB)
PK	2.48G	106.83	Inf	-Inf	75.11	3	Vertical	19	1.77	-	28.08	3.64	-
AV	2.4802G	102.95	Inf	-Inf	71.23	3	Vertical	19	1.77	-	28.08	3.64	-
PK	2.4835G	58.91	74.00	-15.09	27.17	3	Vertical	19	1.77	-	28.10	3.64	-
AV	2.4835G	53.07	54.00	-0.93	21.33	3	Vertical	19	1.77	-	28.10	3.64	-

2.4-2.4835GHz_BT-EDR(3Mbps)

2480MHz_TX

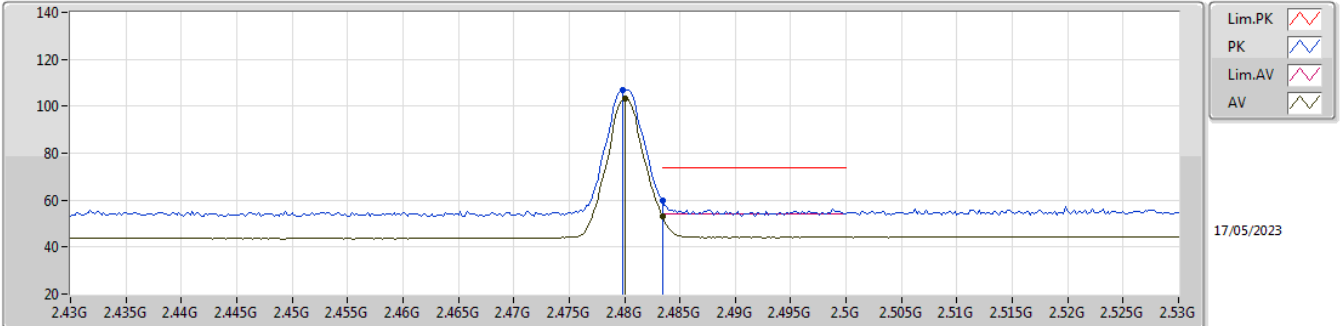

EUT Y_1TX
Setting 9
01-E-P-5

Type	Freq (Hz)	Level (dBuV/m)	Limit (dBuV/m)	Margin (dB)	Raw (dBuV)	Dist (m)	Condition	Azimuth (°)	Height (m)	Comment	AF (dB)	CL (dB)	PA (dB)
PK	2.4798G	107.02	Inf	-Inf	75.30	3	Horizontal	300	2.17	-	28.08	3.64	-
AV	2.48G	103.13	Inf	-Inf	71.41	3	Horizontal	300	2.17	-	28.08	3.64	-
PK	2.4835G	59.87	74.00	-14.13	28.13	3	Horizontal	300	2.17	-	28.10	3.64	-
AV	2.4835G	53.33	54.00	-0.67	21.59	3	Horizontal	300	2.17	-	28.10	3.64	-

2.4-2.4835GHz_BT-EDR(3Mbps)

2480MHz_TX

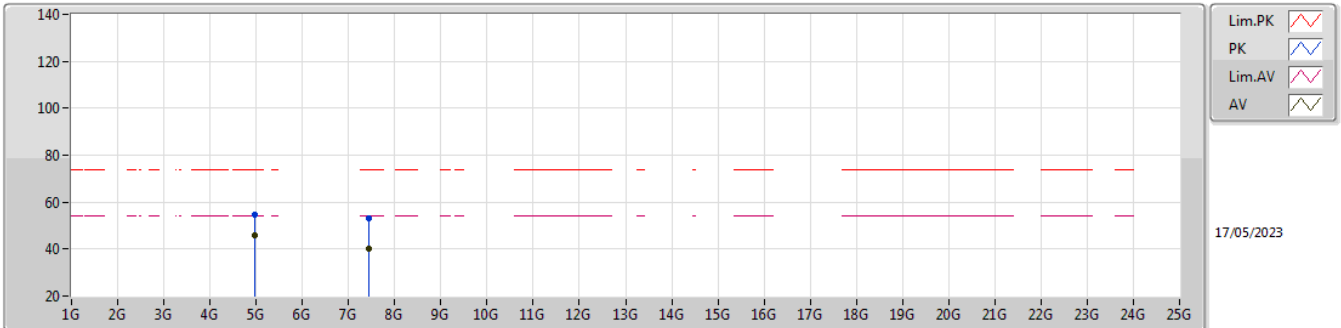

EUT Y_1TX
Setting 9
01-E-P-5

Type	Freq (Hz)	Level (dBuV/m)	Limit (dBuV/m)	Margin (dB)	Raw (dBuV)	Dist (m)	Condition	Azimuth (°)	Height (m)	Comment	AF (dB)	CL (dB)	PA (dB)
PK	4.96011G	54.47	74.00	-19.53	48.45	3	Vertical	324	3.00	-	33.02	5.86	32.86
AV	4.96003G	46.06	54.00	-7.94	40.04	3	Vertical	324	3.00	-	33.02	5.86	32.86
PK	7.43868G	53.23	74.00	-20.77	41.76	3	Vertical	182	1.65	-	37.50	7.22	33.25
AV	7.44089G	40.26	54.00	-13.74	28.79	3	Vertical	182	1.65	-	37.50	7.22	33.25

2.4-2.4835GHz_BT-EDR(3Mbps)

2480MHz_TX

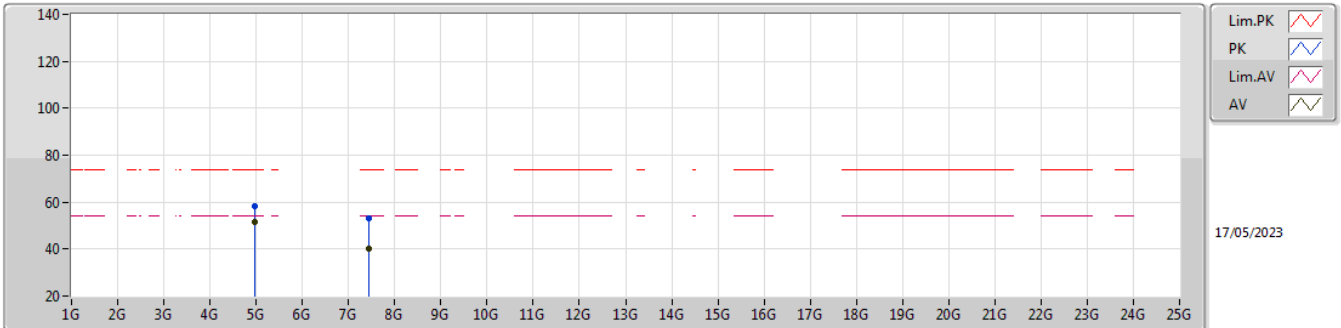

EUT Y_1TX
Setting 9
01-E-P-5

Type	Freq (Hz)	Level (dBuV/m)	Limit (dBuV/m)	Margin (dB)	Raw (dBuV)	Dist (m)	Condition	Azimuth (°)	Height (m)	Comment	AF (dB)	CL (dB)	PA (dB)
PK	4.96031G	58.37	74.00	-15.63	52.35	3	Horizontal	354	1.80	-	33.02	5.86	32.86
AV	4.96009G	51.45	54.00	-2.55	45.43	3	Horizontal	354	1.80	-	33.02	5.86	32.86
PK	7.43996G	53.14	74.00	-20.86	41.67	3	Horizontal	56	1.10	-	37.50	7.22	33.25
AV	7.43859G	40.05	54.00	-13.95	28.58	3	Horizontal	56	1.10	-	37.50	7.22	33.25



Summary

Mode	Result	Type	Freq (Hz)	Level (dBuV/m)	Limit (dBuV/m)	Margin (dB)	Condition
Mode 1	Pass	AV	1.36803G	37.81	54.00	-16.19	Vertical

Mode 1

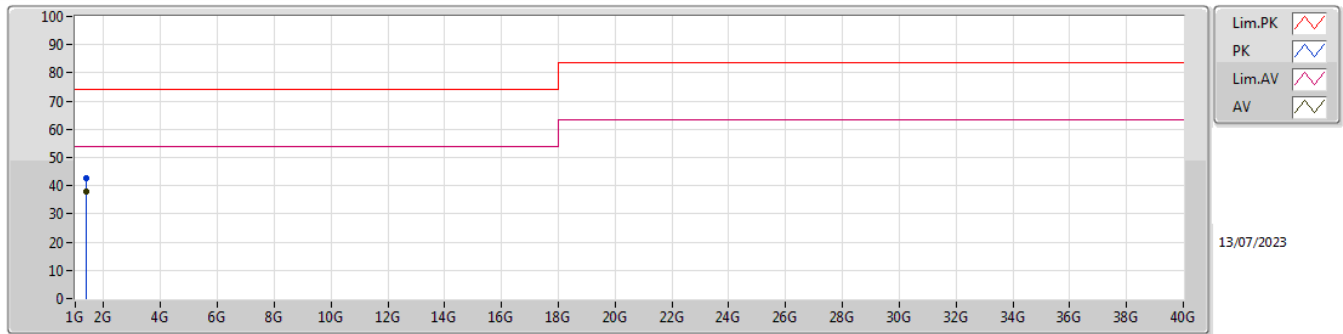

Type	Freq (Hz)	Level (dBuV/m)	Limit (dBuV/m)	Margin (dB)	Factor (dB/m)	Dist (m)	Condition	Azimuth (°)	Height (m)	Comment	Raw (dBuV/m)	AF (dB/m)	CL (dB)	PA (dB)
PK	1.36803G	42.67	74.00	-31.33	-7.81	3	Vertical	230	1.27	-	50.48	25.34	3.27	36.42
AV	1.36803G	37.81	54.00	-16.19	-7.81	3	Vertical	230	1.27	-	45.62	25.34	3.27	36.42

Mode 1

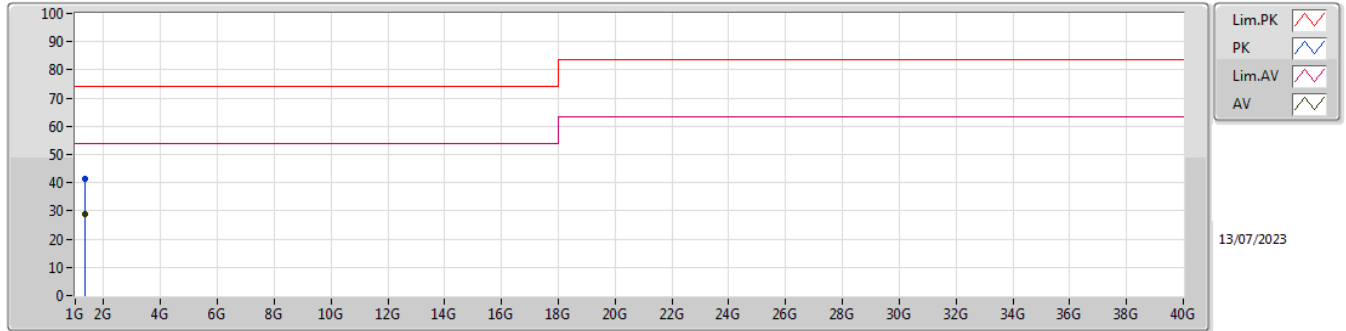

Type	Freq (Hz)	Level (dBuV/m)	Limit (dBuV/m)	Margin (dB)	Factor (dB/m)	Dist (m)	Condition	Azimuth (°)	Height (m)	Comment	Raw (dBuV/m)	AF (dB/m)	CL (dB)	PA (dB)
PK	1.36208G	41.18	74.00	-32.82	-7.70	3	Horizontal	83	1.17	-	48.88	25.46	3.26	36.42
AV	1.36208G	28.69	54.00	-25.31	-7.70	3	Horizontal	83	1.17	-	36.39	25.46	3.26	36.42