



RADIO TEST REPORT

FCC ID : UDX-600128010
Equipment : SMART Camera
Brand Name : CISCO
Model Name : MV33-HW
Applicant : Cisco Systems, Inc.
170 West Tasman Drive, San Jose, CA 95134 USA
Manufacturer : Cisco Systems, Inc.
170 West Tasman Drive, San Jose, CA 95134 USA
Standard : 47 CFR FCC Part 15.247

The product was received on Mar. 18, 2023, and testing was started from Mar. 22, 2023 and completed on Jul. 19, 2023. We, Sporton International Inc. Hsinchu Laboratory, would like to declare that the tested sample has been evaluated in accordance with the procedures given in ANSI C63.10-2013 and shown compliance with the applicable technical standards.

The test results in this report apply exclusively to the tested model / sample. Without written approval of Sporton International Inc. Hsinchu Laboratory, the test report shall not be reproduced except in full.

Approved by: Sam Chen

Sporton International Inc. Hsinchu Laboratory

No.8, Ln. 724, Bo'ai St., Zhubei City, Hsinchu County 302010, Taiwan (R.O.C.)



Table of Contents

History of this test report.....3

Summary of Test Result.....4

1 General Description5

1.1 Information.....5

1.2 Applicable Standards9

1.3 Testing Location Information9

1.4 Measurement Uncertainty10

2 Test Configuration of EUT11

2.1 Test Channel Mode11

2.2 The Worst Case Measurement Configuration12

2.3 EUT Operation during Test14

2.4 Accessories14

2.5 Support Equipment.....15

2.6 Test Setup Diagram16

3 Transmitter Test Result19

3.1 AC Power-line Conducted Emissions19

3.2 DTS Bandwidth.....21

3.3 Maximum Conducted Output Power22

3.4 Power Spectral Density25

3.5 Emissions in Non-restricted Frequency Bands27

3.6 Emissions in Restricted Frequency Bands.....28

4 Test Equipment and Calibration Data32

Appendix A. Test Results of AC Power-line Conducted Emissions

Appendix B. Test Results of DTS Bandwidth

Appendix C. Test Results of Maximum Conducted Output Power

Appendix D. Test Results of Power Spectral Density

Appendix E. Test Results of Emissions in Non-restricted Frequency Bands

Appendix F. Test Results of Emissions in Restricted Frequency Bands

Appendix G. Test Results of Radiated Emission Co-location

Appendix H. Test Photos

Photographs of EUT v01



Summary of Test Result

Report Clause	Ref Std. Clause	Test Items	Result (PASS/FAIL)	Remark
1.1.2	15.203	Antenna Requirement	PASS	-
3.1	15.207	AC Power-line Conducted Emissions	PASS	-
3.2	15.247(a)	DTS Bandwidth	PASS	-
3.3	15.247(b)	Maximum Conducted Output Power	PASS	-
3.4	15.247(e)	Power Spectral Density	PASS	-
3.5	15.247(d)	Emissions in Non-restricted Frequency Bands	PASS	-
3.6	15.247(d)	Emissions in Restricted Frequency Bands	PASS	-

Conformity Assessment Condition:

1. The test results (PASS/FAIL) with all measurement uncertainty excluded are presented against the regulation limits or in accordance with the requirements stipulated by the applicant/manufacture who shall bear all the risks of non-compliance that may potentially occur if measurement uncertainty is taken into account.
2. The measurement uncertainty please refer to each test result in the chapter "Measurement Uncertainty".

Disclaimer:

The product specifications of the EUT presented in the test report that may affect the test assessments are declared by the manufacturer who shall take full responsibility for the authenticity.

Reviewed by: **Sam Chen**
Report Producer: **Sandy Chuang**



1 General Description

1.1 Information

1.1.1 RF General Information

Frequency Range (MHz)	Bluetooth Mode	Ch. Frequency (MHz)	Channel Number
2400-2483.5	LE	2402-2480	0-39 [40]

Band	Mode	BWch (MHz)	Nant
2.4-2.4835GHz	BT-LE(1Mbps)	1	1TX
2.4-2.4835GHz	BT-LE(500Kb/s)	1	1TX
2.4-2.4835GHz	BT-LE(125Kb/s)	1	1TX
2.4-2.4835GHz	BT-LE(2Mbps)	2	1TX

Note:

- ◆ Bluetooth LE uses a GFSK modulation.
- ◆ BWch is the nominal channel bandwidth.



1.1.2 Antenna Information

Ant.	Port		Brand	Model Name	Antenna Type	Connector	Gain (dBi)					
	WLAN	Bluetooth					WLAN 2.4GHz	WLAN 5GHz				Bluetooth
								UNII 1	UNII 2A	UNII 2C	UNII 3	
1	1	1	SERCOMM	Ant 1, Ant2	PIFA	I-PEX	2.40	3.31	3.31	3.76	3.05	2.40
2	2	2	SERCOMM	Ant 1, Ant2	PIFA	I-PEX	0.98	2.40	2.40	2.10	2.50	0.98

Note: The above information was declared by manufacturer.

For 2.4GHz function:

For IEEE 802.11b/g/n/VHT mode (1TX/1RX):

The EUT supports the antenna with TX and RX diversity functions.

Both Port 1 and Port 2 support transmit and receive functions, but only one of them will be used at one time.

The Port 1 generated the worst case, so it was selected to test and record in the report.

For 5GHz function:

For IEEE 802.11a/n/ac mode (1TX/1RX):

The EUT supports the antenna with TX and RX diversity functions.

Both Port 1 and Port 2 support transmit and receive functions, but only one of them will be used at one time.

The Port 1 generated the worst case, so it was selected to test and record in the report.

For Bluetooth function (1TX/1RX):

The EUT supports the antenna with TX and RX diversity functions.

Both Port 1 and Port 2 support transmit and receive functions, but only one of them will be used at one time.

The Port 1 generated the worst case, so it was selected to test and record in the report.



1.1.3 Mode Test Duty Cycle

Mode	DC	DCF(dB)	T(s)	VBW(Hz) ≥ 1/T
BT-LE(1Mbps)	0.628	2.02	392.5u	3k
BT-LE(2Mbps)	0.333	4.78	208.125u	10k

Note:

- ◆ DC is Duty Cycle.
- ◆ DCF is Duty Cycle Factor.

1.1.4 EUT Operational Condition

EUT Power Type	From PoE			
Function	<input checked="" type="checkbox"/> Point-to-multipoint	<input type="checkbox"/>	Point-to-point	
Test Software Version	QRCT_v4.0.00201.0			
Support Mode	<input checked="" type="checkbox"/>	LE 1M PHY: 1 Mb/s		
	<input checked="" type="checkbox"/>	LE Coded PHY (S=2): 500 Kb/s		
	<input checked="" type="checkbox"/>	LE Coded PHY (S=8): 125 Kb/s		
	<input checked="" type="checkbox"/>	LE 2M PHY: 2 Mb/s		

Note: The above information was declared by manufacturer.



1.1.5 Multiple Sources

The EUT has second source verify for DDR4, UFS-3.1 256GB, PoE Transformer, LAN Transformer, ACT2, RF Connector, CMOS Coaxial Cable, LED Board Cable.

Note: The above information was declared by manufacturer.

1.1.6 EUT Combination Information

Item	Type	EUT 1	EUT 2
1	DDR4	Main Source	Second Source
2	UFS-3.1 256GB	Main Source	Second Source
3	PoE Transformer	Main Source	Second Source
4	LAN Transformer	Main Source	Second Source
5	ACT2	Main Source	Second Source
6	RF Connector	Main Source	Second Source
7	CMOS Coaxial Cable	Main Source	Second Source
8	LED Board Cable	Main Source	Second Source

Note 1: From the above, EUT 1 was selected to test all items and EUT 2 was selected to test AC Power-line Conducted Emissions and Emissions in Restricted Frequency Bands below 1GHz only, and their data was recorded in this report.

Note 2: The above information was declared by manufacturer.



1.2 Applicable Standards

According to the specifications of the manufacturer, the EUT must comply with the requirements of the following standards:

- ◆ 47 CFR FCC Part 15.247
- ◆ ANSI C63.10-2013

The following reference test guidance is not within the scope of accreditation of TAF.

- ◆ FCC KDB 558074 D01 v05r02
- ◆ FCC KDB 414788 D01 v01r01

1.3 Testing Location Information

Testing Location Information	
Test Lab. : Sporton International Inc. Hsinchu Laboratory	
Hsinchu (TAF: 3787)	ADD: No.8, Ln. 724, Bo'ai St., Zhubei City, Hsinchu County 302010, Taiwan (R.O.C.) TEL: 886-3-656-9065 FAX: 886-3-656-9085 Test site Designation No. TW3787 with FCC. Conformity Assessment Body Identifier (CABID) TW3787 with ISED.

Test Condition	Test Site No.	Test Engineer	Test Environment (°C / %)	Test Date
RF Conducted	TH02-CB	Ken Yeh	22.6~24.3 / 60~62	Mar. 22, 2023~ May 18, 2023
Radiated <1GHz	03CH05-CB	Mark Hsu	21~22 / 55~58	Jul. 13, 2023
Radiated >1GHz	03CH01-CB	Paul Huang	22.4~23.9 / 59~60	May 17, 2023~ May 18, 2023
Radiated Co-location	03CH05-CB	Paul Huang	23~24.7 / 58~63	Jul. 13, 2023
AC Conduction	CO01-CB	Gray Lee	21~22 / 53~54	Jul. 19, 2023



1.4 Measurement Uncertainty

ISO/IEC 17025 requires that an estimate of the measurement uncertainties associated with the emissions test results be included in the report. The measurement uncertainties given below are based on a 95% confidence level (based on a coverage factor (k=2))

Test Date: Before Jun. 01, 2023

Test Items	Uncertainty	Remark
Radiated Emission (1GHz ~ 18GHz)	5.2 dB	Confidence levels of 95%
Radiated Emission (18GHz ~ 40GHz)	4.7 dB	Confidence levels of 95%
Conducted Emission	3.2 dB	Confidence levels of 95%
Output Power Measurement	0.8 dB	Confidence levels of 95%
Power Density Measurement	3.2 dB	Confidence levels of 95%
Bandwidth Measurement	2.0 %	Confidence levels of 95%

Test Date: After May 31, 2023

Test Items	Uncertainty	Remark
Conducted Emission (150kHz ~ 30MHz)	3.4 dB	Confidence levels of 95%
Radiated Emission (9kHz ~ 30MHz)	3.7 dB	Confidence levels of 95%
Radiated Emission (30MHz ~ 1,000MHz)	5.1 dB	Confidence levels of 95%
Radiated Emission (1GHz ~ 18GHz)	4.1 dB	Confidence levels of 95%
Radiated Emission (18GHz ~ 40GHz)	4.2 dB	Confidence levels of 95%



2 Test Configuration of EUT

2.1 Test Channel Mode

Mode	Power Setting
BT-LE(1Mbps)	-
2402MHz	Maximum
2440MHz	Maximum
2478MHz	Maximum
2480MHz	Default
BT-LE(2Mbps)	-
2402MHz	Maximum
2440MHz	Maximum
2478MHz	Maximum
2480MHz	Default



2.2 The Worst Case Measurement Configuration

The Worst Case Mode for Following Conformance Tests	
Tests Item	AC power-line conducted emissions
Condition	AC power-line conducted measurement for line and neutral Test Voltage: 120Vac / 60Hz
Operating Mode	Normal Link
1	EUT 1 + LAN mode-Day mode + Bluetooth + PoE 1
2	EUT 1 + LAN mode-Night mode + Bluetooth + PoE 1
Mode 2 has been evaluated to be the worst case among Mode 1~2, thus measurement for Mode 3 ~ 6 will follow this same test mode.	
3	EUT 1 + WLAN 2.4GHz mode-Night mode + Bluetooth + PoE 1
4	EUT 1 + WLAN 2.4GHz mode-Night mode + Bluetooth + PoE 2
5	EUT 1 + WLAN 5GHz mode-Night mode + Bluetooth + PoE 1
6	EUT 1 + WLAN 5GHz mode-Night mode + Bluetooth + PoE 2
Mode 2 has been evaluated to be the worst case among Mode 1~6, thus measurement for Mode 7 will follow this same test mode.	
7	EUT 2 + LAN mode-Night mode + Bluetooth + PoE 1
For operating mode 2 is the worst case and it was record in this test report.	

The Worst Case Mode for Following Conformance Tests	
Tests Item	DTS Bandwidth Maximum Conducted Output Power Power Spectral Density Emissions in Non-restricted Frequency Bands
Test Condition	Conducted measurement at transmit chains
Test Mode	EUT 1



The Worst Case Mode for Following Conformance Tests	
Tests Item	Emissions in Restricted Frequency Bands
Test Condition	Radiated measurement If EUT consist of multiple antenna assembly (multiple antenna are used in EUT regardless of spatial multiplexing MIMO configuration), the radiated test should be performed with highest antenna gain of each antenna type.
Operating Mode < 1GHz	Normal Link
1	EUT 1 at Z axis + LAN mode-Day mode + Bluetooth + PoE 1
2	EUT 1 at Y axis + LAN mode-Day mode + Bluetooth + PoE 1
3	EUT 1 at X axis + LAN mode-Day mode + Bluetooth + PoE 1
Mode 1 has been evaluated to be the worst case among Mode 1~3, thus measurement for Mode 4 will follow this same test mode	
4	EUT 1 at Z axis + LAN mode-Night mode + Bluetooth + PoE 1
Mode 1 has been evaluated to be the worst case among Mode 1~4, thus measurement for Mode 5~ 8 will follow this same test mode.	
5	EUT 1 at Z axis + WLAN 2.4GHz mode-Day mode + Bluetooth + PoE 1
6	EUT 1 at Z axis + WLAN 2.4GHz mode-Day mode + Bluetooth + PoE 2
7	EUT 1 at Z axis + WLAN 5GHz mode-Day mode + Bluetooth + PoE 1
8	EUT 1 at Z axis + WLAN 5GHz mode-Day mode + Bluetooth + PoE 2
Mode 1 has been evaluated to be the worst case among Mode 1~8, thus measurement for Mode 9 will follow this same test mode.	
9	EUT 2 at Z axis + LAN mode-Day mode + Bluetooth + PoE 1
Mode 1 generated the worst test result, so it was recorded in this report.	
Operating Mode > 1GHz	CTX
	The EUT was performed at X axis, Y axis and Z axis position, and the worst case as below, Thus measurement will follow this same test configuration.
1	EUT 1 at Y axis



The Worst Case Mode for Following Conformance Tests	
Tests Item	Simultaneous Transmission Analysis - Radiated Emission Co-location
Test Condition	Radiated measurement
Operating Mode	Normal Link
The EUT was performed at X axis, Y axis and Z axis position for Radiated Emissions <Above 1GHz>, the worst case was found at Y axis position. Thus the measurement will follow.	
1	EUT 1 at Y axis + Bluetooth + WLAN 2.4GHz + PoE 1
2	EUT 1 at Y axis + Bluetooth + WLAN 5GHz + PoE 1
Mode 1 generated the worst test result, so it was recorded in this report.	
Refer to Appendix G for Radiated Emission Co-location.	

The Worst Case Mode for Following Conformance Tests	
Tests Item	Simultaneous Transmission Analysis - Co-location RF Exposure Evaluation
Operating Mode	
1	EUT 1 + Bluetooth + WLAN 2.4GHz
2	EUT 1 + Bluetooth + WLAN 5GHz
Refer to Sporton Test Report No.: FA282322-03 for Co-location RF Exposure Evaluation.	

Note: The PoEs are for measurement only, would not be marketed.

PoEs information as below:

Power	Brand	Model
PoE 1	PHIHONG	POEA33U-1ATE
PoE 2	CISCO	MA-PWR-MV-LV

2.3 EUT Operation during Test

For CTX Mode:

The EUT was programmed to be in continuously transmitting mode.

For Normal Link:

During the test, the EUT operation to normal function.

2.4 Accessories

Wall Bracket*3



2.5 Support Equipment

For AC Conduction:

Support Equipment				
No.	Equipment	Brand Name	Model Name	FCC ID
A	PoE 1	PHIHONG	POEA33U-1ATE	N/A
B	LAN NB	DELL	E6430	N/A
C	Smart phone	Samsung	Galaxy J2	N/A

For Radiated (below 1GHz):

Support Equipment				
No.	Equipment	Brand Name	Model Name	FCC ID
A	NB	DELL	E4300	N/A
B	PoE 1	PHIHONG	POEA33U-1ATE	N/A
C	Smart phone	Samsung	Galaxy J2	N/A

For Radiated (above 1GHz) and RF Conducted:

Support Equipment				
No.	Equipment	Brand Name	Model Name	FCC ID
A	NB	DELL	E4300	N/A
B	PoE 1	PHIHONG	PORA33U-1ATE	N/A

2.6 Test Setup Diagram

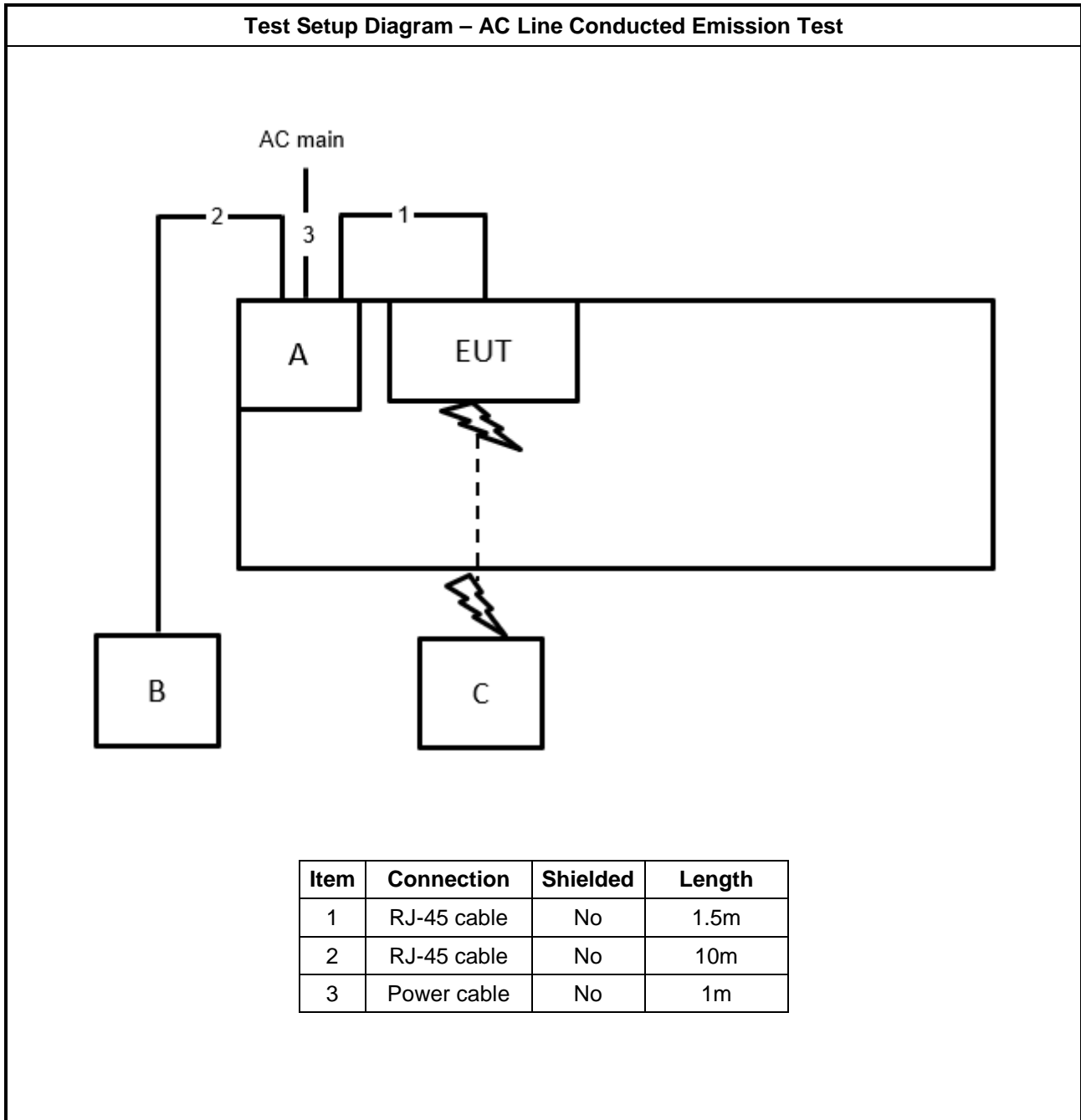

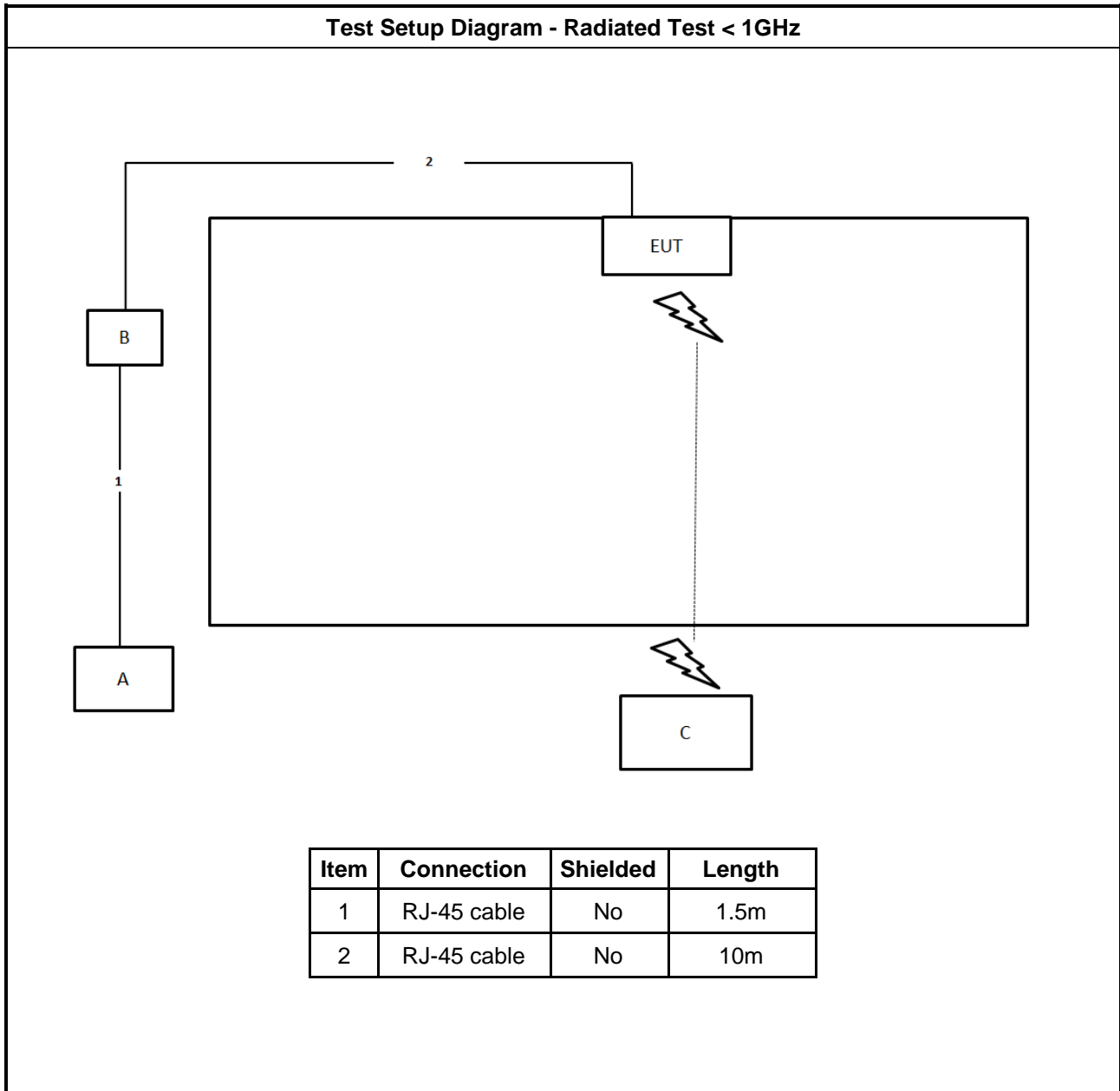



Test Setup Diagram - Radiated Test > 1GHz

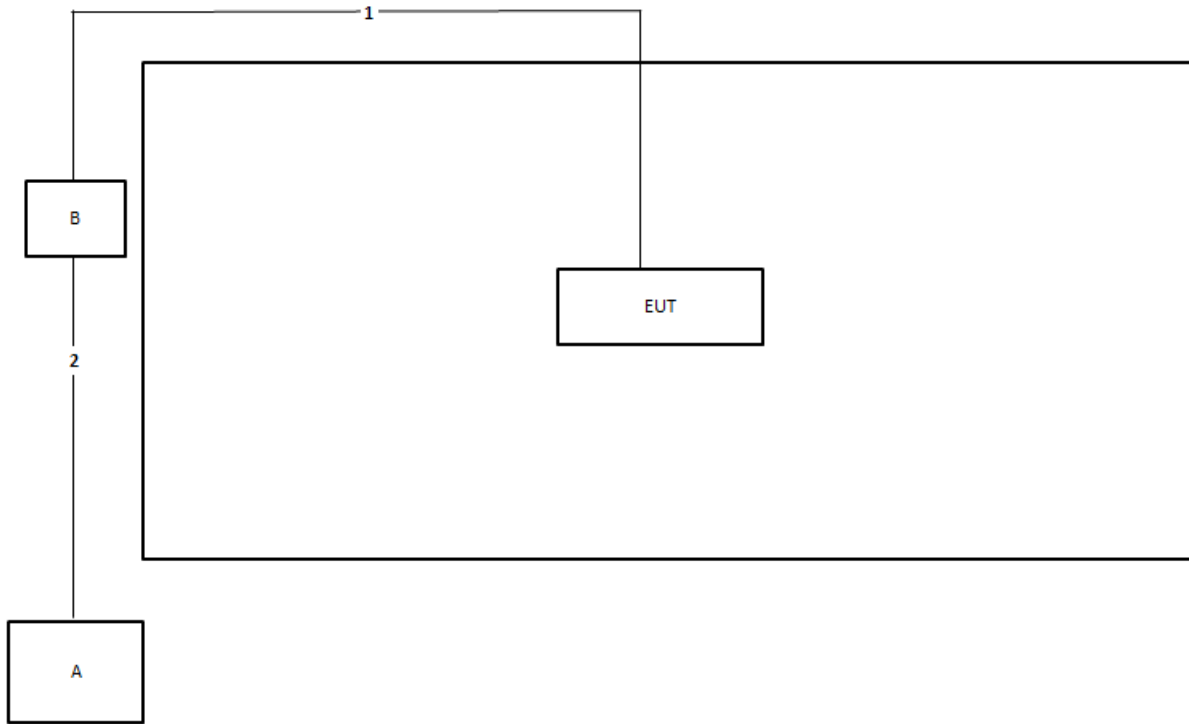

Item	Connection	Shielded	Length
1	RJ-45 cable	No	10m
2	RJ-45 cable	No	1.5m



3 Transmitter Test Result

3.1 AC Power-line Conducted Emissions

3.1.1 AC Power-line Conducted Emissions Limit

AC Power-line Conducted Emissions Limit		
Frequency Emission (MHz)	Quasi-Peak	Average
0.15-0.5	66 - 56 *	56 - 46 *
0.5-5	56	46
5-30	60	50

Note 1: * Decreases with the logarithm of the frequency.

3.1.2 Measuring Instruments

Refer a test equipment and calibration data table in this test report.

3.1.3 Test Procedures

Test Method
▪ Refer as ANSI C63.10-2013, clause 6.2 for AC power-line conducted emissions.

3.1.4 Test Setup

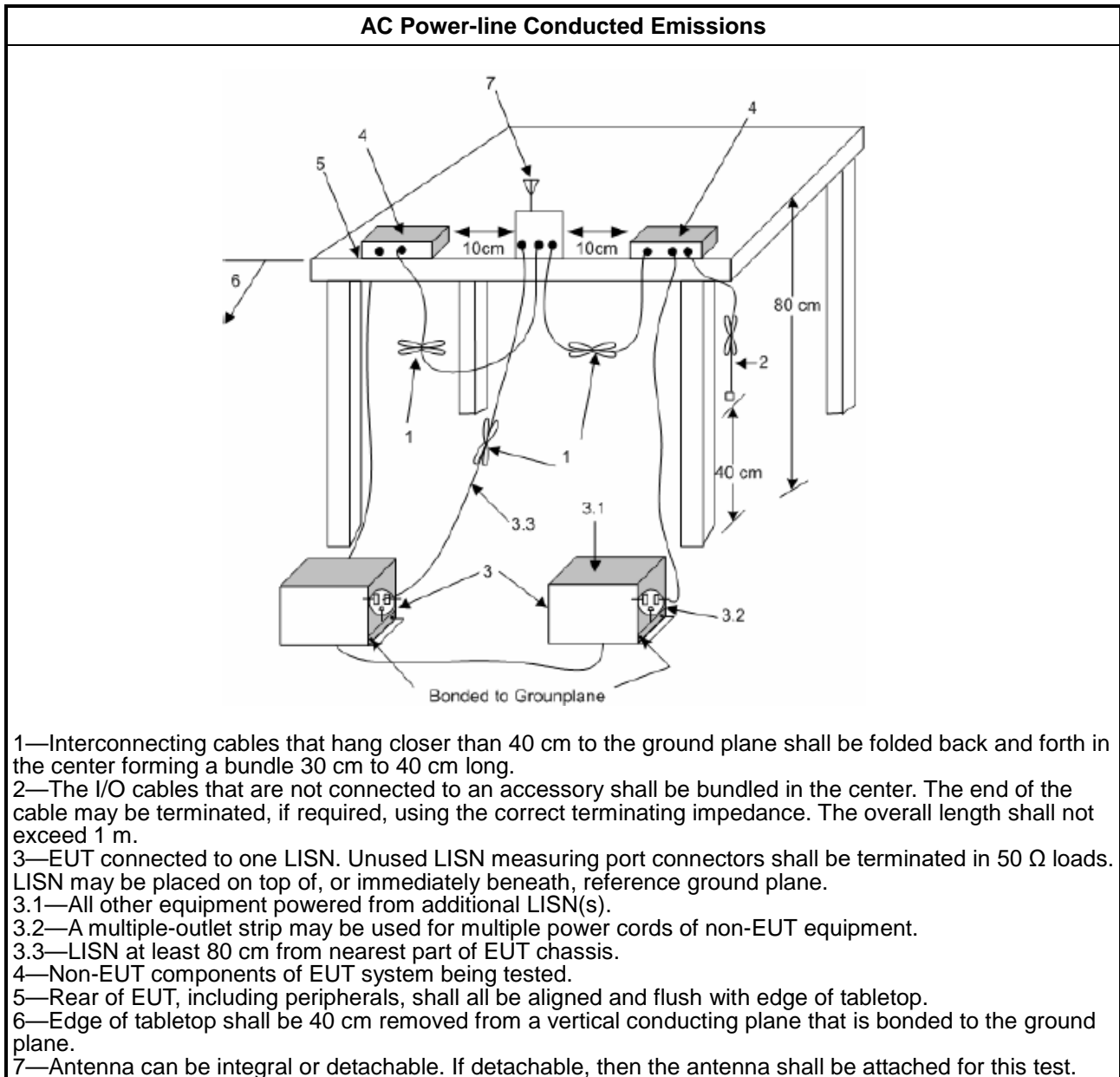

1.1.1. Measurement Results Calculation

The measured Level is calculated using:

- a. Corrected Reading: LISN Factor (LISN) + Attenuator (AT/AUX) + Cable Loss (CL) + Read Level (Raw) = Level
- b. Margin = -Limit + Level

3.1.5 Test Result of AC Power-line Conducted Emissions

Refer as Appendix A

3.2 DTS Bandwidth

3.2.1 6dB Bandwidth Limit

6dB Bandwidth Limit
Systems using digital modulation techniques:
<ul style="list-style-type: none"> ▪ 6 dB bandwidth \geq 500 kHz.

3.2.2 Measuring Instruments

Refer a test equipment and calibration data table in this test report.

3.2.3 Test Procedures

Test Method
<ul style="list-style-type: none"> ▪ For the emission bandwidth shall be measured using one of the options below:
<input checked="" type="checkbox"/> Refer as FCC KDB 558074, clause 8.2 & C63.10 clause 11.8.1 Option 1 for 6 dB bandwidth measurement.
<input type="checkbox"/> Refer as FCC KDB 558074, clause 8.2 & C63.10 clause 11.8.2 Option 2 for 6 dB bandwidth measurement.
<input type="checkbox"/> Refer as ANSI C63.10, clause 6.9.1 for occupied bandwidth testing.

3.2.4 Test Setup

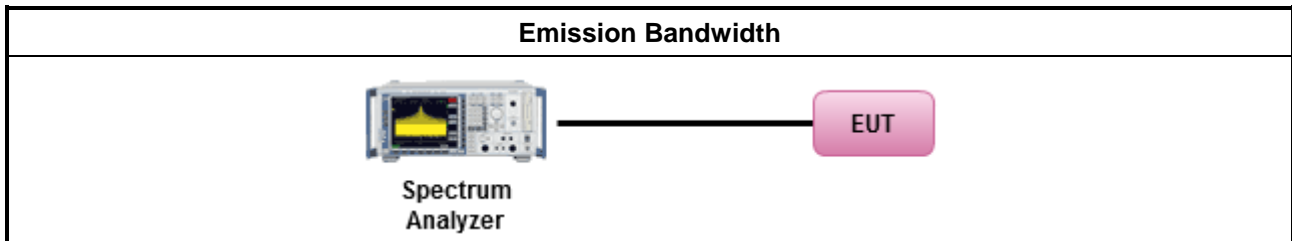

3.2.5 Test Result of Emission Bandwidth

Refer as Appendix B



3.3 Maximum Conducted Output Power

3.3.1 Maximum Conducted Output Power Limit

Maximum Conducted Output Power Limit	
	<ul style="list-style-type: none"> ▪ If $G_{TX} \leq 6$ dBi, then $P_{Out} \leq 30$ dBm (1 W)
	<ul style="list-style-type: none"> ▪ Point-to-multipoint systems (P2M): If $G_{TX} > 6$ dBi, then $P_{Out} = 30 - (G_{TX} - 6)$ dBm
	<ul style="list-style-type: none"> ▪ Point-to-point systems (P2P): If $G_{TX} > 6$ dBi, then $P_{Out} = 30 - (G_{TX} - 6)/3$ dBm
	<ul style="list-style-type: none"> ▪ Smart antenna system (SAS):
	<ul style="list-style-type: none"> - Single beam: If $G_{TX} > 6$ dBi, then $P_{Out} = 30 - (G_{TX} - 6)/3$ dBm
	<ul style="list-style-type: none"> - Overlap beam: If $G_{TX} > 6$ dBi, then $P_{Out} = 30 - (G_{TX} - 6)/3$ dBm
	<ul style="list-style-type: none"> - Aggregate power on all beams: If $G_{TX} > 6$ dBi, then $P_{Out} = 30 - (G_{TX} - 6)/3 + 8$ dB dBm
<p>P_{Out} = maximum peak conducted output power or maximum conducted output power in dBm, G_{TX} = the maximum transmitting antenna directional gain in dBi.</p>	

3.3.2 Measuring Instruments

Refer a test equipment and calibration data table in this test report.



3.3.3 Test Procedures

Test Method	
<ul style="list-style-type: none"> ▪ Maximum Peak Conducted Output Power 	
	<input type="checkbox"/> Refer as FCC KDB 558074, clause 8.3.1.1 & C63.10 clause 11.9.1.1 (RBW ≥ EBW method).
	<input type="checkbox"/> Refer as FCC KDB 558074, clause 8.3.1.3 & C63.10 clause 11.9.1.3 (peak power meter).
<ul style="list-style-type: none"> ▪ Maximum Conducted Output Power 	
[duty cycle ≥ 98% or external video / power trigger]	
	<input type="checkbox"/> Refer as FCC KDB 558074, clause 8.3.2.2 & C63.10 clause 11.9.2.2.2 Method AVGSA-1.
	<input type="checkbox"/> Refer as FCC KDB 558074, clause 8.3.2.2 & C63.10 clause 11.9.2.2.3 Method AVGSA-1A. (alternative)
duty cycle < 98% and average over on/off periods with duty factor	
	<input type="checkbox"/> Refer as FCC KDB 558074, clause 8.3.2.2 & C63.10 clause 11.9.2.2.4 Method AVGSA-2.
	<input type="checkbox"/> Refer as FCC KDB 558074, clause 8.3.2.2 & C63.10 clause 11.9.2.2.5 Method AVGSA-2A (alternative)
	<input type="checkbox"/> Refer as FCC KDB 558074, clause 8.3.2.2 & C63.10 clause 11.9.2.2.6 Method AVGSA-3
	<input type="checkbox"/> Refer as FCC KDB 558074, clause 8.3.2.2 & C63.10 clause 11.9.2.2.7 Method AVGSA-3A (alternative)
Measurement using a power meter (PM)	
	<input type="checkbox"/> Refer as FCC KDB 558074, clause 8.3.2.3 & C63.10 clause 11.9.2.3.1 Method AVGPM (using an RF average power meter).
	<input checked="" type="checkbox"/> Refer as FCC KDB 558074, clause 8.3.2.3 & C63.10 clause 11.9.2.3.2 Method AVGPM-G (using an gate RF average power meter).
<ul style="list-style-type: none"> ▪ For conducted measurement. 	
<ul style="list-style-type: none"> ▪ If the EUT supports multiple transmit chains using options given below: Refer as FCC KDB 662911, In-band power measurements. Using the measure-and-sum approach, measured all transmit ports individually. Sum the power (in linear power units e.g., mW) of all ports for each individual sample and save them. 	
<ul style="list-style-type: none"> ▪ If multiple transmit chains, EIRP calculation could be following as methods: $P_{total} = P_1 + P_2 + \dots + P_n$ (calculated in linear unit [mW] and transfer to log unit [dBm]) $EIRP_{total} = P_{total} + DG$ 	

3.3.4 Test Setup

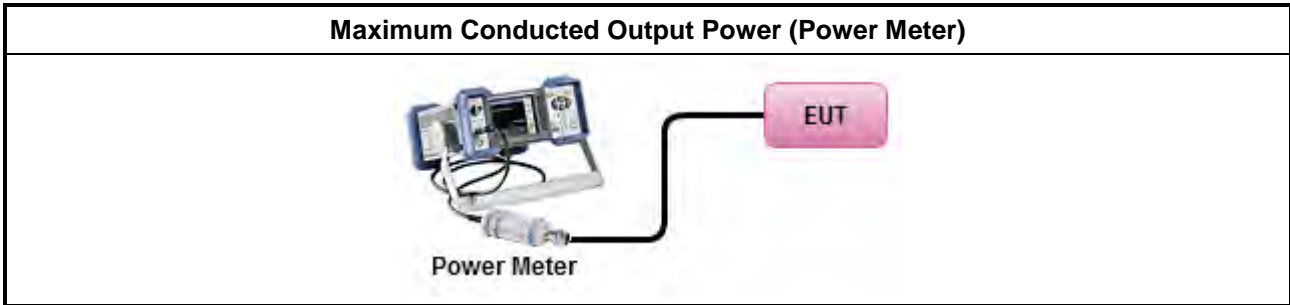

3.3.5 Test Result of Maximum Conducted Output Power

Refer as Appendix C



3.4 Power Spectral Density

3.4.1 Power Spectral Density Limit

Power Spectral Density Limit
<ul style="list-style-type: none"> Power Spectral Density (PSD) ≤ 8 dBm/3kHz

3.4.2 Measuring Instruments

Refer a test equipment and calibration data table in this test report.

3.4.3 Test Procedures

Test Method
<ul style="list-style-type: none"> Peak power spectral density procedures that the same method as used to determine the conducted output power. If maximum peak conducted output power was measured to demonstrate compliance to the output power limit, then the peak PSD procedure below (Method PKPSD) shall be used. If maximum conducted output power was measured to demonstrate compliance to the output power limit, then one of the average PSD procedures shall be used, as applicable based on the following criteria (the peak PSD procedure is also an acceptable option).
<input checked="" type="checkbox"/> Refer as FCC KDB 558074, clause 8.4 & C63.10 clause 11.10 Method Max. PSD. [duty cycle ≥ 98% or external video / power trigger]
<ul style="list-style-type: none"> For conducted measurement.
<ul style="list-style-type: none"> If The EUT supports multiple transmit chains using options given below: <ul style="list-style-type: none"> <input type="checkbox"/> Option 1: Measure and sum the spectra across the outputs. Refer as FCC KDB 662911, In-band power spectral density (PSD). Sample all transmit ports simultaneously using a spectrum analyzer for each transmit port. Where the trace bin-by-bin of each transmit port summing can be performed. (i.e., in the first spectral bin of output 1 is summed with that in the first spectral bin of output 2 and that from the first spectral bin of output 3, and so on up to the NTX output to obtain the value for the first frequency bin of the summed spectrum.). Add up the amplitude (power) values for the different transmit chains and use this as the new data trace. <input type="checkbox"/> Option 2: Measure and sum spectral maxima across the outputs. With this technique, spectra are measured at each output of the device at the required resolution bandwidth. The maximum value (peak) of each spectrum is determined. These maximum values are then summed mathematically in linear power units across the outputs. These operations shall be performed separately over frequency spans that have different out-of-band or spurious emission limits, <input type="checkbox"/> Option 3: Measure and add 10 log(N) dB, where N is the number of transmit chains. Refer as FCC KDB 662911, In-band power spectral density (PSD). Performed at each transmit chains and each transmit chains shall be compared with the limit have been reduced with 10 log(N). Or each transmit chains shall be add 10 log(N) to compared with the limit.

3.4.4 Test Setup

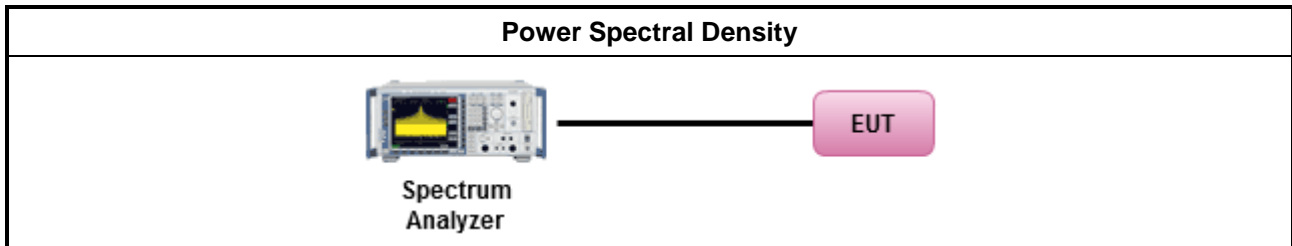

3.4.5 Test Result of Power Spectral Density

Refer as Appendix D

3.5 Emissions in Non-restricted Frequency Bands

3.5.1 Emissions in Non-restricted Frequency Bands Limit

Un-restricted Band Emissions Limit	
RF output power procedure	Limit (dBc)
Peak output power procedure	20
Average output power procedure	30

Note 1: If the peak output power procedure is used to measure the fundamental emission power to demonstrate compliance to requirements, then the peak conducted output power measured within any 100 kHz outside the authorized frequency band shall be attenuated by at least 20 dB relative to the maximum measured in-band peak PSD level.

Note 2: If the average output power procedure is used to measure the fundamental emission power to demonstrate compliance to requirements, then the power in any 100 kHz outside of the authorized frequency band shall be attenuated by at least 30 dB relative to the maximum measured in-band average PSD level.

3.5.2 Measuring Instruments

Refer a test equipment and calibration data table in this test report.

3.5.3 Test Procedures

Test Method
<ul style="list-style-type: none"> Refer as FCC KDB 558074, clause 8.5 for unwanted emissions into non-restricted bands.

3.5.4 Test Setup

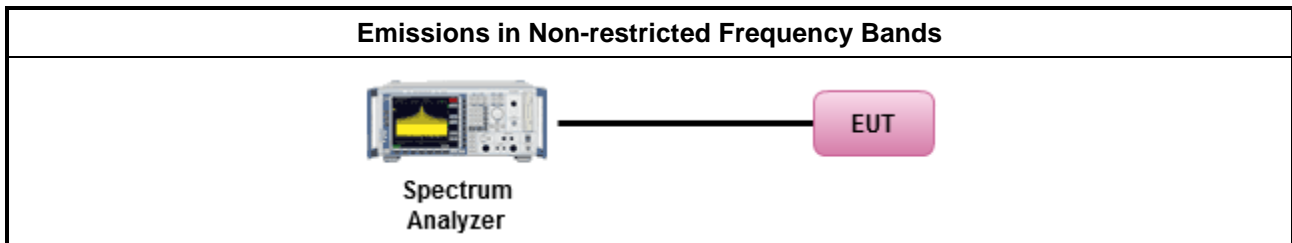

3.5.5 Test Result of Emissions in Non-restricted Frequency Bands

Refer as Appendix E



3.6 Emissions in Restricted Frequency Bands

3.6.1 Emissions in Restricted Frequency Bands Limit

Restricted Band Emissions Limit			
Frequency Range (MHz)	Field Strength (uV/m)	Field Strength (dBuV/m)	Measure Distance (m)
0.009~0.490	2400/F(kHz)	48.5 - 13.8	300
0.490~1.705	24000/F(kHz)	33.8 - 23	30
1.705~30.0	30	29	30
30~88	100	40	3
88~216	150	43.5	3
216~960	200	46	3
Above 960	500	54	3

Note 1: Test distance for frequencies at or above 30 MHz, measurements may be performed at a distance other than the limit distance provided they are not performed in the near field and the emissions to be measured can be detected by the measurement equipment. When performing measurements at a distance other than that specified, the results shall be extrapolated to the specified distance using an extrapolation factor of 20 dB/decade (inverse of linear distance for field-strength measurements, inverse of linear distance-squared for power-density measurements).

Note 2: Test distance for frequencies at below 30 MHz, measurements may be performed at a distance closer than the EUT limit distance; however, an attempt should be made to avoid making measurements in the near field. When performing measurements below 30 MHz at a closer distance than the limit distance, the results shall be extrapolated to the specified distance by either making measurements at a minimum of two or more distances on at least one radial to determine the proper extrapolation factor or by using the square of an inverse linear distance extrapolation factor (40 dB / decade). The test report shall specify the extrapolation method used to determine compliance of the EUT.

Note 3: Using the distance of 1m during the test for above 18 GHz, and the test value to correct for the distance factor at 3m.

3.6.2 Measuring Instruments

Refer a test equipment and calibration data table in this test report.



3.6.3 Test Procedures

Test Method	
<ul style="list-style-type: none"> ▪ The average emission levels shall be measured in [duty cycle \geq 98 or duty factor]. 	
<ul style="list-style-type: none"> ▪ Refer as ANSI C63.10, clause 6.10.3 band-edge testing shall be performed at the lowest frequency channel and highest frequency channel within the allowed operating band. 	
<ul style="list-style-type: none"> ▪ For the transmitter unwanted emissions shall be measured using following options below: 	
	<ul style="list-style-type: none"> ▪ Refer as FCC KDB 558074, clause 8.6 for unwanted emissions into restricted bands.
<input type="checkbox"/>	Refer as FCC KDB 558074, clause 8.6 & C63.10 clause 11.12.2.5.1(trace averaging for duty cycle \geq 98%).
<input type="checkbox"/>	Refer as FCC KDB 558074, clause 8.6 & C63.10 clause 11.12.2.5.2(trace averaging + duty factor).
<input checked="" type="checkbox"/>	Refer as FCC KDB 558074, clause 8.6 & C63.10 clause 11.12.2.5.3(Reduced VBW \geq 1/T).
<input type="checkbox"/>	Refer as ANSI C63.10, clause 11.12.2.5.3 (Reduced VBW). VBW \geq 1/T, where T is pulse time.
<input type="checkbox"/>	Refer as ANSI C63.10, clause 7.5 average value of pulsed emissions.
<input checked="" type="checkbox"/>	Refer as FCC KDB 558074, clause 8.6 & C63.10 clause 11.12.2.4 measurement procedure peak limit.
<ul style="list-style-type: none"> ▪ For the transmitter band-edge emissions shall be measured using following options below: 	
	<ul style="list-style-type: none"> ▪ Refer as FCC KDB 558074 clause 8.7 & c63.10 clause 11.13.1, When the performing peak or average radiated measurements, emissions within 2 MHz of the authorized band edge may be measured using the marker-delta method described below.
	<ul style="list-style-type: none"> ▪ Refer as FCC KDB 558074, clause 8.7 (ANSI C63.10, clause 6.10.6) for marker-delta method for band-edge measurements.
	<ul style="list-style-type: none"> ▪ Refer as FCC KDB 558074, clause 8.7 for narrower resolution bandwidth (100kHz) using the band power and summing the spectral levels (i.e., 1 MHz).
	<ul style="list-style-type: none"> ▪ For conducted unwanted emissions into restricted bands (absolute emission limits). Devices with multiple transmit chains using options given below: (1) Measure and sum the spectra across the outputs or (2) Measure and add 10 log(N) dB
	<ul style="list-style-type: none"> ▪ For FCC KDB 662911 The methodology described here may overestimate array gain, thereby resulting in apparent failures to satisfy the out-of-band limits even if the device is actually compliant. In such cases, compliance may be demonstrated by performing radiated tests around the frequencies at which the apparent failures occurred.

3.6.4 Test Setup

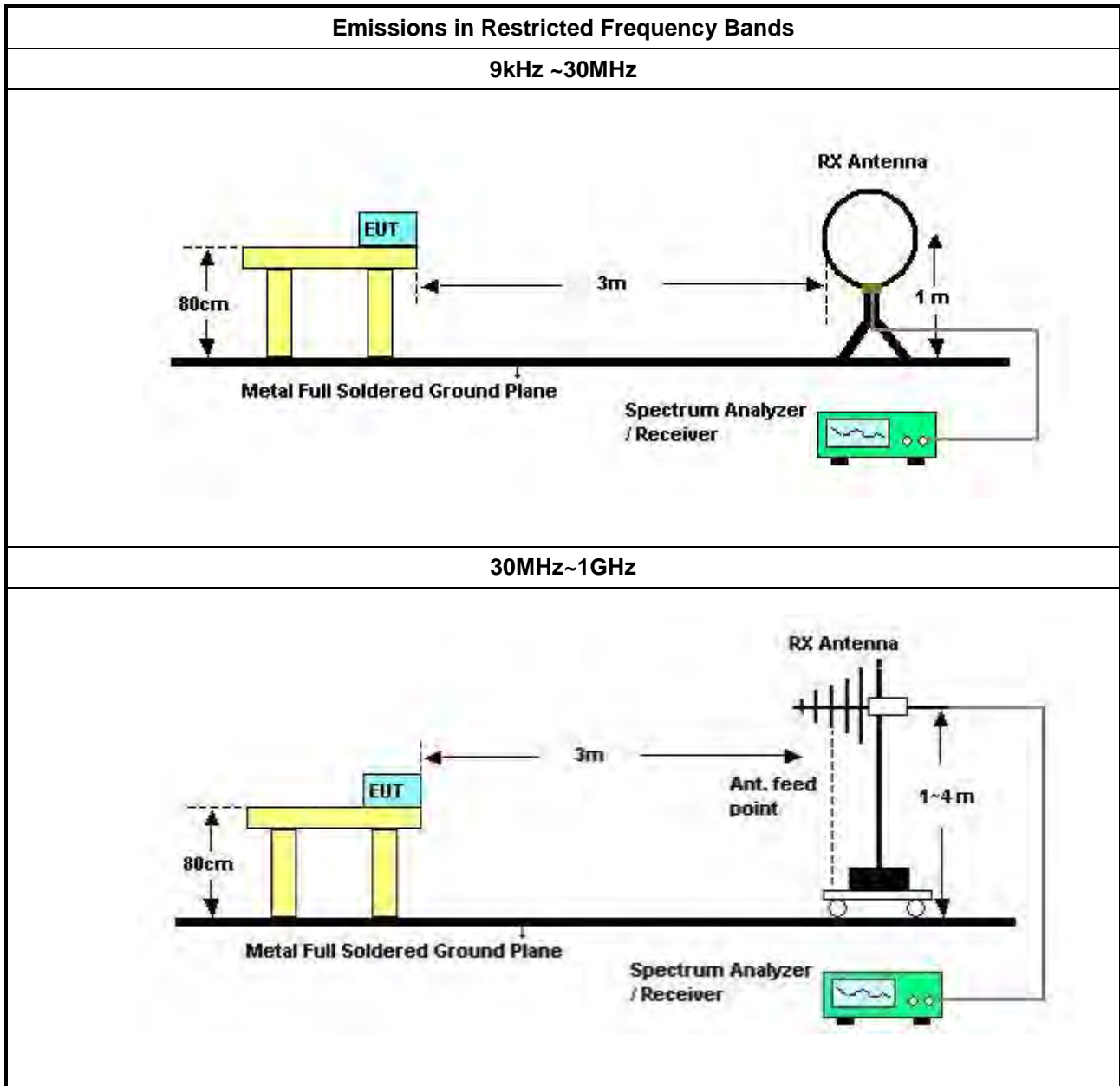

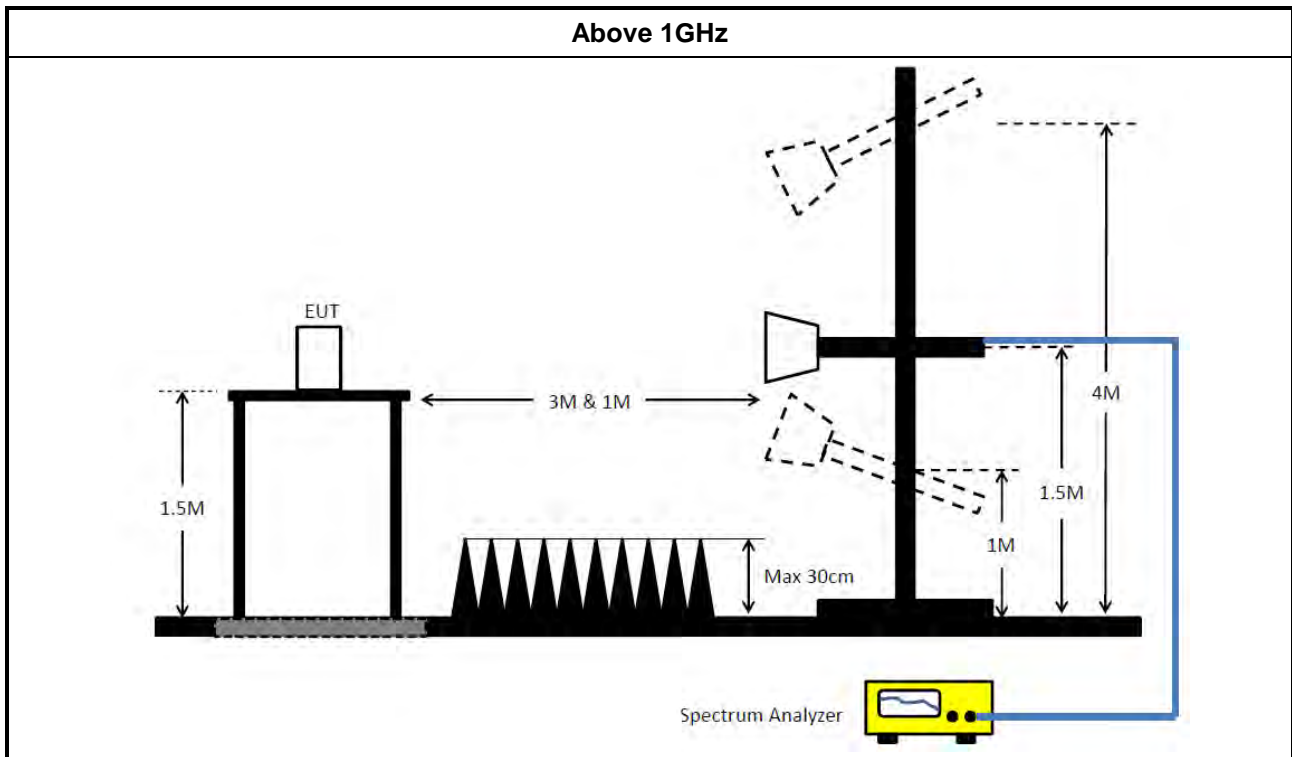

3.6.5 Measurement Results Calculation

The measured Level is calculated using:
 Corrected Reading: Antenna factor (AF) + Cable loss (CL) + Read level (Raw) - Preamp factor (PA)(if applicable) = Level.

3.6.6 Emissions in Restricted Frequency Bands (Below 30MHz)

There is a comparison data of both open-field test site and alternative test site - semi-Anechoic chamber according to KDB414788 Radiated Test Site, and the result came out very similar.
 All amplitude of spurious emissions that are attenuated by more than 20 dB below the permissible value has no need to be reported.
 The radiated emissions were investigated from 9 kHz or the lowest frequency generated within the device, up to the 10th harmonic or 40 GHz, whichever is appropriate.

3.6.7 Test Result of Emissions in Restricted Frequency Bands

Refer as Appendix F



4 Test Equipment and Calibration Data

Instrument	Brand	Model No.	Serial No.	Characteristics	Calibration Date	Calibration Due Date	Remark
EMI Receiver	Agilent	N9038A	My52260123	9kHz ~ 8.4GHz	Feb. 20, 2023	Feb. 19, 2024	Conduction (CO01-CB)
LISN	F.C.C.	FCC-LISN-50-16-2	04083	150kHz ~ 100MHz	Feb. 16, 2023	Feb. 15, 2024	Conduction (CO01-CB)
LISN	Schwarzbeck	NSLK 8127	8127647	9kHz ~ 30MHz	Apr. 27, 2023	Apr. 26, 2024	Conduction (CO01-CB)
Pulse Limiter	Rohde&Schwarz	ESH3-Z2	100430	9kHz ~ 30MHz	Feb. 09, 2023	Feb. 08, 2024	Conduction (CO01-CB)
COND Cable	Woken	Cable	Low cable-CO01	9kHz ~ 30MHz	Oct. 18, 2022	Oct. 17, 2023	Conduction (CO01-CB)
Software	SPORTON	SENSE	V5.10	-	N.C.R.	N.C.R.	Conduction (CO01-CB)
Loop Antenna	Teseq	HLA 6120	31244	9kHz - 30 MHz	Mar. 23, 2023	Mar. 22, 2024	Radiation (03CH05-CB)
3m Semi Anechoic Chamber NSA	TDK	SAC-3M	03CH05-CB	30 MHz ~ 1 GHz	Aug. 03, 2022	Aug. 02, 2023	Radiation (03CH05-CB)
3m Semi Anechoic Chamber VSWR	TDK	SAC-3M	03CH05-CB	1GHz ~18GHz 3m	Nov. 06, 2022	Nov. 05, 2023	Radiation (03CH05-CB)
Bilog Antenna with 6dB Attenuator	TESEQ & EMCI	CBL 6112D & N-6-06	35236 & AT-N0610	30MHz ~ 2GHz	Mar. 24, 2023	Mar. 23, 2024	Radiation (03CH05-CB)
Horn Antenna	SCHWARZBECK	BBHA9120D	BBHA 9120 D-1291	1GHz~18GHz	Jun. 08, 2023	Jun. 07, 2024	Radiation (03CH05-CB)
Horn Antenna	Schwarzbeck	BBHA 9170	BBHA9170252	15GHz ~ 40GHz	Aug. 22, 2022	Aug. 21, 2023	Radiation (03CH05-CB)
Amplifier	EMCI	EMC330N	980331	20MHz ~ 3GHz	May 03, 2023	May 02, 2024	Radiation (03CH05-CB)
Pre-Amplifier	EMCI	EMC12630SE	980287	1GHz ~ 26.5GHz	Jun. 30, 2023	Jun. 29, 2024	Radiation (03CH05-CB)
Pre-Amplifier	SGH	SGH184	20221107-3	18GHz ~ 40GHz	Nov. 16, 2022	Nov. 15, 2023	Radiation (03CH05-CB)
Spectrum Analyzer	R&S	FSP40	100304	9kHz ~ 40GHz	Apr. 18, 2023	Apr. 17, 2024	Radiation (03CH05-CB)
EMI Test Receiver	R&S	ESCS	826547/017	9kHz ~ 2.75GHz	Jun. 13, 2023	Jun. 12, 2024	Radiation (03CH05-CB)
RF Cable-low	Woken	RG402	Low Cable-04+23	30MHz~1GHz	Oct. 03, 2022	Oct. 02, 2023	Radiation (03CH05-CB)
RF Cable-high	Woken	RG402	High Cable-28	1GHz~18GHz	Oct. 03, 2022	Oct. 02, 2023	Radiation (03CH05-CB)
RF Cable-high	Woken	RG402	High Cable-04+28	1GHz~18GHz	Oct. 03, 2022	Oct. 02, 2023	Radiation (03CH05-CB)
High Cable	Woken	WCA0929M	40G#5+6	1GHz ~ 40 GHz	Dec. 07, 2022	Dec. 06, 2023	Radiation (03CH05-CB)



Instrument	Brand	Model No.	Serial No.	Characteristics	Calibration Date	Calibration Due Date	Remark
High Cable	Woken	WCA0929M	40G#5	1GHz ~ 40 GHz	Dec. 07, 2022	Dec. 06, 2023	Radiation (03CH05-CB)
High Cable	Woken	WCA0929M	40G#6	1GHz ~ 40 GHz	Dec. 07, 2022	Dec. 06, 2023	Radiation (03CH05-CB)
Test Software	SPORTON	SENSE	V5.10	-	N.C.R.	N.C.R.	Radiation (03CH05-CB)
3m Semi Anechoic Chamber VSWR	TDK	SAC-3M	03CH01-CB	1GHz ~18GHz 3m	May 05, 2023	May 04, 2024	Radiation (03CH01-CB)
Horn Antenna	ETS-LINDGREN	3115	00075790	750MHz ~ 18GHz	Nov. 04, 2022	Nov. 03, 2023	Radiation (03CH01-CB)
Horn Antenna	Schwarzbeck	BBHA 9170	BBHA9170252	15GHz ~ 40GHz	Aug. 22, 2022	Aug. 21, 2023	Radiation (03CH01-CB)
Pre-Amplifier	Agilent	8449B	3008A02121	1GHz ~ 26.5GHz	May 19, 2022	May 18, 2023	Radiation (03CH01-CB)
Pre-Amplifier	SGH	SGH184	20221107-3	18GHz ~ 40GHz	Nov. 16, 2022	Nov. 15, 2023	Radiation (03CH01-CB)
Signal Analyzer	R&S	FSV3044	101437	10kHz ~ 44GHz	Nov 29, 2022	Nov 29, 2023	Radiation (03CH01-CB)
RF Cable-high	Woken	RG402	High Cable-16	1 GHz ~ 18 GHz	Oct. 03, 2022	Oct. 02, 2023	Radiation (03CH01-CB)
RF Cable-high	Woken	RG402	High Cable-16+17	1 GHz ~ 18 GHz	Oct. 03, 2022	Oct. 02, 2023	Radiation (03CH01-CB)
High Cable	Woken	WCA0929M	40G#5+6	1GHz ~ 40 GHz	Dec. 07, 2022	Dec. 06, 2023	Radiation (03CH01-CB)
High Cable	Woken	WCA0929M	40G#5	1GHz ~ 40 GHz	Dec. 07, 2022	Dec. 06, 2023	Radiation (03CH01-CB)
High Cable	Woken	WCA0929M	40G#6	1GHz ~ 40 GHz	Dec. 07, 2022	Dec. 06, 2023	Radiation (03CH01-CB)
Test Software	SPORTON	SENSE	V5.10	-	N.C.R.	N.C.R.	Radiation (03CH01-CB)
Spectrum analyzer	R&S	FSV40	101027	9kHz~40GHz	Aug. 15, 2022	Aug. 14, 2023	Conducted (TH02-CB)
Power Sensor	Anritsu	MA2411B	1126203	300MHz~40GHz	Oct. 17, 2022	Oct. 16, 2023	Conducted (TH02-CB)
Power Meter	Anritsu	ML2495A	1210004	300MHz~40GHz	Oct. 17, 2022	Oct. 16, 2023	Conducted (TH02-CB)
RF Cable-high	Woken	RG402	High Cable-01	1 GHz – 18 GHz	Oct. 03, 2022	Oct. 02, 2023	Conducted (TH02-CB)
RF Cable-high	Woken	RG402	High Cable-02	1 GHz – 18 GHz	Oct. 03, 2022	Oct. 02, 2023	Conducted (TH02-CB)
RF Cable-high	Woken	RG402	High Cable-03	1 GHz – 18 GHz	Oct. 03, 2022	Oct. 02, 2023	Conducted (TH02-CB)
RF Cable-high	Woken	RG402	High Cable-04	1 GHz – 18 GHz	Oct. 03, 2022	Oct. 02, 2023	Conducted (TH02-CB)
RF Cable-high	Woken	RG402	High Cable-05	1 GHz – 18 GHz	Oct. 03, 2022	Oct. 02, 2023	Conducted (TH02-CB)
Switch	SPTCB	SP-SWI	SWI-02	1 GHz ~26.5 GHz	Oct. 04, 2022	Oct. 03, 2023	Conducted (TH02-CB)



Instrument	Brand	Model No.	Serial No.	Characteristics	Calibration Date	Calibration Due Date	Remark
Test Software	SPORTON	SENSE	V5.10	-	N.C.R.	N.C.R.	Conducted (TH02-CB)

Note: Calibration Interval of instruments listed above is one year.

N.C.R. means Non-Calibration required.



Summary

Mode	Result	Type	Freq (Hz)	Level (dBuV)	Limit (dBuV)	Margin (dB)	Condition
Mode 2	Pass	AV	21.665M	44.89	50.00	-5.11	Neutral

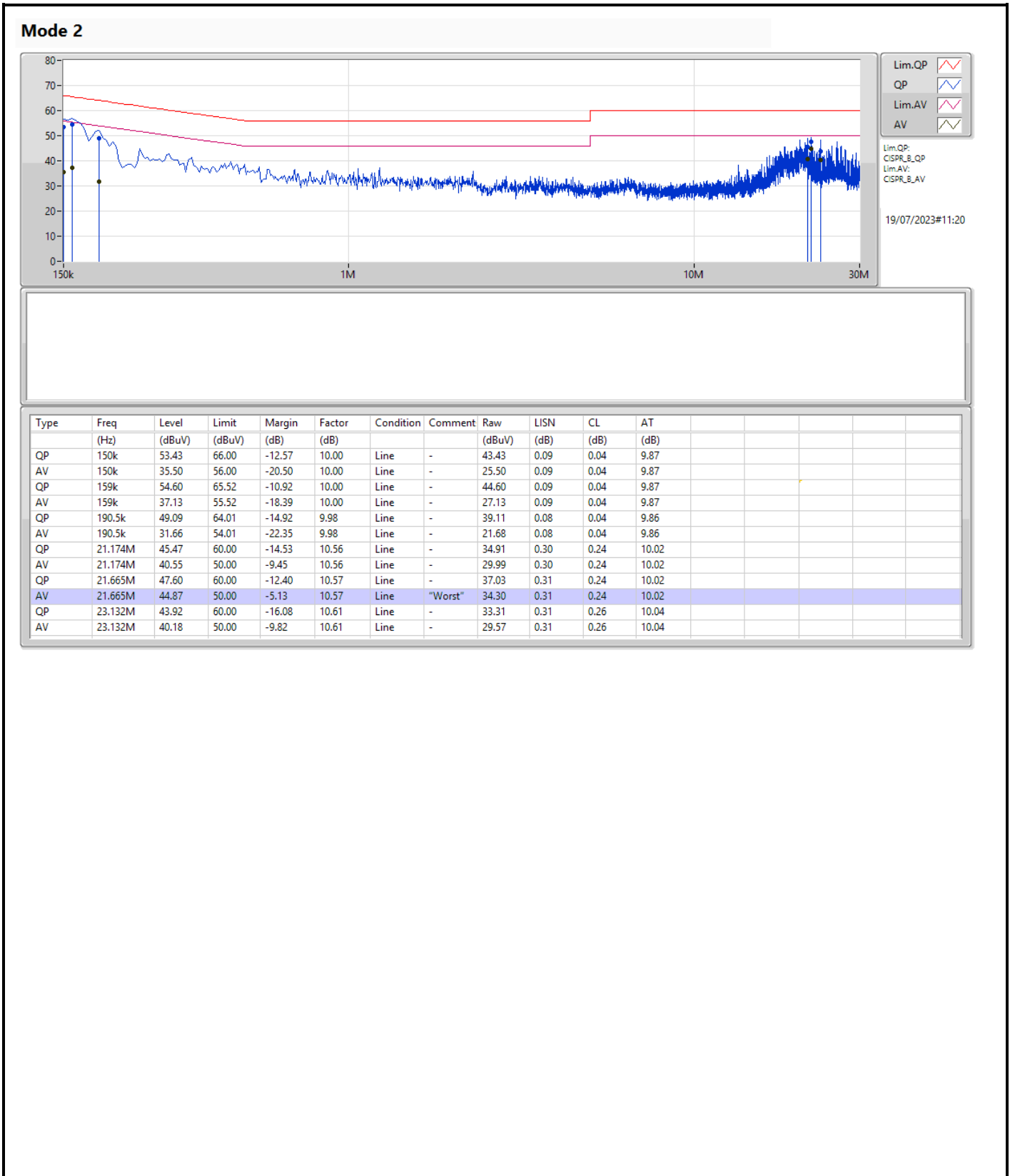

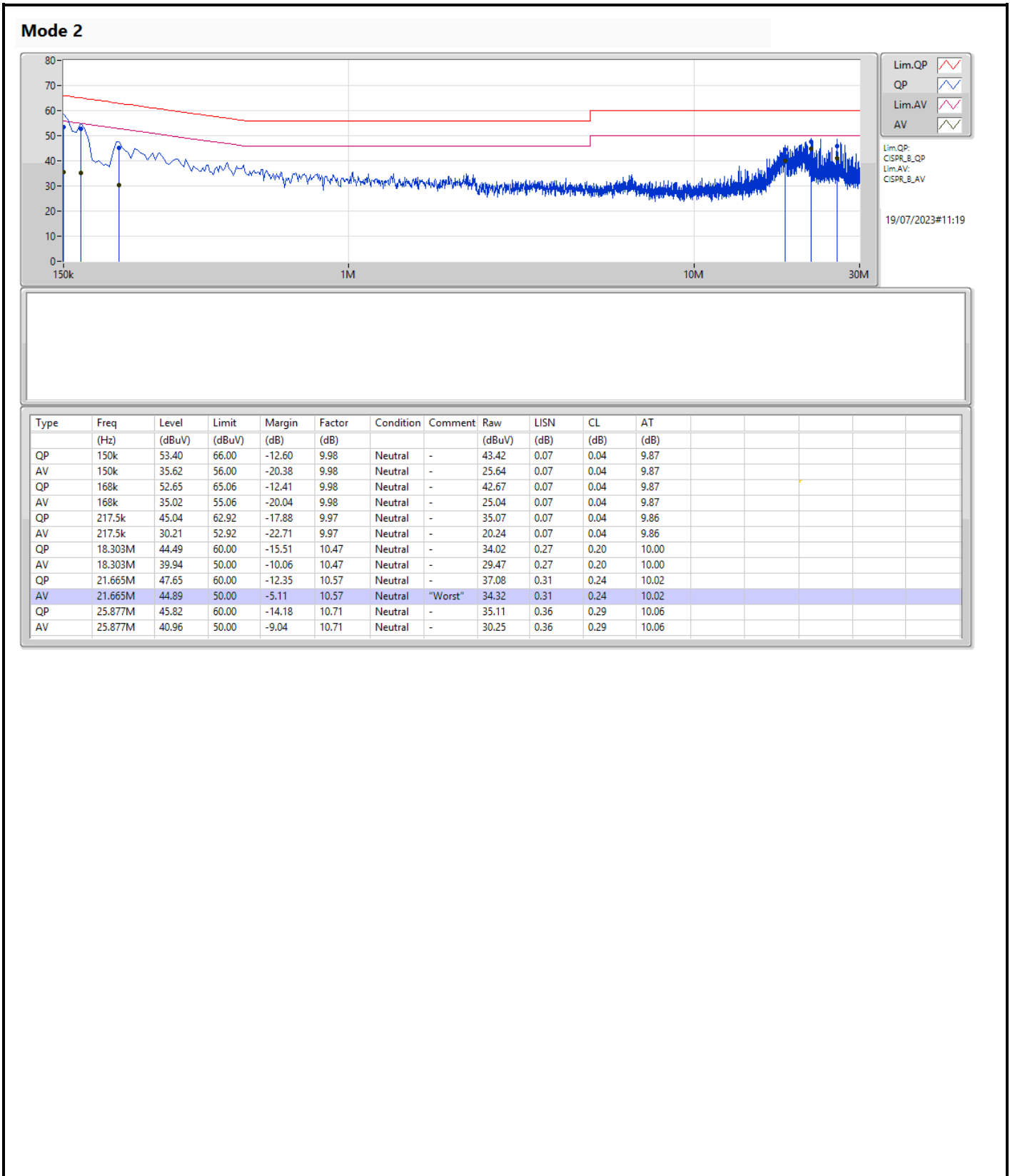



Summary

Mode	Max-N dB (Hz)	Max-OBW (Hz)	ITU-Code	Min-N dB (Hz)	Min-OBW (Hz)
2.4-2.4835GHz	-	-	-	-	-
BT-LE(1Mbps)	665k	1.028M	1M03F1D	662.5k	1.026M
BT-LE(2Mbps)	1.14M	2.039M	2M04F1D	1.133M	2.029M

Max-N dB = Maximum 6dB down bandwidth; Max-OBW = Maximum 99% occupied bandwidth;
Min-N dB = Minimum 6dB down bandwidth; Min-OBW = Minimum 99% occupied bandwidth



Result

Mode	Result	Limit (Hz)	Port 1-N dB (Hz)	Port 1-OBW (Hz)
BT-LE(1Mbps)	-	-	-	-
2402MHz	Pass	500k	662.5k	1.027M
2440MHz	Pass	500k	665k	1.026M
2480MHz	Pass	500k	663.75k	1.028M
BT-LE(2Mbps)	-	-	-	-
2402MHz	Pass	500k	1.133M	2.039M
2440MHz	Pass	500k	1.138M	2.034M
2480MHz	Pass	500k	1.14M	2.029M

Port X-N dB = Port X 6dB down bandwidth;
Port X-OBW = Port X 99% occupied bandwidth

2.4-2.4835GHz_BT-LE(1Mbps)

EBW-DTS

2402MHz

18/05/2023

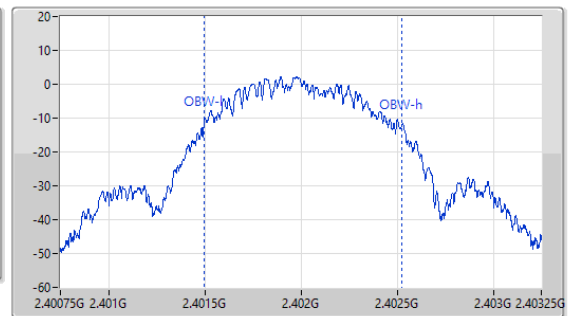
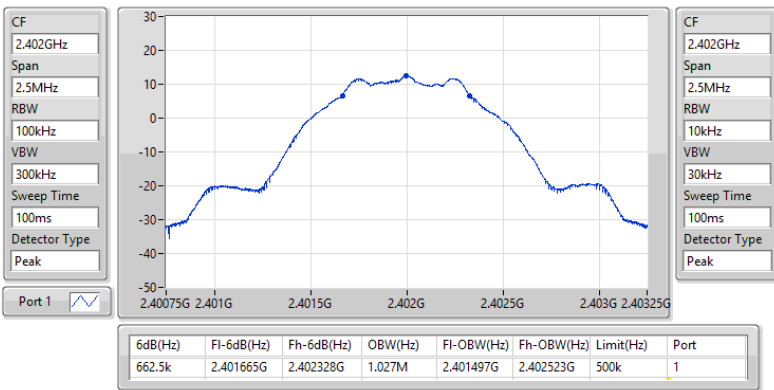

2.4-2.4835GHz_BT-LE(1Mbps)

EBW-DTS

2440MHz

18/05/2023

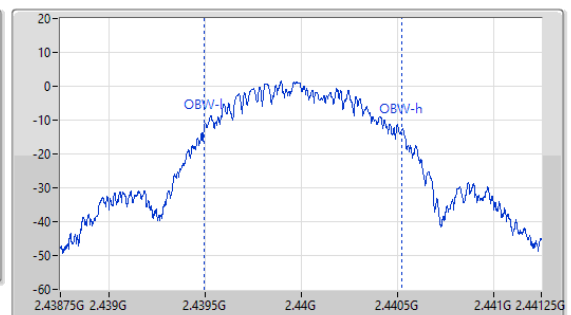
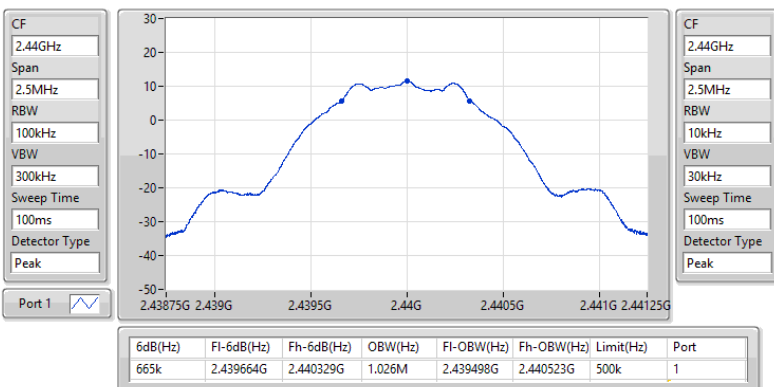

2.4-2.4835GHz_BT-LE(1Mbps)

EBW-DTS

2480MHz

18/05/2023

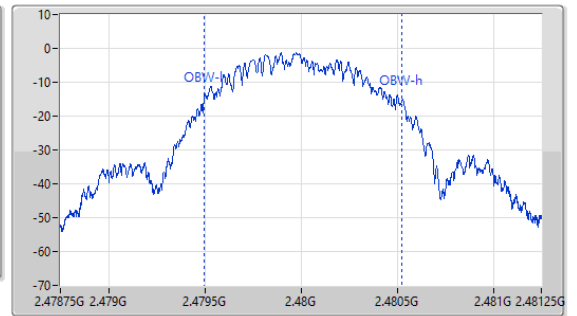
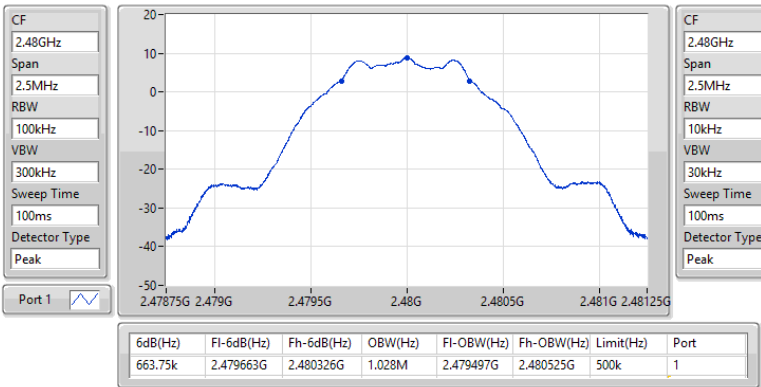

2.4-2.4835GHz_BT-LE(2Mbps)

EBW-DTS

2402MHz

18/05/2023

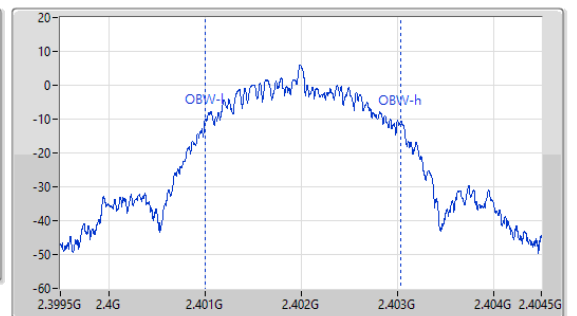
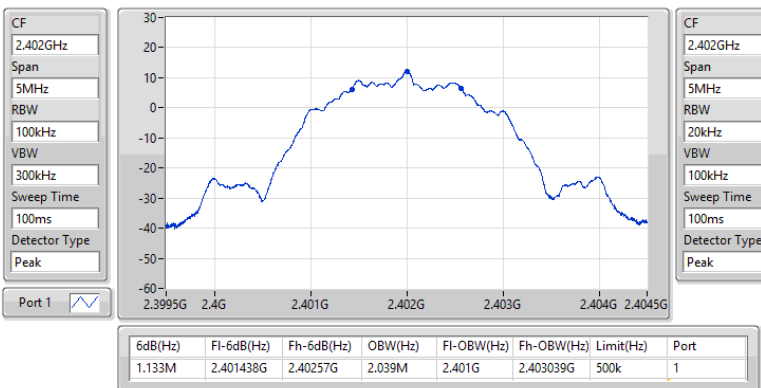

2.4-2.4835GHz_BT-LE(2Mbps)

EBW-DTS

2440MHz

18/05/2023

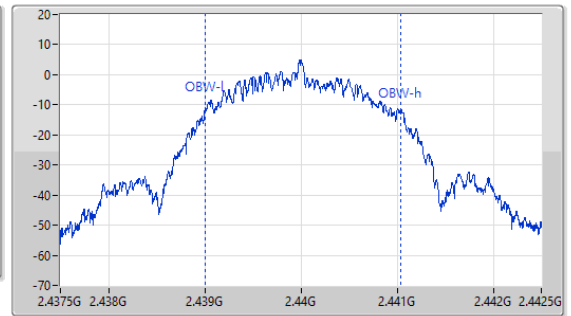
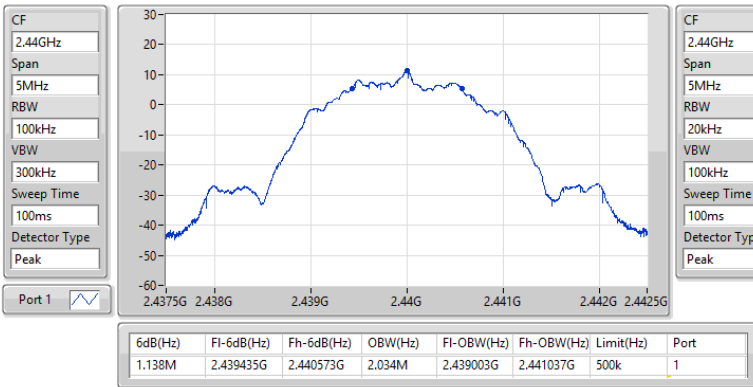

2.4-2.4835GHz_BT-LE(2Mbps)

EBW-DTS

2480MHz

18/05/2023

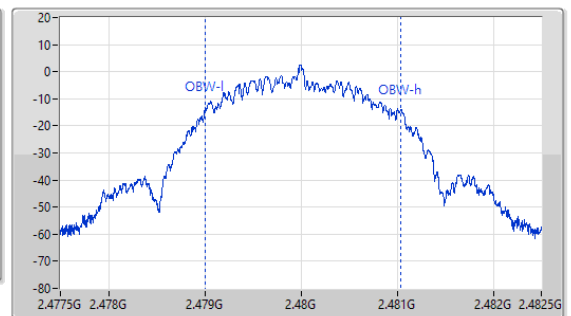
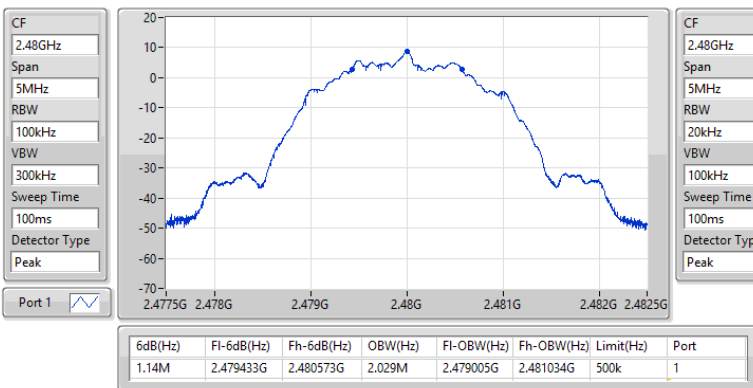



Summary

Mode	Total Power (dBm)	Power (W)
2.4-2.4835GHz	-	-
BT-LE(1Mbps)	12.43	0.01750
BT-LE(2Mbps)	11.80	0.01514



Result

Mode	Result	DG (dBi)	Total Power (dBm)	Power Limit (dBm)
BT-LE(1Mbps)	-	-	-	-
2402MHz	Pass	2.40	12.43	30.00
2440MHz	Pass	2.40	11.60	30.00
2478MHz	Pass	2.40	12.17	30.00
2480MHz	Pass	2.40	8.74	30.00
BT-LE(2Mbps)	-	-	-	-
2402MHz	Pass	2.40	11.80	30.00
2440MHz	Pass	2.40	11.04	30.00
2478MHz	Pass	2.40	11.78	30.00
2480MHz	Pass	2.40	8.29	30.00

DG = Directional Gain; Port X = Port X output power



Summary

Mode	PD (dBm/RBW)
2.4-2.4835GHz	-
BT-LE(1Mbps)	-2.23
BT-LE(2Mbps)	-6.21

RBW = 3kHz;



Result

Mode	Result	DG (dBi)	PD (dBm/RBW)	PD Limit (dBm/RBW)
BT-LE(1Mbps)	-	-	-	-
2402MHz	Pass	2.40	-2.23	8.00
2440MHz	Pass	2.40	-3.21	8.00
2480MHz	Pass	2.40	-6.46	8.00
BT-LE(2Mbps)	-	-	-	-
2402MHz	Pass	2.40	-6.21	8.00
2440MHz	Pass	2.40	-7.03	8.00
2480MHz	Pass	2.40	-9.90	8.00

DG = Directional Gain; RBW = 3kHz;
PD = trace bin-by-bin of each transmits port summing can be performed maximum power density; Port X = Port X Power Density;

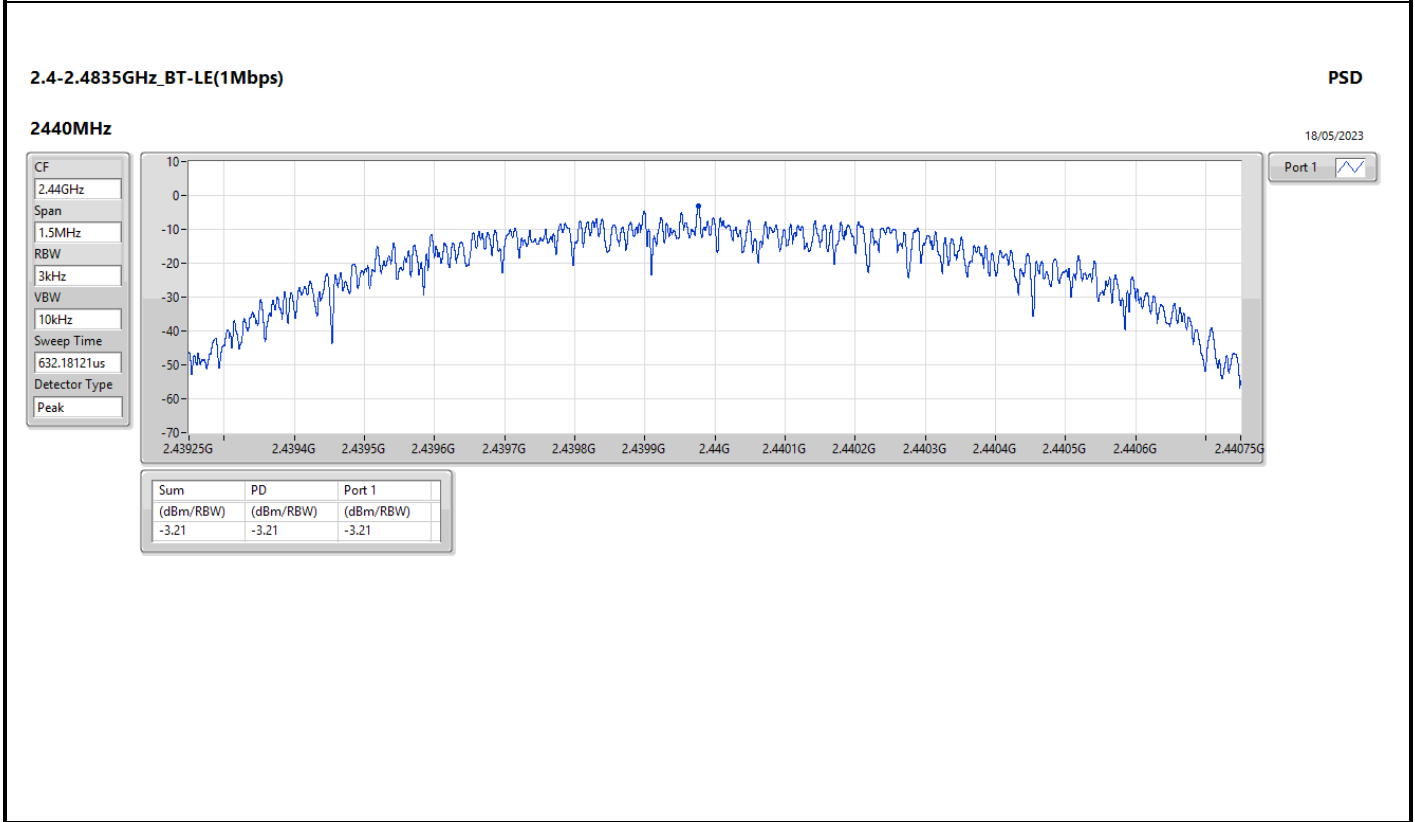
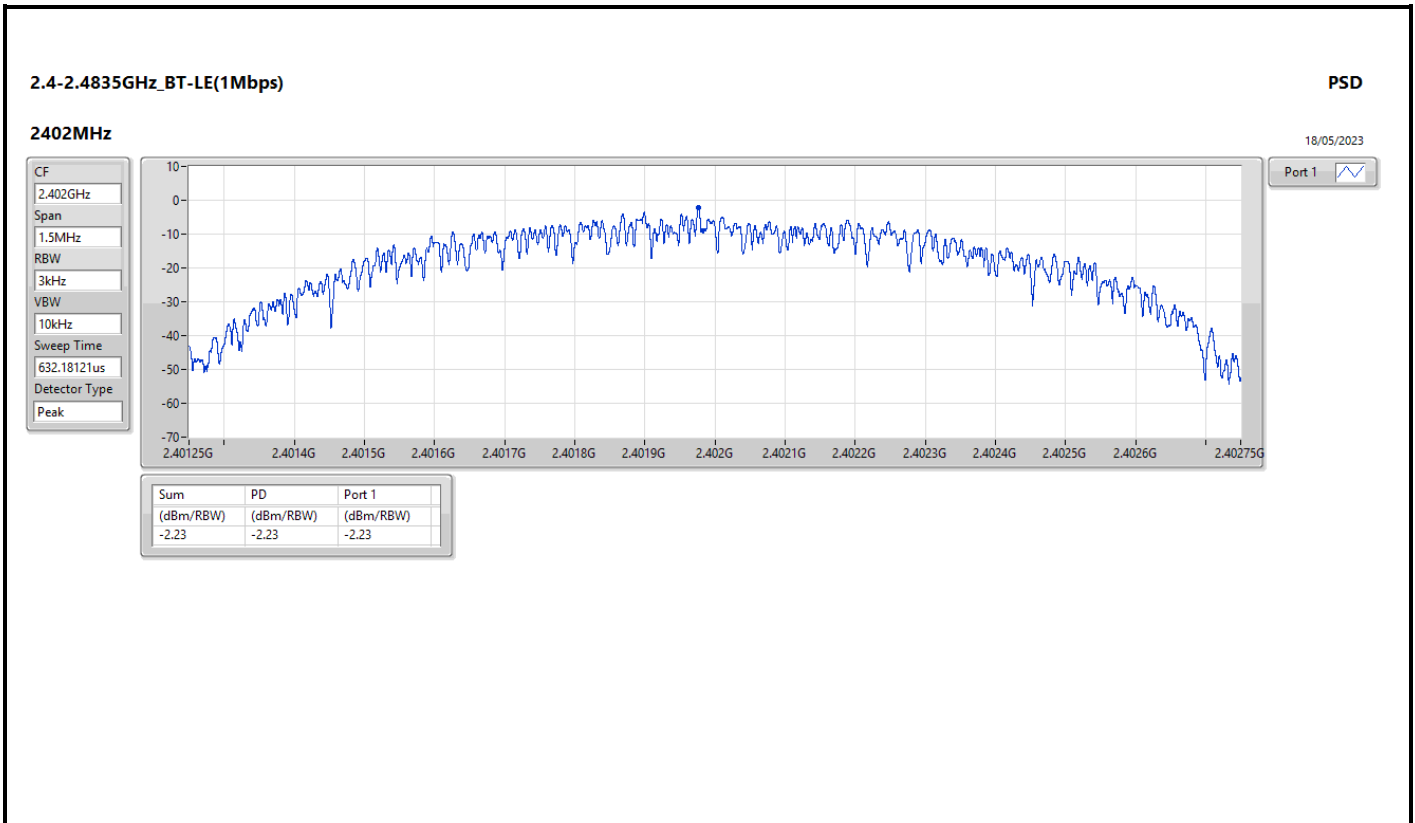

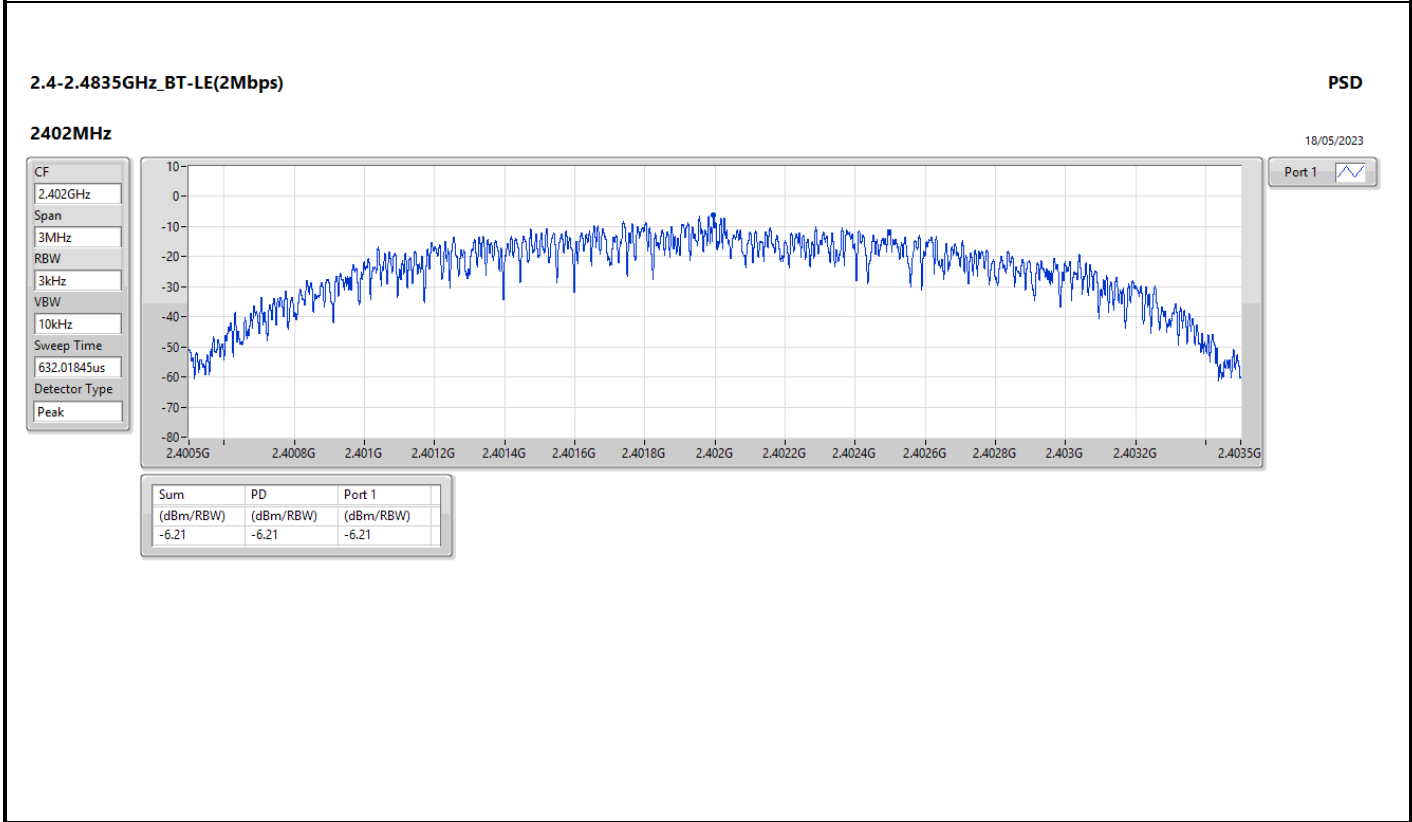
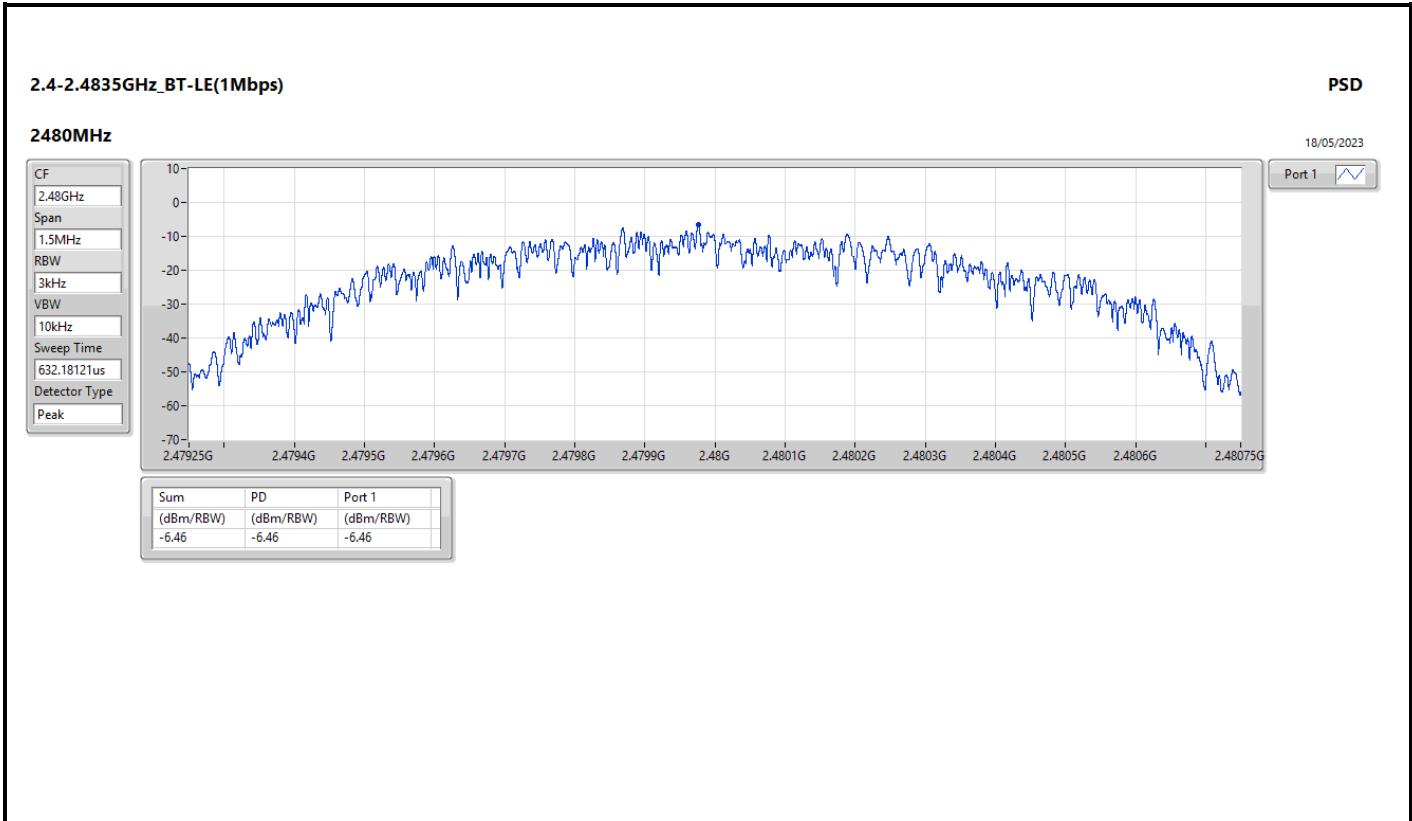

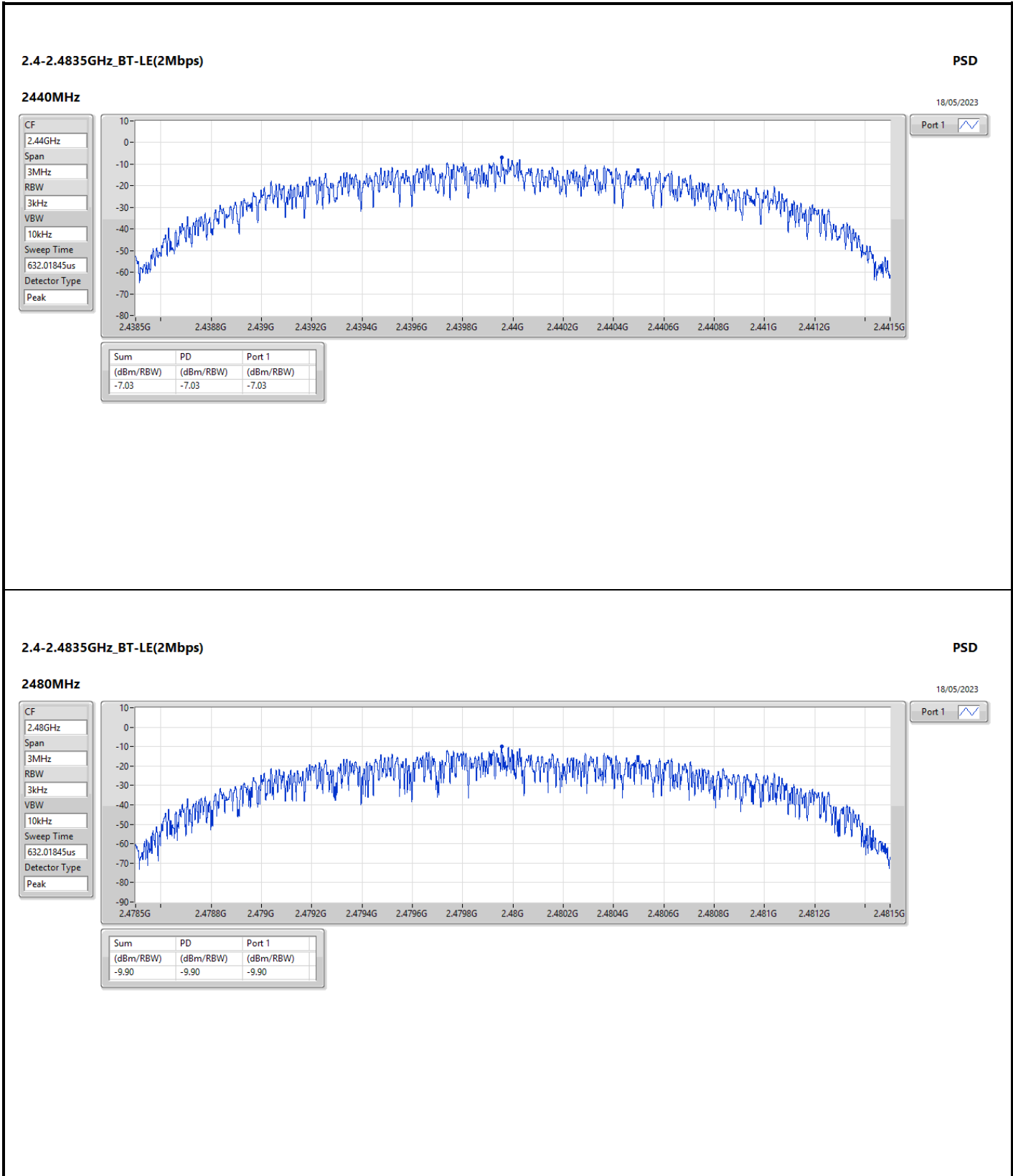



Summary

Mode	Result	Ref (Hz)	Ref (dBm)	Limit (dBm)	Freq (Hz)	Level (dBm)	Freq (Hz)	Level (dBm)	Freq (Hz)	Level (dBm)	Freq (Hz)	Level (dBm)	Freq (Hz)	Level (dBm)	Port
2.4-2.4835GHz	-	-	-	-	-	-	-	-	-	-	-	-	-	-	-
BT-LE(1Mbps)	Pass	2.402G	12.44	-17.56	2.15558G	-52.41	2.39996G	-41.02	2.4G	-39.80	2.50114G	-52.07	16.21512G	-46.85	1
BT-LE(2Mbps)	Pass	2.402G	12.18	-17.82	2.06275G	-52.79	2.4G	-23.76	2.4G	-23.93	2.5003G	-52.70	17.64927G	-46.40	1

Result

Mode	Result	Ref (Hz)	Ref (dBm)	Limit (dBm)	Freq (Hz)	Level (dBm)	Freq (Hz)	Level (dBm)	Freq (Hz)	Level (dBm)	Freq (Hz)	Level (dBm)	Freq (Hz)	Level (dBm)	Port
BT-LE(1Mbps)	-	-	-	-	-	-	-	-	-	-	-	-	-	-	-
2402MHz	Pass	2.402G	12.44	-17.56	2.15558G	-52.41	2.39996G	-41.02	2.4G	-39.80	2.50114G	-52.07	16.21512G	-46.85	1
2440MHz	Pass	2.402G	12.44	-17.56	1.94878G	-51.33	2.39208G	-51.96	2.4G	-53.17	2.50226G	-52.99	16.27136G	-46.27	1
2480MHz	Pass	2.402G	12.44	-17.56	1.98638G	-52.49	2.39592G	-51.51	2.4G	-53.71	2.50206G	-52.13	17.47211G	-47.11	1
BT-LE(2Mbps)	-	-	-	-	-	-	-	-	-	-	-	-	-	-	-
2402MHz	Pass	2.402G	12.18	-17.82	2.06275G	-52.79	2.4G	-23.76	2.4G	-23.93	2.5003G	-52.70	17.64927G	-46.40	1
2440MHz	Pass	2.402G	12.18	-17.82	2.1638G	-52.61	2.39672G	-52.51	2.4G	-54.10	2.5035G	-50.64	16.43727G	-48.09	1
2480MHz	Pass	2.402G	12.18	-17.82	851.33M	-53.28	2.39412G	-52.03	2.4G	-55.36	2.50094G	-52.31	5.91453G	-47.31	1

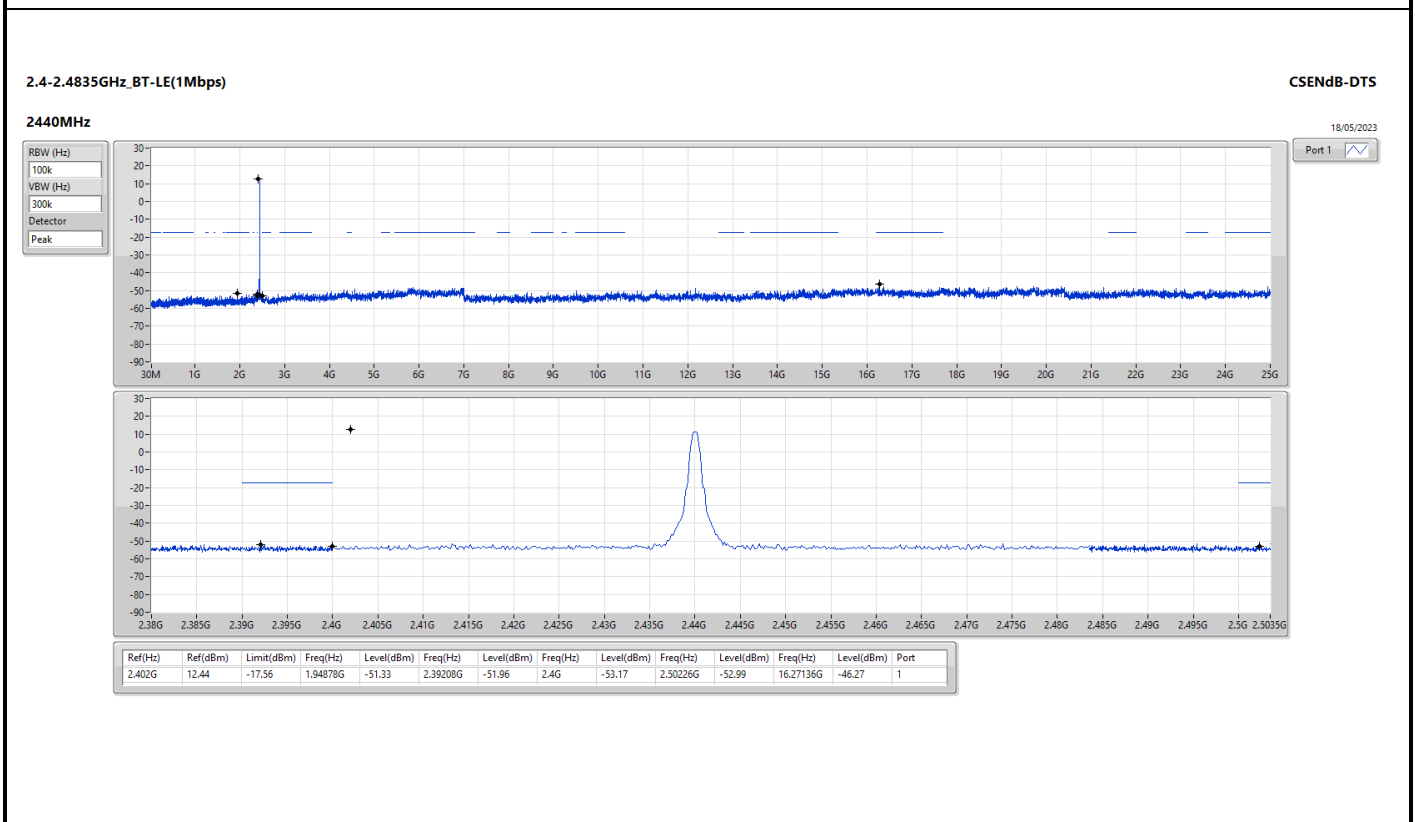
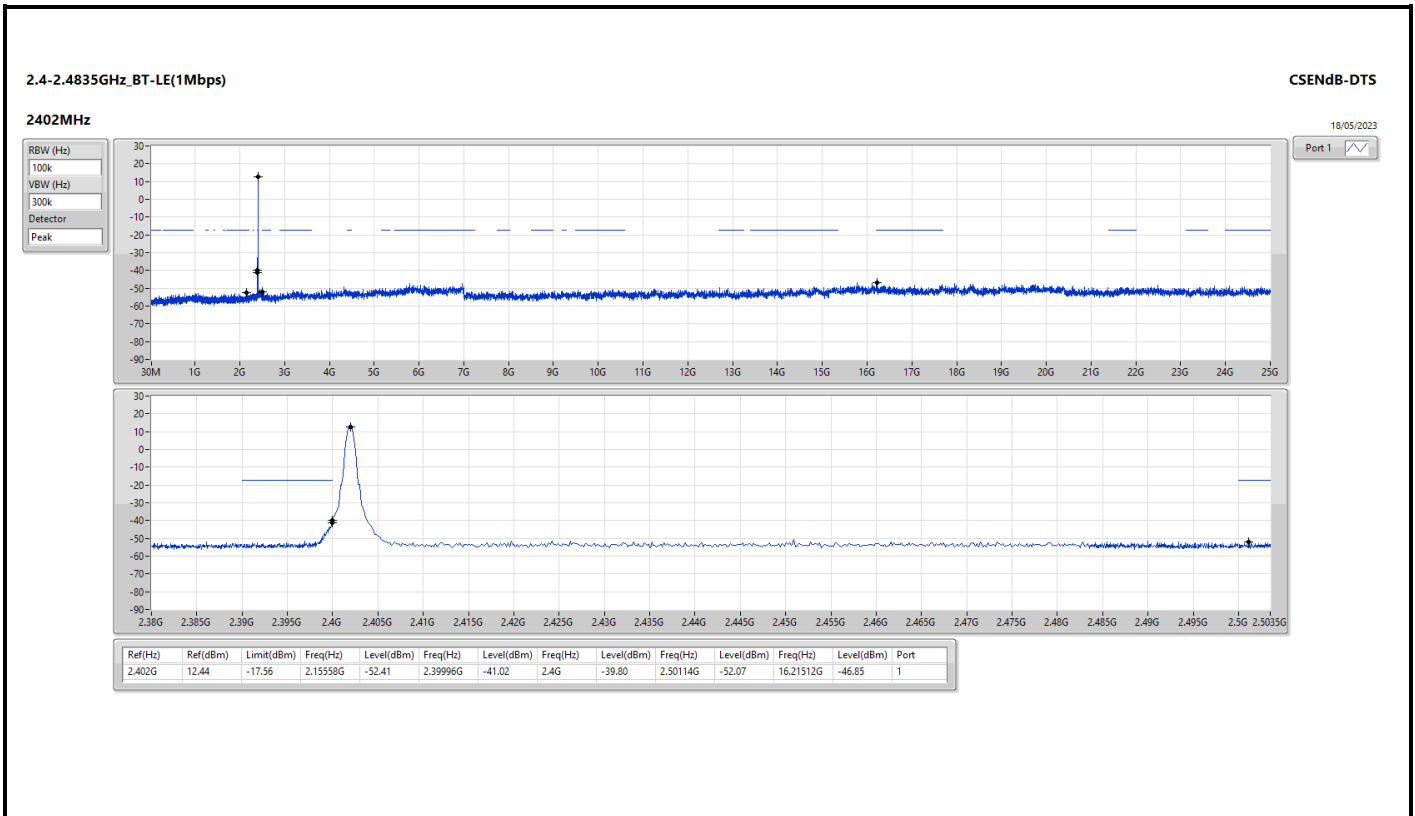

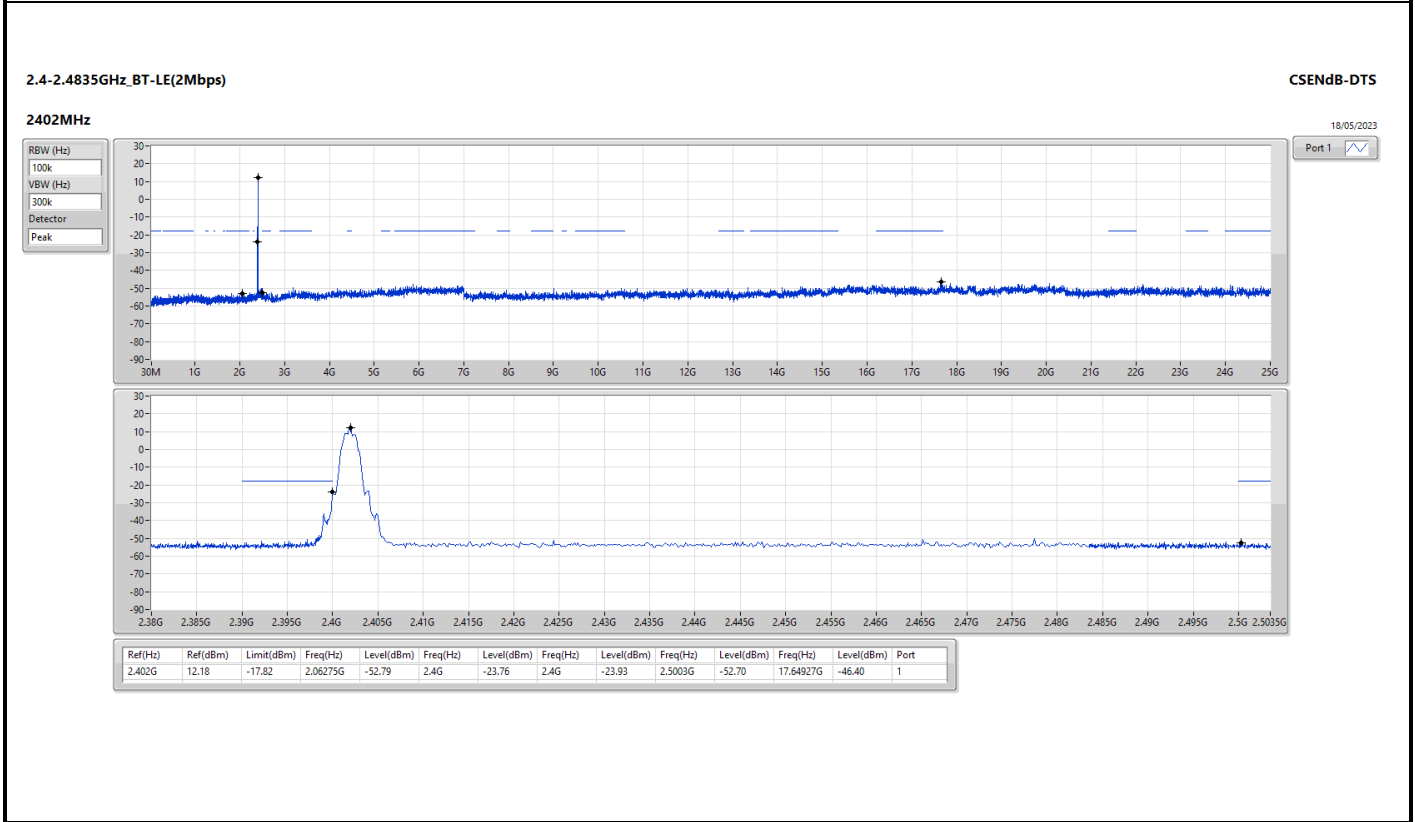
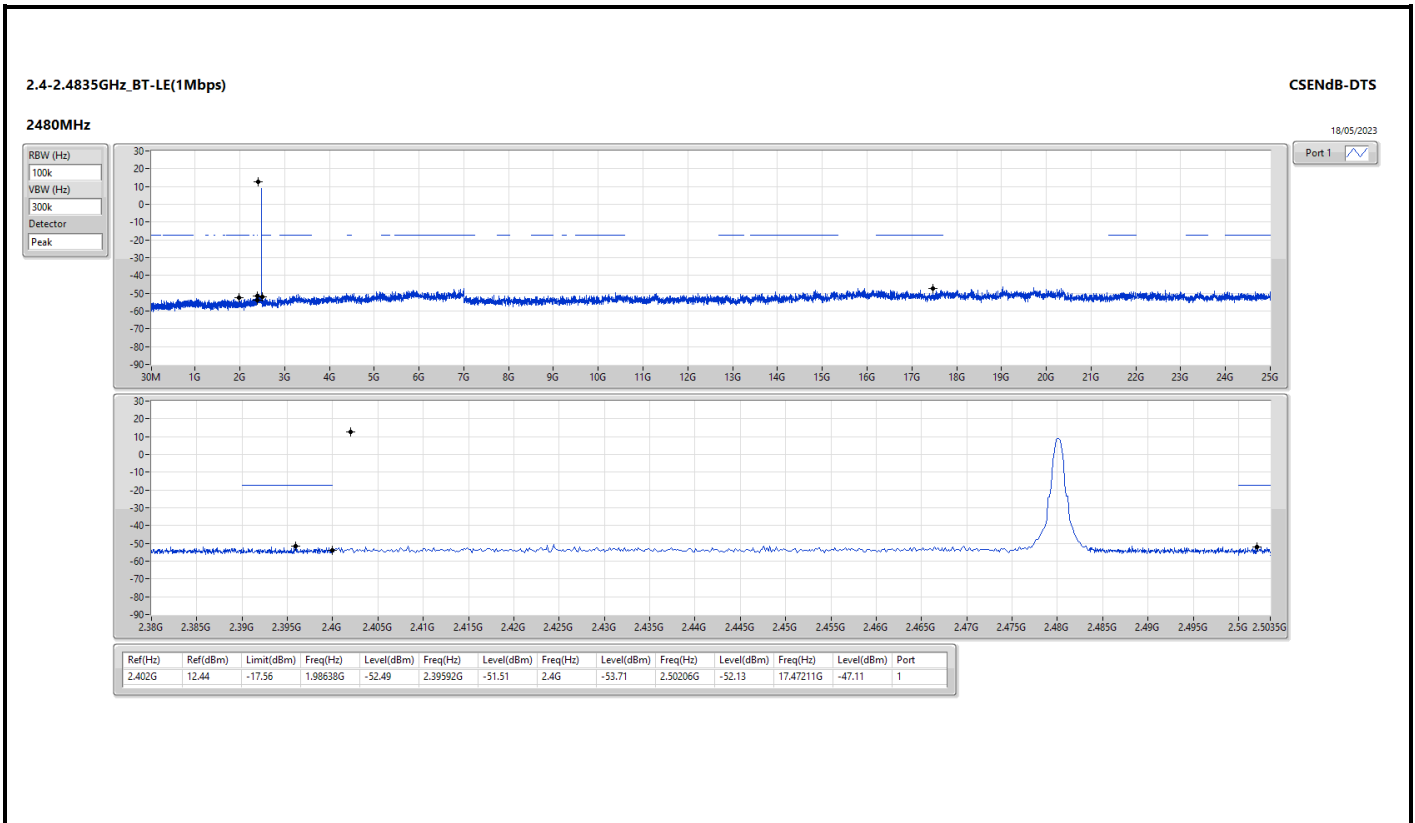

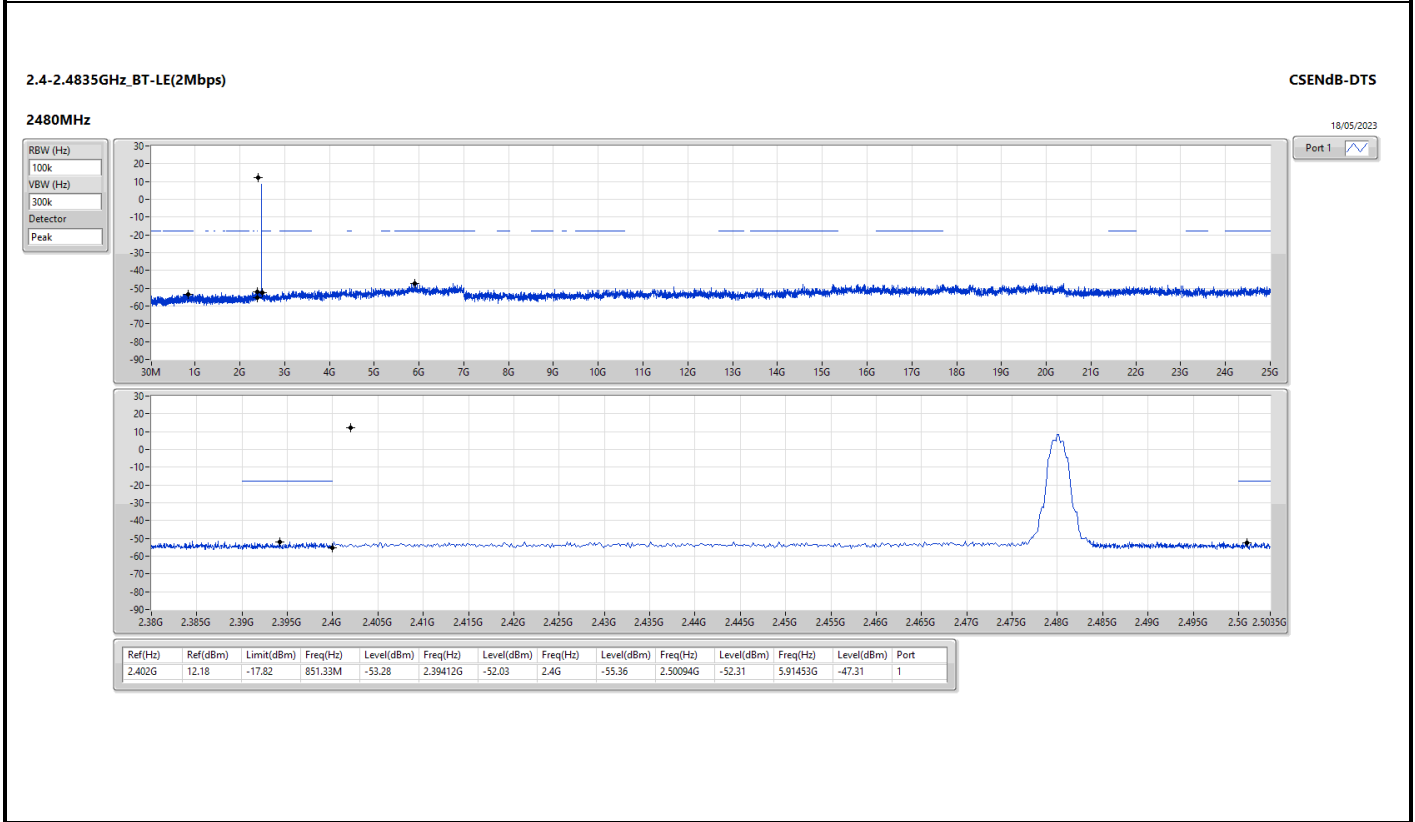
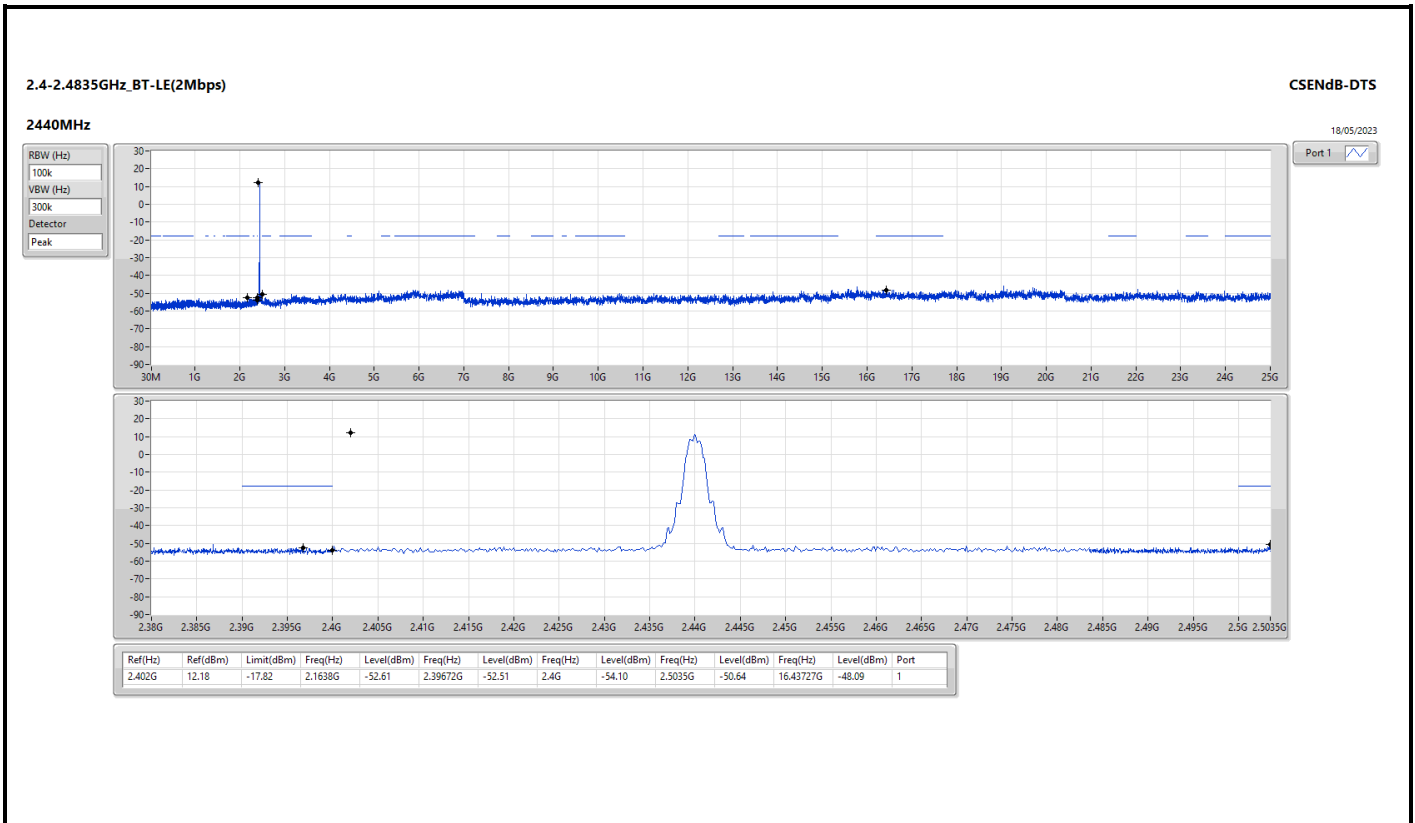



Summary

Mode	Result	Type	Freq (Hz)	Level (dBuV/m)	Limit (dBuV/m)	Margin (dB)	Condition
Mode 1	Pass	PK	250.19M	41.93	46.00	-4.07	Vertical

Mode 1

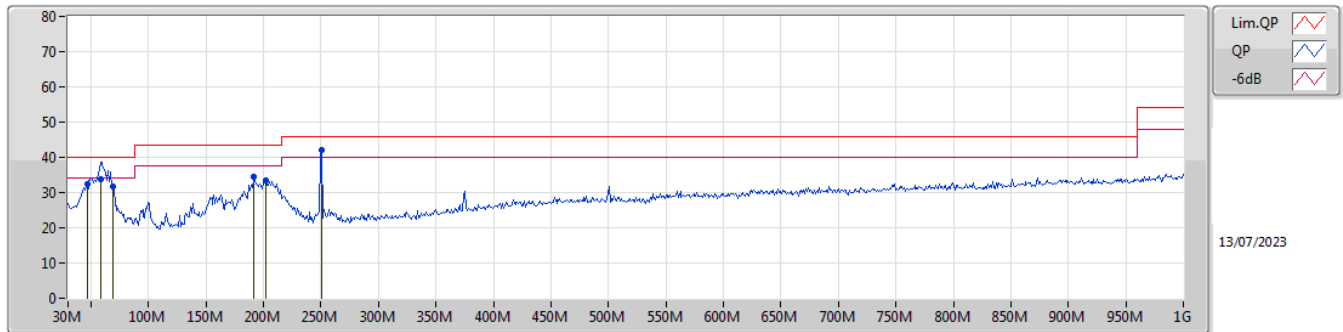

Type	Freq (Hz)	Level (dBuV/m)	Limit (dBuV/m)	Margin (dB)	Factor (dB)	Dist (m)	Condition	Azimuth (°)	Height (m)	Comment	Raw (dBuV)	AF (dB)	CL (dB)	PA (dB)
PK	46.49M	32.26	40.00	-7.74	-15.09	3	Vertical	359	1.00	-	47.35	15.52	1.22	31.83
QP	58.13M	33.63	40.00	-6.37	-18.11	3	Vertical	238	1.00	-	51.74	12.45	1.34	31.90
PK	68.8M	31.79	40.00	-8.21	-18.11	3	Vertical	316	1.50	-	49.90	12.35	1.44	31.90
PK	191.99M	34.63	43.50	-8.87	-14.52	3	Vertical	358	1.00	-	49.15	15.12	2.37	32.01
PK	201.69M	33.33	43.50	-10.17	-14.24	3	Vertical	0	1.50	-	47.57	15.34	2.43	32.01
PK	250.19M	41.93	46.00	-4.07	-11.04	3	Vertical	315	1.00	"Worst"	52.97	18.28	2.72	32.04

Mode 1

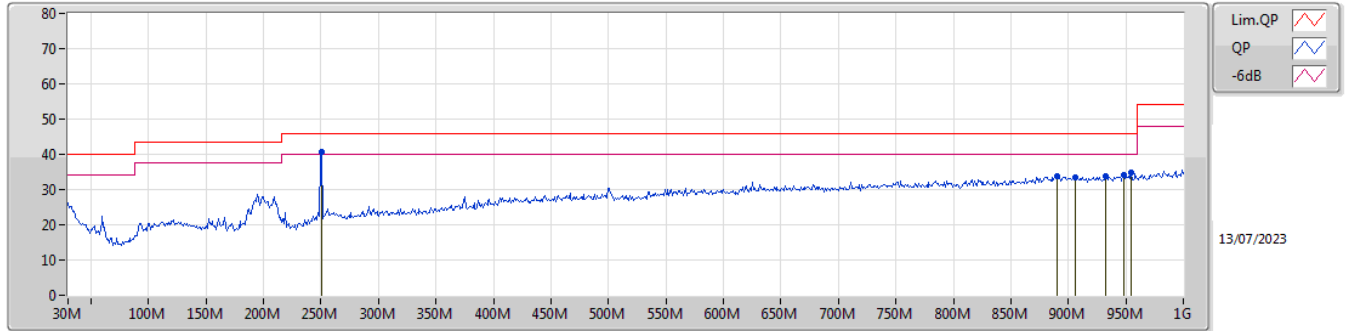

Type	Freq (Hz)	Level (dBuV/m)	Limit (dBuV/m)	Margin (dB)	Factor (dB)	Dist (m)	Condition	Azimuth (°)	Height (m)	Comment	Raw (dBuV)	AF (dB)	CL (dB)	PA (dB)
PK	250.19M	40.62	46.00	-5.38	-11.04	3	Horizontal	98	1.25	"Worst"	51.66	18.28	2.72	32.04
PK	890.39M	33.85	46.00	-12.15	-0.55	3	Horizontal	272	1.00	-	34.40	26.31	5.62	32.48
PK	905.91M	33.61	46.00	-12.39	-0.41	3	Horizontal	351	1.00	-	34.02	26.38	5.67	32.46
PK	932.1M	33.93	46.00	-12.07	-0.30	3	Horizontal	338	3.00	-	34.23	26.53	5.68	32.51
PK	948.59M	34.21	46.00	-11.79	-0.16	3	Horizontal	360	1.00	-	34.37	26.70	5.69	32.55
PK	954.41M	34.73	46.00	-11.27	-0.03	3	Horizontal	220	3.00	-	34.76	26.78	5.71	32.52



Summary

Mode	Result	Type	Freq (Hz)	Level (dBuV/m)	Limit (dBuV/m)	Margin (dB)	Dist (m)	Condition	Azimuth (°)	Height (m)	Comments
2.4-2.4835GHz	-	-	-	-	-	-	-	-	-	-	-
BT-LE(2Mbps)	Pass	AV	2.4835G	52.15	54.00	-1.85	3	Horizontal	303	2.16	-

2.4-2.4835GHz_BT-LE(1Mbps)

2402MHz_TX

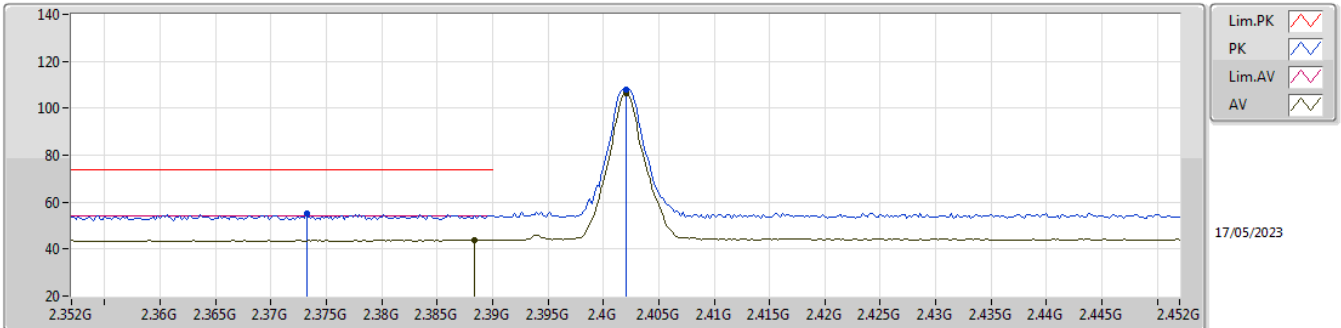

EUT_Y_1TX
Setting Maximum
01-E-P-5

Type	Freq (Hz)	Level (dBuV/m)	Limit (dBuV/m)	Margin (dB)	Raw (dBuV)	Dist (m)	Condition	Azimuth (°)	Height (m)	Comment	AF (dB)	CL (dB)	PA (dB)
PK	2.3732G	54.92	74.00	-19.08	23.60	3	Vertical	19	2.21	-	27.75	3.57	-
AV	2.3884G	43.94	54.00	-10.06	12.57	3	Vertical	19	2.21	-	27.78	3.59	-
PK	2.402G	107.82	Inf	-Inf	76.42	3	Vertical	19	2.21	-	27.80	3.60	-
AV	2.402G	106.49	Inf	-Inf	75.09	3	Vertical	19	2.21	-	27.80	3.60	-

2.4-2.4835GHz_BT-LE(1Mbps)

2402MHz_TX

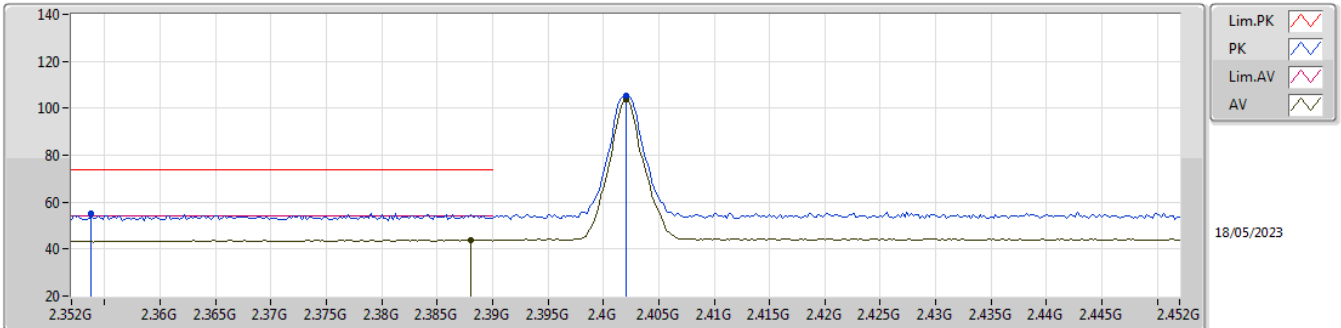

EUT_Y_1TX
Setting Maximum
01-E-P-5

Type	Freq (Hz)	Level (dBuV/m)	Limit (dBuV/m)	Margin (dB)	Raw (dBuV)	Dist (m)	Condition	Azimuth (°)	Height (m)	Comment	AF (dB)	CL (dB)	PA (dB)
PK	2.3538G	55.30	74.00	-18.70	24.04	3	Horizontal	343	1.66	-	27.71	3.55	-
AV	2.388G	44.00	54.00	-10.00	12.63	3	Horizontal	343	1.66	-	27.78	3.59	-
PK	2.402G	105.10	Inf	-Inf	73.70	3	Horizontal	343	1.66	-	27.80	3.60	-
AV	2.402G	103.55	Inf	-Inf	72.15	3	Horizontal	343	1.66	-	27.80	3.60	-

2.4-2.4835GHz_BT-LE(1Mbps)

2402MHz_TX

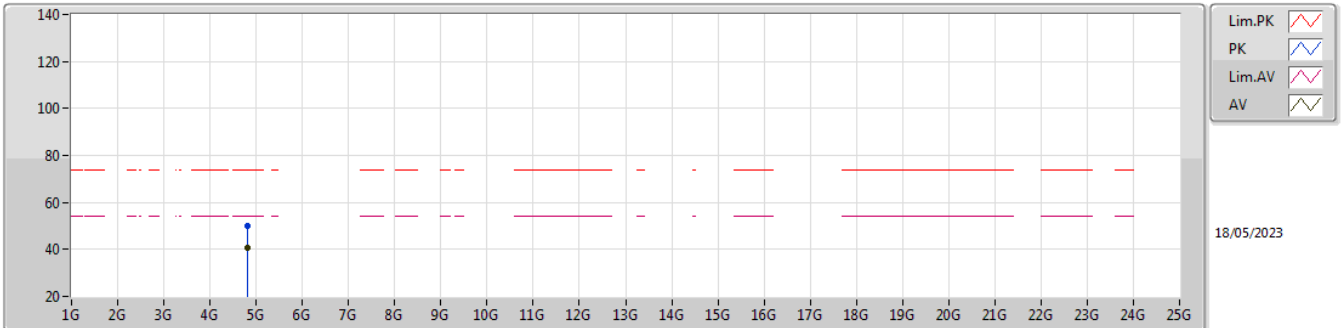

EUT Y_1TX
Setting Maximum
01-E-P-5

Type	Freq	Level	Limit	Margin	Raw	Dist	Condition	Azimuth	Height	Comment	AF	CL	PA			
	(Hz)	(dBuV/m)	(dBuV/m)	(dB)	(dBuV)	(m)		(°)	(m)		(dB)	(dB)	(dB)			
PK	4.803913G	50.13	74.00	-23.87	44.60	3	Vertical	51	1.77	-	32.72	5.70	32.89			
AV	4.80413G	40.69	54.00	-13.31	35.16	3	Vertical	51	1.77	-	32.72	5.70	32.89			

2.4-2.4835GHz_BT-LE(1Mbps)

2402MHz_TX

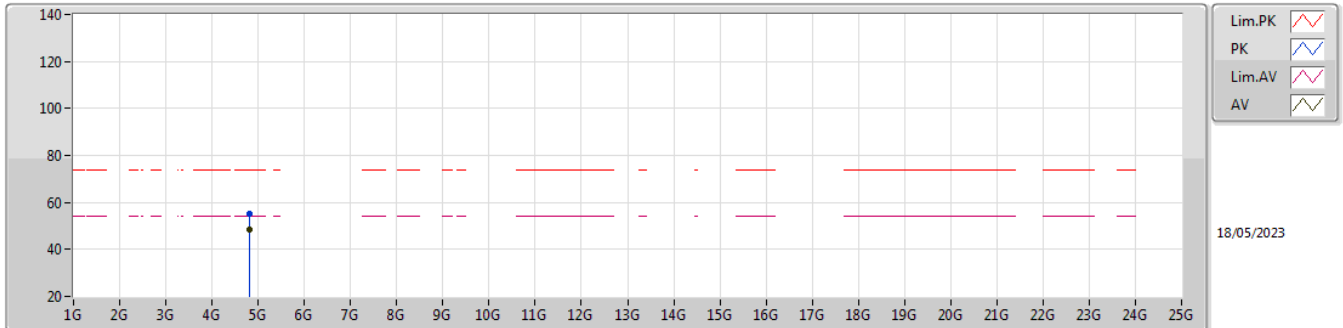

EUT Y_1TX
Setting Maximum
01-E-P-5

Type	Freq (Hz)	Level (dBuV/m)	Limit (dBuV/m)	Margin (dB)	Raw (dBuV)	Dist (m)	Condition	Azimuth (°)	Height (m)	Comment	AF (dB)	CL (dB)	PA (dB)
PK	4.80414G	55.32	74.00	-18.68	49.79	3	Horizontal	348	1.76	-	32.72	5.70	32.89
AV	4.80405G	48.19	54.00	-5.81	42.66	3	Horizontal	348	1.76	-	32.72	5.70	32.89

2.4-2.4835GHz_BT-LE(1Mbps)

2440MHz_TX

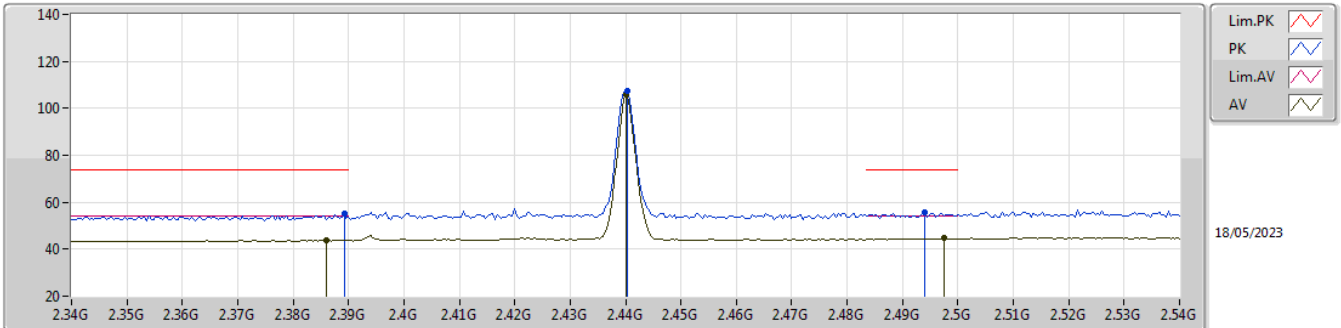

EUT_Y_1TX
Setting Maximum
01-E-P-5

Type	Freq (Hz)	Level (dBuV/m)	Limit (dBuV/m)	Margin (dB)	Raw (dBuV)	Dist (m)	Condition	Azimuth (°)	Height (m)	Comment	AF (dB)	CL (dB)	PA (dB)
PK	2.3892G	55.02	74.00	-18.98	23.65	3	Vertical	17	1.77	-	27.78	3.59	-
AV	2.386G	43.98	54.00	-10.02	12.62	3	Vertical	17	1.77	-	27.77	3.59	-
PK	2.4404G	107.17	Inf	-Inf	75.67	3	Vertical	17	1.77	-	27.88	3.62	-
AV	2.44G	105.83	Inf	-Inf	74.33	3	Vertical	17	1.77	-	27.88	3.62	-
PK	2.494G	55.57	74.00	-18.43	23.76	3	Vertical	17	1.77	-	28.16	3.65	-
AV	2.4976G	44.64	54.00	-9.36	12.80	3	Vertical	17	1.77	-	28.19	3.65	-

2.4-2.4835GHz_BT-LE(1Mbps)

2440MHz_TX

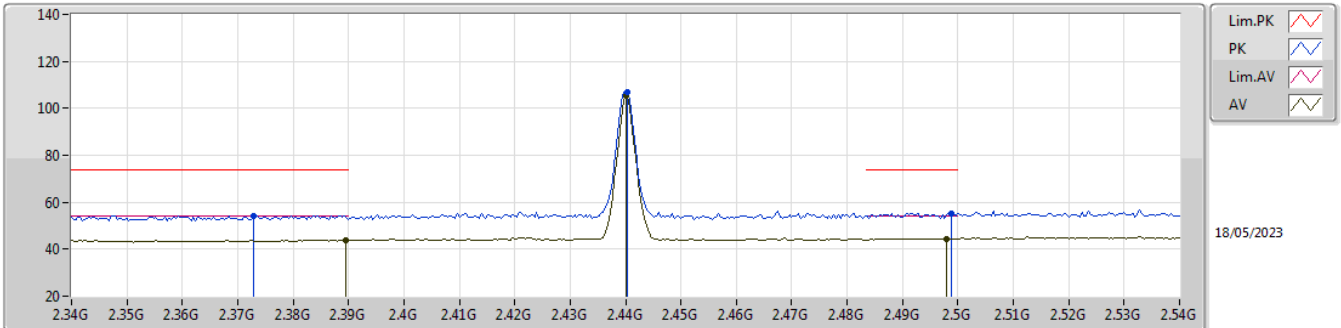

EUT_Y_1TX
Setting Maximum
01-E-P-5

Type	Freq (Hz)	Level (dBuV/m)	Limit (dBuV/m)	Margin (dB)	Raw (dBuV)	Dist (m)	Condition	Azimuth (°)	Height (m)	Comment	AF (dB)	CL (dB)	PA (dB)
PK	2.3728G	54.34	74.00	-19.66	23.02	3	Horizontal	311	2.29	-	27.75	3.57	-
AV	2.3896G	43.90	54.00	-10.10	12.53	3	Horizontal	311	2.29	-	27.78	3.59	-
PK	2.4404G	106.94	Inf	-Inf	75.44	3	Horizontal	311	2.29	-	27.88	3.62	-
AV	2.44G	105.50	Inf	-Inf	74.00	3	Horizontal	311	2.29	-	27.88	3.62	-
PK	2.4988G	55.38	74.00	-18.62	23.54	3	Horizontal	311	2.29	-	28.19	3.65	-
AV	2.498G	44.53	54.00	-9.47	12.69	3	Horizontal	311	2.29	-	28.19	3.65	-

2.4-2.4835GHz_BT-LE(1Mbps)

2440MHz_TX

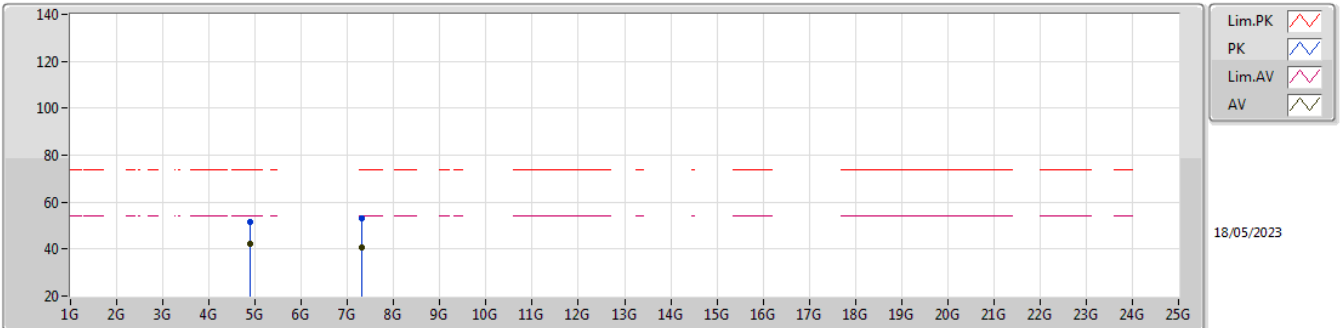

EUT Y_1TX
Setting Maximum
01-E-P-5

Type	Freq (Hz)	Level (dBuV/m)	Limit (dBuV/m)	Margin (dB)	Raw (dBuV)	Dist (m)	Condition	Azimuth (°)	Height (m)	Comment	AF (dB)	CL (dB)	PA (dB)
PK	4.87947G	51.74	74.00	-22.26	45.83	3	Vertical	44	1.76	-	33.00	5.78	32.87
AV	4.87976G	42.25	54.00	-11.75	36.34	3	Vertical	44	1.76	-	33.00	5.78	32.87
PK	7.31783G	53.14	74.00	-20.86	41.57	3	Vertical	152	1.73	-	37.60	7.16	33.19
AV	7.32135G	40.83	54.00	-13.17	29.26	3	Vertical	152	1.73	-	37.60	7.16	33.19

2.4-2.4835GHz_BT-LE(1Mbps)

2440MHz_TX

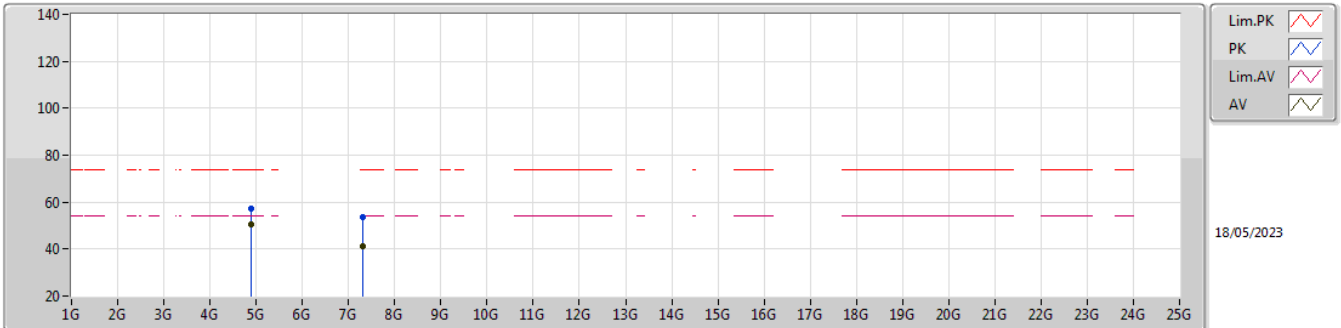

EUT Y_1TX
Setting Maximum
01-E-P-5

Type	Freq (Hz)	Level (dBuV/m)	Limit (dBuV/m)	Margin (dB)	Raw (dBuV)	Dist (m)	Condition	Azimuth (°)	Height (m)	Comment	AF (dB)	CL (dB)	PA (dB)
PK	4.88006G	57.03	74.00	-16.97	51.12	3	Horizontal	354	1.90	-	33.00	5.78	32.87
AV	4.88006G	50.66	54.00	-3.34	44.75	3	Horizontal	354	1.90	-	33.00	5.78	32.87
PK	7.31896G	53.66	74.00	-20.34	42.09	3	Horizontal	116	1.48	-	37.60	7.16	33.19
AV	7.31808G	40.99	54.00	-13.01	29.42	3	Horizontal	116	1.48	-	37.60	7.16	33.19

2.4-2.4835GHz_BT-LE(1Mbps)

2478MHz_TX

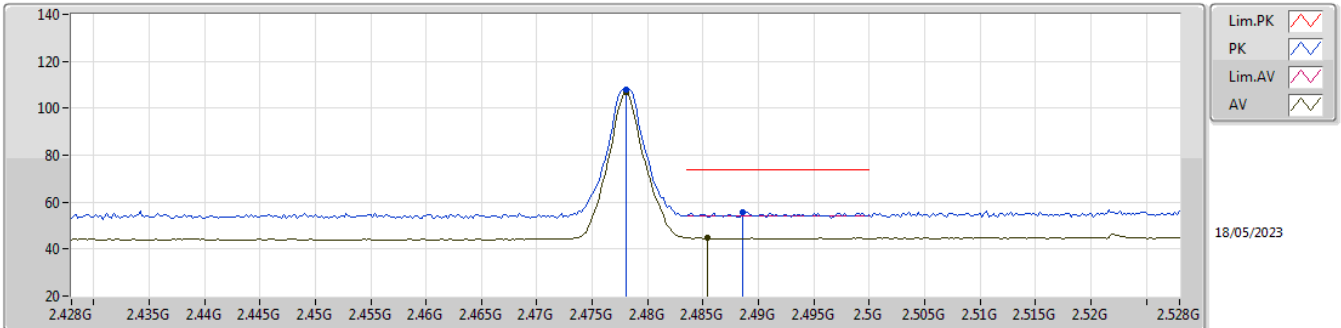

EUT Y_1TX
Setting Maximum
01-E-P-5

Type	Freq (Hz)	Level (dBuV/m)	Limit (dBuV/m)	Margin (dB)	Raw (dBuV)	Dist (m)	Condition	Azimuth (°)	Height (m)	Comment	AF (dB)	CL (dB)	PA (dB)
PK	2.478G	108.08	Inf	-Inf	76.37	3	Vertical	16	1.77	-	28.07	3.64	-
AV	2.478G	106.71	Inf	-Inf	75.00	3	Vertical	16	1.77	-	28.07	3.64	-
PK	2.4886G	55.94	74.00	-18.06	24.17	3	Vertical	16	1.77	-	28.13	3.64	-
AV	2.4854G	44.84	54.00	-9.16	13.09	3	Vertical	16	1.77	-	28.11	3.64	-

2.4-2.4835GHz_BT-LE(1Mbps)

2478MHz_TX

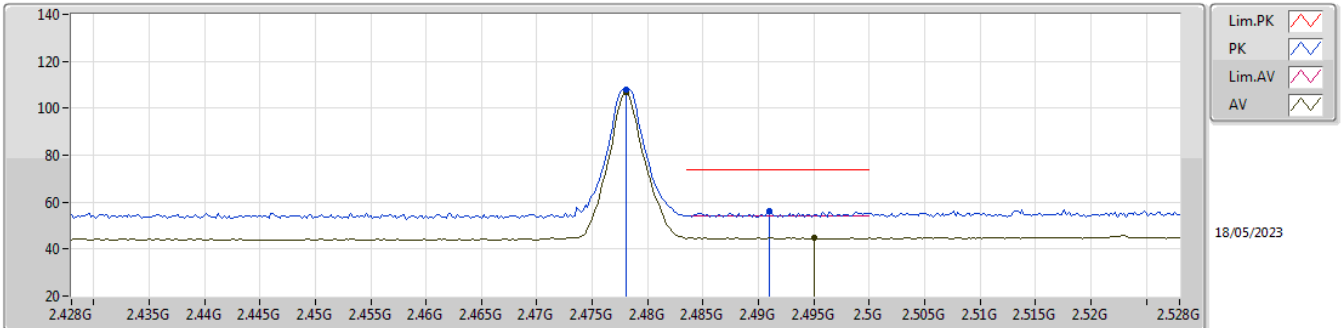

EUT_Y_1TX
Setting Maximum
01-E-P-5

Type	Freq (Hz)	Level (dBuV/m)	Limit (dBuV/m)	Margin (dB)	Raw (dBuV)	Dist (m)	Condition	Azimuth (°)	Height (m)	Comment	AF (dB)	CL (dB)	PA (dB)
PK	2.478G	108.05	Inf	-Inf	76.34	3	Horizontal	296	2.19	-	28.07	3.64	-
AV	2.478G	106.72	Inf	-Inf	75.01	3	Horizontal	296	2.19	-	28.07	3.64	-
PK	2.491G	56.12	74.00	-17.88	24.32	3	Horizontal	296	2.19	-	28.15	3.65	-
AV	2.495G	44.77	54.00	-9.23	12.95	3	Horizontal	296	2.19	-	28.17	3.65	-

2.4-2.4835GHz_BT-LE(1Mbps)

2480MHz_TX

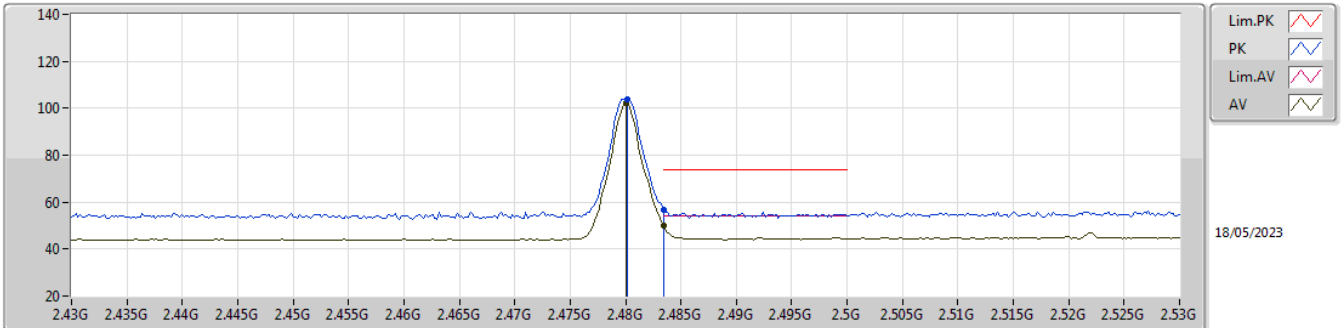

EUT Y_1TX
Setting Default
01-E-P-5

Type	Freq (Hz)	Level (dBuV/m)	Limit (dBuV/m)	Margin (dB)	Raw (dBuV)	Dist (m)	Condition	Azimuth (°)	Height (m)	Comment	AF (dB)	CL (dB)	PA (dB)
PK	2.4802G	103.77	Inf	-Inf	72.05	3	Vertical	16	1.78	-	28.08	3.64	-
AV	2.48G	102.28	Inf	-Inf	70.56	3	Vertical	16	1.78	-	28.08	3.64	-
PK	2.4835G	56.74	74.00	-17.26	25.00	3	Vertical	16	1.78	-	28.10	3.64	-
AV	2.4835G	50.23	54.00	-3.77	18.49	3	Vertical	16	1.78	-	28.10	3.64	-

2.4-2.4835GHz_BT-LE(1Mbps)

2480MHz_TX

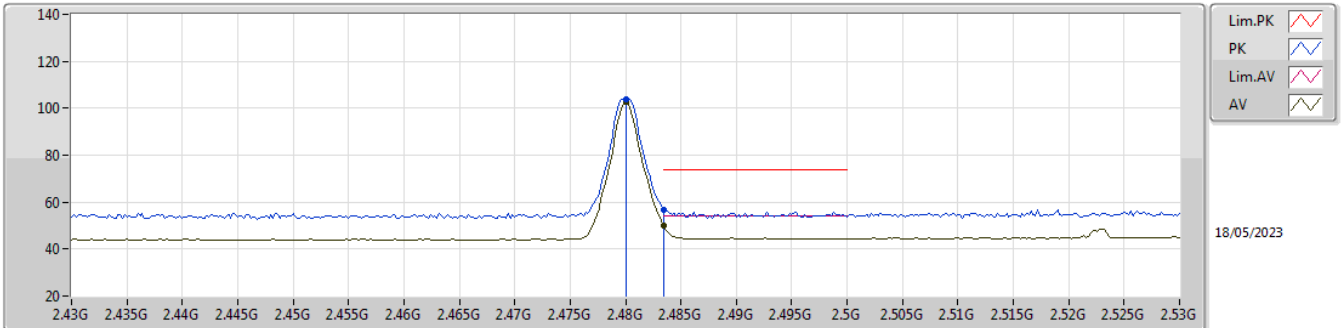

EUT Y_1TX
Setting Default
01-E-P-5

Type	Freq (Hz)	Level (dBuV/m)	Limit (dBuV/m)	Margin (dB)	Raw (dBuV)	Dist (m)	Condition	Azimuth (°)	Height (m)	Comment	AF (dB)	CL (dB)	PA (dB)
PK	2.48G	103.88	Inf	-Inf	72.16	3	Horizontal	302	2.18	-	28.08	3.64	-
AV	2.48G	102.51	Inf	-Inf	70.79	3	Horizontal	302	2.18	-	28.08	3.64	-
PK	2.4835G	56.87	74.00	-17.13	25.13	3	Horizontal	302	2.18	-	28.10	3.64	-
AV	2.4835G	50.17	54.00	-3.83	18.43	3	Horizontal	302	2.18	-	28.10	3.64	-

2.4-2.4835GHz_BT-LE(1Mbps)

2480MHz_TX

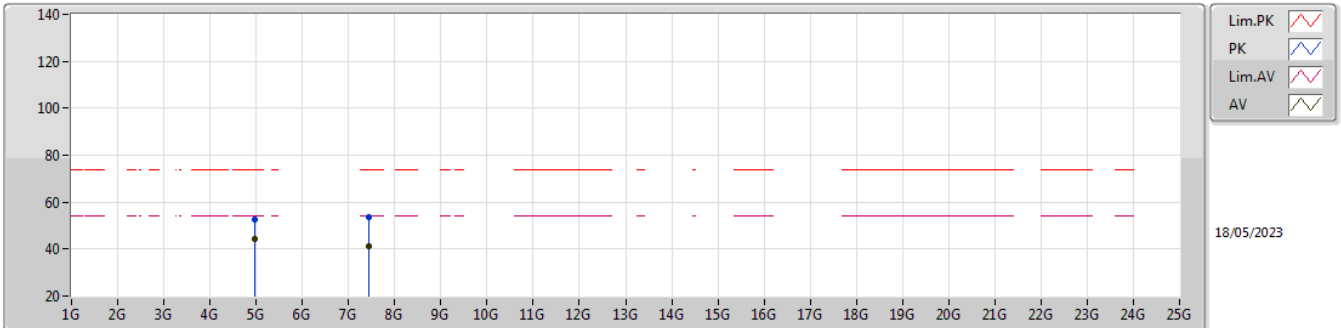

EUT Y_1TX
Setting Default
01-E-P-5

Type	Freq (Hz)	Level (dBuV/m)	Limit (dBuV/m)	Margin (dB)	Raw (dBuV)	Dist (m)	Condition	Azimuth (°)	Height (m)	Comment	AF (dB)	CL (dB)	PA (dB)
PK	4.95994G	52.63	74.00	-21.37	46.61	3	Vertical	324	3.00	-	33.02	5.86	32.86
AV	4.96007G	44.26	54.00	-9.74	38.24	3	Vertical	324	3.00	-	33.02	5.86	32.86
PK	7.44011G	53.58	74.00	-20.42	42.11	3	Vertical	197	2.32	-	37.50	7.22	33.25
AV	7.4417G	41.06	54.00	-12.94	29.59	3	Vertical	197	2.32	-	37.50	7.22	33.25

2.4-2.4835GHz_BT-LE(1Mbps)

2480MHz_TX

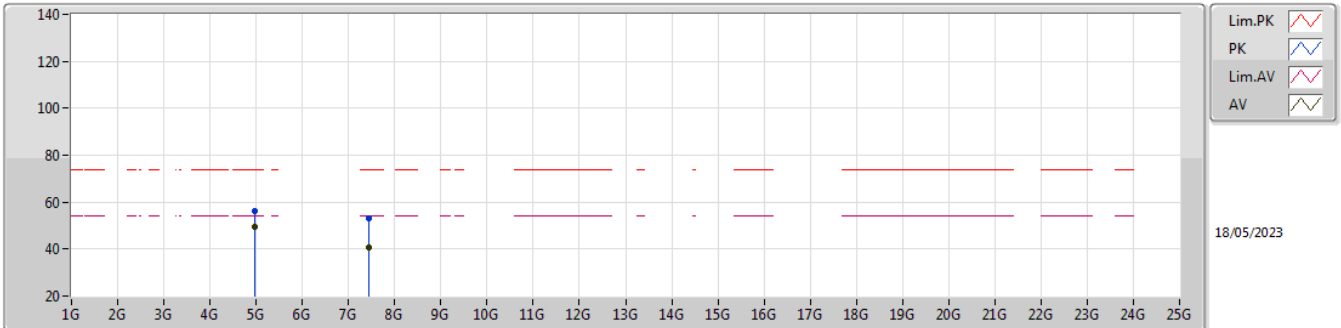

EUT Y_1TX
Setting Default
01-E-P-5

Type	Freq (Hz)	Level (dBuV/m)	Limit (dBuV/m)	Margin (dB)	Raw (dBuV)	Dist (m)	Condition	Azimuth (°)	Height (m)	Comment	AF (dB)	CL (dB)	PA (dB)
PK	4.95952G	56.26	74.00	-17.74	50.24	3	Horizontal	356	1.80	-	33.02	5.86	32.86
AV	4.96008G	49.36	54.00	-4.64	43.34	3	Horizontal	356	1.80	-	33.02	5.86	32.86
PK	7.44119G	53.24	74.00	-20.76	41.77	3	Horizontal	174	1.40	-	37.50	7.22	33.25
AV	7.44243G	40.84	54.00	-13.16	29.37	3	Horizontal	174	1.40	-	37.50	7.22	33.25

2.4-2.4835GHz_BT-LE(2Mbps)

2402MHz_TX

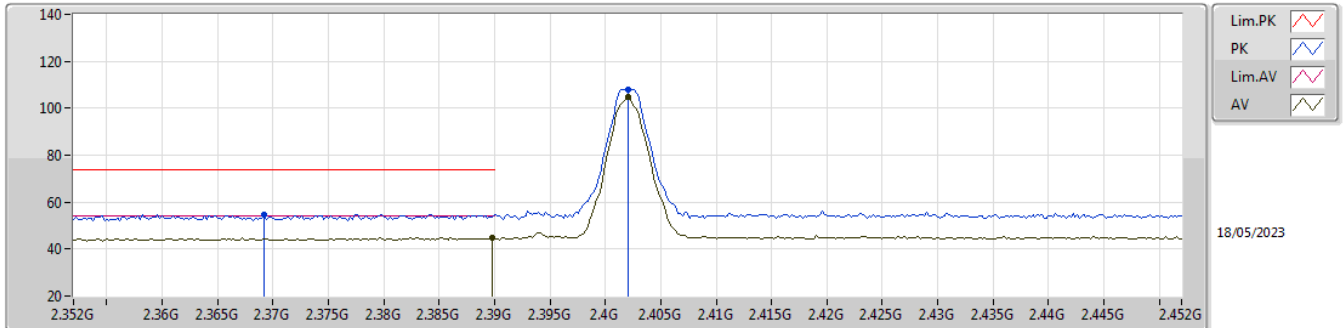

EUT Y_1TX
Setting Maximum
01-E-P-5

Type	Freq (Hz)	Level (dBuV/m)	Limit (dBuV/m)	Margin (dB)	Raw (dBuV)	Dist (m)	Condition	Azimuth (°)	Height (m)	Comment	AF (dB)	CL (dB)	PA (dB)
PK	2.3692G	54.83	74.00	-19.17	23.52	3	Vertical	16	1.80	-	27.74	3.57	-
AV	2.3898G	44.76	54.00	-9.24	13.39	3	Vertical	16	1.80	-	27.78	3.59	-
PK	2.402G	107.85	Inf	-Inf	76.45	3	Vertical	16	1.80	-	27.80	3.60	-
AV	2.402G	104.72	Inf	-Inf	73.32	3	Vertical	16	1.80	-	27.80	3.60	-

2.4-2.4835GHz_BT-LE(2Mbps)

2402MHz_TX

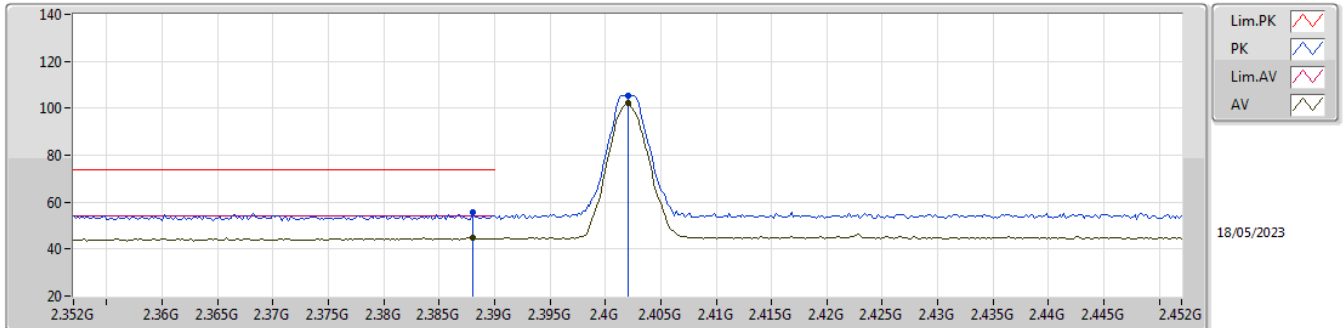

EUT_Y_1TX
Setting Maximum
01-E-P-5

Type	Freq (Hz)	Level (dBuV/m)	Limit (dBuV/m)	Margin (dB)	Raw (dBuV)	Dist (m)	Condition	Azimuth (°)	Height (m)	Comment	AF (dB)	CL (dB)	PA (dB)
PK	2.388G	55.73	74.00	-18.27	24.36	3	Horizontal	323	1.66	-	27.78	3.59	-
AV	2.388G	44.70	54.00	-9.30	13.33	3	Horizontal	323	1.66	-	27.78	3.59	-
PK	2.402G	105.34	Inf	-Inf	73.94	3	Horizontal	323	1.66	-	27.80	3.60	-
AV	2.402G	102.35	Inf	-Inf	70.95	3	Horizontal	323	1.66	-	27.80	3.60	-

2.4-2.4835GHz_BT-LE(2Mbps)

2402MHz_TX

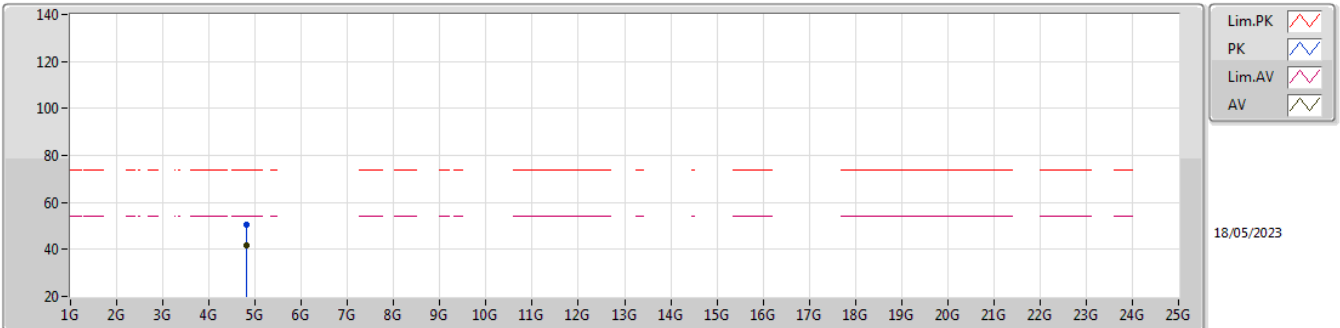

EUT Y_1TX
Setting Maximum
01-E-P-5

Type	Freq	Level	Limit	Margin	Raw	Dist	Condition	Azimuth	Height	Comment	AF	CL	PA			
	(Hz)	(dBuV/m)	(dBuV/m)	(dB)	(dBuV)	(m)		(°)	(m)		(dB)	(dB)	(dB)			
PK	4.80296G	50.40	74.00	-23.60	44.87	3	Vertical	43	1.77	-	32.72	5.70	32.89			
AV	4.80302G	41.50	54.00	-12.50	35.97	3	Vertical	43	1.77	-	32.72	5.70	32.89			

2.4-2.4835GHz_BT-LE(2Mbps)

2402MHz_TX

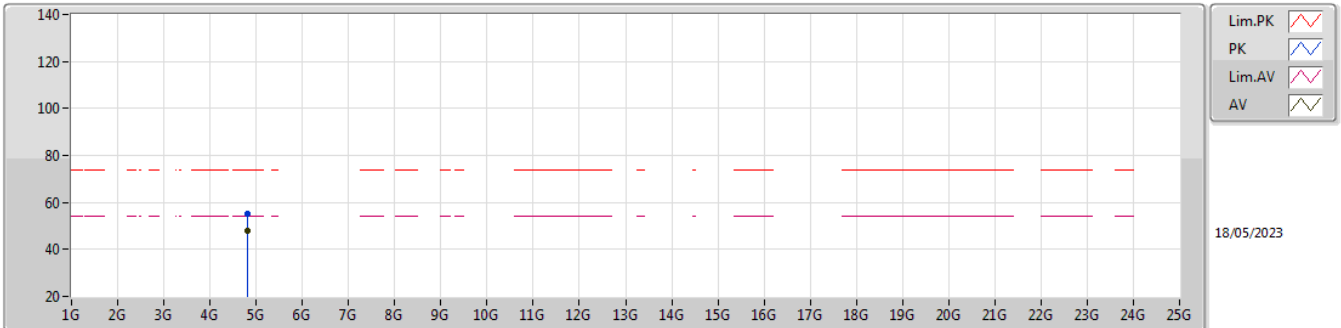

EUT Y_1TX
Setting Maximum
01-E-P-5

Type	Freq (Hz)	Level (dBuV/m)	Limit (dBuV/m)	Margin (dB)	Raw (dBuV)	Dist (m)	Condition	Azimuth (°)	Height (m)	Comment	AF (dB)	CL (dB)	PA (dB)
PK	4.80401G	55.05	74.00	-18.95	49.52	3	Horizontal	350	1.80	-	32.72	5.70	32.89
AV	4.80295G	47.81	54.00	-6.19	42.28	3	Horizontal	350	1.80	-	32.72	5.70	32.89

2.4-2.4835GHz_BT-LE(2Mbps)

2440MHz_TX

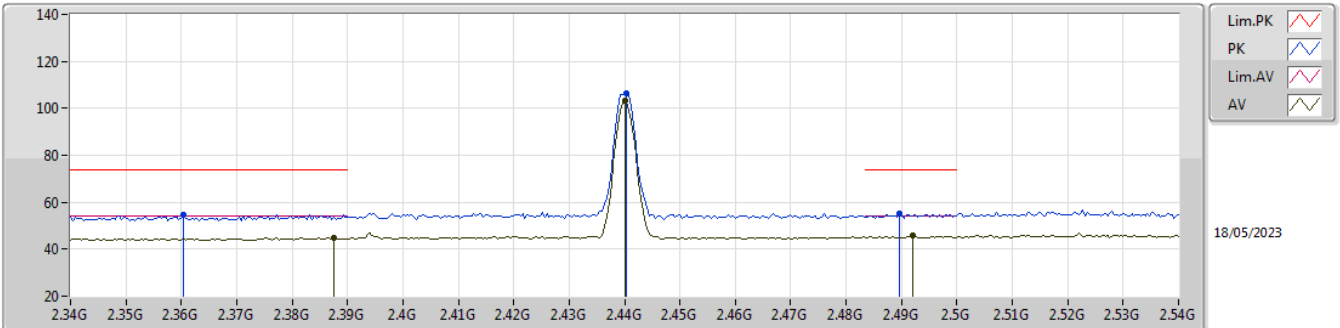

EUT_Y_1TX
Setting Maximum
01-E-P-5

Type	Freq (Hz)	Level (dBuV/m)	Limit (dBuV/m)	Margin (dB)	Raw (dBuV)	Dist (m)	Condition	Azimuth (°)	Height (m)	Comment	AF (dB)	CL (dB)	PA (dB)
PK	2.3604G	54.75	74.00	-19.25	23.47	3	Vertical	0	1.80	-	27.72	3.56	-
AV	2.3876G	44.71	54.00	-9.29	13.34	3	Vertical	0	1.80	-	27.78	3.59	-
PK	2.4404G	106.32	Inf	-Inf	74.82	3	Vertical	0	1.80	-	27.88	3.62	-
AV	2.44G	103.39	Inf	-Inf	71.89	3	Vertical	0	1.80	-	27.88	3.62	-
PK	2.4896G	54.97	74.00	-19.03	23.19	3	Vertical	0	1.80	-	28.14	3.64	-
AV	2.492G	45.62	54.00	-8.38	13.82	3	Vertical	0	1.80	-	28.15	3.65	-

2.4-2.4835GHz_BT-LE(2Mbps)

2440MHz_TX

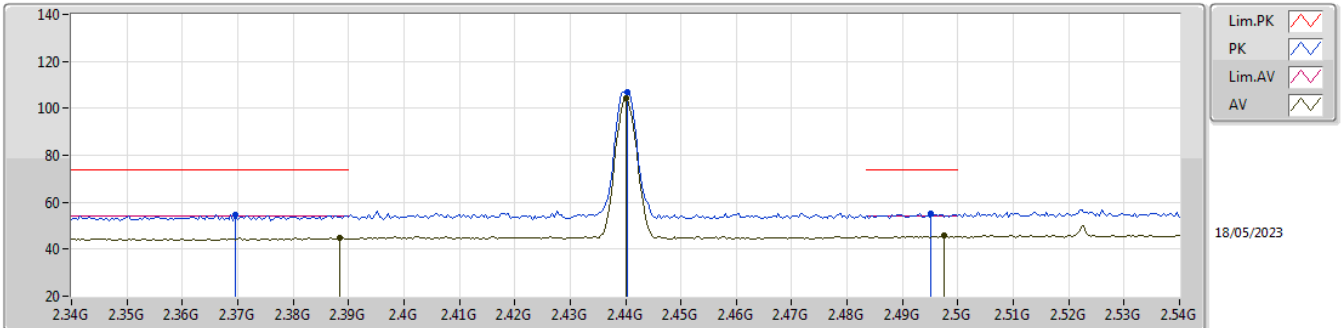

EUT_Y_1TX
Setting Maximum
01-E-P-5

Type	Freq (Hz)	Level (dBuV/m)	Limit (dBuV/m)	Margin (dB)	Raw (dBuV)	Dist (m)	Condition	Azimuth (°)	Height (m)	Comment	AF (dB)	CL (dB)	PA (dB)
PK	2.3696G	54.49	74.00	-19.51	23.18	3	Horizontal	303	2.29	-	27.74	3.57	-
AV	2.3884G	44.93	54.00	-9.07	13.56	3	Horizontal	303	2.29	-	27.78	3.59	-
PK	2.4404G	106.96	Inf	-Inf	75.46	3	Horizontal	303	2.29	-	27.88	3.62	-
AV	2.44G	104.13	Inf	-Inf	72.63	3	Horizontal	303	2.29	-	27.88	3.62	-
PK	2.4952G	55.22	74.00	-18.78	23.40	3	Horizontal	303	2.29	-	28.17	3.65	-
AV	2.4976G	45.66	54.00	-8.34	13.82	3	Horizontal	303	2.29	-	28.19	3.65	-

2.4-2.4835GHz_BT-LE(2Mbps)

2440MHz_TX

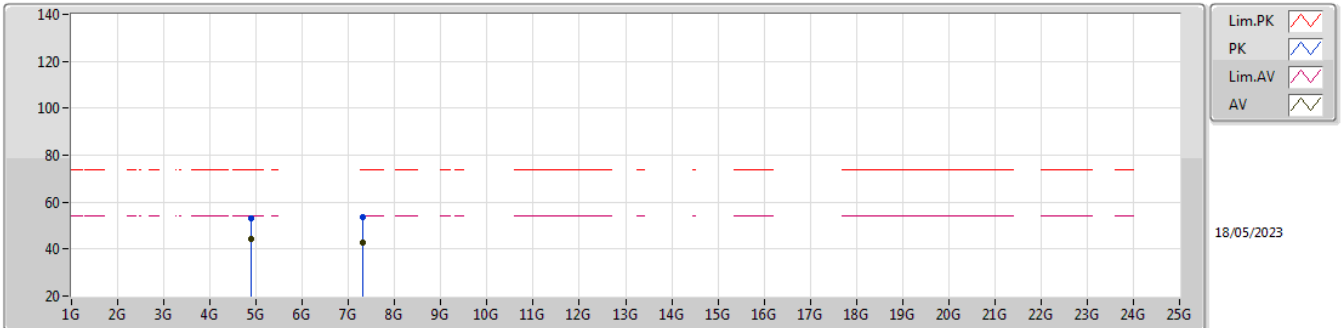

EUT Y_1TX
Setting Maximum
01-E-P-5

Type	Freq (Hz)	Level (dBuV/m)	Limit (dBuV/m)	Margin (dB)	Raw (dBuV)	Dist (m)	Condition	Azimuth (°)	Height (m)	Comment	AF (dB)	CL (dB)	PA (dB)
PK	4.87978G	52.90	74.00	-21.10	46.99	3	Vertical	313	3.00	-	33.00	5.78	32.87
AV	4.87903G	44.23	54.00	-9.77	38.32	3	Vertical	313	3.00	-	33.00	5.78	32.87
PK	7.31785G	53.77	74.00	-20.23	42.20	3	Vertical	18	1.75	-	37.60	7.16	33.19
AV	7.31812G	42.54	54.00	-11.46	30.97	3	Vertical	18	1.75	-	37.60	7.16	33.19

2.4-2.4835GHz_BT-LE(2Mbps)

2440MHz_TX

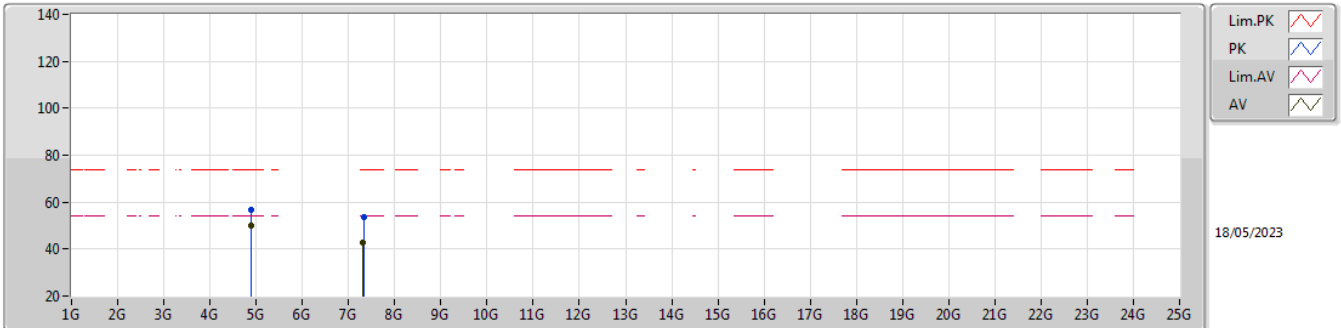

EUT_Y_1TX
Setting Maximum
01-E-P-5

Type	Freq (Hz)	Level (dBuV/m)	Limit (dBuV/m)	Margin (dB)	Raw (dBuV)	Dist (m)	Condition	Azimuth (°)	Height (m)	Comment	AF (dB)	CL (dB)	PA (dB)
PK	4.88107G	56.79	74.00	-17.21	50.88	3	Horizontal	0	1.80	-	33.00	5.78	32.87
AV	4.87901G	50.00	54.00	-4.00	44.09	3	Horizontal	0	1.80	-	33.00	5.78	32.87
PK	7.3223G	53.64	74.00	-20.36	42.07	3	Horizontal	72	2.11	-	37.60	7.16	33.19
AV	7.3206G	42.86	54.00	-11.14	31.29	3	Horizontal	72	2.11	-	37.60	7.16	33.19

2.4-2.4835GHz_BT-LE(2Mbps)

2478MHz_TX

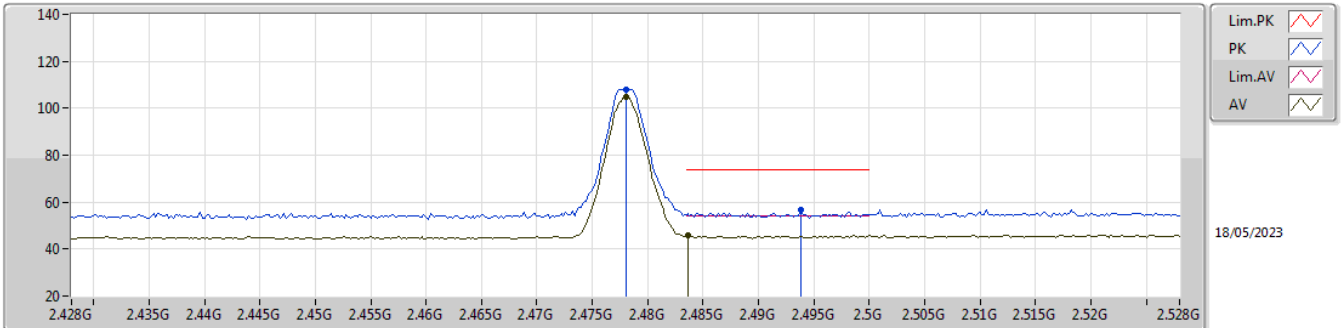





EUT Y_1TX
Setting Maximum
01-E-P-5

Type	Freq (Hz)	Level (dBuV/m)	Limit (dBuV/m)	Margin (dB)	Raw (dBuV)	Dist (m)	Condition	Azimuth (°)	Height (m)	Comment	AF (dB)	CL (dB)	PA (dB)
PK	2.478G	108.05	Inf	-Inf	76.34	3	Vertical	11	1.77	-	28.07	3.64	-
AV	2.478G	105.08	Inf	-Inf	73.37	3	Vertical	11	1.77	-	28.07	3.64	-
PK	2.4938G	56.75	74.00	-17.25	24.94	3	Vertical	11	1.77	-	28.16	3.65	-
AV	2.4836G	45.67	54.00	-8.33	13.93	3	Vertical	11	1.77	-	28.10	3.64	-

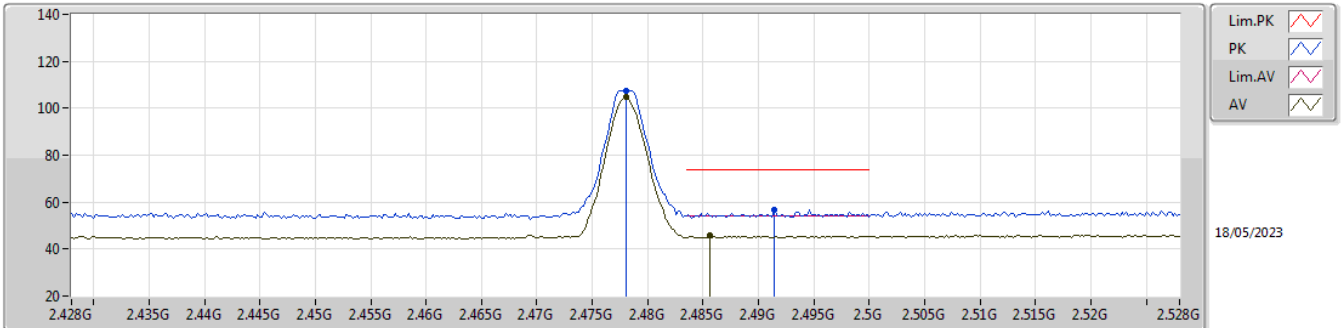
2.4-2.4835GHz_BT-LE(2Mbps)

2478MHz_TX



Lim.PK 
 PK 
 Lim.AV 
 AV 

18/05/2023

EUT Y_1TX
Setting Maximum
01-E-P-5

Type	Freq (Hz)	Level (dBuV/m)	Limit (dBuV/m)	Margin (dB)	Raw (dBuV)	Dist (m)	Condition	Azimuth (°)	Height (m)	Comment	AF (dB)	CL (dB)	PA (dB)
PK	2.478G	107.59	Inf	-Inf	75.88	3	Horizontal	298	1.80	-	28.07	3.64	-
AV	2.478G	104.65	Inf	-Inf	72.94	3	Horizontal	298	1.80	-	28.07	3.64	-
PK	2.4914G	56.73	74.00	-17.27	24.93	3	Horizontal	298	1.80	-	28.15	3.65	-
AV	2.4856G	45.65	54.00	-8.35	13.90	3	Horizontal	298	1.80	-	28.11	3.64	-

2.4-2.4835GHz_BT-LE(2Mbps)

2480MHz_TX

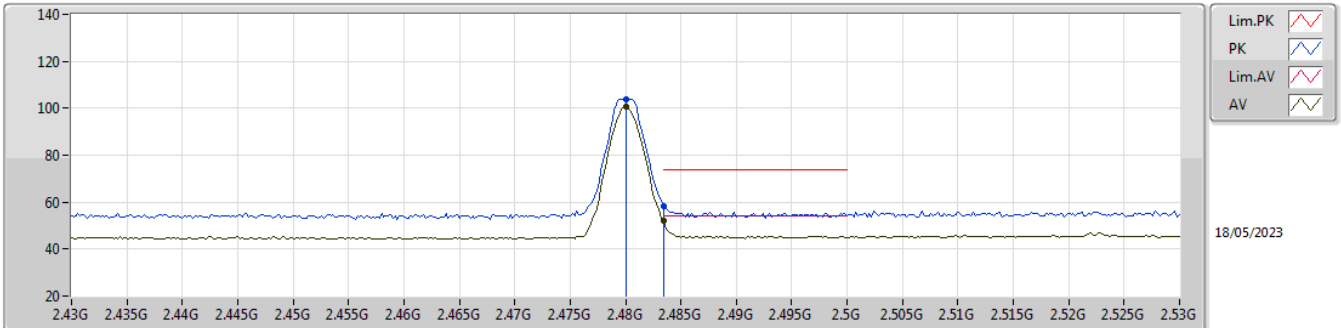

EUT Y_1TX
Setting Default
01-E-P-5

Type	Freq (Hz)	Level (dBuV/m)	Limit (dBuV/m)	Margin (dB)	Raw (dBuV)	Dist (m)	Condition	Azimuth (°)	Height (m)	Comment	AF (dB)	CL (dB)	PA (dB)
PK	2.48G	103.84	Inf	-Inf	72.12	3	Vertical	12	1.79	-	28.08	3.64	-
AV	2.48G	100.80	Inf	-Inf	69.08	3	Vertical	12	1.79	-	28.08	3.64	-
PK	2.4835G	58.47	74.00	-15.53	26.73	3	Vertical	12	1.79	-	28.10	3.64	-
AV	2.4835G	51.90	54.00	-2.10	20.16	3	Vertical	12	1.79	-	28.10	3.64	-

2.4-2.4835GHz_BT-LE(2Mbps)

2480MHz_TX

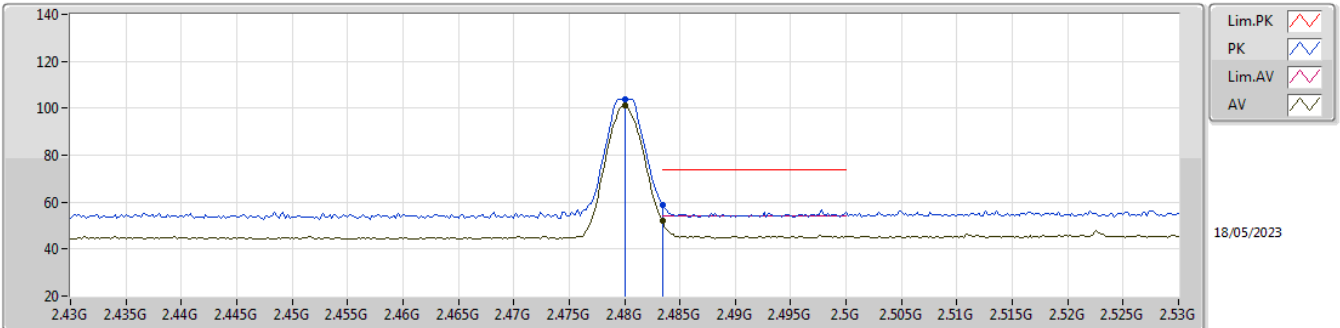

EUT Y_1TX
Setting Default
01-E-P-5

Type	Freq (Hz)	Level (dBuV/m)	Limit (dBuV/m)	Margin (dB)	Raw (dBuV)	Dist (m)	Condition	Azimuth (°)	Height (m)	Comment	AF (dB)	CL (dB)	PA (dB)
PK	2.48G	104.03	Inf	-Inf	72.31	3	Horizontal	303	2.16	-	28.08	3.64	-
AV	2.48G	101.00	Inf	-Inf	69.28	3	Horizontal	303	2.16	-	28.08	3.64	-
PK	2.4835G	58.82	74.00	-15.18	27.08	3	Horizontal	303	2.16	-	28.10	3.64	-
AV	2.4835G	52.15	54.00	-1.85	20.41	3	Horizontal	303	2.16	-	28.10	3.64	-

2.4-2.4835GHz_BT-LE(2Mbps)

2480MHz_TX

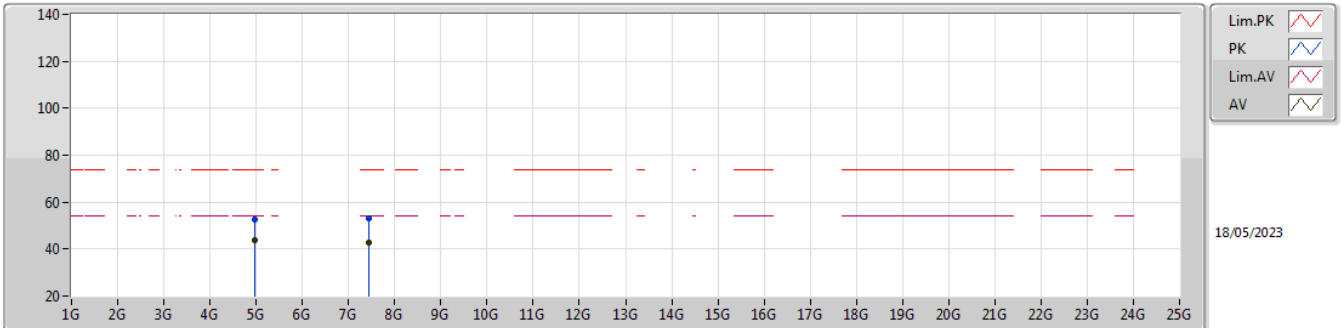

EUT Y_1TX
Setting Default
01-E-P-5

Type	Freq (Hz)	Level (dBuV/m)	Limit (dBuV/m)	Margin (dB)	Raw (dBuV)	Dist (m)	Condition	Azimuth (°)	Height (m)	Comment	AF (dB)	CL (dB)	PA (dB)
PK	4.96105G	52.40	74.00	-21.60	46.38	3	Vertical	328	2.44	-	33.02	5.86	32.86
AV	4.95905G	43.88	54.00	-10.12	37.86	3	Vertical	328	2.44	-	33.02	5.86	32.86
PK	7.43817G	53.16	74.00	-20.84	41.69	3	Vertical	214	2.46	-	37.50	7.22	33.25
AV	7.44204G	42.76	54.00	-11.24	31.29	3	Vertical	214	2.46	-	37.50	7.22	33.25

2.4-2.4835GHz_BT-LE(2Mbps)

2480MHz_TX

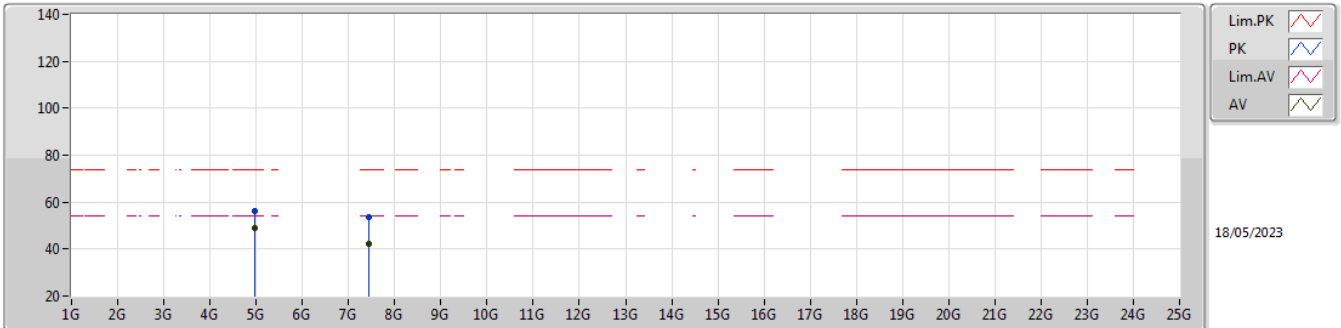

EUT Y_1TX
Setting Default
01-E-P-5

Type	Freq (Hz)	Level (dBuV/m)	Limit (dBuV/m)	Margin (dB)	Raw (dBuV)	Dist (m)	Condition	Azimuth (°)	Height (m)	Comment	AF (dB)	CL (dB)	PA (dB)
PK	4.96008G	55.99	74.00	-18.01	49.97	3	Horizontal	356	1.80	-	33.02	5.86	32.86
AV	4.95895G	48.90	54.00	-5.10	42.88	3	Horizontal	356	1.80	-	33.02	5.86	32.86
PK	7.44109G	53.71	74.00	-20.29	42.24	3	Horizontal	133	1.79	-	37.50	7.22	33.25
AV	7.44243G	42.43	54.00	-11.57	30.96	3	Horizontal	133	1.79	-	37.50	7.22	33.25



Summary

Mode	Result	Type	Freq (Hz)	Level (dBuV/m)	Limit (dBuV/m)	Margin (dB)	Condition
Mode 1	Pass	AV	1.36803G	37.81	54.00	-16.19	Vertical

Mode 1

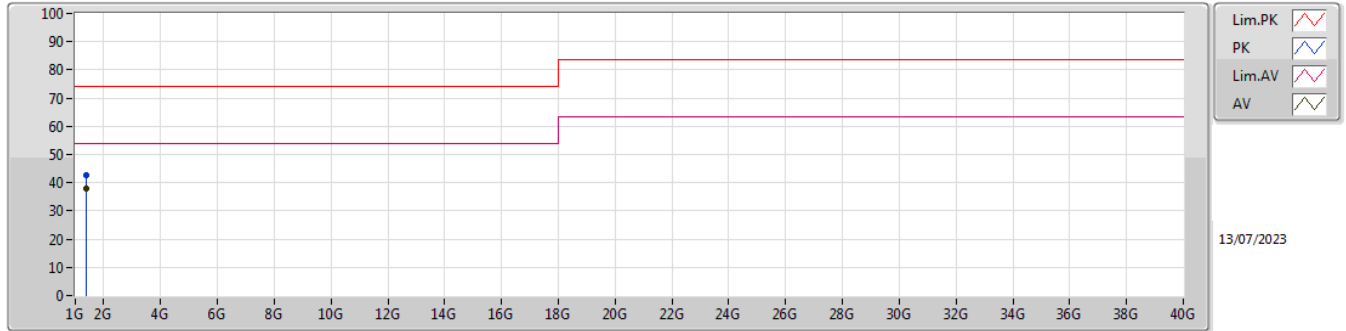

Type	Freq (Hz)	Level (dBuV/m)	Limit (dBuV/m)	Margin (dB)	Factor (dB/m)	Dist (m)	Condition	Azimuth (°)	Height (m)	Comment	Raw (dBuV/m)	AF (dB/m)	CL (dB)	PA (dB)
PK	1.36803G	42.67	74.00	-31.33	-7.81	3	Vertical	230	1.27	-	50.48	25.34	3.27	36.42
AV	1.36803G	37.81	54.00	-16.19	-7.81	3	Vertical	230	1.27	-	45.62	25.34	3.27	36.42

Mode 1

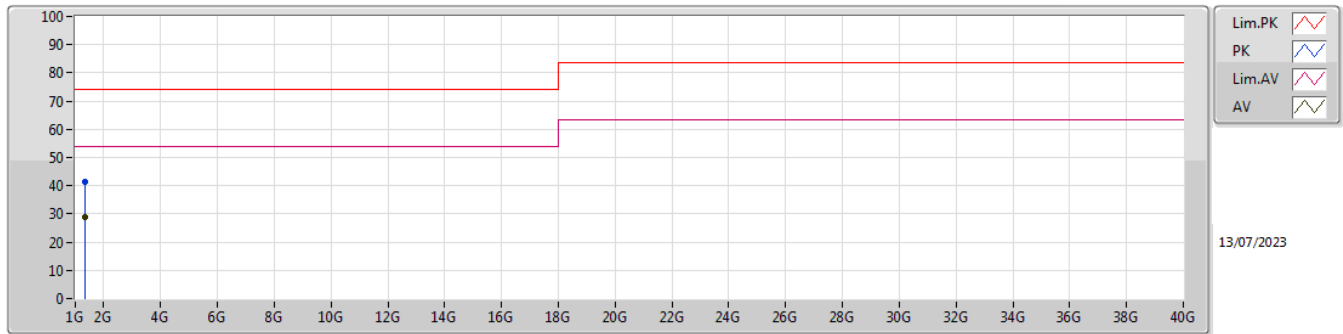

Type	Freq (Hz)	Level (dBuV/m)	Limit (dBuV/m)	Margin (dB)	Factor (dB/m)	Dist (m)	Condition	Azimuth (°)	Height (m)	Comment	Raw (dBuV/m)	AF (dB/m)	CL (dB)	PA (dB)
PK	1.36208G	41.18	74.00	-32.82	-7.70	3	Horizontal	83	1.17	-	48.88	25.46	3.26	36.42
AV	1.36208G	28.69	54.00	-25.31	-7.70	3	Horizontal	83	1.17	-	36.39	25.46	3.26	36.42