



RADIO TEST REPORT

FCC ID : UDX-600107010
Equipment : SMART Camera
Brand Name : CISCO
Model Name : MV63X-HW, MV63-HW
Applicant : Cisco Systems, Inc.
170 West Tasman Drive, San Jose, CA 95134 USA
Manufacturer : Cisco Systems, Inc.
170 West Tasman Drive, San Jose, CA 95134 USA
Standard : 47 CFR FCC Part 15.247

The product was received on Sep. 14, 2022, and testing was started from Sep. 21, 2022 and completed on Oct. 11, 2022. We, Sporton International Inc. Hsinchu Laboratory, would like to declare that the tested sample has been evaluated in accordance with the procedures given in ANSI C63.10-2013 and shown compliance with the applicable technical standards.

The test results in this report apply exclusively to the tested model / sample. Without written approval of Sporton International Inc. Hsinchu Laboratory, the test report shall not be reproduced except in full.



Approved by: Sam Chen

Sporton International Inc. Hsinchu Laboratory
No.8, Ln. 724, Bo'ai St., Zhubei City, Hsinchu County 302010, Taiwan (R.O.C.)



Table of Contents

History of this test report.....3

Summary of Test Result.....4

1 General Description5

1.1 Information.....5

1.2 Applicable Standards8

1.3 Testing Location Information8

1.4 Measurement Uncertainty9

2 Test Configuration of EUT10

2.1 Test Channel Mode10

2.2 The Worst Case Measurement Configuration11

2.3 EUT Operation during Test13

2.4 Accessories13

2.5 Support Equipment.....14

2.6 Test Setup Diagram15

3 Transmitter Test Result18

3.1 AC Power-line Conducted Emissions18

3.2 20dB Bandwidth and Carrier Frequency Separation.....20

3.3 Maximum Conducted Output Power21

3.4 Number of Hopping Frequencies and Hopping Bandedge22

3.5 Time of Occupancy (Dwell Time)23

3.6 Emissions in Non-restricted Frequency Bands24

3.7 Emissions in Restricted Frequency Bands.....25

4 Test Equipment and Calibration Data28

Appendix A. Test Results of AC Power-line Conducted Emissions

Appendix B. Test Results of 20dB Bandwidth and Carrier Frequency Separation

Appendix C. Test Results of Maximum Conducted Output Power

Appendix D. Test Results of Number of Hopping Frequencies and Hopping oppBandedge

Appendix E. Test Results of Time of Occupancy (Dwell Time)

Appendix F. Test Results of Emissions in Non-restricted Frequency Bands

Appendix G. Test Results of Emissions in Restricted Frequency Bands

Appendix H. Test Results of Radiated Emission Co-location

Appendix I. Test Photos

Photographs of EUT v01



Summary of Test Result

Report Clause	Ref Std. Clause	Test Items	Result (PASS/FAIL)	Remark
1.1.2	15.203	Antenna Requirement	PASS	-
3.1	15.207	AC Power-line Conducted Emissions	PASS	-
3.2	15.247(a)	20dB Bandwidth	PASS	-
3.2	15.247(a)	Carrier Frequency Separation	PASS	-
3.3	15.247(b)	Maximum Conducted Output Power	PASS	-
3.4	15.247(a)	Number of Hopping Frequencies and Hopping Band edge	PASS	-
3.5	15.247(a)	Time of Occupancy (Dwell Time)	PASS	-
3.6	15.247(d)	Emissions in Non-restricted Frequency Bands	PASS	-
3.7	15.247(d)	Emissions in Restricted Frequency Bands	PASS	-

Declaration of Conformity:

1. The test results with all measurement uncertainty excluded are presented in accordance with the regulation limits or requirements declared by manufacturers. It's means measurement values may risk exceeding the limit of regulation standards, if measurement uncertainty is include in test results.
2. The measurement uncertainty please refer to report "Measurement Uncertainty".

Comments and Explanations:

- 1.The test configuration, test mode and test software were written in this test report are declared by the manufacturer.
- 2.The declared of product specification for EUT presented in the report are provided by the manufacturer, and the manufacturer takes all the responsibilities for the accuracy of product specification.

Reviewed by: Sam Chen**Report Producer: Wendy Pan**



1 General Description

1.1 Information

1.1.1 RF General Information

Frequency Range (MHz)	Bluetooth Version	Ch. Frequency (MHz)	Channel Number
2400-2483.5	BR / EDR	2402-2480	0-78 [79]

Band	Mode	BWch (MHz)	Nant
2.4-2.4835GHz	BT-BR(1Mbps)	1	1TX
2.4-2.4835GHz	BT-EDR(2Mbps)	1	1TX
2.4-2.4835GHz	BT-EDR(3Mbps)	1	1TX

Note:

- ◆ Bluetooth BR uses a GFSK (1Mbps).
- ◆ Bluetooth EDR uses a combination of $\pi/4$ -DQPSK (2Mbps) and 8DPSK (3Mbps).
- ◆ Bluetooth BR/EDR uses as a system using FHSS modulation.
- ◆ BWch is the nominal channel bandwidth.



1.1.2 Antenna Information

Ant.	Port		Brand	Model Name	Antenna Type	Connector	Gain (dBi)					
	WLAN	Bluetooth					WLAN 2.4GHz	WLAN 5GHz				Bluetooth
								UNII 1	UNII 2A	UNII 2C	UNII 3	
1	1	-	SERCOMM	HC910	PIFA Antenna	I-PEX	3.38	5.50	5.50	4.79	5.17	-
2	2	1	SERCOMM	HC910	PIFA Antenna	I-PEX	2.54	5.33	5.33	6.64	5.68	2.54

Note: The above information was declared by manufacturer.

For 2.4GHz function:

For IEEE 802.11b/g/n/VHT mode (1TX/1RX):

The EUT supports the antenna with TX and RX diversity functions.

Both Port 1 and Port 2 support transmit and receive functions, but only one of them will be used at one time.

The Port 1 generated the worst case, so it was selected to test and record in the report.

For 5GHz function:

For IEEE 802.11a/n/ac mode (1TX/1RX):

For UNII 1 and UNII 2A:

The EUT supports the antenna with TX and RX diversity functions.

Both Port 1 and Port 2 support transmit and receive functions, but only one of them will be used at one time.

The Port 1 generated the worst case, so it was selected to test and record in the report.

For UNII2C and UNII 3:

The EUT supports the antenna with TX and RX diversity functions.

Both Port 1 and Port 2 support transmit and receive functions, but only one of them will be used at one time.

The Port 2 generated the worst case, so it was selected to test and record in the report.

For Bluetooth function (1TX/1RX):

Only Port 1 can be used as transmitting/receiving antenna.

**1.1.3 Mode Test Duty Cycle**

Mode	DC	DCF(dB)	T(s)	VBW(Hz) ≥ 1/T
BT-BR(1Mbps)	0.784	1.06	2.888m	1k
BT-EDR(2Mbps)	0.747	1.27	2.889m	1k
BT-EDR(3Mbps)	0.785	1.05	2.891m	1k

Note:

- ♦ DC is Duty Cycle.
- ♦ DCF is Duty Cycle Factor.

1.1.4 EUT Operational Condition

EUT Power Type	From PoE
Test Software Version	QRCT (Version :4.0.72.1)

1.1.5 Table for Multiple Listing

The model names in the following table are all refer to the identical product.

Brand Name	Model Name	EUT	Memory Capacities
CISCO	MV63X-HW	EUT 1	1TB
	MV63-HW	EUT 2	256GB

Note 1: From the above EUT 1 for all test items and EUT 2 for Emissions in Restricted Frequency Bands below 1GHz were selected as representative EUT for the test and its data was recorded in this report.

Note 2: The above information was declared by manufacturer.



1.2 Applicable Standards

According to the specifications of the manufacturer, the EUT must comply with the requirements of the following standards:

- ♦ 47 CFR FCC Part 15.247

The following reference test guidance is not within the scope of accreditation of TAF.

- ♦ FCC KDB 558074 D01 v05r02
- ♦ FCC KDB 414788 D01 v01r01

1.3 Testing Location Information

Testing Location Information	
Test Lab. : Sporton International Inc. Hsinchu Laboratory	
Hsinchu (TAF: 3787)	ADD: No.8, Ln. 724, Bo'ai St., Zhubei City, Hsinchu County 302010, Taiwan (R.O.C.) TEL: 886-3-656-9065 FAX: 886-3-656-9085 Test site Designation No. TW3787 with FCC. Conformity Assessment Body Identifier (CABID) TW3787 with ISED.

Test Condition	Test Site No.	Test Engineer	Test Environment (°C / %)	Test Date
RF Conducted	TH03-CB	Jay Lo	23.4-23.6 / 58-66	Sep. 23, 2022 ~ Sep. 26, 2022
Radiated <1GHz	03CH05-CB	Simmon Cheng	23.4-24.4 / 55-60	Sep. 28, 2022~ Sep. 29, 2022
Radiated >1GHz	03CH01-CB	Simmon Cheng	23~23.5 / 55-60	Sep. 21, 2022~ Sep. 24, 2022
	03CH04-CB	Simmon Cheng	24.4-25.3 / 60-63	Sep. 21, 2022~ Sep. 24, 2022
Radiated Co-location	03CH05-CB	Simmon Cheng	24.9-25.2 / 61-63	Oct. 11, 2022
AC Conduction	CO02-CB	Joe Chu	22-23 / 59-60	Sep. 29, 2022



1.4 Measurement Uncertainty

ISO/IEC 17025 requires that an estimate of the measurement uncertainties associated with the emissions test results be included in the report. The measurement uncertainties given below are based on a 95% confidence level (based on a coverage factor (k=2))

Test Items	Uncertainty	Remark
Conducted Emission (150kHz ~ 30MHz)	3.4 dB	Confidence levels of 95%
Radiated Emission (9kHz ~ 30MHz)	3.4 dB	Confidence levels of 95%
Radiated Emission (30MHz ~ 1,000MHz)	5.6 dB	Confidence levels of 95%
Radiated Emission (1GHz ~ 18GHz)	5.2 dB	Confidence levels of 95%
Radiated Emission (18GHz ~ 40GHz)	4.7 dB	Confidence levels of 95%
Conducted Emission	3.2 dB	Confidence levels of 95%
Output Power Measurement	0.8 dB	Confidence levels of 95%
Power Density Measurement	3.2 dB	Confidence levels of 95%
Bandwidth Measurement	2.0 %	Confidence levels of 95%



2 Test Configuration of EUT

2.1 Test Channel Mode

Mode	Power Setting
BT-BR(1Mbps)	-
2402MHz	9
2440MHz	9
2480MHz	8
BT-EDR(2Mbps)	-
2402MHz	9
2440MHz	9
2480MHz	8
BT-EDR(3Mbps)	-
2402MHz	9
2440MHz	9
2480MHz	8



2.2 The Worst Case Measurement Configuration

The Worst Case Mode for Following Conformance Tests	
Tests Item	AC power-line conducted emissions
Condition	AC power-line conducted measurement for line and neutral Test Voltage: 120Vac / 60Hz
Operating Mode	Normal Link
1	EUT 1 connected via Ethernet - Day mode + PoE 1
2	EUT 1 connected via Ethernet - Night mode + PoE 1
Mode 2 has been evaluated to be the worst case between Mode 1~2, thus measurement for Mode 3 ~ 6 will follow this same test mode.	
3	EUT 1 connected via WLAN 2.4GHz - Night mode + PoE 1
4	EUT 1 connected via WLAN 2.4GHz - Night mode + PoE 2
5	EUT 1 connected via WLAN 5GHz - Night mode + PoE 1
6	EUT 1 connected via WLAN 5GHz - Night mode + PoE 2
For operating mode 2 is the worst case and it was record in this test report.	

The Worst Case Mode for Following Conformance Tests	
Tests Item	20dB Bandwidth Carrier Frequency Separation Maximum Conducted Output Power Number of Hopping Frequencies Hopping Bandedge Time of Occupancy (Dwell Time) Emissions in Non-restricted Frequency Bands
Test Condition	Conducted measurement at transmit chains
Test Mode	EUT 1



The Worst Case Mode for Following Conformance Tests	
Tests Item	Emissions in Restricted Frequency Bands
Test Condition	Radiated measurement If EUT consist of multiple antenna assembly (multiple antenna are used in EUT regardless of spatial multiplexing MIMO configuration), the radiated test should be performed with highest antenna gain of each antenna type.
Operating Mode < 1GHz	Normal Link
1	EUT 1 at Z axis connected via Ethernet - Day mode + PoE 1
2	EUT 1 at Y axis connected via Ethernet - Day mode + PoE 1
3	EUT 1 at X axis connected via Ethernet - Day mode + PoE 1
Mode 2 has been evaluated to be the worst case among Mode 1~3, thus measurement for Mode 4 will follow this same test mode.	
4	EUT 1 at Y axis connected via Ethernet - Night mode + PoE 1
Mode 4 has been evaluated to be the worst case among Mode 1~4, thus measurement for Mode 5 ~ 8 will follow this same test mode.	
5	EUT 1 at Y axis connected via WLAN 2.4GHz - Night mode + PoE 1
6	EUT 1 at Y axis connected via WLAN 2.4GHz - Night mode + PoE 2
7	EUT 1 at Y axis connected via WLAN 5GHz - Night mode + PoE 1
8	EUT 1 at Y axis connected via WLAN 5GHz - Night mode + PoE 2
Mode 4 has been evaluated to be the worst case among Mode 1~8, thus measurement for Mode 9 will follow this same test mode.	
9	EUT 2 at Y axis connected via Ethernet - Night mode + PoE 1
For operating mode 9 is the worst case and it was record in this test report.	
Operating Mode > 1GHz	CTX The EUT was performed at X axis, Y axis and Z axis position and the worst case was found at Z axis. So the measurement will follow this same test configuration.
1	EUT 1 at Z axis



The Worst Case Mode for Following Conformance Tests	
Tests Item	Simultaneous Transmission Analysis - Radiated Emission Co-location
Test Condition	Radiated measurement
Operating Mode	Normal Link
	The EUT was performed at X axis, Y axis and Z axis position and the worst case was found at Y axis. So the measurement will follow this same test configuration.
1	EUT 1 at Y axis + Bluetooth+WLAN 2.4GHz
2	EUT 1 at Y axis + Bluetooth+WLAN 5GHz
Refer to Appendix H for Radiated Emission Co-location.	

The Worst Case Mode for Following Conformance Tests	
Tests Item	Simultaneous Transmission Analysis - Co-location RF Exposure Evaluation
Operating Mode	
1	EUT 1 + Bluetooth+WLAN 2.4GHz
2	EUT 1 + Bluetooth+WLAN 5GHz
Refer to Sporton Test Report No.: FA291332 for Co-location RF Exposure Evaluation.	

Note: The PoEs are for measurement only, would not be marketed.

PoEs information as below:

Power	Brand	Model
PoE 1	PHIHONG	POEA33U-1ATE
PoE 2	CISCO	MA-PWR-MV-LV

2.3 EUT Operation during Test

For CTX Mode:

The EUT was programmed to be in continuously transmitting mode.

For Normal Link:

During the test, the EUT operation to normal function.

2.4 Accessories

Wall Bracket*4



2.5 Support Equipment

For AC Conduction:

Support Equipment				
No.	Equipment	Brand Name	Model Name	FCC ID
A	PoE 1	PHIHONG	POEA33U-1ATE	N/A
B	LAN NB	DELL	E6430	N/A
C	Smart phone	Samsung	Galaxy J2	N/A

For Radiated (below 1GHz):

Support Equipment				
No.	Equipment	Brand Name	Model Name	FCC ID
A	PoE 1	PHIHONG	POEA33U-1ATE	N/A
B	Notebook	Lenovo	L440	N/A
C	iPhone 12	Apple	A2403	BCG-E3544A

For Radiated (above 1GHz) and RF Conducted:

Support Equipment				
No.	Equipment	Brand Name	Model Name	FCC ID
A	Notebook	Lenovo	L440	N/A
B	PoE 1	PHIHONG	PORA33U-1ATE	N/A

2.6 Test Setup Diagram

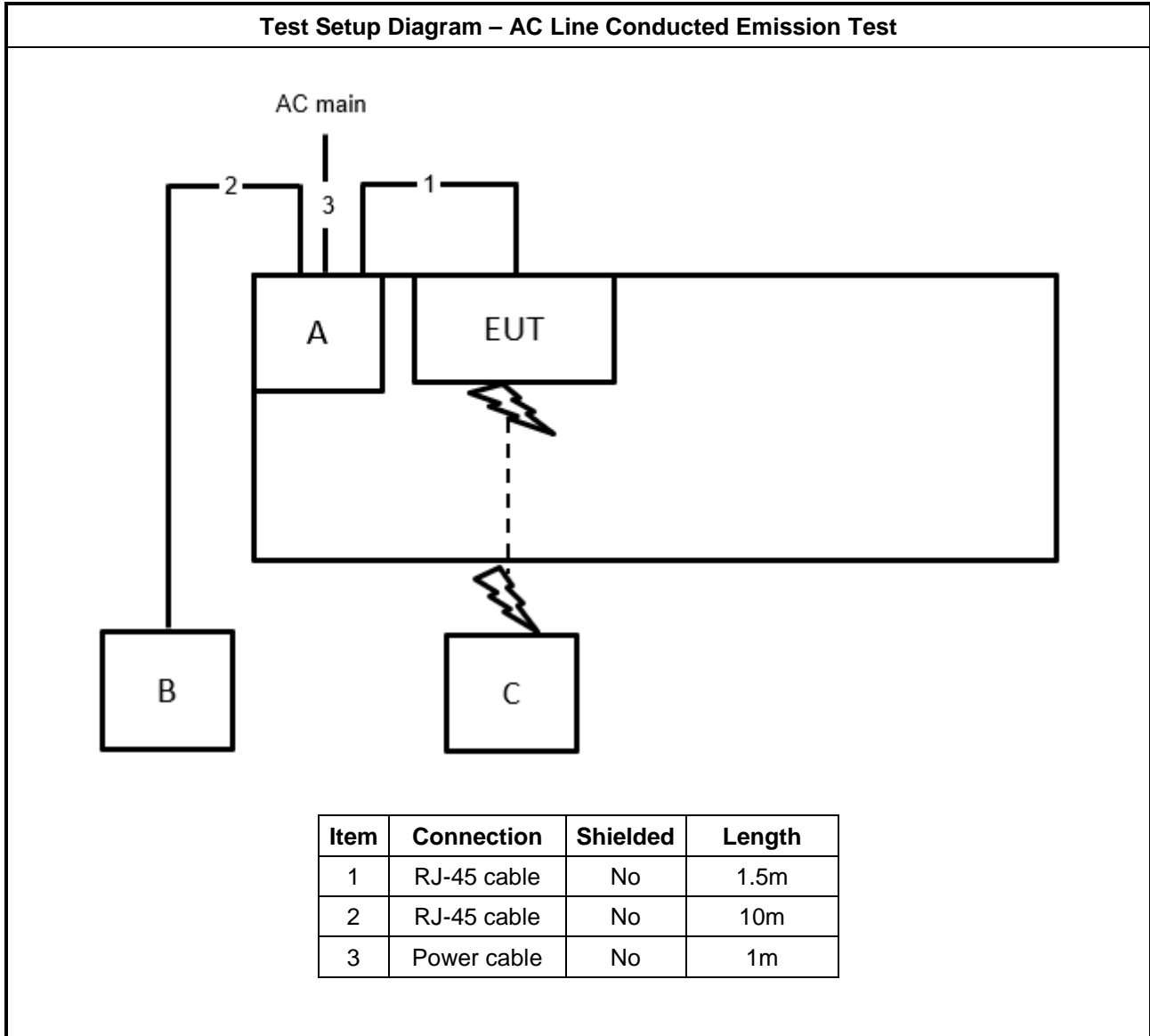

Test Setup Diagram - Radiated Test < 1GHz

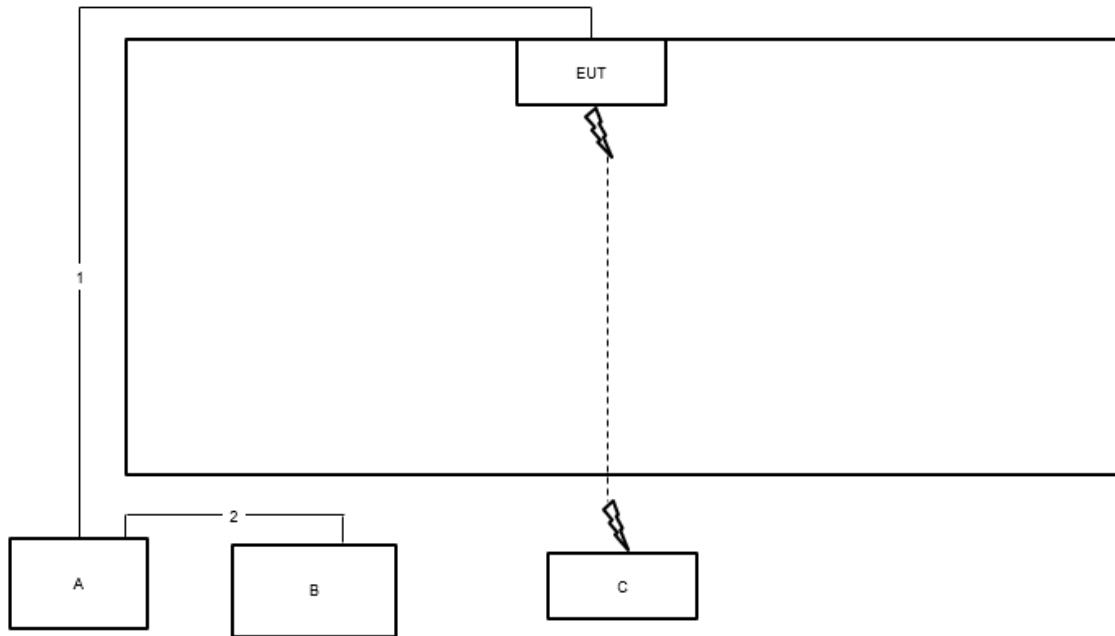

Item	Connection	Shielded	Length
1	RJ-45 cable	No	10m
2	RJ-45 cable	No	1.5m

Test Setup Diagram - Radiated Test > 1GHz

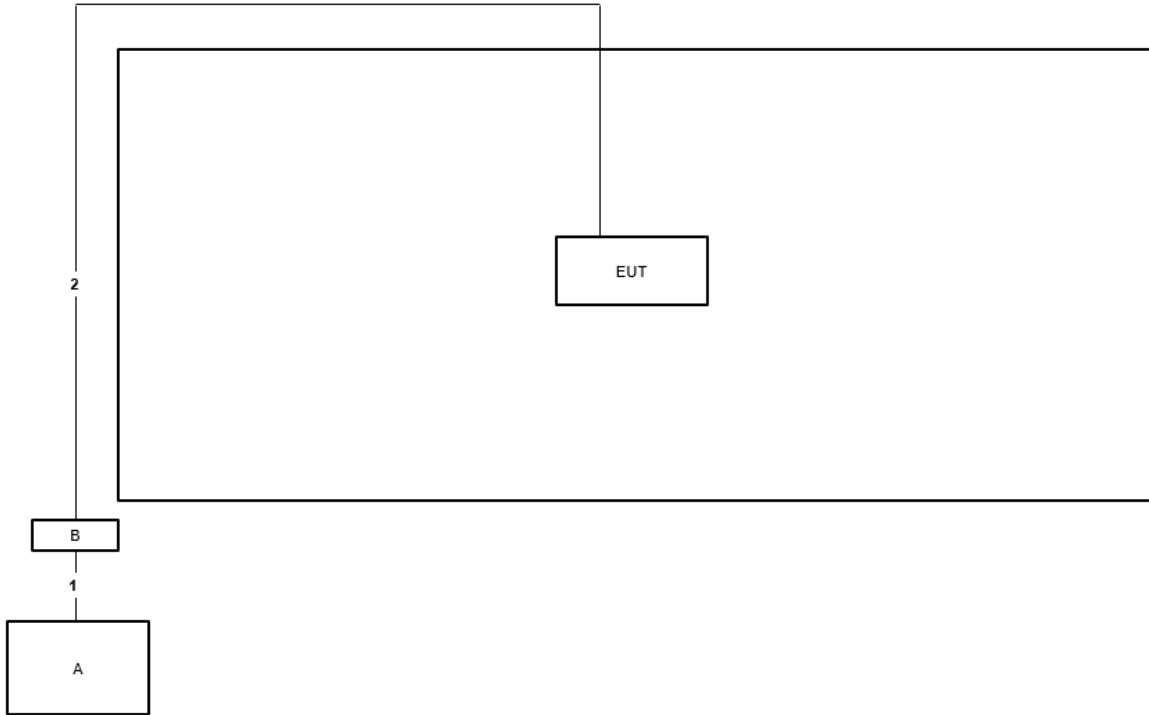

Item	Connection	Shielded	Length
1	RJ-45 cable	No	1m
2	RJ-45 cable	No	10m



3 Transmitter Test Result

3.1 AC Power-line Conducted Emissions

3.1.1 AC Power-line Conducted Emissions Limit

AC Power-line Conducted Emissions Limit		
Frequency Emission (MHz)	Quasi-Peak	Average
0.15-0.5	66 - 56 *	56 - 46 *
0.5-5	56	46
5-30	60	50

Note 1: * Decreases with the logarithm of the frequency.

3.1.2 Measuring Instruments

Refer a test equipment and calibration data table in this test report.

3.1.3 Test Procedures

Test Method
▪ Refer as ANSI C63.10-2013, clause 6.2 for AC power-line conducted emissions.

3.1.4 Test Setup

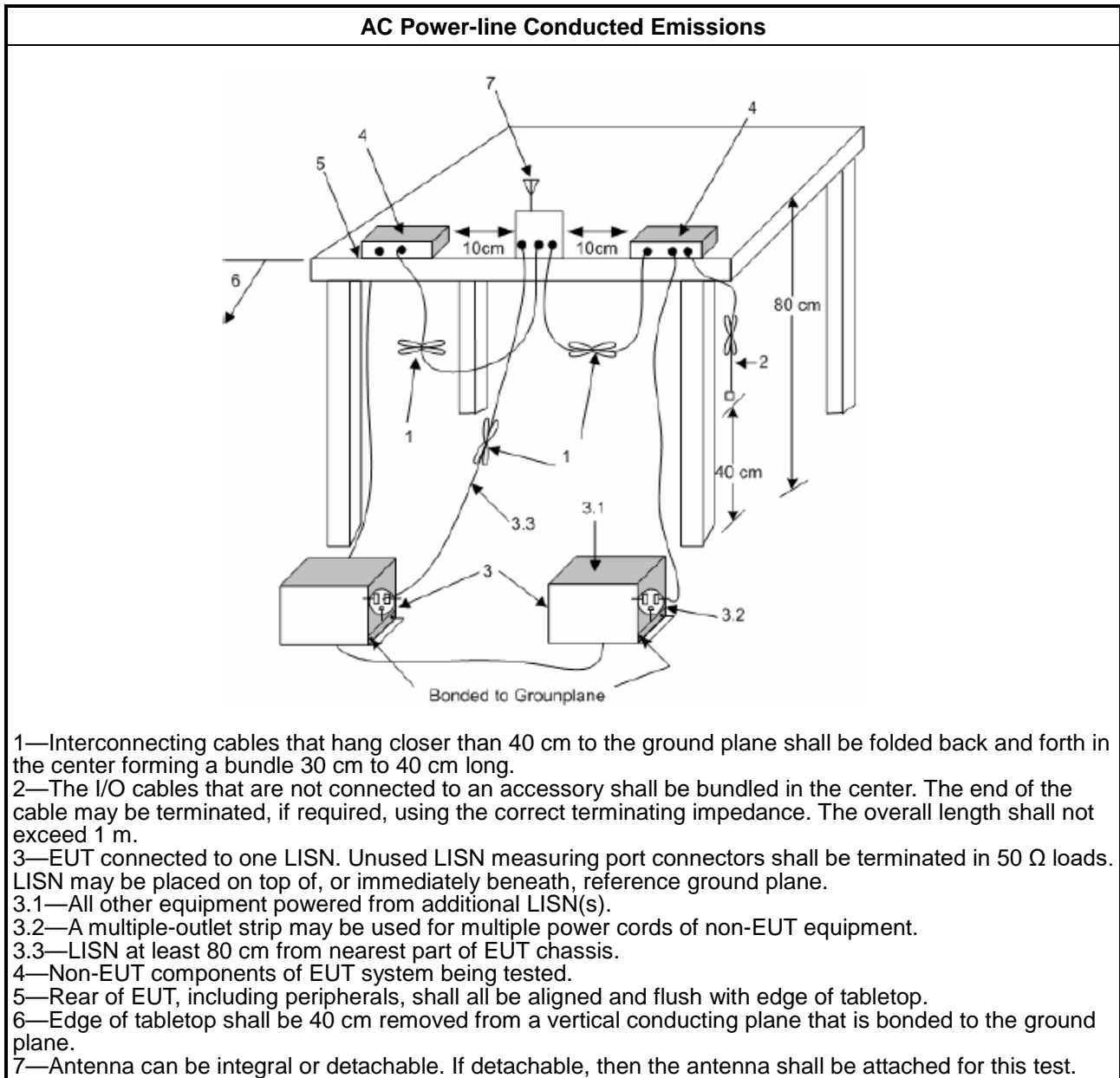

1.1.1. Measurement Results Calculation

The measured Level is calculated using:

- a. Corrected Reading: LISN Factor (LISN) + Attenuator (AT/AUX) + Cable Loss (CL) + Read Level (Raw) = Level
- b. Margin = -Limit + Level

3.1.5 Test Result of AC Power-line Conducted Emissions

Refer as Appendix A

3.2 20dB Bandwidth and Carrier Frequency Separation

3.2.1 20dB Bandwidth and Carrier Frequency Separation Limit

20dB Bandwidth and Carrier Frequency Separation Limit for Frequency Hopping Systems	
▪ 902-928 MHz Band:	
	▪ $N \geq 50$ and $ChS \geq MAX$ (20 dB bandwidth, 25 kHz); 20 dB bandwidth \leq 250 kHz.
	▪ $50 > N \geq 25$ and $ChS \geq MAX$ (20 dB bandwidth, 25 kHz); 20 dB bandwidth $>$ 250 kHz.
▪ 2400-2483.5 MHz Band:	
	▪ $N \geq 75$ and $ChS \geq MAX$ (20 dB bandwidth, 25 kHz).
	▪ $75 > N \geq 15$ and $ChS \geq MAX$ (20 dB bandwidth 2/3, 25 kHz).
▪ 5725-5850 MHz Band:	
	▪ $N \geq 75$ and $ChS \geq MAX$ (20 dB bandwidth, 25 kHz); 20 dB bandwidth \leq 1 MHz.
N: Number of Hopping Frequencies; ChS: Hopping Channel Separation	

3.2.2 Measuring Instruments

Refer a test equipment and calibration data table in this test report.

3.2.3 Test Procedures

Test Method
▪ Refer as ANSI C63.10-2013, clause 6.9.1 for 20 dB bandwidth measurement.
▪ Refer as ANSI C63.10-2013, clause 7.8.2 for carrier frequency separation measurement.

3.2.4 Test Setup

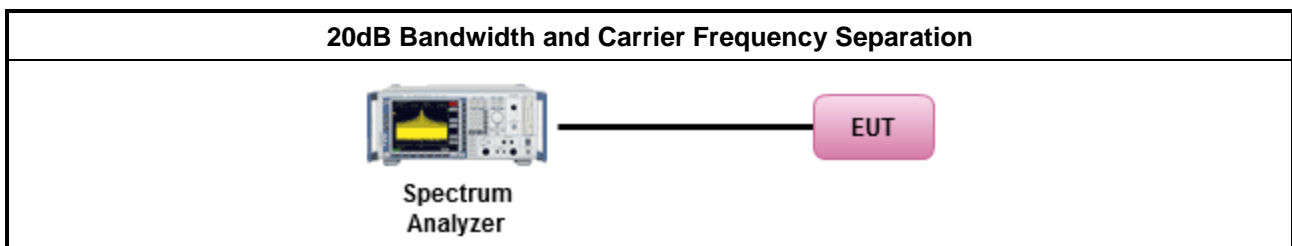

3.2.5 Test Result of 20dB Bandwidth

Refer as Appendix B

3.2.6 Test Result of Carrier Frequency Separation

Refer as Appendix B

3.3 Maximum Conducted Output Power

3.3.1 Maximum Conducted Output Power Limit

Maximum Conducted Output Power Limit	
<ul style="list-style-type: none"> ▪ 902-928 MHz Band: 	
	<ul style="list-style-type: none"> ▪ $N \geq 50$; Power 30dBm; EIRP 36dBm
	<ul style="list-style-type: none"> ▪ $50 > N \geq 25$; Power 23.98dBm; EIRP 29.98dBm
<ul style="list-style-type: none"> ▪ 2400-2483.5 MHz Band: 	
	<ul style="list-style-type: none"> ▪ $N \geq 75$; Power 30dBm; EIRP 36dBm
	<ul style="list-style-type: none"> ▪ $75 > N \geq 15$; Power 21dBm; EIRP 27dBm
<ul style="list-style-type: none"> ▪ 5725-5850 MHz Band: 	
	<ul style="list-style-type: none"> ▪ $N \geq 75$; Power 30dBm; EIRP 36dBm
N: Number of Hopping Frequencies	

3.3.2 Measuring Instruments

Refer a test equipment and calibration data table in this test report.

3.3.3 Test Procedures

Test Method
<ul style="list-style-type: none"> ▪ Refer as ANSI C63.10-2013, clause 7.8.5 for output power measurement.

3.3.4 Test Setup

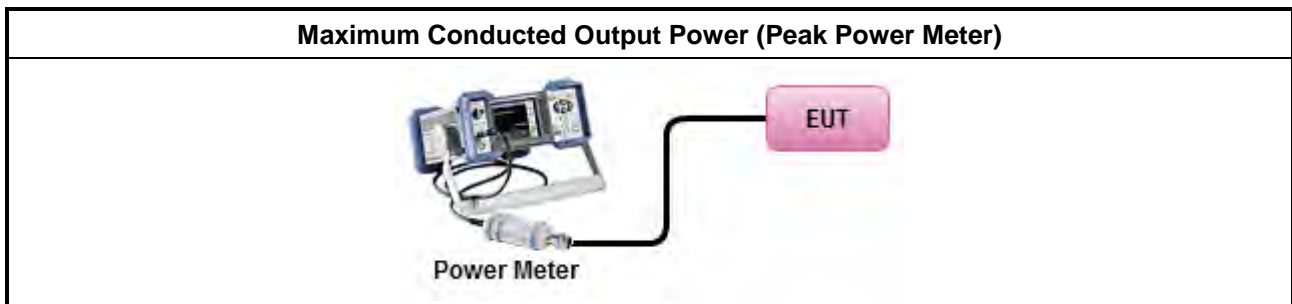

3.3.5 Test Result of Maximum Conducted Output Power

Refer as Appendix C

3.4 Number of Hopping Frequencies and Hopping Bandedge

3.4.1 Number of Hopping Frequencies Limit

Number of Hopping Frequencies Limit	
<ul style="list-style-type: none"> 902-928 MHz Band: 	
	<ul style="list-style-type: none"> N ≥ 50 and ChS ≥ MAX (20 dB bandwidth, 25 kHz); 20 dB bandwidth ≤ 250 kHz.
	<ul style="list-style-type: none"> 50 > N ≥ 25 and ChS ≥ MAX (20 dB bandwidth, 25 kHz); 20 dB bandwidth > 250 kHz.
<ul style="list-style-type: none"> 2400-2483.5 MHz Band: 	
	<ul style="list-style-type: none"> N ≥ 75 and ChS ≥ MAX (20 dB bandwidth, 25 kHz).
	<ul style="list-style-type: none"> 75 > N ≥ 15 and ChS ≥ MAX (20 dB bandwidth 2/3, 25 kHz).
<ul style="list-style-type: none"> 5725-5850 MHz Band: 	
	<ul style="list-style-type: none"> N ≥ 75 and ChS ≥ MAX (20 dB bandwidth, 25 kHz); 20 dB bandwidth ≤ 1 MHz.
<p>N: Number of Hopping Frequencies; ChS : Hopping Channel Separation</p>	

3.4.2 Hopping Bandedge Limit

Refer clause 3.6.1 and clause 3.7.1

3.4.3 Measuring Instruments

Refer a test equipment and calibration data table in this test report.

3.4.4 Test Procedures

Test Method
<ul style="list-style-type: none"> Refer as ANSI C63.10-2013, clause 7.8.3 for number of hopping frequencies measurement.
<ul style="list-style-type: none"> Refer as ANSI C63.10-2013, clause 7.8.6 for hopping frequencies Bandedge measurement.

3.4.5 Test Setup

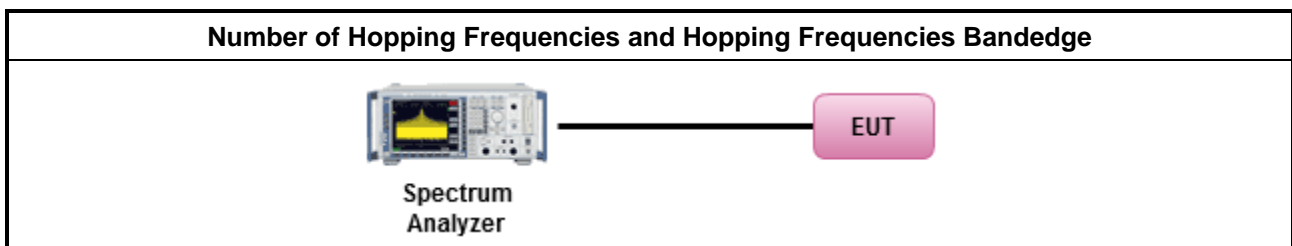

3.4.6 Test Result of Number of Hopping Frequencies

Refer as Appendix D

3.4.7 Test Result of Number of Hopping Frequencies Bandedge

Refer as Appendix D

3.5 Time of Occupancy (Dwell Time)

3.5.1 Time of Occupancy (Dwell Time) Limit

20dB Bandwidth and Carrier Frequency Separation Limit for Frequency Hopping Systems	
▪ 902-928 MHz Band:	
	▪ $N \geq 50$; 0.4s in 20s period
	▪ $50 > N \geq 25$; 0.4s in 10s period
▪ 2400-2483.5 MHz Band:	
	▪ $N \geq 75$; 0.4s in $N \times 0.4$ period
	▪ $75 > N \geq 15$; 0.4s in $N \times 0.4$ period
▪ 5725-5850 MHz Band:	
	▪ $N \geq 75$; 0.4s in 30s period
N: Number of Hopping Frequencies	

3.5.2 Measuring Instruments

Refer a test equipment and calibration data table in this test report.

3.5.3 Test Procedures

Test Method	
▪ Refer as ANSI C63.10-2013, clause 7.8.4 for dwell time measurement.	
▪ Bluetooth ACL packets can be 1, 3, or 5 time slots. Following as dwell time. Operate DH5 at maximum dwell time and maximum duty cycle.	
	▪ The DH5 packet can cover up to 5 time slots. Operate DH5 at maximum dwell time and maximum duty cycle. A maximum length packet has duration of 5 time slots. The hopping rate is 1600 hops/second so the maximum dwell time is $5/1600$ seconds, or 3.125ms. DH5 Packet permit maximum $1600 / 79 / 6 = 3.37$ hops per second in each channel.

3.5.4 Test Setup

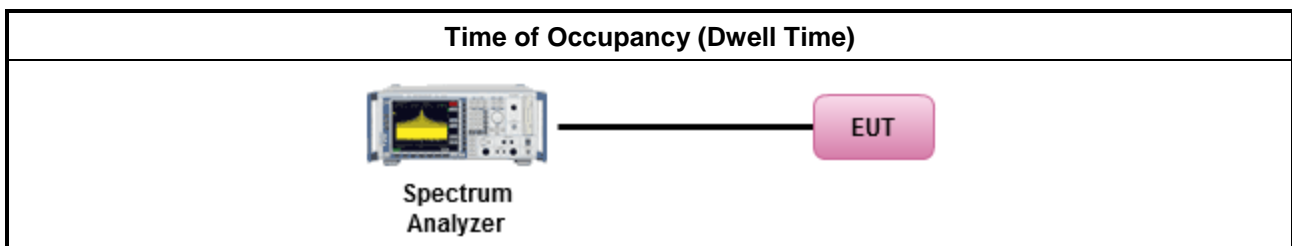

3.5.5 Test Result of Time of Occupancy (Dwell Time)

Refer as Appendix E

3.6 Emissions in Non-restricted Frequency Bands

3.6.1 Emissions in Non-restricted Frequency Bands Limit

Un-restricted Band Emissions Limit	
RF output power procedure	Limit (dBc)
Peak output power procedure	20
Note 1: If the peak output power procedure is used to measure the fundamental emission power to demonstrate compliance to requirements, then the peak conducted output power measured within any 100 kHz outside the authorized frequency band shall be attenuated by at least 20 dB relative to the maximum measured in-band peak PSD level.	

3.6.2 Measuring Instruments

Refer a test equipment and calibration data table in this test report.

3.6.3 Test Procedures

Test Method
<ul style="list-style-type: none"> Refer as ANSI C63.10-2013, clause 7.8.8 for unwanted emissions into non-restricted bands.

3.6.4 Test Setup

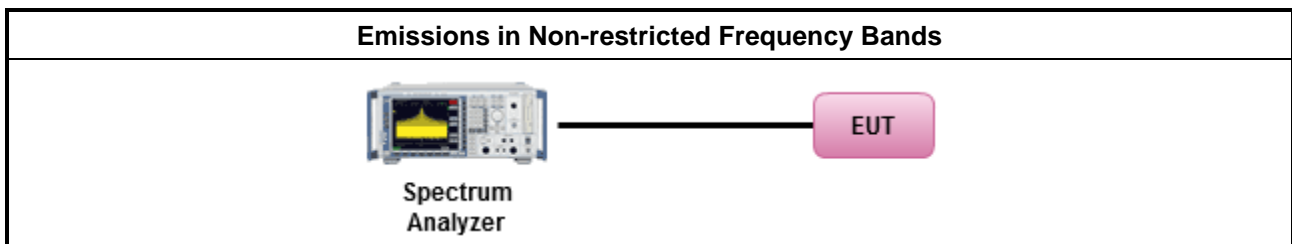

3.6.5 Test Result of Emissions in Non-restricted Frequency Bands

Refer as Appendix F



3.7 Emissions in Restricted Frequency Bands

3.7.1 Emissions in Restricted Frequency Bands Limit

Restricted Band Emissions Limit			
Frequency Range (MHz)	Field Strength (uV/m)	Field Strength (dBuV/m)	Measure Distance (m)
0.009~0.490	2400/F(kHz)	48.5 - 13.8	300
0.490~1.705	24000/F(kHz)	33.8 - 23	30
1.705~30.0	30	29	30
30~88	100	40	3
88~216	150	43.5	3
216~960	200	46	3
Above 960	500	54	3

Note 1: Test distance for frequencies at or above 30 MHz, measurements may be performed at a distance other than the limit distance provided they are not performed in the near field and the emissions to be measured can be detected by the measurement equipment. When performing measurements at a distance other than that specified, the results shall be extrapolated to the specified distance using an extrapolation factor of 20 dB/decade (inverse of linear distance for field-strength measurements, inverse of linear distance-squared for power-density measurements).

Note 2: Test distance for frequencies at below 30 MHz, measurements may be performed at a distance closer than the EUT limit distance; however, an attempt should be made to avoid making measurements in the near field. When performing measurements below 30 MHz at a closer distance than the limit distance, the results shall be extrapolated to the specified distance by either making measurements at a minimum of two or more distances on at least one radial to determine the proper extrapolation factor or by using the square of an inverse linear distance extrapolation factor (40 dB / decade). The test report shall specify the extrapolation method used to determine compliance of the EUT.

Note 3: Using the distance of 1m during the test for above 18 GHz, and the test value to correct for the distance factor at 3m.

3.7.2 Measuring Instruments

Refer a test equipment and calibration data table in this test report.

3.7.3 Test Procedures

Test Method				
<ul style="list-style-type: none"> The average emission levels shall be measured in [hopping duty factor]. 				
<ul style="list-style-type: none"> Refer as ANSI C63.10; clause 6.10.3 band-edge testing shall be performed at the lowest frequency channel and highest frequency channel within the allowed operating band. 				
<ul style="list-style-type: none"> For the transmitter unwanted emissions shall be measured using following options below: <table border="1" data-bbox="188 1776 1428 1912"> <tbody> <tr> <td> <ul style="list-style-type: none"> Refer as ANSI C63.10, clause 4.1.4.2.1 QP value. </td> </tr> <tr> <td> <ul style="list-style-type: none"> Refer as ANSI C63.10, clause 4.1.4.2.2 measurement procedure peak. </td> </tr> <tr> <td> <ul style="list-style-type: none"> Refer as ANSI C63.10, clause 4.1.4.2.4 average value of hopping pulsed emissions. </td> </tr> </tbody> </table> 		<ul style="list-style-type: none"> Refer as ANSI C63.10, clause 4.1.4.2.1 QP value. 	<ul style="list-style-type: none"> Refer as ANSI C63.10, clause 4.1.4.2.2 measurement procedure peak. 	<ul style="list-style-type: none"> Refer as ANSI C63.10, clause 4.1.4.2.4 average value of hopping pulsed emissions.
<ul style="list-style-type: none"> Refer as ANSI C63.10, clause 4.1.4.2.1 QP value. 				
<ul style="list-style-type: none"> Refer as ANSI C63.10, clause 4.1.4.2.2 measurement procedure peak. 				
<ul style="list-style-type: none"> Refer as ANSI C63.10, clause 4.1.4.2.4 average value of hopping pulsed emissions. 				

3.7.4 Test Setup

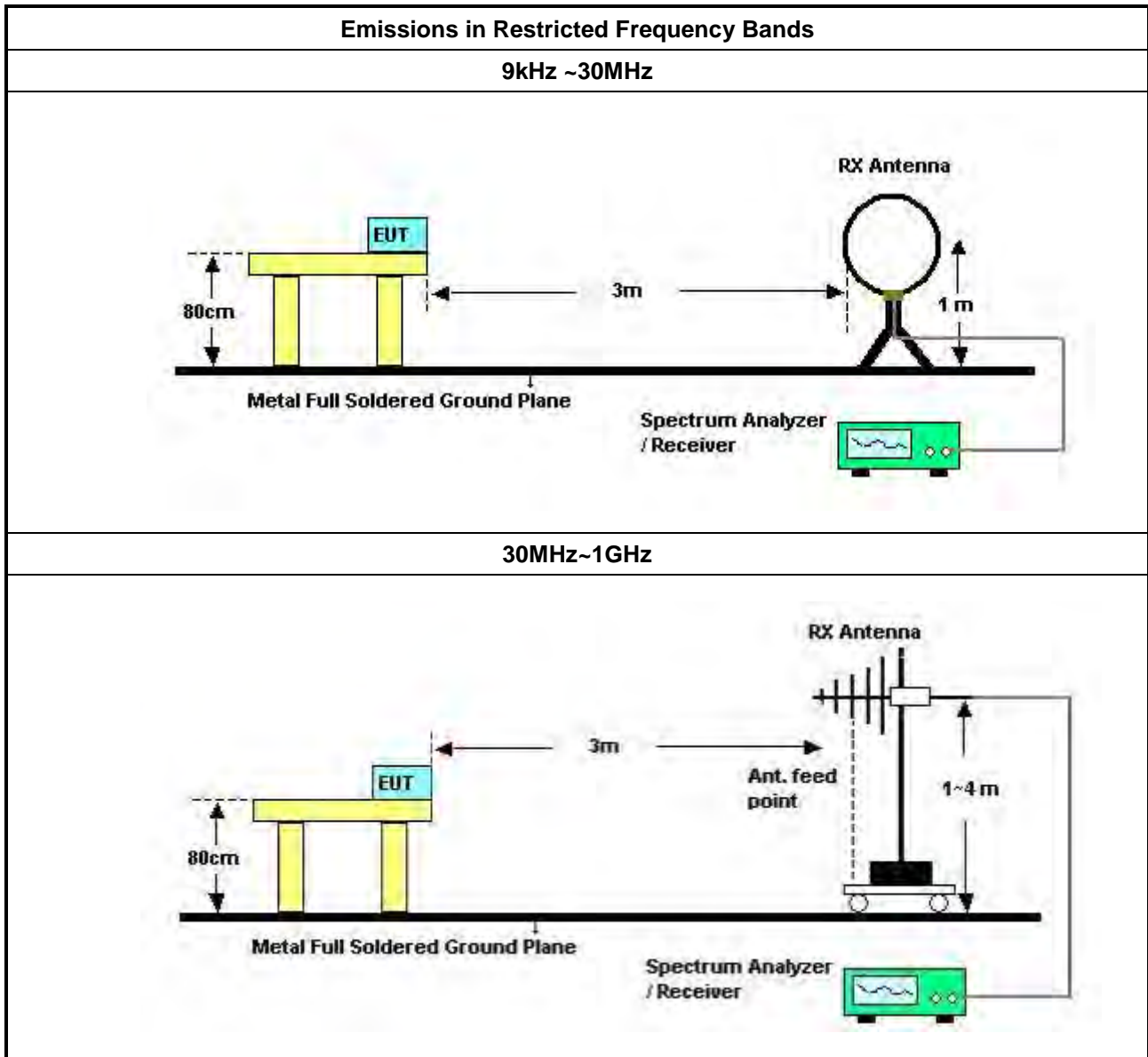

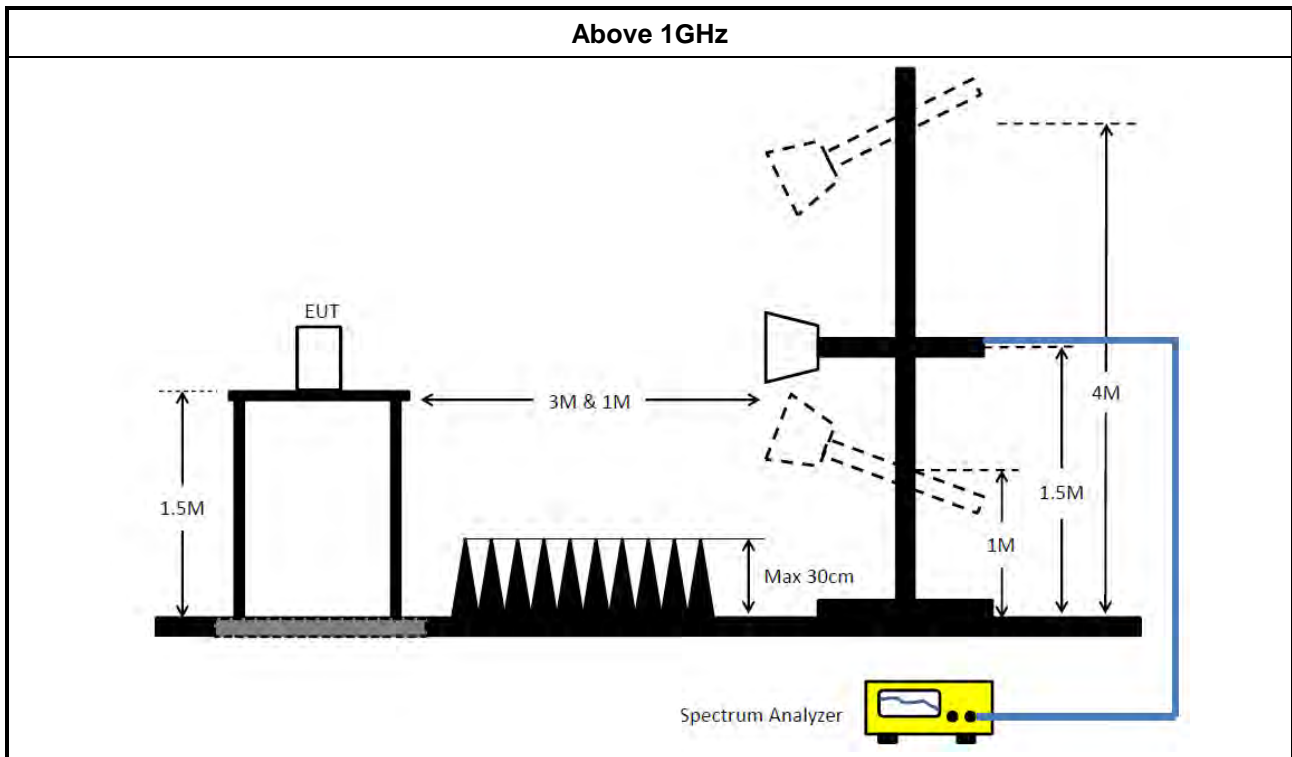

3.7.5 Measurement Results Calculation

The measured Level is calculated using:

Corrected Reading: Antenna factor (AF) + Cable loss (CL) + Read level (Raw) - Preamp factor (PA)(if applicable) = Level.

3.7.6 Emissions in Restricted Frequency Bands (Below 30MHz)

There is a comparison data of both open-field test site and alternative test site - semi-Anechoic chamber according to KDB414788 Radiated Test Site, and the result came out very similar.

All amplitude of spurious emissions that are attenuated by more than 20 dB below the permissible value has no need to be reported.

The radiated emissions were investigated from 9 kHz or the lowest frequency generated within the device, up to the 10th harmonic or 40 GHz, whichever is appropriate.

3.7.7 Test Result of Emissions in Restricted Frequency Bands

Refer as Appendix G



4 Test Equipment and Calibration Data

Instrument	Brand	Model No.	Serial No.	Characteristics	Calibration Date	Calibration Due Date	Remark
LISN	Schwarzbeck	NSLK 8127	8127650	9kHz ~ 30MHz	Jan. 07, 2022	Jan. 06, 2023	Conduction (CO02-CB)
LISN	Schwarzbeck	NSLK 8127	8127478	9kHz ~ 30MHz	Dec. 22, 2021	Dec. 21, 2022	Conduction (CO02-CB)
EMI Receiver	Agilent	N9038A	MY52260140	9kHz ~ 8.4GHz	May 06, 2022	May 05, 2023	Conduction (CO02-CB)
Pulse Limiter	Schwarzbeck	VTSD 9561F-N	00378	9kHz ~ 30MHz	Mar. 18, 2022	Mar. 17, 2023	Conduction (CO02-CB)
COND Cable	Woken	Cable	2	0.15MHz ~ 30MHz	Oct. 19, 2021	Oct. 18, 2022	Conduction (CO02-CB)
Software	SPORTON	SENSE	V5.10	-	N.C.R.	N.C.R.	Conduction (CO02-CB)
Loop Antenna	Teseq	HLA 6120	24155	9kHz - 30 MHz	May 14, 2022	May 13, 2023	Radiation (03CH05-CB)
3m Semi Anechoic Chamber NSA	TDK	SAC-3M	03CH05-CB	30 MHz ~ 1 GHz	Aug. 03, 2022	Aug. 02, 2023	Radiation (03CH05-CB)
3m Semi Anechoic Chamber VSWR	TDK	SAC-3M	03CH05-CB	1GHz ~18GHz 3m	Nov. 07, 2021	Nov. 06, 2022	Radiation (03CH05-CB)
Bilog Antenna with 6dB Attenuator	TESEQ & EMCI	CBL 6112D & N-6-06	35236 & AT-N0610	30MHz ~ 2GHz	Mar. 25, 2022	Mar. 24, 2023	Radiation (03CH05-CB)
Horn Antenna	SCHWARZBECK	BBHA9120D	BBHA 9120 D-1291	1GHz~18GHz	Jun. 23, 2022	Jun. 22, 2023	Radiation (03CH05-CB)
Horn Antenna	Schwarzbeck	BBHA 9170	BBHA9170252	15GHz ~ 40GHz	Aug. 22, 2022	Aug. 21, 2023	Radiation (03CH05-CB)
Pre-Amplifier	EMCI	EMC330N	980331	20MHz ~ 3GHz	Apr. 26, 2022	Apr. 25, 2023	Radiation (03CH05-CB)
Pre-Amplifier	EMCI	EMC12630SE	980287	1GHz ~ 26.5GHz	Jul. 01, 2022	Jun. 30, 2023	Radiation (03CH05-CB)
Pre-Amplifier	MITEQ	TTA1840-35-H G	1864479	18GHz ~ 40GHz	Jul. 20, 2022	Jul. 19, 2023	Radiation (03CH05-CB)
Spectrum Analyzer	R&S	FSP40	100304	9kHz ~ 40GHz	Mar. 14, 2022	Mar. 13, 2023	Radiation (03CH05-CB)
EMI Test Receiver	R&S	ESCS	826547/017	9kHz ~ 2.75GHz	Jun. 17, 2022	Jun. 16, 2023	Radiation (03CH05-CB)
RF Cable-low	Woken	RG402	Low Cable-04+23	30MHz~1GHz	Oct. 13, 2021	Oct. 12, 2022	Radiation (03CH05-CB)
RF Cable-high	Woken	RG402	High Cable-28	1GHz~18GHz	Oct. 13, 2021	Oct. 12, 2022	Radiation (03CH05-CB)
RF Cable-high	Woken	RG402	High Cable-04+28	1GHz~18GHz	Oct. 13, 2021	Oct. 12, 2022	Radiation (03CH05-CB)
High Cable	Woken	WCA0929M	40G#5+7	1GHz ~ 40 GHz	Dec. 14, 2021	Dec. 13, 2022	Radiation (03CH05-CB)



Instrument	Brand	Model No.	Serial No.	Characteristics	Calibration Date	Calibration Due Date	Remark
High Cable	Woken	WCA0929M	40G#5	1GHz ~ 40 GHz	Dec. 08, 2021	Dec. 07, 2022	Radiation (03CH05-CB)
High Cable	Woken	WCA0929M	40G#7	1GHz ~ 40 GHz	Dec. 14, 2021	Dec. 13, 2022	Radiation (03CH05-CB)
Test Software	SPORTON	SENSE	V5.10	-	N.C.R.	N.C.R.	Radiation (03CH05-CB)
3m Semi Anechoic Chamber VSWR	TDK	SAC-3M	03CH01-CB	1GHz ~18GHz 3m	May 06, 2022	May 05, 2023	Radiation (03CH01-CB)
Horn Antenna	ETS-LINDGREN	3115	00075790	750MHz ~ 18GHz	Nov. 06, 2021	Nov. 05, 2022	Radiation (03CH01-CB)
Horn Antenna	Schwarzbeck	BBHA 9170	BBHA9170252	15GHz ~ 40GHz	Aug. 22, 2022	Aug. 21, 2023	Radiation (03CH01-CB)
Pre-Amplifier	Agilent	8449B	3008A02121	1GHz ~ 26.5GHz	May 19, 2022	May 18, 2023	Radiation (03CH01-CB)
Pre-Amplifier	MITEQ	TTA1840-35-HG	1864479	18GHz ~ 40GHz	Jul. 20, 2022	Jul. 19, 2023	Radiation (03CH01-CB)
Spectrum Analyzer	R&S	FSP40	100056	9kHz ~ 40GHz	May 06, 2022	May 05, 2023	Radiation (03CH01-CB)
RF Cable-high	Woken	RG402	High Cable-16	1 GHz ~ 18 GHz	Oct. 04, 2021	Oct. 03, 2022	Radiation (03CH01-CB)
RF Cable-high	Woken	RG402	High Cable-16+17	1 GHz ~ 18 GHz	Oct. 04, 2021	Oct. 03, 2022	Radiation (03CH01-CB)
High Cable	Woken	WCA0929M	40G#5+7	1GHz ~ 40 GHz	Dec. 14, 2021	Dec. 13, 2022	Radiation (03CH01-CB)
High Cable	Woken	WCA0929M	40G#5	1GHz ~ 40 GHz	Dec. 08, 2021	Dec. 07, 2022	Radiation (03CH01-CB)
High Cable	Woken	WCA0929M	40G#7	1GHz ~ 40 GHz	Dec. 14, 2021	Dec. 13, 2022	Radiation (03CH01-CB)
Test Software	SPORTON	SENSE	V5.10	-	N.C.R.	N.C.R.	Radiation (03CH01-CB)
3m Semi Anechoic Chamber VSWR	TDK	SAC-3M	03CH04-CB	1GHz ~18GHz 3m	Feb. 24, 2022	Feb. 23, 2023	Radiation (03CH04-CB)
Horn Antenna	ETS · Lindgren	3115	00143147	750MHz~18GHz	Oct. 25, 2021	Oct. 24, 2022	Radiation (03CH04-CB)
Horn Antenna	Schwarzbeck	BBHA 9170	BBHA9170252	15GHz ~ 40GHz	Aug. 22, 2022	Aug. 21, 2023	Radiation (03CH04-CB)
Pre-Amplifier	Agilent	83017A	MY53270063	0.5GHz ~ 26.5GHz	Jul. 01, 2022	Jun. 30, 2023	Radiation (03CH04-CB)
Pre-Amplifier	MITEQ	TTA1840-35-HG	1864479	18GHz ~ 40GHz	Jul. 20, 2022	Jul. 19, 2023	Radiation (03CH04-CB)
Spectrum Analyzer	R&S	FSP40	100142	9kHz~40GHz	Mar. 28, 2022	Mar. 27, 2023	Radiation (03CH04-CB)
RF Cable-high	Woken	RG402	High Cable-21	1GHz - 18GHz	Oct. 04, 2021	Oct. 03, 2022	Radiation (03CH04-CB)



Instrument	Brand	Model No.	Serial No.	Characteristics	Calibration Date	Calibration Due Date	Remark
RF Cable-high	Woken	RG402	High Cable-21+67	1GHz - 18GHz	Oct. 04, 2021	Oct. 03, 2022	Radiation (03CH04-CB)
High Cable	Woken	WCA0929M	40G#5+7	1GHz ~ 40 GHz	Dec. 14, 2021	Dec. 13, 2022	Radiation (03CH04-CB)
High Cable	Woken	WCA0929M	40G#5	1GHz ~ 40 GHz	Dec. 08, 2021	Dec. 07, 2022	Radiation (03CH04-CB)
High Cable	Woken	WCA0929M	40G#7	1GHz ~ 40 GHz	Dec. 14, 2021	Dec. 13, 2022	Radiation (03CH04-CB)
Test Software	SPORTON	SENSE	V5.10	-	N.C.R.	N.C.R.	Radiation (03CH04-CB)
Spectrum analyzer	R&S	FSV40	101028	9kHz~40GHz	Jan. 07, 2022	Jan. 06, 2023	Conducted (TH03-CB)
Power Sensor	Anritsu	MA2411B	1531344	300MHz~40GHz	Jul. 31, 2022	Jul. 30, 2023	Conducted (TH03-CB)
Power Meter	Anritsu	ML2495A	1728002	300MHz~40GHz	Jul. 31, 2022	Jul. 30, 2023	Conducted (TH03-CB)
RF Cable-high	Woken	RG402	High Cable-11	1 GHz –18 GHz	Oct. 04, 2021	Oct. 03, 2022	Conducted (TH03-CB)
RF Cable-high	Woken	RG402	High Cable-12	1 GHz –18 GHz	Oct. 04, 2021	Oct. 03, 2022	Conducted (TH03-CB)
RF Cable-high	Woken	RG402	High Cable-13	1 GHz –18 GHz	Oct. 04, 2021	Oct. 03, 2022	Conducted (TH03-CB)
RF Cable-high	Woken	RG402	High Cable-14	1 GHz –18 GHz	Oct. 04, 2021	Oct. 03, 2022	Conducted (TH03-CB)
RF Cable-high	Woken	RG402	High Cable-15	1 GHz –18 GHz	Oct. 04, 2021	Oct. 03, 2022	Conducted (TH03-CB)
Switch	SPTCB	SP-SWI	SWI-03	1 GHz –26.5 GHz	Dec. 13, 2021	Dec. 12, 2022	Conducted (TH03-CB)
RF Cable-high	Woken	RG402	SWI-03-P1	1 GHz –26.5 GHz	Dec. 13, 2021	Dec. 12, 2022	Conducted (TH03-CB)
RF Cable-high	Woken	RG402	SWI-03-P2	1 GHz –26.5 GHz	Dec. 13, 2021	Dec. 12, 2022	Conducted (TH03-CB)
RF Cable-high	Woken	RG402	SWI-03-P3	1 GHz –26.5 GHz	Dec. 13, 2021	Dec. 12, 2022	Conducted (TH03-CB)
RF Cable-high	Woken	RG402	SWI-03-P4	1 GHz –26.5 GHz	Dec. 13, 2021	Dec. 12, 2022	Conducted (TH03-CB)
RF Cable-high	Woken	RG402	SWI-03-P5	1 GHz –26.5 GHz	Dec. 13, 2021	Dec. 12, 2022	Conducted (TH03-CB)
Test Software	SPORTON	SENSE	V5.10	-	N.C.R.	N.C.R.	Conducted (TH03-CB)

Note: Calibration Interval of instruments listed above is one year.

N.C.R. means Non-Calibration required.



Summary

Mode	Result	Type	Freq (Hz)	Level (dBuV)	Limit (dBuV)	Margin (dB)	Condition
Mode 2	Pass	QP	154.5k	58.02	65.75	-7.73	Line

Mode 2

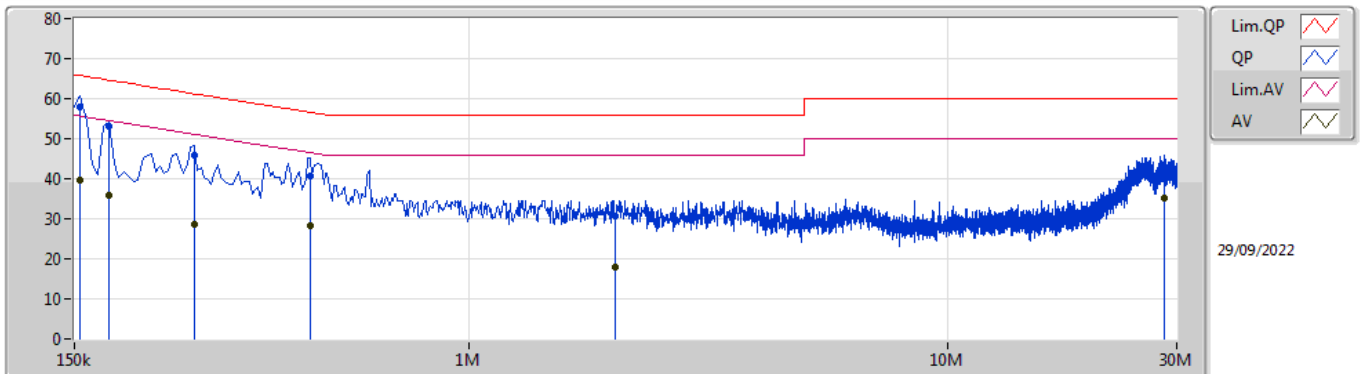

Type	Freq (Hz)	Level (dBuV)	Limit (dBuV)	Margin (dB)	Factor (dB)	Condition	Comment	Raw (dBuV)	LISN (dB)	CL (dB)	AT (dB)
QP	154.5k	58.02	65.75	-7.73	10.24	Line	"Worst"	47.78	0.12	0.02	10.10
AV	154.5k	39.67	55.75	-16.08	10.24	Line	-	29.43	0.12	0.02	10.10
QP	177k	53.12	64.62	-11.50	10.22	Line	-	42.90	0.12	0.02	10.08
AV	177k	35.98	54.62	-18.64	10.22	Line	-	25.76	0.12	0.02	10.08
QP	267k	45.81	61.20	-15.39	10.22	Line	-	35.59	0.12	0.02	10.08
AV	267k	28.78	51.20	-22.42	10.22	Line	-	18.56	0.12	0.02	10.08
QP	465k	40.60	56.61	-16.01	10.25	Line	-	30.35	0.12	0.02	10.11
AV	465k	28.21	46.61	-18.40	10.25	Line	-	17.96	0.12	0.02	10.11
QP	2.018M	30.67	56.00	-25.33	10.37	Line	-	20.30	0.17	0.05	10.15
AV	2.018M	17.89	46.00	-28.11	10.37	Line	-	7.52	0.17	0.05	10.15
QP	28.266M	41.71	60.00	-18.29	10.87	Line	-	30.84	0.41	0.23	10.23
AV	28.266M	35.21	50.00	-14.79	10.87	Line	-	24.34	0.41	0.23	10.23

Mode 2

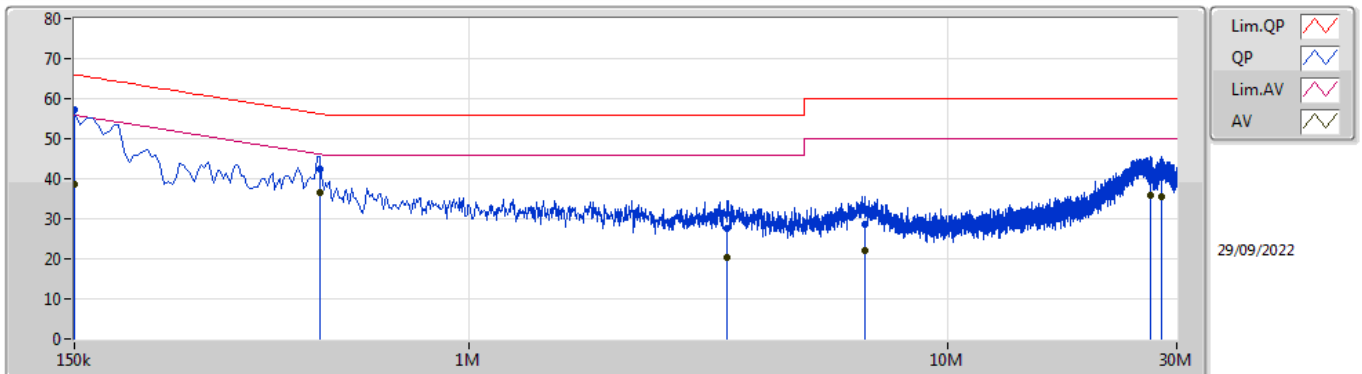

Type	Freq (Hz)	Level (dBuV)	Limit (dBuV)	Margin (dB)	Factor (dB)	Condition	Comment	Raw (dBuV)	LISN (dB)	CL (dB)	AT (dB)
QP	150k	57.25	66.00	-8.75	10.29	Neutral	"Worst"	46.96	0.16	0.02	10.11
AV	150k	38.74	56.00	-17.26	10.29	Neutral	-	28.45	0.16	0.02	10.11
QP	487.5k	42.53	56.21	-13.68	10.30	Neutral	-	32.23	0.16	0.02	10.12
AV	487.5k	36.61	46.21	-9.60	10.30	Neutral	-	26.31	0.16	0.02	10.12
QP	3.462M	27.55	56.00	-28.45	10.46	Neutral	-	17.09	0.21	0.07	10.18
AV	3.462M	20.49	46.00	-25.51	10.46	Neutral	-	10.03	0.21	0.07	10.18
QP	6.707M	28.69	60.00	-31.31	10.52	Neutral	-	18.17	0.26	0.07	10.19
AV	6.707M	22.15	50.00	-27.85	10.52	Neutral	-	11.63	0.26	0.07	10.19
QP	26.48M	42.06	60.00	-17.94	10.80	Neutral	-	31.26	0.36	0.21	10.23
AV	26.48M	35.76	50.00	-14.24	10.80	Neutral	-	24.96	0.36	0.21	10.23
QP	27.951M	41.81	60.00	-18.19	10.82	Neutral	-	30.99	0.37	0.22	10.23
AV	27.951M	35.45	50.00	-14.55	10.82	Neutral	-	24.63	0.37	0.22	10.23



Summary

Mode	Max-N dB (Hz)	Max-OBW (Hz)	ITU-Code	Min-N dB (Hz)	Min-OBW (Hz)
2.4-2.4835GHz	-	-	-	-	-
BT-BR(1Mbps)	880k	854.088k	854KF1D	880k	848.693k
BT-EDR(2Mbps)	1.256M	1.194M	1M19G1D	1.254M	1.188M
BT-EDR(3Mbps)	1.258M	1.2M	1M20G1D	1.255M	1.189M

Max-N dB = Maximum 20dB down bandwidth; Max-OBW = Maximum 99% occupied bandwidth;
Min-N dB = Minimum 20dB down bandwidth; Min-OBW = Minimum 99% occupied bandwidth

Result

Mode	Result	Limit (Hz)	Port 1-N dB (Hz)	Port 1-OBW (Hz)	Port 2-N dB (Hz)	Port 2-OBW (Hz)
BT-BR(1Mbps)	-	-	-	-	-	-
2402MHz	Pass	Inf			880k	854.088k
2440MHz	Pass	Inf			880k	852.064k
2480MHz	Pass	Inf			880k	848.693k
BT-EDR(2Mbps)	-	-	-	-	-	-
2402MHz	Pass	Inf			1.255M	1.189M
2440MHz	Pass	Inf			1.254M	1.188M
2480MHz	Pass	Inf			1.256M	1.194M
BT-EDR(3Mbps)	-	-	-	-	-	-
2402MHz	Pass	Inf			1.256M	1.198M
2440MHz	Pass	Inf			1.255M	1.189M
2480MHz	Pass	Inf			1.258M	1.2M

Port X-N dB = Port X 20dB down bandwidth;
 Port X-OBW = Port X 99% occupied bandwidth

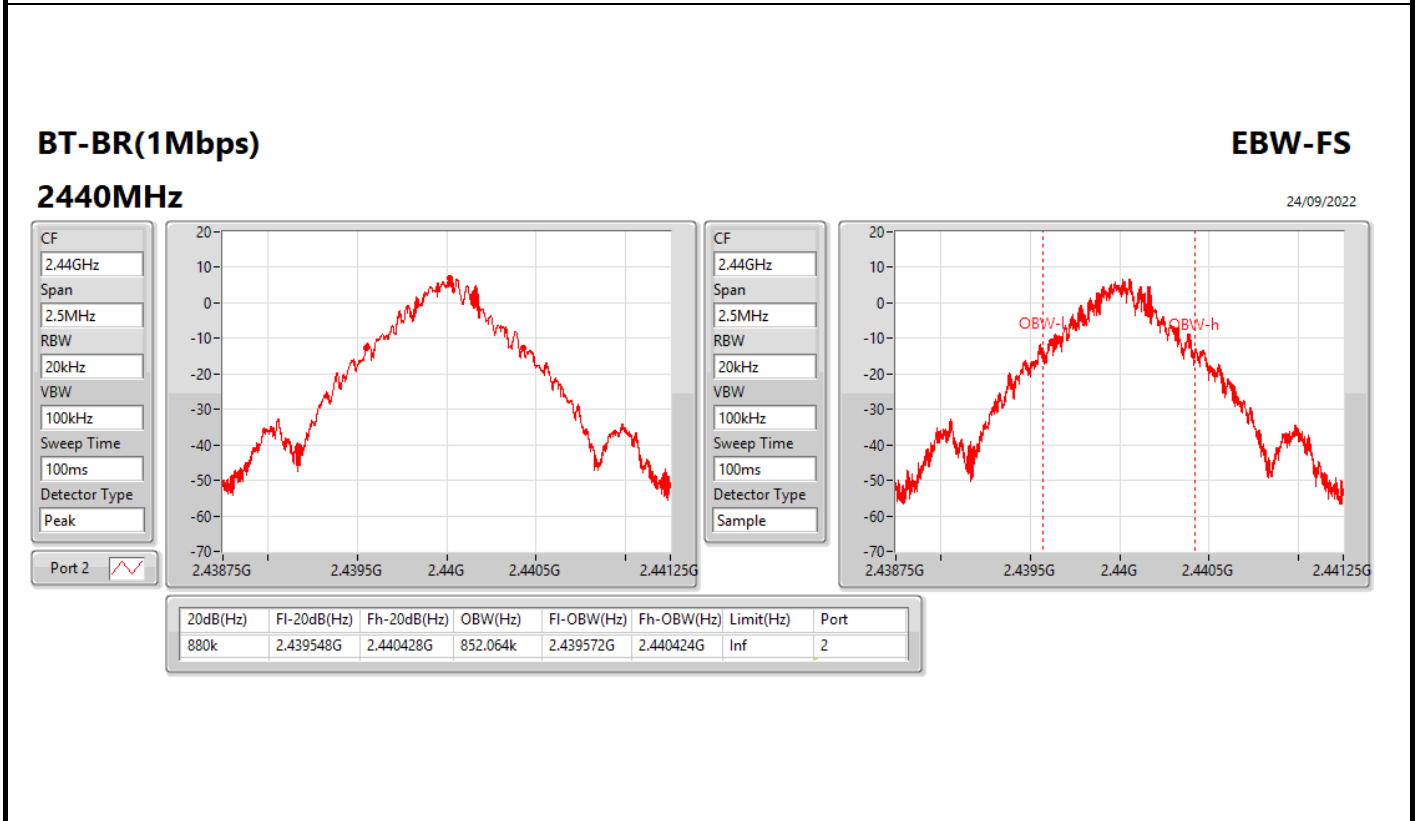
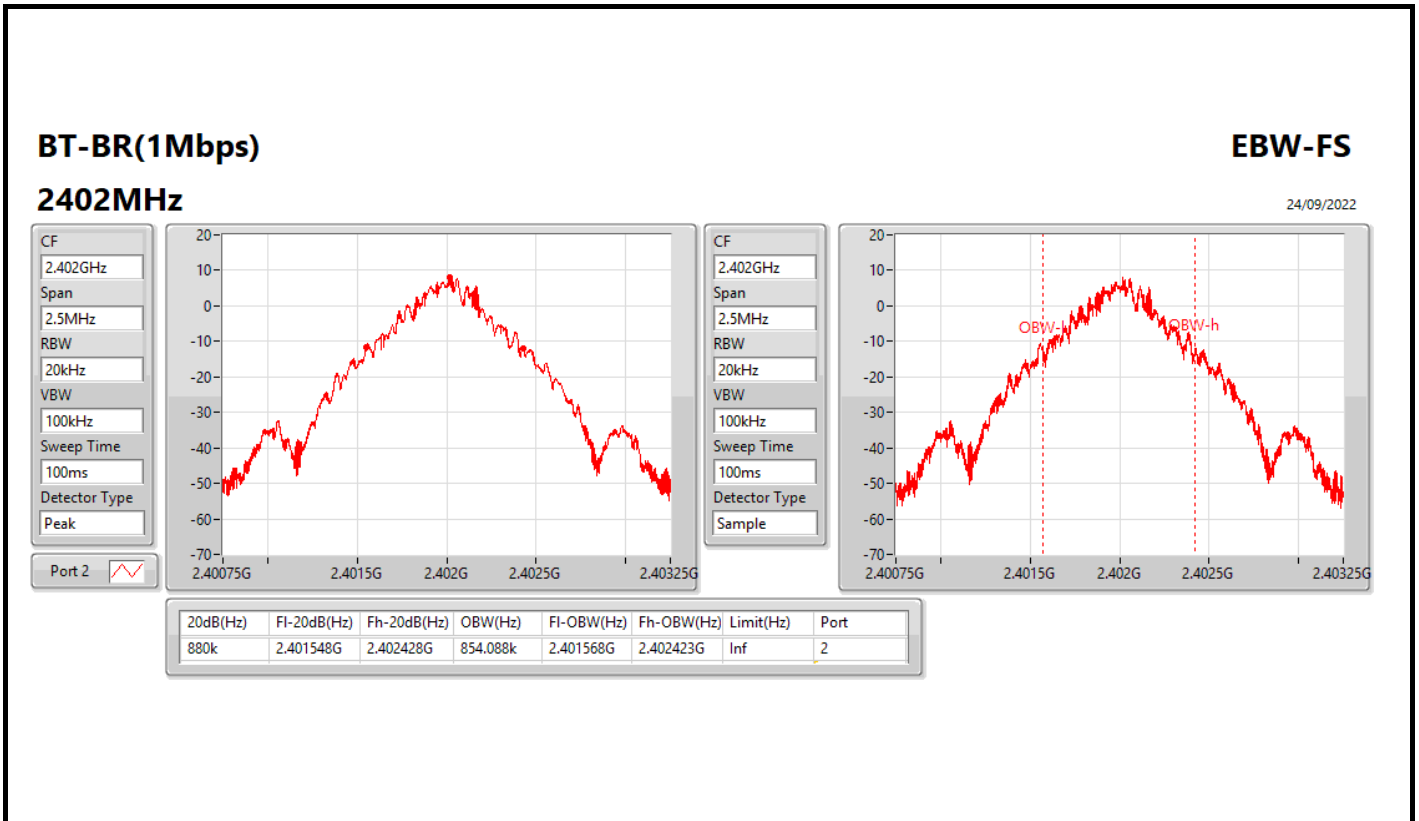

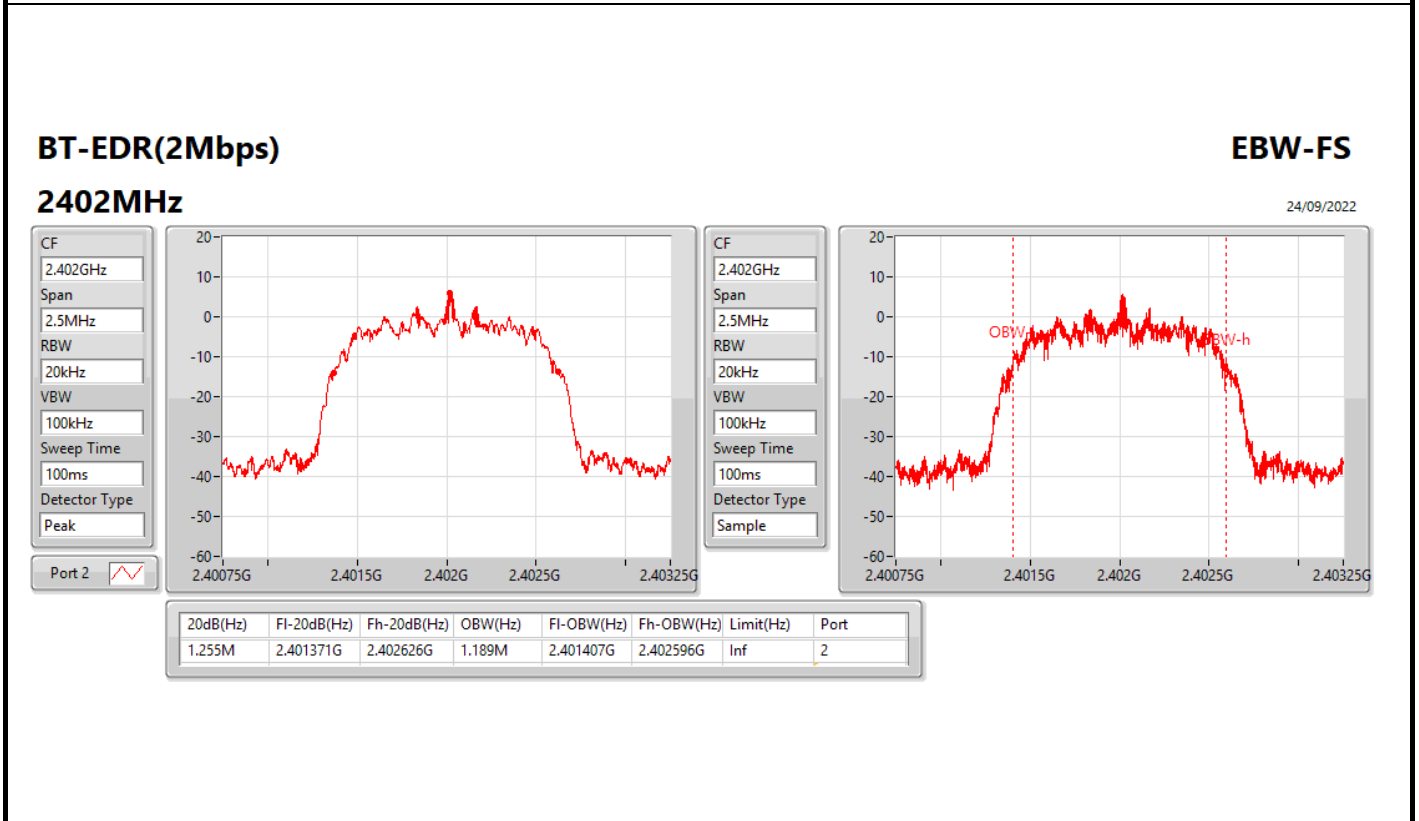
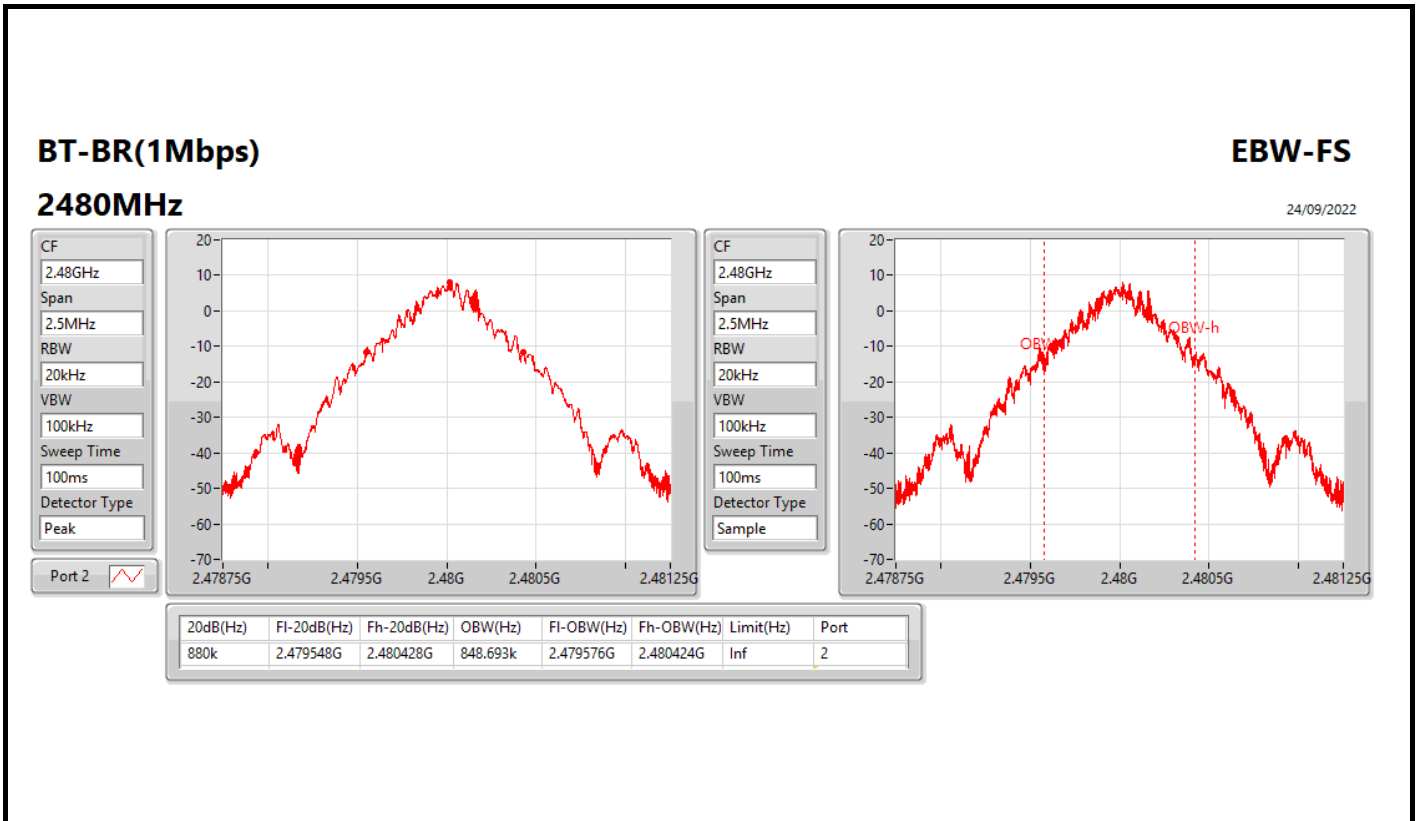

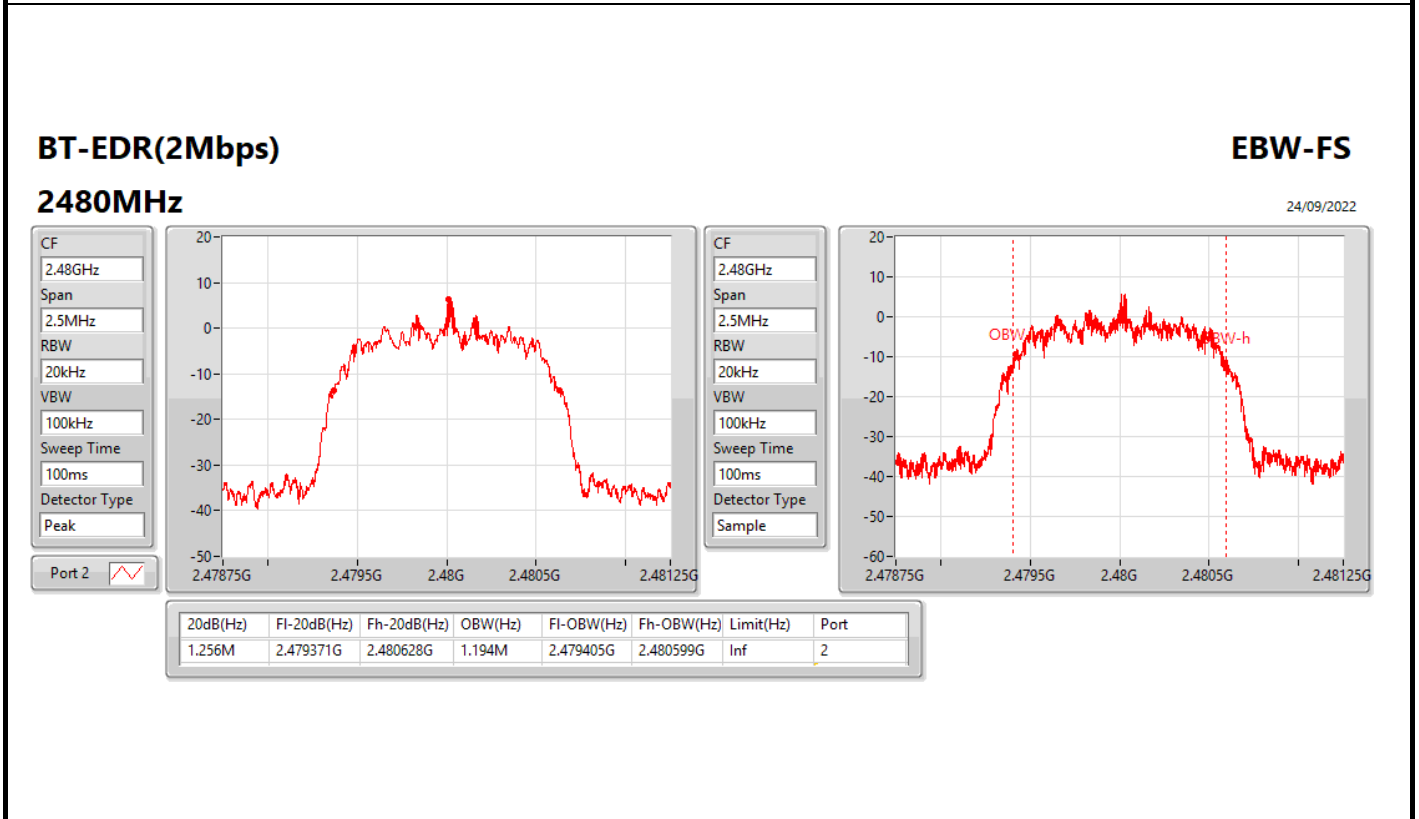
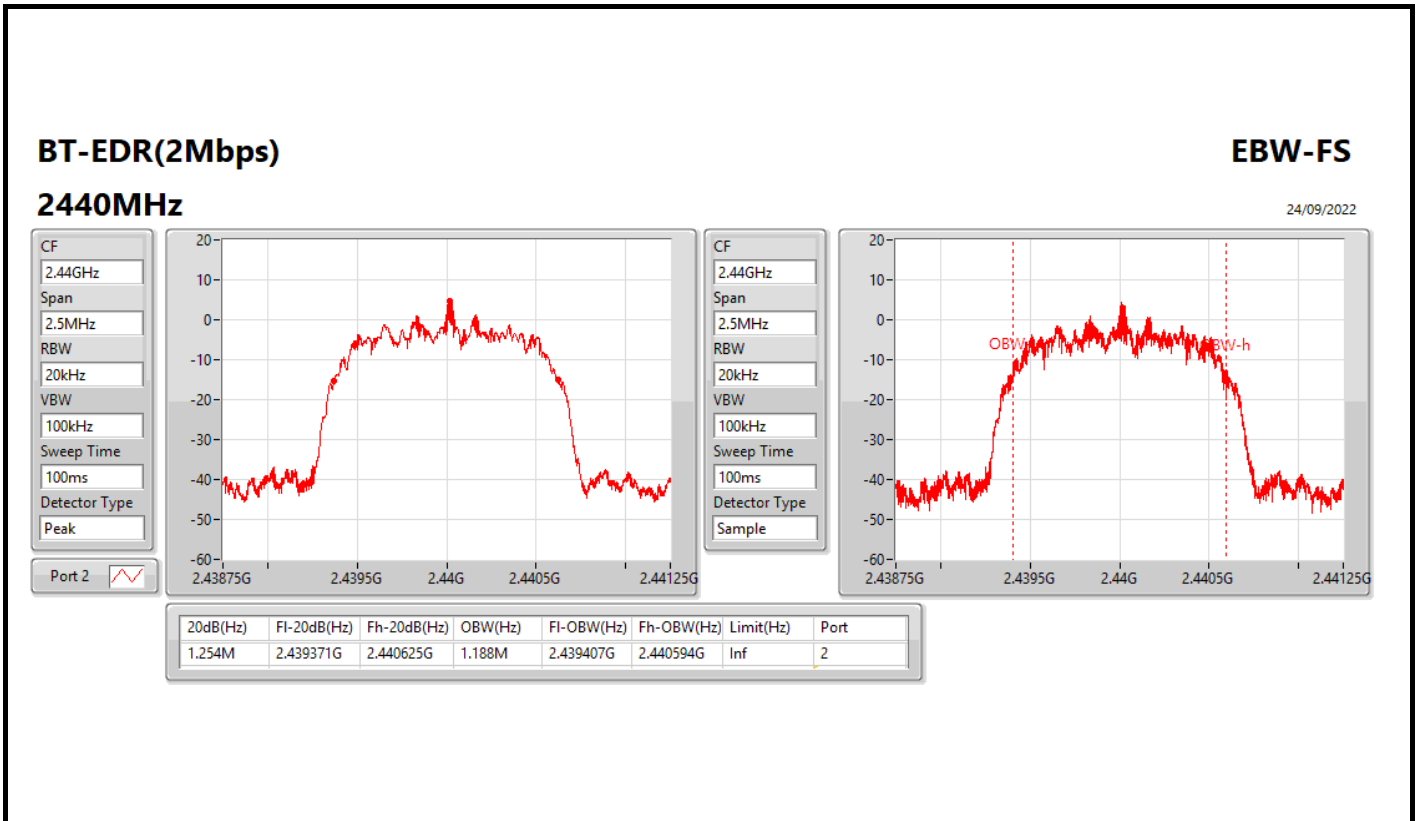

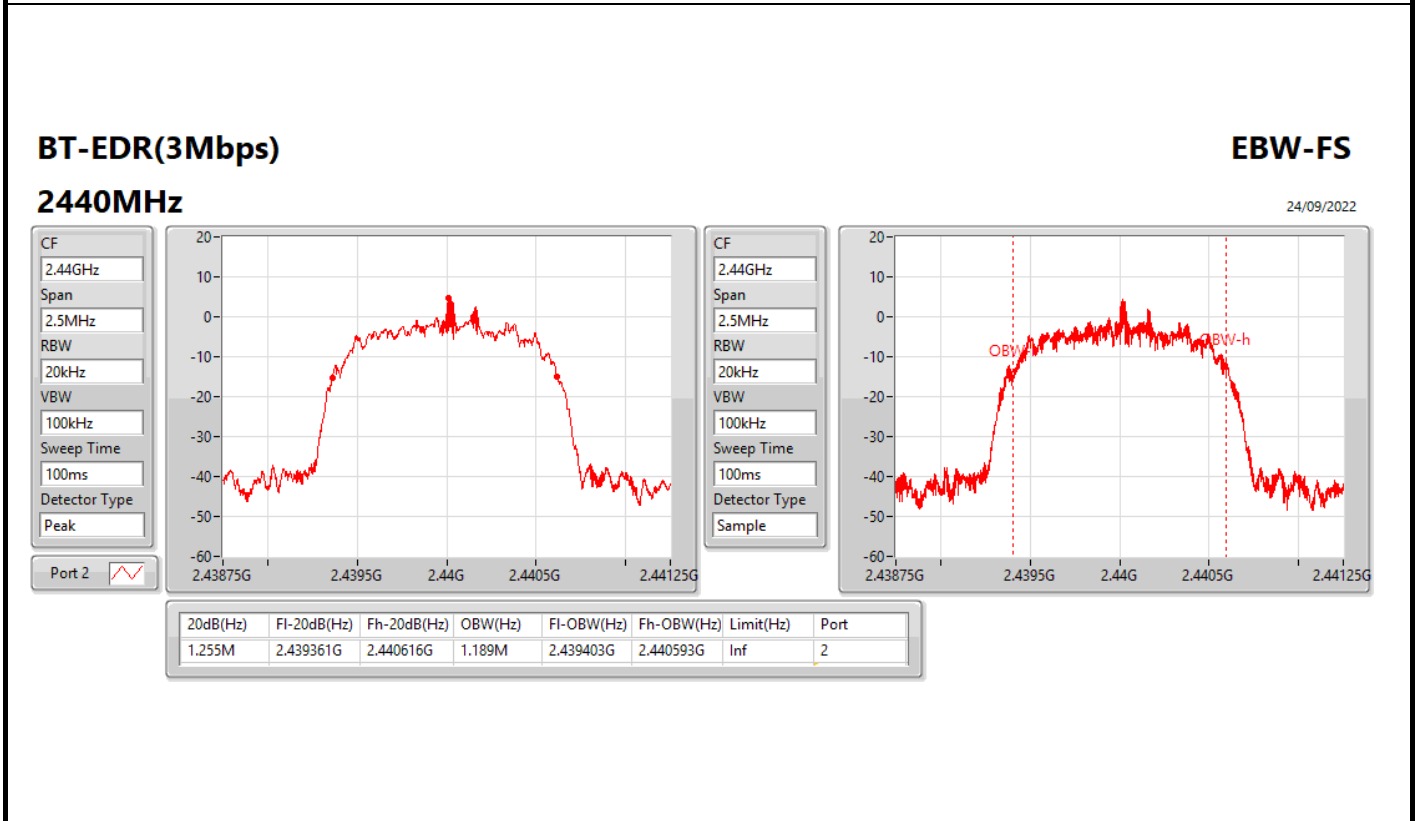
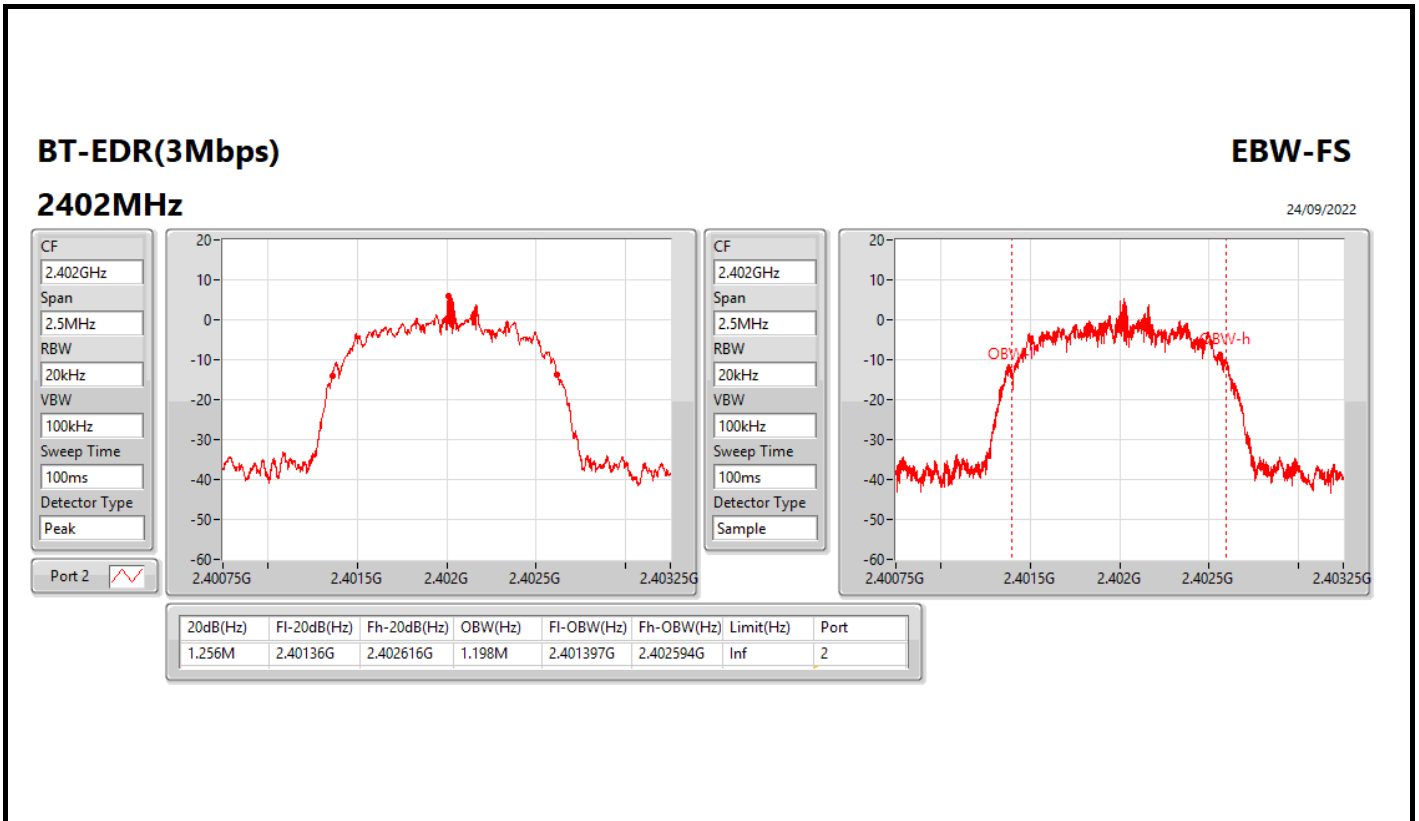

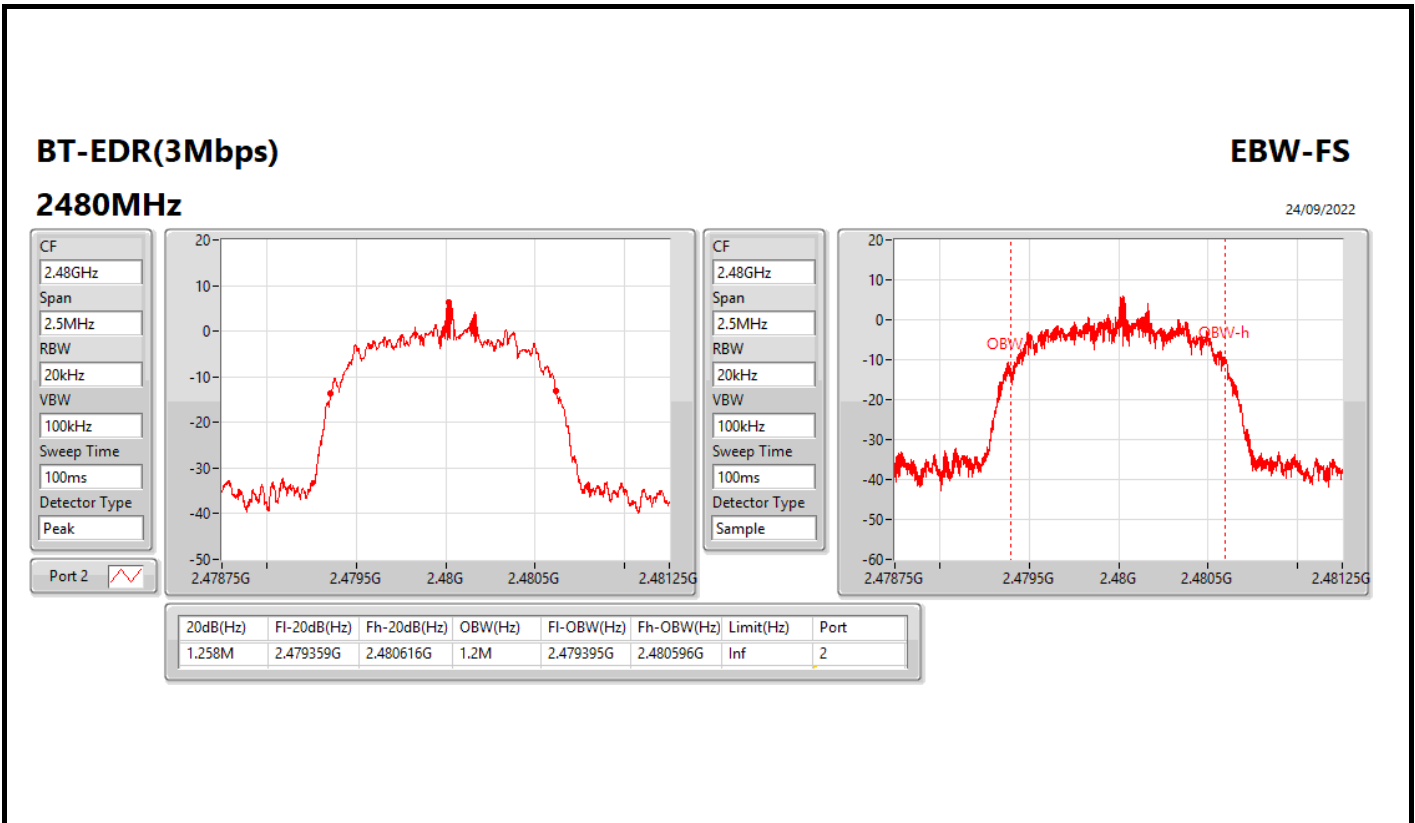



Summary

Mode	Max-Space (Hz)	Min-Space (Hz)
2.4-2.4835GHz	-	-
BT-BR(1Mbps)	1.002M	999k
BT-EDR(2Mbps)	1.002M	999k
BT-EDR(3Mbps)	1.0005M	1.0005M



Result

Mode	Result	Fl (Hz)	Fh (Hz)	Ch.Space (Hz)	Limit (Hz)
BT-BR(1Mbps)	-	-	-	-	-
2402MHz	Pass	2.402014G	2.403016G	1.002M	586.08k
2440MHz	Pass	2.440014G	2.441015G	1.0005M	586.08k
2480MHz	Pass	2.479014G	2.480013G	999k	586.08k
BT-EDR(2Mbps)	-	-	-	-	-
2402MHz	Pass	2.402013G	2.403015G	1.002M	835.83k
2440MHz	Pass	2.440016G	2.441015G	999k	835.164k
2480MHz	Pass	2.479014G	2.480013G	999k	586.08k
BT-EDR(3Mbps)	-	-	-	-	-
2402MHz	Pass	2.402014G	2.403015G	1.0005M	836.496k
2440MHz	Pass	2.440014G	2.441015G	1.0005M	835.83k
2480MHz	Pass	2.479014G	2.480015G	1.0005M	837.828k

BT-BR(1Mbps)

Channel Separation-FS

2.402G/2.403GHz

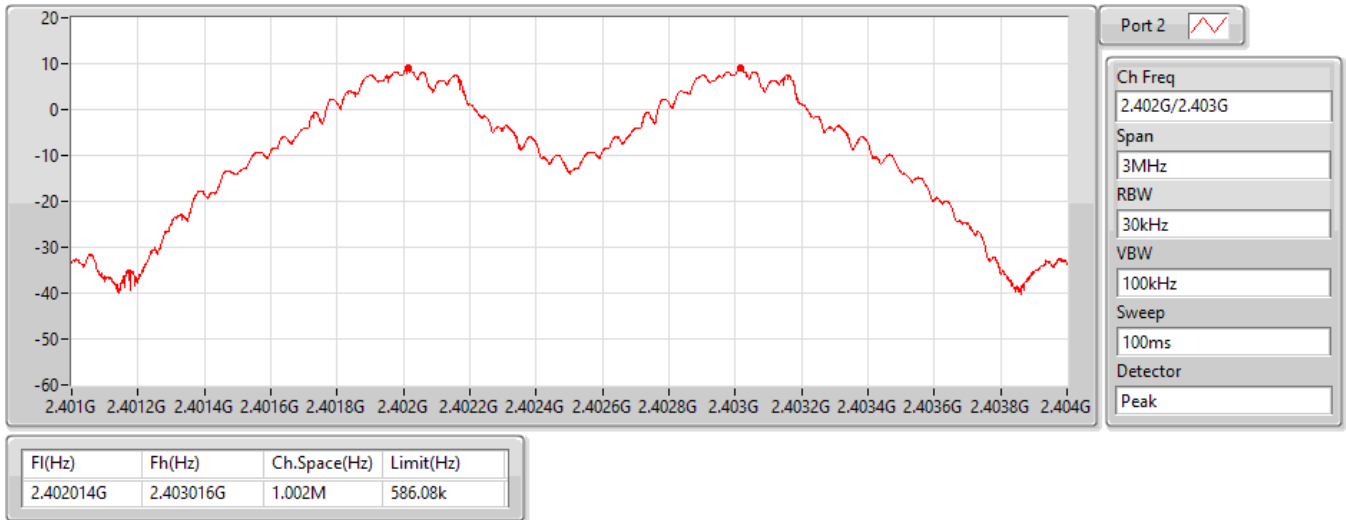

BT-BR(1Mbps)

Channel Separation-FS

2.44G/2.441GHz

24/09/2022

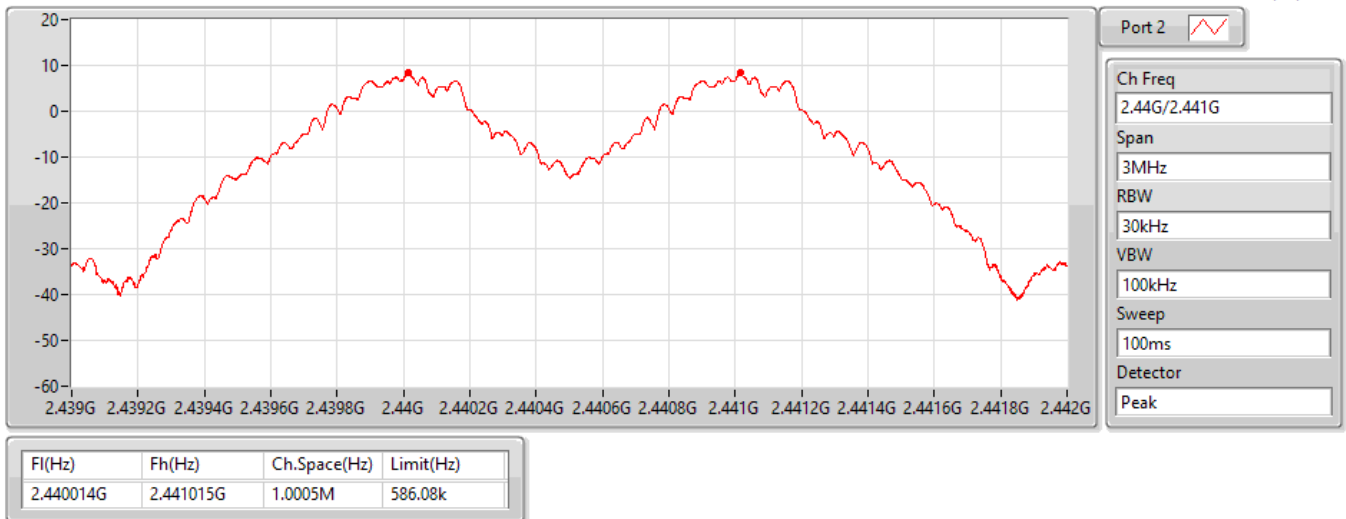



BT-BR(1Mbps)

2.48G/2.479GHz

Channel Separation-FS

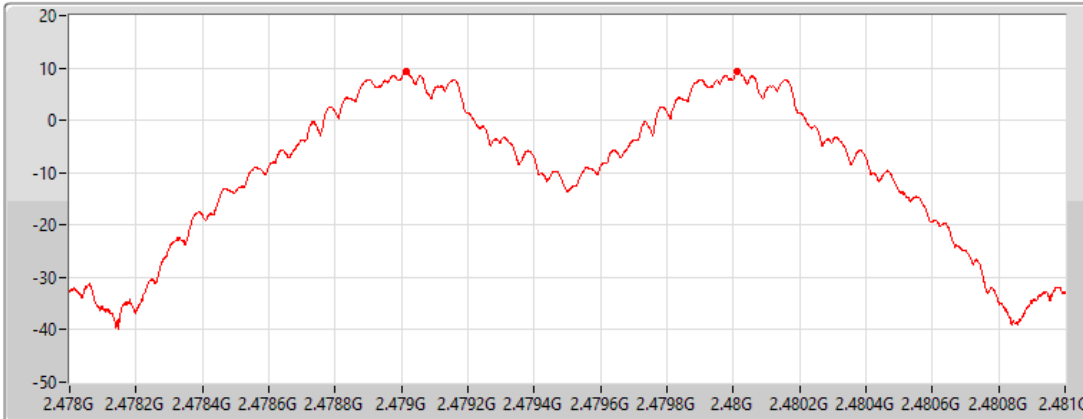
24/09/2022



Port 2 

Ch Freq
2.48G/2.479G

Span
3MHz

RBW
30kHz

VBW
100kHz

Sweep
100ms

Detector
Peak

Fl(Hz)	Fh(Hz)	Ch.Space(Hz)	Limit(Hz)
2.479014G	2.480013G	999k	586.08k

BT-EDR(2Mbps)

2.402G/2.403GHz

Channel Separation-FS

24/09/2022

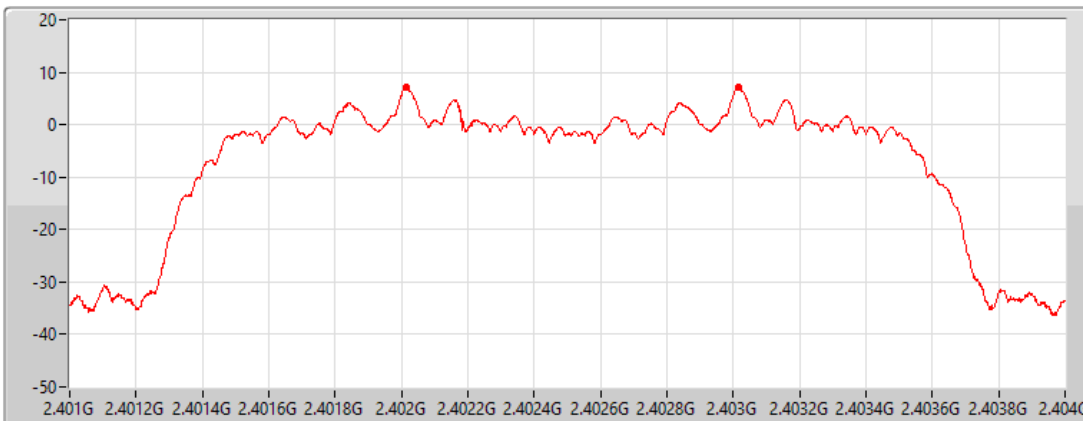

Port 2 

Ch Freq
2.402G/2.403G

Span
3MHz

RBW
30kHz

VBW
100kHz

Sweep
100ms

Detector
Peak

Fl(Hz)	Fh(Hz)	Ch.Space(Hz)	Limit(Hz)
2.402013G	2.403015G	1.002M	835.83k

BT-EDR(2Mbps)

Channel Separation-FS

2.44G/2.441GHz

24/09/2022

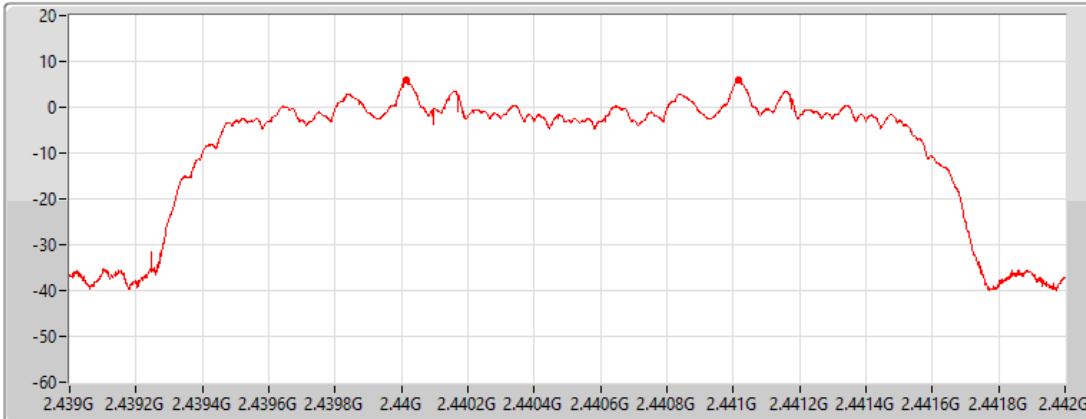

Port 2 

Ch Freq
2.44G/2.441G

Span
3MHz

RBW
30kHz

VBW
100kHz

Sweep
100ms

Detector
Peak

F1(Hz)	Fh(Hz)	Ch.Space(Hz)	Limit(Hz)
2.440016G	2.441015G	999k	835.164k

BT-EDR(2Mbps)

Channel Separation-FS

2.48G/2.479GHz

24/09/2022



Port 2 

Ch Freq
2.48G/2.479G

Span
3MHz

RBW
30kHz

VBW
100kHz

Sweep
100ms

Detector
Peak

F1(Hz)	Fh(Hz)	Ch.Space(Hz)	Limit(Hz)
2.479014G	2.480013G	999k	586.08k

BT-EDR(3Mbps)

Channel Separation-FS

2.402G/2.403GHz

24/09/2022



Port 2 

Ch Freq
2.402G/2.403G

Span
3MHz

RBW
30kHz

VBW
100kHz

Sweep
100ms

Detector
Peak

Fl(Hz)	Fh(Hz)	Ch.Space(Hz)	Limit(Hz)
2.402014G	2.403015G	1.0005M	836.496k

BT-EDR(3Mbps)

Channel Separation-FS

2.44G/2.441GHz

24/09/2022

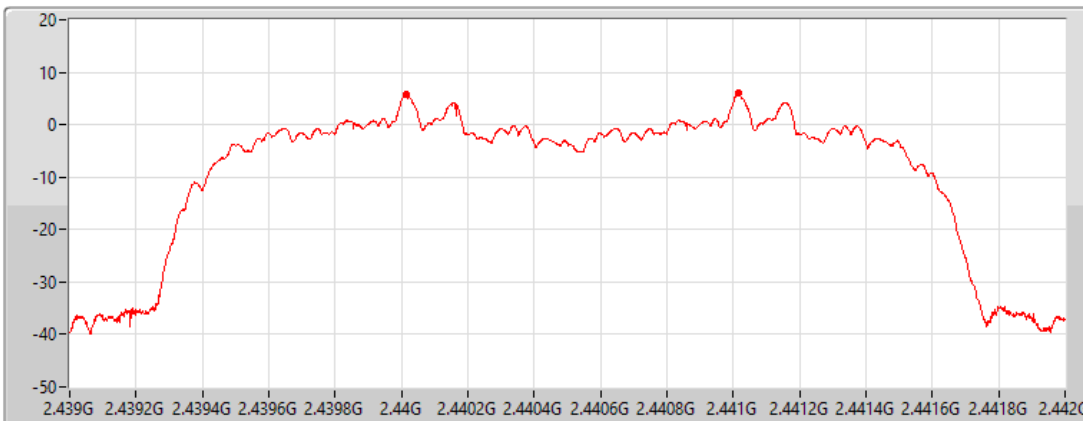

Port 2 

Ch Freq
2.44G/2.441G

Span
3MHz

RBW
30kHz

VBW
100kHz

Sweep
100ms

Detector
Peak

Fl(Hz)	Fh(Hz)	Ch.Space(Hz)	Limit(Hz)
2.440014G	2.441015G	1.0005M	835.83k

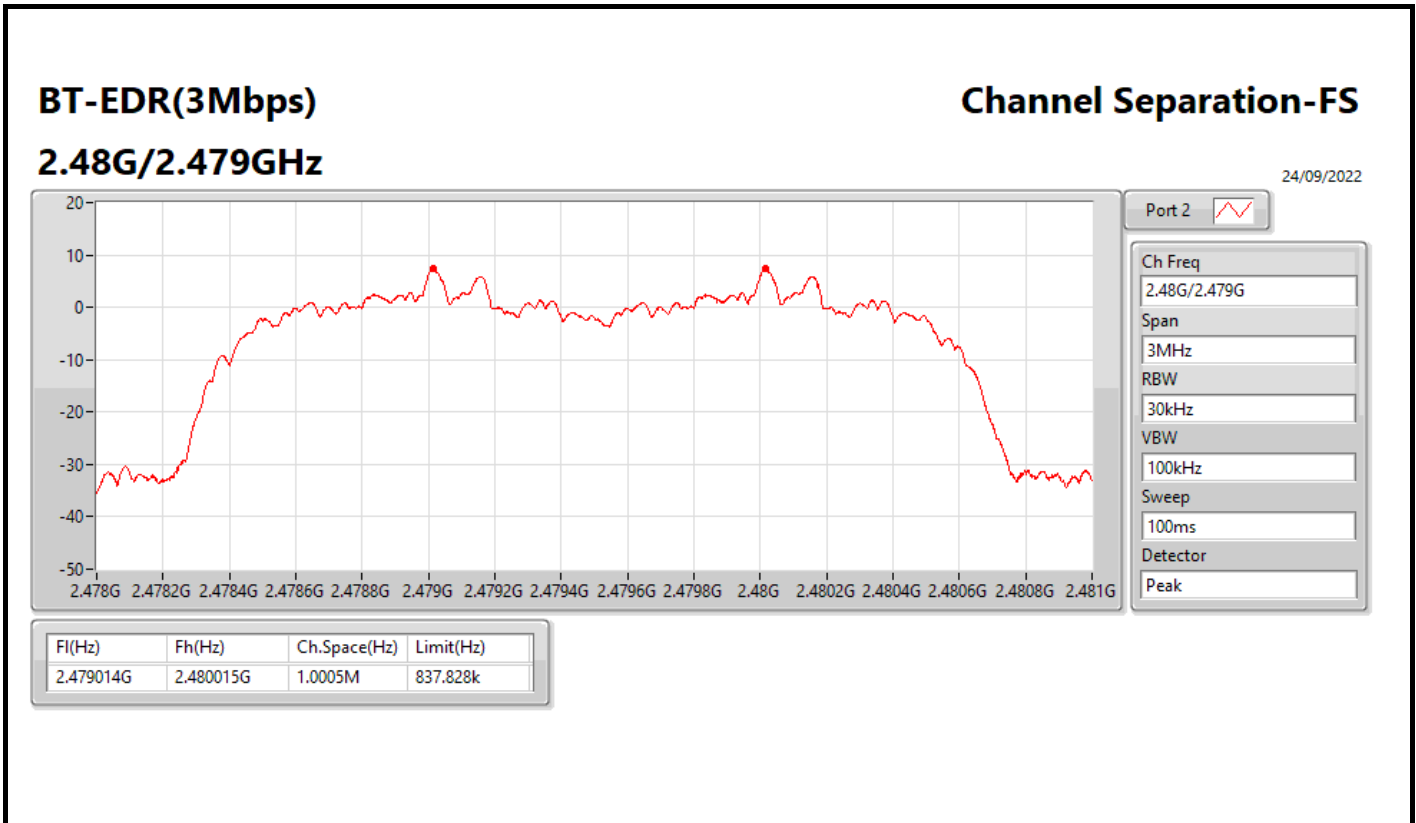



Summary

Mode	Power (dBm)	Power (W)
2.4-2.4835GHz	-	-
BT-BR(1Mbps)	11.48	0.01406
BT-EDR(2Mbps)	8.96	0.00787
BT-EDR(3Mbps)	8.94	0.00783



Result

Mode	Result	Gain (dBi)	Power (dBm)	Power Limit (dBm)
BT-BR(1Mbps)	-	-	-	-
2402MHz	Pass	2.54	11.48	21.00
2440MHz	Pass	2.54	10.53	21.00
2480MHz	Pass	2.54	7.53	21.00
BT-EDR(2Mbps)	-	-	-	-
2402MHz	Pass	2.54	8.96	21.00
2440MHz	Pass	2.54	7.60	21.00
2480MHz	Pass	2.54	4.15	21.00
BT-EDR(3Mbps)	-	-	-	-
2402MHz	Pass	2.54	8.94	21.00
2440MHz	Pass	2.54	7.59	21.00
2480MHz	Pass	2.54	4.13	21.00

DG = Directional Gain; Port X = Port X output power



Summary

Mode	Power (dBm)	Power (W)
2.4-2.4835GHz	-	-
BT-BR(1Mbps)	11.23	0.01327
BT-EDR(2Mbps)	10.71	0.01178
BT-EDR(3Mbps)	10.87	0.01222



Result

Mode	Result	Gain (dBi)	Power (dBm)	Power Limit (dBm)
BT-BR(1Mbps)	-	-	-	-
2402MHz	Pass	2.54	11.23	21.00
2440MHz	Pass	2.54	10.35	21.00
2480MHz	Pass	2.54	7.39	21.00
BT-EDR(2Mbps)	-	-	-	-
2402MHz	Pass	2.54	10.71	21.00
2440MHz	Pass	2.54	9.66	21.00
2480MHz	Pass	2.54	6.56	21.00
BT-EDR(3Mbps)	-	-	-	-
2402MHz	Pass	2.54	10.87	21.00
2440MHz	Pass	2.54	9.99	21.00
2480MHz	Pass	2.54	6.83	21.00

DG = Directional Gain; Port X = Port X output power

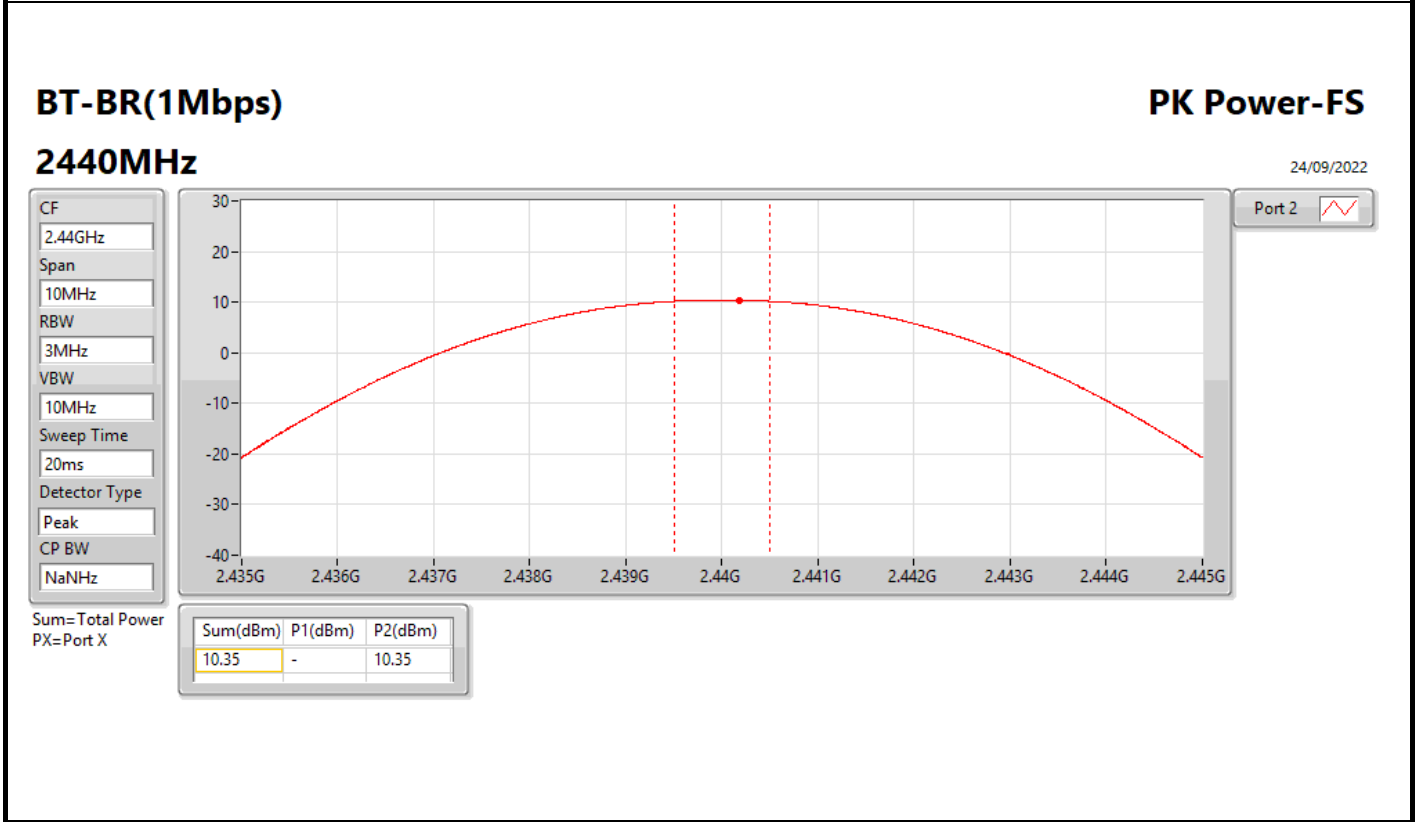
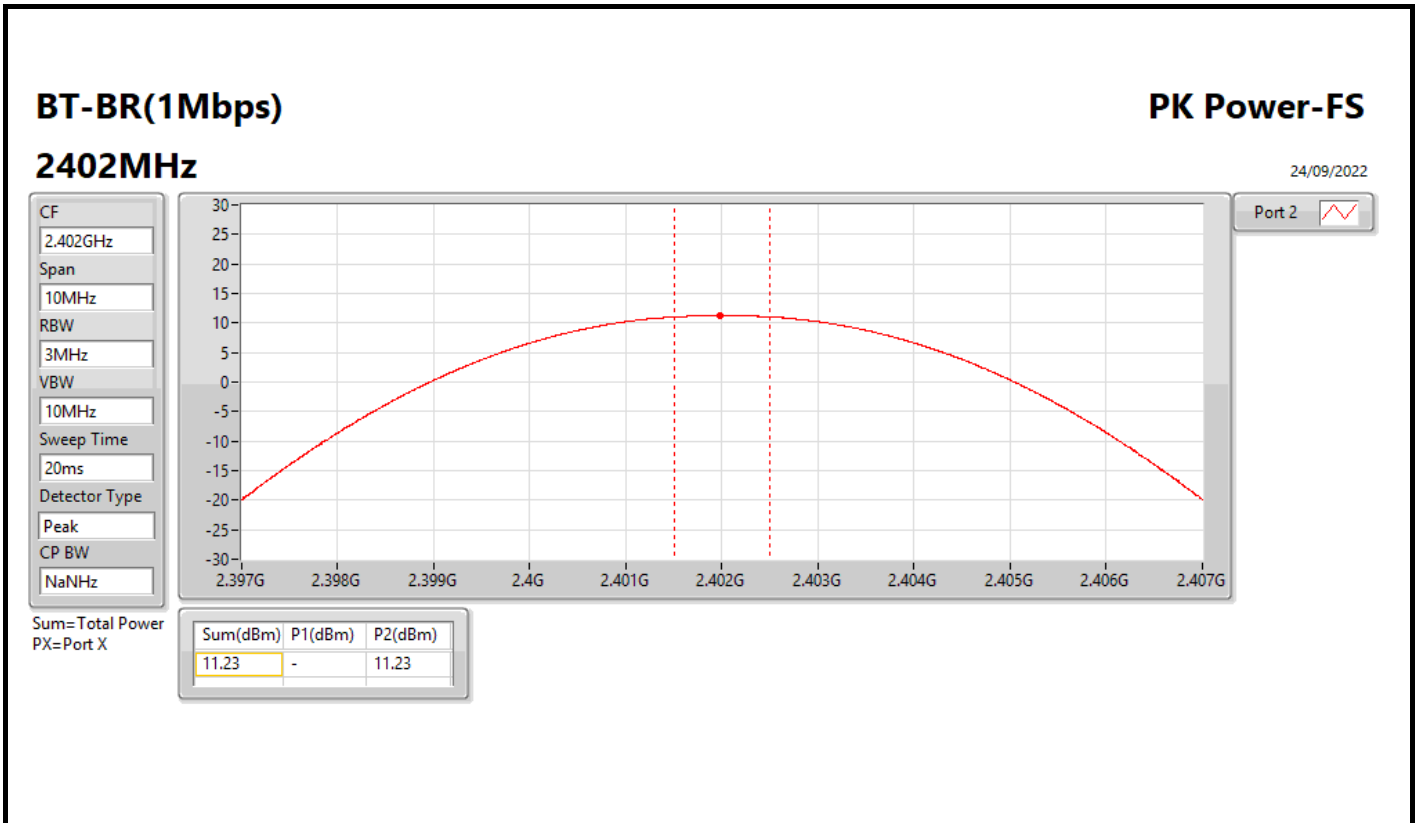

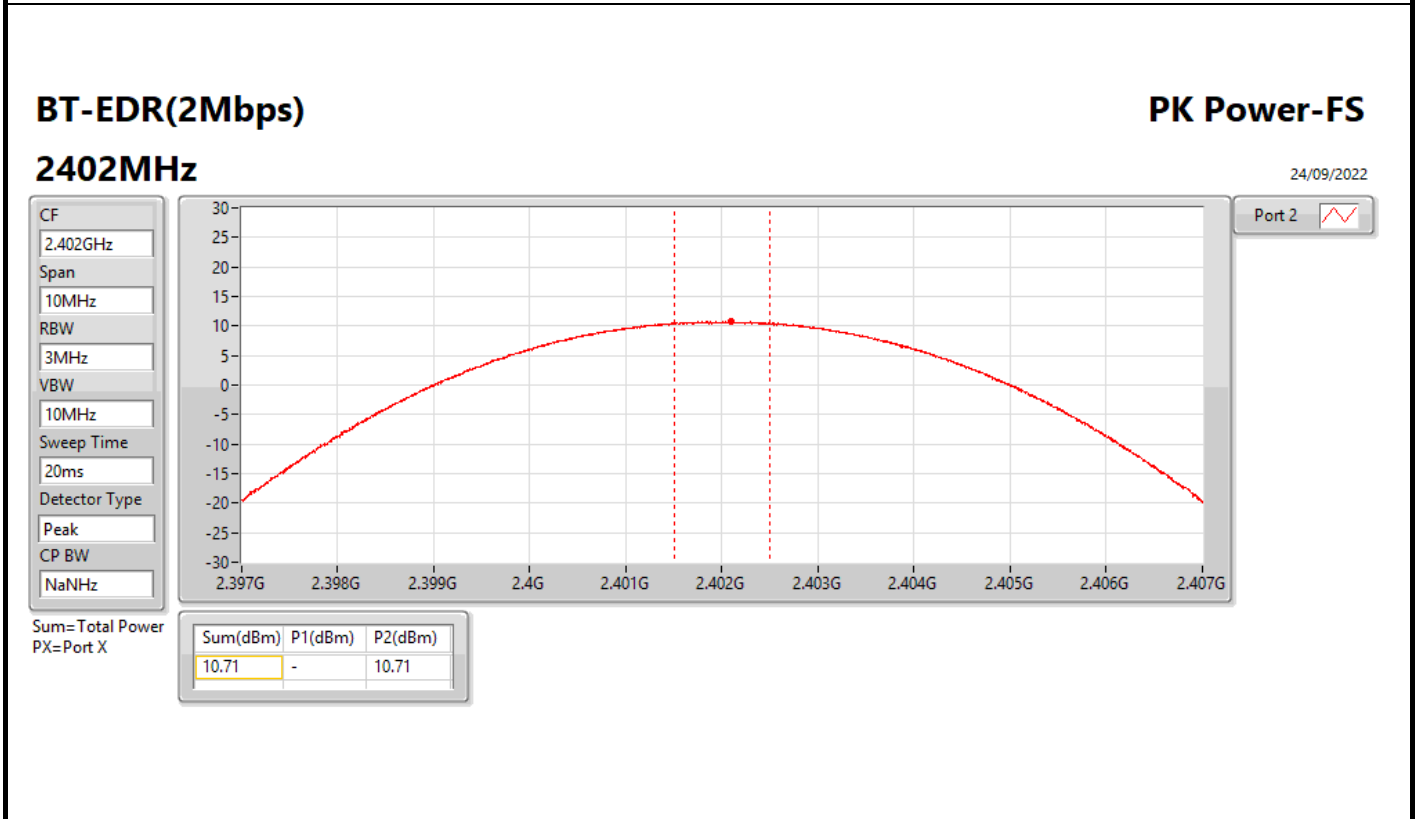
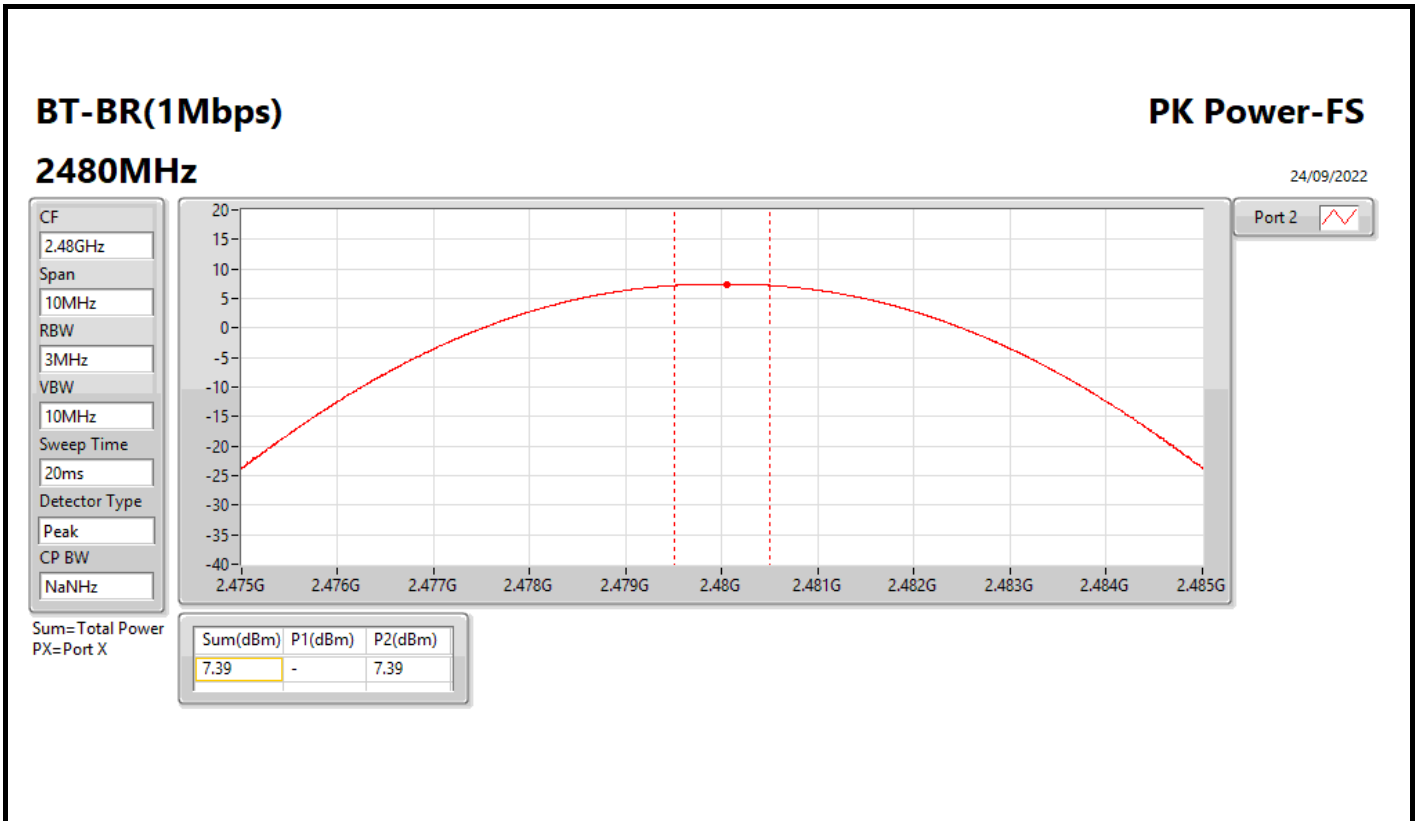

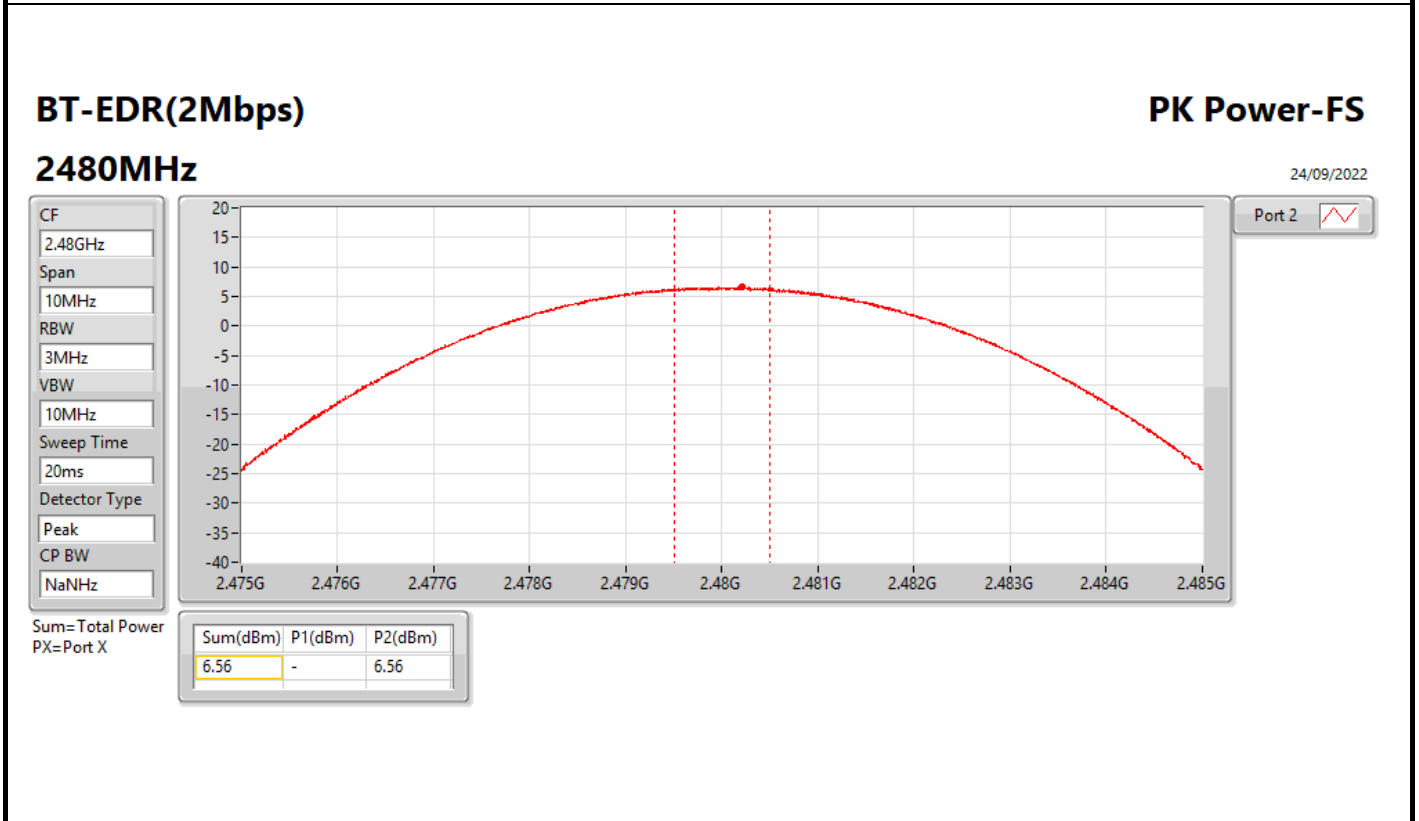
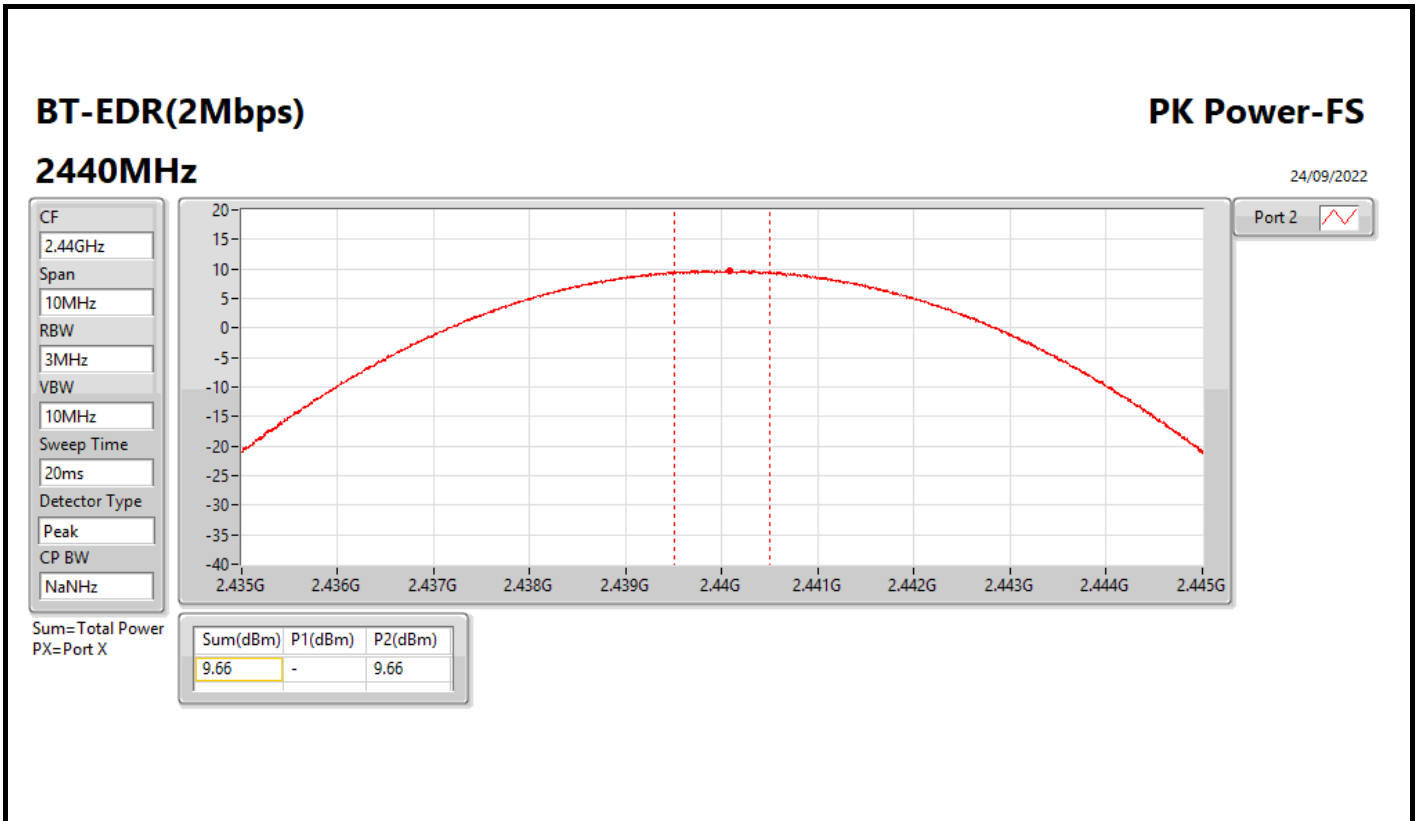

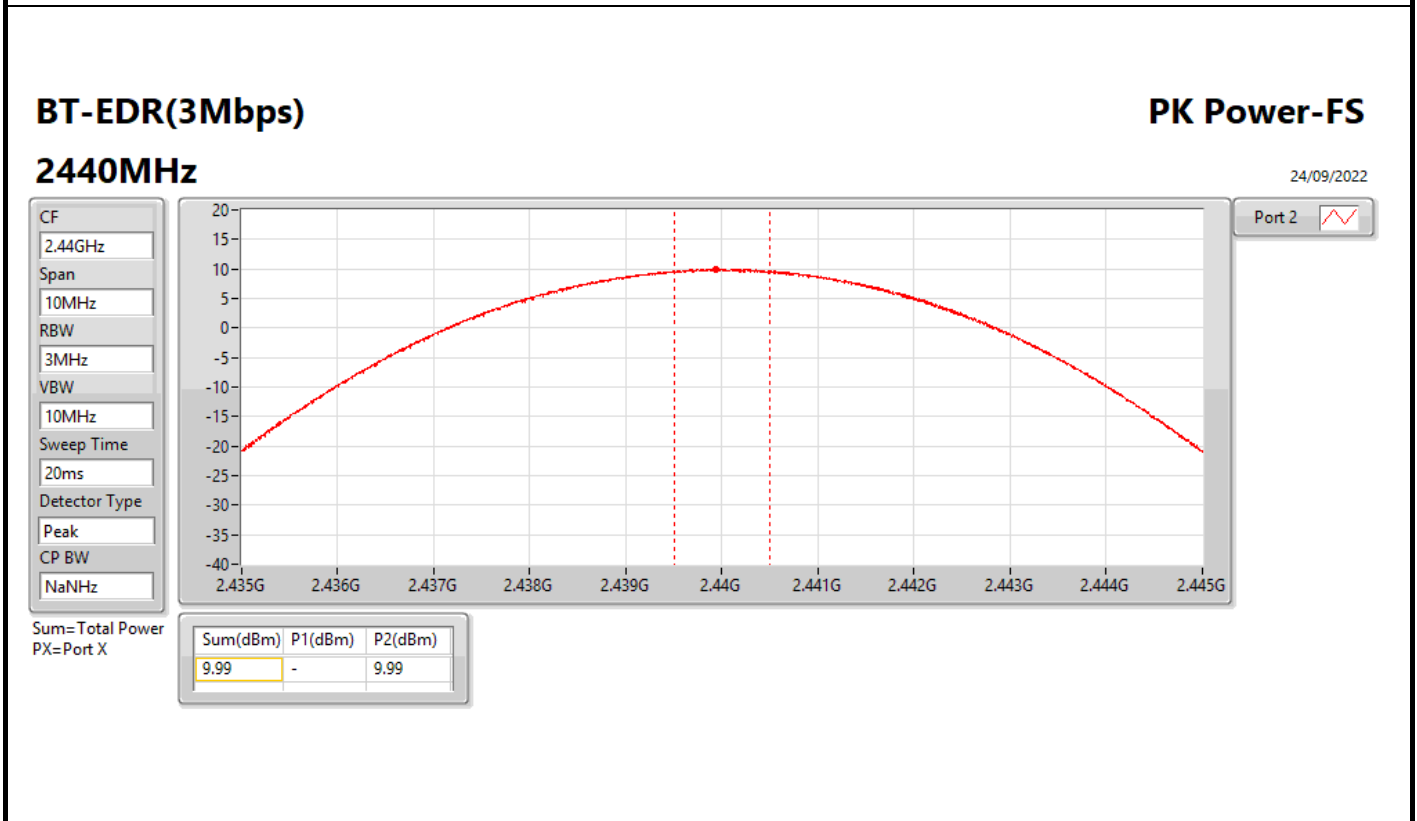
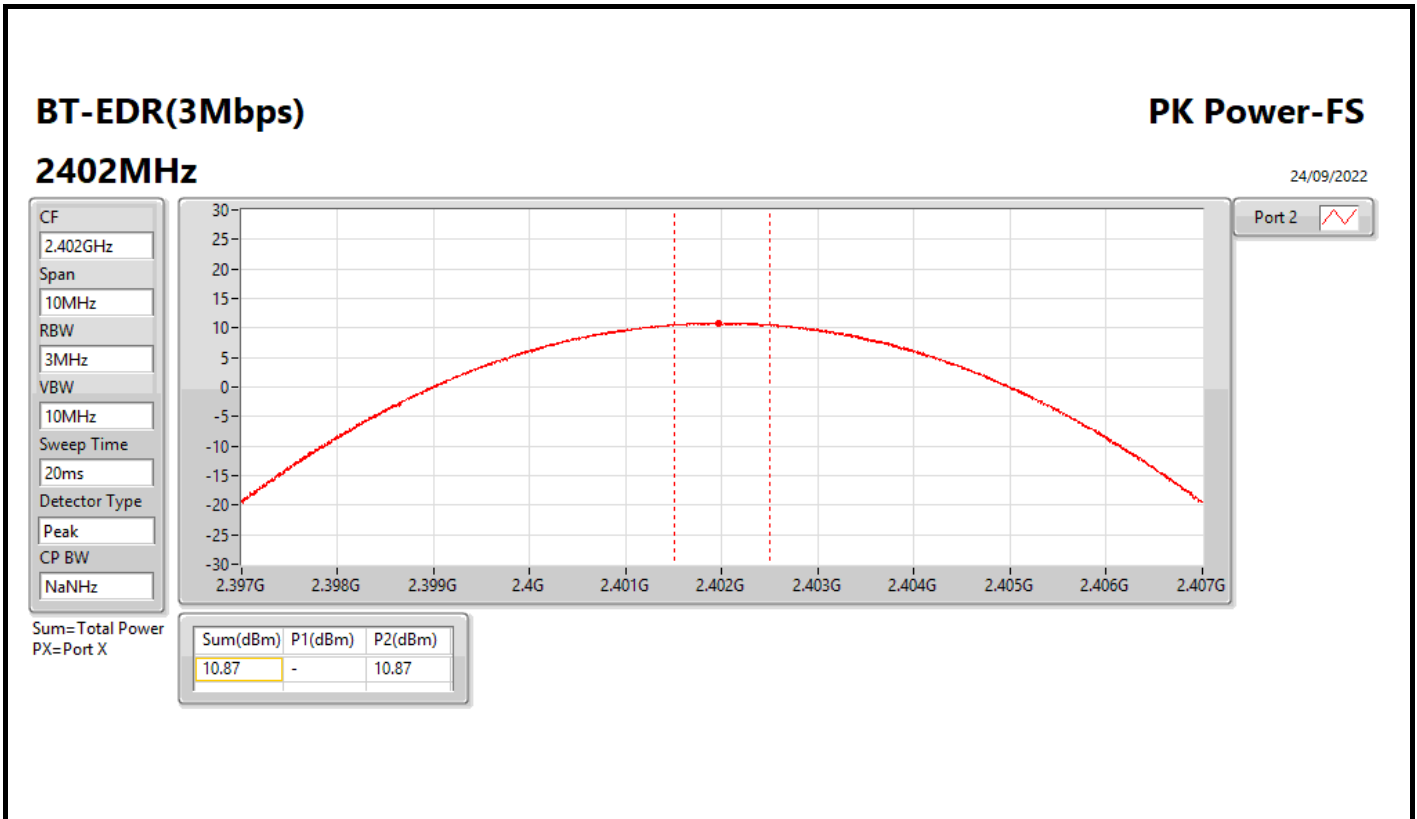

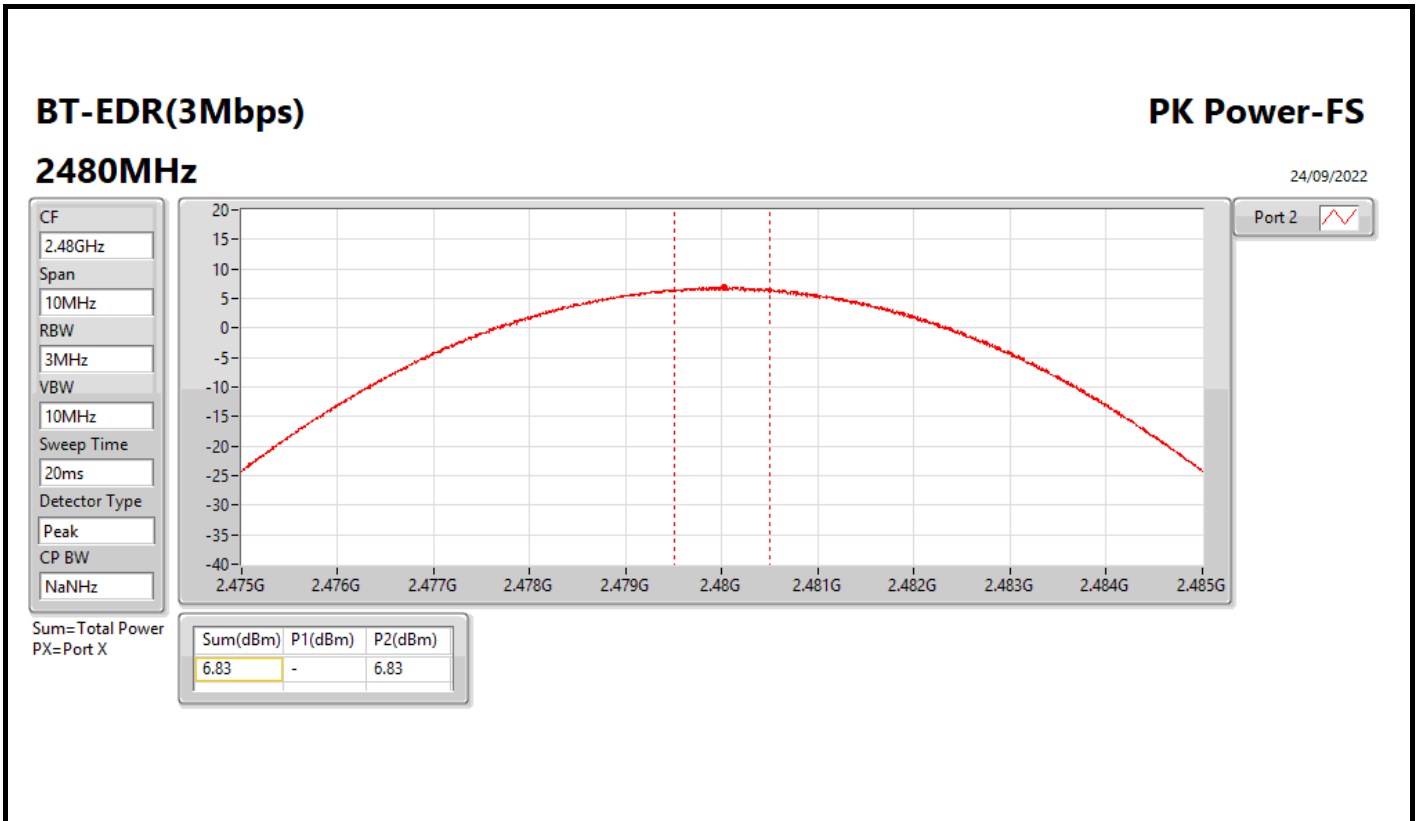



Summary

Mode	Max-Hop No
2.4-2.4835GHz	-
BT-BR(1Mbps)	79
BT-EDR(2Mbps)	79
BT-EDR(3Mbps)	79



Result

Mode	Result	Hopping No	Limit
BT-BR(1Mbps)	-	-	-
2440MHz	Pass	79	15
BT-EDR(2Mbps)	-	-	-
2440MHz	Pass	79	15
BT-EDR(3Mbps)	-	-	-
2440MHz	Pass	79	15

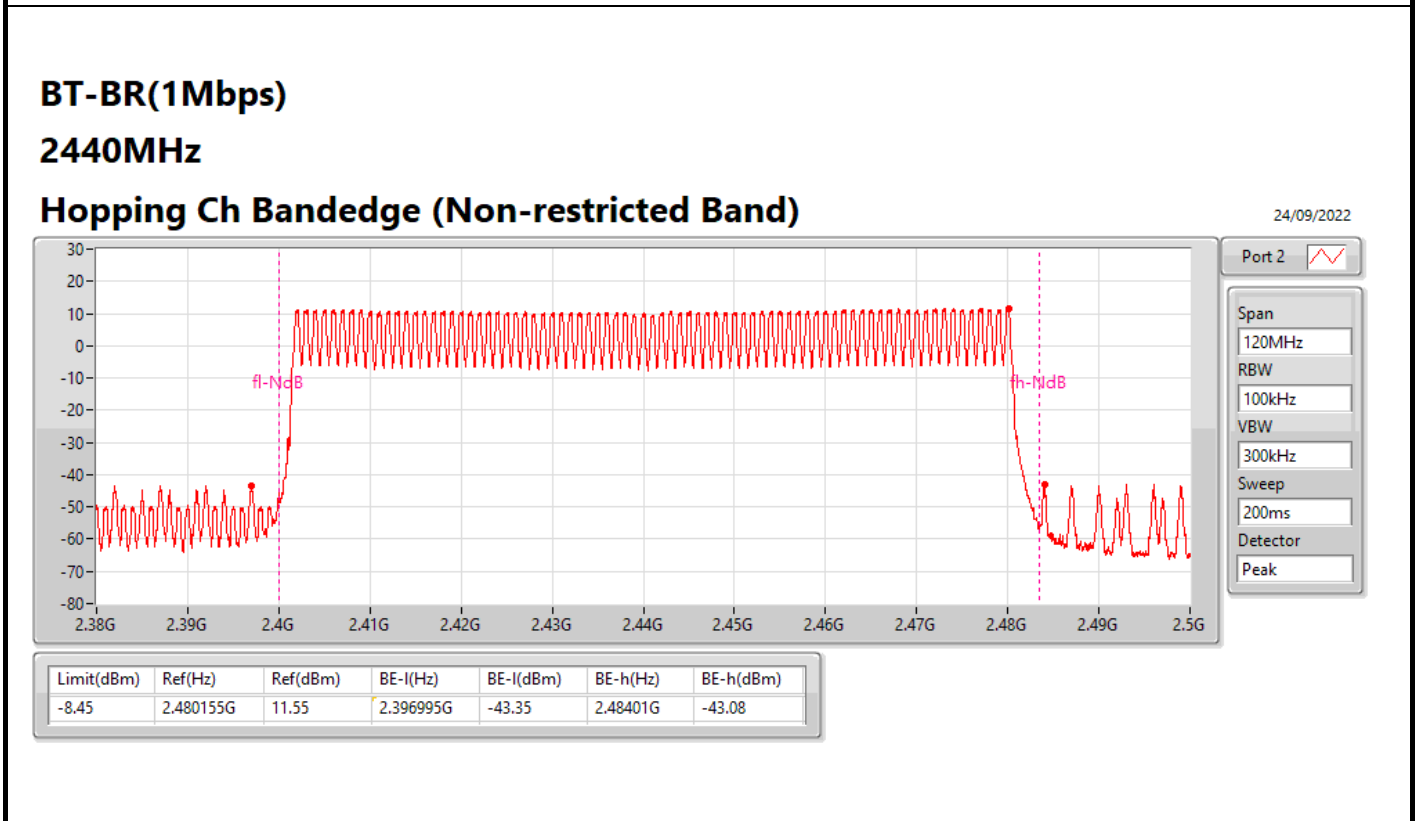
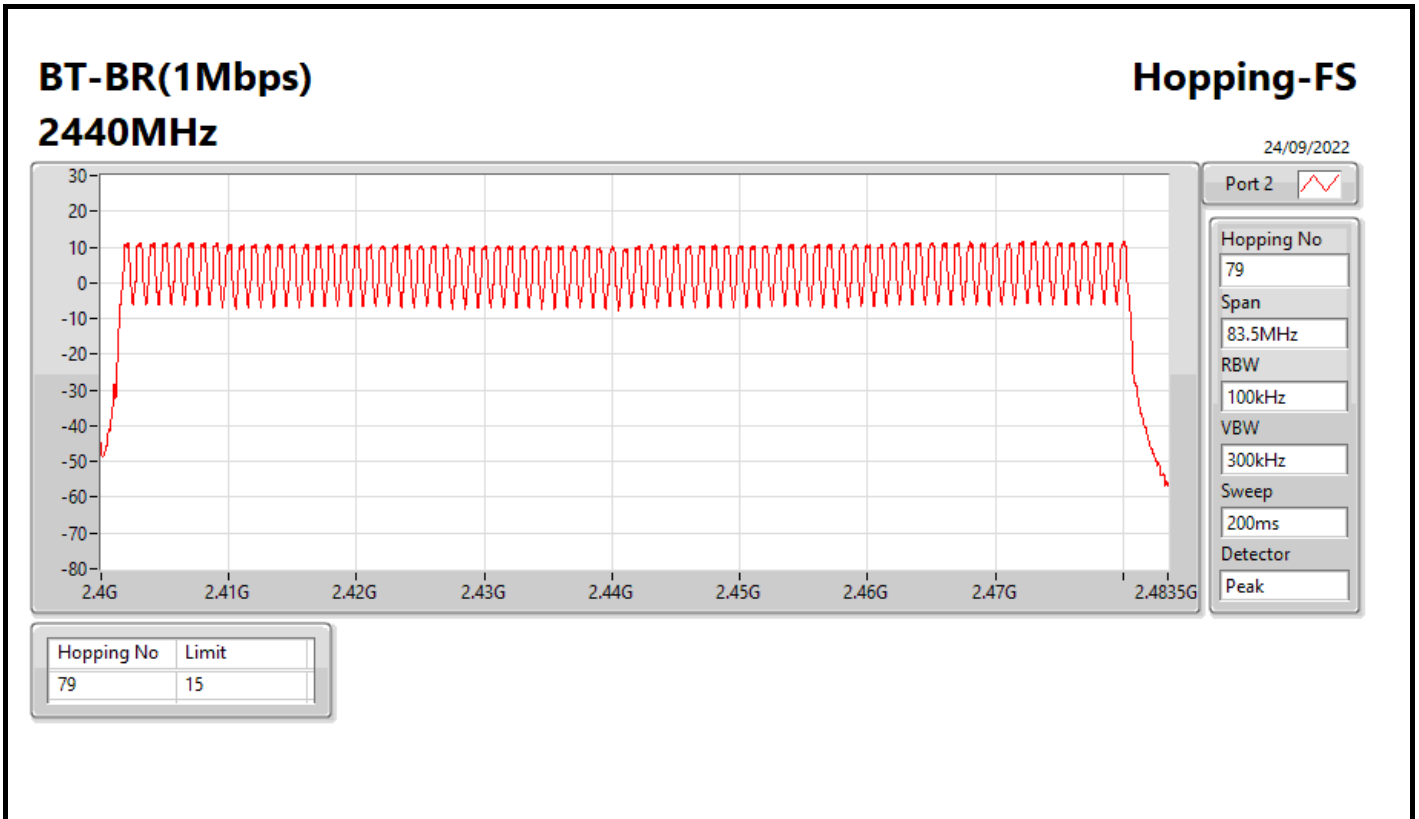

BT-BR(1Mbps)
2440MHz
Hopping Ch Bandedge (Restricted Band)

24/09/2022

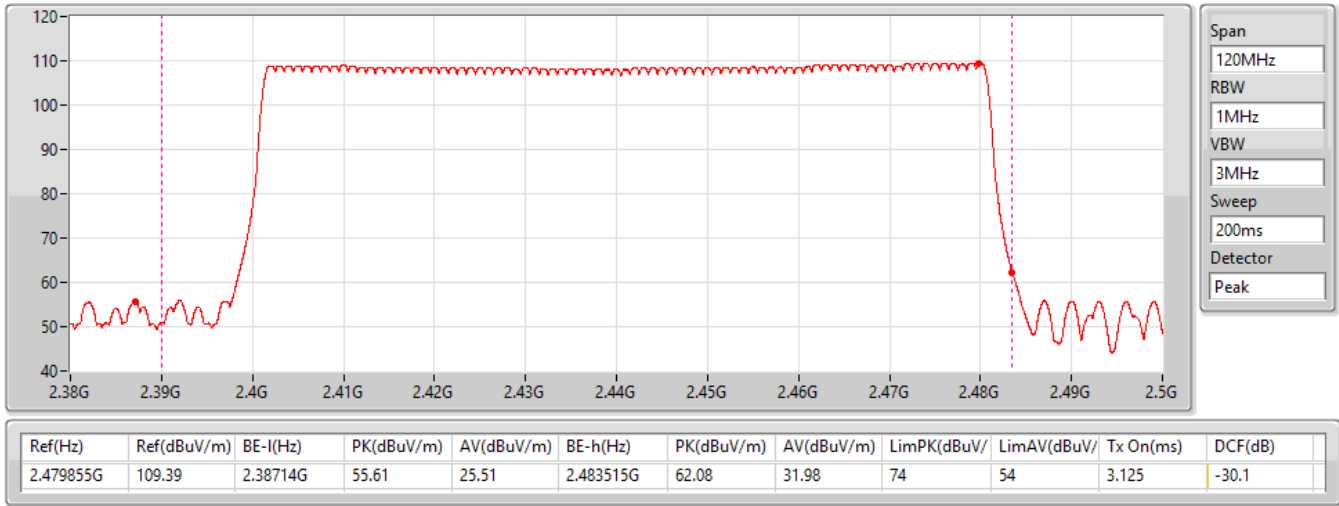

BT-EDR(2Mbps) **Hopping-FS**
2440MHz

24/09/2022

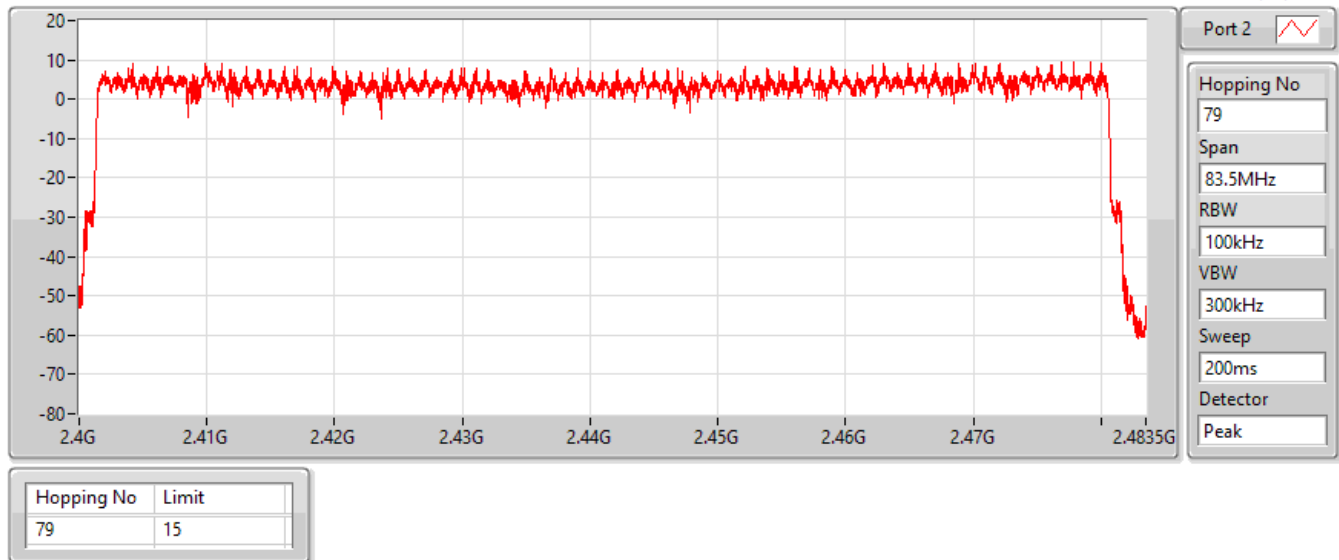

BT-EDR(2Mbps)
2440MHz
Hopping Ch Bandedge (Non-restricted Band)

24/09/2022

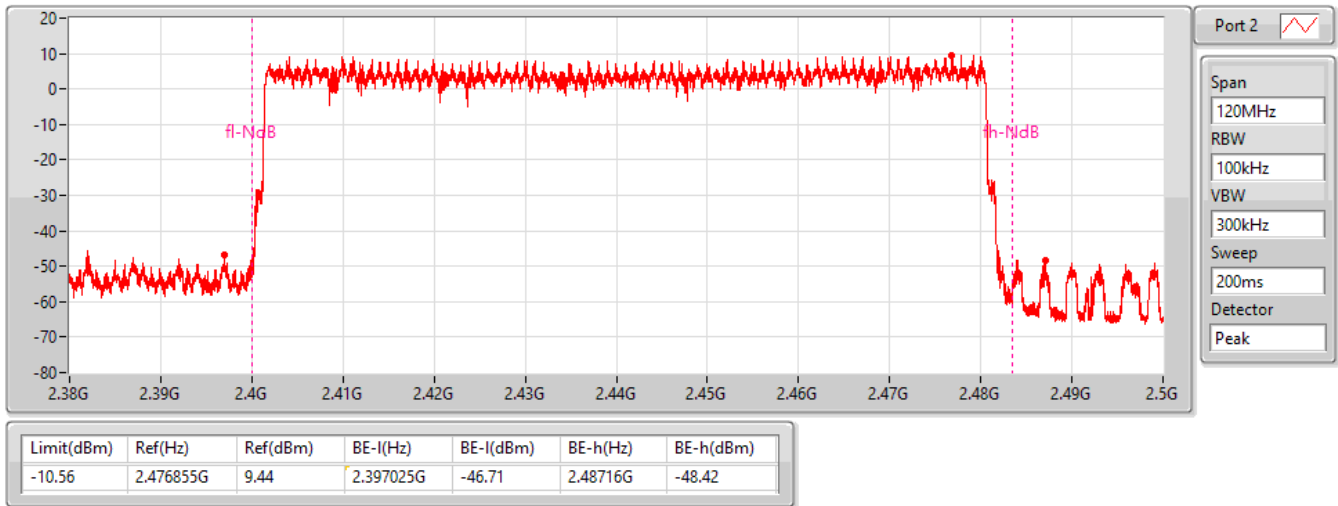

BT-EDR(2Mbps)
2440MHz
Hopping Ch Bandedge (Restricted Band)

24/09/2022

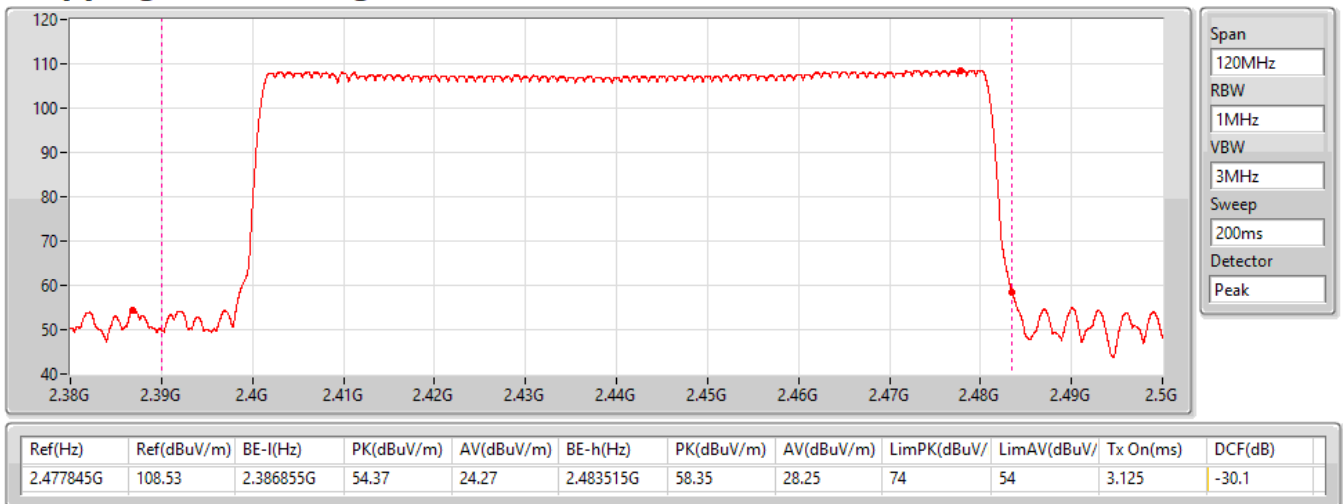

BT-EDR(3Mbps)
2440MHz

Hopping-FS

24/09/2022

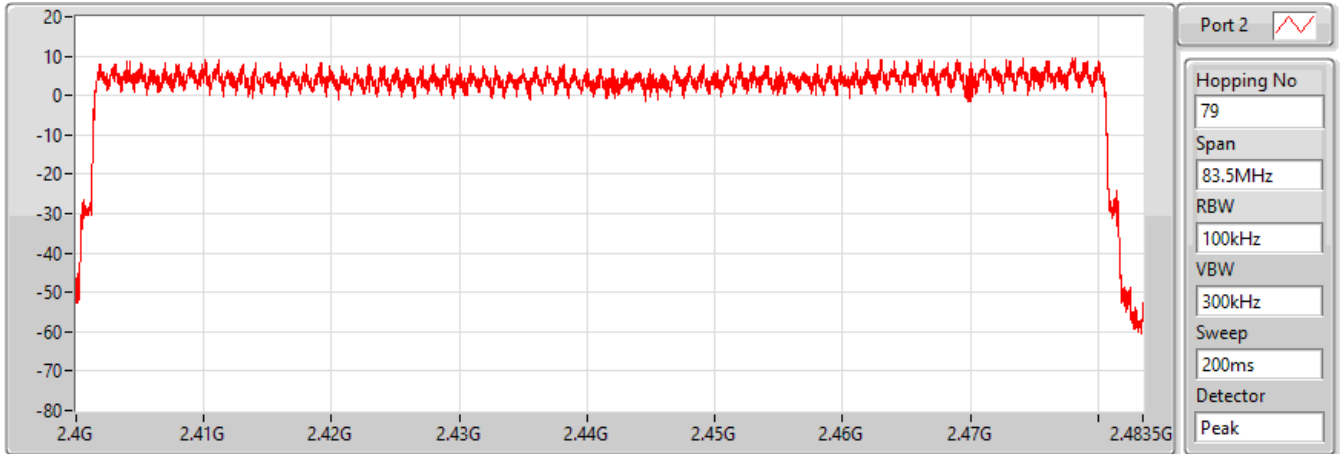

Hopping No	Limit
79	15

BT-EDR(3Mbps)
2440MHz

Hopping Ch Bandedge (Non-restricted Band)

24/09/2022

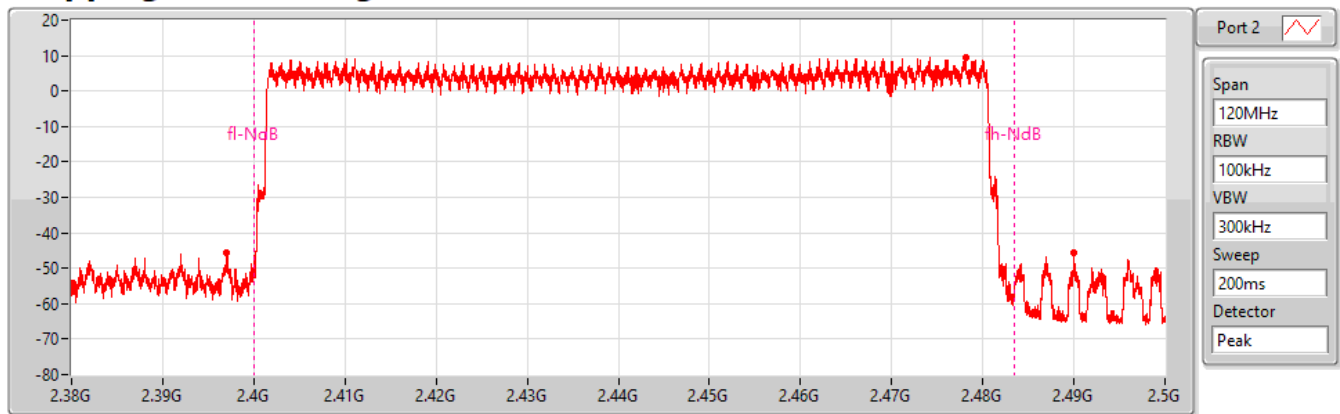

Limit(dBm)	Ref(Hz)	Ref(dBm)	BE-l(Hz)	BE-l(dBm)	BE-h(Hz)	BE-h(dBm)
-10.56	2.47816G	9.44	2.39698G	-45.77	2.490025G	-45.75

BT-EDR(3Mbps)
2440MHz
Hopping Ch Bandedge (Restricted Band)

24/09/2022

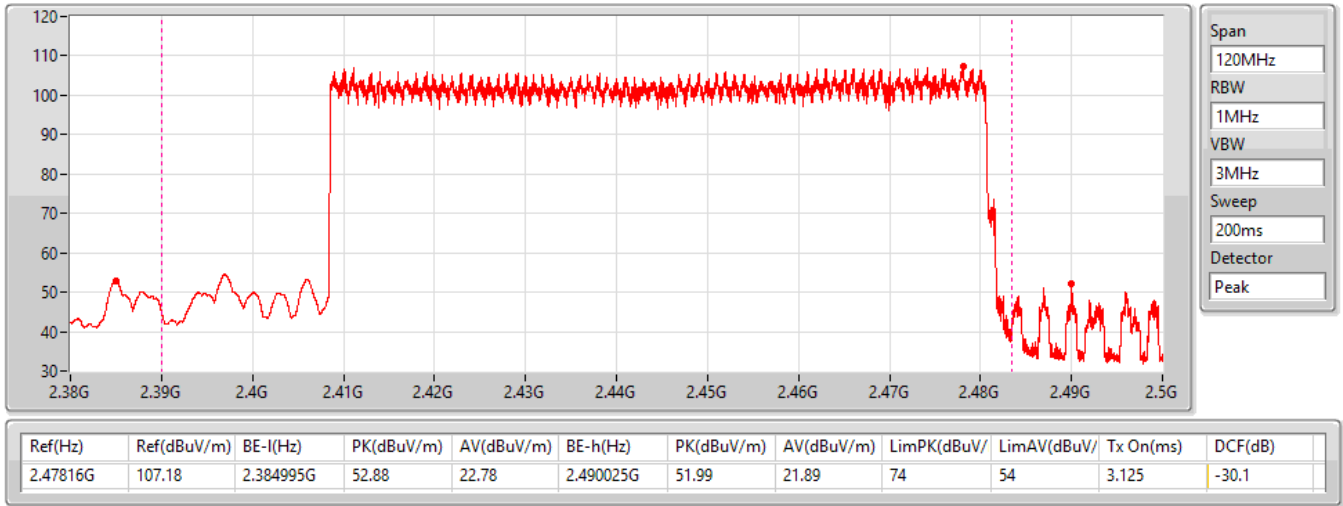



Summary

Mode	Max-Dwell (s)
2.4-2.4835GHz	-
BT-BR(1Mbps)	308.10065m_DH5
BT-EDR(2Mbps)	308.9801m_DH5
BT-EDR(3Mbps)	309.16665m_DH5

Result

Mode	Result	Period (s)	Dwell (s)	Limit (s)	Tx On (s)
BT-BR(1Mbps)	-	-	-	-	-
2440MHz	Pass	31.6	308.10065m_DH5	400m	2.89025m
2440MHz	Pass	8	154.037m_DH5-AFH	400m	2.89m
BT-EDR(2Mbps)	-	-	-	-	-
2440MHz	Pass	31.6	308.9801m_DH5	400m	2.8985m
2440MHz	Pass	8	154.476725m_DH5-AFH	400m	2.89825m
BT-EDR(3Mbps)	-	-	-	-	-
2440MHz	Pass	31.6	309.16665m_DH5	400m	2.90025m
2440MHz	Pass	8	154.57m_DH5-AFH	400m	2.9m

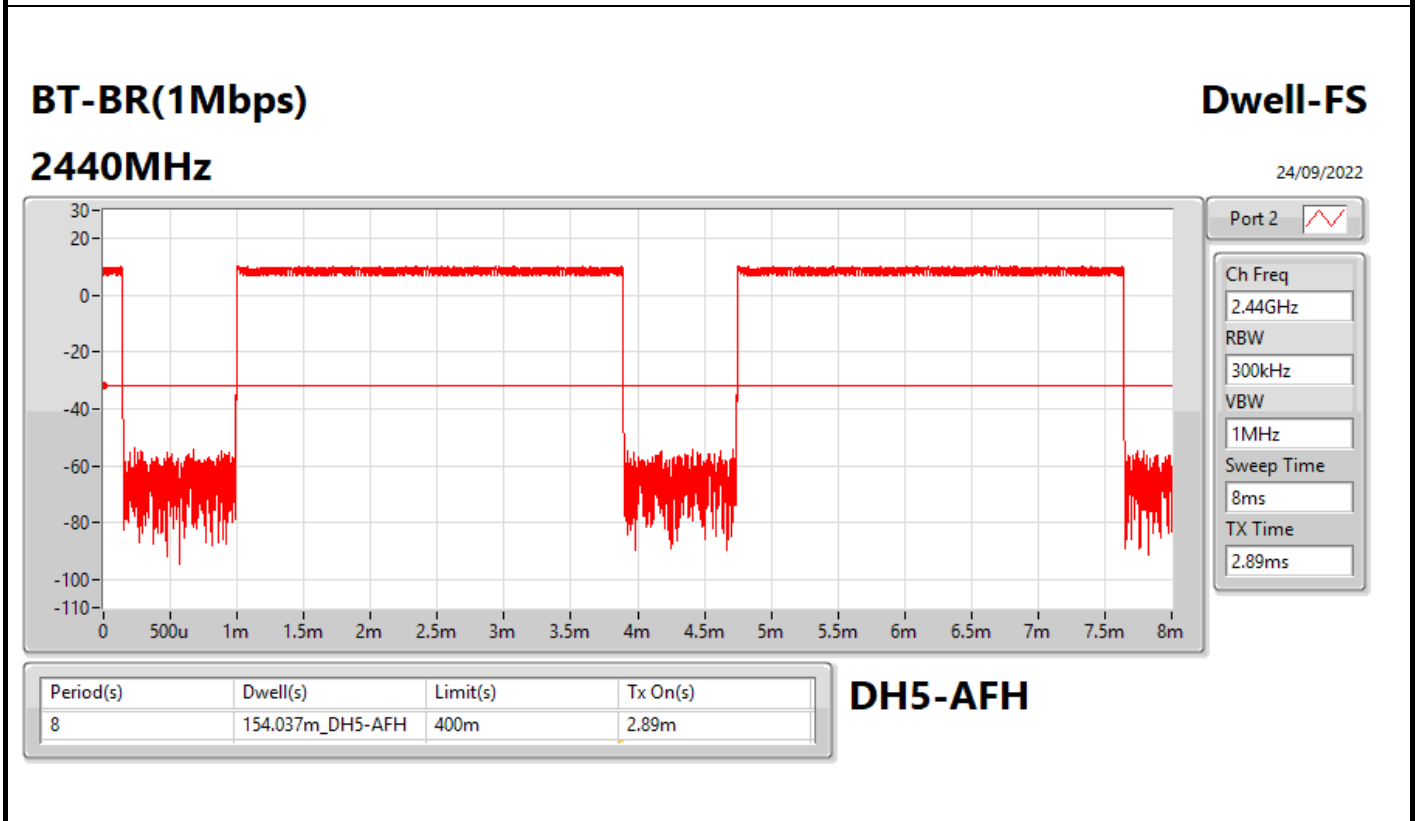
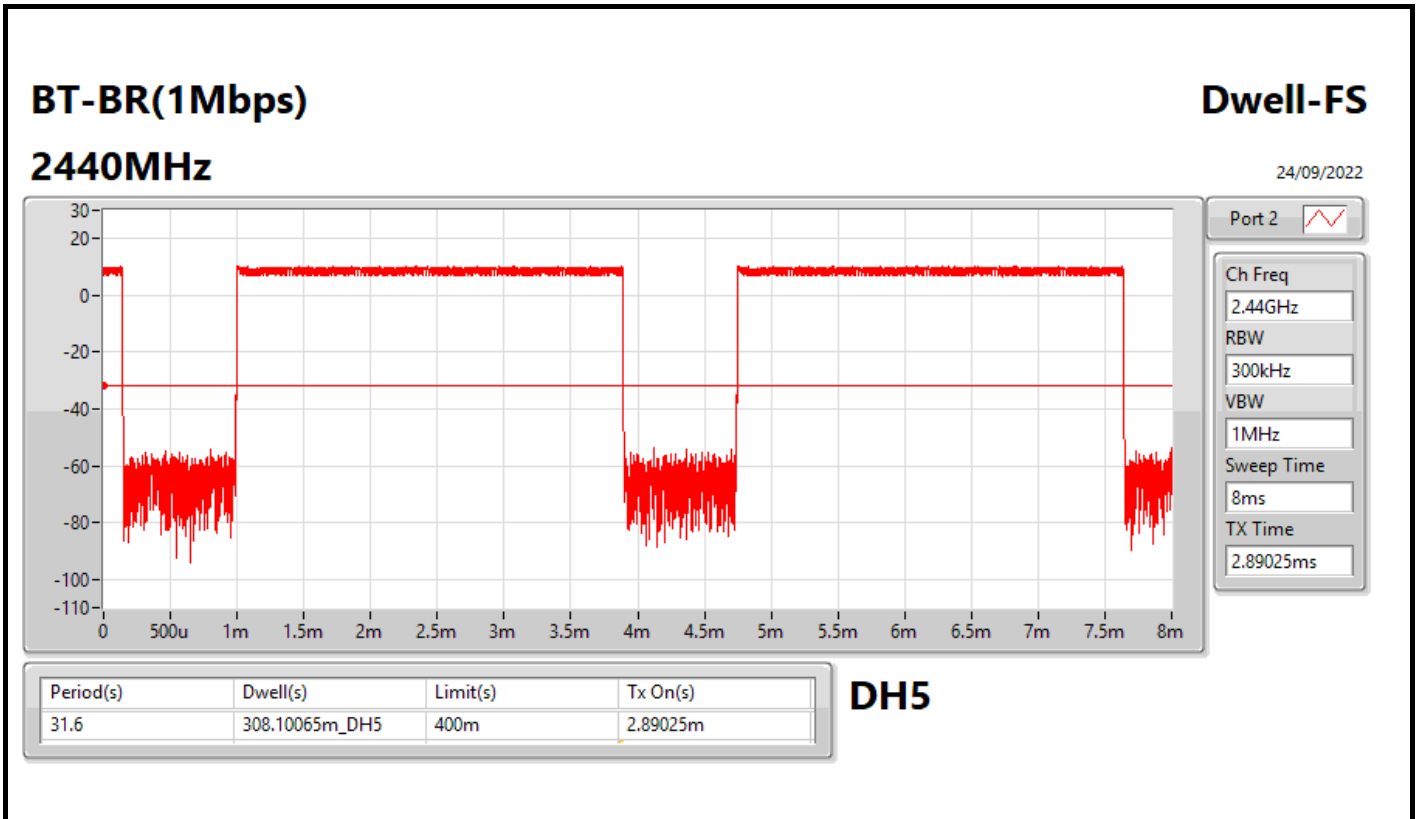

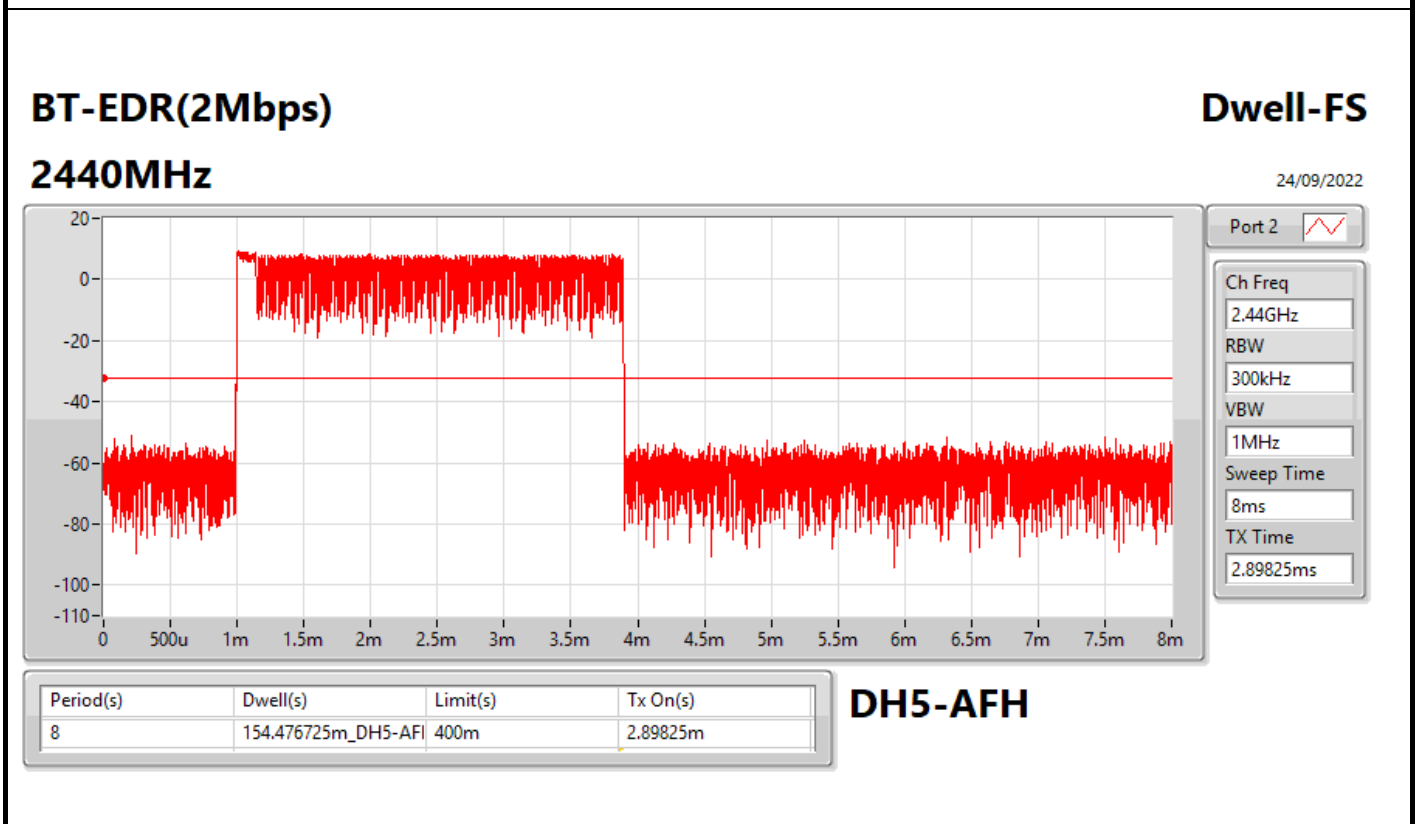
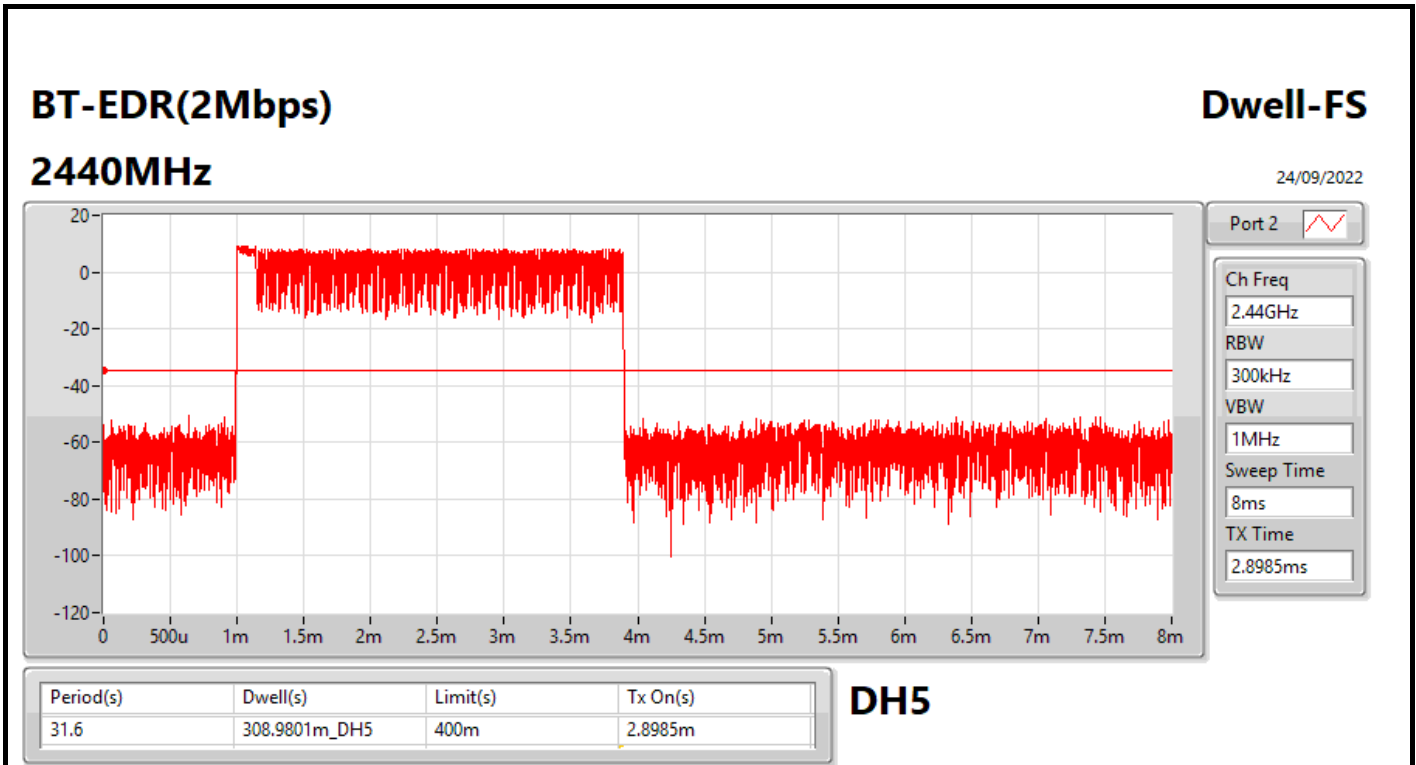

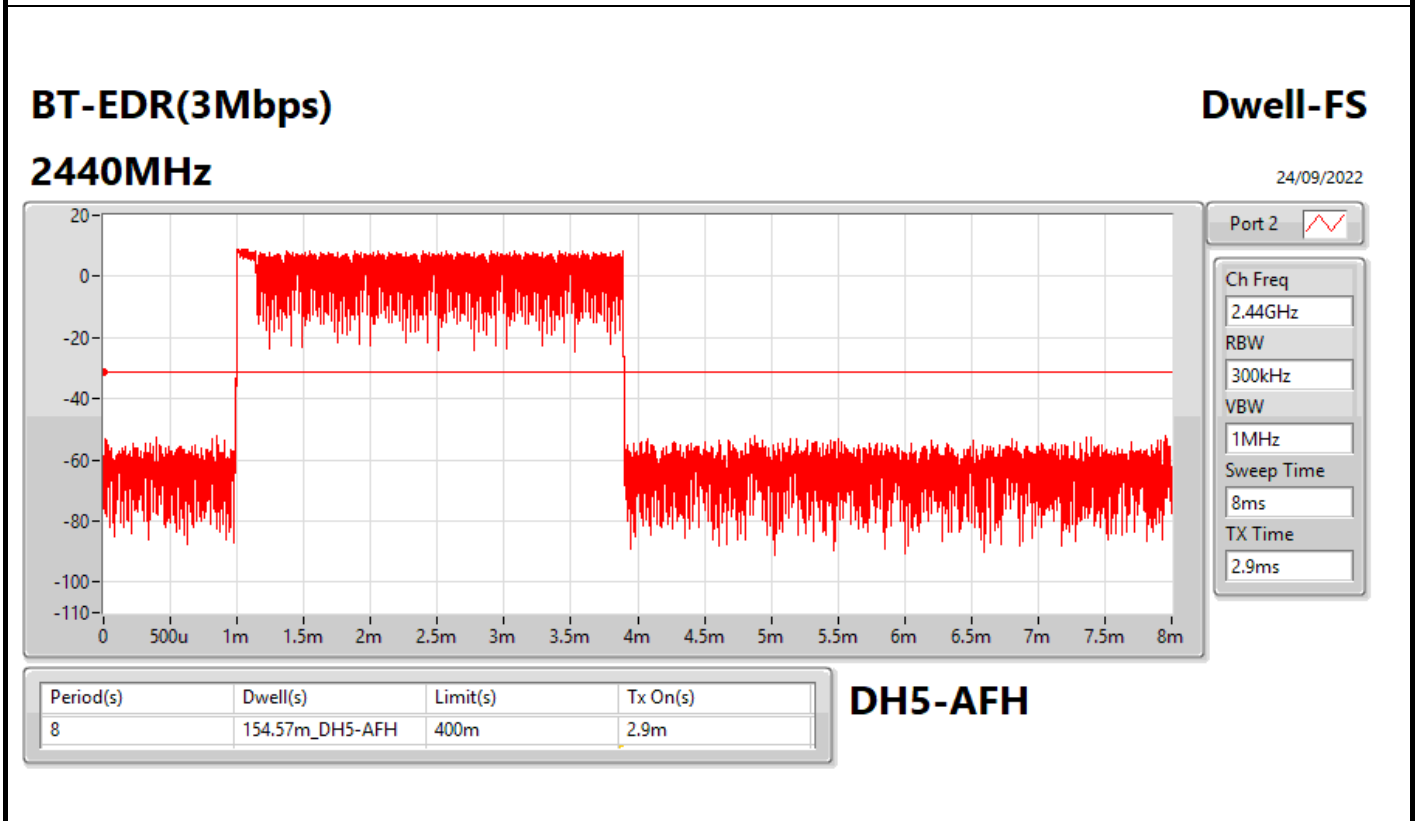
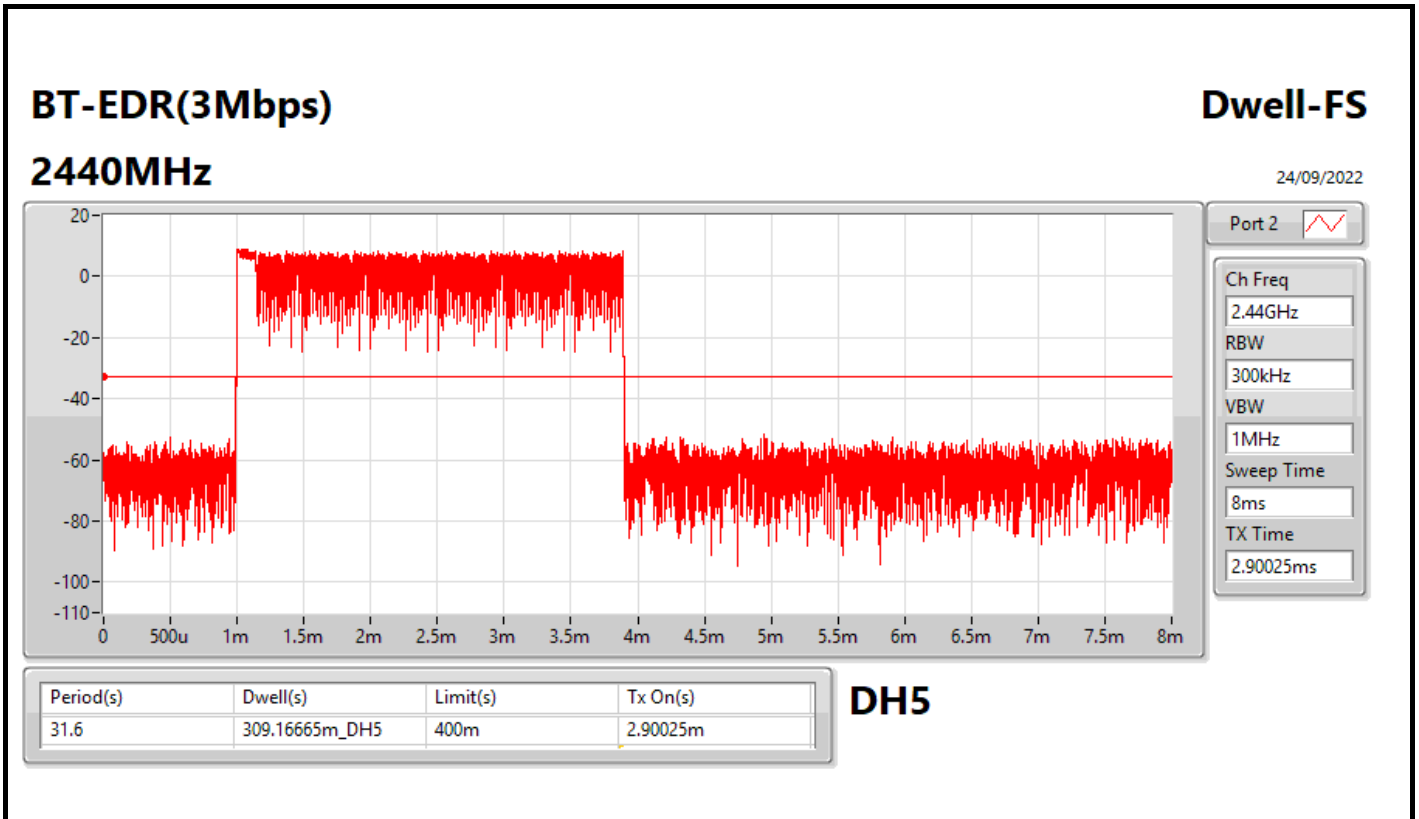



Summary

Mode	Result	Ref (Hz)	Ref (dBm)	Limit (dBm)	Freq (Hz)	Level (dBm)	Freq (Hz)	Level (dBm)	Freq (Hz)	Level (dBm)	Freq (Hz)	Level (dBm)	Freq (Hz)	Level (dBm)	Port
2.4-2.4835GHz	-	-	-	-	-	-	-	-	-	-	-	-	-	-	-
BT-BR(1Mbps)	Pass	2.40184G	10.69	-9.31	2.30186G	-46.58	2.39992G	-44.21	2.4G	-51.16	2.50201G	-43.54	21.85611G	-49.02	2
BT-EDR(2Mbps)	Pass	2.40196G	8.57	-11.43	2.30216G	-49.81	2.39998G	-46.36	2.4G	-46.99	2.50204G	-47.53	21.57491G	-49.14	2
BT-EDR(3Mbps)	Pass	2.40196G	9.07	-10.93	2.30216G	-48.75	2.39988G	-45.92	2.4G	-51.35	2.50201G	-44.44	21.65927G	-48.55	2



Result

Mode	Result	Ref (Hz)	Ref (dBm)	Limit (dBm)	Freq (Hz)	Level (dBm)	Freq (Hz)	Level (dBm)	Freq (Hz)	Level (dBm)	Freq (Hz)	Level (dBm)	Freq (Hz)	Level (dBm)	Port
BT-BR(1Mbps)	-	-	-	-	-	-	-	-	-	-	-	-	-	-	-
2402MHz	Pass	2.40184G	10.69	-9.31	2.30186G	-46.58	2.39992G	-44.21	2.4G	-51.16	2.50201G	-43.54	21.85611G	-49.02	2
2440MHz	Pass	2.44004G	9.65	-10.35	2.15793G	-54.83	2.39428G	-52.98	2.4G	-57.39	2.49196G	-47.69	21.62553G	-49.28	2
2480MHz	Pass	2.4802G	11.20	-8.80	1.89649G	-54.73	2.39029G	-52.83	2.4835G	-55.34	2.48365G	-51.51	21.90954G	-48.29	2
BT-EDR(2Mbps)	-	-	-	-	-	-	-	-	-	-	-	-	-	-	-
2402MHz	Pass	2.40196G	8.57	-11.43	2.30216G	-49.81	2.39998G	-46.36	2.4G	-46.99	2.50204G	-47.53	21.57491G	-49.14	2
2440MHz	Pass	2.44004G	6.67	-13.33	169.24M	-54.91	2.3961G	-52.73	2.4835G	-57.00	2.49233G	-49.45	21.95735G	-48.73	2
2480MHz	Pass	2.48003G	9.25	-10.75	2.06774G	-54.76	2.39562G	-51.04	2.4835G	-56.39	2.48368G	-50.73	23.15247G	-49.16	2
BT-EDR(3Mbps)	-	-	-	-	-	-	-	-	-	-	-	-	-	-	-
2402MHz	Pass	2.40196G	9.07	-10.93	2.30216G	-48.75	2.39988G	-45.92	2.4G	-51.35	2.50201G	-44.44	21.65927G	-48.55	2
2440MHz	Pass	2.44G	7.48	-12.52	2.02045G	-53.99	2.39782G	-52.86	2.4835G	-56.04	2.49198G	-49.58	21.98266G	-48.31	2
2480MHz	Pass	2.48003G	9.03	-10.97	2.19553G	-55.02	2.39824G	-51.32	2.4835G	-54.28	2.48375G	-51.99	21.67052G	-49.20	2

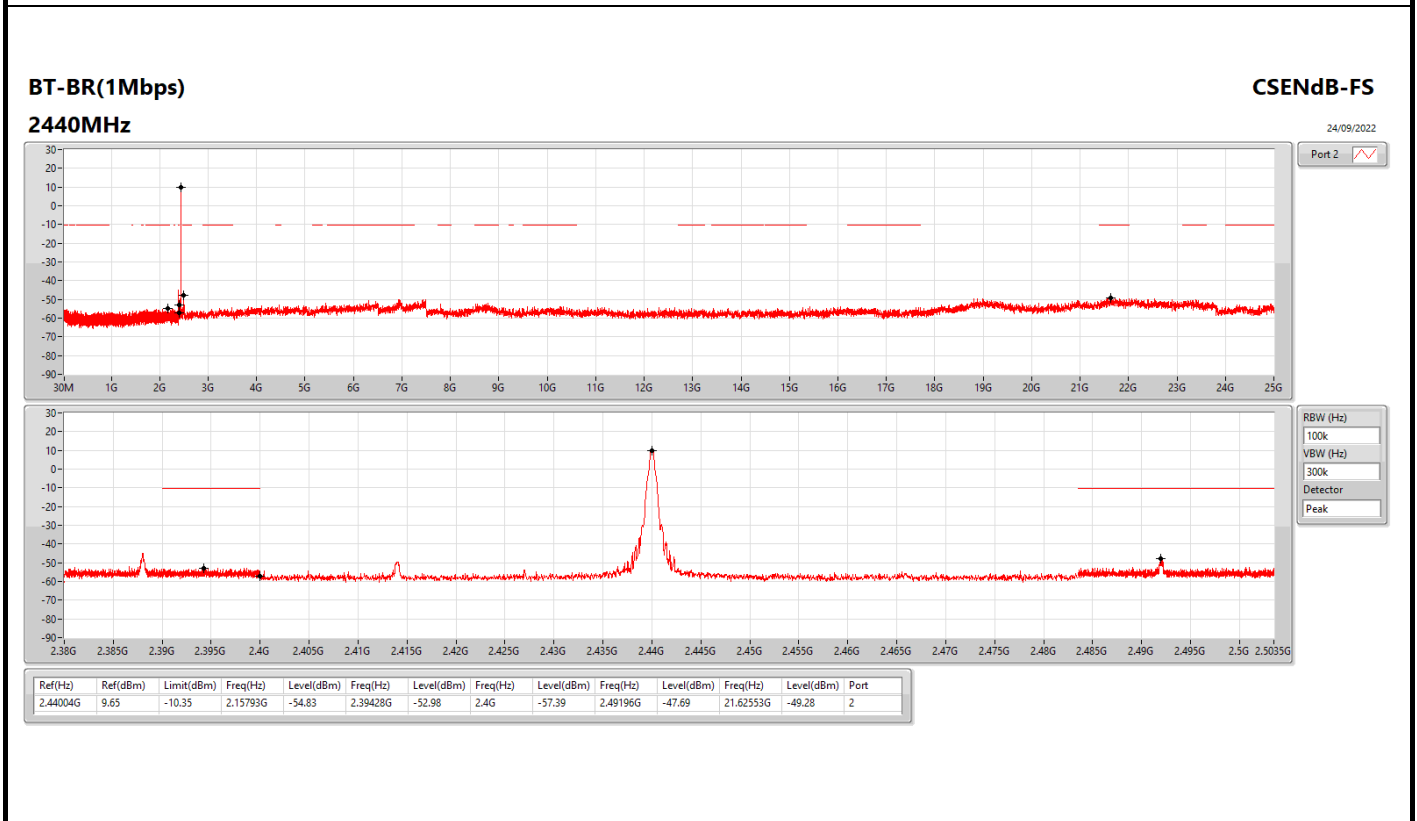
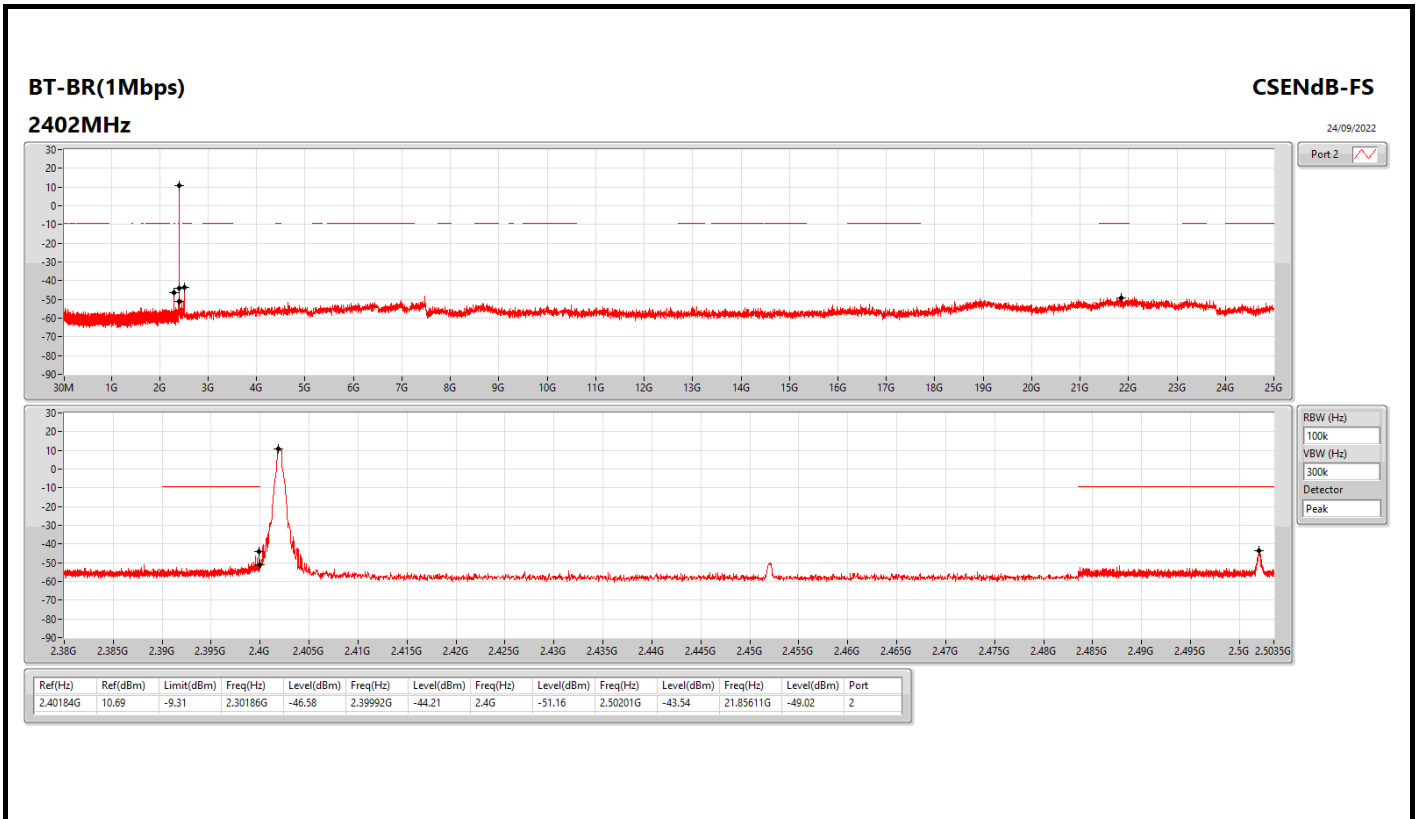

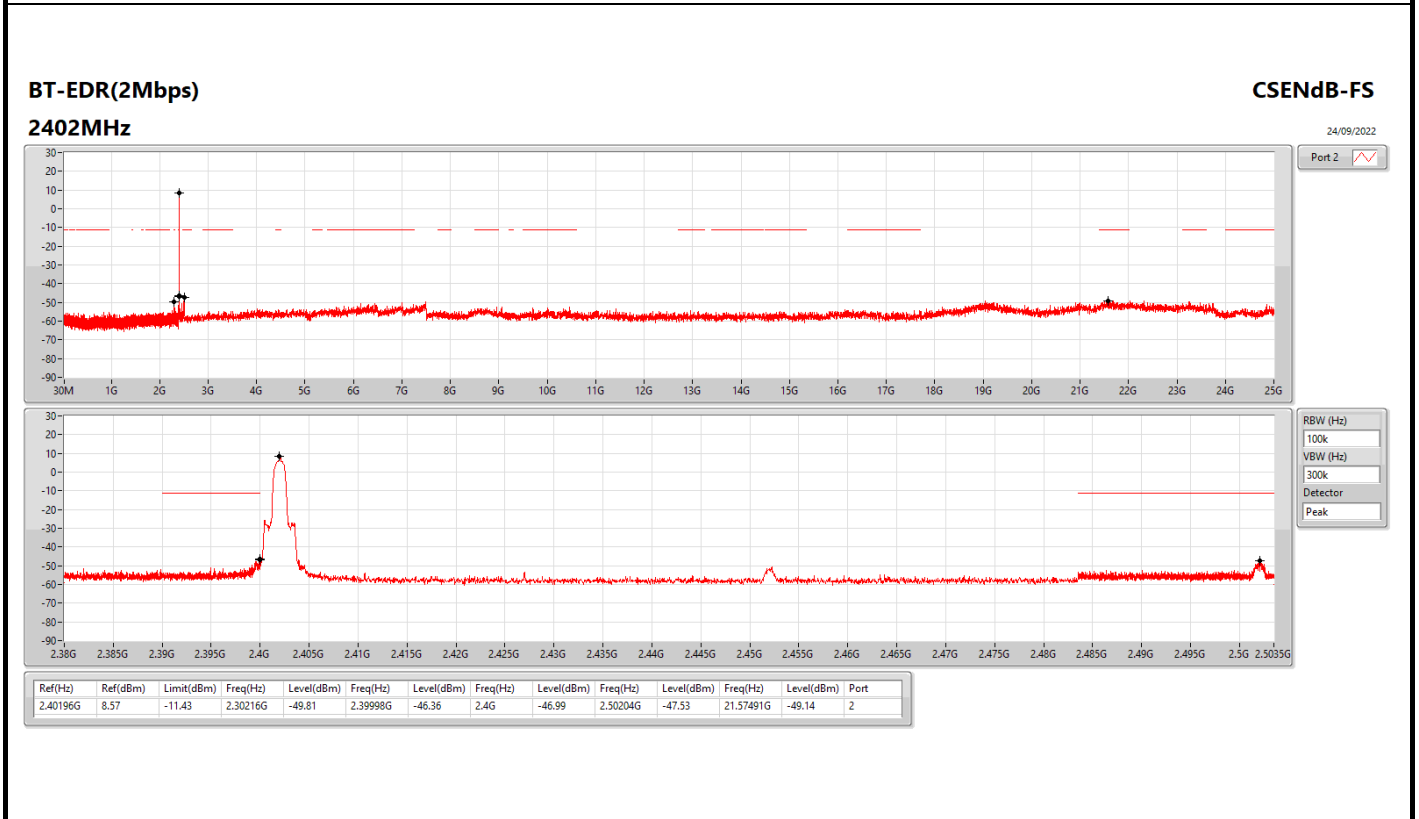
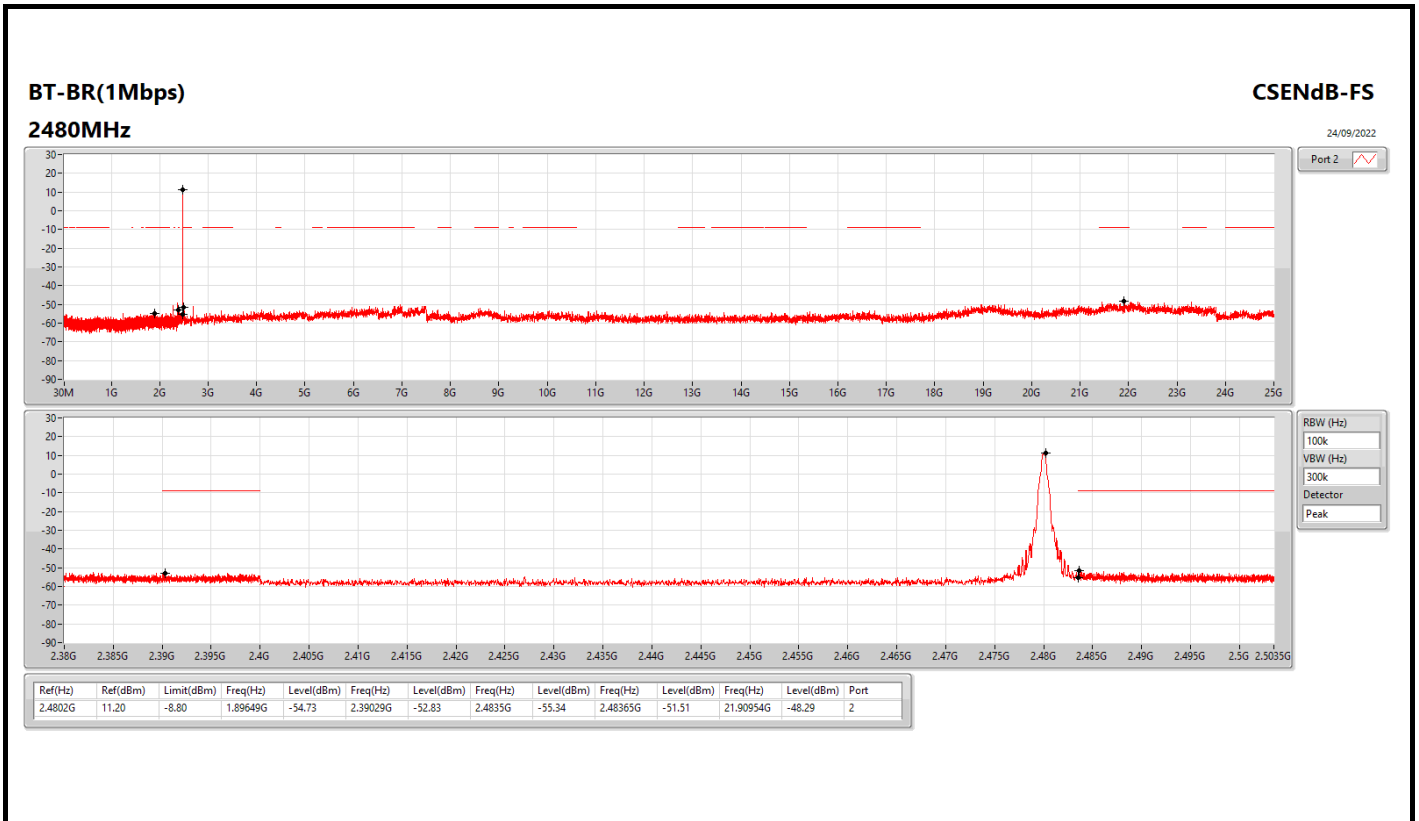

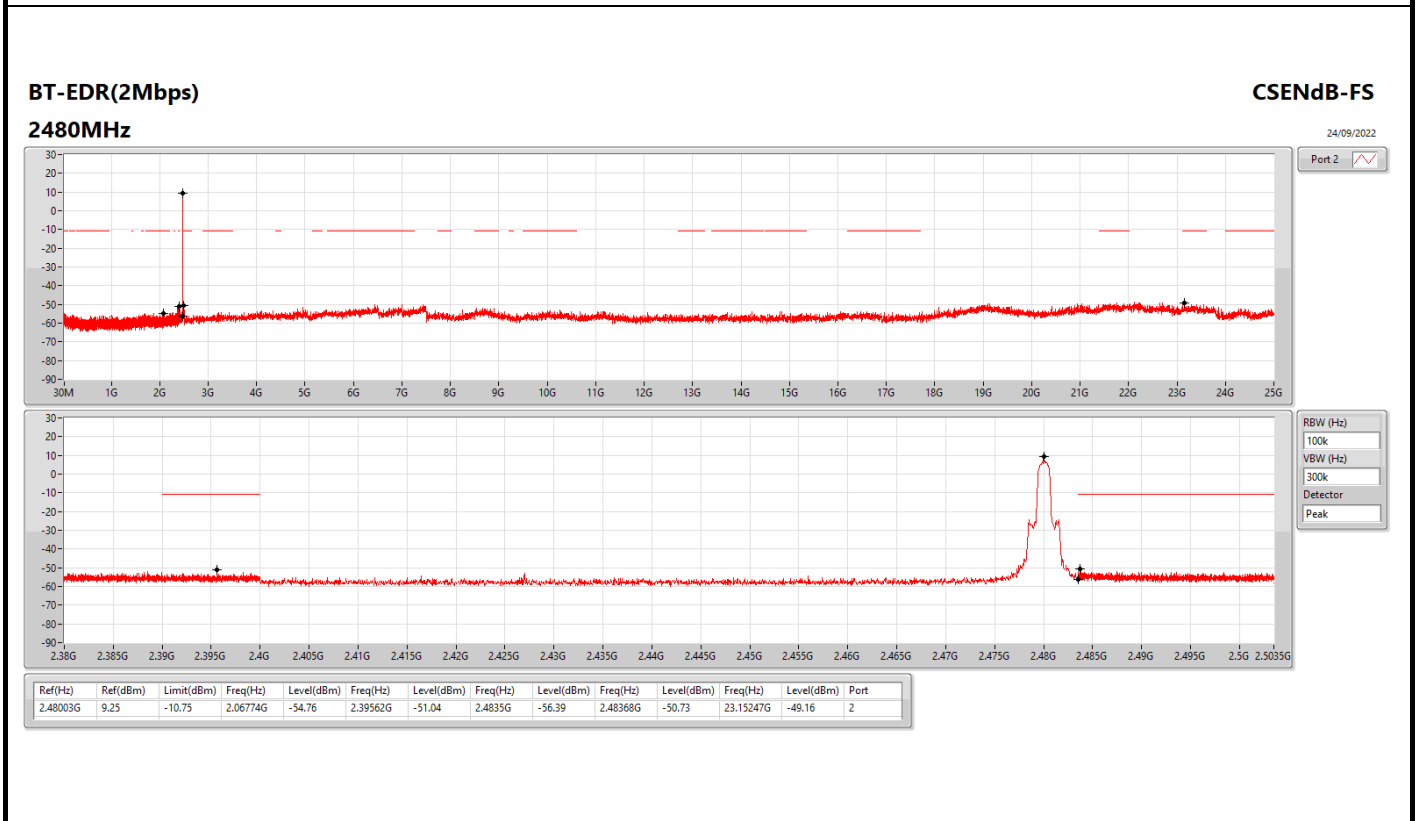
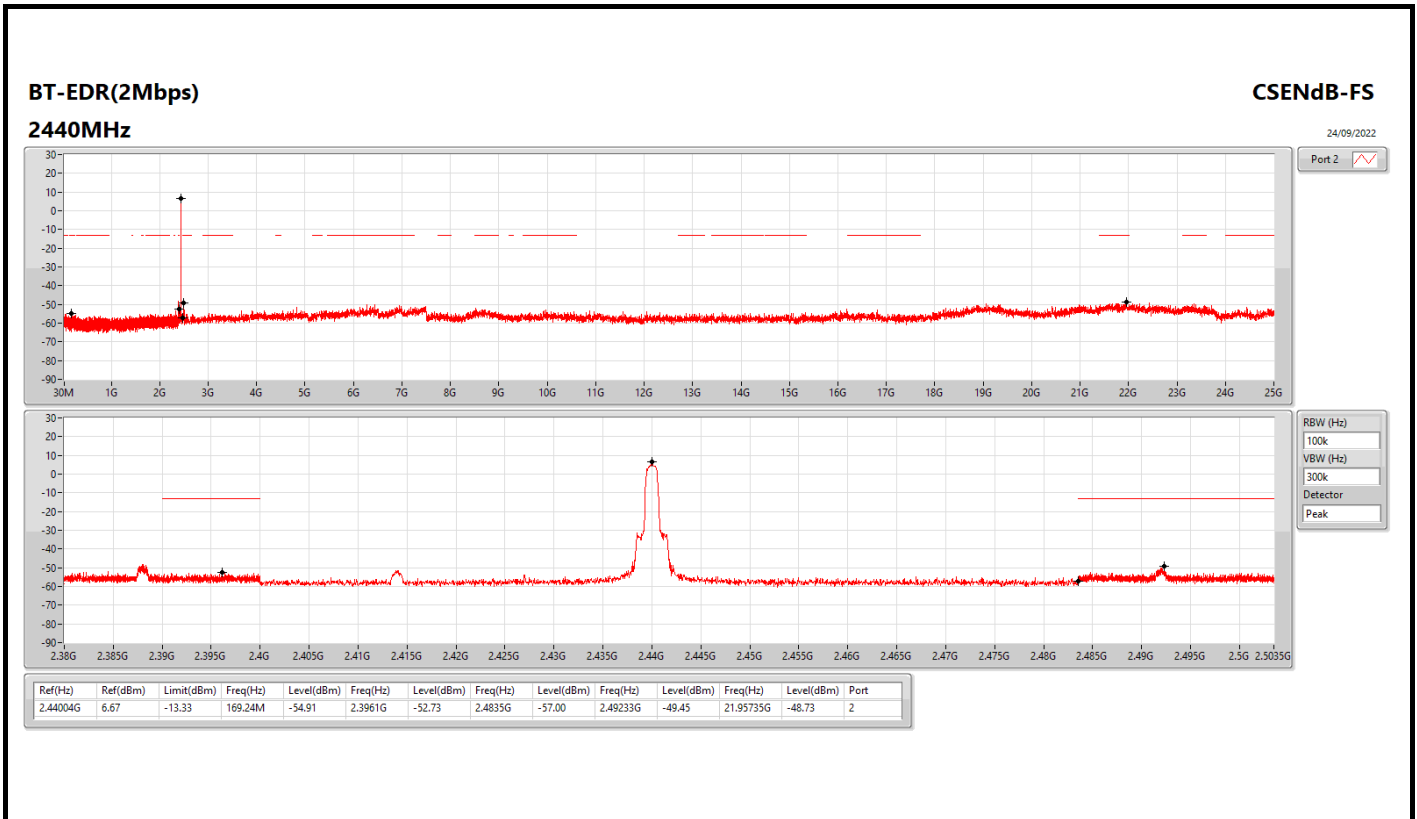

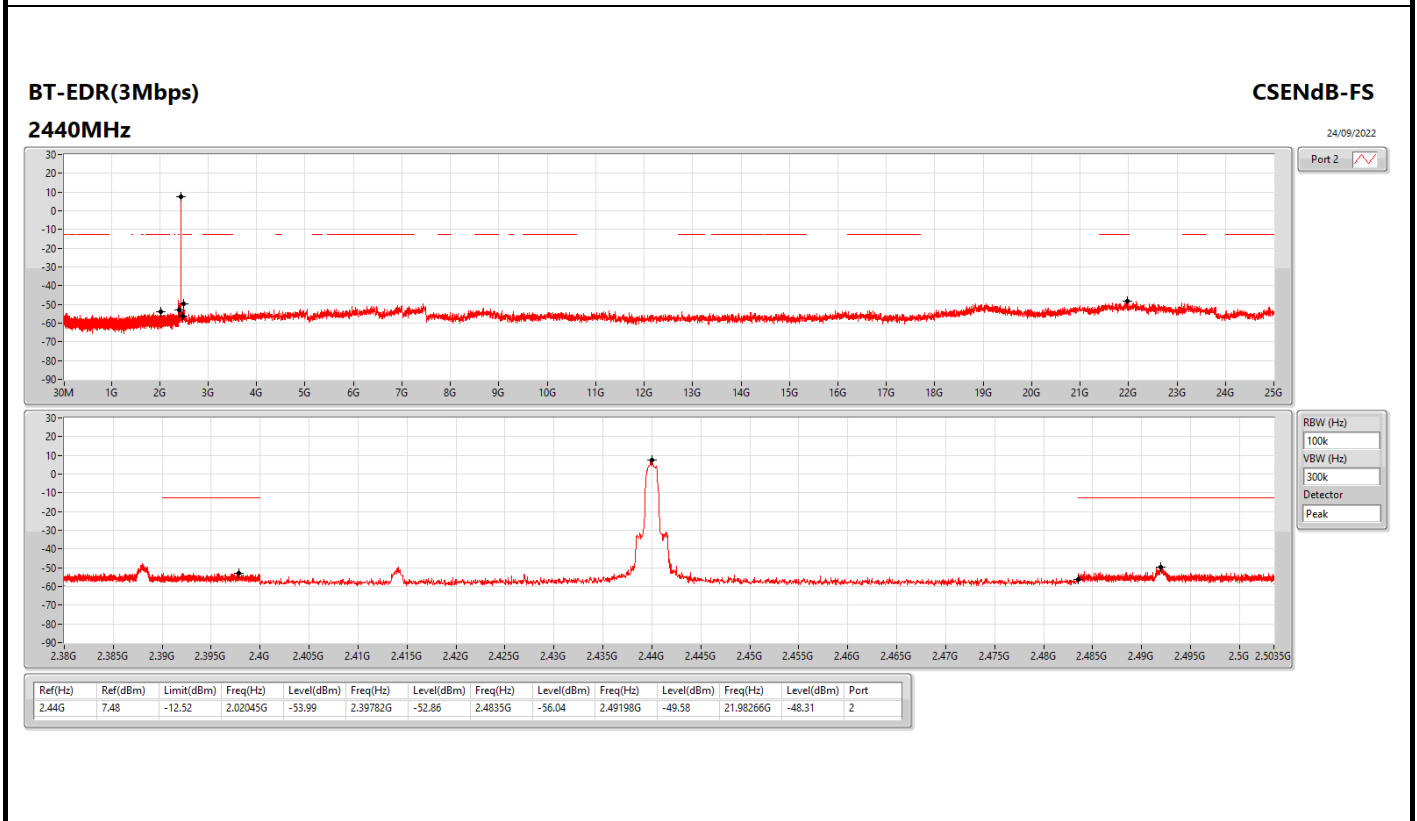
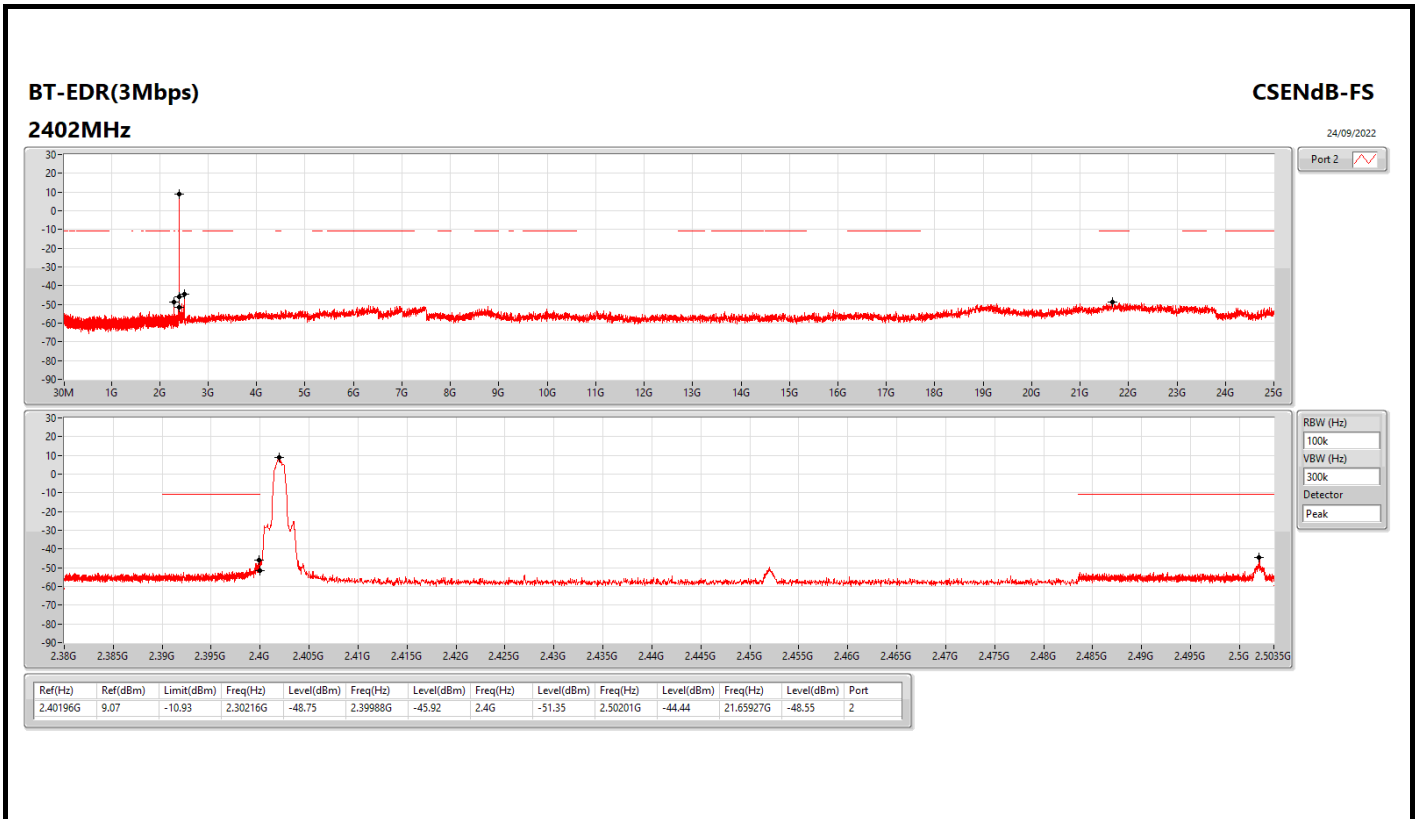

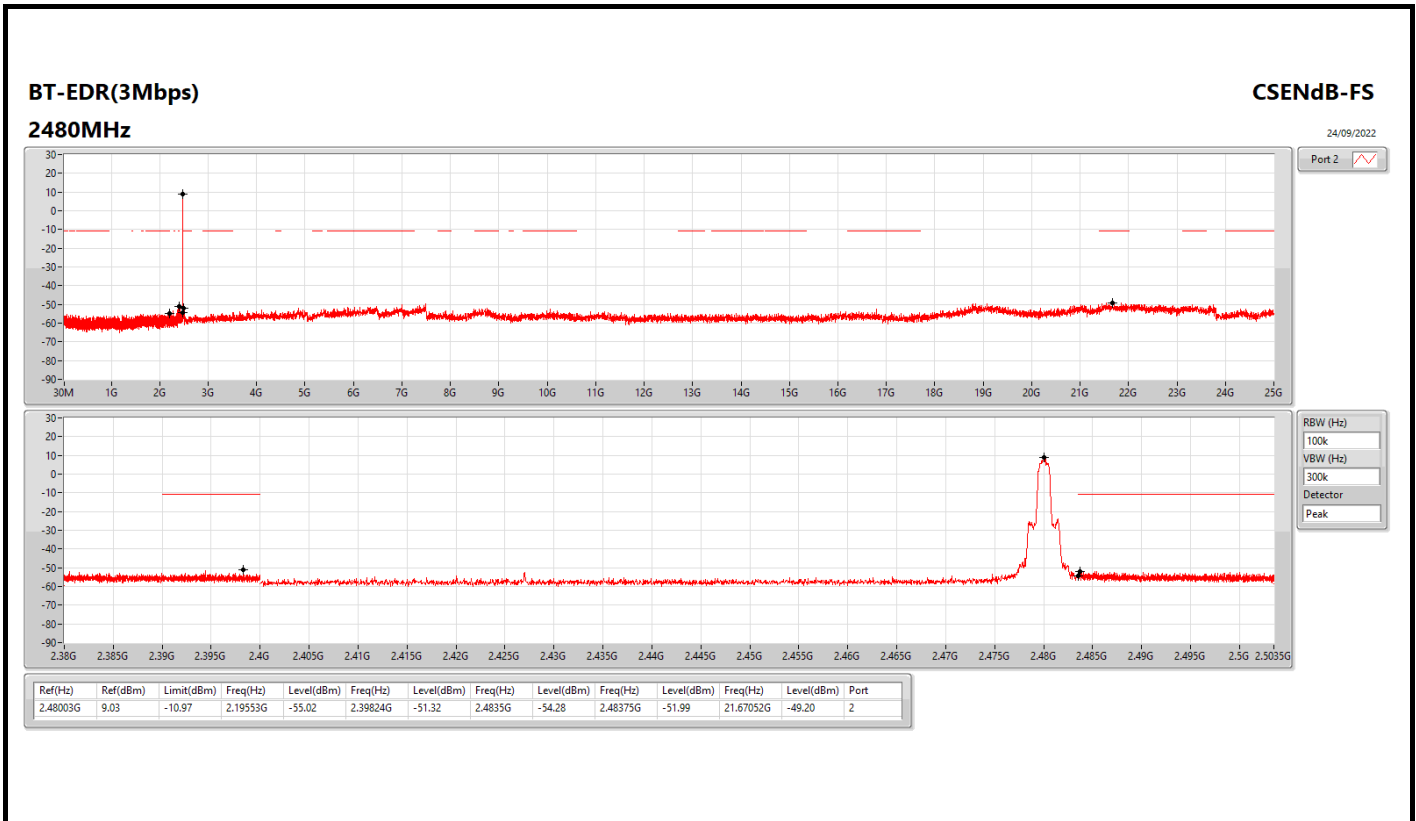



Summary

Mode	Result	Type	Freq (Hz)	Level (dBuV/m)	Limit (dBuV/m)	Margin (dB)	Condition
Mode 9	Pass	QP	48.43M	35.98	40.00	-4.02	Vertical

Mode 9

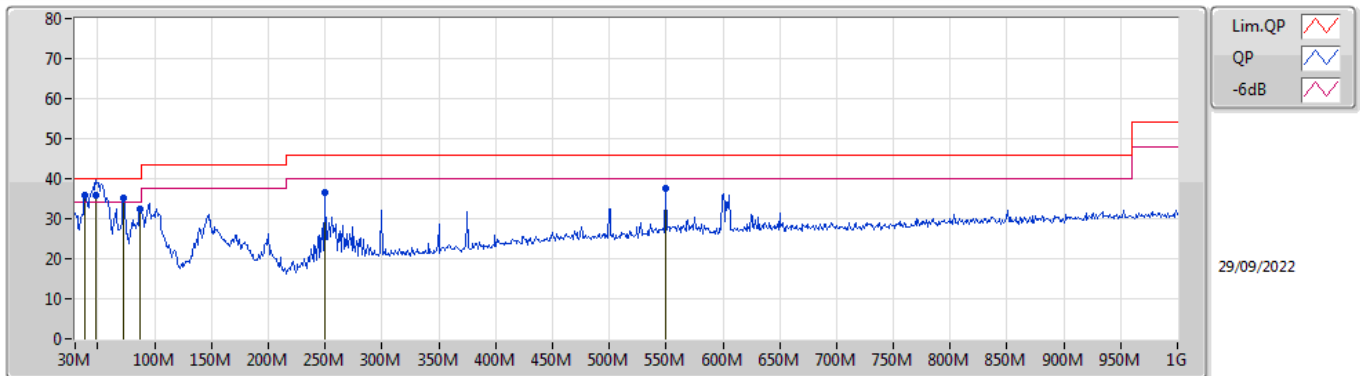

Type	Freq (Hz)	Level (dBuV/m)	Limit (dBuV/m)	Margin (dB)	Factor (dB/m)	Dist (m)	Condition	Azimuth (°)	Height (m)	Comment	Raw (dBuV/m)	AF (dB/m)	CL (dB)	PA (dB)
PK	38.73M	35.92	40.00	-4.08	-11.48	3	Vertical	306	1.00	-	47.40	19.35	0.90	31.73
QP	48.43M	35.98	40.00	-4.02	-16.19	3	Vertical	314	1.00	"Worst"	52.17	14.59	1.07	31.85
PK	72.68M	35.08	40.00	-4.92	-18.50	3	Vertical	72	2.00	-	53.58	12.17	1.30	31.97
PK	87.23M	32.46	40.00	-7.54	-16.49	3	Vertical	331	1.00	-	48.95	14.02	1.44	31.95
PK	250.19M	36.49	46.00	-9.51	-11.28	3	Vertical	0	1.25	-	47.77	18.22	2.50	32.00
PK	549.92M	37.75	46.00	-8.25	-4.10	3	Vertical	170	1.00	-	41.85	24.48	3.80	32.38

Mode 9

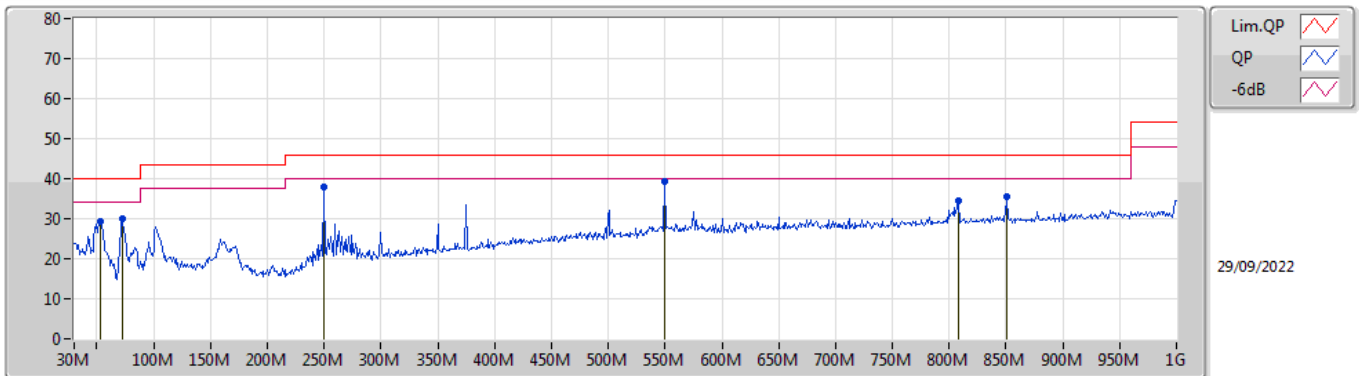

Type	Freq (Hz)	Level (dBuV/m)	Limit (dBuV/m)	Margin (dB)	Factor (dB/m)	Dist (m)	Condition	Azimuth (°)	Height (m)	Comment	Raw (dBuV/m)	AF (dB/m)	CL (dB)	PA (dB)
PK	53.28M	29.39	40.00	-10.61	-17.82	3	Horizontal	89	1.25	-	47.21	12.96	1.10	31.88
PK	72.68M	29.91	40.00	-10.09	-18.50	3	Horizontal	359	1.00	-	48.41	12.17	1.30	31.97
PK	250.19M	37.99	46.00	-8.01	-11.28	3	Horizontal	49	1.50	-	49.27	18.22	2.50	32.00
PK	549.92M	39.19	46.00	-6.81	-4.10	3	Horizontal	85	2.00	"Worst"	43.29	24.48	3.80	32.38
PK	807.94M	34.42	46.00	-11.58	-2.03	3	Horizontal	141	1.00	-	36.45	25.55	4.93	32.51
PK	850.62M	35.53	46.00	-10.47	-1.51	3	Horizontal	87	2.00	-	37.04	25.88	5.10	32.49



Summary

Mode	Result	Type	Freq (Hz)	Level (dBuV/m)	Limit (dBuV/m)	Margin (dB)	Dist (m)	Condition	Azimuth (°)	Height (m)	Comments
2.4-2.4835GHz	-	-	-	-	-	-	-	-	-	-	-
BT-BR(1Mbps)	Pass	AV	2.4835G	53.45	54.00	-0.55	3	Vertical	72	2.79	-

BT-BR(1Mbps)

2402MHz_TX

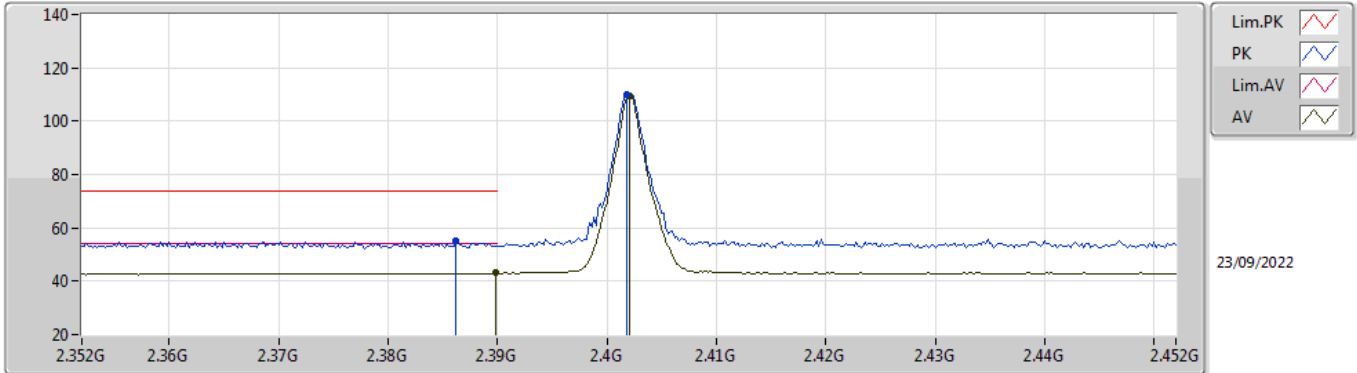

EUT_Z_1TX
Setting 9
01-A-B-5

Type	Freq (Hz)	Level (dBuV/m)	Limit (dBuV/m)	Margin (dB)	Raw (dBuV)	Dist (m)	Condition	Azimuth (°)	Height (m)	Comment	AF (dB)	CL (dB)	PA (dB)
PK	2.3862G	55.13	74.00	-18.87	23.80	3	Vertical	60	3.00	-	27.54	3.79	-
AV	2.3898G	43.13	54.00	-10.87	11.78	3	Vertical	60	3.00	-	27.56	3.79	-
PK	2.4018G	110.15	Inf	-Inf	78.75	3	Vertical	60	3.00	-	27.60	3.80	-
AV	2.402G	109.35	Inf	-Inf	77.95	3	Vertical	60	3.00	-	27.60	3.80	-

BT-BR(1Mbps)

2402MHz_TX

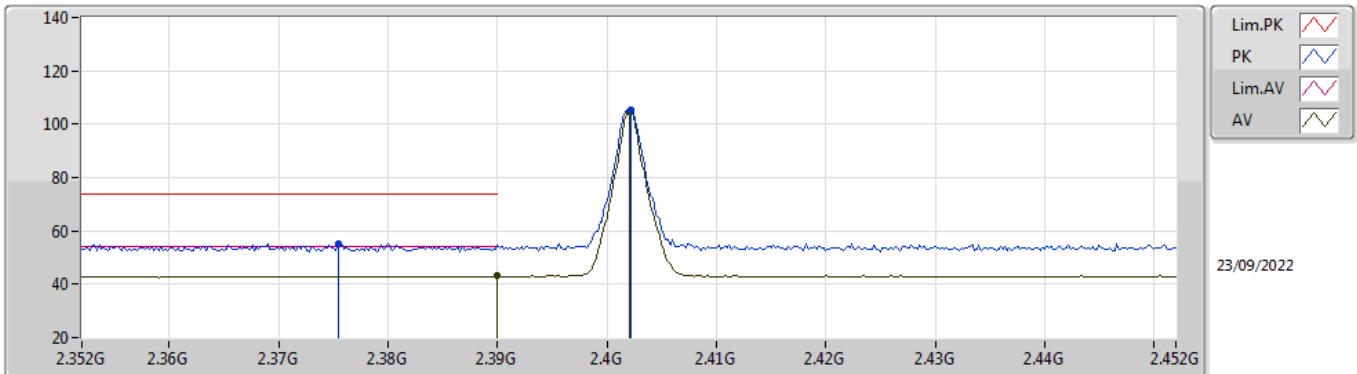

EUT Z_1TX
Setting 9
01-A-B-5

Type	Freq (Hz)	Level (dBuV/m)	Limit (dBuV/m)	Margin (dB)	Raw (dBuV)	Dist (m)	Condition	Azimuth (°)	Height (m)	Comment	AF (dB)	CL (dB)	PA (dB)
PK	2.3754G	55.18	74.00	-18.82	23.90	3	Horizontal	264	2.97	-	27.50	3.78	-
AV	2.39G	43.04	54.00	-10.96	11.69	3	Horizontal	264	2.97	-	27.56	3.79	-
PK	2.4022G	105.40	Inf	-Inf	74.00	3	Horizontal	264	2.97	-	27.60	3.80	-
AV	2.402G	104.57	Inf	-Inf	73.17	3	Horizontal	264	2.97	-	27.60	3.80	-

BT-BR(1Mbps)

2402MHz_TX

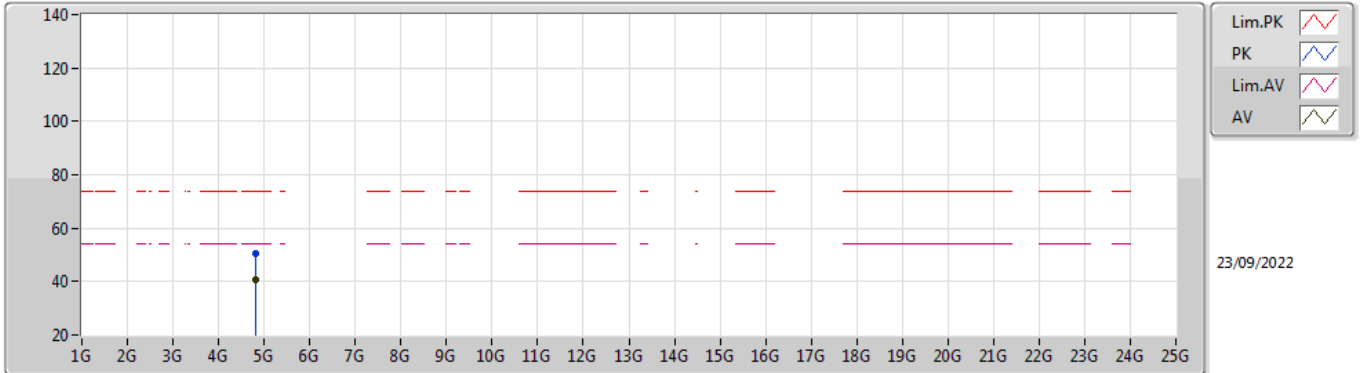

EUT_Z_1TX
Setting 9
01-A-B-5

Type	Freq (Hz)	Level (dBuV/m)	Limit (dBuV/m)	Margin (dB)	Raw (dBuV)	Dist (m)	Condition	Azimuth (°)	Height (m)	Comment	AF (dB)	CL (dB)	PA (dB)
PK	4.8039G	50.51	74.00	-23.49	44.79	3	Vertical	332	2.43	-	32.41	6.20	32.89
AV	4.80403G	40.75	54.00	-13.25	35.03	3	Vertical	332	2.43	-	32.41	6.20	32.89

BT-BR(1Mbps)

2402MHz_TX

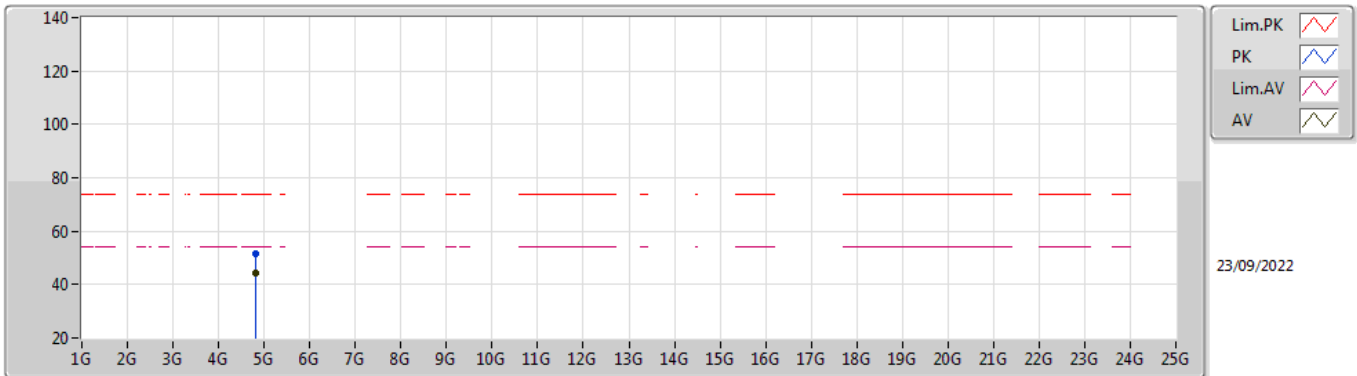

EUT_Z_1TX
Setting 9
01-A-B-5

Type	Freq (Hz)	Level (dBuV/m)	Limit (dBuV/m)	Margin (dB)	Raw (dBuV)	Dist (m)	Condition	Azimuth (°)	Height (m)	Comment	AF (dB)	CL (dB)	PA (dB)
PK	4.80427G	51.65	74.00	-22.35	45.93	3	Horizontal	32	2.90	-	32.41	6.20	32.89
AV	4.80399G	44.14	54.00	-9.86	38.42	3	Horizontal	32	2.90	-	32.41	6.20	32.89

BT-BR(1Mbps)

2440MHz_TX

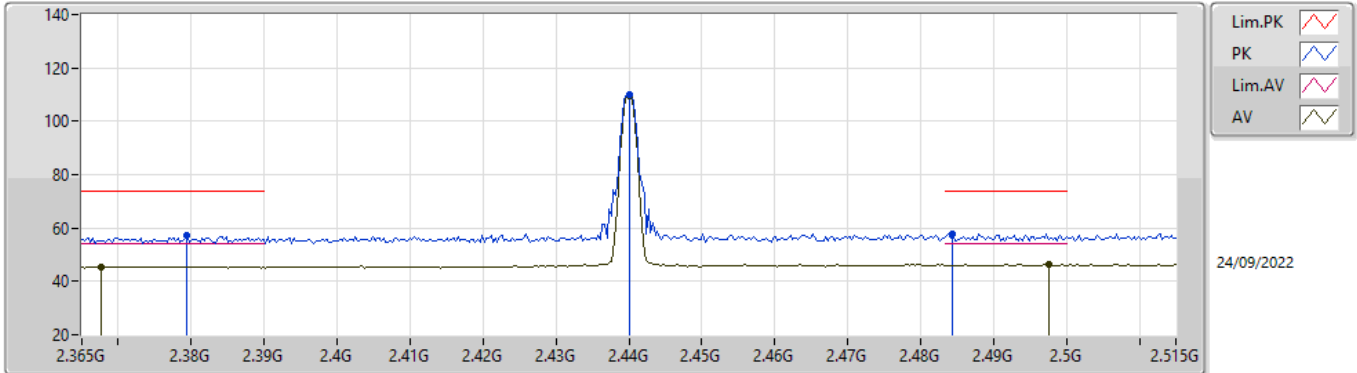

EUT_Z_1TX
Setting 9
04-A-S-5

Type	Freq (Hz)	Level (dBuV/m)	Limit (dBuV/m)	Margin (dB)	Raw (dBuV)	Dist (m)	Condition	Azimuth (°)	Height (m)	Comment	AF (dB)	CL (dB)	PA (dB)
PK	2.3794G	57.11	74.00	-16.89	26.86	3	Vertical	89	2.62	-	27.46	2.79	-
AV	2.3677G	45.39	54.00	-8.61	15.17	3	Vertical	89	2.62	-	27.44	2.78	-
PK	2.44G	110.11	Inf	-Inf	79.71	3	Vertical	89	2.62	-	27.58	2.82	-
AV	2.44G	109.74	Inf	-Inf	79.34	3	Vertical	89	2.62	-	27.58	2.82	-
PK	2.4844G	57.74	74.00	-16.26	27.09	3	Vertical	89	2.62	-	27.81	2.84	-
AV	2.4976G	46.23	54.00	-7.77	15.49	3	Vertical	89	2.62	-	27.89	2.85	-

BT-BR(1Mbps)

2440MHz_TX

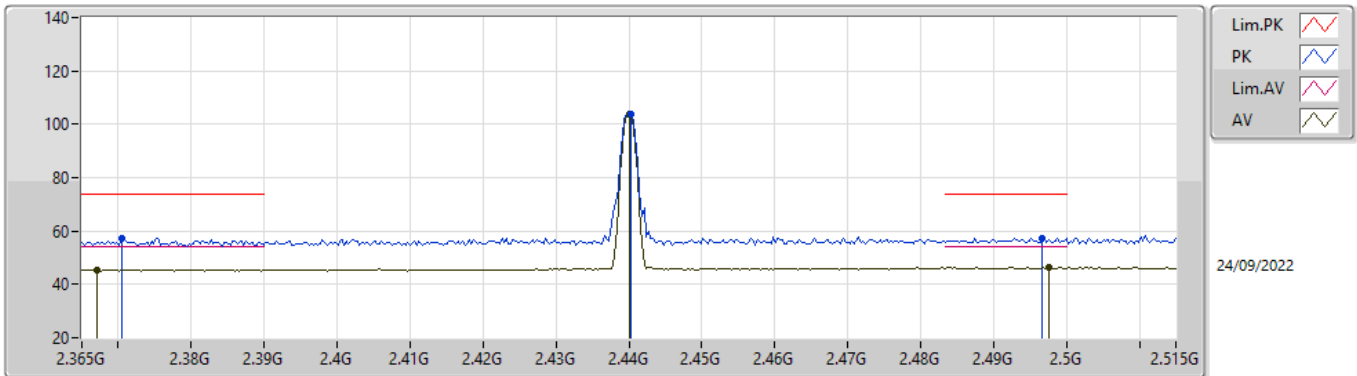

EUT_Z1TX
Setting 9
04-A-S-5

Type	Freq (Hz)	Level (dBuV/m)	Limit (dBuV/m)	Margin (dB)	Raw (dBuV)	Dist (m)	Condition	Azimuth (°)	Height (m)	Comment	AF (dB)	CL (dB)	PA (dB)
PK	2.3704G	57.20	74.00	-16.80	26.97	3	Horizontal	319	2.66	-	27.44	2.79	-
AV	2.3671G	45.38	54.00	-8.62	15.17	3	Horizontal	319	2.66	-	27.43	2.78	-
PK	2.4403G	103.95	Inf	-Inf	73.55	3	Horizontal	319	2.66	-	27.58	2.82	-
AV	2.44G	103.56	Inf	-Inf	73.16	3	Horizontal	319	2.66	-	27.58	2.82	-
PK	2.4967G	57.49	74.00	-16.51	26.76	3	Horizontal	319	2.66	-	27.88	2.85	-
AV	2.4976G	46.23	54.00	-7.77	15.49	3	Horizontal	319	2.66	-	27.89	2.85	-

BT-BR(1Mbps)

2440MHz_TX

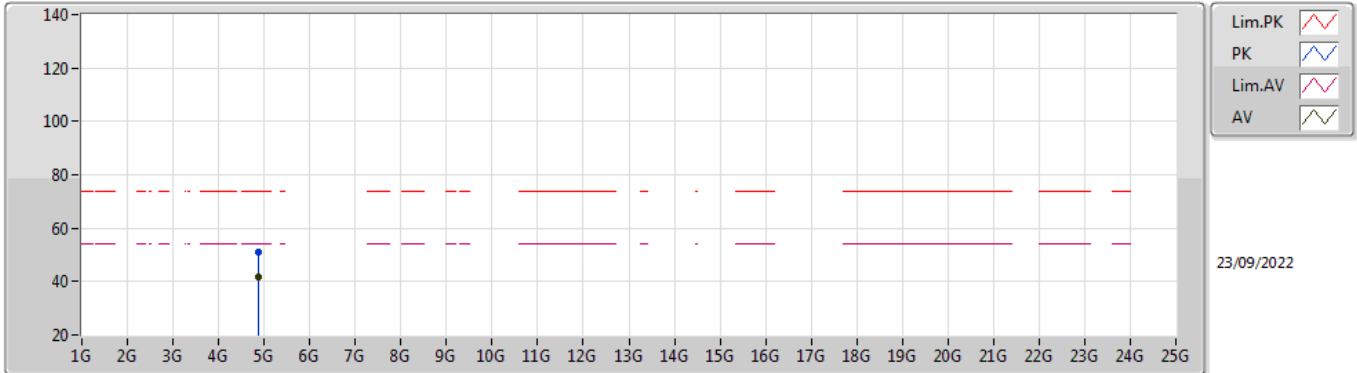

EUT_Z_1TX
Setting 9
01-A-B-5

Type	Freq (Hz)	Level (dBuV/m)	Limit (dBuV/m)	Margin (dB)	Raw (dBuV)	Dist (m)	Condition	Azimuth (°)	Height (m)	Comment	AF (dB)	CL (dB)	PA (dB)
PK	4.88041G	51.28	74.00	-22.72	45.31	3	Vertical	85	2.47	-	32.56	6.28	32.87
AV	4.87999G	41.97	54.00	-12.03	36.00	3	Vertical	85	2.47	-	32.56	6.28	32.87

BT-BR(1Mbps)

2440MHz_TX

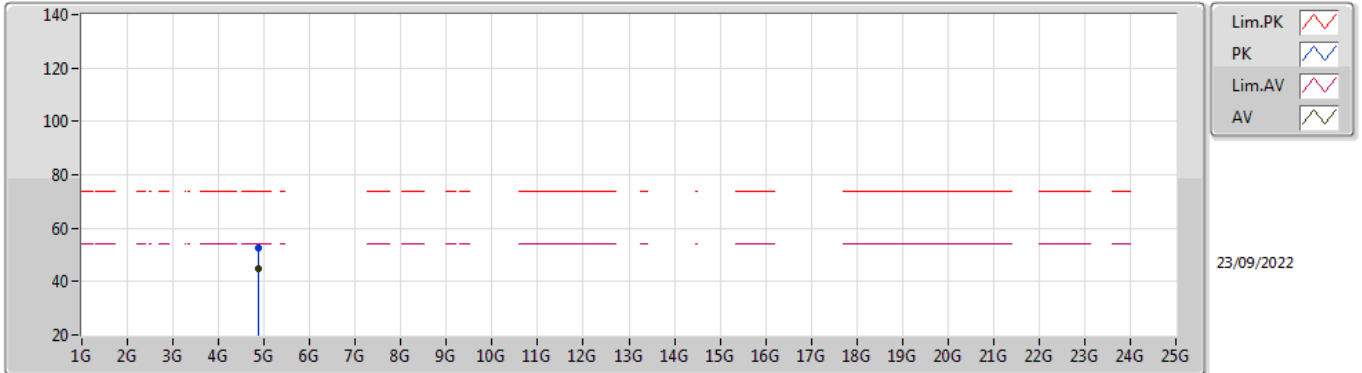

EUT_Z_1TX
Setting 9
01-A-B-5

Type	Freq (Hz)	Level (dBuV/m)	Limit (dBuV/m)	Margin (dB)	Raw (dBuV)	Dist (m)	Condition	Azimuth (°)	Height (m)	Comment	AF (dB)	CL (dB)	PA (dB)
PK	4.88007G	52.39	74.00	-21.61	46.42	3	Horizontal	34	2.83	-	32.56	6.28	32.87
AV	4.87998G	44.65	54.00	-9.35	38.68	3	Horizontal	34	2.83	-	32.56	6.28	32.87

BT-BR(1Mbps)

2480MHz_TX

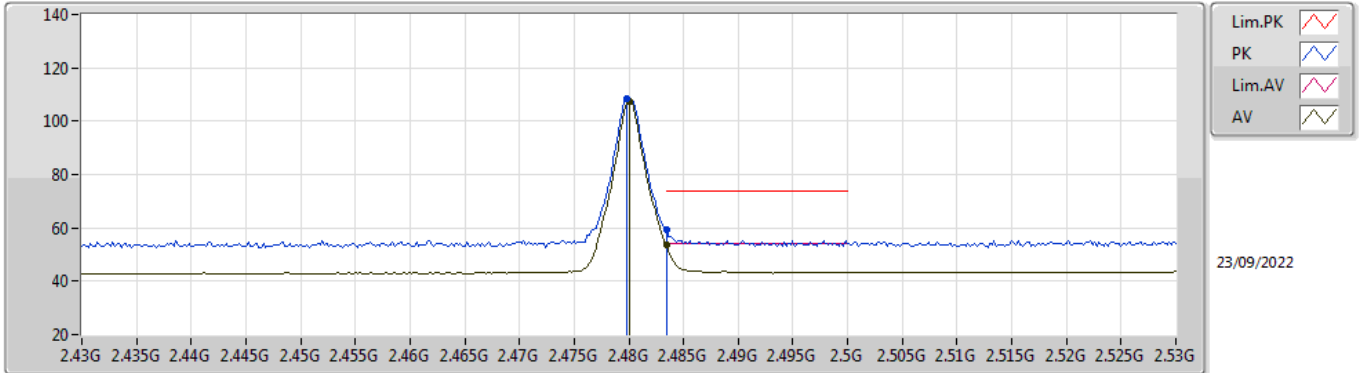

EUT_Z_1TX
Setting 8
01-A-B-5

Type	Freq (Hz)	Level (dBuV/m)	Limit (dBuV/m)	Margin (dB)	Raw (dBuV)	Dist (m)	Condition	Azimuth (°)	Height (m)	Comment	AF (dB)	CL (dB)	PA (dB)
PK	2.4798G	108.28	Inf	-Inf	76.76	3	Vertical	72	2.79	-	27.68	3.84	-
AV	2.48G	107.45	Inf	-Inf	75.93	3	Vertical	72	2.79	-	27.68	3.84	-
PK	2.4835G	59.20	74.00	-14.80	27.66	3	Vertical	72	2.79	-	27.70	3.84	-
AV	2.4835G	53.45	54.00	-0.55	21.91	3	Vertical	72	2.79	-	27.70	3.84	-

BT-BR(1Mbps)

2480MHz_TX

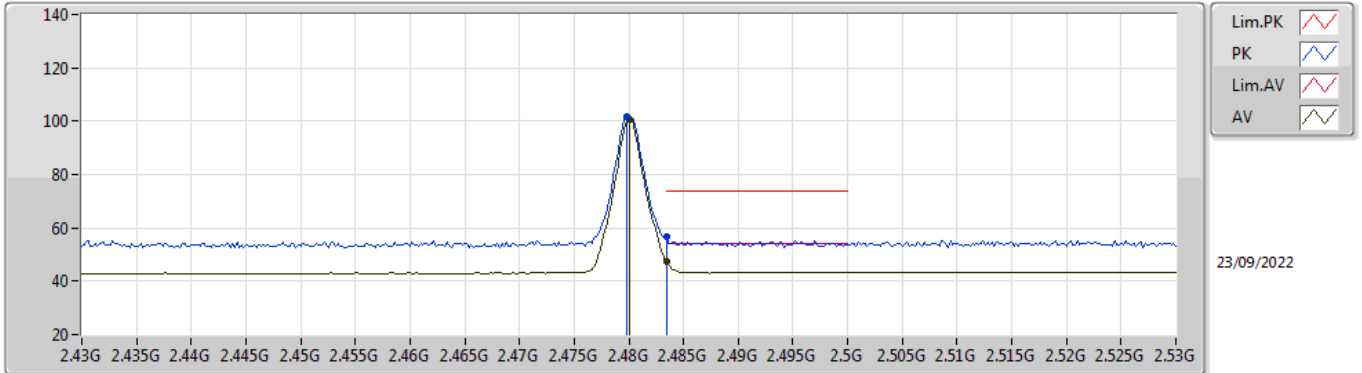

EUT_Z_1TX
Setting 8
01-A-B-5

Type	Freq (Hz)	Level (dBuV/m)	Limit (dBuV/m)	Margin (dB)	Raw (dBuV)	Dist (m)	Condition	Azimuth (°)	Height (m)	Comment	AF (dB)	CL (dB)	PA (dB)
PK	2.4798G	101.67	Inf	-Inf	70.15	3	Horizontal	262	2.86	-	27.68	3.84	-
AV	2.48G	100.79	Inf	-Inf	69.27	3	Horizontal	262	2.86	-	27.68	3.84	-
PK	2.4835G	56.58	74.00	-17.42	25.04	3	Horizontal	262	2.86	-	27.70	3.84	-
AV	2.4835G	47.53	54.00	-6.47	15.99	3	Horizontal	262	2.86	-	27.70	3.84	-

BT-BR(1Mbps)

2480MHz_TX

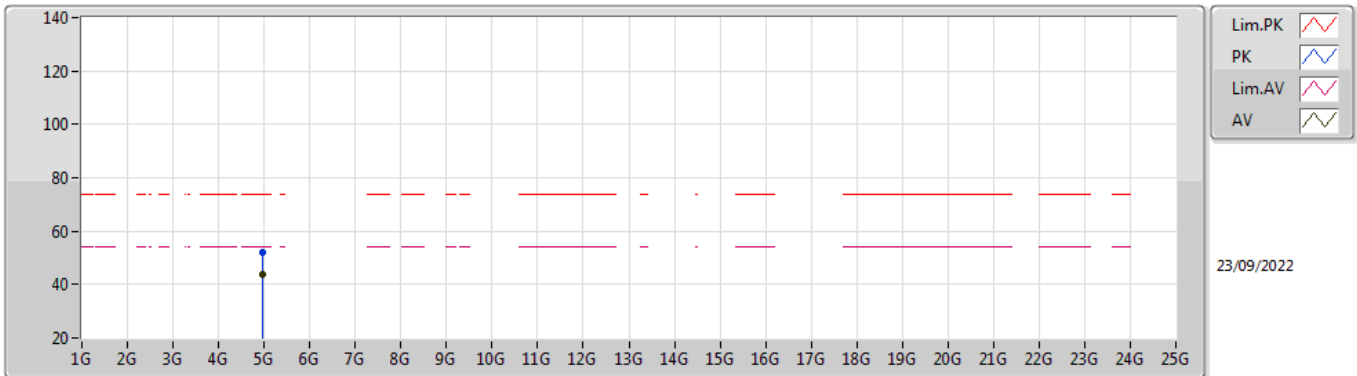

EUT_Z_1TX
Setting 8
01-A-B-5

Type	Freq (Hz)	Level (dBuV/m)	Limit (dBuV/m)	Margin (dB)	Raw (dBuV)	Dist (m)	Condition	Azimuth (°)	Height (m)	Comment	AF (dB)	CL (dB)	PA (dB)
PK	4.96008G	51.89	74.00	-22.11	45.63	3	Vertical	58	2.27	-	32.76	6.36	32.86
AV	4.95999G	43.64	54.00	-10.36	37.38	3	Vertical	58	2.27	-	32.76	6.36	32.86

BT-BR(1Mbps)

2480MHz_TX

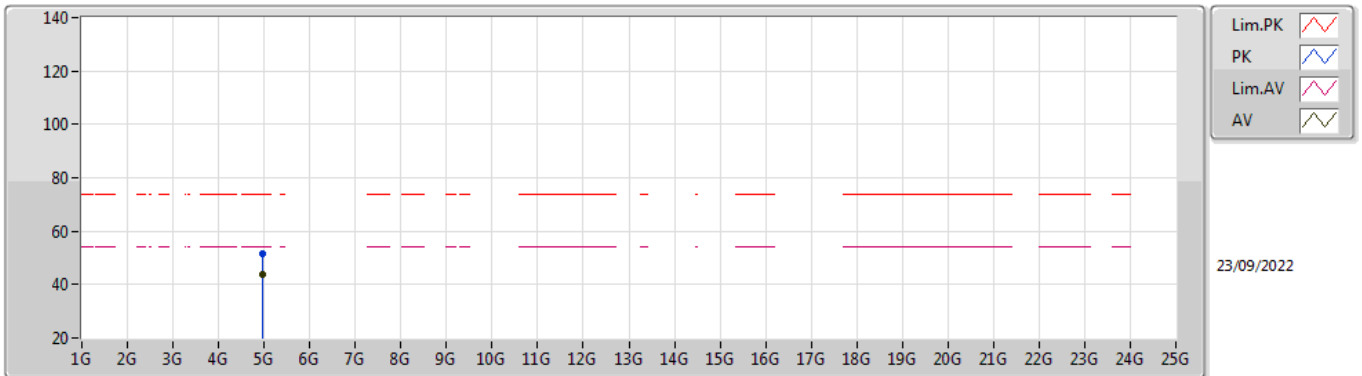

EUT_Z_1TX
Setting 8
01-A-B-5

Type	Freq (Hz)	Level (dBuV/m)	Limit (dBuV/m)	Margin (dB)	Raw (dBuV)	Dist (m)	Condition	Azimuth (°)	Height (m)	Comment	AF (dB)	CL (dB)	PA (dB)
PK	4.95975G	51.79	74.00	-22.21	45.53	3	Horizontal	33	2.47	-	32.76	6.36	32.86
AV	4.95997G	43.83	54.00	-10.17	37.57	3	Horizontal	33	2.47	-	32.76	6.36	32.86

BT-EDR(3Mbps)

2402MHz_TX

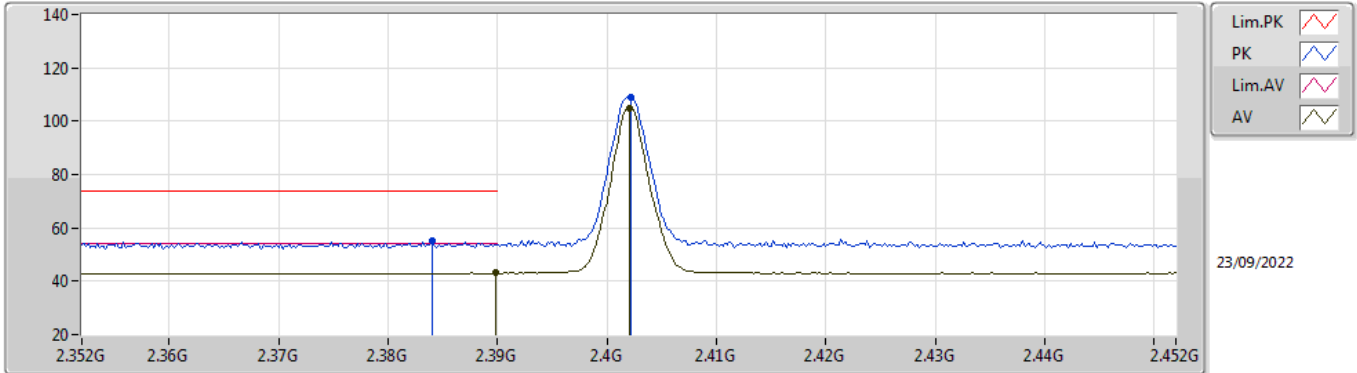

EUT_Z_1TX
Setting 9
01-A-B-5

Type	Freq (Hz)	Level (dBuV/m)	Limit (dBuV/m)	Margin (dB)	Raw (dBuV)	Dist (m)	Condition	Azimuth (°)	Height (m)	Comment	AF (dB)	CL (dB)	PA (dB)
PK	2.384G	55.20	74.00	-18.80	23.88	3	Vertical	59	2.94	-	27.54	3.78	-
AV	2.3898G	43.06	54.00	-10.94	11.71	3	Vertical	59	2.94	-	27.56	3.79	-
PK	2.4022G	108.92	Inf	-Inf	77.52	3	Vertical	59	2.94	-	27.60	3.80	-
AV	2.402G	105.06	Inf	-Inf	73.66	3	Vertical	59	2.94	-	27.60	3.80	-

BT-EDR(3Mbps)

2402MHz_TX

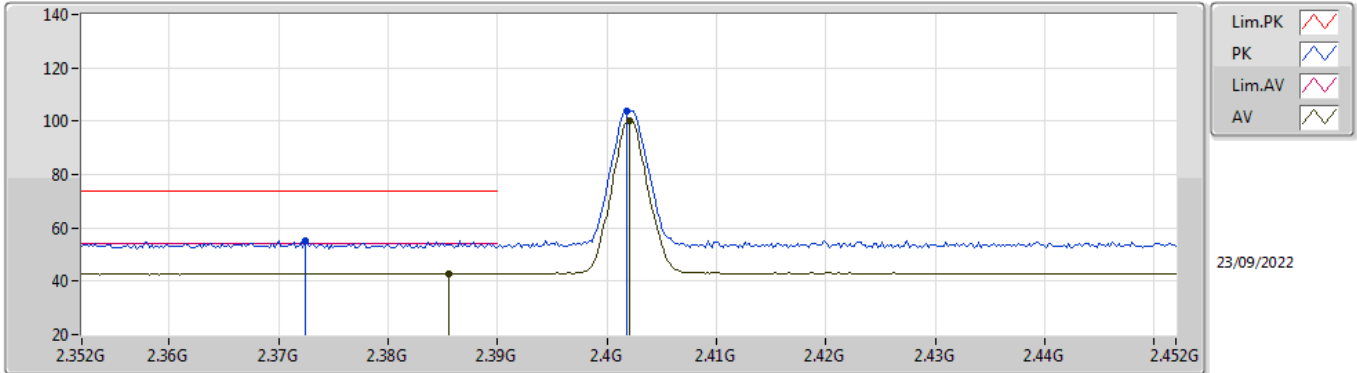

EUT_Z_1TX
Setting 9
01-A-B-5

Type	Freq (Hz)	Level (dBuV/m)	Limit (dBuV/m)	Margin (dB)	Raw (dBuV)	Dist (m)	Condition	Azimuth (°)	Height (m)	Comment	AF (dB)	CL (dB)	PA (dB)
PK	2.3724G	55.11	74.00	-18.89	23.85	3	Horizontal	265	2.97	-	27.49	3.77	-
AV	2.3856G	42.98	54.00	-11.02	11.65	3	Horizontal	265	2.97	-	27.54	3.79	-
PK	2.4018G	103.91	Inf	-Inf	72.51	3	Horizontal	265	2.97	-	27.60	3.80	-
AV	2.402G	100.13	Inf	-Inf	68.73	3	Horizontal	265	2.97	-	27.60	3.80	-

BT-EDR(3Mbps)

2402MHz_TX

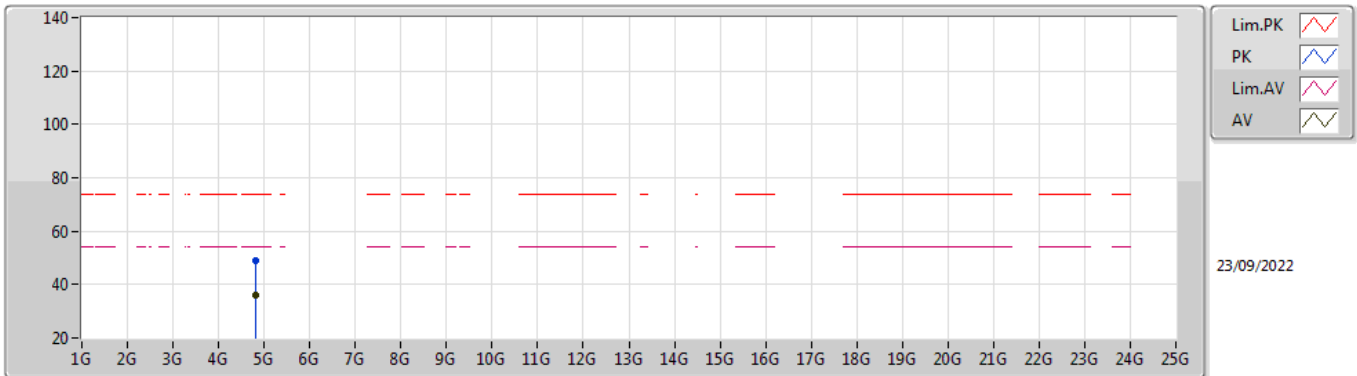

EUT_Z_1TX
Setting 9
01-A-B-5

Type	Freq (Hz)	Level (dBuV/m)	Limit (dBuV/m)	Margin (dB)	Raw (dBuV)	Dist (m)	Condition	Azimuth (°)	Height (m)	Comment	AF (dB)	CL (dB)	PA (dB)
PK	4.80484G	49.09	74.00	-24.91	43.37	3	Vertical	335	2.53	-	32.41	6.20	32.89
AV	4.80406G	35.95	54.00	-18.05	30.23	3	Vertical	335	2.53	-	32.41	6.20	32.89

BT-EDR(3Mbps)

2402MHz_TX

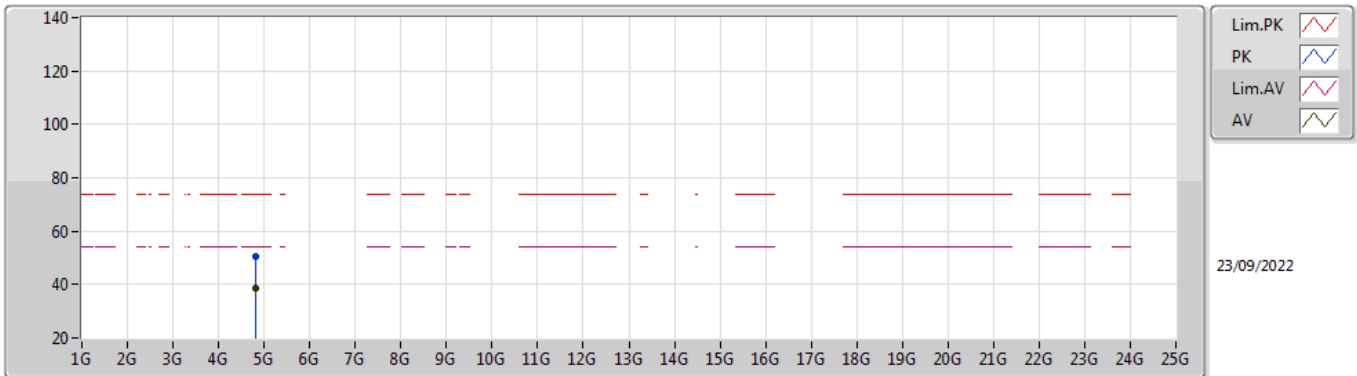

EUT_Z_1TX
Setting 9
01-A-B-5

Type	Freq (Hz)	Level (dBuV/m)	Limit (dBuV/m)	Margin (dB)	Raw (dBuV)	Dist (m)	Condition	Azimuth (°)	Height (m)	Comment	AF (dB)	CL (dB)	PA (dB)
PK	4.80416G	50.44	74.00	-23.56	44.72	3	Horizontal	32	2.89	-	32.41	6.20	32.89
AV	4.80398G	38.52	54.00	-15.48	32.80	3	Horizontal	32	2.89	-	32.41	6.20	32.89

BT-EDR(3Mbps)

2440MHz_TX

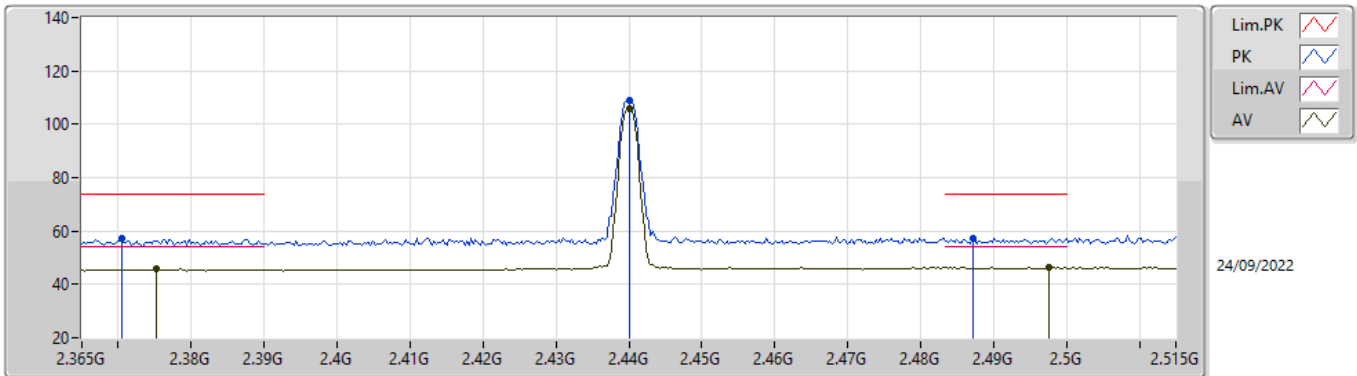

EUT_Z_1TX
Setting 9
04-A-S-5

Type	Freq (Hz)	Level (dBuV/m)	Limit (dBuV/m)	Margin (dB)	Raw (dBuV)	Dist (m)	Condition	Azimuth (°)	Height (m)	Comment	AF (dB)	CL (dB)	PA (dB)
PK	2.3704G	57.26	74.00	-16.74	27.03	3	Vertical	90	2.63	-	27.44	2.79	-
AV	2.3752G	45.62	54.00	-8.38	15.38	3	Vertical	90	2.63	-	27.45	2.79	-
PK	2.44G	108.87	Inf	-Inf	78.47	3	Vertical	90	2.63	-	27.58	2.82	-
AV	2.44G	105.62	Inf	-Inf	75.22	3	Vertical	90	2.63	-	27.58	2.82	-
PK	2.4871G	57.25	74.00	-16.75	26.59	3	Vertical	90	2.63	-	27.82	2.84	-
AV	2.4976G	46.23	54.00	-7.77	15.49	3	Vertical	90	2.63	-	27.89	2.85	-

BT-EDR(3Mbps)

2440MHz_TX

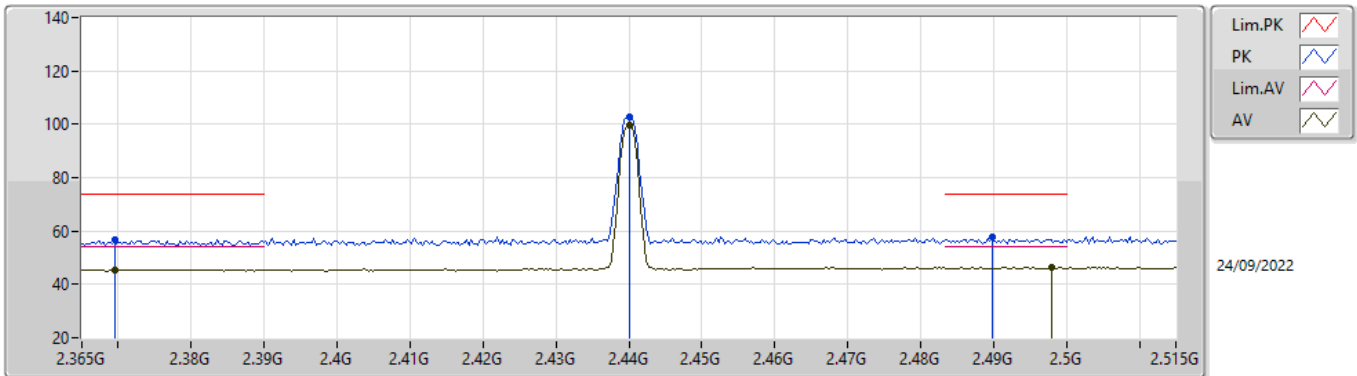

EUT_Z_1TX
Setting 9
04-A-S-5

Type	Freq (Hz)	Level (dBuV/m)	Limit (dBuV/m)	Margin (dB)	Raw (dBuV)	Dist (m)	Condition	Azimuth (°)	Height (m)	Comment	AF (dB)	CL (dB)	PA (dB)
PK	2.3695G	56.92	74.00	-17.08	26.70	3	Horizontal	317	2.67	-	27.44	2.78	-
AV	2.3695G	45.38	54.00	-8.62	15.16	3	Horizontal	317	2.67	-	27.44	2.78	-
PK	2.44G	102.69	Inf	-Inf	72.29	3	Horizontal	317	2.67	-	27.58	2.82	-
AV	2.44G	99.48	Inf	-Inf	69.08	3	Horizontal	317	2.67	-	27.58	2.82	-
PK	2.4898G	57.54	74.00	-16.46	26.86	3	Horizontal	317	2.67	-	27.84	2.84	-
AV	2.4979G	46.23	54.00	-7.77	15.49	3	Horizontal	317	2.67	-	27.89	2.85	-

BT-EDR(3Mbps)

2440MHz_TX

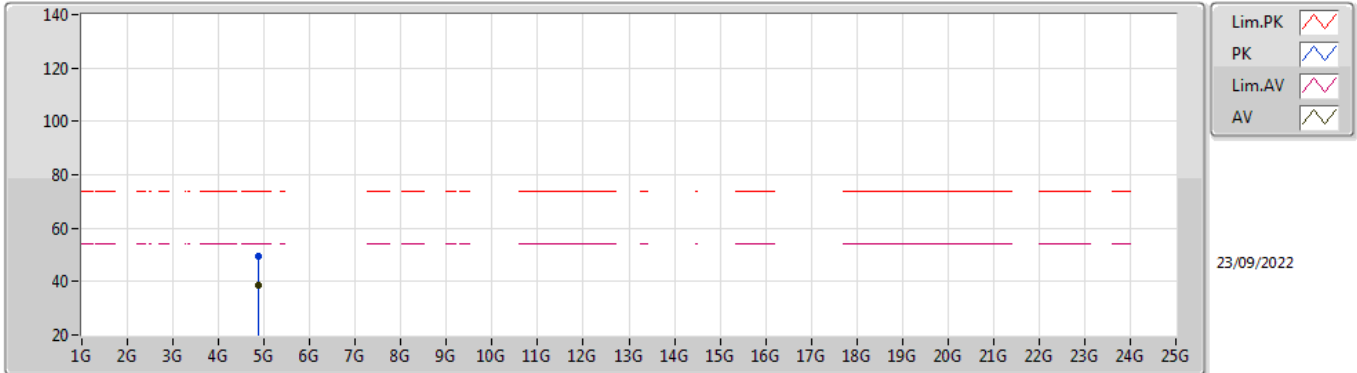

EUT_Z_1TX
Setting 9
01-A-B-5

Type	Freq (Hz)	Level (dBuV/m)	Limit (dBuV/m)	Margin (dB)	Raw (dBuV)	Dist (m)	Condition	Azimuth (°)	Height (m)	Comment	AF (dB)	CL (dB)	PA (dB)
PK	4.87929G	49.73	74.00	-24.27	43.76	3	Vertical	56	2.52	-	32.56	6.28	32.87
AV	4.87996G	38.58	54.00	-15.42	32.61	3	Vertical	56	2.52	-	32.56	6.28	32.87

BT-EDR(3Mbps)

2440MHz_TX

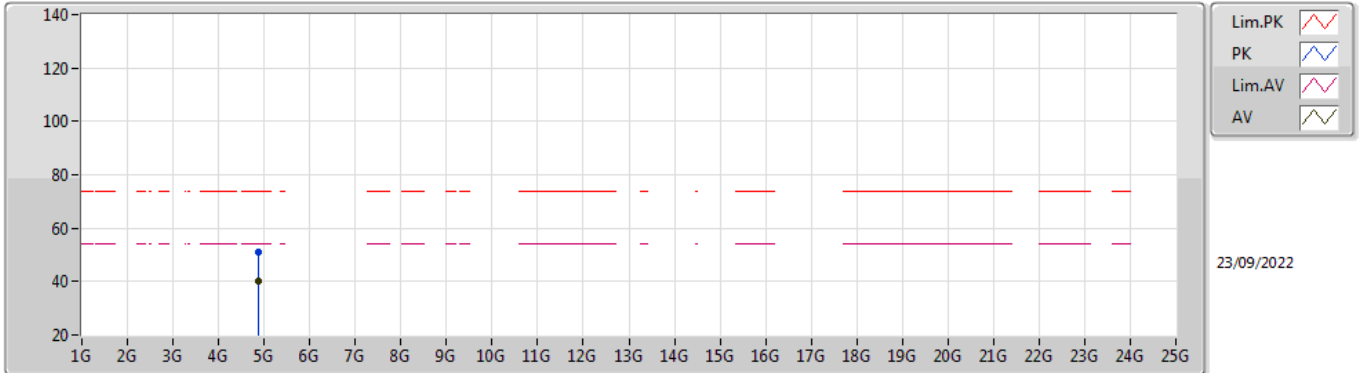

EUT_Z_1TX
Setting 9
01-A-B-5

Type	Freq (Hz)	Level (dBuV/m)	Limit (dBuV/m)	Margin (dB)	Raw (dBuV)	Dist (m)	Condition	Azimuth (°)	Height (m)	Comment	AF (dB)	CL (dB)	PA (dB)
PK	4.88021G	51.21	74.00	-22.79	45.24	3	Horizontal	26	2.81	-	32.56	6.28	32.87
AV	4.88006G	40.40	54.00	-13.60	34.43	3	Horizontal	26	2.81	-	32.56	6.28	32.87

BT-EDR(3Mbps)

2480MHz_TX

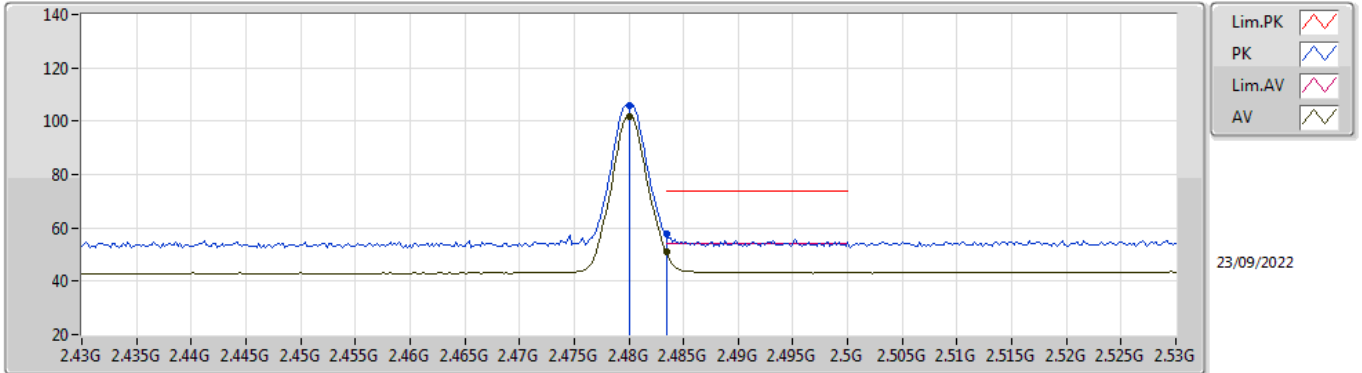

EUT_Z_1TX
Setting 8
01-A-B-5

Type	Freq (Hz)	Level (dBuV/m)	Limit (dBuV/m)	Margin (dB)	Raw (dBuV)	Dist (m)	Condition	Azimuth (°)	Height (m)	Comment	AF (dB)	CL (dB)	PA (dB)
PK	2.48G	105.98	Inf	-Inf	74.46	3	Vertical	74	2.81	-	27.68	3.84	-
AV	2.48G	101.85	Inf	-Inf	70.33	3	Vertical	74	2.81	-	27.68	3.84	-
PK	2.4835G	57.99	74.00	-16.01	26.45	3	Vertical	74	2.81	-	27.70	3.84	-
AV	2.4835G	50.83	54.00	-3.17	19.29	3	Vertical	74	2.81	-	27.70	3.84	-

BT-EDR(3Mbps)

2480MHz_TX

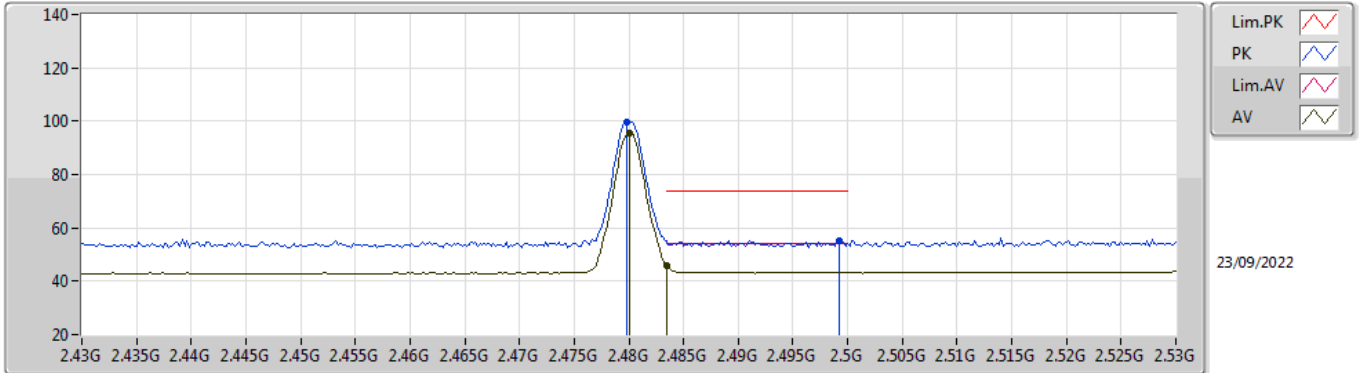

EUT_Z_1TX
Setting 8
01-A-B-5

Type	Freq (Hz)	Level (dBuV/m)	Limit (dBuV/m)	Margin (dB)	Raw (dBuV)	Dist (m)	Condition	Azimuth (°)	Height (m)	Comment	AF (dB)	CL (dB)	PA (dB)
PK	2.4798G	99.57	Inf	-Inf	68.05	3	Horizontal	262	2.86	-	27.68	3.84	-
AV	2.48G	95.39	Inf	-Inf	63.87	3	Horizontal	262	2.86	-	27.68	3.84	-
PK	2.4992G	55.37	74.00	-18.63	23.72	3	Horizontal	262	2.86	-	27.80	3.85	-
AV	2.4835G	46.07	54.00	-7.93	14.53	3	Horizontal	262	2.86	-	27.70	3.84	-

BT-EDR(3Mbps)

2480MHz_TX

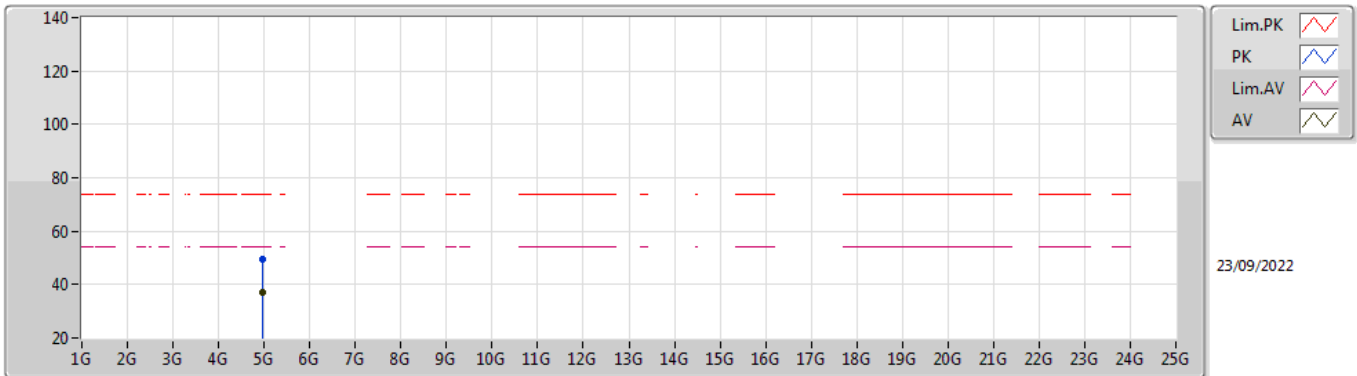

EUT_Z_1TX
Setting 8
01-A-B-5

Type	Freq (Hz)	Level (dBuV/m)	Limit (dBuV/m)	Margin (dB)	Raw (dBuV)	Dist (m)	Condition	Azimuth (°)	Height (m)	Comment	AF (dB)	CL (dB)	PA (dB)
PK	4.96025G	49.62	74.00	-24.38	43.36	3	Vertical	58	2.42	-	32.76	6.36	32.86
AV	4.96008G	37.28	54.00	-16.72	31.02	3	Vertical	58	2.42	-	32.76	6.36	32.86

BT-EDR(3Mbps)

2480MHz_TX

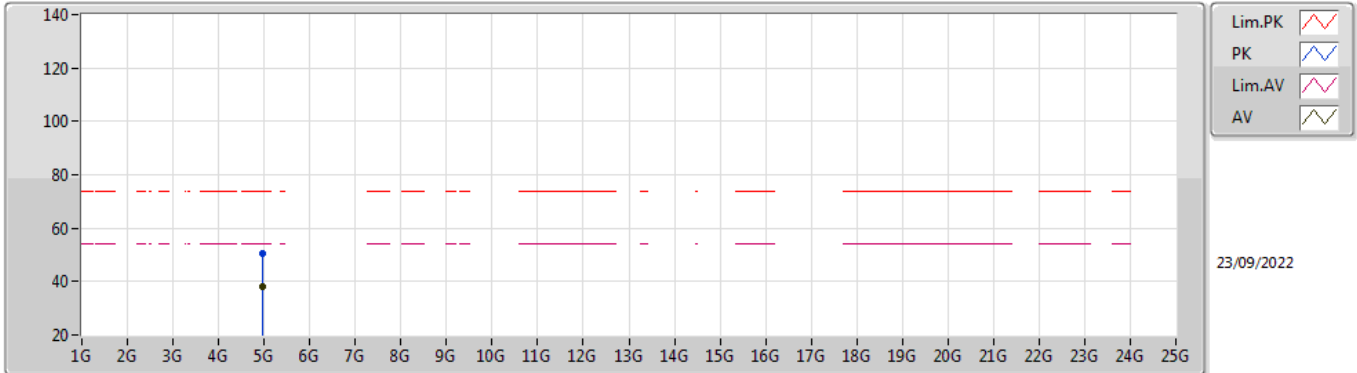

EUT_Z_1TX
Setting 8
01-A-B-5

Type	Freq (Hz)	Level (dBuV/m)	Limit (dBuV/m)	Margin (dB)	Raw (dBuV)	Dist (m)	Condition	Azimuth (°)	Height (m)	Comment	AF (dB)	CL (dB)	PA (dB)
PK	4.95981G	50.56	74.00	-23.44	44.30	3	Horizontal	22	2.57	-	32.76	6.36	32.86
AV	4.95998G	38.18	54.00	-15.82	31.92	3	Horizontal	22	2.57	-	32.76	6.36	32.86



Summary

Mode	Result	Type	Freq (Hz)	Level (dBuV/m)	Limit (dBuV/m)	Margin (dB)	Condition
Mode 1	Pass	AV	1.77765G	41.14	54.00	-12.86	Horizontal

Mode 1

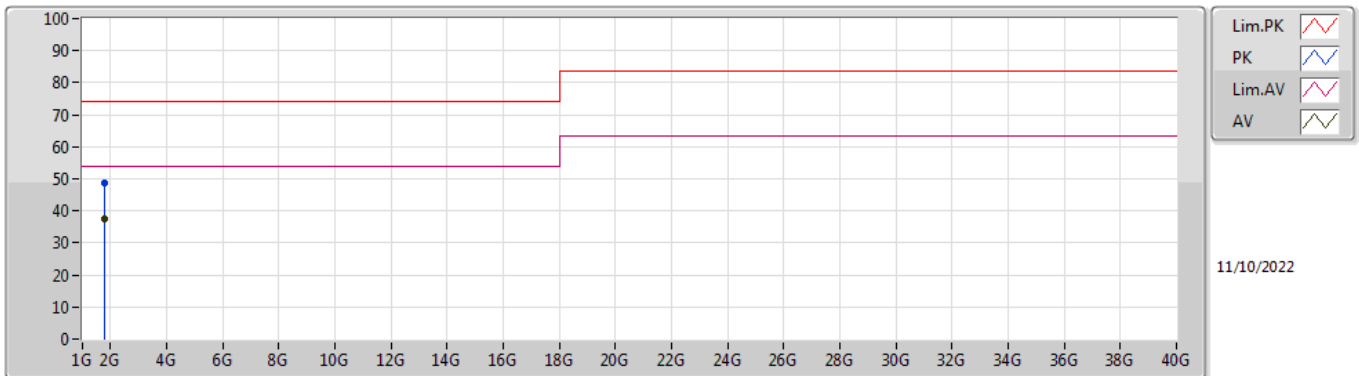

Type	Freq (Hz)	Level (dBuV/m)	Limit (dBuV/m)	Margin (dB)	Factor (dB/m)	Dist (m)	Condition	Azimuth (°)	Height (m)	Comment	Raw (dBuV/m)	AF (dB/m)	CL (dB)	PA (dB)
PK	1.78035G	48.78	74.00	-25.22	-7.43	3	Vertical	164	2.15	-	56.21	25.20	3.78	36.41
AV	1.77779G	37.34	54.00	-16.66	-7.43	3	Vertical	164	2.15	"Worst"	44.77	25.20	3.78	36.41

Mode 1

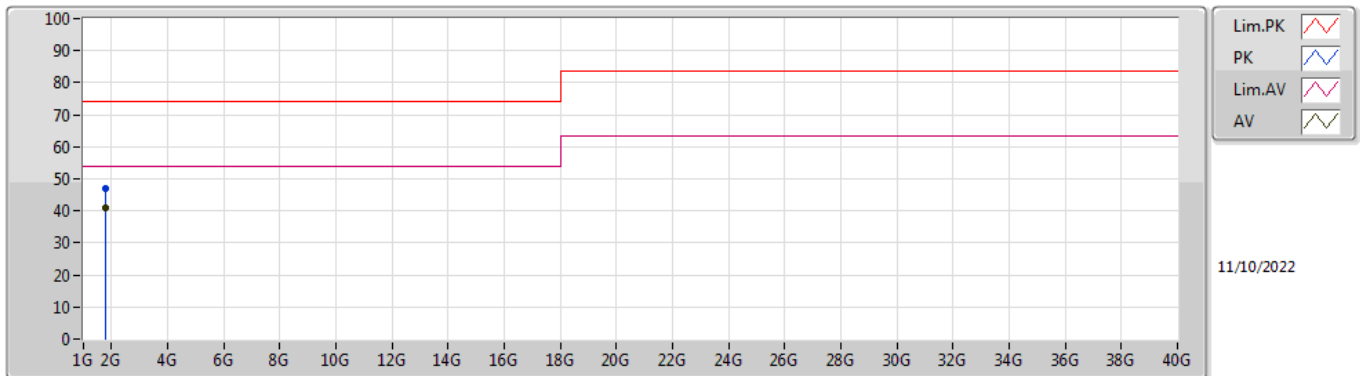

Type	Freq (Hz)	Level (dBuV/m)	Limit (dBuV/m)	Margin (dB)	Factor (dB/m)	Dist (m)	Condition	Azimuth (°)	Height (m)	Comment	Raw (dBuV/m)	AF (dB/m)	CL (dB)	PA (dB)
PK	1.78027G	46.83	74.00	-27.17	-7.43	3	Horizontal	178	1.58	-	54.26	25.20	3.78	36.41
AV	1.77765G	41.14	54.00	-12.86	-7.43	3	Horizontal	178	1.58	"Worst"	48.57	25.20	3.78	36.41