



SPORTON International Inc.

No. 52, Hwa Ya 1st Rd., Kwei-Shan Hsiang, TaoYuan Hsien, Taiwan, R.O.C.
Ph: 886-3-327-3456 / FAX: 886-3-327-0973 / www.sporton.com.tw

FCC RADIO TEST REPORT

Applicant's company	Meraki, Inc.
Applicant Address	99 Rhode Island St., San Francisco, CA 94103
FCC ID	UDX-60010030
Manufacturer's company	Wistron NeWeb Corporation
Manufacturer Address	No.10-1,Li-hsin Road I,Hsinchu Science Park,Hsinchu 300,Taiwan, R.O.C.

Product Name	802.11a/b/g/n Dual Radio
Brand Name	Meraki
Model Name	MR14
Test Rule Part(s)	47 CFR FCC Part 15 Subpart E § 15.407
Test Freq. Range	5150 ~ 5250MHz
Received Date	Mar. 18, 2009
Final Test Date	Apr. 02, 2009
Submission Type	Original Equipment



Statement

Test result included is for the Draft n and 802.11a (5150 ~ 5250MHz) of the product.

The test result in this report refers exclusively to the presented test model / sample.

Without written approval of SPORTON International Inc., the test report shall not be reproduced except in full.

The measurements and test results shown in this test report were made in accordance with the procedures and found in compliance with the limit given in ANSI C63.4-2003 and 47 CFR FCC Part 15 Subpart E.

The test equipment used to perform the test is calibrated and traceable to NML/ROC.





Table of Contents

1. CERTIFICATE OF COMPLIANCE 1

2. SUMMARY OF THE TEST RESULT 2

3. GENERAL INFORMATION 3

3.1. Product Details.....3

3.2. Accessories.....5

3.3. Table for Filed Antenna.....5

3.4. Table for Carrier Frequencies5

3.5. Table for Test Modes6

3.6. Table for Testing Locations.....7

3.7. Table for Supporting Units7

3.8. Table for Parameters of Test Software Setting7

3.9. Test Configurations9

4. TEST RESULT 11

4.1. AC Power Line Conducted Emissions Measurement.....11

4.2. 99% Occupied Bandwidth Measurement17

4.3. Maximum Conducted Output Power Measurement.....24

4.4. Power Spectral Density Measurement37

4.5. Peak Excursion Measurement44

4.6. Radiated Emissions Measurement51

4.7. Band Edge Emissions Measurement73

4.8. Frequency Stability Measurement77

4.9. Antenna Requirements79

5. LIST OF MEASURING EQUIPMENTS 80

6. TEST LOCATION..... 82

7. TAF CERTIFICATE OF ACCREDITATION 83

APPENDIX A. PHOTOGRAPHS OF EUT.....A1 ~ A18

APPENDIX B. TEST PHOTOS..... B1 ~ B7

APPENDIX C. MAXIMUM PERMISSIBLE EXPOSURE..... C1 ~ C3

APPENDIX D. CO-LOCATION D1 ~D3



1. CERTIFICATE OF COMPLIANCE

Product Name : 802.11a/b/g/n Dual Radio
Brand Name : Meraki
Model Name : MR14
Applicant : Meraki, Inc.
Test Rule Part(s) : 47 CFR FCC Part 15 Subpart E § 15.407

Sporton International as requested by the applicant to evaluate the EMC performance of the product sample received on Mar. 18, 2009 would like to declare that the tested sample has been evaluated and found to be in compliance with the tested rule parts. The data recorded as well as the test configuration specified is true and accurate for showing the sample's EMC nature.

A handwritten signature in blue ink, appearing to read 'Wayne Hsu', is written over a horizontal line. The signature is stylized and includes a date '2009/4/24' at the end.

Wayne Hsu

SPORTON INTERNATIONAL INC.

2. SUMMARY OF THE TEST RESULT

Applied Standard: 47 CFR FCC Part 15 Subpart E				
Part	Rule Section	Description of Test	Result	Under Limit
4.1	15.207	AC Power Line Conducted Emissions	Complies	4.57 dB
4.2	15.407(a)	26dB Spectrum Bandwidth	Complies	-
4.3	15.407(a)	Maximum Conducted Output Power	Complies	0.13 dB
4.4	15.407(a)	Power Spectral Density	Complies	0.14 dB
4.5	15.407(a)	Peak Excursion	Complies	6.26 dB
4.6	15.407(b)	Radiated Emissions	Complies	0.98 dB
4.7	15.407(b)	Band Edge Emissions	Complies	0.09 dB
4.8	15.407(g)	Frequency Stability	Complies	-
4.9	15.203	Antenna Requirements	Complies	-

Note:

This device used designated two wireless modules, and their internal circuit boards are exactly identical. The wireless module brand is WNC (model No.: DNMA-92), Product Name: WLAN a/b/g/n mini-PCI Module, FCC ID: NKR-DNMA-92.

Due to the system cannot execute RF program, so only use module to test in this report.

Test Items	Uncertainty	Remark
AC Power Line Conducted Emissions	±2.3dB	Confidence levels of 95%
Maximum Conducted Output Power	±0.5dB	Confidence levels of 95%
Power Spectral Density	±0.5dB	Confidence levels of 95%
Peak Excursion	±0.5dB	Confidence levels of 95%
26dB Spectrum Bandwidth / Frequency Stability	±8.5×10 ⁻⁸	Confidence levels of 95%
Radiated Emissions (9kHz~30MHz)	±0.8dB	Confidence levels of 95%
Radiated Emissions (30MHz~1000MHz)	±1.9dB	Confidence levels of 95%
Radiated / Band Edge Emissions (1GHz~18GHz)	±1.9dB	Confidence levels of 95%
Radiated Emissions (18GHz~40GHz)	±1.9dB	Confidence levels of 95%
Temperature	±0.7°C	Confidence levels of 95%
Humidity	±3.2%	Confidence levels of 95%
DC / AC Power Source	±1.4%	Confidence levels of 95%

3. GENERAL INFORMATION

3.1. Product Details

Draft n

Items	Description
Product Type	WLAN (2TX, 2RX)
Radio Type	Intentional Transceiver
Power Type	System: From POE System Module: From Host System
Modulation	see the below table for draft n
Data Modulation	OFDM (BPSK / QPSK / 16QAM / 64QAM)
Data Rate (Mbps)	see the below table for Draft n
Frequency Range	5150 ~ 5250MHz
Channel Number	4 for 20MHz bandwidth ; 2 for 40MHz bandwidth
Channel Band Width (99%)	MCS0 (20MHz): 18.40 MHz ; MCS0 (40MHz): 36.64 MHz
Conducted Output Power	Band 1: MCS0 (20MHz): 16.41 dBm ; MCS0 (40MHz): 16.50 dBm
Carrier Frequencies	Please refer to section 3.4
Antenna	Please refer to section 3.3

802.11a

Items	Description
Product Type	WLAN (2TX, 2RX)
Radio Type	Intentional Transceiver
Power Type	System: From POE System Module: From Host System
Modulation	OFDM for IEEE 802.11a
Data Modulation	OFDM (BPSK / QPSK / 16QAM / 64QAM)
Data Rate (Mbps)	OFDM (6/9/12/18/24/36/48/54)
Frequency Range	5150 ~ 5250MHz
Channel Number	4
Channel Band Width (99%)	Band 1: 17.12 MHz
Conducted Output Power	Band 1: 16.87 dBm
Carrier Frequencies	Please refer to section 3.4
Antenna	Please refer to section 3.3

Antenna & Band width

Antenna	Single (TX)		Two (TX)	
	20 MHz	40 MHz	20 MHz	40 MHz
Band width Mode				
802.11a	X	X	V	X
Draft n	X	X	V	V

Draft n spec

MCS Index	Nss	Modulation	R	NBPSC	NCBPS		NDBPS		Datarate(Mbps)			
					20MHz	40MHz	20MHz	40MHz	800nsGI		400nsGI	
									20MHz	40MHz	20MHz	40MHz
0	1	BPSK	1/2	1	52	108	26	54	6.5	13.5	7.200	15
1	1	QPSK	1/2	2	104	216	52	108	13.0	27.0	14.400	30
2	1	QPSK	3/4	2	104	216	78	162	19.5	40.5	21.700	45
3	1	16-QAM	1/2	4	208	432	104	216	26.0	54.0	28.900	60
4	1	16-QAM	3/4	4	208	432	156	324	39.0	81.0	43.300	90
5	1	64-QAM	2/3	6	312	648	208	432	52.0	108.0	57.800	120
6	1	64-QAM	3/4	6	312	648	234	486	58.5	121.5	65.000	135
7	1	64-QAM	5/6	6	312	648	260	540	65.0	135.0	72.200	150
8	2	BPSK	1/2	1	104	216	52	108	13.0	27.0	14.444	30
9	2	QPSK	1/2	2	208	432	104	216	26.0	54.0	28.889	60
10	2	QPSK	3/4	2	208	432	156	324	39.0	81.0	43.333	90
11	2	16-QAM	1/2	4	416	864	208	432	52.0	108.0	57.778	120
12	2	16-QAM	3/4	4	416	864	312	648	78.0	162.0	86.667	180
13	2	64-QAM	2/3	6	624	1296	416	864	104.0	216.0	115.556	240
14	2	64-QAM	3/4	6	624	1296	468	972	117.0	243.0	130.000	270
15	2	64-QAM	5/6	6	624	1296	520	1080	130.0	270.0	144.444	300

Symbol	Explanation
NSS	Number of spatial streams
R	Code rate
NBPSC	Number of coded bits per single carrier
NCBPS	Number of coded bits per symbol
NDBPS	Number of data bits per symbol
GI	guard interval

3.2. Accessories

N/A

3.3. Table for Filed Antenna

For 5GHz Band

Ant.	Brand	Model Name	Antenna Type	Connector	Gain (dBi)	Remark
A	WNC	XCAB-D1	PIFA Antenna	NA	5.112	TX/RX
B	WNC	XCAB-D1	PIFA Antenna	NA	4.214	TX/RX

Note: The EUT has two Antennas.

Both antenna A and B can be used as transmitting/receiving antenna.

3.4. Table for Carrier Frequencies

Frequency Allocation for 802.11a

There are two bandwidth systems for draft n.

For both 20MHz bandwidth systems, use Channel 36, 40, 44, 48.

For both 40MHz bandwidth systems, use Channel 38, 46.

Frequency Band	Channel No.	Frequency	Channel No.	Frequency
5150~5250 MHz Band 1	36	5180 MHz	44	5220 MHz
	38	5190 MHz	46	5230 MHz
	40	5200 MHz	48	5240 MHz

3.5. Table for Test Modes

Preliminary tests were performed in different data rate to find the worst radiated emission. The data rate shown in the table below is the worst-case rate with respect to the specific test item. Investigation has been done on all the possible configurations for searching the worst cases. The following table is a list of the test modes shown in this test report.

Test Items	Mode		Data Rate	Channel	Antenna
AC Power Conducted Emission	Normal Link		Auto	-	-
Max. Conducted Output Power	MCS0/20MHz	Band 1	13Mbps	36/40/48	A/B/A+B
	MCS0/40MHz	Band 1	27Mbps	38/46	A/B/A+B
	11a/BPSK	Band 1	13Mbps	36/40/48	A/B/A+B
26dB Spectrum Bandwidth 99% Occupied Bandwidth Measurement Power Spectral Density Peak Excursion	MCS0/20MHz	Band 1	13Mbps	36/40/48	A+B
	MCS0/40MHz	Band 1	27Mbps	38/46	A+B
	11a/BPSK	Band 1	13Mbps	36/40/48	A+B
Radiated Emission Below 1GHz	Normal Link		Auto	-	-
Radiated Emission Above 1GHz	MCS0/20MHz	Band 1	13Mbps	36/40/48	A+B
	MCS0/40MHz	Band 1	27Mbps	38/46	A+B
	11a/BPSK	Band 1	13Mbps	36/40/48	A+B
Band Edge Emission	MCS0/20MHz	Band 1	13Mbps	36/40/48	A+B
	MCS0/40MHz	Band 1	27Mbps	38/46	A+B
	11a/BPSK	Band 1	13Mbps	36/40/48	A+B
Frequency Stability	Un-modulation		-	40	N/A

Note:

This device used designated two wireless modules, and their internal circuit boards are exactly identical. The wireless module brand is WNC (model No.: DNMA-92), Product Name: WLAN a/b/g/n mini-PCI Module, FCC ID: NKR-DNMA-92.

Due to the system cannot execute RF program, so only use module to test in this report.

The AP could be applied with two wireless modules; therefore Co-location (please refer to Appendix D) tests are added for simultaneously transmit between wireless LAN.

3.6. Table for Testing Locations

Test Site No.	Site Category	Location	FCC Reg. No.	IC File No.	VCCI Reg. No
03CH03-HY	SAC	Hwa Ya	101377	IC 4088	-
CO04-HY	Conduction	Hwa Ya	101377	IC 4088	-
TH01-HY	OVEN Room	Hwa Ya	-	-	-

Open Area Test Site (OATS); Semi Anechoic Chamber (SAC); Fully Anechoic Chamber (FAC).

Please refer section 6 for Test Site Address.

3.7. Table for Supporting Units

Support Unit	Brand	Model	FCC ID
Notebook	DELL	D400	E2K24GBRL
Notebook	DELL	D520	E2KWM3945ABG
Mouse	HP	M-UAE96	DoC
Wireless AP	Planex	GW-AP54SGX	DoC
Modem	ACEEX	DM1414	IFAXDM1414

3.8. Table for Parameters of Test Software Setting

During testing, Channel & Power Controlling Software provided by the customer was used to control the operating channel as well as the output power level. The RF output power selection is for the setting of RF output power expected by the customer and is going to be fixed on the firmware of the final end product.

Power Parameters of Draft n MCS0 20MHz

Test Software Version	ART		
Frequency	5180 MHz	5200 MHz	5240 MHz
Draft n MCS0 20MHz	12.5	12.5	12.5

Power Parameters of Draft n MCS0 40MHz

Test Software Version	ART	
Frequency	5190 MHz	5230 MHz
Draft n MCS0 40MHz	11	12

Power Parameters of IEEE 802.11a

Test Software Version	ART		
Frequency	5180 MHz	5200 MHz	5240 MHz
IEEE 802.11a	12	12	12.5

An executive program, EMCTEST.EXE under WIN XP, which generates a complete line of continuously repeating " H " pattern was used as the test software.

The program was executed as follows:

- a. Turn on the power of all equipment.
- b. The NB sends " H " messages to the panel, and the panel displays " H " patterns on the screen.
- c. The NB sends " H " messages to the modem.
- d. Repeat the steps from b to C.

At the same time, the following programs were executed:

Executed "ping.exe" to link with the remote workstation to receive and transmit signal by WLAN.

3.9. Test Configurations

3.9.1. Radiation Emissions Test Configuration

Test Configuration: 9kHz~1GHz

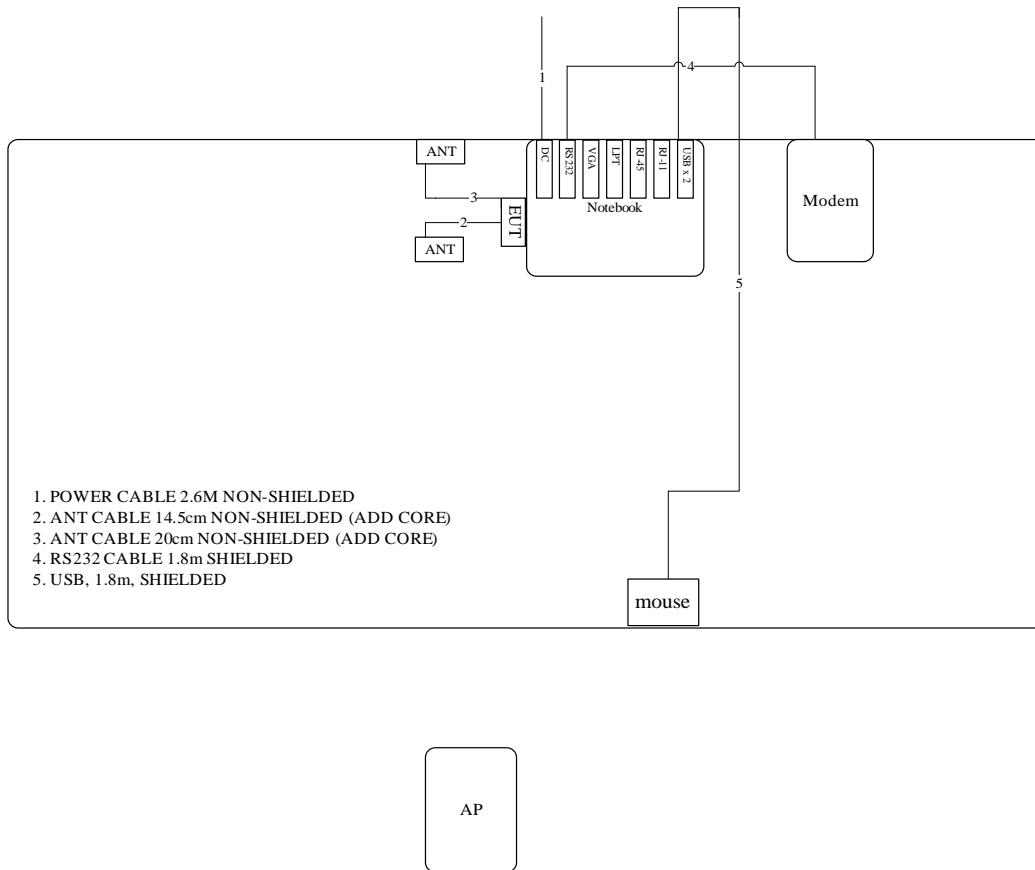

Test Configuration: above 1GHz

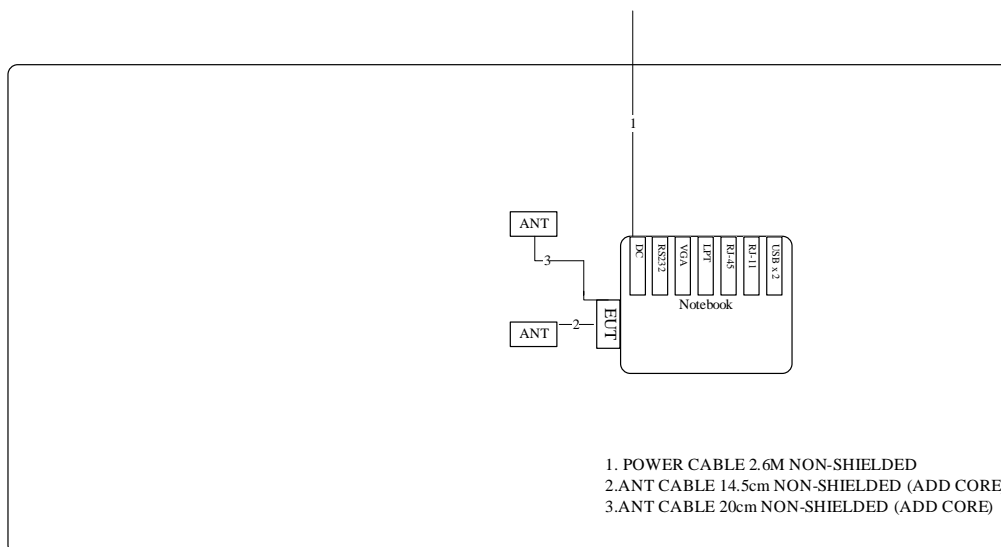

3.9.2. AC Power Line Conduction Emissions Test Configuration

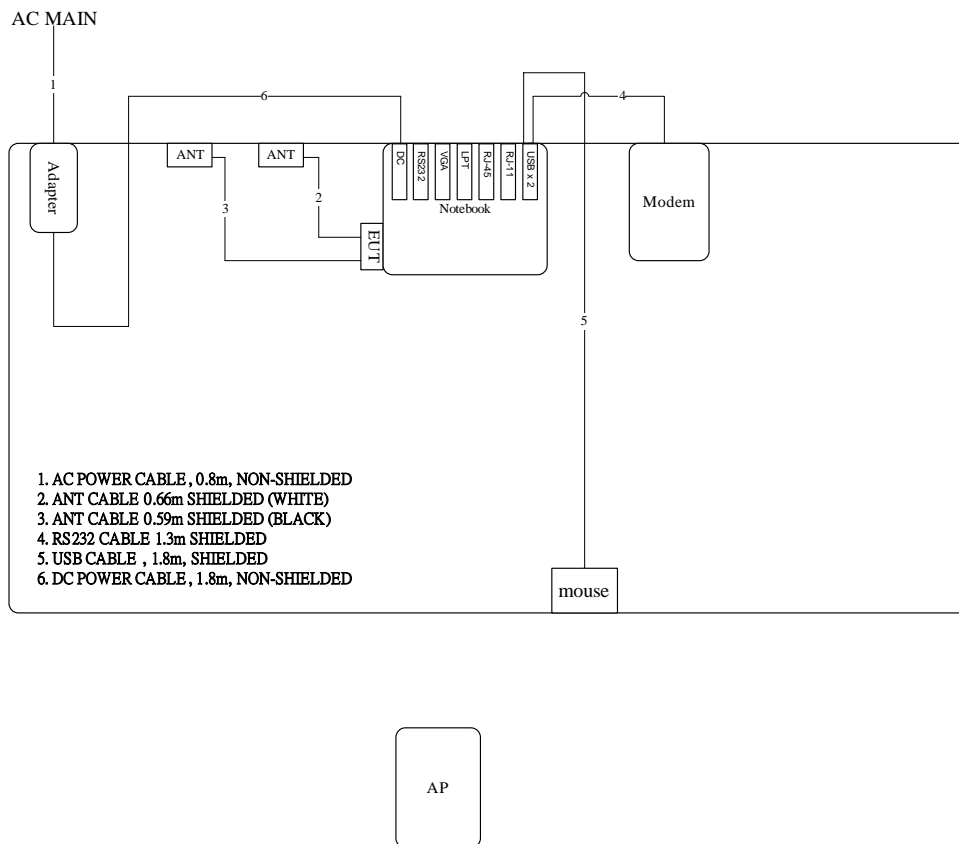

4. TEST RESULT

4.1. AC Power Line Conducted Emissions Measurement

4.1.1. Limit

For this product that is designed to connect to the AC power line, the radio frequency voltage that is conducted back onto the AC power line on any frequency or frequencies within the band 150 kHz to 30 MHz shall not exceed below limits table.

Frequency (MHz)	QP Limit (dBuV)	AV Limit (dBuV)
0.15~0.5	66~56	56~46
0.5~5	56	46
5~30	60	50

4.1.2. Measuring Instruments and Setting

Please refer to section 5 of equipments list in this report. The following table is the setting of the receiver.

Receiver Parameters	Setting
Attenuation	10 dB
Start Frequency	0.15 MHz
Stop Frequency	30 MHz
IF Bandwidth	9 KHz

4.1.3. Test Procedures

1. Configure the EUT according to ANSI C63.4. The EUT or host of EUT has to be placed 0.4 meter far from the conducting wall of the shielding room and at least 80 centimeters from any other grounded conducting surface.
2. Connect EUT or host of EUT to the power mains through a line impedance stabilization network (LISN).
3. All the support units are connected to the other LISNs. The LISN should provide 50uH/50ohms coupling impedance.
4. The frequency range from 150 KHz to 30 MHz was searched.
5. Set the test-receiver system to Peak Detect Function and Specified Bandwidth with Maximum Hold Mode.
6. The measurement has to be done between each power line and ground at the power terminal.

4.1.6. EUT Operation during Test

The EUT was placed on the test table and programmed in normal function.

4.1.7. Results of AC Power Line Conducted Emissions Measurement

Temperature	20°C	Humidity	49%
Test Engineer	Howar Sung	Phase	Line
Configuration	Normal Link		

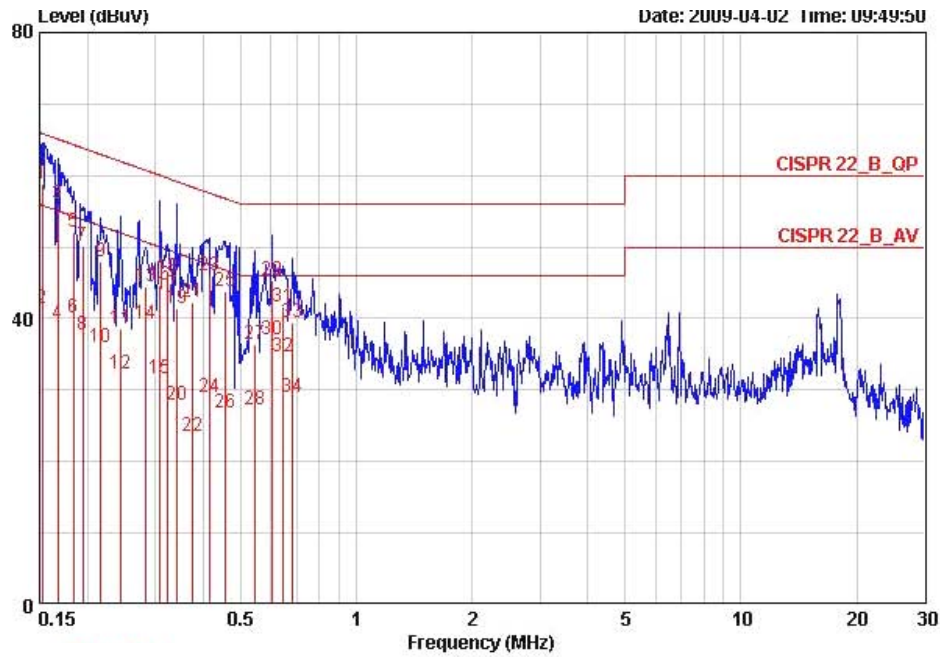

	Freq	Level	Over Limit	Limit Line	Read Level	LISN Factor	Cable Loss	Remark
	MHz	dBuV	dB	dBuV	dBuV	dB	dB	
1	0.15281	58.88	-6.96	65.85	58.61	0.07	0.20	QP
2	0.15281	41.44	-14.40	55.85	41.17	0.07	0.20	AVERAGE
3	0.16765	56.11	-8.97	65.08	55.84	0.07	0.20	QP
4	0.16765	39.23	-15.85	55.08	38.96	0.07	0.20	AVERAGE
5	0.18346	52.10	-12.23	64.33	51.84	0.06	0.20	QP
6	0.18346	40.20	-14.13	54.33	39.94	0.06	0.20	AVERAGE
7	0.19447	50.08	-13.76	63.84	49.83	0.05	0.20	QP
8	0.19447	37.65	-16.19	53.84	37.40	0.05	0.20	AVERAGE
9	0.21620	47.92	-15.05	62.96	47.67	0.05	0.20	QP
10	0.21620	36.02	-16.95	52.96	35.77	0.05	0.20	AVERAGE
11	0.24293	38.54	-23.45	62.00	38.30	0.04	0.20	QP
12	0.24293	32.15	-19.84	52.00	31.91	0.04	0.20	AVERAGE
13	0.28328	44.44	-16.28	60.72	44.20	0.04	0.20	QP
14	0.28328	39.29	-11.43	50.72	39.05	0.04	0.20	AVERAGE
15	0.30834	31.55	-18.47	50.02	31.31	0.04	0.20	AVERAGE
16	0.30834	44.63	-15.39	60.02	44.39	0.04	0.20	QP
17	0.32154	43.30	-6.37	49.67	43.06	0.04	0.20	AVERAGE
18	0.32154	45.77	-13.90	59.67	45.53	0.04	0.20	QP
19	0.34100	41.47	-17.70	59.18	41.24	0.03	0.20	QP
20	0.34100	27.79	-21.38	49.18	27.56	0.03	0.20	AVERAGE
21	0.37314	42.38	-16.05	58.43	42.15	0.03	0.20	QP
22	0.37314	23.58	-24.85	48.43	23.35	0.03	0.20	AVERAGE
23	0.41485	45.96	-11.59	57.55	45.73	0.03	0.20	QP
24	0.41485	29.04	-18.51	47.55	28.81	0.03	0.20	AVERAGE
25	0.45636	43.78	-12.98	56.76	43.55	0.03	0.20	QP



	Freq	Level	Over Limit	Limit Line	Read Level	LISN Factor	Cable Loss	Remark
	MHz	dBuV	dB	dBuV	dBuV	dB	dB	
26	0.45636	26.81	-19.95	46.76	26.58	0.03	0.20	AVERAGE
27	0.54355	36.49	-19.51	56.00	36.26	0.03	0.20	QP
28	0.54355	27.32	-18.68	46.00	27.09	0.03	0.20	AVERAGE
29	0.60112	45.30	-10.70	56.00	45.07	0.03	0.20	QP
30	0.60112	37.01	-8.99	46.00	36.78	0.03	0.20	AVERAGE
31	0.64740	41.74	-14.26	56.00	41.51	0.03	0.20	QP
32	0.64740	34.60	-11.40	46.00	34.37	0.03	0.20	AVERAGE
33	0.68263	39.49	-16.51	56.00	39.26	0.03	0.20	QP
34	0.68263	29.10	-16.90	46.00	28.87	0.03	0.20	AVERAGE

Temperature	20°C	Humidity	49%
Test Engineer	Howar Sung	Phase	Neutral
Configuration	Normal Link		

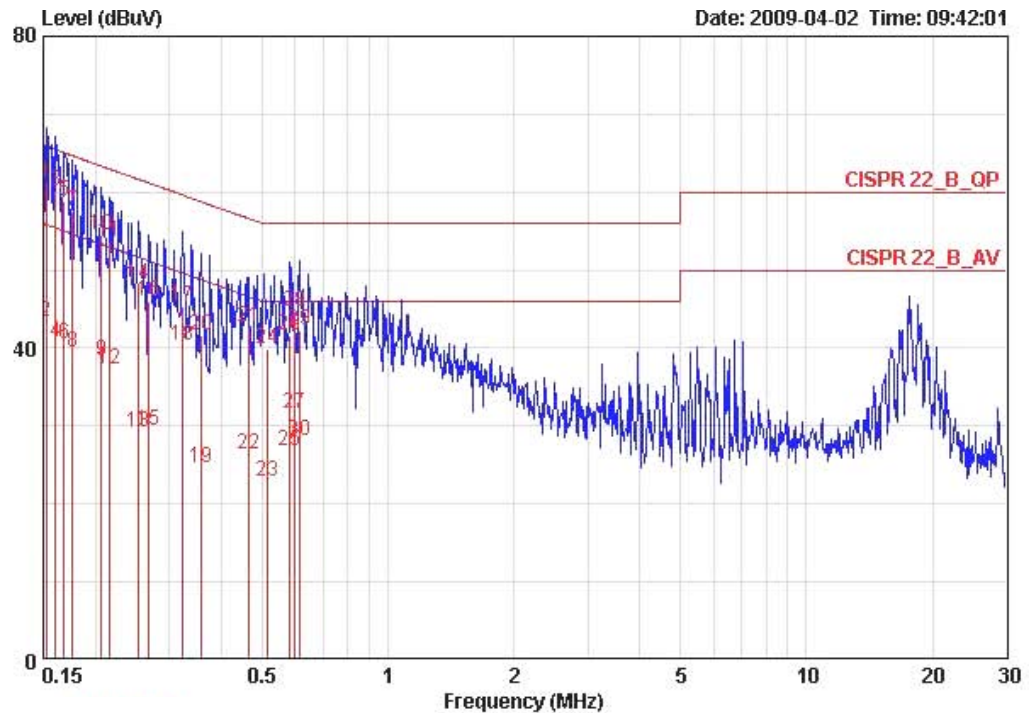

	Freq	Level	Over	Limit	Read	LISN	Cable	Remark
	MHz	dBuV	Limit	Line	Level	Factor	Loss	
			dB	dBuV	dBuV	dB	dB	
1	0.15240	61.29	-4.57	65.87	60.99	0.10	0.20	QP
2	0.15240	43.41	-12.45	55.87	43.11	0.10	0.20	AVERAGE
3	0.16070	60.11	-5.32	65.43	59.81	0.10	0.20	QP
4	0.16070	40.69	-14.74	55.43	40.39	0.10	0.20	AVERAGE
5	0.16854	58.75	-6.28	65.03	58.46	0.09	0.20	QP
6	0.16854	40.54	-14.49	55.03	40.25	0.09	0.20	AVERAGE
7	0.17584	57.51	-7.17	64.68	57.22	0.09	0.20	QP
8	0.17584	39.45	-15.23	54.68	39.16	0.09	0.20	AVERAGE
9	0.20614	38.40	-14.96	53.36	38.12	0.08	0.20	AVERAGE
10	0.20614	54.50	-8.86	63.36	54.22	0.08	0.20	QP
11	0.21620	53.73	-9.23	62.96	53.45	0.08	0.20	QP
12	0.21620	37.23	-15.73	52.96	36.95	0.08	0.20	AVERAGE
13	0.25211	29.27	-22.42	51.69	28.99	0.08	0.20	AVERAGE
14	0.25211	48.18	-13.51	61.69	47.90	0.08	0.20	QP
15	0.26724	29.42	-21.79	51.20	29.14	0.08	0.20	AVERAGE
16	0.26724	45.99	-15.22	61.20	45.71	0.08	0.20	QP
17	0.32169	45.42	-14.24	59.66	45.15	0.07	0.20	QP
18	0.32169	40.24	-9.42	49.66	39.97	0.07	0.20	AVERAGE
19	0.35765	24.61	-24.17	48.78	24.34	0.07	0.20	AVERAGE
20	0.35765	41.64	-17.14	58.78	41.37	0.07	0.20	QP
21	0.46367	42.67	-13.96	56.63	42.40	0.07	0.20	QP
22	0.46367	26.40	-20.23	46.63	26.13	0.07	0.20	AVERAGE
23	0.51457	22.97	-23.03	46.00	22.70	0.07	0.20	AVERAGE
24	0.51457	39.83	-16.17	56.00	39.56	0.07	0.20	QP
25	0.58231	26.78	-19.22	46.00	26.51	0.07	0.20	AVERAGE



	Freq	Level	Over Limit	Limit Line	Read Level	LISN Factor	Cable Loss	Remark
	MHz	dBuV	dB	dBuV	dBuV	dB	dB	
26	0.58231	41.53	-14.47	56.00	41.26	0.07	0.20	QP
27	0.59871	31.66	-14.34	46.00	31.39	0.07	0.20	AVERAGE
28	0.59871	44.69	-11.31	56.00	44.42	0.07	0.20	QP
29	0.61560	42.35	-13.65	56.00	42.08	0.07	0.20	QP
30	0.61560	28.06	-17.94	46.00	27.79	0.07	0.20	AVERAGE

Note:

Level = Read Level + LISN Factor + Cable Loss

4.2. 99% Occupied Bandwidth Measurement

4.2.1. Limit

No restriction limits. But resolution bandwidth within band edge measurement is 1% of the 99% occupied bandwidth.

4.2.2. Measuring Instruments and Setting

Please refer to section 5 of equipments list in this report. The following table is the setting of the spectrum analyzer.

Spectrum Parameters	Setting
Attenuation	Auto
Span Frequency	> 26dB Bandwidth
RB	300 kHz
VB	1000 kHz
Detector	Peak
Trace	Max Hold
Sweep Time	Auto

4.2.3. Test Procedures

1. The transmitter output (antenna port) was connected to the spectrum analyzer in peak hold mode.
2. The resolution bandwidth of 300 kHz and the video bandwidth of 1000 kHz were used.
3. Measured the spectrum width with power higher than 26dB below carrier.
4. Measuring multiple antennas, the connector is required to link with spectrum analyzer through a combiner.

4.2.4. Test Setup Layout

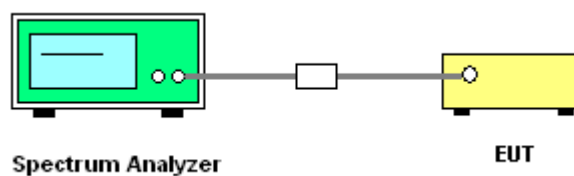

4.2.5. Test Deviation

There is no deviation with the original standard.

4.2.6. EUT Operation during Test

The EUT was programmed to be in continuously transmitting mode.

4.2.7. Test Result of 99% Occupied Bandwidth

Temperature	24°C	Humidity	56%
Test Engineer	Allen Liu	Configurations	Draft n

Configuration Draft n MCS0 20MHz Ant. A + Ant. B

Channel	Frequency	26dB Bandwidth (MHz)	99% Occupied Bandwidth (MHz)
36	5180 MHz	25.44	18.40
40	5200 MHz	25.60	18.40
48	5240 MHz	25.60	18.40

Configuration Draft n MCS0 40MHz Ant. A + Ant. B

Channel	Frequency	26dB Bandwidth (MHz)	99% Occupied Bandwidth (MHz)
38	5190 MHz	45.60	36.48
46	5230 MHz	47.04	36.64



Temperature	24°C	Humidity	56%
Test Engineer	Allen Liu	Configurations	802.11a

Configuration IEEE 802.11a Ant. A + Ant. B

Channel	Frequency	26dB Bandwidth (MHz)	99% Occupied Bandwidth (MHz)
36	5180 MHz	23.52	16.96
40	5200 MHz	23.52	17.12
48	5240 MHz	23.68	16.96

26 dB Bandwidth Plot on Configuration Drafft n MCS0 20MHz Ant. A + Ant. B / 5180 MHz

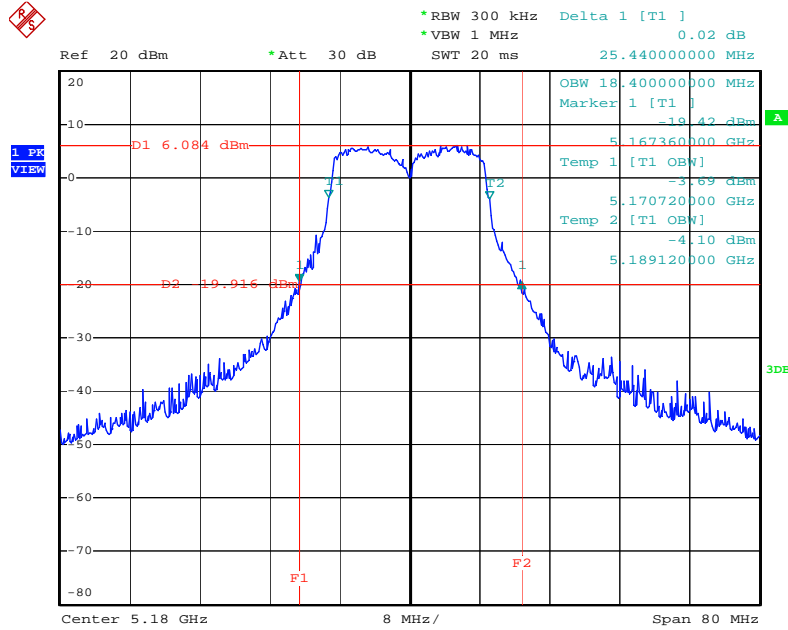

Date: 26.MAR.2009 13:24:25

26 dB Bandwidth Plot on Configuration Drafft n MCS0 20MHz Ant. A + Ant. B / 5200 MHz

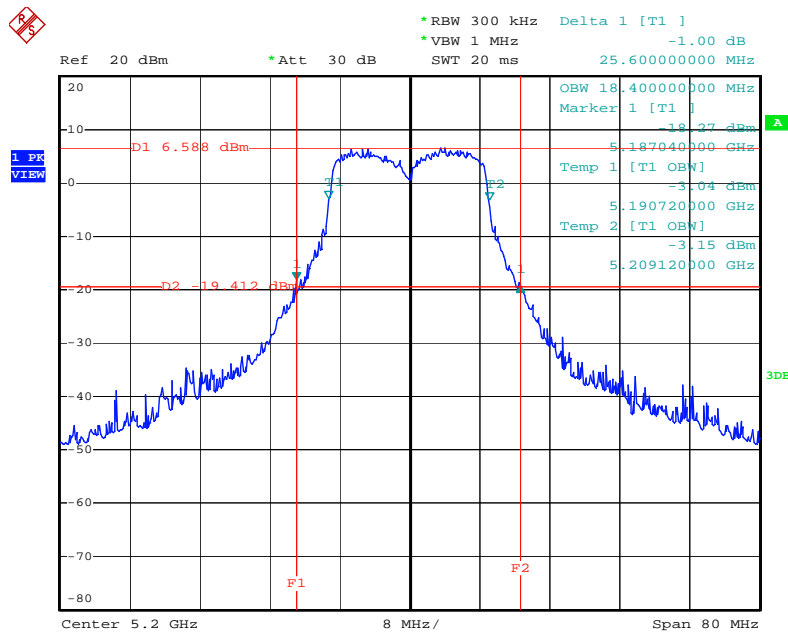

Date: 26.MAR.2009 13:23:41

26 dB Bandwidth Plot on Configuration Drafft n MCS0 20MHz Ant. A + Ant. B / 5240 MHz

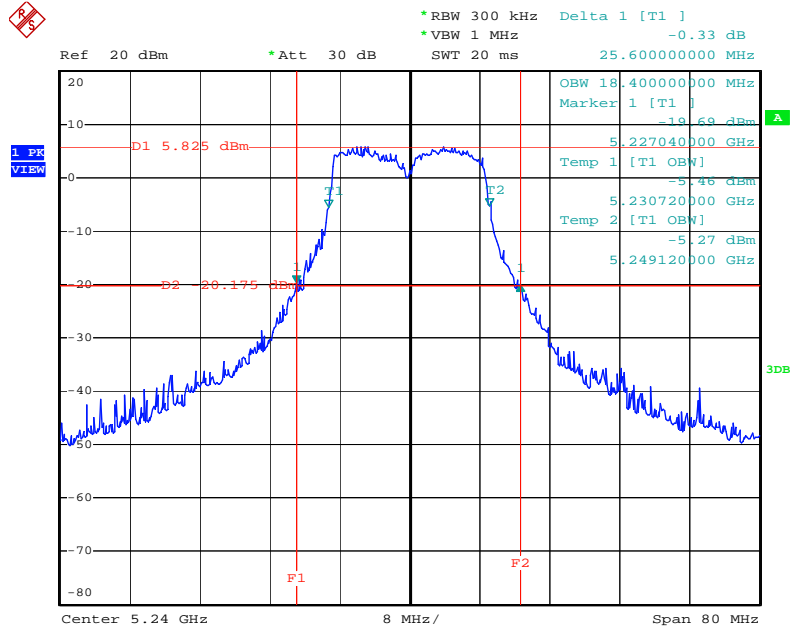

Date: 26.MAR.2009 13:22:56

26 dB Bandwidth Plot on Configuration Drafft n MCS0 40MHz Ant. A + Ant. B / 5190 MHz

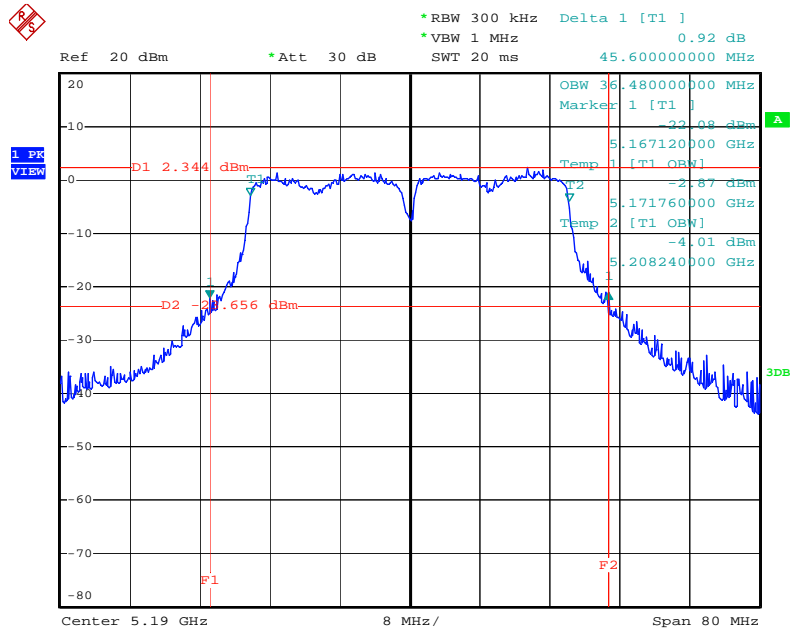

Date: 26.MAR.2009 13:27:44

26 dB Bandwidth Plot on Configuration Draft n MCS0 40MHz Ant. A + Ant. B / 5230 MHz

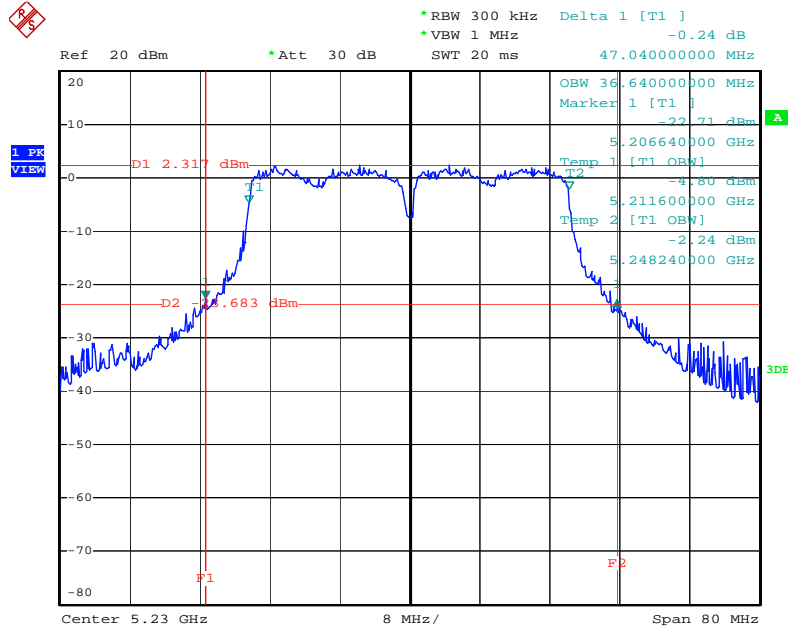

Date: 26.MAR.2009 13:30:11

26 dB Bandwidth Plot on Configuration IEEE 802.11a Ant. A + Ant. B / 5180 MHz

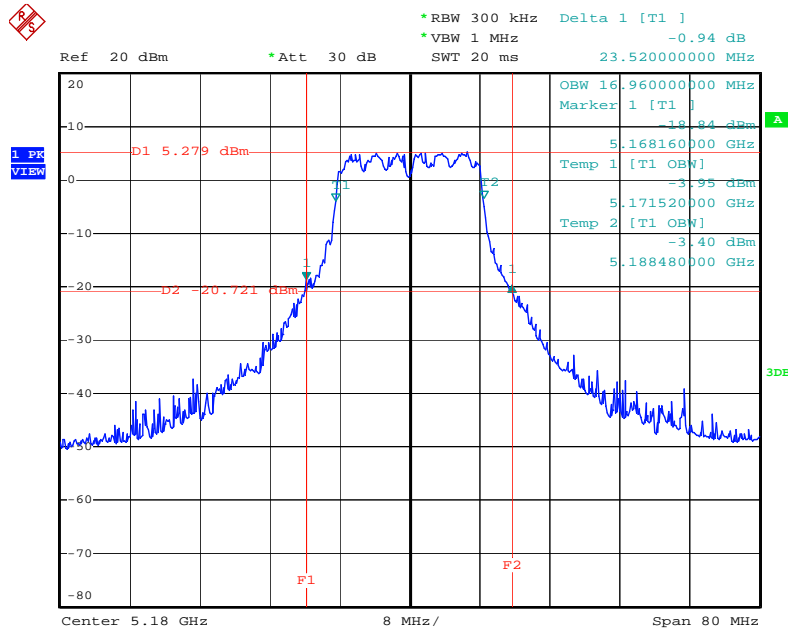

Date: 26.MAR.2009 13:04:04

26 dB Bandwidth Plot on Configuration IEEE 802.11a Ant. A + Ant. B / 5200 MHz

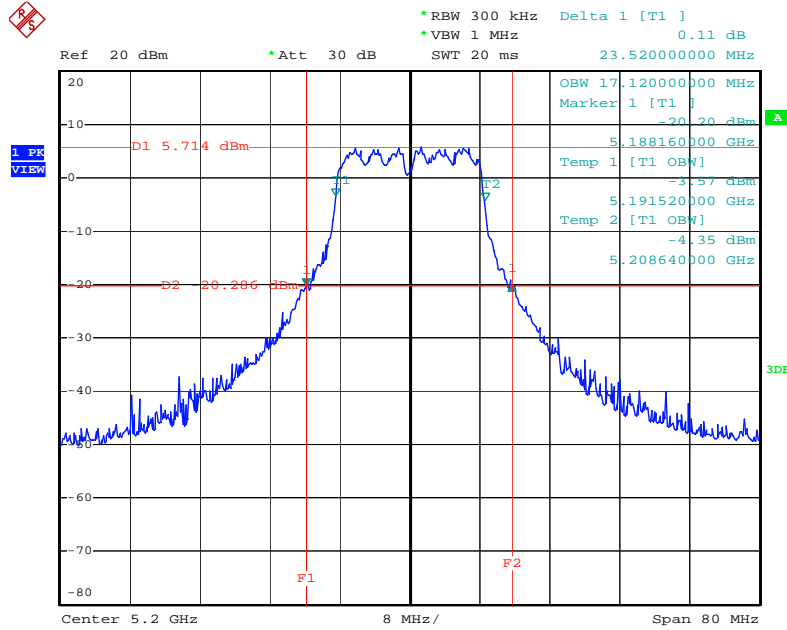

Date: 26.MAR.2009 13:05:45

26 dB Bandwidth Plot on Configuration IEEE 802.11a Ant. A + Ant. B / 5240 MHz

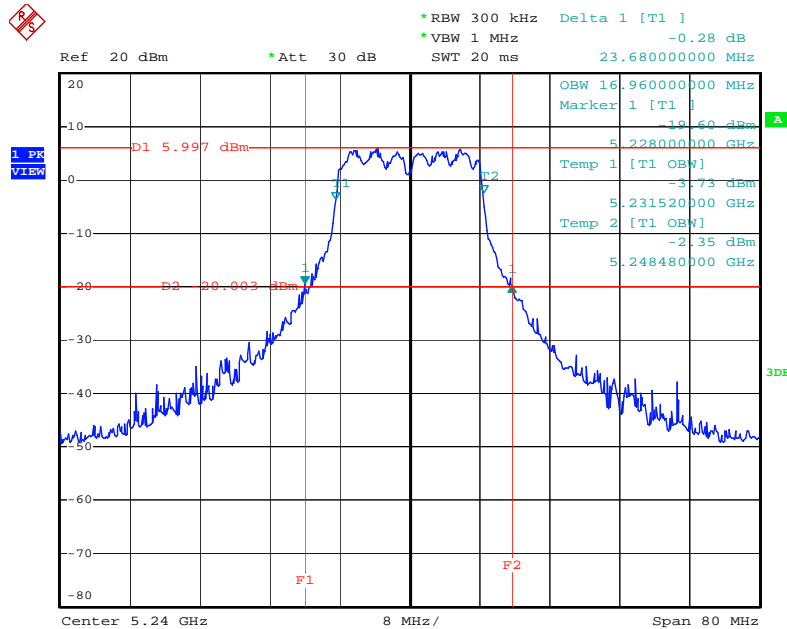

Date: 26.MAR.2009 13:10:08

4.3. Maximum Conducted Output Power Measurement

4.3.1. Limit

For the band 5.15~5.25 GHz, the maximum conducted output power over the frequency band of operation shall not exceed the lesser of 50 mW (17dBm) or $4 \text{ dBm} + 10\log B$, where B is the 26 dB emissions bandwidth in MHz. If transmitting antennas of directional gain greater than 6 dBi are used, the peak output power and power density from the intentional radiator shall be reduced by the amount in dB that the directional gain of the antenna exceeds 6 dBi.

For the 5.25-5.35 GHz and 5.470-5.725 GHz bands, the maximum conducted output power over the frequency bands of operation shall not exceed the lesser of 250 mW (24dBm) or $11 \text{ dBm} + 10\log B$. If transmitting antennas of directional gain greater than 6 dBi are used, the peak output power and power density from the intentional radiator shall be reduced by the amount in dB that the directional gain of the antenna exceeds 6 dBi.

For the band 5.725-5.825 GHz, the maximum conducted output power over the frequency band of operation shall not exceed the lesser of 1 W (30dBm) or $17 \text{ dBm} + 10\log B$. If transmitting antennas of directional gain greater than 6 dBi are used, the peak output power and power density from the intentional radiator shall be reduced by the amount in dB that the directional gain of the antenna exceeds 6 dBi. However, fixed point-to-point U-NII devices operating in this band may employ transmitting antennas with directional gain up to 23 dBi without any corresponding reduction in the transmitter peak output power and peak power spectral density. For fixed, point-to-point U-NII transmitters that employ a directional antenna gain greater than 23 dBi, a 1 dB reduction in peak transmitter power and peak power spectral density for each 1 dB of antenna gain in excess of 23 dBi would be required.

4.3.2. Measuring Instruments and Setting

Please refer to section 5 of equipments list in this report. The following table is the setting of the spectrum analyzer.

Spectrum Parameter	Setting
Attenuation	Auto
Span Frequency	Encompass the entire emissions bandwidth (EBW) of the signal
RB	1000 kHz
VB	3000 kHz
Detector	PEAK
Trace	MAX HOLD
Sweep Time	Auto

4.3.3. Test Procedures

1. The transmitter output (antenna port) was connected to the spectrum analyzer.
2. Test was performed in accordance with FCC Public Notice DA 02-2138, August 30, 2002.
3. When measuring maximum conducted output power with multiple antenna systems, add every result of the values by mathematic formula.

4.3.4. Test Setup Layout

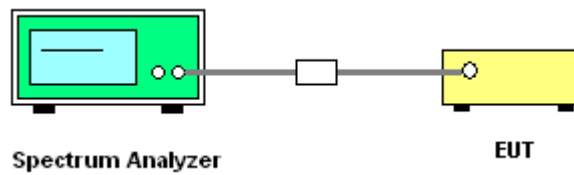

4.3.5. Test Deviation

There is no deviation with the original standard.

4.3.6. EUT Operation during Test

The EUT was programmed to be in continuously transmitting mode.

4.3.7. Test Result of Maximum Conducted Output Power

Temperature	24°C	Humidity	56%
Test Engineer	Allen Liu	Configurations	Draft n

Configuration Draft n MCS0 20MHz Ant. A

Channel	Frequency	Conducted Power (dBm)	Max. Limit (dBm)	Result
36	5180 MHz	13.51	17.00	Complies
40	5200 MHz	13.84	17.00	Complies
48	5240 MHz	13.50	17.00	Complies

Configuration Draft n MCS0 20MHz Ant. B

Channel	Frequency	Conducted Power (dBm)	Max. Limit (dBm)	Result
36	5180 MHz	13.22	17.00	Complies
40	5200 MHz	12.90	17.00	Complies
48	5240 MHz	13.13	17.00	Complies

Configuration Draft n MCS0 20MHz Ant. A + Ant. B

Channel	Frequency	Conducted Power (dBm)	Max. Limit (dBm)	Result
36	5180 MHz	16.38	17.00	Complies
40	5200 MHz	16.41	17.00	Complies
48	5240 MHz	16.33	17.00	Complies

Configuration Draft n MCS0 40MHz Ant. A

Channel	Frequency	Conducted Power (dBm)	Max. Limit (dBm)	Result
38	5190 MHz	13.00	17.00	Complies
46	5230 MHz	13.81	17.00	Complies

Configuration Draft n MCS0 40MHz Ant. B

Channel	Frequency	Conducted Power (dBm)	Max. Limit (dBm)	Result
38	5190 MHz	12.27	17.00	Complies
46	5230 MHz	13.14	17.00	Complies

Configuration Draft n MCS0 40MHz Ant. A + Ant. B

Channel	Frequency	Conducted Power (dBm)	Max. Limit (dBm)	Result
38	5190 MHz	15.66	17.00	Complies
46	5230 MHz	16.50	17.00	Complies

Temperature	24°C	Humidity	56%
Test Engineer	Allen Liu	Configurations	802.11a

Configuration IEEE 802.11a Ant. A

Channel	Frequency	Conducted Power (dBm)	Max. Limit (dBm)	Result
36	5180 MHz	13.84	17.00	Complies
40	5200 MHz	14.02	17.00	Complies
48	5240 MHz	14.10	17.00	Complies

Configuration IEEE 802.11a Ant. B

Channel	Frequency	Conducted Power (dBm)	Max. Limit (dBm)	Result
36	5180 MHz	13.73	17.00	Complies
40	5200 MHz	13.65	17.00	Complies
48	5240 MHz	13.60	17.00	Complies

Configuration IEEE 802.11a Ant. A + Ant. B

Channel	Frequency	Conducted Power (dBm)	Max. Limit (dBm)	Result
36	5180 MHz	16.80	17.00	Complies
40	5200 MHz	16.85	17.00	Complies
48	5240 MHz	16.87	17.00	Complies

Conducted Output Power Plot on Configuration Draft n MCS0 20MHz Ant. A / 5240 MHz

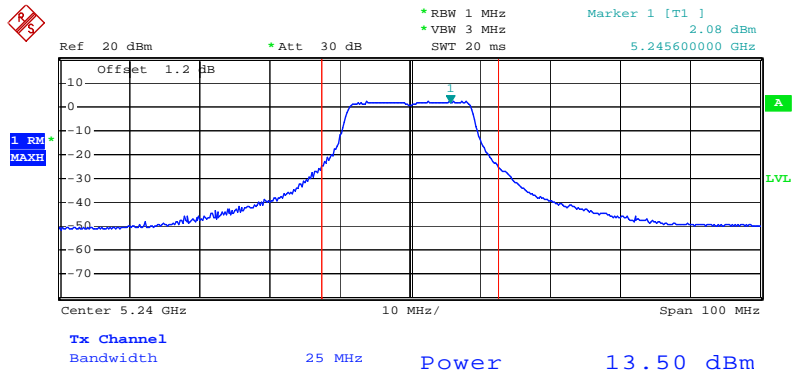

Date: 25.MAR.2009 17:31:54

Conducted Output Power Plot on Configuration Draft n MCS0 20MHz Ant. B / 5180 MHz

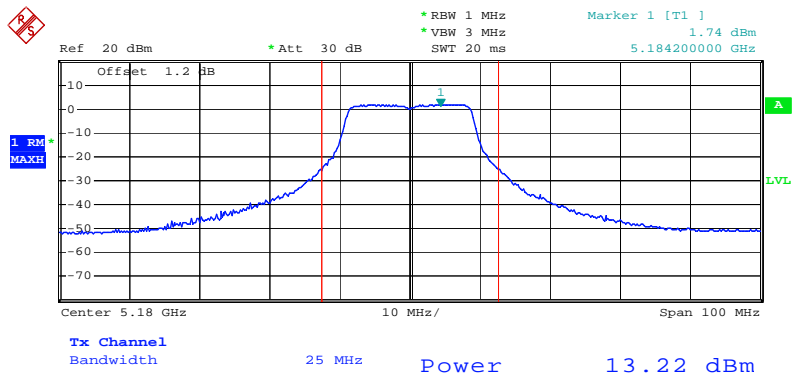

Date: 25.MAR.2009 17:29:02

Conducted Output Power Plot on Configuration Draft n MCS0 40MHz Ant. B / 5190 MHz

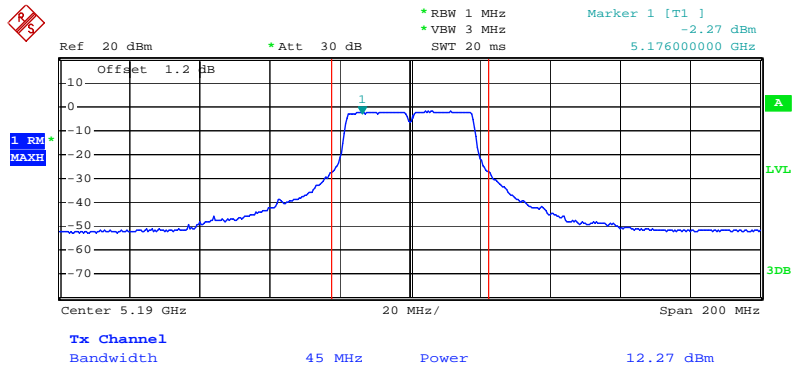

Date: 25.MAR.2009 11:56:44

Conducted Output Power Plot on Configuration Draft n MCS0 40MHz Ant. B / 5230 MHz

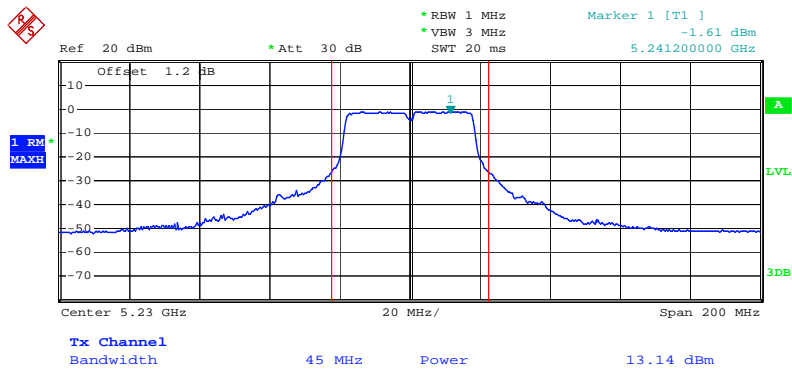

Date: 25.MAR.2009 12:00:35

Conducted Output Power Plot on Configuration IEEE 802.11a Ant. A / 5180 MHz

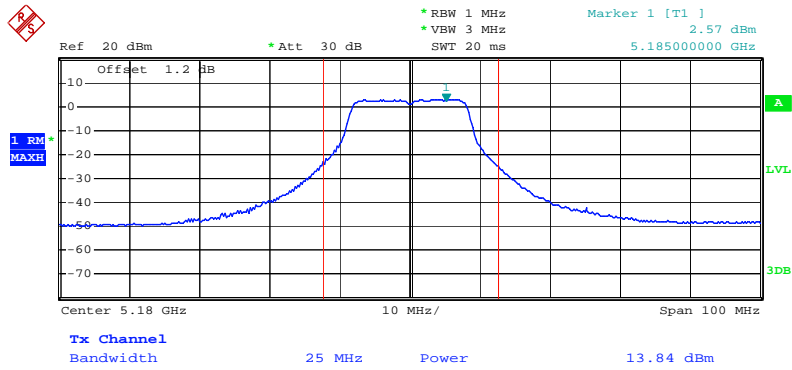

Date: 25.MAR.2009 10:51:22

Conducted Output Power Plot on Configuration IEEE 802.11a Ant. A / 5200 MHz

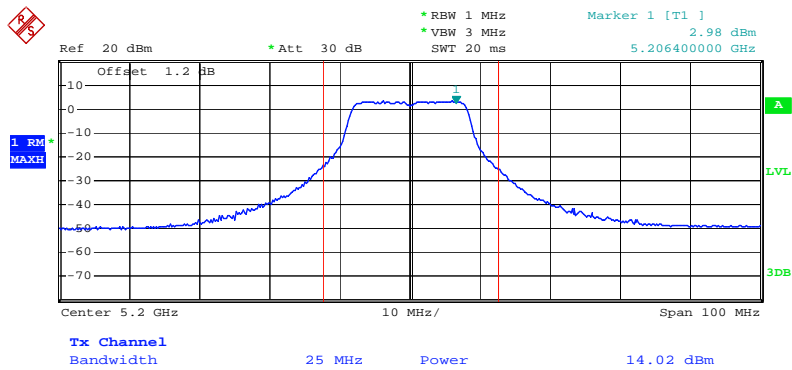

Date: 25.MAR.2009 10:53:59

Conducted Output Power Plot on Configuration IEEE 802.11a Ant. A / 5240 MHz

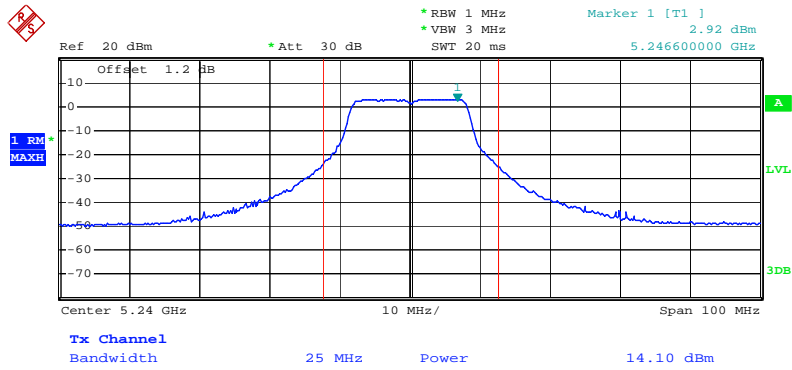

Date: 25.MAR.2009 10:56:19

Conducted Output Power Plot on Configuration IEEE 802.11a Ant. B / 5180 MHz

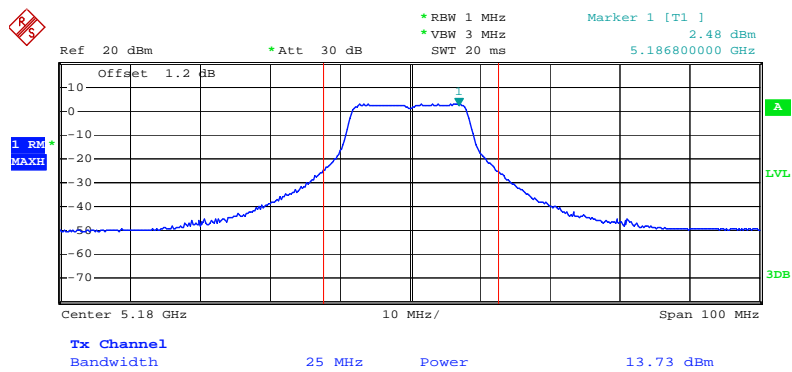

Date: 25.MAR.2009 10:52:42

Conducted Output Power Plot on Configuration IEEE 802.11a Ant. B / 5200 MHz

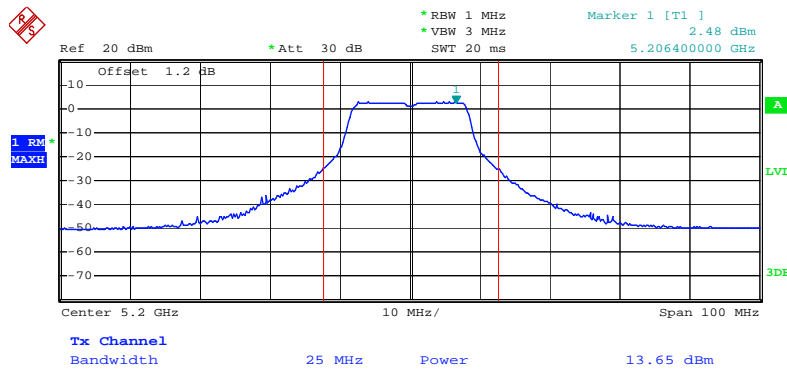

Date: 25.MAR.2009 10:54:50

Conducted Output Power Plot on Configuration IEEE 802.11a Ant. B / 5240 MHz

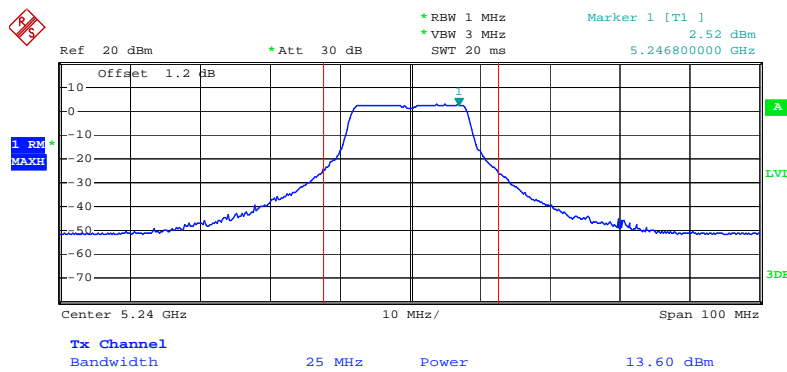

Date: 25.MAR.2009 10:57:19

4.4. Power Spectral Density Measurement

4.4.1. Limit

The power spectral density is defined as the highest level of power in dBm per MHz generated by the transmitter within the power envelope. The following table is power spectral density limits and decrease power density limit rule refer to section 4.3.1.

Frequency Range	Power Spectral Density limit (dBm/MHz)
5.15~5.25 GHz	4

4.4.2. Measuring Instruments and Setting

Please refer to section 5 of equipments list in this report. The following table is the setting of the spectrum analyzer.

Spectrum Parameter	Setting
Attenuation	Auto
Span Frequency	Encompass the entire emissions bandwidth (EBW) of the signal
RB	1000 kHz
VB	3000 kHz
Detector	Peak
Trace	Max Hold
Sweep Time	Auto

4.4.3. Test Procedures

1. The transmitter output (antenna port) was connected to the spectrum analyzer.
2. Set RBW of spectrum analyzer to 1000kHz and VBW to 3000kHz. Set Detector to Peak, Trace to Max Hold. Mark the frequency with maximum peak power as the center of the display of the spectrum.
3. Measuring multiple antennas, the connector is required to link with spectrum analyzer through a combiner.

4.4.4. Test Setup Layout

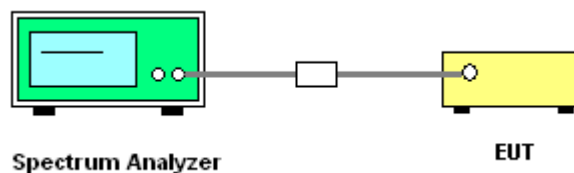

4.4.5. Test Deviation

There is no deviation with the original standard.

4.4.6. EUT Operation during Test

The EUT was programmed to be in continuously transmitting mode.

4.4.7. Test Result of Power Spectral Density

Temperature	24°C	Humidity	56%
Test Engineer	Allen Liu	Configurations	Draft n

Configuration Draft n MCS0 20MHz Ant. A + Ant. B

Channel	Frequency	Power Density (dBm)	Max. Limit (dBm)	Result
36	5180 MHz	3.14	4.00	Complies
40	5200 MHz	3.34	4.00	Complies
48	5240 MHz	2.83	4.00	Complies

Configuration Draft n MCS0 40MHz Ant. A + Ant. B

Channel	Frequency	Power Density (dBm)	Max. Limit (dBm)	Result
38	5190 MHz	-0.93	4.00	Complies
46	5230 MHz	-0.30	4.00	Complies

Temperature	24°C	Humidity	56%
Test Engineer	Allen Liu	Configurations	802.11a

Configuration IEEE 802.11a Ant. A + Ant. B

Channel	Frequency	Power Density (dBm)	Max. Limit (dBm)	Result
36	5180 MHz	3.36	4.00	Complies
40	5200 MHz	3.29	4.00	Complies
48	5240 MHz	3.86	4.00	Complies

Power Density Plot on Configuration Drafft n MCS0 20MHz Ant. A + Ant. B / 5180 MHz

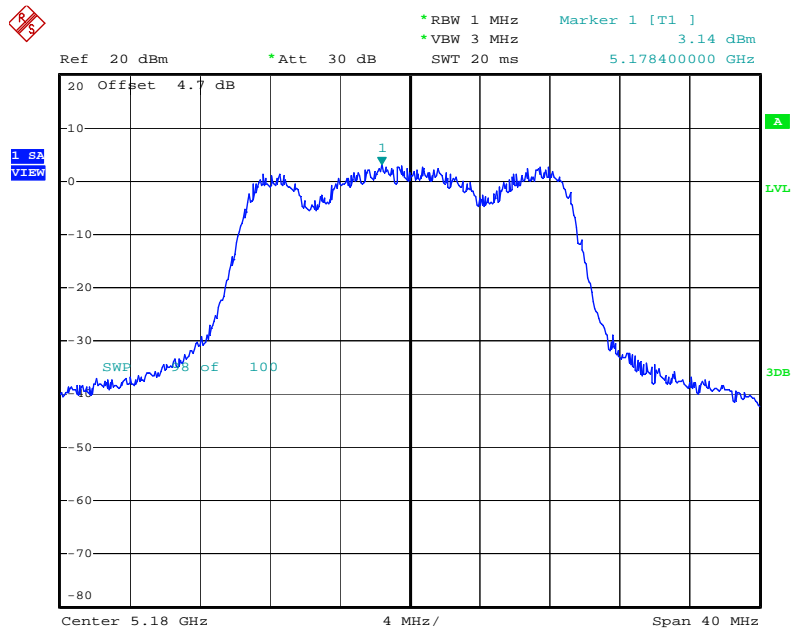

Date: 26.MAR.2009 13:24:31

Power Density Plot on Configuration Drafft n MCS0 20MHz Ant. A + Ant. B / 5200 MHz

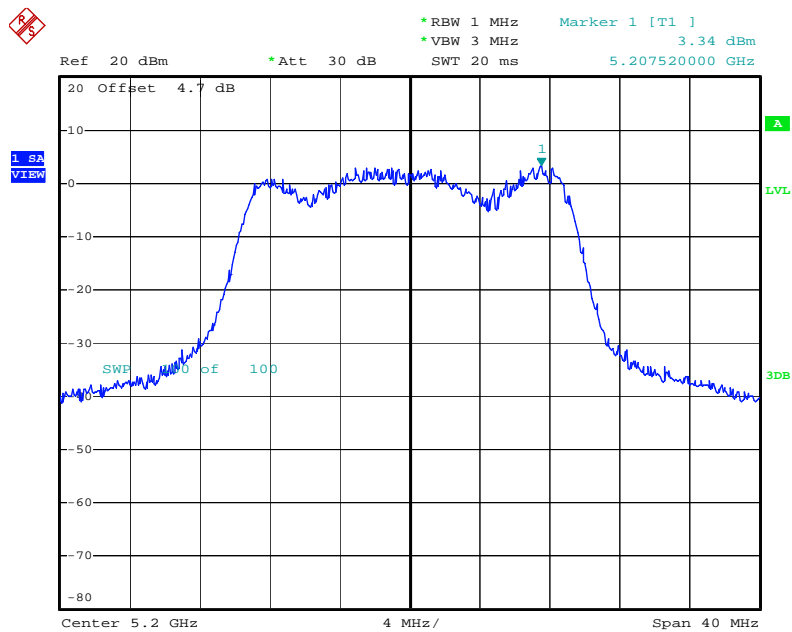

Date: 26.MAR.2009 13:23:48

Power Density Plot on Configuration Drafft n MCS0 20MHz Ant. A + Ant. B / 5240 MHz

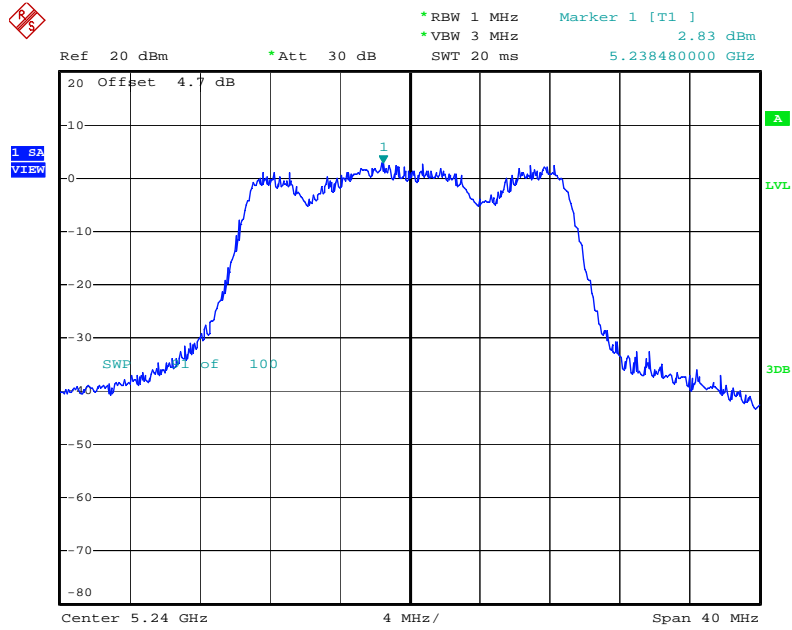

Date: 26.MAR.2009 13:23:02

Power Density Plot on Configuration Drafft n MCS0 40MHz Ant. A + Ant. B / 5190 MHz

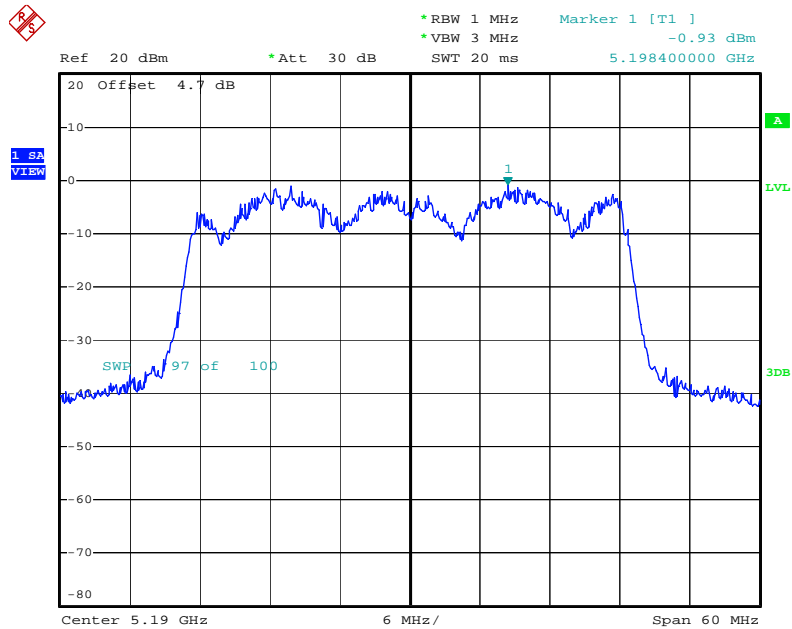

Date: 26.MAR.2009 13:27:50

Power Density Plot on Configuration Draft n MCS0 40MHz Ant. A + Ant. B / 5230 MHz

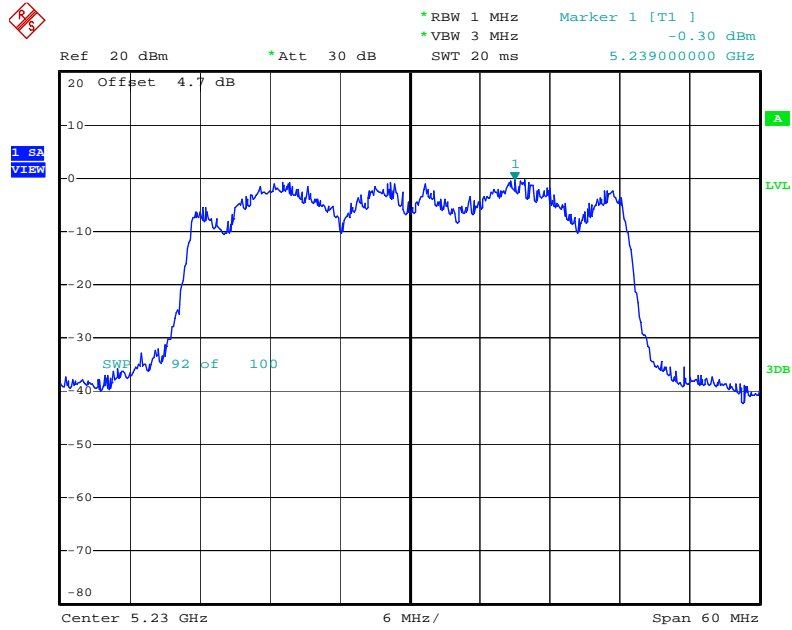

Date: 26.MAR.2009 13:30:18

Power Density Plot on Configuration IEEE 802.11a Ant. A + Ant. B / 5180 MHz

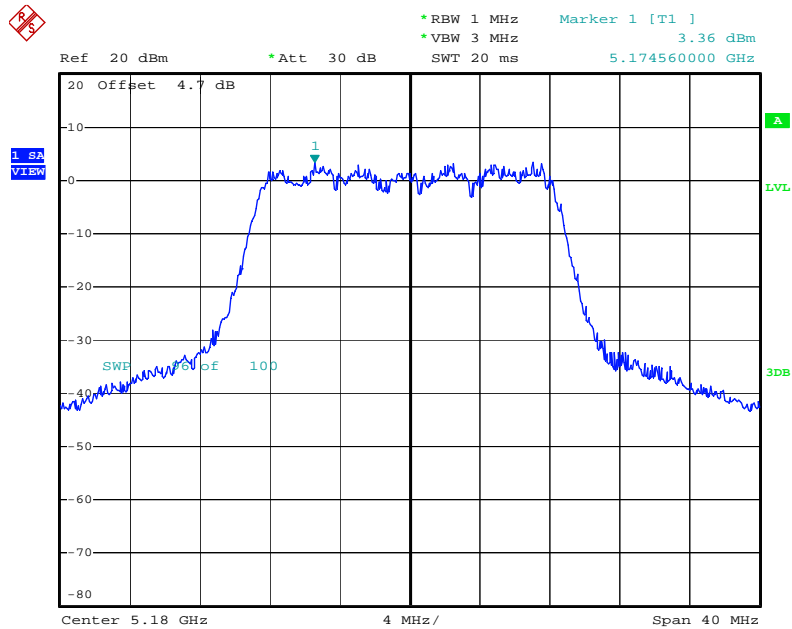

Date: 26.MAR.2009 13:04:11

Power Density Plot on Configuration IEEE 802.11a Ant. A + Ant. B / 5200 MHz

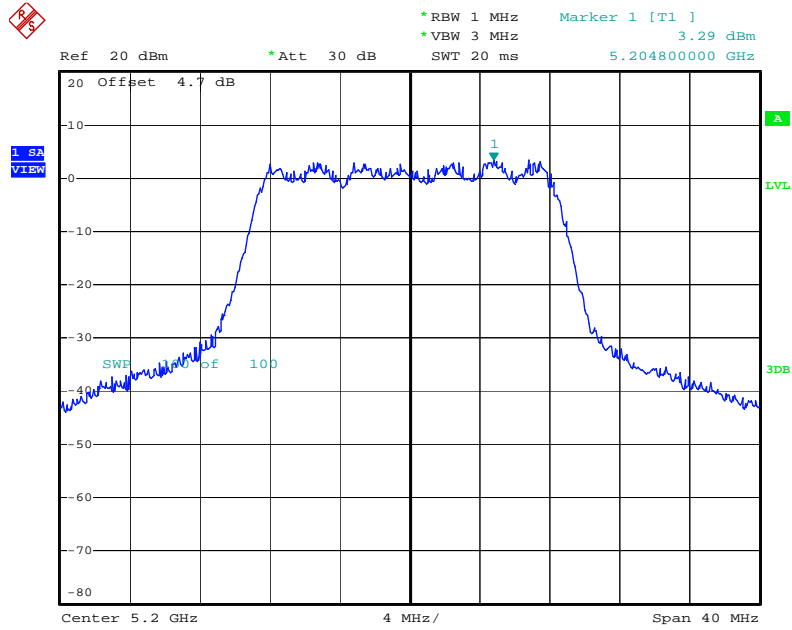

Date: 26.MAR.2009 13:05:51

Power Density Plot on Configuration IEEE 802.11a Ant. A + Ant. B / 5240 MHz

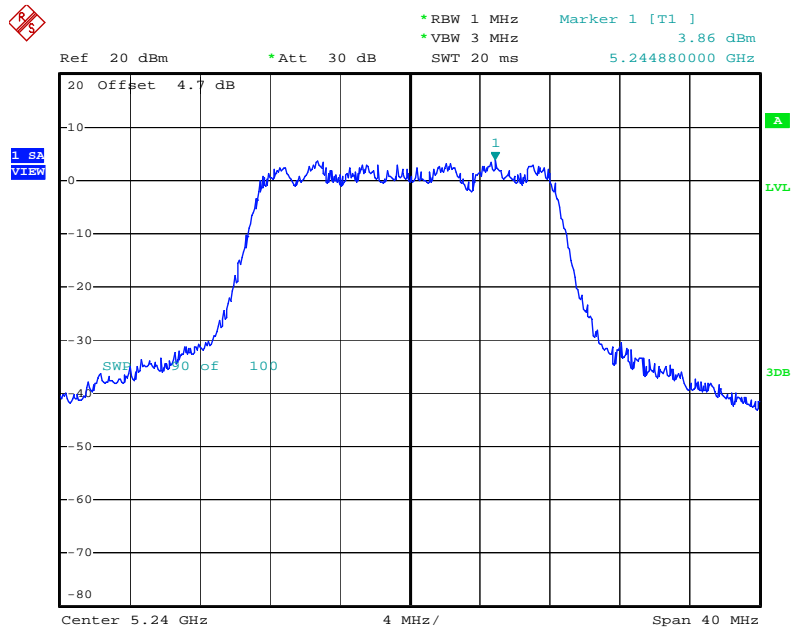

Date: 26.MAR.2009 13:10:15

4.5. Peak Excursion Measurement

4.5.1. Limit

The ratio of the peak excursion of the modulation envelope (measured using a peak hold function) to the maximum conducted output power (measured as specified above) shall not exceed 13 dB across any 1 MHz bandwidth or the emissions bandwidth whichever is less.

4.5.2. Measuring Instruments and Setting

Please refer to section 5 of equipments list in this report. The following table is the setting of the spectrum analyzer.

Spectrum Parameter	Setting
Attenuation	Auto
Span Frequency	Encompass the entire emissions bandwidth (EBW) of the signal
RB	1000 kHz (Peak Trace) / 1000 kHz (Average Trace)
VB	3000 kHz (Peak Trace) / 300 kHz (Average Trace)
Detector	Peak (Peak Trace) / Sample (Average Trace)
Trace	Max Hold
Sweep Time	60s

4.5.3. Test Procedures

1. The transmitter output (antenna port) was connected to the spectrum analyzer.
2. Set the spectrum analyzer span to view the entire emissions bandwidth. The largest difference between the following two traces (Peak Trace and Average Trace) must be ≤ 13 dB for all frequencies across the emissions bandwidth. Submit a plot.
3. Peak Trace: Set RBW = 1 MHz, VBW ≥ 3 MHz with peak detector and max-hold settings.
4. Average Trace: Method #3—video averaging with max hold--and sum power across the band. Set span to encompass the entire emissions bandwidth (EBW) of the signal. Set sweep trigger to "free run". Set RBW = 1 MHz. Set VBW $\geq 1/T$ (Draft n VBW = 300kHz $\geq 1/4\mu$ s). Use sample detector mode if bin width (i.e., span/number of points in spectrum) < 0.5 RBW. Otherwise use peak detector mode. Set max hold. Allow max hold to run for 60 seconds.
5. Measuring multiple antennas, the connector is required to link with Power Meter through a combiner.

4.5.4. Test Setup Layout

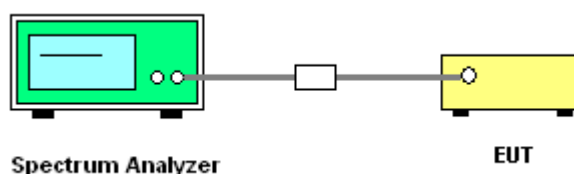

4.5.5. Test Deviation

There is no deviation with the original standard.

4.5.6. EUT Operation during Test

The EUT was programmed to be in continuously transmitting mode.

4.5.7. Test Result of Peak Excursion

Temperature	24°C	Humidity	56%
Test Engineer	Allen Liu	Configurations	Draft n

Configuration Draft n MCS0 20MHz Ant. A + Ant. B

Channel	Frequency	Peak Excursion (dB)	Max. Limit (dB)	Result
36	5180 MHz	5.53	13	Complies
40	5200 MHz	5.75	13	Complies
48	5240 MHz	6.30	13	Complies

Configuration Draft n MCS0 40MHz Ant. A + Ant. B

Channel	Frequency	Peak Excursion (dB)	Max. Limit (dB)	Result
38	5190 MHz	6.74	13	Complies
46	5230 MHz	5.67	13	Complies

Temperature	24°C	Humidity	56%
Test Engineer	Allen Liu	Configurations	802.11a

Configuration IEEE 802.11a Ant. A + Ant. B

Channel	Frequency	Peak Excursion (dB)	Max. Limit (dB)	Result
36	5180 MHz	4.71	13	Complies
40	5200 MHz	4.94	13	Complies
48	5240 MHz	5.31	13	Complies

Peak Excursion Plot on Configuration Drafft n MCS0 20MHz Ant. A + Ant. B / 5180 MHz

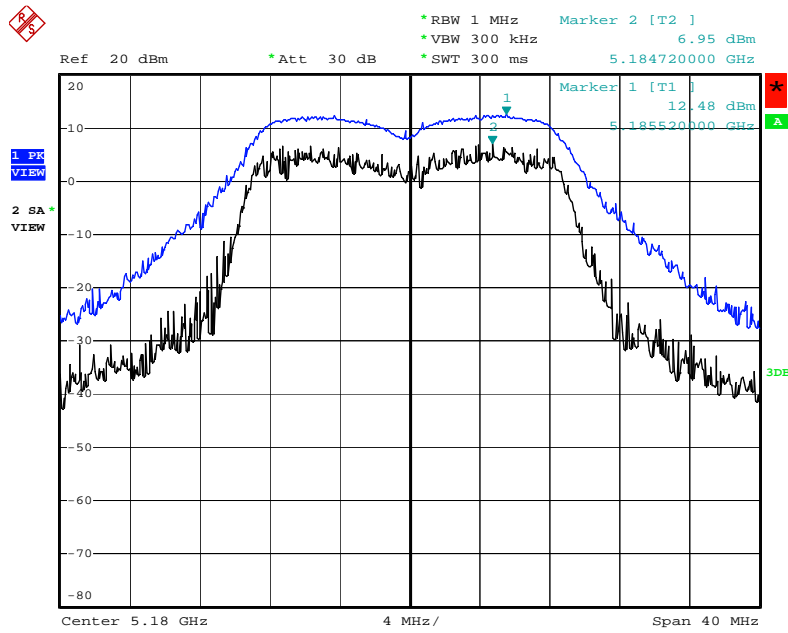

Date: 26.MAR.2009 13:24:43

Peak Excursion Plot on Configuration Drafft n MCS0 20MHz Ant. A + Ant. B / 5200 MHz

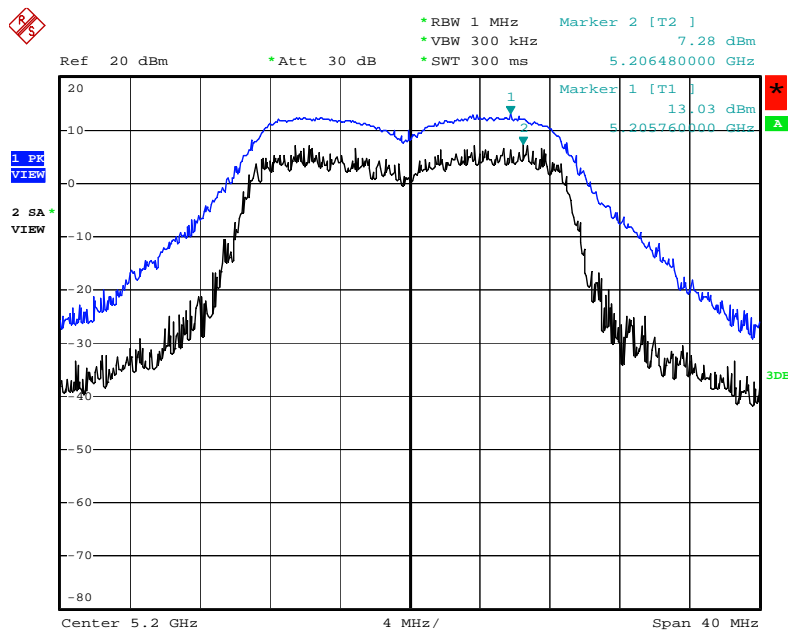

Date: 26.MAR.2009 13:24:00

Peak Excursion Plot on Configuration Drafft n MCS0 20MHz Ant. A + Ant. B / 5240 MHz

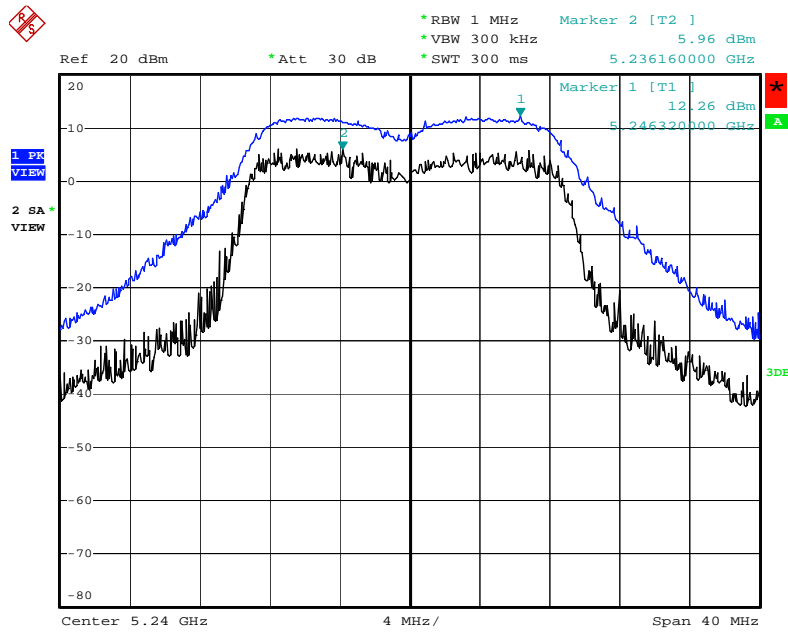

Date: 26.MAR.2009 13:23:14

Peak Excursion Plot on Configuration Drafft n MCS0 40MHz Ant. A + Ant. B / 5190 MHz

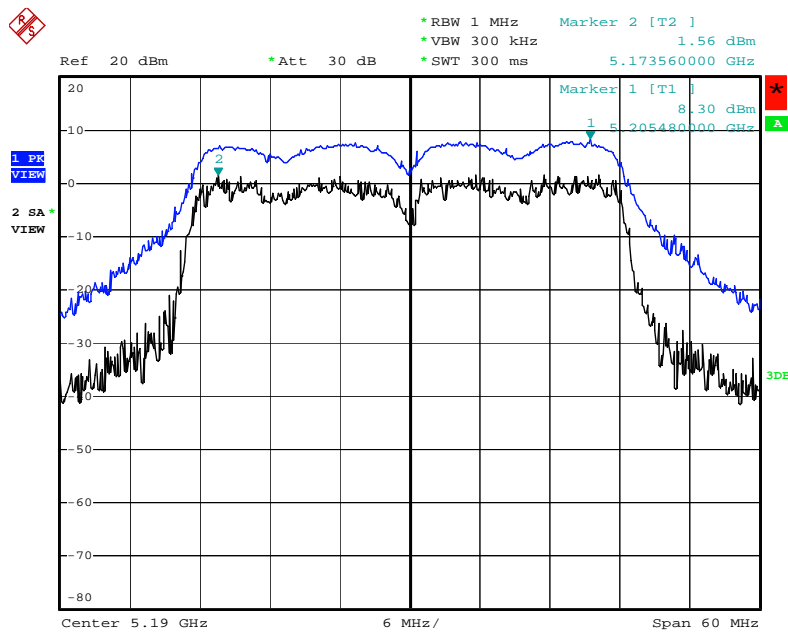

Date: 26.MAR.2009 13:28:02

Peak Excursion Plot on Configuration Drafft n MCS0 40MHz Ant. A + Ant. B / 5230 MHz

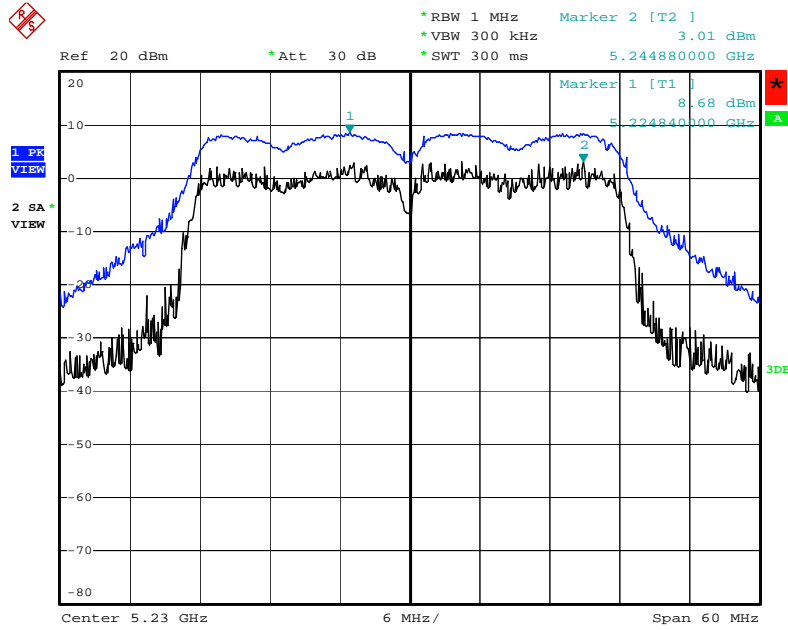

Date: 26.MAR.2009 13:30:30

Peak Excursion Plot on Configuration IEEE 802.11a Ant. A + Ant. B / 5180 MHz

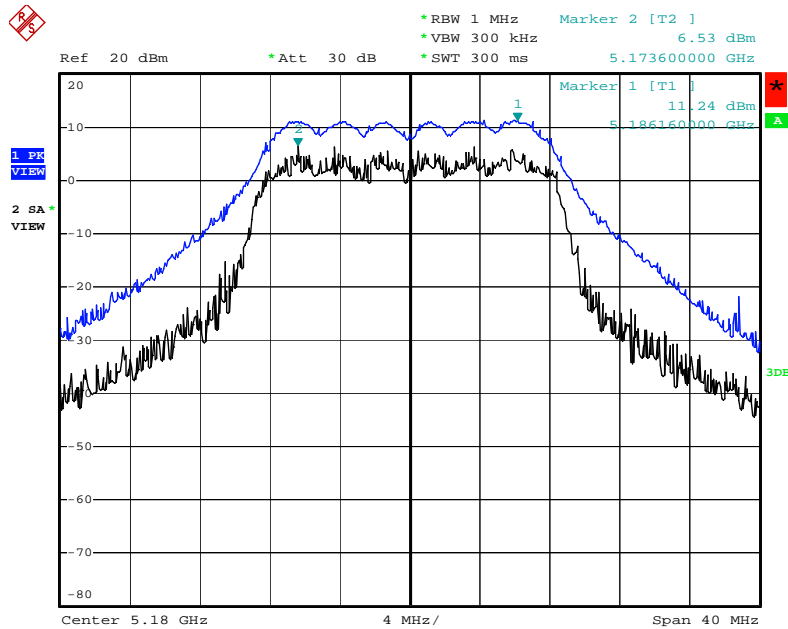

Date: 26.MAR.2009 13:04:23

Peak Excursion Plot on Configuration IEEE 802.11a Ant. A + Ant. B / 5200 MHz

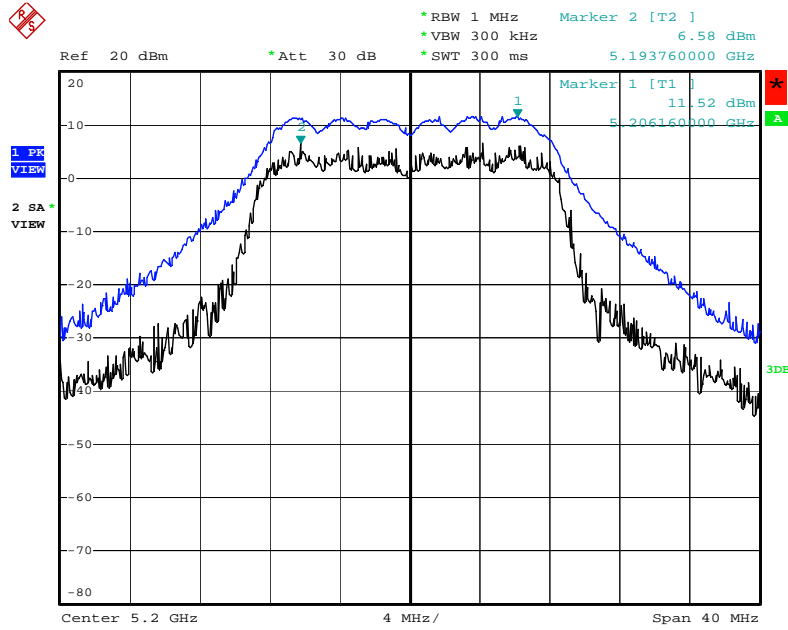

Date: 26.MAR.2009 13:06:03

Peak Excursion Plot on Configuration IEEE 802.11a Ant. A + Ant. B / 5240 MHz

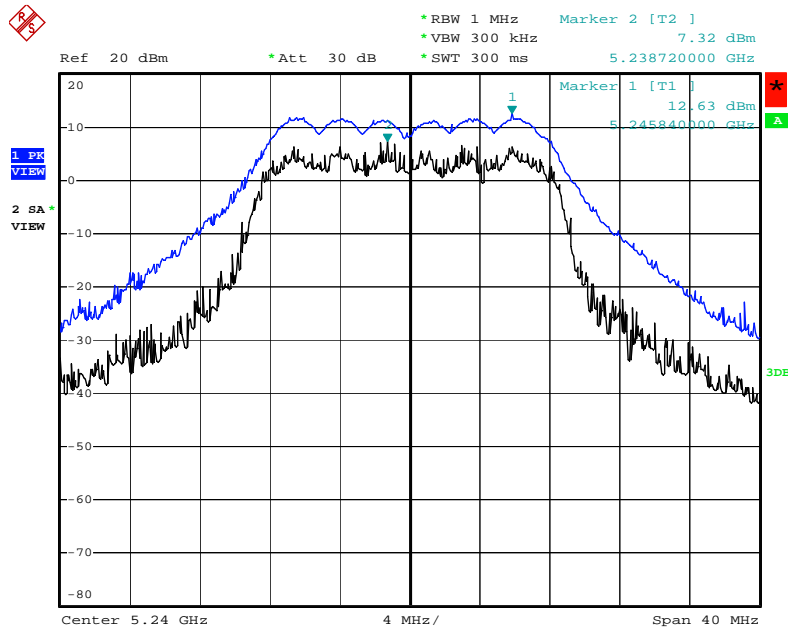

Date: 26.MAR.2009 13:10:27

4.6. Radiated Emissions Measurement

4.6.1. Limit

For transmitters operating in the 5.15-5.35 GHz band: all emissions outside of the 5.15-5.35 GHz band shall not exceed an EIRP of -27 dBm/MHz (68.3dBuV/m at 3m). For transmitters operating in the 5.470-5.725 GHz band: all emissions outside of the 5.470-5.725 GHz band shall not exceed an EIRP of -27 dBm/MHz (68.3dBuV/m at 3m). For transmitters operating in the 5.725-5.825 GHz band: all emissions within the frequency range from the band edge to 10 MHz above or below the band edge shall not exceed an EIRP of -17 dBm/MHz (78.3dBuV/m at 3m); for frequencies 10 MHz or greater above or below the band edge, emissions shall not exceed an EIRP of -27 dBm/MHz (68.3dBuV/m at 3m). In addition, in case the emission falls within the restricted band specified on 15.205(a), then the 15.209(a) limit in the table below has to be followed.

Frequencies (MHz)	Field Strength (microrvolts/meter)	Measurement Distance (meters)
0.009~0.490	2400/F(KHz)	300
0.490~1.705	24000/F(KHz)	30
1.705~30.0	30	30
30~88	100	3
88~216	150	3
216~960	200	3
Above 960	500	3

4.6.2. Measuring Instruments and Setting

Please refer to section 5 of equipments list in this report. The following table is the setting of spectrum analyzer and receiver.

Spectrum Parameter	Setting
Attenuation	Auto
Start Frequency	1000 MHz
Stop Frequency	40 GHz
RB / VB (Emission in restricted band)	1MHz / 1MHz for Peak, 1 MHz / 10Hz for Average
RB / VB (Emission in non-restricted band)	1000KHz / 1000KHz for peak

Receiver Parameter	Setting
Attenuation	Auto
Start ~ Stop Frequency	9kHz~150kHz / RB 200Hz for QP
Start ~ Stop Frequency	150kHz~30MHz / RB 9kHz for QP
Start ~ Stop Frequency	30MHz~1000MHz / RB 120kHz for QP

4.6.3. Test Procedures

1. Configure the EUT according to ANSI C63.4. The EUT was placed on the top of the turntable 0.8 meter above ground. The phase center of the receiving antenna mounted on the top of a height-variable antenna tower was placed 3 meters far away from the turntable.
2. Power on the EUT and all the supporting units. The turntable was rotated by 360 degrees to determine the position of the highest radiation.
3. The height of the broadband receiving antenna was varied between one meter and four meters above ground to find the maximum emissions field strength of both horizontal and vertical polarization.
4. For each suspected emissions, the antenna tower was scan (from 1 M to 4 M) and then the turntable was rotated (from 0 degree to 360 degrees) to find the maximum reading.
5. Set the test-receiver system to Peak or CISPR quasi-peak Detect Function with specified bandwidth under Maximum Hold Mode.
6. For emissions above 1GHz, use 1MHz VBW and RBW for peak reading. Then 1MHz RBW and 10Hz VBW for average reading in spectrum analyzer.
7. When the radiated emissions limits are expressed in terms of the average value of the emissions, and pulsed operation is employed, the measurement field strength shall be determined by averaging over one complete pulse train, including blanking intervals, as long as the pulse train does not exceed 0.1 seconds. As an alternative (provided the transmitter operates for longer than 0.1 seconds) or in cases where the pulse train exceeds 0.1 seconds, the measured field strength shall be determined from the average absolute voltage during a 0.1 second interval during which the field strength is at its maximum value.
8. If the emissions level of the EUT in peak mode was 3 dB lower than the average limit specified, then testing will be stopped and peak values of EUT will be reported, otherwise, the emissions which do not have 3 dB margin will be repeated one by one using the quasi-peak method for below 1GHz.
9. For testing above 1GHz, the emissions level of the EUT in peak mode was lower than average limit (that means the emissions level in peak mode also complies with the limit in average mode), then testing will be stopped and peak values of EUT will be reported, otherwise, the emissions will be measured in average mode again and reported.
10. In case the emission is lower than 30MHz, loop antenna has to be used for measurement and the recorded data should be QP measured by receiver. High – Low scan is not required in this case.

4.6.4. Test Setup Layout

For radiated emissions below 30MHz

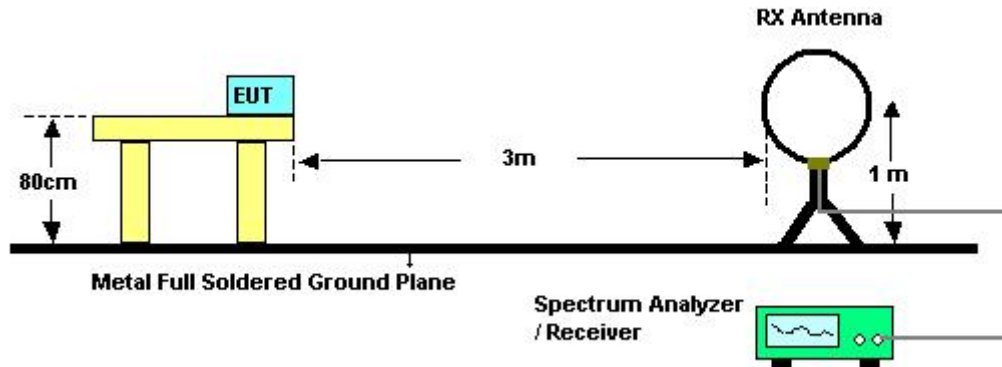

For radiated emissions above 30MHz

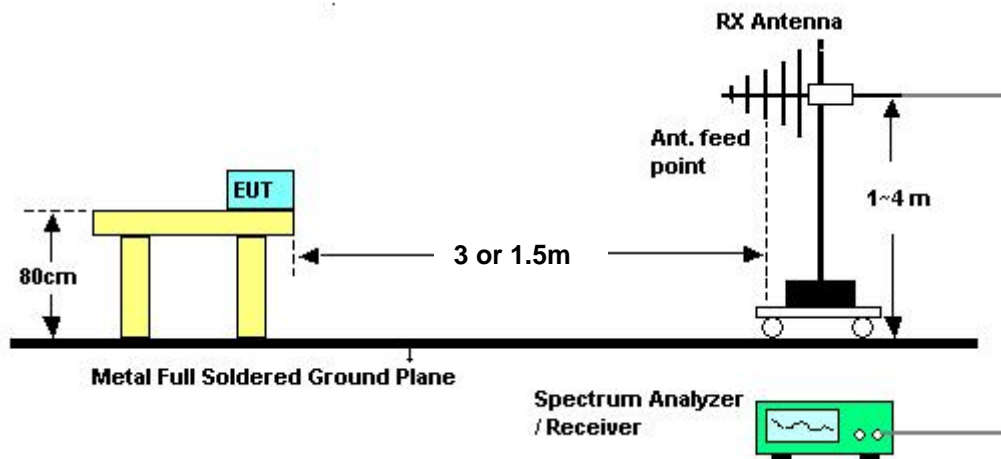

Above 5GHz shall be extrapolated to the specified distance using an extrapolation factor of 20 dB/decade from 3m to 1.5m.

Distance extrapolation factor = $20 \log (\text{specific distance [3m]} / \text{test distance [1.5m]})$ (dB);

Limit line = specific limits (dBuV) + distance extrapolation factor [6 dB].

4.6.5. Test Deviation

There is no deviation with the original standard.

4.6.6. EUT Operation during Test

The EUT was programmed to be in continuously transmitting mode.

4.6.7. Results of Radiated Emissions (9kHz~30MHz)

Temperature	25°C	Humidity	56%
Test Engineer	Johnson Chang	Configurations	Normal Link

Freq. (MHz)	Level (dBuV)	Over Limit (dB)	Limit Line (dBuV)	Remark
-	-	-	-	See Note

Note:

The amplitude of spurious emissions that are attenuated by more than 20dB below the permissible value has no need to be reported.

Distance extrapolation factor = $40 \log(\text{specific distance} / \text{test distance})$ (dB);

Limit line = specific limits (dBuV) + distance extrapolation factor.

4.6.8. Results of Radiated Emissions (30MHz~1GHz)

Temperature	25°C	Humidity	56%
Test Engineer	Johnson Chang	Configurations	Normal Link

Horizontal

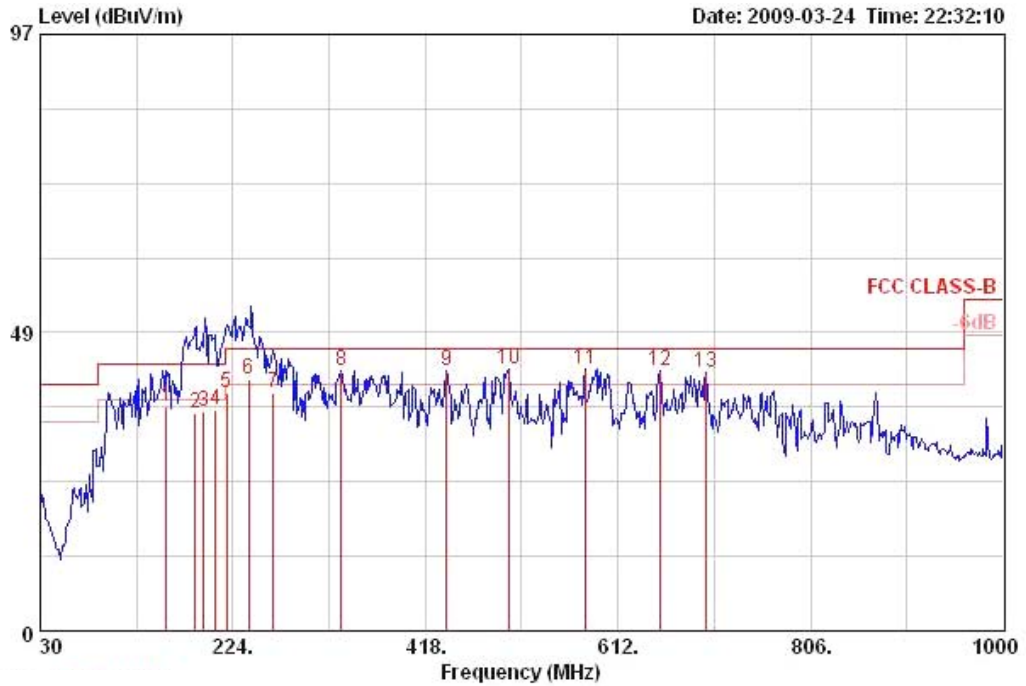

	Freq	Level	Over	Limit	Read	Antenna	Preamp	Cable	Remark	Pol/Phase	Table	Ant
	MHz	dBuV/m	Limit	Line	Level	Factor	Factor	Loss			Pos	Pos
			dB	dBuV/m	dBuV	dB/m	dB	dB			deg	cm
1	157.070	36.41	-7.09	43.50	50.26	11.98	27.31	1.49	QP	HORIZONTAL	347	100
2	186.210	35.51	-7.99	43.50	49.33	11.71	27.16	1.63	QP	HORIZONTAL	344	118
3	195.000	35.72	-7.78	43.50	51.10	10.07	27.13	1.67	QP	HORIZONTAL	344	118
4	206.540	35.79	-7.71	43.50	51.60	9.55	27.09	1.73	QP	HORIZONTAL	341	119
5	218.180	38.64	-7.36	46.00	53.52	10.41	27.06	1.77	QP	HORIZONTAL	343	117
6 !	240.040	41.02	-4.98	46.00	54.12	12.05	27.02	1.86	QP	HORIZONTAL	173	100
7	264.740	38.71	-7.29	46.00	50.78	12.94	26.97	1.96	QP	HORIZONTAL	340	119
8 !	333.610	42.34	-3.66	46.00	53.03	14.28	27.13	2.17	Peak	HORIZONTAL	0	400
9 !	439.340	42.22	-3.78	46.00	50.80	16.68	27.80	2.54	Peak	HORIZONTAL	0	400
10 !	501.420	42.54	-3.46	46.00	50.30	17.64	28.10	2.70	Peak	HORIZONTAL	0	400
11 !	579.020	42.66	-3.34	46.00	49.38	18.53	28.10	2.86	Peak	HORIZONTAL	178	100
12 !	653.710	42.37	-3.63	46.00	47.99	18.94	28.05	3.48	Peak	HORIZONTAL	0	400
13 !	700.270	42.06	-3.94	46.00	47.66	19.09	27.99	3.30	Peak	HORIZONTAL	0	400

Vertical

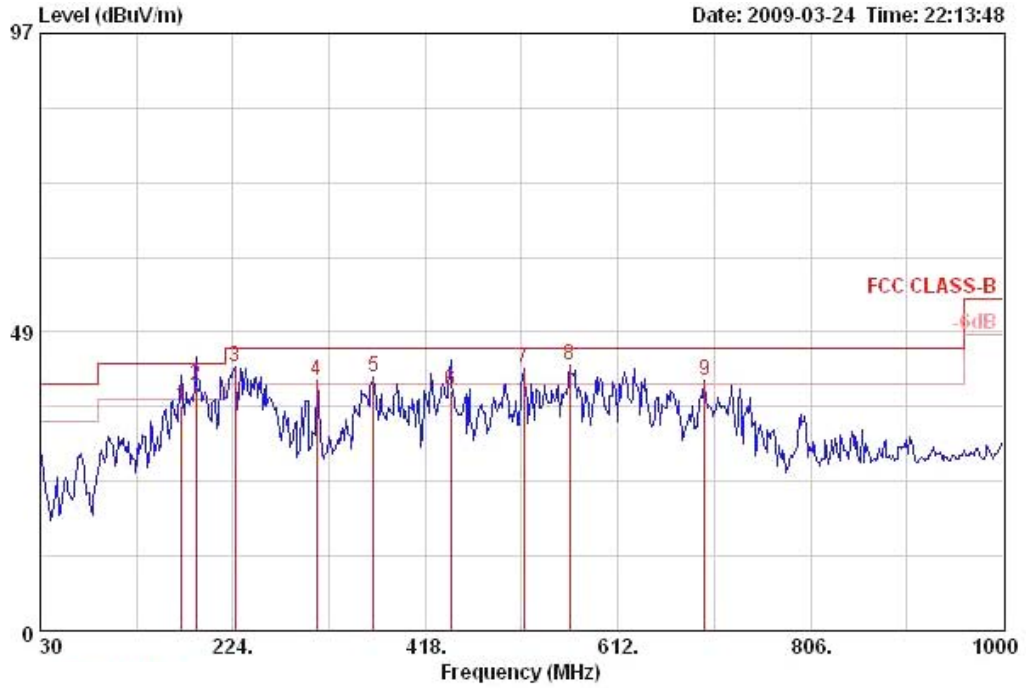

	Freq	Level	Over Limit	Limit Line	Read Level	Antenna Factor	Preamp Factor	Cable Loss	Remark	Pol/Phase	Table Pos	Ant Pos
	MHz	dBuV/m	dB	dBuV/m	dBuV	dB/m	dB	dB			deg	cm
1	172.590	36.36	-7.14	43.50	49.06	12.97	27.23	1.56	QP	VERTICAL	187	100
2 !	187.140	39.68	-3.82	43.50	53.50	11.71	27.16	1.63	QP	VERTICAL	188	100
3 !	225.940	42.82	-3.18	46.00	57.09	10.98	27.05	1.80	Peak	VERTICAL	0	400
4 !	308.390	40.53	-5.47	46.00	51.77	13.60	26.95	2.12	Peak	VERTICAL	0	400
5 !	365.620	41.22	-4.78	46.00	51.20	15.14	27.36	2.23	Peak	VERTICAL	0	400
6	443.220	38.88	-7.12	46.00	47.39	16.74	27.82	2.56	QP	VERTICAL	236	100
7 !	516.940	42.57	-3.43	46.00	50.12	17.82	28.10	2.73	Peak	VERTICAL	0	400
8 ☒	563.500	42.98	-3.02	46.00	49.90	18.35	28.10	2.83	Peak	VERTICAL	233	100
9 !	699.300	40.57	-5.43	46.00	46.18	19.09	28.00	3.30	Peak	VERTICAL	0	400

Note:

The amplitude of spurious emissions that are attenuated by more than 20dB below the permissible value has no need to be reported.

Emission level (dBuV/m) = 20 log Emission level (uV/m).

Corrected Reading: Antenna Factor + Cable Loss + Read Level - Preamp Factor = Level.

4.6.9. Results for Radiated Emissions (1GHz~40GHz)

Temperature	25°C	Humidity	56%
Test Engineer	Johnson Chang	Configurations	Draft n MCS0 20MHz Ch 36 / Ant. A + Ant. B

Horizontal

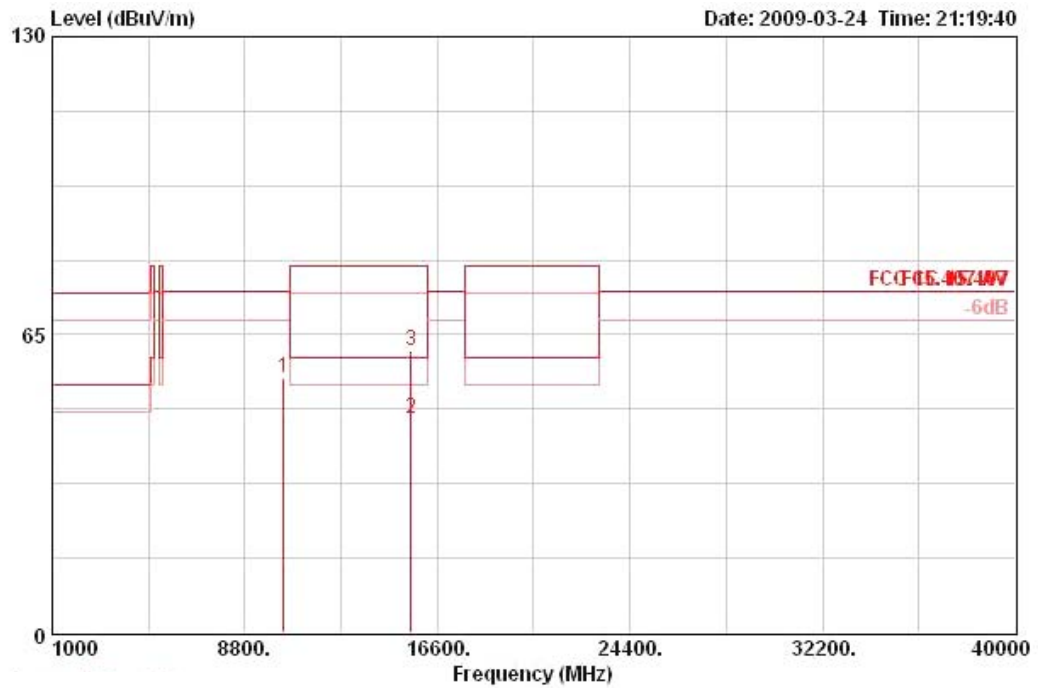

	Freq	Level	Over Limit	Limit Line	ReadAntenna	Preamp	Cable	Remark	Pol/Phase	Table Pos	Ant Pos
	MHz	dBuV/m	dB	dBuV/m	dBuV	dB/m	dB			deg	cm
1	10360.000	55.51	-18.79	74.30	40.66	39.85	35.27	10.27 PEAK	HORIZONTAL	360	100
2	15540.000	46.56	-13.44	60.00	32.35	38.09	35.59	11.71 AVERAGE	HORIZONTAL	360	100
3	15542.000	61.57	-18.43	80.00	47.36	38.09	35.59	11.71 PEAK	HORIZONTAL	360	100

Vertical

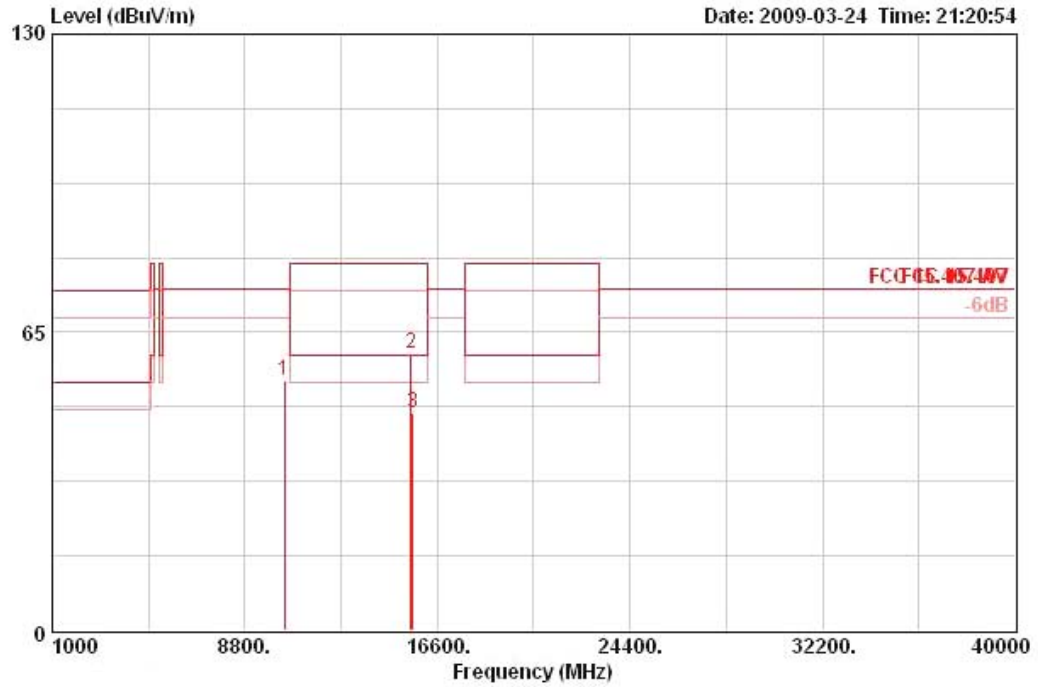

	Freq	Level	Over Limit	Limit Line	ReadAntenna	Preamp	Cable	Remark	Pol/Phase	Table Pos	Ant Pos
	MHz	dBuV/m	dB	dBuV/m	dBuV	dB/m	dB			deg	cm
1	10410.000	54.42	-19.88	74.30	39.57	39.85	35.27	10.27 PEAK	VERTICAL	0	100
2	15540.000	60.26	-19.74	80.00	46.01	38.14	35.59	11.69 PEAK	VERTICAL	0	100
3	15586.800	47.34	-12.66	60.00	33.13	38.06	35.58	11.73 AVERAGE	VERTICAL	0	100

Temperature	25°C	Humidity	56%
Test Engineer	Johnson Chang	Configurations	Draft n MCS0 20MHz Ch 40 / Ant. A + Ant. B

Horizontal

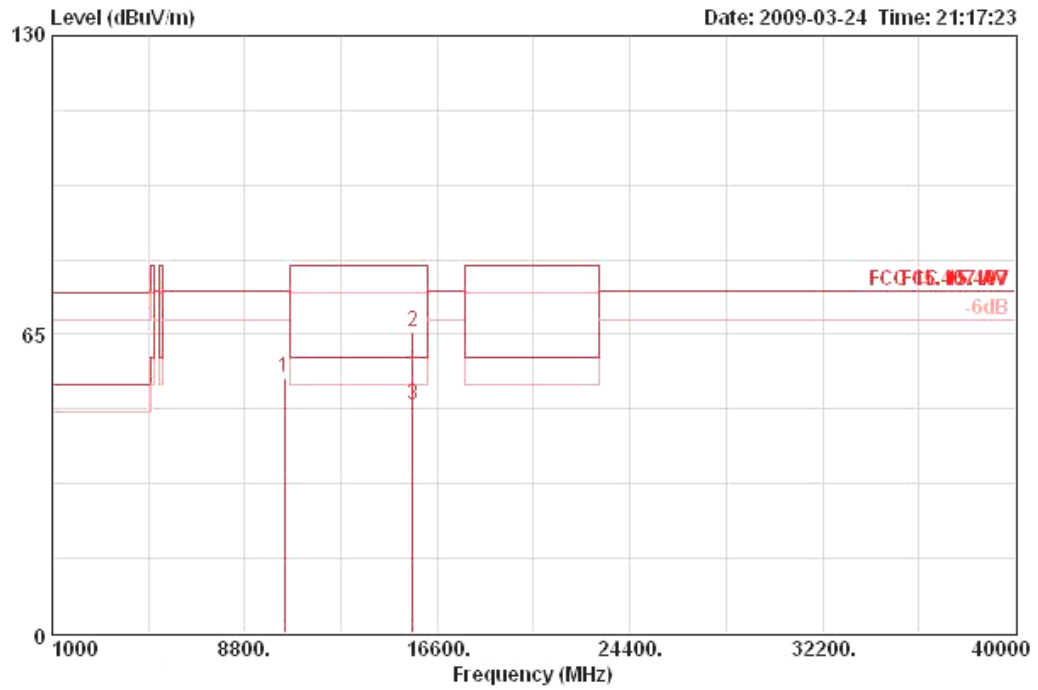

	Freq	Level	Over Limit	Limit Line	Read Level	Antenna Factor	Preamp Factor	Cable Loss	Remark	Pol/Phase	Table Pos	Ant Pos
	MHz	dBuV/m	dB	dBuV/m	dBuV	dB/m	dB	dB			deg	cm
1	10406.900	55.69	-18.61	74.30	40.88	39.82	35.28	10.27	PEAK	HORIZONTAL	272	100
2	15602.700	65.57	-14.43	80.00	51.36	38.03	35.58	11.75	PEAK	HORIZONTAL	272	100
3	15605.820	49.53	-10.47	60.00	35.33	38.03	35.58	11.75	AVERAGE	HORIZONTAL	272	100

Vertical

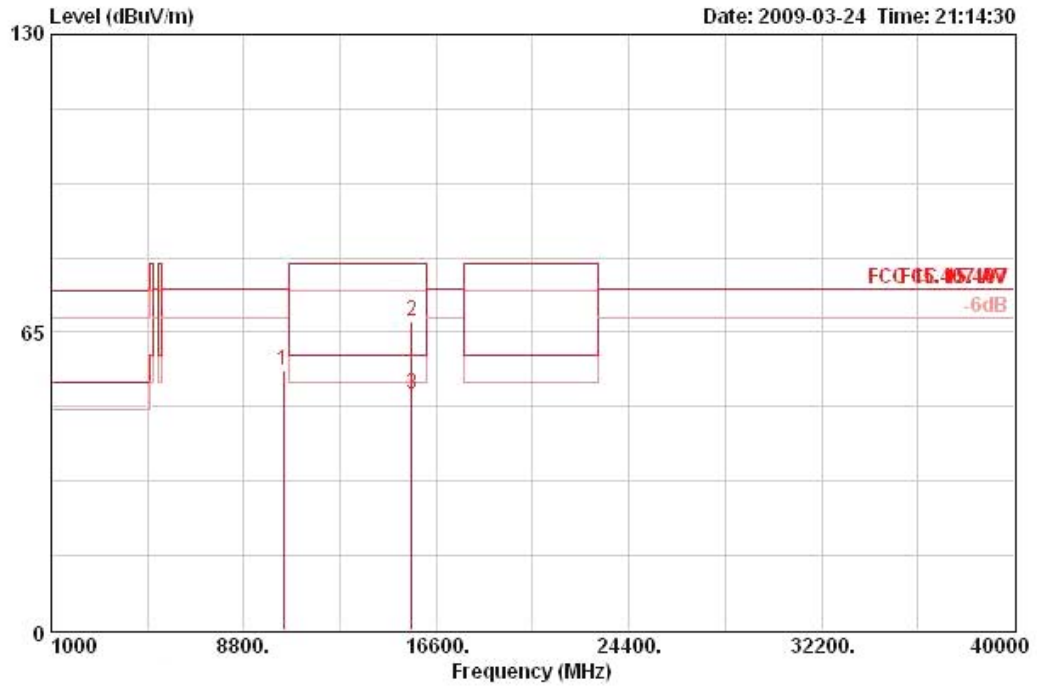

	Freq	Level	Over	Limit	Read	Antenna	Preamp	Cable		Table	Ant
	MHz	dBuV/m	Limit	Line	Level	Factor	Factor	Loss	Remark	Pos	Pos
			dB	dBuV/m	dBuV	dB/m	dB	dB		deg	cm
1	10402.500	56.56	-17.74	74.30	41.75	39.82	35.28	10.27	PEAK	172	147
2	15601.680	67.45	-12.55	80.00	53.25	38.03	35.58	11.75	PERK	172	147
3	15602.380	51.35	-8.65	60.00	37.14	38.03	35.58	11.75	AVERAGE	172	147

Temperature	25°C	Humidity	56%
Test Engineer	Johnson Chang	Configurations	Draft n MCS0 20MHz Ch 48 / Ant. A + Ant. B

Horizontal

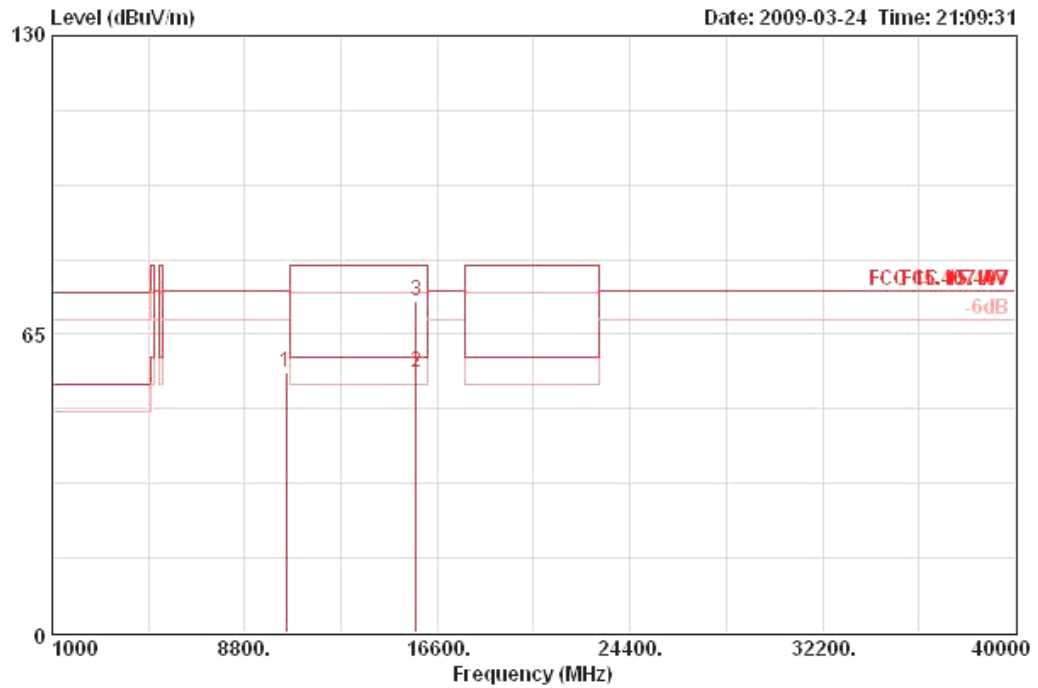

	Freq	Level	Over Limit	Limit Line	Read Level	Antenna Factor	Preamp Factor	Cable Loss	Remark	Pol/Phase	Table Pos	Ant Pos
	MHz	dBuV/m	dB	dBuV/m	dBuV	dB/m	dB	dB			deg	cm
1	10482.500	56.71	-17.59	74.30	41.60	39.97	35.21	10.35	PEAK	HORIZONTAL	269	100
2 @	15719.990	56.75	-3.25	60.00	42.63	37.84	35.56	11.83	AVERAGE	HORIZONTAL	269	100
3	15720.070	72.26	-7.74	80.00	58.15	37.84	35.56	11.83	PEAK	HORIZONTAL	269	100

Vertical

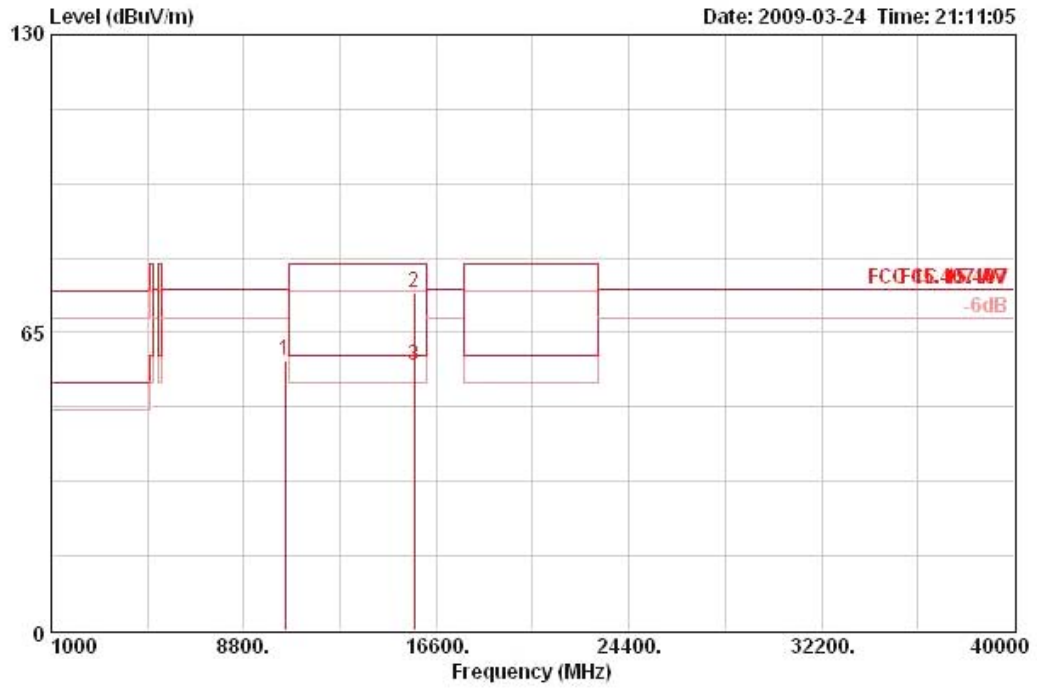

	Freq	Level	Over Limit	Limit Line	ReadAntenna	Preamp	Cable	Remark	Pol/Phase	Table Pos	Ant Pos
	MHz	dBuV/m	dB	dBuV/m	dBuV	dB/m	dB			deg	cm
1	10481.100	58.98	-15.32	74.30	43.88	39.97	35.21	10.35 PEAK	VERTICAL	280	100
2	15717.720	73.67	-6.33	80.00	59.55	37.84	35.56	11.83 PEAK	VERTICAL	280	100
3	15719.490	57.84	-2.16	60.00	43.72	37.84	35.56	11.83 AVERAGE	VERTICAL	280	100

Temperature	25°C	Humidity	56%
Test Engineer	Johnson Chang	Configurations	Draft n MCS0 40MHz Ch 38 / Ant. A + Ant. B

Horizontal

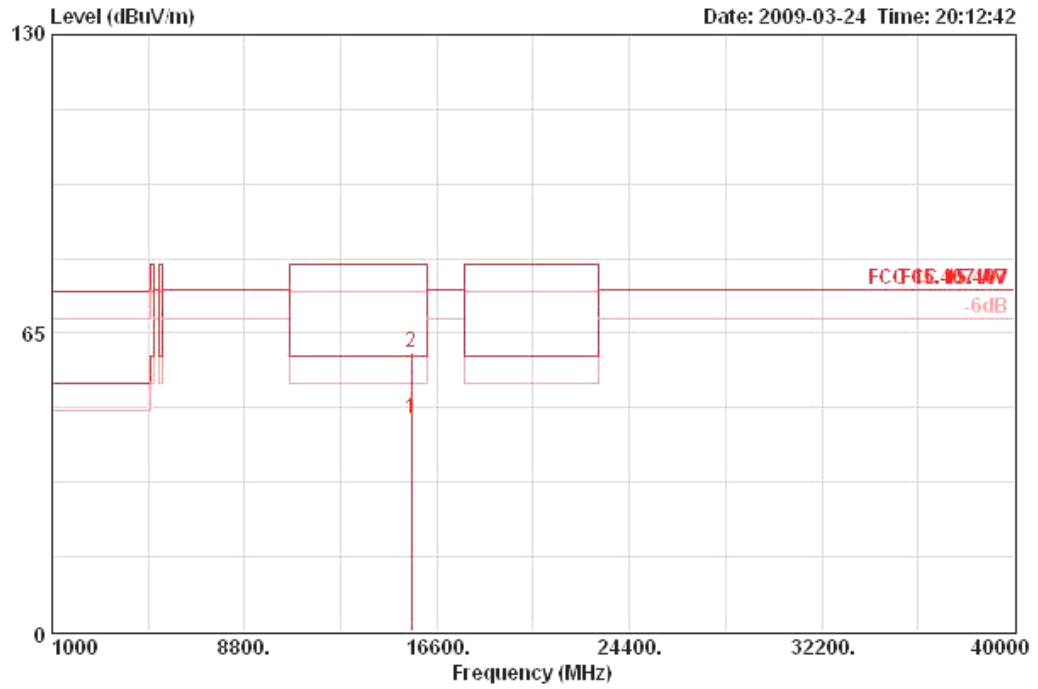

	Freq	Level	Over Limit	Limit Line	Read Level	Antenna Factor	Preamp Factor	Cable Loss	Remark	Pol/Phase	Table Pos	Ant Pos
	MHz	dBuV/m	dB	dBuV/m	dBuV	dB/m	dB	dB			deg	cm
1	15568.260	46.20	-13.80	60.00	31.99	38.09	35.59	11.71	AVERAGE	HORIZONTAL	322	104
2	15570.440	60.64	-19.36	80.00	46.43	38.09	35.59	11.71	PERK	HORIZONTAL	322	104

Vertical

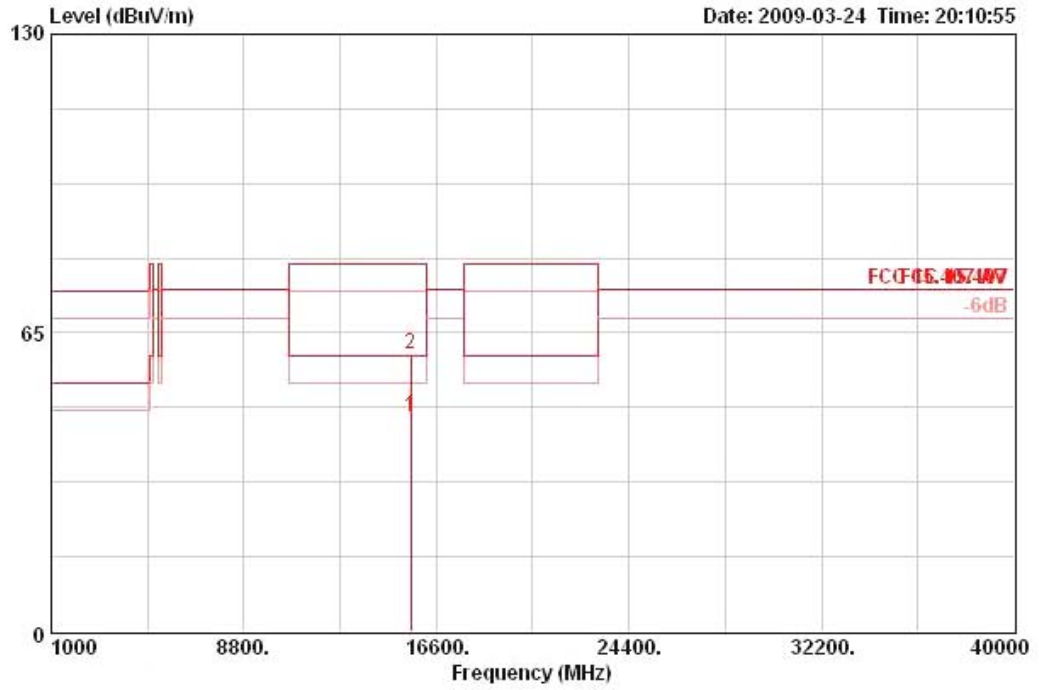

	Freq	Level	Over	Limit	Read	Antenna	Preamp	Cable	Remark	Pol/Phase	Table	Ant
	MHz	dBuV/m	Limit	Line	Level	Factor	Factor	Loss			Pos	Pos
			dB	dBuV/m	dBuV	dB/m	dB	dB			deg	cm
1	15568.150	46.77	-13.23	60.00	32.56	38.09	35.59	11.71	AVERAGE	VERTICAL	22	116
2	15568.570	60.38	-19.62	80.00	46.17	38.09	35.59	11.71	PERK	VERTICAL	22	116

Temperature	25°C	Humidity	56%
Test Engineer	Johnson Chang	Configurations	Draft n MCS0 40MHz Ch 46 / Ant. A + Ant. B

Horizontal

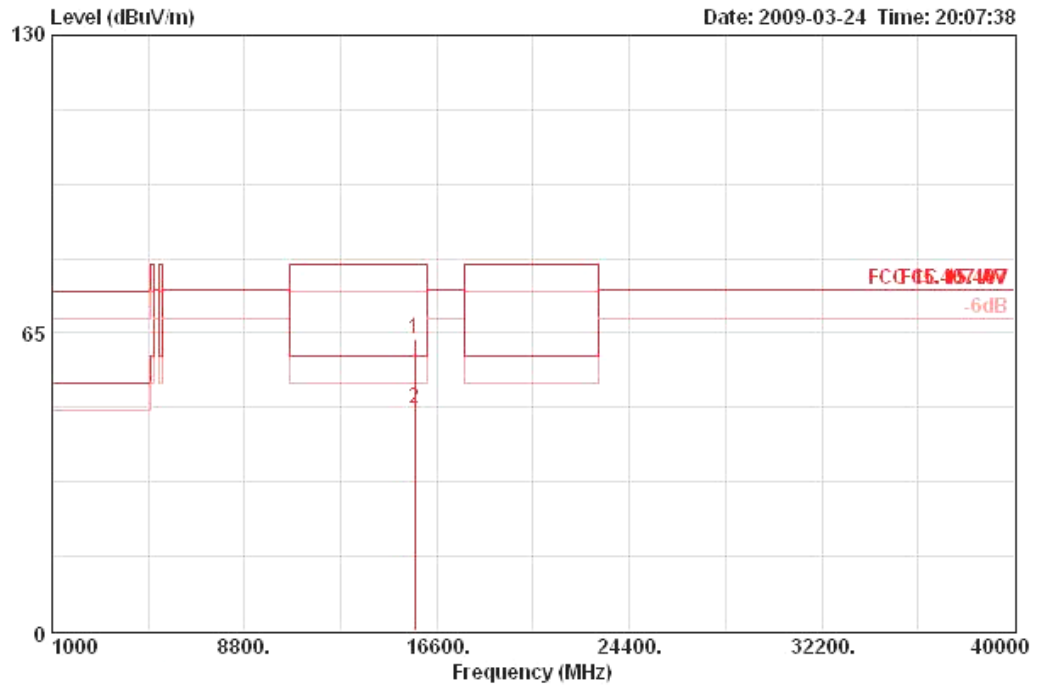

	Freq	Level	Over	Limit	Read	Antenna	Preamp	Cable	Remark	Pol/Phase	Table	Ant
	MHz	dBuV/m	dB	dBuV/m	Level	Factor	Factor	Loss			Pos	Pos
					dBuV	dB/m	dB	dB			deg	cm
1	15688.900	63.65	-16.35	80.00	49.51	37.90	35.56	11.81	PEAK	HORIZONTAL	323	121
2	15691.130	48.64	-11.36	60.00	34.49	37.90	35.56	11.81	AVERAGE	HORIZONTAL	323	121

Vertical

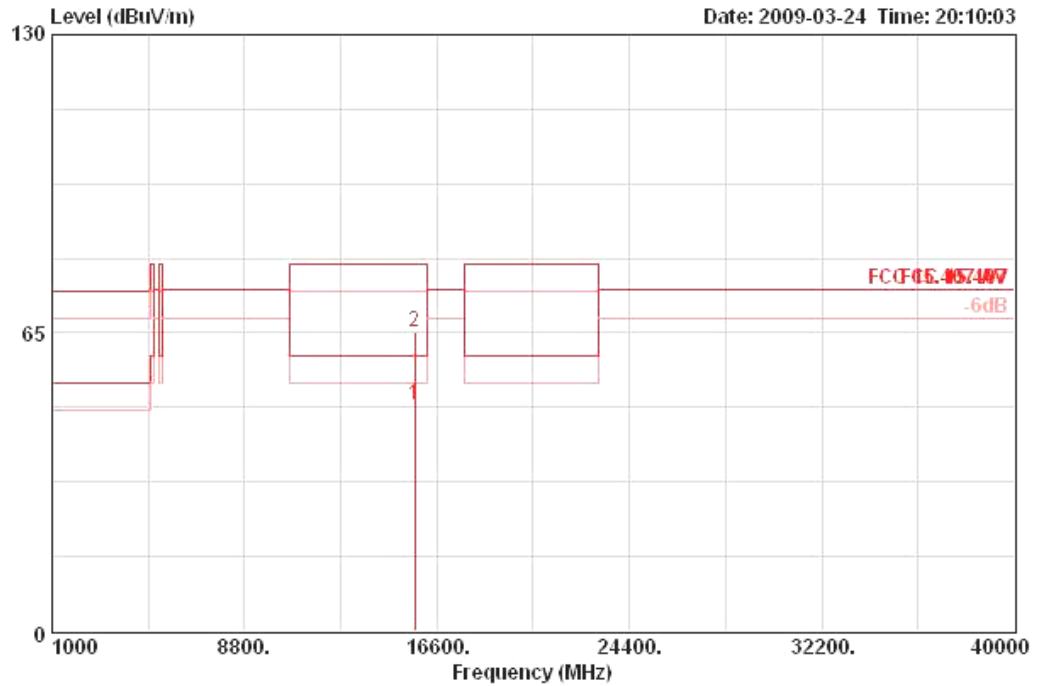

	Freq	Level	Over Limit	Limit Line	Read Level	Antenna Factor	Preamp Factor	Cable Loss	Remark	Pol/Phase	Table Pos	Ant Pos
	MHz	dBuV/m	dB	dBuV/m	dBuV	dB/m	dB	dB			deg	cm
1	15687.040	49.16	-10.84	60.00	35.02	37.90	35.56	11.81	AVERAGE	VERTICAL	22	116
2	15688.470	65.21	-14.79	80.00	51.06	37.90	35.56	11.81	PEAK	VERTICAL	22	116

Note:

The amplitude of spurious emissions that are attenuated by more than 20dB below the permissible value has no need to be reported.

Emission level (dBuV/m) = 20 log Emission level (uV/m).

Corrected Reading: Antenna Factor + Cable Loss + Read Level - Preamp Factor = Level.

The limits above 5GHz shall be extrapolated to the specified distance using an extrapolation factor of 20 dB/decade form 3m to 1.5m.

Distance extrapolation factor = 20 log (specific distance [3m] / test distance [1.5m]) (dB);

Limit line = specific limits (dBuV) + distance extrapolation factor [6 dB].

Temperature	25°C	Humidity	56%
Test Engineer	Johnson Chang	Configurations	802.11a Ch 36 / Ant. A + Ant. B

Horizontal

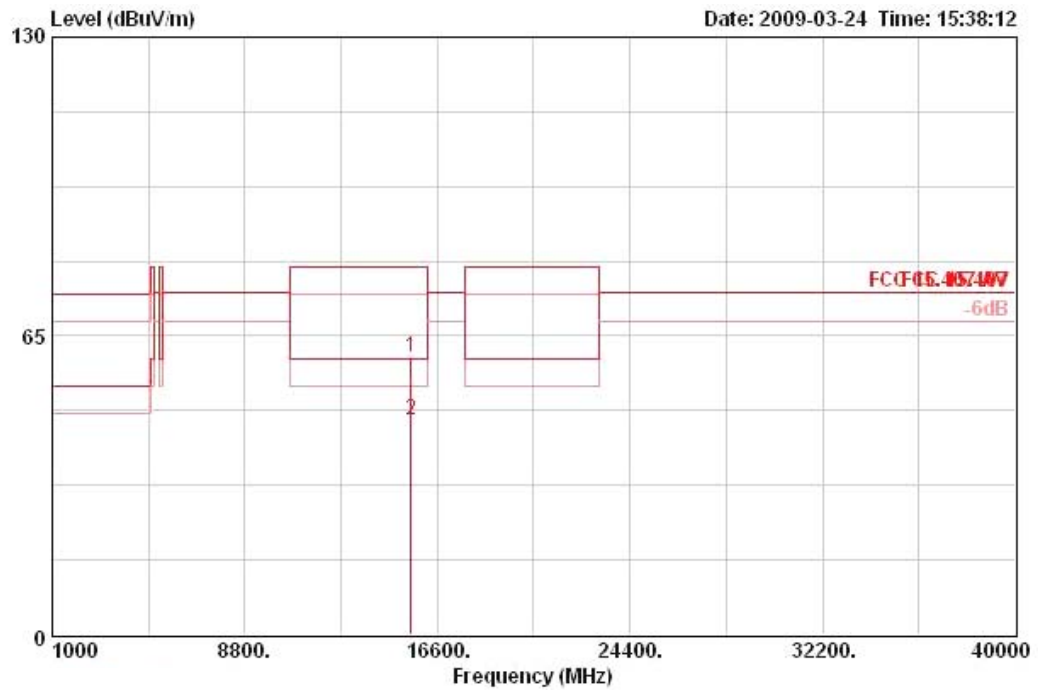

	Freq	Level	Over Limit	Limit Line	Read Level	Antenna Factor	Preamp Factor	Cable Loss	Remark	Pol/Phase	Table Pos	Ant Pos
	MHz	dBuV/m	dB	dBuV/m	dBuV	dB/m	dB	dB			deg	cm
1	15530.000	60.40	-19.60	80.00	46.16	38.14	35.59	11.69	PEAK	HORIZONTAL	360	100
2	15543.600	46.60	-13.40	60.00	32.38	38.12	35.59	11.69	AVERAGE	HORIZONTAL	360	100

Vertical

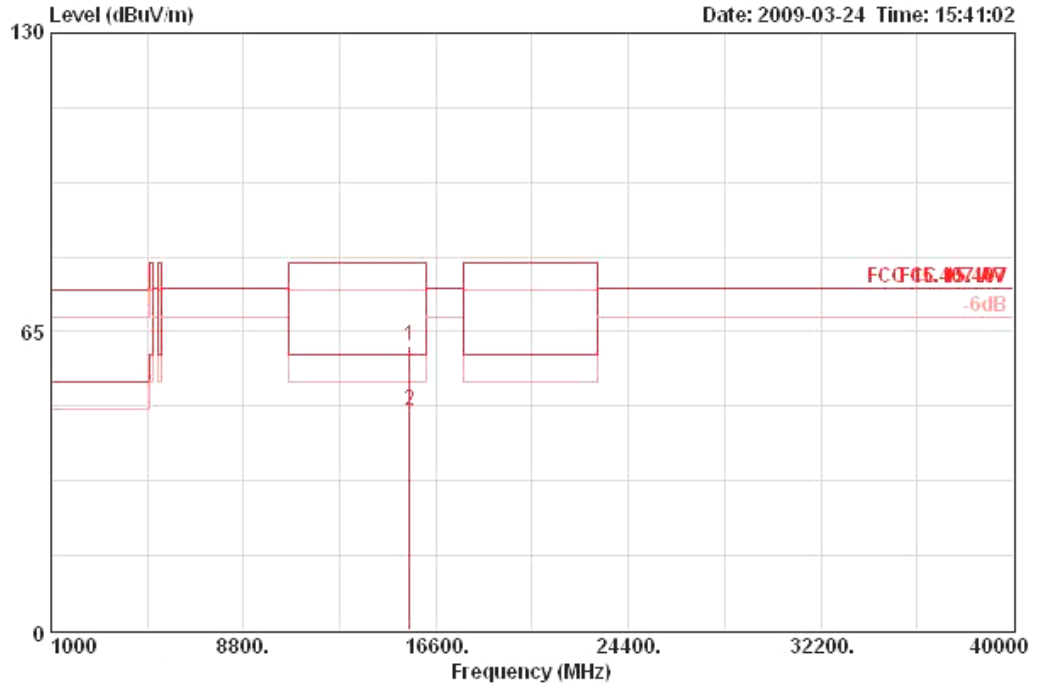

	Freq	Level	Over Limit	Limit Line	Read Level	Antenna Factor	Preamp Factor	Cable Loss	Remark	Pol/Phase	Table Pos	Ant Pos
	MHz	dBuV/m	dB	dBuV/m	dBuV	dB/m	dB	dB			deg	cm
1	15531.200	61.79	-18.21	80.00	47.55	38.14	35.59	11.69	PEAK	VERTICAL	0	150
2	15541.600	47.80	-12.20	60.00	33.56	38.14	35.59	11.69	AVERAGE	VERTICAL	0	150

Temperature	25°C	Humidity	56%
Test Engineer	Johnson Chang	Configurations	802.11a Ch 40 / Ant. A + Ant. B

Horizontal

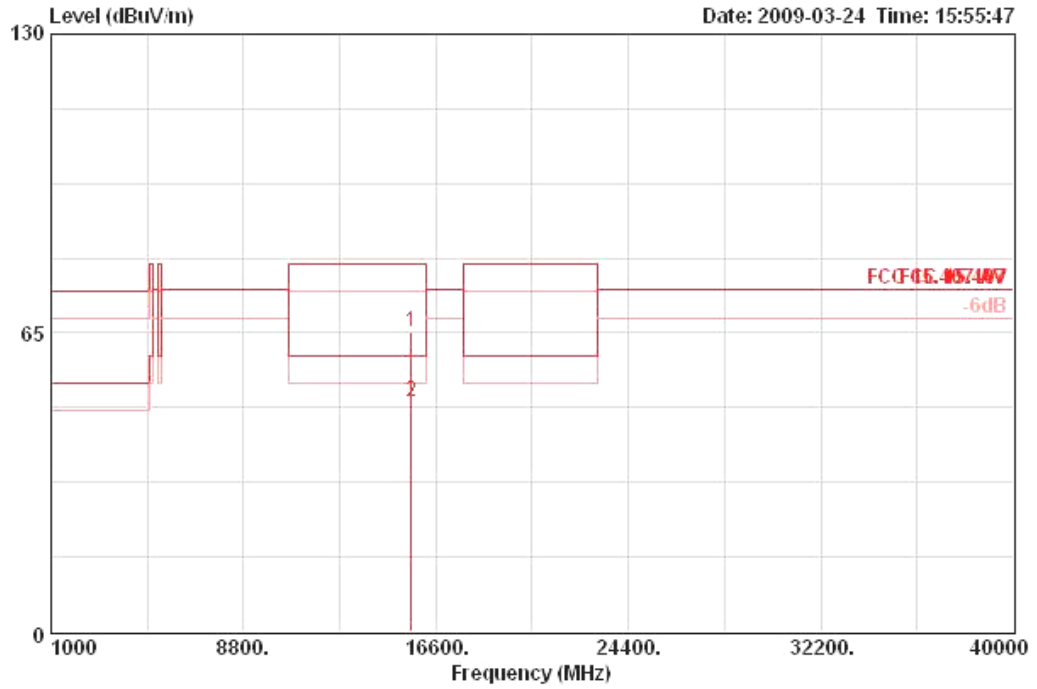

Vertical

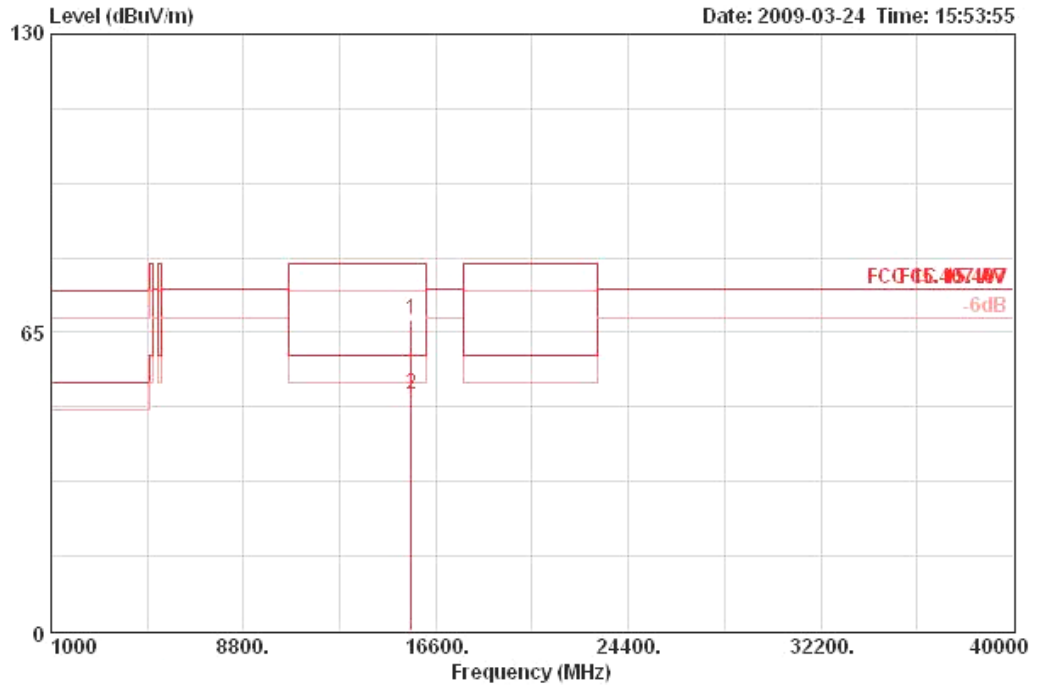

	Freq	Level	Over Limit	Limit Line	Read Level	Antenna Factor	Preamp Factor	Cable Loss	Remark	Pol/Phase	Table Pos	Ant Pos
	MHz	dBuV/m	dB	dBuV/m	dBuV	dB/m	dB	dB			deg	cm
1	15601.110	67.71	-12.29	80.00	53.51	38.03	35.58	11.75	PEAK	VERTICAL	0	150
2	15601.490	51.46	-8.54	60.00	37.26	38.03	35.58	11.75	AVERAGE	VERTICAL	0	150

Temperature	25°C	Humidity	56%
Test Engineer	Johnson Chang	Configurations	802.11a Ch 48 / Ant. A + Ant. B

Horizontal

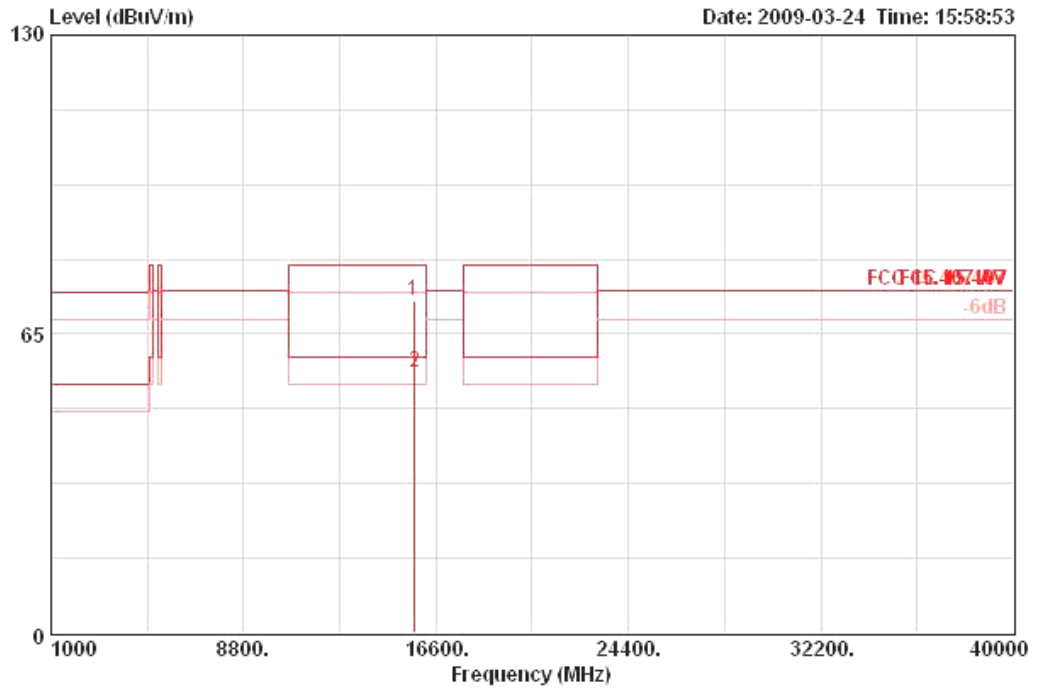

	Freq	Level	Over Limit	Limit Line	Read Level	Antenna Factor	Preamp Factor	Cable Loss	Remark	Pol/Phase	Table Pos	Ant Pos
	MHz	dBuV/m	dB	dBuV/m	dBuV	dB/m	dB	dB			deg	cm
1	15717.790	72.18	-7.82	80.00	58.07	37.84	35.56	11.83	PEAK	HORIZONTAL	269	100
2	15722.020	56.80	-3.20	60.00	42.68	37.84	35.56	11.83	AVERAGE	HORIZONTAL	269	100

Vertical

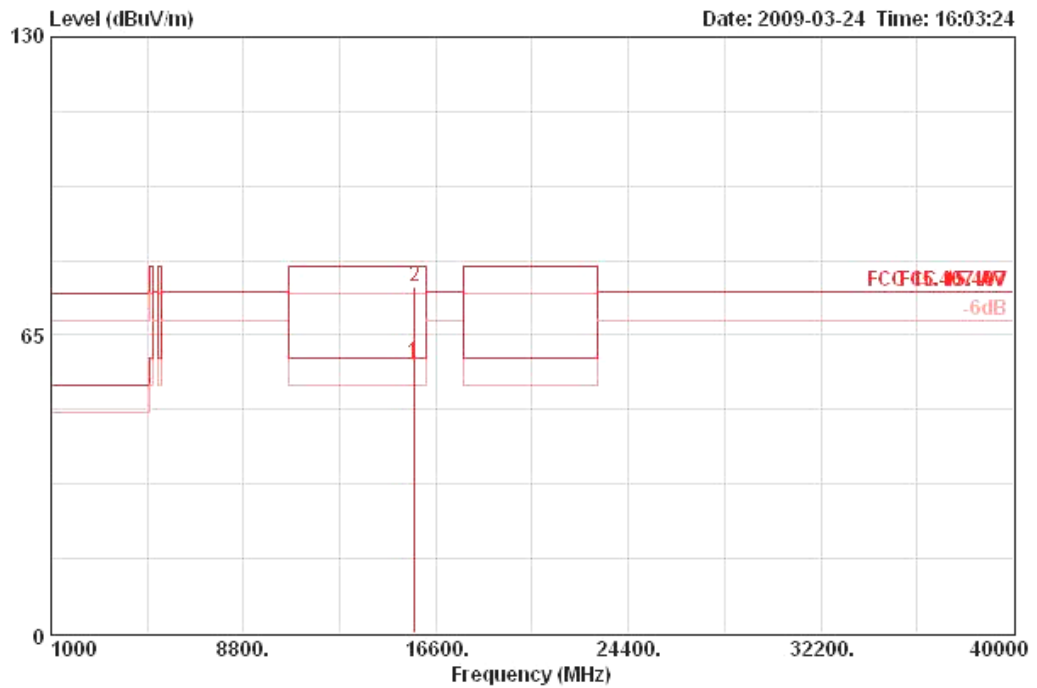

	Freq	Level	Over Limit	Limit Line	Read Level	Antenna Factor	Preamp Factor	Cable Loss	Remark	Pol/Phase	Table Pos	Ant Pos
	MHz	dBuV/m	dB	dBuV/m	dBuV	dB/m	dB	dB			deg	cm
1	15719.280	59.02	-0.98	60.00	44.90	37.84	35.56	11.83	AVERAGE	VERTICAL	20	117
2	15719.900	75.37	-4.63	80.00	61.26	37.84	35.56	11.83	PEAK	VERTICAL	20	117

Note:

The amplitude of spurious emissions that are attenuated by more than 20dB below the permissible value has no need to be reported.

Emission level (dBuV/m) = 20 log Emission level (uV/m).

Corrected Reading: Antenna Factor + Cable Loss + Read Level - Preamp Factor = Level.

The limits above 5GHz shall be extrapolated to the specified distance using an extrapolation factor of 20 dB/decade form 3m to 1.5m.

Distance extrapolation factor = 20 log (specific distance [3m] / test distance [1.5m]) (dB);

Limit line = specific limits (dBuV) + distance extrapolation factor [6 dB].

4.7. Band Edge Emissions Measurement

4.7.1. Limit

For transmitters operating in the 5.15-5.35 GHz band: all emissions outside of the 5.15-5.35 GHz band shall not exceed an EIRP of -27 dBm/MHz (68.3dBuV/m at 3m). For transmitters operating in the 5.470-5.725 GHz band: all emissions outside of the 5.470-5.725 GHz band shall not exceed an EIRP of -27 dBm/MHz (68.3dBuV/m at 3m). For transmitters operating in the 5.725-5.825 GHz band: all emissions within the frequency range from the band edge to 10 MHz above or below the band edge shall not exceed an EIRP of -17 dBm/MHz (78.3dBuV/m at 3m); for frequencies 10 MHz or greater above or below the band edge, emissions shall not exceed an EIRP of -27 dBm/MHz (68.3dBuV/m at 3m). In addition, in case the emission falls within the restricted band specified on 15.205(a), then the 15.209(a) limit in the table below has to be followed.

Frequencies (MHz)	Field Strength (microrvolts/meter)	Measurement Distance (meters)
0.009~0.490	2400/F(KHz)	300
0.490~1.705	24000/F(KHz)	30
1.705~30.0	30	30
30~88	100	3
88~216	150	3
216~960	200	3
Above 960	500	3

4.7.2. Measuring Instruments and Setting

Please refer to section 5 of equipments list in this report. The following table is the setting of the spectrum analyzer.

Spectrum Parameter	Setting
Attenuation	Auto
Span Frequency	100 MHz
RB / VB (Emission in restricted band)	1MHz / 1MHz for Peak, 1 MHz / 10Hz for Average
RB / VB (Emission in non-restricted band)	1 MHz / 1 MHz for Peak

4.7.3. Test Procedures

1. The test procedure is the same as section 4.6.3, only the frequency range investigated is limited to 100MHz around bandedges.
2. In case the emission is fail due to the used RB/VB is too wide, marker-delta method of FCC Public Notice DA00-705 will be followed.

4.7.4. Test Setup Layout

This test setup layout is the same as that shown in section 4.6.4.

4.7.5. Test Deviation

There is no deviation with the original standard.

4.7.6. EUT Operation during Test

The EUT was programmed to be in continuously transmitting mode.

4.7.7. Test Result of Band Edge and Fundamental Emissions

Temperature	25°C	Humidity	56%
Test Engineer	Johnson Chang	Configurations	Draft n MCS0 20MHz Ch 36, 40 / Ant. A + Ant. B
Test Date	Mar. 24, 2009		

Channel 36

	Freq	Level	Over Limit	Limit Line	ReadAntenna Level	Antenna Factor	Preamp Factor	Cable Loss	Remark	Pol/Phase	Table Pos	Ant Pos
	MHz	dBuV/m	dB	dBuV/m	dBuV	dB/m	dB	dB			deg	cm
1 ☺	5146.000	79.35	-0.65	80.00	40.91	34.00	0.00	4.44	PEAK	VERTICAL	223	100
2 ☺	5150.000	58.06	-1.94	60.00	19.61	34.00	0.00	4.44	AVERAGE	VERTICAL	223	100
3 ☺	5174.200	104.57			66.07	34.07	0.00	4.43	AVERAGE	VERTICAL	223	100
4 ☺	5177.800	118.72			80.22	34.07	0.00	4.43	PEAK	VERTICAL	223	100

Item 3, 4 are the fundamental frequency at 5180 MHz.

Channel 40

	Freq	Level	Over Limit	Limit Line	ReadAntenna Level	Antenna Factor	Preamp Factor	Cable Loss	Remark	Pol/Phase	Table Pos	Ant Pos
	MHz	dBuV/m	dB	dBuV/m	dBuV	dB/m	dB	dB			deg	cm
1 !	5149.600	75.29	-4.71	80.00	36.85	34.00	0.00	4.44	PEAK	VERTICAL	223	100
2 ☺	5150.000	59.44	-0.56	60.00	21.00	34.00	0.00	4.44	AVERAGE	VERTICAL	223	100
3 ☺	5198.800	109.14			70.61	34.10	0.00	4.43	AVERAGE	VERTICAL	223	100
4 ☺	5205.200	122.27			83.75	34.10	0.00	4.43	PEAK	VERTICAL	223	100

Item 3, 4 are the fundamental frequency at 5200 MHz.



Temperature	25°C	Humidity	56%
Test Engineer	Johnson Chang	Configurations	Draft n MCS0 40MHz Ch 38, 46 / Ant. A + Ant. B
Test Date	Mar. 24, 2009		

Channel 38

	Freq	Level	Over Limit	Limit Line	Read Level	Antenna Factor	Preamp Factor	Cable Loss	Remark	Pol/Phase	Table Pos	Ant Pos
	MHz	dBuV/m	dB	dBuV/m	dBuV	dB/m	dB	dB			deg	cm
1 ☺	5149.200	79.23	-0.77	80.00	40.79	34.00	0.00	4.44	PEAK	HORIZONTAL	76	101
2 ☺	5150.000	59.20	-0.80	60.00	20.76	34.00	0.00	4.44	AVERAGE	HORIZONTAL	76	101
3 ☺	5188.000	113.15			74.65	34.07	0.00	4.43	PEAK	HORIZONTAL	76	101
4 ☺	5199.600	99.06			60.53	34.10	0.00	4.43	AVERAGE	HORIZONTAL	76	101

Item 3, 4 are the fundamental frequency at 5190 MHz.

Channel 46

	Freq	Level	Over Limit	Limit Line	Read Level	Antenna Factor	Preamp Factor	Cable Loss	Remark	Pol/Phase	Table Pos	Ant Pos
	MHz	dBuV/m	dB	dBuV/m	dBuV	dB/m	dB	dB			deg	cm
1 ☺	5146.400	76.85	-3.15	80.00	38.41	34.00	0.00	4.44	PEAK	HORIZONTAL	67	100
2 ☺	5150.000	59.52	-0.48	60.00	21.08	34.00	0.00	4.44	AVERAGE	HORIZONTAL	67	100
3 ☺	5244.800	107.25			68.63	34.20	0.00	4.42	AVERAGE	HORIZONTAL	67	100
4 ☺	5246.800	120.73			82.12	34.20	0.00	4.41	PEAK	HORIZONTAL	67	100

Item 3, 4 are the fundamental frequency at 5230 MHz.

Note:

Emission level (dBuV/m) = 20 log Emission level (uV/m)

Corrected Reading: Antenna Factor + Cable Loss + Read Level - Preamp Factor = Level

The limits above 5GHz shall be extrapolated to the specified distance using an extrapolation factor of 20 dB/decade form 3m to 1.5m.

Distance extrapolation factor = 20 log (specific distance [3m] / test distance [1.5m]) (dB);

Limit line = specific limits (dBuV) + distance extrapolation factor [6 dB].



Temperature	25°C	Humidity	56%
Test Engineer	Johnson Chang	Configurations	802.11a Ch 36, 40 / Ant. A
Test Date	Mar. 24, 2009		

Channel 36

	Freq	Level	Over Limit	Limit Line	Read Level	Antenna Factor	Cable Loss	Preamp Factor	Remark	Ant Pos	Table Pos	Pol/Phase
	MHz	dBuV/m	dB	dBuV/m	dBuV	dB/m	dB	dB		cm	deg	
1 !	5149.200	79.46	-0.54	80.00	40.03	33.07	6.36	0.00	PEAK	100	11	VERTICAL
2 !	5150.000	59.91	-0.09	60.00	20.48	33.07	6.36	0.00	AVERAGE	100	11	VERTICAL
3	5182.800	106.55			67.15	33.13	6.27	0.00	AVERAGE	100	11	VERTICAL
4 @	5185.200	118.07			78.66	33.13	6.27	0.00	PEAK	100	11	VERTICAL

Item 3, 4 are the fundamental frequency at 5180 MHz.

Channel 40

	Freq	Level	Over Limit	Limit Line	Read Level	Antenna Factor	Cable Loss	Preamp Factor	Remark	Ant Pos	Table Pos	Pol/Phase
	MHz	dBuV/m	dB	dBuV/m	dBuV	dB/m	dB	dB		cm	deg	
1	5147.600	73.88	-6.12	80.00	34.44	33.07	6.36	0.00	PEAK	106	74	HORIZONTAL
2 !	5150.000	59.81	-0.19	60.00	20.38	33.07	6.36	0.00	AVERAGE	106	74	HORIZONTAL
3 @	5192.800	121.15			81.72	33.16	6.27	0.00	PEAK	106	74	HORIZONTAL
4	5204.400	109.78			70.43	33.16	6.18	0.00	AVERAGE	106	74	HORIZONTAL

Item 3, 4 are the fundamental frequency at 5200 MHz.

Note:

Emission level (dBuV/m) = 20 log Emission level (uV/m)

Corrected Reading: Antenna Factor + Cable Loss + Read Level - Preamp Factor = Level

The limits above 5GHz shall be extrapolated to the specified distance using an extrapolation factor of 20 dB/decade form 3m to 1.5m.

Distance extrapolation factor = 20 log (specific distance [3m] / test distance [1.5m]) (dB);

Limit line = specific limits (dBuV) + distance extrapolation factor [6 dB].

4.8. Frequency Stability Measurement

4.8.1. Limit

Manufacturers of U-NII devices are responsible for ensuring frequency stability such that an emissions is maintained within the band of operation under all conditions of normal operation as specified in the user's manual or $\pm 20\text{ppm}$ (Draft n specification).

4.8.2. Measuring Instruments and Setting

Please refer to section 5 of equipments list in this report. The following table is the setting of the spectrum analyzer.

Spectrum Parameter	Setting
Attenuation	Auto
Span Frequency	Entire absence of modulation emissions bandwidth
RB	10 kHz
VB	10 kHz
Sweep Time	Auto

4.8.3. Test Procedures

1. The transmitter output (antenna port) was connected to the spectrum analyser.
2. EUT have transmitted absence of modulation signal and fixed channelize.
3. Set the spectrum analyzer span to view the entire absence of modulation emissions bandwidth.
4. Set RBW = 10 kHz, VBW = 10 kHz with peak detector and maxhold settings.
5. f_c is declaring of channel frequency. Then the frequency error formula is $(f_c - f) / f_c \times 10^6$ ppm and the limit is less than $\pm 20\text{ppm}$ (Draft n specification).
6. The test extreme voltage is to change the primary supply voltage from 85 to 115 percent of the nominal value
7. Extreme temperature rule is $-30^\circ\text{C} \sim 50^\circ\text{C}$.
8. Measuring multiple antennas, the connector is required to link with spectrum analyser through a combiner.

4.8.4. Test Setup Layout

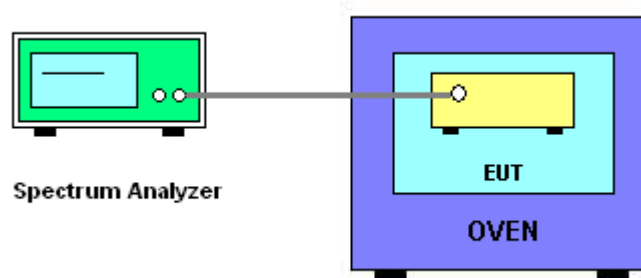

4.8.5. Test Deviation

There is no deviation with the original standard.

4.8.6. EUT Operation during Test

The EUT was programmed to be in continuously un-modulation transmitting mode.

4.8.7. Test Result of Frequency Stability

Voltage vs. Frequency Stability

Voltage	Measurement Frequency (MHz)
(V)	5200
126.50	5199.993800
110.00	5199.997600
93.50	5200.003600
Max. Deviation (MHz)	0.006200
Max. Deviation (ppm)	1.19

Temperature vs. Frequency Stability

Temperature	Measurement Frequency (MHz)
(°C)	5200
-30	5200.026100
-20	5200.017200
-10	5200.006400
0	5199.994400
10	5199.989600
20	5199.979200
30	5199.968400
40	5199.961600
50	5199.956800
Max. Deviation (MHz)	0.043200
Max. Deviation (ppm)	8.31

4.9. Antenna Requirements

4.9.1. Limit

Except for special regulations, the Low-power Radio-frequency Devices must not be equipped with any jacket for installing an antenna with extension cable. An intentional radiator shall be designed to ensure that no antenna other than that furnished by the responsible party shall be used with the device. The use of a permanently attached antenna or of an antenna that uses a unique coupling to the intentional radiator shall be considered sufficient to comply with the provisions of this Section. The manufacturer may design the unit so that the user can replace a broken antenna, but the use of a standard antenna jack or electrical connector is prohibited. Further, this requirement does not apply to intentional radiators that must be professionally installed.

4.9.2. Antenna Connector Construction

Please refer to section 3.3 in this test report; antenna connector complied with the requirements.

5. LIST OF MEASURING EQUIPMENTS

Instrument	Manufacturer	Model No.	Serial No.	Characteristics	Calibration Date	Remark
EMC Receiver	R&S	ESCS 30	100174	9kHz – 2.75GHz	Mar. 03, 2009	Conduction (CO04-HY)
LISN	MessTec	NNB-2/16Z	99079	9kHz – 30MHz	Mar. 31, 2009	Conduction (CO04-HY)
LISN (Support Unit)	EMCO	3810/2NM	9703-1839	9kHz – 30MHz	Mar. 22, 2009	Conduction (CO04-HY)
RF Cable-CON	UTIFLEX	3102-26886-4	CB049	9kHz – 30MHz	Apr. 20, 2008	Conduction (CO04-HY)
ISN	SCHAFFNER	ISN T400	21653	9kHz – 30MHz	Mar. 27, 2009	Conduction (CO04-HY)
EMI Filter	LINDGREN	LRE-2030	2651	< 450 Hz	N/A	Conduction (CO04-HY)
3m Semi Anechoic Chamber	SIDT FRANKONIA	SAC-3M	03CH03-HY	30 MHz - 1 GHz 3m	Jun. 14, 2008	Radiation (03CH03-HY)
Amplifier	SCHAFFNER	COA9231A	18667	9 kHz - 2 GHz	Jan. 23, 2009	Radiation (03CH03-HY)
Amplifier	Agilent	8449B	3008A02120	1 GHz - 26.5 GHz	Jul. 21, 2008	Radiation (03CH03-HY)
Amplifier	MITEQ	AMF-6F-260400	9121372	26.5 GHz - 40 GHz	Jan. 22, 2009*	Radiation (03CH03-HY)
Spectrum Analyzer	R&S	FSP40	100004	9 kHz - 30 GHz	Oct. 06, 2008	Radiation (03CH03-HY)
Loop Antenna	R&S	HFH2-Z2	860004/001	9 kHz - 30 MHz	Jul. 28, 2008*	Radiation (03CH03-HY)
Bilog Antenna	SCHAFFNER	CBL 6112D	22237	30 MHz – 1 GHz	Jul. 12, 2008	Radiation (03CH03-HY)
Horn Antenna	EMCO	3115	6741	1GHz ~ 18GHz	Apr. 04, 2008	Radiation (03CH03-HY)
Horn Antenna	SCHWARZBECK	BBHA9170	BBHA9170154	15 GHz - 40 GHz	Jan. 16, 2009	Radiation (03CH03-HY)
RF Cable-R03m	Jye Bao	RG142	CB021	30 MHz - 1 GHz	Jan. 05, 2009	Radiation (03CH03-HY)
RF Cable-HIGH	SUHNER	SUCOFLEX 106	03CH03-HY	1 GHz - 40 GHz	Jan. 05, 2009	Radiation (03CH03-HY)
Turn Table	HD	DS 420	420/650/00	0 – 360 degree	N/A	Radiation (03CH03-HY)
Antenna Mast	HD	MA 240	240/560/00	1 m - 4 m	N/A	Radiation (03CH03-HY)
Spectrum Analyzer	R&S	FSP30	100023	9kHz ~ 30GHz	Jan. 09, 2009	Conducted (TH01-HY)
Power Meter	R&S	NRVS	100444	DC ~ 40GHz	Jul. 11, 2008	Conducted (TH01-HY)
Power Sensor	R&S	NRV-Z51	100458	DC ~ 30GHz	Jul. 11, 2008	Conducted (TH01-HY)
Power Sensor	R&S	NRV-Z32	100057	30MHz ~ 6GHz	Jul. 11, 2008	Conducted (TH01-HY)
AC Power Source	HPC	HPA-500W	HPA-9100024	AC 0 ~ 300V	May 30, 2008*	Conducted (TH01-HY)
DC Power Source	G.W.	GPC-6030D	C671845	DC 1V ~ 60V	Mar. 13, 2009	Conducted (TH01-HY)
Temp. and Humidity Chamber	Giant Force	GTH-225-20-S	MAB0103-001	N/A	Jul. 18, 2008	Conducted (TH01-HY)
RF CABLE-1m	Jye Bao	RG142	CB034-1m	20MHz ~ 7GHz	Dec. 01, 2008	Conducted (TH01-HY)
RF CABLE-2m	Jye Bao	RG142	CB035-2m	20MHz ~ 1GHz	Dec. 01, 2008	Conducted (TH01-HY)



Instrument	Manufacturer	Model No.	Serial No.	Characteristics	Calibration Date	Remark
Vector Signal Generator	R&S	SMU200A	102098	100kHz ~ 6GHz	Dec. 14, 2008	Conducted (TH01-HY)
Signal Generator	R&S	SMR40	100116	10MHz ~ 40GHz	Mar. 10, 2009	Conducted (TH01-HY)
Oscilloscope	Tektonix	TDS380	B016197	400MHz/ 2GS/s	Jun. 27, 2008	Conducted (TH01-HY)

Note: Calibration Interval of instruments listed above is one year.

Note: *Calibration Interval of instruments listed above is two year.

6. TEST LOCATION

SHIJR	ADD : 6Fl., No. 106, Sec. 1, Shintai 5th Rd., Shijr City, Taipei, Taiwan 221, R.O.C. TEL : 886-2-2696-2468 FAX : 886-2-2696-2255
HWA YA	ADD : No. 52, Hwa Ya 1st Rd., Kwei-Shan Hsiang, Tao Yuan Hsien, Taiwan, R.O.C. TEL : 886-3-327-3456 FAX : 886-3-318-0055
LINKOU	ADD : No. 30-2, Dingfu Tsuen, Linkou Shiang, Taipei, Taiwan 244, R.O.C TEL : 886-2-2601-1640 FAX : 886-2-2601-1695
DUNGHU	ADD : No. 3, Lane 238, Kangle St., Neihu Chiu, Taipei, Taiwan 114, R.O.C. TEL : 886-2-2631-4739 FAX : 886-2-2631-9740
JUNGHE	ADD : 7Fl., No. 758, Jungjeng Rd., Junghe City, Taipei, Taiwan 235, R.O.C. TEL : 886-2-8227-2020 FAX : 886-2-8227-2626
NEIHU	ADD : 4Fl., No. 339, Hsin Hu 2 nd Rd., Taipei 114, Taiwan, R.O.C. TEL : 886-2-2794-8886 FAX : 886-2-2794-9777
JHUBEI	ADD : No.8, Lane 724, Bo-ai St., Jhubei City, HsinChu County 302, Taiwan, R.O.C. TEL : 886-3-656-9065 FAX : 886-3-656-9085

7. TAF CERTIFICATE OF ACCREDITATION



Certificate No. : L1190-070110

財團法人全國認證基金會
Taiwan Accreditation Foundation

Certificate of Accreditation

This is to certify that

Sporton International Inc.
EMC & Wireless Communications Laboratory
No.52, Hwa Ya 1st Rd., Hwa Ya Technology Park, Kwei-Shan Hsiang, Tao Yuan Hsien,
Taiwan, R.O.C.

is accredited in respect of laboratory

Accreditation Criteria	: ISO/IEC 17025:2005
Accreditation Number	: 1190
Originally Accredited	: December 15, 2003
Effective Period	: January 10, 2007 to January 09, 2010
Accredited Scope	: Testing Field, see described in the Appendix
Specific Accreditation Program	: Accreditation Program for Designated Testing Laboratory for Commodities Inspection : Accreditation Program for Telecommunication Equipment Testing Laboratory

Jay-San Chen
President, Taiwan Accreditation Foundation
Date : January 10, 2007

PI, total 9 pages

The Appendix forms an integral part of this Certificate, which shall be invalid when used without the Appendix.