



SPORTON International Inc.

No. 52, Hwa Ya 1st Rd., Kwei-Shan Hsiang, TaoYuan Hsien, Taiwan, R.O.C.
Ph: 886-3-327-3456 / FAX: 886-3-327-0973 / www.sporton.com.tw

FCC RADIO TEST REPORT

Applicant's company	Meraki, Inc.
Applicant Address	99 Rhode Island St., San Francisco, CA 94103
FCC ID	UDX-60010030
Manufacturer's company	Wistron NeWeb Corporation
Manufacturer Address	No.10-1,Li-hsin Road I,Hsinchu Science Park,Hsinchu 300,Taiwan, R.O.C.

Product Name	802.11a/b/g/n Dual Radio
Brand Name	Meraki
Model Name	MR14
Test Rule Part(s)	47 CFR FCC Part 15 Subpart C § 15.247
Test Freq. Range	2400 ~ 2483.5MHz / 5725 ~ 5850MHz
Received Date	Mar. 18, 2009
Final Test Date	Apr. 02, 2009
Submission Type	Original Equipment



Statement

Test result included is only for the Draft n, 802.11b/g part and 802.11a (5725 ~ 5850MHz) of the product.

The test result in this report refers exclusively to the presented test model / sample.

Without written approval of SPORTON International Inc., the test report shall not be reproduced except in full.

The measurements and test results shown in this test report were made in accordance with the procedures and found in compliance with the limit given in **ANSI C63.4-2003** and **47 CFR FCC Part 15 Subpart C**.

The test equipment used to perform the test is calibrated and traceable to NML/ROC.



Table of Contents

1. CERTIFICATE OF COMPLIANCE	1
2. SUMMARY OF THE TEST RESULT	2
3. GENERAL INFORMATION	3
3.1. Product Details.....	3
3.2. Accessories.....	5
3.3. Table for Filed Antenna.....	6
3.4. Table for Carrier Frequencies	6
3.5. Table for Test Modes	7
3.6. Table for Testing Locations.....	8
3.7. Table for Supporting Units	9
3.8. Table for Parameters of Test Software Setting	9
3.9. Test Configurations	11
4. TEST RESULT	13
4.1. AC Power Line Conducted Emissions Measurement.....	13
4.2. Maximum Conducted Output Power Measurement.....	19
4.3. Power Spectral Density Measurement	47
4.4. 6dB Spectrum Bandwidth Measurement	61
4.5. Radiated Emissions Measurement	74
4.6. Band Edge Emissions Measurement	120
4.7. Antenna Requirements	132
5. LIST OF MEASURING EQUIPMENTS	133
6. TEST LOCATION.....	135
7. TAF CERTIFICATE OF ACCREDITATION	136
APPENDIX A. PHOTOGRAPHS OF EUT.....	A1 ~ A18
APPENDIX B. TEST PHOTOS.....	B1 ~ B7
APPENDIX C. MAXIMUM PERMISSIBLE EXPOSURE.....	C1 ~C3
APPENDIX D. CO-LOCATION	D1 ~D3



1. CERTIFICATE OF COMPLIANCE

Product Name : 802.11 a/b/g/n Dual Radio
Brand Name : Meraki
Model Name : MR14
Applicant : Meraki, Inc.
Test Rule Part(s) : 47 CFR FCC Part 15 Subpart C § 15.247

Sporton International as requested by the applicant to evaluate the EMC performance of the product sample received on Mar. 18, 2009 would like to declare that the tested sample has been evaluated and found to be in compliance with the tested rule parts. The data recorded as well as the test configuration specified is true and accurate for showing the sample's EMC nature.

A handwritten signature in blue ink, appearing to read 'Wayne Hsu 2009.4.24', is written over a horizontal line.

Wayne Hsu

SPORTON INTERNATIONAL INC.

2. SUMMARY OF THE TEST RESULT

Applied Standard: 47 CFR FCC Part 15 Subpart C				
Part	Rule Section	Description of Test	Result	Under Limit
4.1	15.207	AC Power Line Conducted Emissions	Complies	4.57 dB
4.2	15.247(b)(3)	Maximum Conducted Output Power	Complies	3.54 dB
4.3	15.247(e)	Power Spectral Density	Complies	6.83 dB
4.4	15.247(a)(2)	6dB Spectrum Bandwidth	Complies	-
4.5	15.247(d)	Radiated Emissions	Complies	0.85 dB
4.6	15.247(d)	Band Edge Emissions	Complies	0.06 dB
4.7	15.203	Antenna Requirements	Complies	-

Note:

This device used designated two wireless modules, and their internal circuit boards are exactly identical. The wireless module brand is WNC (model No.: DNMA-92), Product Name: WLAN a/b/g/n mini-PCI Module, FCC ID: NKR-DNMA-92.

Due to the system cannot execute RF program, so only use module to test in this report.

Test Items	Uncertainty	Remark
AC Power Line Conducted Emissions	±2.3dB	Confidence levels of 95%
Maximum Conducted Output Power	±0.8dB	Confidence levels of 95%
Power Spectral Density	±0.5dB	Confidence levels of 95%
6dB Spectrum Bandwidth	±8.5×10 ⁻⁸	Confidence levels of 95%
Radiated Emissions (9kHz~30MHz)	±0.8dB	Confidence levels of 95%
Radiated Emissions (30MHz~1000MHz)	±1.9dB	Confidence levels of 95%
Radiated / Band Edge Emissions (1GHz~18GHz)	±1.9dB	Confidence levels of 95%
Radiated Emissions (18GHz~40GHz)	±1.9dB	Confidence levels of 95%
Temperature	±0.7°C	Confidence levels of 95%
Humidity	±3.2%	Confidence levels of 95%
DC / AC Power Source	±1.4%	Confidence levels of 95%

3. GENERAL INFORMATION

3.1. Product Details

Draft n

Items	Description
Product Type	WLAN (2TX, 2RX)
Radio Type	Intentional Transceiver
Power Type	System: From POE System Module: From Host System
Modulation	see the below table for draft n
Data Modulation	OFDM (BPSK / QPSK / 16QAM / 64QAM)
Data Rate (Mbps)	see the below table for Draft n
Frequency Range	2400 ~ 2483.5MHz / 5725 ~ 5850MHz
Channel Number	For 2.4GHz Band: 11 for 20MHz bandwidth ; 7 for 40MHz bandwidth For 5GHz Band: 5 for 20MHz bandwidth ; 2 for 40MHz bandwidth
Channel Band Width (99%)	For 2.4GHz Band: MCS0 (20MHz): 17.72 MHz ; MCS0 (40MHz): 36.32 MHz For 5GHz Band: MCS0 (20MHz): 17.68 MHz ; MCS0 (40MHz): 36.32 MHz
Conducted Output Power	For 2.4GHz Band: MCS0 (20MHz): 25.80 dBm ; MCS0 (40MHz): 19.96 dBm For 5GHz Band: MCS0 (20MHz): 22.53 dBm ; MCS0 (40MHz): 21.47 dBm
Carrier Frequencies	Please refer to section 3.4
Antenna	Please refer to section 3.3

802.11a/b/g

Items	Description
Product Type	WLAN (2TX, 2RX)
Radio Type	Intentional Transceiver
Power Type	System: From POE System Module: From Host System
Modulation	DSSS for IEEE 802.11b ; OFDM for IEEE 802.11a/g
Data Modulation	DSSS (BPSK / QPSK / CCK) ; OFDM (BPSK / QPSK / 16QAM / 64QAM)
Data Rate (Mbps)	DSSS (1/ 2/ 5.5/11) ; OFDM (6/9/12/18/24/36/48/54)
Frequency Range	2400 ~ 2483.5MHz / 5725 ~ 5850MHz
Channel Number	11b/g: 11 ; 11a: 5
Channel Band Width (99%)	11b: 15.84 MHz ; 11g: 16.52 MHz ; 11a: 16.84 MHz
Conducted Output Power	11b: 22.09 dBm ; 11g: 26.46 dBm ; 11a: 22.72 dBm
Carrier Frequencies	Please refer to section 3.4
Antenna	Please refer to section 3.3

Antenna & Band width

Antenna	Single (TX)		Two (TX)	
	20 MHz	40 MHz	20 MHz	40 MHz
802.11a	X	X	V	X
802.11b	X	X	V	X
802.11g	X	X	V	X
Draft n	X	X	V	V

Draft n spec

MCS Index	Nss	Modulation	R	NBPS	NCBPS		NDBPS		Datarate(Mbps)			
					20MHz	40MHz	20MHz	40MHz	800nsGI		400nsGI	
									20MHz	40MHz	20MHz	40MHz
0	1	BPSK	1/2	1	52	108	26	54	6.5	13.5	7.200	15
1	1	QPSK	1/2	2	104	216	52	108	13.0	27.0	14.400	30
2	1	QPSK	3/4	2	104	216	78	162	19.5	40.5	21.700	45
3	1	16-QAM	1/2	4	208	432	104	216	26.0	54.0	28.900	60
4	1	16-QAM	3/4	4	208	432	156	324	39.0	81.0	43.300	90
5	1	64-QAM	2/3	6	312	648	208	432	52.0	108.0	57.800	120
6	1	64-QAM	3/4	6	312	648	234	486	58.5	121.5	65.000	135
7	1	64-QAM	5/6	6	312	648	260	540	65.0	135.0	72.200	150
8	2	BPSK	1/2	1	104	216	52	108	13.0	27.0	14.444	30
9	2	QPSK	1/2	2	208	432	104	216	26.0	54.0	28.889	60
10	2	QPSK	3/4	2	208	432	156	324	39.0	81.0	43.333	90
11	2	16-QAM	1/2	4	416	864	208	432	52.0	108.0	57.778	120
12	2	16-QAM	3/4	4	416	864	312	648	78.0	162.0	86.667	180
13	2	64-QAM	2/3	6	624	1296	416	864	104.0	216.0	115.556	240
14	2	64-QAM	3/4	6	624	1296	468	972	117.0	243.0	130.000	270
15	2	64-QAM	5/6	6	624	1296	520	1080	130.0	270.0	144.444	300

Symbol	Explanation
NSS	Number of spatial streams
R	Code rate
NBPS	Number of coded bits per single carrier
NCBPS	Number of coded bits per symbol
NDBPS	Number of data bits per symbol
GI	guard interval

3.2. Accessories

N/A

3.3. Table for Filed Antenna

For 2.4GHz Band

Ant.	Brand	Model Name	Antenna Type	Connector	Gain (dBi)	Remark
A	WNC	XCAB-D1	PIFA Antenna	NA	3.90	TX/RX
B	WNC	XCAB-D1	PIFA Antenna	NA	2.407	TX/RX

For 5GHz Band

Ant.	Brand	Model Name	Antenna Type	Connector	Gain (dBi)	Remark
A	WNC	XCAB-D1	PIFA Antenna	NA	5.112	TX/RX
B	WNC	XCAB-D1	PIFA Antenna	NA	4.214	TX/RX

Note: The EUT has two Antennas.

Both antenna A and B can be used as transmitting/receiving antenna.

3.4. Table for Carrier Frequencies

For 2.4GHz Band

Frequency Allocation for 802.11b/g

There are two bandwidth systems for draft n.

For both 20MHz bandwidth systems, use Channel 1~Channel 11.

For both 40MHz bandwidth systems, use Channel 3~Channel 9.

Frequency Band	Channel No.	Frequency	Channel No.	Frequency
2400~2483.5MHz	1	2412 MHz	7	2442 MHz
	2	2417 MHz	8	2447 MHz
	3	2422 MHz	9	2452 MHz
	4	2427 MHz	10	2457 MHz
	5	2432 MHz	11	2462 MHz
	6	2437 MHz		

For 5GHz Band

Frequency Allocation for 802.11a

There are two bandwidth systems for draft n.

For 20MHz bandwidth systems, use Channel 149, 153, 157, 161, 165.

For 40MHz bandwidth systems, use Channel 151, 159.

Frequency Band	Channel No.	Frequency	Channel No.	Frequency
5725~5850 MHz	149	5745 MHz	159	5795 MHz
	151	5755 MHz	161	5805 MHz
	153	5765 MHz	165	5825 MHz
	157	5785 MHz		

3.5. Table for Test Modes

Preliminary tests were performed in different data rate to find the worst radiated emission. The data rate shown in the table below is the worst-case rate with respect to the specific test item. Investigation has been done on all the possible configurations for searching the worst cases. The following table is a list of the test modes shown in this test report.

For 2.4GHz Band

Test Items	Mode	Data Rate	Channel	Antenna
AC Power Line Conducted Emissions	Normal Link	Auto	-	-
Max. Peak Conducted Output Power	MCS0/20MHz	13 Mbps	1/6/11	A/B/A+B
	MCS0/40MHz	27 Mbps	3/6/9	A/B/A+B
	11b/CCK	1 Mbps	1/6/11	A/B/A+B
	11g/BPSK	6 Mbps	1/6/11	A/B/A+B
Power Spectral Density 6dB Spectrum Bandwidth	MCS0/20MHz	13 Mbps	1/6/11	A+B
	MCS0/40MHz	27 Mbps	3/6/9	A+B
	11b/CCK	1 Mbps	1/6/11	A+B
	11g/BPSK	6 Mbps	1/6/11	A+B
Radiated Emissions Below 1GHz	Normal Link	Auto	-	-
Radiated Emissions Above 1GHz	MCS0/20MHz	13 Mbps	1/6/11	A+B
	MCS0/40MHz	27 Mbps	3/6/9	A+B
	11b/CCK	1 Mbps	1/6/11	A+B
	11g/BPSK	6 Mbps	1/6/11	A+B
Band Edge Emissions	MCS0/20MHz	13 Mbps	1/11	A+B
	MCS0/40MHz	27 Mbps	3/9	A+B
	11b/CCK	1 Mbps	1/11	A+B
	11g/BPSK	6 Mbps	1/11	A+B

For 5GHz Band

Test Items	Mode	Data Rate	Channel	Antenna
AC Power Line Conducted Emissions	Normal Link	Auto	-	-
Max. Peak Conducted Output Power	MCS0/20MHz	13 Mbps	149/157/165	A/B/A+B
	MCS0/40MHz	27 Mbps	151/159	A/B/A+B
	11a/BPSK	6 Mbps	149/157/165	A/B/A+B
Power Spectral Density 6dB Spectrum Bandwidth	MCS0/20MHz	13 Mbps	149/157/165	A+B
	MCS0/40MHz	27 Mbps	151/159	A+B
	11a/BPSK	6 Mbps	149/157/165	A+B
Radiated Emissions Below 1GHz	Normal Link	Auto	-	-
Radiated Emissions Above 1GHz	MCS0/20MHz	13 Mbps	149/157/165	A+B
	MCS0/40MHz	27 Mbps	151/159	A+B
	11a/BPSK	6 Mbps	149/157/165	A+B
Band Edge Emissions	MCS0/20MHz	13 Mbps	149/157/165	A+B
	MCS0/40MHz	27 Mbps	151/159	A+B
	11a/BPSK	6 Mbps	149/157/165	A+B

Note:

This device used designated two wireless modules, and their internal circuit boards are exactly identical. The wireless module brand is WNC (model No.: DNMA-92), Product Name: WLAN a/b/g/n mini-PCI Module, FCC ID: NKR-DNMA-92.

Due to the system cannot execute RF program, so only use module to test in this report.

The AP could be applied with two wireless modules; therefore Co-location (please refer to Appendix D) tests are added for simultaneously transmit between wireless LAN.

3.6. Table for Testing Locations

Test Site No.	Site Category	Location	FCC Reg. No.	IC File No.	VCCI Reg. No
03CH03-HY	SAC	Hwa Ya	101377	IC 4088	-
CO04-HY	Conduction	Hwa Ya	-	-	-
TH01-HY	OVEN Room	Hwa Ya	-	-	-

Open Area Test Site (OATS); Semi Anechoic Chamber (SAC); Fully Anechoic Chamber (FAC).

Please refer section 6 for Test Site Address.

3.7. Table for Supporting Units

Support Unit	Brand	Model	FCC ID
Notebook	DELL	D400	E2K24GBRL
Notebook	DELL	D520	E2KWM3945ABG
Mouse	HP	M-UAE96	DoC
Wireless AP	Planex	GW-AP54SGX	DoC
Modem	ACEEX	DM1414	IFAXDM1414

3.8. Table for Parameters of Test Software Setting

During testing, Channel & Power Controlling Software provided by the customer was used to control the operating channel as well as the output power level. The RF output power selection is for the setting of RF output power expected by the customer and is going to be fixed on the firmware of the final end product.

For 2.4GHz Band

Test Software Version	ART		
Frequency	2412 MHz	2437 MHz	2462 MHz
Draft n MCS0 20MHz	13.5	20.5	12
Frequency	2422 MHz	2437 MHz	2452 MHz
Draft n MCS0 40MHz	10	15	8.5

Power Parameters of IEEE 802.11b/g

Test Software Version	ART		
Frequency	2412 MHz	2437 MHz	2462 MHz
IEEE 802.11b	16.5	18.5	16.5
IEEE 802.11g	14	21	13

For 5GHz Band

Test Software Version	ART		
Frequency	5745 MHz	5785 MHz	5825 MHz
Draft n MCS0 20MHz	18	18	18
Frequency	5755 MHz		5795 MHz
Draft n MCS0 40MHz	18	18	

Power Parameters of IEEE 802.11a

Test Software Version	ART		
Frequency	5745 MHz	5785 MHz	5825 MHz
IEEE 802.11a	18	18	18

An executive program, EMCTEST.EXE under WIN XP, which generates a complete line of continuously repeating " H " pattern was used as the test software.

The program was executed as follows:

- a. Turn on the power of all equipment.
- b. The NB sends " H " messages to the panel, and the panel displays " H " patterns on the screen.
- c. The NB sends " H " messages to the modem.
- d. Repeat the steps from b to C.

At the same time, the following programs were executed:

Executed "ping.exe" to link with the remote workstation to receive and transmit signal by WLAN.

3.9. Test Configurations

3.9.1. Radiation Emissions Test Configuration

Test Configuration: 9kHz~1GHz

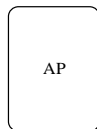
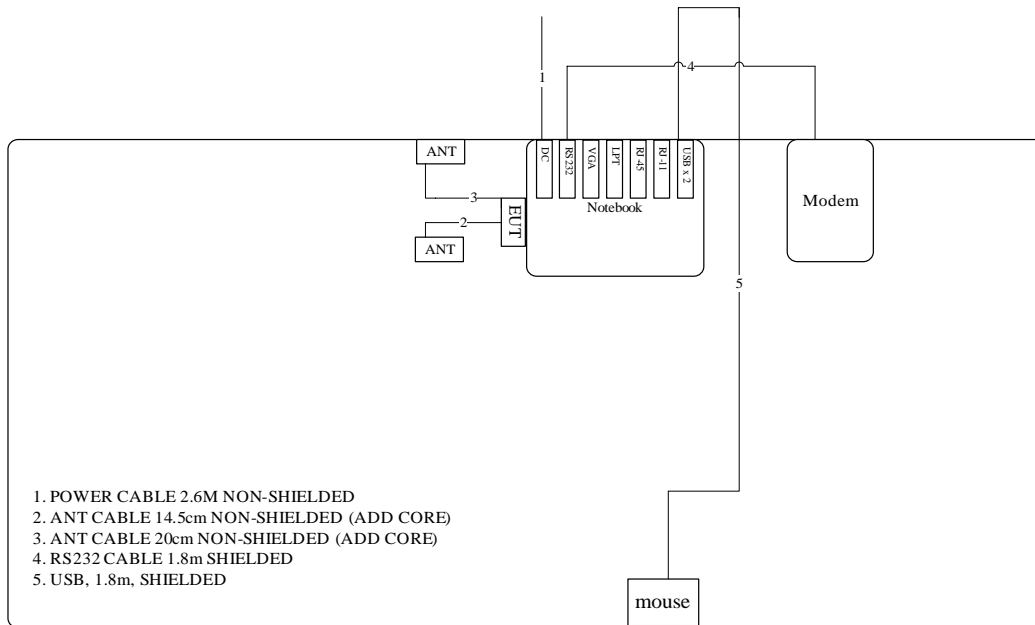

Test Configuration: above 1GHz

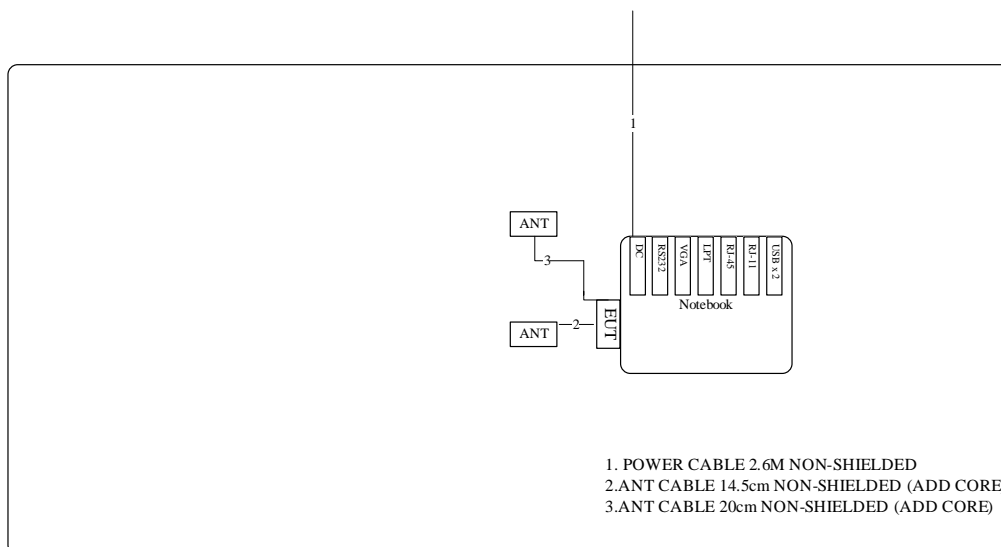

3.9.2. AC Power Line Conduction Emissions Test Configuration

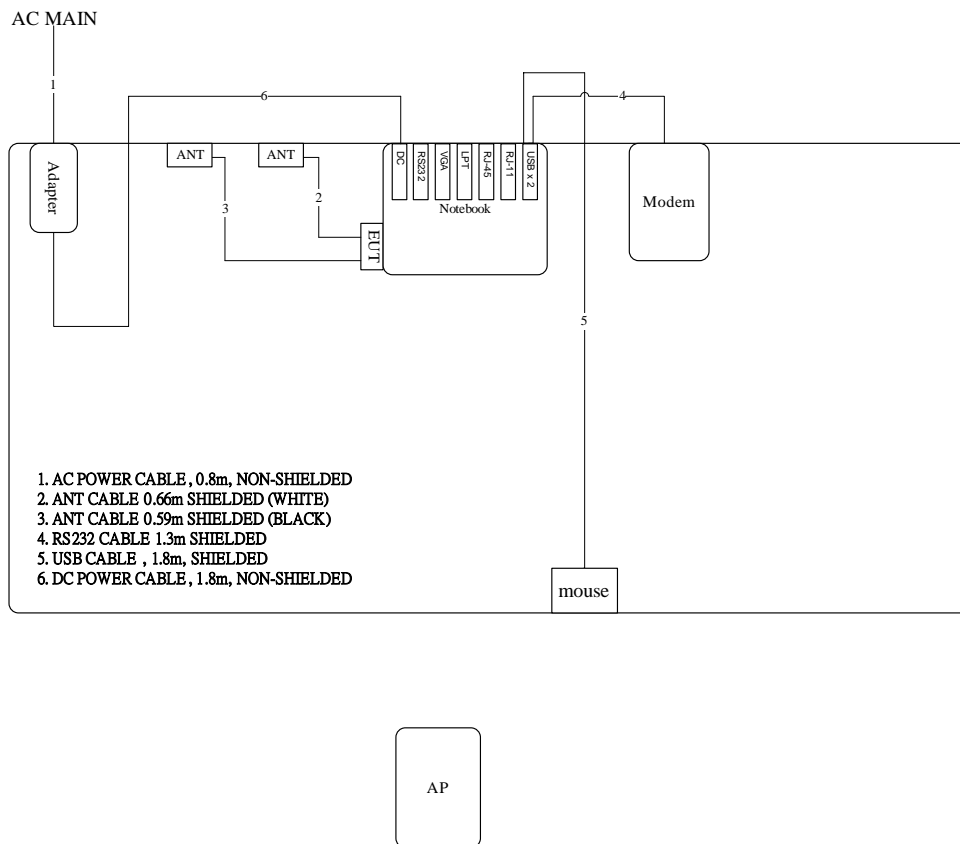

4. TEST RESULT

4.1. AC Power Line Conducted Emissions Measurement

4.1.1. Limit

For this product which is designed to be connected to the AC power line, the radio frequency voltage that is conducted back onto the AC power line on any frequency or frequencies within the band 150 kHz to 30 MHz shall not exceed below limits table.

Frequency (MHz)	QP Limit (dBuV)	AV Limit (dBuV)
0.15~0.5	66~56	56~46
0.5~5	56	46
5~30	60	50

4.1.2. Measuring Instruments and Setting

Please refer to section 5 of equipments list in this report. The following table is the setting of the receiver.

Receiver Parameters	Setting
Attenuation	10 dB
Start Frequency	0.15 MHz
Stop Frequency	30 MHz
IF Bandwidth	9 KHz

4.1.3. Test Procedures

1. Configure the EUT according to ANSI C63.4. The EUT or host of EUT has to be placed 0.4 meter far from the conducting wall of the shielding room and at least 80 centimeters from any other grounded conducting surface.
2. Connect EUT or host of EUT to the power mains through a line impedance stabilization network (LISN).
3. All the support units are connected to the other LISNs. The LISN should provide 50uH/50ohms coupling impedance.
4. The frequency range from 150 KHz to 30 MHz was searched.
5. Set the test-receiver system to Peak Detect Function and Specified Bandwidth with Maximum Hold Mode.
6. The measurement has to be done between each power line and ground at the power terminal.

4.1.4. Test Setup Layout

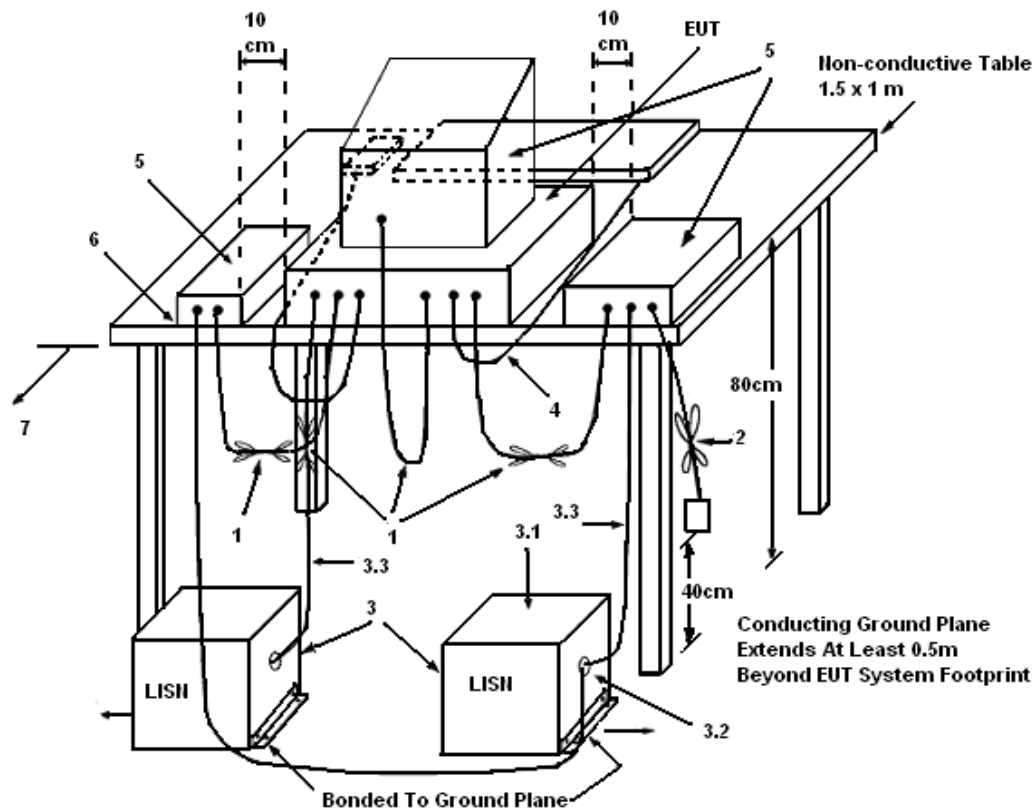

LEGEND:

- (1) Interconnecting cables that hang closer than 40 cm to the ground plane shall be folded back and forth in the center forming a bundle 30 to 40 cm long.
- (2) I/O cables that are not connected to a peripheral shall be bundled in the center. The end of the cable may be terminated, if required, using the correct terminating impedance. The overall length shall not exceed 1 m.
- (3) EUT connected to one LISN. Unused LISN measuring port connectors shall be terminated in 50 Ω. LISN can be placed on top of, or immediately beneath, reference ground plane.
 - (3.1) All other equipment powered from additional LISN(s).
 - (3.2) Multiple outlet strip can be used for multiple power cords of non-EUT equipment.
 - (3.3) LISN at least 80 cm from nearest part of EUT chassis.
- (4) Cables of hand-operated devices, such as keyboards, mice, etc., shall be placed as for normal use.
- (5) Non-EUT components of EUT system being tested.
- (6) Rear of EUT, including peripherals, shall all be aligned and flush with rear of tabletop.
- (7) Rear of tabletop shall be 40 cm removed from a vertical conducting plane that is bonded to the ground plane.

4.1.5. Test Deviation

There is no deviation with the original standard.

4.1.6. EUT Operation during Test

The EUT was placed on the test table and programmed in normal function.

4.1.7. Results of AC Power Line Conducted Emissions Measurement

Temperature	20°C	Humidity	49%
Test Engineer	Howar Sung	Phase	Line
Configuration	Normal Link		

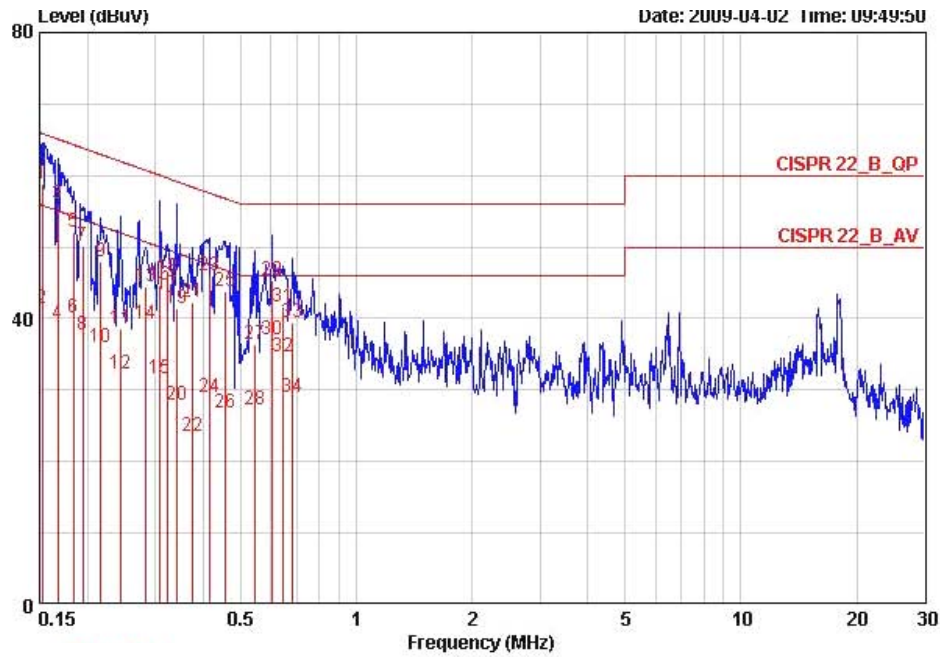

	Freq	Level	Over Limit	Limit Line	Read Level	LISN Factor	Cable Loss	Remark
	MHz	dBuV	dB	dBuV	dBuV	dB	dB	
1	0.15281	58.88	-6.96	65.85	58.61	0.07	0.20	QP
2	0.15281	41.44	-14.40	55.85	41.17	0.07	0.20	AVERAGE
3	0.16765	56.11	-8.97	65.08	55.84	0.07	0.20	QP
4	0.16765	39.23	-15.85	55.08	38.96	0.07	0.20	AVERAGE
5	0.18346	52.10	-12.23	64.33	51.84	0.06	0.20	QP
6	0.18346	40.20	-14.13	54.33	39.94	0.06	0.20	AVERAGE
7	0.19447	50.08	-13.76	63.84	49.83	0.05	0.20	QP
8	0.19447	37.65	-16.19	53.84	37.40	0.05	0.20	AVERAGE
9	0.21620	47.92	-15.05	62.96	47.67	0.05	0.20	QP
10	0.21620	36.02	-16.95	52.96	35.77	0.05	0.20	AVERAGE
11	0.24293	38.54	-23.45	62.00	38.30	0.04	0.20	QP
12	0.24293	32.15	-19.84	52.00	31.91	0.04	0.20	AVERAGE
13	0.28328	44.44	-16.28	60.72	44.20	0.04	0.20	QP
14	0.28328	39.29	-11.43	50.72	39.05	0.04	0.20	AVERAGE
15	0.30834	31.55	-18.47	50.02	31.31	0.04	0.20	AVERAGE
16	0.30834	44.63	-15.39	60.02	44.39	0.04	0.20	QP
17	0.32154	43.30	-6.37	49.67	43.06	0.04	0.20	AVERAGE
18	0.32154	45.77	-13.90	59.67	45.53	0.04	0.20	QP
19	0.34100	41.47	-17.70	59.18	41.24	0.03	0.20	QP
20	0.34100	27.79	-21.38	49.18	27.56	0.03	0.20	AVERAGE
21	0.37314	42.38	-16.05	58.43	42.15	0.03	0.20	QP
22	0.37314	23.58	-24.85	48.43	23.35	0.03	0.20	AVERAGE
23	0.41485	45.96	-11.59	57.55	45.73	0.03	0.20	QP
24	0.41485	29.04	-18.51	47.55	28.81	0.03	0.20	AVERAGE
25	0.45636	43.78	-12.98	56.76	43.55	0.03	0.20	QP



	Freq	Level	Over Limit	Limit Line	Read Level	LISN Factor	Cable Loss	Remark
	MHz	dBuV	dB	dBuV	dBuV	dB	dB	
26	0.45636	26.81	-19.95	46.76	26.58	0.03	0.20	AVERAGE
27	0.54355	36.49	-19.51	56.00	36.26	0.03	0.20	QP
28	0.54355	27.32	-18.68	46.00	27.09	0.03	0.20	AVERAGE
29	0.60112	45.30	-10.70	56.00	45.07	0.03	0.20	QP
30	0.60112	37.01	-8.99	46.00	36.78	0.03	0.20	AVERAGE
31	0.64740	41.74	-14.26	56.00	41.51	0.03	0.20	QP
32	0.64740	34.60	-11.40	46.00	34.37	0.03	0.20	AVERAGE
33	0.68263	39.49	-16.51	56.00	39.26	0.03	0.20	QP
34	0.68263	29.10	-16.90	46.00	28.87	0.03	0.20	AVERAGE

Temperature	20°C	Humidity	49%
Test Engineer	Howar Sung	Phase	Neutral
Configuration	Normal Link		

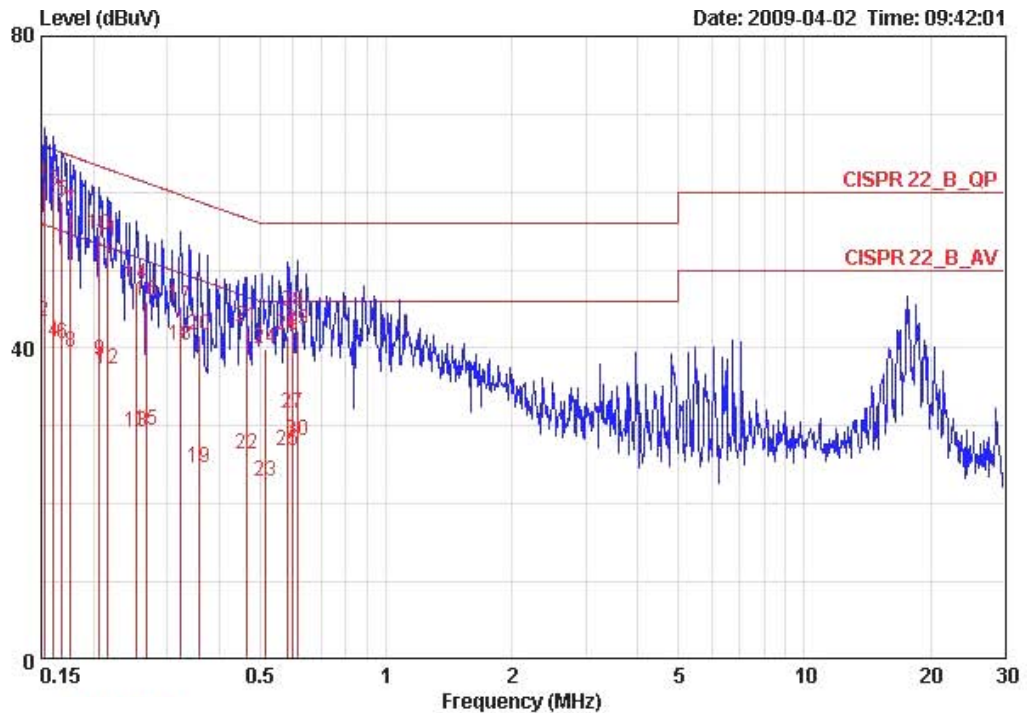

	Freq	Level	Over	Limit	Read	LISN	Cable	Remark
	MHz	dBuV	Limit	Line	Level	Factor	Loss	
			dB	dBuV	dBuV	dB	dB	
1	0.15240	61.29	-4.57	65.87	60.99	0.10	0.20	QP
2	0.15240	43.41	-12.45	55.87	43.11	0.10	0.20	AVERAGE
3	0.16070	60.11	-5.32	65.43	59.81	0.10	0.20	QP
4	0.16070	40.69	-14.74	55.43	40.39	0.10	0.20	AVERAGE
5	0.16854	58.75	-6.28	65.03	58.46	0.09	0.20	QP
6	0.16854	40.54	-14.49	55.03	40.25	0.09	0.20	AVERAGE
7	0.17584	57.51	-7.17	64.68	57.22	0.09	0.20	QP
8	0.17584	39.45	-15.23	54.68	39.16	0.09	0.20	AVERAGE
9	0.20614	38.40	-14.96	53.36	38.12	0.08	0.20	AVERAGE
10	0.20614	54.50	-8.86	63.36	54.22	0.08	0.20	QP
11	0.21620	53.73	-9.23	62.96	53.45	0.08	0.20	QP
12	0.21620	37.23	-15.73	52.96	36.95	0.08	0.20	AVERAGE
13	0.25211	29.27	-22.42	51.69	28.99	0.08	0.20	AVERAGE
14	0.25211	48.18	-13.51	61.69	47.90	0.08	0.20	QP
15	0.26724	29.42	-21.79	51.20	29.14	0.08	0.20	AVERAGE
16	0.26724	45.99	-15.22	61.20	45.71	0.08	0.20	QP
17	0.32169	45.42	-14.24	59.66	45.15	0.07	0.20	QP
18	0.32169	40.24	-9.42	49.66	39.97	0.07	0.20	AVERAGE
19	0.35765	24.61	-24.17	48.78	24.34	0.07	0.20	AVERAGE
20	0.35765	41.64	-17.14	58.78	41.37	0.07	0.20	QP
21	0.46367	42.67	-13.96	56.63	42.40	0.07	0.20	QP
22	0.46367	26.40	-20.23	46.63	26.13	0.07	0.20	AVERAGE
23	0.51457	22.97	-23.03	46.00	22.70	0.07	0.20	AVERAGE
24	0.51457	39.83	-16.17	56.00	39.56	0.07	0.20	QP
25	0.58231	26.78	-19.22	46.00	26.51	0.07	0.20	AVERAGE



	Freq	Level	Over Limit	Limit Line	Read Level	LISN Factor	Cable Loss	Remark
	MHz	dBuV	dB	dBuV	dBuV	dB	dB	
26	0.58231	41.53	-14.47	56.00	41.26	0.07	0.20	QP
27	0.59871	31.66	-14.34	46.00	31.39	0.07	0.20	AVERAGE
28	0.59871	44.69	-11.31	56.00	44.42	0.07	0.20	QP
29	0.61560	42.35	-13.65	56.00	42.08	0.07	0.20	QP
30	0.61560	28.06	-17.94	46.00	27.79	0.07	0.20	AVERAGE

Note:

Level = Read Level + LISN Factor + Cable Loss

4.2. Maximum Conducted Output Power Measurement

4.2.1. Limit

For systems using digital modulation in the 2400-2483.5MHz, the limit for peak output power is 30dBm. The limited has to be reduced by the amount in dB that the gain of the antenna exceed 6dBi. In case of point-to-point operation, the limit has to be reduced by 1dB for every 3dB that the directional gain of the antenna exceeds 6dBi. Systems operating in the 5725-5850 MHz band that are used exclusively for fixed, point-to-point operations may employ transmitting antennas with directional gain greater than 6 dBi without any corresponding reduction in transmitter conducted output power.

4.2.2. Measuring Instruments and Setting

Please refer to section 5 of equipments list in this report. The following table is the setting of the spectrum analyzer.

Spectrum Parameter	Setting
Attenuation	Auto
Span Frequency	Encompass the entire emissions bandwidth (EBW) of the signal
RB	1MHz
VB	3MHz
Detector	RMS
Trace	Max Hold
Sweep Time	Auto

4.2.3. Test Procedures

1. The transmitter output (antenna port) was connected to the spectrum analyzer.
2. Test was performed in accordance with Measurement of Digital Transmission Systems Operating under Section 15.247 March 23, 2005.
3. When measuring maximum conducted output power with multiple antenna systems, add every result of the values by mathematic formula.

4.2.4. Test Setup Layout

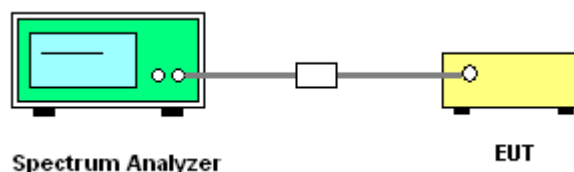

4.2.5. Test Deviation

There is no deviation with the original standard.

4.2.6. EUT Operation during Test

The EUT was programmed to be in continuously transmitting mode.

4.2.7. Test Result of Maximum Conducted Output Power

Temperature	24°C	Humidity	56%
Test Engineer	Allen Liu	Configurations	Draft n

For 2.4GHz Band

Configuration Draft n MCS0 20MHz Ant. A

Channel	Frequency	Conducted Power (dBm)	Max. Limit (dBm)	Result
1	2412 MHz	16.50	30.00	Complies
6	2437 MHz	22.54	30.00	Complies
11	2462 MHz	14.32	30.00	Complies

Configuration Draft n MCS0 20MHz Ant. B

Channel	Frequency	Conducted Power (dBm)	Max. Limit (dBm)	Result
1	2412 MHz	16.04	30.00	Complies
6	2437 MHz	23.02	30.00	Complies
11	2462 MHz	14.51	30.00	Complies

Configuration Draft n MCS0 20MHz Ant. A + Ant. B

Channel	Frequency	Conducted Power (dBm)	Max. Limit (dBm)	Result
1	2412 MHz	19.29	30.00	Complies
6	2437 MHz	25.80	30.00	Complies
11	2462 MHz	17.43	30.00	Complies

Configuration Draft n MCS0 40MHz Ant. A

Channel	Frequency	Conducted Power (dBm)	Max. Limit (dBm)	Result
3	2422 MHz	12.15	30.00	Complies
6	2437 MHz	16.73	30.00	Complies
9	2452 MHz	11.50	30.00	Complies

Configuration Draft n MCS0 40MHz Ant. B

Channel	Frequency	Conducted Power (dBm)	Max. Limit (dBm)	Result
3	2422 MHz	12.05	30.00	Complies
6	2437 MHz	17.15	30.00	Complies
9	2452 MHz	11.01	30.00	Complies

Configuration Draft n MCS0 40MHz Ant. A + Ant. B

Channel	Frequency	Conducted Power (dBm)	Max. Limit (dBm)	Result
3	2422 MHz	15.11	30.00	Complies
6	2437 MHz	19.96	30.00	Complies
9	2452 MHz	14.27	30.00	Complies

For 5GHz Band
Configuration Draft n MCS0 20MHz Ant. A

Channel	Frequency	Conducted Power (dBm)	Max. Limit (dBm)	Result
149	5745 MHz	20.79	30.00	Complies
157	5785 MHz	20.00	30.00	Complies
165	5825 MHz	19.51	30.00	Complies

Configuration Draft n MCS0 20MHz Ant. B

Channel	Frequency	Conducted Power (dBm)	Max. Limit (dBm)	Result
149	5745 MHz	17.73	30.00	Complies
157	5785 MHz	17.01	30.00	Complies
165	5825 MHz	16.66	30.00	Complies

Configuration Draft n MCS0 20MHz Ant. A + Ant. B

Channel	Frequency	Conducted Power (dBm)	Max. Limit (dBm)	Result
149	5745 MHz	22.53	30.00	Complies
157	5785 MHz	21.77	30.00	Complies
165	5825 MHz	21.33	30.00	Complies

Configuration Draft n MCS0 40MHz Ant. A

Channel	Frequency	Conducted Power (dBm)	Max. Limit (dBm)	Result
151	5755 MHz	19.64	30.00	Complies
159	5795 MHz	19.09	30.00	Complies

Configuration Draft n MCS0 40MHz Ant. B

Channel	Frequency	Conducted Power (dBm)	Max. Limit (dBm)	Result
151	5755 MHz	16.83	30.00	Complies
159	5795 MHz	16.50	30.00	Complies

Configuration Draft n MCS0 40MHz Ant. A + Ant. B

Channel	Frequency	Conducted Power (dBm)	Max. Limit (dBm)	Result
151	5755 MHz	21.47	30.00	Complies
159	5795 MHz	21.00	30.00	Complies

Temperature	24°C	Humidity	56%
Test Engineer	Allen Liu	Configurations	802.11a/b/g

Configuration IEEE 802.11b Ant. A

Channel	Frequency	Conducted Power (dBm)	Max. Limit (dBm)	Result
1	2412 MHz	16.87	30.00	Complies
6	2437 MHz	18.75	30.00	Complies
11	2462 MHz	16.39	30.00	Complies

Configuration IEEE 802.11b Ant. B

Channel	Frequency	Conducted Power (dBm)	Max. Limit (dBm)	Result
1	2412 MHz	17.59	30.00	Complies
6	2437 MHz	19.39	30.00	Complies
11	2462 MHz	17.99	30.00	Complies

Configuration IEEE 802.11b Ant. A + Ant. B

Channel	Frequency	Conducted Power (dBm)	Max. Limit (dBm)	Result
1	2412 MHz	20.26	30.00	Complies
6	2437 MHz	22.09	30.00	Complies
11	2462 MHz	20.27	30.00	Complies

Configuration IEEE 802.11g Ant. A

Channel	Frequency	Conducted Power (dBm)	Max. Limit (dBm)	Result
1	2412 MHz	17.04	30.00	Complies
6	2437 MHz	22.97	30.00	Complies
11	2462 MHz	15.07	30.00	Complies

Configuration IEEE 802.11g Ant. B

Channel	Frequency	Conducted Power (dBm)	Max. Limit (dBm)	Result
1	2412 MHz	16.87	30.00	Complies
6	2437 MHz	23.88	30.00	Complies
11	2462 MHz	16.02	30.00	Complies

Configuration IEEE 802.11g Ant. A + Ant. B

Channel	Frequency	Conducted Power (dBm)	Max. Limit (dBm)	Result
1	2412 MHz	19.97	30.00	Complies
6	2437 MHz	26.46	30.00	Complies
11	2462 MHz	18.58	30.00	Complies

Configuration IEEE 802.11a Ant. A

Channel	Frequency	Conducted Power (dBm)	Max. Limit (dBm)	Result
149	5745 MHz	20.76	30.00	Complies
157	5785 MHz	20.02	30.00	Complies
165	5825 MHz	20.03	30.00	Complies

Configuration IEEE 802.11a Ant. B

Channel	Frequency	Conducted Power (dBm)	Max. Limit (dBm)	Result
149	5745 MHz	18.33	30.00	Complies
157	5785 MHz	17.13	30.00	Complies
165	5825 MHz	17.00	30.00	Complies

Configuration IEEE 802.11a Ant. A+Ant. B

Channel	Frequency	Conducted Power (dBm)	Max. Limit (dBm)	Result
149	5745 MHz	22.72	30.00	Complies
157	5785 MHz	21.82	30.00	Complies
165	5825 MHz	21.78	30.00	Complies

Channel Output Power Plot on Configuration Draft n MCS0 20MHz Ant. A / 2412 MHz

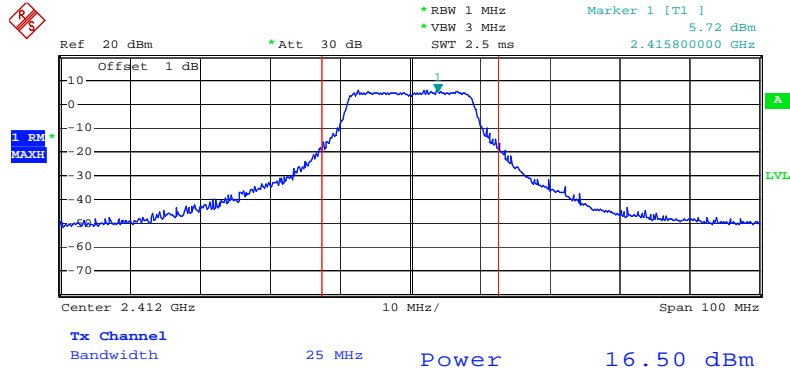

Date: 25.MAR.2009 15:54:21

Channel Output Power Plot on Configuration Draft n MCS0 20MHz Ant. A / 2437 MHz

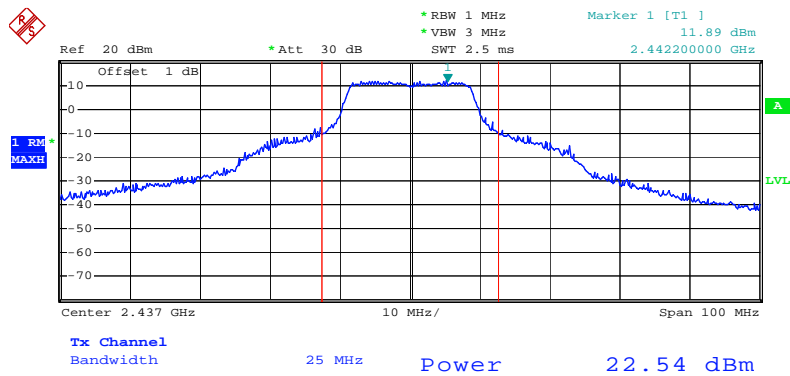

Date: 25.MAR.2009 15:50:39

Channel Output Power Plot on Configuration Draft n MCS0 20MHz Ant. A / 2462 MHz

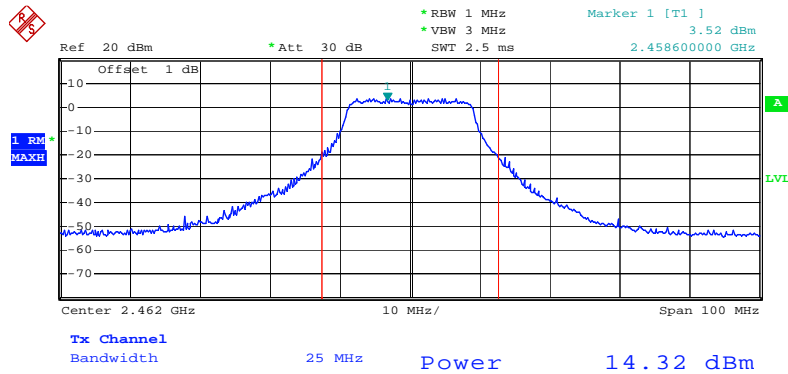

Date: 25.MAR.2009 15:48:59

Channel Output Power Plot on Configuration Draft n MCS0 20MHz Ant. B / 2412 MHz

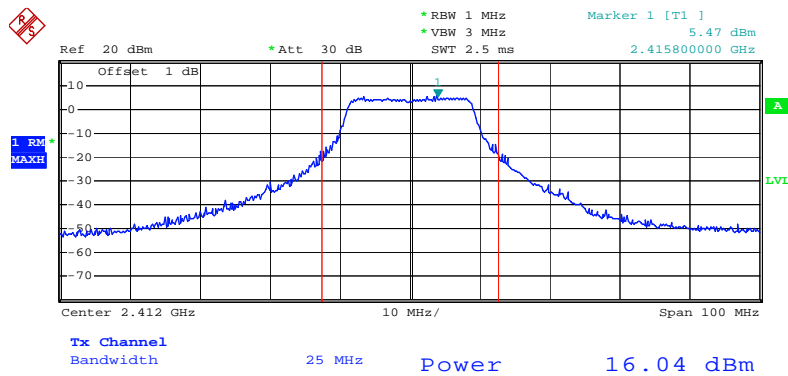

Date: 25.MAR.2009 15:53:09

Channel Output Power Plot on Configuration Draft n MCS0 20MHz Ant. B / 2437 MHz

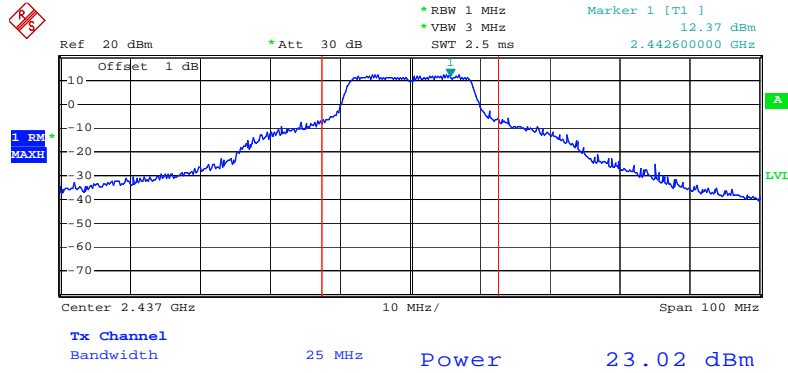

Date: 25.MAR.2009 15:51:55

Channel Output Power Plot on Configuration Draft n MCS0 20MHz Ant. B / 2462 MHz

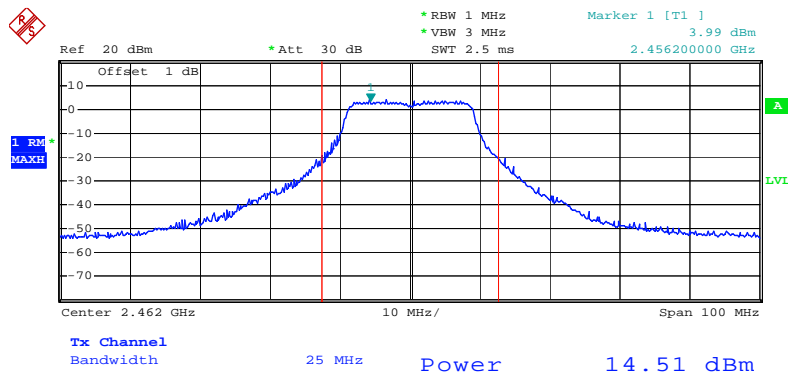

Date: 25.MAR.2009 15:48:04

Channel Output Power Plot on Configuration Draft n MCS0 40MHz Ant. A / 2422 MHz

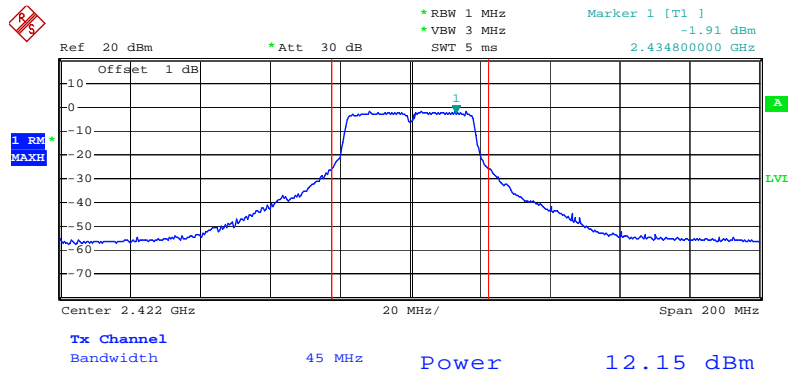

Date: 25.MAR.2009 15:57:43

Channel Output Power Plot on Configuration Draft n MCS0 40MHz Ant. A / 2437 MHz

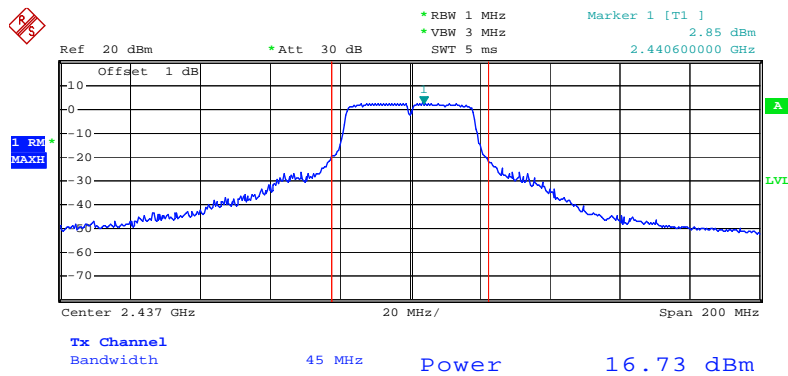

Date: 25.MAR.2009 16:01:19

Channel Output Power Plot on Configuration 11a Draft n MCS0 20MHz Ant. A / 5745 MHz

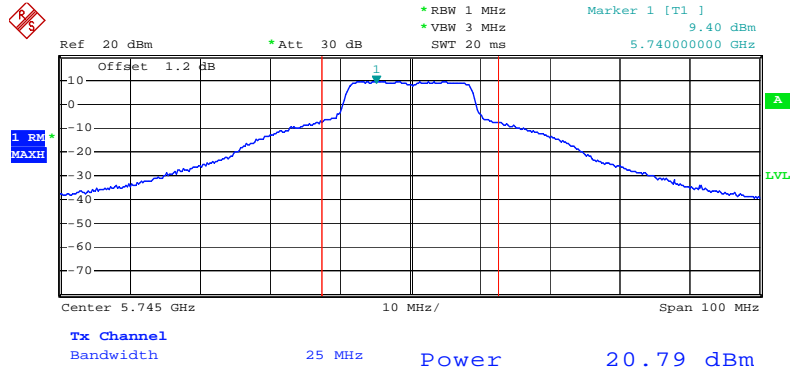

Date: 25.MAR.2009 16:24:25

Channel Output Power Plot on Configuration 11a Draft n MCS0 20MHz Ant. A / 5785MHz

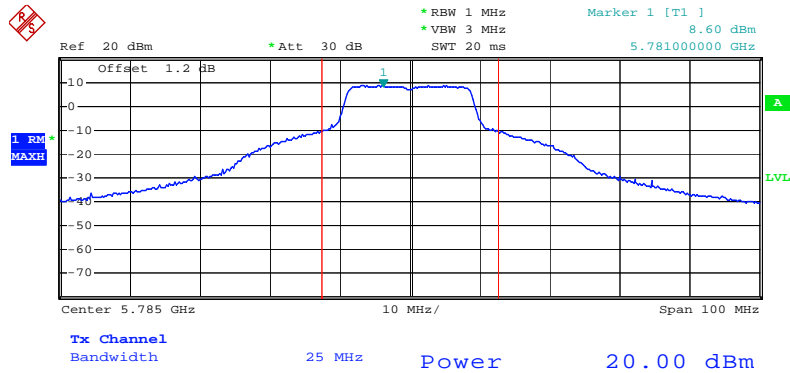

Date: 25.MAR.2009 16:27:46

Channel Output Power Plot on Configuration 11a Draft n MCS0 20MHz Ant. A / 5825 MHz

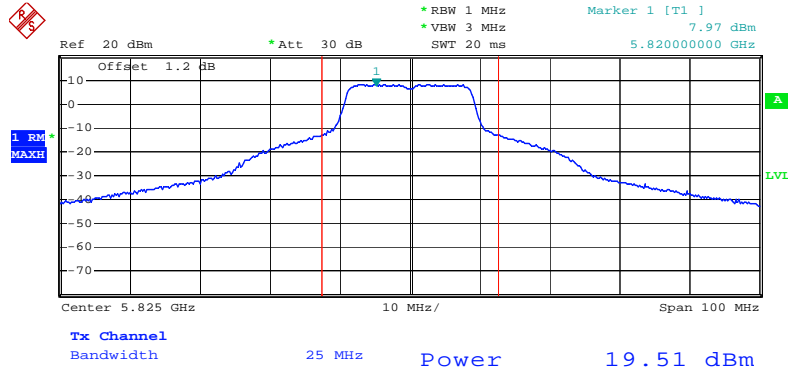

Date: 25.MAR.2009 16:30:02

Channel Output Power Plot on Configuration 11a Draft n MCS0 20MHz Ant. B / 5745 MHz

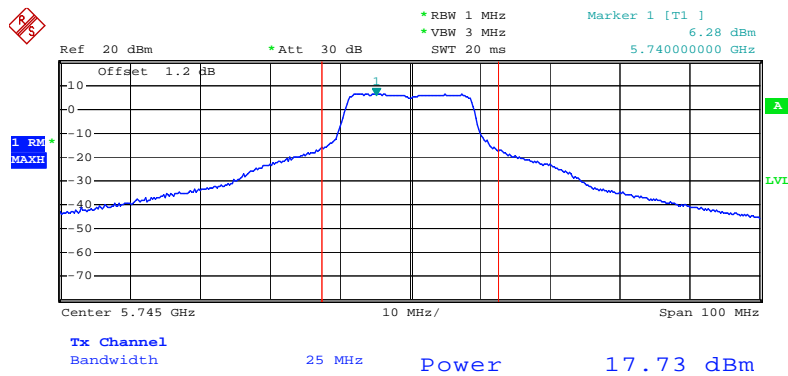

Date: 25.MAR.2009 16:25:36

Channel Output Power Plot on Configuration 11a Draft n MCS0 20MHz Ant. B / 5785MHz

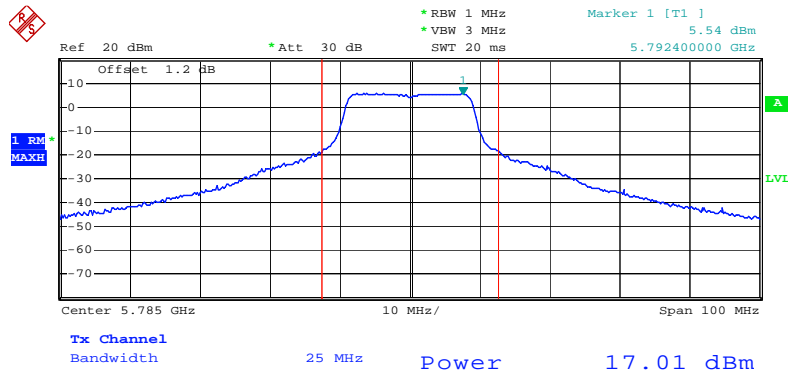

Date: 25.MAR.2009 16:26:42

Channel Output Power Plot on Configuration 11a Draft n MCS0 20MHz Ant. B / 5825 MHz

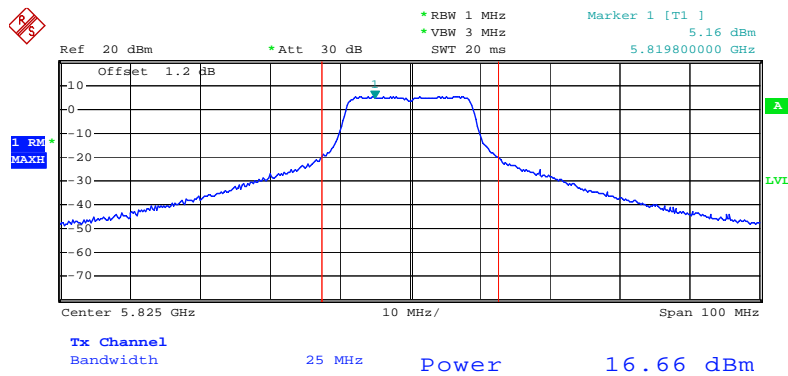

Date: 25.MAR.2009 16:30:45

Channel Output Power Plot on Configuration 11a Draft n MCS0 40MHz Ant. A / 5755 MHz

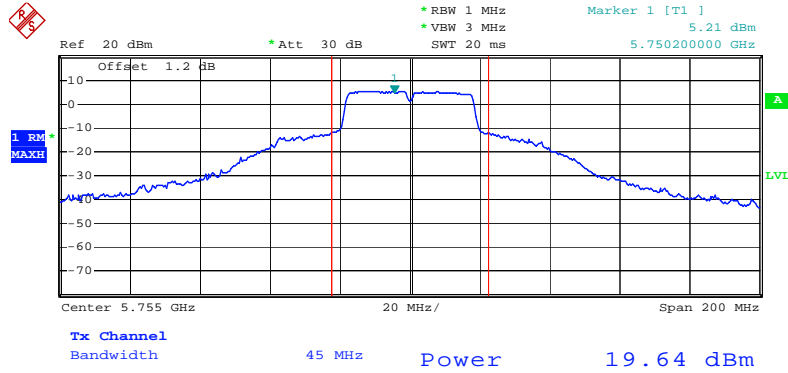

Date: 25.MAR.2009 16:55:36

Channel Output Power Plot on Configuration 11a Draft n MCS0 40MHz Ant. A / 5795 MHz

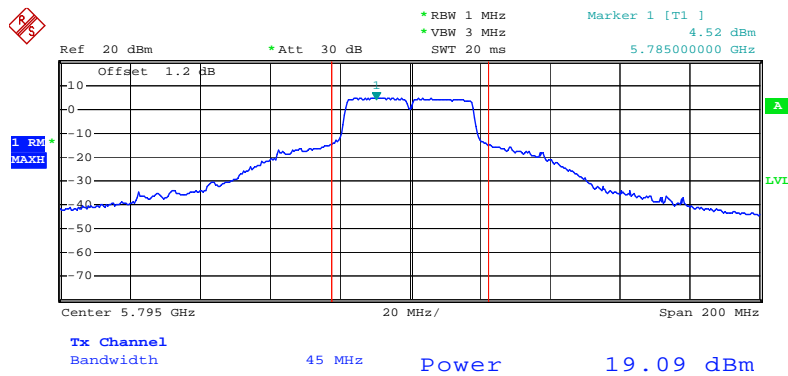

Date: 25.MAR.2009 16:54:45

Channel Output Power Plot on Configuration 11a Draft n MCS0 40MHz Ant. B / 5755 MHz

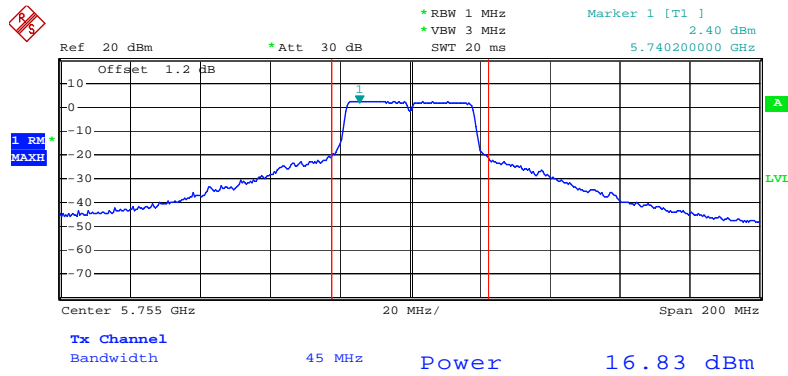

Date: 25.MAR.2009 16:58:48

Channel Output Power Plot on Configuration 11a Draft n MCS0 40MHz Ant. B / 5795 MHz

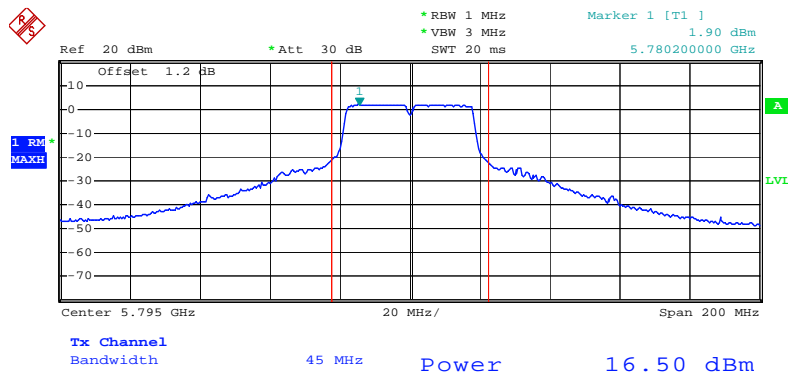

Date: 25.MAR.2009 16:52:54

Conducted Output Power Plot on Configuration IEEE 802.11b Ant. A / 2462 MHz

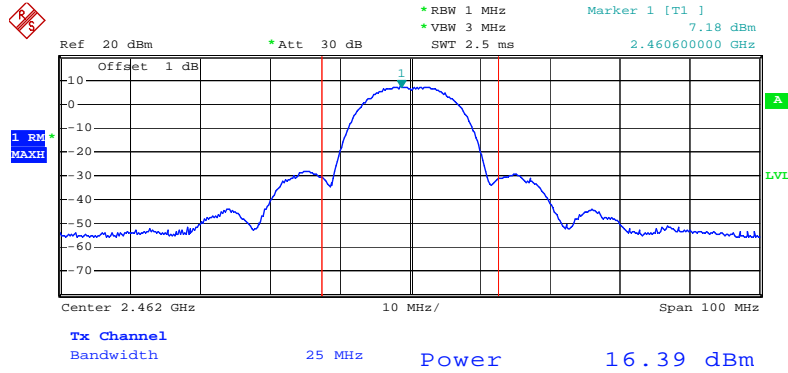

Date: 25.MAR.2009 15:21:17

Conducted Output Power Plot on Configuration IEEE 802.11b Ant. B / 2412 MHz

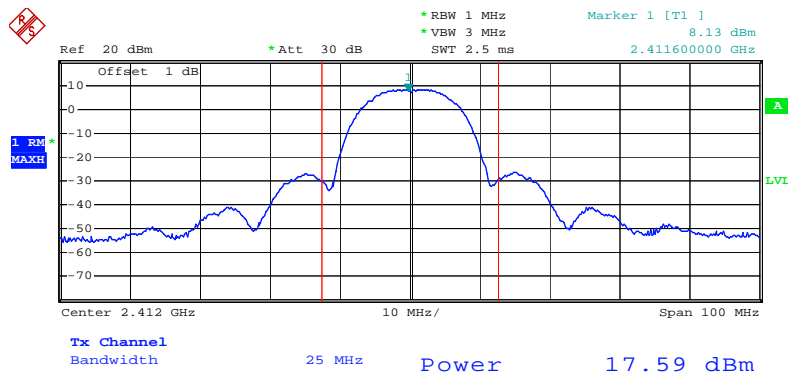

Date: 25.MAR.2009 15:16:56

Conducted Output Power Plot on Configuration IEEE 802.11b Ant. B / 2437 MHz

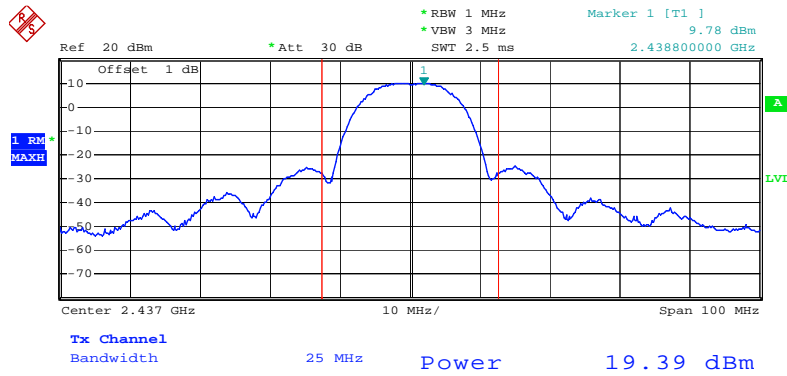

Date: 25.MAR.2009 15:19:11

Conducted Output Power Plot on Configuration IEEE 802.11b Ant. B / 2462 MHz

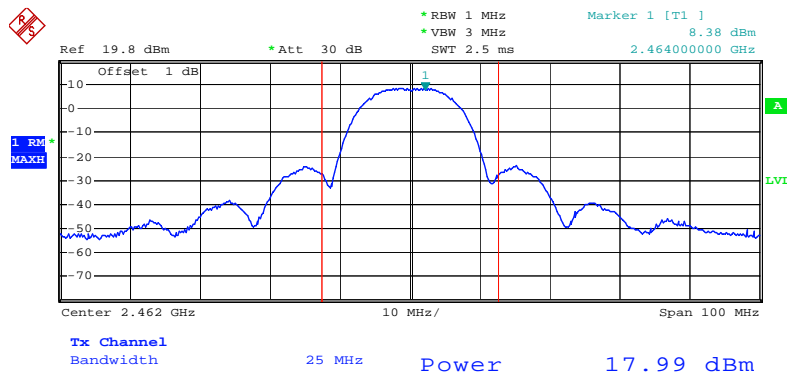

Date: 25.MAR.2009 15:31:00

Conducted Output Power Plot on Configuration IEEE 802.11g Ant. A / 2412 MHz

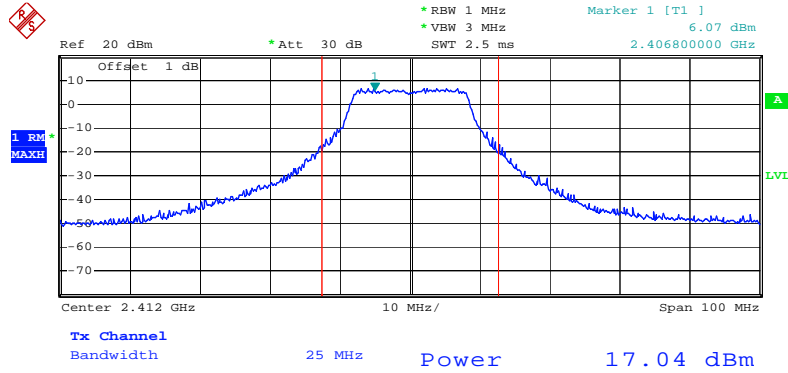

Date: 25.MAR.2009 15:38:31

Conducted Output Power Plot on Configuration IEEE 802.11g Ant. A / 2437 MHz

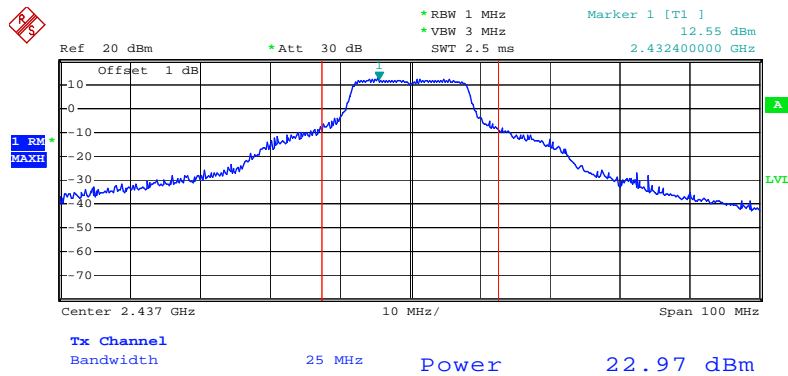

Date: 25.MAR.2009 15:43:35

Conducted Output Power Plot on Configuration IEEE 802.11g Ant. B / 2437 MHz

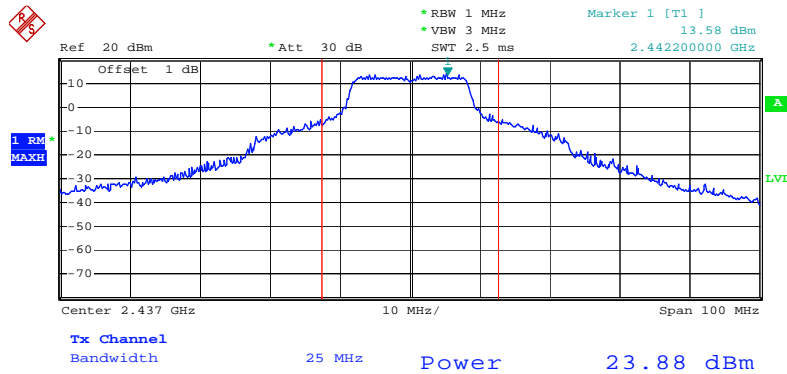

Date: 25.MAR.2009 15:41:05

Conducted Output Power Plot on Configuration IEEE 802.11g Ant. B / 2462 MHz

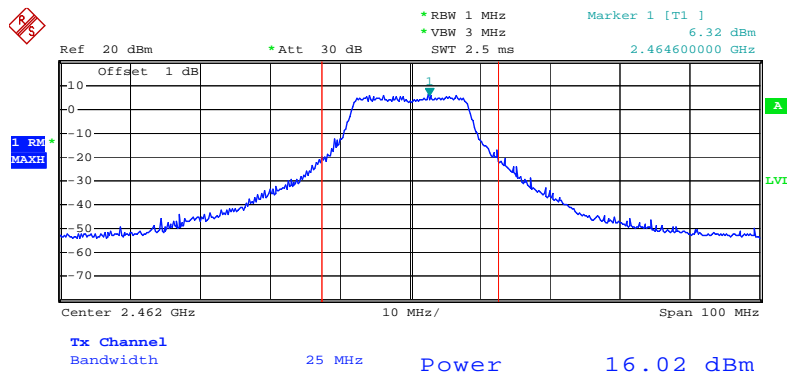

Date: 25.MAR.2009 15:46:01

Conducted Output Power Plot on Configuration IEEE 802.11a Ant. A / 5745 MHz

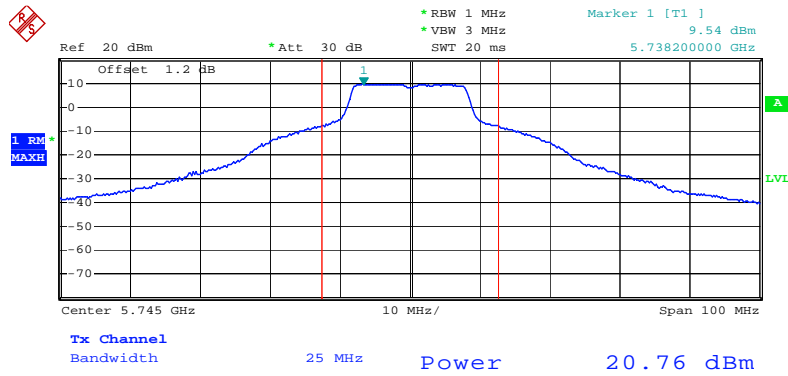

Date: 25.MAR.2009 16:13:37

Conducted Output Power Plot on Configuration IEEE 802.11a Ant. A / 5785 MHz

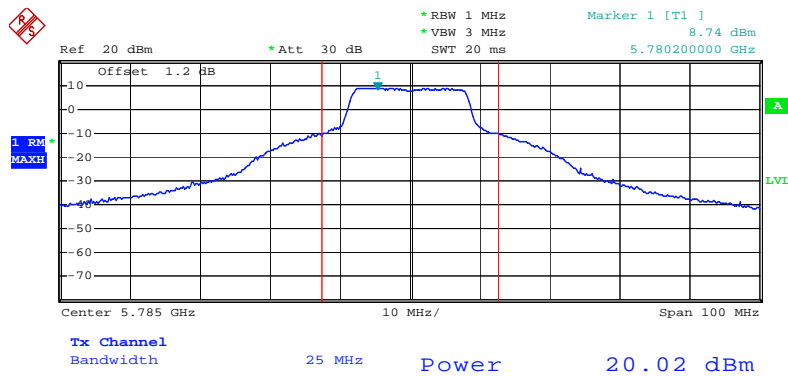

Date: 25.MAR.2009 16:16:44

Conducted Output Power Plot on Configuration IEEE 802.11a Ant. B / 5785 MHz

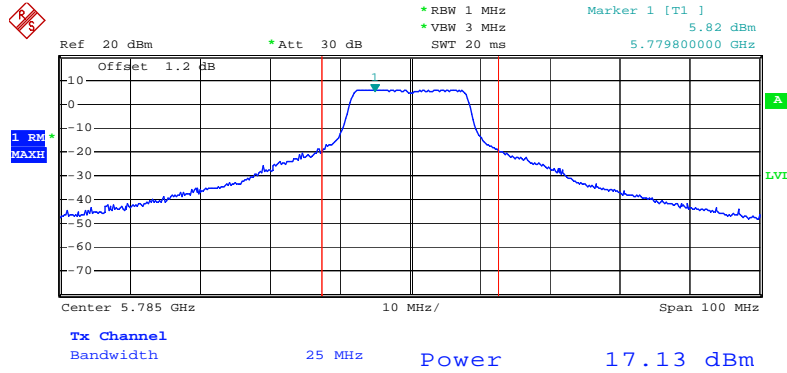

Date: 25.MAR.2009 16:17:34

Conducted Output Power Plot on Configuration IEEE 802.11a Ant. B / 5825 MHz

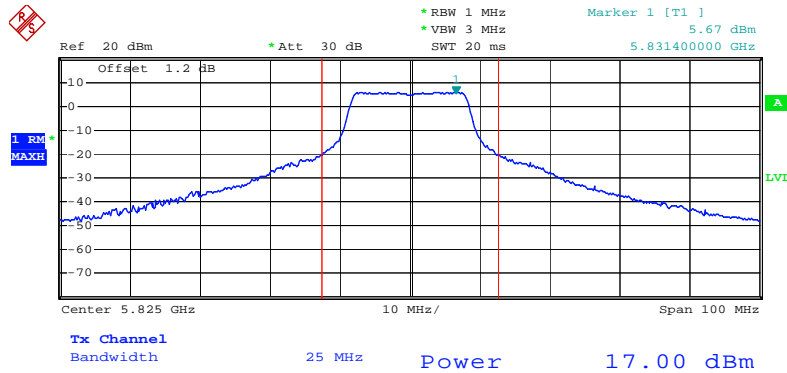

Date: 25.MAR.2009 16:19:51

4.3. Power Spectral Density Measurement

4.3.1. Limit

For digitally modulated systems, the power spectral density conducted from the intentional radiator to the antenna shall not be greater than 8dBm in any 3 kHz band during any time interval of continuous transmission.

4.3.2. Measuring Instruments and Setting

Please refer to section 5 of equipments list in this report. The following table is the setting of the spectrum analyzer.

Spectrum Parameter	Setting
Attenuation	Auto
Span Frequency	30 kHz
RB	3 kHz
VB	30 kHz
Detector	Peak
Trace	Max Hold
Sweep Time	10s

4.3.3. Test Procedures

1. The transmitter output (antenna port) was connected to the spectrum analyser.
2. Set RBW of spectrum analyzer to 3kHz and VBW to 30kHz. Set Detector to Peak, Trace to Max Hold.
3. Mark the frequency with maximum peak power as the center of the display of the spectrum.
4. Set the span to 30kHz and the sweep time to 10s and record the maximum peak value.
5. Measuring multiple antennas, the connector is required to link with spectrum analyser through a combiner.

4.3.4. Test Setup Layout

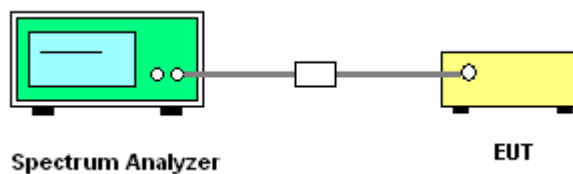

4.3.5. Test Deviation

There is no deviation with the original standard.

4.3.6. EUT Operation during Test

The EUT was programmed to be in continuously transmitting mode.

4.3.7. Test Result of Power Spectral Density

Temperature	24°C	Humidity	56%
Test Engineer	Allen Liu	Configurations	Draft n

For 2.4GHz Band

Configuration Draft n MCS0 20MHz Ant. A + Ant. B

Channel	Frequency	Power Density (dBm)	Max. Limit (dBm)	Result
1	2412 MHz	-3.35	8.00	Complies
6	2437 MHz	-1.94	8.00	Complies
11	2462 MHz	-6.17	8.00	Complies

Configuration Draft n MCS0 40MHz Ant. A + Ant. B

Channel	Frequency	Power Density (dBm)	Max. Limit (dBm)	Result
3	2422 MHz	-12.77	8.00	Complies
6	2437 MHz	-7.85	8.00	Complies
9	2452 MHz	-13.62	8.00	Complies

For 5GHz Band

Configuration 11a Draft n MCS0 20MHz Ant. A + Ant. B

Channel	Frequency	Power Density (dBm)	Max. Limit (dBm)	Result
149	5745 MHz	-1.43	8.00	Complies
157	5785 MHz	-1.10	8.00	Complies
165	5825 MHz	-2.48	8.00	Complies

Configuration 11a Draft n MCS0 40MHz Ant. A + Ant. B

Channel	Frequency	Power Density (dBm)	Max. Limit (dBm)	Result
151	5755 MHz	-3.87	8.00	Complies
159	5795 MHz	-3.12	8.00	Complies

Temperature	24°C	Humidity	56%
Test Engineer	Allen Liu	Configurations	802.11a/b/g

Configuration IEEE 802.11b Ant. A + Ant. B

Channel	Frequency	Power Density (dBm)	Max. Limit (dBm)	Result
1	2412 MHz	-3.51	8.00	Complies
6	2437 MHz	-1.80	8.00	Complies
11	2462 MHz	-5.57	8.00	Complies

Configuration IEEE 802.11g Ant. A + Ant. B

Channel	Frequency	Power Density (dBm)	Max. Limit (dBm)	Result
1	2412 MHz	-3.26	8.00	Complies
6	2437 MHz	1.17	8.00	Complies
11	2462 MHz	-3.47	8.00	Complies

Configuration IEEE 802.11a Ant. A + Ant. B

Channel	Frequency	Power Density (dBm)	Max. Limit (dBm)	Result
149	5745 MHz	1.01	8.00	Complies
157	5785 MHz	-0.70	8.00	Complies
165	5825 MHz	-0.21	8.00	Complies

Power Density Plot on Configuration Drafft n MCS0 20MHz Ant. A + Ant. B / 2412 MHz

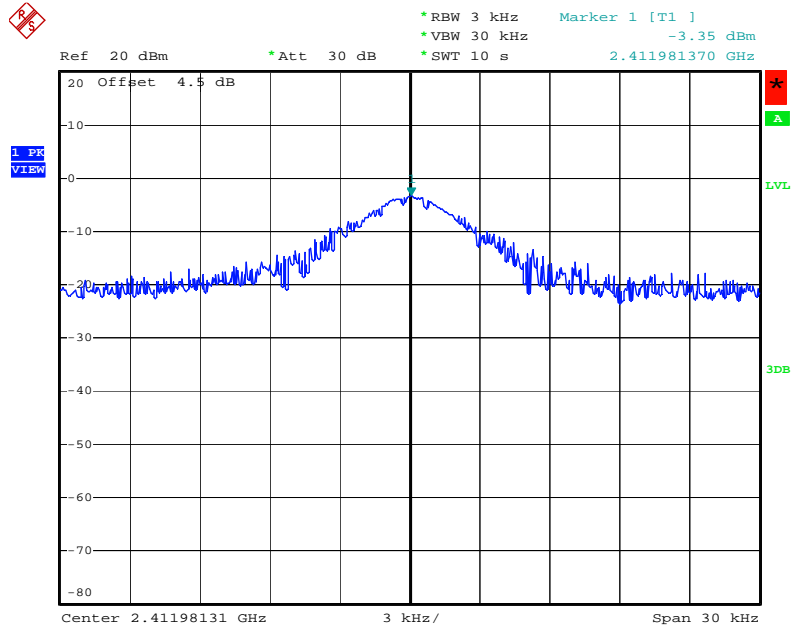

Date: 26.MAR.2009 12:33:23

Power Density Plot on Configuration Drafft n MCS0 20MHz Ant. A + Ant. B / 2437 MHz

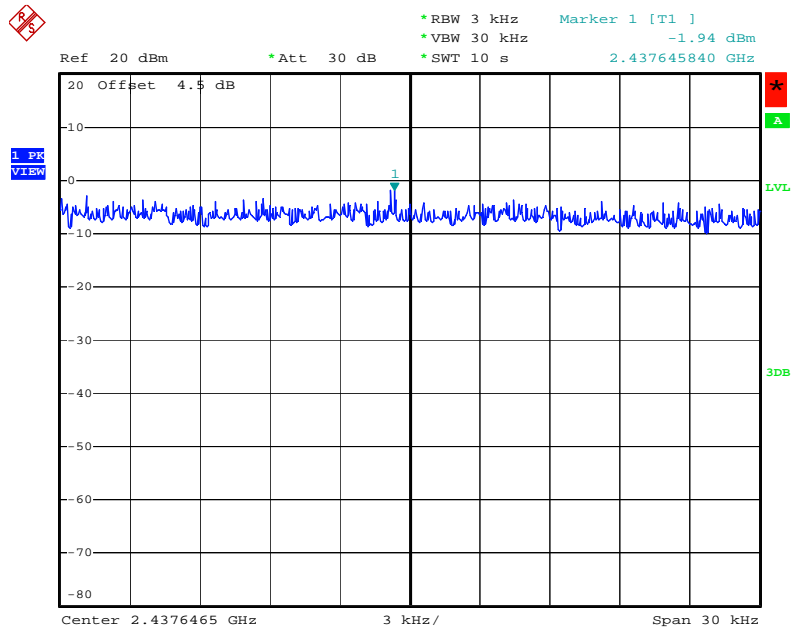

Date: 26.MAR.2009 12:34:28

Power Density Plot on Configuration 11a Draft n MCS0 20MHz Ant. A + Ant. B / 5745 MHz

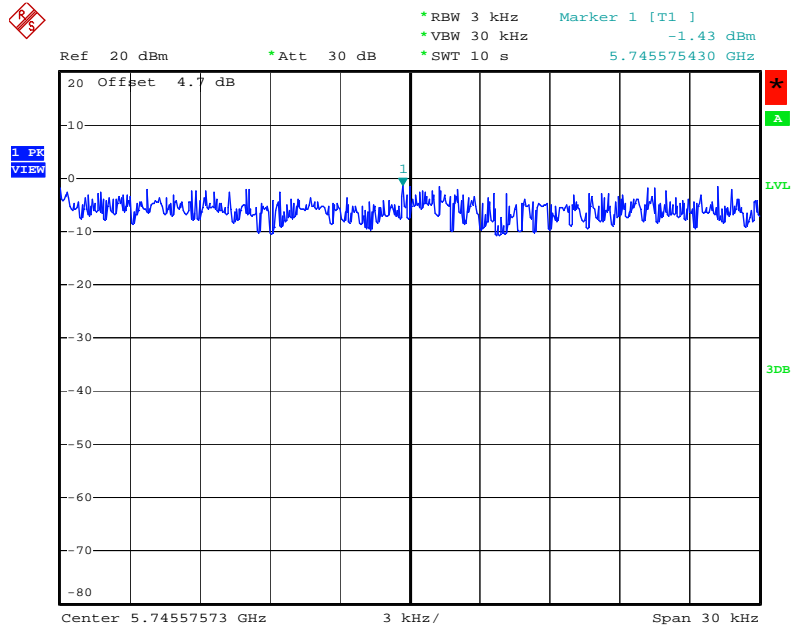

Date: 26.MAR.2009 12:26:20

Power Density Plot on Configuration 11a Draft n MCS0 20MHz Ant. A + Ant. B / 5785 MHz

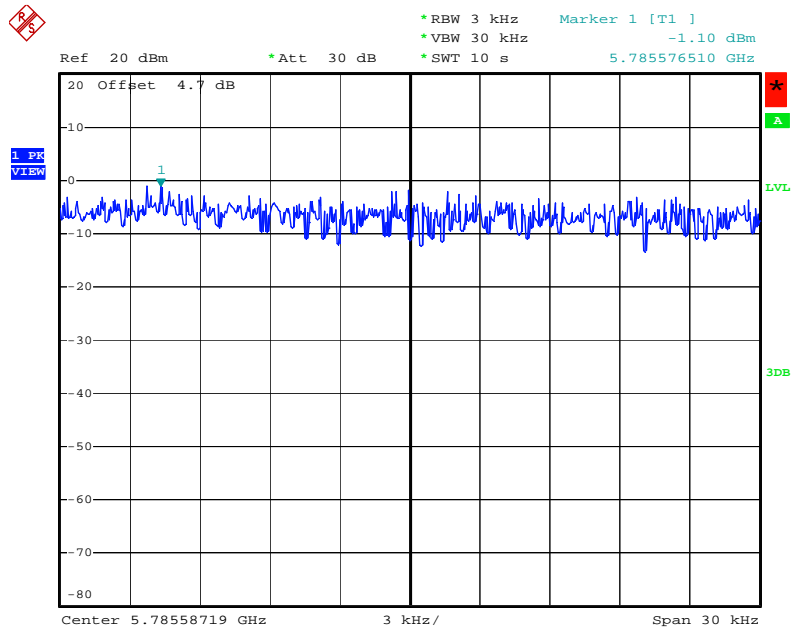

Date: 26.MAR.2009 12:28:06

Power Density Plot on Configuration 11a Draft n MCS0 20MHz Ant. A + Ant. B / 5825 MHz

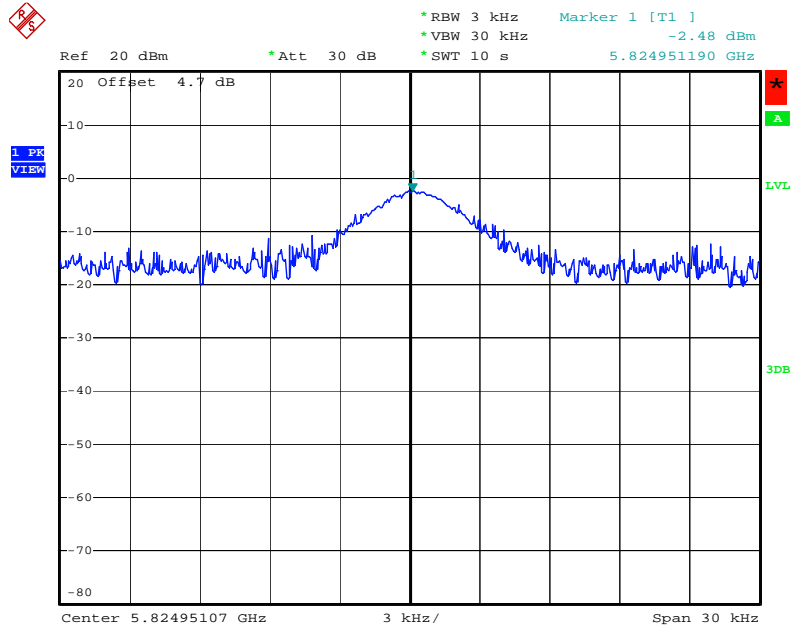

Date: 26.MAR.2009 12:30:45

Power Density Plot on Configuration 11a Draft n MCS0 40MHz Ant. A + Ant. B / 5755 MHz

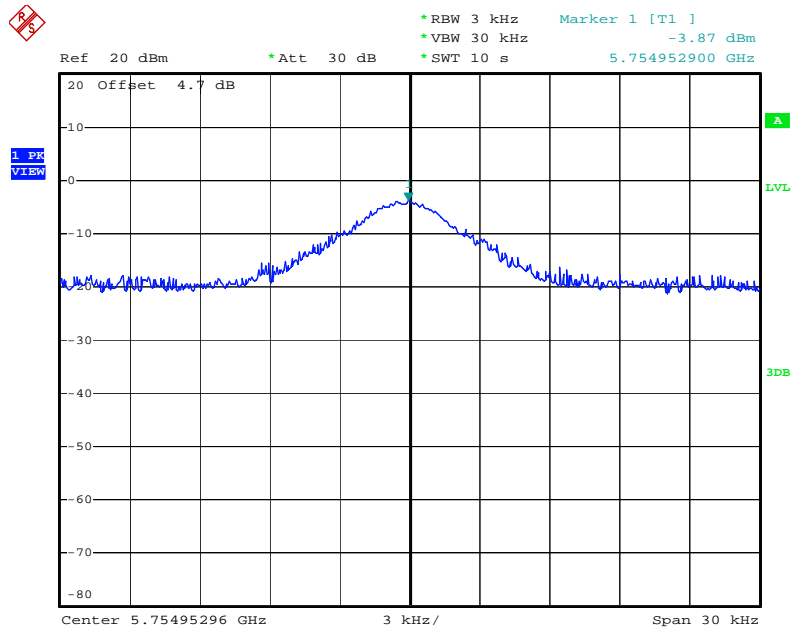

Date: 26.MAR.2009 13:38:50

Power Density Plot on Configuration IEEE 802.11b Ant. A + Ant. B / 2412 MHz

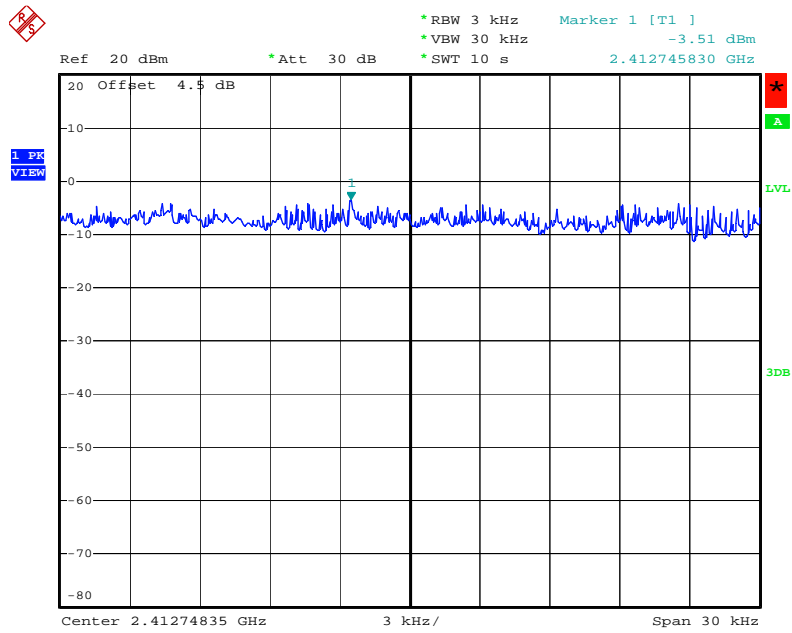

Date: 26.MAR.2009 12:02:30

Power Density Plot on Configuration IEEE 802.11b Ant. A + Ant. B / 2437 MHz

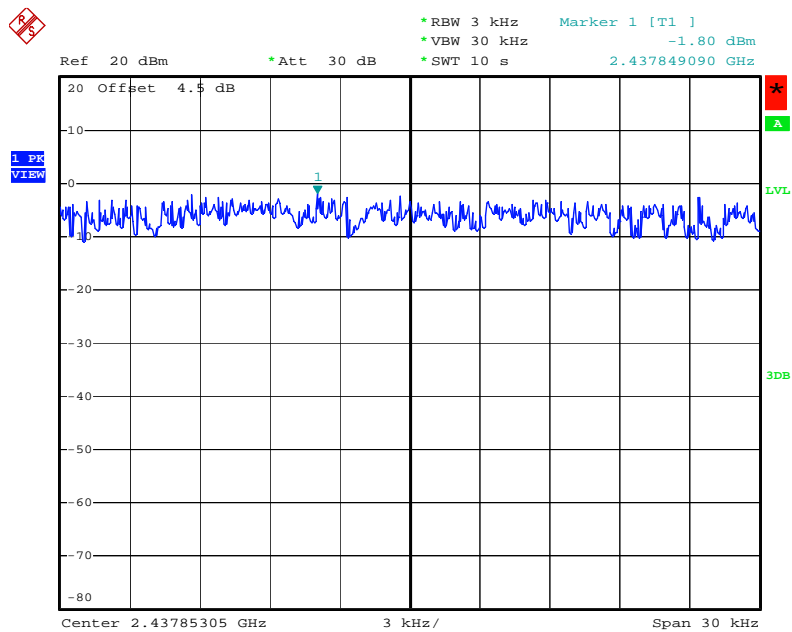

Date: 26.MAR.2009 12:04:18

Power Density Plot on Configuration IEEE 802.11a Ant. A + Ant. B / 5745 MHz

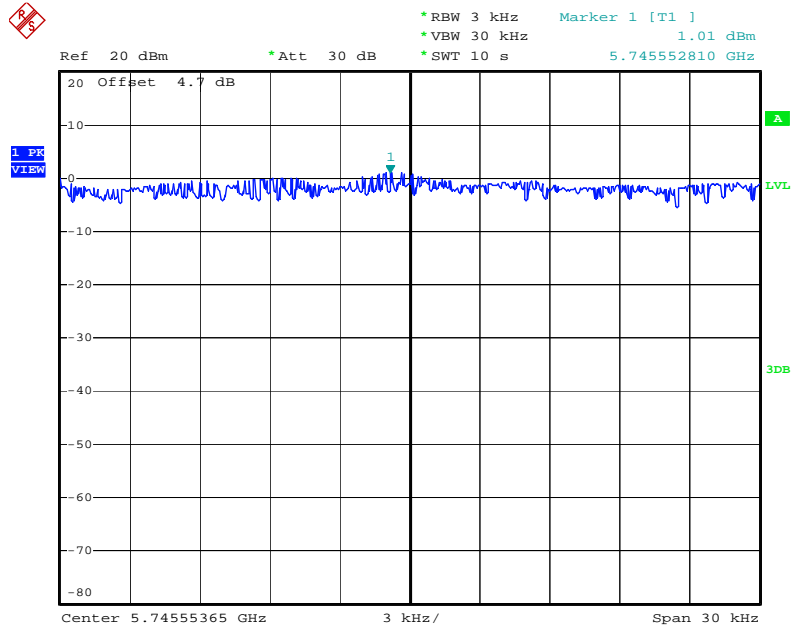

Date: 26.MAR.2009 14:03:05

Power Density Plot on Configuration IEEE 802.11a Ant. A + Ant. B / 5785 MHz

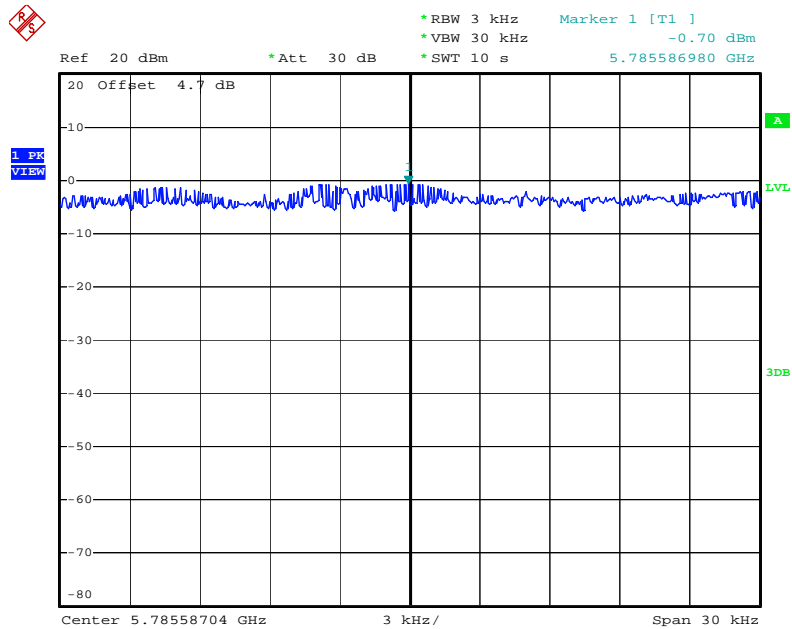

Date: 26.MAR.2009 13:50:02

Power Density Plot on Configuration IEEE 802.11a Ant. A + Ant. B / 5825 MHz

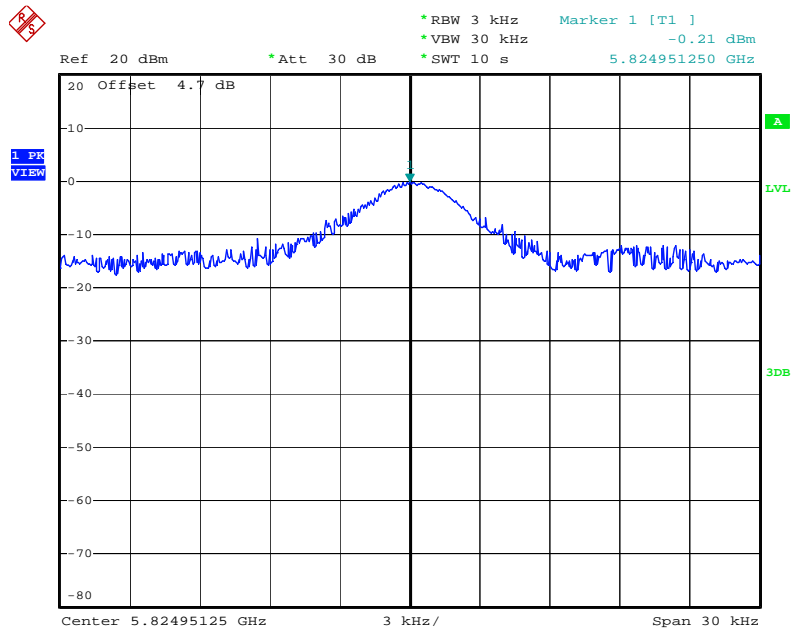

Date: 26.MAR.2009 13:48:05

4.4. 6dB Spectrum Bandwidth Measurement

4.4.1. Limit

For digital modulation systems, the minimum 6dB bandwidth shall be at least 500 kHz.

4.4.2. Measuring Instruments and Setting

Please refer to section 5 of equipments list in this report. The following table is the setting of the spectrum analyzer.

Spectrum Parameters	Setting
Attenuation	Auto
Span Frequency	> 6dB Bandwidth
RB	100 kHz
VB	100 kHz
Detector	Peak
Trace	Max Hold
Sweep Time	Auto

4.4.3. Test Procedures

1. The transmitter output (antenna port) was connected to the spectrum analyser in peak hold mode.
2. The resolution bandwidth of 100 kHz and the video bandwidth of 100 kHz were used.
3. Measured the spectrum width with power higher than 6dB below carrier.
4. Measuring multiple antennas, the connector is required to link with spectrum analyzer through a combiner.

4.4.4. Test Setup Layout

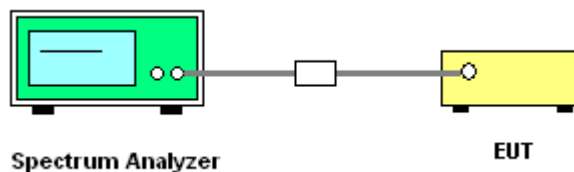

4.4.5. Test Deviation

There is no deviation with the original standard.

4.4.6. EUT Operation during Test

The EUT was programmed to be in continuously transmitting mode.

4.4.7. Test Result of 6dB Spectrum Bandwidth

Temperature	24°C	Humidity	56%
Test Engineer	Allen Liu	Configurations	Draft n

For 2.4GHz Band

Configuration Draft n MCS0 20MHz Ant. A + Ant. B

Channel	Frequency	6dB Bandwidth (MHz)	99% Occupied Bandwidth (MHz)	Min. Limit (kHz)	Test Result
1	2412 MHz	16.32	17.72	500	Complies
6	2437 MHz	17.32	17.68	500	Complies
11	2462 MHz	17.60	17.68	500	Complies

Configuration Draft n MCS0 40MHz Ant. A + Ant. B

Channel	Frequency	6dB Bandwidth (MHz)	99% Occupied Bandwidth (MHz)	Min. Limit (kHz)	Test Result
3	2422 MHz	36.56	36.32	500	Complies
6	2437 MHz	36.32	36.32	500	Complies
9	2452 MHz	36.00	36.24	500	Complies

For 5GHz Band

Configuration 11a Draft n MCS0 20MHz Ant. A+ Ant. B

Channel	Frequency	6dB Bandwidth (MHz)	99% Occupied Bandwidth (MHz)	Min. Limit (kHz)	Test Result
149	5745 MHz	16.32	17.68	500	Complies
157	5785 MHz	16.68	17.68	500	Complies
165	5825 MHz	16.32	17.68	500	Complies

Configuration 11a Draft n MCS0 40MHz Ant. A+ Ant. B

Channel	Frequency	6dB Bandwidth (MHz)	99% Occupied Bandwidth (MHz)	Min. Limit (kHz)	Test Result
151	5755 MHz	35.76	36.32	500	Complies
159	5795 MHz	35.76	36.24	500	Complies

Temperature	24°C	Humidity	56%
Test Engineer	Allen Liu	Configurations	802.11 a/b/g

Configuration IEEE 802.11b Ant. A + Ant. B

Channel	Frequency	6dB Bandwidth (MHz)	99% Occupied Bandwidth (MHz)	Min. Limit (kHz)	Test Result
1	2412 MHz	12.52	15.84	500	Complies
6	2437 MHz	12.08	15.72	500	Complies
11	2462 MHz	13.08	15.84	500	Complies

Configuration IEEE 802.11g Ant. A+ Ant. B

Channel	Frequency	6dB Bandwidth (MHz)	99% Occupied Bandwidth (MHz)	Min. Limit (kHz)	Test Result
1	2412 MHz	16.40	16.48	500	Complies
6	2437 MHz	16.48	16.52	500	Complies
11	2462 MHz	16.36	16.48	500	Complies

Configuration IEEE 802.11a Ant. A+ Ant. B

Channel	Frequency	6dB Bandwidth (MHz)	99% Occupied Bandwidth (MHz)	Min. Limit (kHz)	Test Result
149	5745 MHz	16.36	16.84	500	Complies
157	5785 MHz	16.32	16.60	500	Complies
165	5825 MHz	15.68	16.52	500	Complies

6 dB Bandwidth Plot on Configuration Draft n MCS0 20MHz Ant. A + Ant. B / 2412 MHz

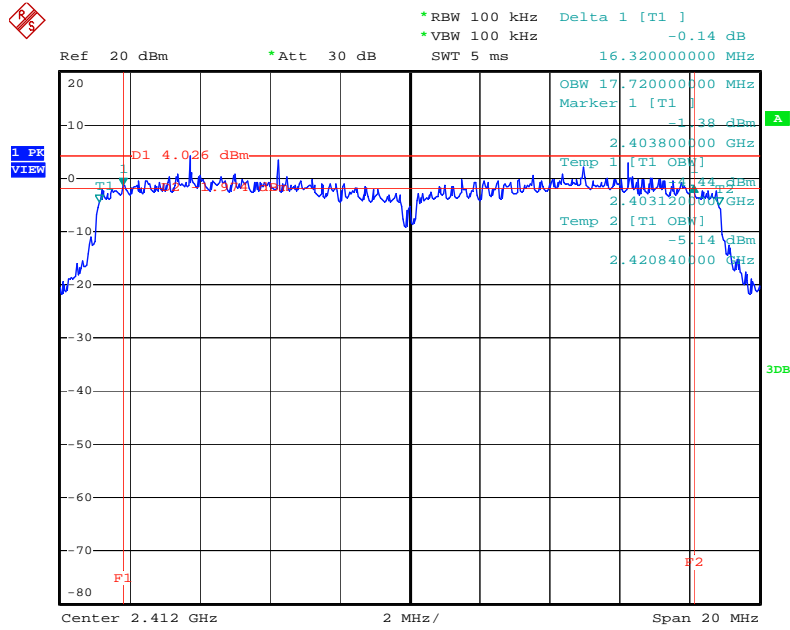

Date: 26.MAR.2009 12:32:58

6 dB Bandwidth Plot on Configuration Draft n MCS0 20MHz Ant. A + Ant. B / 2437 MHz

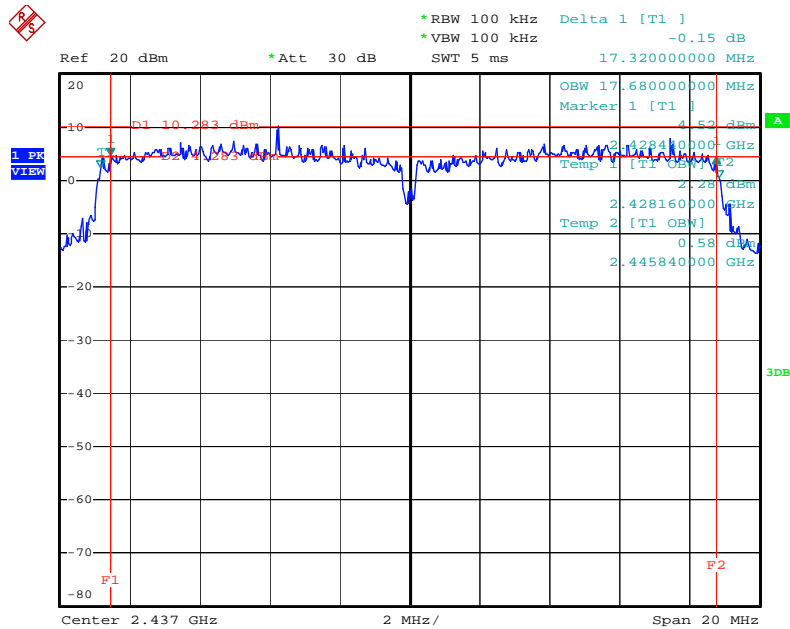

Date: 26.MAR.2009 12:34:11

6 dB Bandwidth Plot on Configuration Draft n MCS0 20MHz Ant. A + Ant. B / 2462 MHz

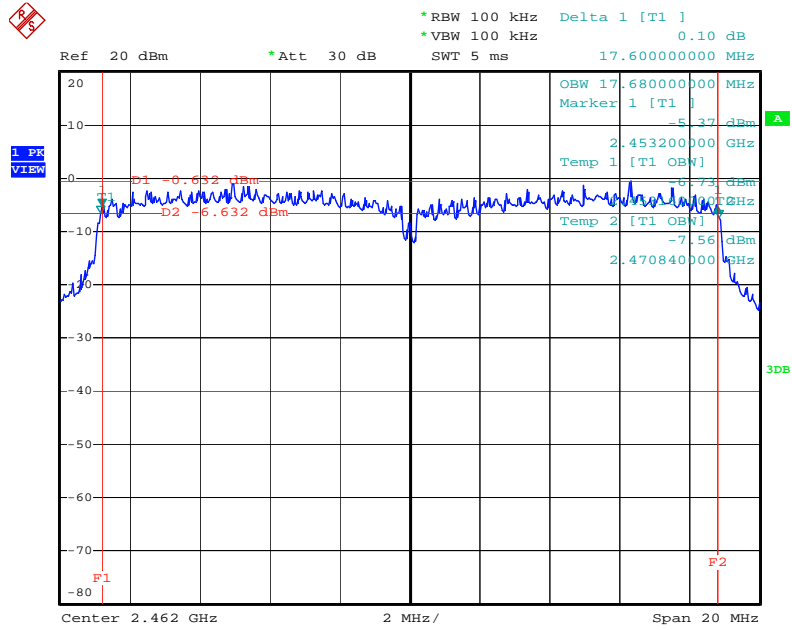

Date: 26.MAR.2009 12:34:55

6 dB Bandwidth Plot on Configuration Draft n MCS0 40MHz Ant. A + Ant. B / 2422 MHz

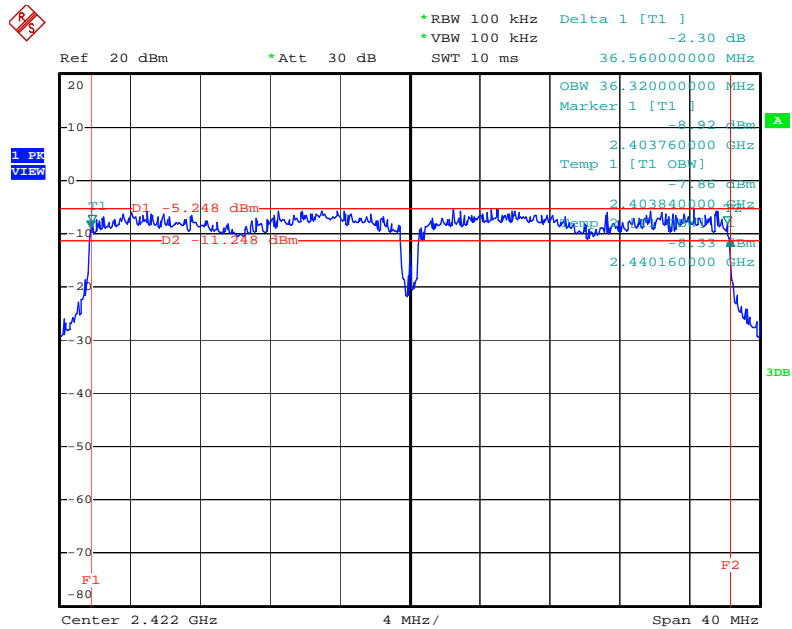

Date: 26.MAR.2009 12:40:48

6 dB Bandwidth Plot on Configuration Draft n MCS0 40MHz Ant. A + Ant. B / 2437 MHz

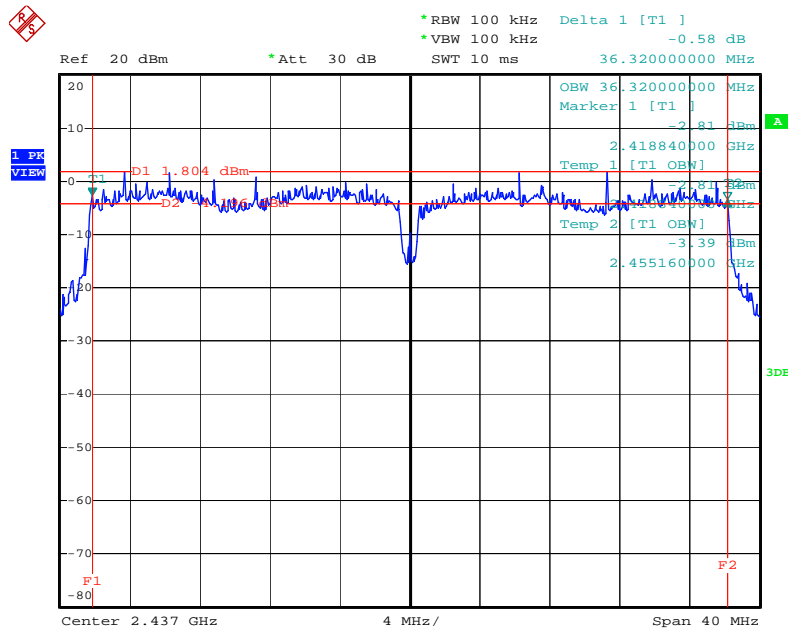

Date: 26.MAR.2009 12:55:42

6 dB Bandwidth Plot on Configuration Draft n MCS0 40MHz Ant. A + Ant. B / 2452 MHz

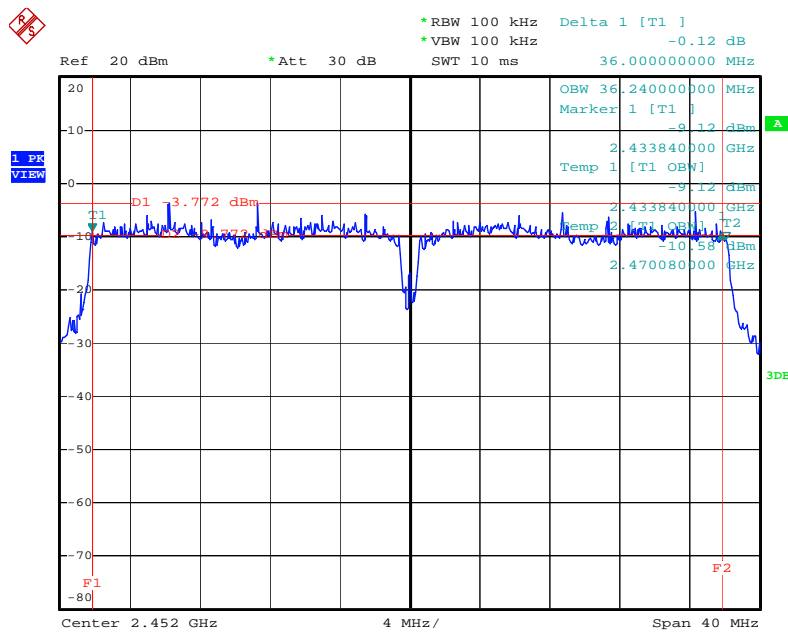

Date: 26.MAR.2009 12:58:49

6 dB Bandwidth Plot on Configuration 11 a Draff n MCS0 20MHz Ant. A+ Ant. B / 5745 MHz

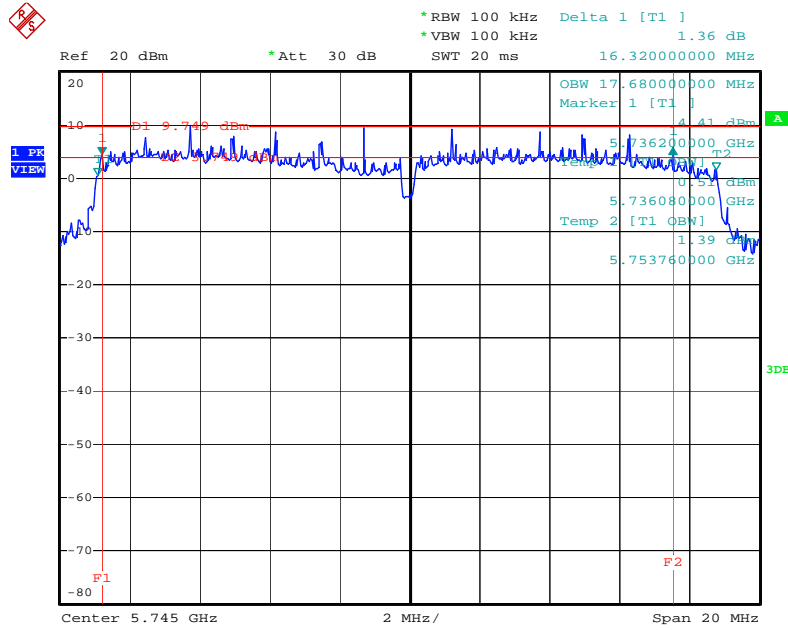

Date: 26.MAR.2009 12:25:55

6 dB Bandwidth Plot on Configuration 11 a Draff n MCS0 20MHz Ant. A+ Ant. B / 5785MHz

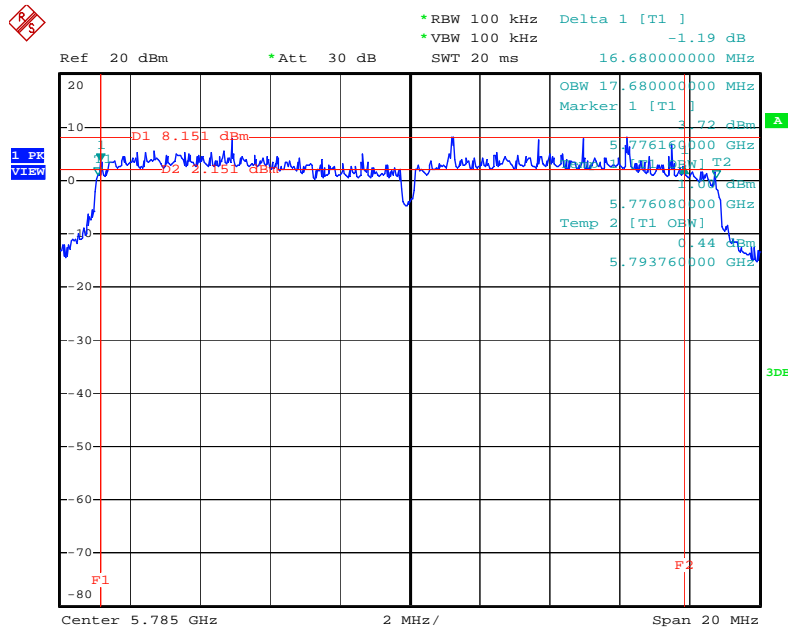

Date: 26.MAR.2009 12:27:40

6 dB Bandwidth Plot on Configuration 11 a Draft n MCS0 20MHz Ant. A+ Ant. B / 5825 MHz

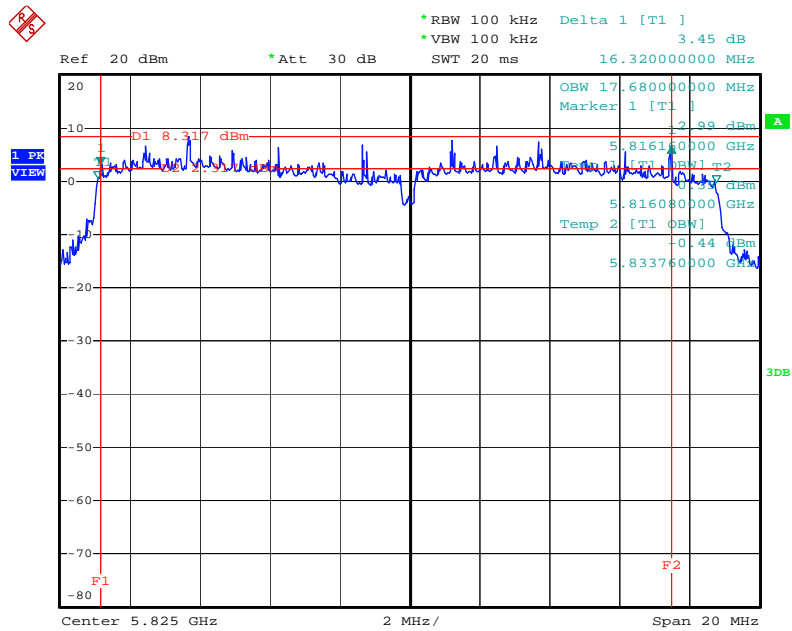

Date: 26.MAR.2009 12:30:19

6 dB Bandwidth Plot on Configuration 11 a Draft n MCS0 40MHz Ant. A+ Ant. B / 5755MHz

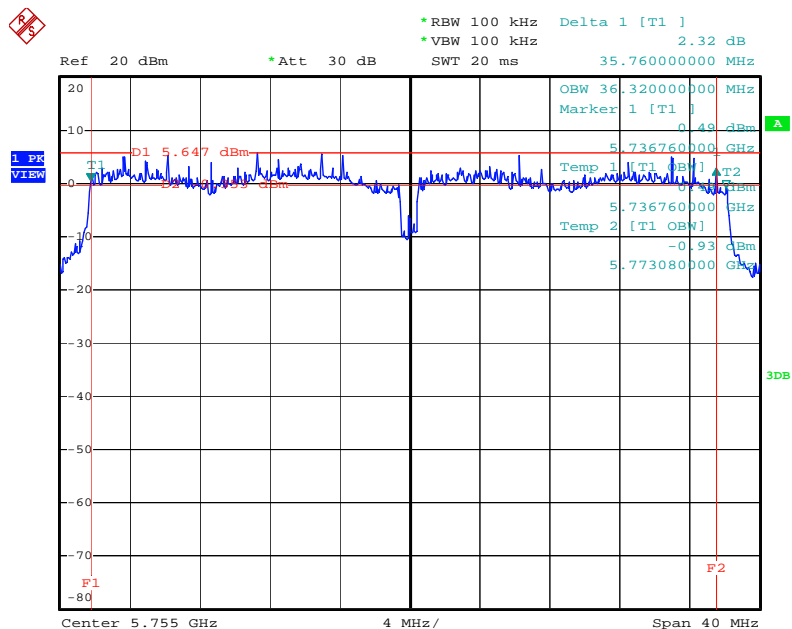

Date: 26.MAR.2009 13:37:23

6 dB Bandwidth Plot on Configuration 11a Draft n MCS0 40MHz Ant. A+ Ant. B / 5795 MHz

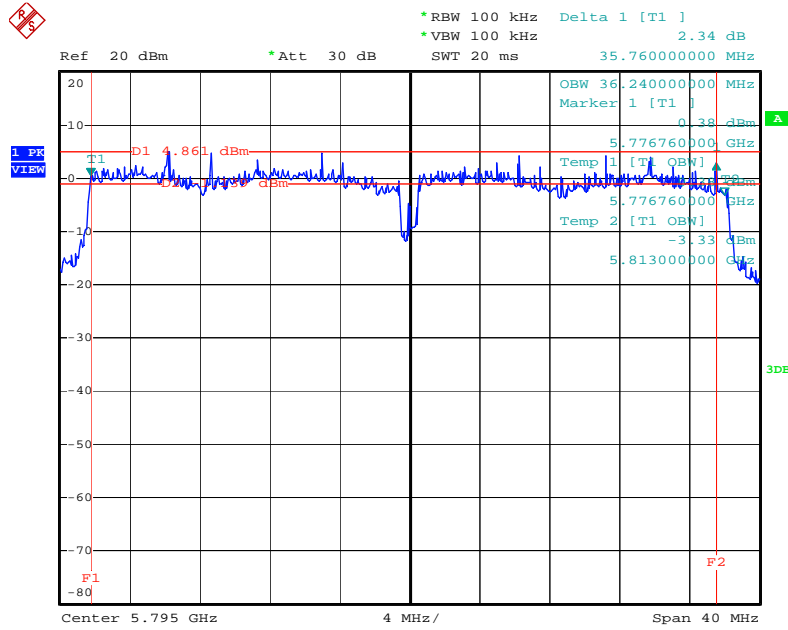

Date: 26.MAR.2009 13:39:21

6 dB Bandwidth Plot on Configuration IEEE 802.11b Ant. A + Ant. B / 2412 MHz

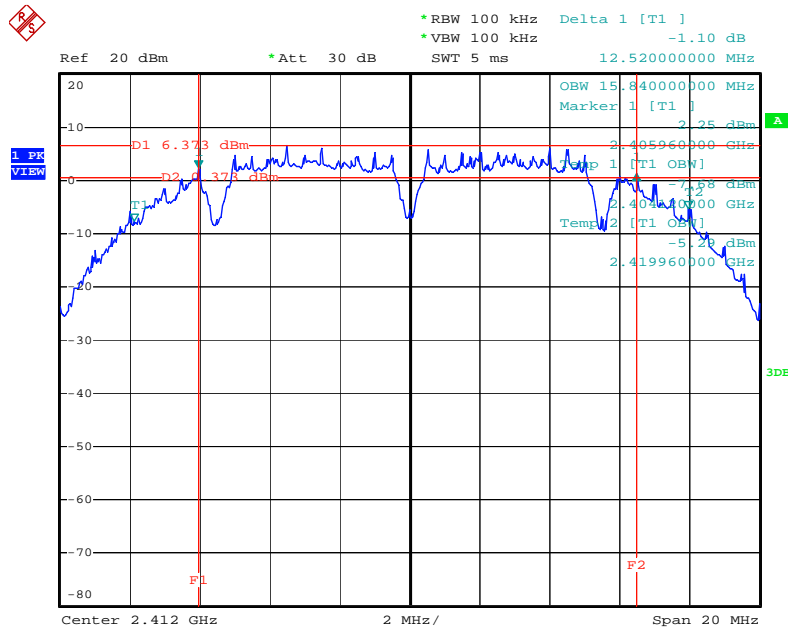

Date: 26.MAR.2009 12:02:05

6 dB Bandwidth Plot on Configuration IEEE 802.11b Ant. A + Ant. B / 2437 MHz

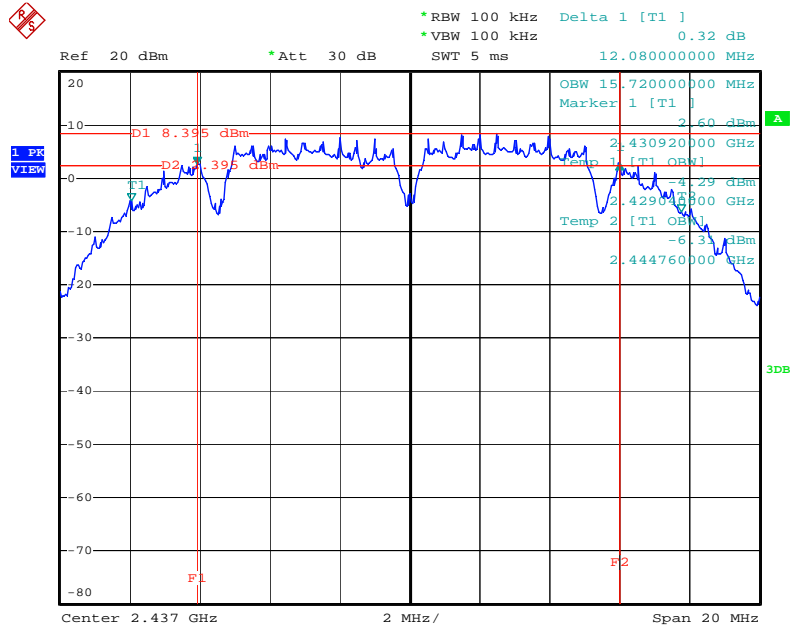

Date: 26.MAR.2009 12:04:02

6 dB Bandwidth Plot on Configuration IEEE 802.11b Ant. A + Ant. B / 2462 MHz

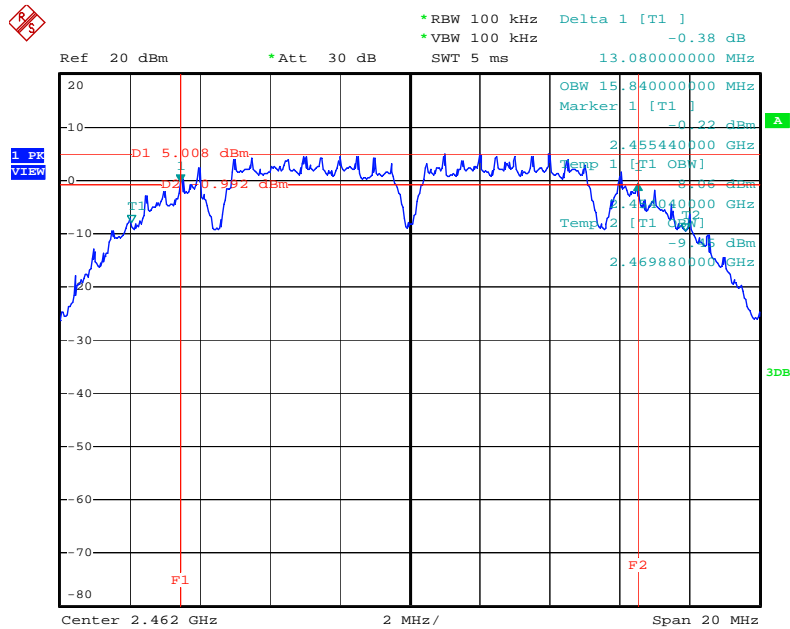

Date: 26.MAR.2009 12:05:04

6 dB Bandwidth Plot on Configuration IEEE 802.11g Ant. A+ Ant. B / 2412 MHz

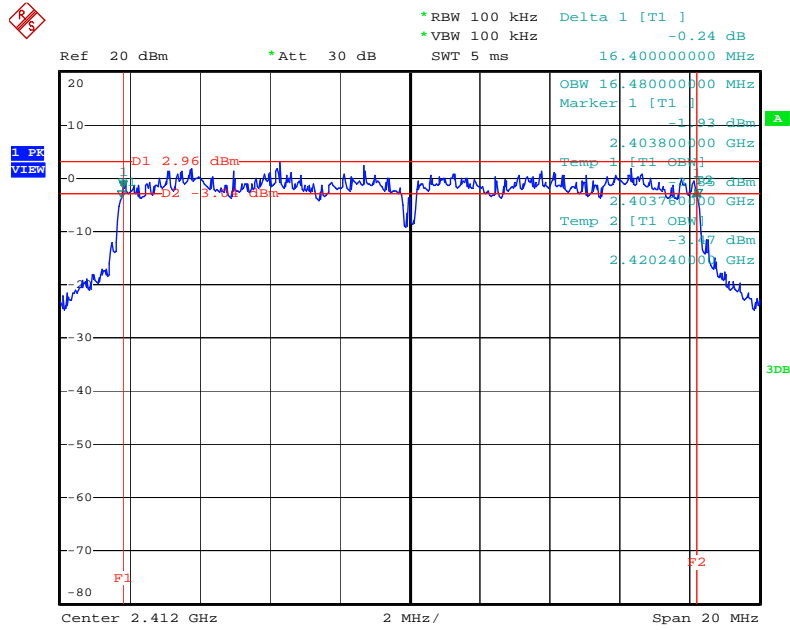

Date: 26.MAR.2009 12:06:28

6 dB Bandwidth Plot on Configuration IEEE 802.11g Ant. A+ Ant. B / 2437 MHz

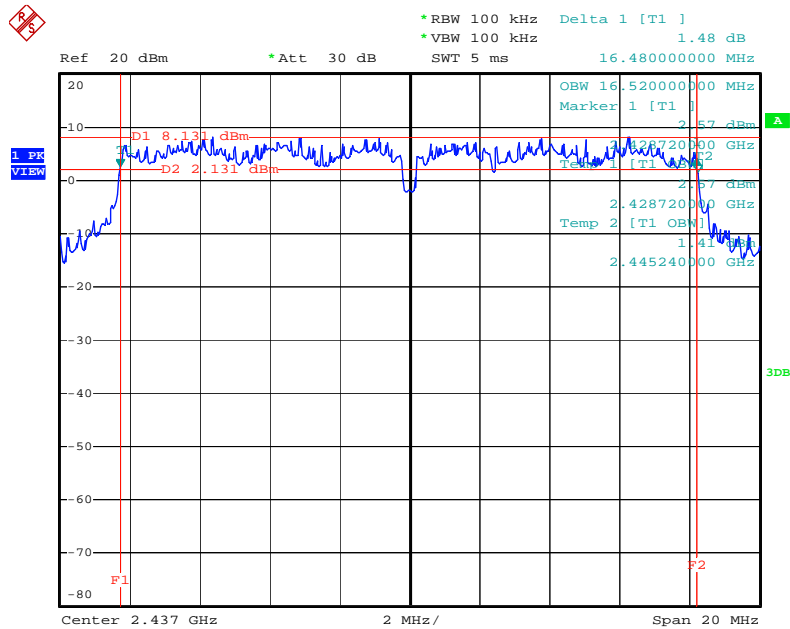

Date: 26.MAR.2009 12:07:25

6 dB Bandwidth Plot on Configuration IEEE 802.11g Ant. A+ Ant. B / 2462 MHz

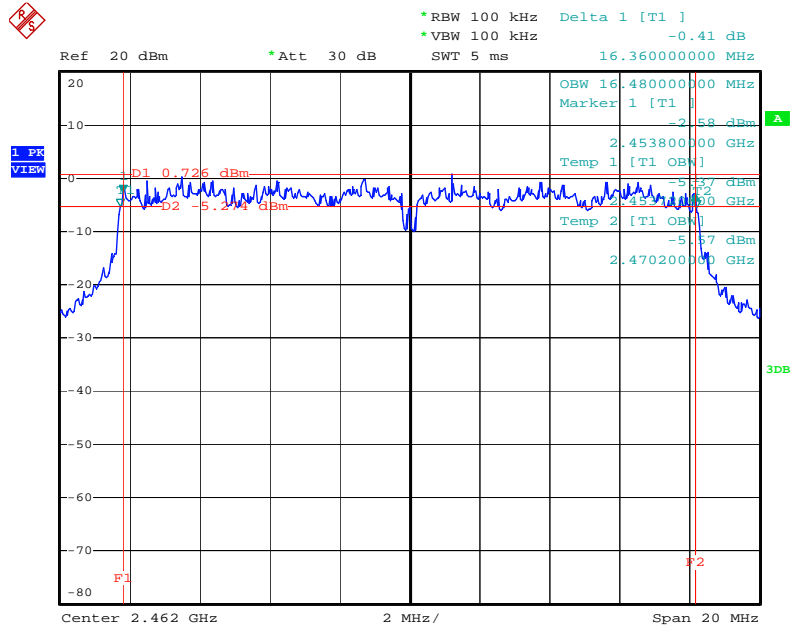

Date: 26.MAR.2009 12:08:35

6 dB Bandwidth Plot on Configuration IEEE 802.11a Ant. A+ Ant. B / 5745 MHz

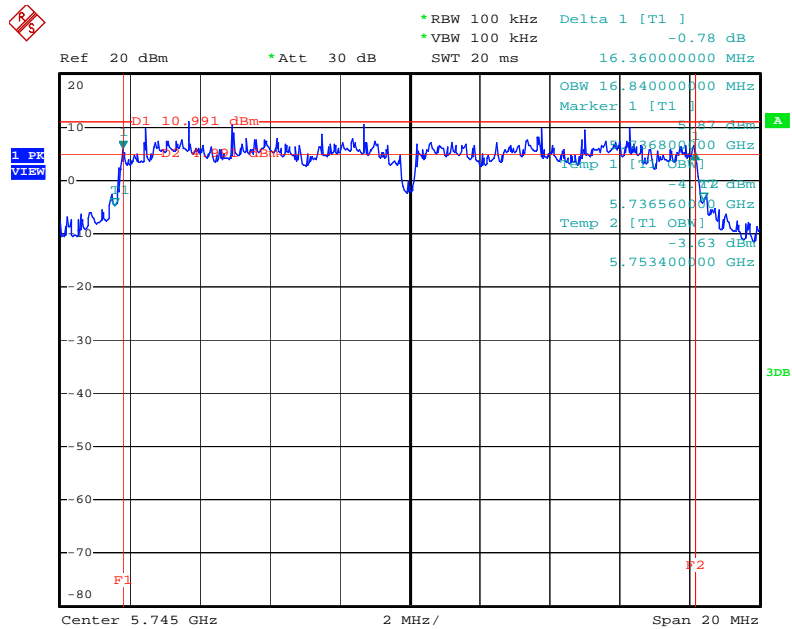

Date: 26.MAR.2009 14:01:37

6 dB Bandwidth Plot on Configuration IEEE 802.11a Ant. A+ Ant. B / 5785 MHz

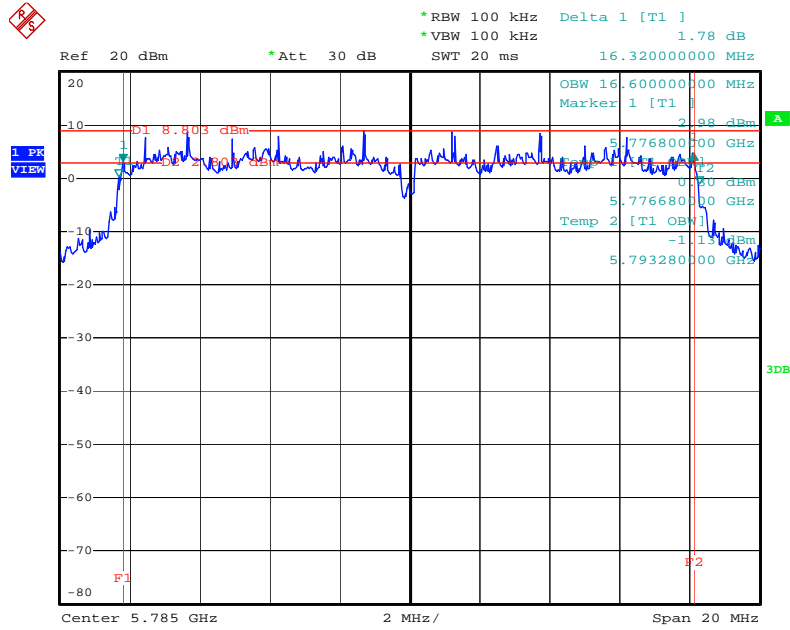

Date: 26.MAR.2009 13:48:35

6 dB Bandwidth Plot on Configuration IEEE 802.11a Ant. A+ Ant. B / 5825 MHz

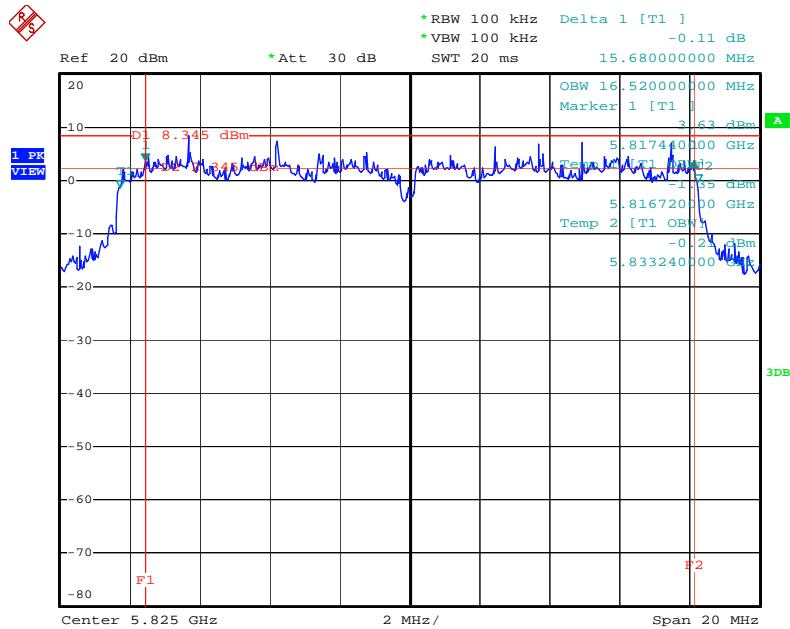

Date: 26.MAR.2009 13:46:38

4.5. Radiated Emissions Measurement

4.5.1. Limit

20dBc in any 100 kHz bandwidth outside the operating frequency band. In case the emission fall within the restricted band specified on 15.205(a), then the 15.209(a) limit in the table below has to be followed.

Frequencies (MHz)	Field Strength (micorvolts/meter)	Measurement Distance (meters)
0.009~0.490	2400/F(KHz)	300
0.490~1.705	24000/F(KHz)	30
1.705~30.0	30	30
30~88	100	3
88~216	150	3
216~960	200	3
Above 960	500	3

4.5.2. Measuring Instruments and Setting

Please refer to section 5 of equipments list in this report. The following table is the setting of spectrum analyzer and receiver.

Spectrum Parameter	Setting
Attenuation	Auto
Start Frequency	1000 MHz
Stop Frequency	10th carrier harmonic
RB / VB (Emission in restricted band)	1MHz / 3MHz for Peak, 1 MHz / 10Hz for Average
RB / VB (Emission in non-restricted band)	1MHz / 3MHz for peak

Receiver Parameter	Setting
Attenuation	Auto
Start ~ Stop Frequency	9kHz~150kHz / RB 200Hz for QP
Start ~ Stop Frequency	150kHz~30MHz / RB 9kHz for QP
Start ~ Stop Frequency	30MHz~1000MHz / RB 120kHz for QP

4.5.3. Test Procedures

1. Configure the EUT according to ANSI C63.4. The EUT was placed on the top of the turntable 0.8 meter above ground. The phase center of the receiving antenna mounted on the top of a height-variable antenna tower was placed 3 meters far away from the turntable.
2. Power on the EUT and all the supporting units. The turntable was rotated by 360 degrees to determine the position of the highest radiation.
3. The height of the broadband receiving antenna was varied between one meter and four meters above ground to find the maximum emissions field strength of both horizontal and vertical polarization.
4. For each suspected emissions, the antenna tower was scan (from 1 M to 4 M) and then the turntable was rotated (from 0 degree to 360 degrees) to find the maximum reading.
5. Set the test-receiver system to Peak or CISPR quasi-peak Detect Function with specified bandwidth under Maximum Hold Mode.
6. For emissions above 1GHz, use 1MHz VBW and RBW for peak reading. Then 1MHz RBW and 10Hz VBW for average reading in spectrum analyzer.
7. When the radiated emissions limits are expressed in terms of the average value of the emissions, and pulsed operation is employed, the measurement field strength shall be determined by averaging over one complete pulse train, including blanking intervals, as long as the pulse train does not exceed 0.1 seconds. As an alternative (provided the transmitter operates for longer than 0.1 seconds) or in cases where the pulse train exceeds 0.1 seconds, the measured field strength shall be determined from the average absolute voltage during a 0.1 second interval during which the field strength is at its maximum value.
8. If the emissions level of the EUT in peak mode was 3 dB lower than the average limit specified, then testing will be stopped and peak values of EUT will be reported, otherwise, the emissions which do not have 3 dB margin will be repeated one by one using the quasi-peak method for below 1GHz.
9. For testing above 1GHz, the emissions level of the EUT in peak mode was lower than average limit (that means the emissions level in peak mode also complies with the limit in average mode), then testing will be stopped and peak values of EUT will be reported, otherwise, the emissions will be measured in average mode again and reported.
10. In case the emission is lower than 30MHz, loop antenna has to be used for measurement and the recorded data should be QP measured by receiver. High – Low scan is not required in this case.

4.5.4. Test Setup Layout

For radiated emissions below 30MHz

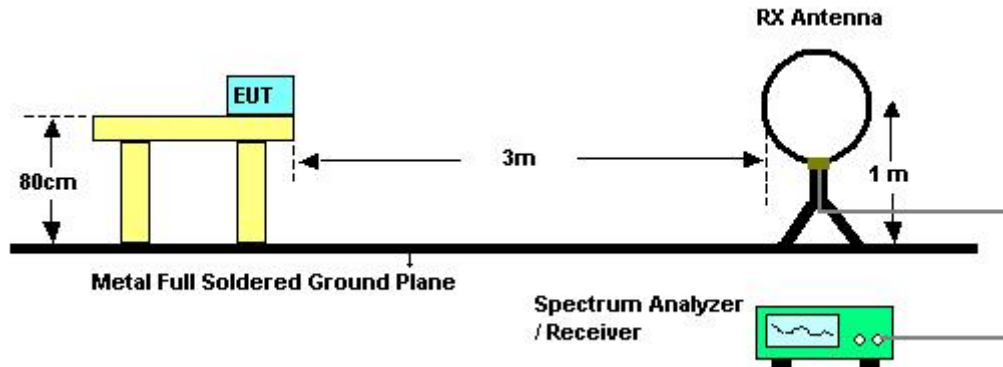

For radiated emissions above 30MHz

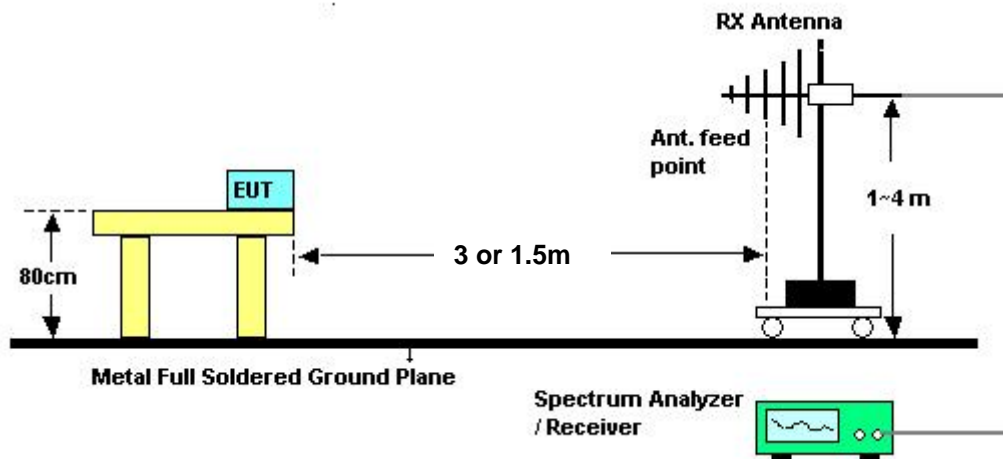

Above 10 GHz shall be extrapolated to the specified distance using an extrapolation factor of 20 dB/decade from 3m to 1.5m.

Distance extrapolation factor = $20 \log (\text{specific distance [3m]} / \text{test distance [1.5m]})$ (dB);

Limit line = specific limits (dBuV) + distance extrapolation factor [6 dB].

4.5.5. Test Deviation

There is no deviation with the original standard.

4.5.6. EUT Operation during Test

The EUT was programmed to be in continuously transmitting mode.

4.5.7. Results of Radiated Emissions (9kHz~30MHz)

Temperature	25°C	Humidity	56%
Test Engineer	Johnson Chang		

Freq. (MHz)	Level (dBuV)	Over Limit (dB)	Limit Line (dBuV)	Remark
-	-	-	-	See Note

Note:

The amplitude of spurious emissions that are attenuated by more than 20 dB below the permissible value has no need to be reported.

Distance extrapolation factor = $40 \log(\text{specific distance} / \text{test distance})$ (dB);

Limit line = specific limits (dBuV) + distance extrapolation factor.

4.5.8. Results of Radiated Emissions (30MHz~1GHz)

Temperature	25°C	Humidity	56%
Test Engineer	Johnson Chang	Configurations	Normal Link

Horizontal

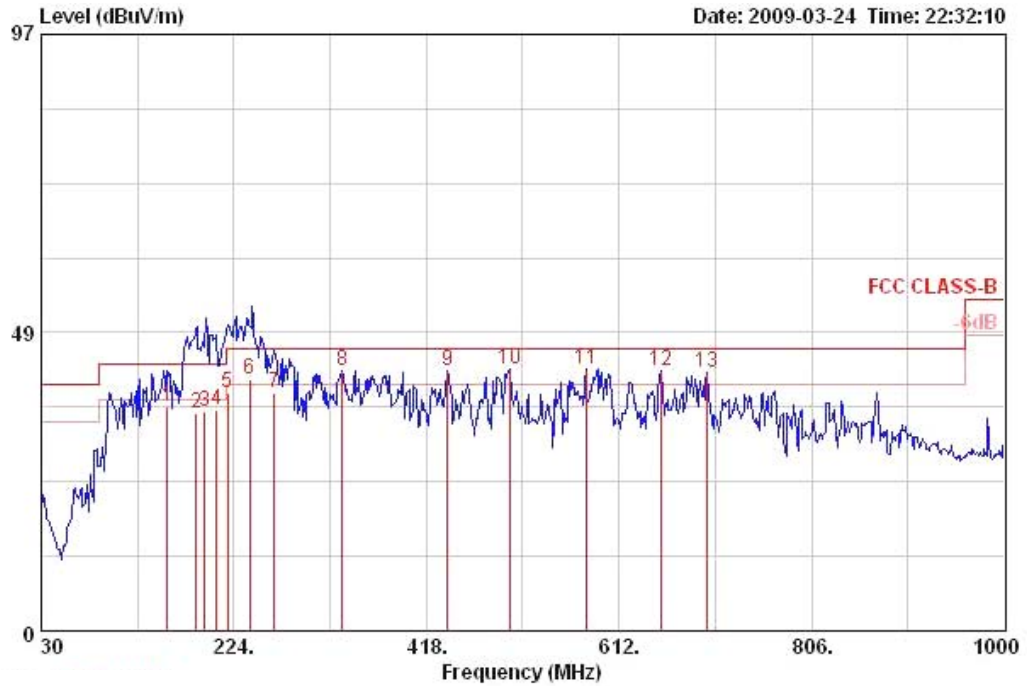

	Freq	Level	Over	Limit	ReadAntenna	Preamp	Cable	Table	Ant
	MHz	dBuV/m	Limit	Line	Level	Factor	Factor	Loss	Pos
			dB	dBuV/m	dBuV	dB/m	dB	dB	deg
1	157.070	36.41	-7.09	43.50	50.26	11.98	27.31	1.49	347
2	186.210	35.51	-7.99	43.50	49.33	11.71	27.16	1.63	344
3	195.000	35.72	-7.78	43.50	51.10	10.07	27.13	1.67	344
4	206.540	35.79	-7.71	43.50	51.60	9.55	27.09	1.73	341
5	218.180	38.64	-7.36	46.00	53.52	10.41	27.06	1.77	343
6 !	240.040	41.02	-4.98	46.00	54.12	12.05	27.02	1.86	173
7	264.740	38.71	-7.29	46.00	50.78	12.94	26.97	1.96	340
8 !	333.610	42.34	-3.66	46.00	53.03	14.28	27.13	2.17	0
9 !	439.340	42.22	-3.78	46.00	50.80	16.68	27.80	2.54	0
10 !	501.420	42.54	-3.46	46.00	50.30	17.64	28.10	2.70	0
11 !	579.020	42.66	-3.34	46.00	49.38	18.53	28.10	2.86	178
12 !	653.710	42.37	-3.63	46.00	47.99	18.94	28.05	3.48	0
13 !	700.270	42.06	-3.94	46.00	47.66	19.09	27.99	3.30	0

Vertical

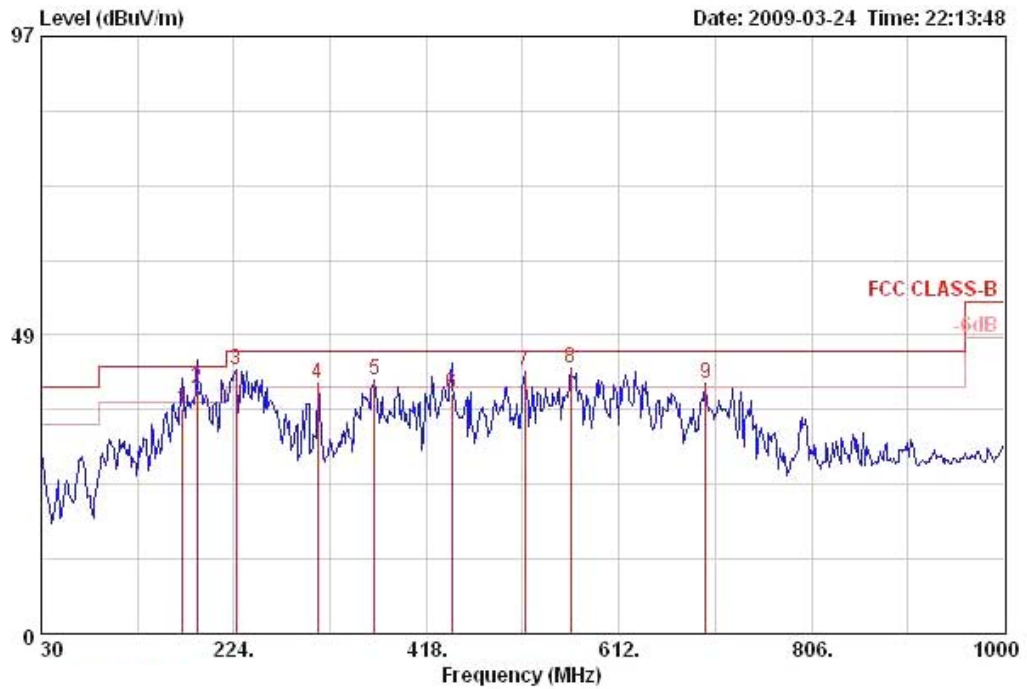

	Freq	Level	Over Limit	Limit Line	Read Level	Antenna Factor	Preamp Factor	Cable Loss	Remark	Pol/Phase	Table Pos	Ant Pos
	MHz	dBuV/m	dB	dBuV/m	dBuV	dB/m	dB	dB			deg	cm
1	172.590	36.36	-7.14	43.50	49.06	12.97	27.23	1.56	QP	VERTICAL	187	100
2 !	187.140	39.68	-3.82	43.50	53.50	11.71	27.16	1.63	QP	VERTICAL	188	100
3 !	225.940	42.82	-3.18	46.00	57.09	10.98	27.05	1.80	Peak	VERTICAL	0	400
4 !	308.390	40.53	-5.47	46.00	51.77	13.60	26.95	2.12	Peak	VERTICAL	0	400
5 !	365.620	41.22	-4.78	46.00	51.20	15.14	27.36	2.23	Peak	VERTICAL	0	400
6	443.220	38.88	-7.12	46.00	47.39	16.74	27.82	2.56	QP	VERTICAL	236	100
7 !	516.940	42.57	-3.43	46.00	50.12	17.82	28.10	2.73	Peak	VERTICAL	0	400
8 3	563.500	42.98	-3.02	46.00	49.90	18.35	28.10	2.83	Peak	VERTICAL	233	100
9 !	699.300	40.57	-5.43	46.00	46.18	19.09	28.00	3.30	Peak	VERTICAL	0	400

Note:

The amplitude of spurious emissions that are attenuated by more than 20dB below the permissible value has no need to be reported.

Emission level (dBuV/m) = 20 log Emission level (uV/m).

Corrected Reading: Antenna Factor + Cable Loss + Read Level - Preamp Factor = Level.

4.5.9. Results for Radiated Emissions (1GHz~10th Harmonic)

Temperature	25°C	Humidity	56%
Test Engineer	Johnson Chang	Configurations	Draft n MCS0 20MHz Ch 1 / Ant. A + Ant. B

Horizontal

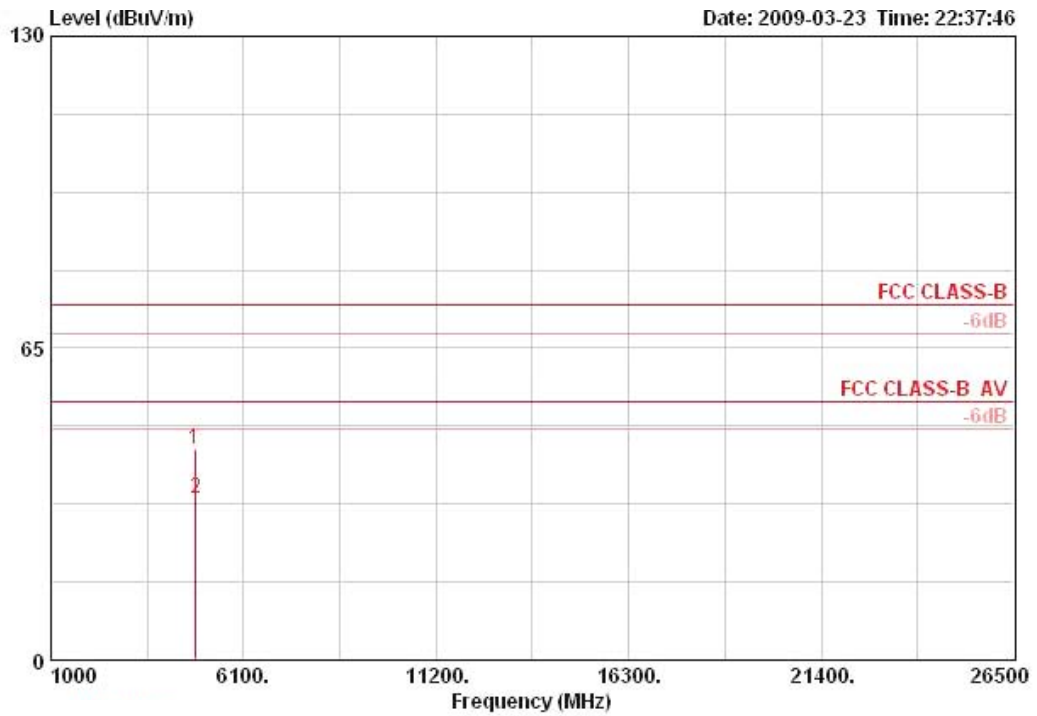

	Freq	Level	Over Limit	Limit Line	ReadAntenna	Cable	Preamp	Remark	Ant Pos	Table Pos	Pol/Phase
	MHz	dBuV/m	dB	dBuV/m	dBuV	dB	dB		cm	deg	
1	4821.890	44.03	-29.97	74.00	40.44	32.46	6.39	35.26 PEAK	100	360	HORIZONTAL
2	4823.210	33.83	-20.17	54.00	30.25	32.46	6.39	35.26 AVERAGE	100	360	HORIZONTAL

Vertical

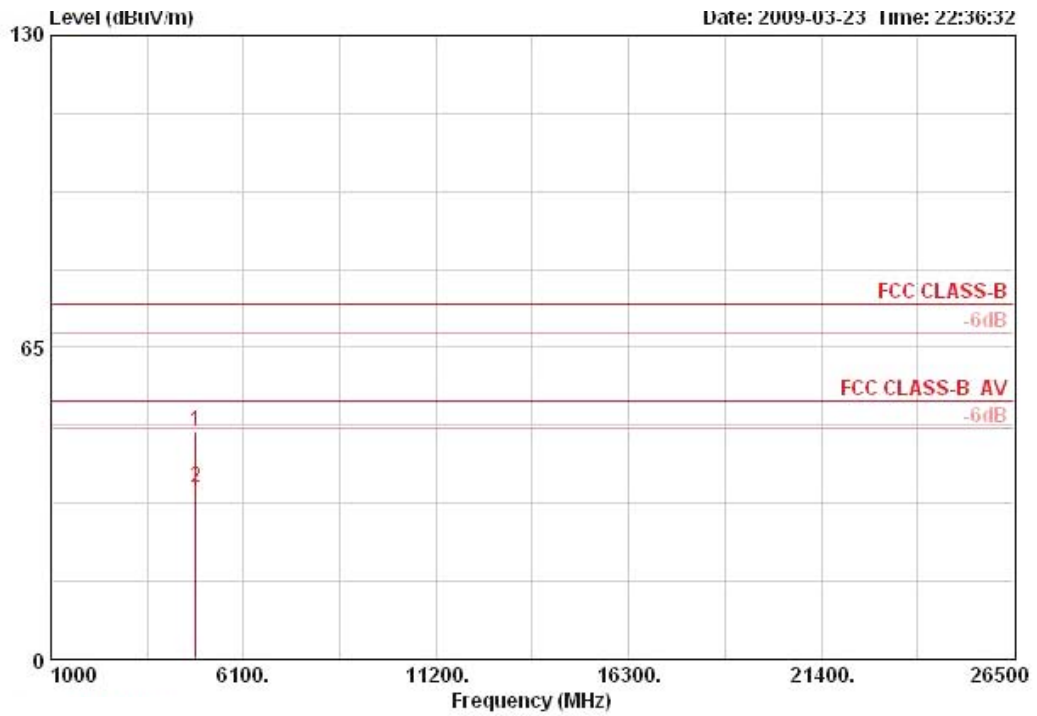

	Freq	Level	Over Limit	Limit Line	ReadAntenna Level	Antenna Factor	Cable Loss	Preamp Factor	Remark	Ant Pos	Table Pos	Pol/Phase
	MHz	dBuV/m	dB	dBuV/m	dBuV	dB/m	dB	dB		cm	deg	
1	4825.840	47.40	-26.60	74.00	43.81	32.46	6.39	35.26	PEAK	100	0	VERTICAL
2	4826.260	35.67	-18.33	54.00	32.09	32.46	6.39	35.26	AVERAGE	100	0	VERTICAL

Temperature	25°C	Humidity	56%
Test Engineer	Johnson Chang	Configurations	Draft n MCS0 20MHz Ch 6 / Ant. A + Ant. B

Horizontal

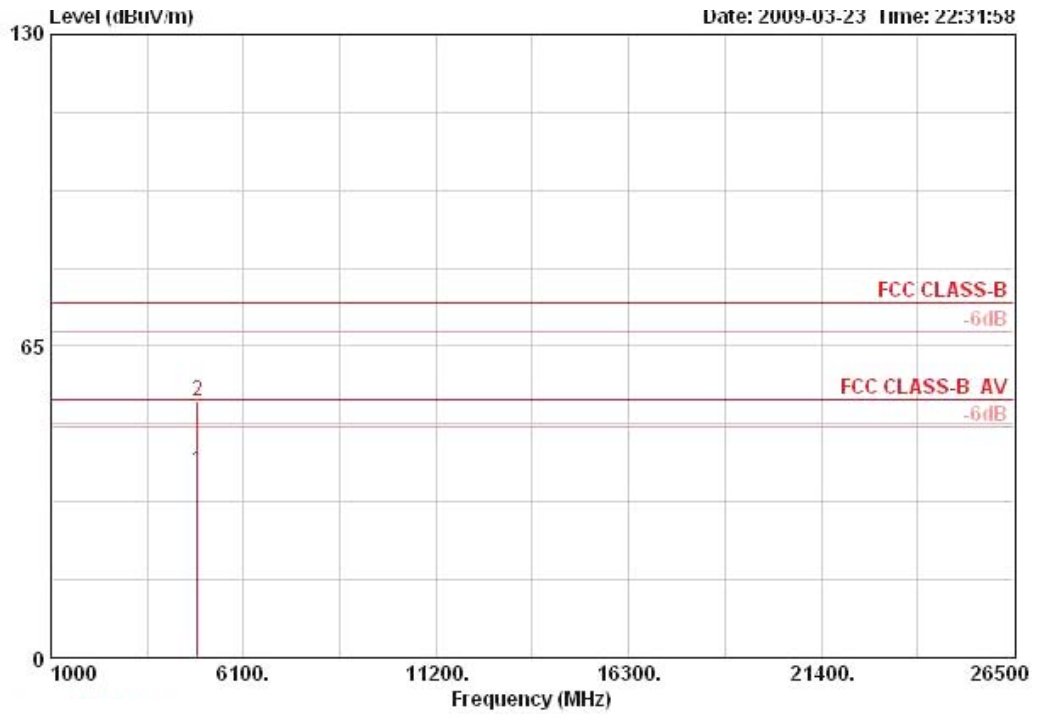

	Over	Limit	Read	Antenna	Cable	Preamp		Ant	Table			
	Freq	Level	Limit	Line	Level	Factor	Loss	Factor	Remark	Pos	Pos	Pol/Phase
	MHz	dBuV/m	dB	dBuV/m	dBuV	dB/m	dB	dB		cm	deg	
1	4872.910	39.12	-14.88	54.00	35.17	32.56	6.53	35.15	AVERAGE	144	77	HORIZONTAL
2	4873.790	53.42	-20.58	74.00	49.47	32.56	6.53	35.15	PEAK	144	77	HORIZONTAL

Vertical

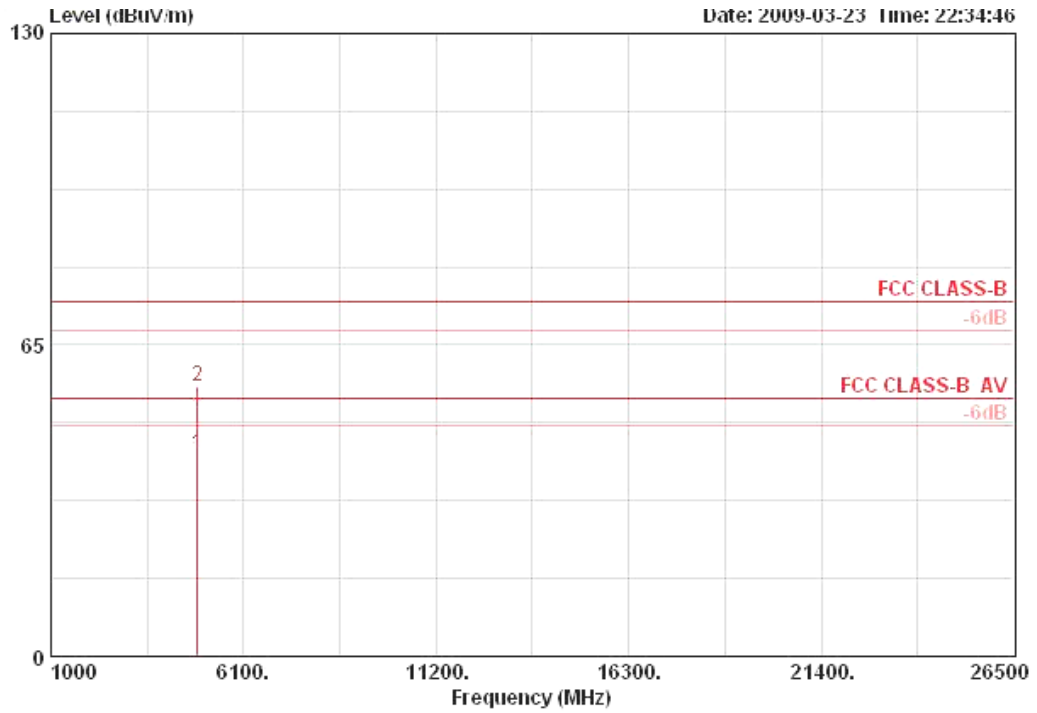

	Freq	Level	Over Limit	Limit Line	ReadAntenna Level	Antenna Factor	Cable Loss	Preamp Factor	Remark	Ant Pos	Table Pos	Pol/Phase
	MHz	dBuV/m	dB	dBuV/m	dBuV	dB/m	dB	dB		cm	deg	
1	4873.470	42.14	-11.86	54.00	38.19	32.56	6.53	35.15	AVERAGE	100	332	VERTICAL
2	4876.160	56.29	-17.71	74.00	52.35	32.56	6.53	35.15	PEAK	100	332	VERTICAL

Temperature	25°C	Humidity	56%
Test Engineer	Johnson Chang	Configurations	Draft n MCS0 20MHz Ch11 / Ant. A + Ant. B

Horizontal

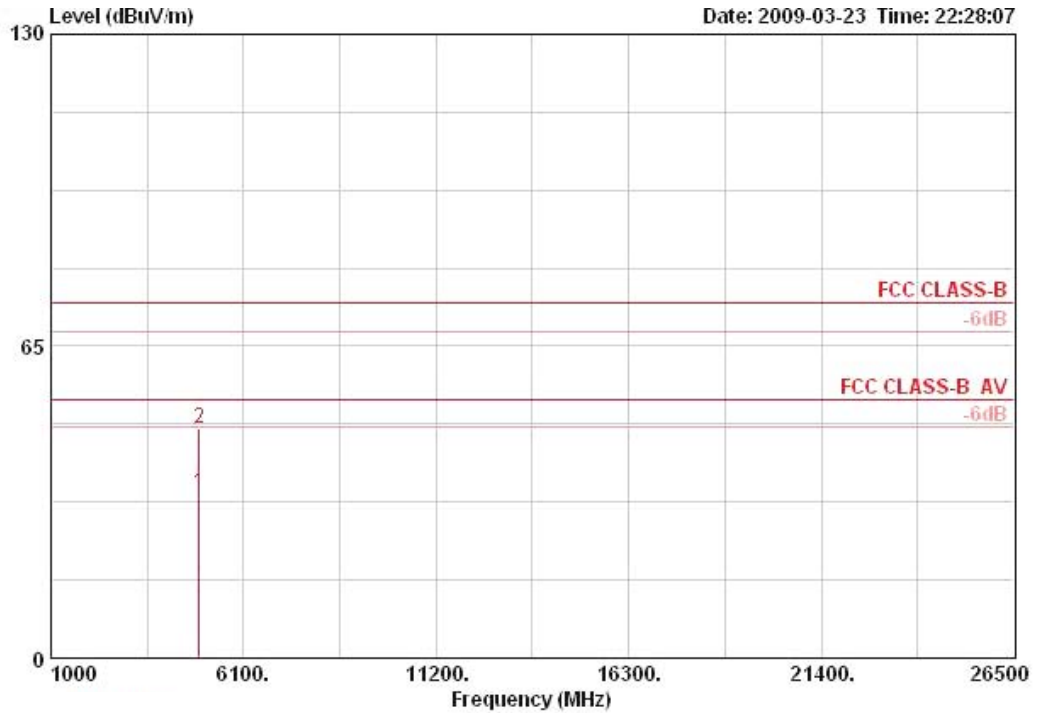

	Freq	Level	Over Limit	Limit Line	Read Level	Antenna Factor	Cable Loss	Preamp	Remark	Ant Pos	Table Pos	Pol/Phase
	MHz	dBuV/m	dB	dBuV/m	dBuV	dB/m	dB	dB		cm	deg	
1	4921.860	34.35	-19.65	54.00	30.04	32.66	6.68	35.03	AVERAGE	100	360	HORIZONTAL
2	4922.800	47.73	-26.27	74.00	43.42	32.66	6.68	35.03	PEAK	100	360	HORIZONTAL

Vertical

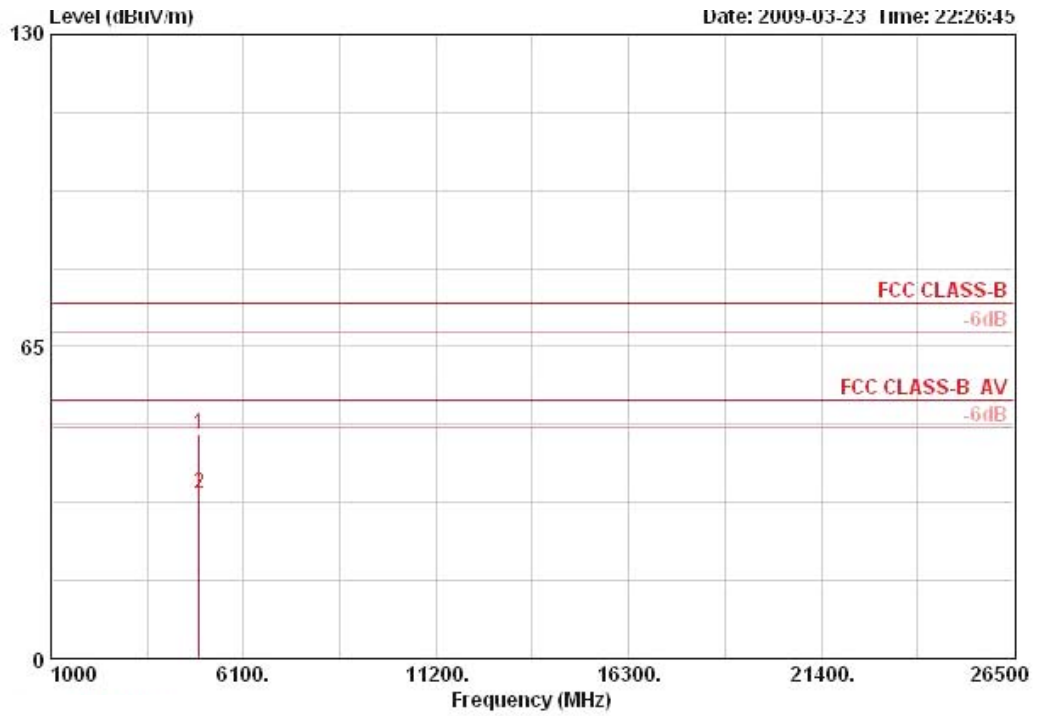

	Freq	Level	Over Limit	Limit Line	ReadAntenna Level	Antenna Factor	Cable Loss	Preamp Factor	Remark	Ant Pos	Table Pos	Pol/Phase
	MHz	dBuV/m	dB	dBuV/m	dBuV	dB/m	dB	dB		cm	deg	
1	4922.360	46.60	-27.40	74.00	42.29	32.66	6.68	35.03	PEAK	100	0	VERTICAL
2	4925.360	34.45	-19.55	54.00	30.14	32.66	6.68	35.03	AVERAGE	100	0	VERTICAL

Temperature	25°C	Humidity	56%
Test Engineer	Johnson Chang	Configurations	Draft n MCS0 40MHz Ch 3 / Ant. A + Ant. B

Horizontal

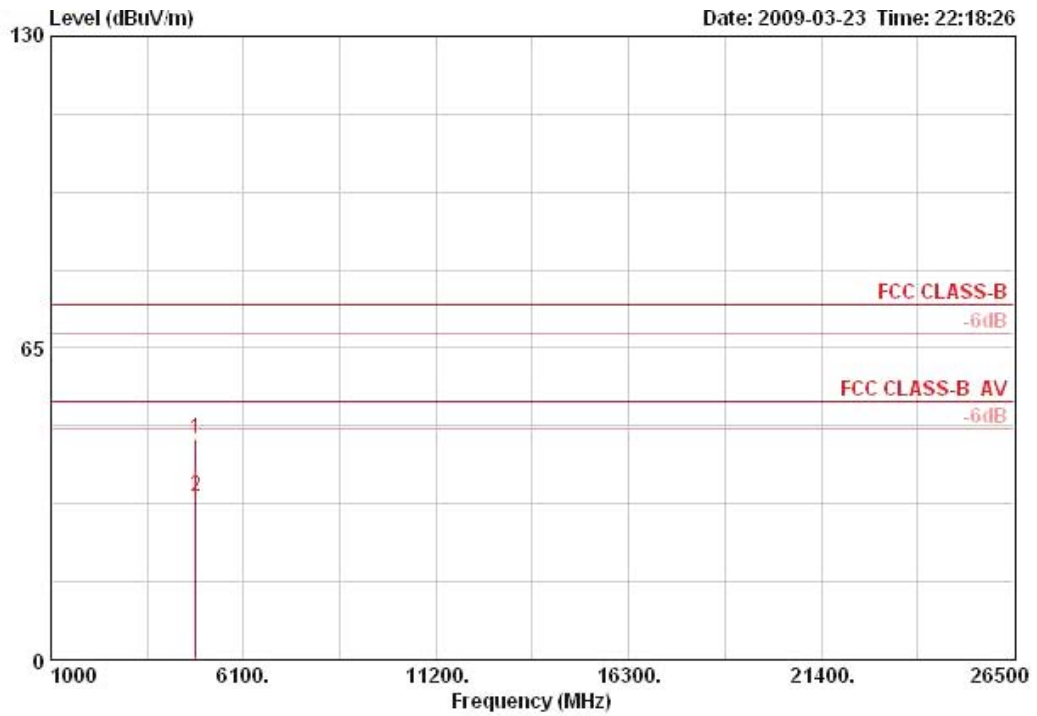

	Over	Limit	Read	Antenna	Cable	Preamp		Ant	Table			
Freq	Level	Limit	Line	Level	Factor	Loss	Factor	Pos	Pos			
MHz	dBuV/m	dB	dBuV/m	dBuV	dB/m	dB	dB	cm	deg			
1	4843.000	45.95	-28.05	74.00	42.21	32.49	6.46	35.20	PEAK	100	0	HORIZONTAL
2	4843.720	34.15	-19.85	54.00	30.41	32.49	6.46	35.20	AVERAGE	100	0	HORIZONTAL

Vertical

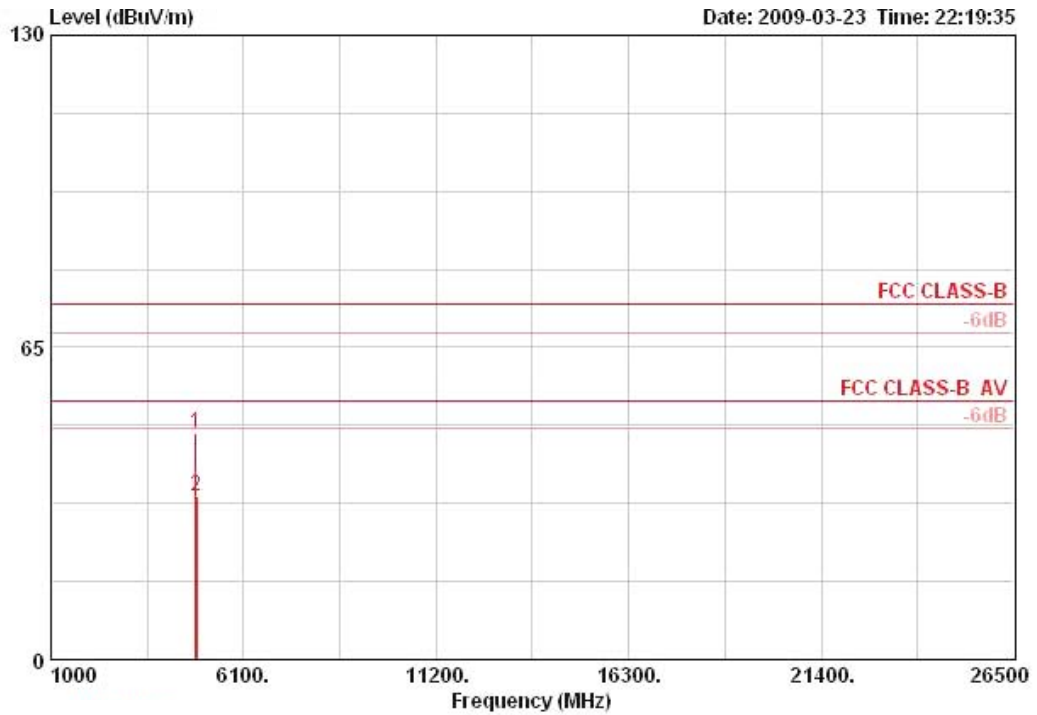

	Freq	Level	Over Limit	Limit Line	Read Level	Antenna Factor	Cable Loss	Preamp Factor	Remark	Ant Pos	Table Pos	Pol/Phase
	MHz	dBuV/m	dB	dBuV/m	dBuV	dB/m	dB	dB		cm	deg	
1	4844.360	47.06	-26.94	74.00	43.32	32.49	6.46	35.20	PEAK	100	360	VERTICAL
2	4846.460	34.16	-19.84	54.00	30.41	32.49	6.46	35.20	AVERAGE	100	360	VERTICAL