



# FCC Radio Test Report

**FCC ID** : UDX-600100011  
**Equipment** : Wi-Fi 6 Outdoor Access Point  
**Brand Name** : CISCO  
**Model Name** : MR76-HW  
**Applicant** : Cisco Systems, Inc.  
170 West Tasman Drive San Jose, CA 95134 USA  
**Manufacturer** : Cisco Systems, Inc.  
170 West Tasman Drive San Jose, CA 95134 USA  
**Standard** : 47 CFR FCC Part 15.407

The product was received on Nov. 01, 2019, and testing was started from Nov. 29, 2019 and completed on Nov. 30, 2022. We, SPORTON INTERNATIONAL INC. Hsinhua Laboratory, would like to declare that the tested sample has been evaluated in accordance with the procedures given in ANSI C63.10-2013 and shown compliance with the applicable technical standards.

The test results in this report apply exclusively to the tested model / sample. Without written approval of SPORTON INTERNATIONAL INC. Hsinhua Laboratory, the test report shall not be reproduced except in full.

Approved by: Jackson Tsai

**SPORTON INTERNATIONAL INC. Hsinhua Laboratory**

No.52, Huaya 1st Rd., Guishan Dist., Taoyuan City 333411, Taiwan (R.O.C.)



# Table of Contents

**HISTORY OF THIS TEST REPORT .....3**

**SUMMARY OF TEST RESULT .....4**

**1 GENERAL DESCRIPTION .....5**

1.1 Information.....5

1.2 Testing Applied Standards .....13

1.3 Testing Location Information .....13

1.4 Measurement Uncertainty .....13

**2 TEST CONFIGURATION OF EUT.....14**

2.1 Test Channel Mode .....14

2.2 The Worst Case Measurement Configuration .....33

2.3 Accessories .....34

2.4 Support Equipment.....34

2.5 Test Setup Diagram .....35

**3 TRANSMITTER TEST RESULT .....37**

3.1 Emission Bandwidth .....37

3.2 Maximum Conducted Output Power .....38

3.3 Peak Power Spectral Density .....40

3.4 Unwanted Emissions .....42

**4 TEST EQUIPMENT AND CALIBRATION DATA.....46**

**APPENDIX A. TEST RESULTS OF EMISSION BANDWIDTH**

**APPENDIX B. TEST RESULTS OF MAXIMUM CONDUCTED OUTPUT POWER**

**APPENDIX C. TEST RESULTS OF PEAK POWER SPECTRAL DENSITY**

**APPENDIX D. TEST RESULTS OF UNWANTED EMISSIONS**

**APPENDIX E. TEST RESULTS OF RADIATED EMISSION CO-LOCATION**

**APPENDIX F. TEST PHOTOS**

**PHOTOGRAPHS OF EUT V01**



### History of this test report

Report No.	Version	Description	Issued Date
FR972312-12BN	01	Initial issue of report	Mar. 21, 2023



### Summary of Test Result

Report Clause	Ref. Std. Clause	Test Items	Result (PASS/FAIL)	Remark
1.1.2	15.203	Antenna Requirement	PASS	-
3.1	15.407(a)	Emission Bandwidth	PASS	-
3.2	15.407(a)	Maximum Conducted Output Power	PASS	-
3.3	15.407(a)	Peak Power Spectral Density	PASS	-
3.4	15.407(b)	Unwanted Emissions	PASS	-

Note 1: From Sporton Project No.: FR972312-03AN

<b>Declaration of Conformity:</b>
The test results with all measurement uncertainty excluded are presented in accordance with the regulation limits or requirements declared by manufacturers.
<b>Comments and explanations:</b>
None

Reviewed by: Barry Hsiao  
Report Producer: Ann Hou



# 1 General Description

## 1.1 Information

### 1.1.1 RF General Information

Frequency Range (MHz)	IEEE Std. 802.11	Ch. Frequency (MHz)	Channel Number
5250-5350	a, n (HT20), ac (VHT20), ax (HEW20)	5260-5320	52-64 [4]
5470-5725		5500-5700	100-140 [11]
Straddle 5720		5720	144 [1]
5250-5350	n (HT40), ac (VHT40), ax (HEW40)	5270-5310	54-62 [2]
5470-5725		5510-5670	102-134 [5]
Straddle 5710		5710	142 [1]
5250-5350	ac (VHT80), ax (HEW80)	5290	58 [1]
5470-5725		5530-5610	106-122 [2]
Straddle 5690		5690	138 [1]

#### Group 1

Band	Mode	BWch (MHz)	Nant
5.25-5.35GHz	802.11a	20	1TX(Port 1)
5.47-5.725GHz	802.11a	20	1TX(Port 1)
5.725-5.85GHz	802.11a	20	1TX(Port 1)
5.25-5.35GHz	802.11a	20	2TX
5.47-5.725GHz	802.11a	20	2TX
5.725-5.85GHz	802.11a	20	2TX
5.25-5.35GHz	802.11ac VHT20	20	1TX(Port 1)
5.47-5.725GHz	802.11ac VHT20	20	1TX(Port 1)
5.725-5.85GHz	802.11ac VHT20	20	1TX(Port 1)
5.25-5.35GHz	802.11ac VHT20	20	2TX
5.47-5.725GHz	802.11ac VHT20	20	2TX
5.725-5.85GHz	802.11ac VHT20	20	2TX
5.25-5.35GHz	802.11ac VHT40	40	1TX(Port 1)
5.47-5.725GHz	802.11ac VHT40	40	1TX(Port 1)
5.725-5.85GHz	802.11ac VHT40	40	1TX(Port 1)
5.25-5.35GHz	802.11ac VHT40	40	2TX
5.47-5.725GHz	802.11ac VHT40	40	2TX
5.725-5.85GHz	802.11ac VHT40	40	2TX
5.25-5.35GHz	802.11ac VHT80	80	1TX(Port 1)
5.47-5.725GHz	802.11ac VHT80	80	1TX(Port 1)
5.725-5.85GHz	802.11ac VHT80	80	1TX(Port 1)
5.25-5.35GHz	802.11ac VHT80	80	2TX
5.47-5.725GHz	802.11ac VHT80	80	2TX



Band	Mode	BWch (MHz)	Nant
5.725-5.85GHz	802.11ac VHT80	80	2TX
5.25-5.35GHz	802.11ax HEW20	20	1TX(Port 1)
5.47-5.725GHz	802.11ax HEW20	20	1TX(Port 1)
5.725-5.85GHz	802.11ax HEW20	20	1TX(Port 1)
5.25-5.35GHz	802.11ax HEW20	20	2TX
5.47-5.725GHz	802.11ax HEW20	20	2TX
5.725-5.85GHz	802.11ax HEW20	20	2TX
5.25-5.35GHz	802.11ax HEW40	40	1TX(Port 1)
5.47-5.725GHz	802.11ax HEW40	40	1TX(Port 1)
5.725-5.85GHz	802.11ax HEW40	40	1TX(Port 1)
5.25-5.35GHz	802.11ax HEW40	40	2TX
5.47-5.725GHz	802.11ax HEW40	40	2TX
5.725-5.85GHz	802.11ax HEW40	40	2TX
5.25-5.35GHz	802.11ax HEW80	80	1TX(Port 1)
5.47-5.725GHz	802.11ax HEW80	80	1TX(Port 1)
5.725-5.85GHz	802.11ax HEW80	80	1TX(Port 1)
5.25-5.35GHz	802.11ax HEW80	80	2TX
5.47-5.725GHz	802.11ax HEW80	80	2TX
5.725-5.85GHz	802.11ax HEW80	80	2TX

Group 2/3/4

Band	Mode	BWch (MHz)	Nant
5.25-5.35GHz	802.11a	20	1TX(Port2)
5.47-5.725GHz	802.11a	20	1TX(Port2)
5.725-5.85GHz	802.11a	20	1TX(Port2)
5.25-5.35GHz	802.11a	20	2TX
5.47-5.725GHz	802.11a	20	2TX
5.725-5.85GHz	802.11a	20	2TX
5.25-5.35GHz	802.11ac VHT20	20	1TX(Port2)
5.47-5.725GHz	802.11ac VHT20	20	1TX(Port2)
5.725-5.85GHz	802.11ac VHT20	20	1TX(Port2)
5.25-5.35GHz	802.11ac VHT20	20	2TX
5.47-5.725GHz	802.11ac VHT20	20	2TX
5.725-5.85GHz	802.11ac VHT20	20	2TX
5.25-5.35GHz	802.11ac VHT40	40	1TX(Port2)
5.47-5.725GHz	802.11ac VHT40	40	1TX(Port2)
5.725-5.85GHz	802.11ac VHT40	40	1TX(Port2)
5.25-5.35GHz	802.11ac VHT40	40	2TX
5.47-5.725GHz	802.11ac VHT40	40	2TX
5.725-5.85GHz	802.11ac VHT40	40	2TX
5.25-5.35GHz	802.11ac VHT80	80	1TX(Port2)
5.47-5.725GHz	802.11ac VHT80	80	1TX(Port2)
5.725-5.85GHz	802.11ac VHT80	80	1TX(Port2)
5.25-5.35GHz	802.11ac VHT80	80	2TX



Band	Mode	BWch (MHz)	Nant
5.47-5.725GHz	802.11ac VHT80	80	2TX
5.725-5.85GHz	802.11ac VHT80	80	2TX
5.25-5.35GHz	802.11ax HEW20	20	1TX(Port2)
5.47-5.725GHz	802.11ax HEW20	20	1TX(Port2)
5.725-5.85GHz	802.11ax HEW20	20	1TX(Port2)
5.25-5.35GHz	802.11ax HEW20	20	2TX
5.47-5.725GHz	802.11ax HEW20	20	2TX
5.725-5.85GHz	802.11ax HEW20	20	2TX
5.25-5.35GHz	802.11ax HEW40	40	1TX(Port2)
5.47-5.725GHz	802.11ax HEW40	40	1TX(Port2)
5.725-5.85GHz	802.11ax HEW40	40	1TX(Port2)
5.25-5.35GHz	802.11ax HEW40	40	2TX
5.47-5.725GHz	802.11ax HEW40	40	2TX
5.725-5.85GHz	802.11ax HEW40	40	2TX
5.25-5.35GHz	802.11ax HEW80	80	1TX(Port2)
5.47-5.725GHz	802.11ax HEW80	80	1TX(Port2)
5.725-5.85GHz	802.11ax HEW80	80	1TX(Port2)
5.25-5.35GHz	802.11ax HEW80	80	2TX
5.47-5.725GHz	802.11ax HEW80	80	2TX
5.725-5.85GHz	802.11ax HEW80	80	2TX

Scanning Radio

Band	Mode	BWch (MHz)	Nant
5.25-5.35GHz	802.11a	20	1TX
5.47-5.725GHz	802.11a	20	1TX
5.725-5.85GHz	802.11a	20	1TX
5.25-5.35GHz	802.11ac VHT20	20	1TX
5.47-5.725GHz	802.11ac VHT20	20	1TX
5.725-5.85GHz	802.11ac VHT20	20	1TX
5.25-5.35GHz	802.11ac VHT40	40	1TX
5.47-5.725GHz	802.11ac VHT40	40	1TX
5.725-5.85GHz	802.11ac VHT40	40	1TX
5.25-5.35GHz	802.11ac VHT80	80	1TX
5.47-5.725GHz	802.11ac VHT80	80	1TX
5.725-5.85GHz	802.11ac VHT80	80	1TX



Group 1/2/3/4(BF)

Band	Mode	BWch (MHz)	Nant
5.25-5.35GHz	802.11ac VHT20-BF	20	2TX
5.47-5.725GHz	802.11ac VHT20-BF	20	2TX
5.725-5.85GHz	802.11ac VHT20-BF	20	2TX
5.25-5.35GHz	802.11ac VHT40-BF	40	2TX
5.47-5.725GHz	802.11ac VHT40-BF	40	2TX
5.725-5.85GHz	802.11ac VHT40-BF	40	2TX
5.25-5.35GHz	802.11ac VHT80-BF	80	2TX
5.47-5.725GHz	802.11ac VHT80-BF	80	2TX
5.725-5.85GHz	802.11ac VHT80-BF	80	2TX
5.25-5.35GHz	802.11ax HEW20-BF	20	2TX
5.47-5.725GHz	802.11ax HEW20-BF	20	2TX
5.725-5.85GHz	802.11ax HEW20-BF	20	2TX
5.25-5.35GHz	802.11ax HEW40-BF	40	2TX
5.47-5.725GHz	802.11ax HEW40-BF	40	2TX
5.725-5.85GHz	802.11ax HEW40-BF	40	2TX
5.25-5.35GHz	802.11ax HEW80-BF	80	2TX
5.47-5.725GHz	802.11ax HEW80-BF	80	2TX
5.725-5.85GHz	802.11ax HEW80-BF	80	2TX

Note:

- ♦ 11a, HT20 and HT40 use a combination of OFDM-BPSK, QPSK, 16QAM, 64QAM modulation.
- ♦ VHT20, VHT40, VHT80 use a combination of OFDM-BPSK, QPSK, 16QAM, 64QAM, 256QAM modulation.
- ♦ HEW20, HEW40, HEW80 use a combination of OFDMA-BPSK, QPSK, 16QAM, 64QAM, 256QAM, 1024QAM modulation.
- ♦ BWch is the nominal channel bandwidth.





1.1.2 Antenna Information

Group	Ant. No.	Brand	Model Name	Antenna Type	Connector	
1	20	1	Grand-Tek	MA-ANT-20	Omni	N-Type
		2	Grand-Tek	MA-ANT-20	Omni	N-Type
		3	Grand-Tek	MA-ANT-20	Omni	N-Type
		4	Grand-Tek	MA-ANT-20	Omni	N-Type
2	21+23	1	Grand-Tek	MA-ANT-23	Sector	N-Type
		2	Grand-Tek	MA-ANT-23	Sector	N-Type
		3	Grand-Tek	MA-ANT-21	Sector	N-Type
		4	Grand-Tek	MA-ANT-21	Sector	N-Type
3	25	1	Grand-Tek	MA-ANT-25	Sector	N-Type
		2	Grand-Tek	MA-ANT-25	Sector	N-Type
		3	Grand-Tek	MA-ANT-25	Sector	N-Type
		4	Grand-Tek	MA-ANT-25	Sector	N-Type
4	27	1	Grand-Tek	MA-ANT-27	Sector	N-Type
		2	Grand-Tek	MA-ANT-27	Sector	N-Type
		3	Grand-Tek	MA-ANT-27	Sector	N-Type
		4	Grand-Tek	MA-ANT-27	Sector	N-Type
-	-	5	Senao	MR76	PIFA	I-PEX
-	-	6	Senao	MR76	PIFA	I-PEX



Group	Ant. No.		Gain (dBi)			Elevation angle above 30 degrees Gain (dBi)	Remark
			2.4G	5G	BT		
1	20	1	4	-	-	-	Radio 1
		2	4	-	-	-	Radio 1
		3	-	7	-	-1	Radio 2
		4	-	7	-	-1	Radio 2
2	21+23	1	11	-	-	-	Radio 1
		2	11	-	-	-	Radio 1
		3	-	13	-	11.2	Radio 2
		4	-	13	-	11.2	Radio 2
3	25	1	8.1	-	-	-	Radio 1
		2	8.1	-	-	-	Radio 1
		3	-	7.1	-	1.8	Radio 2
		4	-	7.1	-	1.8	Radio 2
4	27	1	9.8	-	-	-	Radio 1
		2	9.8	-	-	-	Radio 1
		3	-	11.3	-	9.7	Radio 2
		4	-	11.3	-	9.7	Radio 2
-	-	5	4.6	5.9	-	5.2	Radio 3 (Scanning Radio)
-	-	6	-	-	4.7	-	Radio 4 (BT LE)

Note 1: The EUT has six antennas.

Note 2: The antenna mentioned above group 1~4 will not be sold with the EUT in the market.

**For 2.4GHz function:**

**<Radio 1>**

For IEEE 802.11 b/g/n/ac/ax mode (1TX/1RX)

Support diversity function and pre-tested on each single chain, the worst case was recorded in this test report.

For IEEE 802.11 b/g/n/ac/ax mode (2TX/2RX)

Ant. 1 and Ant. 2 could transmit/receive simultaneously.

**<Radio 3>**

For IEEE 802.11 b/g/n/ac mode (1TX/1RX)

Ant. 5 could transmit/receive simultaneously.

**For 5GHz function:**

**<Radio 2>**

For IEEE 802.11 a/an/ac/ax mode (1TX/1RX)

Support diversity function and pre-tested on each single chain, the worst case was recorded in this test report.

For IEEE 802.11 a/an/ac/ax mode (2TX/2RX)

Ant. 3 and Ant. 4 could transmit/receive simultaneously.

**<Radio 3>**

For IEEE 802.11 a/an/ac mode (1TX/1RX)



Ant. 5 could transmit/receive simultaneously.

For BT function:

<Radio 4>

For IEEE 802.15.1 Bluetooth mode (1TX/1RX)

Ant. 6 could transmit/receive simultaneously.

### 1.1.3 EUT Information

Operational Condition			
EUT Power Type	From PoE		
EUT Function	<input checked="" type="checkbox"/>	Outdoor AP (Radio 2)	<input type="checkbox"/> Indoor AP
	<input type="checkbox"/>	Fixed P2P AP	<input type="checkbox"/> Client (Radio 3)
Beamforming Function	<input checked="" type="checkbox"/>	With beamforming	<input type="checkbox"/> Without beamforming
TPC Function	<input checked="" type="checkbox"/>	With TPC Function	<input type="checkbox"/> Without TPC Function
Weather Band	<input checked="" type="checkbox"/>	With 5600~5650MHz	<input type="checkbox"/> Without 5600~5650MHz
Resource Unit(802.11ax)	<input checked="" type="checkbox"/>	Full RU	<input type="checkbox"/> Partial RU
Type of EUT			
<input checked="" type="checkbox"/>	Stand-alone		
<input type="checkbox"/>	Combined (EUT where the radio part is fully integrated within another device)		
	Combined Equipment - Brand Name / Model No.: ...		
<input type="checkbox"/>	Plug-in radio (EUT intended for a variety of host systems)		
	Host System - Brand Name / Model No.:		
<input type="checkbox"/>	Other:		

### 1.1.4 Mode Test Duty Cycle

#### Group 1/2/3/4

Mode	DC	DCF(dB)	T(s)	VBW(Hz) ≥ 1/T
802.11a	0.944	0.25	1.978m	1k
802.11ac VHT20	0.957	0.19	5.43m	300
802.11ac VHT40	0.956	0.2	5.43m	300
802.11ac VHT80	0.953	0.21	5.429m	300
802.11ax HEW20	0.958	0.19	5.446m	300
802.11ax HEW40	0.956	0.2	5.446m	300
802.11ax HEW80	0.956	0.2	5.446m	300

Note. If DC < 0.98, the DCF was added while measuring Output power and PSD.

#### Scanning Radio

Mode	DC	DCF(dB)	T(s)	VBW(Hz) ≥ 1/T
802.11a	0.962	0.17	2.028m	1k
802.11ac VHT20	0.964	0.16	1.901m	1k
802.11ac VHT40	0.928	0.32	936.563u	3k
802.11ac VHT80	0.867	0.62	456.563u	3k

Note. If DC < 0.98, the DCF was added while measuring Output power and PSD.



Group 1/2/3/4(Beamforming)

Mode	DC	DCF(dB)	T(s)	VBW(Hz) ≥ 1/T
802.11ac VHT20-BF	0.94	0.27	1.759m	1k
802.11ac VHT40-BF	0.922	0.35	1.694m	1k
802.11ac VHT80-BF	0.915	0.39	1.95m	1k
802.11ax HEW20-BF	0.888	0.52	1.759m	1k
802.11ax HEW40-BF	0.919	0.37	1.694m	1k
802.11ax HEW80-BF	0.916	0.38	1.949m	1k

Note. If DC < 0.98, the DCF was added while measuring Output power and PSD.

1.1.5 Table for Multiple Listing

The brand/model names in the following table are all refer to the identical product.

Sample	Description
SKU1: Screened C-temp	All the Samples are identical, the difference samples for difference NAND, DDR, Security chip.
SKU2: unscreened C-temp	



## 1.2 Testing Applied Standards

According to the specifications of the manufacturer, the EUT must comply with the requirements of the following standards:

- ♦ 47 CFR FCC Part 15
- ♦ ANSI C63.10-2013
- ♦ KDB 789033 D02 v02r01

The following reference test guidance is not within the scope of accreditation of TAF:

- ♦ KDB 662911 D01 v02r01
- ♦ KDB 414788 D01 v01r01

## 1.3 Testing Location Information

<b>Test Lab. : Sporton International Inc. Hsinhua Laboratory</b>				
<input checked="" type="checkbox"/>	Hsinhua (TAF: 3785)	ADD: No.52, Huaya 1st Rd., Guishan Dist., Taoyuan City 333411, Taiwan (R.O.C.)		
		TEL: 886-3-327-3456	FAX: 886-3-327-0973	
Test site Designation No. TW3785 with FCC.				
Test Condition	Test Site No.	Test Engineer	Test Environment	Test Date
RF Conducted	TH06-HY	Gary	23.5~25.9°C / 65~66.8%	04/Dec/2019~09/Dec/2019
Radiated	03CH02-HY	Dexter	23.6~24.8°C / 54.3~56.9%	29/Nov/2019~09/Dec/2019
Radiated (Co-location)	03CH02-HY	Jack	21.5~22.3°C / 57~61%	30/Nov/2022
<input checked="" type="checkbox"/>	Wen 33rd.St. (TAF: 3785)	ADD: No.14-1, Ln. 19, Wen 33rd St., Guishan Dist., Taoyuan City 333010, Taiwan (R.O.C.)		
		TEL: 886-3-318-0787	FAX: 886-3-318-0287	
Test site Designation No. TW0008 with FCC.				
Test Condition	Test Site No.	Test Engineer	Test Environment	Test Date
Radiated	03CH09-HY	Lego	22.4~24.7°C / 52.1~57.9%	29/Nov/2019~09/Dec/2019

Note 1: Laboratory number TAF 3785 is a spin-off from the original Laboratory number TAF 1190.

Note 2: The tested sample of the verified test item was received on Oct. 25, 2022.

## 1.4 Measurement Uncertainty

ISO/IEC 17025 requires that an estimate of the measurement uncertainties associated with the emissions test results be included in the report. The measurement uncertainties given below are based on a 95% confidence level (based on a coverage factor (k=2))

Test Items	Uncertainty	Remark
Conducted Emission (150kHz ~ 30MHz)	3.54 dB	Confidence levels of 95%
Radiated Emission (9kHz ~ 30MHz)	1.6 dB	Confidence levels of 95%
Radiated Emission (30MHz ~ 1,000MHz)	4.3 dB	Confidence levels of 95%
Radiated Emission (1GHz ~ 18GHz)	3.9 dB	Confidence levels of 95%
Radiated Emission (18GHz ~ 40GHz)	3.5 dB	Confidence levels of 95%
Conducted Emission	1.3 dB	Confidence levels of 95%
Temperature	0.7 °C	Confidence levels of 95%
Humidity	4 %	Confidence levels of 95%

### Radiated(Co-location)

Test Items	Uncertainty	Remark
Unwanted Emissions	4.8 dB	Confidence levels of 95%



## 2 Test Configuration of EUT

### 2.1 Test Channel Mode

Test Software Version	QRCT V4.0 00123 (Radio 2) QRCT V3.0 0297 (Radio 3)
-----------------------	---

#### Group 1

Mode	Power Setting
802.11a_Nss1,(6Mbps)_1TX(Port 1)	-
5260MHz	21
5300MHz	20.5
5320MHz	19
5500MHz	18
5580MHz	22
5700MHz	16.5
5720MHz Straddle 5.47-5.725GHz	21.5
5720MHz Straddle 5.725-5.85GHz	21.5
802.11a_Nss1,(6Mbps)_2TX	-
5260MHz	17
5300MHz	17
5320MHz	17
5500MHz	17.5
5580MHz	17
5700MHz	16
5720MHz Straddle 5.47-5.725GHz	17
5720MHz Straddle 5.725-5.85GHz	17
802.11ac VHT20_Nss1,(MCS0)_1TX(Port 1)	-
5260MHz	21
5300MHz	20.5
5320MHz	18.5
5500MHz	18.5
5580MHz	22
5700MHz	17
5720MHz Straddle 5.47-5.725GHz	21.5
5720MHz Straddle 5.725-5.85GHz	21.5
802.11ac VHT20_Nss1,(MCS0)_2TX	-
5260MHz	17
5300MHz	17.5
5320MHz	17.5
5500MHz	18



Mode	Power Setting
5580MHz	17.5
5700MHz	17.5
5720MHz Straddle 5.47-5.725GHz	17.5
5720MHz Straddle 5.725-5.85GHz	17.5
802.11ac VHT40_Nss1,(MCS0)_1TX(Port 1)	-
5270MHz	20
5310MHz	18
5510MHz	17
5550MHz	20
5670MHz	18.5
5710MHz Straddle 5.47-5.725GHz	21.5
5710MHz Straddle 5.725-5.85GHz	21.5
802.11ac VHT40_Nss1,(MCS0)_2TX	-
5270MHz	19
5310MHz	16.5
5510MHz	16.5
5550MHz	19
5670MHz	17.5
5710MHz Straddle 5.47-5.725GHz	20.5
5710MHz Straddle 5.725-5.85GHz	20.5
802.11ac VHT80_Nss1,(MCS0)_1TX(Port 1)	-
5290MHz	17.5
5530MHz	17
5610MHz	19
5690MHz Straddle 5.47-5.725GHz	20
5690MHz Straddle 5.725-5.85GHz	20
802.11ac VHT80_Nss1,(MCS0)_2TX	-
5290MHz	16
5530MHz	16
5610MHz	17
5690MHz Straddle 5.47-5.725GHz	19
5690MHz Straddle 5.725-5.85GHz	19
802.11ax HEW20_Nss1,(MCS0)_1TX(Port 1)	-
5260MHz	21
5300MHz	20.5
5320MHz	18.5
5500MHz	18.5
5580MHz	22
5700MHz	17
5720MHz Straddle 5.47-5.725GHz	21.5



Mode	Power Setting
5720MHz Straddle 5.725-5.85GHz	21.5
802.11ax HEW20_Nss1,(MCS0)_2TX	-
5260MHz	17
5300MHz	17.5
5320MHz	17.5
5500MHz	18
5580MHz	17.5
5700MHz	17.5
5720MHz Straddle 5.47-5.725GHz	17.5
5720MHz Straddle 5.725-5.85GHz	17.5
802.11ax HEW40_Nss1,(MCS0)_1TX(Port 1)	-
5270MHz	20
5310MHz	18
5510MHz	17
5550MHz	20
5670MHz	18.5
5710MHz Straddle 5.47-5.725GHz	21.5
5710MHz Straddle 5.725-5.85GHz	21.5
802.11ax HEW40_Nss1,(MCS0)_2TX	-
5270MHz	19
5310MHz	16.5
5510MHz	16.5
5550MHz	19
5670MHz	17.5
5710MHz Straddle 5.47-5.725GHz	20.5
5710MHz Straddle 5.725-5.85GHz	20.5
802.11ax HEW80_Nss1,(MCS0)_1TX(Port 1)	-
5290MHz	17.5
5530MHz	17
5610MHz	19
5690MHz Straddle 5.47-5.725GHz	20
5690MHz Straddle 5.725-5.85GHz	20
802.11ax HEW80_Nss1,(MCS0)_2TX	-
5290MHz	16
5530MHz	16
5610MHz	17
5690MHz Straddle 5.47-5.725GHz	19
5690MHz Straddle 5.725-5.85GHz	19





Group 2

Mode	Power Setting
802.11a_Nss1,(6Mbps)_1TX(Port2)	-
5260MHz	16.5
5300MHz	17
5320MHz	17.5
5500MHz	17
5580MHz	17
5700MHz	16.5
5720MHz Straddle 5.47-5.725GHz	17
5720MHz Straddle 5.725-5.85GHz	17
802.11a_Nss1,(6Mbps)_2TX	-
5260MHz	11.5
5300MHz	12
5320MHz	12
5500MHz	11.5
5580MHz	11.5
5700MHz	11.5
5720MHz Straddle 5.47-5.725GHz	11.5
5720MHz Straddle 5.725-5.85GHz	11.5
802.11ac VHT20_Nss1,(MCS0)_1TX(Port2)	-
5260MHz	16.5
5300MHz	17
5320MHz	17.5
5500MHz	17
5580MHz	17
5700MHz	15
5720MHz Straddle 5.47-5.725GHz	17.5
5720MHz Straddle 5.725-5.85GHz	17.5
802.11ac VHT20_Nss1,(MCS0)_2TX	-
5260MHz	12
5300MHz	12.5
5320MHz	12.5
5500MHz	12
5580MHz	11.5
5700MHz	12
5720MHz Straddle 5.47-5.725GHz	12
5720MHz Straddle 5.725-5.85GHz	12



Mode	Power Setting
802.11ac VHT40_Nss1,(MCS0)_1TX(Port2)	-
5270MHz	16.5
5310MHz	15
5510MHz	15
5550MHz	16.5
5670MHz	16.5
5710MHz Straddle 5.47-5.725GHz	17.5
5710MHz Straddle 5.725-5.85GHz	17.5
802.11ac VHT40_Nss1,(MCS0)_2TX	-
5270MHz	13.5
5310MHz	14
5510MHz	13.5
5550MHz	13.5
5670MHz	14
5710MHz Straddle 5.47-5.725GHz	14.5
5710MHz Straddle 5.725-5.85GHz	14.5
802.11ac VHT80_Nss1,(MCS0)_1TX(Port2)	-
5290MHz	14.5
5530MHz	15
5610MHz	16.5
5690MHz Straddle 5.47-5.725GHz	17
5690MHz Straddle 5.725-5.85GHz	17
802.11ac VHT80_Nss1,(MCS0)_2TX	-
5290MHz	14
5530MHz	13.5
5610MHz	13.5
5690MHz Straddle 5.47-5.725GHz	14
5690MHz Straddle 5.725-5.85GHz	14
802.11ax HEW20_Nss1,(MCS0)_1TX(Port2)	-
5260MHz	16.5
5300MHz	17
5320MHz	17.5
5500MHz	17
5580MHz	17
5700MHz	15
5720MHz Straddle 5.47-5.725GHz	17.5
5720MHz Straddle 5.725-5.85GHz	17.5



Mode	Power Setting
802.11ax HEW20_Nss1,(MCS0)_2TX	-
5260MHz	12
5300MHz	12.5
5320MHz	12.5
5500MHz	12
5580MHz	11.5
5700MHz	12
5720MHz Straddle 5.47-5.725GHz	12
5720MHz Straddle 5.725-5.85GHz	12
802.11ax HEW40_Nss1,(MCS0)_1TX(Port2)	-
5270MHz	16.5
5310MHz	15
5510MHz	15
5550MHz	16.5
5670MHz	16.5
5710MHz Straddle 5.47-5.725GHz	17.5
5710MHz Straddle 5.725-5.85GHz	17.5
802.11ax HEW40_Nss1,(MCS0)_2TX	-
5270MHz	13.5
5310MHz	14
5510MHz	13.5
5550MHz	13.5
5670MHz	14
5710MHz Straddle 5.47-5.725GHz	14.5
5710MHz Straddle 5.725-5.85GHz	14.5
802.11ax HEW80_Nss1,(MCS0)_1TX(Port2)	-
5290MHz	14.5
5530MHz	15
5610MHz	16.5
5690MHz Straddle 5.47-5.725GHz	17
5690MHz Straddle 5.725-5.85GHz	17
802.11ax HEW80_Nss1,(MCS0)_2TX	-
5290MHz	14
5530MHz	13.5
5610MHz	13.5
5690MHz Straddle 5.47-5.725GHz	14
5690MHz Straddle 5.725-5.85GHz	14



Group 3

Mode	Power Setting
802.11a_Nss1,(6Mbps)_1TX(Port2)	-
5260MHz	21.5
5300MHz	22
5320MHz	19
5500MHz	19
5580MHz	21.5
5700MHz	16.5
5720MHz Straddle 5.47-5.725GHz	20.5
5720MHz Straddle 5.725-5.85GHz	20.5
802.11a_Nss1,(6Mbps)_2TX	-
5260MHz	16.5
5300MHz	17
5320MHz	17
5500MHz	17
5580MHz	17
5700MHz	16.5
5720MHz Straddle 5.47-5.725GHz	17
5720MHz Straddle 5.725-5.85GHz	17
802.11ac VHT20_Nss1,(MCS0)_1TX(Port2)	-
5260MHz	21.5
5300MHz	22
5320MHz	18
5500MHz	18
5580MHz	22
5700MHz	16.5
5720MHz Straddle 5.47-5.725GHz	21
5720MHz Straddle 5.725-5.85GHz	21
802.11ac VHT20_Nss1,(MCS0)_2TX	-
5260MHz	17
5300MHz	17
5320MHz	17.5
5500MHz	18
5580MHz	17.5
5700MHz	16.5
5720MHz Straddle 5.47-5.725GHz	17.5
5720MHz Straddle 5.725-5.85GHz	17.5
802.11ac VHT40_Nss1,(MCS0)_1TX(Port2)	-



Mode	Power Setting
5270MHz	19
5310MHz	17.5
5510MHz	17.5
5550MHz	20
5670MHz	18
5710MHz Straddle 5.47-5.725GHz	21
5710MHz Straddle 5.725-5.85GHz	21
802.11ac VHT40_Nss1,(MCS0)_2TX	-
5270MHz	19
5310MHz	17
5510MHz	16
5550MHz	19.5
5670MHz	17
5710MHz Straddle 5.47-5.725GHz	20
5710MHz Straddle 5.725-5.85GHz	20
802.11ac VHT80_Nss1,(MCS0)_1TX(Port2)	-
5290MHz	17.5
5530MHz	17
5610MHz	18.5
5690MHz Straddle 5.47-5.725GHz	20
5690MHz Straddle 5.725-5.85GHz	20
802.11ac VHT80_Nss1,(MCS0)_2TX	-
5290MHz	16
5530MHz	16
5610MHz	17.5
5690MHz Straddle 5.47-5.725GHz	20
5690MHz Straddle 5.725-5.85GHz	20
802.11ax HEW20_Nss1,(MCS0)_1TX(Port2)	-
5260MHz	21.5
5300MHz	22
5320MHz	18
5500MHz	18
5580MHz	22
5700MHz	16.5
5720MHz Straddle 5.47-5.725GHz	21
5720MHz Straddle 5.725-5.85GHz	21
802.11ax HEW20_Nss1,(MCS0)_2TX	-
5260MHz	17



Mode	Power Setting
5300MHz	17
5320MHz	17.5
5500MHz	18
5580MHz	17.5
5700MHz	16.5
5720MHz Straddle 5.47-5.725GHz	17.5
5720MHz Straddle 5.725-5.85GHz	17.5
802.11ax HEW40_Nss1,(MCS0)_1TX(Port2)	-
5270MHz	19
5310MHz	17.5
5510MHz	17.5
5550MHz	20
5670MHz	18
5710MHz Straddle 5.47-5.725GHz	22
5710MHz Straddle 5.725-5.85GHz	22
802.11ax HEW40_Nss1,(MCS0)_2TX	-
5270MHz	19
5310MHz	17
5510MHz	16
5550MHz	19.5
5670MHz	17
5710MHz Straddle 5.47-5.725GHz	20
5710MHz Straddle 5.725-5.85GHz	20
802.11ax HEW80_Nss1,(MCS0)_1TX(Port2)	-
5290MHz	17.5
5530MHz	17
5610MHz	18.5
5690MHz Straddle 5.47-5.725GHz	20
5690MHz Straddle 5.725-5.85GHz	20
802.11ax HEW80_Nss1,(MCS0)_2TX	-
5290MHz	16
5530MHz	16
5610MHz	17.5
5690MHz Straddle 5.47-5.725GHz	20
5690MHz Straddle 5.725-5.85GHz	20



Group 4

Mode	Power Setting
802.11a_Nss1,(6Mbps)_1TX(Port2)	-
5260MHz	19
5300MHz	19
5320MHz	17
5500MHz	18
5580MHz	19
5700MHz	16.5
5720MHz Straddle 5.47-5.725GHz	19
5720MHz Straddle 5.725-5.85GHz	19
802.11a_Nss1,(6Mbps)_2TX	-
5260MHz	13
5300MHz	13
5320MHz	13
5500MHz	12.5
5580MHz	12.5
5700MHz	13
5720MHz Straddle 5.47-5.725GHz	13
5720MHz Straddle 5.725-5.85GHz	13
802.11ac VHT20_Nss1,(MCS0)_1TX(Port2)	-
5260MHz	19
5300MHz	19
5320MHz	17
5500MHz	17.5
5580MHz	19.5
5700MHz	15.5
5720MHz Straddle 5.47-5.725GHz	19.5
5720MHz Straddle 5.725-5.85GHz	19.5
802.11ac VHT20_Nss1,(MCS0)_2TX	-
5260MHz	13.5
5300MHz	13.5
5320MHz	13
5500MHz	13
5580MHz	13
5700MHz	13.5
5720MHz Straddle 5.47-5.725GHz	13.5
5720MHz Straddle 5.725-5.85GHz	13.5
802.11ac VHT40_Nss1,(MCS0)_1TX(Port2)	-



Mode	Power Setting
5270MHz	18.5
5310MHz	16
5510MHz	16
5550MHz	18.5
5670MHz	17
5710MHz Straddle 5.47-5.725GHz	19
5710MHz Straddle 5.725-5.85GHz	19
802.11ac VHT40_Nss1,(MCS0)_2TX	-
5270MHz	15.5
5310MHz	15.5
5510MHz	15.5
5550MHz	15.5
5670MHz	16
5710MHz Straddle 5.47-5.725GHz	16
5710MHz Straddle 5.725-5.85GHz	16
802.11ac VHT80_Nss1,(MCS0)_1TX(Port2)	-
5290MHz	15
5530MHz	15
5610MHz	17
5690MHz Straddle 5.47-5.725GHz	19
5690MHz Straddle 5.725-5.85GHz	19
802.11ac VHT80_Nss1,(MCS0)_2TX	-
5290MHz	15
5530MHz	13.5
5610MHz	16
5690MHz Straddle 5.47-5.725GHz	15.5
5690MHz Straddle 5.725-5.85GHz	15.5
802.11ax HEW20_Nss1,(MCS0)_1TX(Port2)	-
5260MHz	19
5300MHz	19
5320MHz	17
5500MHz	17.5
5580MHz	19.5
5700MHz	15.5
5720MHz Straddle 5.47-5.725GHz	19.5
5720MHz Straddle 5.725-5.85GHz	19.5
802.11ax HEW20_Nss1,(MCS0)_2TX	-
5260MHz	13.5





Mode	Power Setting
5300MHz	13.5
5320MHz	13
5500MHz	13
5580MHz	13
5700MHz	13.5
5720MHz Straddle 5.47-5.725GHz	13.5
5720MHz Straddle 5.725-5.85GHz	13.5
802.11ax HEW40_Nss1,(MCS0)_1TX(Port2)	-
5270MHz	18.5
5310MHz	16
5510MHz	16
5550MHz	18.5
5670MHz	17
5710MHz Straddle 5.47-5.725GHz	19
5710MHz Straddle 5.725-5.85GHz	19
802.11ax HEW40_Nss1,(MCS0)_2TX	-
5270MHz	15.5
5310MHz	15.5
5510MHz	15.5
5550MHz	15.5
5670MHz	16
5710MHz Straddle 5.47-5.725GHz	16
5710MHz Straddle 5.725-5.85GHz	16
802.11ax HEW80_Nss1,(MCS0)_1TX(Port2)	-
5290MHz	15
5530MHz	15
5610MHz	17
5690MHz Straddle 5.47-5.725GHz	19
5690MHz Straddle 5.725-5.85GHz	19
802.11ax HEW80_Nss1,(MCS0)_2TX	-
5290MHz	15
5530MHz	13.5
5610MHz	16
5690MHz Straddle 5.47-5.725GHz	15.5
5690MHz Straddle 5.725-5.85GHz	15.5



Scanning Radio

Mode	Power Setting
802.11a_Nss1,(6Mbps)_1TX	-
5260MHz	17.5
5300MHz	17.5
5320MHz	17.5
5500MHz	17
5580MHz	16.5
5700MHz	14.5
5720MHz Straddle 5.47-5.725GHz	13
5720MHz Straddle 5.725-5.85GHz	13
802.11ac VHT20_Nss1,(MCS0)_1TX	-
5260MHz	17.5
5300MHz	17.5
5320MHz	17.5
5500MHz	17
5580MHz	17
5700MHz	15
5720MHz Straddle 5.47-5.725GHz	15
5720MHz Straddle 5.725-5.85GHz	15
802.11ac VHT40_Nss1,(MCS0)_1TX	-
5270MHz	17.5
5310MHz	14.5
5510MHz	15
5550MHz	18
5670MHz	17
5710MHz Straddle 5.47-5.725GHz	16
5710MHz Straddle 5.725-5.85GHz	16
802.11ac VHT80_Nss1,(MCS0)_1TX	-
5290MHz	12
5530MHz	13.5
5610MHz	18
5690MHz Straddle 5.47-5.725GHz	17.5
5690MHz Straddle 5.725-5.85GHz	17.5



Group 1 \_Beamforming

Mode	Power Setting
802.11ac VHT20-BF_Nss1,(MCS0)_2TX	-
5260MHz	20
5300MHz	20
5320MHz	20
5500MHz	20
5580MHz	20
5700MHz	18
5720MHz Straddle 5.47-5.725GHz	20
5720MHz Straddle 5.725-5.85GHz	20
802.11ac VHT40-BF_Nss1,(MCS0)_2TX	-
5270MHz	20
5310MHz	19
5510MHz	16
5550MHz	20
5670MHz	18
5710MHz Straddle 5.47-5.725GHz	20
5710MHz Straddle 5.725-5.85GHz	20
802.11ac VHT80-BF_Nss1,(MCS0)_2TX	-
5290MHz	18
5530MHz	19
5610MHz	20
5690MHz Straddle 5.47-5.725GHz	20
5690MHz Straddle 5.725-5.85GHz	20
802.11ax HEW20-BF_Nss1,(MCS0)_2TX	-
5260MHz	20
5300MHz	20
5320MHz	20
5500MHz	20
5580MHz	20
5700MHz	18
5720MHz Straddle 5.47-5.725GHz	20
5720MHz Straddle 5.725-5.85GHz	20
802.11ax HEW40-BF_Nss1,(MCS0)_2TX	-
5270MHz	20
5310MHz	19



Mode	Power Setting
5510MHz	16
5550MHz	20
5670MHz	18
5710MHz Straddle 5.47-5.725GHz	20
5710MHz Straddle 5.725-5.85GHz	20
802.11ax HEW80-BF_Nss1,(MCS0)_2TX	-
5290MHz	18
5530MHz	19
5610MHz	20
5690MHz Straddle 5.47-5.725GHz	20
5690MHz Straddle 5.725-5.85GHz	20

Group 2\_Beamforming

Mode	Power Setting
802.11ac VHT20-BF_Nss1,(MCS0)_2TX	-
5260MHz	13
5300MHz	14
5320MHz	14
5500MHz	14
5580MHz	13
5700MHz	13
5720MHz Straddle 5.47-5.725GHz	14
5720MHz Straddle 5.725-5.85GHz	14
802.11ac VHT40-BF_Nss1,(MCS0)_2TX	-
5270MHz	13
5310MHz	13
5510MHz	14
5550MHz	13
5670MHz	13
5710MHz Straddle 5.47-5.725GHz	15
5710MHz Straddle 5.725-5.85GHz	15
802.11ac VHT80-BF_Nss1,(MCS0)_2TX	-
5290MHz	13
5530MHz	14
5610MHz	12
5690MHz Straddle 5.47-5.725GHz	14



Mode	Power Setting
5690MHz Straddle 5.725-5.85GHz	14
802.11ax HEW20-BF_Nss1,(MCS0)_2TX	-
5260MHz	13
5300MHz	14
5320MHz	14
5500MHz	14
5580MHz	13
5700MHz	13
5720MHz Straddle 5.47-5.725GHz	14
5720MHz Straddle 5.725-5.85GHz	14
802.11ax HEW40-BF_Nss1,(MCS0)_2TX	-
5270MHz	13
5310MHz	13
5510MHz	14
5550MHz	13
5670MHz	13
5710MHz Straddle 5.47-5.725GHz	15
5710MHz Straddle 5.725-5.85GHz	15
802.11ax HEW80-BF_Nss1,(MCS0)_2TX	-
5290MHz	13
5530MHz	14
5610MHz	12
5690MHz Straddle 5.47-5.725GHz	14
5690MHz Straddle 5.725-5.85GHz	14



Group 3 \_Beamforming

Mode	Power Setting
802.11ac VHT20-BF_Nss1,(MCS0)_2TX	-
5260MHz	20
5300MHz	20
5320MHz	20
5500MHz	20
5580MHz	20
5700MHz	20
5720MHz Straddle 5.47-5.725GHz	20
5720MHz Straddle 5.725-5.85GHz	20
802.11ac VHT40-BF_Nss1,(MCS0)_2TX	-
5270MHz	20
5310MHz	18
5510MHz	15
5550MHz	20
5670MHz	18
5710MHz Straddle 5.47-5.725GHz	20
5710MHz Straddle 5.725-5.85GHz	20
802.11ac VHT80-BF_Nss1,(MCS0)_2TX	-
5290MHz	18
5530MHz	18
5610MHz	16
5690MHz Straddle 5.47-5.725GHz	20
5690MHz Straddle 5.725-5.85GHz	20
802.11ax HEW20-BF_Nss1,(MCS0)_2TX	-
5260MHz	20
5300MHz	20
5320MHz	20
5500MHz	20
5580MHz	20
5700MHz	20
5720MHz Straddle 5.47-5.725GHz	20
5720MHz Straddle 5.725-5.85GHz	20
802.11ax HEW40-BF_Nss1,(MCS0)_2TX	-
5270MHz	20
5310MHz	18



Mode	Power Setting
5510MHz	15
5550MHz	20
5670MHz	18
5710MHz Straddle 5.47-5.725GHz	20
5710MHz Straddle 5.725-5.85GHz	20
802.11ax HEW80-BF_Nss1,(MCS0)_2TX	-
5290MHz	18
5530MHz	18
5610MHz	16
5690MHz Straddle 5.47-5.725GHz	20
5690MHz Straddle 5.725-5.85GHz	20

Group 4 \_Beamforming

Mode	Power Setting
802.11ac VHT20-BF_Nss1,(MCS0)_2TX	-
5260MHz	15
5300MHz	15
5320MHz	15
5500MHz	15
5580MHz	15
5700MHz	15
5720MHz Straddle 5.47-5.725GHz	16
5720MHz Straddle 5.725-5.85GHz	16
802.11ac VHT40-BF_Nss1,(MCS0)_2TX	-
5270MHz	15
5310MHz	15
5510MHz	15
5550MHz	15
5670MHz	15
5710MHz Straddle 5.47-5.725GHz	16
5710MHz Straddle 5.725-5.85GHz	16
802.11ac VHT80-BF_Nss1,(MCS0)_2TX	-
5290MHz	15
5530MHz	15
5610MHz	15
5690MHz Straddle 5.47-5.725GHz	16





Mode	Power Setting
5690MHz Straddle 5.725-5.85GHz	16
802.11ax HEW20-BF_Nss1,(MCS0)_2TX	-
5260MHz	15
5300MHz	15
5320MHz	15
5500MHz	15
5580MHz	15
5700MHz	15
5720MHz Straddle 5.47-5.725GHz	16
5720MHz Straddle 5.725-5.85GHz	16
802.11ax HEW40-BF_Nss1,(MCS0)_2TX	-
5270MHz	15
5310MHz	15
5510MHz	15
5550MHz	15
5670MHz	15
5710MHz Straddle 5.47-5.725GHz	16
5710MHz Straddle 5.725-5.85GHz	16
802.11ax HEW80-BF_Nss1,(MCS0)_2TX	-
5290MHz	15
5530MHz	15
5610MHz	15
5690MHz Straddle 5.47-5.725GHz	16
5690MHz Straddle 5.725-5.85GHz	16



## 2.2 The Worst Case Measurement Configuration

The Worst Case Mode for Following Conformance Tests	
<b>Tests Item</b>	Emission Bandwidth Maximum Conducted Output Power Peak Power Spectral Density
<b>Test Condition</b>	Conducted measurement at transmit chains

The Worst Case Mode for Following Conformance Tests			
<b>Tests Item</b>	Unwanted Emissions		
<b>Test Condition</b>	Radiated measurement If EUT consist of multiple antenna assembly (multiple antenna are used in EUT regardless of spatial multiplexing MIMO configuration), the radiated test should be performed with highest antenna gain of each antenna type.		
<b>Operating Mode &gt; 1GHz</b>	CTX		
1	PoE mode		
<b>Orthogonal Planes of EUT</b>	<b>X Plane</b>	<b>Y Plane</b>	<b>Z Plane</b>
			
<b>Worst Planes of EUT</b>			V

The Worst Case Mode for Following Conformance Tests	
<b>Tests Item</b>	Simultaneous Transmission Analysis
<b>Test Condition</b>	Radiated measurement
<b>Operating Mode</b>	CTX
1	WLAN 2.4GHz+ WLAN 5GHz+ Scanning Radio WLAN 2.4GHz+Bluetooth
2	WLAN 2.4GHz+ WLAN 5GHz+ Scanning Radio WLAN 5GHz+Bluetooth
Refer to Sporton Test Report No.: FA972312-12 for Co-location RF Exposure Evaluation and Appendix E for Radiated Emission Co-location.	



### 2.3 Accessories

Accessories				
Mounting bracket	Brand Name	CISCO	Model Name	MR76-HW

Reminder: Regarding to more detail and other information, please refer to user manual.

### 2.4 Support Equipment

Support Equipment – Conducted					
No.	Equipment	Brand Name	Model Name	FCC ID	Remark
1	Notebook	DELL	E5410	DoC	-
2	Adapter for NB	DELL	HA65NM130	DoC	-

Support Equipment – Radiated					
No.	Equipment	Brand Name	Model Name	FCC ID	Remark
1	LAN Cable	Power sync	CAT-6E-10	N/A	-
2	PoE	PHIHONG	POEA30U-1ATE	N/A	Remote
3	Power Cable	CHING CHANG	N/A	N/A	Remote Provided by Customer
4	LAN Cable	Power sync	N/A	N/A	Remote

## 2.5 Test Setup Diagram

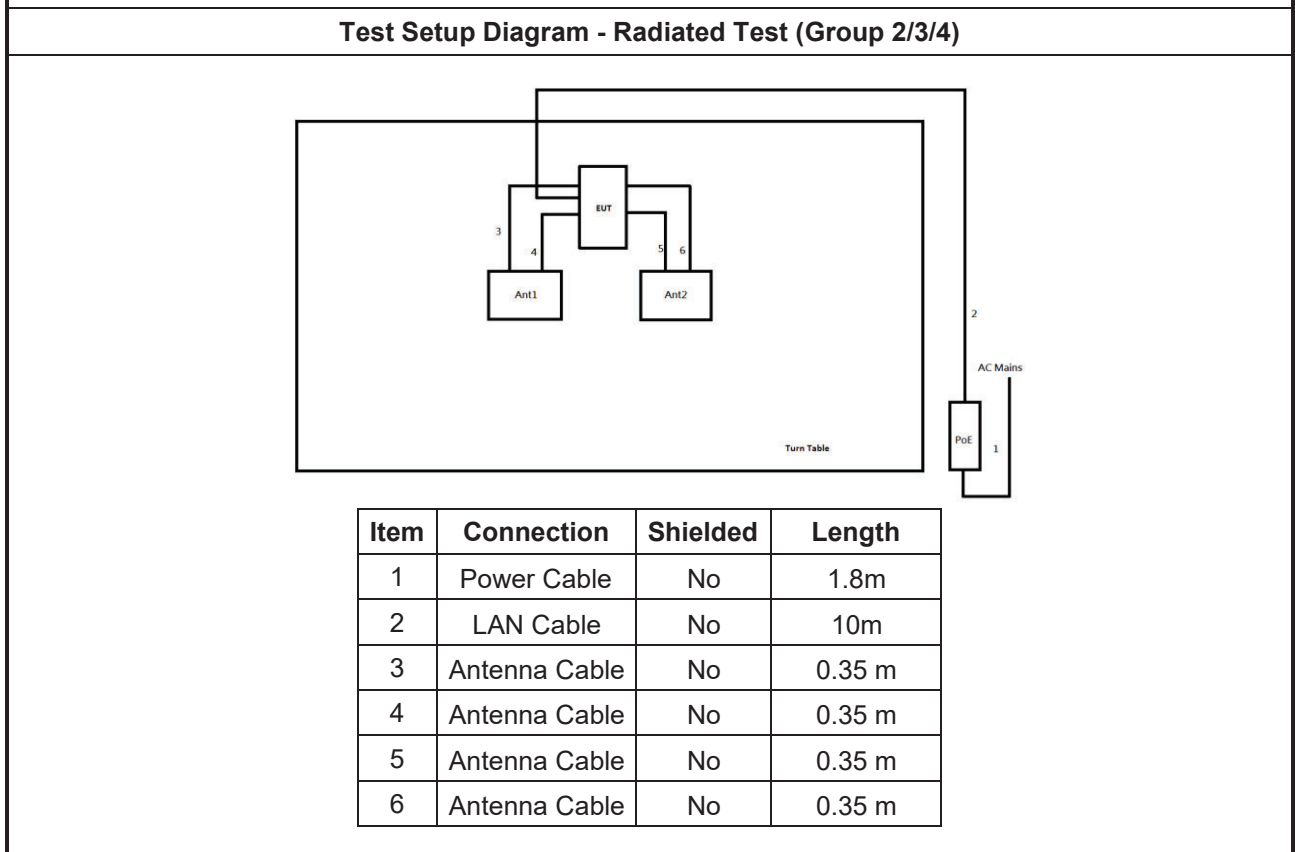
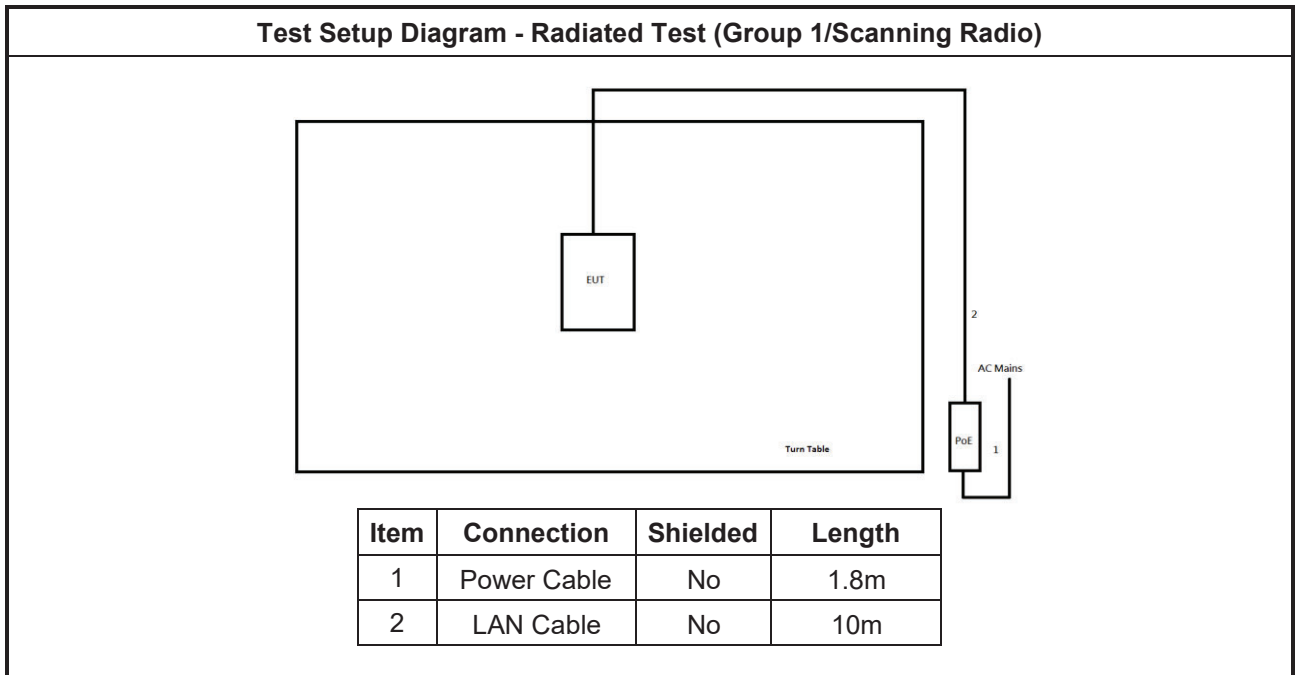

**Test Setup Diagram - Radiated Test (Group 1/Scanning Radio)**

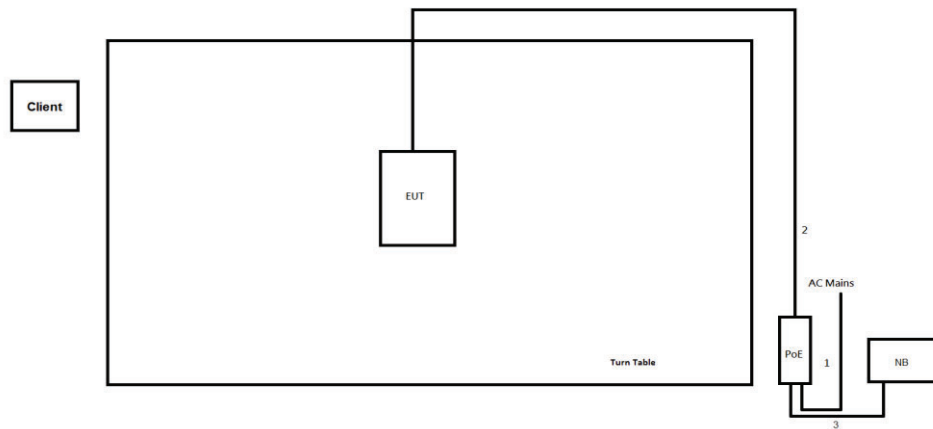

Item	Connection	Shielded	Length
1	Power Cable	No	1.8m
2	LAN Cable	No	10m
3	LAN Cable	No	1m

**Test Setup Diagram - Radiated Test (Group 2/3/4)**

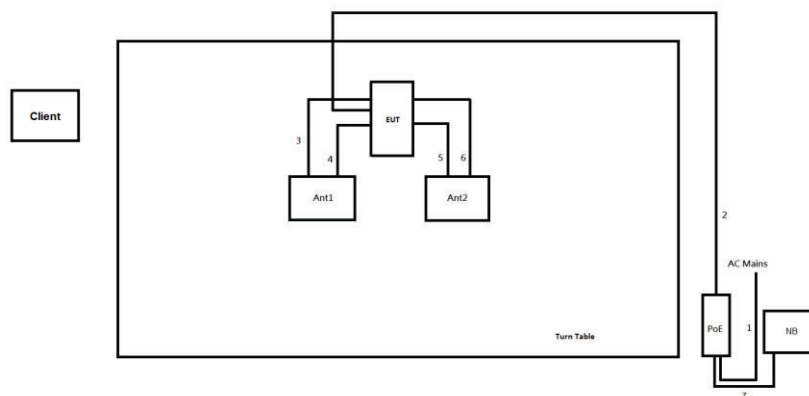

Item	Connection	Shielded	Length
1	Power Cable	No	1.8m
2	LAN Cable	No	10m
3	Antenna Cable	No	0.35m
4	Antenna Cable	No	0.35m
5	Antenna Cable	No	0.35m
6	Antenna Cable	No	0.35m
7	LAN Cable	No	1m

### 3 Transmitter Test Result

#### 3.1 Emission Bandwidth

##### 3.1.1 Emission Bandwidth Limit

Emission Bandwidth Limit	
<b>UNII Devices</b>	
<input type="checkbox"/>	For the 5.15-5.25 GHz band, N/A
<input checked="" type="checkbox"/>	For the 5.25-5.35 GHz band, N/A
<input checked="" type="checkbox"/>	For the 5.47-5.725 GHz band, N/A
<input checked="" type="checkbox"/>	For the 5.725-5.85 GHz band, 6 dB emission bandwidth $\geq$ 500kHz.

##### 3.1.2 Measuring Instruments

Refer a test equipment and calibration data table in this test report.

##### 3.1.3 Test Procedures

Test Method	
<ul style="list-style-type: none"> <li>For the emission bandwidth shall be measured using one of the options below:</li> </ul>	
<input checked="" type="checkbox"/>	Refer as KDB 789033, clause C for EBW and clause D for OBW measurement.
<input type="checkbox"/>	Refer as ANSI C63.10, clause 6.9.3 for occupied bandwidth testing.
<input type="checkbox"/>	Refer as IC RSS-Gen, clause 6.7 for bandwidth testing.

##### 3.1.4 Test Setup

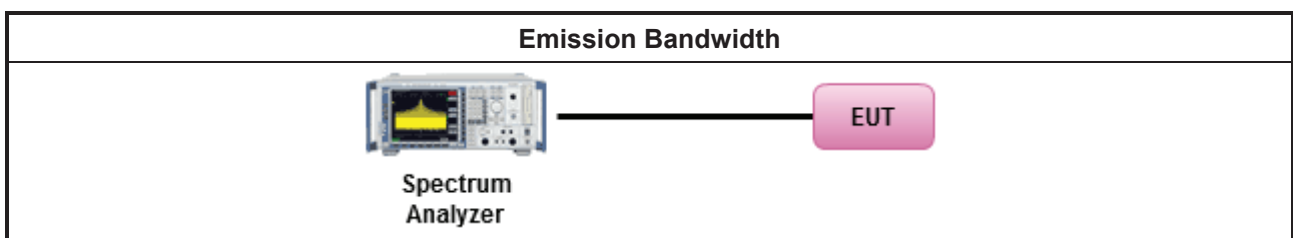

##### 3.1.5 Test Result of Emission Bandwidth

Refer as Appendix A



### 3.2 Maximum Conducted Output Power

#### 3.2.1 Maximum Conducted Output Power Limit

Maximum Conducted Output Power Limit	
<b>UNII Devices</b>	
<input type="checkbox"/> For the 5.15-5.25 GHz band:	
	<ul style="list-style-type: none"> <li>▪ Outdoor AP: the maximum conducted output power (<math>P_{Out}</math>) shall not exceed the lesser of 1 W. If <math>G_{TX} &gt; 6</math> dBi, then <math>P_{Out} = 30 - (G_{TX} - 6)</math>. e.i.r.p. at any elevation angle above 30 degrees <math>\leq 125mW</math> [21dBm]</li> </ul>
	<ul style="list-style-type: none"> <li>▪ Indoor AP: the maximum conducted output power (<math>P_{Out}</math>) shall not exceed the lesser of 1 W. If <math>G_{TX} &gt; 6</math> dBi, then <math>P_{Out} = 30 - (G_{TX} - 6)</math></li> </ul>
	<ul style="list-style-type: none"> <li>▪ Point-to-point AP: the maximum conducted output power (<math>P_{Out}</math>) shall not exceed the lesser of 1 W. If <math>G_{TX} &gt; 23</math> dBi, then <math>P_{Out} = 30 - (G_{TX} - 23)</math>.</li> </ul>
	<ul style="list-style-type: none"> <li>▪ Mobile or Portable Client: the maximum conducted output power (<math>P_{Out}</math>) shall not exceed the lesser of 250 mW. If <math>G_{TX} &gt; 6</math> dBi, then <math>P_{Out} = 24 - (G_{TX} - 6)</math>.</li> </ul>
<input checked="" type="checkbox"/> For the 5.25-5.35 GHz band, the maximum conducted output power ( $P_{Out}$ ) shall not exceed the lesser of 250 mW or $11 \text{ dBm} + 10 \log B$ , where B is the 26 dB emission bandwidth in MHz. If $G_{TX} > 6$ dBi, then $P_{Out} = 24 - (G_{TX} - 6)$ .	
<input checked="" type="checkbox"/> For the 5.47-5.725 GHz band, the maximum conducted output power ( $P_{Out}$ ) shall not exceed the lesser of 250 mW or $11 \text{ dBm} + 10 \log B$ , where B is the 26 dB emission bandwidth in MHz. If $G_{TX} > 6$ dBi, then $P_{Out} = 24 - (G_{TX} - 6)$ .	
<input checked="" type="checkbox"/> For the 5.725-5.85 GHz band:	
	<ul style="list-style-type: none"> <li>▪ Point-to-multipoint systems (P2M): the maximum conducted output power (<math>P_{Out}</math>) shall not exceed the lesser of 1 W. If <math>G_{TX} &gt; 6</math> dBi, then <math>P_{Out} = 30 - (G_{TX} - 6)</math>.</li> </ul>
	<ul style="list-style-type: none"> <li>▪ Point-to-point systems (P2P): the maximum conducted output power (<math>P_{Out}</math>) shall not exceed the lesser of 1 W.</li> </ul>
$P_{Out}$ = maximum conducted output power in dBm, $G_{TX}$ = the maximum transmitting antenna directional gain in dBi.	

#### 3.2.2 Measuring Instruments

Refer a test equipment and calibration data table in this test report.

### 3.2.3 Test Procedures

Test Method	
<ul style="list-style-type: none"> <li>Maximum Conducted Output Power</li> </ul>	
<ul style="list-style-type: none"> <li>Duty cycle <math>\geq 98\%</math> <ul style="list-style-type: none"> <li><input type="checkbox"/> Refer as KDB 789033, clause E Method SA-2 (spectral trace averaging).</li> </ul> </li> <li>Duty cycle <math>&lt; 98\%</math> <ul style="list-style-type: none"> <li><input checked="" type="checkbox"/> Refer as KDB 789033, clause E Method SA-2 Alt. (RMS detection with slow sweep speed)</li> </ul> </li> </ul>	
Wideband RF power meter and average over on/off periods with duty factor	
<ul style="list-style-type: none"> <li><input checked="" type="checkbox"/> Refer as KDB 789033, clause E Method PM (using an RF average power meter).</li> </ul>	
<ul style="list-style-type: none"> <li>For conducted measurement.           <ul style="list-style-type: none"> <li>If the EUT supports multiple transmit chains using options given below: Refer as KDB 662911, In-band power measurements. Using the measure-and-sum approach, measured all transmit ports individually. Sum the power (in linear power units e.g., mW) of all ports for each individual sample and save them.</li> <li>If multiple transmit chains, EIRP calculation could be following as methods:  <math>P_{total} = P_1 + P_2 + \dots + P_n</math>                (calculated in linear unit [mW] and transfer to log unit [dBm])  <math>EIRP_{total} = P_{total} + DG</math> </li> </ul> </li> </ul>	

### 3.2.4 Test Setup

For Straddle channel

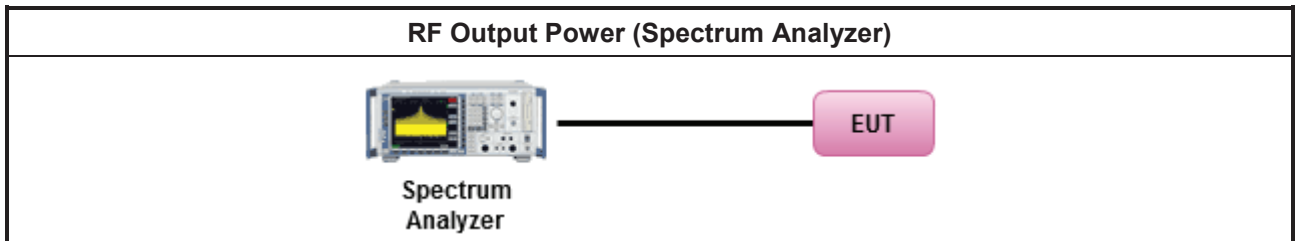

For Other channel

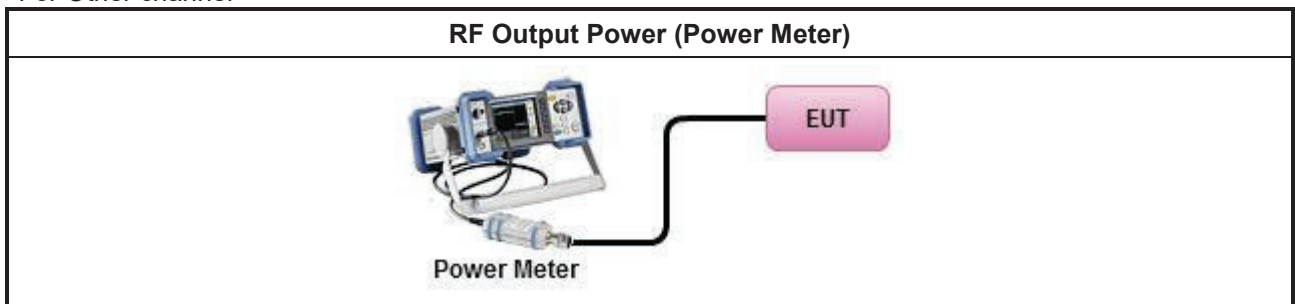

### 3.2.5 Test Result of Maximum Conducted Output Power

Refer as Appendix B



### 3.3 Peak Power Spectral Density

#### 3.3.1 Peak Power Spectral Density Limit

Peak Power Spectral Density Limit	
<b>UNII Devices</b>	
<input type="checkbox"/>	For the 5.15-5.25 GHz band:
<input type="checkbox"/>	<ul style="list-style-type: none"> <li>▪ Outdoor AP: the peak power spectral density (PPSD) shall not exceed the lesser of 17dBm/MHz. If <math>G_{TX} &gt; 6</math> dBi, then <math>P_{Out} = 17 - (G_{TX} - 6)</math>.</li> <li>▪ Indoor AP: the peak power spectral density (PPSD) shall not exceed the lesser of 17dBm/MHz. If <math>G_{TX} &gt; 6</math> dBi, then <math>P_{Out} = 17 - (G_{TX} - 6)</math>.</li> <li>▪ Point-to-point AP: the peak power spectral density (PPSD) shall not exceed the lesser of 17dBm/MHz. If <math>G_{TX} &gt; 23</math> dBi, then <math>P_{Out} = 17 - (G_{TX} - 23)</math>.</li> <li>▪ Mobile or Portable Client: the peak power spectral density (PPSD) <math>\leq 11</math> dBm/MHz. If <math>G_{TX} &gt; 6</math> dBi, then <math>PPSD = 11 - (G_{TX} - 6)</math>.</li> </ul>
<input checked="" type="checkbox"/>	For the 5.25-5.35 GHz band, the peak power spectral density (PPSD) $\leq 11$ dBm/MHz. If $G_{TX} > 6$ dBi, then $PPSD = 11 - (G_{TX} - 6)$ .
<input checked="" type="checkbox"/>	For the 5.47-5.725 GHz band, the peak power spectral density (PPSD) $\leq 11$ dBm/MHz. If $G_{TX} > 6$ dBi, then $PPSD = 11 - (G_{TX} - 6)$ .
<input checked="" type="checkbox"/>	For the 5.725-5.85 GHz band:
<input type="checkbox"/>	<ul style="list-style-type: none"> <li>▪ Point-to-multipoint systems (P2M): the peak power spectral density (PPSD) <math>\leq 30</math> dBm/500kHz. If <math>G_{TX} &gt; 6</math> dBi, then <math>PPSD = 30 - (G_{TX} - 6)</math>.</li> <li>▪ Point-to-point systems (P2P): the peak power spectral density (PPSD) <math>\leq 30</math> dBm/500kHz.</li> </ul>
<p><b>PPSD</b> = peak power spectral density that he same method as used to determine the conducted output power shall be used to determine the power spectral density. And power spectral density in dBm/MHz  <b>G<sub>TX</sub></b> = the maximum transmitting antenna directional gain in dBi.</p>	

#### 3.3.2 Measuring Instruments

Refer a test equipment and calibration data table in this test report.



### 3.3.3 Test Procedures

Test Method	
<ul style="list-style-type: none"> <li>▪ Peak power spectral density procedures that the same method as used to determine the conducted output power shall be used to determine the peak power spectral density and use the peak search function on the spectrum analyzer to find the peak of the spectrum. For the peak power spectral density shall be measured using below options:</li> </ul>	
<input type="checkbox"/>	Refer as KDB 789033, F)5) power spectral density can be measured using resolution bandwidths < 1 MHz provided that the results are integrated over 1 MHz bandwidth
Duty cycle ≥ 98%	
<input type="checkbox"/>	Refer as KDB 789033, clause E Method SA-2 (spectral trace averaging).
Duty cycle < 98%	
<input checked="" type="checkbox"/>	Refer as KDB 789033, clause E Method SA-2 Alt. (RMS detection with slow sweep speed)
<ul style="list-style-type: none"> <li>▪ For conducted measurement.</li> </ul>	
<ul style="list-style-type: none"> <li>▪ If the EUT supports multiple transmit chains using options given below:           <ul style="list-style-type: none"> <li>▪ Measure and sum the spectra across the outputs. Refer as KDB 662911, In-band power spectral density (PSD). Sample all transmit ports simultaneously using a spectrum analyzer for each transmit port. Where the trace bin-by-bin of each transmit port summing can be performed. (i.e., in the first spectral bin of output 1 is summed with that in the first spectral bin of output 2 and that from the first spectral bin of output 3, and so on up to the NTX output to obtain the value for the first frequency bin of the summed spectrum.). Add up the amplitude (power) values for the different transmit chains and use this as the new data trace.</li> </ul> </li> <li>▪ If multiple transmit chains, EIRP PPSD calculation could be following as methods:  <math>PPSD_{total} = PPSD_1 + PPSD_2 + \dots + PPSD_n</math>            (calculated in linear unit [mW] and transfer to log unit [dBm])  <math>EIRP_{total} = PPSD_{total} + DG</math> </li> </ul>	

### 3.3.4 Test Setup

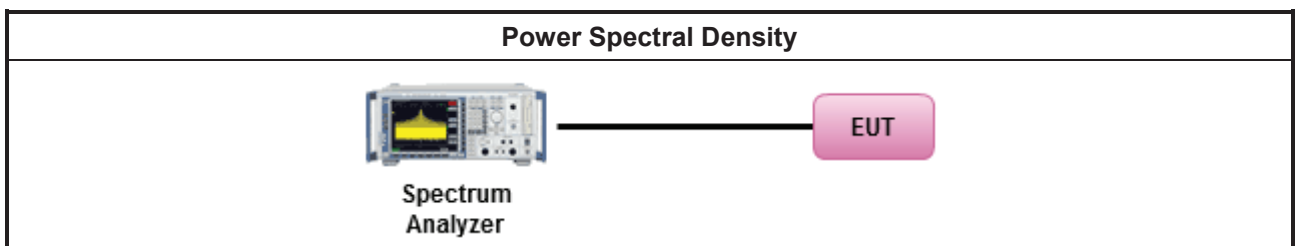

### 3.3.5 Test Result of Peak Power Spectral Density

Refer as Appendix C



### 3.4 Unwanted Emissions

#### 3.4.1 Transmitter Radiated Unwanted Emissions Limit

Unwanted emissions below 1 GHz and restricted band emissions above 1GHz limit			
Frequency Range (MHz)	Field Strength (uV/m)	Field Strength (dBuV/m)	Measure Distance (m)
0.009~0.490	2400/F(kHz)	48.5 - 13.8	300
0.490~1.705	24000/F(kHz)	33.8 - 23	30
1.705~30.0	30	29	30
30~88	100	40	3
88~216	150	43.5	3
216~960	200	46	3
Above 960	500	54	3

Note 1: Test distance for frequencies at or above 30 MHz, measurements may be performed at a distance other than the limit distance provided they are not performed in the near field and the emissions to be measured can be detected by the measurement equipment. When performing measurements at a distance other than that specified, the results shall be extrapolated to the specified distance using an extrapolation factor of 20 dB/decade (inverse of linear distance for field-strength measurements, inverse of linear distance-squared for power-density measurements).

Note 2: Test distance for frequencies at below 30 MHz, measurements may be performed at a distance closer than the EUT limit distance; however, an attempt should be made to avoid making measurements in the near field. When performing measurements below 30 MHz at a closer distance than the limit distance, the results shall be extrapolated to the specified distance by either making measurements at a minimum of two or more distances on at least one radial to determine the proper extrapolation factor or by using the square of an inverse linear distance extrapolation factor (40 dB/decade). The test report shall specify the extrapolation method used to determine compliance of the EUT.

Note 3: Using the distance of 1m during the test for above 18 GHz, and the test value to correct for the distance factor at 3m.

Un-restricted band emissions above 1GHz Limit	
Operating Band	Limit
5.15 - 5.25 GHz	e.i.r.p. -27 dBm [68.2 dBuV/m@3m]
5.25 - 5.35 GHz	e.i.r.p. -27 dBm [68.2 dBuV/m@3m]
5.47 - 5.725 GHz	e.i.r.p. -27 dBm [68.2 dBuV/m@3m]
5.725 - 5.85 GHz	5.650-5700 GHz: e.i.r.p. -27 ~ 10 dBm [68.2 ~ 105.2 dBuV/m@3m] 5.700-5720 GHz: e.i.r.p. 10 ~ 15.6 dBm [105.2 ~ 110.8 dBuV/m@3m] 5.720-5725 GHz: e.i.r.p. 15.6 ~ 27 dBm [110.8 ~ 122.2 dBuV/m@3m] 5.850-5.855 GHz: e.i.r.p. 27 ~ 15.6 dBm [122.2 ~ 110.8 dBuV/m@3m] 5.855-5.875 GHz: e.i.r.p. 15.6 ~ 10 dBm [110.8 ~ 105.2 dBuV/m@3m] 5.875-5.925 GHz: e.i.r.p. 10 ~ -27 dBm [105.2 ~ 68.2dBuV/m@3m] Other un-restricted band: e.i.r.p. -27 dBm [68.2 dBuV/m@3m]

Note 1: Measurements may be performed at a distance other than the limit distance provided they are not performed in the near field and the emissions to be measured can be detected by the measurement equipment. When performing measurements at a distance other than that specified, the results shall be extrapolated to the specified distance using an extrapolation factor of 20 dB/decade (inverse of linear distance for field-strength measurements, inverse of linear distance-squared for power-density measurements).

### 3.4.2 Measuring Instruments

Refer a test equipment and calibration data table in this test report.

### 3.4.3 Test Procedures

Test Method	
<ul style="list-style-type: none"> <li>Measurements may be performed at a distance other than the limit distance provided they are not performed in the near field and the emissions to be measured can be detected by the measurement equipment. Measurements shall not be performed at a distance greater than 30 m for frequencies above 30 MHz, unless it can be further demonstrated that measurements at a distance of 30 m or less are impractical. When performing measurements at a distance other than that specified, the results shall be extrapolated to the specified distance using an extrapolation factor of 20 dB/decade (inverse of linear distance for field-strength measurements, inverse of linear distance-squared for power-density measurements).</li> </ul>	
<ul style="list-style-type: none"> <li>The average emission levels shall be measured in [duty cycle ≥ 98 or duty factor].</li> </ul>	
<ul style="list-style-type: none"> <li>For the transmitter unwanted emissions shall be measured using following options below:           <ul style="list-style-type: none"> <li>Refer as KDB 789033, clause G)2) for unwanted emissions into non-restricted bands.</li> <li>Refer as KDB 789033, clause G)1) for unwanted emissions into restricted bands.</li> <li><input checked="" type="checkbox"/> Refer as KDB 789033, G)6) Method VB (ANSI C63.10, clause 4.1.4.2.3), Reduced VBW.</li> <li><input checked="" type="checkbox"/> Refer as KDB 789033, clause G)5) (ANSI C63.10, clause 4.1.4.2.2), measurement procedure peak limit.</li> </ul> </li> </ul>	
<ul style="list-style-type: none"> <li>For radiated measurement.           <ul style="list-style-type: none"> <li>Refer as ANSI C63.10, clause 6.4 for radiated emissions below 30 MHz and test distance is 3m.</li> <li>Refer as ANSI C63.10, clause 6.5 for radiated emissions 30 MHz to 1 GHz and test distance is 3m.</li> <li>Refer as ANSI C63.10, clause 6.6 for radiated emissions above 1GHz.</li> </ul> </li> </ul>	
<ul style="list-style-type: none"> <li>The any unwanted emissions level shall not exceed the fundamental emission level.</li> </ul>	
<ul style="list-style-type: none"> <li>All amplitude of spurious emissions that are attenuated by more than 20 dB below the permissible value has no need to be reported.</li> </ul>	
<ul style="list-style-type: none"> <li>Use the following spectrum analyzer settings:           <ul style="list-style-type: none"> <li>Set RBW=100 kHz for f &lt; 1 GHz; VBW=3 * RBW; Sweep = auto; Detector function = peak; Trace = max hold.</li> <li>Set RBW = 1 MHz, VBW= 3MHz for f ≥ 1 GHz for peak measurement. For average measurement, refer as 1.1.4.</li> </ul> </li> </ul>	
<ul style="list-style-type: none"> <li>KDB 414788 Open-Field Test Sites and Chamber Correlation Justification.           <ul style="list-style-type: none"> <li>Based on FCC 15.31(f)(2): measurements may be performed at a distance closer than that specified in regulations; however, an attempt should be made to avoid making measurements in the near field.</li> <li>Open-field site and chamber correlation testing had been performed and chamber measured test result is the worst case test result.</li> </ul> </li> </ul>	

### 3.4.4 Measurement Results Calculation

The measured Level is calculated using:

Corrected Reading: Raw(Read Level) + AF(Antenna Factor) + CL(Cable Loss) - PA(Preamplifier Factor)

### 3.4.5 Test Setup

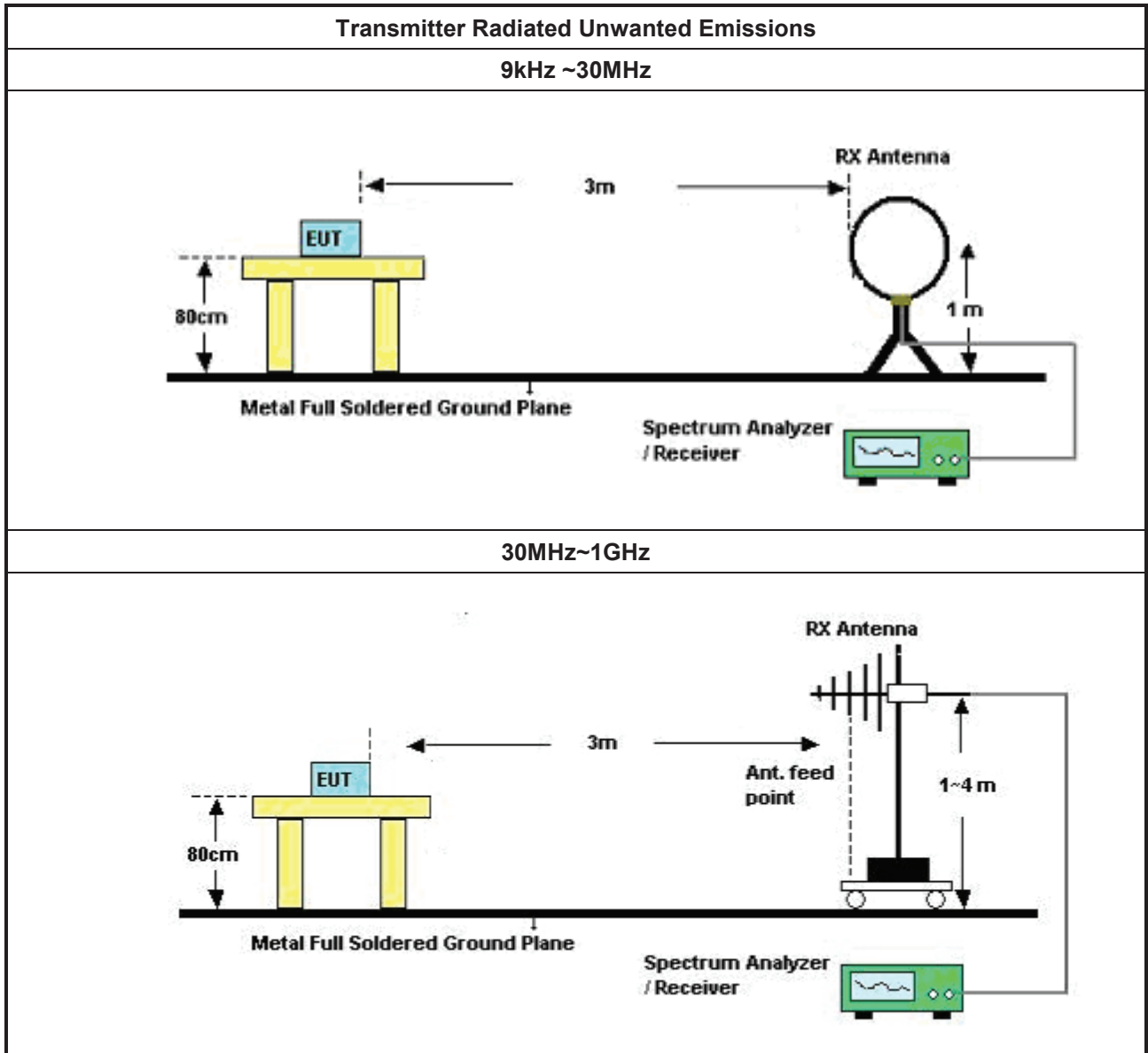

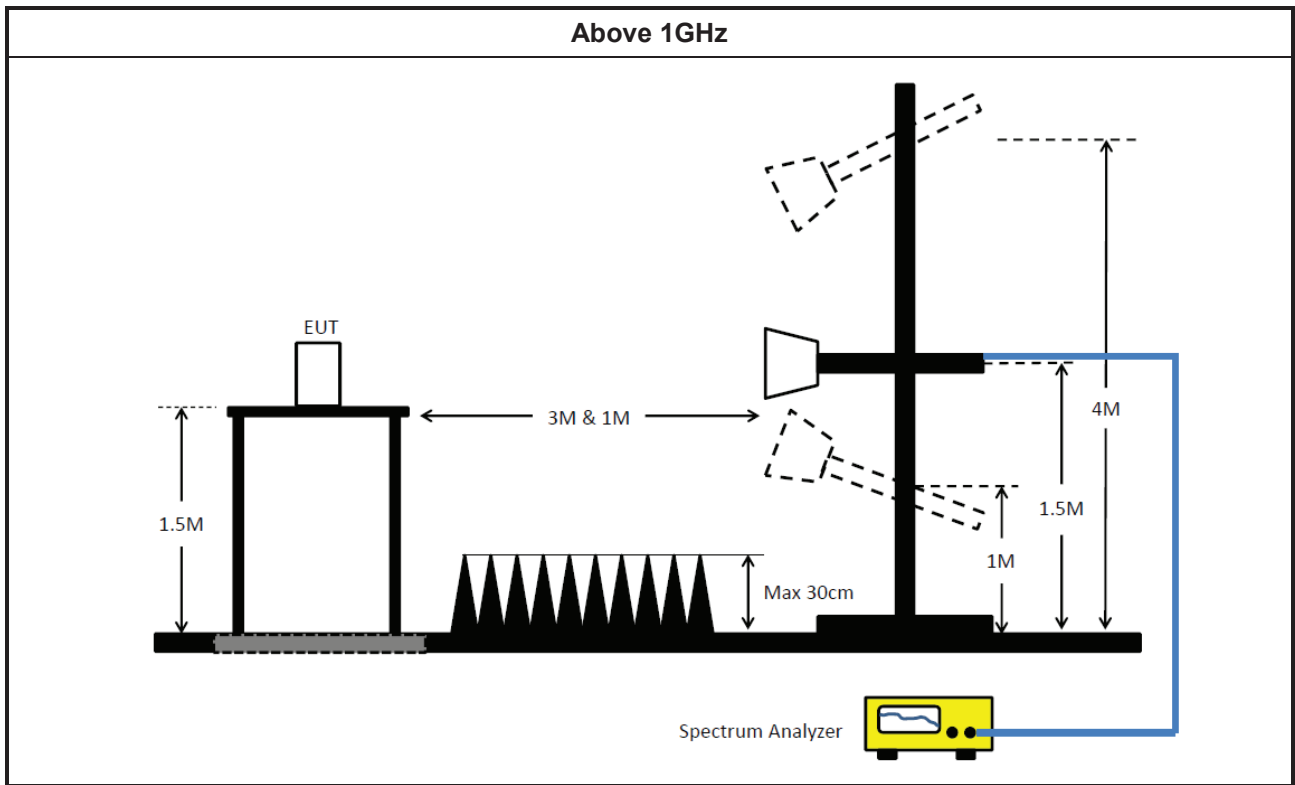

### 3.4.6 Transmitter Unwanted Emissions (Below 30MHz)

The amplitude of spurious emissions which are attenuated by more than 20dB below the permissible value has no need to be reported.

### 3.4.7 Test Result of Transmitter Unwanted Emissions

Refer as Appendix D



## 4 Test Equipment and Calibration Data

### Instrument for Conducted Test

Instrument	Manufacturer	Model No.	Serial No.	Spec.	Calibration Date	Calibration Due Date
Spectrum Analyzer	R&S	FSV 40	101013	10Hz ~ 40GHz	13/Mar/2019	12/Mar/2020
Power Sensor	Anritsu	MA2411B	0917017	300MHz ~ 40GHz	19/Feb/2019	18/Feb/2020
Power Meter	Anritsu	ML2495A	0949003	300MHz ~ 40GHz	19/Feb/2019	18/Feb/2020
SMB100A Signal Generator	R&S	SMB100A03	181147	100kHz~40GHz	12/Nov/2018	10/Nov/2020

### Instrument for Radiated Test (03CH02-HY)

Instrument	Manufacturer	Model No.	Serial No.	Spec.	Calibration Date	Calibration Due Date
3m Semi Anechoic Chamber	SIDT FRANKONIA	SAC-3M	03CH02-HY	1GHz ~ 18GHz 3m	29/Aug/2019	28/Aug/2020
Microwave Preamplifier	Agilent	8449B	3008A02373	1GHz ~ 26.5GHz	16/Oct/2019	15/Oct/2020
Spectrum Analyzer	Rohde & Schwarz	FSV40	101500	10Hz - 40GHz	15/Aug/2019	14/Aug/2020
RF Cable-high 6m	SUHNER	SUCOFLEX104	SN805193	1GHz~40GHz	09/Apr/2019	08/Apr/2020
RF Cable-high 7m	SUHNER	SUCOFLEX104	SN805192	1GHz~40GHz	09/Apr/2019	08/Apr/2020
Broadband Horn Antenna	SCHWARZBECK	BBHA 9170	BBHA 9170221	15GHz ~ 40GHz	22/Mar//2019	21/Mar/2020
Preamplifier	MITEQ	TTA1840-35-HG	1864481	18GHz ~ 40GHz	05/Aug/2019	04/Aug/2020
Double Ridged Guide Horn Antenna	SCHWARZBECK	BBHA 9120 D	BBHA 9120 D 01543	1GHz ~ 18GHz	03/Jun/2019	02/Jun/2020

### Instrument for Radiated Test (03CH09-HY)

Instrument	Manufacturer	Model No.	Serial No.	Spec.	Calibration Date	Calibration Due Date
3m Semi Anechoic Chamber	TDK	SAC-3M	03CH09-HY	1GHz~18GHz	20/Mar/2019	19/Mar/2020
Microwave Preamplifier	Agilent	8449B	3008A02096	1GHz~26.5GHz	04/Sep/2019	03/Sep/2020
EXA Signal Analyzer	KEYSIGHT	N9010A	MY54200885	10Hz~44GHz	07/Aug/2019	06/Aug/2020
Double Ridged Guide Horn Antenna	SCHWARZBECK	BBHA 9120 D	BBHA9120 D 1534	1GHz~18GHz	22/May/2019	21/May/2020
Broadband Horn Antenna	SCHWARZBECK	BBHA 9170	BBHA 9170221	18GHz~40GHz	13/Mar/2020	12/Mar/2021
Preamplifier	MITEQ	TTA1840-35-HG	1864481	18GHz~40GHz	05/Aug/2019	04/Aug/2020
RF Cable-high	HUBER+SUHNER	SUCOFLEX104	324530/4+17 173/4	1GHz~40GHz	03/Jul/2019	02/Jul/2020



Instrument for Radiated Test (Co-location)

Instrument	Manufacturer /Brand	Model No.	Serial No.	Spec.	Calibration Date	Calibration Due Date
3m Semi Anechoic Chamber	SIDT FRANKONIA	SAC-3M	03CH02-HY	1GHz~18GHz 3m	30/Jul/2022	29/Jul/2023
Signal Analyzer	R&S	FSP40	100593	9kHz~40GHz	08/Apr/2022	07/Apr/2023
Microwave Preamplifier	Agilent	8449B	3008A02373	1GHz~26.5GHz	02/Nov/2022	01/Nov/2023
Double Ridged Guide Horn Antenna	SCHWARZBECK	BBHA 9120 D	02268	1GHz ~18GHz	27/Sep/2022	26/Sep/2023
RF Cable-R03m	HUBER+SUHNER	SUCOFLEX104	805193/4+805192/4	1GHz~40GHz	01/Apr/2022	31/Mar/2023
Broadband Horn Antenna	SCHWARZBECK	BBHA 9170	BBHA 9170221	15GHz~40GHz	18/Mar/2022	17/Mar/2023
Microwave Preamplifier	EMC INSTRUMENTS	EM18G40G	060604	18GHz~40GHz	08/Mar/2022	07/Mar/2023
SENSE-EMI	Sporton	V5.10.8.3	N/A	N/A	N/A	N/A



Summary

Mode	Max-N dB (Hz)	Max-OBW (Hz)	ITU-Code	Min-N dB (Hz)	Min-OBW (Hz)
5.25-5.35GHz	-	-	-	-	-
802.11a_Nss1,(6Mbps)_1TX	35.67M	19.22M	19M2D1D	22.92M	16.552M
802.11a_Nss1,(6Mbps)_2TX	20.37M	16.402M	16M4D1D	19.59M	16.372M
802.11ac_VHT20_Nss1,(MCS0)_1TX	36.21M	18.771M	18M8D1D	23.16M	17.691M
802.11ac_VHT20_Nss1,(MCS0)_2TX	22.29M	17.601M	17M6D1D	20.76M	17.541M
802.11ac_VHT40_Nss1,(MCS0)_1TX	80.82M	37.421M	37M4D1D	44.28M	36.282M
802.11ac_VHT40_Nss1,(MCS0)_2TX	62.52M	36.582M	36M6D1D	42.72M	36.162M
802.11ac_VHT80_Nss1,(MCS0)_1TX	84.72M	75.442M	75M4D1D	84.72M	75.442M
802.11ac_VHT80_Nss1,(MCS0)_2TX	83.52M	75.442M	75M4D1D	83.52M	75.322M
802.11ax_HEW20_Nss1,(MCS0)_1TX	38.88M	19.49M	19M5D1D	23.97M	19.01M
802.11ax_HEW20_Nss1,(MCS0)_2TX	21.96M	18.951M	19M0D1D	21.27M	18.921M
802.11ax_HEW40_Nss1,(MCS0)_1TX	77.22M	38.321M	38M3D1D	43.8M	37.841M
802.11ax_HEW40_Nss1,(MCS0)_2TX	63.66M	38.081M	38M1D1D	41.94M	37.781M
802.11ax_HEW80_Nss1,(MCS0)_1TX	84.72M	77.361M	77M4D1D	84.72M	77.361M
802.11ax_HEW80_Nss1,(MCS0)_2TX	84.96M	77.241M	77M2D1D	83.64M	77.121M
5.47-5.725GHz	-	-	-	-	-
802.11a_Nss1,(6Mbps)_1TX	36.78M	19.64M	19M6D1D	19.56M	14.093M
802.11a_Nss1,(6Mbps)_2TX	19.77M	16.402M	16M4D1D	14.7M	13.193M
802.11ac_VHT20_Nss1,(MCS0)_1TX	38.25M	19.43M	19M4D1D	20.64M	14.273M
802.11ac_VHT20_Nss1,(MCS0)_2TX	21.24M	17.571M	17M6D1D	15.12M	13.763M
802.11ac_VHT40_Nss1,(MCS0)_1TX	55.615M	36.402M	36M4D1D	41.58M	34.213M
802.11ac_VHT40_Nss1,(MCS0)_2TX	53.095M	36.282M	36M3D1D	40.98M	33.023M
802.11ac_VHT80_Nss1,(MCS0)_1TX	99.375M	75.442M	75M4D1D	83.76M	72.489M
802.11ac_VHT80_Nss1,(MCS0)_2TX	96.45M	75.442M	75M4D1D	78.15M	72.264M
802.11ax_HEW20_Nss1,(MCS0)_1TX	40.17M	19.67M	19M7D1D	21.42M	14.678M
802.11ax_HEW20_Nss1,(MCS0)_2TX	21.78M	18.981M	19M0D1D	15.57M	14.438M
802.11ax_HEW40_Nss1,(MCS0)_1TX	62.58M	37.901M	37M9D1D	42.06M	34.108M
802.11ax_HEW40_Nss1,(MCS0)_2TX	51.835M	37.901M	37M9D1D	42M	33.828M
802.11ax_HEW80_Nss1,(MCS0)_1TX	103.8M	77.241M	77M2D1D	84.36M	73.238M
802.11ax_HEW80_Nss1,(MCS0)_2TX	84.48M	77.241M	77M2D1D	77.625M	73.163M
5.725-5.85GHz	-	-	-	-	-
802.11a_Nss1,(6Mbps)_1TX	3.12M	10.435M	10M4D1D	3.12M	10.435M
802.11a_Nss1,(6Mbps)_2TX	3.14M	3.458M	3M46D1D	3.14M	3.398M
802.11ac_VHT20_Nss1,(MCS0)_1TX	3.76M	9.055M	9M06D1D	3.76M	9.055M
802.11ac_VHT20_Nss1,(MCS0)_2TX	3.76M	4.018M	4M02D1D	3.76M	3.958M
802.11ac_VHT40_Nss1,(MCS0)_1TX	3.16M	24.728M	24M7D1D	3.16M	24.728M
802.11ac_VHT40_Nss1,(MCS0)_2TX	3.14M	21.609M	21M6D1D	3.14M	20.03M
802.11ac_VHT80_Nss1,(MCS0)_1TX	3.12M	31.504M	31M5D1D	3.12M	31.504M
802.11ac_VHT80_Nss1,(MCS0)_2TX	3.22M	24.148M	24M1D1D	3.14M	22.909M
802.11ax_HEW20_Nss1,(MCS0)_1TX	4.46M	11.614M	11M6D1D	4.46M	11.614M
802.11ax_HEW20_Nss1,(MCS0)_2TX	4.44M	4.538M	4M54D1D	4.36M	4.538M
802.11ax_HEW40_Nss1,(MCS0)_1TX	4.12M	25.447M	25M4D1D	4.12M	25.447M
802.11ax_HEW40_Nss1,(MCS0)_2TX	4.08M	23.948M	23M9D1D	4.04M	22.649M
802.11ax_HEW80_Nss1,(MCS0)_1TX	4.04M	31.944M	31M9D1D	4.04M	31.944M





Mode	Max-N dB (Hz)	Max-OBW (Hz)	ITU-Code	Min-N dB (Hz)	Min-OBW (Hz)
802.11ax HEW80_Nss1,(MCS0)_2TX	4.1M	26.727M	26M7D1D	4M	24.608M

**Max-N dB** = Maximum 6dB down bandwidth for 5.725-5.85GHz band / Maximum 26dB down bandwidth for other band;

**Max-OBW** = Maximum 99% occupied bandwidth;

**Min-N dB** = Minimum 6dB down bandwidth for 5.725-5.85GHz band / Maximum 26dB down bandwidth for other band;

**Min-OBW** = Minimum 99% occupied bandwidth;



Result

Mode	Result	Limit (Hz)	Port 1-N dB (Hz)	Port 1-OBW (Hz)	Port 2-N dB (Hz)	Port 2-OBW (Hz)
802.11a_Nss1,(6Mbps)_1TX	-	-	-	-	-	-
5260MHz	Pass	Inf	35.67M	19.22M		
5300MHz	Pass	Inf	34.44M	17.721M		
5320MHz	Pass	Inf	22.92M	16.552M		
5500MHz	Pass	Inf	19.83M	16.372M		
5580MHz	Pass	Inf	36.78M	19.64M		
5700MHz	Pass	Inf	19.56M	16.342M		
5720MHz Straddle 5.47-5.725GHz	Pass	Inf	21.915M	14.093M		
5720MHz Straddle 5.725-5.85GHz	Pass	500k	3.12M	10.435M		
802.11a_Nss1,(6Mbps)_2TX	-	-	-	-	-	-
5260MHz	Pass	Inf	19.92M	16.372M	19.59M	16.402M
5300MHz	Pass	Inf	20.37M	16.372M	20.16M	16.402M
5320MHz	Pass	Inf	19.95M	16.372M	20.16M	16.402M
5500MHz	Pass	Inf	19.56M	16.372M	19.77M	16.402M
5580MHz	Pass	Inf	19.53M	16.372M	19.38M	16.372M
5700MHz	Pass	Inf	19.41M	16.342M	19.35M	16.372M
5720MHz Straddle 5.47-5.725GHz	Pass	Inf	14.94M	13.208M	14.7M	13.193M
5720MHz Straddle 5.725-5.85GHz	Pass	500k	3.14M	3.398M	3.14M	3.458M
802.11ac VHT20_Nss1,(MCS0)_1TX	-	-	-	-	-	-
5260MHz	Pass	Inf	36.21M	18.771M		
5300MHz	Pass	Inf	34.32M	18.261M		
5320MHz	Pass	Inf	23.16M	17.691M		
5500MHz	Pass	Inf	20.88M	17.571M		
5580MHz	Pass	Inf	38.25M	19.43M		
5700MHz	Pass	Inf	20.64M	17.541M		
5720MHz Straddle 5.47-5.725GHz	Pass	Inf	20.76M	14.273M		
5720MHz Straddle 5.725-5.85GHz	Pass	500k	3.76M	9.055M		
802.11ac VHT20_Nss1,(MCS0)_2TX	-	-	-	-	-	-
5260MHz	Pass	Inf	20.76M	17.571M	21M	17.541M
5300MHz	Pass	Inf	21.21M	17.571M	22.29M	17.601M
5320MHz	Pass	Inf	21.3M	17.601M	21.33M	17.571M
5500MHz	Pass	Inf	20.91M	17.571M	21.24M	17.571M
5580MHz	Pass	Inf	20.88M	17.541M	20.76M	17.541M
5700MHz	Pass	Inf	20.7M	17.541M	20.82M	17.571M
5720MHz Straddle 5.47-5.725GHz	Pass	Inf	15.54M	13.778M	15.12M	13.763M
5720MHz Straddle 5.725-5.85GHz	Pass	500k	3.76M	4.018M	3.76M	3.958M
802.11ac VHT40_Nss1,(MCS0)_1TX	-	-	-	-	-	-
5270MHz	Pass	Inf	80.82M	37.421M		
5310MHz	Pass	Inf	44.28M	36.282M		
5510MHz	Pass	Inf	41.58M	36.162M		
5550MHz	Pass	Inf	52.86M	36.402M		
5670MHz	Pass	Inf	42.72M	36.222M		
5710MHz Straddle 5.47-5.725GHz	Pass	Inf	55.615M	34.213M		
5710MHz Straddle 5.725-5.85GHz	Pass	500k	3.16M	24.728M		



Mode	Result	Limit (Hz)	Port 1-N dB (Hz)	Port 1-OBW (Hz)	Port 2-N dB (Hz)	Port 2-OBW (Hz)
802.11ac VHT40_Nss1,(MCS0)_2TX	-	-	-	-	-	-
5270MHz	Pass	Inf	56.94M	36.462M	62.52M	36.582M
5310MHz	Pass	Inf	42.72M	36.162M	42.78M	36.222M
5510MHz	Pass	Inf	41.4M	36.162M	40.98M	36.102M
5550MHz	Pass	Inf	43.86M	36.162M	43.32M	36.282M
5670MHz	Pass	Inf	41.76M	36.162M	42.06M	36.162M
5710MHz Straddle 5.47-5.725GHz	Pass	Inf	47.88M	33.023M	53.095M	33.198M
5710MHz Straddle 5.725-5.85GHz	Pass	500k	3.14M	20.03M	3.14M	21.609M
802.11ac VHT80_Nss1,(MCS0)_1TX	-	-	-	-	-	-
5290MHz	Pass	Inf	84.72M	75.442M		
5530MHz	Pass	Inf	83.76M	75.442M		
5610MHz	Pass	Inf	84.6M	75.442M		
5690MHz Straddle 5.47-5.725GHz	Pass	Inf	99.375M	72.489M		
5690MHz Straddle 5.725-5.85GHz	Pass	500k	3.12M	31.504M		
802.11ac VHT80_Nss1,(MCS0)_2TX	-	-	-	-	-	-
5290MHz	Pass	Inf	83.52M	75.442M	83.52M	75.322M
5530MHz	Pass	Inf	83.52M	75.202M	83.64M	75.442M
5610MHz	Pass	Inf	83.76M	75.322M	82.56M	75.202M
5690MHz Straddle 5.47-5.725GHz	Pass	Inf	78.15M	72.264M	96.45M	72.414M
5690MHz Straddle 5.725-5.85GHz	Pass	500k	3.14M	22.909M	3.22M	24.148M
802.11ax HEW20_Nss1,(MCS0)_1TX	-	-	-	-	-	-
5260MHz	Pass	Inf	38.88M	19.49M		
5300MHz	Pass	Inf	38.43M	19.37M		
5320MHz	Pass	Inf	23.97M	19.01M		
5500MHz	Pass	Inf	21.99M	18.921M		
5580MHz	Pass	Inf	40.17M	19.67M		
5700MHz	Pass	Inf	21.42M	18.921M		
5720MHz Straddle 5.47-5.725GHz	Pass	Inf	24.015M	14.678M		
5720MHz Straddle 5.725-5.85GHz	Pass	500k	4.46M	11.614M		
802.11ax HEW20_Nss1,(MCS0)_2TX	-	-	-	-	-	-
5260MHz	Pass	Inf	21.48M	18.921M	21.27M	18.921M
5300MHz	Pass	Inf	21.87M	18.921M	21.96M	18.951M
5320MHz	Pass	Inf	21.72M	18.951M	21.57M	18.951M
5500MHz	Pass	Inf	21.66M	18.981M	21.78M	18.951M
5580MHz	Pass	Inf	21.15M	18.921M	21.21M	18.921M
5700MHz	Pass	Inf	21.21M	18.891M	21.33M	18.921M
5720MHz Straddle 5.47-5.725GHz	Pass	Inf	15.57M	14.453M	15.945M	14.438M
5720MHz Straddle 5.725-5.85GHz	Pass	500k	4.36M	4.538M	4.44M	4.538M
802.11ax HEW40_Nss1,(MCS0)_1TX	-	-	-	-	-	-
5270MHz	Pass	Inf	77.22M	38.321M		
5310MHz	Pass	Inf	43.8M	37.841M		
5510MHz	Pass	Inf	42.12M	37.721M		
5550MHz	Pass	Inf	62.58M	37.901M		
5670MHz	Pass	Inf	42.06M	37.841M		
5710MHz Straddle 5.47-5.725GHz	Pass	Inf	53.235M	34.108M		



Mode	Result	Limit (Hz)	Port 1-N dB (Hz)	Port 1-OBW (Hz)	Port 2-N dB (Hz)	Port 2-OBW (Hz)
5710MHz Straddle 5.725-5.85GHz	Pass	500k	4.12M	25.447M		
802.11ax HEW40_Nss1,(MCS0)_2TX	-	-	-	-	-	-
5270MHz	Pass	Inf	62.52M	37.961M	63.66M	38.081M
5310MHz	Pass	Inf	41.94M	37.781M	42.24M	37.781M
5510MHz	Pass	Inf	42.06M	37.721M	42M	37.781M
5550MHz	Pass	Inf	42.36M	37.841M	44.16M	37.901M
5670MHz	Pass	Inf	42.06M	37.781M	42.18M	37.781M
5710MHz Straddle 5.47-5.725GHz	Pass	Inf	47.005M	33.828M	51.835M	33.933M
5710MHz Straddle 5.725-5.85GHz	Pass	500k	4.04M	22.649M	4.08M	23.948M
802.11ax HEW80_Nss1,(MCS0)_1TX	-	-	-	-	-	-
5290MHz	Pass	Inf	84.72M	77.361M		
5530MHz	Pass	Inf	84.36M	77.121M		
5610MHz	Pass	Inf	90.96M	77.241M		
5690MHz Straddle 5.47-5.725GHz	Pass	Inf	103.8M	73.238M		
5690MHz Straddle 5.725-5.85GHz	Pass	500k	4.04M	31.944M		
802.11ax HEW80_Nss1,(MCS0)_2TX	-	-	-	-	-	-
5290MHz	Pass	Inf	84.96M	77.121M	83.64M	77.241M
5530MHz	Pass	Inf	84.36M	77.121M	83.76M	77.121M
5610MHz	Pass	Inf	84.48M	77.241M	84.24M	77.121M
5690MHz Straddle 5.47-5.725GHz	Pass	Inf	77.7M	73.163M	77.625M	73.238M
5690MHz Straddle 5.725-5.85GHz	Pass	500k	4.1M	24.608M	4M	26.727M

**Port X-N dB** = Port X 6dB down bandwidth for 5.725-5.85GHz band / 26dB down bandwidth for other band  
**Port X-OBW** = Port X 99% occupied bandwidth;

802.11a\_Nss1,(6Mbps)\_1TX(Port1)

EBW

5260MHz

04/12/2019

CF  
5.26GHz  
Span  
60MHz  
RBW  
300kHz  
VBW  
1MHz  
Sweep Time  
100ms  
Detector Type  
Peak  
Port1

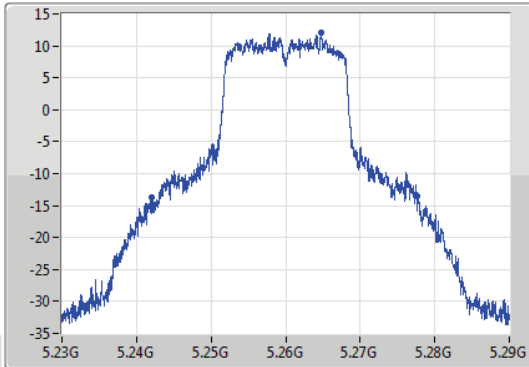

CF  
5.26GHz  
Span  
60MHz  
RBW  
200kHz  
VBW  
1MHz  
Sweep Time  
100ms  
Detector Type  
Peak

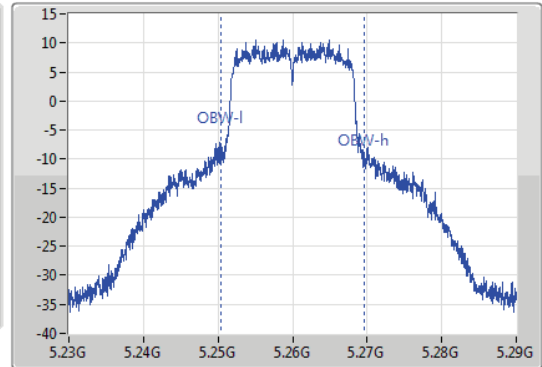

26dB(Hz)	Fl-26dB(Hz)	Fh-26dB(Hz)	OBW(Hz)	Fl-OBW(Hz)	Fh-OBW(Hz)	Limit(Hz)	Port
35.67M	5.24197G	5.27764G	19.22M	5.250315G	5.269535G	Inf	1

802.11a\_Nss1,(6Mbps)\_1TX(Port1)

EBW

5300MHz

04/12/2019

CF  
5.3GHz  
Span  
60MHz  
RBW  
300kHz  
VBW  
1MHz  
Sweep Time  
100ms  
Detector Type  
Peak  
Port1

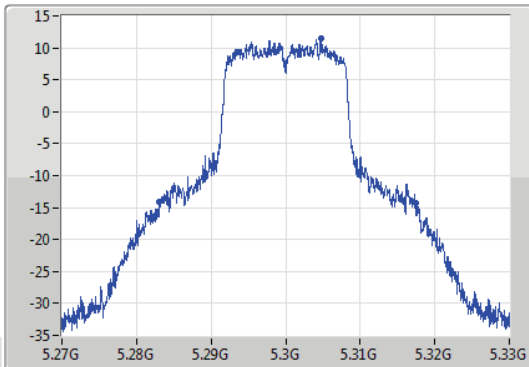

CF  
5.3GHz  
Span  
60MHz  
RBW  
200kHz  
VBW  
1MHz  
Sweep Time  
100ms  
Detector Type  
Peak

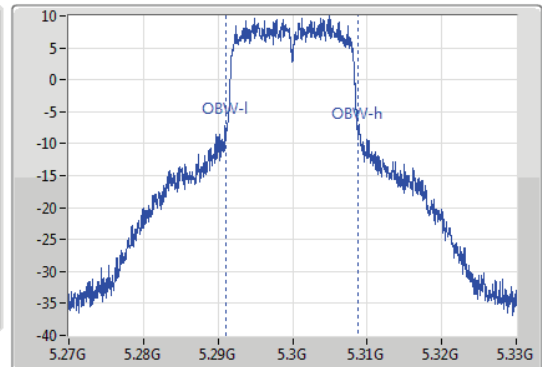

26dB(Hz)	Fl-26dB(Hz)	Fh-26dB(Hz)	OBW(Hz)	Fl-OBW(Hz)	Fh-OBW(Hz)	Limit(Hz)	Port
34.44M	5.28308G	5.31752G	17.721M	5.291094G	5.308816G	Inf	1

802.11a\_Nss1,(6Mbps)\_1TX(Port1)

EBW

5320MHz

04/12/2019

CF: 5.32GHz  
 Span: 60MHz  
 RBW: 300kHz  
 VBW: 1MHz  
 Sweep Time: 100ms  
 Detector Type: Peak  
 Port 1

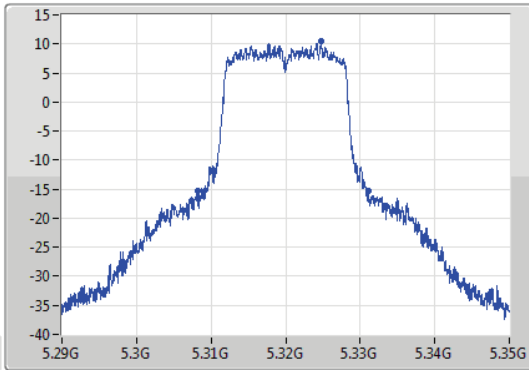

CF: 5.32GHz  
 Span: 60MHz  
 RBW: 200kHz  
 VBW: 1MHz  
 Sweep Time: 100ms  
 Detector Type: Peak

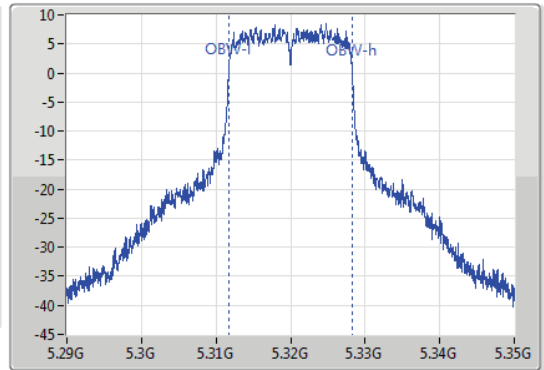

26dB(Hz)	Fl-26dB(Hz)	Fh-26dB(Hz)	OBW(Hz)	Fl-OBW(Hz)	Fh-OBW(Hz)	Limit(Hz)	Port
22.92M	5.30815G	5.33107G	16.552M	5.311694G	5.328246G	Inf	1

802.11a\_Nss1,(6Mbps)\_1TX(Port1)

EBW

5500MHz

04/12/2019

CF: 5.5GHz  
 Span: 60MHz  
 RBW: 300kHz  
 VBW: 1MHz  
 Sweep Time: 100ms  
 Detector Type: Peak  
 Port 1

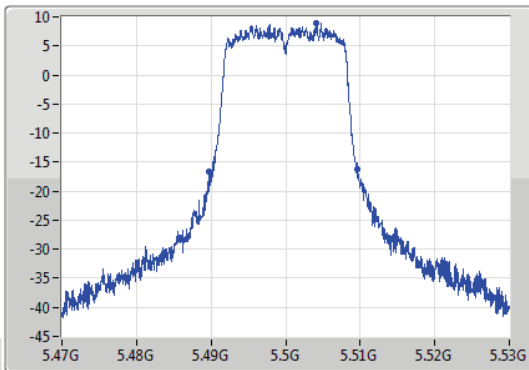

CF: 5.5GHz  
 Span: 60MHz  
 RBW: 200kHz  
 VBW: 1MHz  
 Sweep Time: 100ms  
 Detector Type: Peak

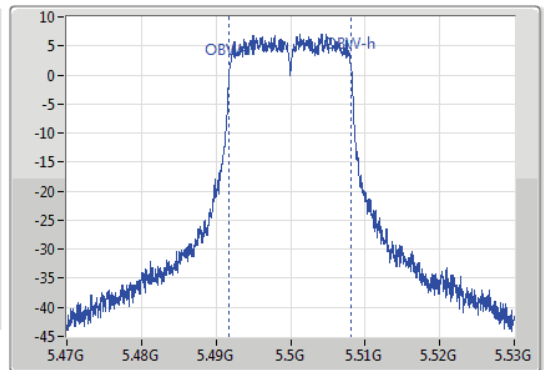

26dB(Hz)	Fl-26dB(Hz)	Fh-26dB(Hz)	OBW(Hz)	Fl-OBW(Hz)	Fh-OBW(Hz)	Limit(Hz)	Port
19.83M	5.48977G	5.5096G	16.372M	5.491784G	5.508156G	Inf	1

802.11a\_Nss1,(6Mbps)\_1TX(Port1)

EBW

5580MHz

04/12/2019

CF  
5.58GHz  
Span  
60MHz  
RBW  
300kHz  
VBW  
1MHz  
Sweep Time  
100ms  
Detector Type  
Peak  
Port 1

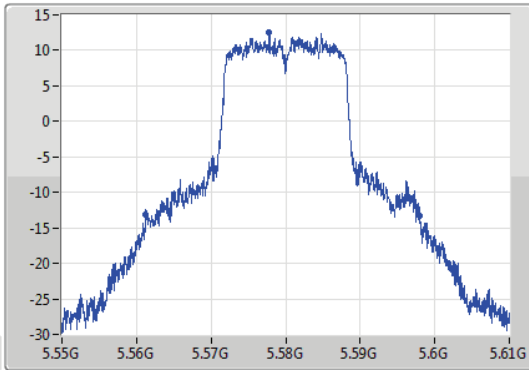

CF  
5.58GHz  
Span  
60MHz  
RBW  
200kHz  
VBW  
1MHz  
Sweep Time  
100ms  
Detector Type  
Peak

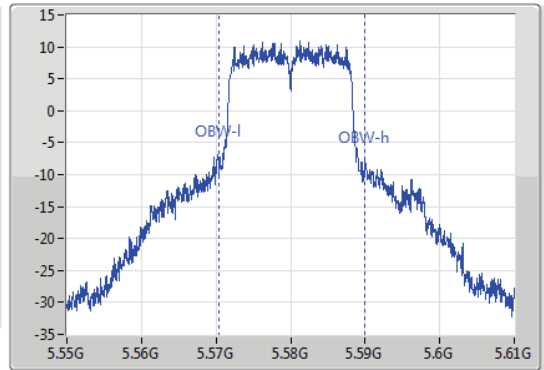

26dB(Hz)	Fl-26dB(Hz)	Fh-26dB(Hz)	OBW(Hz)	Fl-OBW(Hz)	Fh-OBW(Hz)	Limit(Hz)	Port
36.78M	5.56122G	5.598G	19.64M	5.570315G	5.589955G	Inf	1

802.11a\_Nss1,(6Mbps)\_1TX(Port1)

EBW

5700MHz

04/12/2019

CF  
5.7GHz  
Span  
60MHz  
RBW  
300kHz  
VBW  
1MHz  
Sweep Time  
100ms  
Detector Type  
Peak  
Port 1

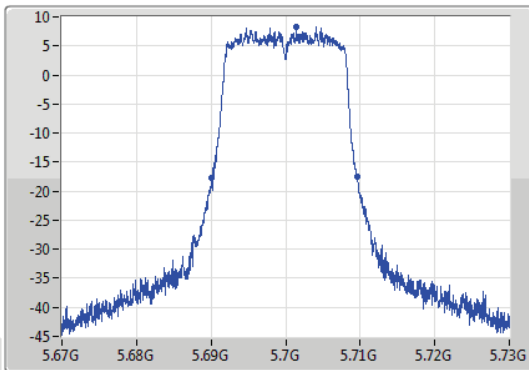

CF  
5.7GHz  
Span  
60MHz  
RBW  
200kHz  
VBW  
1MHz  
Sweep Time  
100ms  
Detector Type  
Peak

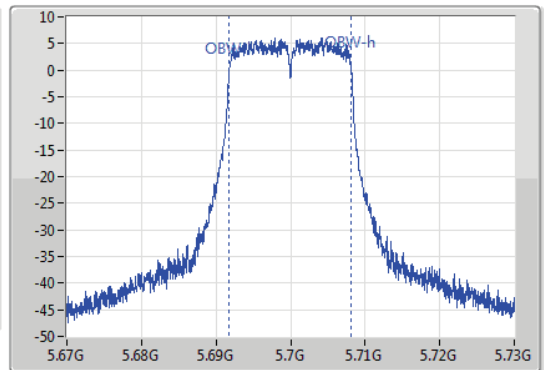

26dB(Hz)	Fl-26dB(Hz)	Fh-26dB(Hz)	OBW(Hz)	Fl-OBW(Hz)	Fh-OBW(Hz)	Limit(Hz)	Port
19.56M	5.69013G	5.70969G	16.342M	5.691784G	5.708126G	Inf	1

802.11a\_Nss1,(6Mbps)\_1TX(Port1)

EBW

5720MHz Straddle 5.47-5.725GHz

04/12/2019

CF: 5.71GHz  
 Span: 30MHz  
 RBW: 300kHz  
 VBW: 1MHz  
 Sweep Time: 100ms  
 Detector Type: Peak  
 Port 1

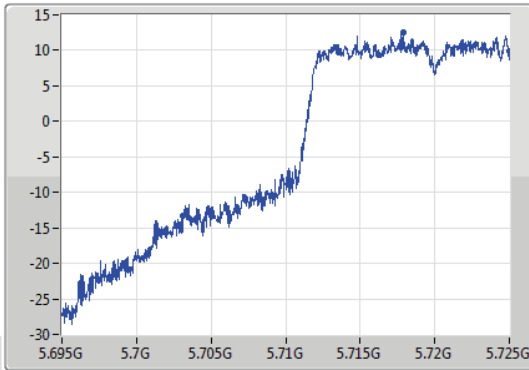

CF: 5.71GHz  
 Span: 30MHz  
 RBW: 200kHz  
 VBW: 1MHz  
 Sweep Time: 100ms  
 Detector Type: Peak

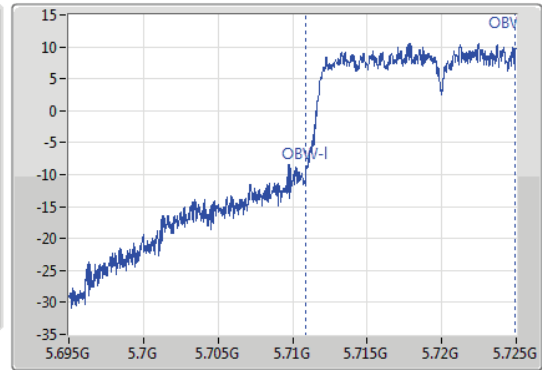

26dB(Hz)	Fl-26dB(Hz)	Fh-26dB(Hz)	OBW(Hz)	Fl-OBW(Hz)	Fh-OBW(Hz)	Limit(Hz)	Port
21.915M	5.703085G	5.725G	14.093M	5.710855G	5.724948G	Inf	1

802.11a\_Nss1,(6Mbps)\_1TX(Port1)

EBW

5720MHz Straddle 5.725-5.85GHz

04/12/2019

CF: 5.745GHz  
 Span: 40MHz  
 RBW: 100kHz  
 VBW: 300kHz  
 Sweep Time: 100ms  
 Detector Type: Peak  
 Port 1

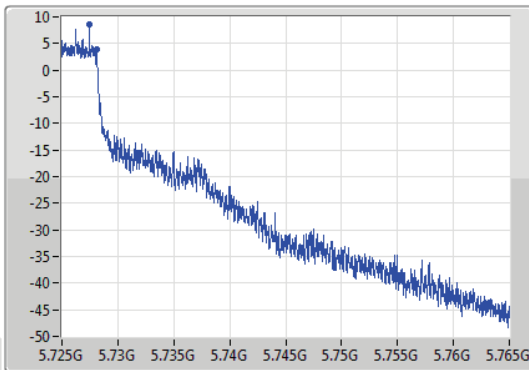

CF: 5.745GHz  
 Span: 40MHz  
 RBW: 50kHz  
 VBW: 200kHz  
 Sweep Time: 100ms  
 Detector Type: Peak

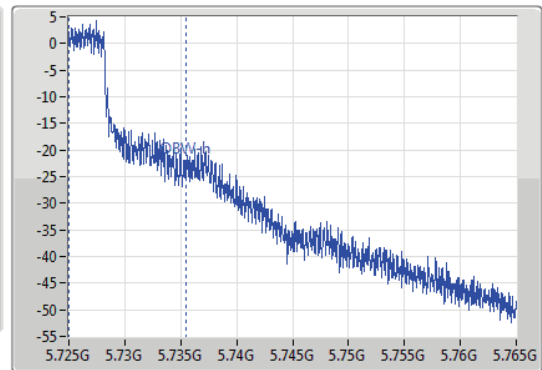

6dB(Hz)	Fl-6dB(Hz)	Fh-6dB(Hz)	OBW(Hz)	Fl-OBW(Hz)	Fh-OBW(Hz)	Limit(Hz)	Port
3.12M	5.725G	5.72812G	10.435M	5.72501G	5.735445G	500k	1



802.11a\_Nss1,(6Mbps)\_2TX

EBW

5260MHz

04/12/2019

CF  
5.26GHz  
Span  
60MHz  
RBW  
300kHz  
VBW  
1MHz  
Sweep Time  
100ms  
Detector Type  
Peak

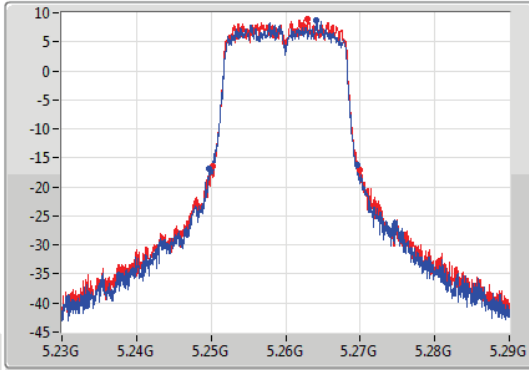

CF  
5.26GHz  
Span  
60MHz  
RBW  
200kHz  
VBW  
1MHz  
Sweep Time  
100ms  
Detector Type  
Peak

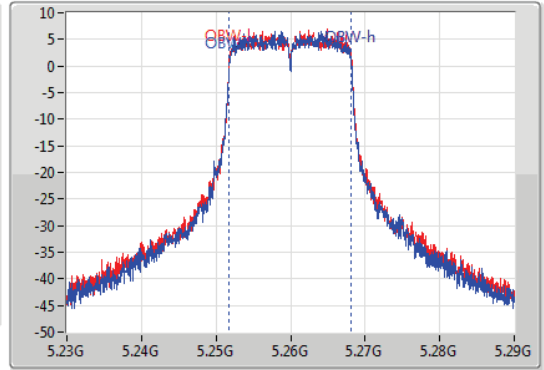

26dB(Hz)	Fl-26dB(Hz)	Fh-26dB(Hz)	OBW(Hz)	Fl-OBW(Hz)	Fh-OBW(Hz)	Limit(Hz)	Port
19.92M	5.24974G	5.26966G	16.372M	5.251784G	5.268156G	Inf	1
19.59M	5.25028G	5.26987G	16.402M	5.251784G	5.268186G	Inf	2

802.11a\_Nss1,(6Mbps)\_2TX

EBW

5300MHz

04/12/2019

CF  
5.3GHz  
Span  
60MHz  
RBW  
300kHz  
VBW  
1MHz  
Sweep Time  
100ms  
Detector Type  
Peak

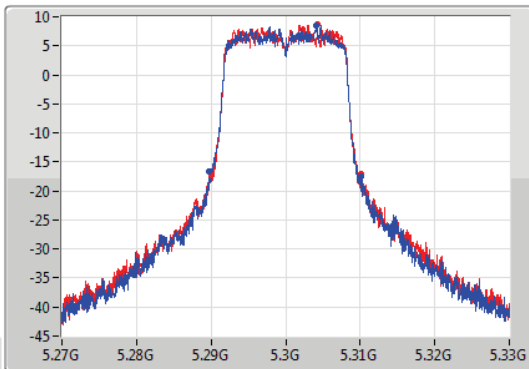

CF  
5.3GHz  
Span  
60MHz  
RBW  
200kHz  
VBW  
1MHz  
Sweep Time  
100ms  
Detector Type  
Peak

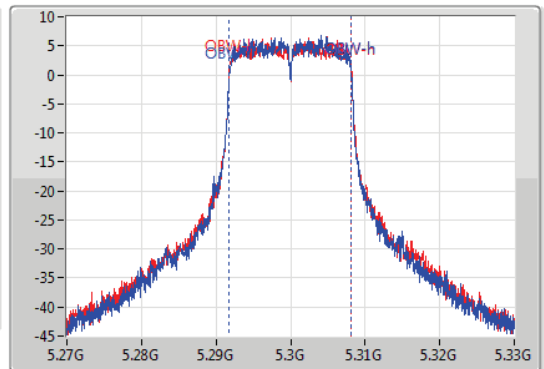

26dB(Hz)	Fl-26dB(Hz)	Fh-26dB(Hz)	OBW(Hz)	Fl-OBW(Hz)	Fh-OBW(Hz)	Limit(Hz)	Port
20.37M	5.28971G	5.31008G	16.372M	5.291784G	5.308156G	Inf	1
20.16M	5.28998G	5.31014G	16.402M	5.291784G	5.308186G	Inf	2

802.11a\_Nss1,(6Mbps)\_2TX

EBW

5320MHz

04/12/2019

CF  
5.32GHz  
Span  
60MHz  
RBW  
300kHz  
VBW  
1MHz  
Sweep Time  
100ms  
Detector Type  
Peak

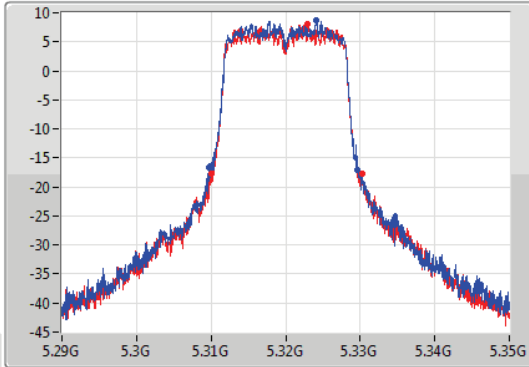

CF  
5.32GHz  
Span  
60MHz  
RBW  
200kHz  
VBW  
1MHz  
Sweep Time  
100ms  
Detector Type  
Peak

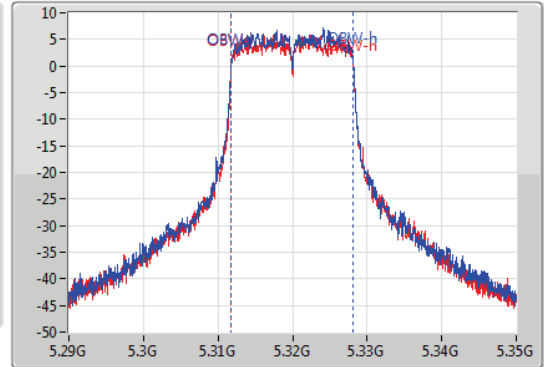

26dB(Hz)	Fl-26dB(Hz)	Fh-26dB(Hz)	OBW(Hz)	Fl-OBW(Hz)	Fh-OBW(Hz)	Limit(Hz)	Port
19.95M	5.30971G	5.32966G	16.372M	5.311784G	5.328156G	Inf	1
20.16M	5.31004G	5.3302G	16.402M	5.311784G	5.328186G	Inf	2

802.11a\_Nss1,(6Mbps)\_2TX

EBW

5500MHz

04/12/2019

CF  
5.5GHz  
Span  
60MHz  
RBW  
300kHz  
VBW  
1MHz  
Sweep Time  
100ms  
Detector Type  
Peak

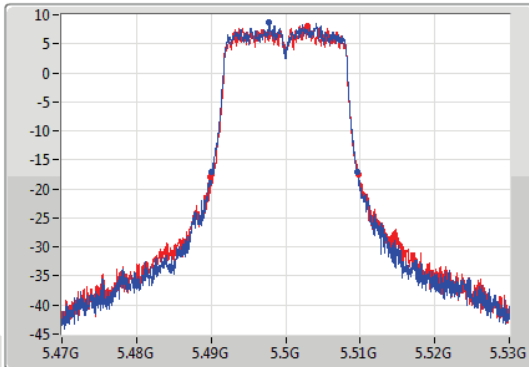

CF  
5.5GHz  
Span  
60MHz  
RBW  
200kHz  
VBW  
1MHz  
Sweep Time  
100ms  
Detector Type  
Peak

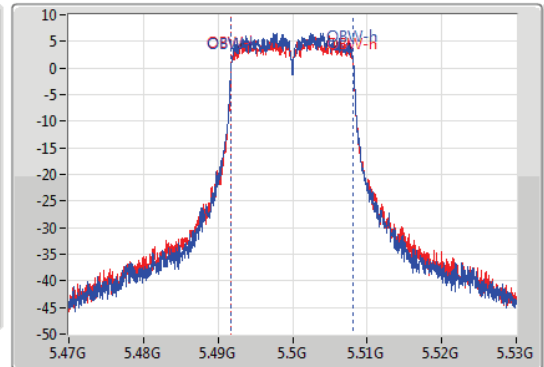

26dB(Hz)	Fl-26dB(Hz)	Fh-26dB(Hz)	OBW(Hz)	Fl-OBW(Hz)	Fh-OBW(Hz)	Limit(Hz)	Port
19.56M	5.49004G	5.5096G	16.372M	5.491784G	5.508156G	Inf	1
19.77M	5.48995G	5.50972G	16.402M	5.491784G	5.508186G	Inf	2

802.11a\_Nss1,(6Mbps)\_2TX

EBW

5580MHz

04/12/2019

CF  
5.58GHz  
Span  
60MHz  
RBW  
300kHz  
VBW  
1MHz  
Sweep Time  
100ms  
Detector Type  
Peak

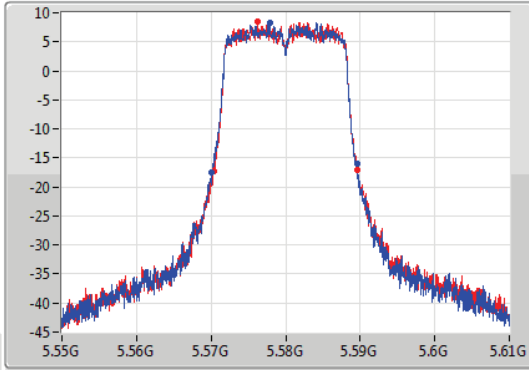

CF  
5.58GHz  
Span  
60MHz  
RBW  
200kHz  
VBW  
1MHz  
Sweep Time  
100ms  
Detector Type  
Peak

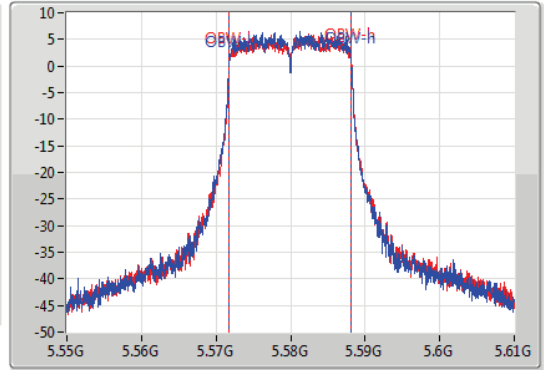

26dB(Hz)	Fl-26dB(Hz)	Fh-26dB(Hz)	OBW(Hz)	Fl-OBW(Hz)	Fh-OBW(Hz)	Limit(Hz)	Port
19.53M	5.5701G	5.58963G	16.372M	5.571784G	5.588156G	Inf	1
19.38M	5.57031G	5.58969G	16.372M	5.571784G	5.588156G	Inf	2

802.11a\_Nss1,(6Mbps)\_2TX

EBW

5700MHz

04/12/2019

CF  
5.7GHz  
Span  
60MHz  
RBW  
300kHz  
VBW  
1MHz  
Sweep Time  
100ms  
Detector Type  
Peak

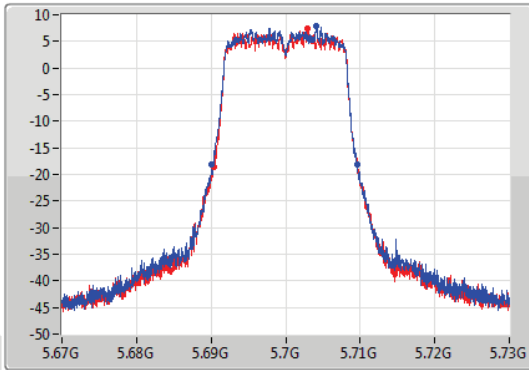

CF  
5.7GHz  
Span  
60MHz  
RBW  
200kHz  
VBW  
1MHz  
Sweep Time  
100ms  
Detector Type  
Peak

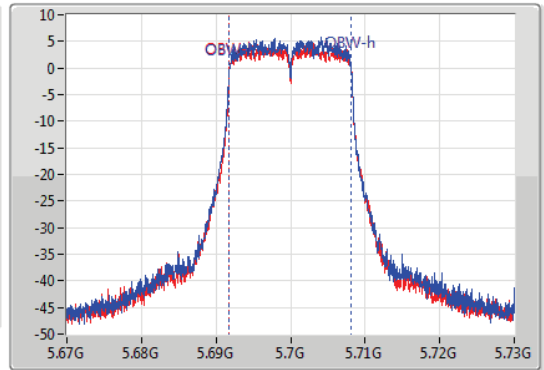

26dB(Hz)	Fl-26dB(Hz)	Fh-26dB(Hz)	OBW(Hz)	Fl-OBW(Hz)	Fh-OBW(Hz)	Limit(Hz)	Port
19.41M	5.69013G	5.70954G	16.342M	5.691784G	5.708126G	Inf	1
19.35M	5.69031G	5.70966G	16.372M	5.691784G	5.708156G	Inf	2

802.11a\_Nss1,(6Mbps)\_2TX

EBW

5720MHz Straddle 5.47-5.725GHz

04/12/2019

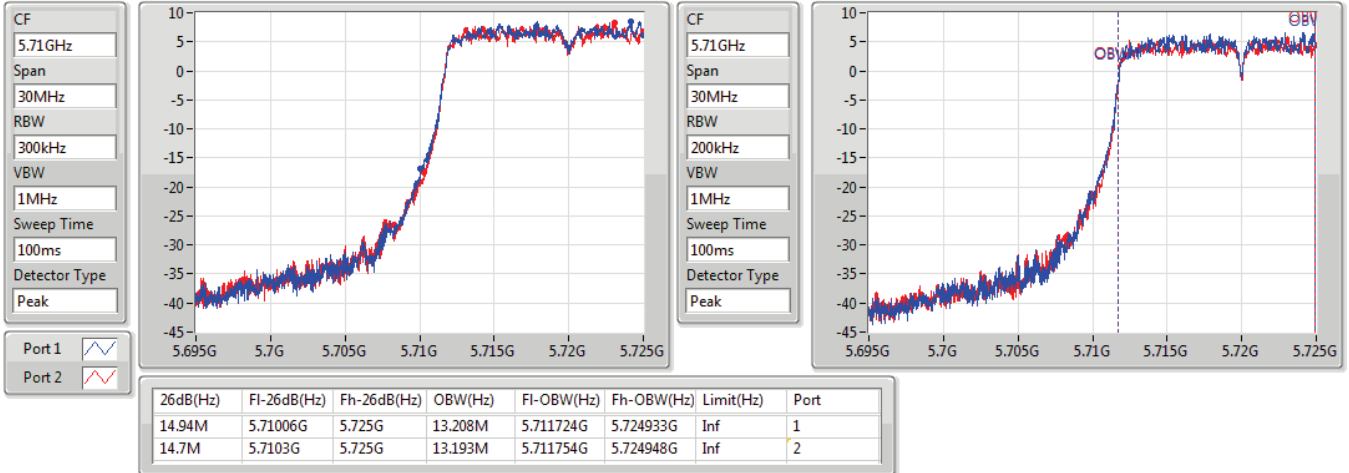

802.11a\_Nss1,(6Mbps)\_2TX

EBW

5720MHz Straddle 5.725-5.85GHz

04/12/2019

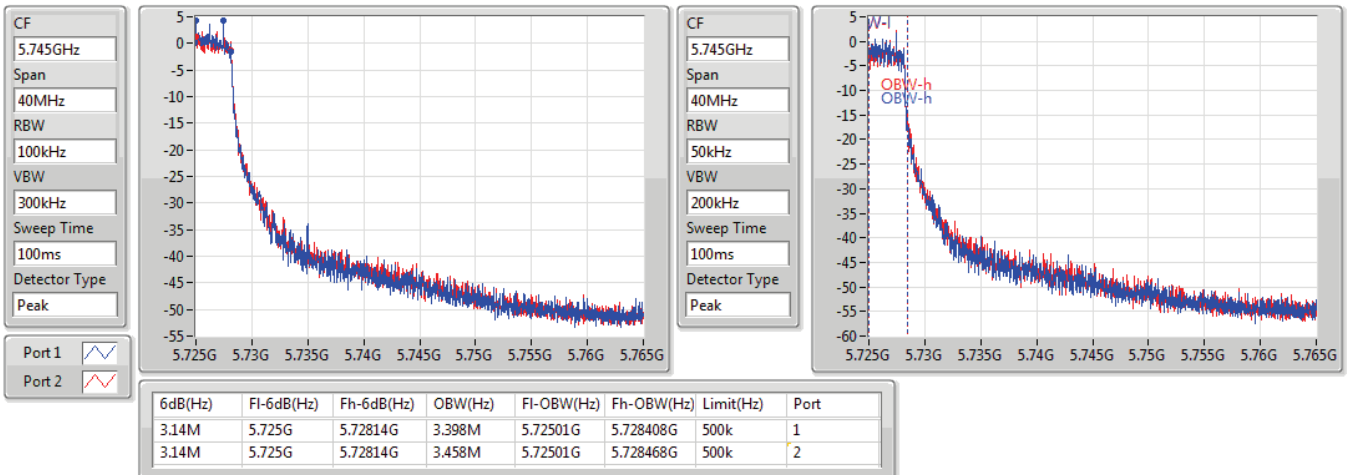

802.11ac VHT20\_Nss1,(MCS0)\_1TX(Port1)

EBW

5260MHz

04/12/2019

CF: 5.26GHz  
 Span: 60MHz  
 RBW: 300kHz  
 VBW: 1MHz  
 Sweep Time: 100ms  
 Detector Type: Peak  
 Port 1

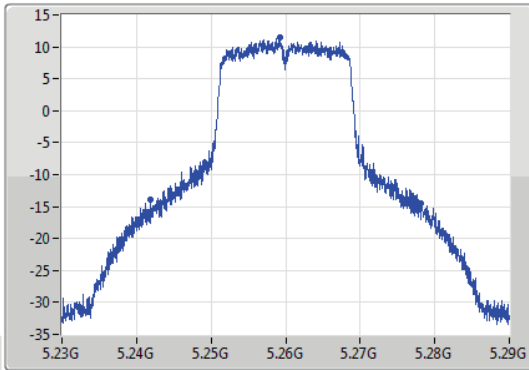

CF: 5.26GHz  
 Span: 60MHz  
 RBW: 200kHz  
 VBW: 1MHz  
 Sweep Time: 100ms  
 Detector Type: Peak

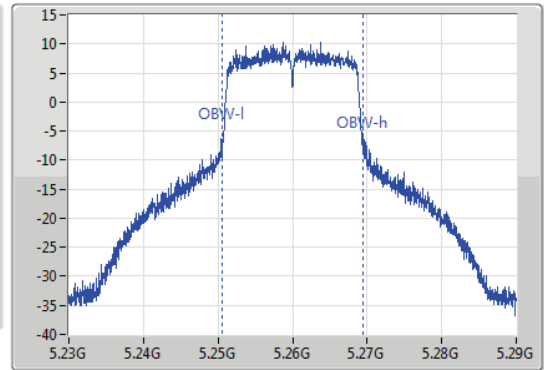

26dB(Hz)	Fl-26dB(Hz)	Fh-26dB(Hz)	OBW(Hz)	Fl-OBW(Hz)	Fh-OBW(Hz)	Limit(Hz)	Port
36.21M	5.24191G	5.27812G	18.771M	5.250615G	5.269385G	Inf	1

802.11ac VHT20\_Nss1,(MCS0)\_1TX(Port1)

EBW

5300MHz

04/12/2019

CF: 5.3GHz  
 Span: 60MHz  
 RBW: 300kHz  
 VBW: 1MHz  
 Sweep Time: 100ms  
 Detector Type: Peak  
 Port 1

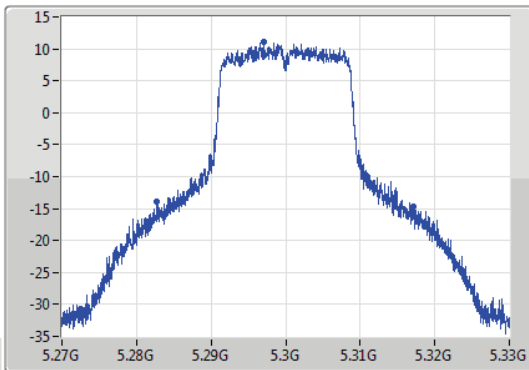

CF: 5.3GHz  
 Span: 60MHz  
 RBW: 200kHz  
 VBW: 1MHz  
 Sweep Time: 100ms  
 Detector Type: Peak

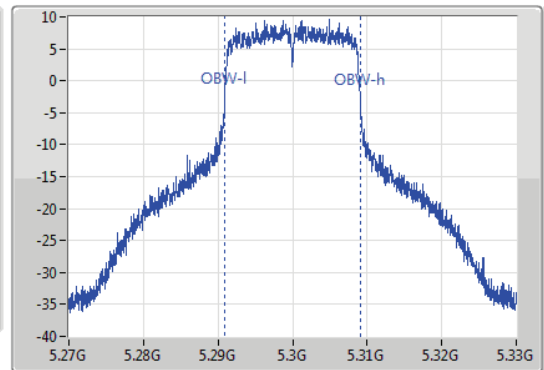

26dB(Hz)	Fl-26dB(Hz)	Fh-26dB(Hz)	OBW(Hz)	Fl-OBW(Hz)	Fh-OBW(Hz)	Limit(Hz)	Port
34.32M	5.28275G	5.31707G	18.261M	5.290855G	5.309115G	Inf	1

802.11ac VHT20\_Nss1,(MCS0)\_1TX(Port1)

EBW

5320MHz

04/12/2019

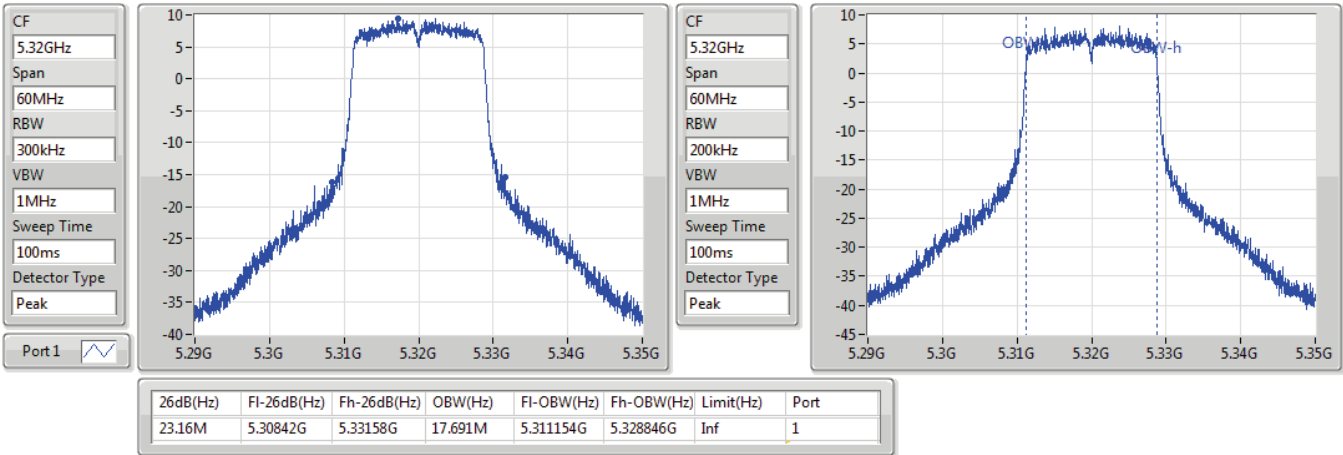

802.11ac VHT20\_Nss1,(MCS0)\_1TX(Port1)

EBW

5500MHz

04/12/2019

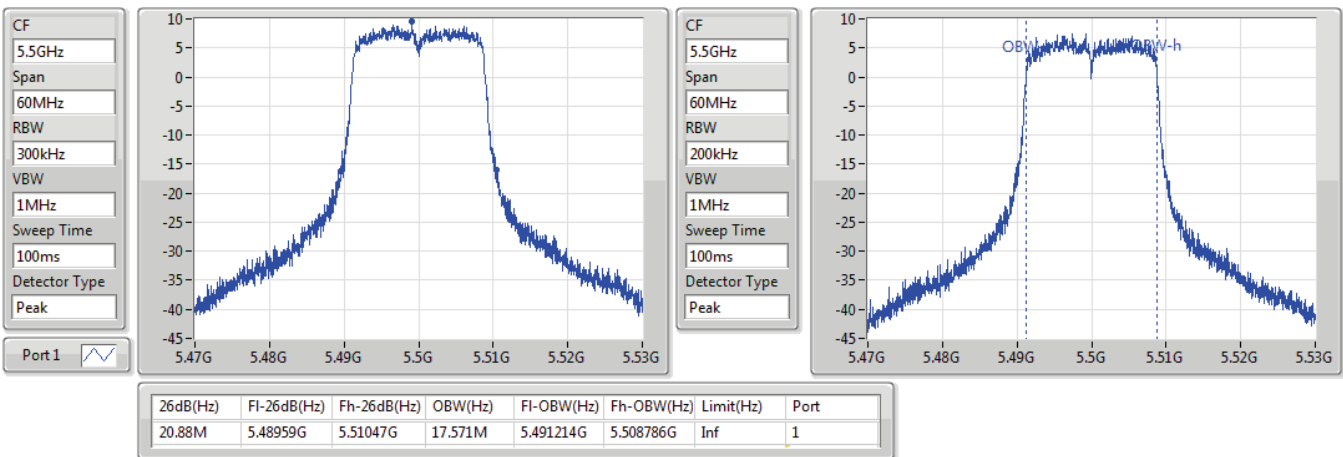

802.11ac VHT20\_Nss1,(MCS0)\_1TX(Port1)

EBW

5580MHz

04/12/2019

CF  
5.58GHz  
Span  
60MHz  
RBW  
300kHz  
VBW  
1MHz  
Sweep Time  
100ms  
Detector Type  
Peak  
Port 1

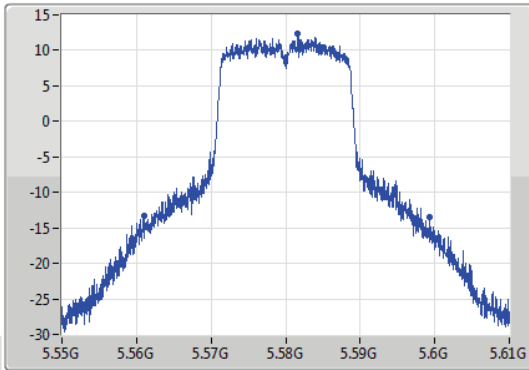

CF  
5.58GHz  
Span  
60MHz  
RBW  
200kHz  
VBW  
1MHz  
Sweep Time  
100ms  
Detector Type  
Peak

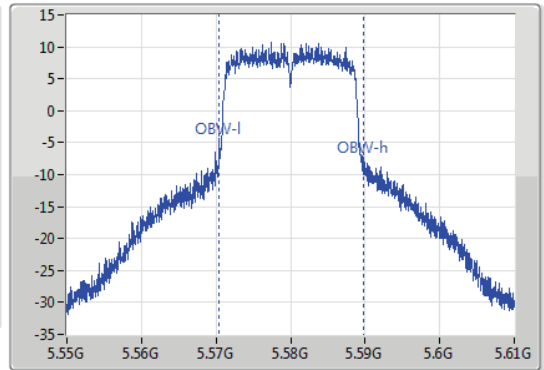

26dB(Hz)	Fl-26dB(Hz)	Fh-26dB(Hz)	OBW(Hz)	Fl-OBW(Hz)	Fh-OBW(Hz)	Limit(Hz)	Port
38.25M	5.56104G	5.59929G	19.43M	5.570405G	5.589835G	Inf	1

802.11ac VHT20\_Nss1,(MCS0)\_1TX(Port1)

EBW

5700MHz

04/12/2019

CF  
5.7GHz  
Span  
60MHz  
RBW  
300kHz  
VBW  
1MHz  
Sweep Time  
100ms  
Detector Type  
Peak  
Port 1

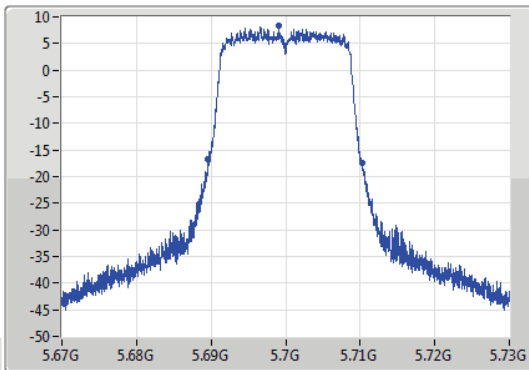

CF  
5.7GHz  
Span  
60MHz  
RBW  
200kHz  
VBW  
1MHz  
Sweep Time  
100ms  
Detector Type  
Peak

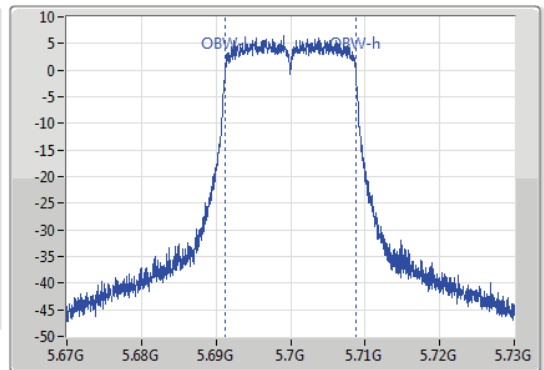

26dB(Hz)	Fl-26dB(Hz)	Fh-26dB(Hz)	OBW(Hz)	Fl-OBW(Hz)	Fh-OBW(Hz)	Limit(Hz)	Port
20.64M	5.68956G	5.7102G	17.541M	5.691214G	5.708756G	Inf	1

**802.11ac VHT20\_Nss1,(MCS0)\_1TX(Port1)**  
**5720MHz Straddle 5.47-5.725GHz**

EBW

04/12/2019

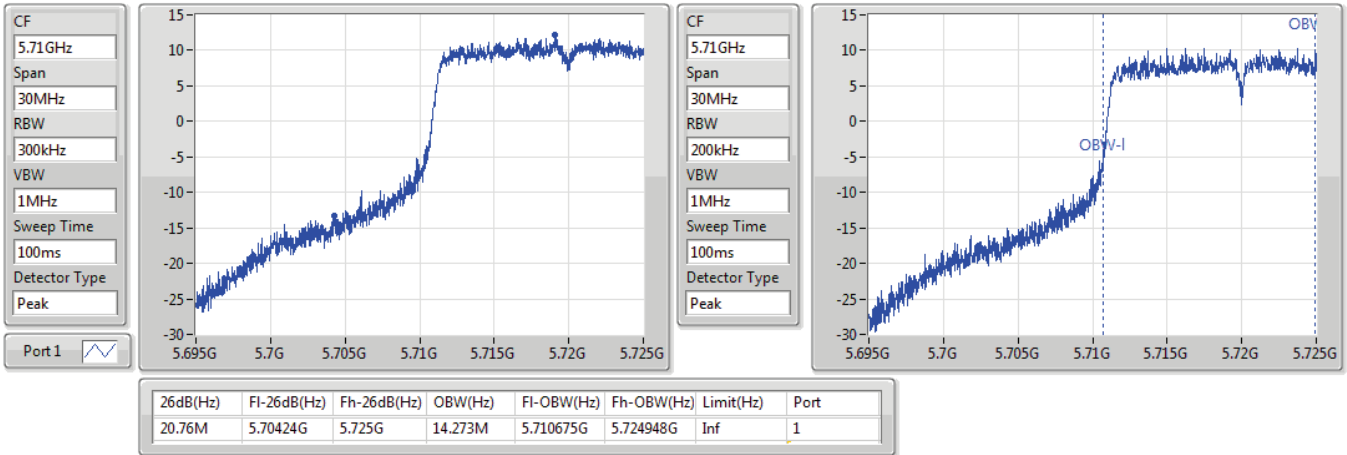

**802.11ac VHT20\_Nss1,(MCS0)\_1TX(Port1)**  
**5720MHz Straddle 5.725-5.85GHz**

EBW

04/12/2019

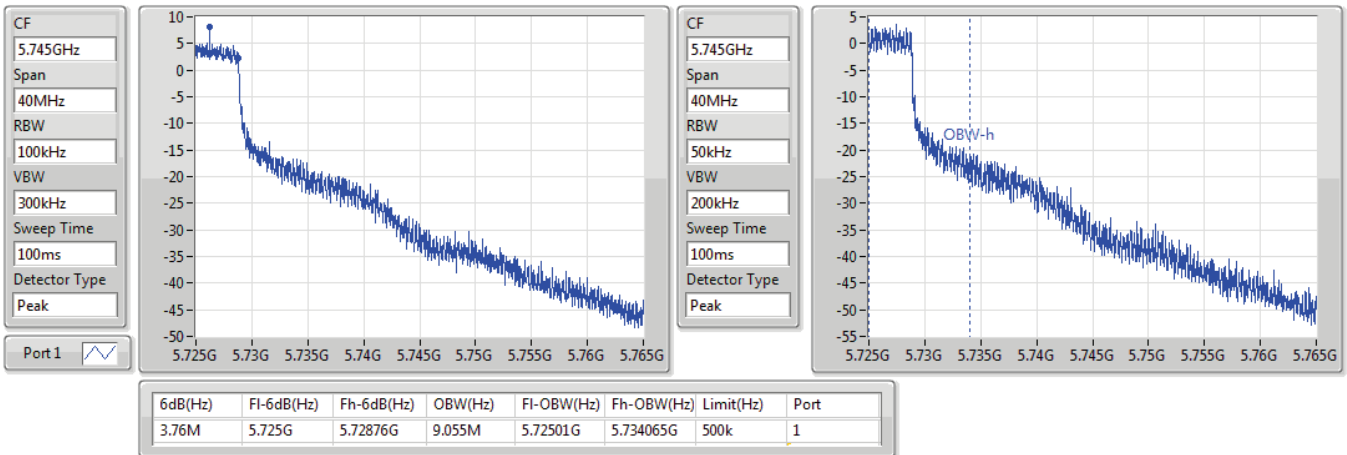



802.11ac VHT20\_Nss1,(MCS0)\_2TX

EBW

5260MHz

04/12/2019

CF  
5.26GHz  
Span  
60MHz  
RBW  
300kHz  
VBW  
1MHz  
Sweep Time  
100ms  
Detector Type  
Peak

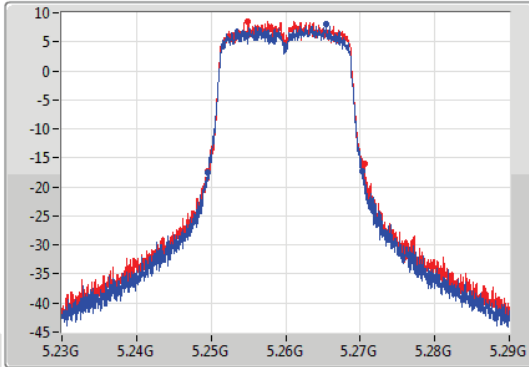

CF  
5.26GHz  
Span  
60MHz  
RBW  
200kHz  
VBW  
1MHz  
Sweep Time  
100ms  
Detector Type  
Peak

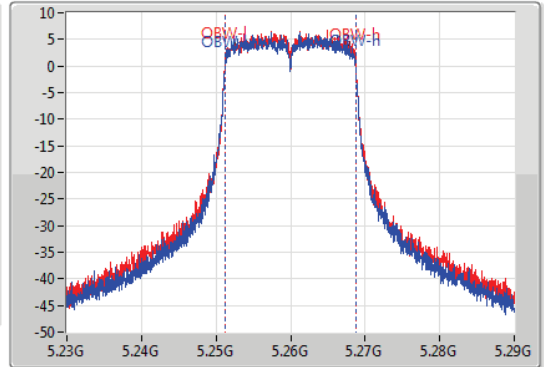

26dB(Hz)	Fl-26dB(Hz)	Fh-26dB(Hz)	OBW(Hz)	Fl-OBW(Hz)	Fh-OBW(Hz)	Limit(Hz)	Port
20.76M	5.24956G	5.27032G	17.571M	5.251184G	5.268756G	Inf	1
21M	5.24953G	5.27053G	17.541M	5.251214G	5.268756G	Inf	2

802.11ac VHT20\_Nss1,(MCS0)\_2TX

EBW

5300MHz

04/12/2019

CF  
5.3GHz  
Span  
60MHz  
RBW  
300kHz  
VBW  
1MHz  
Sweep Time  
100ms  
Detector Type  
Peak

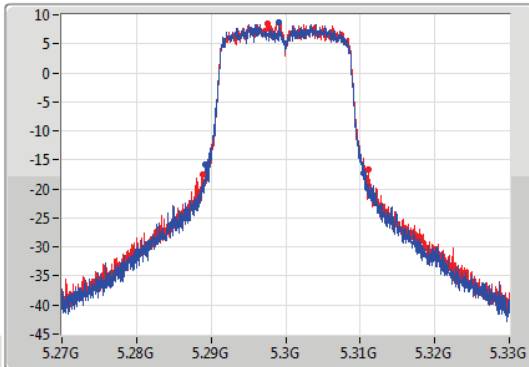

CF  
5.3GHz  
Span  
60MHz  
RBW  
200kHz  
VBW  
1MHz  
Sweep Time  
100ms  
Detector Type  
Peak

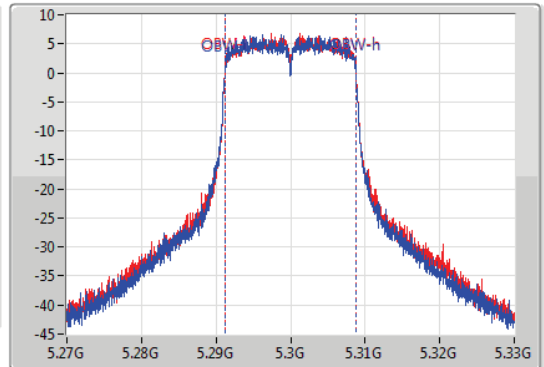

26dB(Hz)	Fl-26dB(Hz)	Fh-26dB(Hz)	OBW(Hz)	Fl-OBW(Hz)	Fh-OBW(Hz)	Limit(Hz)	Port
21.21M	5.28923G	5.31044G	17.571M	5.291184G	5.308756G	Inf	1
22.29M	5.28884G	5.31113G	17.601M	5.291184G	5.308786G	Inf	2

802.11ac VHT20\_Nss1,(MCS0)\_2TX

EBW

5320MHz

04/12/2019

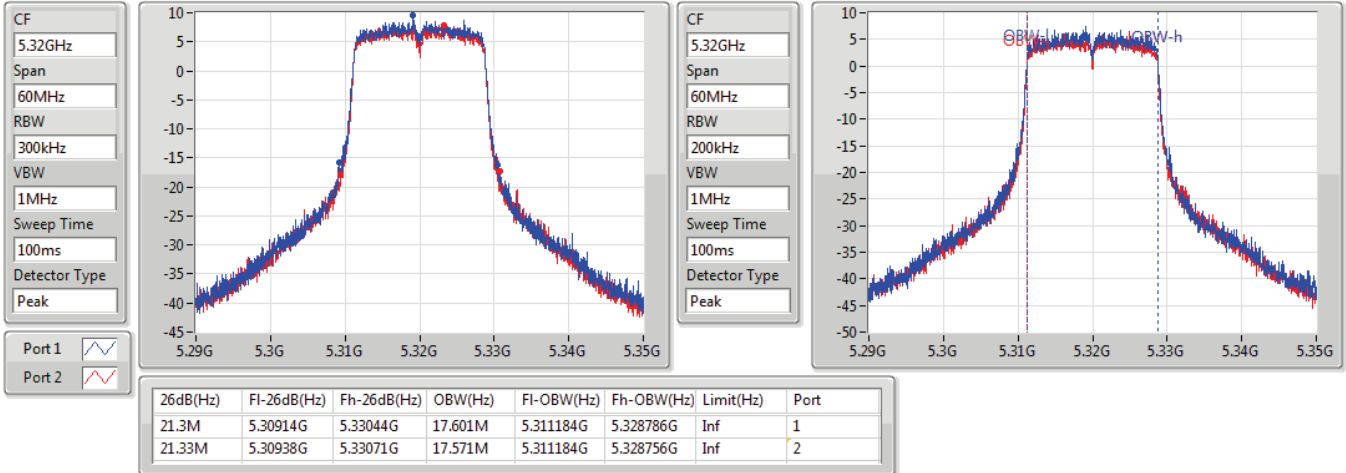

802.11ac VHT20\_Nss1,(MCS0)\_2TX

EBW

5500MHz

04/12/2019

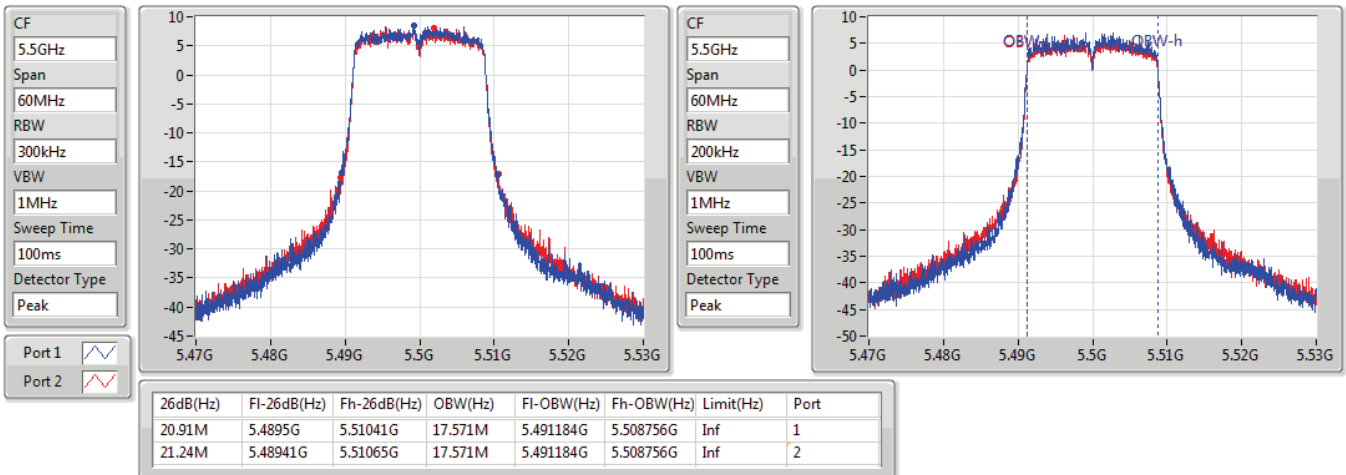

802.11ac VHT20\_Nss1,(MCS0)\_2TX

EBW

5580MHz

04/12/2019

CF  
5.58GHz  
Span  
60MHz  
RBW  
300kHz  
VBW  
1MHz  
Sweep Time  
100ms  
Detector Type  
Peak

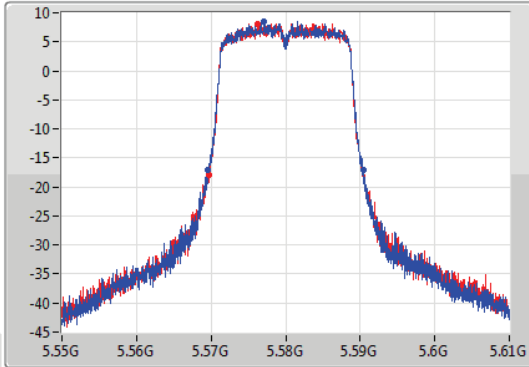

CF  
5.58GHz  
Span  
60MHz  
RBW  
200kHz  
VBW  
1MHz  
Sweep Time  
100ms  
Detector Type  
Peak

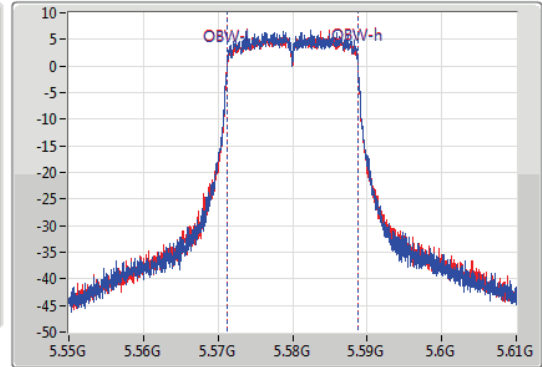

26dB(Hz)	Fl-26dB(Hz)	Fh-26dB(Hz)	OBW(Hz)	Fl-OBW(Hz)	Fh-OBW(Hz)	Limit(Hz)	Port
20.88M	5.56953G	5.59041G	17.541M	5.571214G	5.588756G	Inf	1
20.76M	5.56971G	5.59047G	17.541M	5.571214G	5.588756G	Inf	2

802.11ac VHT20\_Nss1,(MCS0)\_2TX

EBW

5700MHz

04/12/2019

CF  
5.7GHz  
Span  
60MHz  
RBW  
300kHz  
VBW  
1MHz  
Sweep Time  
100ms  
Detector Type  
Peak

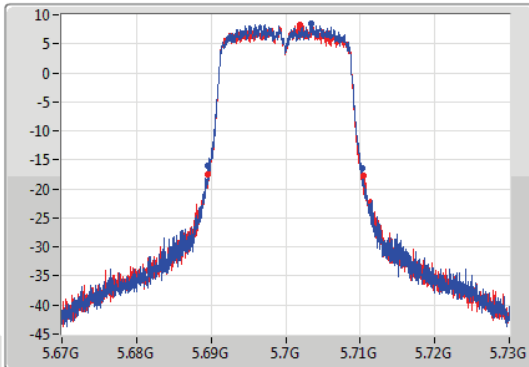

CF  
5.7GHz  
Span  
60MHz  
RBW  
200kHz  
VBW  
1MHz  
Sweep Time  
100ms  
Detector Type  
Peak

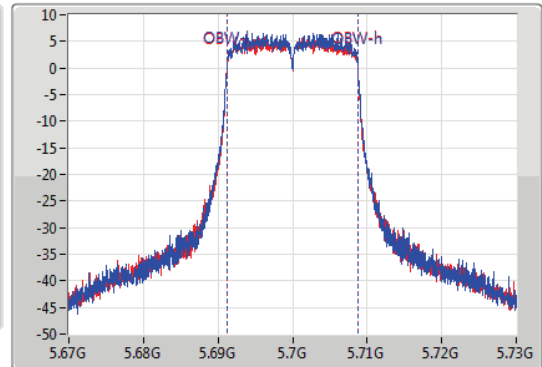

26dB(Hz)	Fl-26dB(Hz)	Fh-26dB(Hz)	OBW(Hz)	Fl-OBW(Hz)	Fh-OBW(Hz)	Limit(Hz)	Port
20.7M	5.68959G	5.71029G	17.541M	5.691214G	5.708756G	Inf	1
20.82M	5.68959G	5.71041G	17.571M	5.691184G	5.708756G	Inf	2

802.11ac VHT20\_Nss1,(MCS0)\_2TX

EBW

5720MHz Straddle 5.47-5.725GHz

04/12/2019

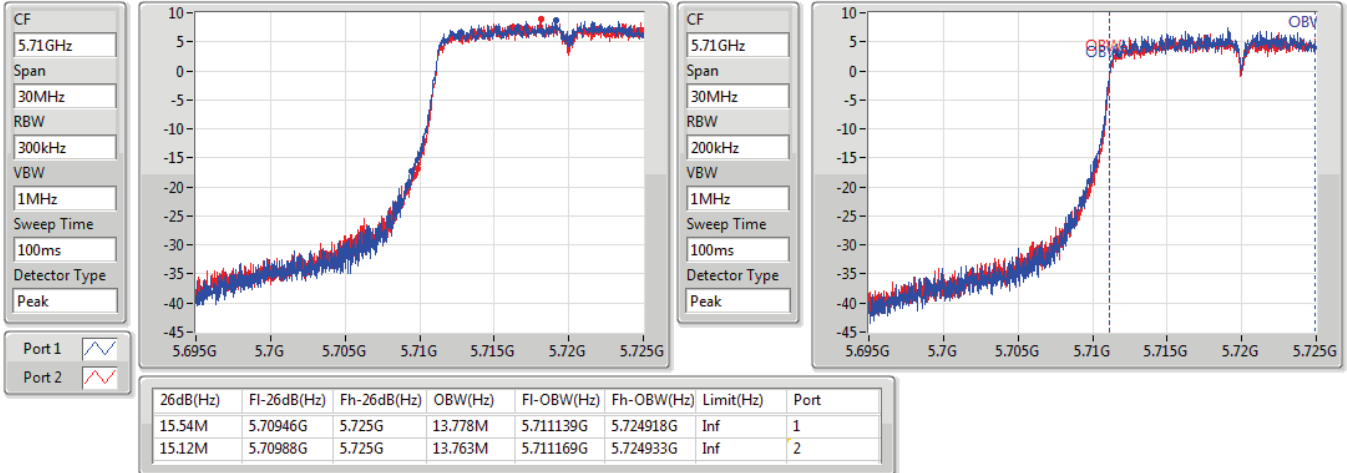

802.11ac VHT20\_Nss1,(MCS0)\_2TX

EBW

5720MHz Straddle 5.725-5.85GHz

04/12/2019

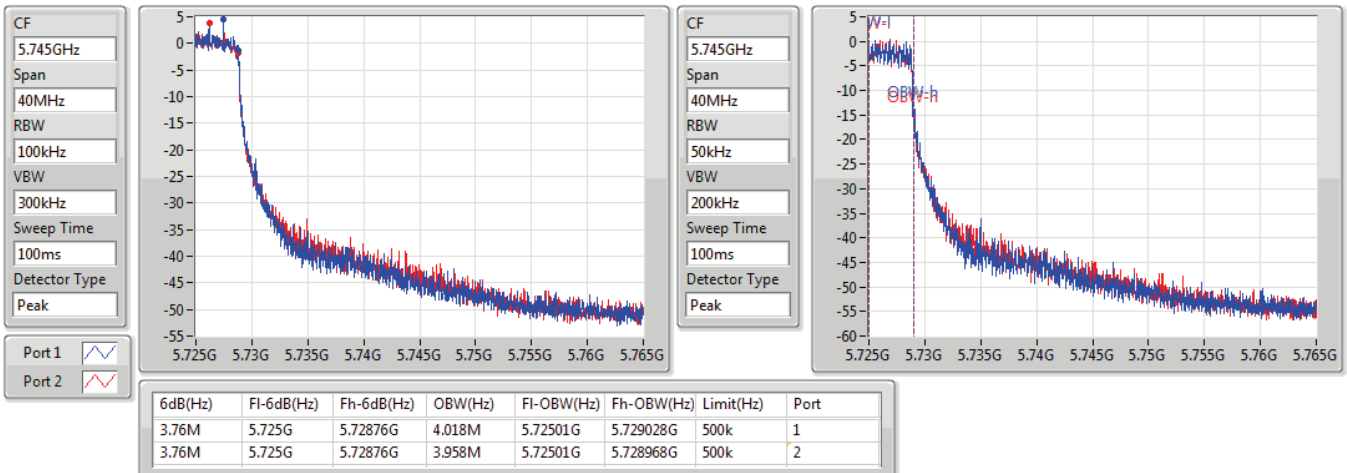

802.11ac VHT40\_Nss1,(MCS0)\_1TX(Port1)

EBW

5270MHz

04/12/2019

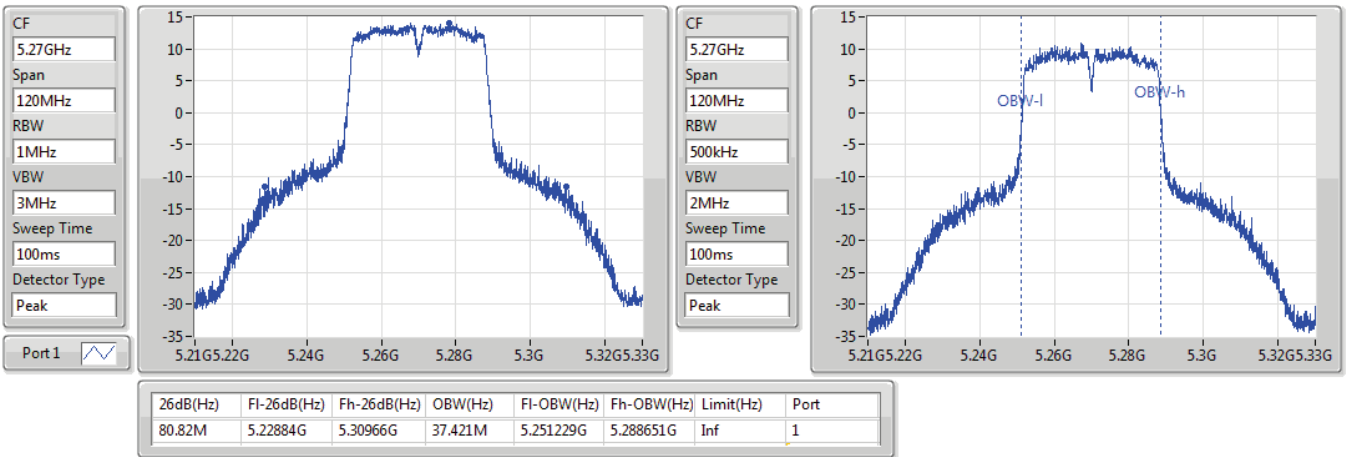

802.11ac VHT40\_Nss1,(MCS0)\_1TX(Port1)

EBW

5310MHz

04/12/2019

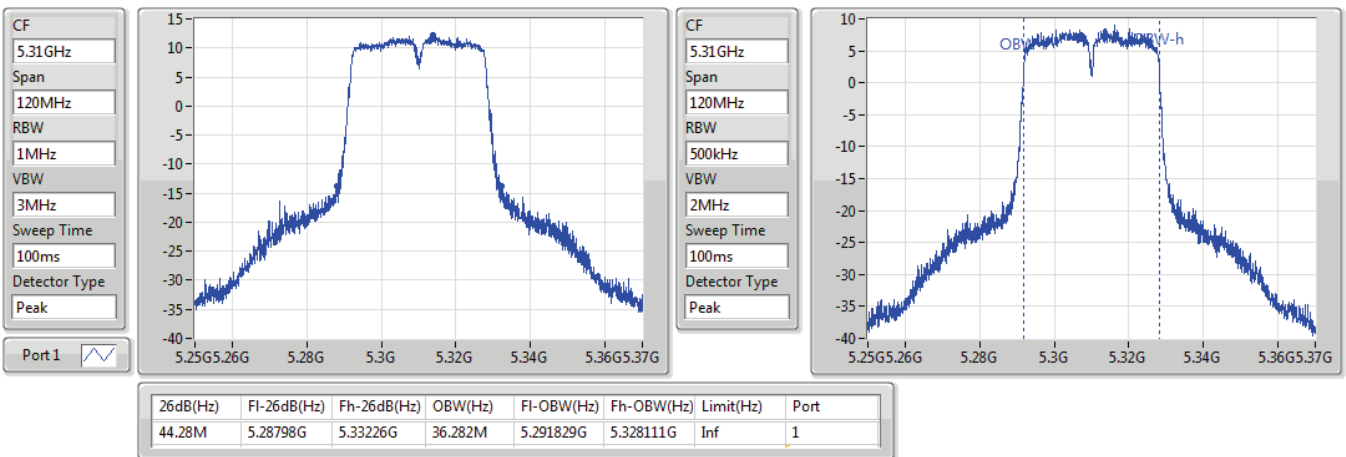

802.11ac VHT40\_Nss1,(MCS0)\_1TX(Port1)

EBW

5510MHz

04/12/2019

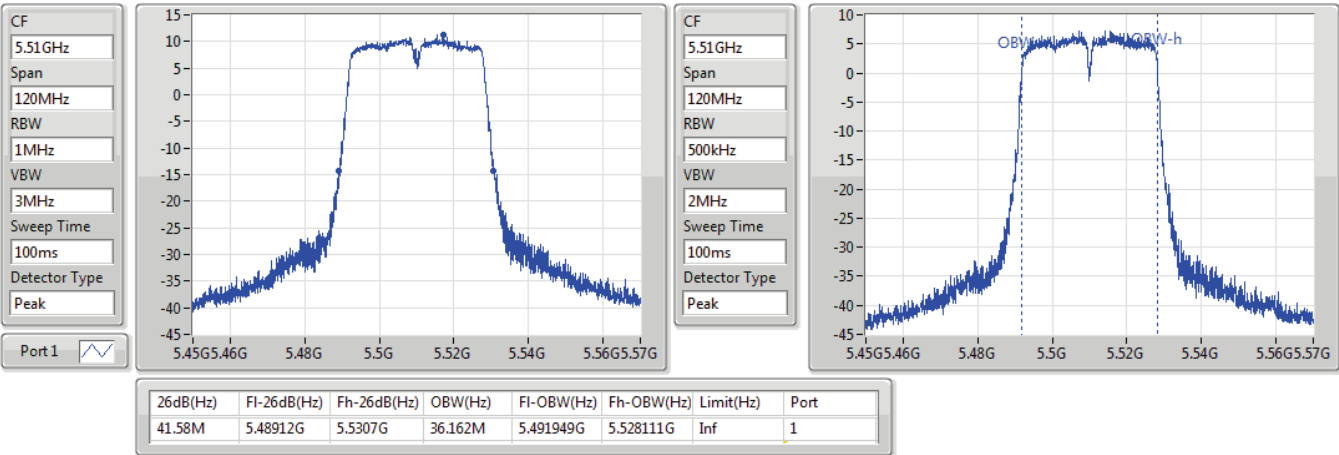

802.11ac VHT40\_Nss1,(MCS0)\_1TX(Port1)

EBW

5550MHz

04/12/2019

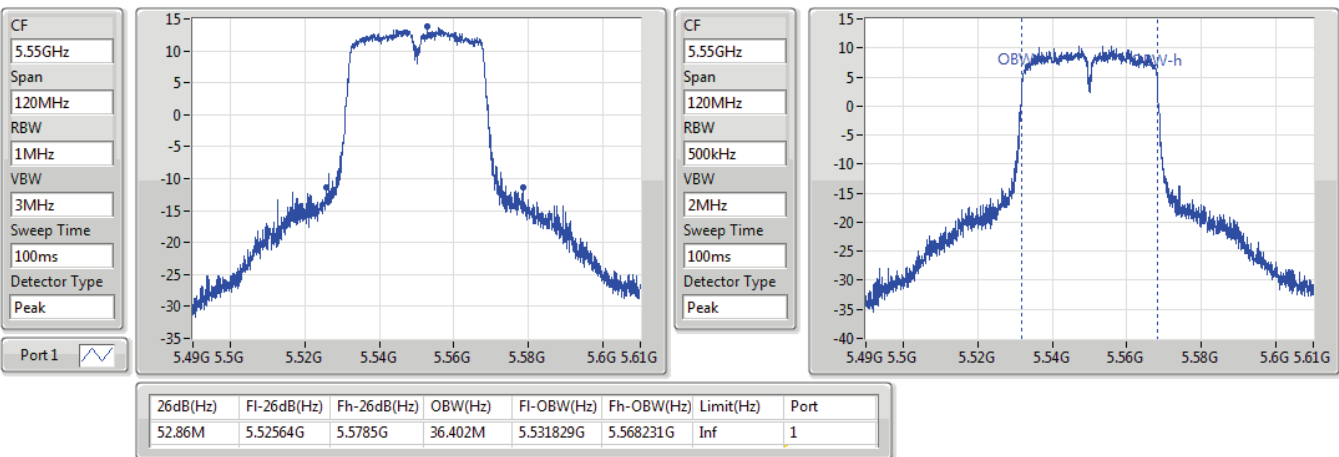

802.11ac VHT40\_Nss1,(MCS0)\_1TX(Port1)

EBW

5670MHz

04/12/2019

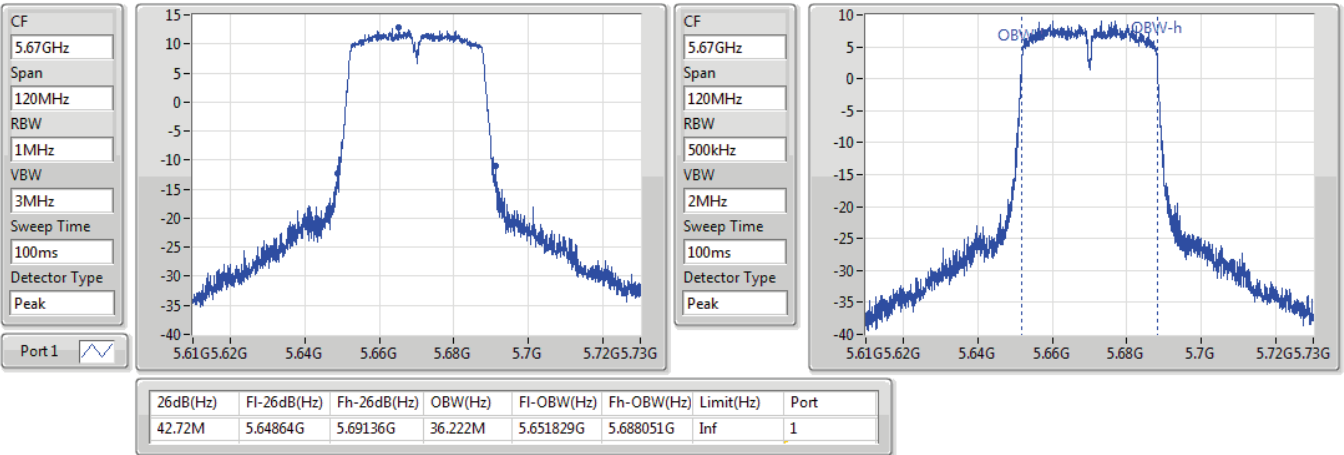

802.11ac VHT40\_Nss1,(MCS0)\_1TX(Port1)

EBW

5710MHz Straddle 5.47-5.725GHz

04/12/2019

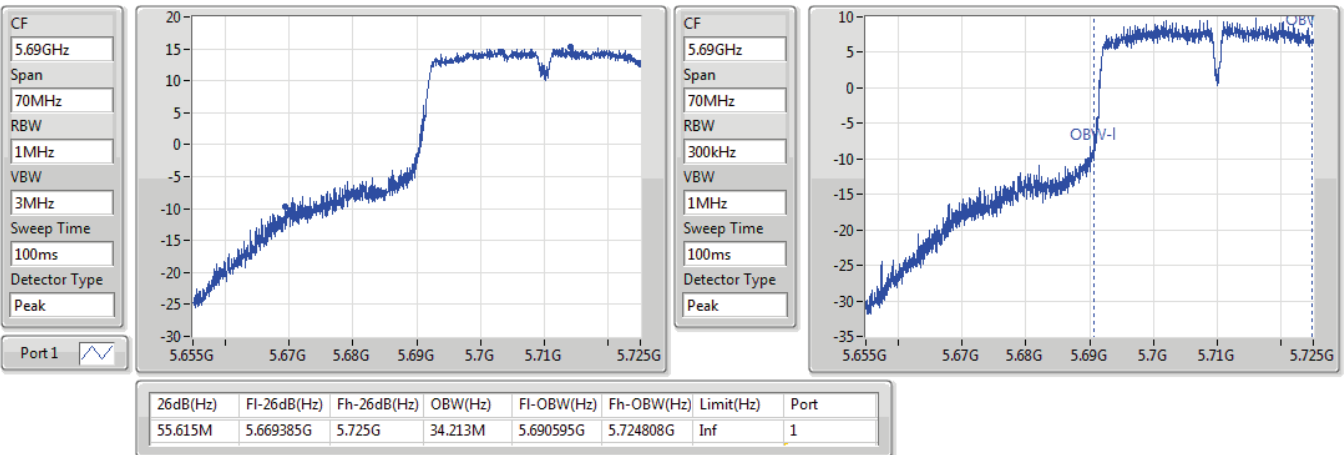

802.11ac VHT40\_Nss1,(MCS0)\_1TX(Port1)

EBW

5710MHz Straddle 5.725-5.85GHz

04/12/2019

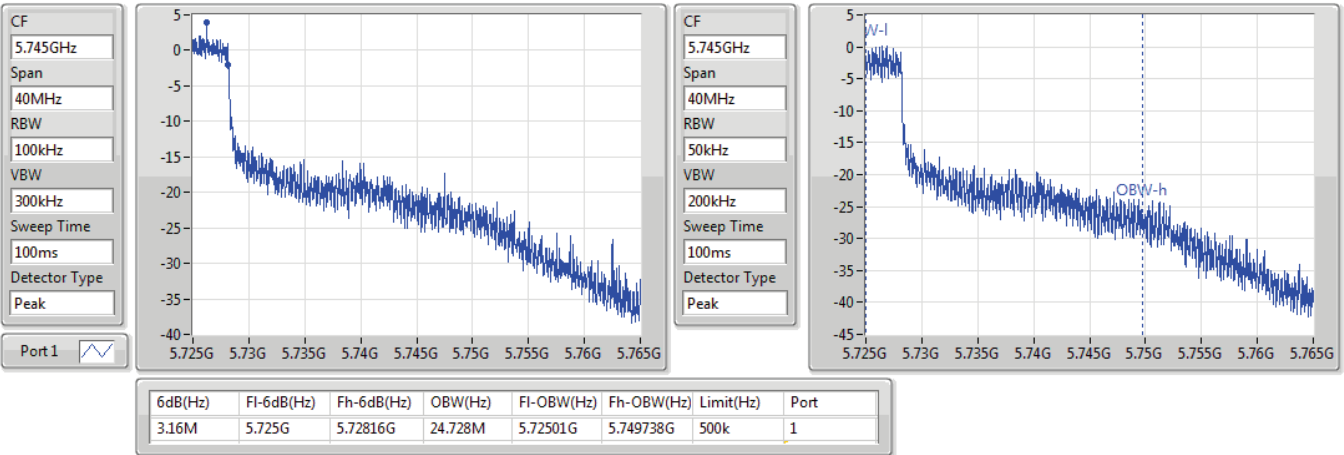

802.11ac VHT40\_Nss1,(MCS0)\_2TX

EBW

5270MHz

04/12/2019

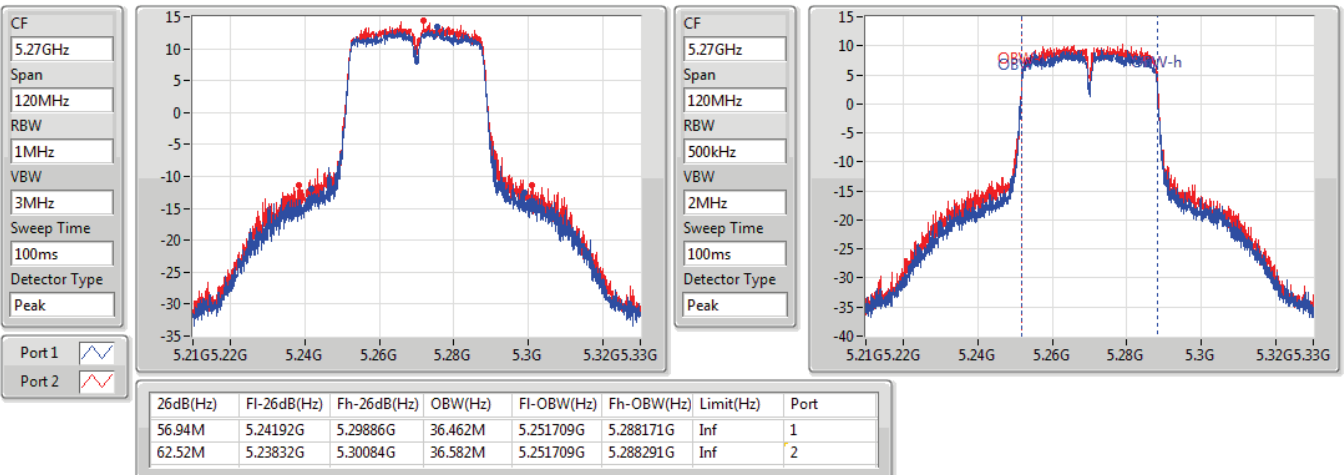



802.11ac VHT40\_Nss1,(MCS0)\_2TX

EBW

5310MHz

04/12/2019

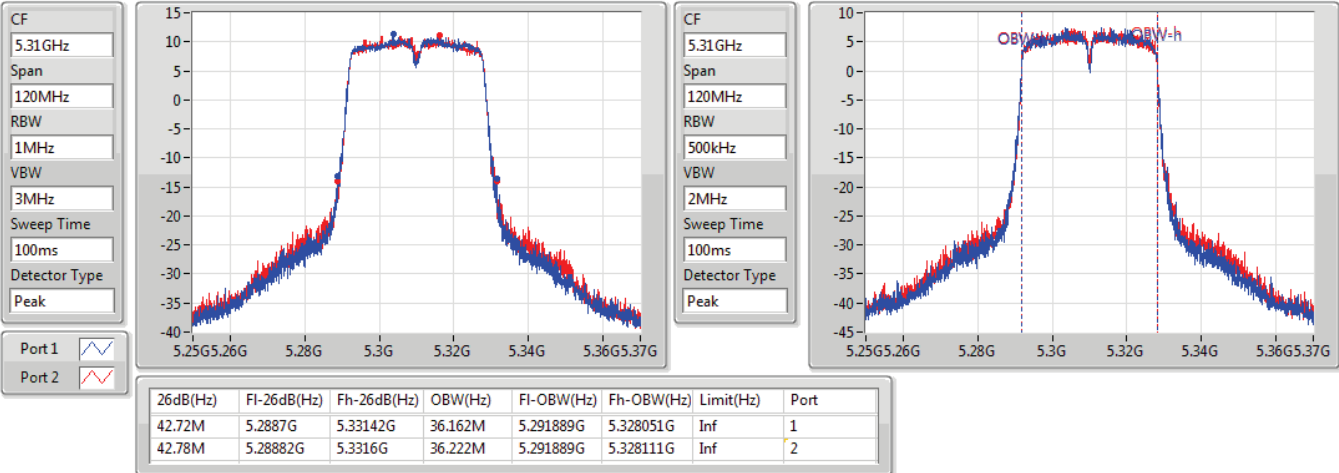

802.11ac VHT40\_Nss1,(MCS0)\_2TX

EBW

5510MHz

04/12/2019

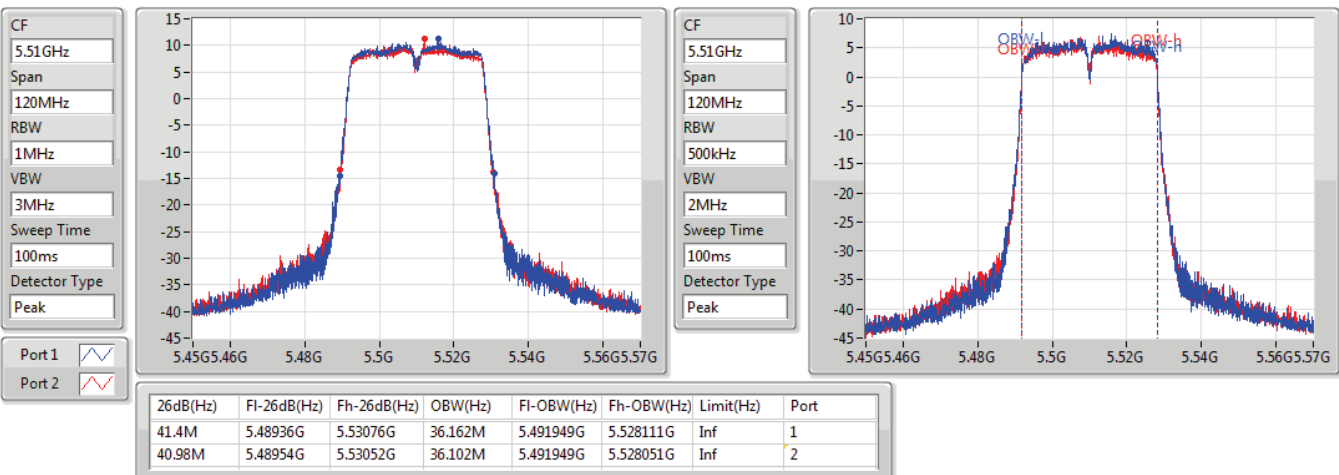

802.11ac VHT40\_Nss1,(MCS0)\_2TX

EBW

5550MHz

04/12/2019

CF  
5.55GHz  
Span  
120MHz  
RBW  
1MHz  
VBW  
3MHz  
Sweep Time  
100ms  
Detector Type  
Peak

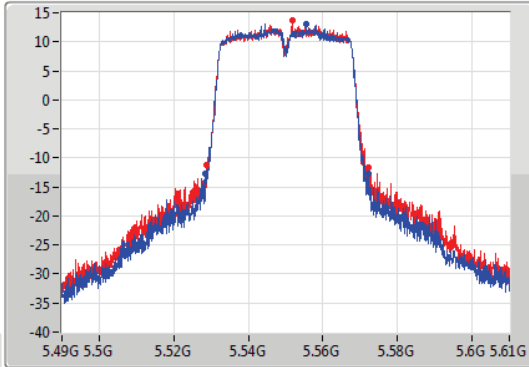

CF  
5.55GHz  
Span  
120MHz  
RBW  
500kHz  
VBW  
2MHz  
Sweep Time  
100ms  
Detector Type  
Peak

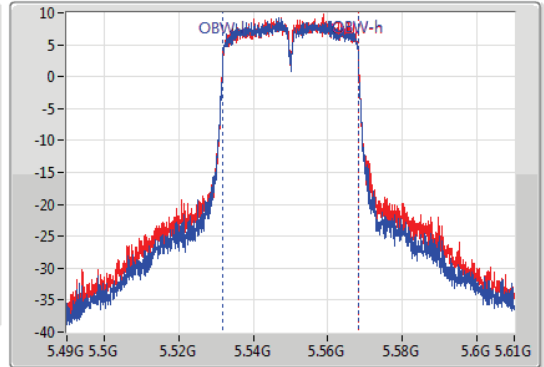

26dB(Hz)	Fl-26dB(Hz)	Fh-26dB(Hz)	OBW(Hz)	Fl-OBW(Hz)	Fh-OBW(Hz)	Limit(Hz)	Port
43.86M	5.52846G	5.57232G	36.162M	5.531949G	5.568111G	Inf	1
43.32M	5.52876G	5.57208G	36.282M	5.531889G	5.568171G	Inf	2

802.11ac VHT40\_Nss1,(MCS0)\_2TX

EBW

5670MHz

04/12/2019

CF  
5.67GHz  
Span  
120MHz  
RBW  
1MHz  
VBW  
3MHz  
Sweep Time  
100ms  
Detector Type  
Peak

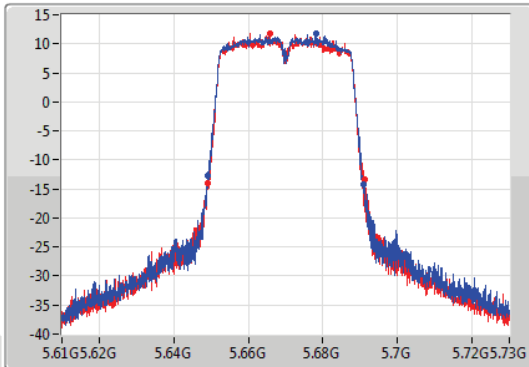

CF  
5.67GHz  
Span  
120MHz  
RBW  
500kHz  
VBW  
2MHz  
Sweep Time  
100ms  
Detector Type  
Peak

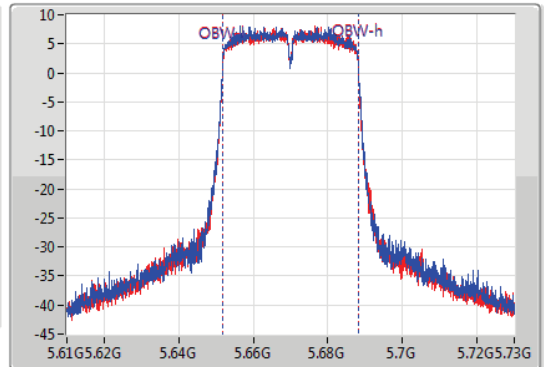

26dB(Hz)	Fl-26dB(Hz)	Fh-26dB(Hz)	OBW(Hz)	Fl-OBW(Hz)	Fh-OBW(Hz)	Limit(Hz)	Port
41.76M	5.649G	5.69076G	36.162M	5.651889G	5.688051G	Inf	1
42.06M	5.64912G	5.69118G	36.162M	5.651889G	5.688051G	Inf	2

802.11ac VHT40\_Nss1,(MCS0)\_2TX

EBW

5710MHz Straddle 5.47-5.725GHz

04/12/2019

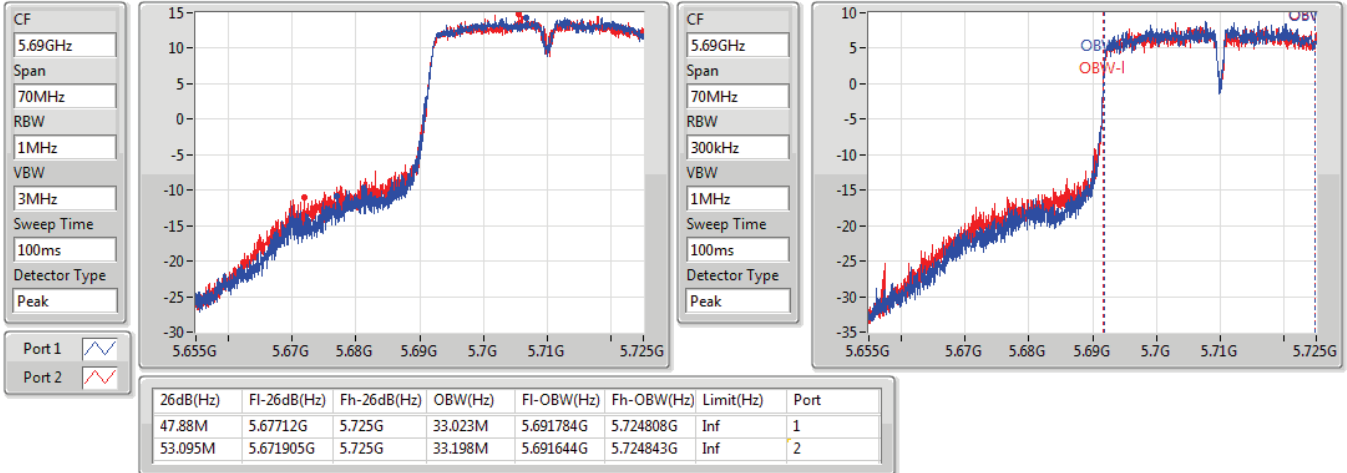

802.11ac VHT40\_Nss1,(MCS0)\_2TX

EBW

5710MHz Straddle 5.725-5.85GHz

04/12/2019

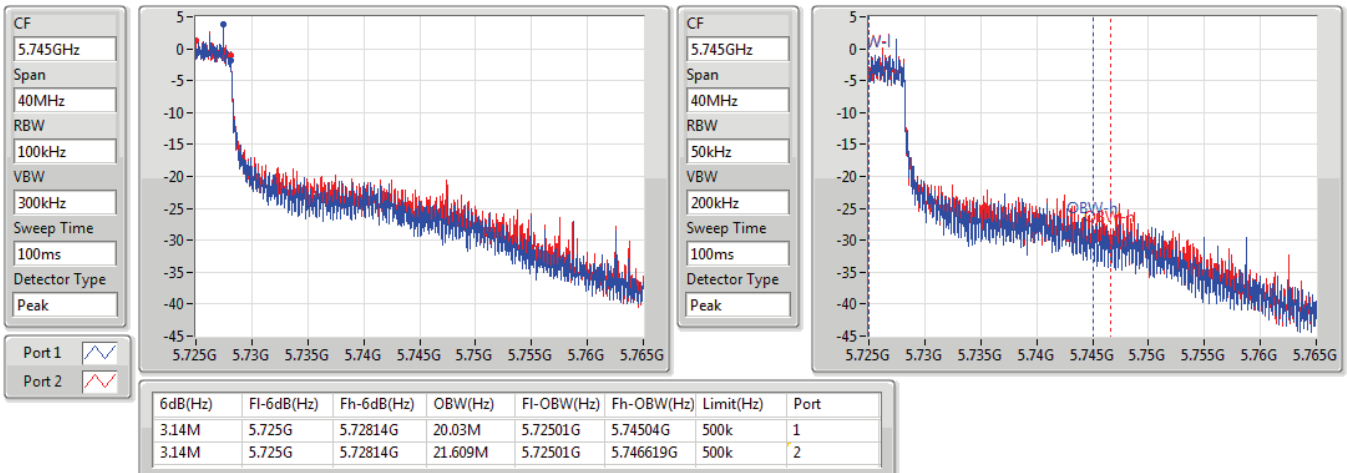

802.11ac VHT80\_Nss1,(MCS0)\_1TX(Port1)

EBW

5290MHz

04/12/2019

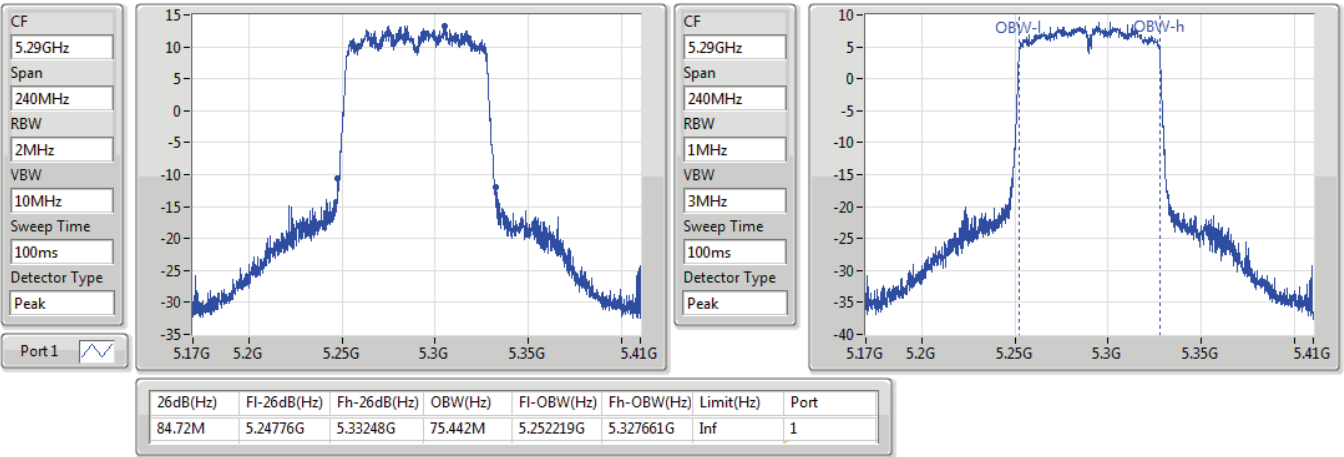

802.11ac VHT80\_Nss1,(MCS0)\_1TX(Port1)

EBW

5530MHz

04/12/2019

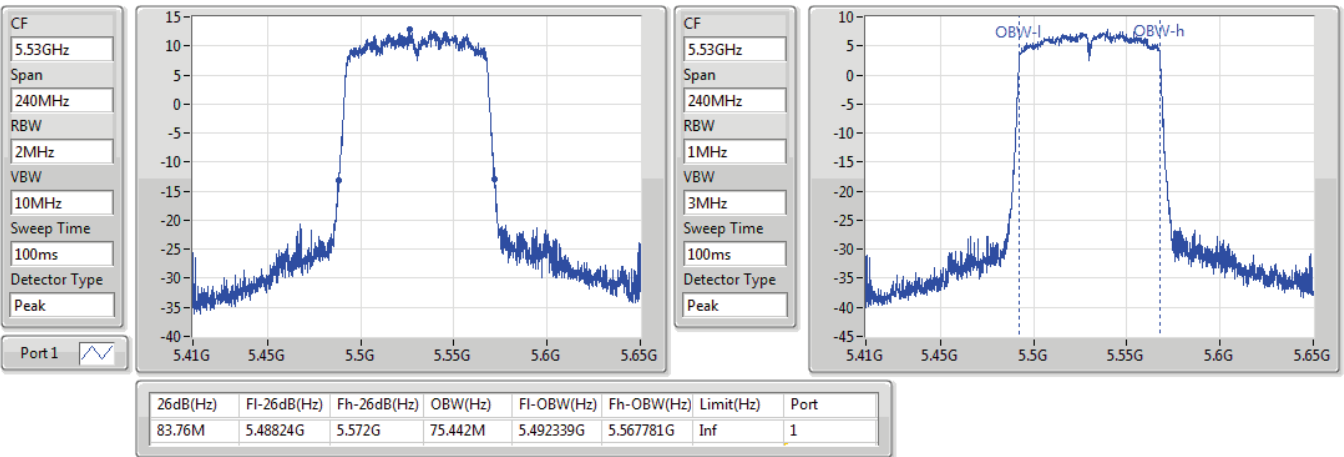

802.11ac VHT80\_Nss1,(MCS0)\_1TX(Port1)

EBW

5610MHz

04/12/2019

CF: 5.61GHz  
 Span: 240MHz  
 RBW: 2MHz  
 VBW: 10MHz  
 Sweep Time: 100ms  
 Detector Type: Peak

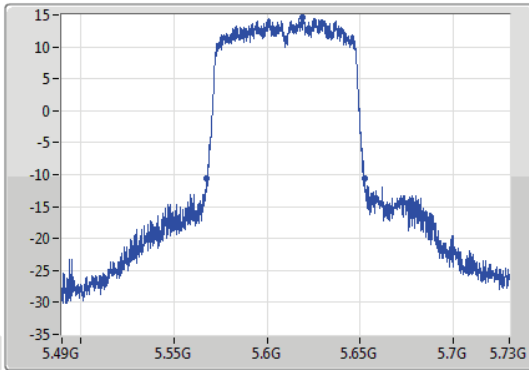

CF: 5.61GHz  
 Span: 240MHz  
 RBW: 1MHz  
 VBW: 3MHz  
 Sweep Time: 100ms  
 Detector Type: Peak

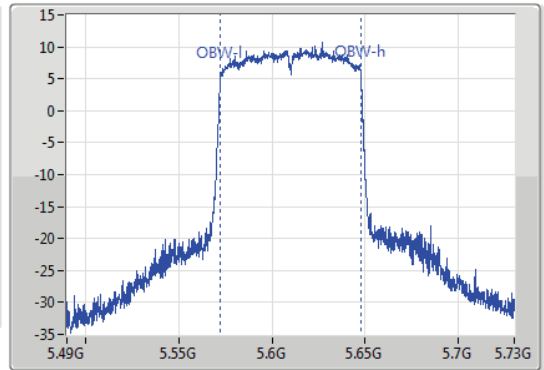

26dB(Hz)	Fl-26dB(Hz)	Fh-26dB(Hz)	OBW(Hz)	Fl-OBW(Hz)	Fh-OBW(Hz)	Limit(Hz)	Port
84.6M	5.56776G	5.65236G	75.442M	5.572339G	5.647781G	Inf	1

802.11ac VHT80\_Nss1,(MCS0)\_1TX(Port1)

EBW

5690MHz Straddle 5.47-5.725GHz

04/12/2019

CF: 5.65GHz  
 Span: 150MHz  
 RBW: 2MHz  
 VBW: 10MHz  
 Sweep Time: 100ms  
 Detector Type: Peak

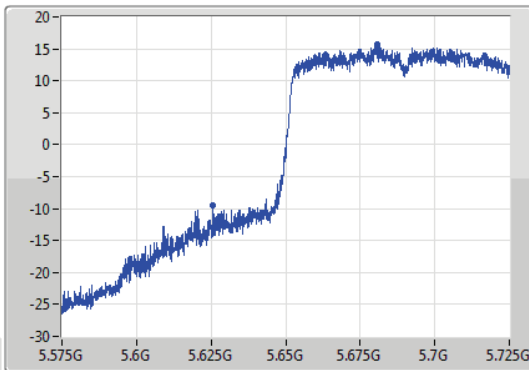

CF: 5.65GHz  
 Span: 150MHz  
 RBW: 1MHz  
 VBW: 3MHz  
 Sweep Time: 100ms  
 Detector Type: Peak

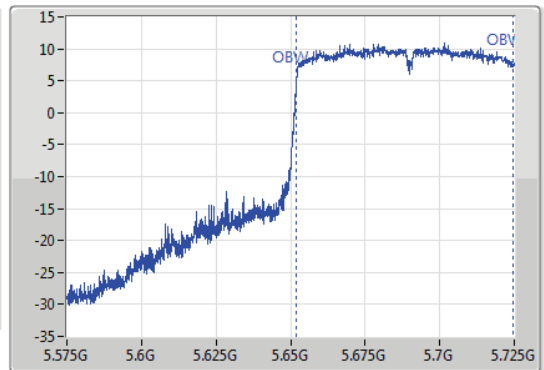

26dB(Hz)	Fl-26dB(Hz)	Fh-26dB(Hz)	OBW(Hz)	Fl-OBW(Hz)	Fh-OBW(Hz)	Limit(Hz)	Port
99.375M	5.625625G	5.725G	72.489M	5.651949G	5.724438G	Inf	1

802.11ac VHT80\_Nss1,(MCS0)\_1TX(Port1)

EBW

5690MHz Straddle 5.725-5.85GHz

04/12/2019

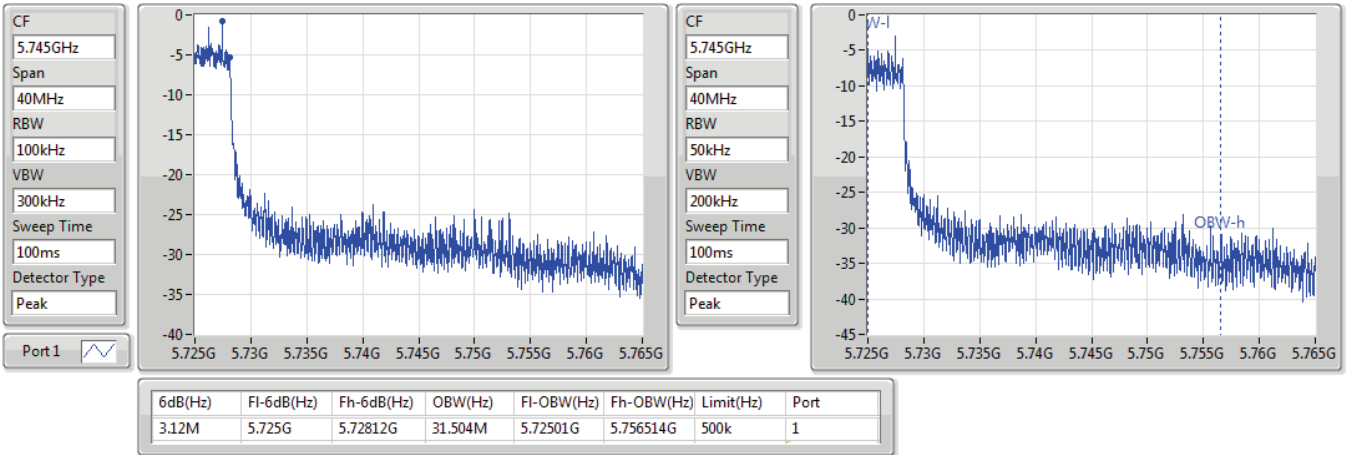

802.11ac VHT80\_Nss1,(MCS0)\_2TX

EBW

5290MHz

04/12/2019

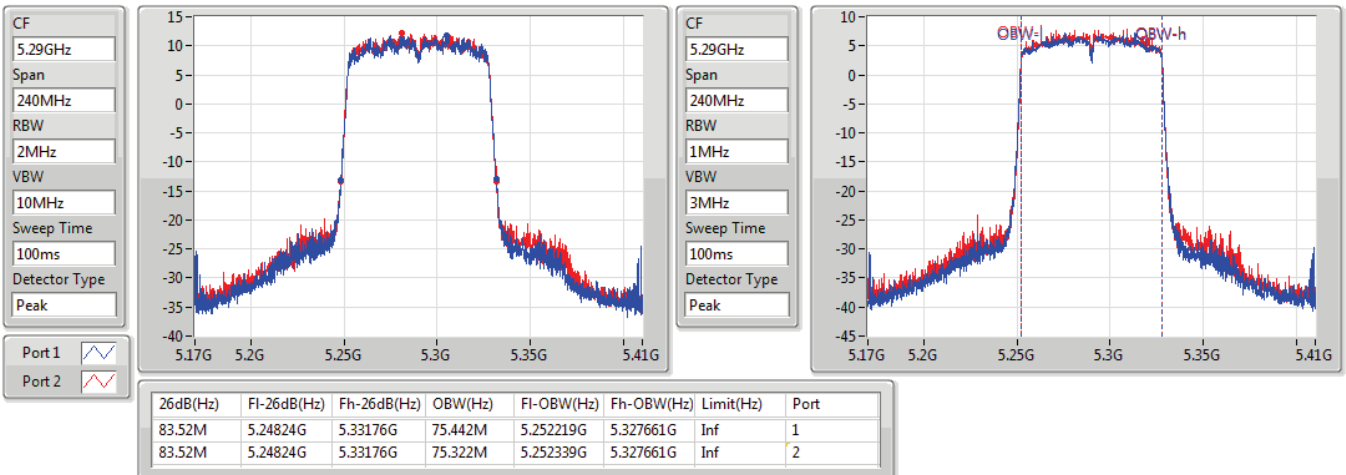

802.11ac VHT80\_Nss1,(MCS0)\_2TX

EBW

5530MHz

04/12/2019

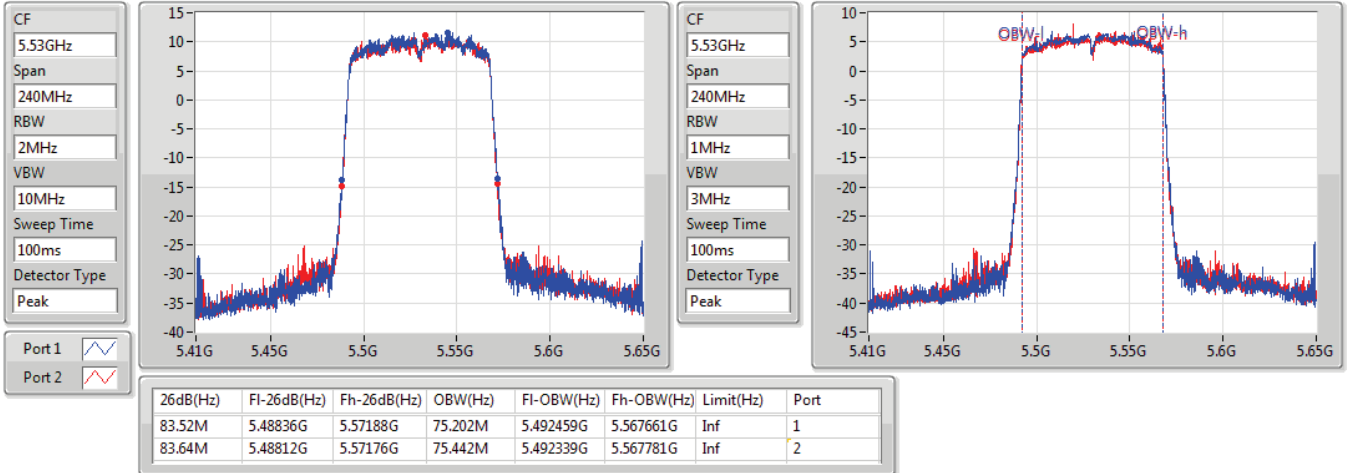

802.11ac VHT80\_Nss1,(MCS0)\_2TX

EBW

5610MHz

04/12/2019

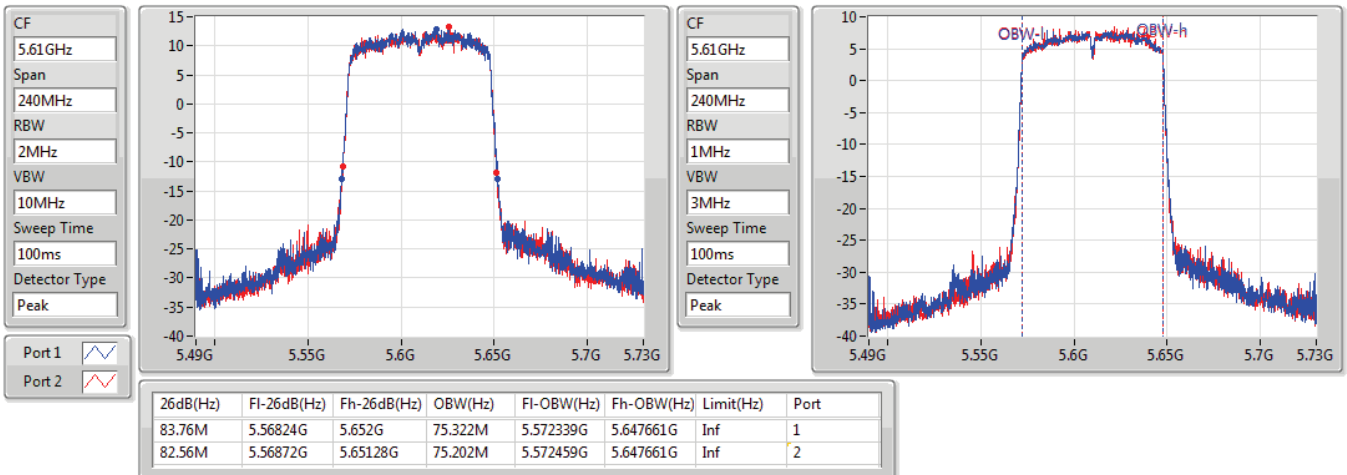

802.11ac VHT80\_Nss1,(MCS0)\_2TX

EBW

5690MHz Straddle 5.47-5.725GHz

04/12/2019

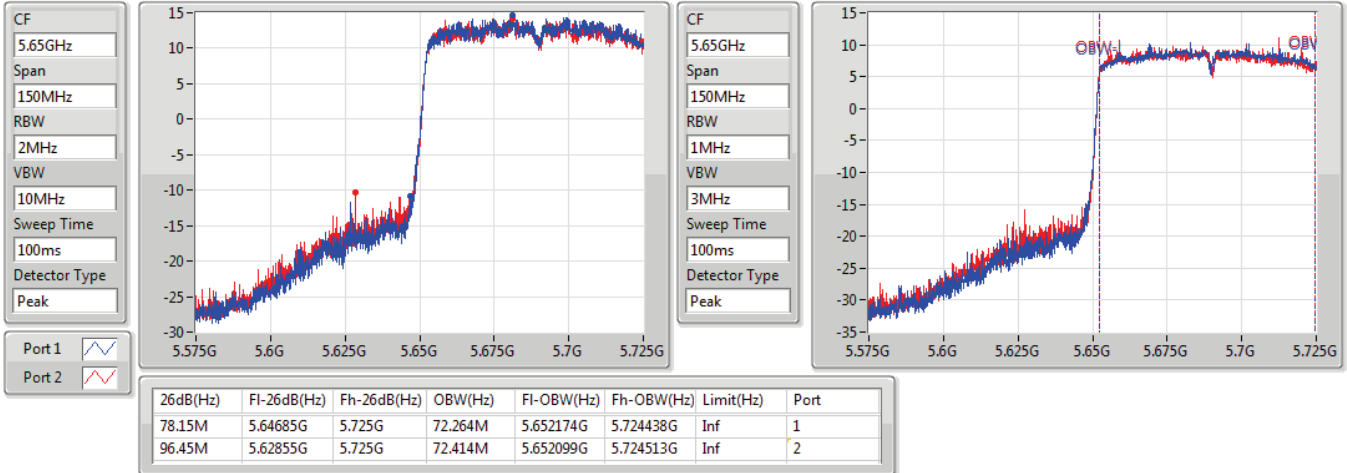

802.11ac VHT80\_Nss1,(MCS0)\_2TX

EBW

5690MHz Straddle 5.725-5.85GHz

04/12/2019

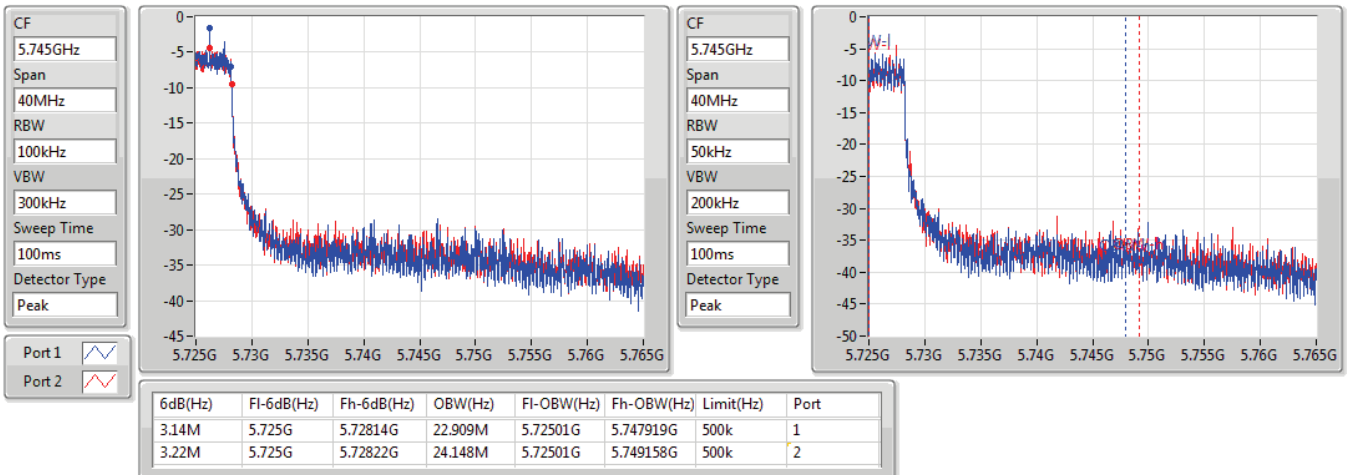



802.11ax HEW20\_Nss1,(MCS0)\_1TX(Port1)

EBW

5260MHz

04/12/2019

CF  
5.26GHz  
Span  
60MHz  
RBW  
300kHz  
VBW  
1MHz  
Sweep Time  
100ms  
Detector Type  
Peak  
Port 1

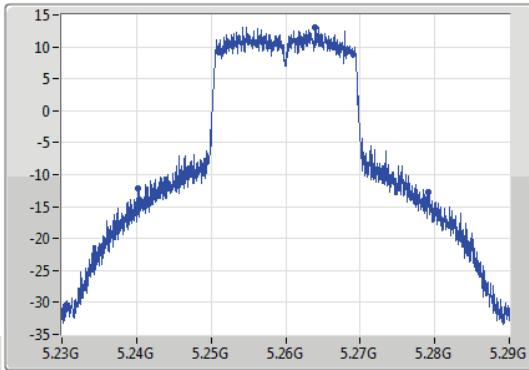

CF  
5.26GHz  
Span  
60MHz  
RBW  
200kHz  
VBW  
1MHz  
Sweep Time  
100ms  
Detector Type  
Peak

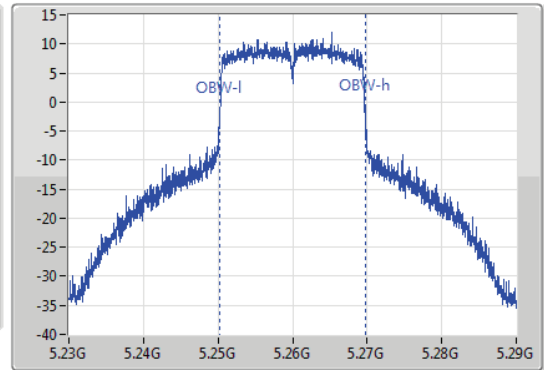

26dB(Hz)	Fl-26dB(Hz)	Fh-26dB(Hz)	OBW(Hz)	Fl-OBW(Hz)	Fh-OBW(Hz)	Limit(Hz)	Port
38.88M	5.24026G	5.27914G	19.49M	5.250225G	5.269715G	Inf	1

802.11ax HEW20\_Nss1,(MCS0)\_1TX(Port1)

EBW

5300MHz

04/12/2019

CF  
5.3GHz  
Span  
60MHz  
RBW  
300kHz  
VBW  
1MHz  
Sweep Time  
100ms  
Detector Type  
Peak  
Port 1

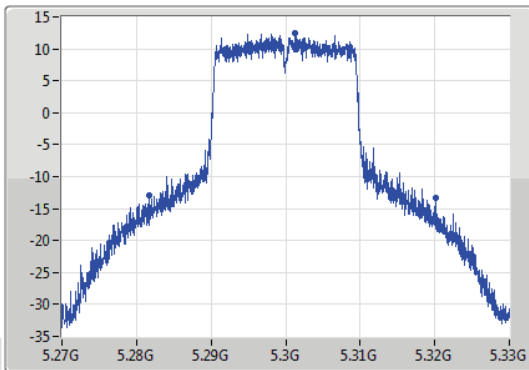

CF  
5.3GHz  
Span  
60MHz  
RBW  
200kHz  
VBW  
1MHz  
Sweep Time  
100ms  
Detector Type  
Peak

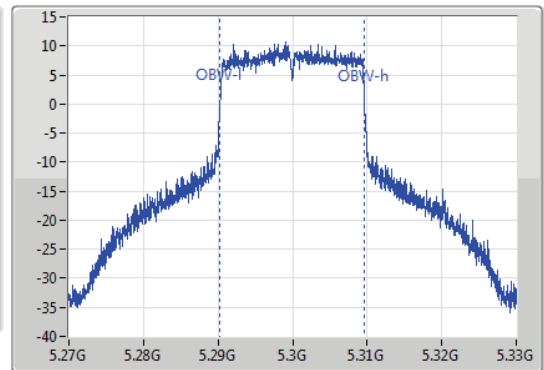

26dB(Hz)	Fl-26dB(Hz)	Fh-26dB(Hz)	OBW(Hz)	Fl-OBW(Hz)	Fh-OBW(Hz)	Limit(Hz)	Port
38.43M	5.28164G	5.32007G	19.37M	5.290285G	5.309655G	Inf	1

802.11ax HEW20\_Nss1,(MCS0)\_1TX(Port1)

EBW

5320MHz

04/12/2019

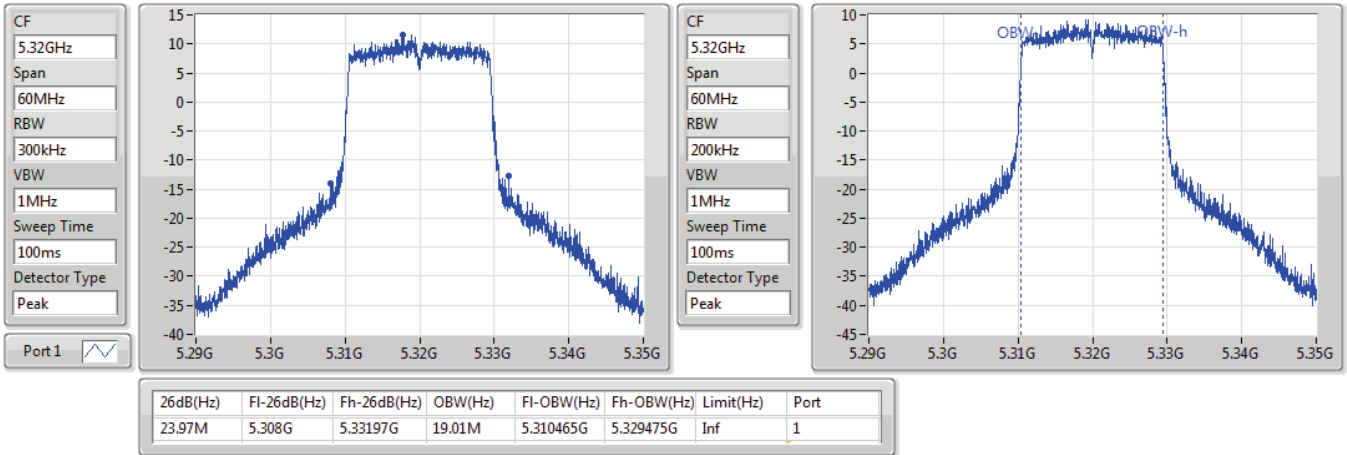

802.11ax HEW20\_Nss1,(MCS0)\_1TX(Port1)

EBW

5500MHz

04/12/2019

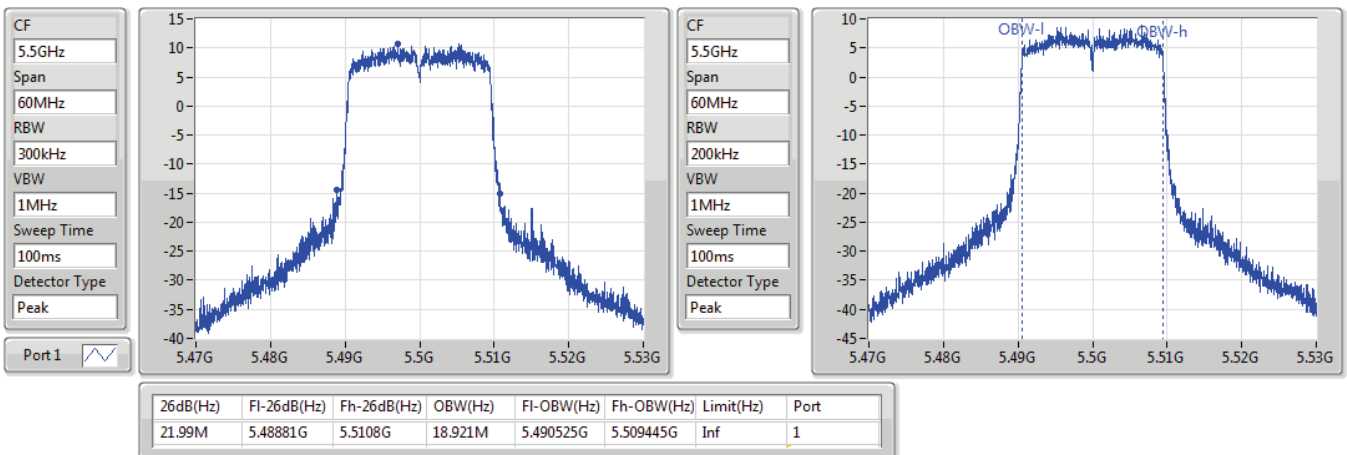

802.11ax HEW20\_Nss1,(MCS0)\_1TX(Port1)

EBW

5580MHz

04/12/2019

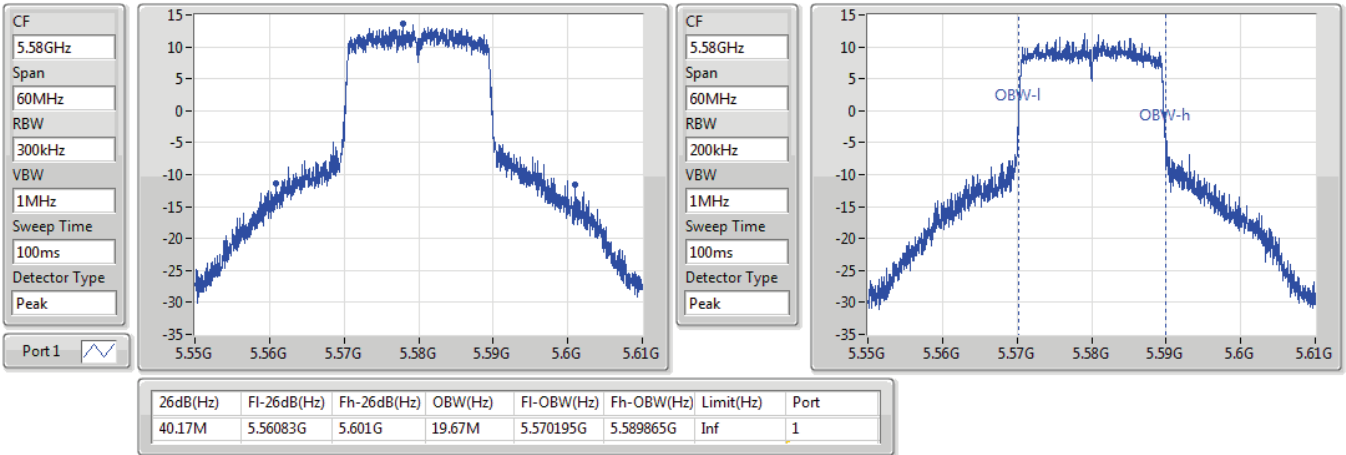

802.11ax HEW20\_Nss1,(MCS0)\_1TX(Port1)

EBW

5700MHz

04/12/2019

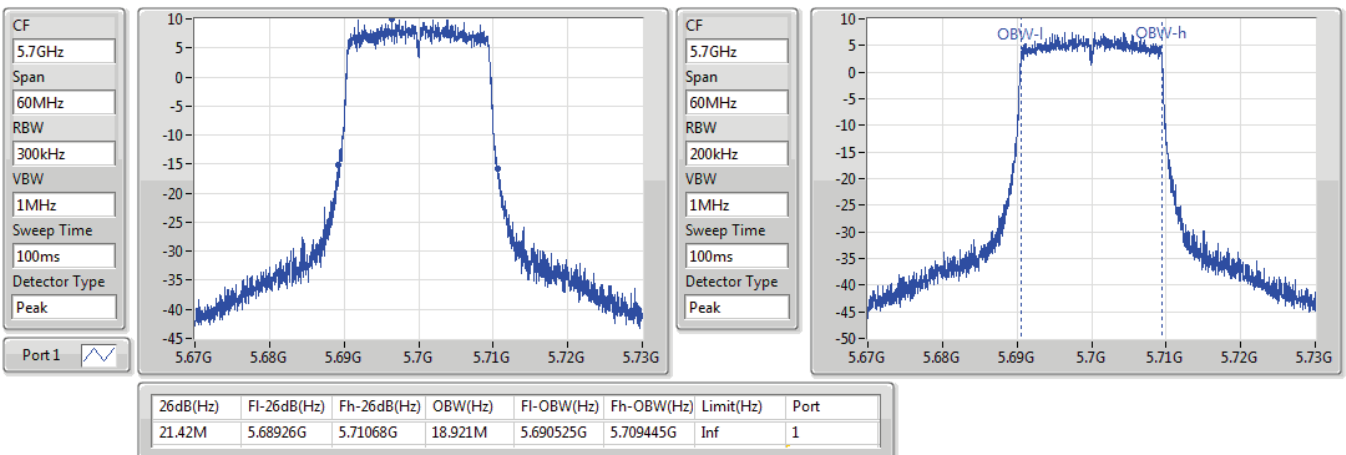

802.11ax HEW20\_Nss1,(MCS0)\_1TX(Port1)

EBW

5720MHz Straddle 5.47-5.725GHz

04/12/2019

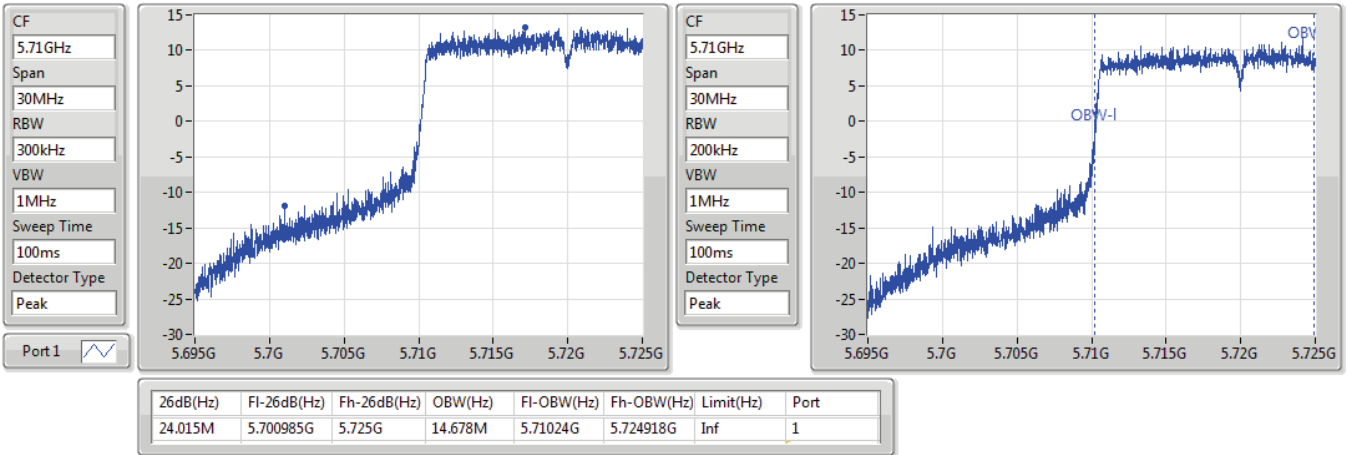

802.11ax HEW20\_Nss1,(MCS0)\_1TX(Port1)

EBW

5720MHz Straddle 5.725-5.85GHz

04/12/2019

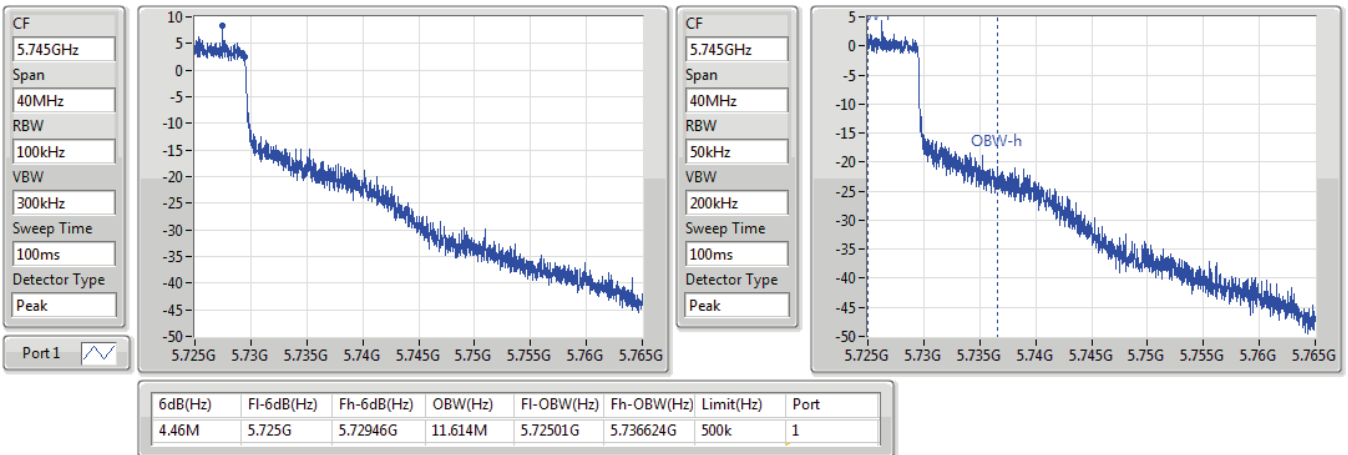

802.11ax HEW20\_Nss1,(MCS0)\_2TX

EBW

5260MHz

04/12/2019

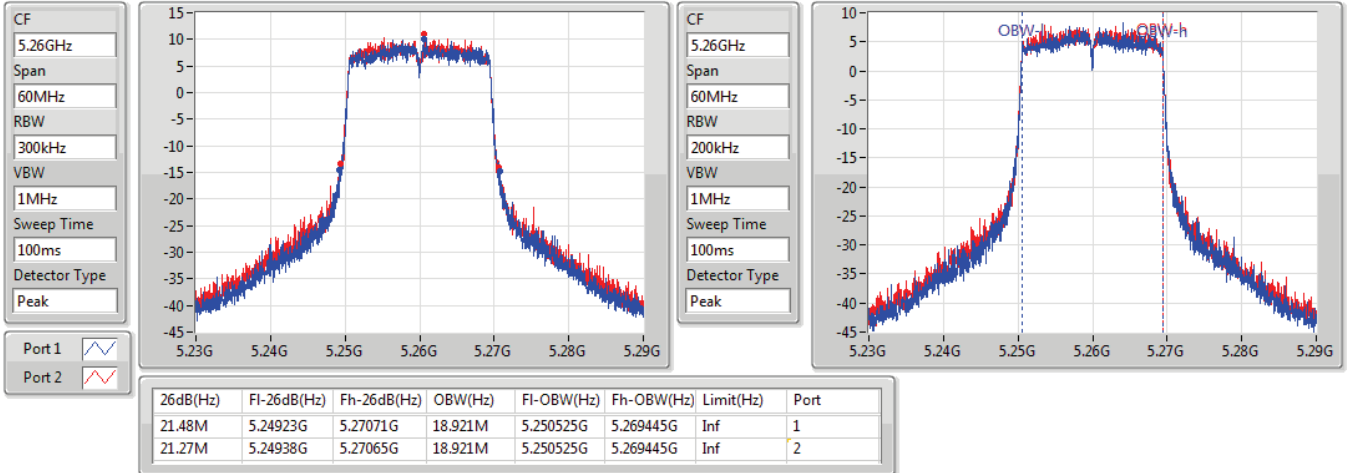

802.11ax HEW20\_Nss1,(MCS0)\_2TX

EBW

5300MHz

04/12/2019

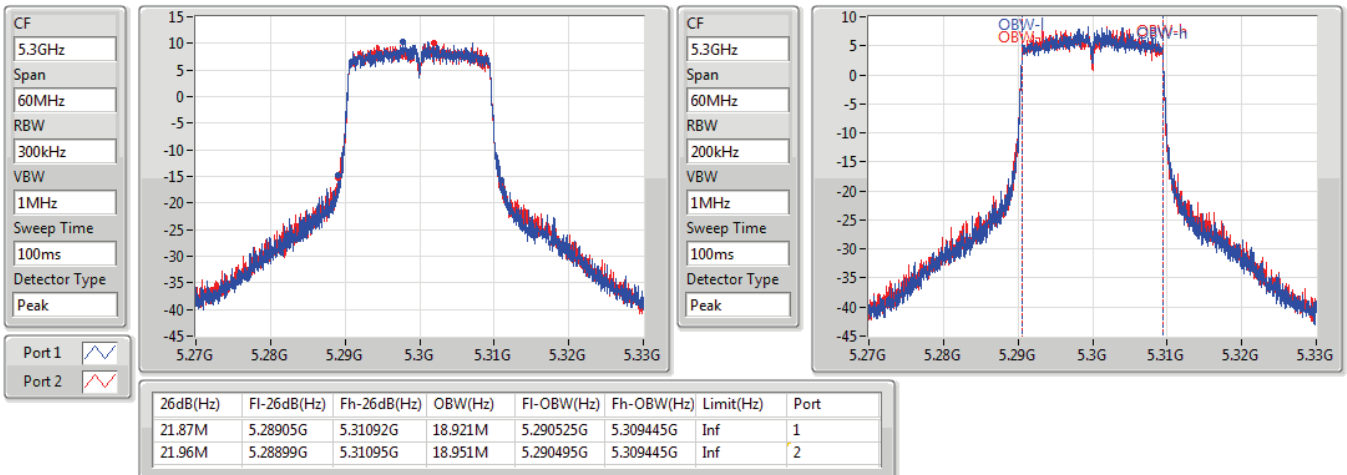

802.11ax HEW20\_Nss1,(MCS0)\_2TX

EBW

5320MHz

04/12/2019

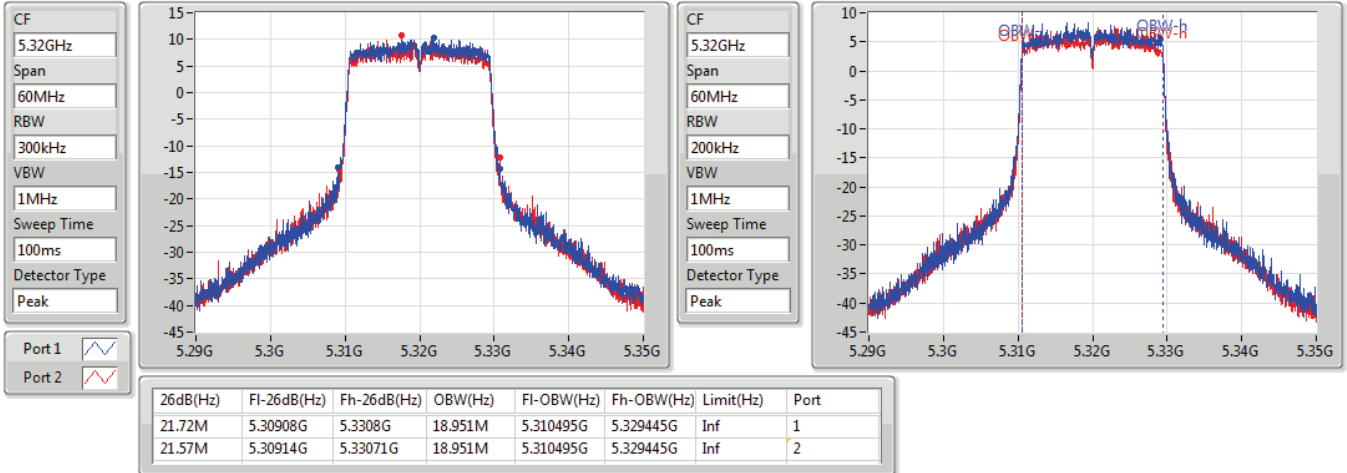

802.11ax HEW20\_Nss1,(MCS0)\_2TX

EBW

5500MHz

04/12/2019

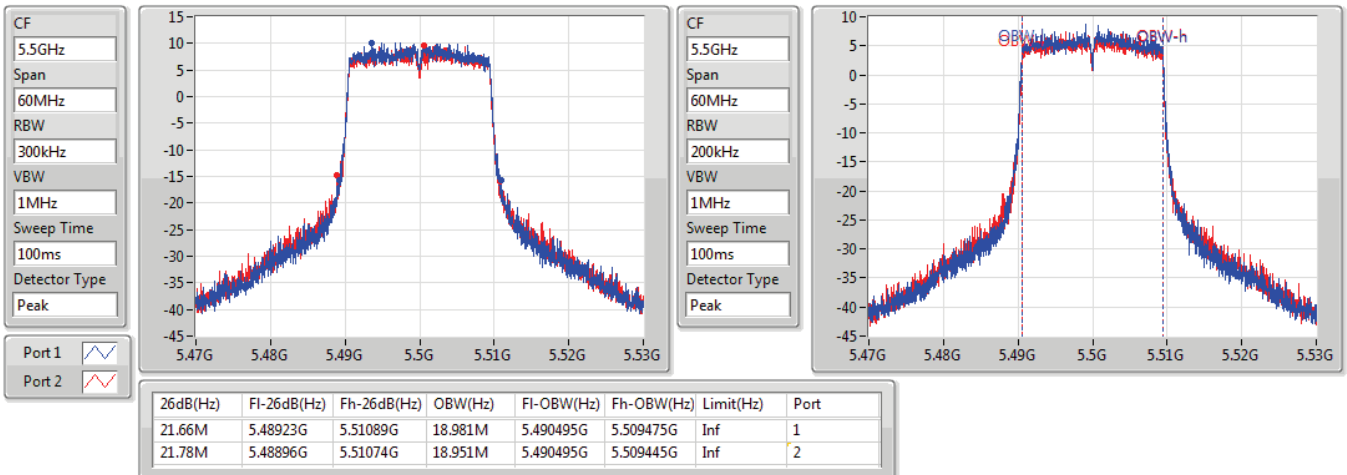

802.11ax HEW20\_Nss1,(MCS0)\_2TX

EBW

5580MHz

04/12/2019

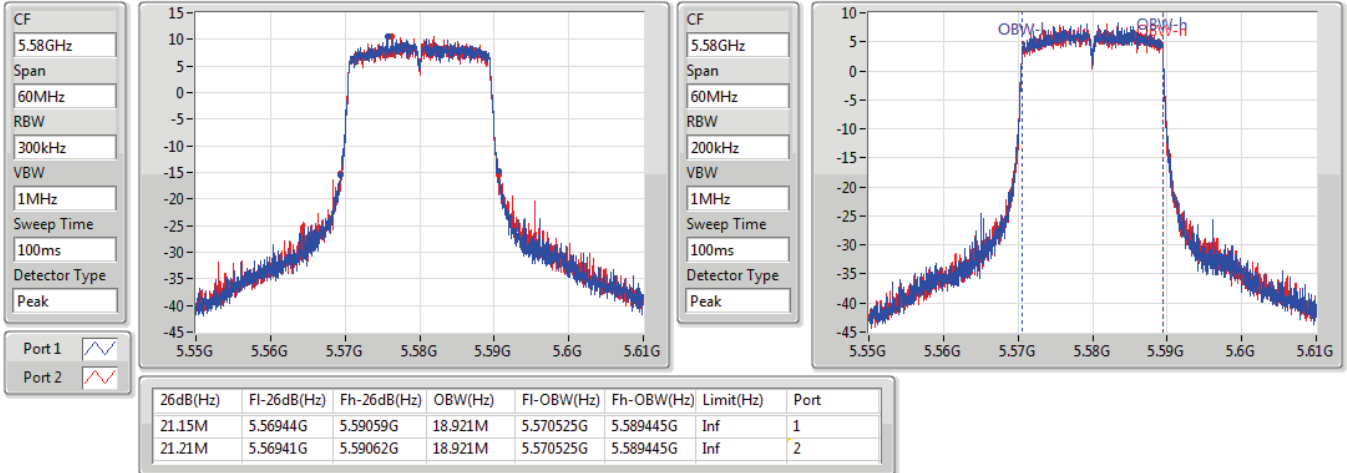

802.11ax HEW20\_Nss1,(MCS0)\_2TX

EBW

5700MHz

04/12/2019

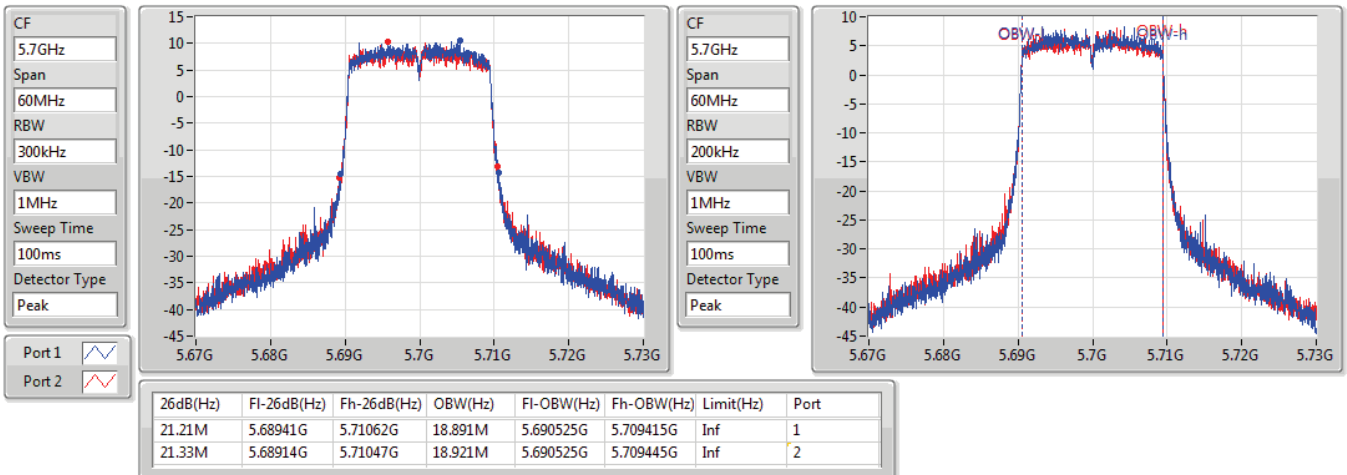

802.11ax HEW20\_Nss1,(MCS0)\_2TX

EBW

5720MHz Straddle 5.47-5.725GHz

04/12/2019

CF: 5.71GHz  
 Span: 30MHz  
 RBW: 300kHz  
 VBW: 1MHz  
 Sweep Time: 100ms  
 Detector Type: Peak  
 Port 1: [Waveform icon]  
 Port 2: [Waveform icon]

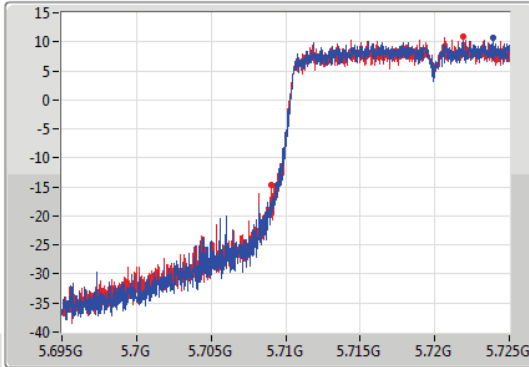

CF: 5.71GHz  
 Span: 30MHz  
 RBW: 200kHz  
 VBW: 1MHz  
 Sweep Time: 100ms  
 Detector Type: Peak

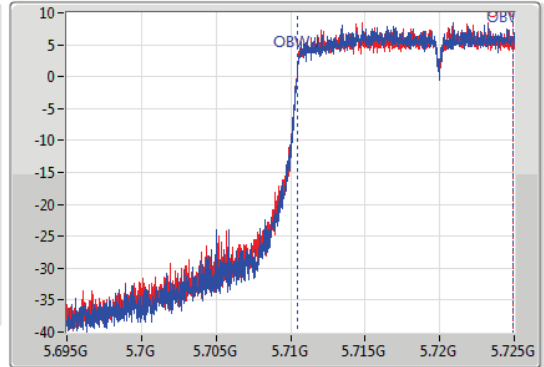

26dB(Hz)	Fl-26dB(Hz)	Fh-26dB(Hz)	OBW(Hz)	Fl-OBW(Hz)	Fh-OBW(Hz)	Limit(Hz)	Port
15.57M	5.70943G	5.725G	14.453M	5.71048G	5.724933G	Inf	1
15.945M	5.709055G	5.725G	14.438M	5.71048G	5.724918G	Inf	2

802.11ax HEW20\_Nss1,(MCS0)\_2TX

EBW

5720MHz Straddle 5.725-5.85GHz

04/12/2019

CF: 5.745GHz  
 Span: 40MHz  
 RBW: 100kHz  
 VBW: 300kHz  
 Sweep Time: 100ms  
 Detector Type: Peak  
 Port 1: [Waveform icon]  
 Port 2: [Waveform icon]

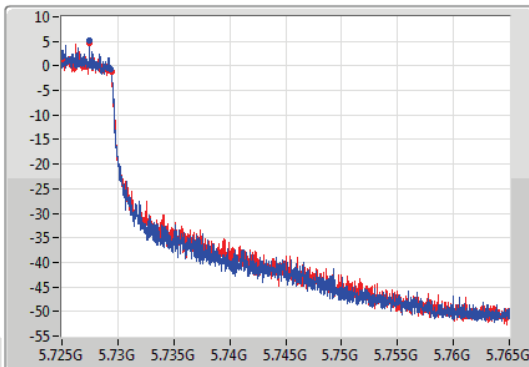

CF: 5.745GHz  
 Span: 40MHz  
 RBW: 50kHz  
 VBW: 200kHz  
 Sweep Time: 100ms  
 Detector Type: Peak

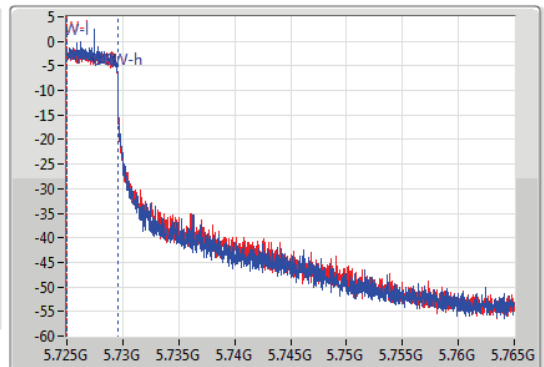

6dB(Hz)	Fl-6dB(Hz)	Fh-6dB(Hz)	OBW(Hz)	Fl-OBW(Hz)	Fh-OBW(Hz)	Limit(Hz)	Port
4.36M	5.725G	5.72936G	4.538M	5.72503G	5.729568G	500k	1
4.44M	5.725G	5.72944G	4.538M	5.72503G	5.729568G	500k	2



802.11ax HEW40\_Nss1,(MCS0)\_1TX(Port1)

EBW

5270MHz

04/12/2019

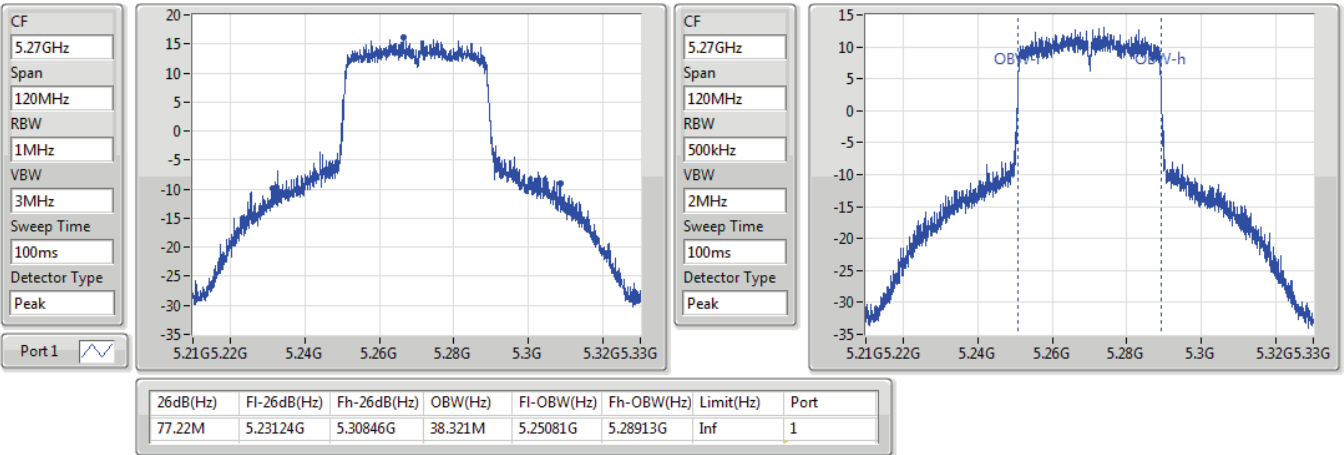

802.11ax HEW40\_Nss1,(MCS0)\_1TX(Port1)

EBW

5310MHz

04/12/2019

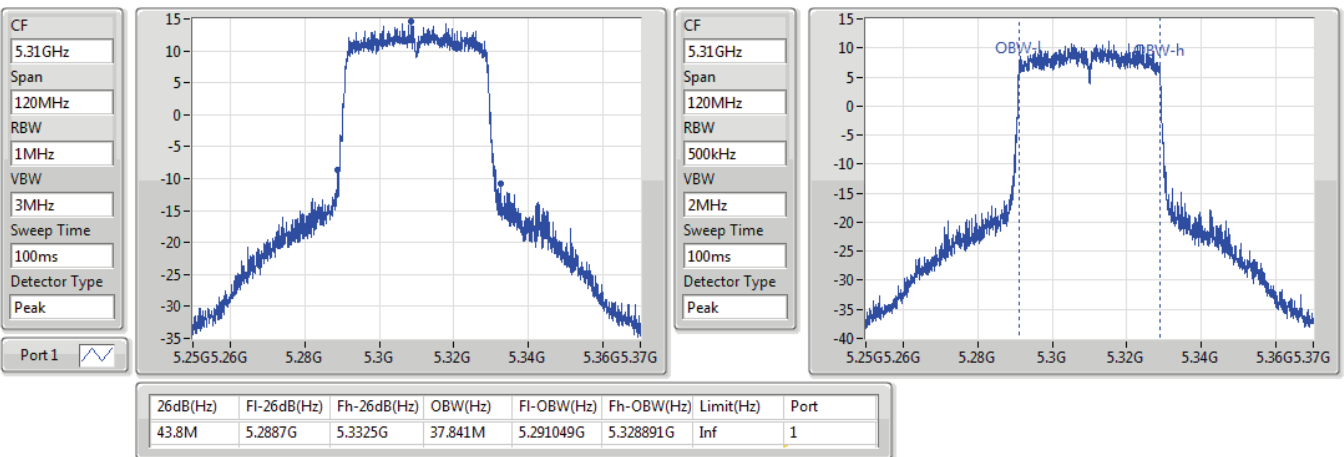

802.11ax HEW40\_Nss1,(MCS0)\_1TX(Port1)

EBW

5510MHz

04/12/2019

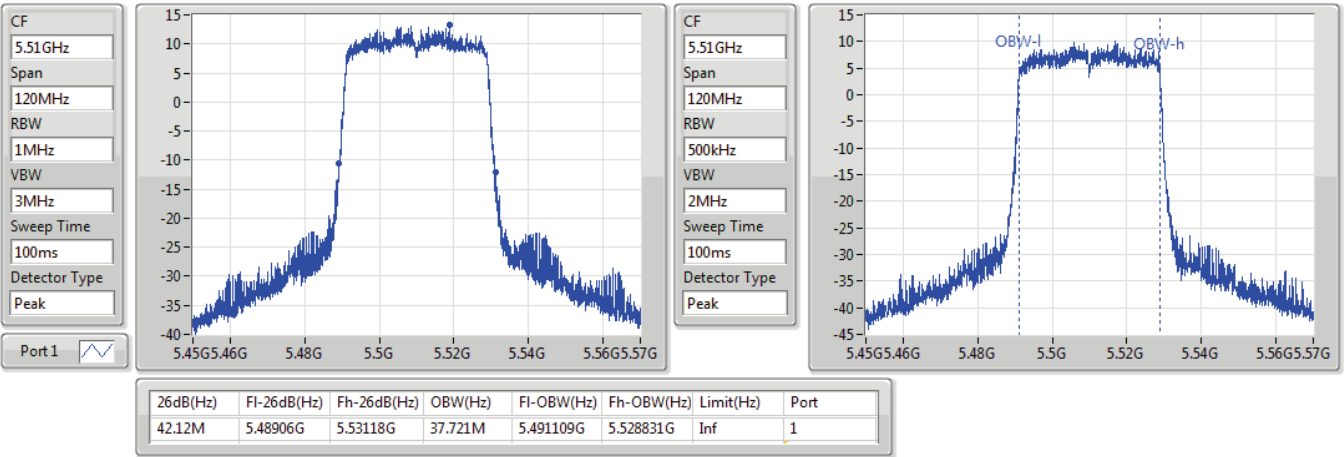

802.11ax HEW40\_Nss1,(MCS0)\_1TX(Port1)

EBW

5550MHz

04/12/2019

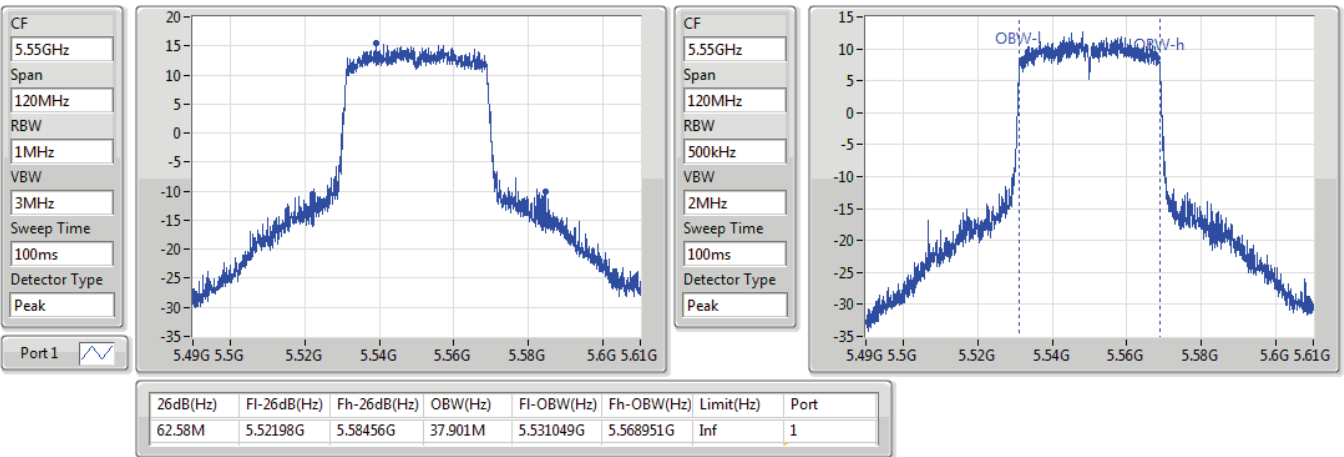

802.11ax HEW40\_Nss1,(MCS0)\_1TX(Port1)

EBW

5670MHz

04/12/2019

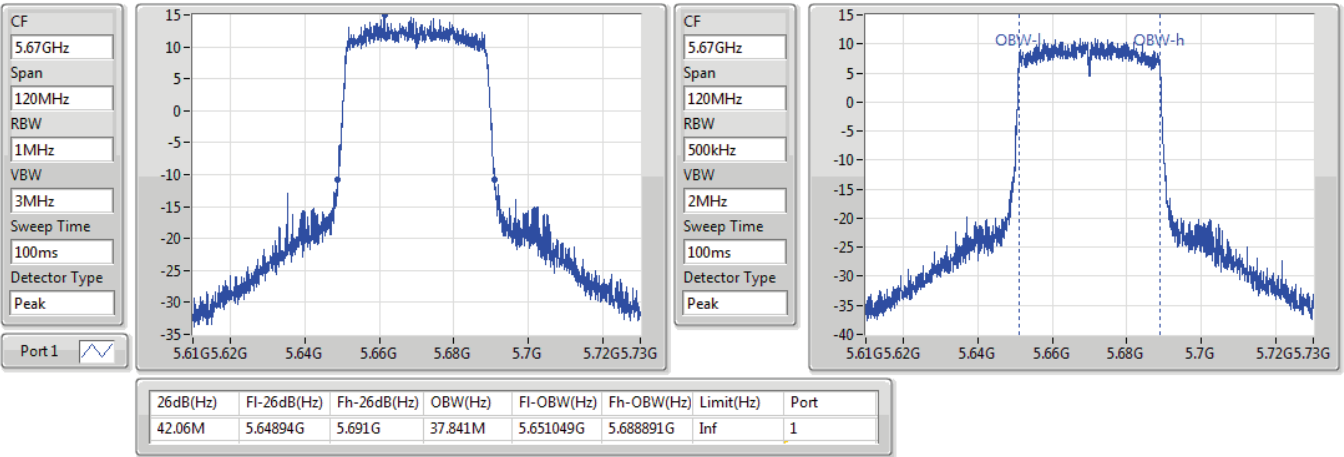

802.11ax HEW40\_Nss1,(MCS0)\_1TX(Port1)

EBW

5710MHz Straddle 5.47-5.725GHz

04/12/2019

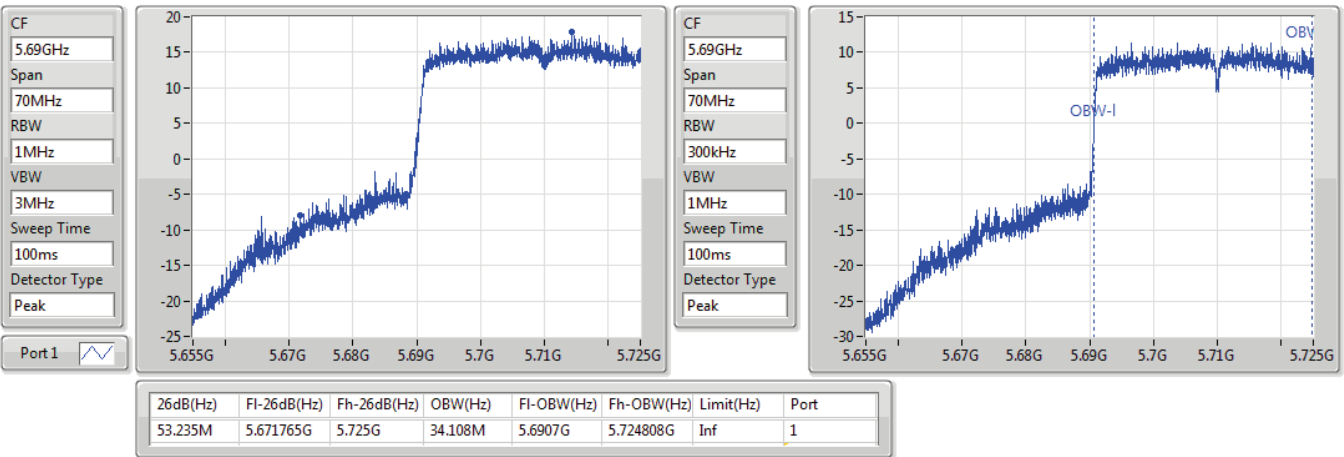

802.11ax HEW40\_Nss1,(MCS0)\_1TX(Port1)

EBW

5710MHz Straddle 5.725-5.85GHz

04/12/2019

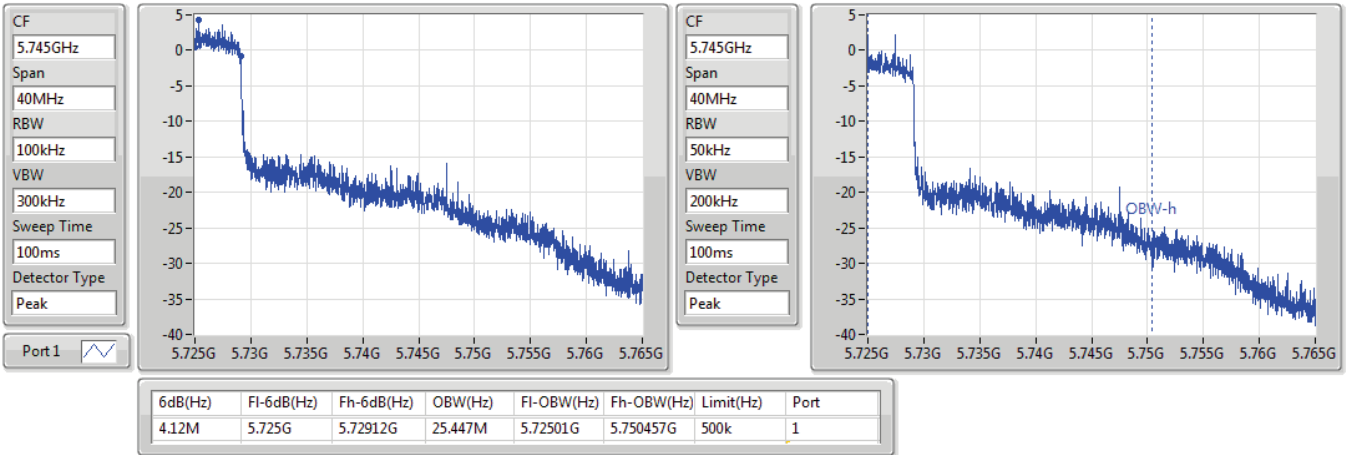

802.11ax HEW40\_Nss1,(MCS0)\_2TX

EBW

5270MHz

04/12/2019



802.11ax HEW40\_Nss1,(MCS0)\_2TX

EBW

5310MHz

04/12/2019

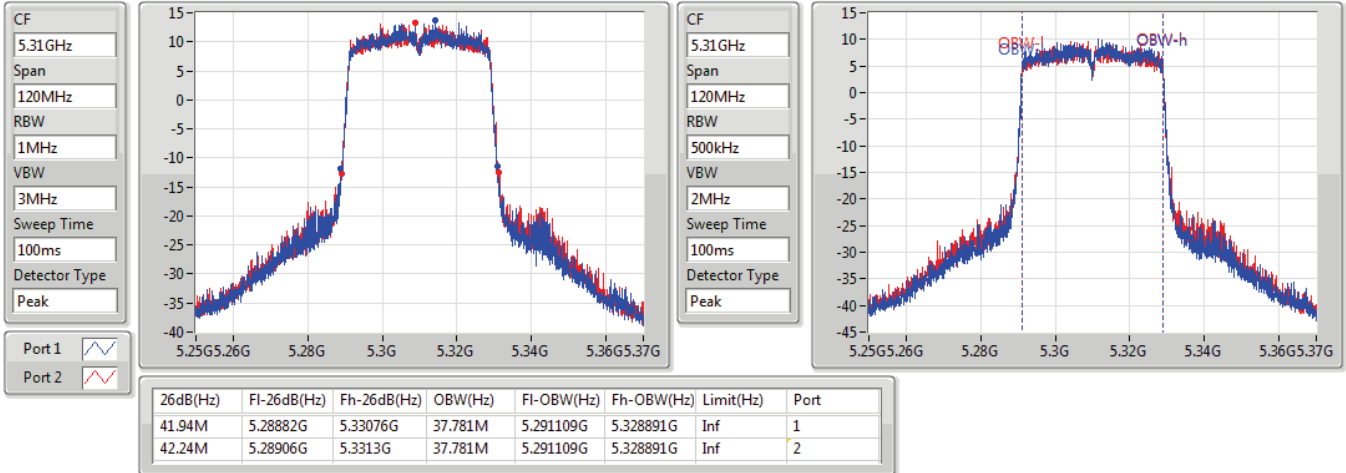

802.11ax HEW40\_Nss1,(MCS0)\_2TX

EBW

5510MHz

04/12/2019

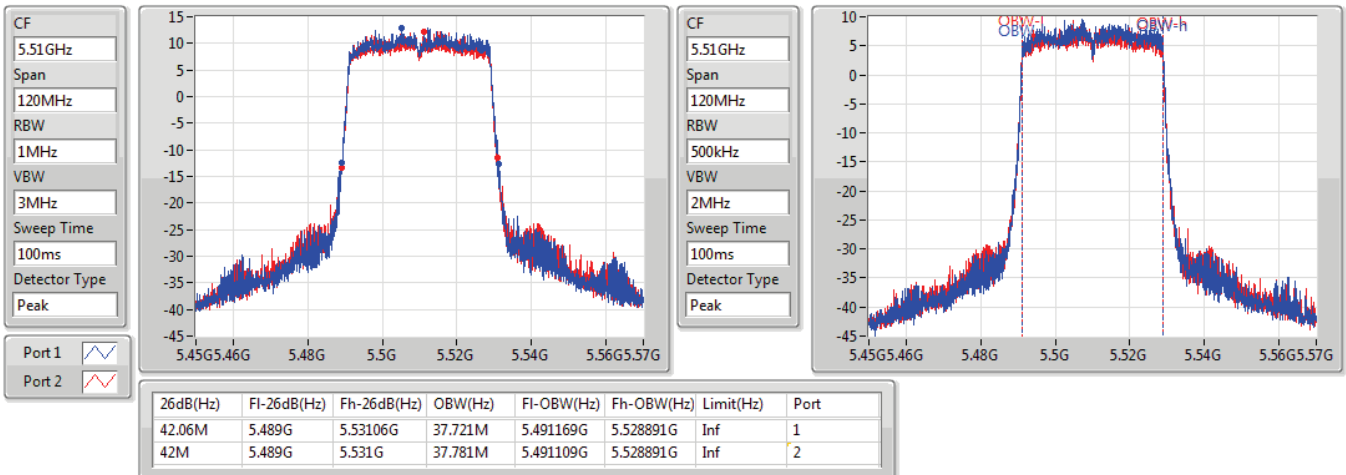

802.11ax HEW40\_Nss1,(MCS0)\_2TX

EBW

5550MHz

04/12/2019

CF  
5.55GHz  
Span  
120MHz  
RBW  
1MHz  
VBW  
3MHz  
Sweep Time  
100ms  
Detector Type  
Peak

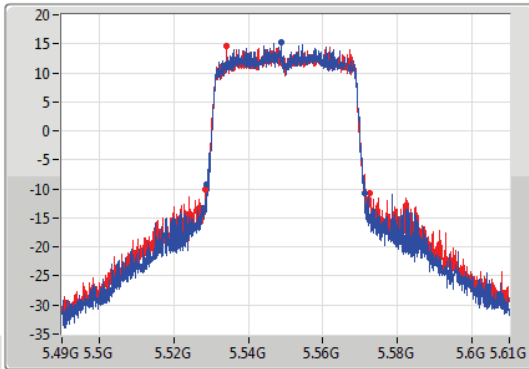

CF  
5.55GHz  
Span  
120MHz  
RBW  
500kHz  
VBW  
2MHz  
Sweep Time  
100ms  
Detector Type  
Peak

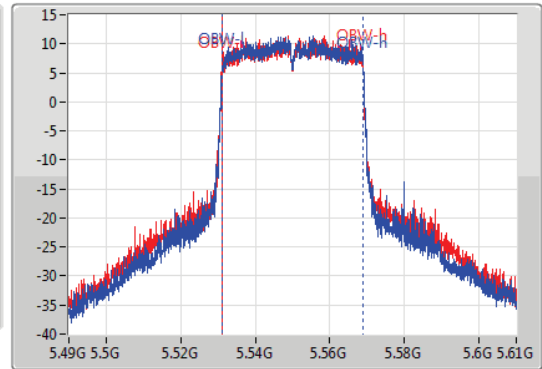

26dB(Hz)	Fl-26dB(Hz)	Fh-26dB(Hz)	OBW(Hz)	Fl-OBW(Hz)	Fh-OBW(Hz)	Limit(Hz)	Port
42.36M	5.52888G	5.57124G	37.841M	5.531109G	5.568951G	Inf	1
44.16M	5.52852G	5.57268G	37.901M	5.531049G	5.568951G	Inf	2

802.11ax HEW40\_Nss1,(MCS0)\_2TX

EBW

5670MHz

04/12/2019

CF  
5.67GHz  
Span  
120MHz  
RBW  
1MHz  
VBW  
3MHz  
Sweep Time  
100ms  
Detector Type  
Peak

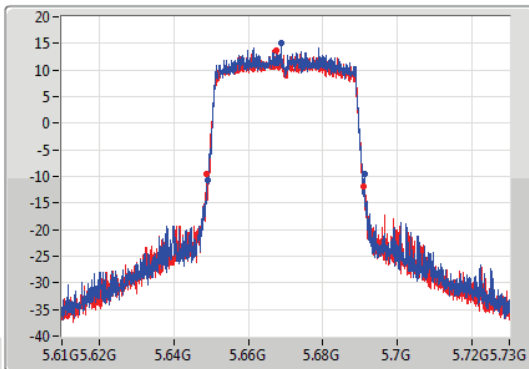

CF  
5.67GHz  
Span  
120MHz  
RBW  
500kHz  
VBW  
2MHz  
Sweep Time  
100ms  
Detector Type  
Peak

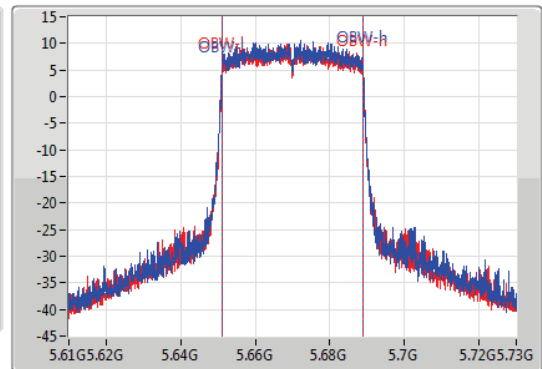

26dB(Hz)	Fl-26dB(Hz)	Fh-26dB(Hz)	OBW(Hz)	Fl-OBW(Hz)	Fh-OBW(Hz)	Limit(Hz)	Port
42.06M	5.649G	5.69106G	37.781M	5.651109G	5.688891G	Inf	1
42.18M	5.64864G	5.69082G	37.781M	5.651049G	5.688831G	Inf	2

802.11ax HEW40\_Nss1,(MCS0)\_2TX

EBW

5710MHz Straddle 5.47-5.725GHz

04/12/2019

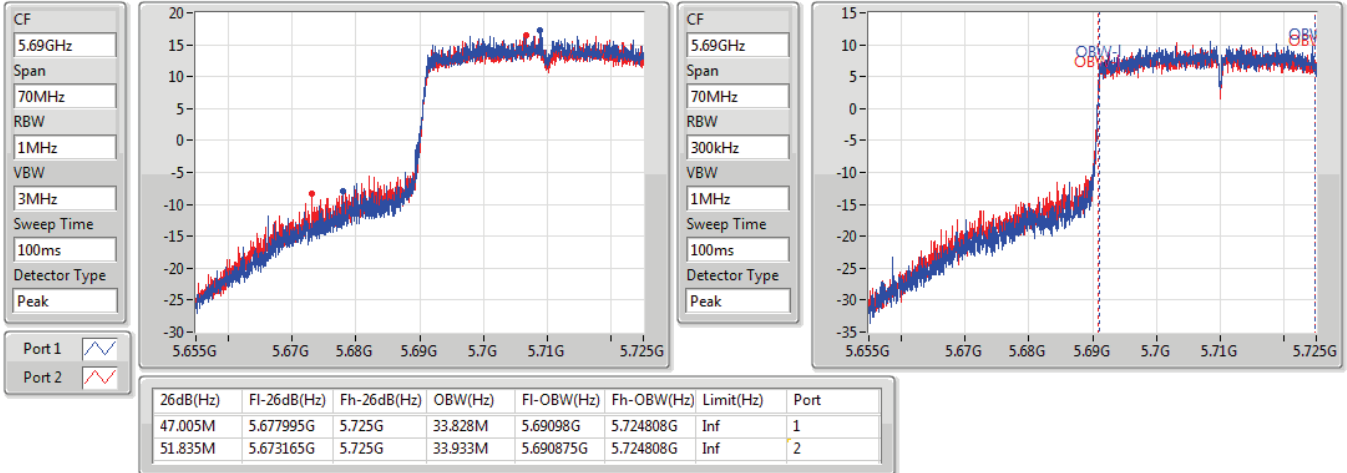

802.11ax HEW40\_Nss1,(MCS0)\_2TX

EBW

5710MHz Straddle 5.725-5.85GHz

04/12/2019

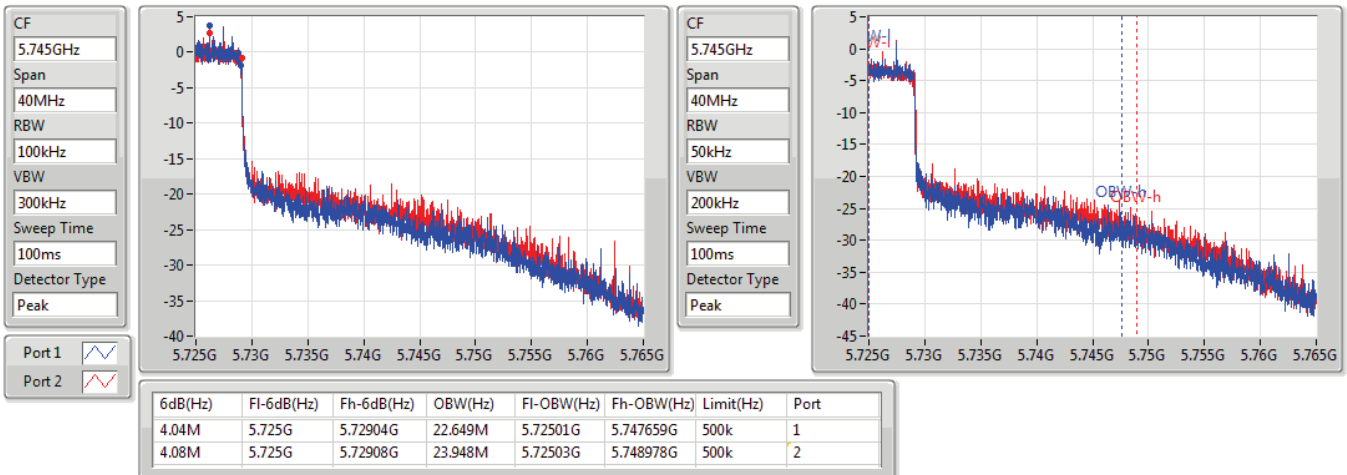

802.11ax HEW80\_Nss1,(MCS0)\_1TX(Port1)

EBW

5290MHz

04/12/2019

CF  
5.29GHz  
Span  
240MHz  
RBW  
2MHz  
VBW  
10MHz  
Sweep Time  
100ms  
Detector Type  
Peak  
Port 1

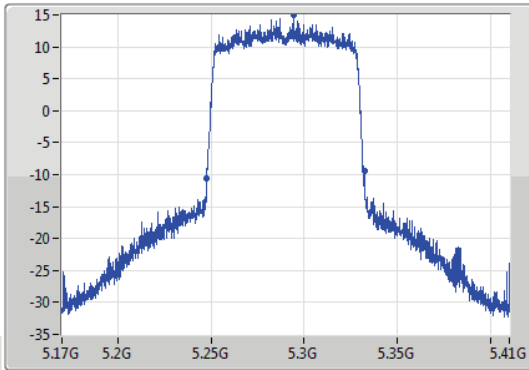

CF  
5.29GHz  
Span  
240MHz  
RBW  
1MHz  
VBW  
3MHz  
Sweep Time  
100ms  
Detector Type  
Peak

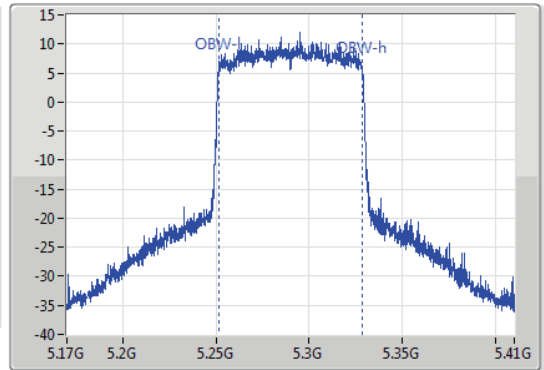

26dB(Hz)	Fl-26dB(Hz)	Fh-26dB(Hz)	OBW(Hz)	Fl-OBW(Hz)	Fh-OBW(Hz)	Limit(Hz)	Port
84.72M	5.24764G	5.33236G	77.361M	5.251259G	5.328621G	Inf	1

802.11ax HEW80\_Nss1,(MCS0)\_1TX(Port1)

EBW

5530MHz

04/12/2019

CF  
5.53GHz  
Span  
240MHz  
RBW  
2MHz  
VBW  
10MHz  
Sweep Time  
100ms  
Detector Type  
Peak  
Port 1

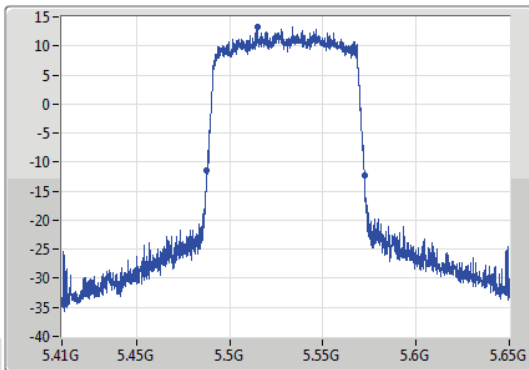

CF  
5.53GHz  
Span  
240MHz  
RBW  
1MHz  
VBW  
3MHz  
Sweep Time  
100ms  
Detector Type  
Peak

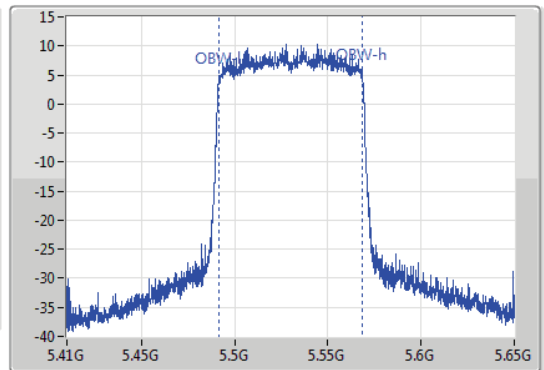

26dB(Hz)	Fl-26dB(Hz)	Fh-26dB(Hz)	OBW(Hz)	Fl-OBW(Hz)	Fh-OBW(Hz)	Limit(Hz)	Port
84.36M	5.48776G	5.57212G	77.121M	5.491499G	5.568621G	Inf	1



802.11ax HEW80\_Nss1,(MCS0)\_1TX(Port1)

EBW

5610MHz

04/12/2019

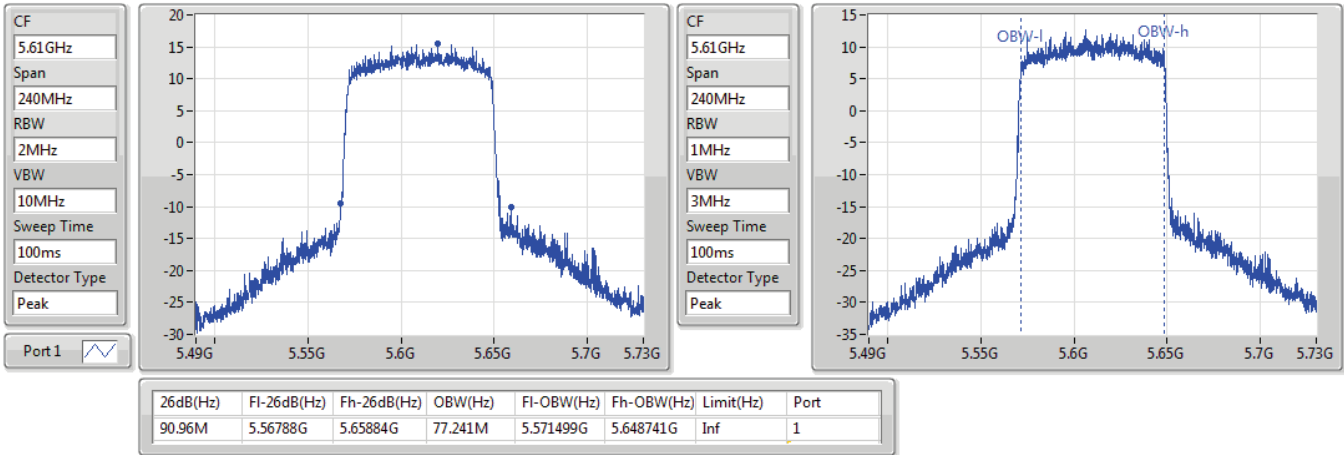

802.11ax HEW80\_Nss1,(MCS0)\_1TX(Port1)

EBW

5690MHz Straddle 5.47-5.725GHz

04/12/2019

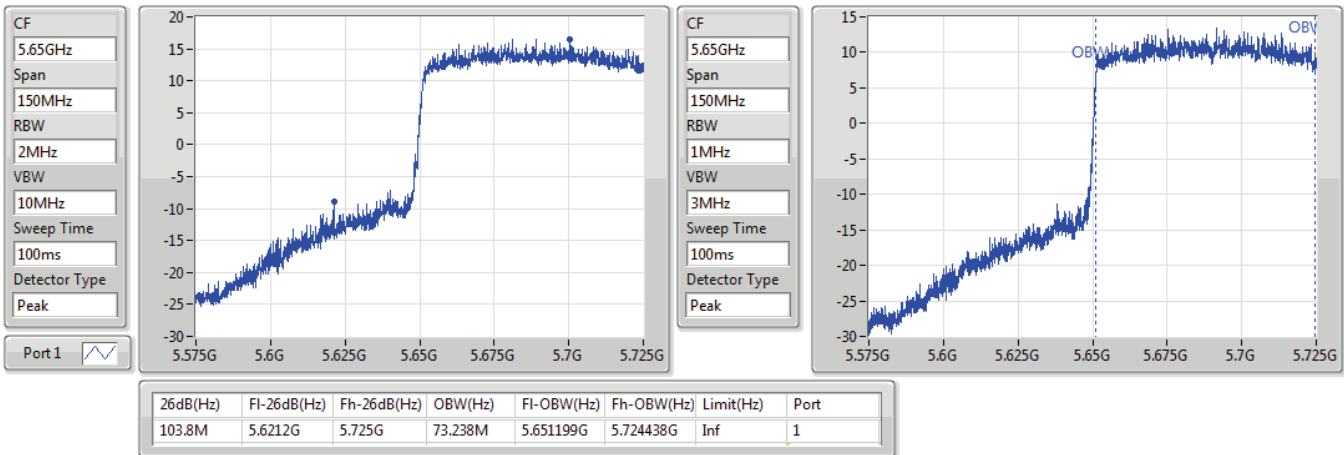

802.11ax HEW80\_Nss1,(MCS0)\_1TX(Port1)

EBW

5690MHz Straddle 5.725-5.85GHz

04/12/2019

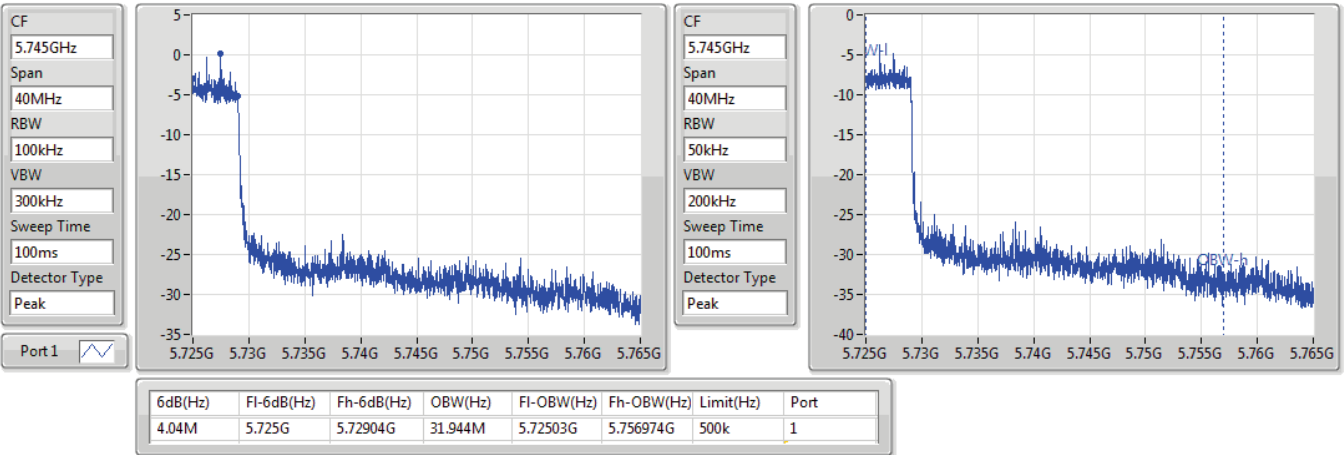

802.11ax HEW80\_Nss1,(MCS0)\_2TX

EBW

5290MHz

04/12/2019

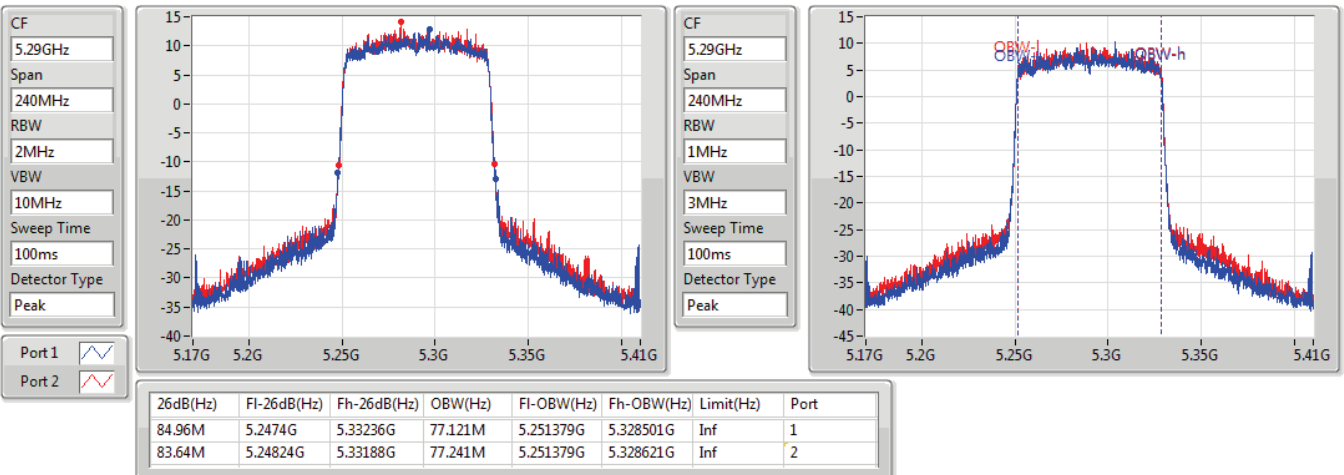

802.11ax HEW80\_Nss1,(MCS0)\_2TX

EBW

5530MHz

04/12/2019

CF  
5.53GHz  
Span  
240MHz  
RBW  
2MHz  
VBW  
10MHz  
Sweep Time  
100ms  
Detector Type  
Peak

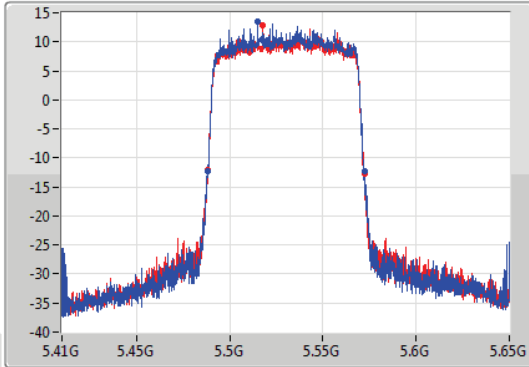

CF  
5.53GHz  
Span  
240MHz  
RBW  
1MHz  
VBW  
3MHz  
Sweep Time  
100ms  
Detector Type  
Peak

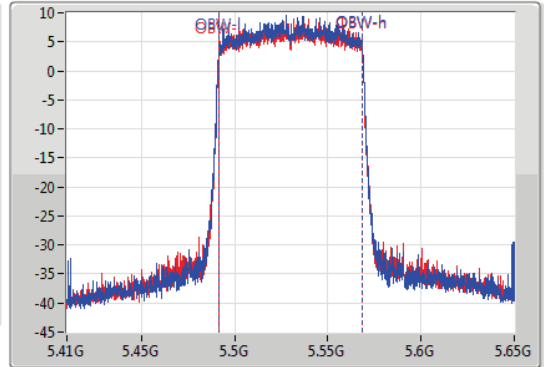

26dB(Hz)	Fl-26dB(Hz)	Fh-26dB(Hz)	OBW(Hz)	Fl-OBW(Hz)	Fh-OBW(Hz)	Limit(Hz)	Port
84.36M	5.488G	5.57236G	77.121M	5.491499G	5.568621G	Inf	1
83.76M	5.48836G	5.57212G	77.121M	5.491499G	5.568621G	Inf	2

802.11ax HEW80\_Nss1,(MCS0)\_2TX

EBW

5610MHz

04/12/2019

CF  
5.61GHz  
Span  
240MHz  
RBW  
2MHz  
VBW  
10MHz  
Sweep Time  
100ms  
Detector Type  
Peak

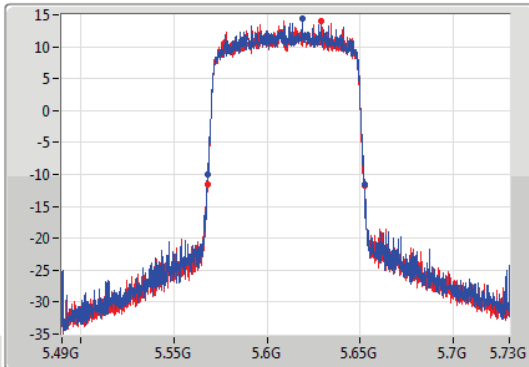

CF  
5.61GHz  
Span  
240MHz  
RBW  
1MHz  
VBW  
3MHz  
Sweep Time  
100ms  
Detector Type  
Peak

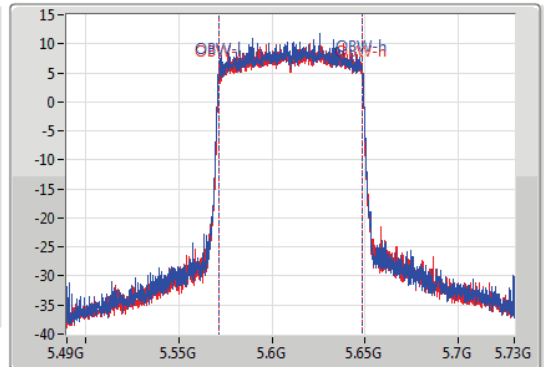

26dB(Hz)	Fl-26dB(Hz)	Fh-26dB(Hz)	OBW(Hz)	Fl-OBW(Hz)	Fh-OBW(Hz)	Limit(Hz)	Port
84.48M	5.568G	5.65248G	77.241M	5.571379G	5.648621G	Inf	1
84.24M	5.568G	5.65224G	77.121M	5.571499G	5.648621G	Inf	2

802.11ax HEW80\_Nss1,(MCS0)\_2TX

EBW

5690MHz Straddle 5.47-5.725GHz

04/12/2019

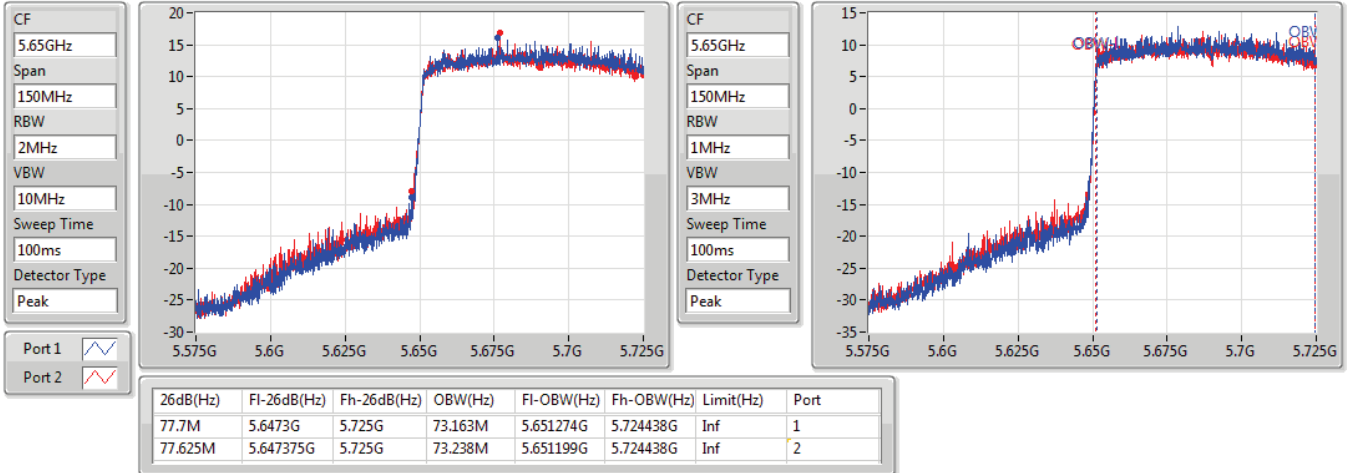

802.11ax HEW80\_Nss1,(MCS0)\_2TX

EBW

5690MHz Straddle 5.725-5.85GHz

04/12/2019

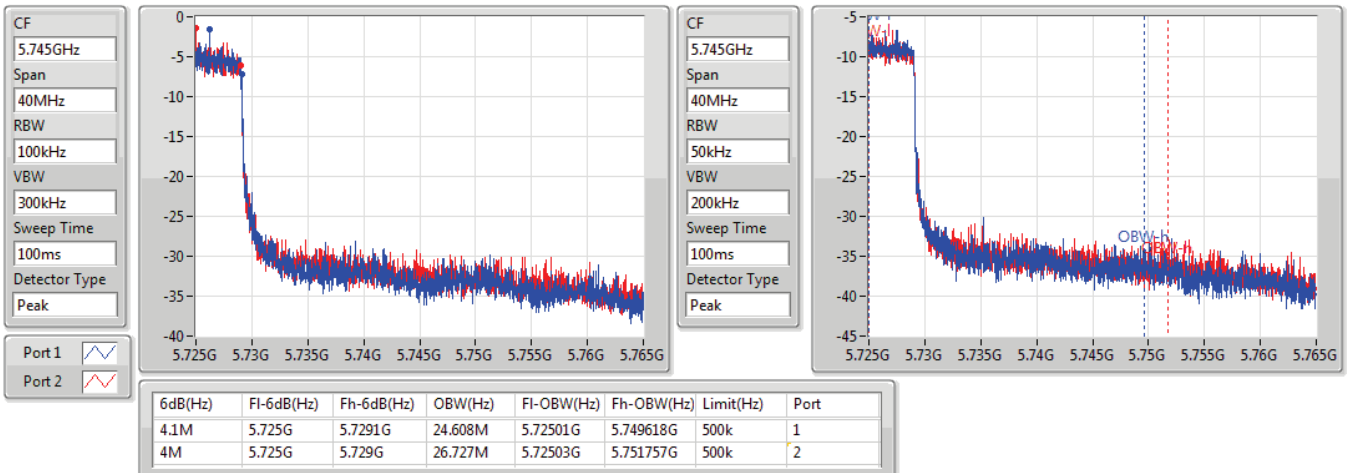



Summary

Mode	Max-N dB (Hz)	Max-OBW (Hz)	ITU-Code	Min-N dB (Hz)	Min-OBW (Hz)
5.25-5.35GHz	-	-	-	-	-
802.11a_Nss1,(6Mbps)_1TX(Port2)	19.26M	16.402M	16M4D1D	19.23M	16.372M
802.11a_Nss1,(6Mbps)_2TX	19.29M	16.372M	16M4D1D	18.93M	16.342M
802.11ac_VHT20_Nss1,(MCS0)_1TX(Port2)	20.1M	17.541M	17M5D1D	20.07M	17.541M
802.11ac_VHT20_Nss1,(MCS0)_2TX	20.37M	17.541M	17M5D1D	20.07M	17.541M
802.11ac_VHT40_Nss1,(MCS0)_1TX(Port2)	40.38M	36.102M	36M1D1D	40.02M	36.102M
802.11ac_VHT40_Nss1,(MCS0)_2TX	40.5M	36.162M	36M2D1D	40.08M	36.102M
802.11ac_VHT80_Nss1,(MCS0)_1TX(Port2)	81.36M	75.322M	75M3D1D	81.36M	75.322M
802.11ac_VHT80_Nss1,(MCS0)_2TX	82.2M	75.322M	75M3D1D	82.08M	75.202M
802.11ax_HEW20_Nss1,(MCS0)_1TX(Port2)	21.06M	18.921M	18M9D1D	20.91M	18.921M
802.11ax_HEW20_Nss1,(MCS0)_2TX	21.6M	18.921M	18M9D1D	20.91M	18.861M
802.11ax_HEW40_Nss1,(MCS0)_1TX(Port2)	40.92M	37.781M	37M8D1D	40.92M	37.721M
802.11ax_HEW40_Nss1,(MCS0)_2TX	40.98M	37.781M	37M8D1D	40.74M	37.721M
802.11ax_HEW80_Nss1,(MCS0)_1TX(Port2)	82.32M	77.121M	77M1D1D	82.32M	77.121M
802.11ax_HEW80_Nss1,(MCS0)_2TX	82.44M	77.121M	77M1D1D	82.08M	77.121M
5.47-5.725GHz	-	-	-	-	-
802.11a_Nss1,(6Mbps)_1TX(Port2)	19.32M	16.372M	16M4D1D	14.665M	13.206M
802.11a_Nss1,(6Mbps)_2TX	19.47M	16.372M	16M4D1D	14.595M	13.206M
802.11ac_VHT20_Nss1,(MCS0)_1TX(Port2)	20.4M	17.541M	17M5D1D	15.348M	13.766M
802.11ac_VHT20_Nss1,(MCS0)_2TX	20.67M	17.571M	17M6D1D	15.208M	13.766M
802.11ac_VHT40_Nss1,(MCS0)_1TX(Port2)	40.62M	36.162M	36M2D1D	35.288M	32.984M
802.11ac_VHT40_Nss1,(MCS0)_2TX	40.68M	36.162M	36M2D1D	35.213M	32.946M
802.11ac_VHT80_Nss1,(MCS0)_1TX(Port2)	81.6M	75.322M	75M3D1D	75.718M	72.194M
802.11ac_VHT80_Nss1,(MCS0)_2TX	82.44M	75.322M	75M3D1D	75.873M	72.194M
802.11ax_HEW20_Nss1,(MCS0)_1TX(Port2)	21.18M	18.921M	18M9D1D	15.61M	14.43M
802.11ax_HEW20_Nss1,(MCS0)_2TX	21.36M	18.921M	18M9D1D	15.453M	14.448M
802.11ax_HEW40_Nss1,(MCS0)_1TX(Port2)	41.22M	37.781M	37M8D1D	35.663M	33.771M
802.11ax_HEW40_Nss1,(MCS0)_2TX	41.22M	37.781M	37M8D1D	35.475M	33.696M
802.11ax_HEW80_Nss1,(MCS0)_1TX(Port2)	82.2M	77.121M	77M1D1D	76.493M	73.046M
802.11ax_HEW80_Nss1,(MCS0)_2TX	82.8M	77.241M	77M2D1D	76.028M	73.123M
5.725-5.85GHz	-	-	-	-	-
802.11a_Nss1,(6Mbps)_1TX(Port2)	3.135M	3.493M	3M49D1D	3.135M	3.493M
802.11a_Nss1,(6Mbps)_2TX	3.135M	3.493M	3M49D1D	3.135M	3.448M
802.11ac_VHT20_Nss1,(MCS0)_1TX(Port2)	3.75M	4.003M	4M00D1D	3.75M	4.003M
802.11ac_VHT20_Nss1,(MCS0)_2TX	3.765M	4.018M	4M02D1D	3.735M	4.018M
802.11ac_VHT40_Nss1,(MCS0)_1TX(Port2)	3.135M	3.688M	3M69D1D	3.135M	3.688M
802.11ac_VHT40_Nss1,(MCS0)_2TX	3.135M	3.598M	3M60D1D	3.12M	3.583M
802.11ac_VHT80_Nss1,(MCS0)_1TX(Port2)	3.12M	3.988M	3M99D1D	3.12M	3.988M
802.11ac_VHT80_Nss1,(MCS0)_2TX	3.12M	3.793M	3M79D1D	3.12M	3.763M
802.11ax_HEW20_Nss1,(MCS0)_1TX(Port2)	4.41M	4.603M	4M60D1D	4.41M	4.603M
802.11ax_HEW20_Nss1,(MCS0)_2TX	4.485M	4.603M	4M60D1D	4.41M	4.588M
802.11ax_HEW40_Nss1,(MCS0)_1TX(Port2)	4.14M	4.198M	4M20D1D	4.14M	4.198M
802.11ax_HEW40_Nss1,(MCS0)_2TX	4.095M	4.168M	4M17D1D	3.96M	4.138M
802.11ax_HEW80_Nss1,(MCS0)_1TX(Port2)	4.095M	4.288M	4M29D1D	4.095M	4.288M



Mode	Max-N dB (Hz)	Max-OBW (Hz)	ITU-Code	Min-N dB (Hz)	Min-OBW (Hz)
802.11ax HEW80_Nss1,(MCS0)_2TX	4.11M	4.243M	4M24D1D	4.08M	4.213M

**Max-N dB** = Maximum 6dB down bandwidth for 5.725-5.85GHz band / Maximum 26dB down bandwidth for other band;

**Max-OBW** = Maximum 99% occupied bandwidth;

**Min-N dB** = Minimum 6dB down bandwidth for 5.725-5.85GHz band / Maximum 26dB down bandwidth for other band;

**Min-OBW** = Minimum 99% occupied bandwidth;



Result

Mode	Result	Limit (Hz)	Port 1-N dB (Hz)	Port 1-OBW (Hz)	Port 2-N dB (Hz)	Port 2-OBW (Hz)
802.11a_Nss1,(6Mbps)_1TX(Port2)	-	-	-	-	-	-
5260MHz	Pass	Inf			19.26M	16.372M
5300MHz	Pass	Inf			19.26M	16.402M
5320MHz	Pass	Inf			19.23M	16.402M
5500MHz	Pass	Inf			19.23M	16.372M
5580MHz	Pass	Inf			19.32M	16.342M
5700MHz	Pass	Inf			19.29M	16.372M
5720MHz Straddle 5.47-5.725GHz	Pass	Inf			14.665M	13.206M
5720MHz Straddle 5.725-5.85GHz	Pass	500k			3.135M	3.493M
802.11a_Nss1,(6Mbps)_2TX	-	-	-	-	-	-
5260MHz	Pass	Inf	18.93M	16.372M	19.26M	16.372M
5300MHz	Pass	Inf	19.08M	16.342M	19.29M	16.372M
5320MHz	Pass	Inf	18.99M	16.342M	19.2M	16.372M
5500MHz	Pass	Inf	18.99M	16.342M	19.05M	16.372M
5580MHz	Pass	Inf	19.05M	16.342M	19.11M	16.372M
5700MHz	Pass	Inf	19.47M	16.342M	19.26M	16.372M
5720MHz Straddle 5.47-5.725GHz	Pass	Inf	14.595M	13.223M	14.7M	13.206M
5720MHz Straddle 5.725-5.85GHz	Pass	500k	3.135M	3.448M	3.135M	3.493M
802.11ac VHT20_Nss1,(MCS0)_1TX(Port2)	-	-	-	-	-	-
5260MHz	Pass	Inf			20.07M	17.541M
5300MHz	Pass	Inf			20.1M	17.541M
5320MHz	Pass	Inf			20.07M	17.541M
5500MHz	Pass	Inf			20.4M	17.541M
5580MHz	Pass	Inf			20.4M	17.541M
5700MHz	Pass	Inf			20.1M	17.541M
5720MHz Straddle 5.47-5.725GHz	Pass	Inf			15.348M	13.766M
5720MHz Straddle 5.725-5.85GHz	Pass	500k			3.75M	4.003M
802.11ac VHT20_Nss1,(MCS0)_2TX	-	-	-	-	-	-
5260MHz	Pass	Inf	20.07M	17.541M	20.1M	17.541M
5300MHz	Pass	Inf	20.37M	17.541M	20.07M	17.541M
5320MHz	Pass	Inf	20.13M	17.541M	20.22M	17.541M
5500MHz	Pass	Inf	20.67M	17.571M	20.25M	17.541M
5580MHz	Pass	Inf	20.31M	17.541M	20.22M	17.541M
5700MHz	Pass	Inf	20.13M	17.541M	20.13M	17.571M
5720MHz Straddle 5.47-5.725GHz	Pass	Inf	15.278M	13.766M	15.208M	13.783M
5720MHz Straddle 5.725-5.85GHz	Pass	500k	3.735M	4.018M	3.765M	4.018M
802.11ac VHT40_Nss1,(MCS0)_1TX(Port2)	-	-	-	-	-	-
5270MHz	Pass	Inf			40.38M	36.102M
5310MHz	Pass	Inf			40.02M	36.102M
5510MHz	Pass	Inf			40.38M	36.162M
5550MHz	Pass	Inf			40.62M	36.162M
5670MHz	Pass	Inf			40.56M	36.102M
5710MHz Straddle 5.47-5.725GHz	Pass	Inf			35.288M	32.984M
5710MHz Straddle 5.725-5.85GHz	Pass	500k			3.135M	3.688M



Mode	Result	Limit (Hz)	Port 1-N dB (Hz)	Port 1-OBW (Hz)	Port 2-N dB (Hz)	Port 2-OBW (Hz)
802.11ac VHT40_Nss1,(MCS0)_2TX	-	-	-	-	-	-
5270MHz	Pass	Inf	40.5M	36.162M	40.08M	36.162M
5310MHz	Pass	Inf	40.08M	36.162M	40.44M	36.102M
5510MHz	Pass	Inf	40.32M	36.102M	40.14M	36.162M
5550MHz	Pass	Inf	40.68M	36.162M	40.26M	36.102M
5670MHz	Pass	Inf	40.62M	36.162M	40.32M	36.102M
5710MHz Straddle 5.47-5.725GHz	Pass	Inf	35.288M	32.946M	35.213M	32.984M
5710MHz Straddle 5.725-5.85GHz	Pass	500k	3.135M	3.583M	3.12M	3.598M
802.11ac VHT80_Nss1,(MCS0)_1TX(Port2)	-	-	-	-	-	-
5290MHz	Pass	Inf			81.36M	75.322M
5530MHz	Pass	Inf			81.6M	75.322M
5610MHz	Pass	Inf			81.12M	75.322M
5690MHz Straddle 5.47-5.725GHz	Pass	Inf			75.718M	72.194M
5690MHz Straddle 5.725-5.85GHz	Pass	500k			3.12M	3.988M
802.11ac VHT80_Nss1,(MCS0)_2TX	-	-	-	-	-	-
5290MHz	Pass	Inf	82.2M	75.202M	82.08M	75.322M
5530MHz	Pass	Inf	82.44M	75.322M	81.72M	75.322M
5610MHz	Pass	Inf	81.84M	75.322M	81.48M	75.322M
5690MHz Straddle 5.47-5.725GHz	Pass	Inf	75.873M	72.194M	76.028M	72.194M
5690MHz Straddle 5.725-5.85GHz	Pass	500k	3.12M	3.793M	3.12M	3.763M
802.11ax HEW20_Nss1,(MCS0)_1TX(Port2)	-	-	-	-	-	-
5260MHz	Pass	Inf			21.06M	18.921M
5300MHz	Pass	Inf			21.03M	18.921M
5320MHz	Pass	Inf			20.91M	18.921M
5500MHz	Pass	Inf			21.18M	18.921M
5580MHz	Pass	Inf			21.09M	18.861M
5700MHz	Pass	Inf			20.61M	18.891M
5720MHz Straddle 5.47-5.725GHz	Pass	Inf			15.61M	14.43M
5720MHz Straddle 5.725-5.85GHz	Pass	500k			4.41M	4.603M
802.11ax HEW20_Nss1,(MCS0)_2TX	-	-	-	-	-	-
5260MHz	Pass	Inf	21.24M	18.921M	21.12M	18.891M
5300MHz	Pass	Inf	21.09M	18.921M	20.91M	18.861M
5320MHz	Pass	Inf	21.12M	18.891M	21.6M	18.891M
5500MHz	Pass	Inf	20.85M	18.891M	20.76M	18.921M
5580MHz	Pass	Inf	20.85M	18.921M	21.03M	18.921M
5700MHz	Pass	Inf	21.36M	18.921M	20.73M	18.891M
5720MHz Straddle 5.47-5.725GHz	Pass	Inf	15.453M	14.448M	15.453M	14.448M
5720MHz Straddle 5.725-5.85GHz	Pass	500k	4.485M	4.588M	4.41M	4.603M
802.11ax HEW40_Nss1,(MCS0)_1TX(Port2)	-	-	-	-	-	-
5270MHz	Pass	Inf			40.92M	37.721M
5310MHz	Pass	Inf			40.92M	37.781M
5510MHz	Pass	Inf			41.16M	37.721M
5550MHz	Pass	Inf			41.22M	37.781M
5670MHz	Pass	Inf			40.74M	37.721M
5710MHz Straddle 5.47-5.725GHz	Pass	Inf			35.663M	33.771M





Mode	Result	Limit (Hz)	Port 1-N dB (Hz)	Port 1-OBW (Hz)	Port 2-N dB (Hz)	Port 2-OBW (Hz)
5710MHz Straddle 5.725-5.85GHz	Pass	500k			4.14M	4.198M
802.11ax HEW40_Nss1,(MCS0)_2TX	-	-	-	-	-	-
5270MHz	Pass	Inf	40.74M	37.781M	40.86M	37.721M
5310MHz	Pass	Inf	40.74M	37.781M	40.98M	37.721M
5510MHz	Pass	Inf	41.1M	37.721M	41.22M	37.721M
5550MHz	Pass	Inf	40.8M	37.721M	40.8M	37.781M
5670MHz	Pass	Inf	40.98M	37.721M	40.44M	37.721M
5710MHz Straddle 5.47-5.725GHz	Pass	Inf	35.625M	33.696M	35.475M	33.808M
5710MHz Straddle 5.725-5.85GHz	Pass	500k	3.96M	4.138M	4.095M	4.168M
802.11ax HEW80_Nss1,(MCS0)_1TX(Port2)	-	-	-	-	-	-
5290MHz	Pass	Inf			82.32M	77.121M
5530MHz	Pass	Inf			82.2M	77.121M
5610MHz	Pass	Inf			81.6M	77.001M
5690MHz Straddle 5.47-5.725GHz	Pass	Inf			76.493M	73.046M
5690MHz Straddle 5.725-5.85GHz	Pass	500k			4.095M	4.288M
802.11ax HEW80_Nss1,(MCS0)_2TX	-	-	-	-	-	-
5290MHz	Pass	Inf	82.08M	77.121M	82.44M	77.121M
5530MHz	Pass	Inf	82.8M	77.121M	82.32M	77.241M
5610MHz	Pass	Inf	82.32M	77.121M	82.08M	77.001M
5690MHz Straddle 5.47-5.725GHz	Pass	Inf	76.028M	73.201M	76.26M	73.123M
5690MHz Straddle 5.725-5.85GHz	Pass	500k	4.11M	4.213M	4.08M	4.243M

**Port X-N dB** = Port X 6dB down bandwidth for 5.725-5.85GHz band / 26dB down bandwidth for other band

**Port X-OBW** = Port X 99% occupied bandwidth;

802.11a\_Nss1,(6Mbps)\_1TX(Port2)

EBW

5260MHz

05/12/2019

CF  
5.26GHz  
Span  
60MHz  
RBW  
200kHz  
VBW  
1MHz  
Sweep Time  
100ms  
Detector Type  
Peak  
Port 2

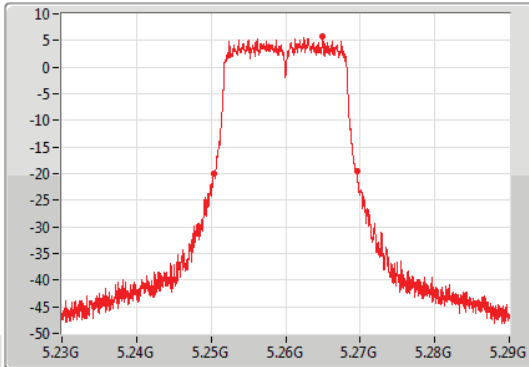

CF  
5.26GHz  
Span  
60MHz  
RBW  
200kHz  
VBW  
1MHz  
Sweep Time  
100ms  
Detector Type  
Peak

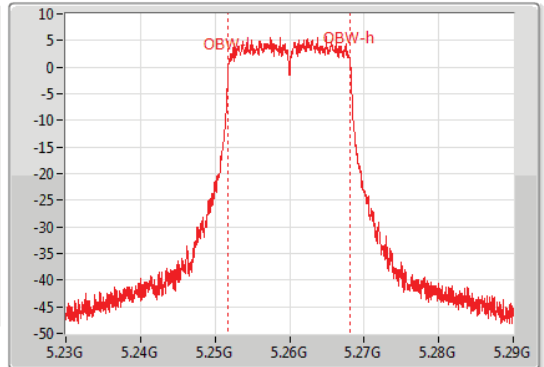

26dB(Hz)	Fl-26dB(Hz)	Fh-26dB(Hz)	OBW(Hz)	Fl-OBW(Hz)	Fh-OBW(Hz)	Limit(Hz)	Port
19.26M	5.25031G	5.26957G	16.372M	5.251784G	5.268156G	Inf	2

802.11a\_Nss1,(6Mbps)\_1TX(Port2)

EBW

5300MHz

05/12/2019

CF  
5.3GHz  
Span  
60MHz  
RBW  
200kHz  
VBW  
1MHz  
Sweep Time  
100ms  
Detector Type  
Peak  
Port 2

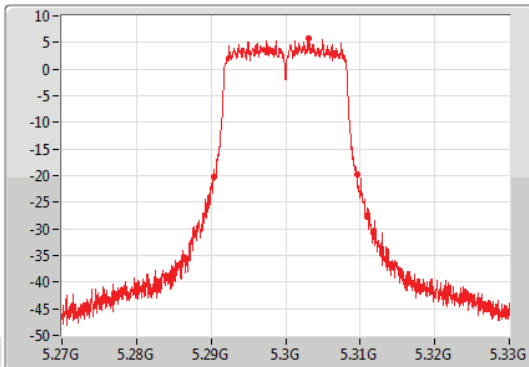

CF  
5.3GHz  
Span  
60MHz  
RBW  
200kHz  
VBW  
1MHz  
Sweep Time  
100ms  
Detector Type  
Peak

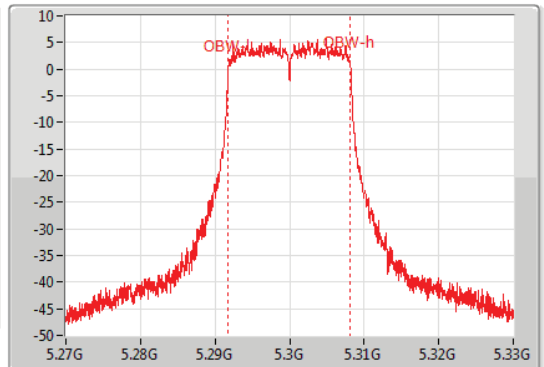

26dB(Hz)	Fl-26dB(Hz)	Fh-26dB(Hz)	OBW(Hz)	Fl-OBW(Hz)	Fh-OBW(Hz)	Limit(Hz)	Port
19.26M	5.29034G	5.3096G	16.402M	5.291784G	5.308186G	Inf	2

802.11a\_Nss1,(6Mbps)\_1TX(Port2)

EBW

5320MHz

05/12/2019

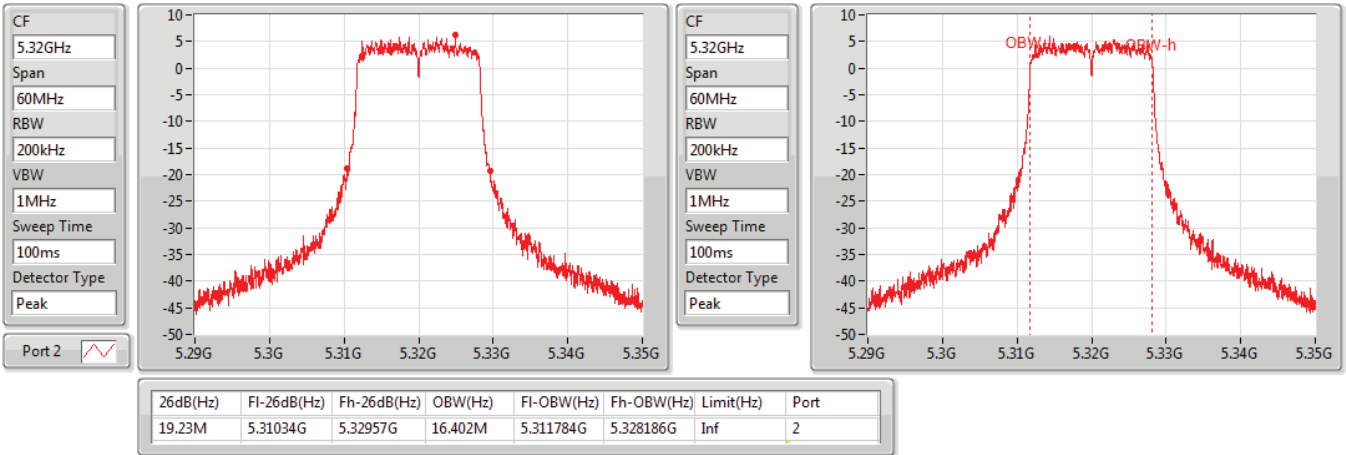

802.11a\_Nss1,(6Mbps)\_1TX(Port2)

EBW

5500MHz

05/12/2019

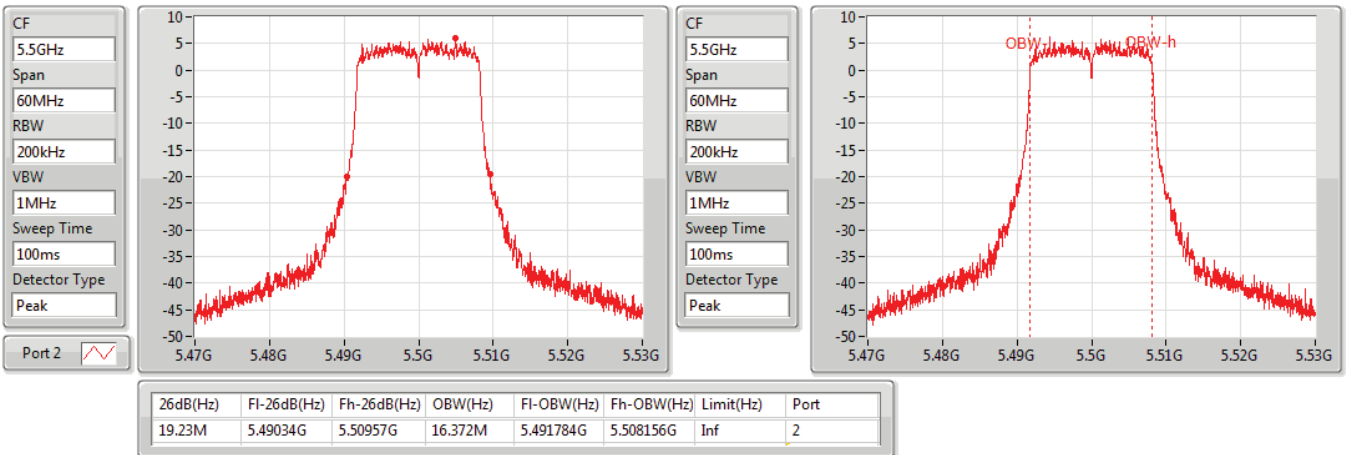

802.11a\_Nss1,(6Mbps)\_1TX(Port2)

EBW

5580MHz

05/12/2019

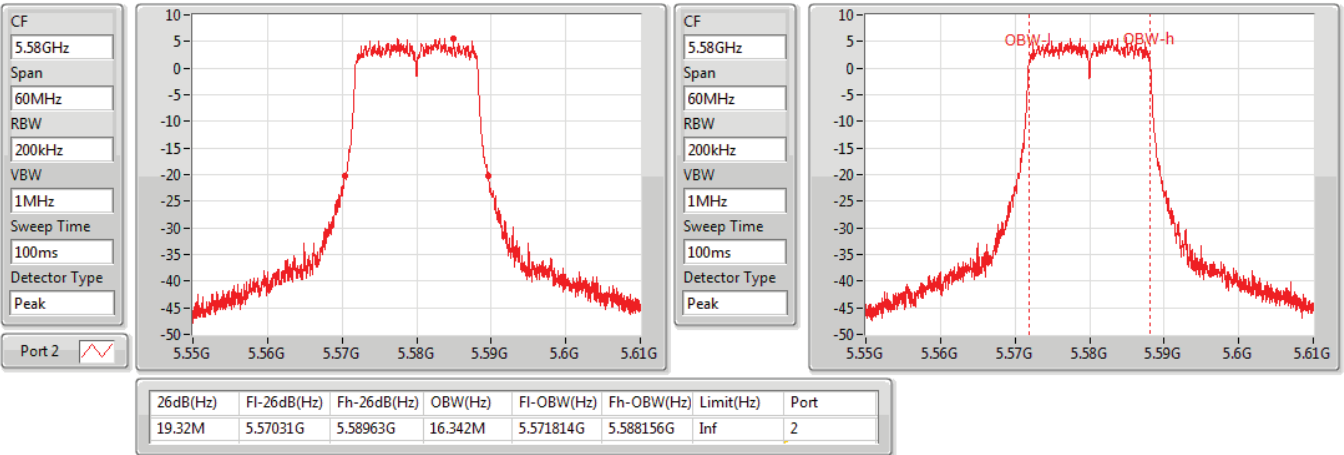

802.11a\_Nss1,(6Mbps)\_1TX(Port2)

EBW

5700MHz

05/12/2019

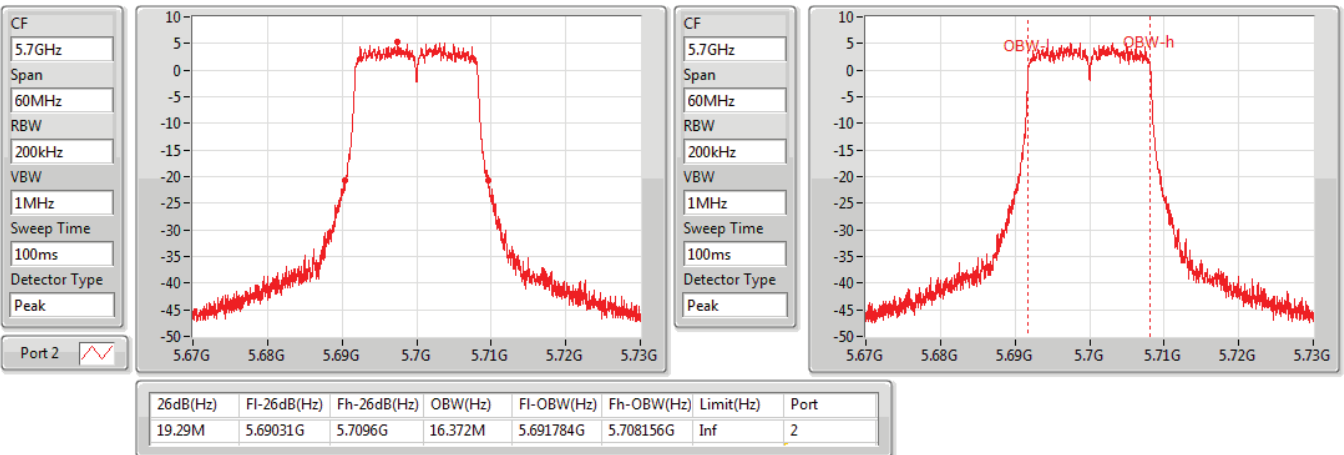

802.11a\_Nss1,(6Mbps)\_1TX(Port2)

EBW

5720MHz Straddle 5.47-5.725GHz

05/12/2019

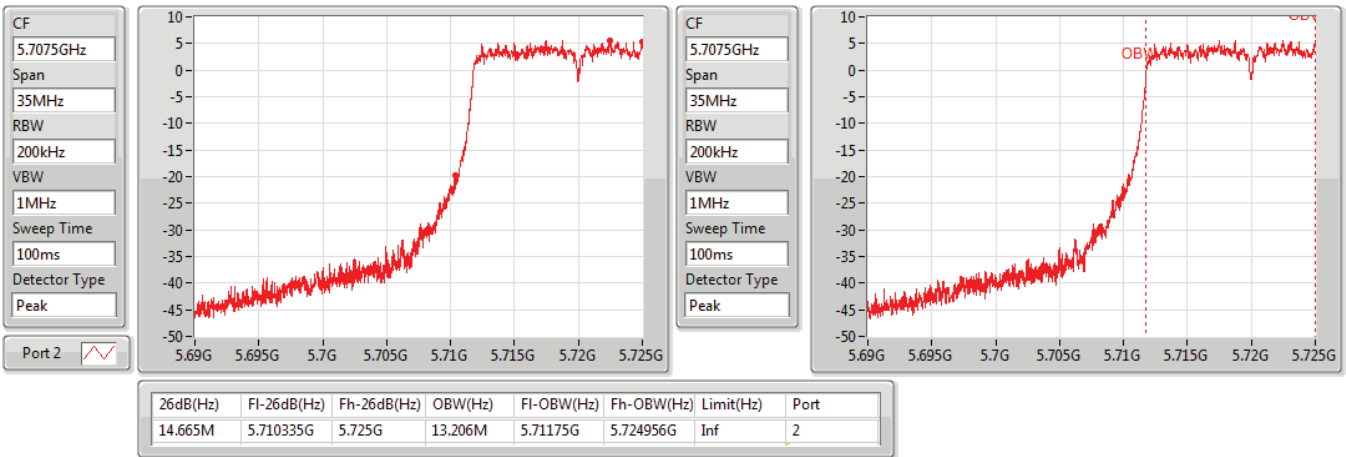

802.11a\_Nss1,(6Mbps)\_1TX(Port2)

EBW

5720MHz Straddle 5.725-5.85GHz

05/12/2019

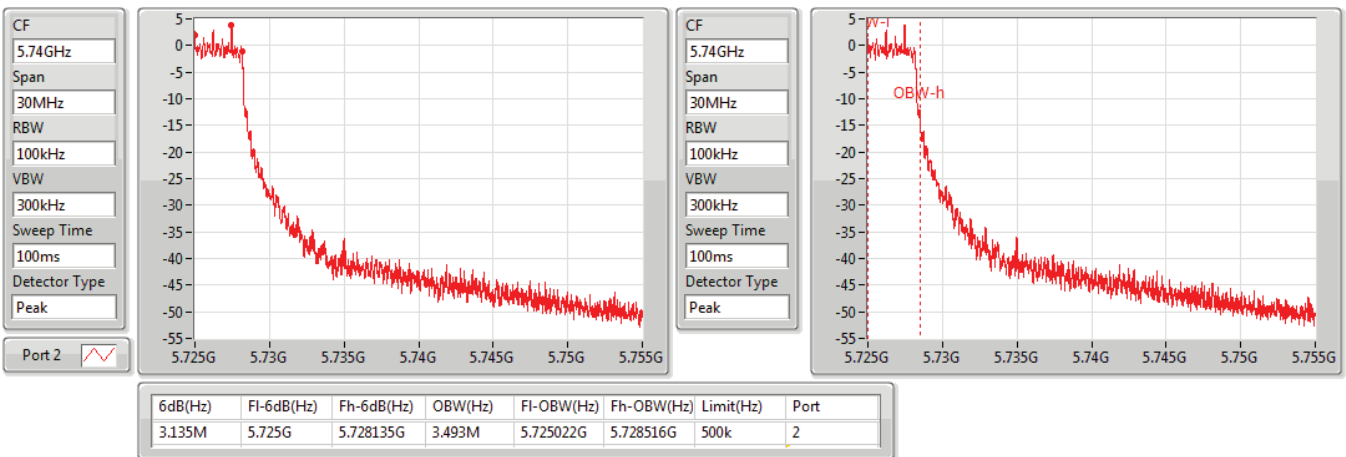

802.11a\_Nss1,(6Mbps)\_2TX

EBW

5260MHz

05/12/2019

CF  
5.26GHz  
Span  
60MHz  
RBW  
200kHz  
VBW  
1MHz  
Sweep Time  
100ms  
Detector Type  
Peak

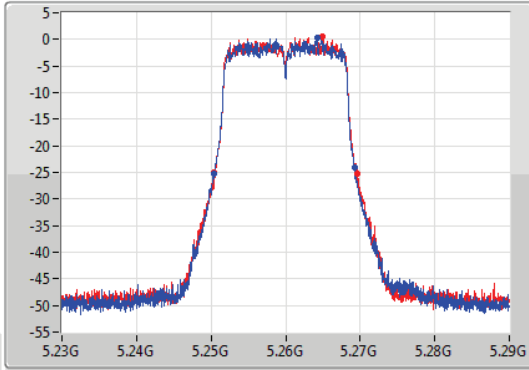

CF  
5.26GHz  
Span  
60MHz  
RBW  
200kHz  
VBW  
1MHz  
Sweep Time  
100ms  
Detector Type  
Peak

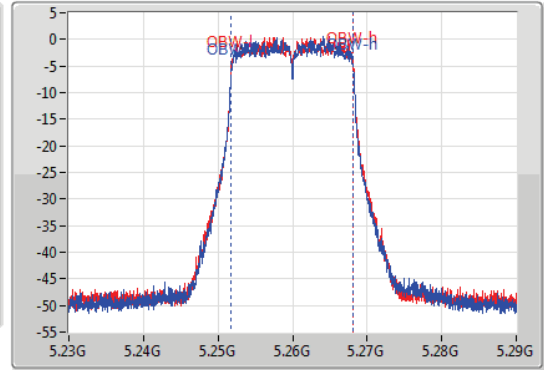

26dB(Hz)	Fl-26dB(Hz)	Fh-26dB(Hz)	OBW(Hz)	Fl-OBW(Hz)	Fh-OBW(Hz)	Limit(Hz)	Port
18.93M	5.25037G	5.2693G	16.372M	5.251784G	5.268156G	Inf	1
19.26M	5.25037G	5.26963G	16.372M	5.251784G	5.268156G	Inf	2

802.11a\_Nss1,(6Mbps)\_2TX

EBW

5300MHz

05/12/2019

CF  
5.3GHz  
Span  
60MHz  
RBW  
200kHz  
VBW  
1MHz  
Sweep Time  
100ms  
Detector Type  
Peak

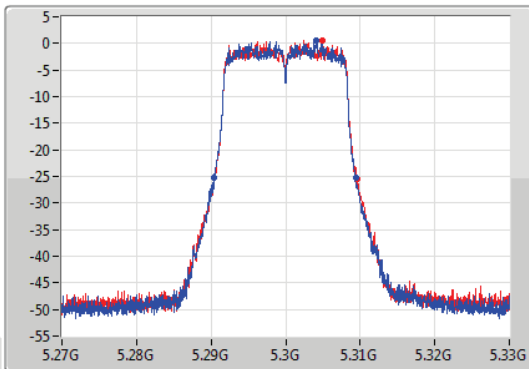

CF  
5.3GHz  
Span  
60MHz  
RBW  
200kHz  
VBW  
1MHz  
Sweep Time  
100ms  
Detector Type  
Peak

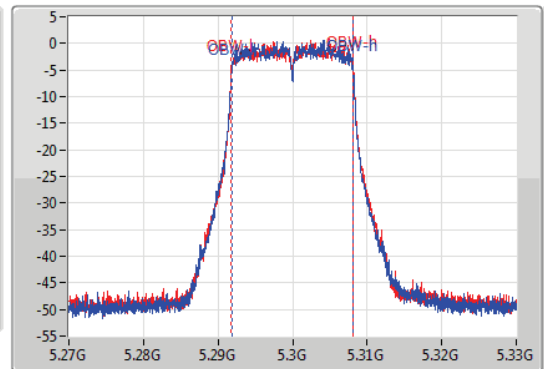

26dB(Hz)	Fl-26dB(Hz)	Fh-26dB(Hz)	OBW(Hz)	Fl-OBW(Hz)	Fh-OBW(Hz)	Limit(Hz)	Port
19.08M	5.29037G	5.30945G	16.342M	5.291814G	5.308156G	Inf	1
19.29M	5.29034G	5.30963G	16.372M	5.291784G	5.308156G	Inf	2

802.11a\_Nss1,(6Mbps)\_2TX

EBW

5320MHz

05/12/2019

CF  
5.32GHz

Span  
60MHz

RBW  
200kHz

VBW  
1MHz

Sweep Time  
100ms

Detector Type  
Peak

Port 1

Port 2

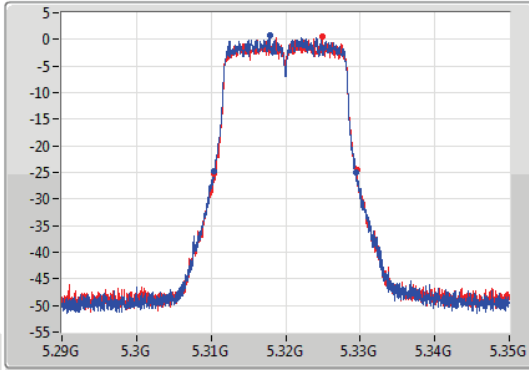

CF  
5.32GHz

Span  
60MHz

RBW  
200kHz

VBW  
1MHz

Sweep Time  
100ms

Detector Type  
Peak

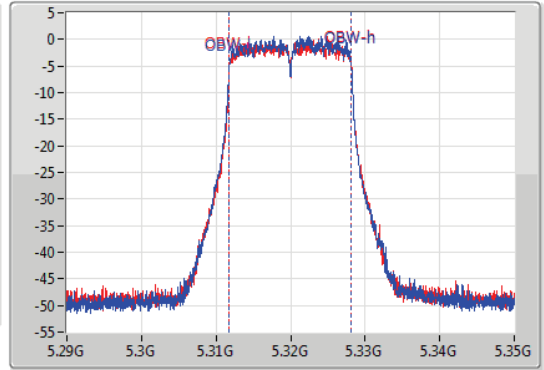

26dB(Hz)	Fl-26dB(Hz)	Fh-26dB(Hz)	OBW(Hz)	Fl-OBW(Hz)	Fh-OBW(Hz)	Limit(Hz)	Port
18.99M	5.31037G	5.32936G	16.342M	5.311784G	5.328126G	Inf	1
19.2M	5.31034G	5.32954G	16.372M	5.311784G	5.328156G	Inf	2

802.11a\_Nss1,(6Mbps)\_2TX

EBW

5500MHz

05/12/2019

CF  
5.5GHz

Span  
60MHz

RBW  
200kHz

VBW  
1MHz

Sweep Time  
100ms

Detector Type  
Peak

Port 1

Port 2

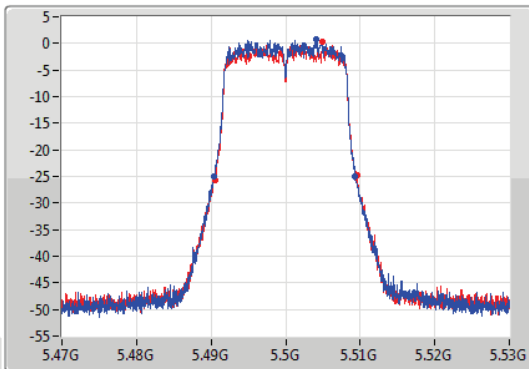

CF  
5.5GHz

Span  
60MHz

RBW  
200kHz

VBW  
1MHz

Sweep Time  
100ms

Detector Type  
Peak

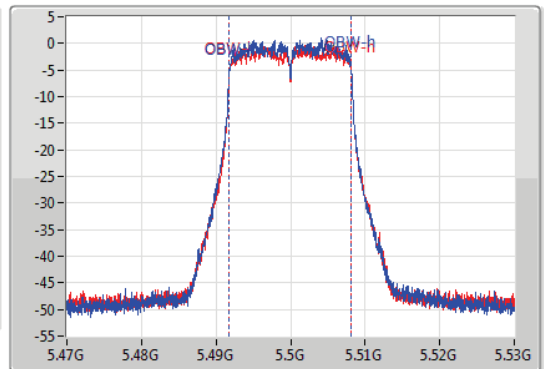

26dB(Hz)	Fl-26dB(Hz)	Fh-26dB(Hz)	OBW(Hz)	Fl-OBW(Hz)	Fh-OBW(Hz)	Limit(Hz)	Port
18.99M	5.49031G	5.5093G	16.342M	5.491784G	5.508126G	Inf	1
19.05M	5.49049G	5.50954G	16.372M	5.491784G	5.508156G	Inf	2

802.11a\_Nss1,(6Mbps)\_2TX

EBW

5580MHz

05/12/2019

CF  
5.58GHz  
Span  
60MHz  
RBW  
200kHz  
VBW  
1MHz  
Sweep Time  
100ms  
Detector Type  
Peak

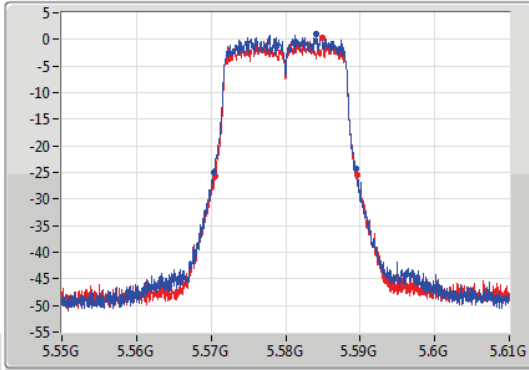

CF  
5.58GHz  
Span  
60MHz  
RBW  
200kHz  
VBW  
1MHz  
Sweep Time  
100ms  
Detector Type  
Peak

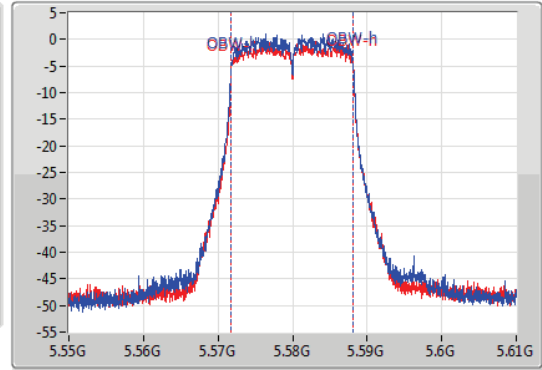

26dB(Hz)	Fl-26dB(Hz)	Fh-26dB(Hz)	OBW(Hz)	Fl-OBW(Hz)	Fh-OBW(Hz)	Limit(Hz)	Port
19.05M	5.57031G	5.58936G	16.342M	5.571784G	5.588126G	Inf	1
19.11M	5.57058G	5.58969G	16.372M	5.571784G	5.588156G	Inf	2

802.11a\_Nss1,(6Mbps)\_2TX

EBW

5700MHz

05/12/2019

CF  
5.7GHz  
Span  
60MHz  
RBW  
200kHz  
VBW  
1MHz  
Sweep Time  
100ms  
Detector Type  
Peak

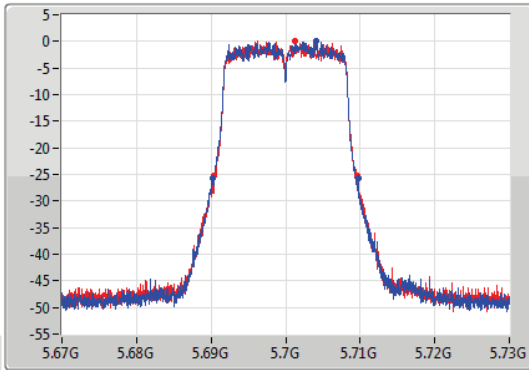

CF  
5.7GHz  
Span  
60MHz  
RBW  
200kHz  
VBW  
1MHz  
Sweep Time  
100ms  
Detector Type  
Peak

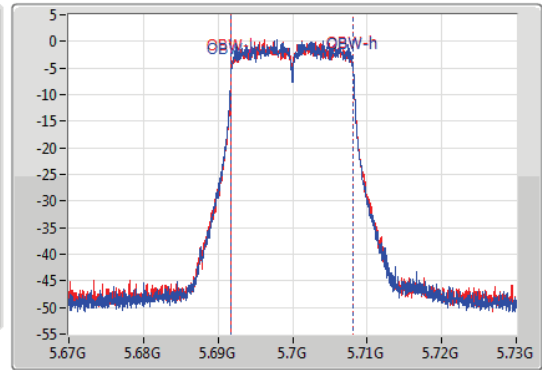

26dB(Hz)	Fl-26dB(Hz)	Fh-26dB(Hz)	OBW(Hz)	Fl-OBW(Hz)	Fh-OBW(Hz)	Limit(Hz)	Port
19.47M	5.69028G	5.70975G	16.342M	5.691784G	5.708126G	Inf	1
19.26M	5.69034G	5.7096G	16.372M	5.691784G	5.708156G	Inf	2



802.11a\_Nss1,(6Mbps)\_2TX

EBW

5720MHz Straddle 5.47-5.725GHz

05/12/2019

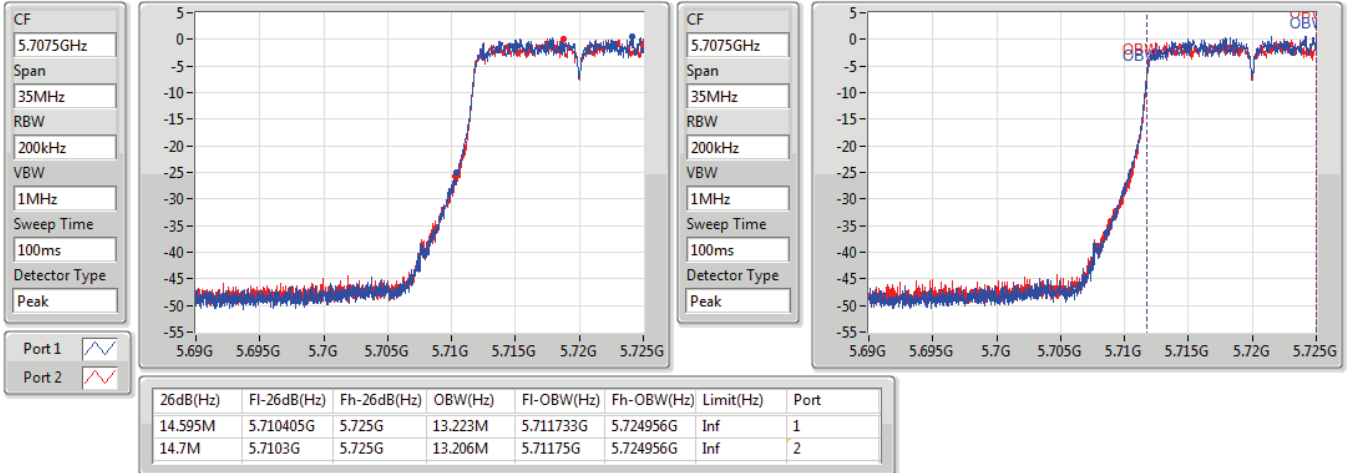

802.11a\_Nss1,(6Mbps)\_2TX

EBW

5720MHz Straddle 5.725-5.85GHz

05/12/2019

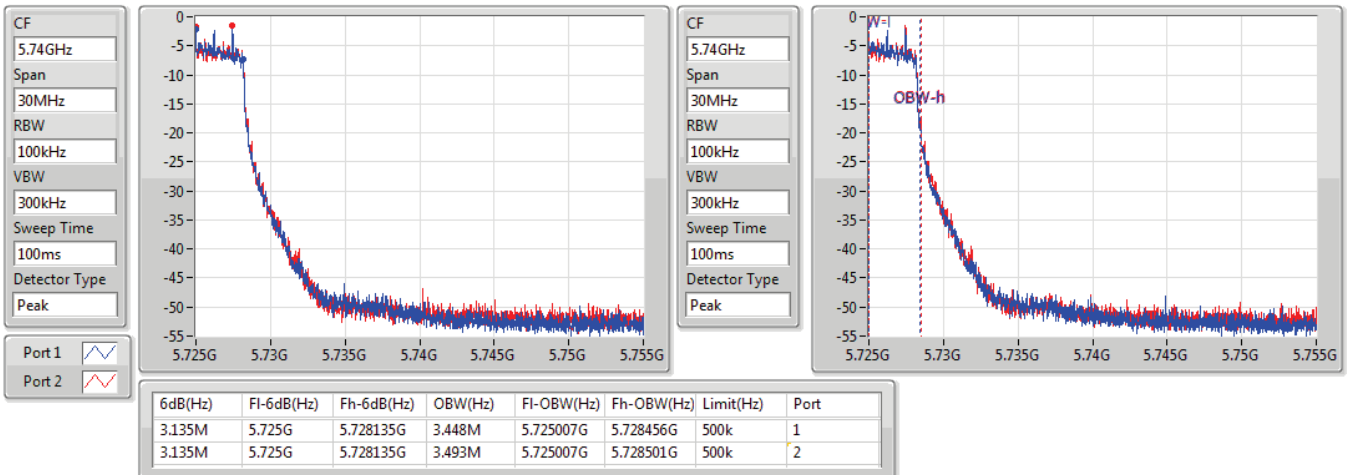

802.11ac VHT20\_Nss1,(MCS0)\_1TX(Port2)

EBW

5260MHz

05/12/2019

CF  
5.26GHz  
Span  
60MHz  
RBW  
200kHz  
VBW  
1MHz  
Sweep Time  
100ms  
Detector Type  
Peak  
Port 2

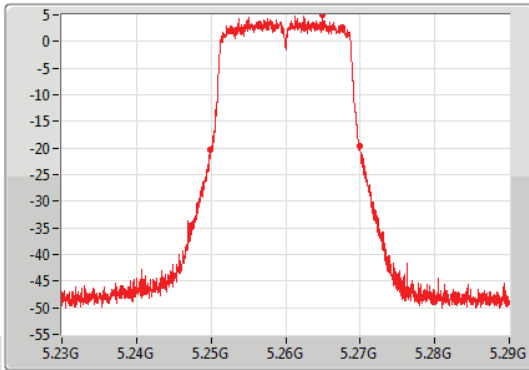

CF  
5.26GHz  
Span  
60MHz  
RBW  
200kHz  
VBW  
1MHz  
Sweep Time  
100ms  
Detector Type  
Peak

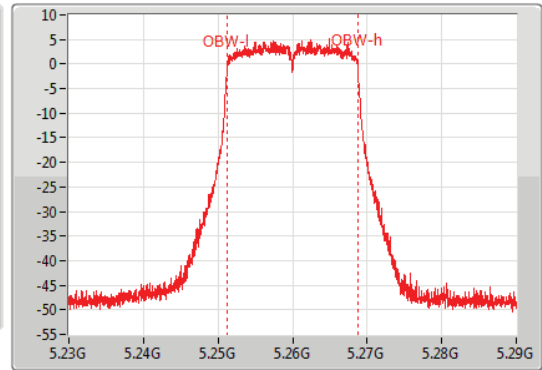

26dB(Hz)	Fl-26dB(Hz)	Fh-26dB(Hz)	OBW(Hz)	Fl-OBW(Hz)	Fh-OBW(Hz)	Limit(Hz)	Port
20.07M	5.24995G	5.27002G	17.541M	5.251214G	5.268756G	Inf	2

802.11ac VHT20\_Nss1,(MCS0)\_1TX(Port2)

EBW

5300MHz

05/12/2019

CF  
5.3GHz  
Span  
60MHz  
RBW  
200kHz  
VBW  
1MHz  
Sweep Time  
100ms  
Detector Type  
Peak  
Port 2

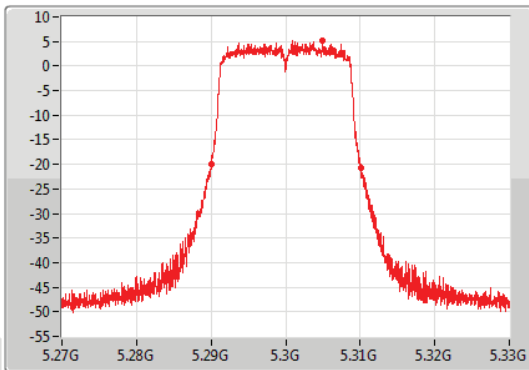

CF  
5.3GHz  
Span  
60MHz  
RBW  
200kHz  
VBW  
1MHz  
Sweep Time  
100ms  
Detector Type  
Peak

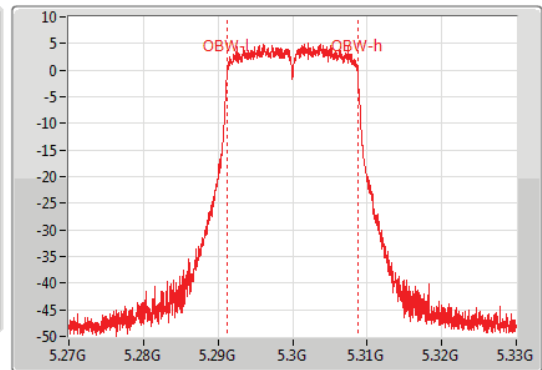

26dB(Hz)	Fl-26dB(Hz)	Fh-26dB(Hz)	OBW(Hz)	Fl-OBW(Hz)	Fh-OBW(Hz)	Limit(Hz)	Port
20.1M	5.29004G	5.31014G	17.541M	5.291214G	5.308756G	Inf	2

802.11ac VHT20\_Nss1,(MCS0)\_1TX(Port2)

EBW

5320MHz

06/12/2019

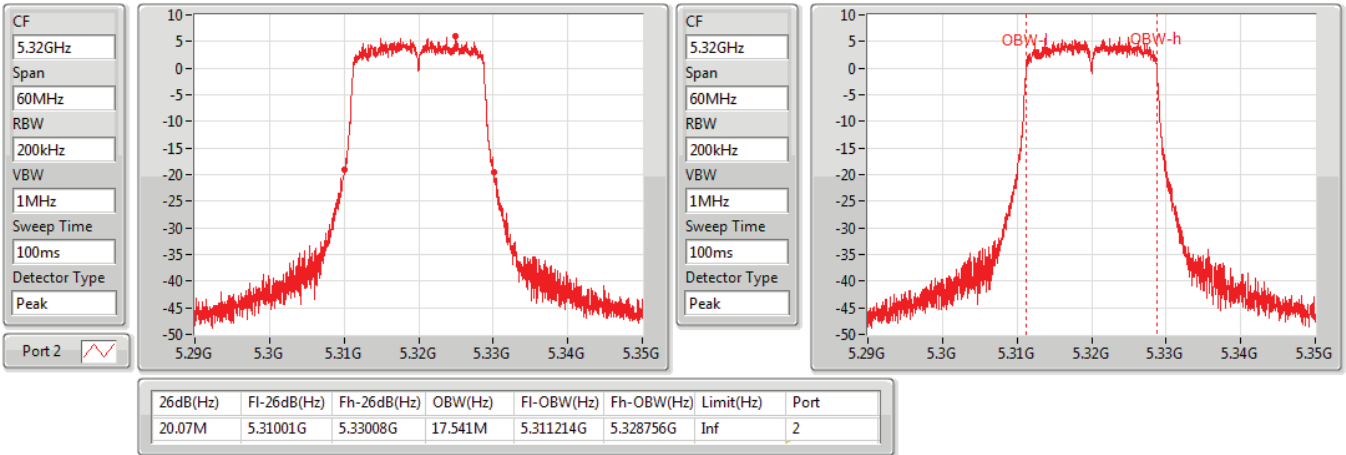

802.11ac VHT20\_Nss1,(MCS0)\_1TX(Port2)

EBW

5500MHz

06/12/2019

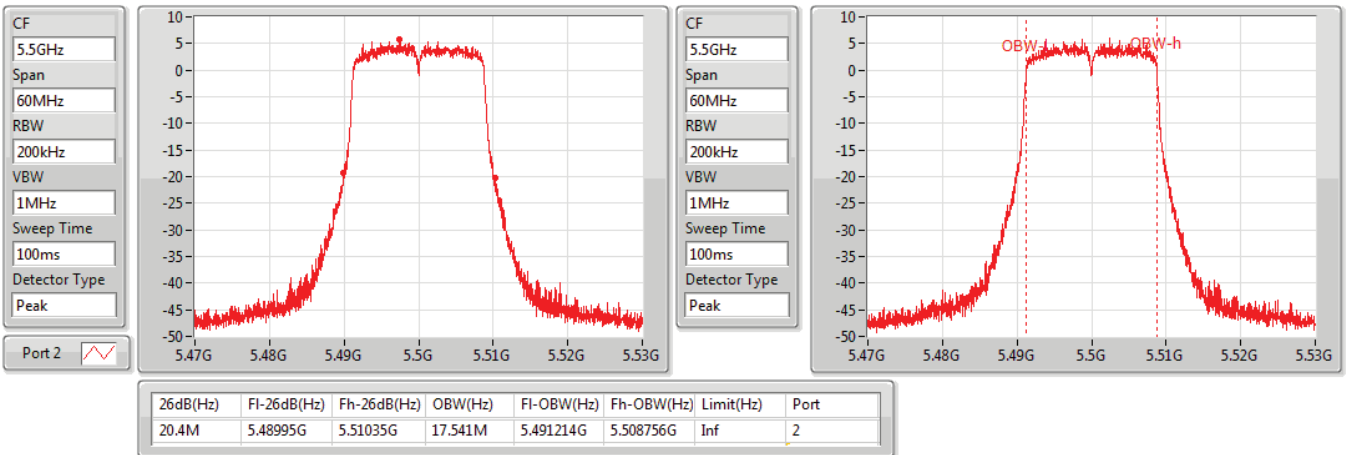

802.11ac VHT20\_Nss1,(MCS0)\_1TX(Port2)

EBW

5580MHz

06/12/2019

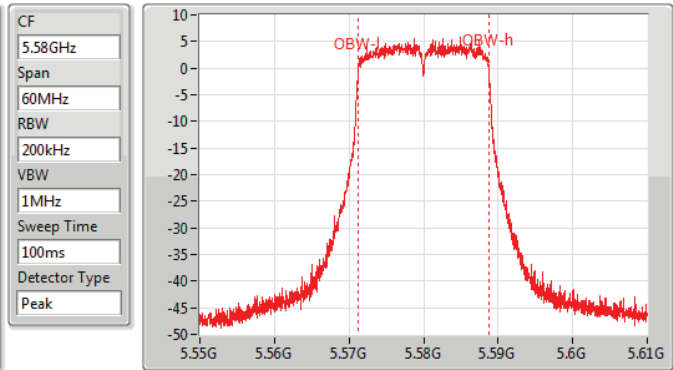
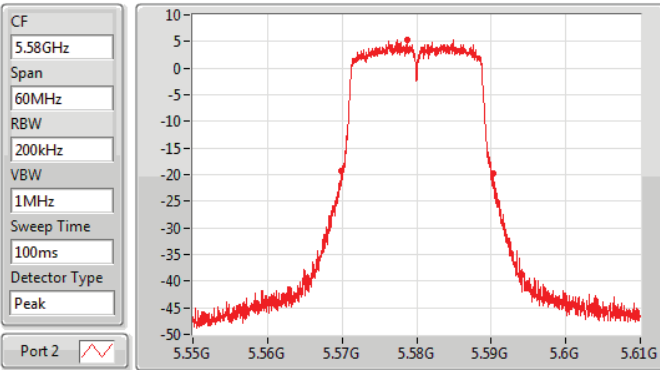

26dB(Hz)	Fl-26dB(Hz)	Fh-26dB(Hz)	OBW(Hz)	Fl-OBW(Hz)	Fh-OBW(Hz)	Limit(Hz)	Port
20.4M	5.56995G	5.59035G	17.541M	5.571214G	5.588756G	Inf	2

802.11ac VHT20\_Nss1,(MCS0)\_1TX(Port2)

EBW

5700MHz

06/12/2019

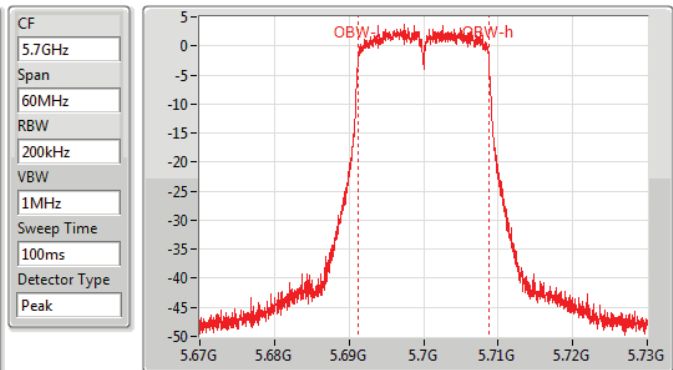
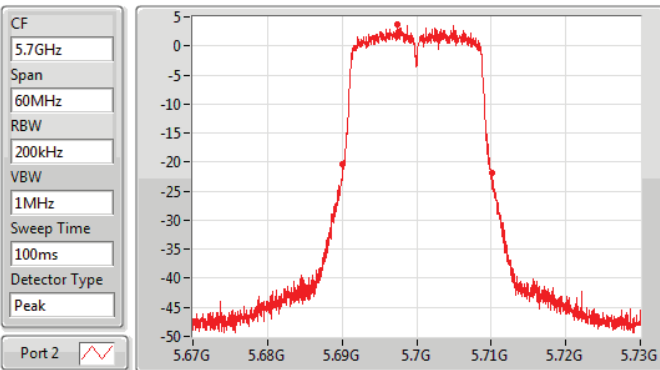

26dB(Hz)	Fl-26dB(Hz)	Fh-26dB(Hz)	OBW(Hz)	Fl-OBW(Hz)	Fh-OBW(Hz)	Limit(Hz)	Port
20.1M	5.69004G	5.71014G	17.541M	5.691214G	5.708756G	Inf	2

802.11ac VHT20\_Nss1,(MCS0)\_1TX(Port2)

EBW

5720MHz Straddle 5.47-5.725GHz

06/12/2019

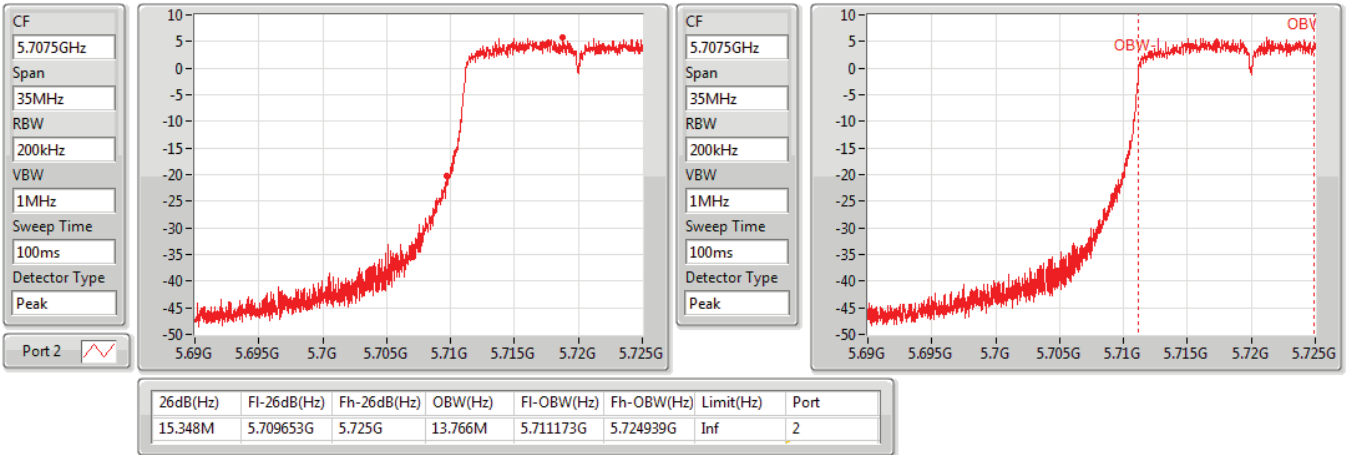

802.11ac VHT20\_Nss1,(MCS0)\_1TX(Port2)

EBW

5720MHz Straddle 5.725-5.85GHz

06/12/2019

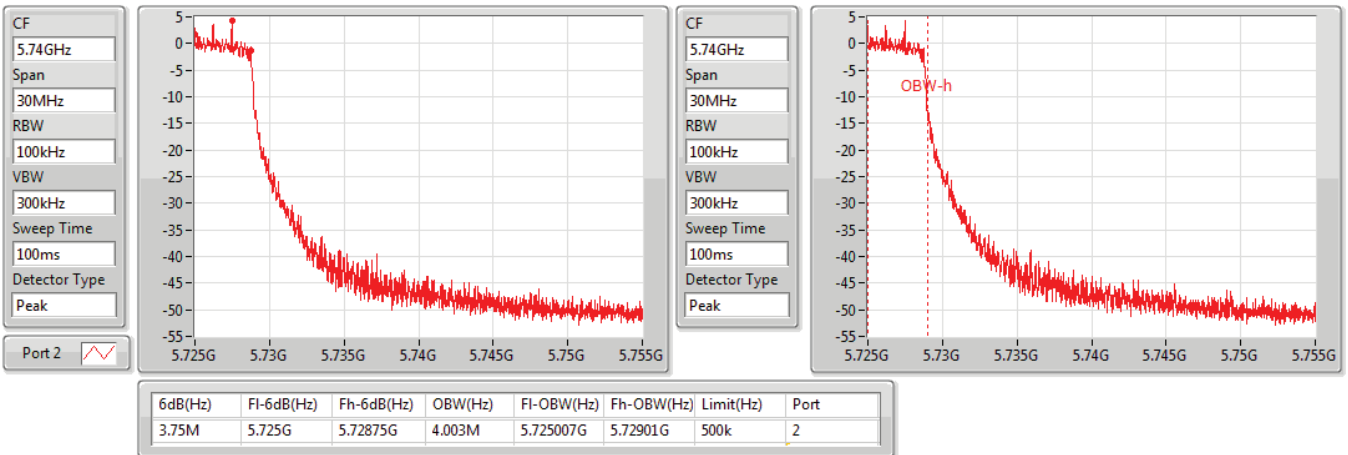

802.11ac VHT20\_Nss1,(MCS0)\_2TX

EBW

5260MHz

06/12/2019

CF  
5.26GHz  
Span  
60MHz  
RBW  
200kHz  
VBW  
1MHz  
Sweep Time  
100ms  
Detector Type  
Peak

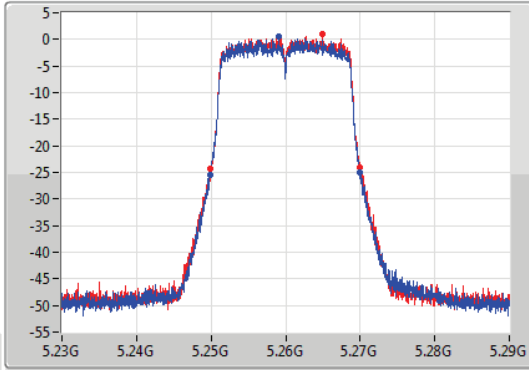

CF  
5.26GHz  
Span  
60MHz  
RBW  
200kHz  
VBW  
1MHz  
Sweep Time  
100ms  
Detector Type  
Peak

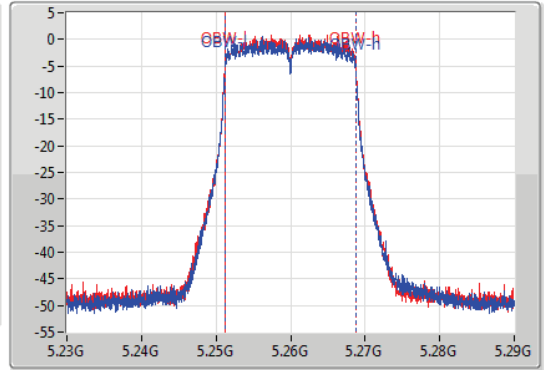

26dB(Hz)	Fl-26dB(Hz)	Fh-26dB(Hz)	OBW(Hz)	Fl-OBW(Hz)	Fh-OBW(Hz)	Limit(Hz)	Port
20.07M	5.24986G	5.26993G	17.541M	5.251214G	5.268756G	Inf	1
20.1M	5.24983G	5.26993G	17.541M	5.251214G	5.268756G	Inf	2

802.11ac VHT20\_Nss1,(MCS0)\_2TX

EBW

5300MHz

06/12/2019

CF  
5.3GHz  
Span  
60MHz  
RBW  
200kHz  
VBW  
1MHz  
Sweep Time  
100ms  
Detector Type  
Peak

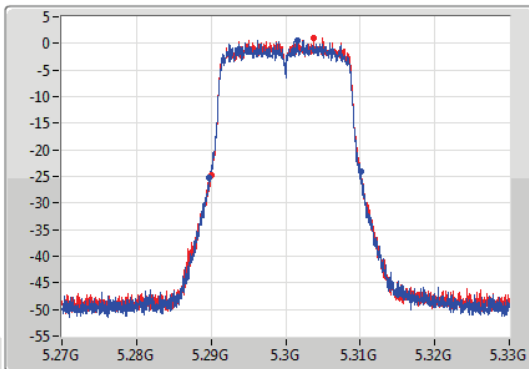

CF  
5.3GHz  
Span  
60MHz  
RBW  
200kHz  
VBW  
1MHz  
Sweep Time  
100ms  
Detector Type  
Peak

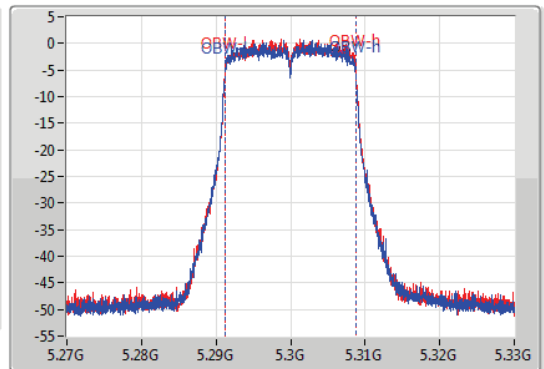

26dB(Hz)	Fl-26dB(Hz)	Fh-26dB(Hz)	OBW(Hz)	Fl-OBW(Hz)	Fh-OBW(Hz)	Limit(Hz)	Port
20.37M	5.28974G	5.31011G	17.541M	5.291184G	5.308726G	Inf	1
20.07M	5.28998G	5.31005G	17.541M	5.291214G	5.308756G	Inf	2

802.11ac VHT20\_Nss1,(MCS0)\_2TX

EBW

5320MHz

06/12/2019

CF  
5.32GHz  
Span  
60MHz  
RBW  
200kHz  
VBW  
1MHz  
Sweep Time  
100ms  
Detector Type  
Peak

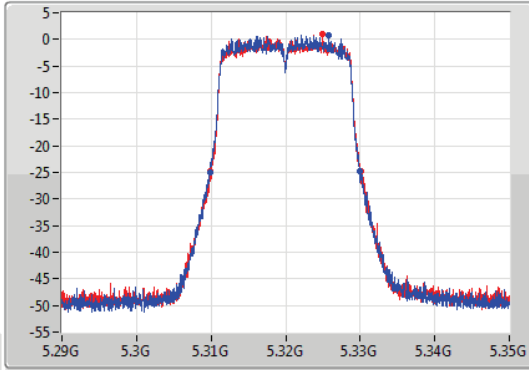

CF  
5.32GHz  
Span  
60MHz  
RBW  
200kHz  
VBW  
1MHz  
Sweep Time  
100ms  
Detector Type  
Peak

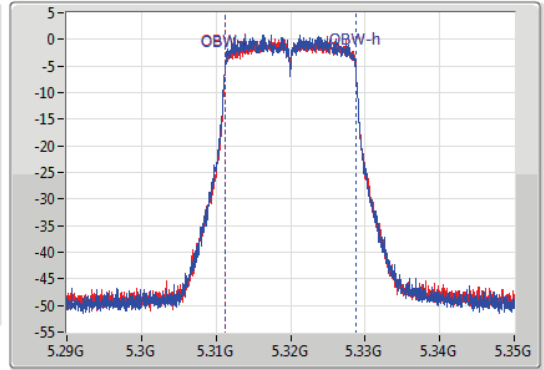

26dB(Hz)	Fl-26dB(Hz)	Fh-26dB(Hz)	OBW(Hz)	Fl-OBW(Hz)	Fh-OBW(Hz)	Limit(Hz)	Port
20.13M	5.30983G	5.32996G	17.541M	5.311184G	5.328726G	Inf	1
20.22M	5.30995G	5.33017G	17.541M	5.311214G	5.328756G	Inf	2

802.11ac VHT20\_Nss1,(MCS0)\_2TX

EBW

5500MHz

06/12/2019

CF  
5.5GHz  
Span  
60MHz  
RBW  
200kHz  
VBW  
1MHz  
Sweep Time  
100ms  
Detector Type  
Peak

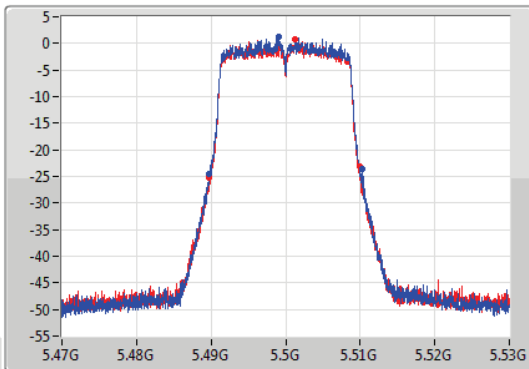

CF  
5.5GHz  
Span  
60MHz  
RBW  
200kHz  
VBW  
1MHz  
Sweep Time  
100ms  
Detector Type  
Peak

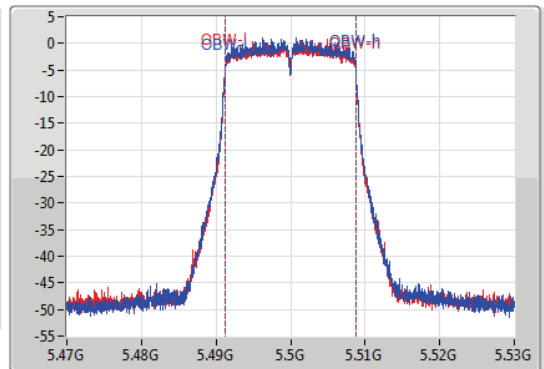

26dB(Hz)	Fl-26dB(Hz)	Fh-26dB(Hz)	OBW(Hz)	Fl-OBW(Hz)	Fh-OBW(Hz)	Limit(Hz)	Port
20.67M	5.48968G	5.51035G	17.571M	5.491184G	5.508756G	Inf	1
20.25M	5.48968G	5.50993G	17.541M	5.491214G	5.508756G	Inf	2

802.11ac VHT20\_Nss1,(MCS0)\_2TX

EBW

5580MHz

06/12/2019

CF  
5.58GHz  
Span  
60MHz  
RBW  
200kHz  
VBW  
1MHz  
Sweep Time  
100ms  
Detector Type  
Peak

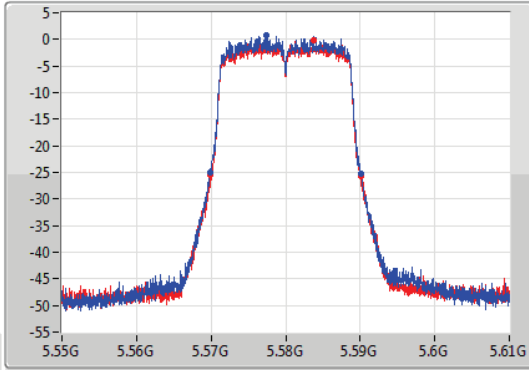

CF  
5.58GHz  
Span  
60MHz  
RBW  
200kHz  
VBW  
1MHz  
Sweep Time  
100ms  
Detector Type  
Peak

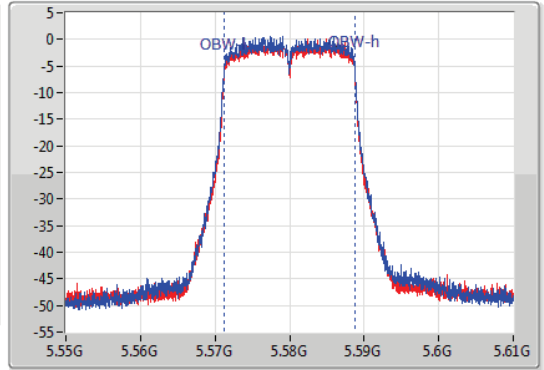

26dB(Hz)	Fl-26dB(Hz)	Fh-26dB(Hz)	OBW(Hz)	Fl-OBW(Hz)	Fh-OBW(Hz)	Limit(Hz)	Port
20.31M	5.56983G	5.59014G	17.541M	5.571214G	5.588756G	Inf	1
20.22M	5.56992G	5.59014G	17.541M	5.571214G	5.588756G	Inf	2

802.11ac VHT20\_Nss1,(MCS0)\_2TX

EBW

5700MHz

06/12/2019

CF  
5.7GHz  
Span  
60MHz  
RBW  
200kHz  
VBW  
1MHz  
Sweep Time  
100ms  
Detector Type  
Peak

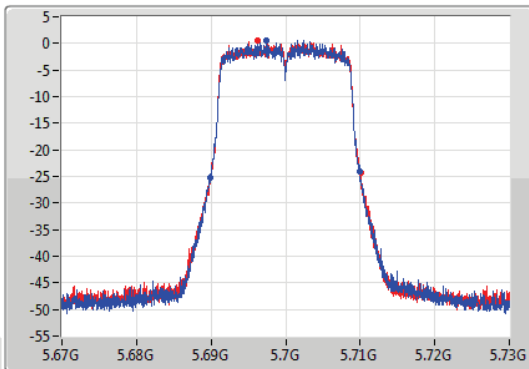

CF  
5.7GHz  
Span  
60MHz  
RBW  
200kHz  
VBW  
1MHz  
Sweep Time  
100ms  
Detector Type  
Peak

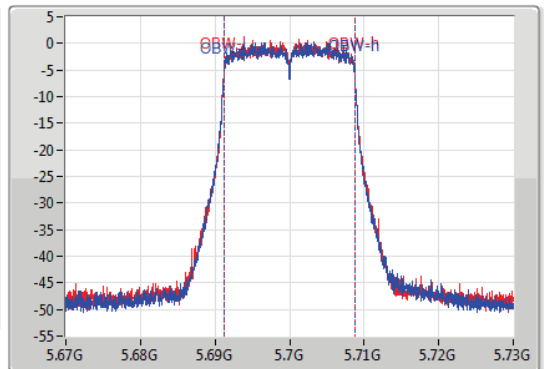

26dB(Hz)	Fl-26dB(Hz)	Fh-26dB(Hz)	OBW(Hz)	Fl-OBW(Hz)	Fh-OBW(Hz)	Limit(Hz)	Port
20.13M	5.68983G	5.70996G	17.541M	5.691184G	5.708726G	Inf	1
20.13M	5.68992G	5.71005G	17.571M	5.691184G	5.708756G	Inf	2



802.11ac VHT20\_Nss1,(MCS0)\_2TX

EBW

5720MHz Straddle 5.47-5.725GHz

06/12/2019

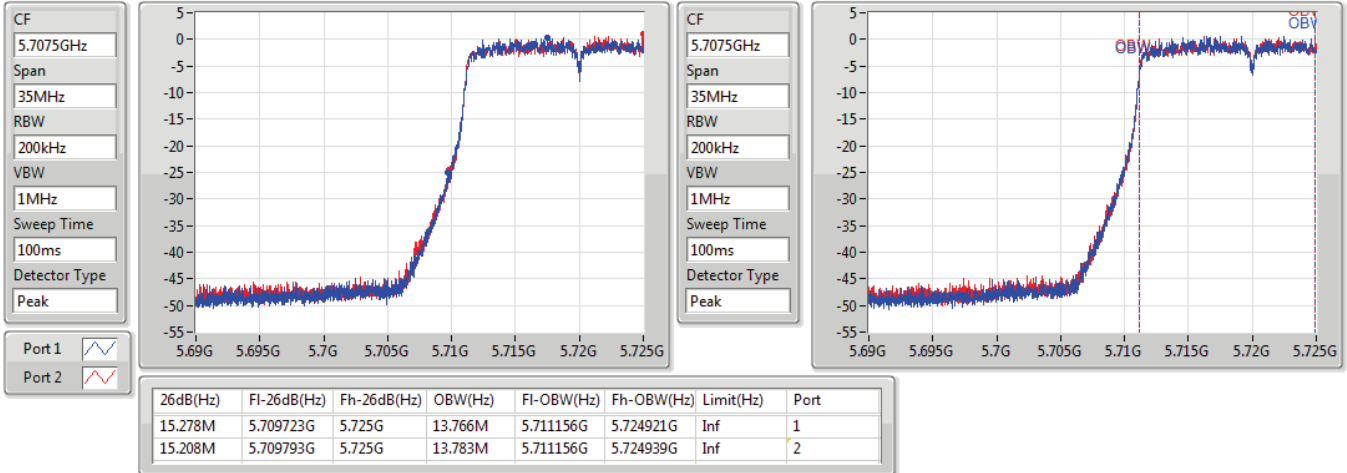

802.11ac VHT20\_Nss1,(MCS0)\_2TX

EBW

5720MHz Straddle 5.725-5.85GHz

06/12/2019

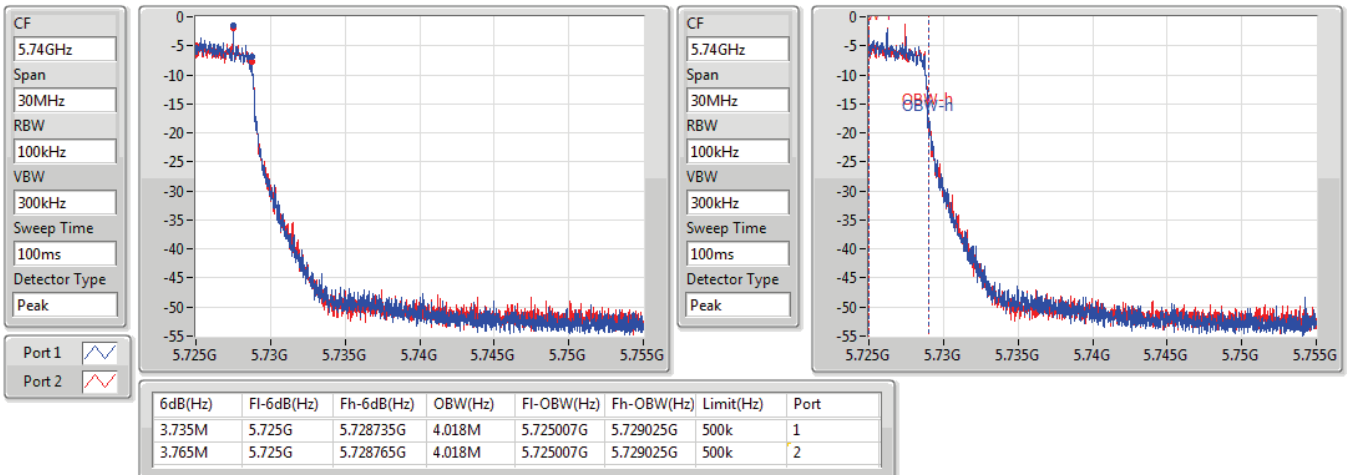

802.11ac VHT40\_Nss1,(MCS0)\_1TX(Port2)

EBW

5270MHz

06/12/2019

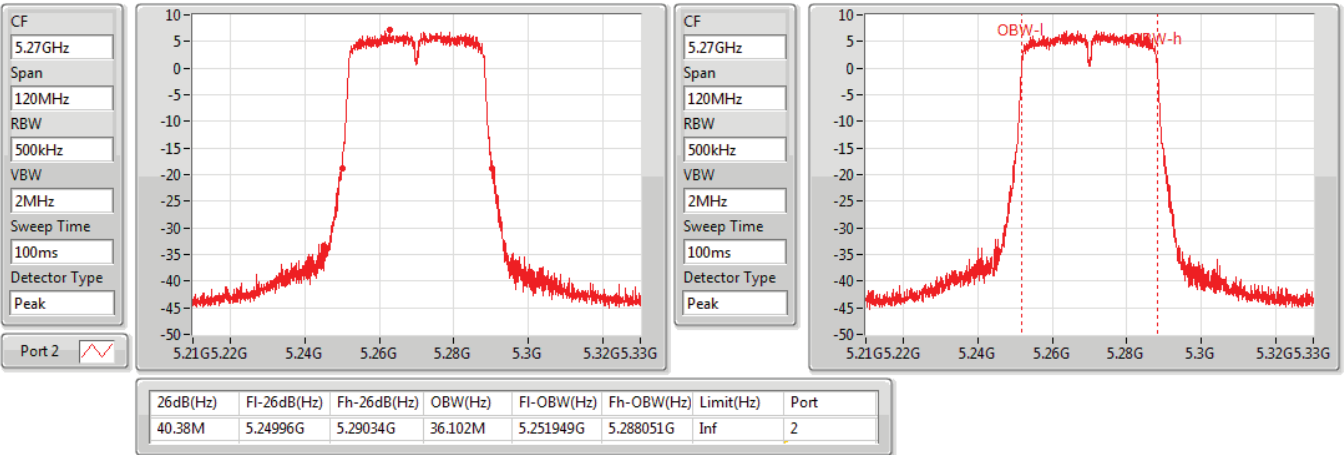

802.11ac VHT40\_Nss1,(MCS0)\_1TX(Port2)

EBW

5310MHz

06/12/2019

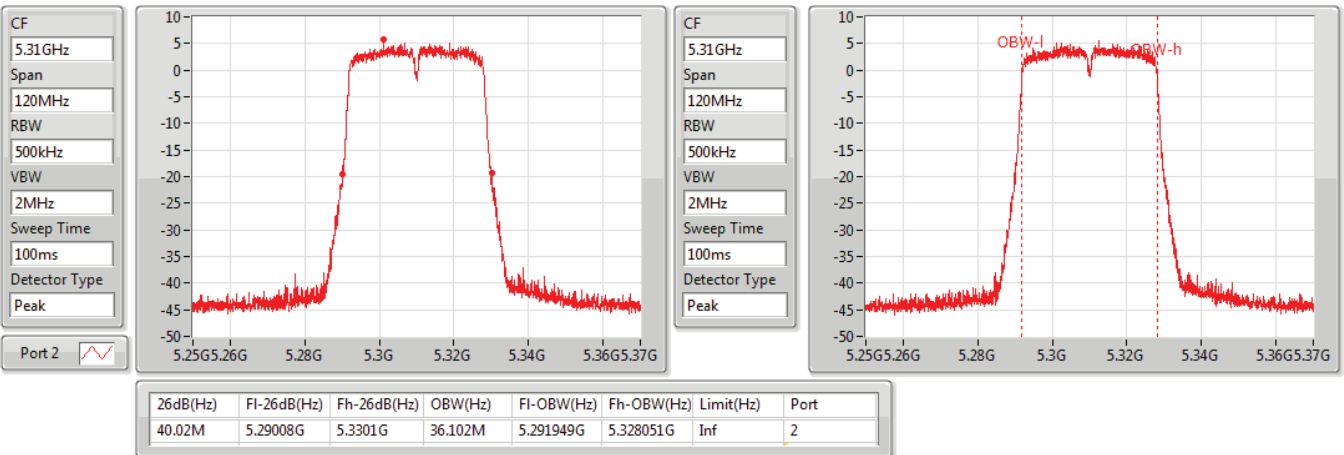

802.11ac VHT40\_Nss1,(MCS0)\_1TX(Port2)

EBW

5510MHz

06/12/2019

CF: 5.51GHz  
 Span: 120MHz  
 RBW: 500kHz  
 VBW: 2MHz  
 Sweep Time: 100ms  
 Detector Type: Peak  
 Port 2

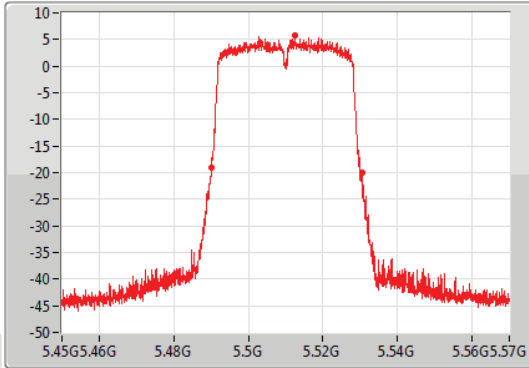

CF: 5.51GHz  
 Span: 120MHz  
 RBW: 500kHz  
 VBW: 2MHz  
 Sweep Time: 100ms  
 Detector Type: Peak

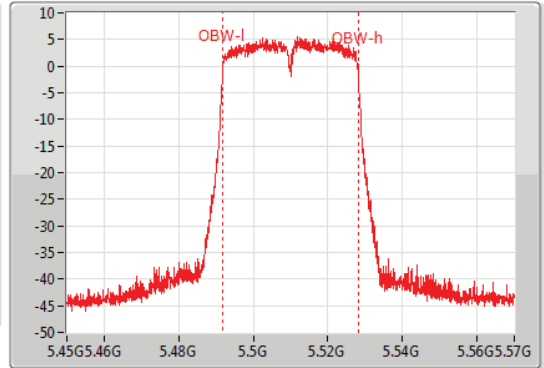

26dB(Hz)	Fl-26dB(Hz)	Fh-26dB(Hz)	OBW(Hz)	Fl-OBW(Hz)	Fh-OBW(Hz)	Limit(Hz)	Port
40.38M	5.49002G	5.5304G	36.162M	5.491889G	5.528051G	Inf	2

802.11ac VHT40\_Nss1,(MCS0)\_1TX(Port2)

EBW

5550MHz

06/12/2019

CF: 5.55GHz  
 Span: 120MHz  
 RBW: 500kHz  
 VBW: 2MHz  
 Sweep Time: 100ms  
 Detector Type: Peak  
 Port 2

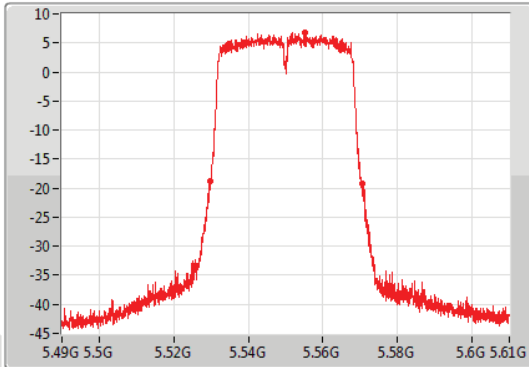

CF: 5.55GHz  
 Span: 120MHz  
 RBW: 500kHz  
 VBW: 2MHz  
 Sweep Time: 100ms  
 Detector Type: Peak

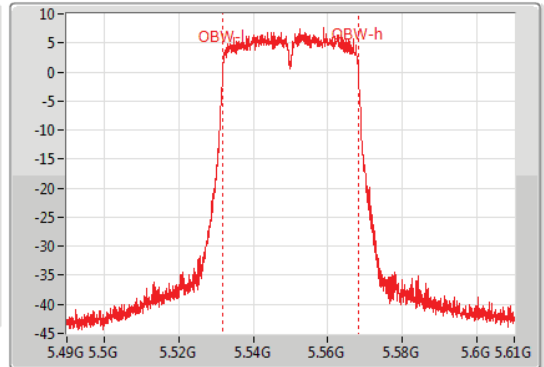

26dB(Hz)	Fl-26dB(Hz)	Fh-26dB(Hz)	OBW(Hz)	Fl-OBW(Hz)	Fh-OBW(Hz)	Limit(Hz)	Port
40.62M	5.52978G	5.5704G	36.162M	5.531889G	5.568051G	Inf	2

802.11ac VHT40\_Nss1,(MCS0)\_1TX(Port2)

EBW

5670MHz

06/12/2019

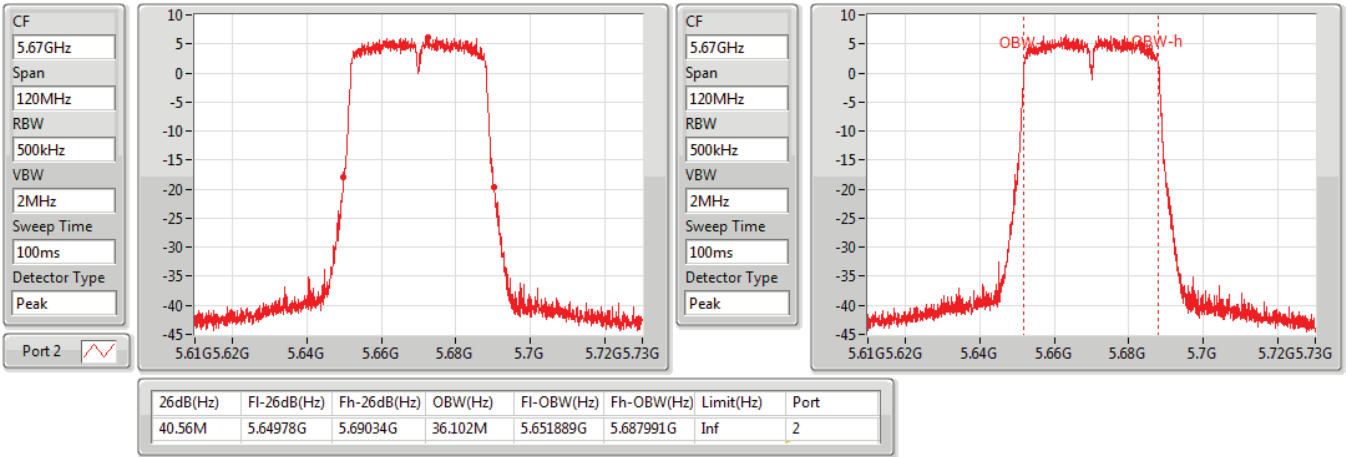

802.11ac VHT40\_Nss1,(MCS0)\_1TX(Port2)

EBW

5710MHz Straddle 5.47-5.725GHz

06/12/2019

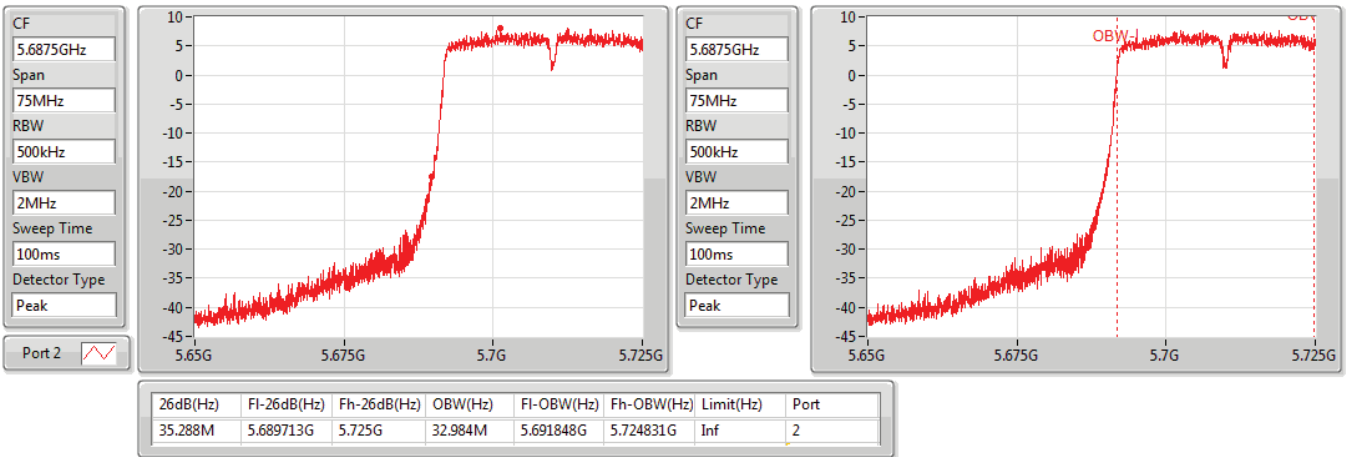

802.11ac VHT40\_Nss1,(MCS0)\_1TX(Port2)

EBW

5710MHz Straddle 5.725-5.85GHz

06/12/2019

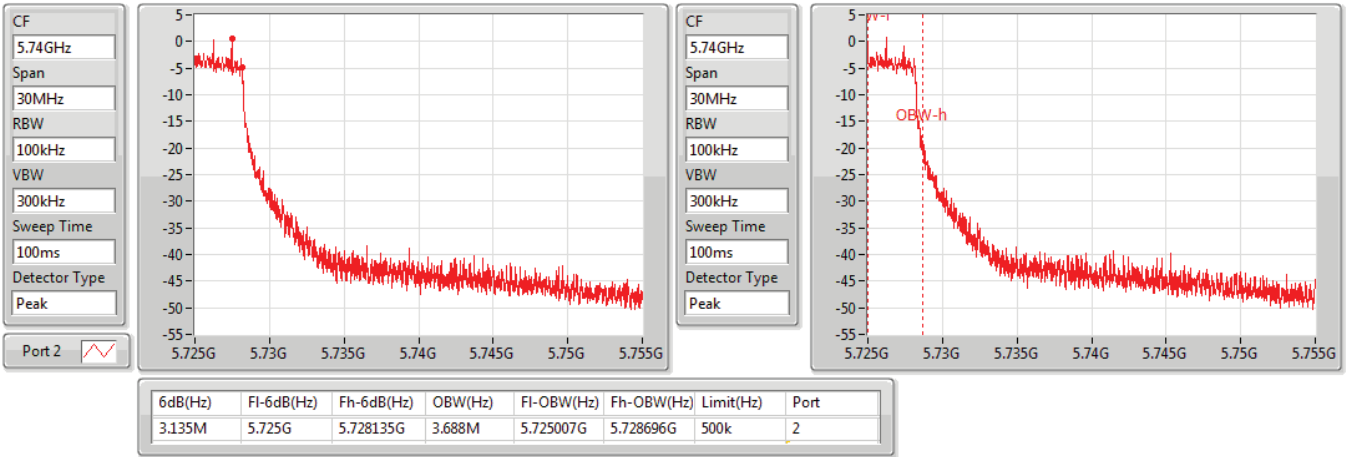

802.11ac VHT40\_Nss1,(MCS0)\_2TX

EBW

5270MHz

06/12/2019

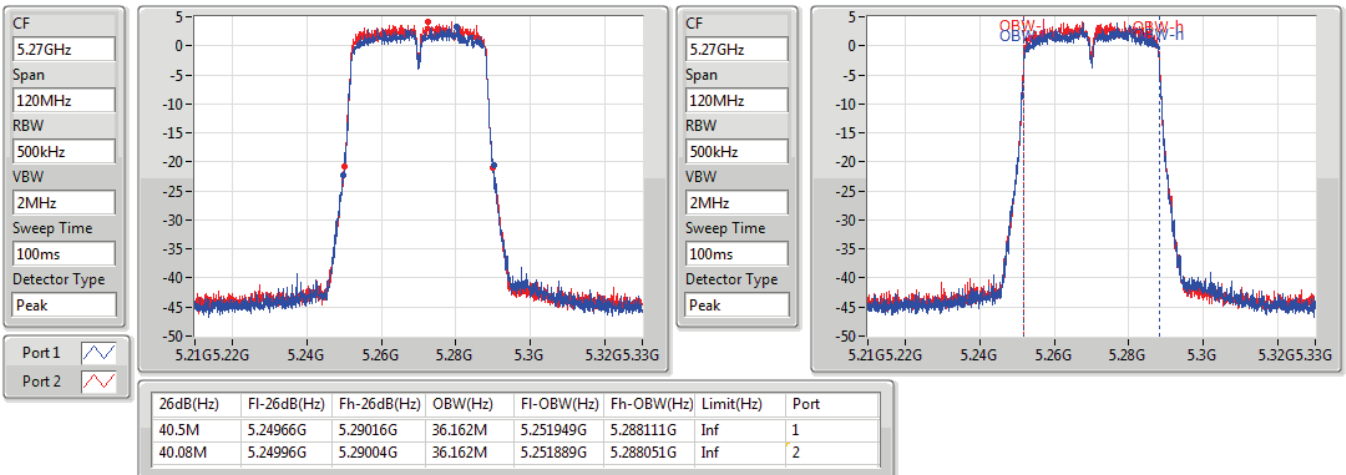

802.11ac VHT40\_Nss1,(MCS0)\_2TX

EBW

5310MHz

06/12/2019

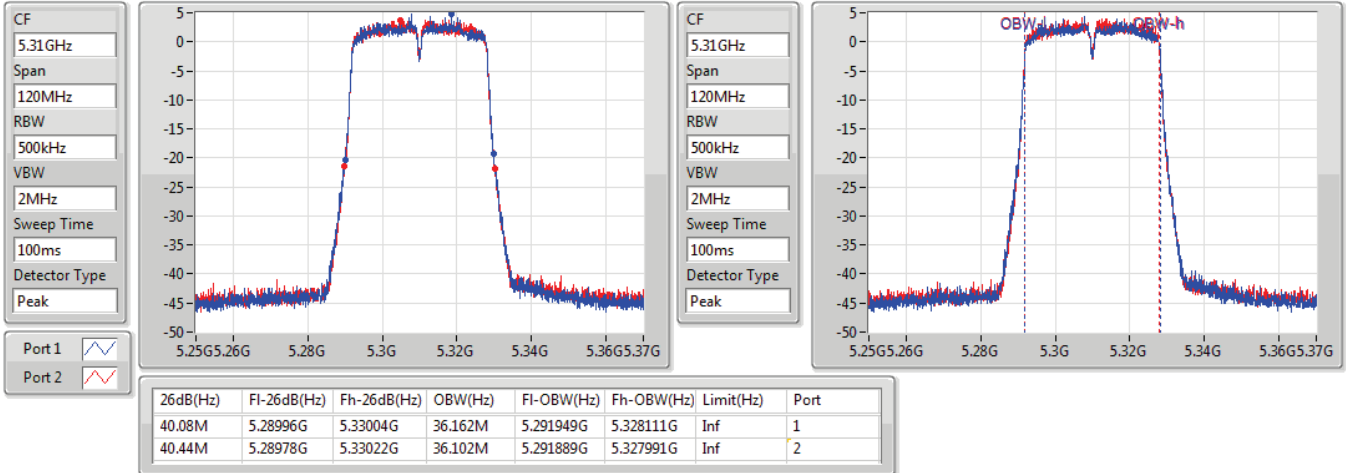

802.11ac VHT40\_Nss1,(MCS0)\_2TX

EBW

5510MHz

06/12/2019

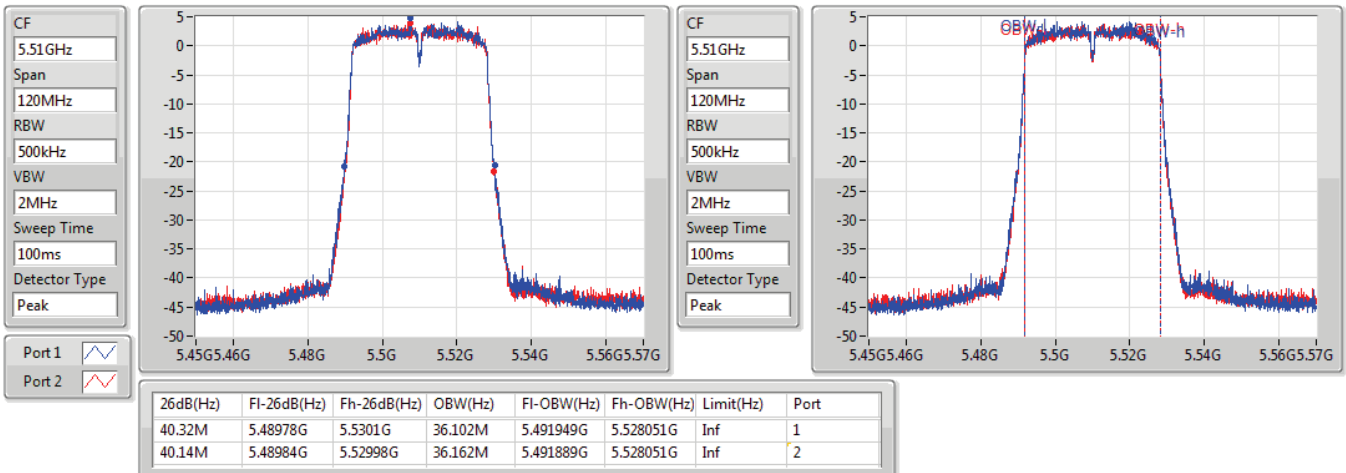

802.11ac VHT40\_Nss1,(MCS0)\_2TX

EBW

5550MHz

06/12/2019

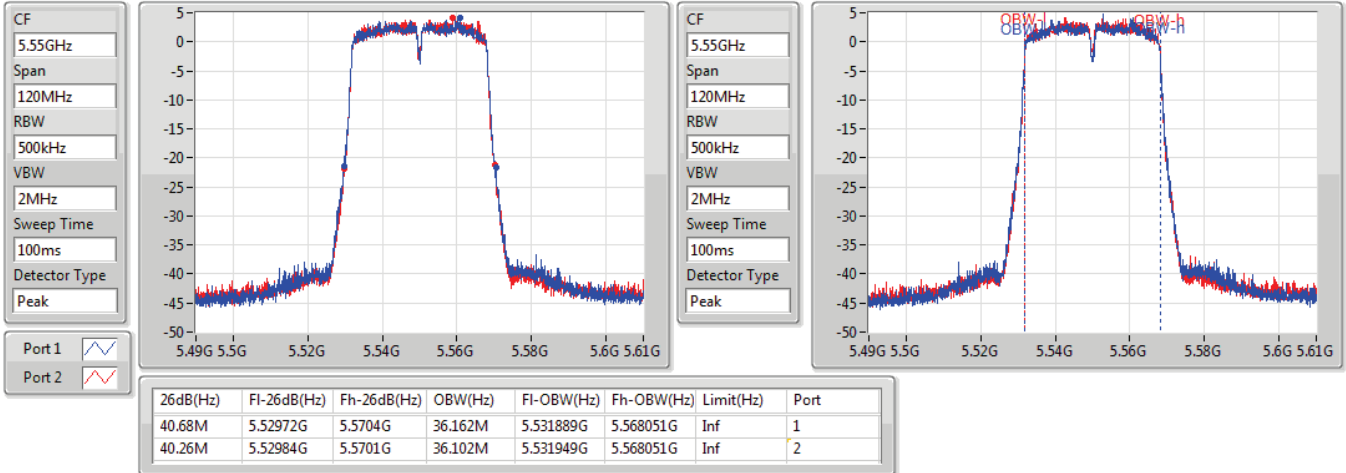

802.11ac VHT40\_Nss1,(MCS0)\_2TX

EBW

5670MHz

06/12/2019

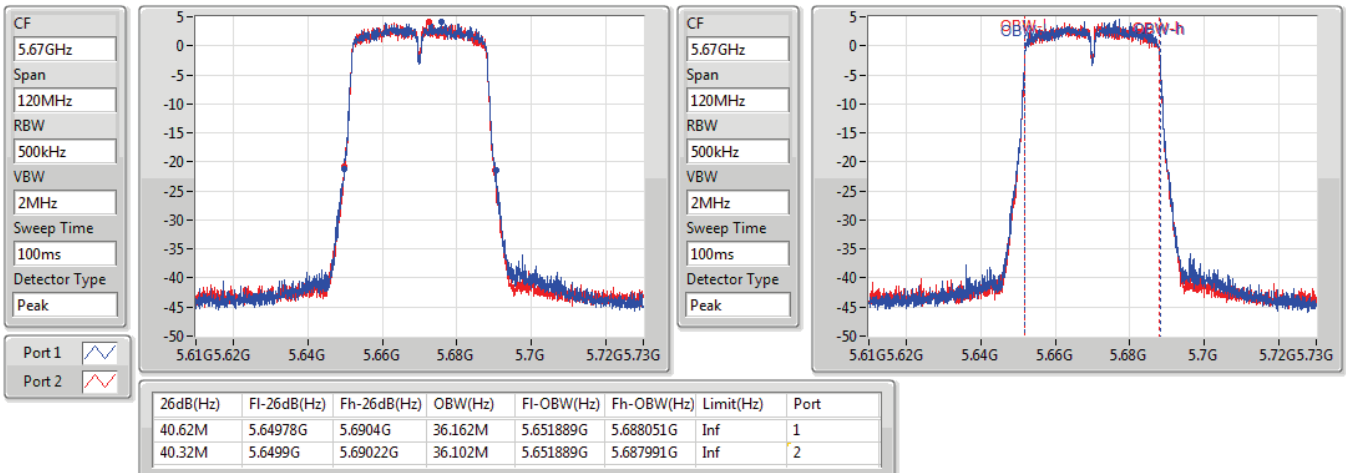

802.11ac VHT40\_Nss1,(MCS0)\_2TX

EBW

5710MHz Straddle 5.47-5.725GHz

06/12/2019

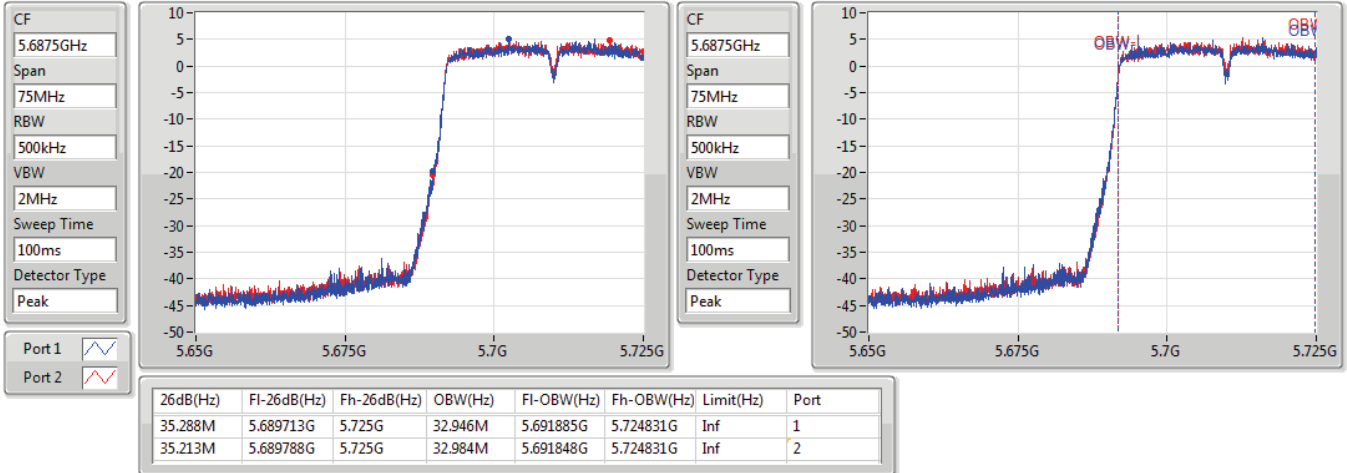

802.11ac VHT40\_Nss1,(MCS0)\_2TX

EBW

5710MHz Straddle 5.725-5.85GHz

06/12/2019

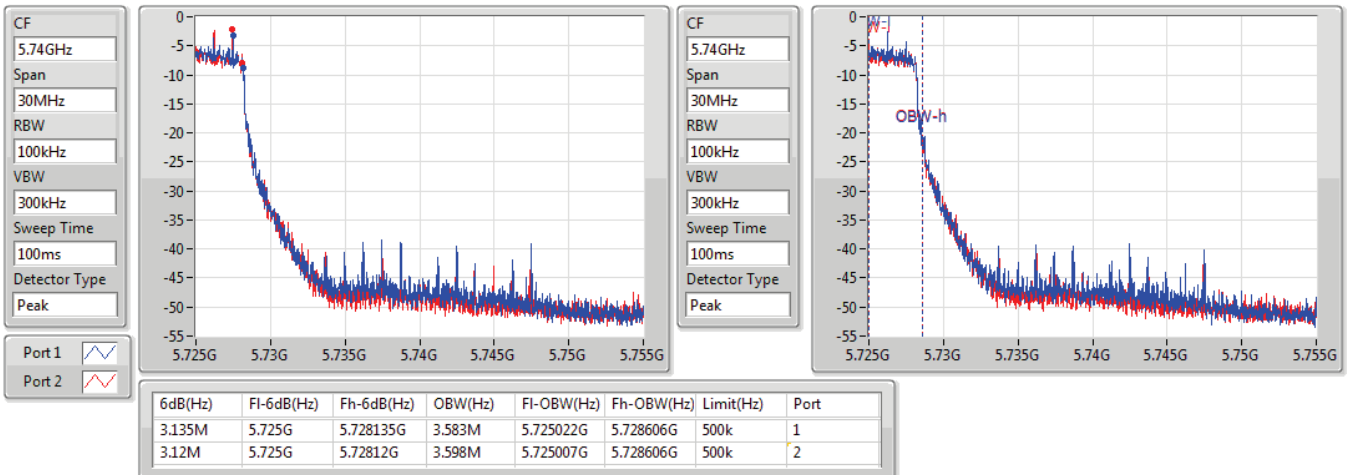



802.11ac VHT80\_Nss1,(MCS0)\_1TX(Port2)

EBW

5290MHz

06/12/2019

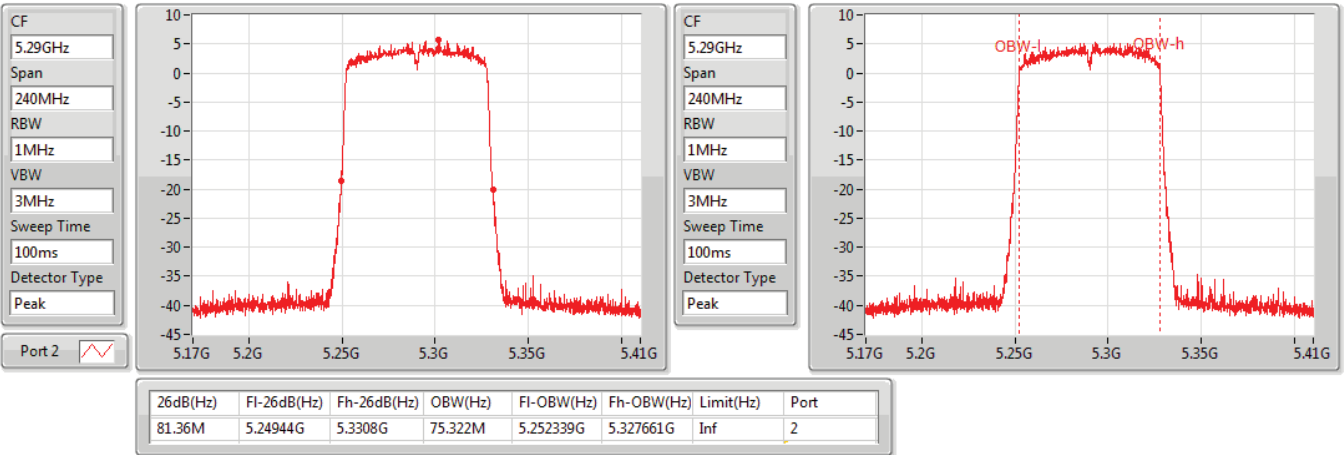

802.11ac VHT80\_Nss1,(MCS0)\_1TX(Port2)

EBW

5530MHz

06/12/2019

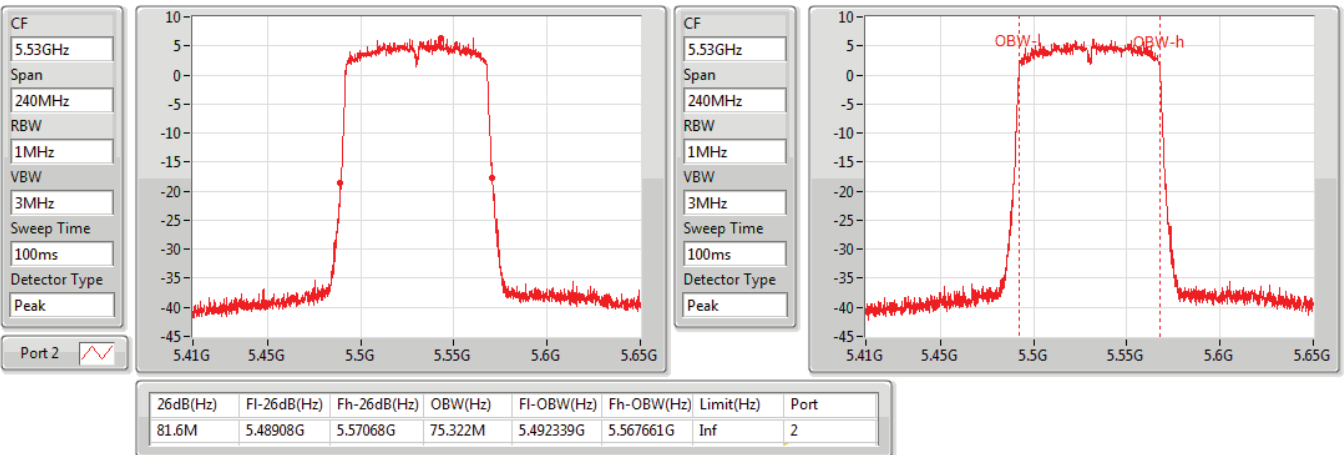

802.11ac VHT80\_Nss1,(MCS0)\_1TX(Port2)

EBW

5610MHz

06/12/2019

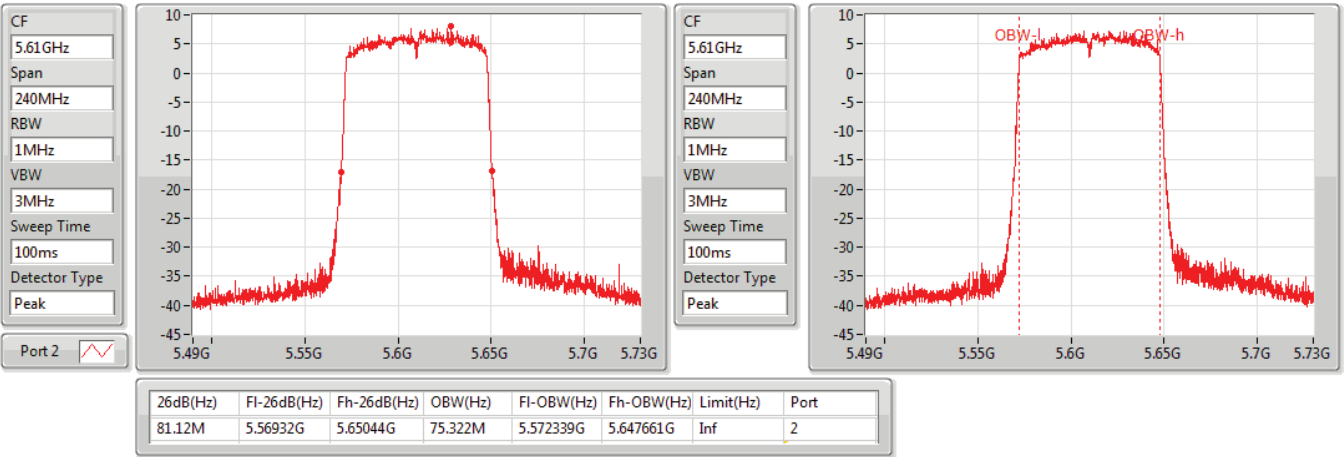

802.11ac VHT80\_Nss1,(MCS0)\_1TX(Port2)

EBW

5690MHz Straddle 5.47-5.725GHz

06/12/2019

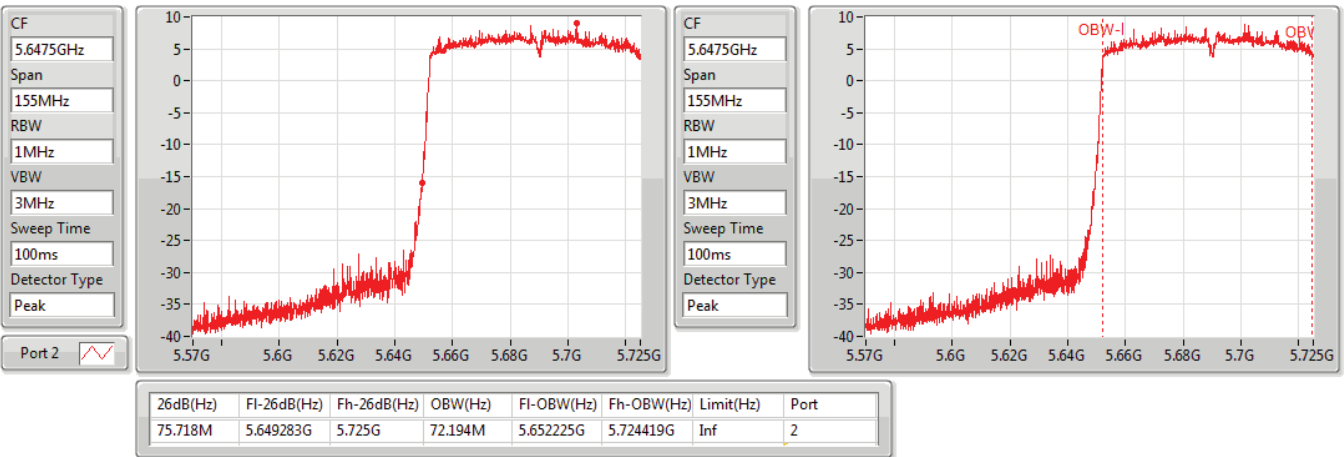

802.11ac VHT80\_Nss1,(MCS0)\_1TX(Port2)

EBW

5690MHz Straddle 5.725-5.85GHz

06/12/2019

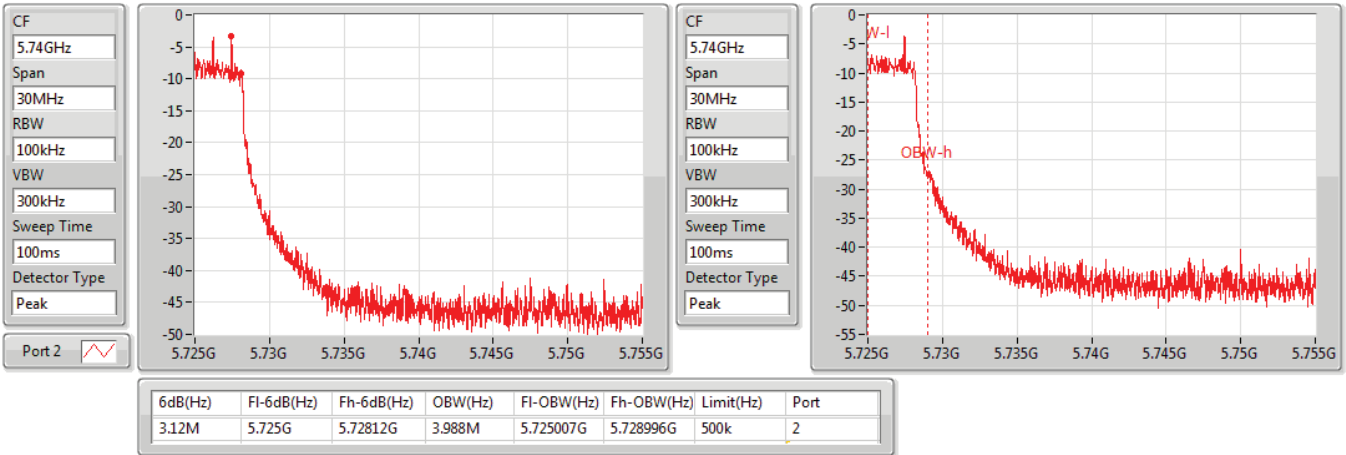

802.11ac VHT80\_Nss1,(MCS0)\_2TX

EBW

5290MHz

06/12/2019

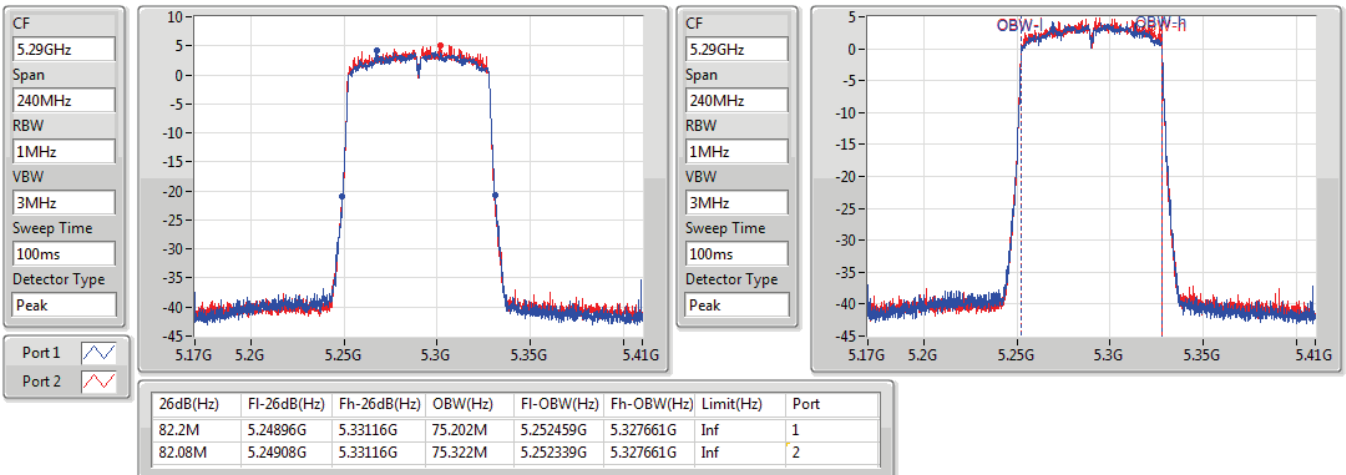

802.11ac VHT80\_Nss1,(MCS0)\_2TX

EBW

5530MHz

06/12/2019

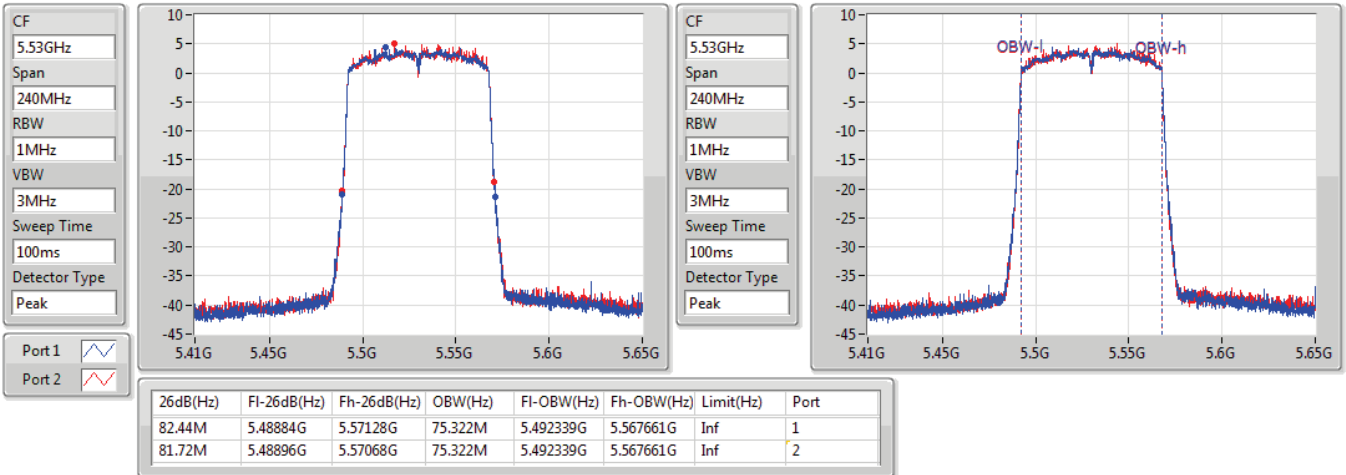

802.11ac VHT80\_Nss1,(MCS0)\_2TX

EBW

5610MHz

06/12/2019

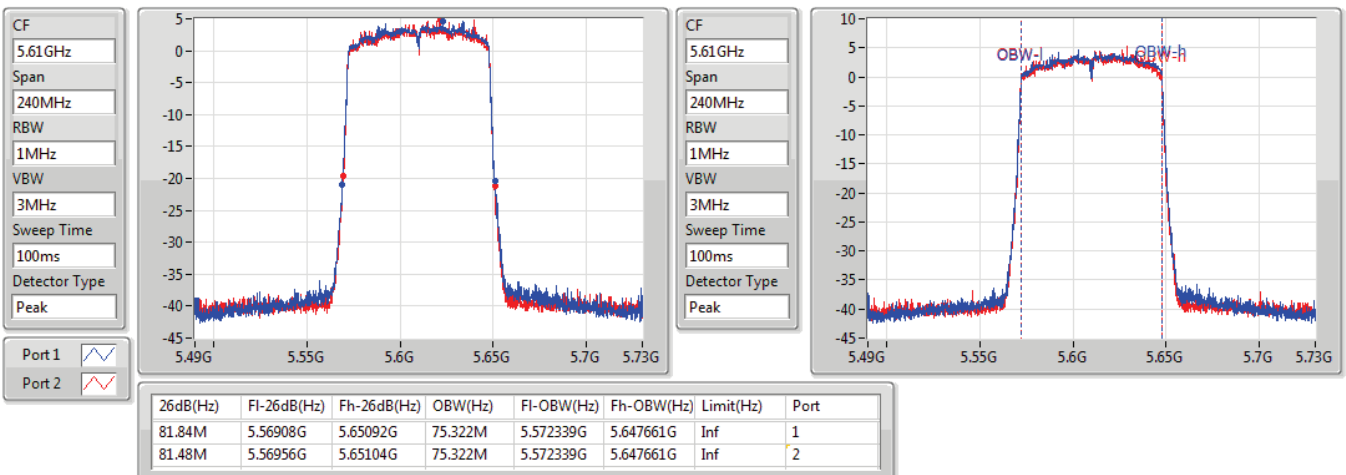

802.11ac VHT80\_Nss1,(MCS0)\_2TX

EBW

5690MHz Straddle 5.47-5.725GHz

06/12/2019

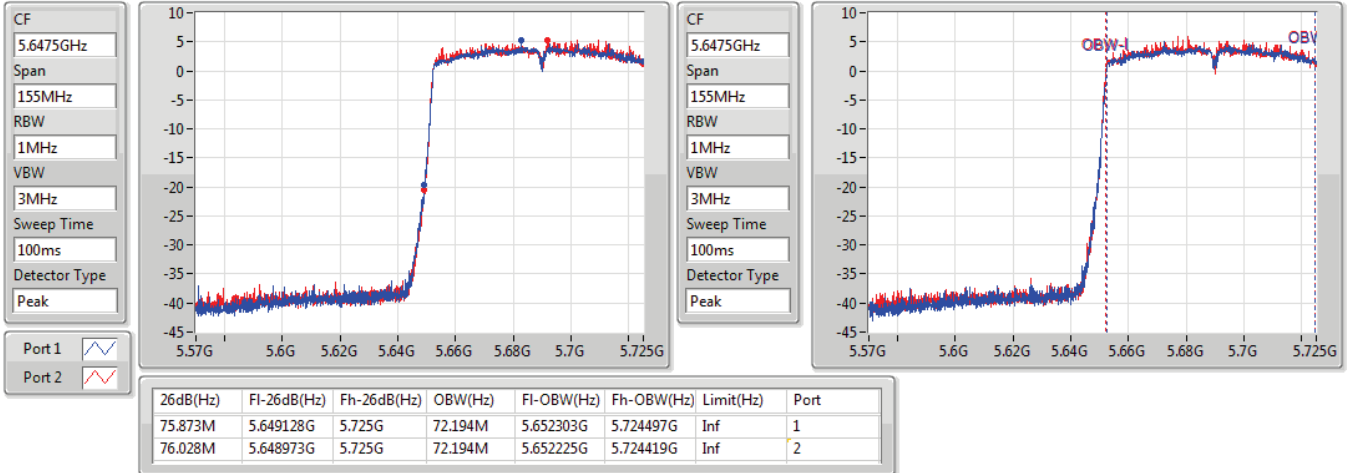

802.11ac VHT80\_Nss1,(MCS0)\_2TX

EBW

5690MHz Straddle 5.725-5.85GHz

06/12/2019

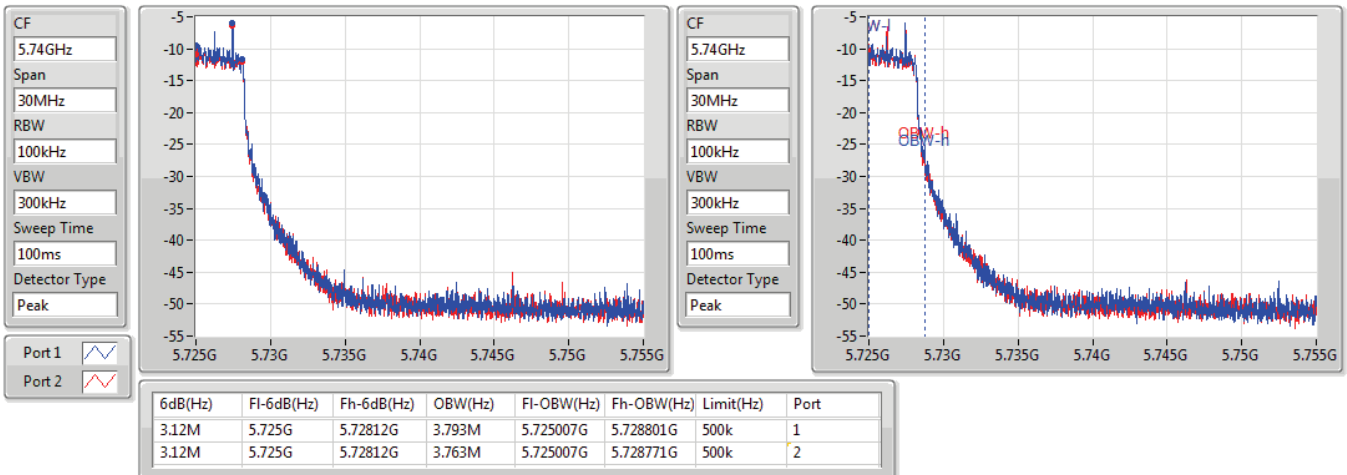

802.11ax HEW20\_Nss1,(MCS0)\_1TX(Port2)

EBW

5260MHz

05/12/2019

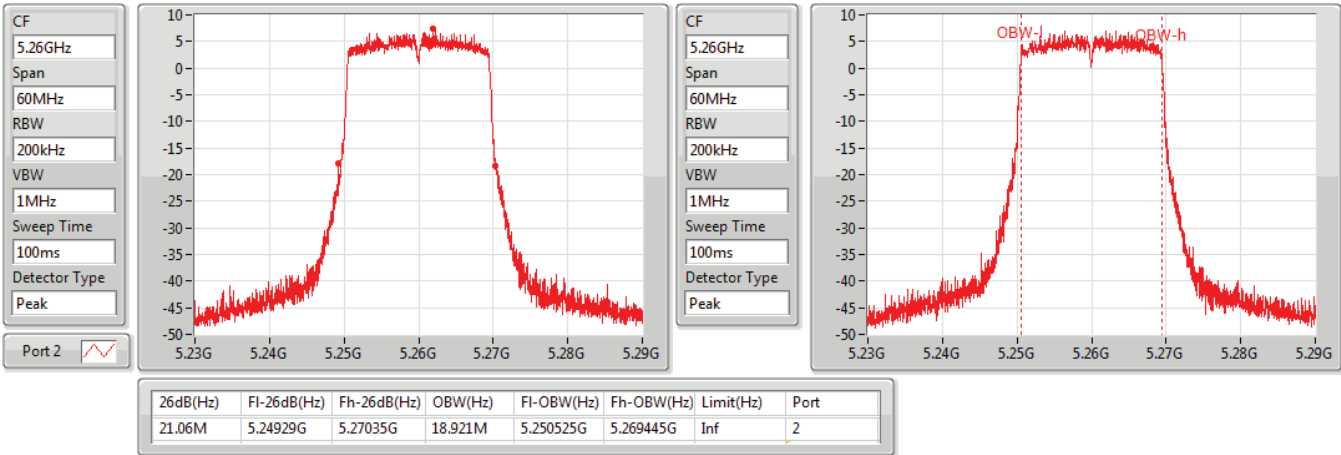

802.11ax HEW20\_Nss1,(MCS0)\_1TX(Port2)

EBW

5300MHz

05/12/2019

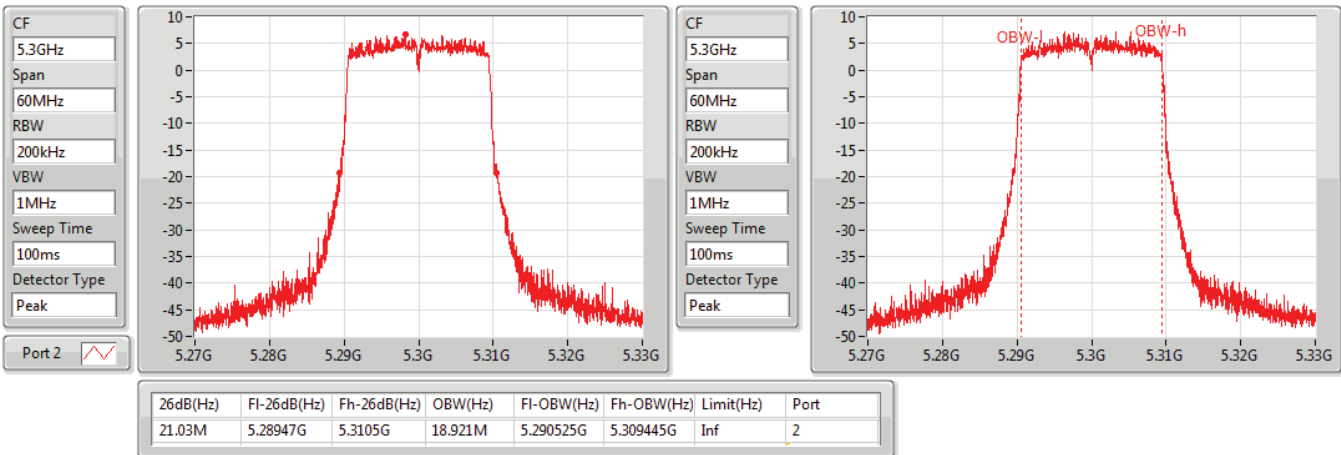

802.11ax HEW20\_Nss1,(MCS0)\_1TX(Port2)

EBW

5320MHz

05/12/2019

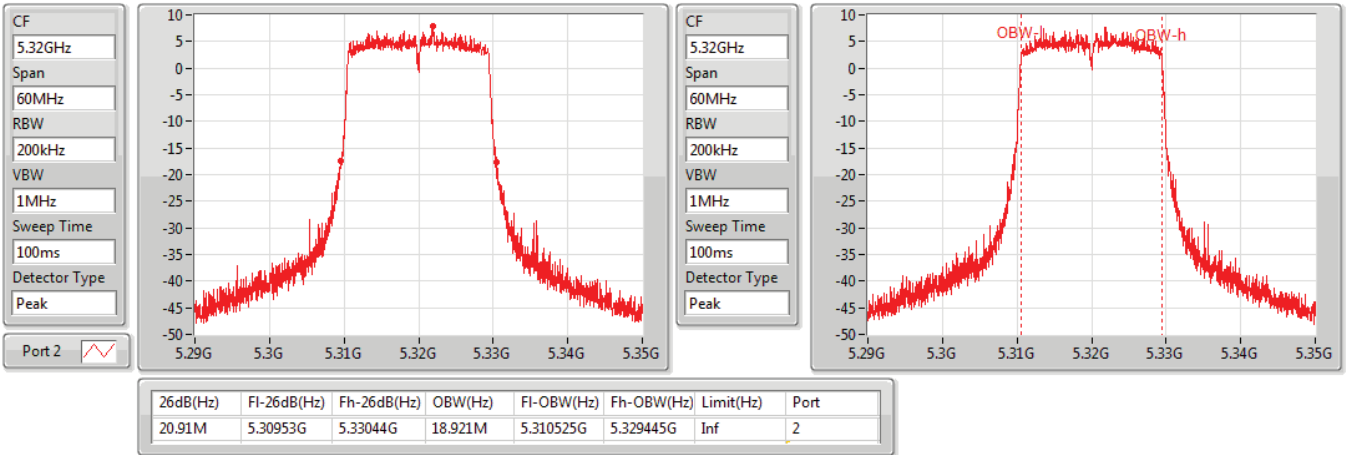

802.11ax HEW20\_Nss1,(MCS0)\_1TX(Port2)

EBW

5500MHz

05/12/2019

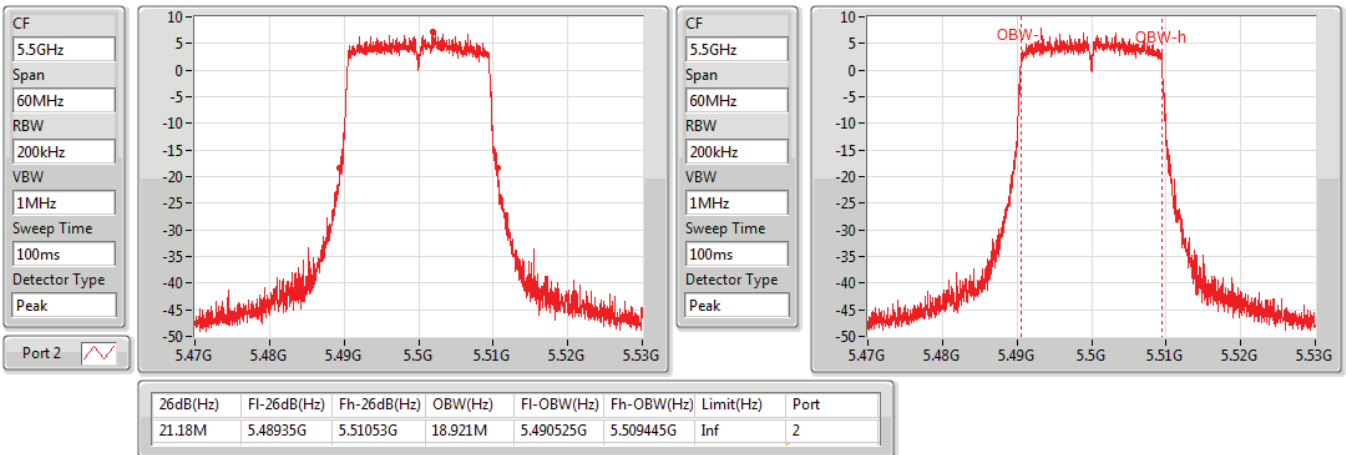

802.11ax HEW20\_Nss1,(MCS0)\_1TX(Port2)

EBW

5580MHz

05/12/2019

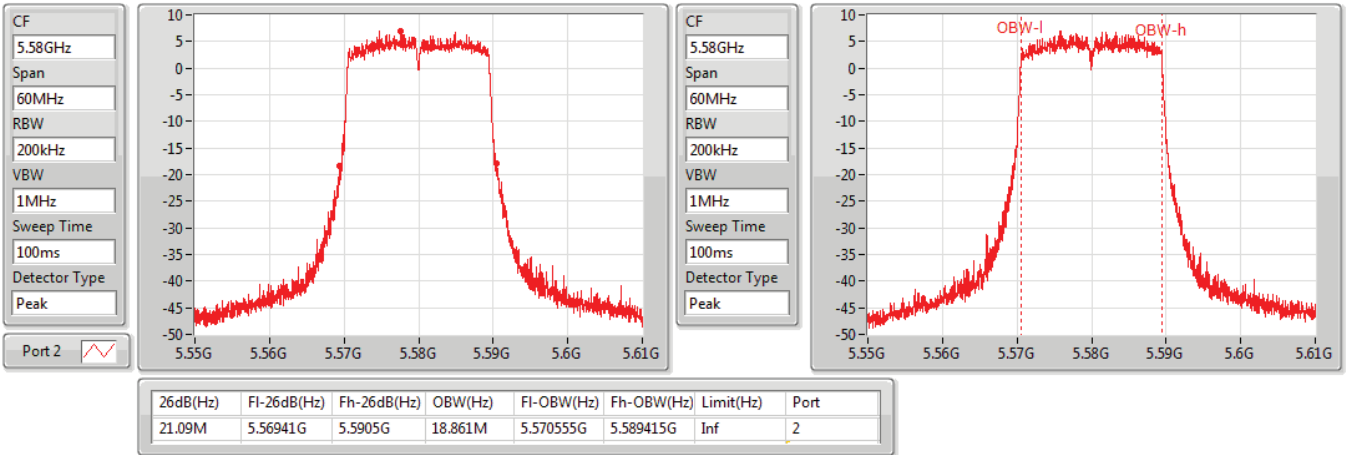

802.11ax HEW20\_Nss1,(MCS0)\_1TX(Port2)

EBW

5700MHz

05/12/2019

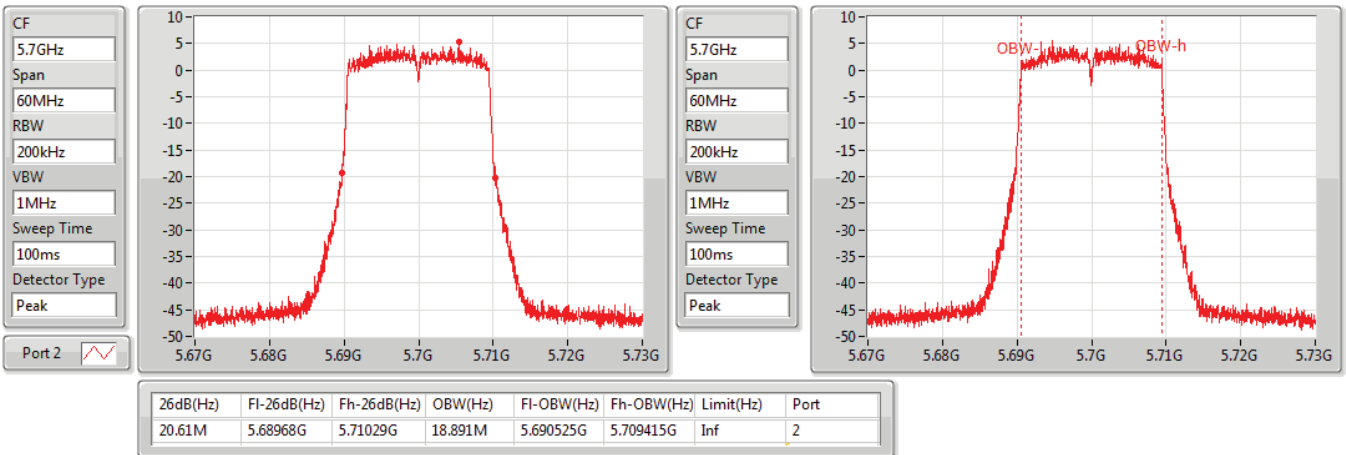



802.11ax HEW20\_Nss1,(MCS0)\_1TX(Port2)

EBW

5720MHz Straddle 5.47-5.725GHz

05/12/2019

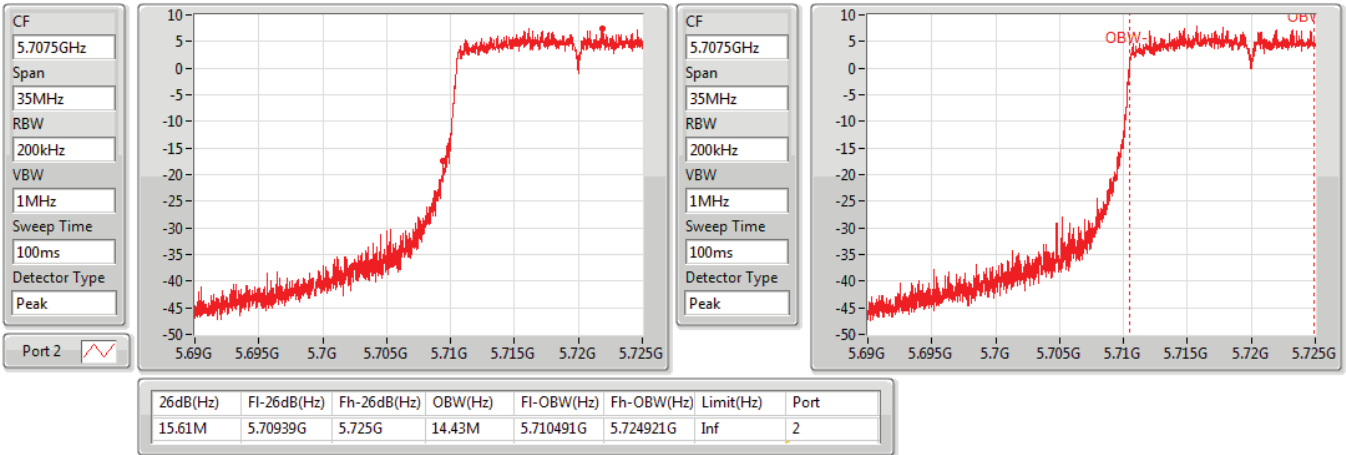

802.11ax HEW20\_Nss1,(MCS0)\_1TX(Port2)

EBW

5720MHz Straddle 5.725-5.85GHz

05/12/2019

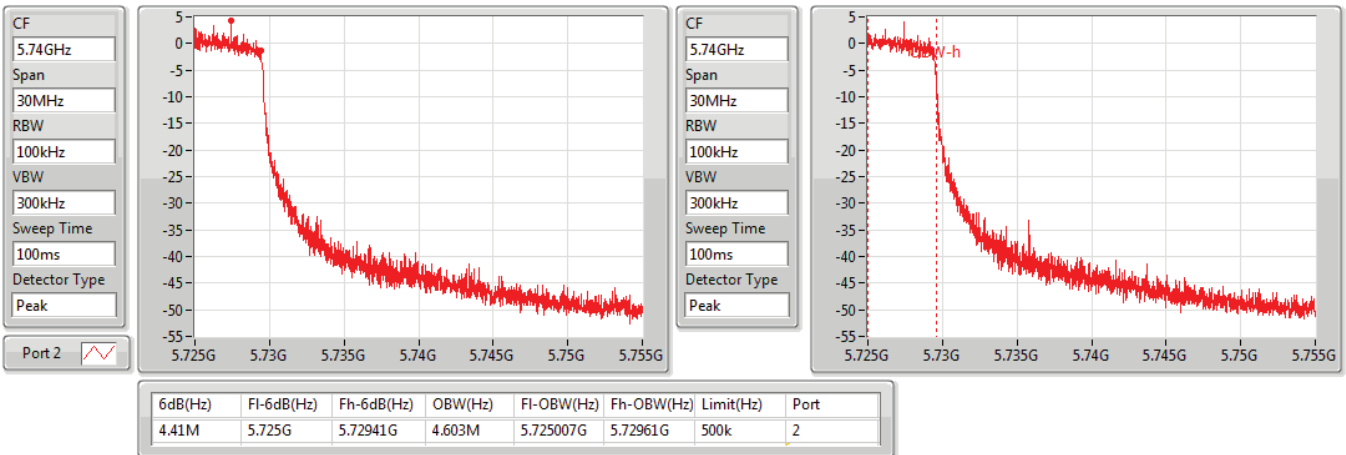

802.11ax HEW20\_Nss1,(MCS0)\_2TX

EBW

5260MHz

05/12/2019

CF  
5.26GHz  
Span  
60MHz  
RBW  
200kHz  
VBW  
1MHz  
Sweep Time  
100ms  
Detector Type  
Peak  
Port 1  
Port 2

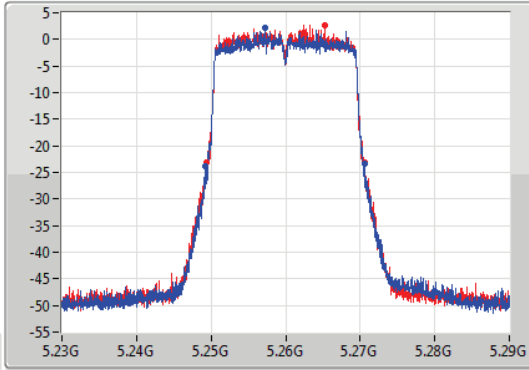

CF  
5.26GHz  
Span  
60MHz  
RBW  
200kHz  
VBW  
1MHz  
Sweep Time  
100ms  
Detector Type  
Peak

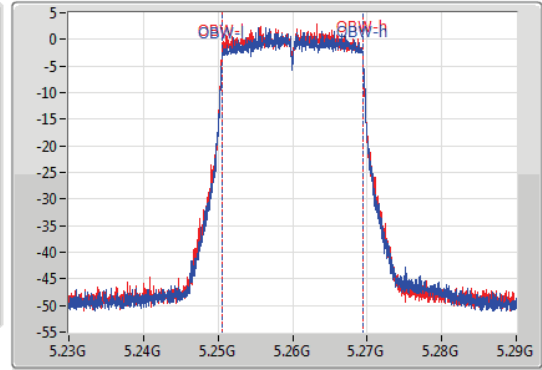

26dB(Hz)	Fl-26dB(Hz)	Fh-26dB(Hz)	OBW(Hz)	Fl-OBW(Hz)	Fh-OBW(Hz)	Limit(Hz)	Port
21.24M	5.24929G	5.27053G	18.921M	5.250525G	5.269445G	Inf	1
21.12M	5.24944G	5.27056G	18.891M	5.250525G	5.269415G	Inf	2

802.11ax HEW20\_Nss1,(MCS0)\_2TX

EBW

5300MHz

05/12/2019

CF  
5.3GHz  
Span  
60MHz  
RBW  
200kHz  
VBW  
1MHz  
Sweep Time  
100ms  
Detector Type  
Peak  
Port 1  
Port 2

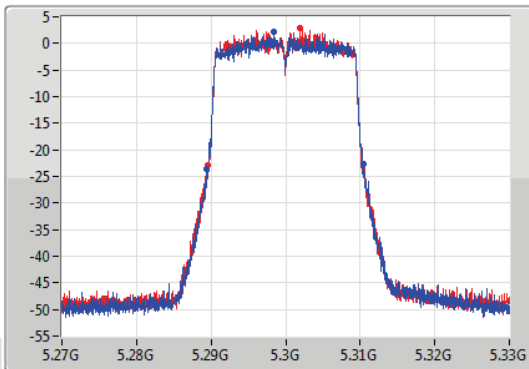

CF  
5.3GHz  
Span  
60MHz  
RBW  
200kHz  
VBW  
1MHz  
Sweep Time  
100ms  
Detector Type  
Peak

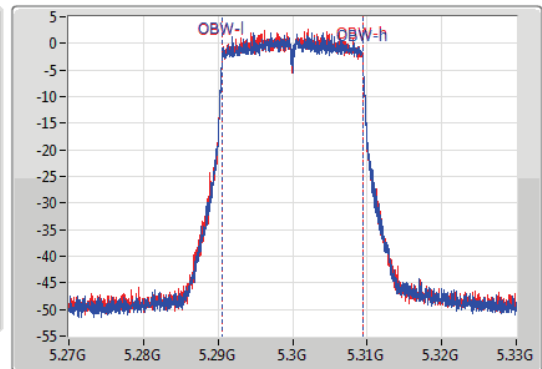

26dB(Hz)	Fl-26dB(Hz)	Fh-26dB(Hz)	OBW(Hz)	Fl-OBW(Hz)	Fh-OBW(Hz)	Limit(Hz)	Port
21.09M	5.28935G	5.31044G	18.921M	5.290525G	5.309445G	Inf	1
20.91M	5.28959G	5.3105G	18.861M	5.290555G	5.309415G	Inf	2

802.11ax HEW20\_Nss1,(MCS0)\_2TX

EBW

5320MHz

05/12/2019

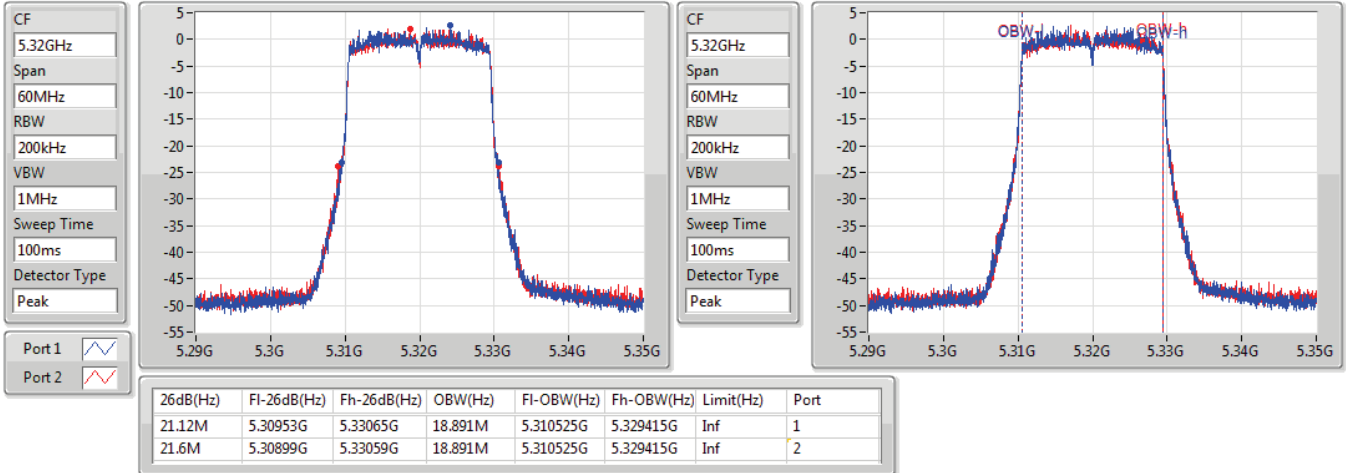

802.11ax HEW20\_Nss1,(MCS0)\_2TX

EBW

5500MHz

05/12/2019

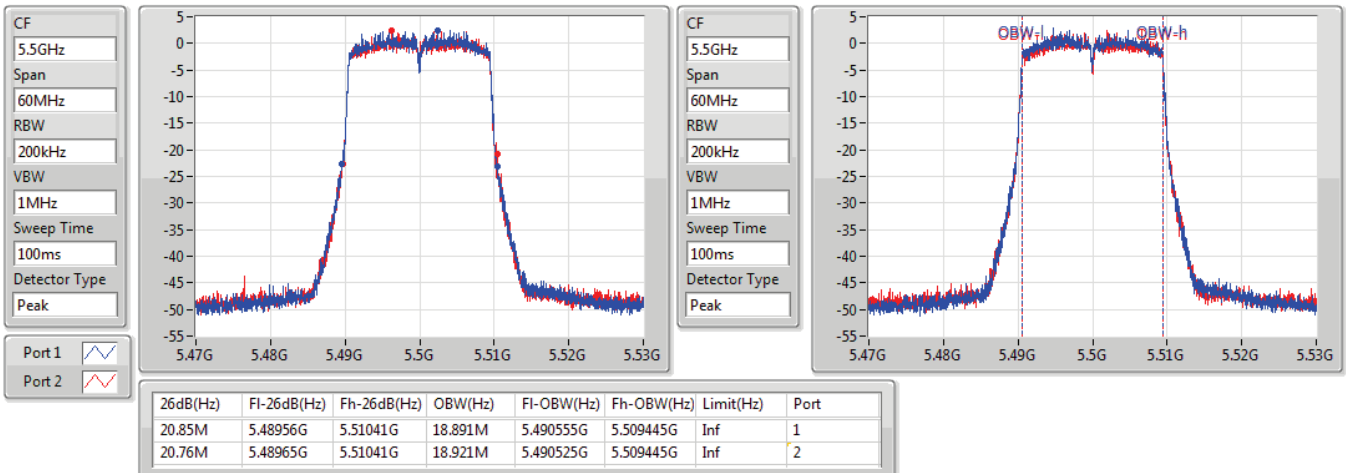

802.11ax HEW20\_Nss1,(MCS0)\_2TX

EBW

5580MHz

05/12/2019

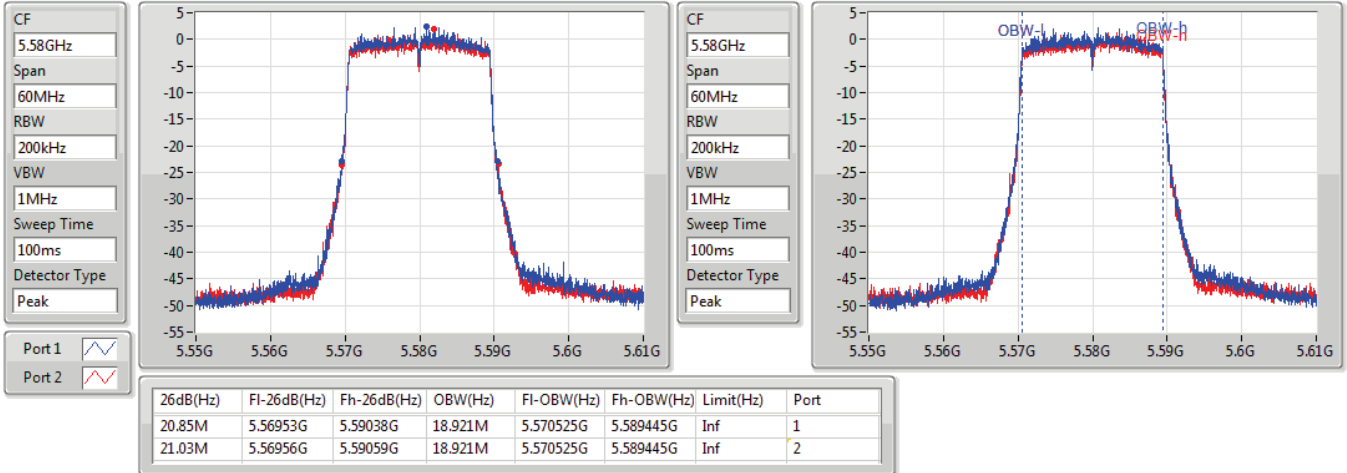

802.11ax HEW20\_Nss1,(MCS0)\_2TX

EBW

5700MHz

05/12/2019

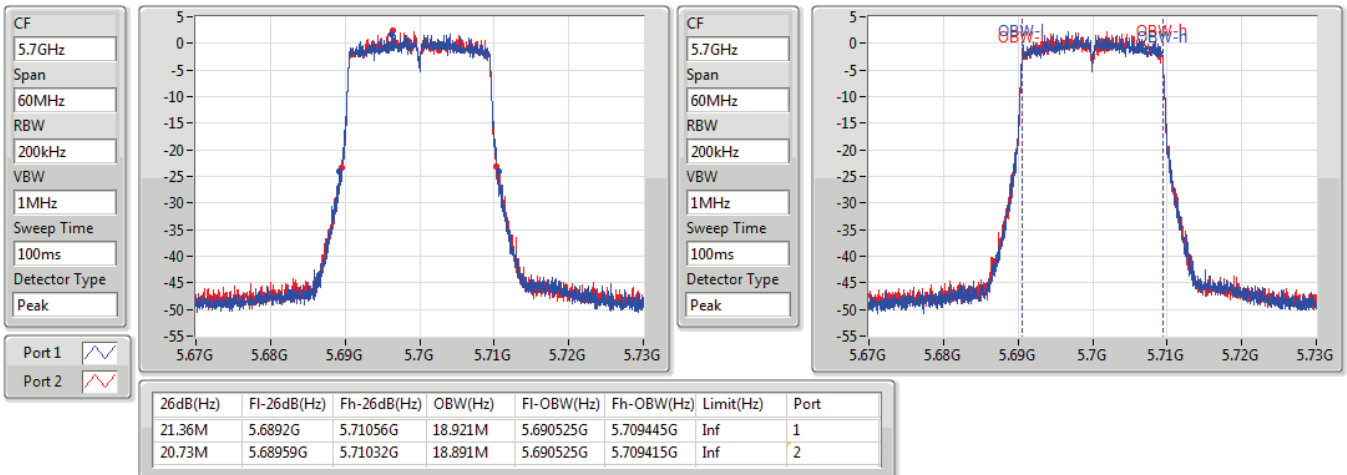

802.11ax HEW20\_Nss1,(MCS0)\_2TX

EBW

5720MHz Straddle 5.47-5.725GHz

05/12/2019

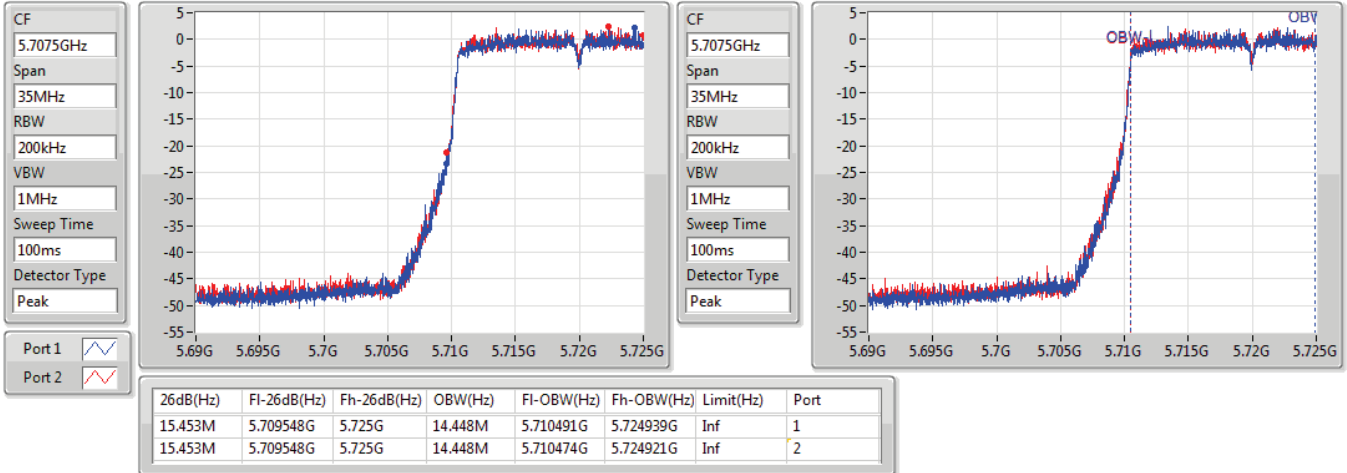

802.11ax HEW20\_Nss1,(MCS0)\_2TX

EBW

5720MHz Straddle 5.725-5.85GHz

05/12/2019

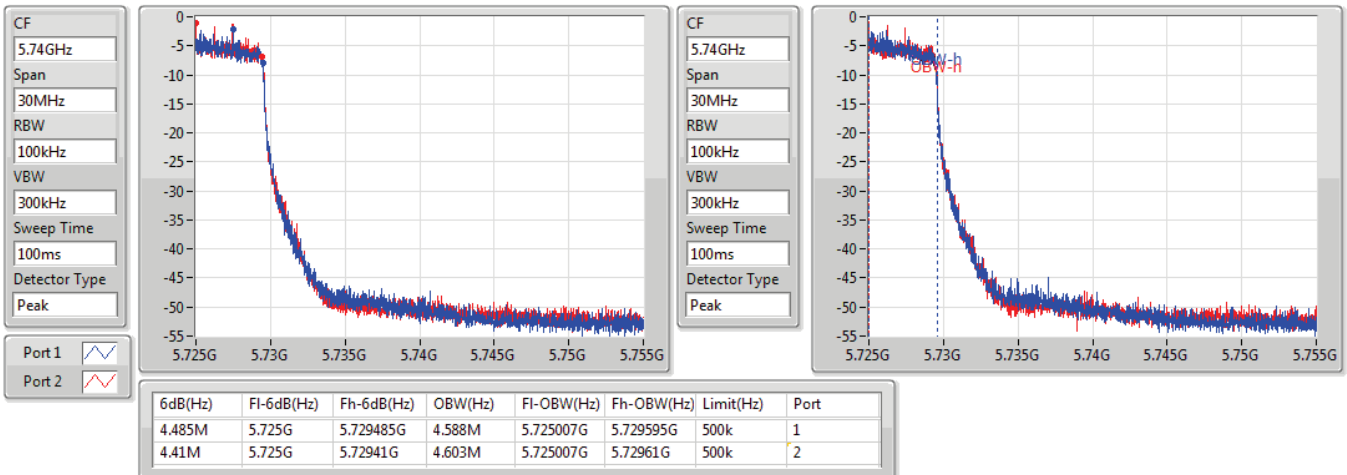

802.11ax HEW40\_Nss1,(MCS0)\_1TX(Port2)

EBW

5270MHz

06/12/2019

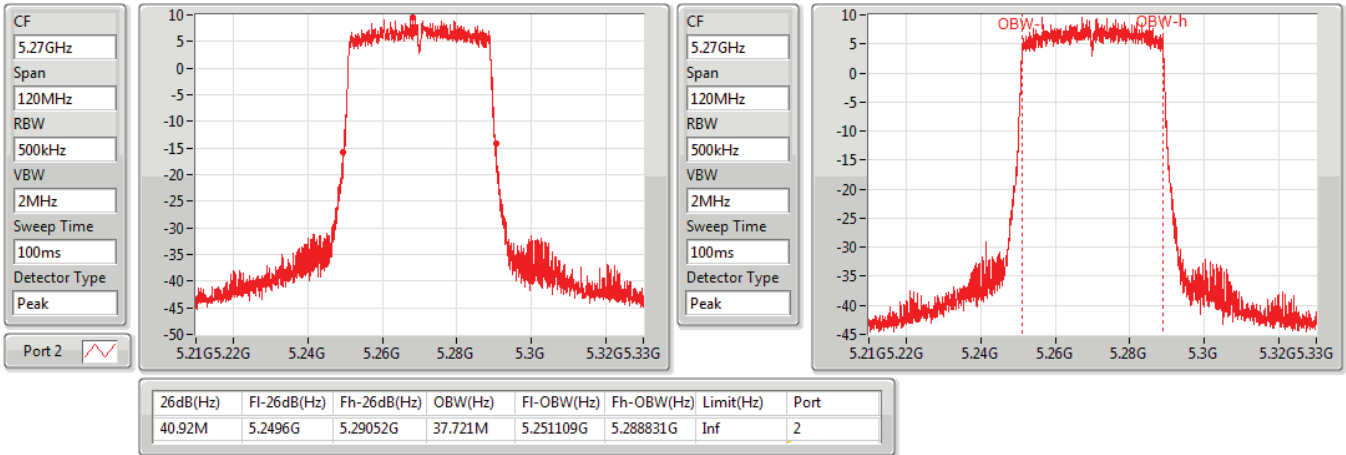

802.11ax HEW40\_Nss1,(MCS0)\_1TX(Port2)

EBW

5310MHz

06/12/2019

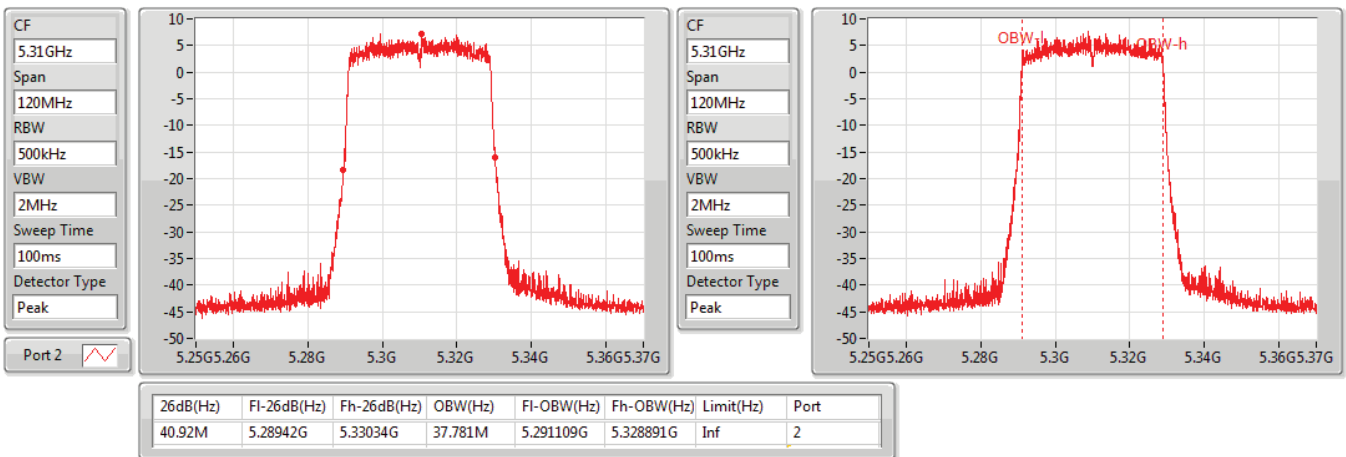

802.11ax HEW40\_Nss1,(MCS0)\_1TX(Port2)

EBW

5510MHz

06/12/2019

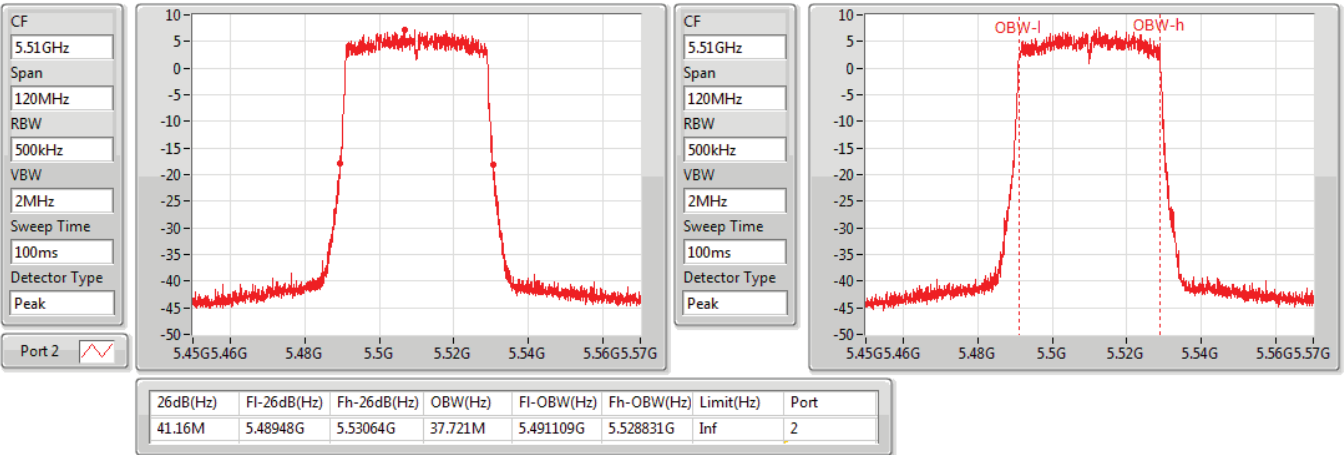

802.11ax HEW40\_Nss1,(MCS0)\_1TX(Port2)

EBW

5550MHz

06/12/2019

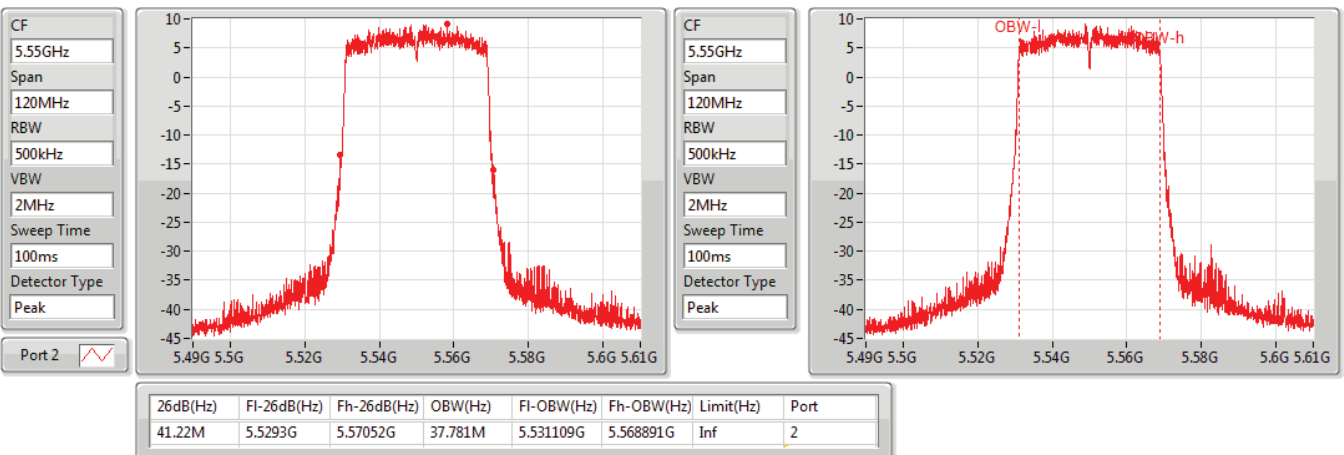

802.11ax HEW40\_Nss1,(MCS0)\_1TX(Port2)

EBW

5670MHz

06/12/2019

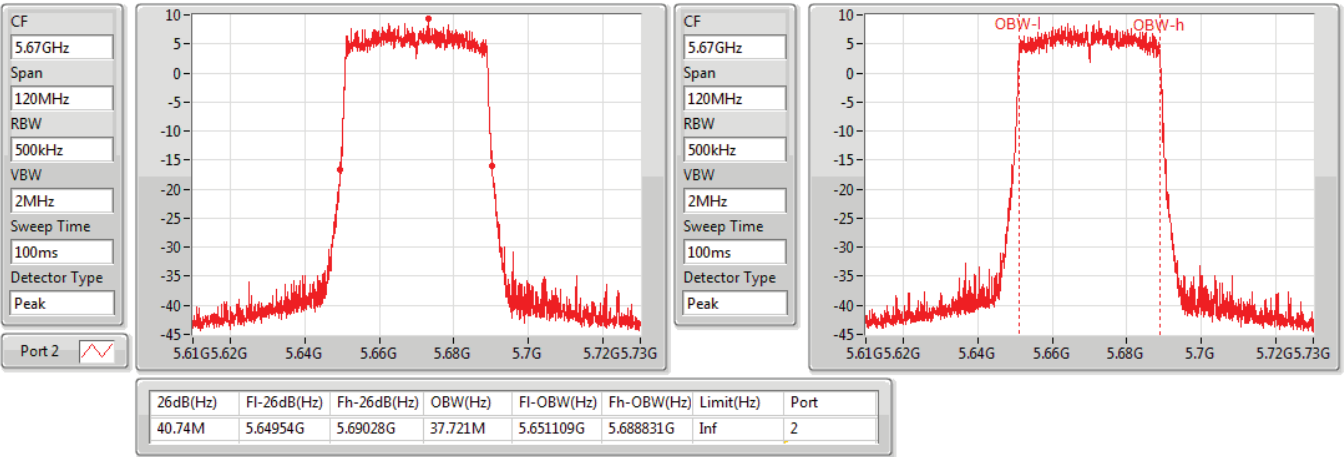

802.11ax HEW40\_Nss1,(MCS0)\_1TX(Port2)

EBW

5710MHz Straddle 5.47-5.725GHz

06/12/2019

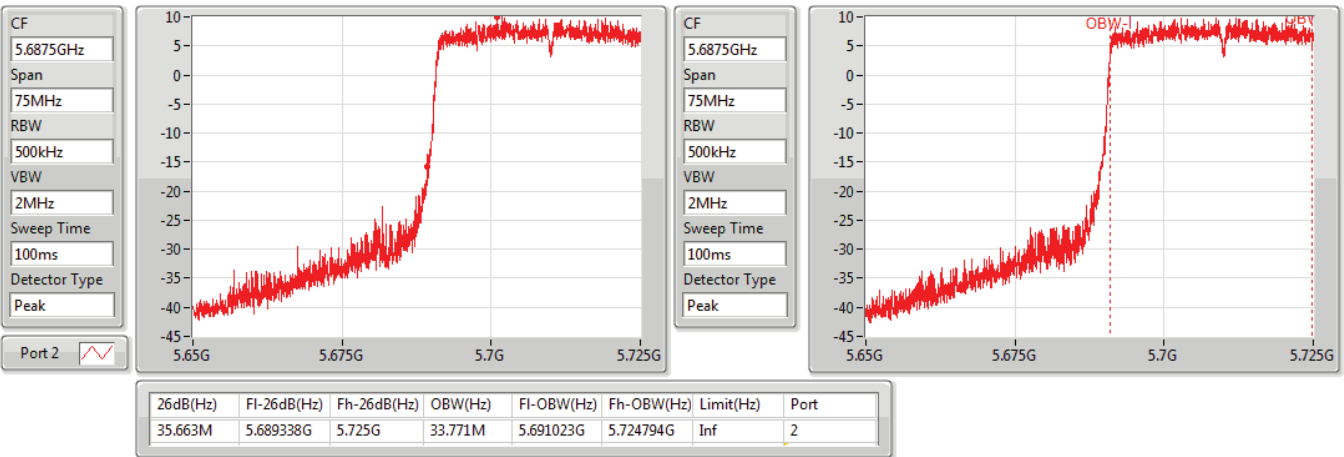



802.11ax HEW40\_Nss1,(MCS0)\_1TX(Port2)

EBW

5710MHz Straddle 5.725-5.85GHz

06/12/2019

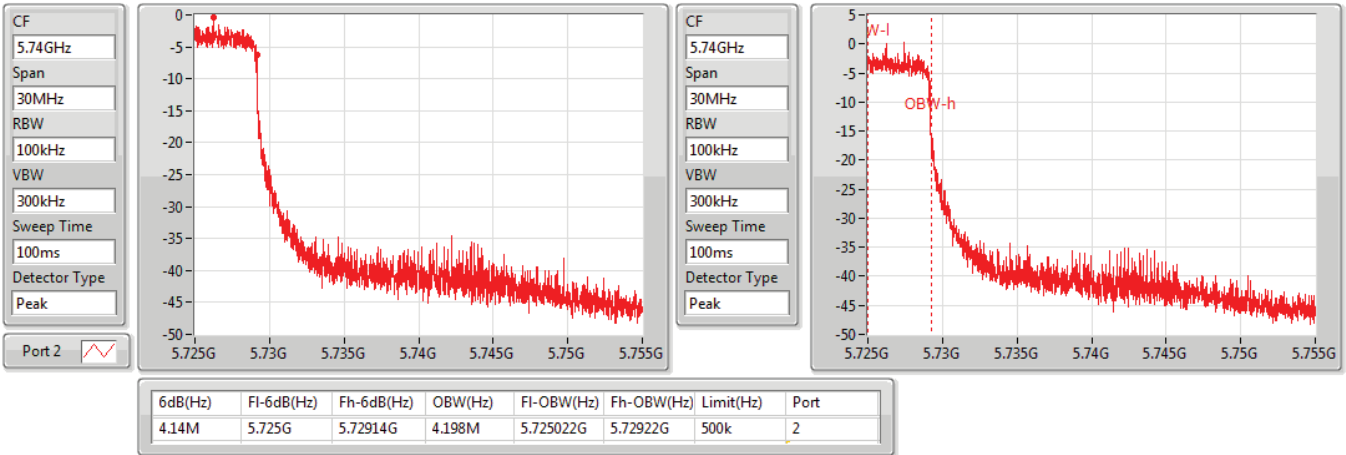

802.11ax HEW40\_Nss1,(MCS0)\_2TX

EBW

5270MHz

06/12/2019

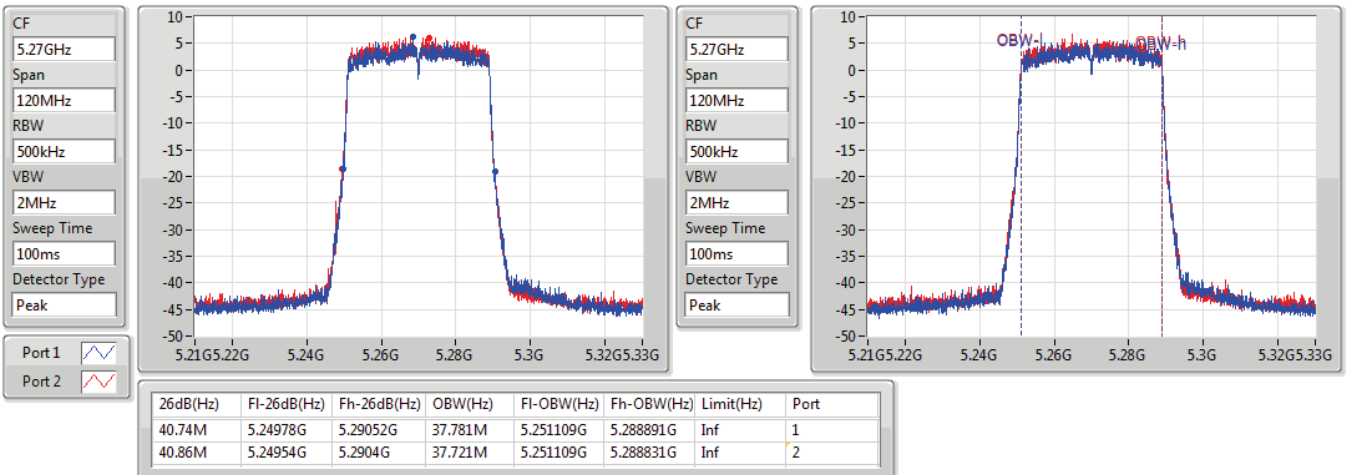

802.11ax HEW40\_Nss1,(MCS0)\_2TX

EBW

5310MHz

06/12/2019

CF  
5.31GHz  
Span  
120MHz  
RBW  
500kHz  
VBW  
2MHz  
Sweep Time  
100ms  
Detector Type  
Peak

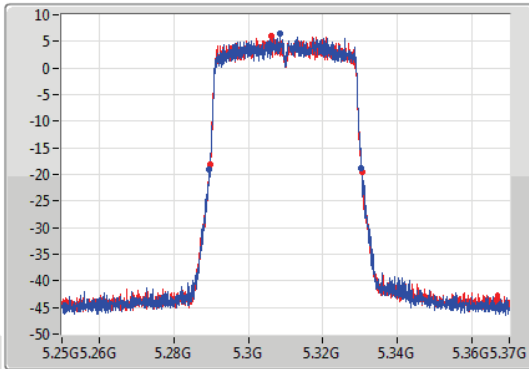

CF  
5.31GHz  
Span  
120MHz  
RBW  
500kHz  
VBW  
2MHz  
Sweep Time  
100ms  
Detector Type  
Peak

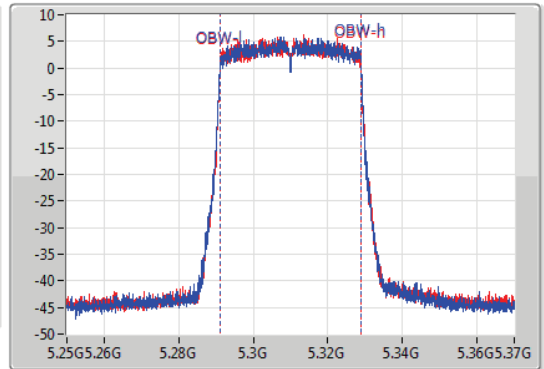

26dB(Hz)	Fl-26dB(Hz)	Fh-26dB(Hz)	OBW(Hz)	Fl-OBW(Hz)	Fh-OBW(Hz)	Limit(Hz)	Port
40.74M	5.2896G	5.33034G	37.781M	5.291109G	5.328891G	Inf	1
40.98M	5.28966G	5.33064G	37.721M	5.291109G	5.328831G	Inf	2

802.11ax HEW40\_Nss1,(MCS0)\_2TX

EBW

5510MHz

06/12/2019

CF  
5.51GHz  
Span  
120MHz  
RBW  
500kHz  
VBW  
2MHz  
Sweep Time  
100ms  
Detector Type  
Peak

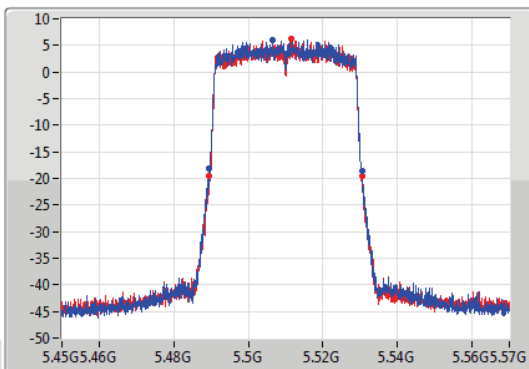

CF  
5.51GHz  
Span  
120MHz  
RBW  
500kHz  
VBW  
2MHz  
Sweep Time  
100ms  
Detector Type  
Peak

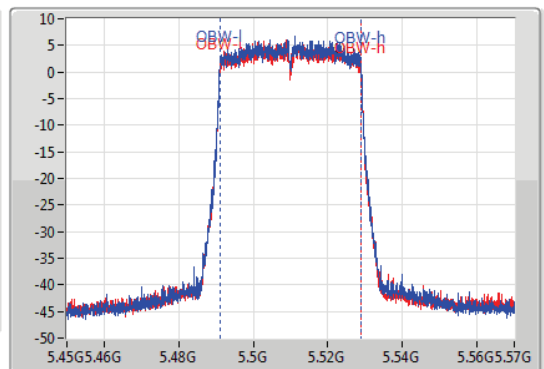

26dB(Hz)	Fl-26dB(Hz)	Fh-26dB(Hz)	OBW(Hz)	Fl-OBW(Hz)	Fh-OBW(Hz)	Limit(Hz)	Port
41.1M	5.48942G	5.53052G	37.721M	5.491109G	5.528831G	Inf	1
41.22M	5.48936G	5.53058G	37.721M	5.491109G	5.528831G	Inf	2

802.11ax HEW40\_Nss1,(MCS0)\_2TX

EBW

5550MHz

06/12/2019

CF  
5.55GHz  
Span  
120MHz  
RBW  
500kHz  
VBW  
2MHz  
Sweep Time  
100ms  
Detector Type  
Peak

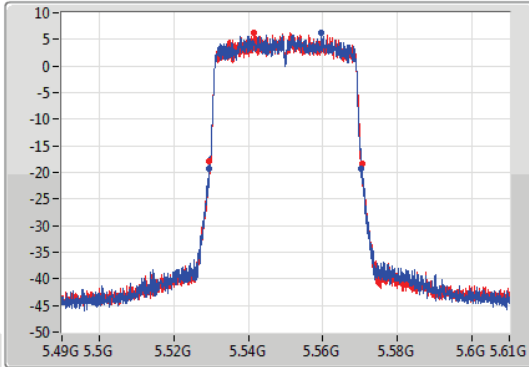

CF  
5.55GHz  
Span  
120MHz  
RBW  
500kHz  
VBW  
2MHz  
Sweep Time  
100ms  
Detector Type  
Peak

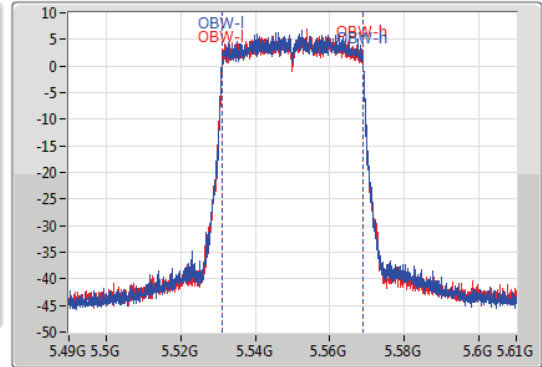

26dB(Hz)	Fl-26dB(Hz)	Fh-26dB(Hz)	OBW(Hz)	Fl-OBW(Hz)	Fh-OBW(Hz)	Limit(Hz)	Port
40.8M	5.52948G	5.57028G	37.721M	5.531109G	5.568831G	Inf	1
40.8M	5.5296G	5.5704G	37.781M	5.531109G	5.568891G	Inf	2

802.11ax HEW40\_Nss1,(MCS0)\_2TX

EBW

5670MHz

06/12/2019

CF  
5.67GHz  
Span  
120MHz  
RBW  
500kHz  
VBW  
2MHz  
Sweep Time  
100ms  
Detector Type  
Peak

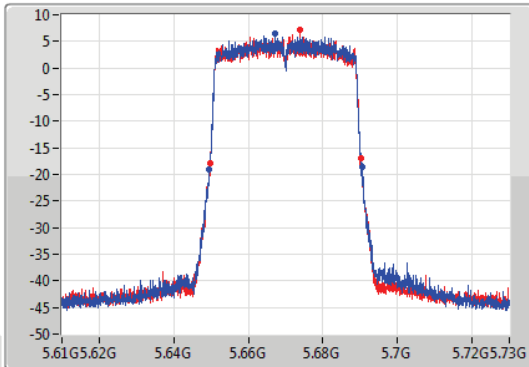

CF  
5.67GHz  
Span  
120MHz  
RBW  
500kHz  
VBW  
2MHz  
Sweep Time  
100ms  
Detector Type  
Peak

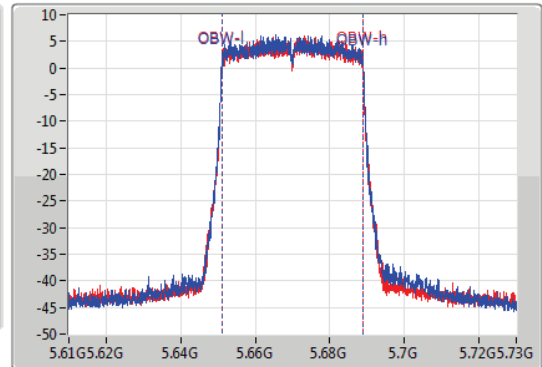

26dB(Hz)	Fl-26dB(Hz)	Fh-26dB(Hz)	OBW(Hz)	Fl-OBW(Hz)	Fh-OBW(Hz)	Limit(Hz)	Port
40.98M	5.64954G	5.69052G	37.721M	5.651109G	5.688831G	Inf	1
40.44M	5.64978G	5.69022G	37.721M	5.651109G	5.688831G	Inf	2

802.11ax HEW40\_Nss1,(MCS0)\_2TX

EBW

5710MHz Straddle 5.47-5.725GHz

06/12/2019

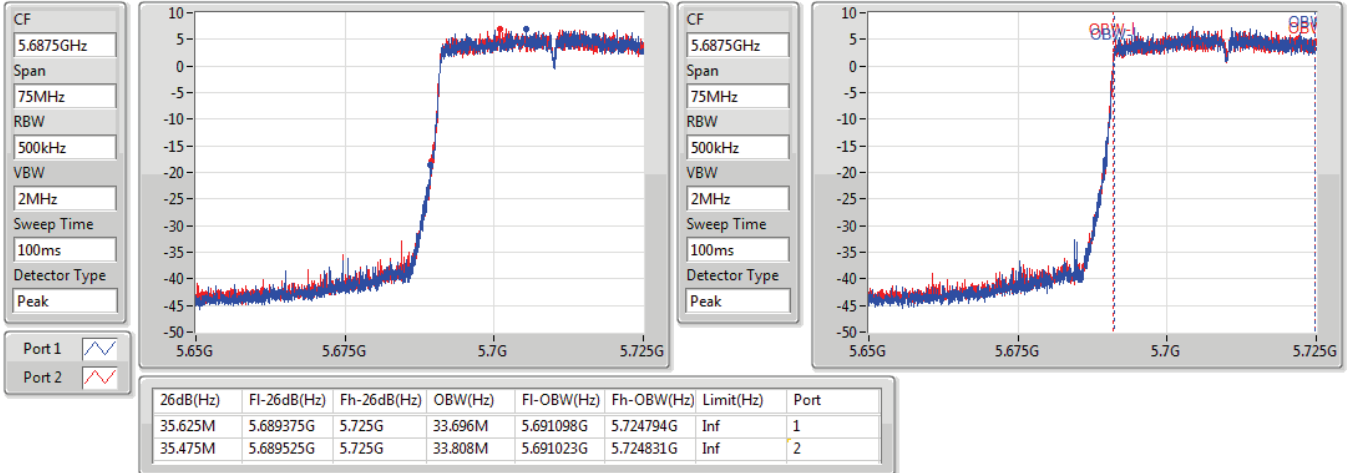

802.11ax HEW40\_Nss1,(MCS0)\_2TX

EBW

5710MHz Straddle 5.725-5.85GHz

06/12/2019

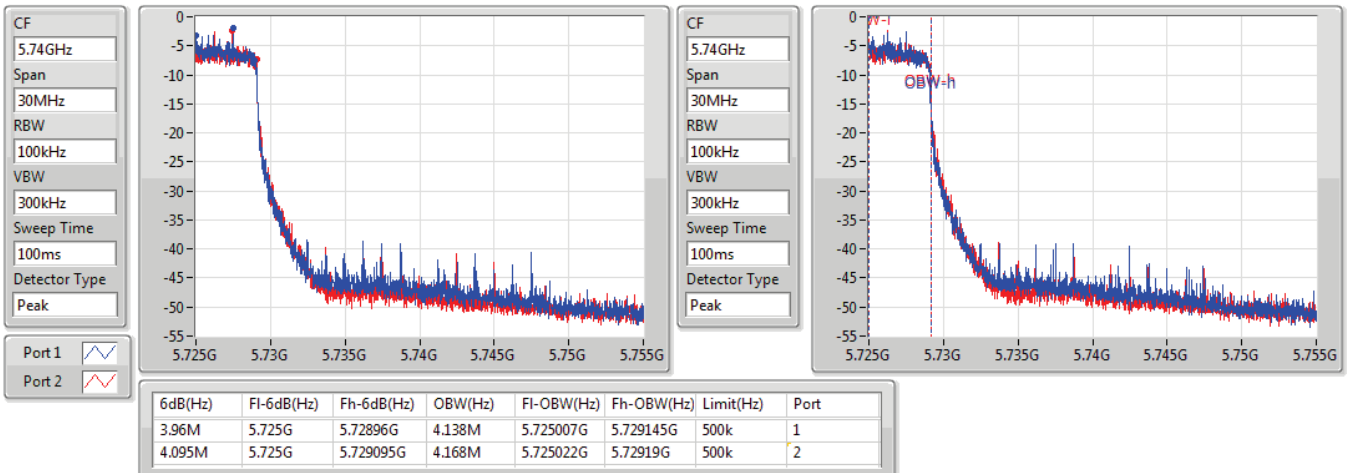

802.11ax HEW80\_Nss1,(MCS0)\_1TX(Port2)

EBW

5290MHz

06/12/2019

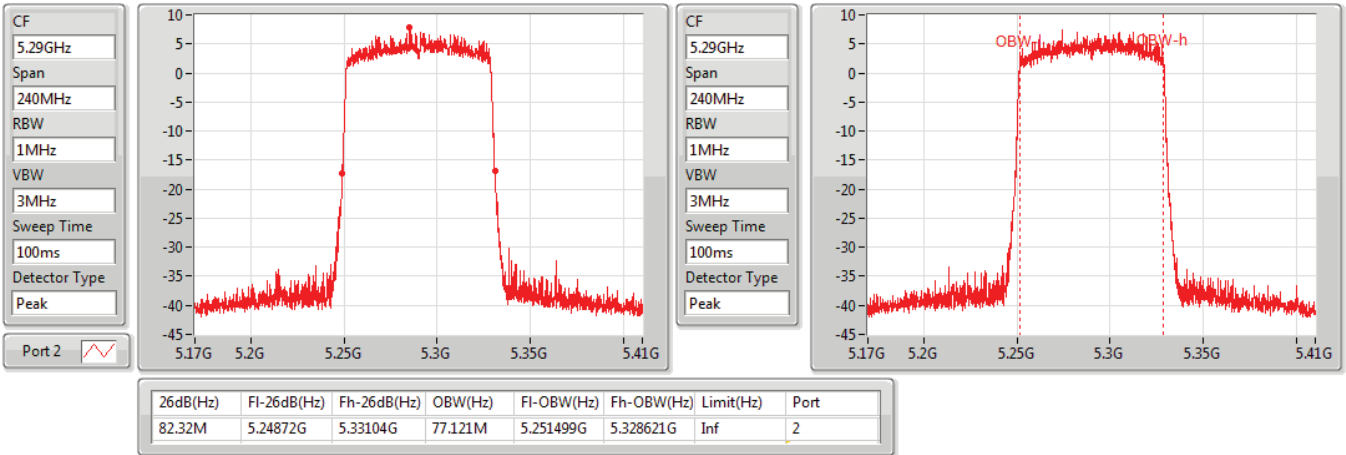

802.11ax HEW80\_Nss1,(MCS0)\_1TX(Port2)

EBW

5530MHz

06/12/2019

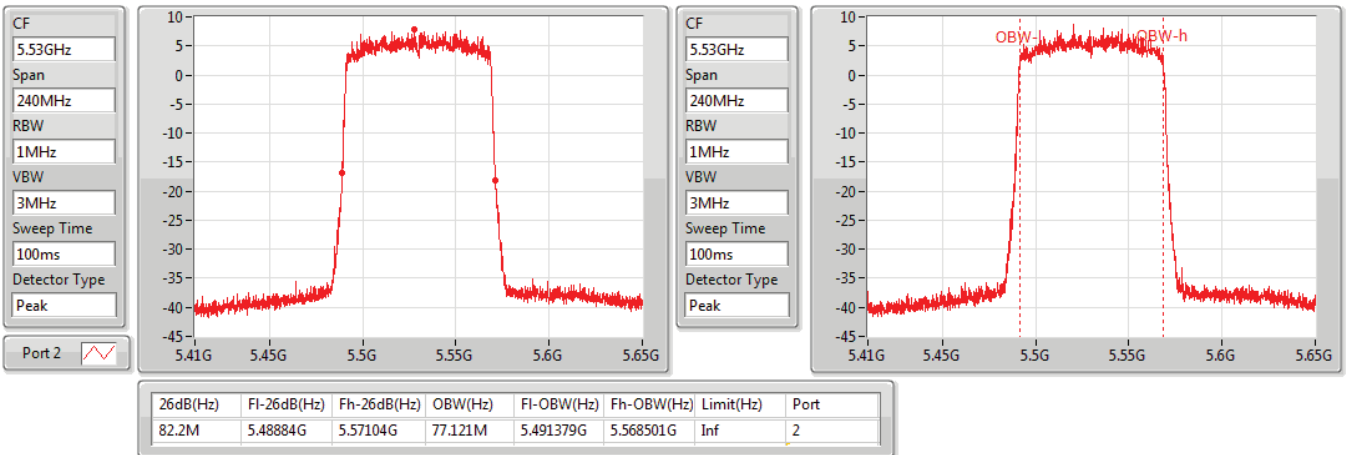

802.11ax HEW80\_Nss1,(MCS0)\_1TX(Port2)

EBW

5610MHz

06/12/2019

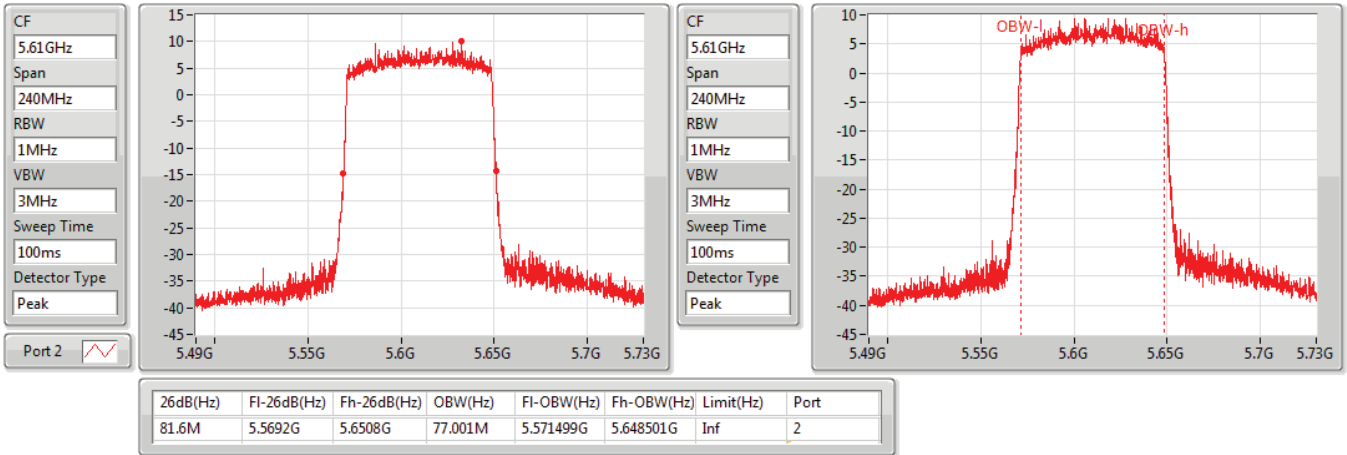

802.11ax HEW80\_Nss1,(MCS0)\_1TX(Port2)

EBW

5690MHz Straddle 5.47-5.725GHz

06/12/2019

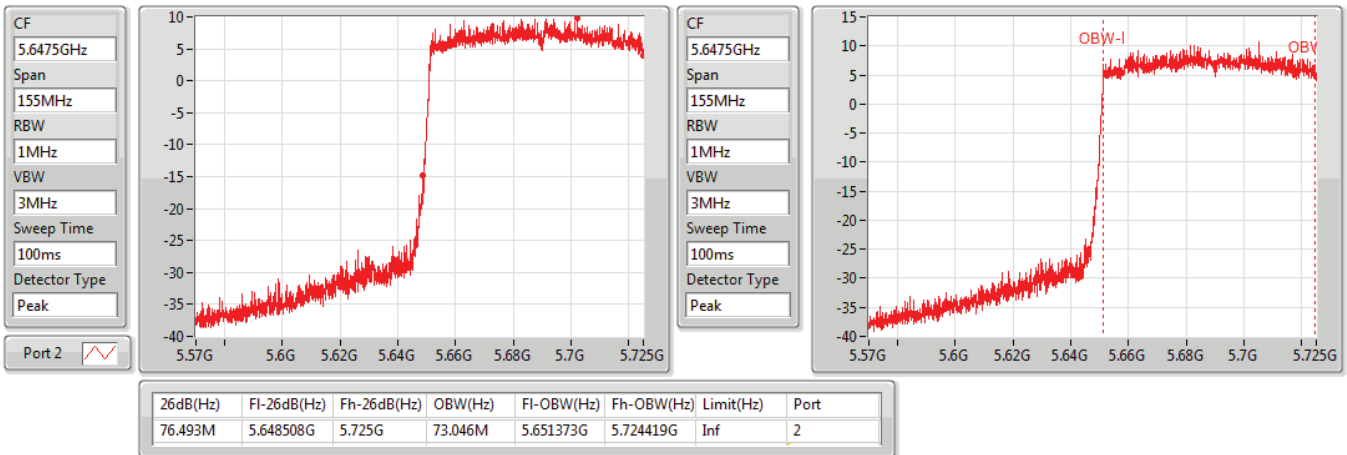

802.11ax HEW80\_Nss1,(MCS0)\_1TX(Port2)

EBW

5690MHz Straddle 5.725-5.85GHz

06/12/2019

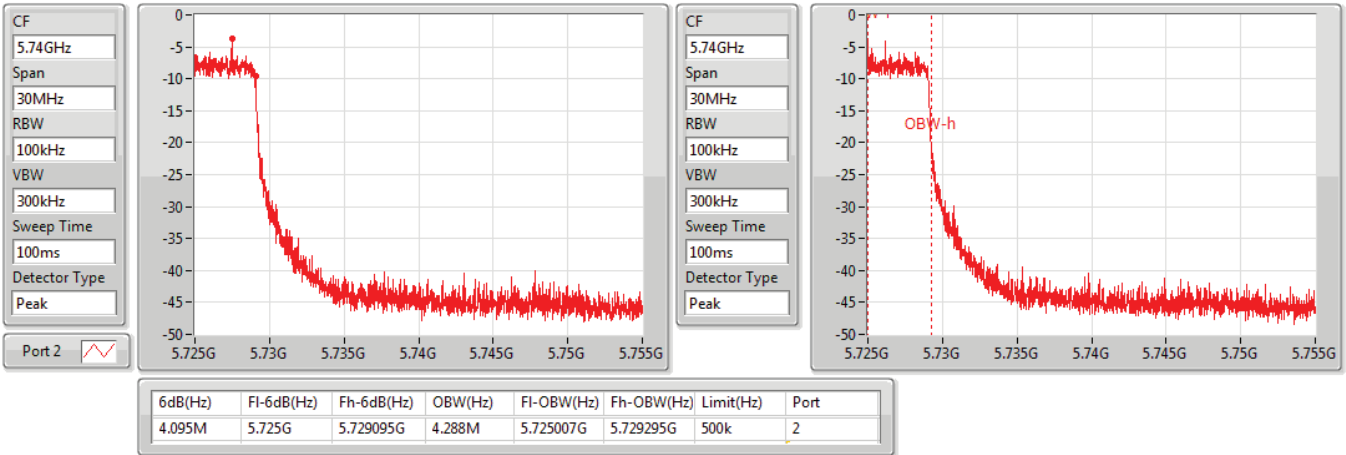

802.11ax HEW80\_Nss1,(MCS0)\_2TX

EBW

5290MHz

06/12/2019

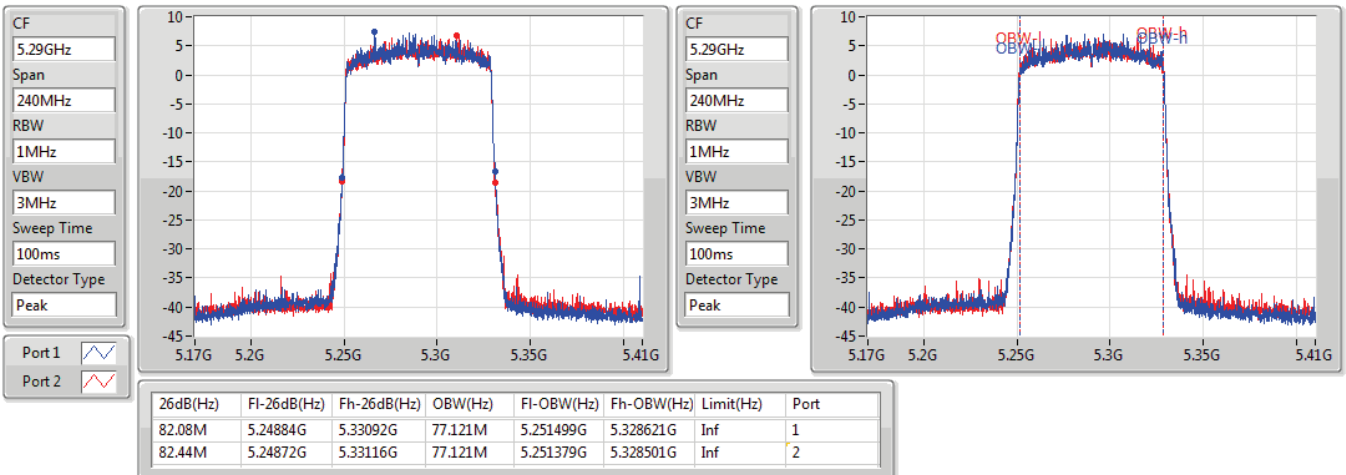

802.11ax HEW80\_Nss1,(MCS0)\_2TX

EBW

5530MHz

06/12/2019

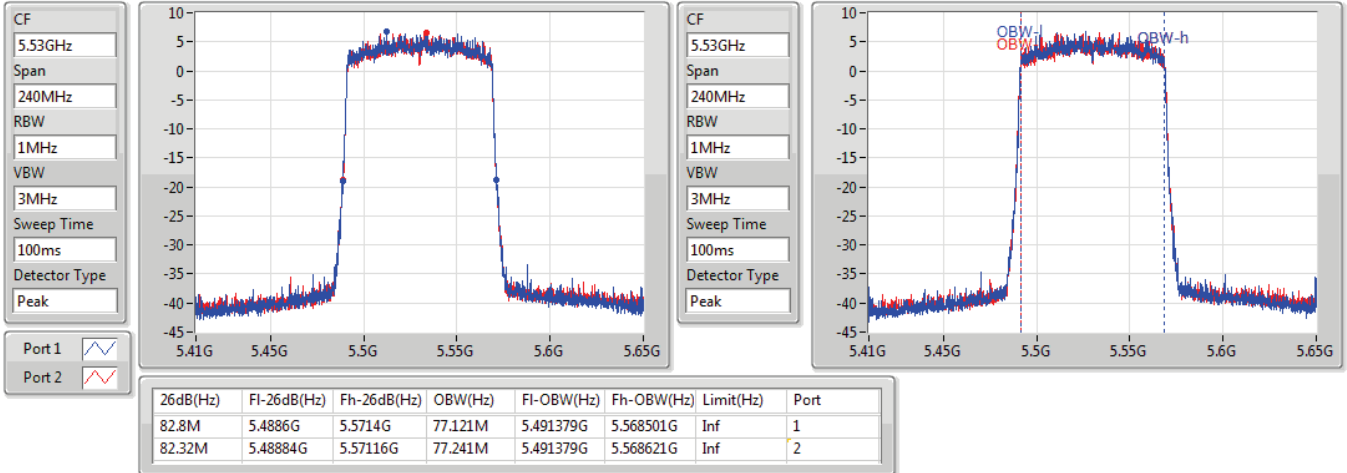

802.11ax HEW80\_Nss1,(MCS0)\_2TX

EBW

5610MHz

06/12/2019

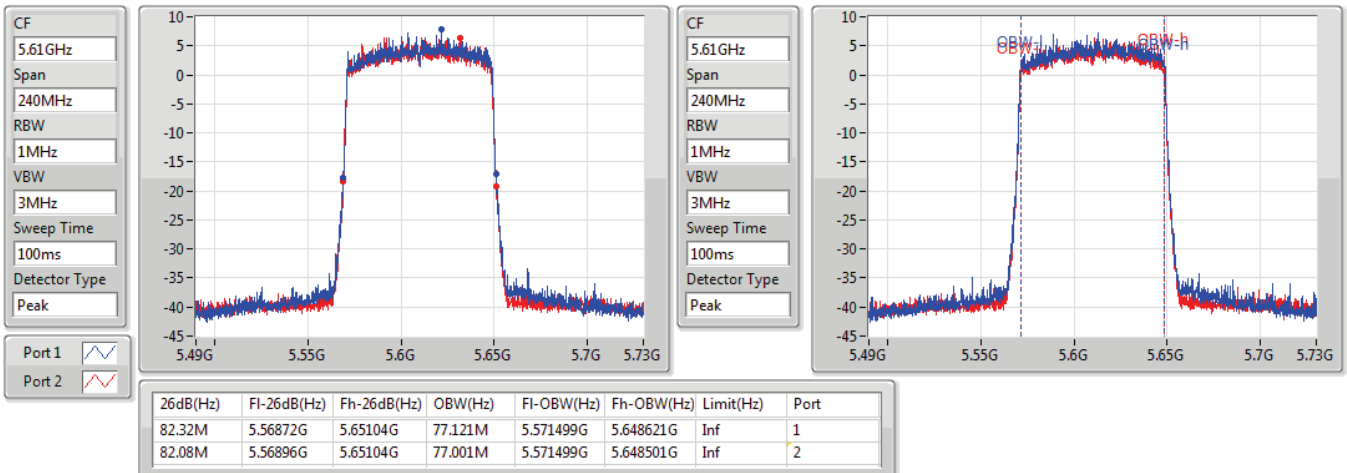



802.11ax HEW80\_Nss1,(MCS0)\_2TX

EBW

5690MHz Straddle 5.47-5.725GHz

06/12/2019

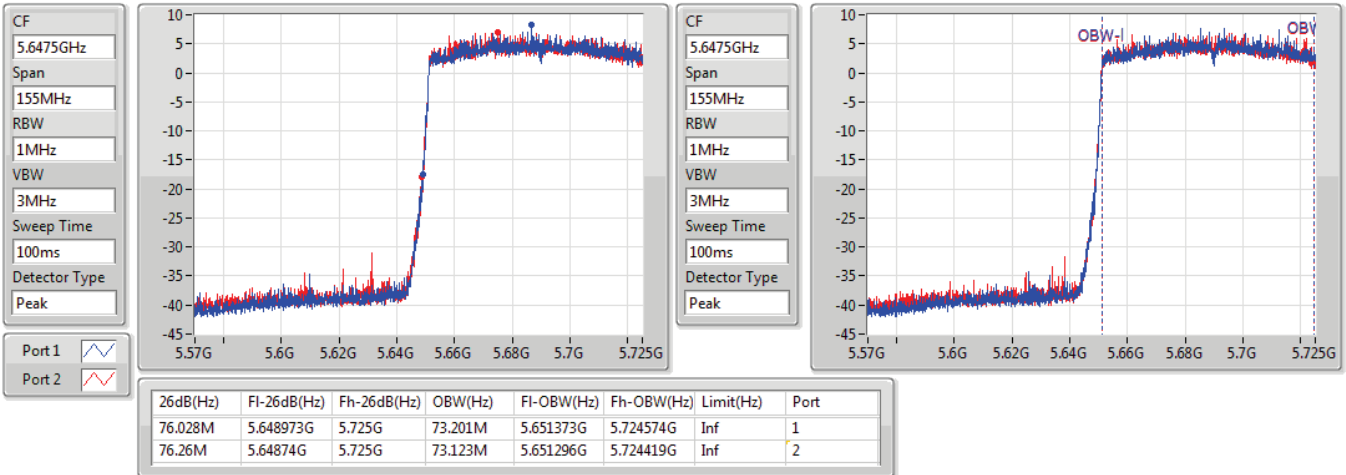

802.11ax HEW80\_Nss1,(MCS0)\_2TX

EBW

5690MHz Straddle 5.725-5.85GHz

06/12/2019

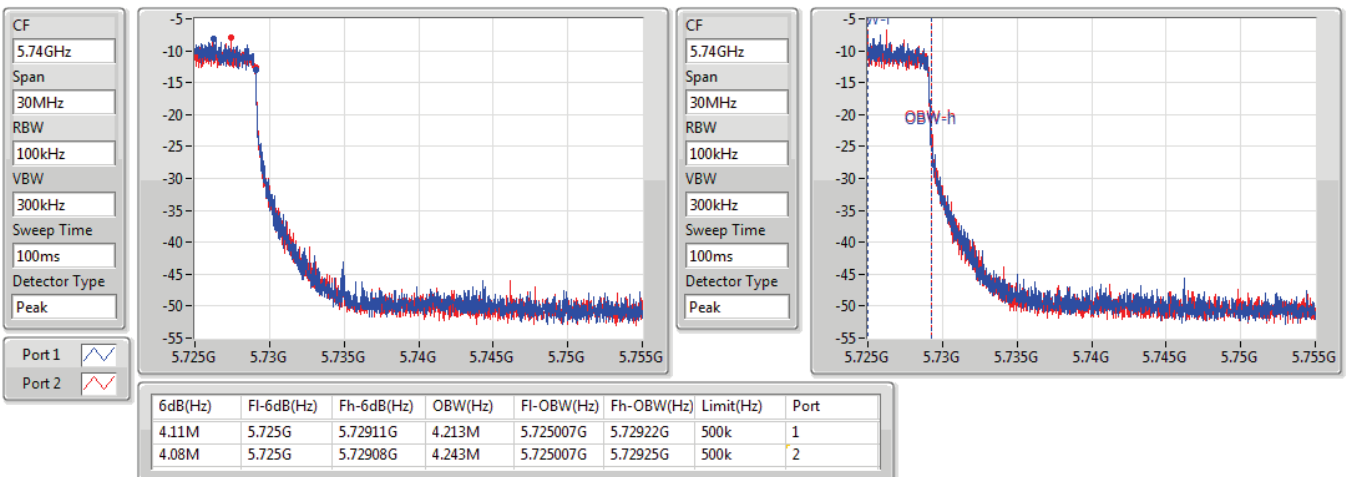



Summary

Mode	Max-N dB (Hz)	Max-OBW (Hz)	ITU-Code	Min-N dB (Hz)	Min-OBW (Hz)
5.25-5.35GHz	-	-	-	-	-
802.11a_Nss1,(6Mbps)_1TX(Port2)	36.84M	19.46M	19M5D1D	20.67M	16.462M
802.11a_Nss1,(6Mbps)_2TX	20.37M	16.402M	16M4D1D	19.32M	16.372M
802.11ac_VHT20_Nss1,(MCS0)_1TX(Port2)	37.8M	19.46M	19M5D1D	20.85M	17.541M
802.11ac_VHT20_Nss1,(MCS0)_2TX	21.33M	17.601M	17M6D1D	20.73M	17.541M
802.11ac_VHT40_Nss1,(MCS0)_1TX(Port2)	43.38M	36.282M	36M3D1D	41.46M	36.102M
802.11ac_VHT40_Nss1,(MCS0)_2TX	62.52M	36.582M	36M6D1D	41.76M	36.162M
802.11ac_VHT80_Nss1,(MCS0)_1TX(Port2)	82.92M	75.322M	75M3D1D	82.92M	75.322M
802.11ac_VHT80_Nss1,(MCS0)_2TX	83.52M	75.442M	75M4D1D	83.52M	75.322M
802.11ax_HEW20_Nss1,(MCS0)_1TX(Port2)	38.76M	19.52M	19M5D1D	21.3M	18.951M
802.11ax_HEW20_Nss1,(MCS0)_2TX	21.72M	18.951M	19M0D1D	21.15M	18.921M
802.11ax_HEW40_Nss1,(MCS0)_1TX(Port2)	46.5M	37.841M	37M8D1D	41.94M	37.781M
802.11ax_HEW40_Nss1,(MCS0)_2TX	63.66M	38.081M	38M1D1D	41.94M	37.781M
802.11ax_HEW80_Nss1,(MCS0)_1TX(Port2)	84.36M	77.241M	77M2D1D	84.36M	77.241M
802.11ax_HEW80_Nss1,(MCS0)_2TX	84.96M	77.241M	77M2D1D	83.64M	77.121M
5.47-5.725GHz	-	-	-	-	-
802.11a_Nss1,(6Mbps)_1TX(Port2)	34.89M	17.541M	17M5D1D	19.35M	13.463M
802.11a_Nss1,(6Mbps)_2TX	19.53M	16.372M	16M4D1D	14.7M	13.193M
802.11ac_VHT20_Nss1,(MCS0)_1TX(Port2)	38.91M	19.46M	19M5D1D	20.31M	14.018M
802.11ac_VHT20_Nss1,(MCS0)_2TX	21.24M	17.571M	17M6D1D	15.12M	13.763M
802.11ac_VHT40_Nss1,(MCS0)_1TX(Port2)	57.575M	36.402M	36M4D1D	41.64M	34.143M
802.11ac_VHT40_Nss1,(MCS0)_2TX	48.12M	36.282M	36M3D1D	41.46M	32.954M
802.11ac_VHT80_Nss1,(MCS0)_1TX(Port2)	103.725M	75.442M	75M4D1D	83.52M	72.639M
802.11ac_VHT80_Nss1,(MCS0)_2TX	102.825M	75.442M	75M4D1D	83.4M	72.489M
802.11ax_HEW20_Nss1,(MCS0)_1TX(Port2)	39.84M	19.7M	19M7D1D	21.15M	14.648M
802.11ax_HEW20_Nss1,(MCS0)_2TX	21.78M	18.981M	19M0D1D	15.57M	14.438M
802.11ax_HEW40_Nss1,(MCS0)_1TX(Port2)	64.56M	38.021M	38M0D1D	41.82M	34.143M
802.11ax_HEW40_Nss1,(MCS0)_2TX	53.865M	37.961M	38M0D1D	41.88M	33.863M
802.11ax_HEW80_Nss1,(MCS0)_1TX(Port2)	104.175M	77.241M	77M2D1D	84M	73.538M
802.11ax_HEW80_Nss1,(MCS0)_2TX	102.825M	77.241M	77M2D1D	83.76M	73.313M
5.725-5.85GHz	-	-	-	-	-
802.11a_Nss1,(6Mbps)_1TX(Port2)	3.08M	8.476M	8M48D1D	3.08M	8.476M
802.11a_Nss1,(6Mbps)_2TX	3.14M	3.458M	3M46D1D	3.14M	3.398M
802.11ac_VHT20_Nss1,(MCS0)_1TX(Port2)	3.76M	8.396M	8M40D1D	3.76M	8.396M
802.11ac_VHT20_Nss1,(MCS0)_2TX	3.76M	4.018M	4M02D1D	3.76M	3.958M
802.11ac_VHT40_Nss1,(MCS0)_1TX(Port2)	3.12M	24.348M	24M3D1D	3.12M	24.348M
802.11ac_VHT40_Nss1,(MCS0)_2TX	3.22M	18.631M	18M6D1D	3.1M	15.632M
802.11ac_VHT80_Nss1,(MCS0)_1TX(Port2)	3.1M	33.263M	33M3D1D	3.1M	33.263M
802.11ac_VHT80_Nss1,(MCS0)_2TX	3.2M	33.343M	33M3D1D	3.08M	30.605M
802.11ax_HEW20_Nss1,(MCS0)_1TX(Port2)	4.42M	10.935M	10M9D1D	4.42M	10.935M
802.11ax_HEW20_Nss1,(MCS0)_2TX	4.44M	4.538M	4M54D1D	4.36M	4.538M
802.11ax_HEW40_Nss1,(MCS0)_1TX(Port2)	14M	30.665M	30M7D1D	14M	30.665M
802.11ax_HEW40_Nss1,(MCS0)_2TX	4.1M	25.127M	25M1D1D	4.06M	23.188M
802.11ax_HEW80_Nss1,(MCS0)_1TX(Port2)	3.92M	34.463M	34M5D1D	3.92M	34.463M



Mode	Max-N dB (Hz)	Max-OBW (Hz)	ITU-Code	Min-N dB (Hz)	Min-OBW (Hz)
802.11ax HEW80_Nss1,(MCS0)_2TX	4.08M	34.363M	34M4D1D	3.94M	31.604M

**Max-N dB** = Maximum 6dB down bandwidth for 5.725-5.85GHz band / Maximum 26dB down bandwidth for other band;

**Max-OBW** = Maximum 99% occupied bandwidth;

**Min-N dB** = Minimum 6dB down bandwidth for 5.725-5.85GHz band / Maximum 26dB down bandwidth for other band;

**Min-OBW** = Minimum 99% occupied bandwidth;



Result

Mode	Result	Limit (Hz)	Port 1-N dB (Hz)	Port 1-OBW (Hz)	Port 2-N dB (Hz)	Port 2-OBW (Hz)
802.11a_Nss1,(6Mbps)_1TX(Port2)	-	-	-	-	-	-
5260MHz	Pass	Inf			34.65M	18.441M
5300MHz	Pass	Inf			36.84M	19.46M
5320MHz	Pass	Inf			20.67M	16.462M
5500MHz	Pass	Inf			20.82M	16.432M
5580MHz	Pass	Inf			34.89M	17.541M
5700MHz	Pass	Inf			19.35M	16.372M
5720MHz Straddle 5.47-5.725GHz	Pass	Inf			20.895M	13.463M
5720MHz Straddle 5.725-5.85GHz	Pass	500k			3.08M	8.476M
802.11a_Nss1,(6Mbps)_2TX	-	-	-	-	-	-
5260MHz	Pass	Inf	19.47M	16.372M	19.32M	16.372M
5300MHz	Pass	Inf	20.37M	16.372M	20.16M	16.402M
5320MHz	Pass	Inf	19.95M	16.372M	20.16M	16.402M
5500MHz	Pass	Inf	19.35M	16.372M	19.41M	16.372M
5580MHz	Pass	Inf	19.53M	16.372M	19.38M	16.372M
5700MHz	Pass	Inf	19.44M	16.372M	19.35M	16.372M
5720MHz Straddle 5.47-5.725GHz	Pass	Inf	14.94M	13.208M	14.7M	13.193M
5720MHz Straddle 5.725-5.85GHz	Pass	500k	3.14M	3.398M	3.14M	3.458M
802.11ac VHT20_Nss1,(MCS0)_1TX(Port2)	-	-	-	-	-	-
5260MHz	Pass	Inf			35.67M	18.501M
5300MHz	Pass	Inf			37.8M	19.46M
5320MHz	Pass	Inf			20.85M	17.541M
5500MHz	Pass	Inf			20.97M	17.601M
5580MHz	Pass	Inf			38.91M	19.46M
5700MHz	Pass	Inf			20.31M	17.541M
5720MHz Straddle 5.47-5.725GHz	Pass	Inf			21.93M	14.018M
5720MHz Straddle 5.725-5.85GHz	Pass	500k			3.76M	8.396M
802.11ac VHT20_Nss1,(MCS0)_2TX	-	-	-	-	-	-
5260MHz	Pass	Inf	20.76M	17.571M	21M	17.541M
5300MHz	Pass	Inf	20.97M	17.571M	20.73M	17.541M
5320MHz	Pass	Inf	21.3M	17.601M	21.33M	17.571M
5500MHz	Pass	Inf	20.91M	17.571M	21.24M	17.571M
5580MHz	Pass	Inf	20.88M	17.541M	20.76M	17.541M
5700MHz	Pass	Inf	20.91M	17.571M	20.52M	17.541M
5720MHz Straddle 5.47-5.725GHz	Pass	Inf	15.54M	13.778M	15.12M	13.763M
5720MHz Straddle 5.725-5.85GHz	Pass	500k	3.76M	4.018M	3.76M	3.958M
802.11ac VHT40_Nss1,(MCS0)_1TX(Port2)	-	-	-	-	-	-
5270MHz	Pass	Inf			43.38M	36.282M
5310MHz	Pass	Inf			41.46M	36.102M
5510MHz	Pass	Inf			41.88M	36.162M
5550MHz	Pass	Inf			57.3M	36.402M
5670MHz	Pass	Inf			41.64M	36.162M
5710MHz Straddle 5.47-5.725GHz	Pass	Inf			57.575M	34.143M
5710MHz Straddle 5.725-5.85GHz	Pass	500k			3.12M	24.348M



Mode	Result	Limit (Hz)	Port 1-N dB (Hz)	Port 1-OBW (Hz)	Port 2-N dB (Hz)	Port 2-OBW (Hz)
802.11ac VHT40_Nss1,(MCS0)_2TX	-	-	-	-	-	-
5270MHz	Pass	Inf	56.94M	36.462M	62.52M	36.582M
5310MHz	Pass	Inf	42.18M	36.222M	41.76M	36.162M
5510MHz	Pass	Inf	42.06M	36.162M	41.46M	36.102M
5550MHz	Pass	Inf	42.72M	36.222M	48.12M	36.282M
5670MHz	Pass	Inf	41.7M	36.102M	41.64M	36.102M
5710MHz Straddle 5.47-5.725GHz	Pass	Inf	44.415M	32.954M	43.61M	32.989M
5710MHz Straddle 5.725-5.85GHz	Pass	500k	3.22M	15.632M	3.1M	18.631M
802.11ac VHT80_Nss1,(MCS0)_1TX(Port2)	-	-	-	-	-	-
5290MHz	Pass	Inf			82.92M	75.322M
5530MHz	Pass	Inf			83.52M	75.442M
5610MHz	Pass	Inf			83.76M	75.442M
5690MHz Straddle 5.47-5.725GHz	Pass	Inf			103.725M	72.639M
5690MHz Straddle 5.725-5.85GHz	Pass	500k			3.1M	33.263M
802.11ac VHT80_Nss1,(MCS0)_2TX	-	-	-	-	-	-
5290MHz	Pass	Inf	83.52M	75.442M	83.52M	75.322M
5530MHz	Pass	Inf	83.52M	75.202M	83.64M	75.442M
5610MHz	Pass	Inf	83.76M	75.322M	83.4M	75.322M
5690MHz Straddle 5.47-5.725GHz	Pass	Inf	89.25M	72.489M	102.825M	72.639M
5690MHz Straddle 5.725-5.85GHz	Pass	500k	3.2M	30.605M	3.08M	33.343M
802.11ax HEW20_Nss1,(MCS0)_1TX(Port2)	-	-	-	-	-	-
5260MHz	Pass	Inf			34.29M	19.4M
5300MHz	Pass	Inf			38.76M	19.52M
5320MHz	Pass	Inf			21.3M	18.951M
5500MHz	Pass	Inf			21.15M	18.921M
5580MHz	Pass	Inf			39.84M	19.7M
5700MHz	Pass	Inf			21.21M	18.921M
5720MHz Straddle 5.47-5.725GHz	Pass	Inf			21.915M	14.648M
5720MHz Straddle 5.725-5.85GHz	Pass	500k			4.42M	10.935M
802.11ax HEW20_Nss1,(MCS0)_2TX	-	-	-	-	-	-
5260MHz	Pass	Inf	21.48M	18.921M	21.27M	18.921M
5300MHz	Pass	Inf	21.36M	18.921M	21.15M	18.921M
5320MHz	Pass	Inf	21.72M	18.951M	21.57M	18.951M
5500MHz	Pass	Inf	21.66M	18.981M	21.78M	18.951M
5580MHz	Pass	Inf	21.15M	18.921M	21.21M	18.921M
5700MHz	Pass	Inf	21M	18.861M	21.24M	18.921M
5720MHz Straddle 5.47-5.725GHz	Pass	Inf	15.57M	14.453M	15.945M	14.438M
5720MHz Straddle 5.725-5.85GHz	Pass	500k	4.36M	4.538M	4.44M	4.538M
802.11ax HEW40_Nss1,(MCS0)_1TX(Port2)	-	-	-	-	-	-
5270MHz	Pass	Inf			46.5M	37.841M
5310MHz	Pass	Inf			41.94M	37.781M
5510MHz	Pass	Inf			41.82M	37.781M
5550MHz	Pass	Inf			64.56M	38.021M
5670MHz	Pass	Inf			42.06M	37.781M
5710MHz Straddle 5.47-5.725GHz	Pass	Inf			50.225M	34.143M



Mode	Result	Limit (Hz)	Port 1-N dB (Hz)	Port 1-OBW (Hz)	Port 2-N dB (Hz)	Port 2-OBW (Hz)
5710MHz Straddle 5.725-5.85GHz	Pass	500k			14M	30.665M
802.11ax HEW40_Nss1,(MCS0)_2TX	-	-	-	-	-	-
5270MHz	Pass	Inf	62.52M	37.961M	63.66M	38.081M
5310MHz	Pass	Inf	41.94M	37.781M	42M	37.841M
5510MHz	Pass	Inf	42M	37.781M	42M	37.781M
5550MHz	Pass	Inf	43.14M	37.841M	49.5M	37.961M
5670MHz	Pass	Inf	41.88M	37.781M	42M	37.721M
5710MHz Straddle 5.47-5.725GHz	Pass	Inf	47.005M	33.863M	53.865M	33.968M
5710MHz Straddle 5.725-5.85GHz	Pass	500k	4.06M	23.188M	4.1M	25.127M
802.11ax HEW80_Nss1,(MCS0)_1TX(Port2)	-	-	-	-	-	-
5290MHz	Pass	Inf			84.36M	77.241M
5530MHz	Pass	Inf			84M	77.121M
5610MHz	Pass	Inf			84M	77.241M
5690MHz Straddle 5.47-5.725GHz	Pass	Inf			104.175M	73.538M
5690MHz Straddle 5.725-5.85GHz	Pass	500k			3.92M	34.463M
802.11ax HEW80_Nss1,(MCS0)_2TX	-	-	-	-	-	-
5290MHz	Pass	Inf	84.96M	77.121M	83.64M	77.241M
5530MHz	Pass	Inf	84.36M	77.121M	83.76M	77.121M
5610MHz	Pass	Inf	84.36M	77.241M	83.76M	77.121M
5690MHz Straddle 5.47-5.725GHz	Pass	Inf	84.375M	73.313M	102.825M	73.463M
5690MHz Straddle 5.725-5.85GHz	Pass	500k	4.08M	31.604M	3.94M	34.363M

**Port X-N dB** = Port X 6dB down bandwidth for 5.725-5.85GHz band / 26dB down bandwidth for other band  
**Port X-OBW** = Port X 99% occupied bandwidth;

802.11a\_Nss1,(6Mbps)\_1TX(Port2)

EBW

5260MHz

05/12/2019

CF  
5.26GHz  
Span  
60MHz  
RBW  
300kHz  
VBW  
1MHz  
Sweep Time  
100ms  
Detector Type  
Peak  
Port 2

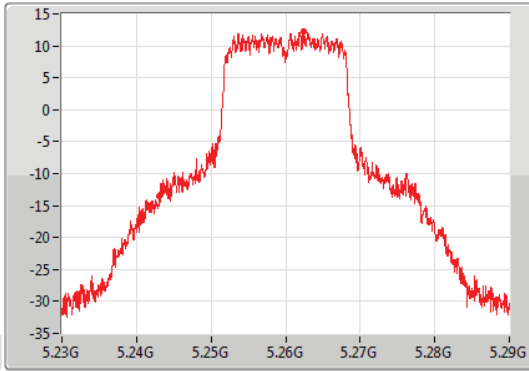

CF  
5.26GHz  
Span  
60MHz  
RBW  
200kHz  
VBW  
1MHz  
Sweep Time  
100ms  
Detector Type  
Peak

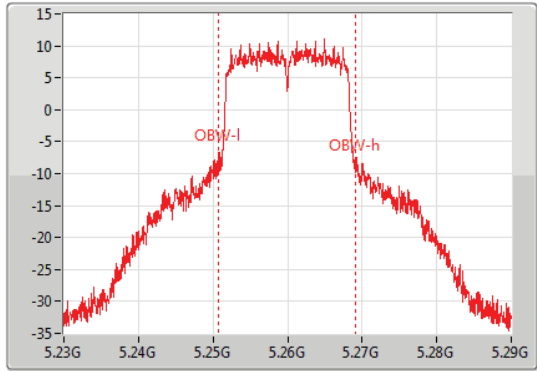

26dB(Hz)	Fl-26dB(Hz)	Fh-26dB(Hz)	OBW(Hz)	Fl-OBW(Hz)	Fh-OBW(Hz)	Limit(Hz)	Port
34.65M	5.24299G	5.27764G	18.441M	5.250735G	5.269175G	Inf	2

802.11a\_Nss1,(6Mbps)\_1TX(Port2)

EBW

5300MHz

05/12/2019

CF  
5.3GHz  
Span  
60MHz  
RBW  
300kHz  
VBW  
1MHz  
Sweep Time  
100ms  
Detector Type  
Peak  
Port 2

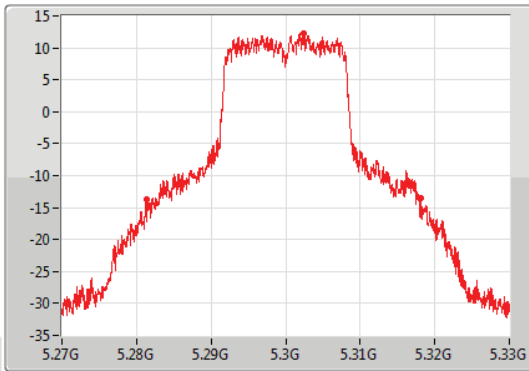

CF  
5.3GHz  
Span  
60MHz  
RBW  
200kHz  
VBW  
1MHz  
Sweep Time  
100ms  
Detector Type  
Peak

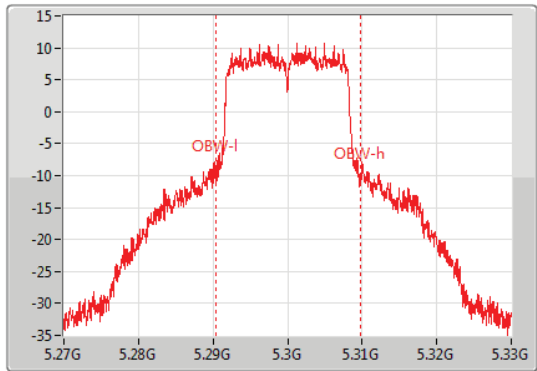

26dB(Hz)	Fl-26dB(Hz)	Fh-26dB(Hz)	OBW(Hz)	Fl-OBW(Hz)	Fh-OBW(Hz)	Limit(Hz)	Port
36.84M	5.28131G	5.31815G	19.46M	5.290345G	5.309805G	Inf	2

802.11a\_Nss1,(6Mbps)\_1TX(Port2)

EBW

5320MHz

05/12/2019

CF: 5.32GHz  
 Span: 60MHz  
 RBW: 300kHz  
 VBW: 1MHz  
 Sweep Time: 100ms  
 Detector Type: Peak  
 Port 2

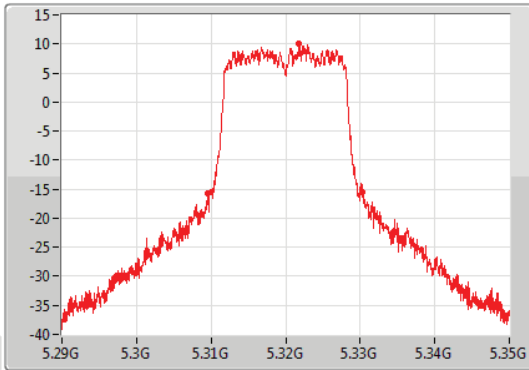

CF: 5.32GHz  
 Span: 60MHz  
 RBW: 200kHz  
 VBW: 1MHz  
 Sweep Time: 100ms  
 Detector Type: Peak

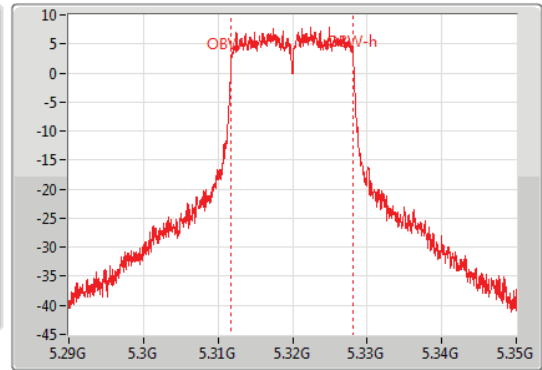

26dB(Hz)	Fl-26dB(Hz)	Fh-26dB(Hz)	OBW(Hz)	Fl-OBW(Hz)	Fh-OBW(Hz)	Limit(Hz)	Port
20.67M	5.30962G	5.33029G	16.462M	5.311724G	5.328186G	Inf	2

802.11a\_Nss1,(6Mbps)\_1TX(Port2)

EBW

5500MHz

05/12/2019

CF: 5.5GHz  
 Span: 60MHz  
 RBW: 300kHz  
 VBW: 1MHz  
 Sweep Time: 100ms  
 Detector Type: Peak  
 Port 2

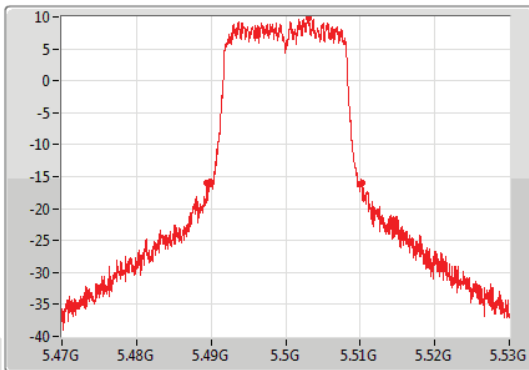

CF: 5.5GHz  
 Span: 60MHz  
 RBW: 200kHz  
 VBW: 1MHz  
 Sweep Time: 100ms  
 Detector Type: Peak

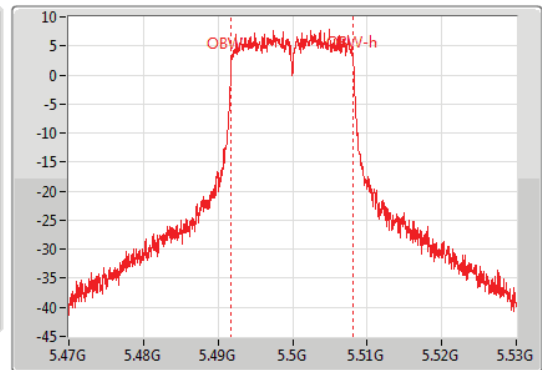

26dB(Hz)	Fl-26dB(Hz)	Fh-26dB(Hz)	OBW(Hz)	Fl-OBW(Hz)	Fh-OBW(Hz)	Limit(Hz)	Port
20.82M	5.48944G	5.51026G	16.432M	5.491754G	5.508186G	Inf	2



802.11a\_Nss1,(6Mbps)\_1TX(Port2)

EBW

5580MHz

05/12/2019

CF: 5.58GHz  
 Span: 60MHz  
 RBW: 300kHz  
 VBW: 1MHz  
 Sweep Time: 100ms  
 Detector Type: Peak  
 Port 2

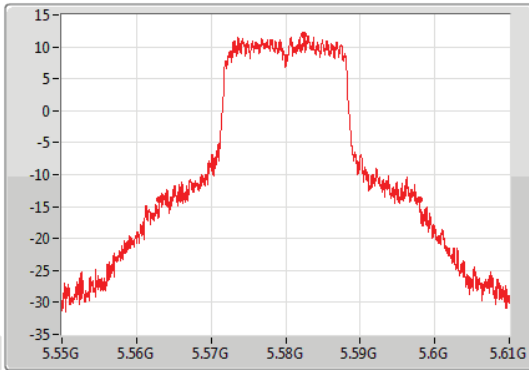

CF: 5.58GHz  
 Span: 60MHz  
 RBW: 200kHz  
 VBW: 1MHz  
 Sweep Time: 100ms  
 Detector Type: Peak

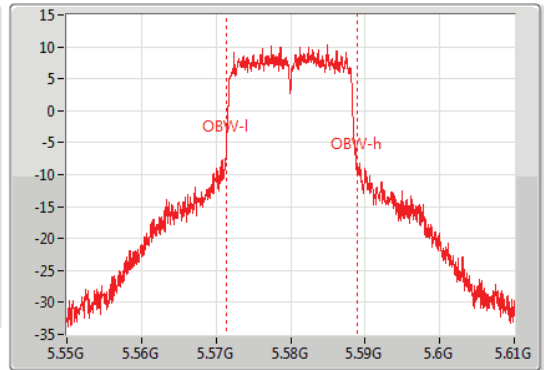

26dB(Hz)	Fl-26dB(Hz)	Fh-26dB(Hz)	OBW(Hz)	Fl-OBW(Hz)	Fh-OBW(Hz)	Limit(Hz)	Port
34.89M	5.56305G	5.59794G	17.541M	5.571364G	5.588906G	Inf	2

802.11a\_Nss1,(6Mbps)\_1TX(Port2)

EBW

5700MHz

05/12/2019

CF: 5.7GHz  
 Span: 60MHz  
 RBW: 300kHz  
 VBW: 1MHz  
 Sweep Time: 100ms  
 Detector Type: Peak  
 Port 2

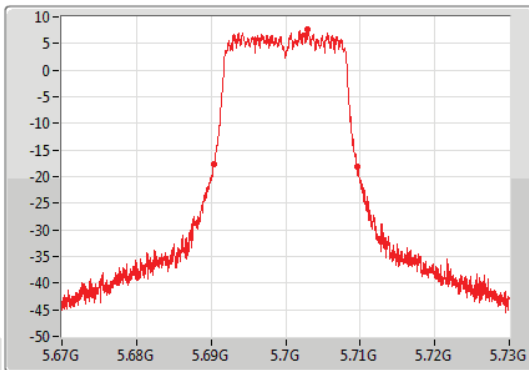

CF: 5.7GHz  
 Span: 60MHz  
 RBW: 200kHz  
 VBW: 1MHz  
 Sweep Time: 100ms  
 Detector Type: Peak

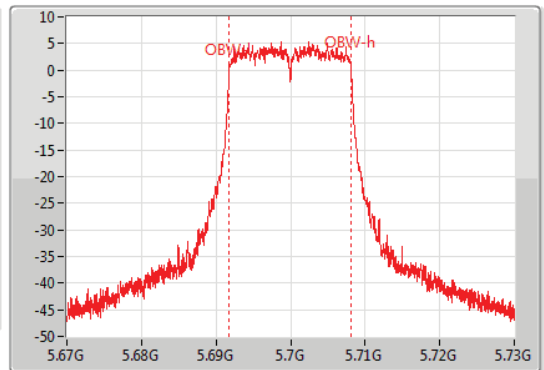

26dB(Hz)	Fl-26dB(Hz)	Fh-26dB(Hz)	OBW(Hz)	Fl-OBW(Hz)	Fh-OBW(Hz)	Limit(Hz)	Port
19.35M	5.69031G	5.70966G	16.372M	5.691754G	5.708126G	Inf	2

**802.11a\_Nss1,(6Mbps)\_1TX(Port2)**  
**5720MHz Straddle 5.47-5.725GHz**

EBW

05/12/2019

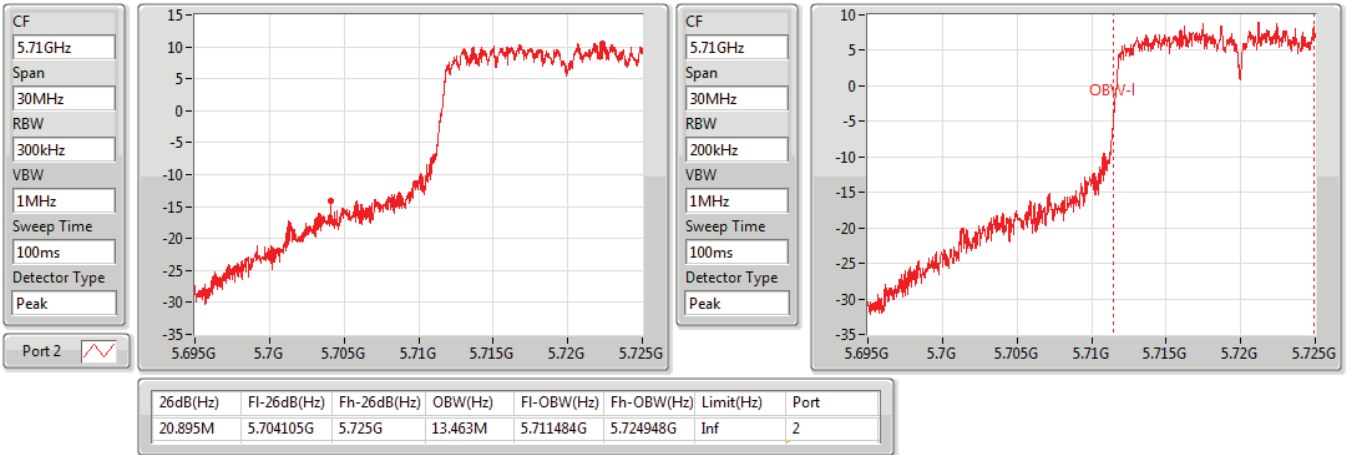

**802.11a\_Nss1,(6Mbps)\_1TX(Port2)**  
**5720MHz Straddle 5.725-5.85GHz**

EBW

05/12/2019

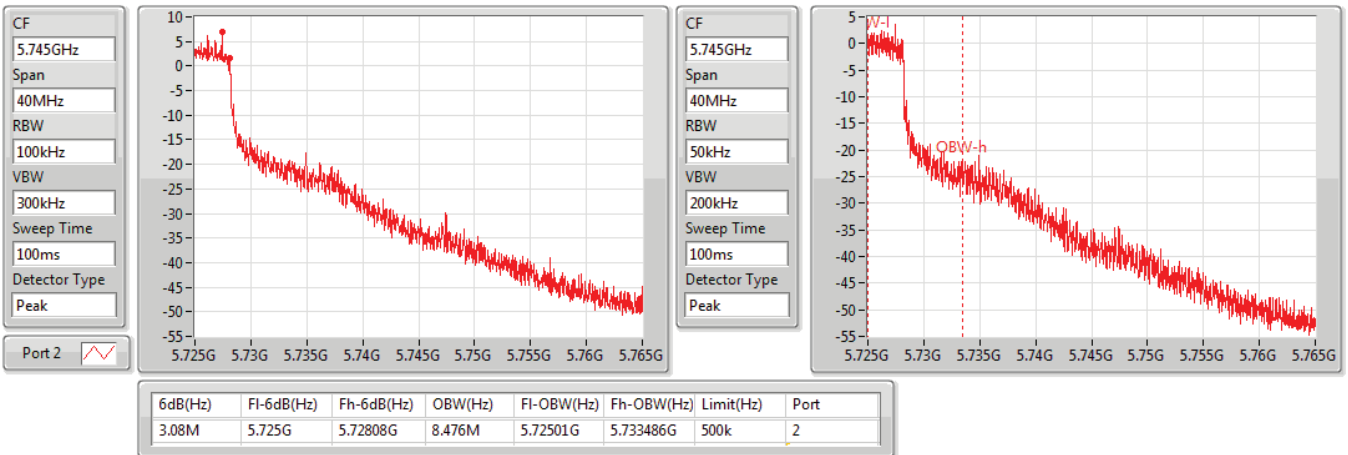

802.11a\_Nss1,(6Mbps)\_2TX

EBW

5260MHz

05/12/2019

CF  
5.26GHz  
Span  
60MHz  
RBW  
300kHz  
VBW  
1MHz  
Sweep Time  
100ms  
Detector Type  
Peak

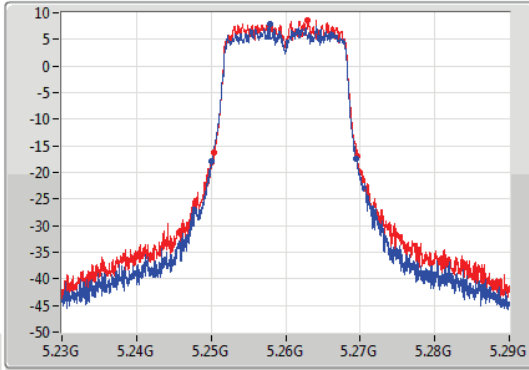

CF  
5.26GHz  
Span  
60MHz  
RBW  
200kHz  
VBW  
1MHz  
Sweep Time  
100ms  
Detector Type  
Peak

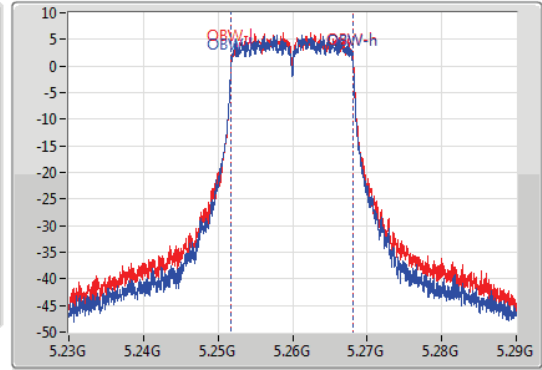

26dB(Hz)	Fl-26dB(Hz)	Fh-26dB(Hz)	OBW(Hz)	Fl-OBW(Hz)	Fh-OBW(Hz)	Limit(Hz)	Port
19.47M	5.25004G	5.26951G	16.372M	5.251754G	5.268126G	Inf	1
19.32M	5.25034G	5.26966G	16.372M	5.251784G	5.268156G	Inf	2

802.11a\_Nss1,(6Mbps)\_2TX

EBW

5300MHz

04/12/2019

CF  
5.3GHz  
Span  
60MHz  
RBW  
300kHz  
VBW  
1MHz  
Sweep Time  
100ms  
Detector Type  
Peak

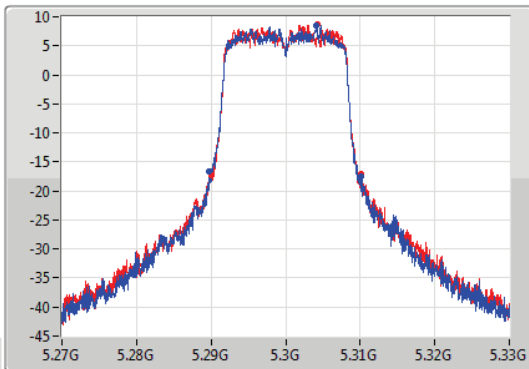

CF  
5.3GHz  
Span  
60MHz  
RBW  
200kHz  
VBW  
1MHz  
Sweep Time  
100ms  
Detector Type  
Peak

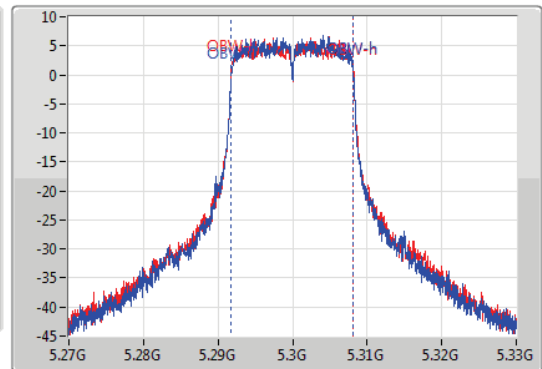

26dB(Hz)	Fl-26dB(Hz)	Fh-26dB(Hz)	OBW(Hz)	Fl-OBW(Hz)	Fh-OBW(Hz)	Limit(Hz)	Port
20.37M	5.28971G	5.31008G	16.372M	5.291784G	5.308156G	Inf	1
20.16M	5.28998G	5.31014G	16.402M	5.291784G	5.308186G	Inf	2

802.11a\_Nss1,(6Mbps)\_2TX

EBW

5320MHz

04/12/2019

CF  
5.32GHz  
Span  
60MHz  
RBW  
300kHz  
VBW  
1MHz  
Sweep Time  
100ms  
Detector Type  
Peak

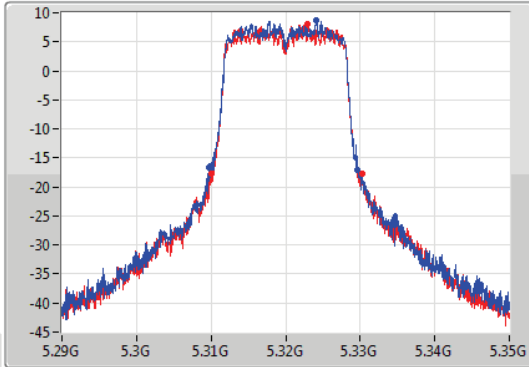

CF  
5.32GHz  
Span  
60MHz  
RBW  
200kHz  
VBW  
1MHz  
Sweep Time  
100ms  
Detector Type  
Peak

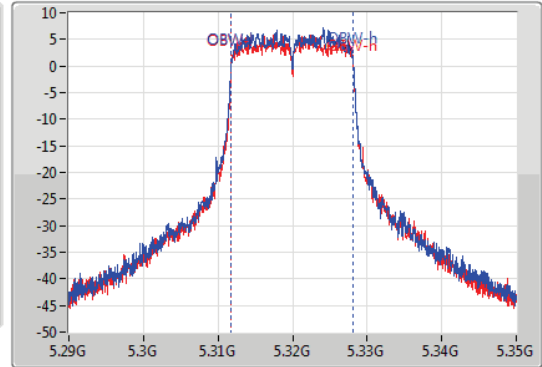

26dB(Hz)	Fl-26dB(Hz)	Fh-26dB(Hz)	OBW(Hz)	Fl-OBW(Hz)	Fh-OBW(Hz)	Limit(Hz)	Port
19.95M	5.30971G	5.32966G	16.372M	5.311784G	5.328156G	Inf	1
20.16M	5.31004G	5.3302G	16.402M	5.311784G	5.328186G	Inf	2

802.11a\_Nss1,(6Mbps)\_2TX

EBW

5500MHz

05/12/2019

CF  
5.5GHz  
Span  
60MHz  
RBW  
300kHz  
VBW  
1MHz  
Sweep Time  
100ms  
Detector Type  
Peak

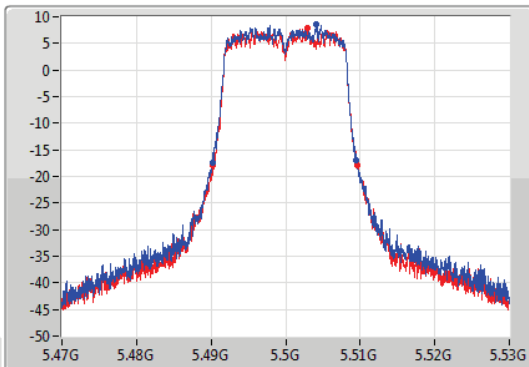

CF  
5.5GHz  
Span  
60MHz  
RBW  
200kHz  
VBW  
1MHz  
Sweep Time  
100ms  
Detector Type  
Peak

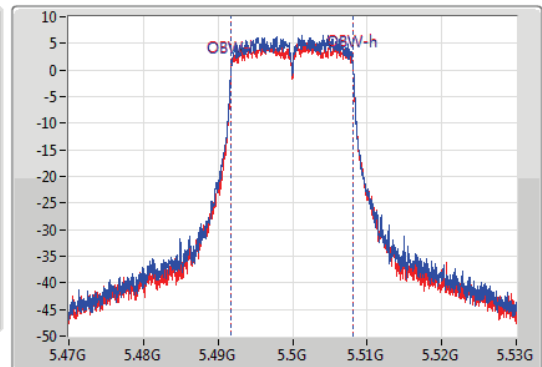

26dB(Hz)	Fl-26dB(Hz)	Fh-26dB(Hz)	OBW(Hz)	Fl-OBW(Hz)	Fh-OBW(Hz)	Limit(Hz)	Port
19.35M	5.49016G	5.50951G	16.372M	5.491754G	5.508126G	Inf	1
19.41M	5.49028G	5.50969G	16.372M	5.491754G	5.508126G	Inf	2

802.11a\_Nss1,(6Mbps)\_2TX

EBW

5580MHz

04/12/2019

CF  
5.58GHz  
Span  
60MHz  
RBW  
300kHz  
VBW  
1MHz  
Sweep Time  
100ms  
Detector Type  
Peak

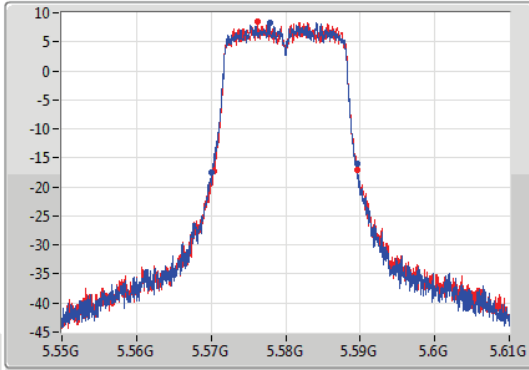

CF  
5.58GHz  
Span  
60MHz  
RBW  
200kHz  
VBW  
1MHz  
Sweep Time  
100ms  
Detector Type  
Peak

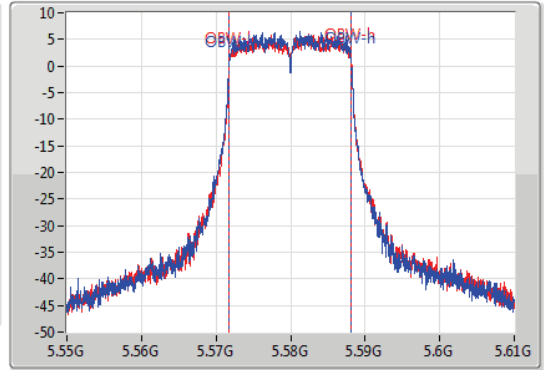

26dB(Hz)	Fl-26dB(Hz)	Fh-26dB(Hz)	OBW(Hz)	Fl-OBW(Hz)	Fh-OBW(Hz)	Limit(Hz)	Port
19.53M	5.5701G	5.58963G	16.372M	5.571784G	5.588156G	Inf	1
19.38M	5.57031G	5.58969G	16.372M	5.571784G	5.588156G	Inf	2

802.11a\_Nss1,(6Mbps)\_2TX

EBW

5700MHz

05/12/2019

CF  
5.7GHz  
Span  
60MHz  
RBW  
300kHz  
VBW  
1MHz  
Sweep Time  
100ms  
Detector Type  
Peak

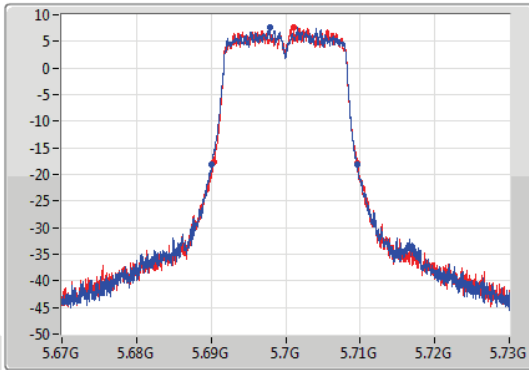

CF  
5.7GHz  
Span  
60MHz  
RBW  
200kHz  
VBW  
1MHz  
Sweep Time  
100ms  
Detector Type  
Peak

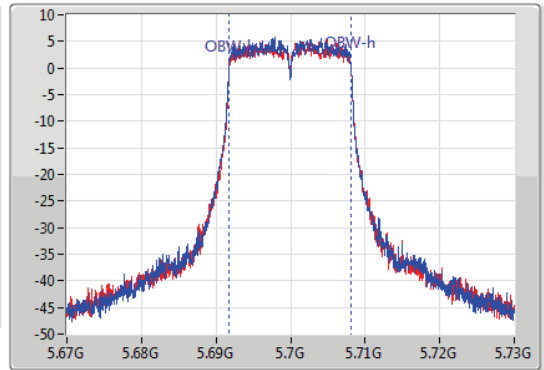

26dB(Hz)	Fl-26dB(Hz)	Fh-26dB(Hz)	OBW(Hz)	Fl-OBW(Hz)	Fh-OBW(Hz)	Limit(Hz)	Port
19.44M	5.6901G	5.70954G	16.372M	5.691754G	5.708126G	Inf	1
19.35M	5.69031G	5.70966G	16.372M	5.691754G	5.708126G	Inf	2

802.11a\_Nss1,(6Mbps)\_2TX

EBW

5720MHz Straddle 5.47-5.725GHz

04/12/2019

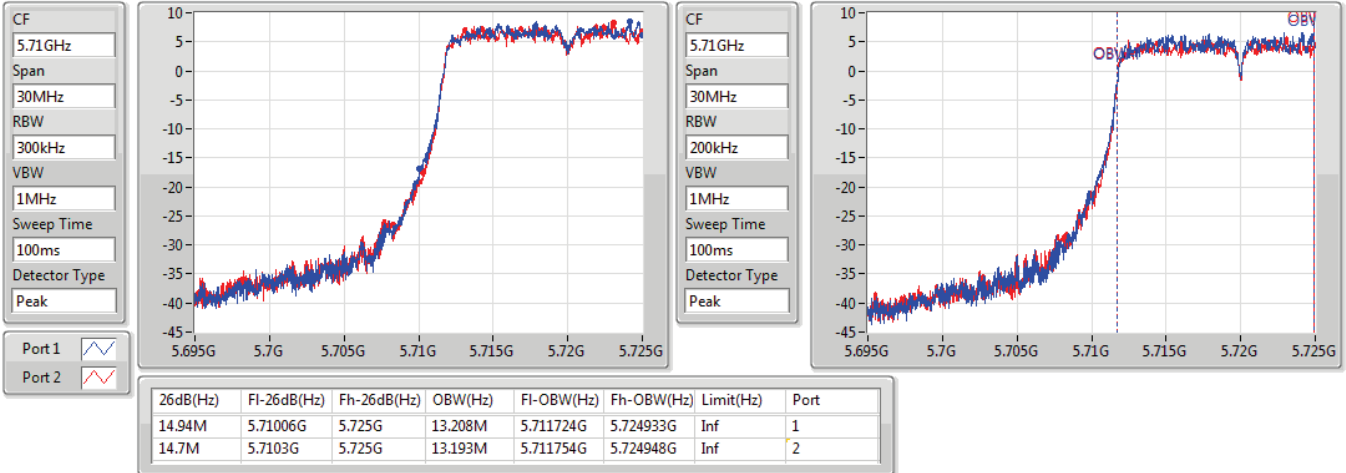

802.11a\_Nss1,(6Mbps)\_2TX

EBW

5720MHz Straddle 5.725-5.85GHz

04/12/2019

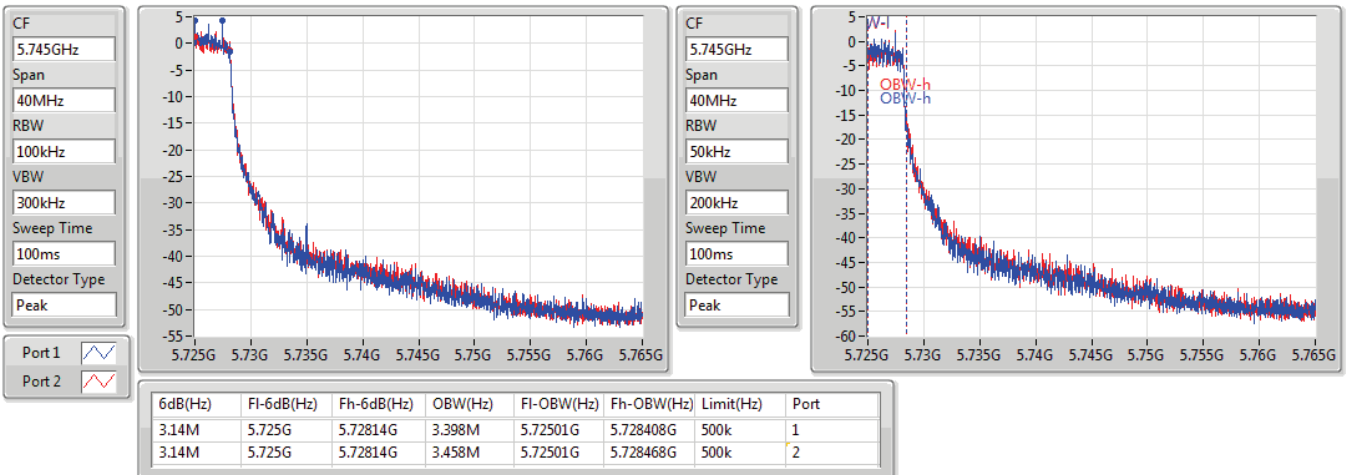

802.11ac VHT20\_Nss1,(MCS0)\_1TX(Port2)

EBW

5260MHz

05/12/2019

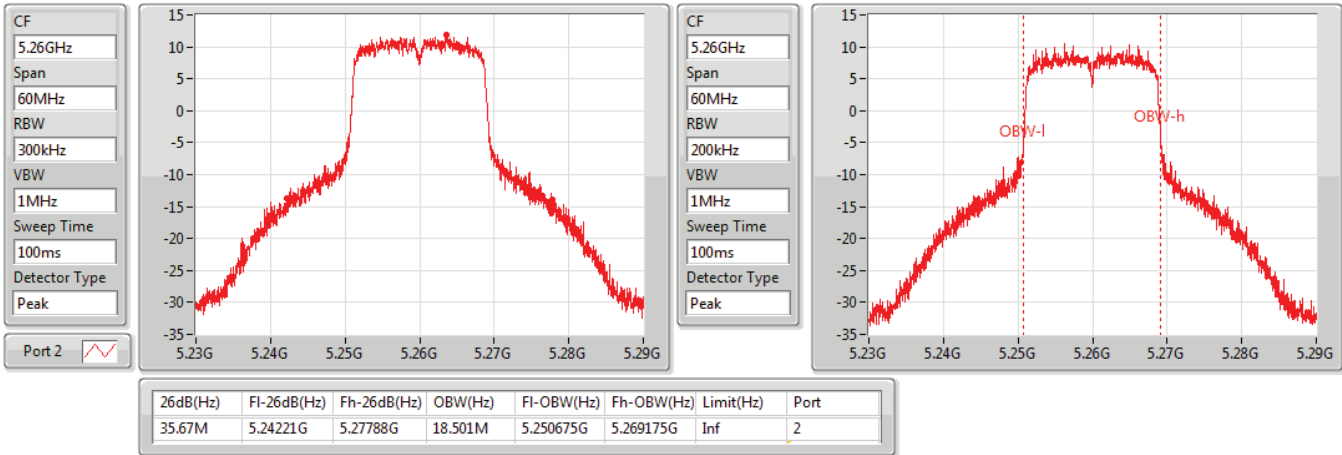

802.11ac VHT20\_Nss1,(MCS0)\_1TX(Port2)

EBW

5300MHz

05/12/2019

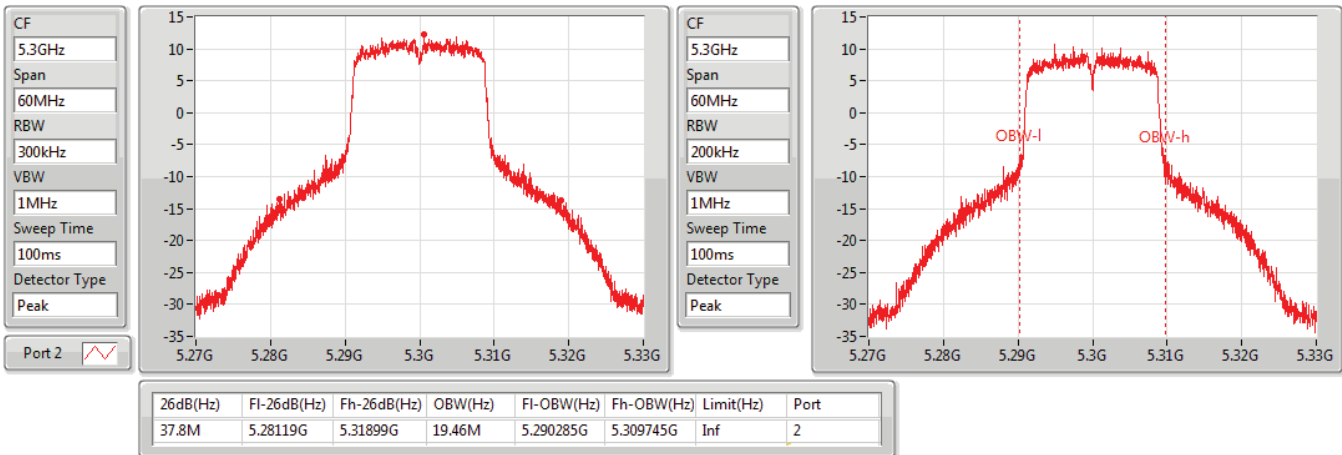

802.11ac VHT20\_Nss1,(MCS0)\_1TX(Port2)

EBW

5320MHz

05/12/2019

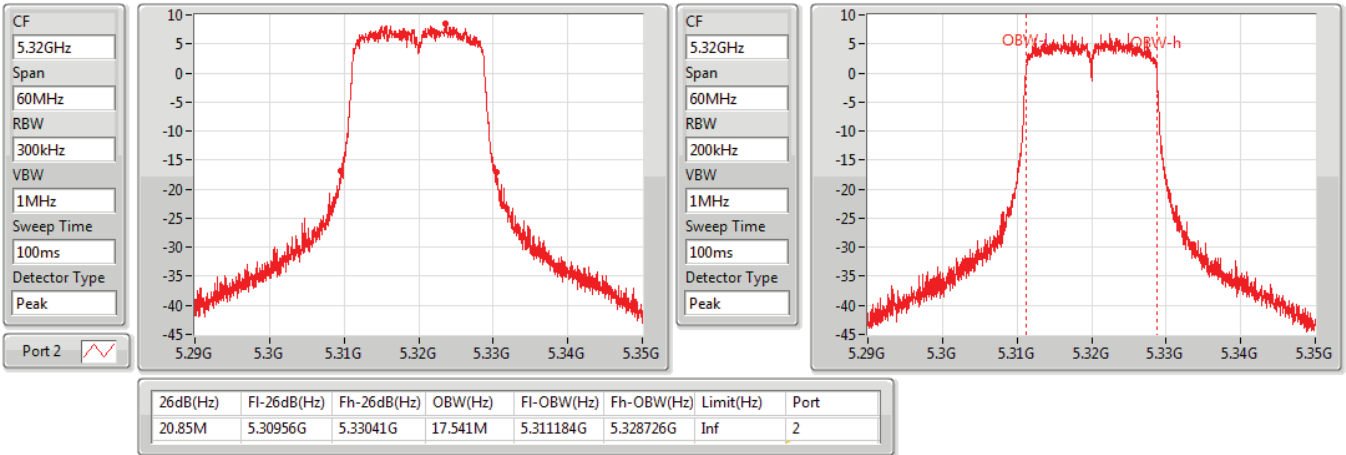

802.11ac VHT20\_Nss1,(MCS0)\_1TX(Port2)

EBW

5500MHz

05/12/2019

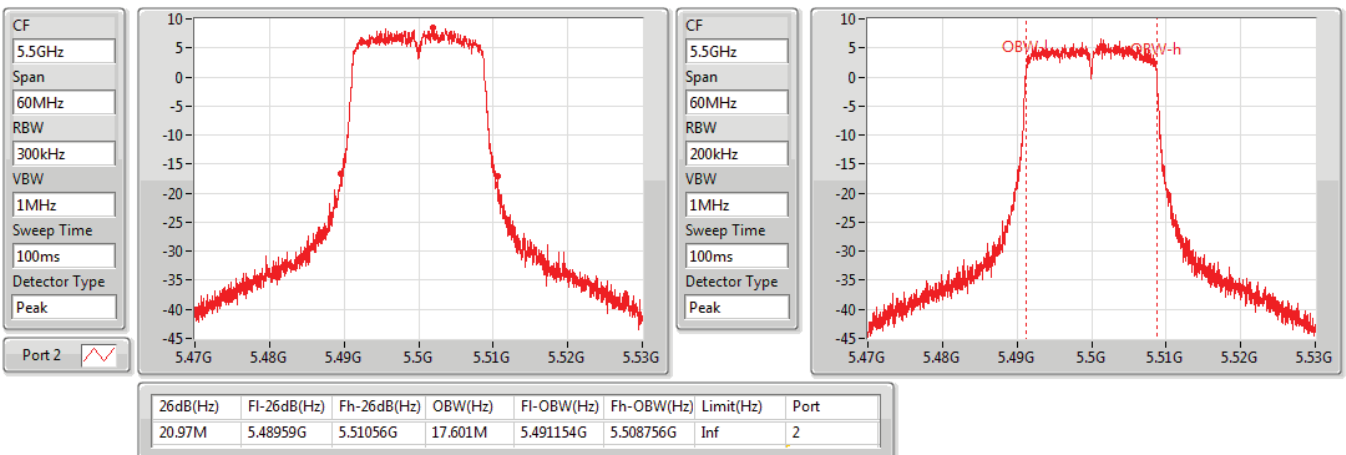



802.11ac VHT20\_Nss1,(MCS0)\_1TX(Port2)

EBW

5580MHz

05/12/2019

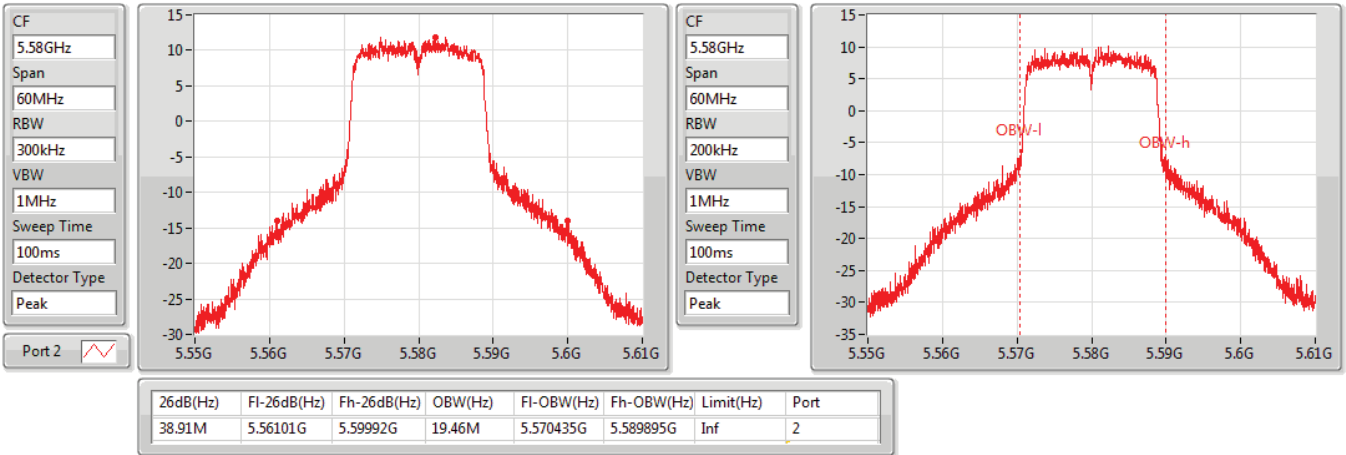

802.11ac VHT20\_Nss1,(MCS0)\_1TX(Port2)

EBW

5700MHz

05/12/2019

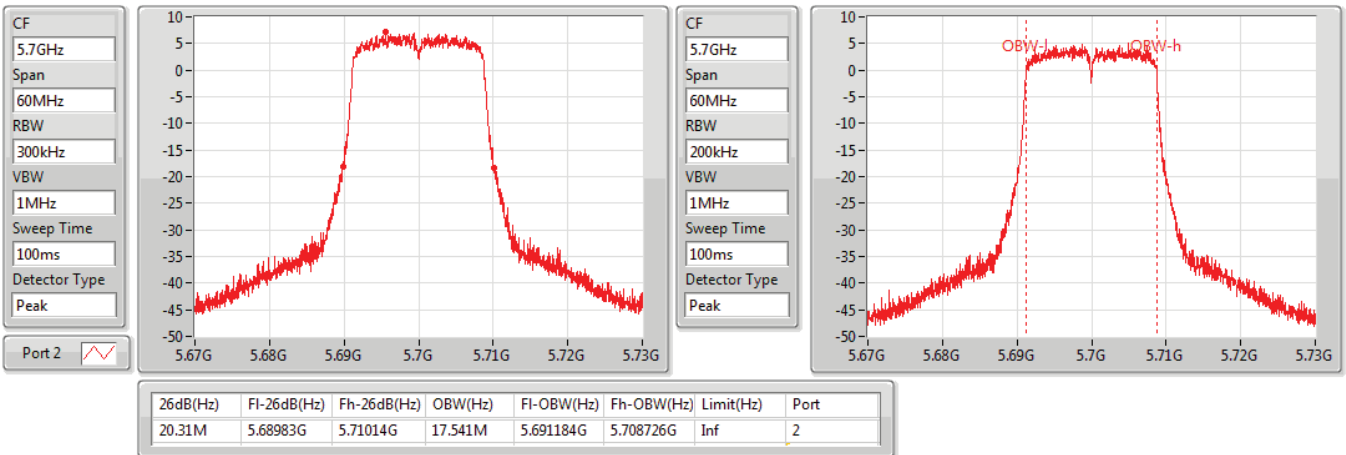

802.11ac VHT20\_Nss1,(MCS0)\_1TX(Port2)

EBW

5720MHz Straddle 5.47-5.725GHz

05/12/2019

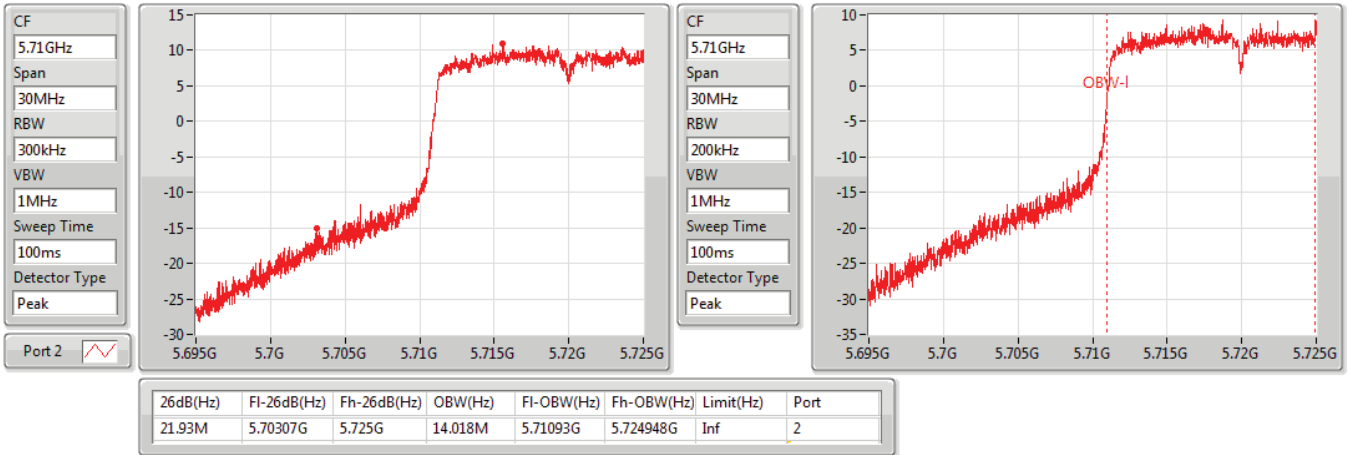

802.11ac VHT20\_Nss1,(MCS0)\_1TX(Port2)

EBW

5720MHz Straddle 5.725-5.85GHz

05/12/2019

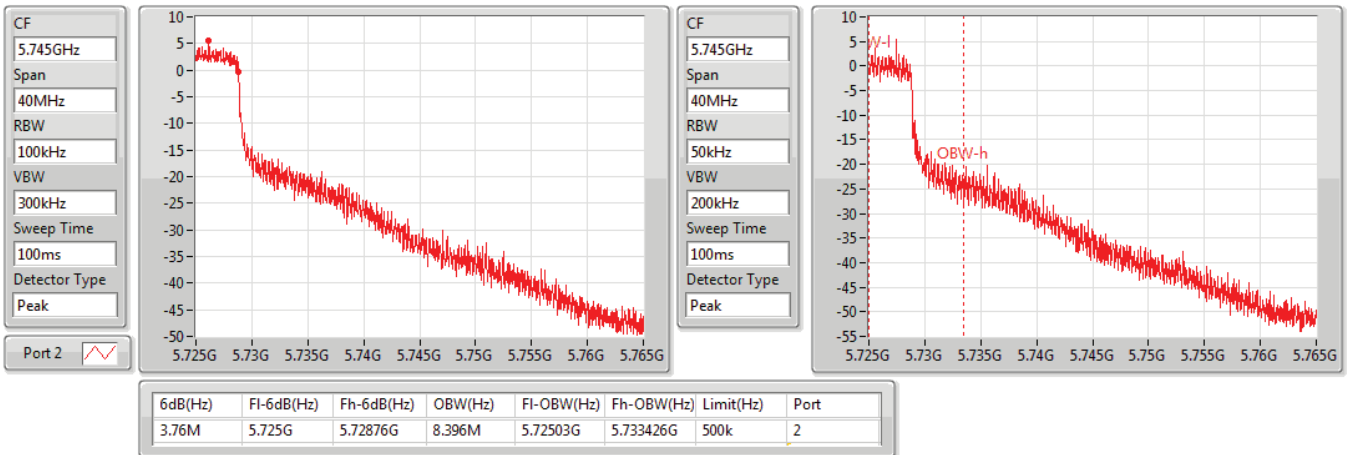

802.11ac VHT20\_Nss1,(MCS0)\_2TX

EBW

5260MHz

04/12/2019

CF  
5.26GHz  
Span  
60MHz  
RBW  
300kHz  
VBW  
1MHz  
Sweep Time  
100ms  
Detector Type  
Peak

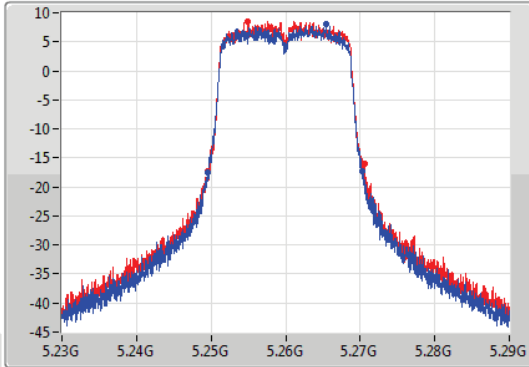

CF  
5.26GHz  
Span  
60MHz  
RBW  
200kHz  
VBW  
1MHz  
Sweep Time  
100ms  
Detector Type  
Peak

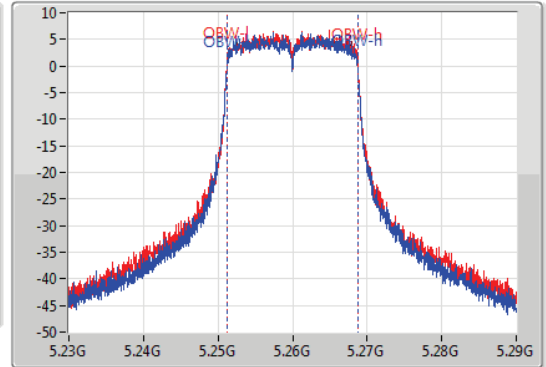

26dB(Hz)	Fl-26dB(Hz)	Fh-26dB(Hz)	OBW(Hz)	Fl-OBW(Hz)	Fh-OBW(Hz)	Limit(Hz)	Port
20.76M	5.24956G	5.27032G	17.571M	5.251184G	5.268756G	Inf	1
21M	5.24953G	5.27053G	17.541M	5.251214G	5.268756G	Inf	2

802.11ac VHT20\_Nss1,(MCS0)\_2TX

EBW

5300MHz

05/12/2019

CF  
5.3GHz  
Span  
60MHz  
RBW  
300kHz  
VBW  
1MHz  
Sweep Time  
100ms  
Detector Type  
Peak

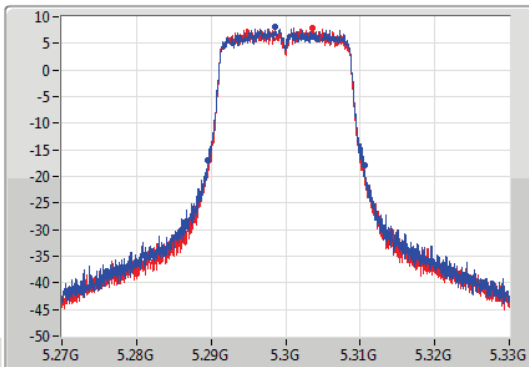

CF  
5.3GHz  
Span  
60MHz  
RBW  
200kHz  
VBW  
1MHz  
Sweep Time  
100ms  
Detector Type  
Peak

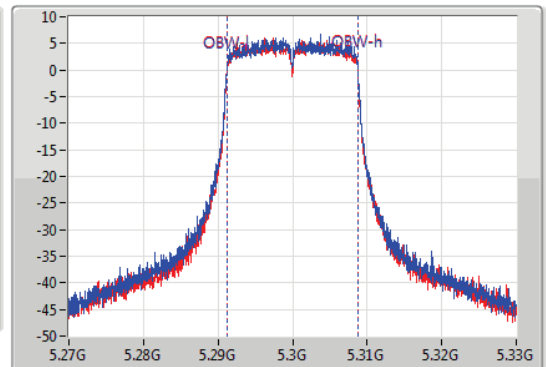

26dB(Hz)	Fl-26dB(Hz)	Fh-26dB(Hz)	OBW(Hz)	Fl-OBW(Hz)	Fh-OBW(Hz)	Limit(Hz)	Port
20.97M	5.28959G	5.31056G	17.571M	5.291184G	5.308756G	Inf	1
20.73M	5.28968G	5.31041G	17.541M	5.291184G	5.308726G	Inf	2

802.11ac VHT20\_Nss1,(MCS0)\_2TX

EBW

5320MHz

04/12/2019

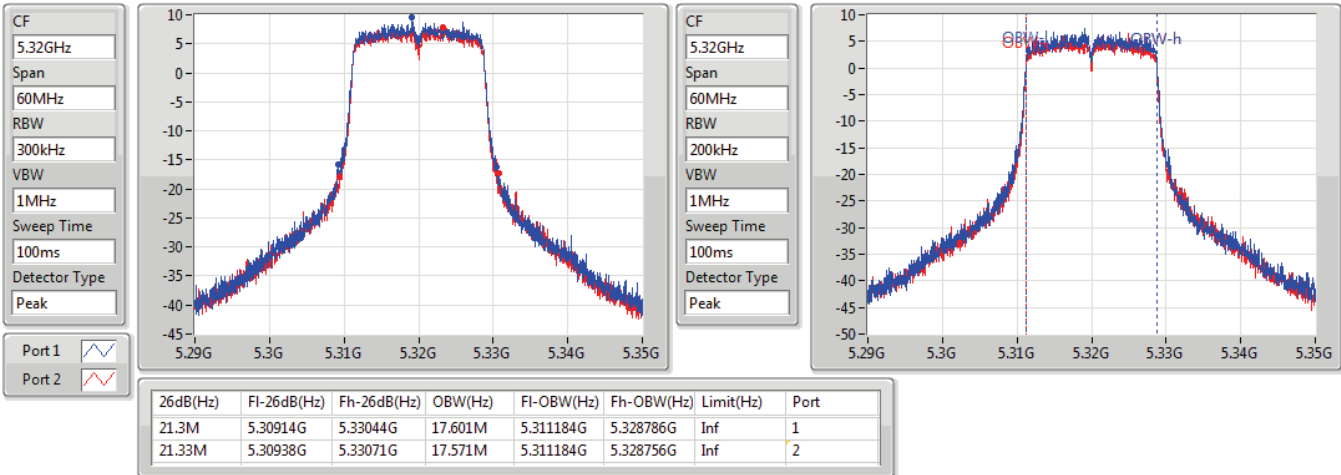

802.11ac VHT20\_Nss1,(MCS0)\_2TX

EBW

5500MHz

04/12/2019

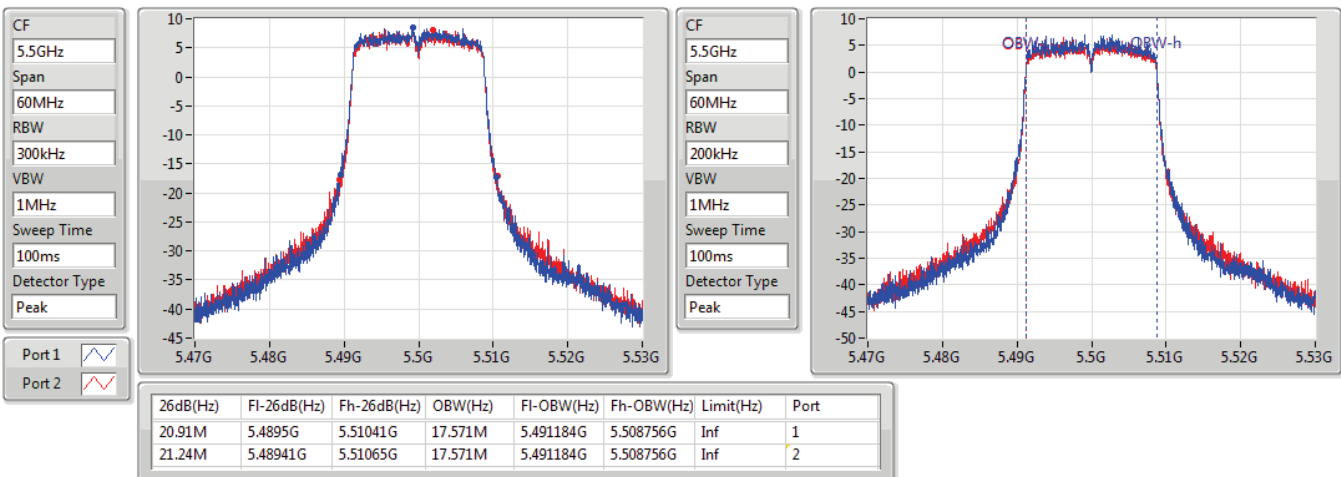

802.11ac VHT20\_Nss1,(MCS0)\_2TX

EBW

5580MHz

04/12/2019

CF  
5.58GHz  
Span  
60MHz  
RBW  
300kHz  
VBW  
1MHz  
Sweep Time  
100ms  
Detector Type  
Peak

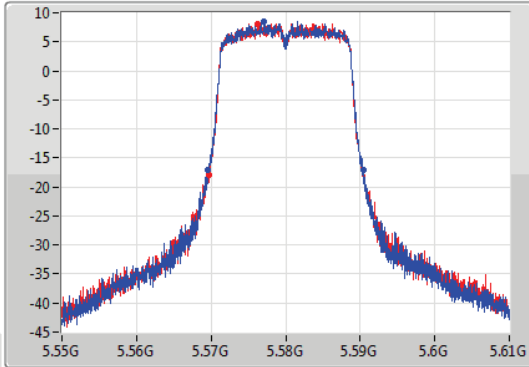

CF  
5.58GHz  
Span  
60MHz  
RBW  
200kHz  
VBW  
1MHz  
Sweep Time  
100ms  
Detector Type  
Peak

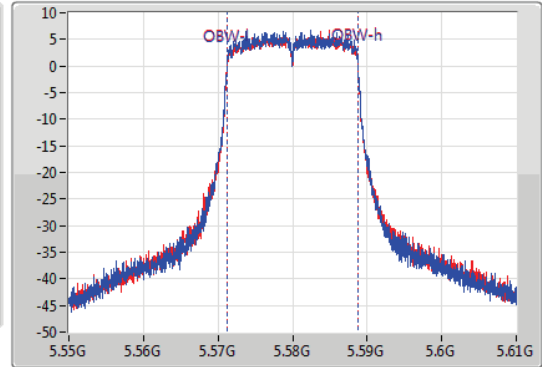

26dB(Hz)	Fl-26dB(Hz)	Fh-26dB(Hz)	OBW(Hz)	Fl-OBW(Hz)	Fh-OBW(Hz)	Limit(Hz)	Port
20.88M	5.56953G	5.59041G	17.541M	5.571214G	5.588756G	Inf	1
20.76M	5.56971G	5.59047G	17.541M	5.571214G	5.588756G	Inf	2

802.11ac VHT20\_Nss1,(MCS0)\_2TX

EBW

5700MHz

05/12/2019

CF  
5.7GHz  
Span  
60MHz  
RBW  
300kHz  
VBW  
1MHz  
Sweep Time  
100ms  
Detector Type  
Peak

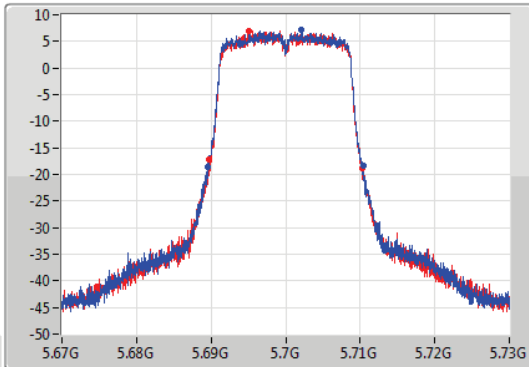

CF  
5.7GHz  
Span  
60MHz  
RBW  
200kHz  
VBW  
1MHz  
Sweep Time  
100ms  
Detector Type  
Peak

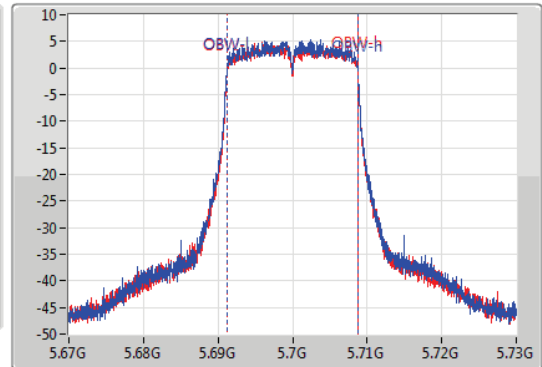

26dB(Hz)	Fl-26dB(Hz)	Fh-26dB(Hz)	OBW(Hz)	Fl-OBW(Hz)	Fh-OBW(Hz)	Limit(Hz)	Port
20.91M	5.68956G	5.71047G	17.571M	5.691184G	5.708756G	Inf	1
20.52M	5.68968G	5.7102G	17.541M	5.691184G	5.708726G	Inf	2

802.11ac VHT20\_Nss1,(MCS0)\_2TX

EBW

5720MHz Straddle 5.47-5.725GHz

04/12/2019

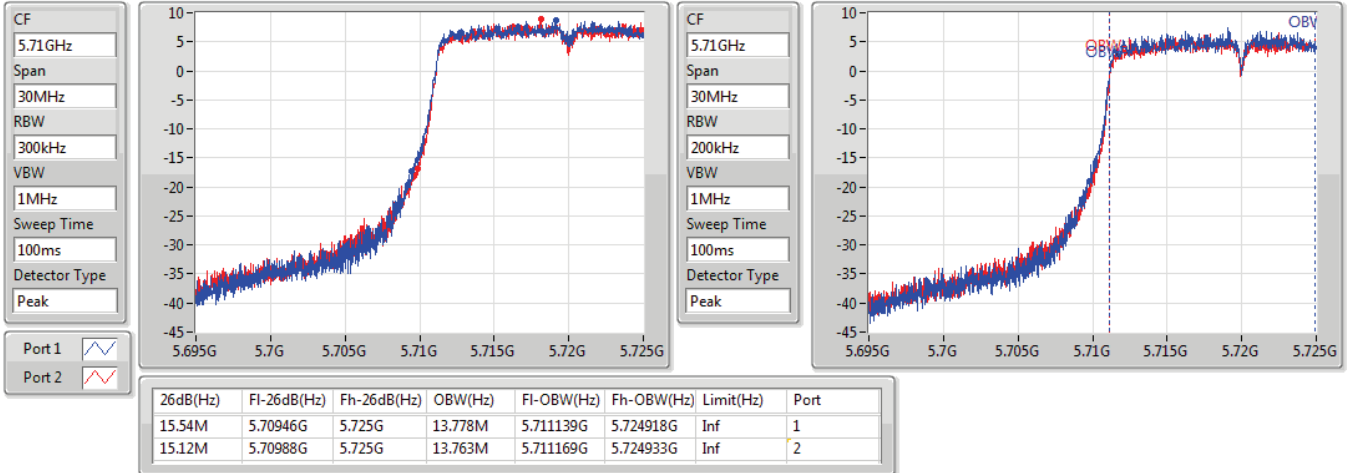

802.11ac VHT20\_Nss1,(MCS0)\_2TX

EBW

5720MHz Straddle 5.725-5.85GHz

04/12/2019

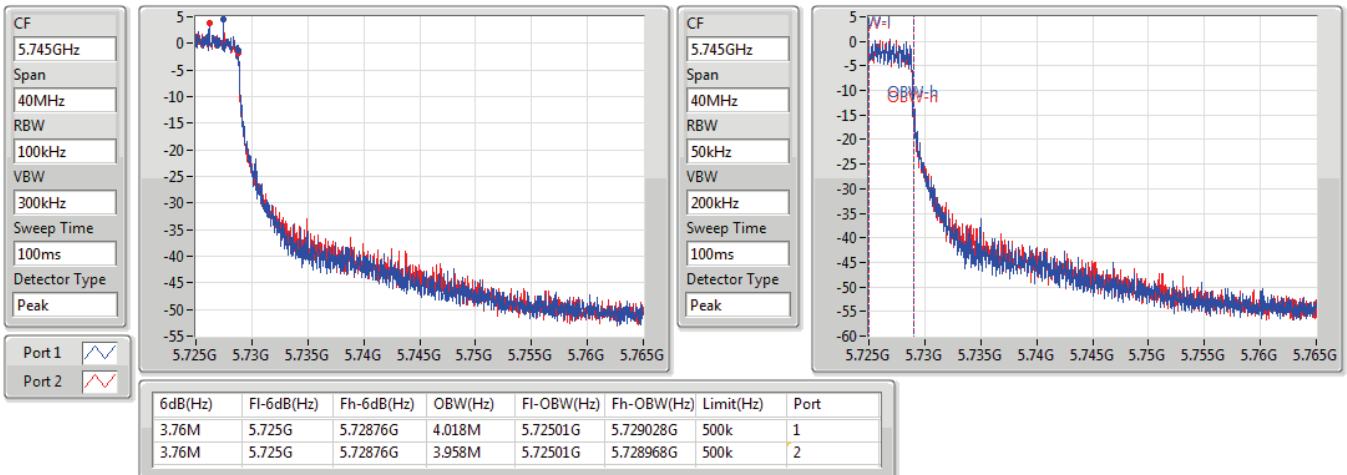

802.11ac VHT40\_Nss1,(MCS0)\_1TX(Port2)

EBW

5270MHz

05/12/2019

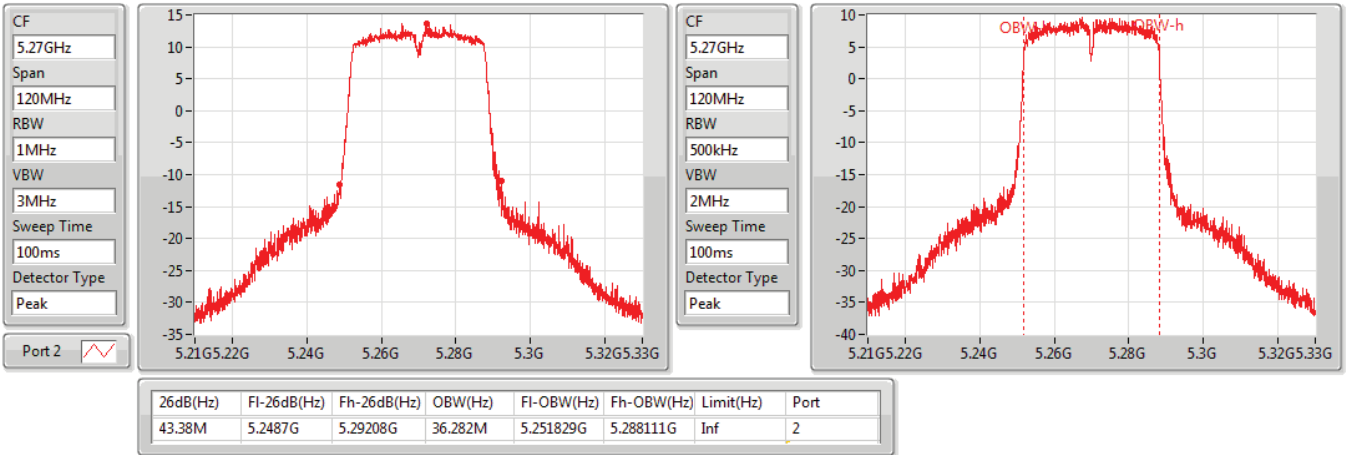

802.11ac VHT40\_Nss1,(MCS0)\_1TX(Port2)

EBW

5310MHz

05/12/2019

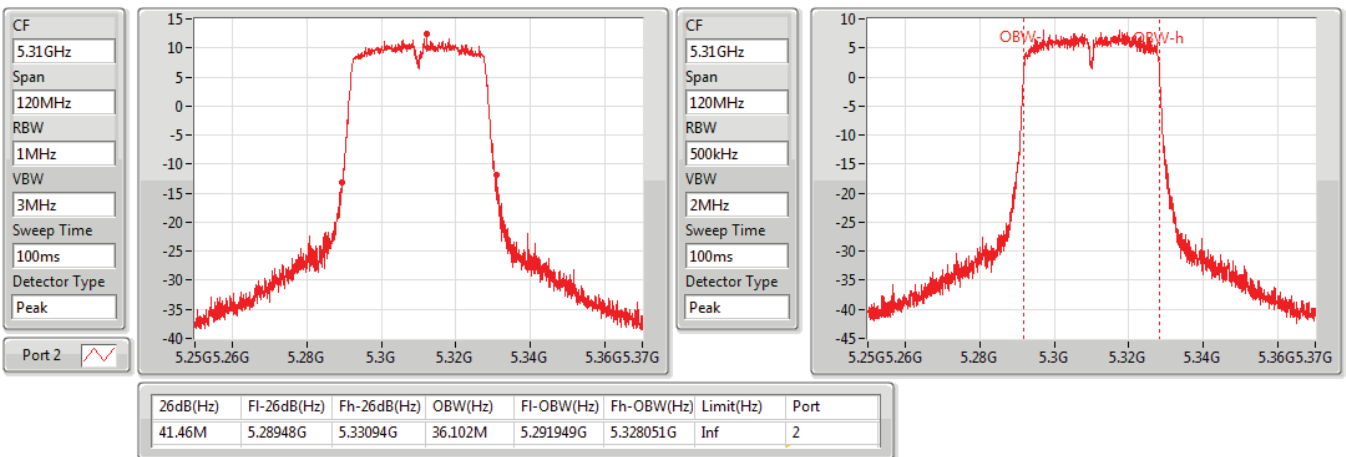

802.11ac VHT40\_Nss1,(MCS0)\_1TX(Port2)

EBW

5510MHz

05/12/2019

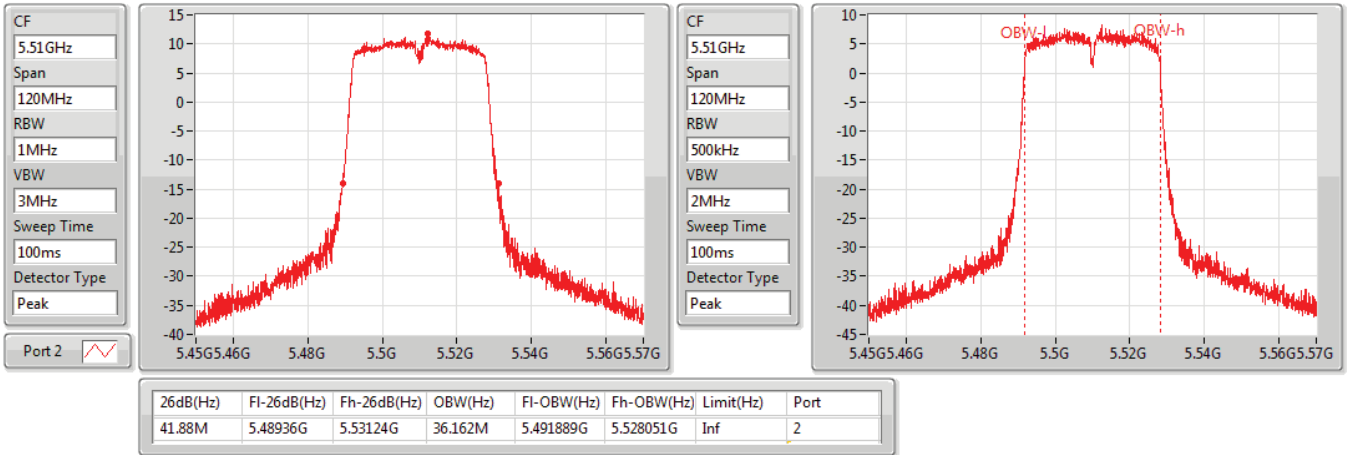

802.11ac VHT40\_Nss1,(MCS0)\_1TX(Port2)

EBW

5550MHz

05/12/2019

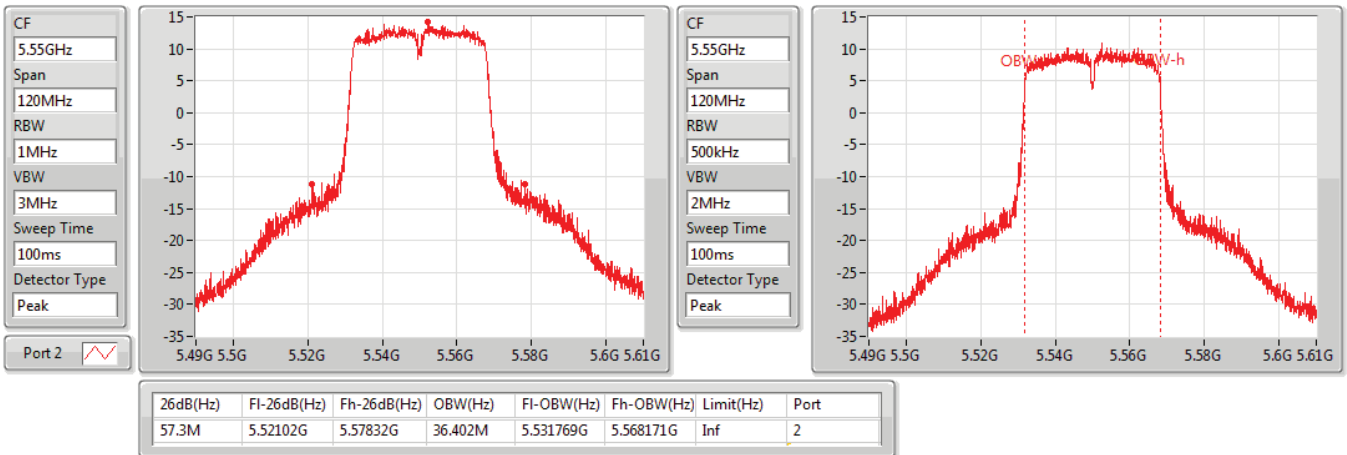



802.11ac VHT40\_Nss1,(MCS0)\_1TX(Port2)

EBW

5670MHz

05/12/2019

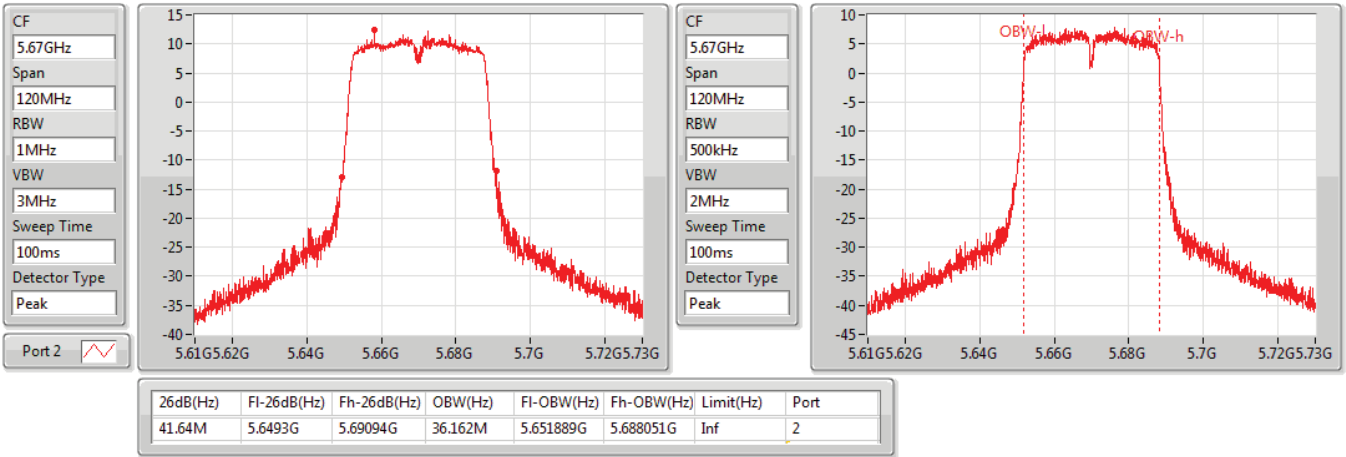

802.11ac VHT40\_Nss1,(MCS0)\_1TX(Port2)

EBW

5710MHz Straddle 5.47-5.725GHz

05/12/2019

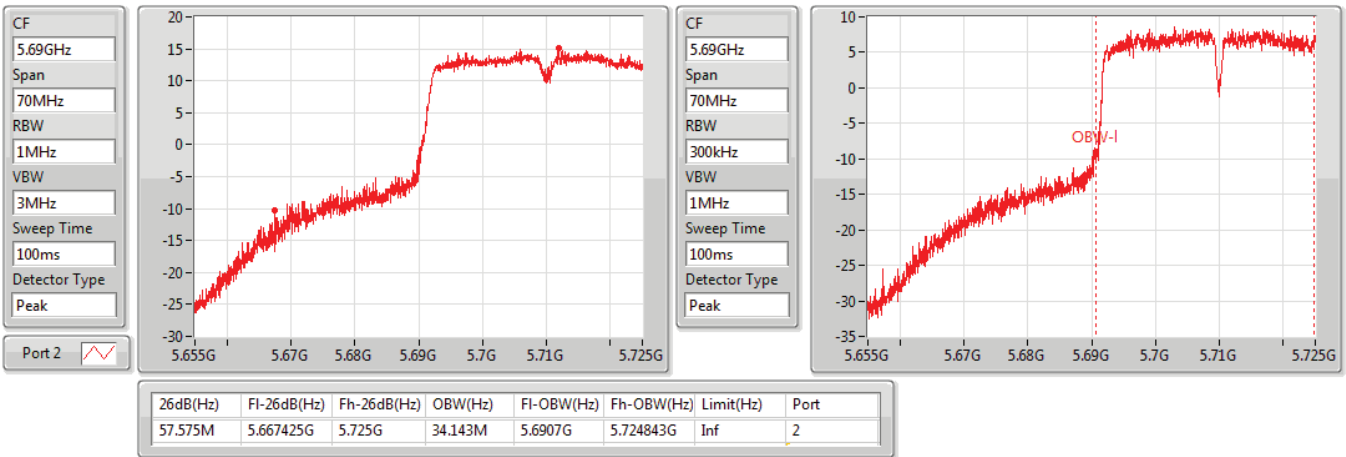

802.11ac VHT40\_Nss1,(MCS0)\_1TX(Port2)

EBW

5710MHz Straddle 5.725-5.85GHz

05/12/2019

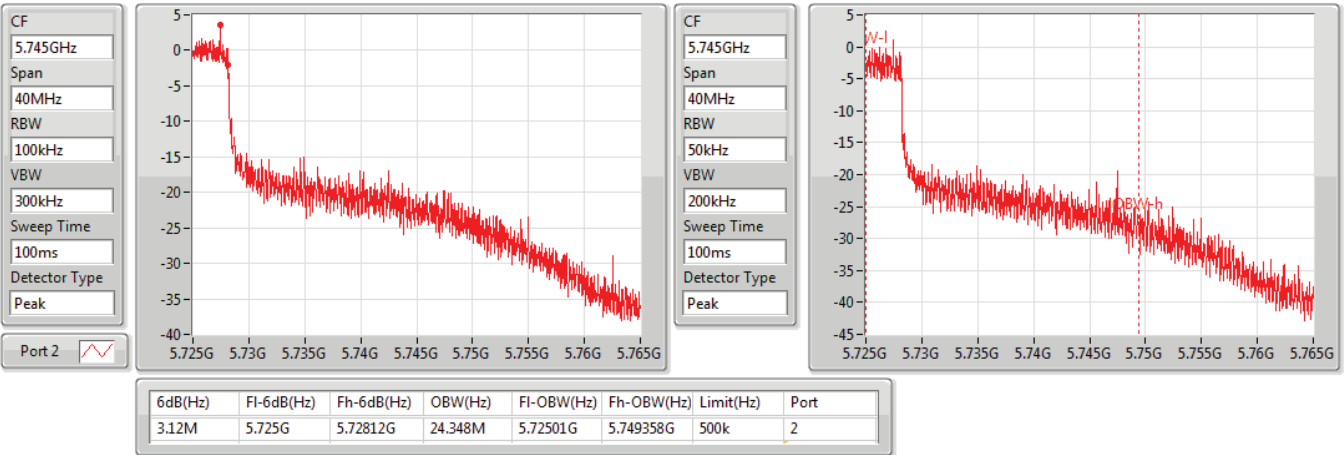

802.11ac VHT40\_Nss1,(MCS0)\_2TX

EBW

5270MHz

04/12/2019

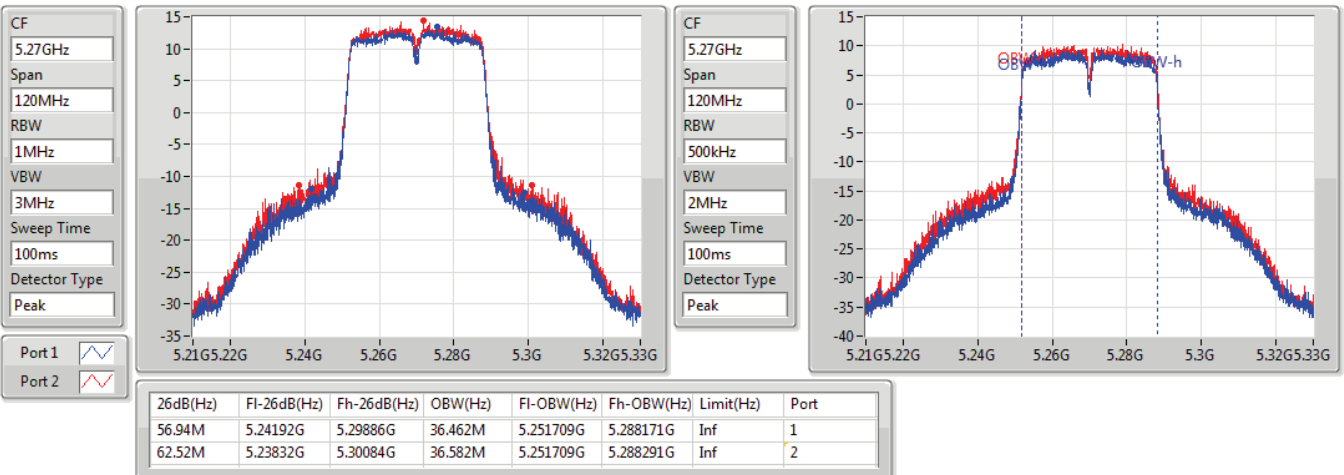

802.11ac VHT40\_Nss1,(MCS0)\_2TX

EBW

5310MHz

05/12/2019

CF  
5.31GHz  
Span  
120MHz  
RBW  
1MHz  
VBW  
3MHz  
Sweep Time  
100ms  
Detector Type  
Peak

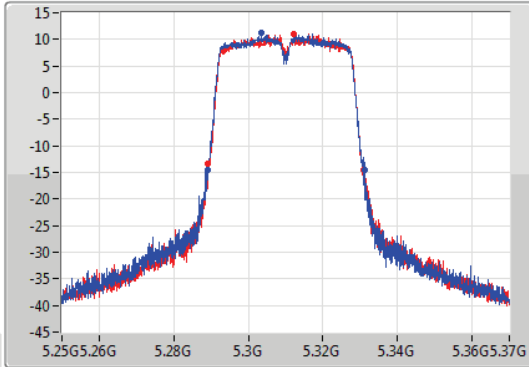

CF  
5.31GHz  
Span  
120MHz  
RBW  
500kHz  
VBW  
2MHz  
Sweep Time  
100ms  
Detector Type  
Peak

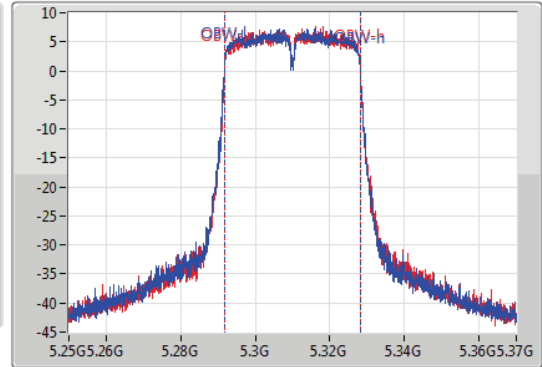

26dB(Hz)	Fl-26dB(Hz)	Fh-26dB(Hz)	OBW(Hz)	Fl-OBW(Hz)	Fh-OBW(Hz)	Limit(Hz)	Port
42.18M	5.28912G	5.3313G	36.222M	5.291829G	5.328051G	Inf	1
41.76M	5.28924G	5.331G	36.162M	5.291889G	5.328051G	Inf	2

802.11ac VHT40\_Nss1,(MCS0)\_2TX

EBW

5510MHz

05/12/2019

CF  
5.51GHz  
Span  
120MHz  
RBW  
1MHz  
VBW  
3MHz  
Sweep Time  
100ms  
Detector Type  
Peak

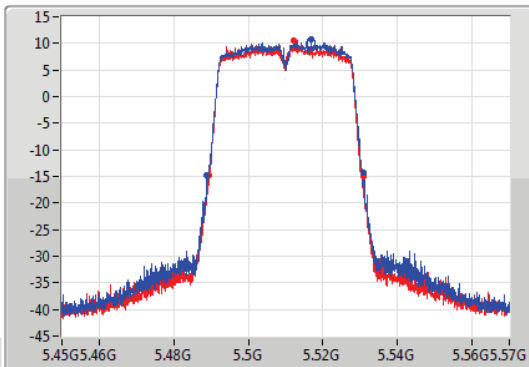

CF  
5.51GHz  
Span  
120MHz  
RBW  
500kHz  
VBW  
2MHz  
Sweep Time  
100ms  
Detector Type  
Peak

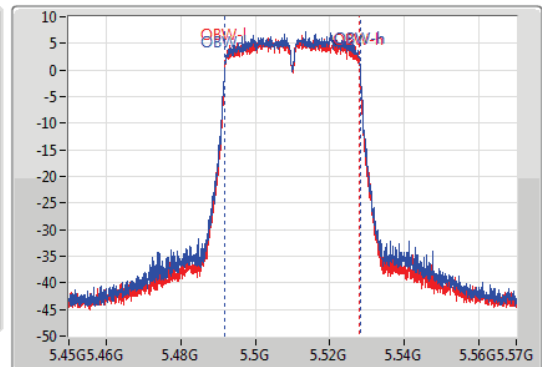

26dB(Hz)	Fl-26dB(Hz)	Fh-26dB(Hz)	OBW(Hz)	Fl-OBW(Hz)	Fh-OBW(Hz)	Limit(Hz)	Port
42.06M	5.48894G	5.531G	36.162M	5.491889G	5.528051G	Inf	1
41.46M	5.4893G	5.53076G	36.102M	5.491889G	5.527991G	Inf	2

802.11ac VHT40\_Nss1,(MCS0)\_2TX

EBW

5550MHz

05/12/2019

CF  
5.55GHz  
Span  
120MHz  
RBW  
1MHz  
VBW  
3MHz  
Sweep Time  
100ms  
Detector Type  
Peak

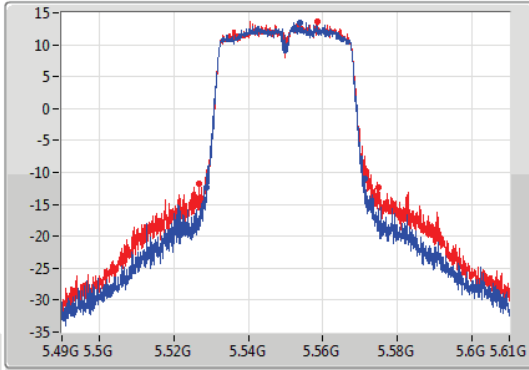

CF  
5.55GHz  
Span  
120MHz  
RBW  
500kHz  
VBW  
2MHz  
Sweep Time  
100ms  
Detector Type  
Peak

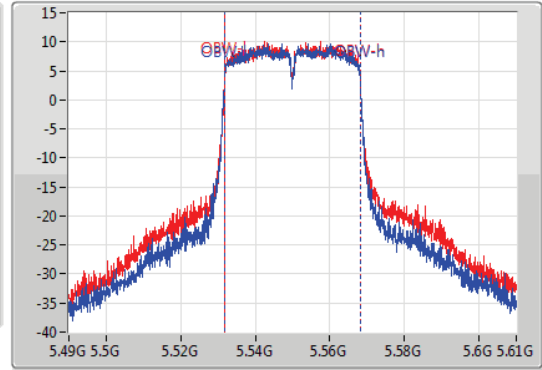

26dB(Hz)	Fl-26dB(Hz)	Fh-26dB(Hz)	OBW(Hz)	Fl-OBW(Hz)	Fh-OBW(Hz)	Limit(Hz)	Port
42.72M	5.52864G	5.57136G	36.222M	5.531829G	5.568051G	Inf	1
48.12M	5.52678G	5.5749G	36.282M	5.531829G	5.568111G	Inf	2

802.11ac VHT40\_Nss1,(MCS0)\_2TX

EBW

5670MHz

05/12/2019

CF  
5.67GHz  
Span  
120MHz  
RBW  
1MHz  
VBW  
3MHz  
Sweep Time  
100ms  
Detector Type  
Peak

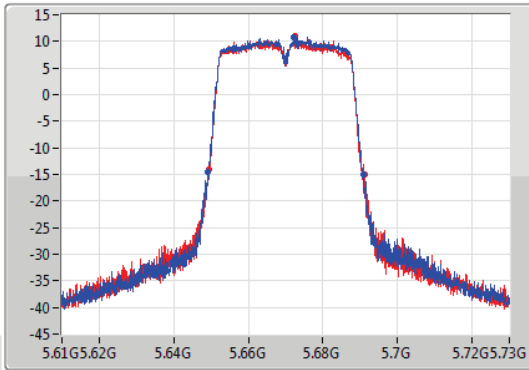

CF  
5.67GHz  
Span  
120MHz  
RBW  
500kHz  
VBW  
2MHz  
Sweep Time  
100ms  
Detector Type  
Peak

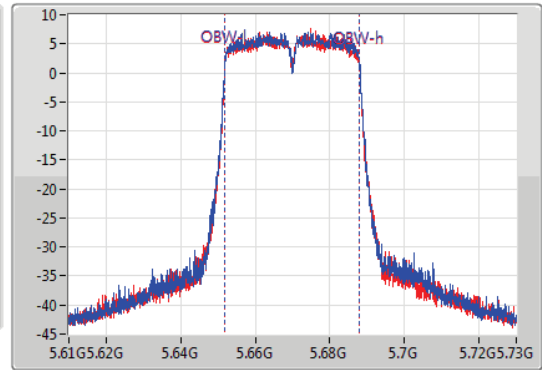

26dB(Hz)	Fl-26dB(Hz)	Fh-26dB(Hz)	OBW(Hz)	Fl-OBW(Hz)	Fh-OBW(Hz)	Limit(Hz)	Port
41.7M	5.64912G	5.69082G	36.102M	5.651889G	5.687991G	Inf	1
41.64M	5.64948G	5.69112G	36.102M	5.651889G	5.687991G	Inf	2

802.11ac VHT40\_Nss1,(MCS0)\_2TX

EBW

5710MHz Straddle 5.47-5.725GHz

05/12/2019

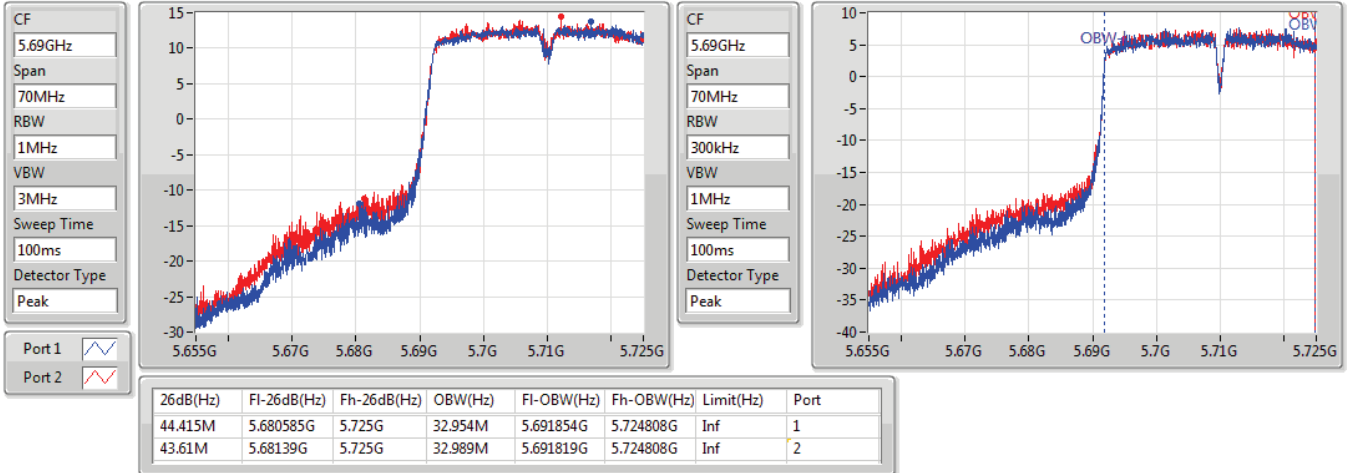

802.11ac VHT40\_Nss1,(MCS0)\_2TX

EBW

5710MHz Straddle 5.725-5.85GHz

05/12/2019

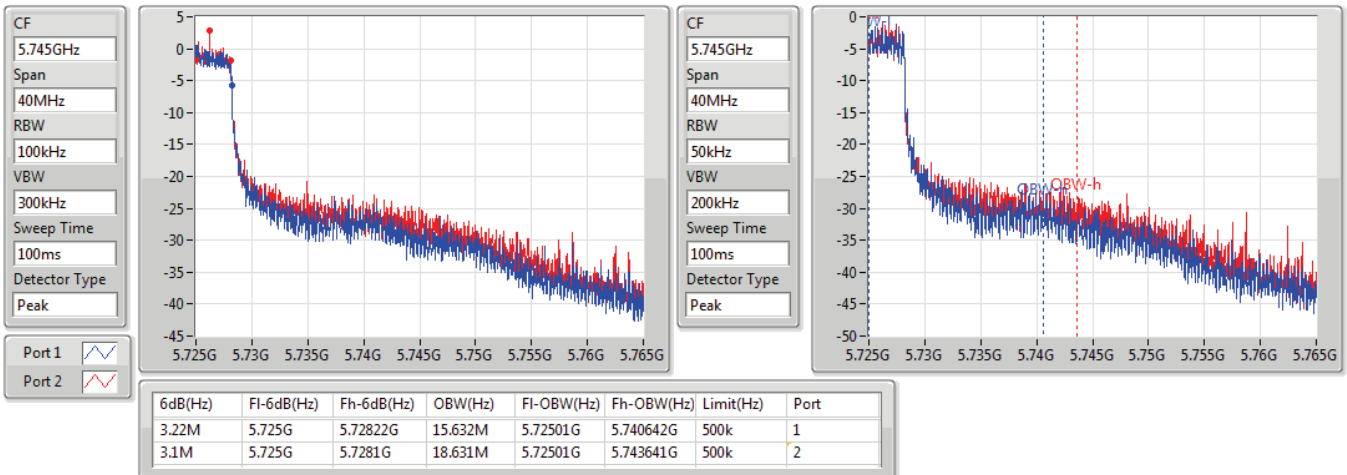

802.11ac VHT80\_Nss1,(MCS0)\_1TX(Port2)

EBW

5290MHz

05/12/2019

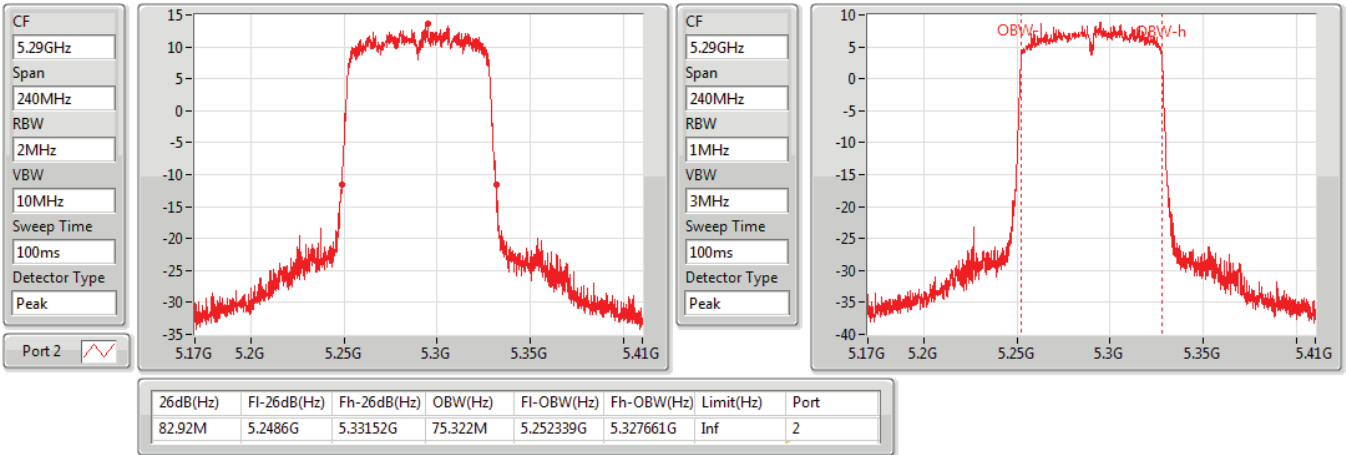

802.11ac VHT80\_Nss1,(MCS0)\_1TX(Port2)

EBW

5530MHz

05/12/2019

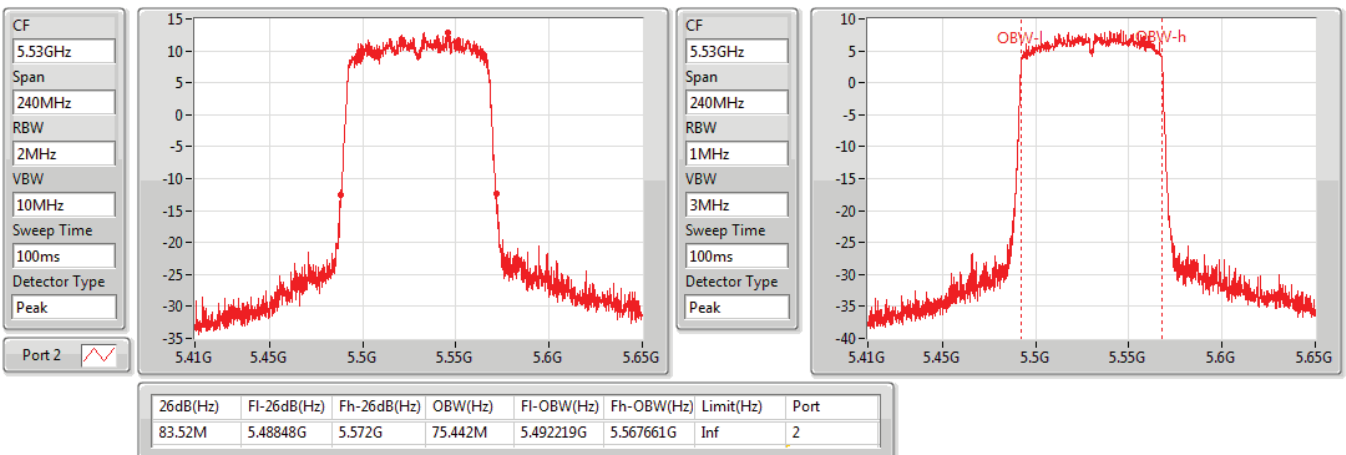

802.11ac VHT80\_Nss1,(MCS0)\_1TX(Port2)

EBW

5610MHz

05/12/2019

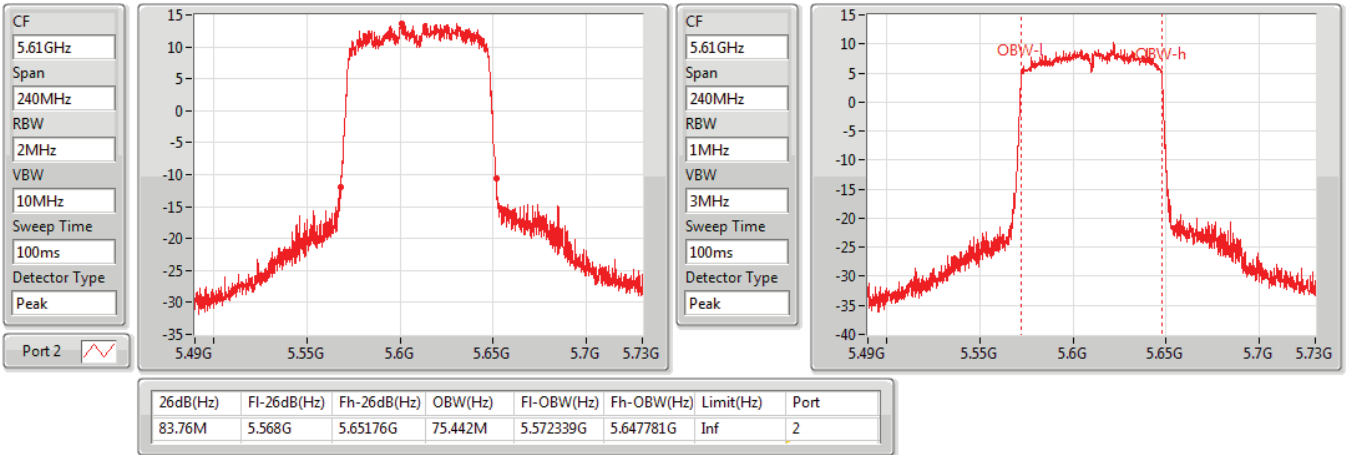

802.11ac VHT80\_Nss1,(MCS0)\_1TX(Port2)

EBW

5690MHz Straddle 5.47-5.725GHz

05/12/2019

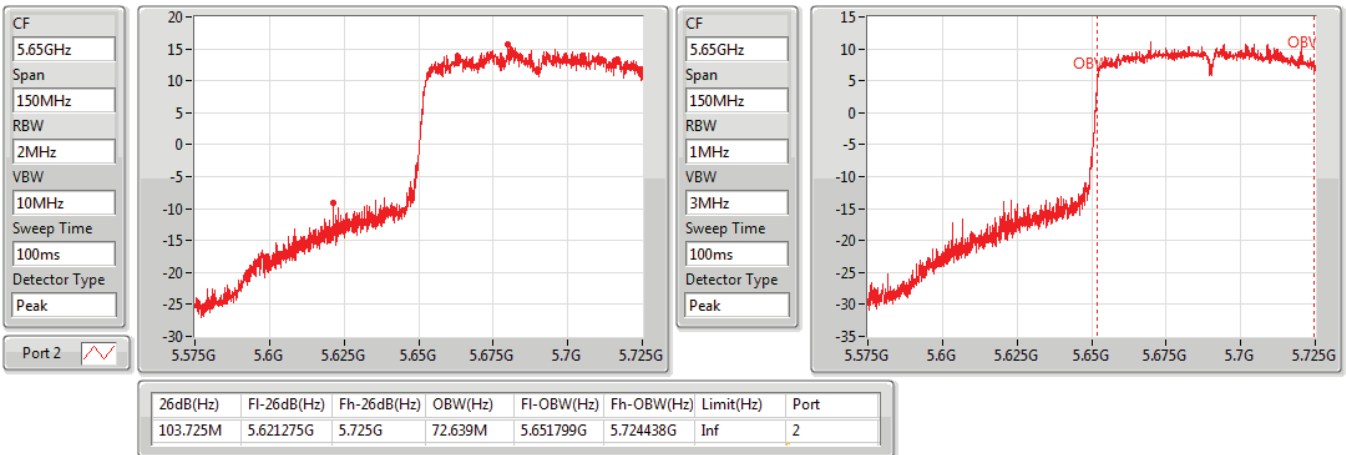

802.11ac VHT80\_Nss1,(MCS0)\_1TX(Port2)

EBW

5690MHz Straddle 5.725-5.85GHz

05/12/2019

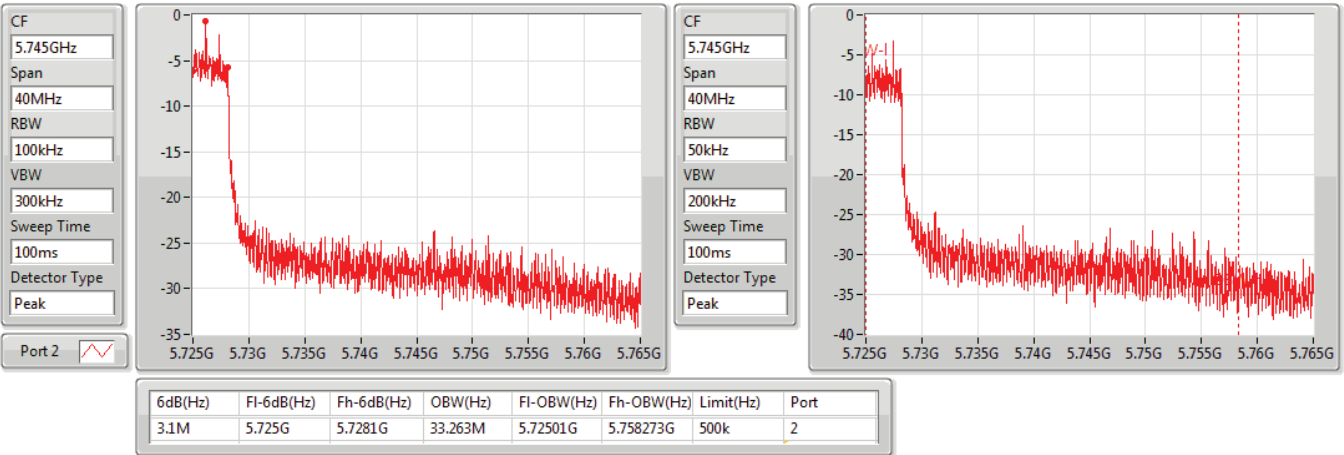

802.11ac VHT80\_Nss1,(MCS0)\_2TX

EBW

5290MHz

04/12/2019

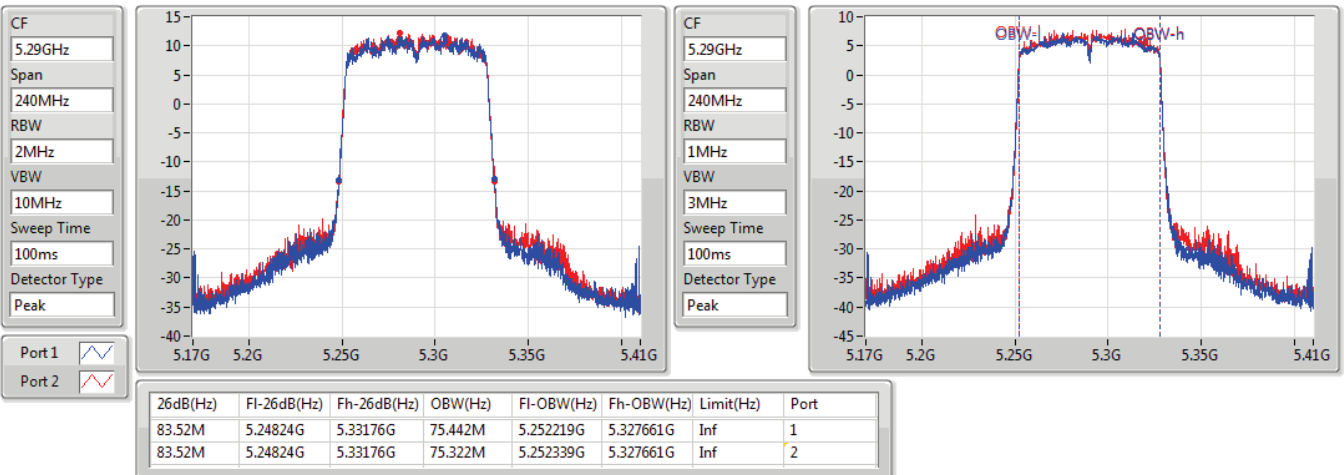



802.11ac VHT80\_Nss1,(MCS0)\_2TX

EBW

5530MHz

04/12/2019

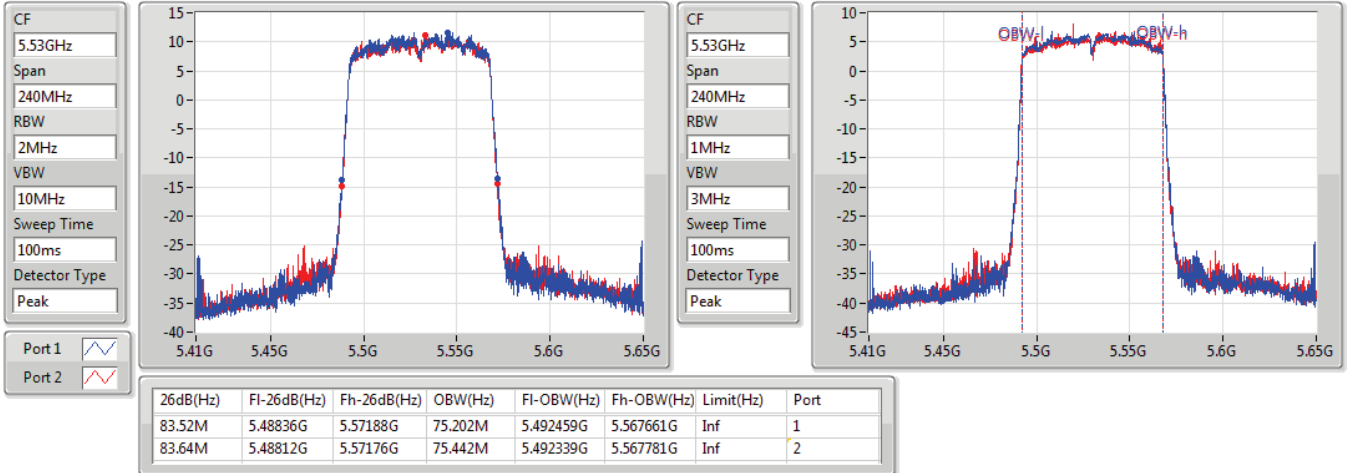

802.11ac VHT80\_Nss1,(MCS0)\_2TX

EBW

5610MHz

05/12/2019

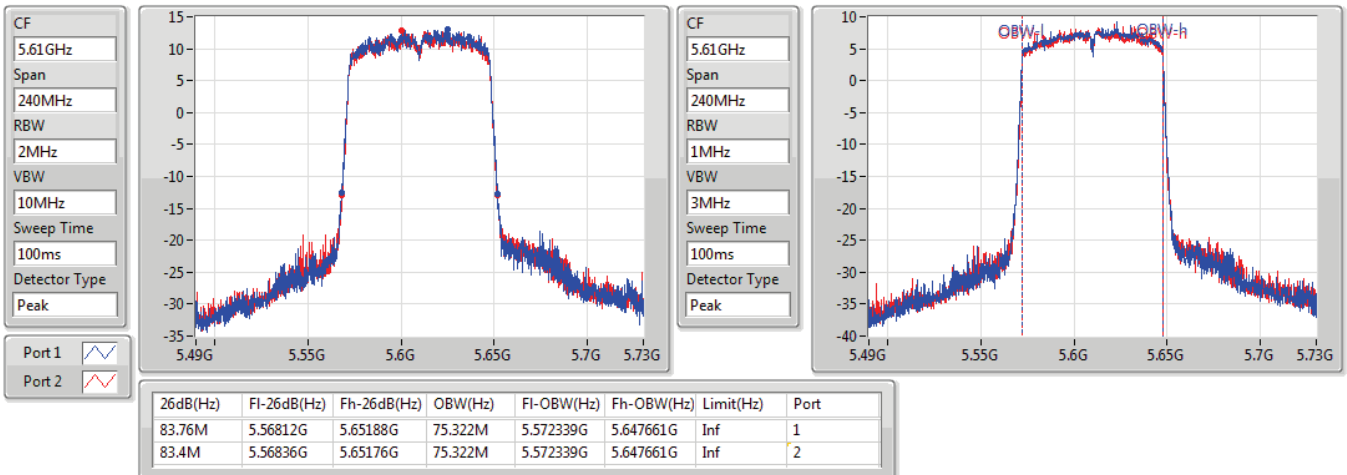

802.11ac VHT80\_Nss1,(MCS0)\_2TX

EBW

5690MHz Straddle 5.47-5.725GHz

05/12/2019

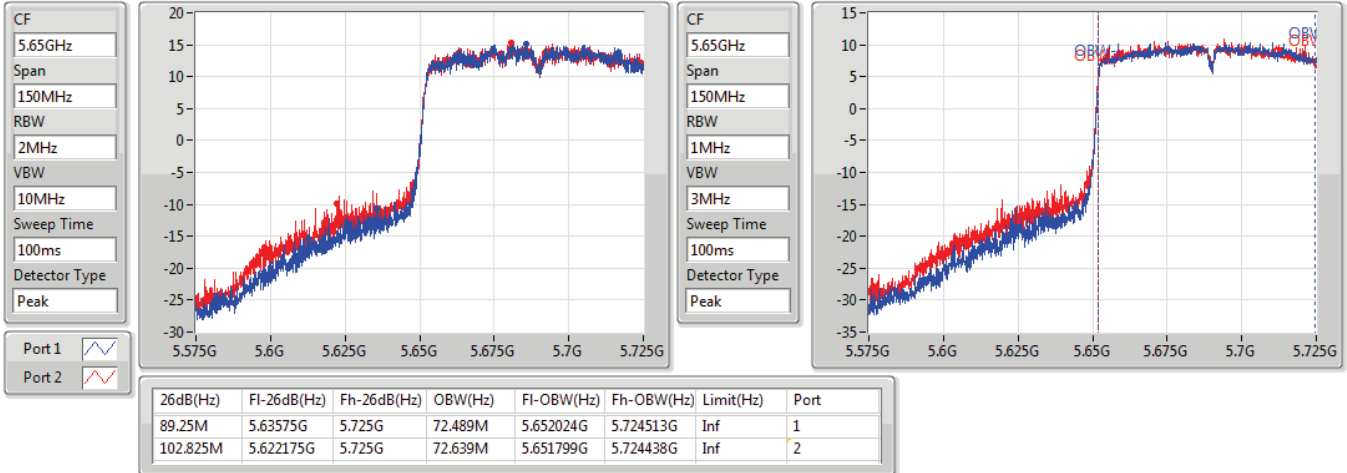

802.11ac VHT80\_Nss1,(MCS0)\_2TX

EBW

5690MHz Straddle 5.725-5.85GHz

05/12/2019

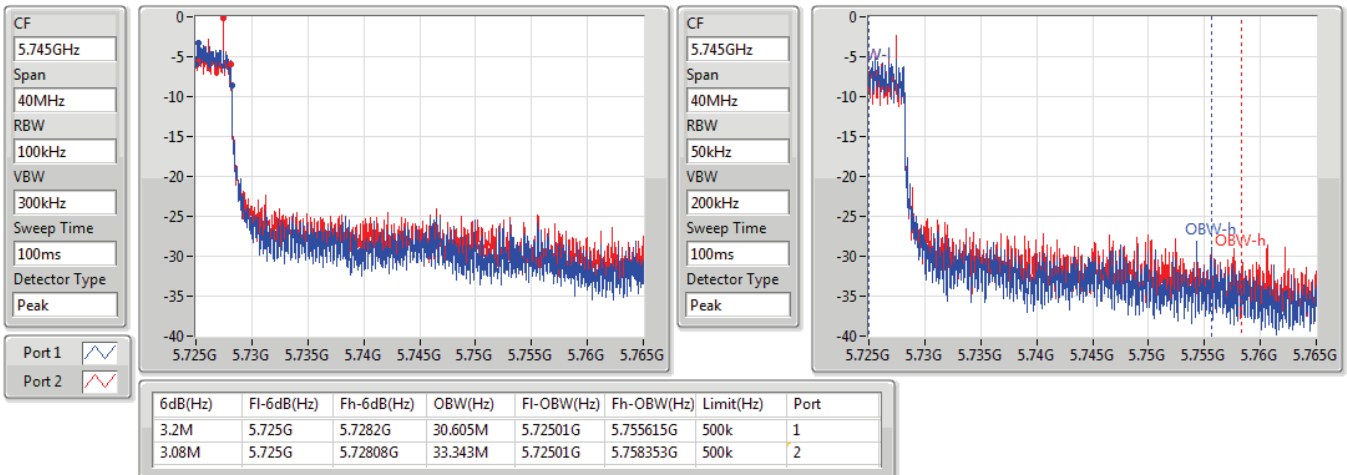

802.11ax HEW20\_Nss1,(MCS0)\_1TX(Port2)

EBW

5260MHz

05/12/2019

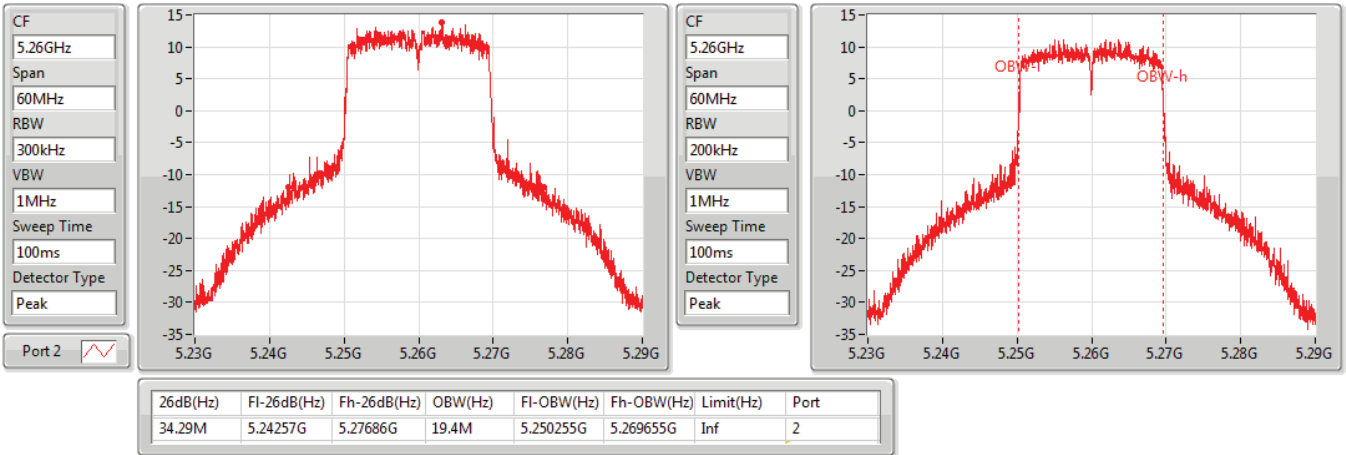

802.11ax HEW20\_Nss1,(MCS0)\_1TX(Port2)

EBW

5300MHz

05/12/2019

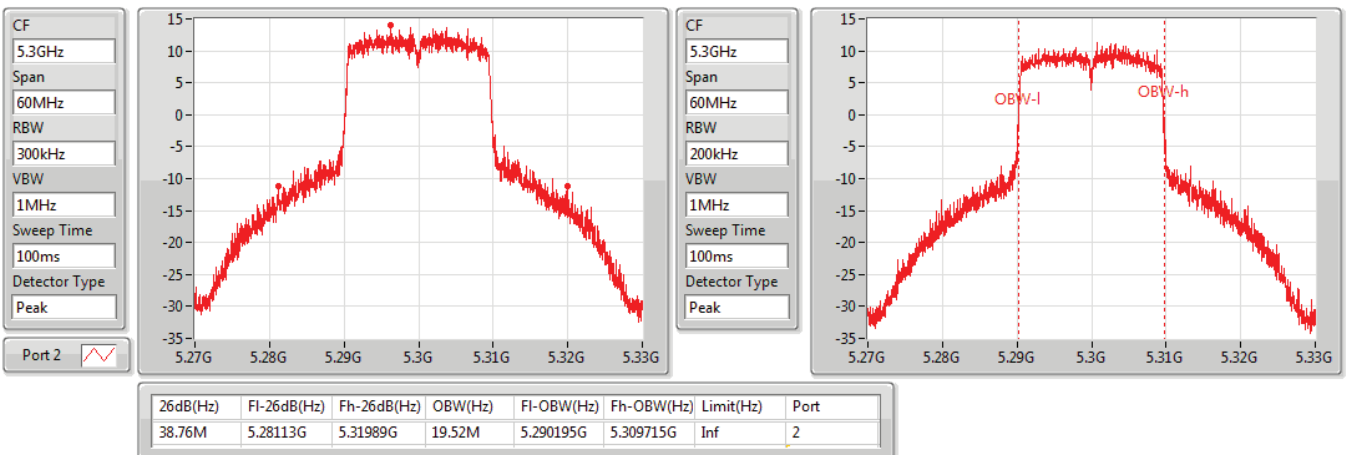

802.11ax HEW20\_Nss1,(MCS0)\_1TX(Port2)

EBW

5320MHz

05/12/2019

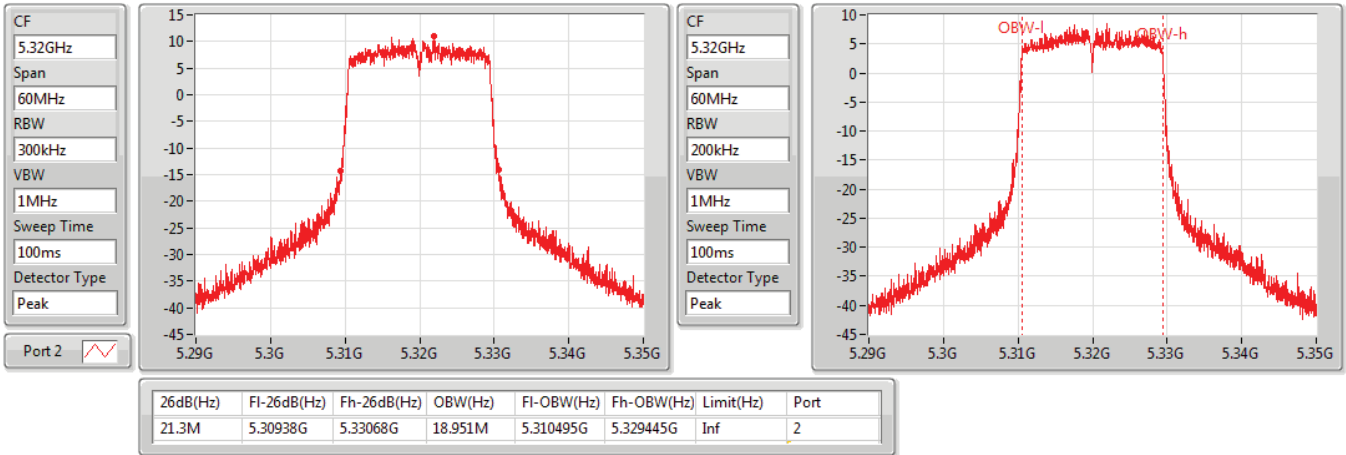

802.11ax HEW20\_Nss1,(MCS0)\_1TX(Port2)

EBW

5500MHz

05/12/2019

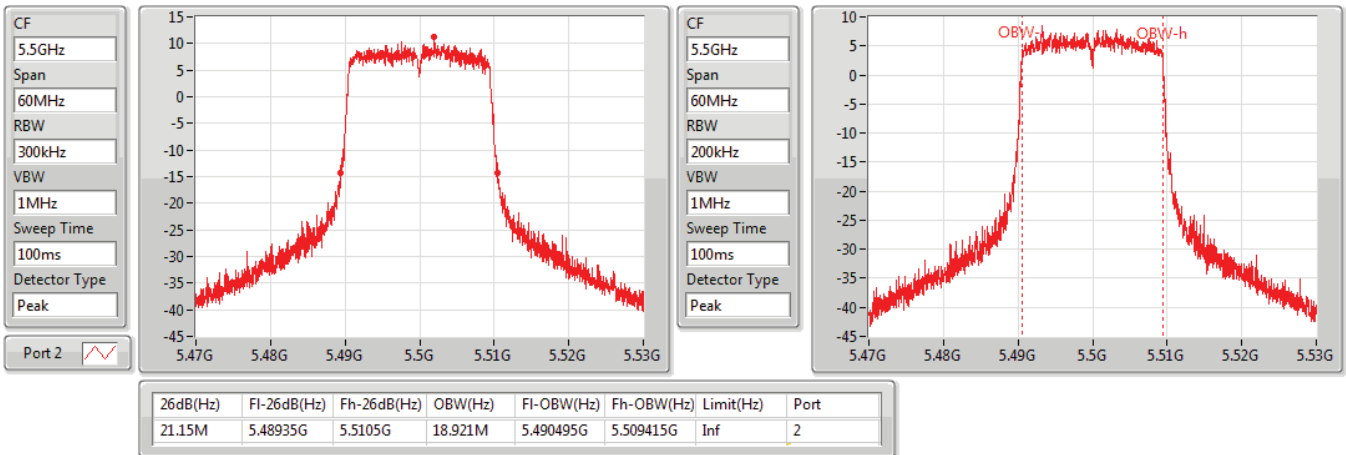

802.11ax HEW20\_Nss1,(MCS0)\_1TX(Port2)

EBW

5580MHz

05/12/2019

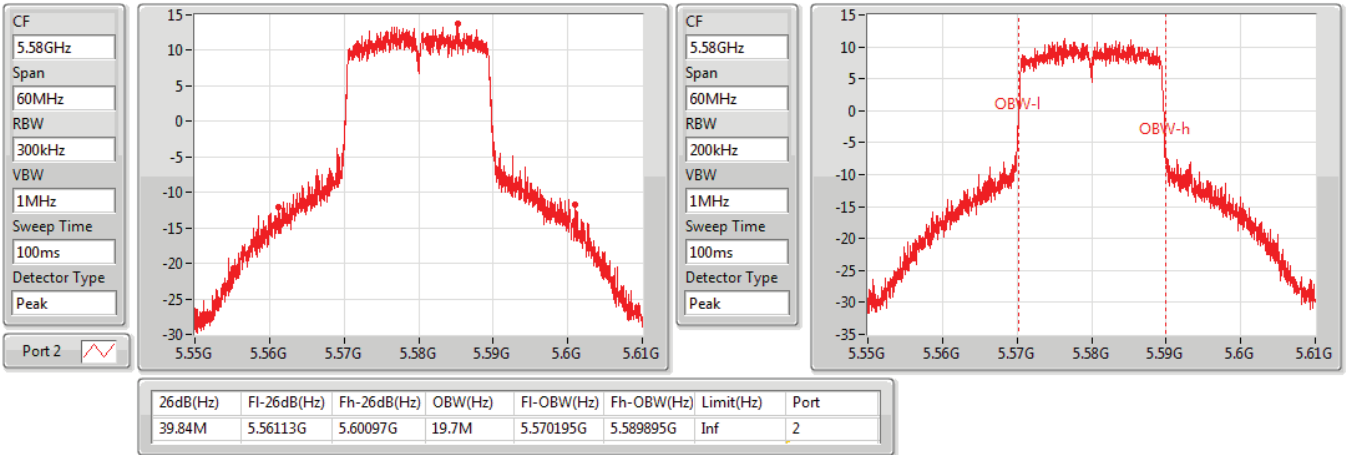

802.11ax HEW20\_Nss1,(MCS0)\_1TX(Port2)

EBW

5700MHz

05/12/2019

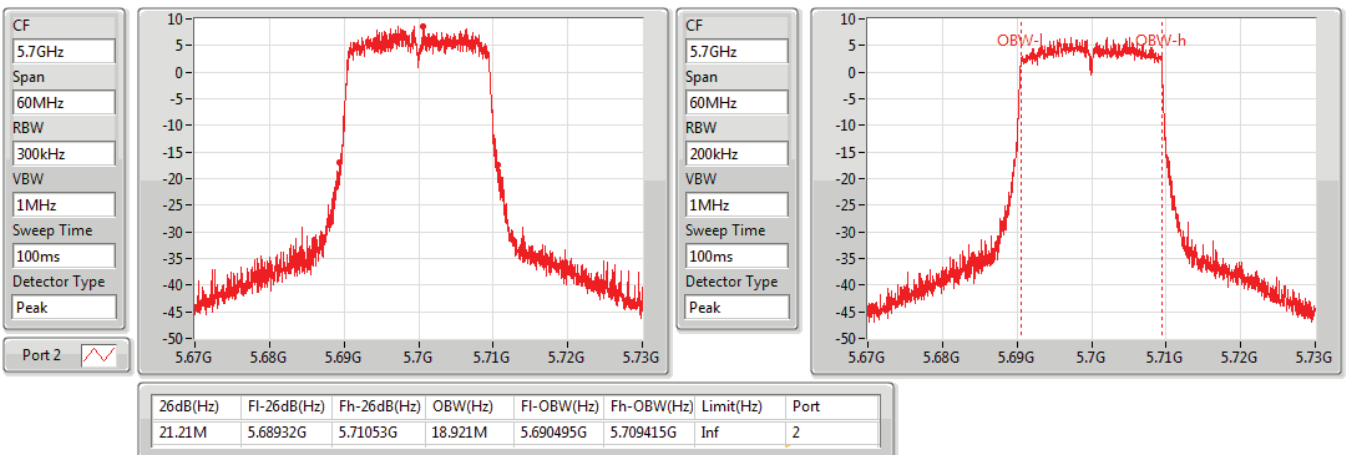

802.11ax HEW20\_Nss1,(MCS0)\_1TX(Port2)

EBW

5720MHz Straddle 5.47-5.725GHz

05/12/2019

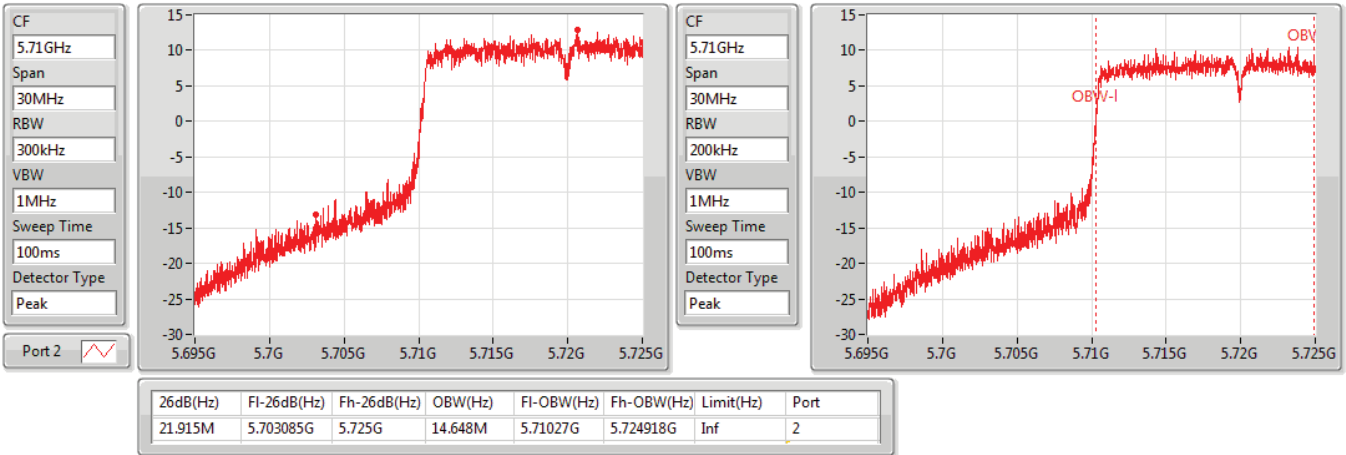

802.11ax HEW20\_Nss1,(MCS0)\_1TX(Port2)

EBW

5720MHz Straddle 5.725-5.85GHz

05/12/2019

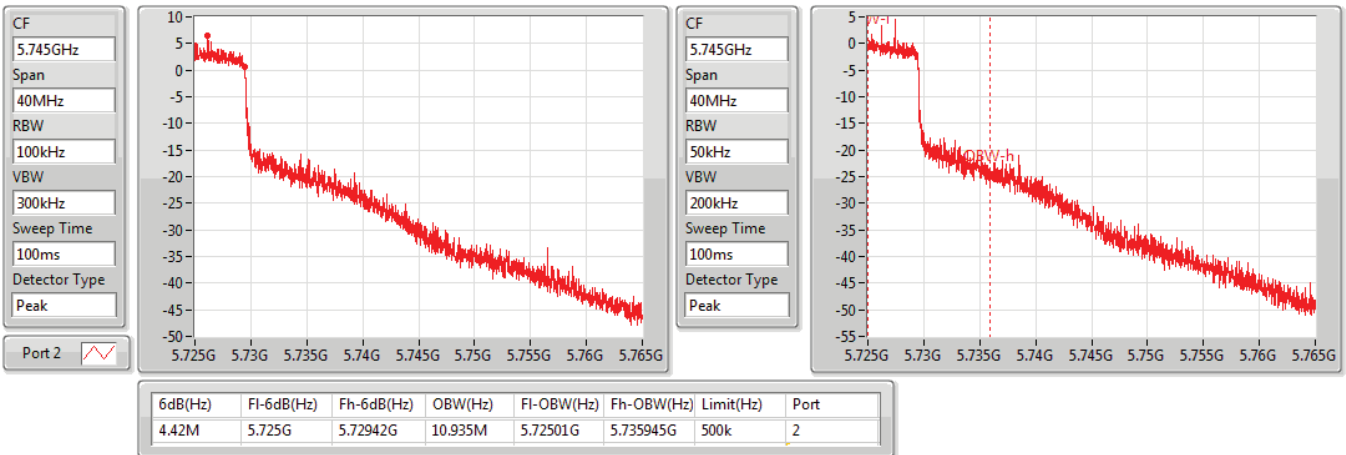

802.11ax HEW20\_Nss1,(MCS0)\_2TX

EBW

5260MHz

04/12/2019

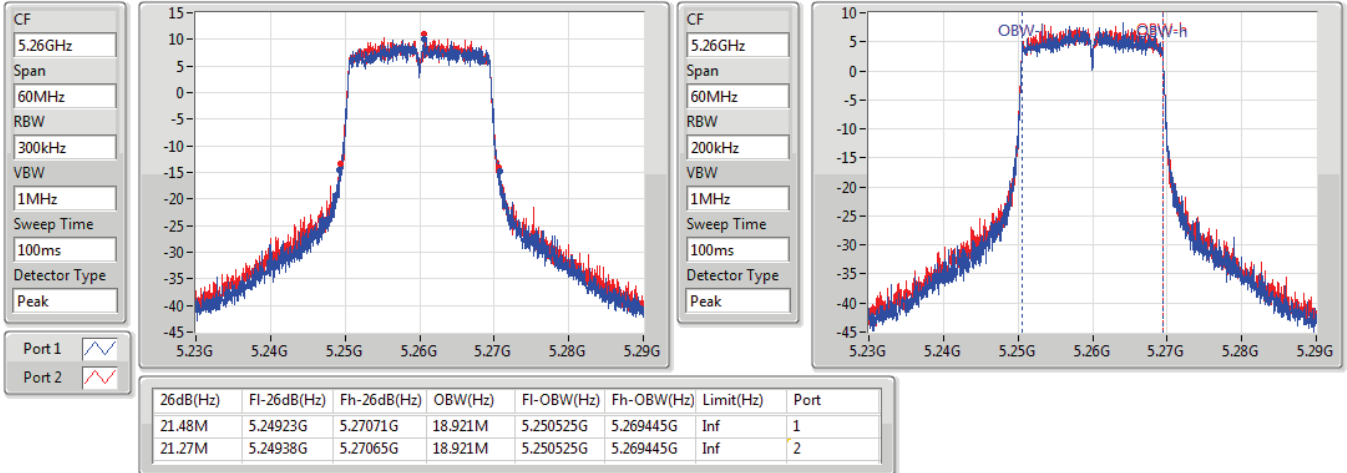

802.11ax HEW20\_Nss1,(MCS0)\_2TX

EBW

5300MHz

05/12/2019

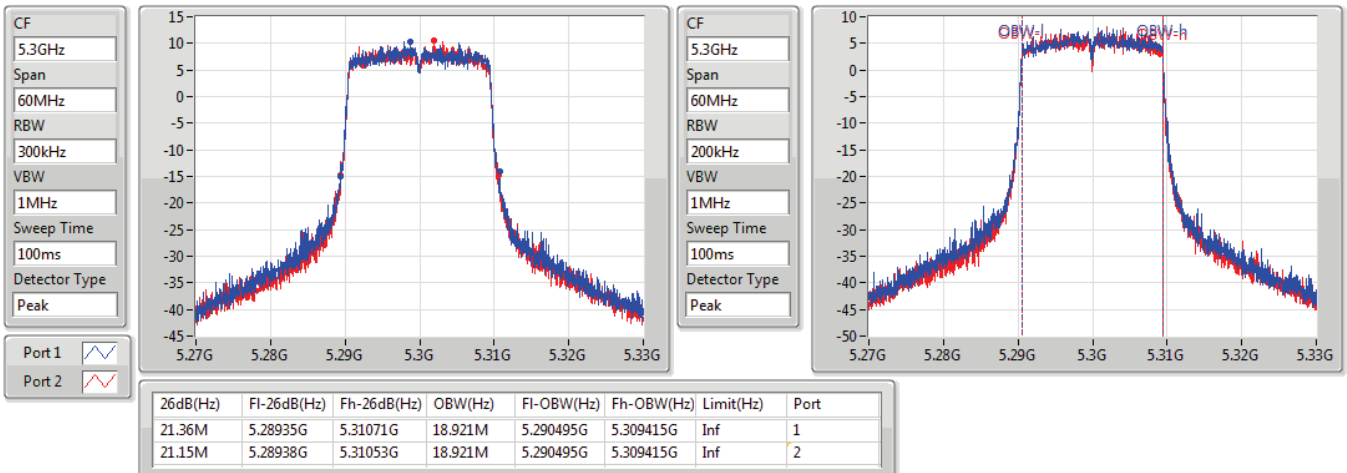

802.11ax HEW20\_Nss1,(MCS0)\_2TX

EBW

5320MHz

04/12/2019

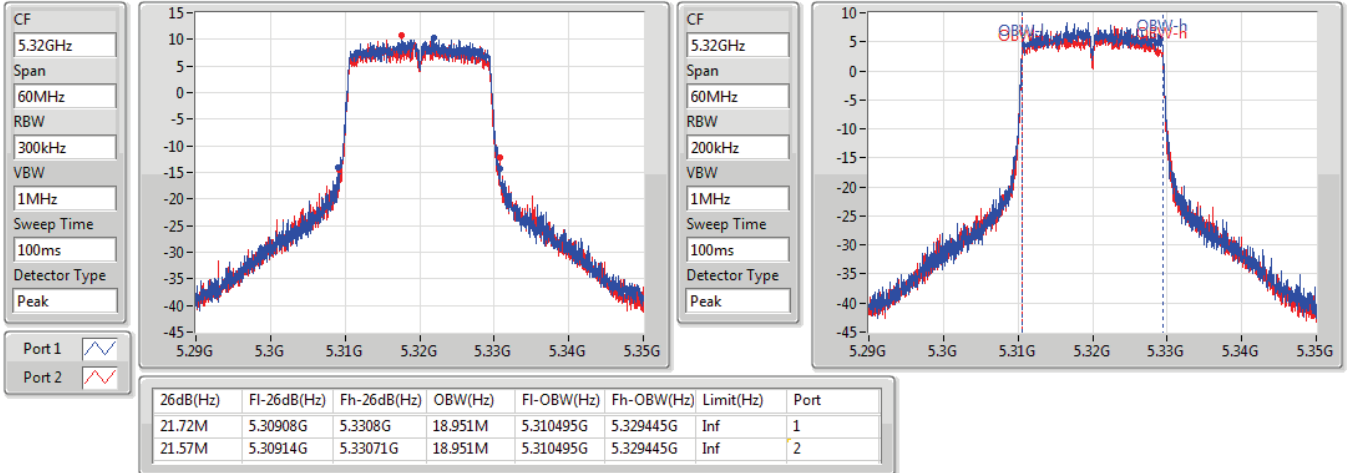

802.11ax HEW20\_Nss1,(MCS0)\_2TX

EBW

5500MHz

04/12/2019

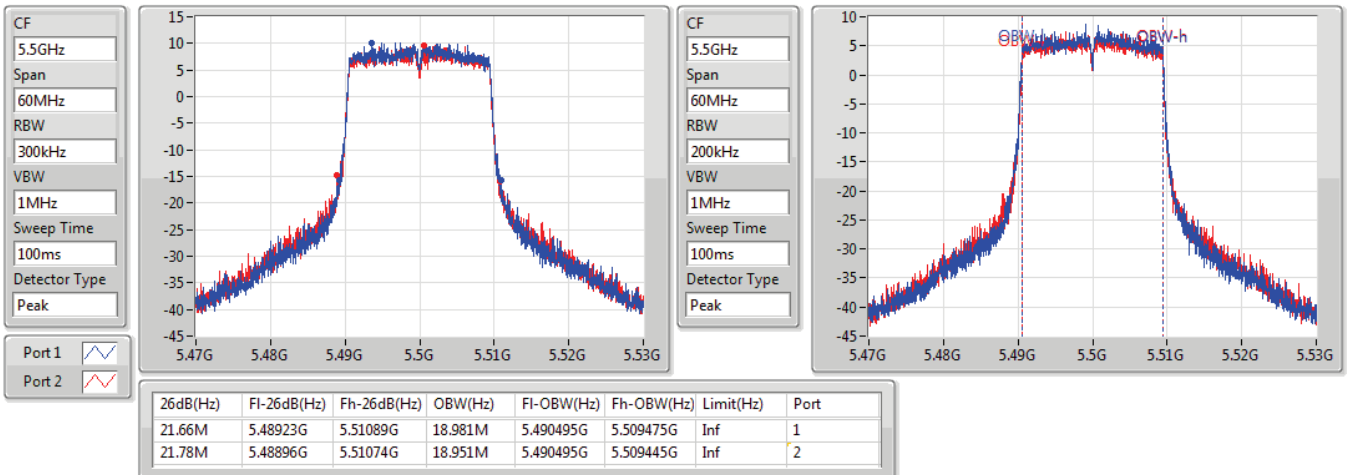



802.11ax HEW20\_Nss1,(MCS0)\_2TX

EBW

5580MHz

04/12/2019

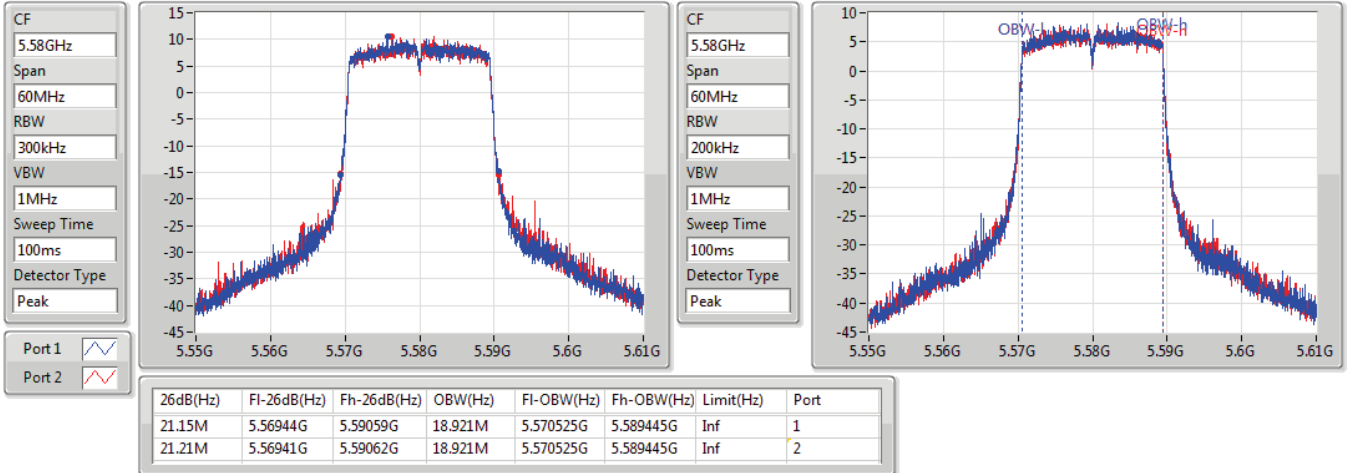

802.11ax HEW20\_Nss1,(MCS0)\_2TX

EBW

5700MHz

05/12/2019

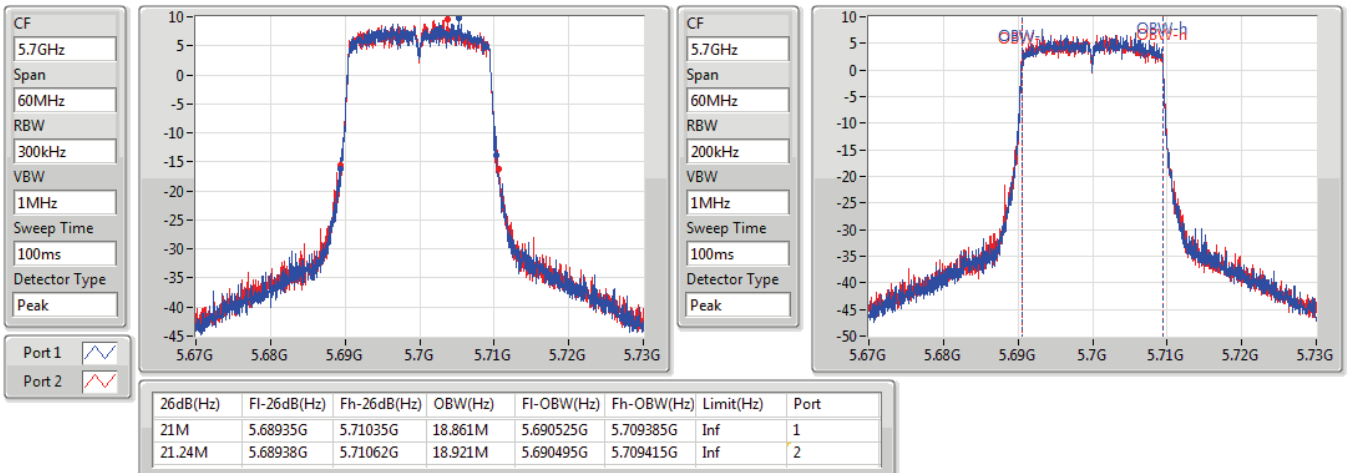

802.11ax HEW20\_Nss1,(MCS0)\_2TX

EBW

5720MHz Straddle 5.47-5.725GHz

04/12/2019

CF: 5.71GHz  
 Span: 30MHz  
 RBW: 300kHz  
 VBW: 1MHz  
 Sweep Time: 100ms  
 Detector Type: Peak

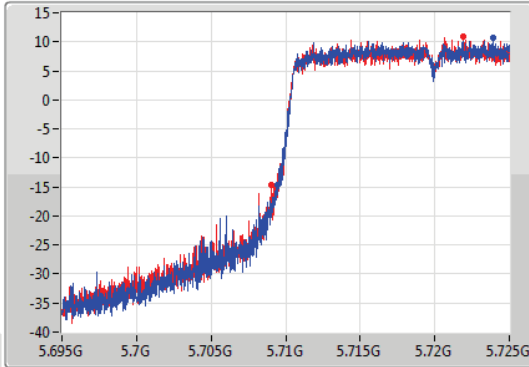

CF: 5.71GHz  
 Span: 30MHz  
 RBW: 200kHz  
 VBW: 1MHz  
 Sweep Time: 100ms  
 Detector Type: Peak

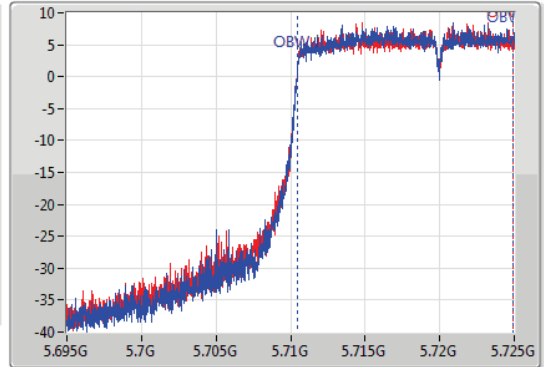

26dB(Hz)	Fl-26dB(Hz)	Fh-26dB(Hz)	OBW(Hz)	Fl-OBW(Hz)	Fh-OBW(Hz)	Limit(Hz)	Port
15.57M	5.70943G	5.725G	14.453M	5.71048G	5.724933G	Inf	1
15.945M	5.709055G	5.725G	14.438M	5.71048G	5.724918G	Inf	2

802.11ax HEW20\_Nss1,(MCS0)\_2TX

EBW

5720MHz Straddle 5.725-5.85GHz

04/12/2019

CF: 5.745GHz  
 Span: 40MHz  
 RBW: 100kHz  
 VBW: 300kHz  
 Sweep Time: 100ms  
 Detector Type: Peak

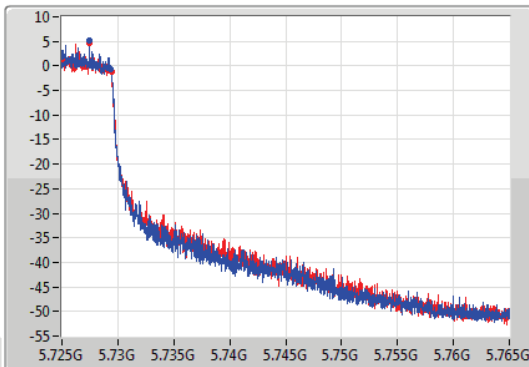

CF: 5.745GHz  
 Span: 40MHz  
 RBW: 50kHz  
 VBW: 200kHz  
 Sweep Time: 100ms  
 Detector Type: Peak

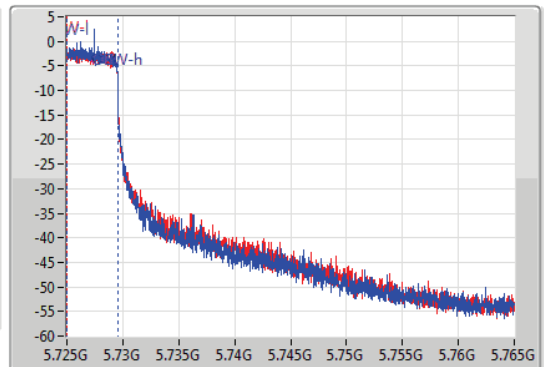

6dB(Hz)	Fl-6dB(Hz)	Fh-6dB(Hz)	OBW(Hz)	Fl-OBW(Hz)	Fh-OBW(Hz)	Limit(Hz)	Port
4.36M	5.725G	5.72936G	4.538M	5.72503G	5.729568G	500k	1
4.44M	5.725G	5.72944G	4.538M	5.72503G	5.729568G	500k	2

802.11ax HEW40\_Nss1,(MCS0)\_1TX(Port2)

EBW

5270MHz

05/12/2019

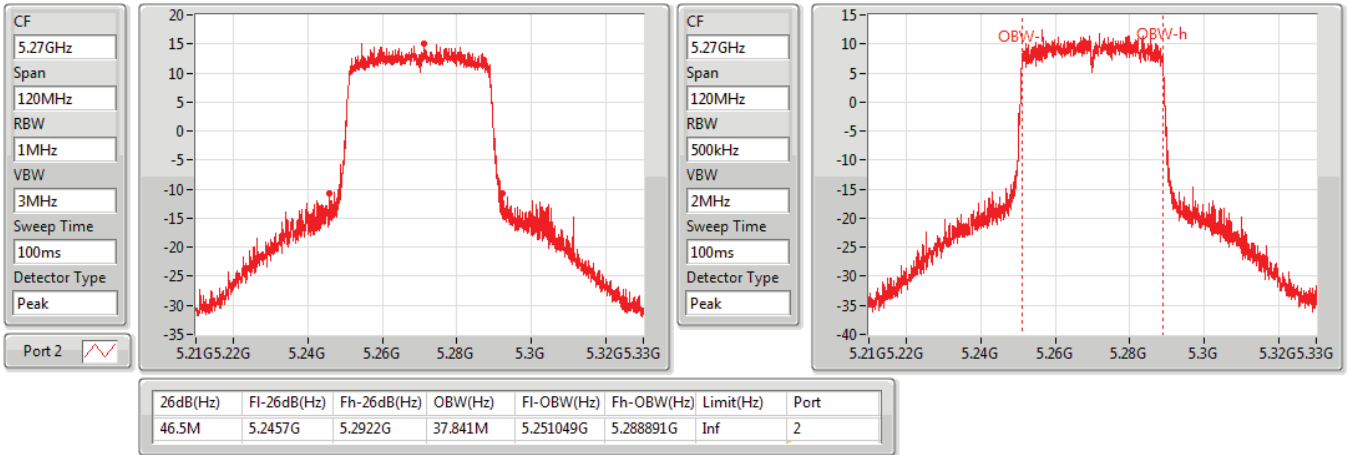

802.11ax HEW40\_Nss1,(MCS0)\_1TX(Port2)

EBW

5310MHz

05/12/2019

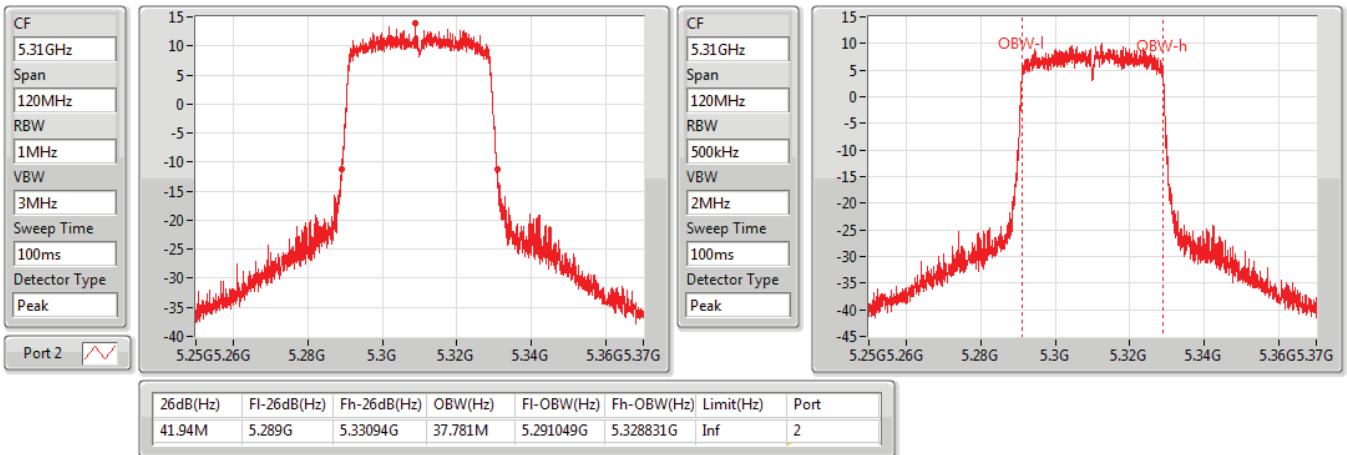

802.11ax HEW40\_Nss1,(MCS0)\_1TX(Port2)

EBW

5510MHz

05/12/2019

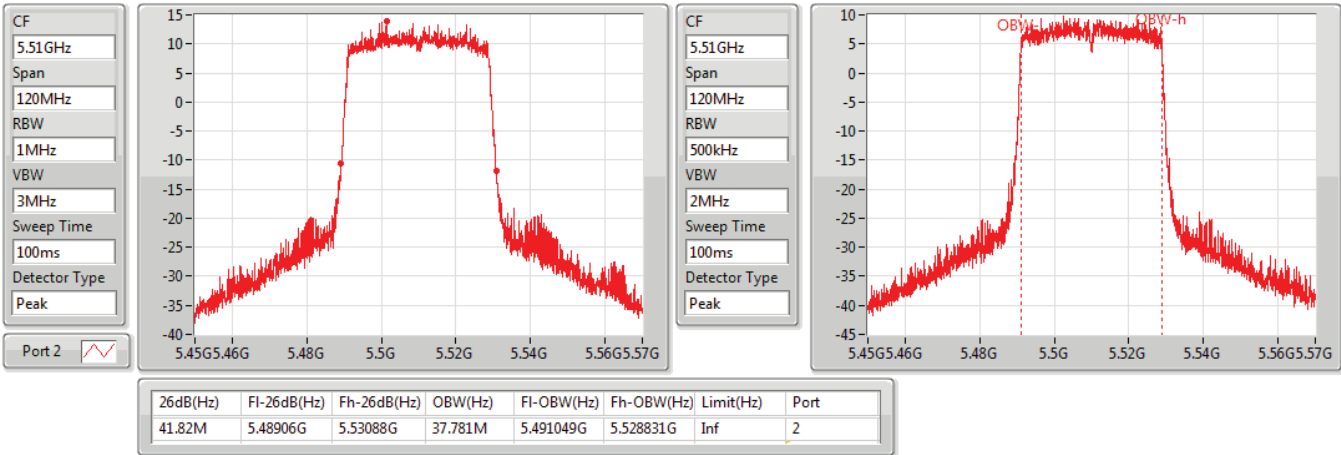

802.11ax HEW40\_Nss1,(MCS0)\_1TX(Port2)

EBW

5550MHz

05/12/2019

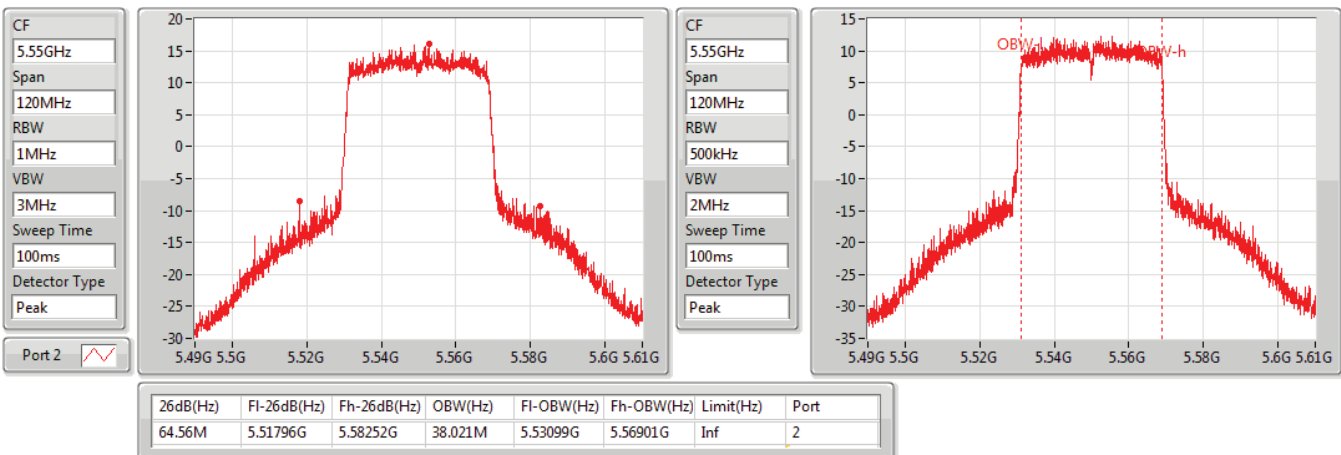

802.11ax HEW40\_Nss1,(MCS0)\_1TX(Port2)

EBW

5670MHz

05/12/2019

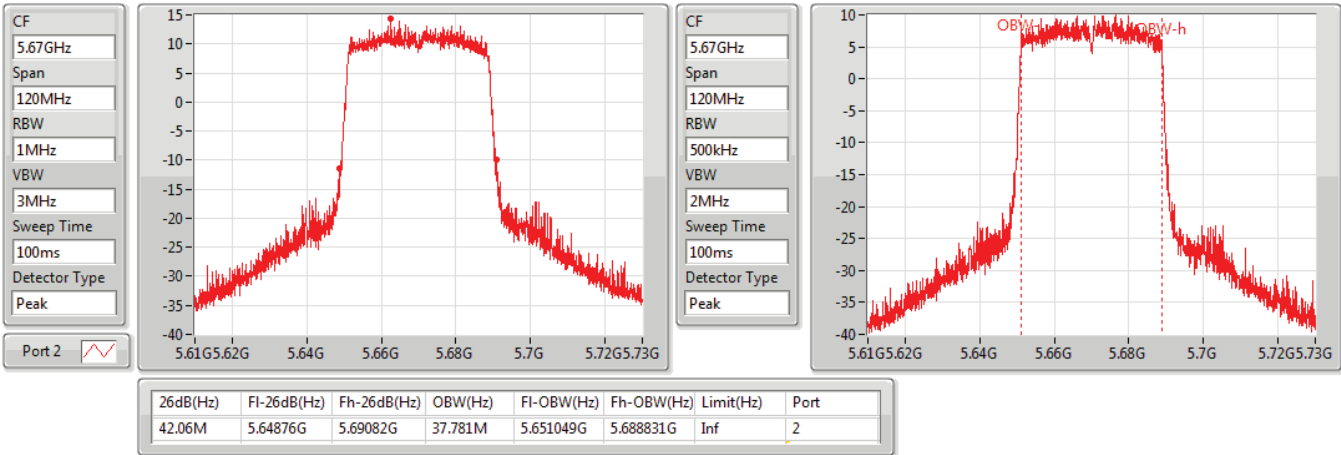

802.11ax HEW40\_Nss1,(MCS0)\_1TX(Port2)

EBW

5710MHz Straddle 5.47-5.725GHz

05/12/2019

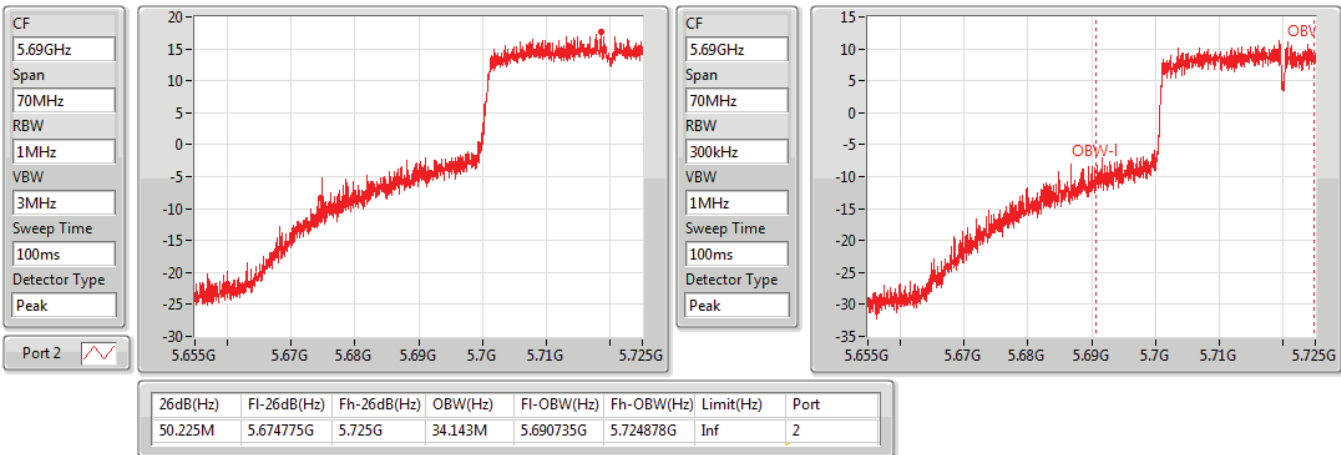

802.11ax HEW40\_Nss1,(MCS0)\_1TX(Port2)

EBW

5710MHz Straddle 5.725-5.85GHz

05/12/2019

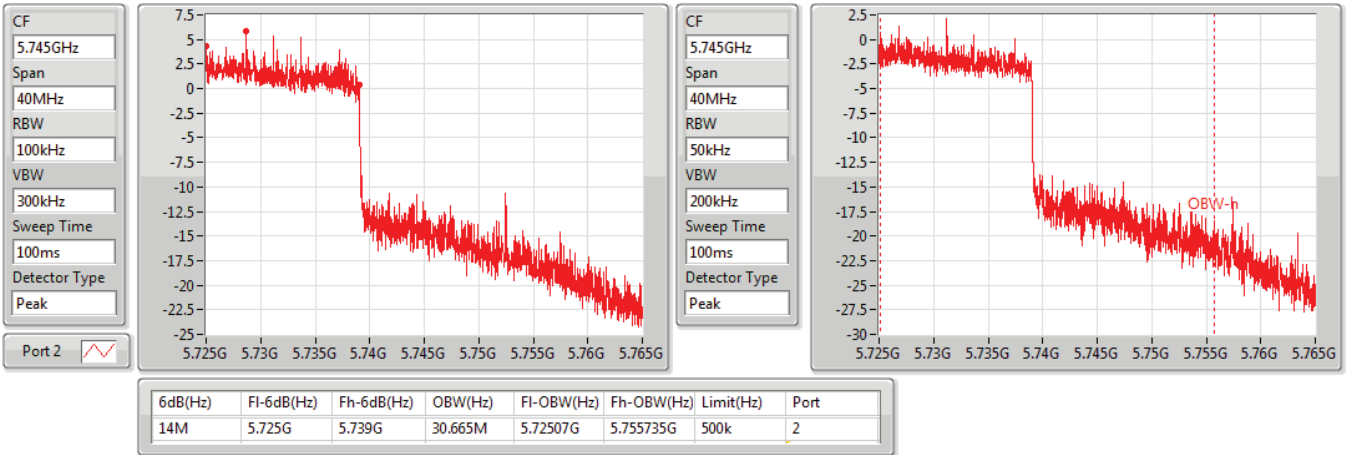

802.11ax HEW40\_Nss1,(MCS0)\_2TX

EBW

5270MHz

04/12/2019

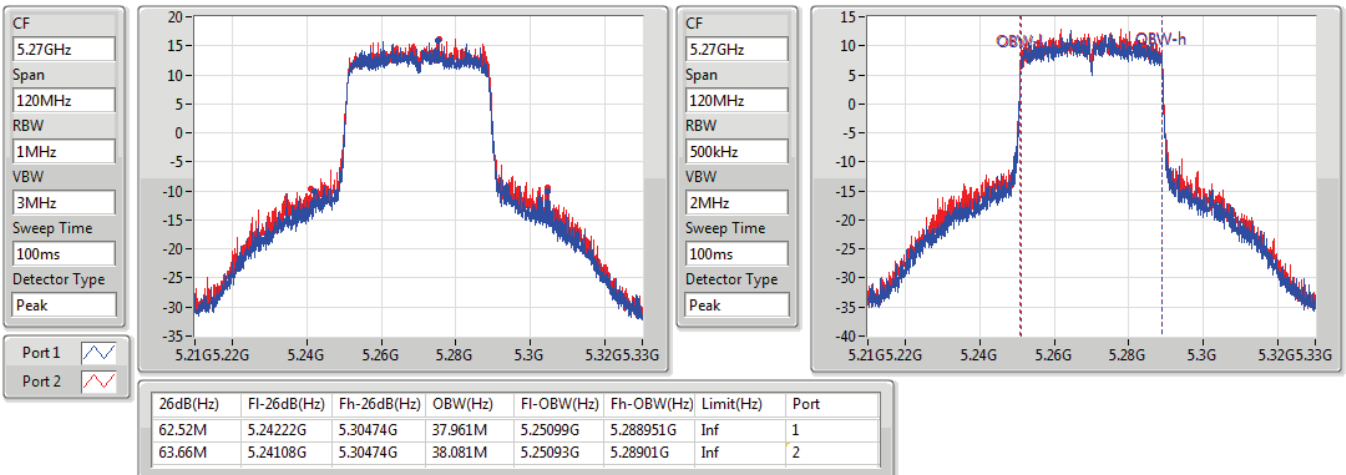

802.11ax HEW40\_Nss1,(MCS0)\_2TX

EBW

5310MHz

05/12/2019

CF  
5.31GHz  
Span  
120MHz  
RBW  
1MHz  
VBW  
3MHz  
Sweep Time  
100ms  
Detector Type  
Peak

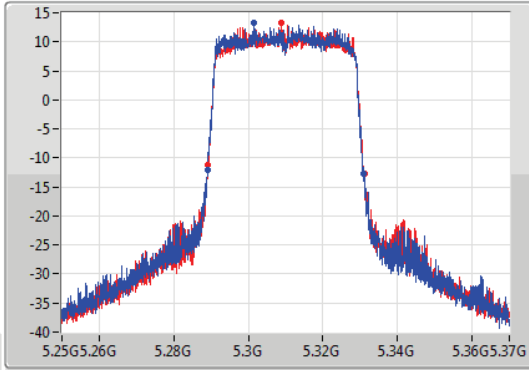

CF  
5.31GHz  
Span  
120MHz  
RBW  
500kHz  
VBW  
2MHz  
Sweep Time  
100ms  
Detector Type  
Peak

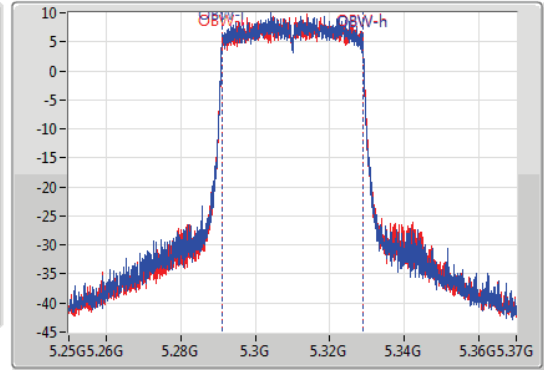

26dB(Hz)	Fl-26dB(Hz)	Fh-26dB(Hz)	OBW(Hz)	Fl-OBW(Hz)	Fh-OBW(Hz)	Limit(Hz)	Port
41.94M	5.28906G	5.331G	37.781M	5.291049G	5.328831G	Inf	1
42M	5.28906G	5.33106G	37.841M	5.291049G	5.328891G	Inf	2

802.11ax HEW40\_Nss1,(MCS0)\_2TX

EBW

5510MHz

05/12/2019

CF  
5.51GHz  
Span  
120MHz  
RBW  
1MHz  
VBW  
3MHz  
Sweep Time  
100ms  
Detector Type  
Peak

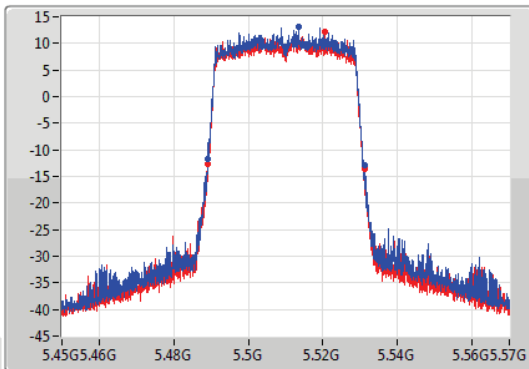

CF  
5.51GHz  
Span  
120MHz  
RBW  
500kHz  
VBW  
2MHz  
Sweep Time  
100ms  
Detector Type  
Peak

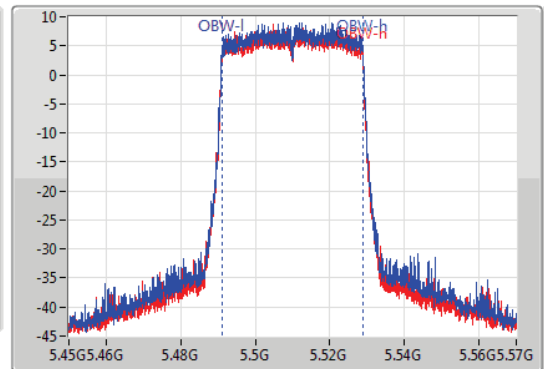

26dB(Hz)	Fl-26dB(Hz)	Fh-26dB(Hz)	OBW(Hz)	Fl-OBW(Hz)	Fh-OBW(Hz)	Limit(Hz)	Port
42M	5.48912G	5.53112G	37.781M	5.491049G	5.528831G	Inf	1
42M	5.48906G	5.53106G	37.781M	5.491049G	5.528831G	Inf	2

802.11ax HEW40\_Nss1,(MCS0)\_2TX

EBW

5550MHz

05/12/2019

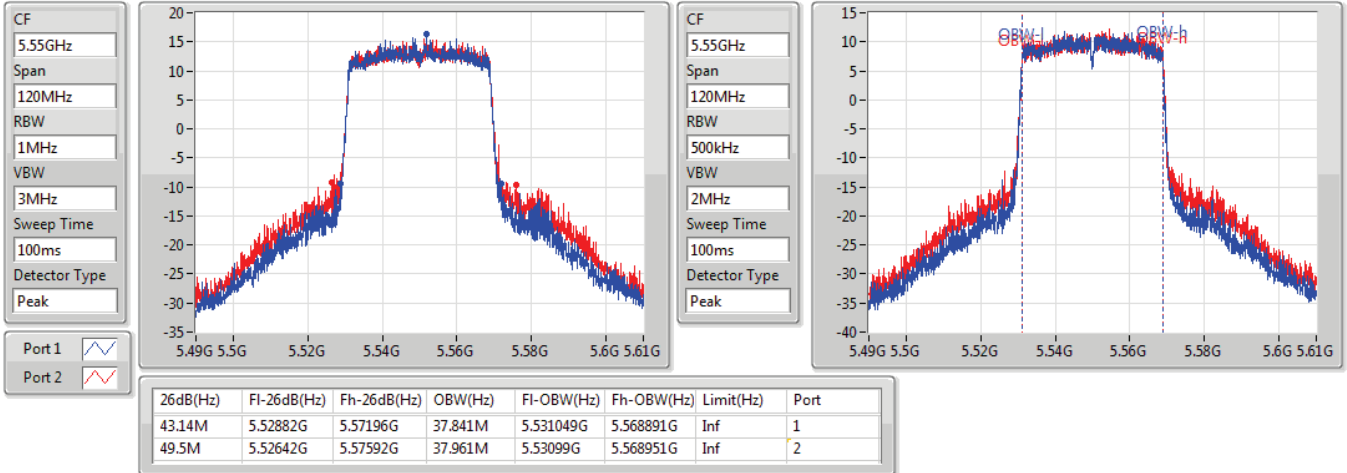

802.11ax HEW40\_Nss1,(MCS0)\_2TX

EBW

5670MHz

05/12/2019

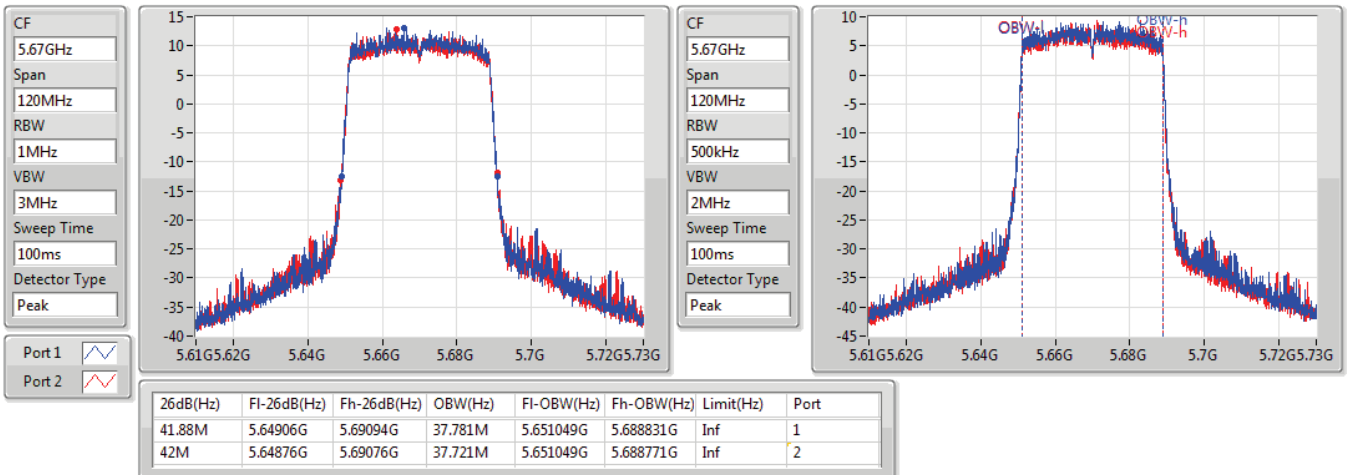



802.11ax HEW40\_Nss1,(MCS0)\_2TX

EBW

5710MHz Straddle 5.47-5.725GHz

05/12/2019

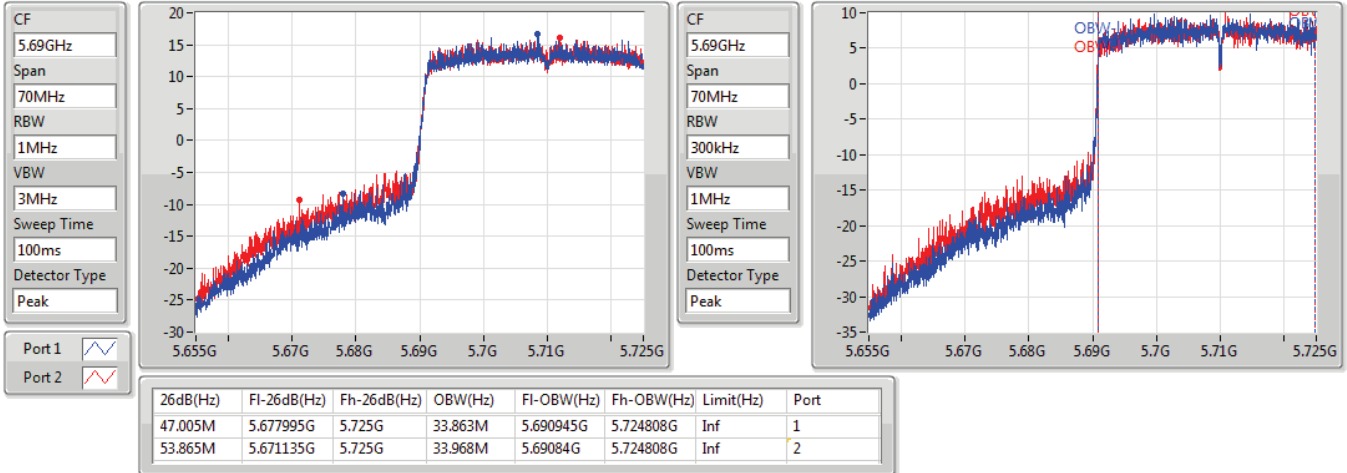

802.11ax HEW40\_Nss1,(MCS0)\_2TX

EBW

5710MHz Straddle 5.725-5.85GHz

05/12/2019

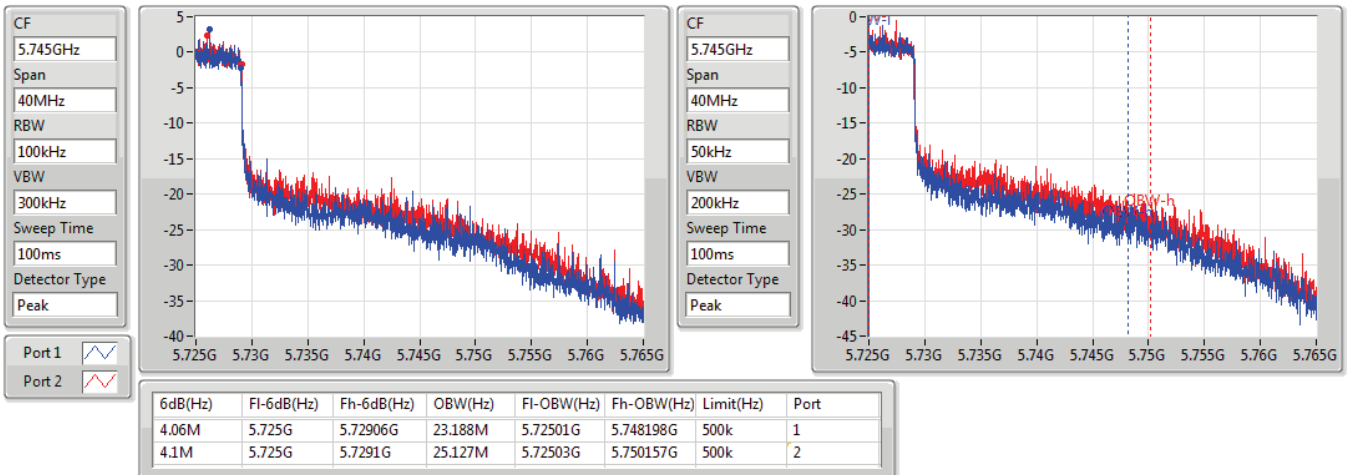

802.11ax HEW80\_Nss1,(MCS0)\_1TX(Port2)

EBW

5290MHz

05/12/2019

CF  
5.29GHz  
Span  
240MHz  
RBW  
2MHz  
VBW  
10MHz  
Sweep Time  
100ms  
Detector Type  
Peak  
Port 2

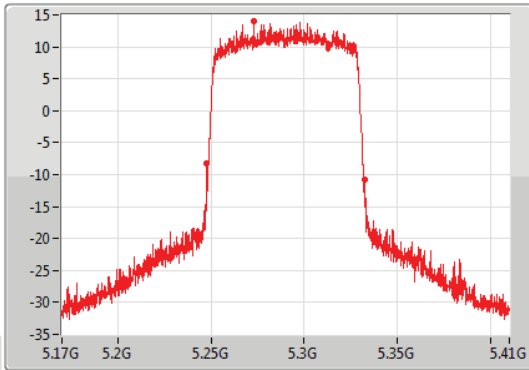

CF  
5.29GHz  
Span  
240MHz  
RBW  
1MHz  
VBW  
3MHz  
Sweep Time  
100ms  
Detector Type  
Peak

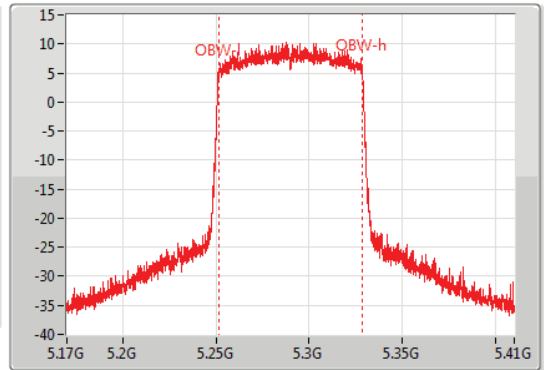

26dB(Hz)	Fl-26dB(Hz)	Fh-26dB(Hz)	OBW(Hz)	Fl-OBW(Hz)	Fh-OBW(Hz)	Limit(Hz)	Port
84.36M	5.24788G	5.33224G	77.241M	5.251379G	5.328621G	Inf	2

802.11ax HEW80\_Nss1,(MCS0)\_1TX(Port2)

EBW

5530MHz

05/12/2019

CF  
5.53GHz  
Span  
240MHz  
RBW  
2MHz  
VBW  
10MHz  
Sweep Time  
100ms  
Detector Type  
Peak  
Port 2

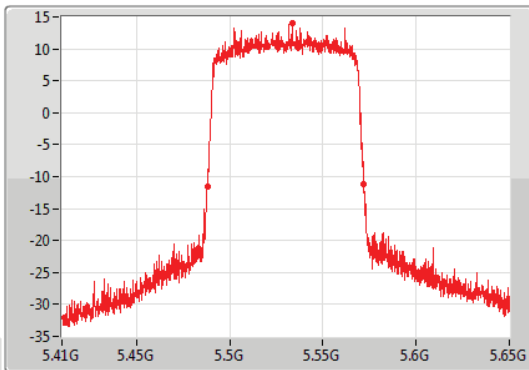

CF  
5.53GHz  
Span  
240MHz  
RBW  
1MHz  
VBW  
3MHz  
Sweep Time  
100ms  
Detector Type  
Peak

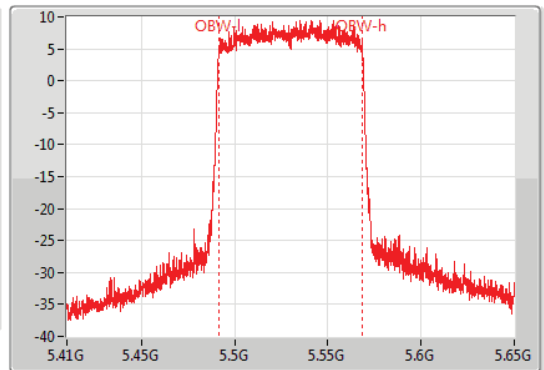

26dB(Hz)	Fl-26dB(Hz)	Fh-26dB(Hz)	OBW(Hz)	Fl-OBW(Hz)	Fh-OBW(Hz)	Limit(Hz)	Port
84M	5.488G	5.572G	77.121M	5.491379G	5.568501G	Inf	2

802.11ax HEW80\_Nss1,(MCS0)\_1TX(Port2)

EBW

5610MHz

05/12/2019

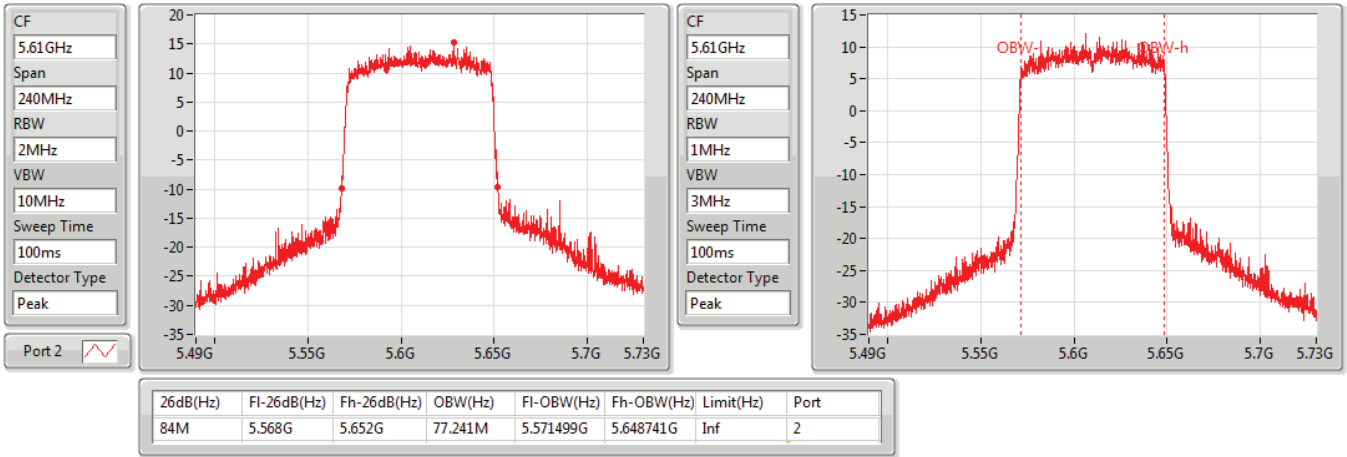

802.11ax HEW80\_Nss1,(MCS0)\_1TX(Port2)

EBW

5690MHz Straddle 5.47-5.725GHz

05/12/2019

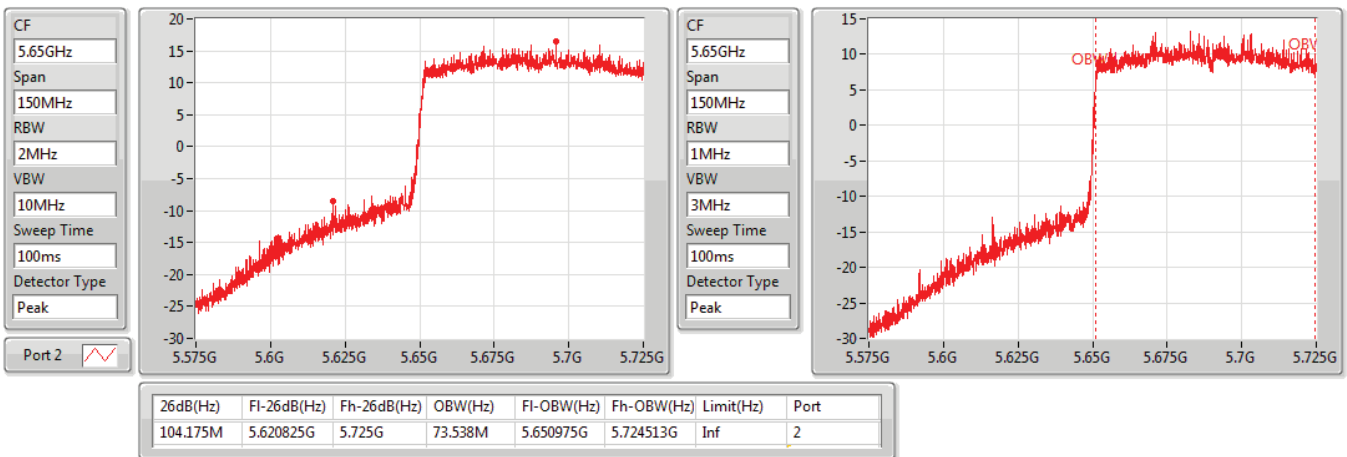

802.11ax HEW80\_Nss1,(MCS0)\_1TX(Port2)

EBW

5690MHz Straddle 5.725-5.85GHz

05/12/2019

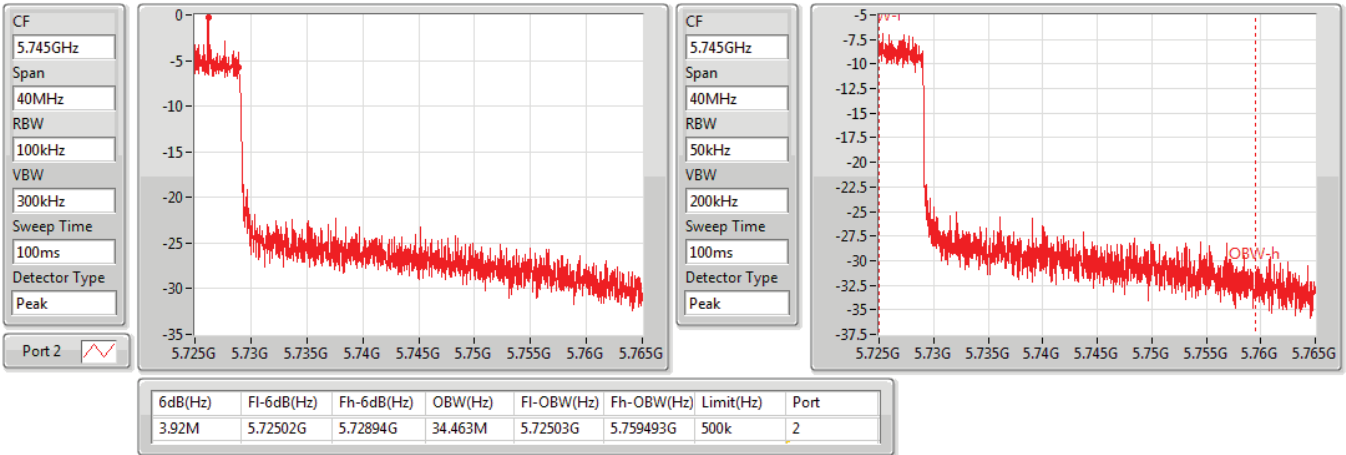

802.11ax HEW80\_Nss1,(MCS0)\_2TX

EBW

5290MHz

04/12/2019

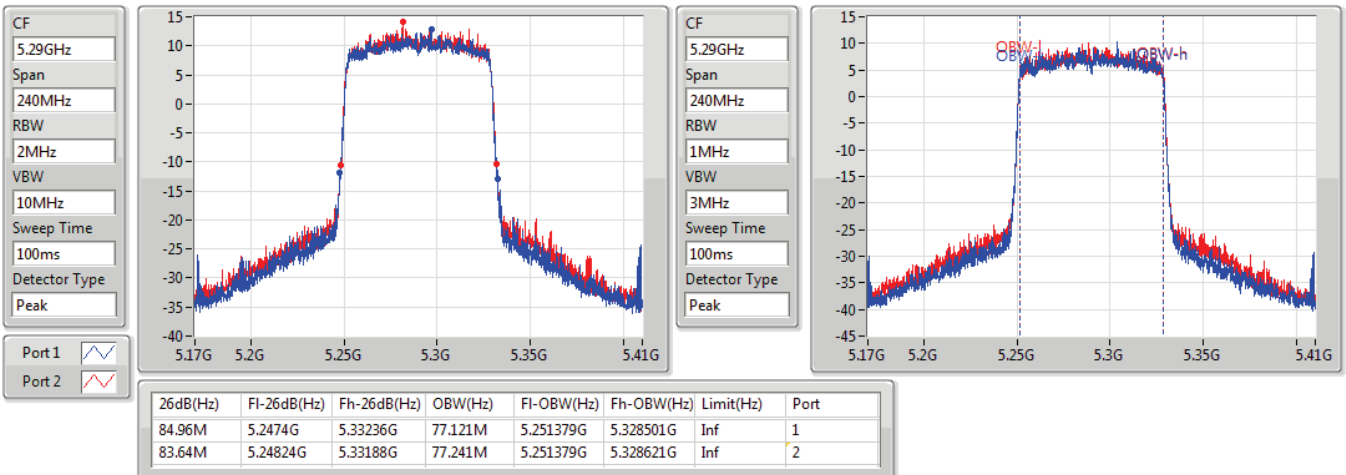

802.11ax HEW80\_Nss1,(MCS0)\_2TX

EBW

5530MHz

04/12/2019

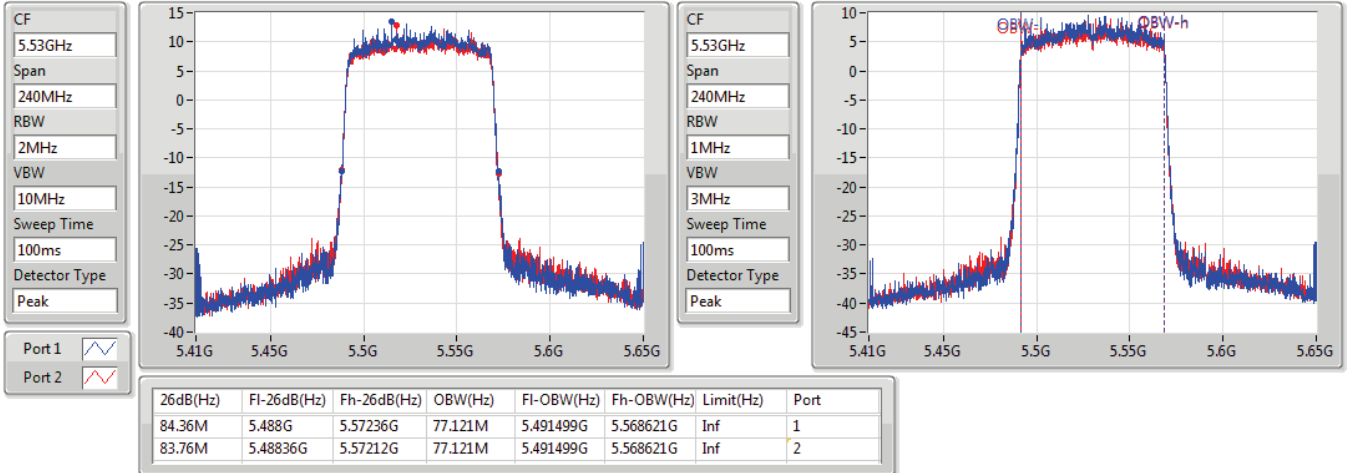

802.11ax HEW80\_Nss1,(MCS0)\_2TX

EBW

5610MHz

05/12/2019

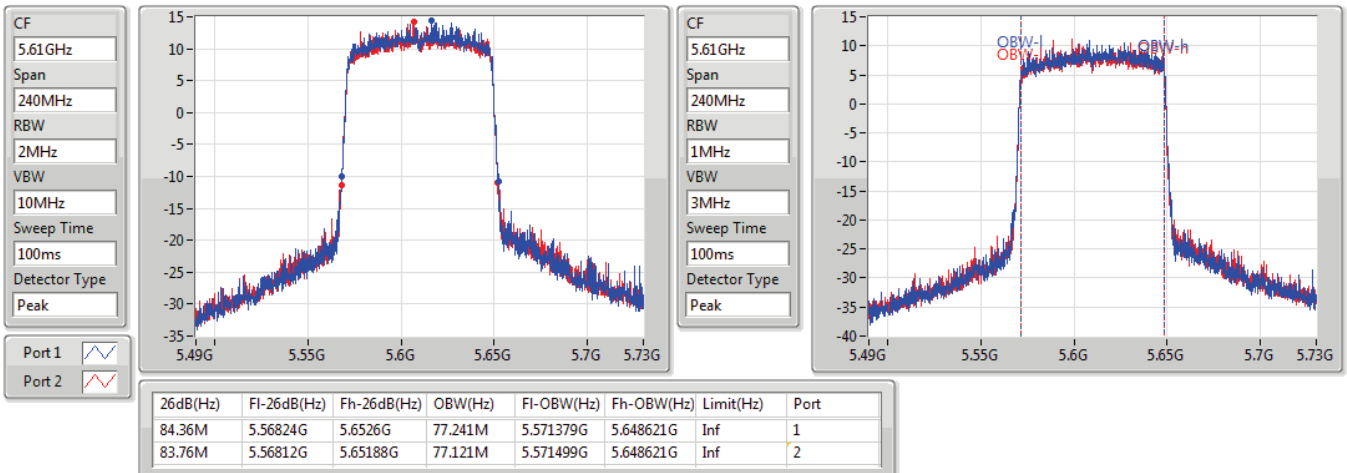

802.11ax HEW80\_Nss1,(MCS0)\_2TX

EBW

5690MHz Straddle 5.47-5.725GHz

05/12/2019

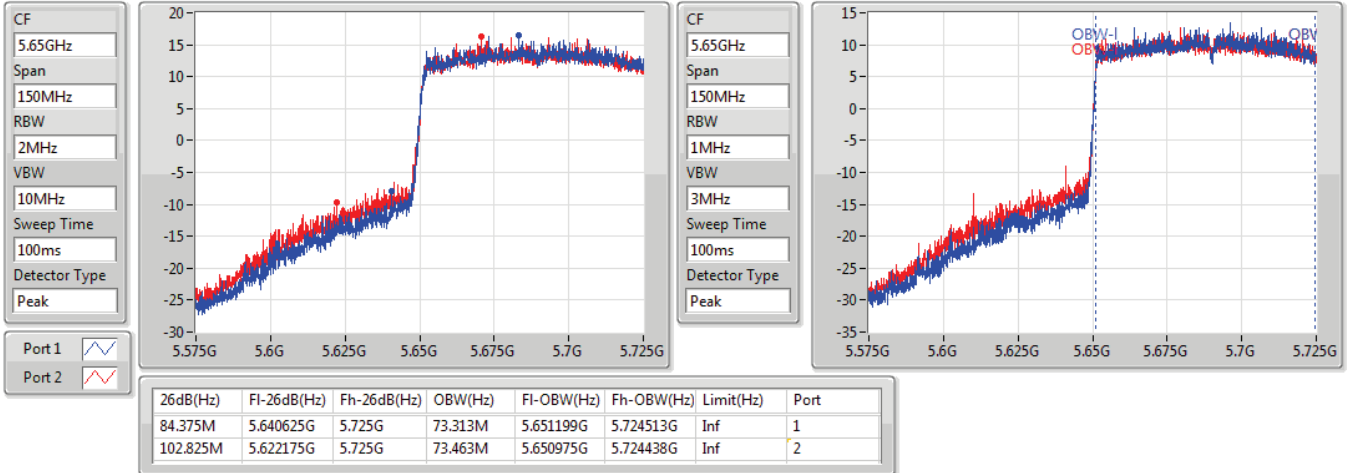

802.11ax HEW80\_Nss1,(MCS0)\_2TX

EBW

5690MHz Straddle 5.725-5.85GHz

05/12/2019

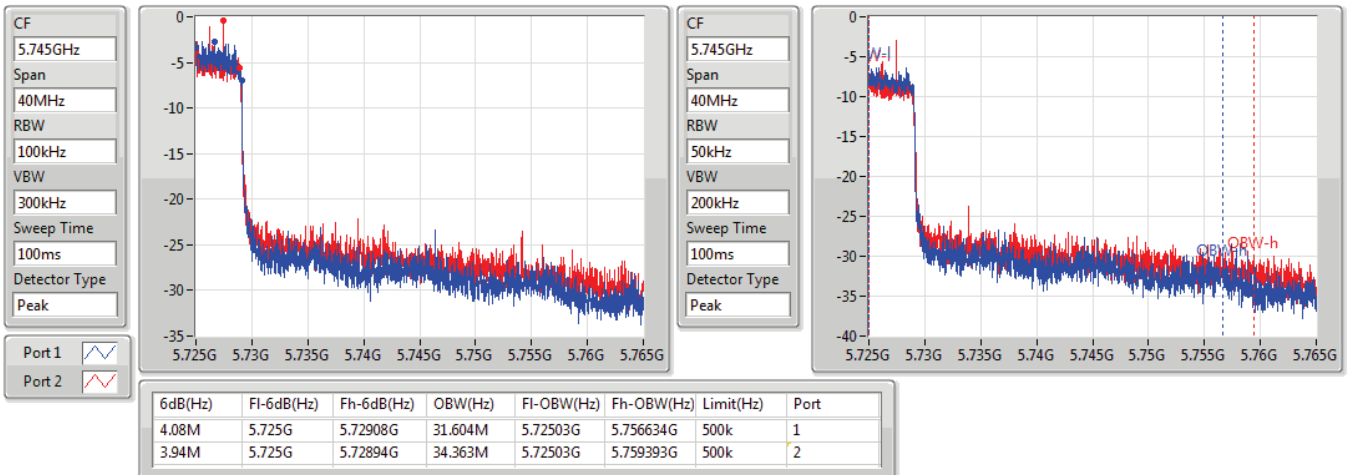



Summary

Mode	Max-N dB (Hz)	Max-OBW (Hz)	ITU-Code	Min-N dB (Hz)	Min-OBW (Hz)
5.25-5.35GHz	-	-	-	-	-
802.11a_Nss1,(6Mbps)_1TX(Port2)	21.27M	16.432M	16M4D1D	19.59M	16.372M
802.11a_Nss1,(6Mbps)_2TX	19.44M	16.402M	16M4D1D	19.32M	16.342M
802.11ac VHT20_Nss1,(MCS0)_1TX(Port2)	21.51M	17.601M	17M6D1D	20.79M	17.541M
802.11ac VHT20_Nss1,(MCS0)_2TX	20.76M	17.571M	17M6D1D	20.4M	17.511M
802.11ac VHT40_Nss1,(MCS0)_1TX(Port2)	42.72M	36.162M	36M2D1D	41.52M	36.162M
802.11ac VHT40_Nss1,(MCS0)_2TX	41.7M	36.162M	36M2D1D	41.28M	36.042M
802.11ac VHT80_Nss1,(MCS0)_1TX(Port2)	83.16M	75.322M	75M3D1D	83.16M	75.322M
802.11ac VHT80_Nss1,(MCS0)_2TX	83.64M	75.322M	75M3D1D	83.04M	75.322M
802.11ax HEW20_Nss1,(MCS0)_1TX(Port2)	22.71M	18.951M	19MOD1D	21.48M	18.921M
802.11ax HEW20_Nss1,(MCS0)_2TX	21.27M	18.951M	19MOD1D	21M	18.861M
802.11ax HEW40_Nss1,(MCS0)_1TX(Port2)	42.24M	37.781M	37M8D1D	41.88M	37.721M
802.11ax HEW40_Nss1,(MCS0)_2TX	42M	37.781M	37M8D1D	41.58M	37.721M
802.11ax HEW80_Nss1,(MCS0)_1TX(Port2)	84.36M	77.121M	77M1D1D	84.36M	77.121M
802.11ax HEW80_Nss1,(MCS0)_2TX	84.24M	77.241M	77M2D1D	84.12M	77.121M
5.47-5.725GHz	-	-	-	-	-
802.11a_Nss1,(6Mbps)_1TX(Port2)	20.49M	16.402M	16M4D1D	15.375M	13.283M
802.11a_Nss1,(6Mbps)_2TX	19.47M	16.372M	16M4D1D	14.79M	13.238M
802.11ac VHT20_Nss1,(MCS0)_1TX(Port2)	22.44M	17.601M	17M6D1D	15.855M	13.823M
802.11ac VHT20_Nss1,(MCS0)_2TX	20.79M	17.571M	17M6D1D	15.21M	13.793M
802.11ac VHT40_Nss1,(MCS0)_1TX(Port2)	43.02M	36.222M	36M2D1D	36.68M	32.919M
802.11ac VHT40_Nss1,(MCS0)_2TX	41.64M	36.162M	36M2D1D	35.49M	32.884M
802.11ac VHT80_Nss1,(MCS0)_1TX(Port2)	95.775M	75.322M	75M3D1D	83.28M	72.264M
802.11ac VHT80_Nss1,(MCS0)_2TX	83.64M	75.442M	75M4D1D	76.8M	72.264M
802.11ax HEW20_Nss1,(MCS0)_1TX(Port2)	21.75M	18.921M	18M9D1D	15.72M	14.483M
802.11ax HEW20_Nss1,(MCS0)_2TX	21.63M	18.921M	18M9D1D	15.57M	14.468M
802.11ax HEW40_Nss1,(MCS0)_1TX(Port2)	42.42M	37.841M	37M8D1D	36.645M	33.758M
802.11ax HEW40_Nss1,(MCS0)_2TX	42.24M	37.781M	37M8D1D	35.98M	33.688M
802.11ax HEW80_Nss1,(MCS0)_1TX(Port2)	84.72M	77.241M	77M2D1D	78.15M	73.238M
802.11ax HEW80_Nss1,(MCS0)_2TX	84.36M	77.241M	77M2D1D	77.325M	73.163M
5.725-5.85GHz	-	-	-	-	-
802.11a_Nss1,(6Mbps)_1TX(Port2)	3.12M	3.778M	3M78D1D	3.12M	3.778M
802.11a_Nss1,(6Mbps)_2TX	3.12M	3.398M	3M40D1D	3.1M	3.378M
802.11ac VHT20_Nss1,(MCS0)_1TX(Port2)	3.72M	3.978M	3M98D1D	3.72M	3.978M
802.11ac VHT20_Nss1,(MCS0)_2TX	3.74M	3.918M	3M92D1D	3.72M	3.898M
802.11ac VHT40_Nss1,(MCS0)_1TX(Port2)	3.1M	3.778M	3M78D1D	3.1M	3.778M
802.11ac VHT40_Nss1,(MCS0)_2TX	3.12M	3.478M	3M48D1D	3.1M	3.458M
802.11ac VHT80_Nss1,(MCS0)_1TX(Port2)	3.2M	15.072M	15M1D1D	3.2M	15.072M
802.11ac VHT80_Nss1,(MCS0)_2TX	3.2M	3.778M	3M78D1D	3.1M	3.658M
802.11ax HEW20_Nss1,(MCS0)_1TX(Port2)	4.44M	4.538M	4M54D1D	4.44M	4.538M
802.11ax HEW20_Nss1,(MCS0)_2TX	4.5M	4.518M	4M52D1D	4.42M	4.518M
802.11ax HEW40_Nss1,(MCS0)_1TX(Port2)	3.98M	4.558M	4M56D1D	3.98M	4.558M
802.11ax HEW40_Nss1,(MCS0)_2TX	4.04M	4.058M	4M06D1D	4.02M	4.058M
802.11ax HEW80_Nss1,(MCS0)_1TX(Port2)	4.1M	17.191M	17M2D1D	4.1M	17.191M



Mode	Max-N dB (Hz)	Max-OBW (Hz)	ITU-Code	Min-N dB (Hz)	Min-OBW (Hz)
802.11ax HEW80_Nss1,(MCS0)_2TX	4.06M	4.098M	4M10D1D	4.04M	4.098M

**Max-N dB** = Maximum 6dB down bandwidth for 5.725-5.85GHz band / Maximum 26dB down bandwidth for other band;

**Max-OBW** = Maximum 99% occupied bandwidth;

**Min-N dB** = Minimum 6dB down bandwidth for 5.725-5.85GHz band / Maximum 26dB down bandwidth for other band;

**Min-OBW** = Minimum 99% occupied bandwidth;





Result

Mode	Result	Limit (Hz)	Port 1-N dB (Hz)	Port 1-OBW (Hz)	Port 2-N dB (Hz)	Port 2-OBW (Hz)
802.11a_Nss1,(6Mbps)_1TX(Port2)	-	-	-	-	-	-
5260MHz_TnomVnom	Pass	Inf			21.27M	16.432M
5300MHz_TnomVnom	Pass	Inf			20.7M	16.432M
5320MHz_TnomVnom	Pass	Inf			19.59M	16.372M
5500MHz_TnomVnom	Pass	Inf			19.77M	16.372M
5580MHz_TnomVnom	Pass	Inf			20.49M	16.402M
5700MHz_TnomVnom	Pass	Inf			19.53M	16.372M
5720MHz Straddle 5.47-5.725GHz_TnomVnom	Pass	Inf			15.375M	13.283M
5720MHz Straddle 5.725-5.85GHz_TnomVnom	Pass	500k			3.12M	3.778M
802.11a_Nss1,(6Mbps)_2TX	-	-	-	-	-	-
5260MHz_TnomVnom	Pass	Inf	19.32M	16.372M	19.38M	16.372M
5300MHz_TnomVnom	Pass	Inf	19.44M	16.372M	19.41M	16.372M
5320MHz_TnomVnom	Pass	Inf	19.44M	16.342M	19.35M	16.402M
5500MHz_TnomVnom	Pass	Inf	19.38M	16.372M	19.44M	16.342M
5580MHz_TnomVnom	Pass	Inf	19.41M	16.372M	19.44M	16.372M
5700MHz_TnomVnom	Pass	Inf	19.26M	16.372M	19.47M	16.372M
5720MHz Straddle 5.47-5.725GHz_TnomVnom	Pass	Inf	14.91M	13.253M	14.79M	13.238M
5720MHz Straddle 5.725-5.85GHz_TnomVnom	Pass	500k	3.1M	3.398M	3.12M	3.378M
802.11ac_VHT20_Nss1,(MCS0)_1TX(Port2)	-	-	-	-	-	-
5260MHz_TnomVnom	Pass	Inf			21.51M	17.601M
5300MHz_TnomVnom	Pass	Inf			21.03M	17.601M
5320MHz_TnomVnom	Pass	Inf			20.79M	17.541M
5500MHz_TnomVnom	Pass	Inf			20.94M	17.571M
5580MHz_TnomVnom	Pass	Inf			22.44M	17.601M
5700MHz_TnomVnom	Pass	Inf			20.85M	17.571M
5720MHz Straddle 5.47-5.725GHz_TnomVnom	Pass	Inf			15.855M	13.823M
5720MHz Straddle 5.725-5.85GHz_TnomVnom	Pass	500k			3.72M	3.978M
802.11ac_VHT20_Nss1,(MCS0)_2TX	-	-	-	-	-	-
5260MHz_TnomVnom	Pass	Inf	20.58M	17.541M	20.76M	17.571M
5300MHz_TnomVnom	Pass	Inf	20.73M	17.571M	20.55M	17.511M
5320MHz_TnomVnom	Pass	Inf	20.73M	17.571M	20.4M	17.541M
5500MHz_TnomVnom	Pass	Inf	20.79M	17.541M	20.7M	17.541M
5580MHz_TnomVnom	Pass	Inf	20.55M	17.571M	20.58M	17.541M
5700MHz_TnomVnom	Pass	Inf	20.73M	17.571M	20.73M	17.541M
5720MHz Straddle 5.47-5.725GHz_TnomVnom	Pass	Inf	15.39M	13.808M	15.21M	13.793M
5720MHz Straddle 5.725-5.85GHz_TnomVnom	Pass	500k	3.74M	3.918M	3.72M	3.898M
802.11ac_VHT40_Nss1,(MCS0)_1TX(Port2)	-	-	-	-	-	-
5270MHz_TnomVnom	Pass	Inf			42.72M	36.162M
5310MHz_TnomVnom	Pass	Inf			41.52M	36.162M
5510MHz_TnomVnom	Pass	Inf			41.64M	36.102M
5550MHz_TnomVnom	Pass	Inf			43.02M	36.222M
5670MHz_TnomVnom	Pass	Inf			41.34M	36.102M
5710MHz Straddle 5.47-5.725GHz_TnomVnom	Pass	Inf			36.68M	32.919M
5710MHz Straddle 5.725-5.85GHz_TnomVnom	Pass	500k			3.1M	3.778M



**EBW\_Group 4\_Non-Beamforming**

**Appendix A.4**

Mode	Result	Limit (Hz)	Port 1-N dB (Hz)	Port 1-OBW (Hz)	Port 2-N dB (Hz)	Port 2-OBW (Hz)
802.11ac VHT40_Nss1,(MCS0)_2TX	-	-	-	-	-	-
5270MHz_TnomVnom	Pass	Inf	41.64M	36.102M	41.28M	36.162M
5310MHz_TnomVnom	Pass	Inf	41.7M	36.162M	41.28M	36.042M
5510MHz_TnomVnom	Pass	Inf	41.58M	36.162M	41.16M	36.102M
5550MHz_TnomVnom	Pass	Inf	41.46M	36.102M	41.64M	36.102M
5670MHz_TnomVnom	Pass	Inf	41.52M	36.102M	41.16M	36.102M
5710MHz Straddle 5.47-5.725GHz_TnomVnom	Pass	Inf	36.015M	32.884M	35.49M	32.919M
5710MHz Straddle 5.725-5.85GHz_TnomVnom	Pass	500k	3.12M	3.478M	3.1M	3.458M
802.11ac VHT80_Nss1,(MCS0)_1TX(Port2)	-	-	-	-	-	-
5290MHz_TnomVnom	Pass	Inf			83.16M	75.322M
5530MHz_TnomVnom	Pass	Inf			83.76M	75.322M
5610MHz_TnomVnom	Pass	Inf			83.28M	75.322M
5690MHz Straddle 5.47-5.725GHz_TnomVnom	Pass	Inf			95.775M	72.264M
5690MHz Straddle 5.725-5.85GHz_TnomVnom	Pass	500k			3.2M	15.072M
802.11ac VHT80_Nss1,(MCS0)_2TX	-	-	-	-	-	-
5290MHz_TnomVnom	Pass	Inf	83.64M	75.322M	83.04M	75.322M
5530MHz_TnomVnom	Pass	Inf	83.64M	75.322M	83.16M	75.442M
5610MHz_TnomVnom	Pass	Inf	83.52M	75.322M	83.16M	75.322M
5690MHz Straddle 5.47-5.725GHz_TnomVnom	Pass	Inf	76.875M	72.264M	76.8M	72.264M
5690MHz Straddle 5.725-5.85GHz_TnomVnom	Pass	500k	3.2M	3.658M	3.1M	3.778M
802.11ax HEW20_Nss1,(MCS0)_1TX(Port2)	-	-	-	-	-	-
5260MHz_TnomVnom	Pass	Inf			21.48M	18.951M
5300MHz_TnomVnom	Pass	Inf			22.71M	18.921M
5320MHz_TnomVnom	Pass	Inf			21.51M	18.921M
5500MHz_TnomVnom	Pass	Inf			21.66M	18.921M
5580MHz_TnomVnom	Pass	Inf			21.75M	18.921M
5700MHz_TnomVnom	Pass	Inf			21.45M	18.921M
5720MHz Straddle 5.47-5.725GHz_TnomVnom	Pass	Inf			15.72M	14.483M
5720MHz Straddle 5.725-5.85GHz_TnomVnom	Pass	500k			4.44M	4.538M
802.11ax HEW20_Nss1,(MCS0)_2TX	-	-	-	-	-	-
5260MHz_TnomVnom	Pass	Inf	21.24M	18.921M	21.09M	18.921M
5300MHz_TnomVnom	Pass	Inf	21.27M	18.951M	21M	18.891M
5320MHz_TnomVnom	Pass	Inf	21.09M	18.861M	21M	18.921M
5500MHz_TnomVnom	Pass	Inf	21.18M	18.921M	20.94M	18.921M
5580MHz_TnomVnom	Pass	Inf	20.97M	18.921M	20.91M	18.891M
5700MHz_TnomVnom	Pass	Inf	21.63M	18.921M	20.94M	18.921M
5720MHz Straddle 5.47-5.725GHz_TnomVnom	Pass	Inf	15.615M	14.468M	15.57M	14.468M
5720MHz Straddle 5.725-5.85GHz_TnomVnom	Pass	500k	4.5M	4.518M	4.42M	4.518M
802.11ax HEW40_Nss1,(MCS0)_1TX(Port2)	-	-	-	-	-	-
5270MHz_TnomVnom	Pass	Inf			42.24M	37.781M
5310MHz_TnomVnom	Pass	Inf			41.88M	37.721M
5510MHz_TnomVnom	Pass	Inf			41.82M	37.721M
5550MHz_TnomVnom	Pass	Inf			42.42M	37.841M
5670MHz_TnomVnom	Pass	Inf			42.06M	37.781M
5710MHz Straddle 5.47-5.725GHz_TnomVnom	Pass	Inf			36.645M	33.758M



Mode	Result	Limit (Hz)	Port 1-N dB (Hz)	Port 1-OBW (Hz)	Port 2-N dB (Hz)	Port 2-OBW (Hz)
5710MHz Straddle 5.725-5.85GHz_TnomVnom	Pass	500k			3.98M	4.558M
802.11ax HEW40_Nss1,(MCS0)_2TX	-	-	-	-	-	-
5270MHz_TnomVnom	Pass	Inf	41.58M	37.721M	42M	37.781M
5310MHz_TnomVnom	Pass	Inf	41.94M	37.781M	41.7M	37.781M
5510MHz_TnomVnom	Pass	Inf	41.88M	37.721M	41.64M	37.661M
5550MHz_TnomVnom	Pass	Inf	41.82M	37.781M	42M	37.721M
5670MHz_TnomVnom	Pass	Inf	42.06M	37.721M	42.24M	37.721M
5710MHz Straddle 5.47-5.725GHz_TnomVnom	Pass	Inf	36.085M	33.758M	35.98M	33.688M
5710MHz Straddle 5.725-5.85GHz_TnomVnom	Pass	500k	4.04M	4.058M	4.02M	4.058M
802.11ax HEW80_Nss1,(MCS0)_1TX(Port2)	-	-	-	-	-	-
5290MHz_TnomVnom	Pass	Inf			84.36M	77.121M
5530MHz_TnomVnom	Pass	Inf			84.24M	77.121M
5610MHz_TnomVnom	Pass	Inf			84.72M	77.241M
5690MHz Straddle 5.47-5.725GHz_TnomVnom	Pass	Inf			78.15M	73.238M
5690MHz Straddle 5.725-5.85GHz_TnomVnom	Pass	500k			4.1M	17.191M
802.11ax HEW80_Nss1,(MCS0)_2TX	-	-	-	-	-	-
5290MHz_TnomVnom	Pass	Inf	84.12M	77.121M	84.24M	77.241M
5530MHz_TnomVnom	Pass	Inf	84.12M	77.241M	83.76M	77.121M
5610MHz_TnomVnom	Pass	Inf	84.36M	77.241M	84M	77.121M
5690MHz Straddle 5.47-5.725GHz_TnomVnom	Pass	Inf	77.4M	73.163M	77.325M	73.163M
5690MHz Straddle 5.725-5.85GHz_TnomVnom	Pass	500k	4.06M	4.098M	4.04M	4.098M

Port X-N dB = Port X 6dB down bandwidth for 5.725-5.85GHz band / 26dB down bandwidth for other band

Port X-OBW = Port X 99% occupied bandwidth;

802.11a\_Nss1,(6Mbps)\_1TX(Port2)

EBW

5260MHz

05/12/2019

CF  
5.26GHz  
Span  
60MHz  
RBW  
300kHz  
VBW  
1MHz  
Sweep Time  
100ms  
Detector Type  
Peak  
Port 2

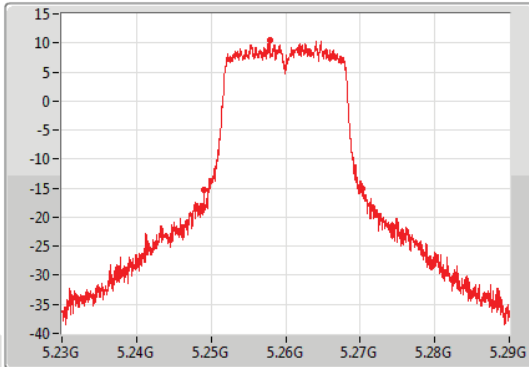

CF  
5.26GHz  
Span  
60MHz  
RBW  
200kHz  
VBW  
1MHz  
Sweep Time  
100ms  
Detector Type  
Peak

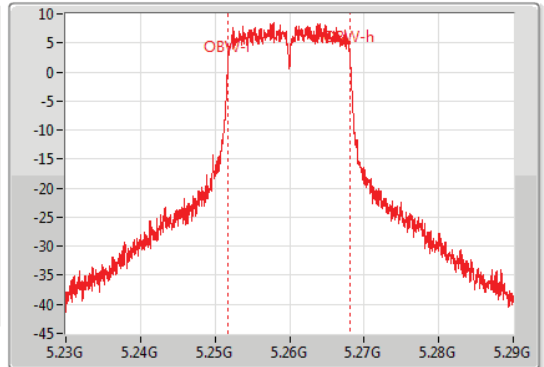

26dB(Hz)	Fl-26dB(Hz)	Fh-26dB(Hz)	OBW(Hz)	Fl-OBW(Hz)	Fh-OBW(Hz)	Limit(Hz)	Port
21.27M	5.24908G	5.27035G	16.432M	5.251724G	5.268156G	Inf	2

802.11a\_Nss1,(6Mbps)\_1TX(Port2)

EBW

5300MHz

05/12/2019

CF  
5.3GHz  
Span  
60MHz  
RBW  
300kHz  
VBW  
1MHz  
Sweep Time  
100ms  
Detector Type  
Peak  
Port 2

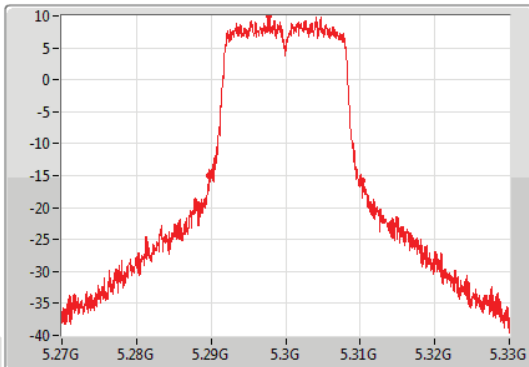

CF  
5.3GHz  
Span  
60MHz  
RBW  
200kHz  
VBW  
1MHz  
Sweep Time  
100ms  
Detector Type  
Peak

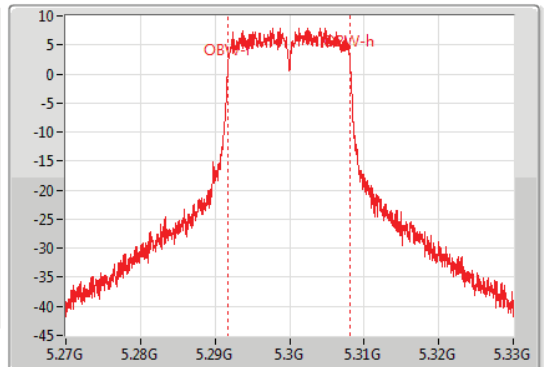

26dB(Hz)	Fl-26dB(Hz)	Fh-26dB(Hz)	OBW(Hz)	Fl-OBW(Hz)	Fh-OBW(Hz)	Limit(Hz)	Port
20.7M	5.28965G	5.31035G	16.432M	5.291724G	5.308156G	Inf	2

802.11a\_Nss1,(6Mbps)\_1TX(Port2)

EBW

5320MHz

05/12/2019

CF  
5.32GHz  
Span  
60MHz  
RBW  
300kHz  
VBW  
1MHz  
Sweep Time  
100ms  
Detector Type  
Peak  
Port 2

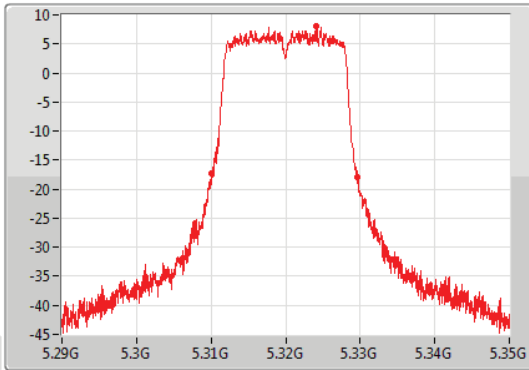

CF  
5.32GHz  
Span  
60MHz  
RBW  
200kHz  
VBW  
1MHz  
Sweep Time  
100ms  
Detector Type  
Peak

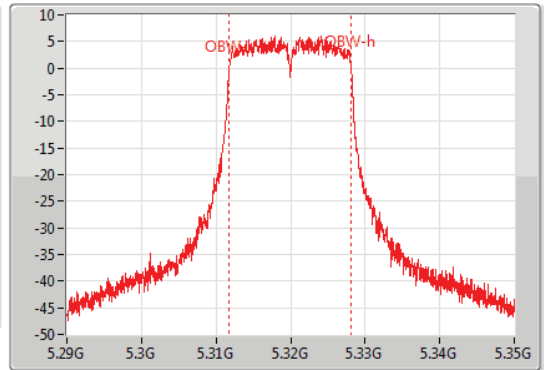

26dB(Hz)	Fl-26dB(Hz)	Fh-26dB(Hz)	OBW(Hz)	Fl-OBW(Hz)	Fh-OBW(Hz)	Limit(Hz)	Port
19.59M	5.31007G	5.32966G	16.372M	5.311754G	5.328126G	Inf	2

802.11a\_Nss1,(6Mbps)\_1TX(Port2)

EBW

5500MHz

05/12/2019

CF  
5.5GHz  
Span  
60MHz  
RBW  
300kHz  
VBW  
1MHz  
Sweep Time  
100ms  
Detector Type  
Peak  
Port 2

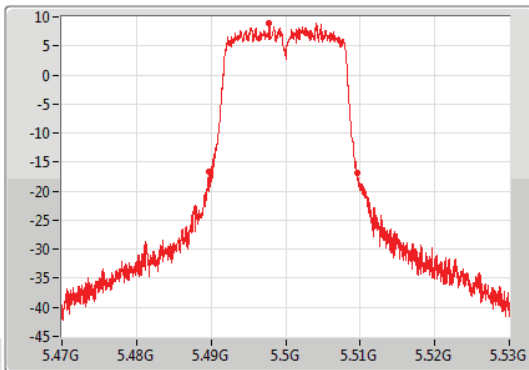

CF  
5.5GHz  
Span  
60MHz  
RBW  
200kHz  
VBW  
1MHz  
Sweep Time  
100ms  
Detector Type  
Peak

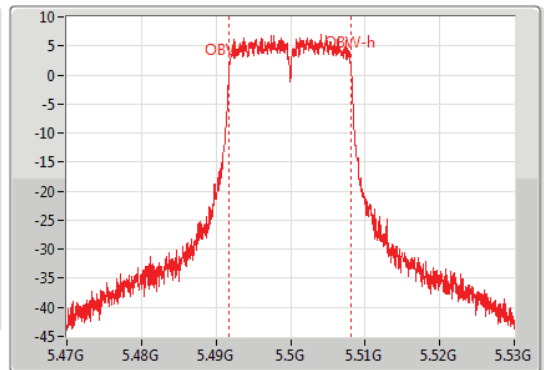

26dB(Hz)	Fl-26dB(Hz)	Fh-26dB(Hz)	OBW(Hz)	Fl-OBW(Hz)	Fh-OBW(Hz)	Limit(Hz)	Port
19.77M	5.48977G	5.50954G	16.372M	5.491754G	5.508126G	Inf	2

802.11a\_Nss1,(6Mbps)\_1TX(Port2)

EBW

5580MHz

05/12/2019

CF  
5.58GHz  
Span  
60MHz  
RBW  
300kHz  
VBW  
1MHz  
Sweep Time  
100ms  
Detector Type  
Peak  
Port 2

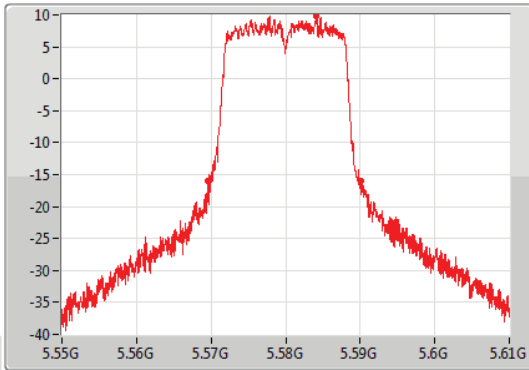

CF  
5.58GHz  
Span  
60MHz  
RBW  
200kHz  
VBW  
1MHz  
Sweep Time  
100ms  
Detector Type  
Peak

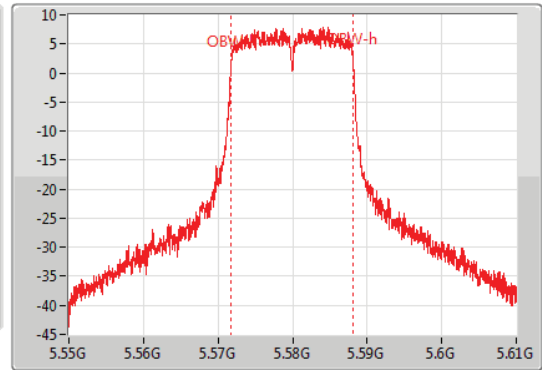

26dB(Hz)	Fl-26dB(Hz)	Fh-26dB(Hz)	OBW(Hz)	Fl-OBW(Hz)	Fh-OBW(Hz)	Limit(Hz)	Port
20.49M	5.56962G	5.59011G	16.402M	5.571754G	5.588156G	Inf	2

802.11a\_Nss1,(6Mbps)\_1TX(Port2)

EBW

5700MHz

05/12/2019

CF  
5.7GHz  
Span  
60MHz  
RBW  
300kHz  
VBW  
1MHz  
Sweep Time  
100ms  
Detector Type  
Peak  
Port 2

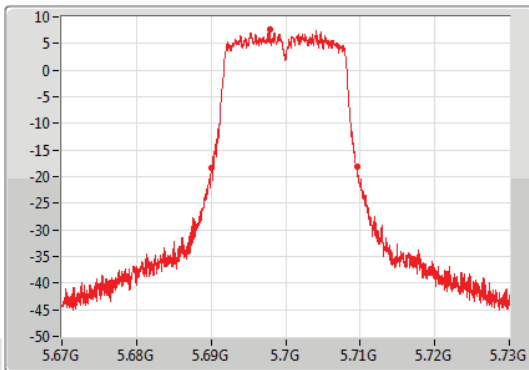

CF  
5.7GHz  
Span  
60MHz  
RBW  
200kHz  
VBW  
1MHz  
Sweep Time  
100ms  
Detector Type  
Peak

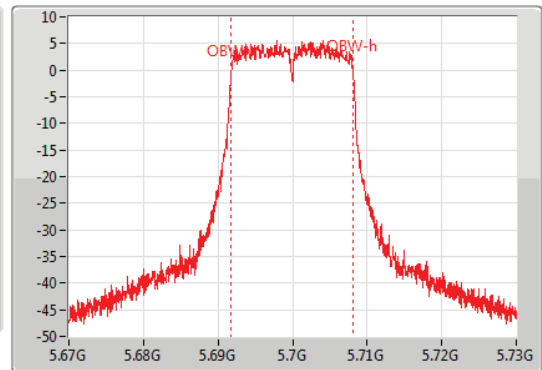

26dB(Hz)	Fl-26dB(Hz)	Fh-26dB(Hz)	OBW(Hz)	Fl-OBW(Hz)	Fh-OBW(Hz)	Limit(Hz)	Port
19.53M	5.69007G	5.7096G	16.372M	5.691754G	5.708126G	Inf	2

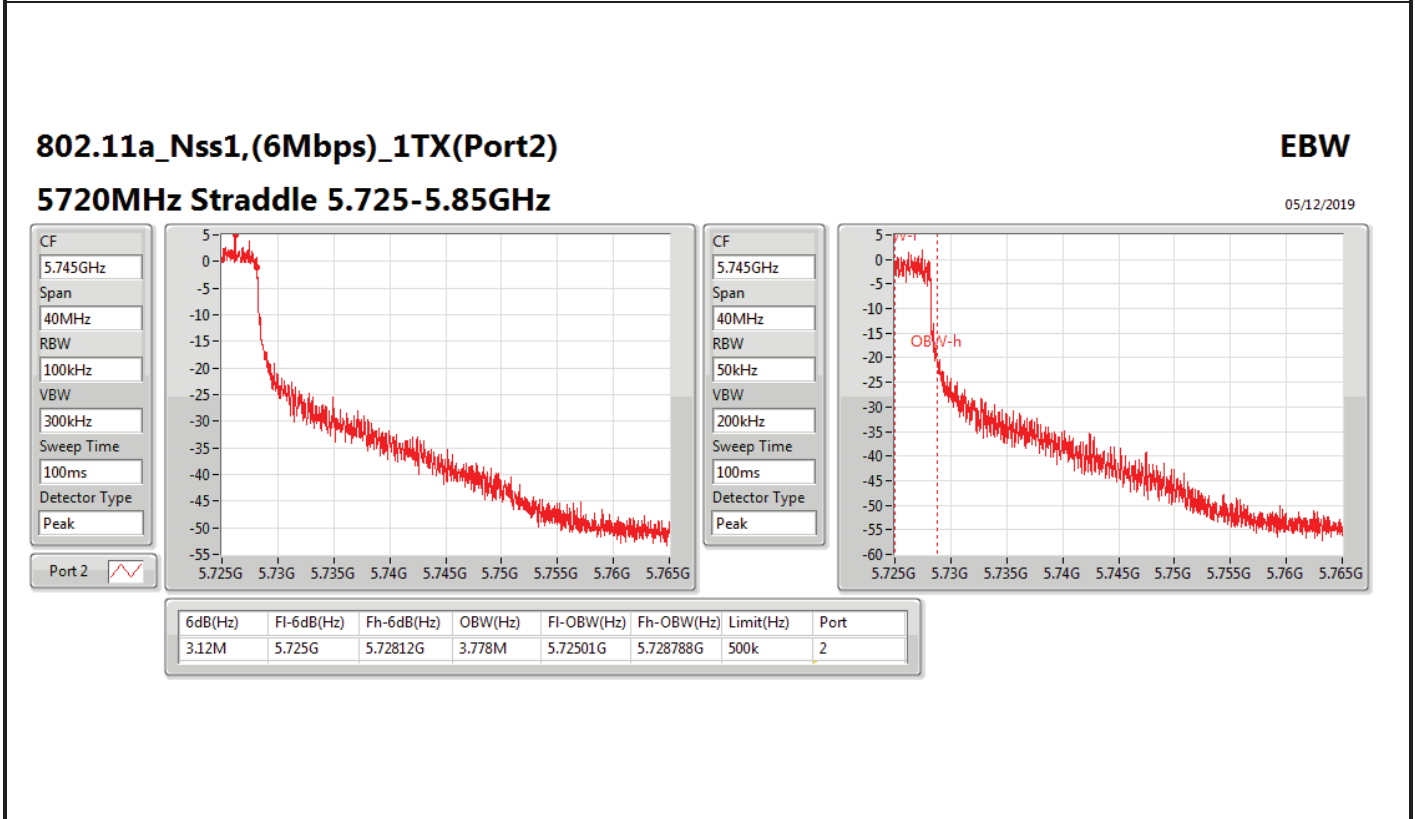
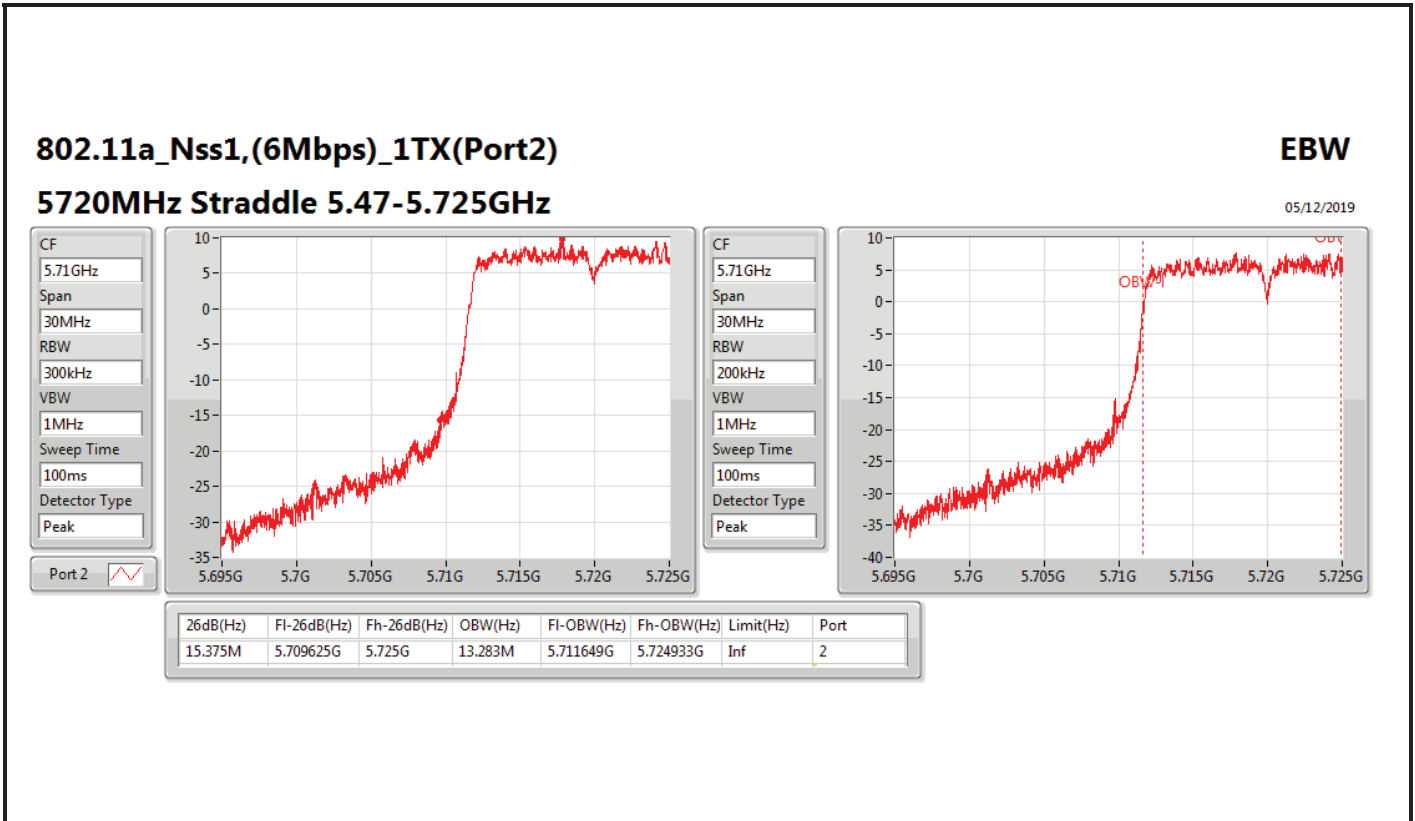

802.11a\_Nss1,(6Mbps)\_2TX

EBW

5260MHz

05/12/2019

CF  
5.26GHz  
Span  
60MHz  
RBW  
300kHz  
VBW  
1MHz  
Sweep Time  
100ms  
Detector Type  
Peak

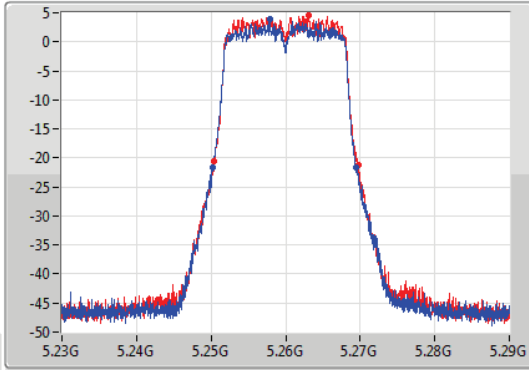

CF  
5.26GHz  
Span  
60MHz  
RBW  
200kHz  
VBW  
1MHz  
Sweep Time  
100ms  
Detector Type  
Peak

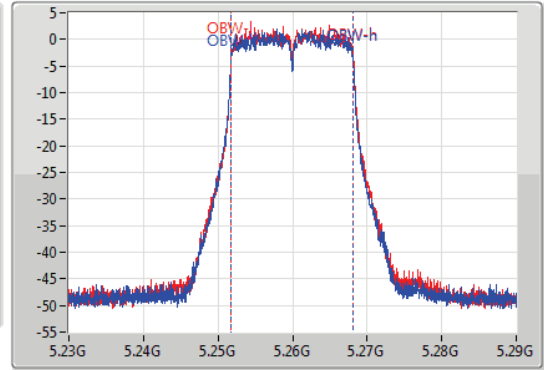

26dB(Hz)	Fl-26dB(Hz)	Fh-26dB(Hz)	OBW(Hz)	Fl-OBW(Hz)	Fh-OBW(Hz)	Limit(Hz)	Port
19.32M	5.25016G	5.26948G	16.372M	5.251754G	5.268126G	Inf	1
19.38M	5.25034G	5.26972G	16.372M	5.251784G	5.268156G	Inf	2

802.11a\_Nss1,(6Mbps)\_2TX

EBW

5300MHz

05/12/2019

CF  
5.3GHz  
Span  
60MHz  
RBW  
300kHz  
VBW  
1MHz  
Sweep Time  
100ms  
Detector Type  
Peak

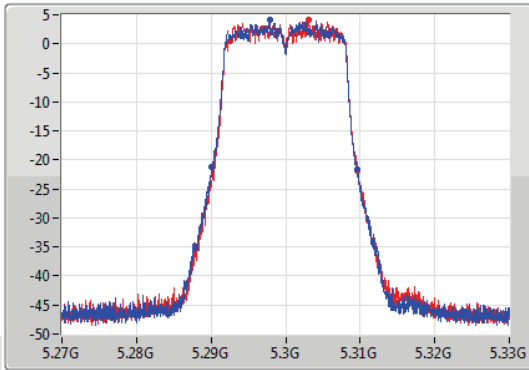

CF  
5.3GHz  
Span  
60MHz  
RBW  
200kHz  
VBW  
1MHz  
Sweep Time  
100ms  
Detector Type  
Peak

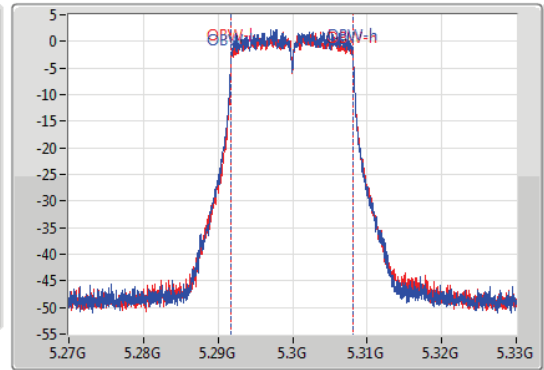

26dB(Hz)	Fl-26dB(Hz)	Fh-26dB(Hz)	OBW(Hz)	Fl-OBW(Hz)	Fh-OBW(Hz)	Limit(Hz)	Port
19.44M	5.2901G	5.30954G	16.372M	5.291754G	5.308126G	Inf	1
19.41M	5.29028G	5.30969G	16.372M	5.291784G	5.308156G	Inf	2