

SAR EVALUATION REPORT

For

Lorex Technology Inc

250 Royal Crest Court

FCC ID: UCZM2251

Report Type: Original Report	Product Type: Digital FHSS Device (Monitor Unit)
Test Engineer: <u>Wilson Chen</u>	<i>Wilson Chen</i>
Report Number: <u>RSZ140425002-20</u>	
Report Date: <u>2014-04-29</u>	
Reviewed By: <u>Sandy Wang SAR Engineer</u>	<i>Sandy Wang</i>
Prepared By: <u>Bay Area Compliance Laboratories Corp. (Shenzhen) 6/F, the 3rd Phase of WanLi Industrial Building, ShiHua Road, FuTian Free Trade Zone Shenzhen, Guangdong, China Tel: +86-755-33320018 Fax: +86-755-33320008 www.baclcorp.com.cn</u>	

]

Note: This test report is prepared for the customer shown above and for the equipment described herein. It may not be duplicated or used in part without prior written consent from Bay Area Compliance Laboratories Corp.

Attestation of Test Results		
EUT Information	Company Name	Lorex Technology Inc
	EUT Description	2.4G video baby monitor
	FCC ID	UCZM2251
	Model Number	LB2251, LB251
	Test Date	2014-04-28
Frequency Band	Max. SAR Level(s) Reported	Limit(W/Kg)
2.4 GHz Band	0.077 W/kg 1g Body SAR	1.6
Applicable Standards	ANSI / IEEE C95.1 : 2005 IEEE Standard for Safety Levels with Respect to Human Exposure to Radio Frequency Electromagnetic Fields,3 kHz to 300 GHz.	
	ANSI / IEEE C95.3 : 2002 IEEE Recommended Practice for Measurements and Computations of Radio Frequency Electromagnetic Fields With Respect to Human Exposure to SuchFields,100 kHz—300 GHz.	
	IEEE1528:2003 IEEE Recommended Practice for Determining the Peak Spatial-Average Specific Absorption Rate (SAR) in the Human Head from Wireless Communications Devices: Measurement Techniques	
	KDB procedures KDB 447498 D01 Mobile and Portable Devices RF Exposure Procedures and Equipment Authorization Policies. KDB 865664 D01 SAR Measurement Requirements for 100 MHz to 6 GHz	
<p>Note: This wireless device has been shown to be capable of compliance for localized specific absorption rate (SAR) for General Population/Uncontrolled Exposure limits specified in ANSI/IEEE Standards and has been tested in accordance with the measurement procedures specified in IEEE 1528-2003 and RF exposure KDB procedures.</p> <p>The results and statements contained in this report pertain only to the device(s) evaluated.</p>		

TABLE OF CONTENTS

DOCUMENT REVISION HISTORY	4
EUT DESCRIPTION	5
TECHNICAL SPECIFICATION	5
REFERENCE, STANDARDS, AND GUIDELINES	6
SAR LIMITS	7
FACILITIES	8
DESCRIPTION OF TEST SYSTEM	9
EQUIPMENT LIST AND CALIBRATION	16
EQUIPMENTS LIST & CALIBRATION INFORMATION	16
SAR MEASUREMENT SYSTEM VERIFICATION	17
LIQUID VERIFICATION	17
SYSTEM ACCURACY VERIFICATION	19
SAR SYSTEM VALIDATION DATA	20
EUT TEST STRATEGY AND METHODOLOGY	22
TEST POSITIONS FOR DEVICE OPERATING NEXT TO A PERSON’S EAR	22
CHEEK/TOUCH POSITION	23
EAR/TILT POSITION	23
TEST POSITIONS FOR BODY-WORN AND OTHER CONFIGURATIONS	24
SAR EVALUATION PROCEDURE	25
CONDUCTED OUTPUT POWER MEASUREMENT	26
PROVISION APPLICABLE	26
TEST PROCEDURE	26
MAXIMUM OUTPUT POWER AMONG PRODUCTION UNITS	26
TEST RESULTS:	26
SAR MEASUREMENT RESULTS	27
SAR TEST DATA	27
EUT SCAN RESULTS	28
APPENDIX A MEASUREMENT UNCERTAINTY	30
APPENDIX B – PROBE CALIBRATION CERTIFICATES	31
APPENDIX C DIPOLE CALIBRATION CERTIFICATES	41
APPENDIX D EUT TEST POSITION PHOTOS	51
LIQUID DEPTH \geq 15CM	51
BODY-WORN BACK SETUP PHOTO; TEST MODEL: ANTENNA FOLDED(0.0MM)	51
BODY-WORN BACK SETUP PHOTO; TEST MODEL: ANTENNA UNFOLDED(0.0MM)	52
APPENDIX E EUT PHOTOS	53
EUT – FRONT VIEW	53
EUT – BACK VIEW (ANTENNA UNFOLDED)	53
EUT – BACK VIEW (ANTENNA FOLDED)	54
EUT–TOP VIEW	54
EUT–BOTTOM VIEW	55
EUT–LEFT VIEW	55
EUT–RIGHT VIEW	56
EUT–BATTERY OFF VIEW	56
PRODUCT SIMILARITY DECLARATION LETTER	57
APPENDIX G INFORMATIVE REFERENCES	58

DOCUMENT REVISION HISTORY

Revision Number	Report Number	Description of Revision	Date of Revision
0	RSZ140425002-20	Original Report	2014-04-29

EUT DESCRIPTION

This report has been prepared on behalf of Lorex Technology Inc and their product, FCC ID: UCZM2251, Model: LB2251 or the EUT (Equipment under Test) as referred to in the rest of this report. The EUT is a monitor unit of 2.4G video baby monitor.

*Note: products model: LB2251, LB251, we select model: LB2251 to test, there is no electrical change has been made to the equipment, please refer to the product similarity letter.

Technical Specification

Product Type	Portable
Exposure Category:	Population / Uncontrolled
Antenna Type(s):	external Antenna
Body-Worn Accessories:	None
Frequency Band:	2400MHz-2483.5MHz
Conducted RF Power:	10.40dBm
Dimensions (L*W*H):	148 mm (L) × 88 mm (W) × 26 mm (H)
Power Source:	3.7 V _{DC} 1700mAh Rechargeable Battery
Normal Operation:	Body-worn

REFERENCE, STANDARDS, AND GUIDELINES

FCC:

The Report and Order requires routine SAR evaluation prior to equipment authorization of portable transmitter devices, including portable telephones. For consumer products, the applicable limit is 1.6 mW/g as recommended by the ANSI/IEEE standard C95.1-1992 [6] for an uncontrolled environment (Paragraph 65). According to the Supplement C of OET Bulletin 65 "Evaluating Compliance with FCC Guide-lines for Human Exposure to Radio frequency Electromagnetic Fields", released on Jun 29, 2001 by the FCC, the device should be evaluated at maximum output power (radiated from the antenna) under "worst-case" conditions for normal or intended use, incorporating normal antenna operating positions, device peak performance frequencies and positions for maximum RF energy coupling.

This report describes the methodology and results of experiments performed on wireless data terminal. The objective was to determine if there is RF radiation and if radiation is found, what is the extent of radiation with respect to safety limits. SAR (Specific Absorption Rate) is the measure of RF exposure determined by the amount of RF energy absorbed by human body (or its parts) – to determine how the RF energy couples to the body or head which is a primary health concern for body worn devices. The limit below which the exposure to RF is considered safe by regulatory bodies in North America is 1.6 mW/g average over 1 gram of tissue mass.

CE:

The order requires routine SAR evaluation prior to equipment authorization of portable transmitter devices, including portable telephones. For consumer products, the applicable limit is 2 mW/g as recommended by EN62209-1 for an uncontrolled environment. According to the Standard, the device should be evaluated at maximum output power (radiated from the antenna) under "worst-case" conditions for normal or intended use, incorporating normal antenna operating positions, device peak performance frequencies and positions for maximum RF energy coupling.

This report describes the methodology and results of experiments performed on wireless data terminal. The objective was to determine if there is RF radiation and if radiation is found, what is the extent of radiation with respect to safety limits. SAR (Specific Absorption Rate) is the measure of RF exposure determined by the amount of RF energy absorbed by human body (or its parts) – to determine how the RF energy couples to the body or head which is a primary health concern for body worn devices. The limit below which the exposure to RF is considered safe by regulatory bodies in Europe is 2 mW/g average over 10 gram of tissue mass.

The test configurations were laid out on a specially designed test fixture to ensure the reproducibility of measurements. Each configuration was scanned for SAR. Analysis of each scan was carried out to characterize the above effects in the device.

SAR Limits

FCC Limit (1g Tissue)

EXPOSURE LIMITS	SAR (W/kg)	
	(General Population / Uncontrolled Exposure Environment)	(Occupational / Controlled Exposure Environment)
Spatial Average (averaged over the whole body)	0.08	0.4
Spatial Peak (averaged over any 1 g of tissue)	1.60	8.0
Spatial Peak (hands/wrists/feet/ankles averaged over 10 g)	4.0	20.0

CE Limit (10g Tissue)

EXPOSURE LIMITS	SAR (W/kg)	
	(General Population / Uncontrolled Exposure Environment)	(Occupational / Controlled Exposure Environment)
Spatial Average (averaged over the whole body)	0.08	0.4
Spatial Peak (averaged over any 10 g of tissue)	2.0	10
Spatial Peak (hands/wrists/feet/ankles averaged over 10 g)	4.0	20.0

Population/Uncontrolled Environments are defined as locations where there is the exposure of individual who have no knowledge or control of their exposure.

Occupational/Controlled Environments are defined as locations where there is exposure that may be incurred by people who are aware of the potential for exposure (i.e. as a result of employment or occupation).

General Population/Uncontrolled environments Spatial Peak limit 1.6W/kg (FCC) & 2 W/kg (CE) applied to the EUT.

FACILITIES

The test site used by Bay Area Compliance Laboratories Corp. (Shenzhen) to collect data is located at 6/F, the 3rd Phase of WanLi Industrial Building, Shi Hua Road, Fu Tian Free Trade Zone, Shenzhen, Guangdong, P.R. of China

DESCRIPTION OF TEST SYSTEM

These measurements were performed with ALSAS 10 Universal Integrated SAR Measurement system from APREL Laboratories.

ALSAS-10U System Description

ALSAS-10-U is fully compliant with the technical and scientific requirements of IEEE 1528, IEC 62209, CENELEC, ARIB, ACA, and the Federal Communications Commission. The system comprises of a six axes articulated robot which utilizes a dedicated controller. ALSAS-10U uses the latest methodologies. And FDTD modeling to provide a platform which is repeatable with minimum uncertainty.

Applications

Predefined measurement procedures compliant with the guidelines of CENELEC, IEEE, IEC, FCC, etc are utilized during the assessment for the device. Automatic detection for all SAR maxima are embedded within the core architecture for the system, ensuring that peak locations used for centering the zoom scan are within a 1mm resolution and a 0.05mm repeatable position. System operation range currently available up-to 6 GHz in simulated tissue.

Area Scans

Area scans are defined prior to the measurement process being executed with a user defined variable spacing between each measurement point (integral) allowing low uncertainty measurements to be conducted. Scans defined for FCC applications utilize a 10mm² step integral, with 1mm interpolation used to locate the peak SAR area used for zoom scan assessments.

Where the system identifies multiple SAR peaks (which are within 25% of peak value) the system will provide the user with the option of assessing each peak location individually for zoom scan averaging.

Zoom Scan (Cube Scan Averaging)

The averaging zoom scan volume utilized in the ALSAS-10U software is in the shape of a cube and the side dimension of a 1 g or 10 g mass is dependent on the density of the liquid representing the simulated tissue. A density of 1000 kg/m³ is used to represent the head and body tissue density and not the phantom liquid density, in order to be consistent with the definition of the liquid dielectric properties, i.e. the side length of the 1 g cube is 10mm, with the side length of the 10 g cube 21,5mm.

When the cube intersects with the surface of the phantom, it is oriented so that 3 vertices touch the surface of the shell or the center of a face is tangent to the surface. The face of the cube closest to the surface is modified in order to conform to the tangent surface.

The zoom scan integer steps can be user defined so as to reduce uncertainty, but normal practice for typical test applications (including FCC) utilize a physical step of 5x5x8 (8mmx8mmx5mm) providing a volume of 32mm³ in the X & Y axis, and 35mm in the Z axis.



ALSAS-10U Interpolation and Extrapolation Uncertainty

The overall uncertainty for the methodology and algorithms the used during the SAR calculation was evaluated using the data from IEEE 1528 based on the example f3 algorithm:

$$f_3(x, y, z) = A \frac{a^2}{\frac{a^2}{4} + x'^2 + y'^2} \cdot \left(e^{-\frac{2z}{a}} + \frac{a^2}{2(a + 2z)^2} \right)$$

Isotropic E-Field Probe

The isotropic E-Field probe has been fully calibrated and assessed for isotropicity, and boundary effect within a controlled environment. Depending on the frequency for which the probe is calibrated the method utilized for calibration will change.

The E-Field probe utilizes a triangular sensor arrangement as detailed in the diagram below:

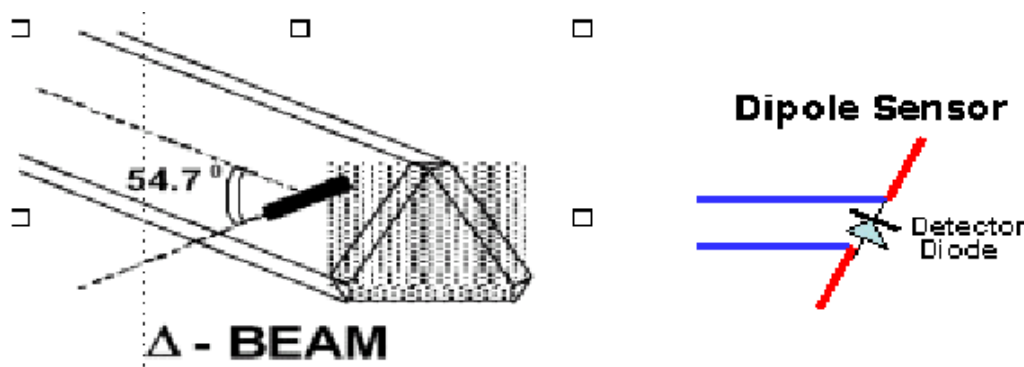

SAR is assessed with a calibrated probe which moves at a default height of 5mm from the center of the diode, which is mounted to the sensor, to the phantom surface (in the Z Axis). The 5mm offset height has been selected so as to minimize any resultant boundary effect due to the probe being in close proximity to the phantom surface.

The following algorithm is an example of the function used by the system for linearization of the output from the probe when measuring complex modulation schemes.

$$V_i = U_i + U_i^2 \cdot \frac{cf}{dcp_i}$$

Isotropic E-Field Probe Specification

Calibration Method	Frequency Dependent Below 1 GHz Calibration in air performed in a TEM Cell Above 1 GHz Calibration in air performed in waveguide
Sensitivity	0.70 $\mu\text{V}/(\text{V}/\text{m})^2$ to 0.85 $\mu\text{V}/(\text{V}/\text{m})^2$
Dynamic Range	0.0005 W/kg to 100 W/kg
Isotropic Response	Better than 0.1 dB
Diode Compression Point (DCP)	Calibration for Specific Frequency
Probe Tip Diameter	< 2.9 mm
Sensor Offset	1.56 (+/- 0.02 mm)
Probe Length	289 mm
Video Bandwidth	@ 500 Hz: 1 dB @ 1.02 kHz: 3 dB
Boundary Effect	Less than 2.1% for distance greater than 0.58 mm
Spatial Resolution	The spatial resolution uncertainty is less than 1.5% for 4.9mm diameter probe. The spatial resolution uncertainty is less than 1.0% for 2.5mm diameter probe

Boundary Detection Unit and Probe Mounting Device

ALSAS-10U incorporates a boundary detection unit with a sensitivity of 0.05mm for detecting all types of surfaces. The robust design allows for detection during probe tilt (probe normalize) exercises, and utilizes a second stage emergency stop. The signal electronics are fed directly into the robot controller for high accuracy surface detection in lateral and axial detection modes (X, Y, & Z).

The probe is mounted directly onto the Boundary Detection unit for accurate tooling and displacement calculations controlled by the robot kinematics. The probe is connect to an isolated probe interconnect where the output stage of the probe is fed directly into the amplifier stage of the Daq-Paq.

Daq-Paq (Analog to Digital Electronics)

ALSAS-10U incorporates a fully calibrated Daq-Paq (analog to digital conversion system) which has a 4 channel input stage, sent via a 2 stage auto-set amplifier module. The input signal is amplified accordingly so as to offer a dynamic range from 5 μV to 800mV. Integration of the fields measured is carried out at board level utilizing a Co-Processor which then sends the measured fields down into the main computational module in digitized form via an RS232 communications port. Probe linearity and duty cycle compensation is carried out within the main Daq-Paq module.

ADC	12 Bit
Amplifier Range	20 mV to 200 mV and 150 mV to 800 mV
Field Integration	Local Co-Processor utilizing proprietary integration algorithms
Number of Input Channels	4 in total 3 dedicated and 1 spare
Communication	Packet data via RS232

Axis Articulated Robot

ALSAS-10U utilizes a six axis articulated robot, which is controlled using a Pentium based real-time movement controller. The movement kinematics engine utilizes proprietary (Thermo CRS) interpolation and extrapolation algorithms, which allow full freedom of movement for each of the six joints within the working envelope. Utilization of joint 6 allows for full probe rotation with a tolerance better than 0.05mm around the central axis.



Robot/Controller Manufacturer	Thermo CRS
Number of Axis	Six independently controlled axis
Positioning Repeatability	0.05 mm
Controller Type	Single phase Pentium based C500C
Robot Reach	710 mm
Communication	RS232 and LAN compatible

ALSAS Universal Workstation

ALSAS Universal workstation allows for repeatability and fast adaptability. It allows users to do calibration, testing and measurements using different types of phantoms with one set up, which significantly speeds up the measurement process.

Universal Device Positioner

The universal device positioner allows complete freedom of movement of the EUT. Developed to hold a EUT in a free-space scenario any additional loading attributable to the material used in the construction of the positioner has been eliminated. Repeatability has been enhanced through the linear scales which form the design used to indicate positioning for any given test scenario in all major axes. A 15° tilt indicator is included for the of aid cheek to tilt movements for head SAR analysis. Overall uncertainty for measurements have been reduced due to the design of the Universal device positioner, which allows positioning of a device in as near to a free-space scenario as possible, and by providing the means for complete repeatability.



Phantom Types

The ALSAS-10U allows the integration of multiple phantom types. SAM Phantoms fully compliant with IEEE 1528, Universal Phantom, and Universal Flat.

APREL SAM Phantoms

The SAM phantoms developed using the IEEE SAM CAD file. They are fully compliant with the requirements for both IEEE 1528 and FCC Supplement C. Both the left and right SAM phantoms are interchangeable, transparent and include the IEEE 1528 grid with visible NF and MB lines.

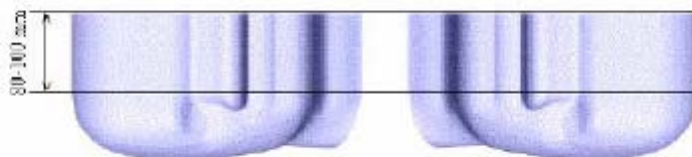

APREL Laboratories Universal Phantom

The Universal Phantom is used on the ALSAS-10U as a system validation phantom. The Universal Phantom has been fully validated both experimentally from 800MHz to 6GHz and numerically using XFDTD numerical software.

The shell thickness is 2mm overall, with a 4mm spacer located at the NF/MB intersection providing an overall thickness of 6mm in line with the requirements of IEEE-1528.

The design allows for fast and accurate measurements, of handsets, by allowing the conservative SAR to be evaluated at on frequency for both left and right head experiments in one measurement.



Tissue Dielectric Parameters for Head and Body Phantoms

The head tissue dielectric parameters recommended by the IEEE SCC-34/SC-2 in P1528 have been incorporated in the following table. These head parameters are derived from planar layer models simulating the highest expected SAR for the dielectric properties and tissue thickness variations in a human head. Other head and body tissue parameters that have not been specified in P1528 are derived from the tissue dielectric parameters computed from the 4-Cole-Cole equations described in Reference [12] and extrapolated according to the head parameters specified in P1528.

Ingredients (% by weight)	Frequency (MHz)									
	450		835		915		1900		2450	
Tissue Type	Head	Body	Head	Body	Head	Body	Head	Body	Head	Body
Water	38.56	51.16	41.45	52.4	41.05	56.0	54.9	40.4	62.7	73.2
Salt (Nacl)	3.95	1.49	1.45	1.4	1.35	0.76	0.18	0.5	0.5	0.04
Sugar	56.32	46.78	56.0	45.0	56.5	41.76	0.0	58.0	0.0	0.0
HEC	0.98	0.52	1.0	1.0	1.0	1.21	0.0	1.0	0.0	0.0
Bactericide	0.19	0.05	0.1	0.1	0.1	0.27	0.0	0.1	0.0	0.0
Triton x-100	0.0	0.0	0.0	0.0	0.0	0.0	0.0	0.0	36.8	0.0
DGBE	0.0	0.0	0.0	0.0	0.0	0.0	44.92	0.0	0.0	26.7
Dielectric Constant	43.42	58.0	42.54	56.1	42.0	56.8	39.9	54.0	39.8	52.5
Conductivity (s/m)	0.85	0.83	0.91	0.95	1.0	1.07	1.42	1.45	1.88	1.78

Recommended Tissue Dielectric Parameters for Head and Body

Frequency (MHz)	Head Tissue		Body Tissue	
	ϵ_r	σ (S/m)	ϵ_r	σ (S/m)
150	52.3	0.76	61.9	0.80
300	45.3	0.87	58.2	0.92
450	43.5	0.87	56.7	0.94
835	41.5	0.90	55.2	0.97
900	41.5	0.97	55.0	1.05
915	41.5	0.98	55.0	1.06
1450	40.5	1.20	54.0	1.30
1610	40.3	1.29	53.8	1.40
1800-2000	40.0	1.40	53.3	1.52
2450	39.2	1.80	52.7	1.95
3000	38.5	2.40	52.0	2.73
5800	35.3	5.27	48.2	6.00

EQUIPMENT LIST AND CALIBRATION

Equipments List & Calibration Information

Equipment	Model	Calibration Date	S/N
CRS F3 robot	ALS-F3	N/A	RAF0805352
CRS F3 Software	ALS-F3-SW	N/A	N/A
CRS C500C controller	ALS-C500	N/A	RCF0805379
Probe mounting device & Boundary Detection Sensor System	ALS-PMDPS-3	N/A	120-00270
Universal Work Station	ALS-UWS	N/A	100-00157
Data Acquisition Package	ALS-DAQ-PAQ-3	2013-10-08	110-00212
Miniature E-Field Probe	ALS-E-020	2013-10-08	500-00283
Dipole,2450MHz	ALS-D-2450-S-2	2011-08-25	220-00758
Dipole Spacer	ALS-DS-U	N/A	250-00907
Device holder/Positioner	ALS-H-E-SET-2	N/A	170-00510
Left ear SAM phantom	ALS-P-SAM-L	N/A	130-00311
Right ear SAM phantom	ALS-P-SAM-R	N/A	140-00359
UniPhantom	ALS-P-UP-1	N/A	150-00413
Simulated Tissue 2450 MHz Body	ALS-TS-2450-B	Each Time	290-01109
Power Amplifier	5S1G4	N/A	71377
Synthesized Sweeper	HP 8341B	2013-05-09	2624A00116
EMI Test Receiver	ESCI	2013-11-12	101120

SAR MEASUREMENT SYSTEM VERIFICATION

Liquid Verification

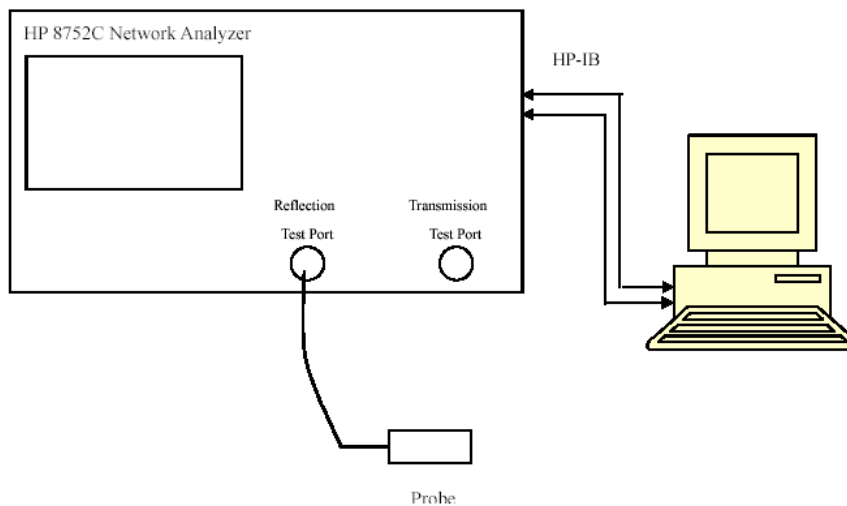

Liquid Verification Setup Block Diagram

Liquid Verification Results

Frequency	Liquid Type	Liquid Parameter		Target Value		Delta (%)		Tolerance (%)
		ϵ_r	σ (S/m)	ϵ_r	σ (S/m)	$\Delta\epsilon_r$	$\Delta\sigma$ (S/m)	
2410.785	Body	52.78	1.94	52.70	1.95	0.152	-0.513	± 5
2441.250	Body	52.79	1.91	52.70	1.95	0.171	-2.051	± 5
2471.625	Body	52.80	1.98	52.70	1.95	0.190	1.538	± 5

*Liquid Verification was performed on 2014-4-28.

Please refer to the following tables.

2450 MHz Body		
Frequency (MHz)	e'	e''
2410	52.7662	14.41258
2411	52.7990	14.4943
2412	52.8181	14.5330
2413	52.7799	14.6051
2414	52.7847	14.7373
2415	52.7459	15.1378
2416	52.7747	14.9185
2417	52.7826	14.6405
2418	52.7963	14.7664
2419	52.7665	14.6176
2420	52.8040	14.5664
2421	52.8090	14.7980
2422	52.7868	14.4635

2450 MHz Body		
Frequency (MHz)	e'	e''
2424	52.7529	14.5232
2425	52.8214	14.6750
2426	52.7443	15.1034
2427	52.7499	14.5781
2428	52.8089	14.5166
2429	52.8122	14.3902
2430	52.7506	14.1287
2431	52.7773	14.5078
2432	52.8144	14.0888
2433	52.7515	14.7667
2434	52.8373	14.1800
2435	52.7863	14.5994
2436	52.8005	14.2700
2437	52.7610	14.0926
2438	52.7748	14.4335
2439	52.7488	14.6600
2440	52.7797	14.0813
2441	52.7897	14.0743
2442	52.7756	14.3107
2443	52.8084	14.3152
2444	52.7587	14.8082
2445	52.7650	14.5628
2446	52.7826	14.4357
2447	52.8186	14.5496
2448	52.7768	14.7826
2449	52.8127	14.2258
2450	52.7471	14.7464
2451	52.8088	14.4650
2452	52.7939	14.7027
2453	52.7693	14.2592
2454	52.7550	14.2314
2455	52.7429	14.2439
2456	52.8144	14.6312
2457	52.7630	14.7159
2458	52.7956	14.1296
2459	52.8355	14.0648
2460	52.7503	14.2347
2461	52.7446	14.1612
2462	52.7403	14.2205
2463	52.7905	14.3747
2464	52.8275	14.3930
2465	52.7848	14.1349
2466	52.7567	14.3585
2467	52.7488	14.0612
2468	52.7586	14.8085
2469	52.7471	14.5214
2470	52.7531	14.4719
2471	52.7873	14.6704
2472	52.8144	14.4265

System Accuracy Verification

Prior to the assessment, the system validation kit was used to test whether the system was operating within its specifications of $\pm 10\%$. The validation results are tabulated below. And also the corresponding SAR plot is attached as well in the SAR plots files.

System Verification Setup Block Diagram

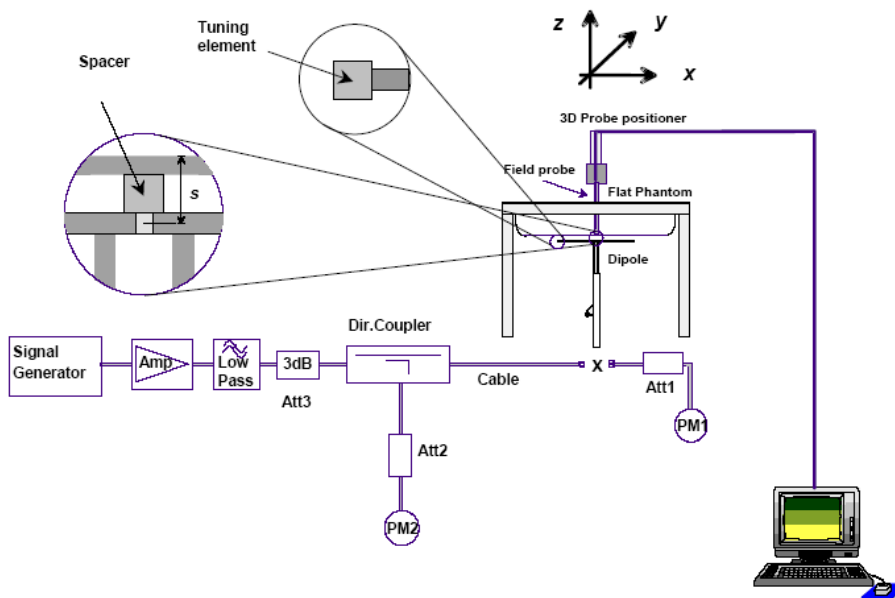

Probe and dipole antenna List and Detail

Manufacturer	Description	Model	Serial Number	Calibration Date	Calibration Due Date
APREL	Probe	ALS-E-020	500-00283	2013-10-08	2014-10-07
APREL	Dipole antenna(2450MHz)	ALS-D-2450-S-2	220-00758	2011-08-25	2014-08-24

System Accuracy Check Results

Date	Frequency Band	Liquid Type	Measured SAR (W/Kg)		Target Value (W/Kg)	Delta (%)	Tolerance (%)
2014-04-28	2450	Body	1g	53.428	52.561	1.650	± 10

*All SAR values are normalized to 1 Watt forward power.

SAR SYSTEM VALIDATION DATA**Test Laboratory: Bay Area Compliance Lab Corp. (Shenzhen)****System Performance Check 2450 MHz Body Liquid****Dipole 2450 MHz; Type: ALS-D-2450-S-2; S/N: 220-00758**

Product Data

Device Name : Dipole 2450MHz
Serial No. : 220-00758
Type : Dipole
Model : ALS-D-2450-S-2
Frequency : 2450 MHz
Max. Transmit Pwr : 1 W
Drift Time : 3 min(s)
Power Drift-Start : 50.021 W/kg
Power Drift-Finish : 49.014 W/kg
Power Drift (%) : -1.987

Phantom Data

Name : APREL-Uni
Type : Uni-Phantom
Size (mm) : 280 x 280 x 200
Serial No. : System Default
Location : Center
Description : Default

Tissue Data

Type : BODY
Serial No. : 290-01109
Frequency : 2450 MHz
Last Calib. Date : 28-Apr-2014
Temperature : 20.00 °C
Ambient Temp. : 21.00 °C
Humidity : 50.00 RH%
Epsilon : 52.75 F/m
Sigma : 2.01 S/m
Density : 1000.00 kg/cu. M

Probe Data

Name : E-Field
Model : E-020
Type : E-Field Triangle
Serial No. : 500-00283
Last Calib. Date : 08-Oct-2013
Frequency : 2450 MHz
Duty Cycle Factor : 1
Conversion Factor : 4.3
Probe Sensitivity : 1.20 1.20 1.20 $\mu\text{V}/(\text{V}/\text{m})^2$
Compression Point : 95.00 mV
Offset : 1.56 mm

Measurement Data

Crest Factor : 1
Scan Type : Complete
Tissue Temp. : 20.00 °C
Ambient Temp. : 20.00 °C
Area Scan : 7x7x1 : Measurement x=10mm, y=10mm, z=4mm
Zoom Scan : 7x7x7 : Measurement x=5mm, y=5mm, z=5mm

1 gram SAR value : 53.428 W/kg
10 gram SAR value : 24.125 W/kg
Area Scan Peak SAR : 55.996 W/kg
Zoom Scan Peak SAR : 98.937 W/kg

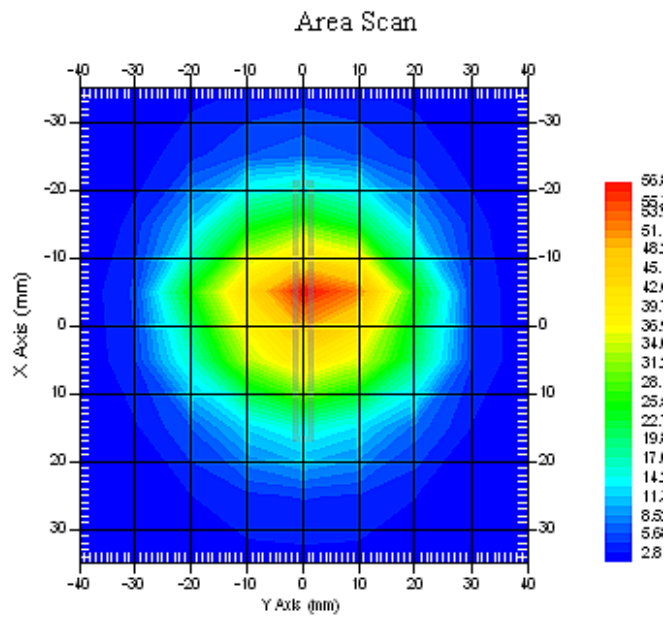

2450 MHz System Body Validation

EUT TEST STRATEGY AND METHODOLOGY

Test Positions for Device Operating Next to a Person’s Ear

This category includes most wireless handsets with fixed, retractable or internal antennas located toward the top half of the device, with or without a foldout, sliding or similar keypad cover. The handset should have its earpiece located within the upper ¼ of the device, either along the centerline or off-centered, as perceived by its users. This type of handset should be positioned in a normal operating position with the “test device reference point” located along the “vertical centerline” on the front of the device aligned to the “ear reference point”. The “test device reference point” should be located at the same level as the center of the earpiece region. The “vertical centerline” should bisect the front surface of the handset at its top and bottom edges. A “ear reference point” is located on the outer surface of the head phantom on each ear spacer. It is located 1.5 cm above the center of the ear canal entrance in the “phantom reference plane” defined by the three lines joining the center of each “ear reference point” (left and right) and the tip of the mouth.

A handset should be initially positioned with the earpiece region pressed against the ear spacer of a head phantom. For the SCC-34/SC-2 head phantom, the device should be positioned parallel to the “N-F” line defined along the base of the ear spacer that contains the “ear reference point”. For interim head phantoms, the device should be positioned parallel to the cheek for maximum RF energy coupling. The “test device reference point” is aligned to the “ear reference point” on the head phantom and the “vertical centerline” is aligned to the “phantom reference plane”. This is called the “initial ear position”. While maintaining these three alignments, the body of the handset is gradually adjusted to each of the following positions for evaluating SAR:

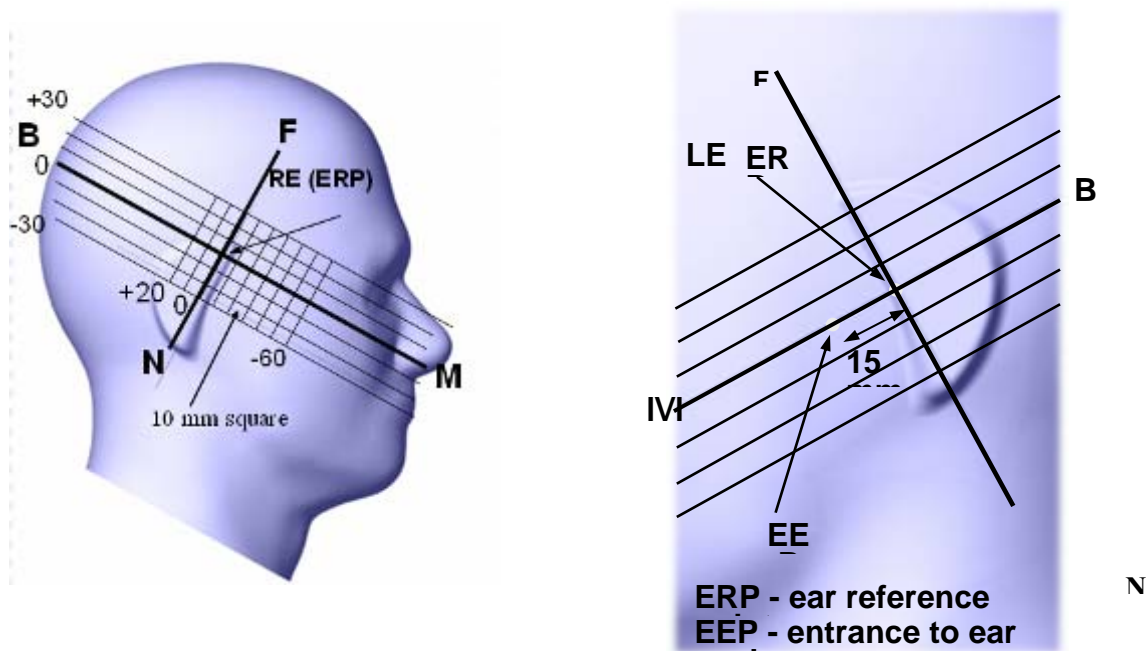

Cheek/Touch Position

The device is brought toward the mouth of the head phantom by pivoting against the “ear reference point” or along the “N-F” line for the SCC-34/SC-2 head phantom.

This test position is established:

- When any point on the display, keypad or mouthpiece portions of the handset is in contact with the phantom.
- (or) When any portion of a foldout, sliding or similar keypad cover opened to its intended self-adjusting normal use position is in contact with the cheek or mouth of the phantom.

For existing head phantoms – when the handset loses contact with the phantom at the pivoting point, rotation should continue until the device touches the cheek of the phantom or breaks its last contact from the ear spacer.

Cheek /Touch Position

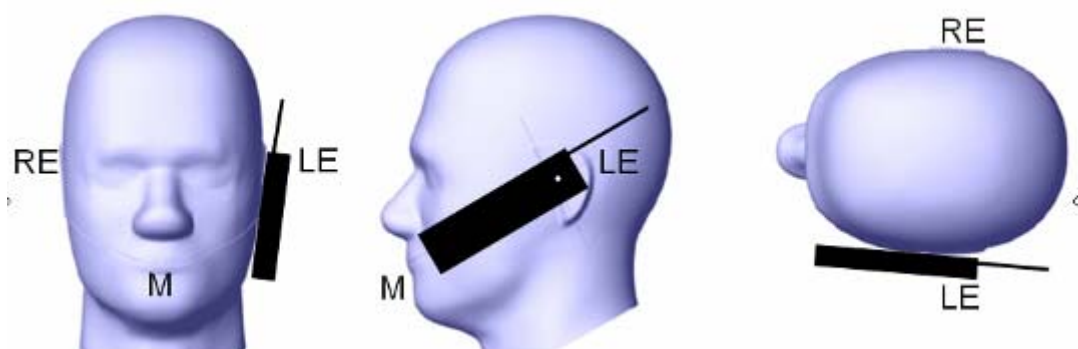

Ear/Tilt Position

With the handset aligned in the “Cheek/Touch Position”:

1) If the earpiece of the handset is not in full contact with the phantom’s ear spacer (in the “Cheek/Touch position”) and the peak SAR location for the “Cheek/Touch” position is located at the ear spacer region or corresponds to the earpiece region of the handset, the device should be returned to the “initial ear position” by rotating it away from the mouth until the earpiece is in full contact with the ear spacer.

2) (otherwise) The handset should be moved (translated) away from the cheek perpendicular to the line passes through both “ear reference points” (note: one of these ear reference points may not physically exist on a split head model) for approximate 2-3 cm. While it is in this position, the device handset is tilted away from the mouth with respect to the “test device reference point” until the inside angle between the vertical centerline on the front surface of the phone and the horizontal line passing through the ear reference point is by 15 80°. After the tilt, it is then moved (translated) back toward the head perpendicular to the line passes through both “ear reference points” until the device touches the phantom or the ear spacer. If the antenna touches the head first, the positioning process should be repeated with a tilt angle less than 15° so that the device and its antenna would touch the phantom simultaneously. This test position may require a device holder or positioner to achieve the translation and tilting with acceptable positioning repeatability.

If a device is also designed to transmit with its keypad cover closed for operating in the head position, such positions should also be considered in the SAR evaluation. The device should be tested on the left and right side of the head phantom in the “Cheek/Touch” and “Ear/Tilt” positions. When applicable, each configuration should be tested with the antenna in its fully extended and fully retracted positions. These test configurations should be tested at the high, middle and low frequency channels of each operating mode; for example, AMPS, CDMA, and TDMA. If the SAR measured at the middle channel for each test configuration (left, right, Cheek/Touch, Tile/Ear, extended and retracted) is at least 2.0 dB lower than the SAR limit, testing at the high and low channels is optional for such test configuration(s). If the transmission band of the test device is less than 10 MHz, testing at the high and low frequency channels is optional.

Ear /Tilt 15° Position

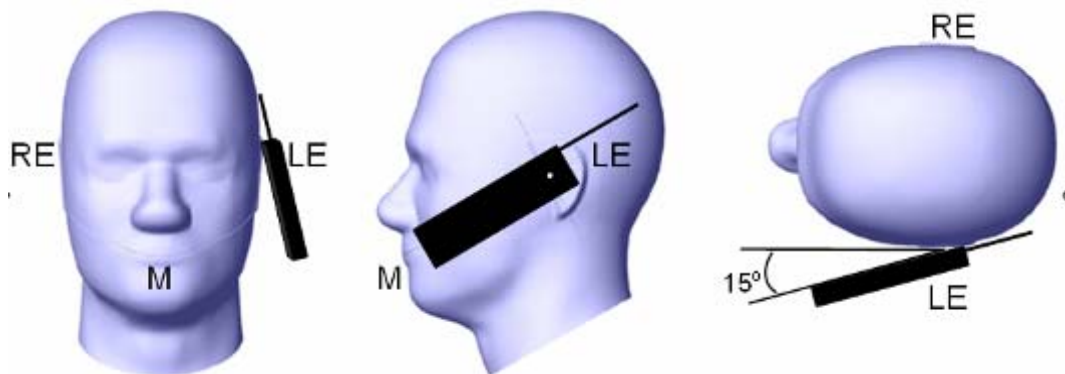

Test positions for body-worn and other configurations

Body-worn operating configurations should be tested with the belt-clips and holsters attached to the device and positioned against a flat phantom in normal use configurations. Devices with a headset output should be tested with a headset connected to the device. When multiple accessories that do not contain metallic components are supplied with the device, the device may be tested with only the accessory that dictates the closest spacing to the body. When multiple accessories that contain metallic components are supplied with the device, the device must be tested with each accessory that contains a unique metallic component. If multiple accessories share an identical metallic component (e.g., the same metallic belt-clip used with different holsters with no other metallic components), only the accessory that dictates the closest spacing to the body must be tested.

Body-worn accessories may not always be supplied or available as options for some devices that are intended to be authorized for body-worn use. A separation distance of 1.5 cm between the back of the device and a flat phantom is recommended for testing body-worn SAR compliance under such circumstances. Other separation distances may be used, but they should not exceed 2.5 cm. In these cases, the device may use body-worn accessories that provide a separation distance greater than that tested for the device provided however that the accessory contains no metallic components.

SAR Evaluation Procedure

The evaluation was performed with the following procedure:

Step 1: Measurement of the SAR value at a fixed location above the ear point or central position was used as a reference value for assessing the power drop. The SAR at this point is measured at the start of the test and then again at the end of the testing.

Step 2: The SAR distribution at the exposed side of the head was measured at a distance of 4 mm from the inner surface of the shell. The area covered the entire dimension of the head or EUT and the horizontal grid spacing was 10 mm x 10 mm. Based on these data, the area of the maximum absorption was determined by spline interpolation. The first Area Scan covers the entire dimension of the EUT to ensure that the hotspot was correctly identified.

Step 3: Around this point, a volume of 35 mm x 35 mm x 35 mm was assessed by measuring 7x 7 x 7 points. On the basis of this data set, the spatial peak SAR value was evaluated under the following procedure:

- 1) The data at the surface were extrapolated, since the center of the dipoles is 1.2 mm away from the tip of the probe and the distance between the surface and the lowest measuring point is 1.3 mm. The extrapolation was based on a least square algorithm. A polynomial of the fourth order was calculated through the points in z-axes. This polynomial was then used to evaluate the points between the surface and the probe tip.
- 2) The maximum interpolated value was searched with a straightforward algorithm. Around this maximum the SAR values averaged over the spatial volumes (1 g or 10 g) were computed by the 3D-Spline interpolation algorithm. The 3D-Spline is composed of three one dimensional splines with the "Not a knot"-condition (in x, y and z-directions). The volume was integrated with the trapezoidal-algorithm. One thousand points (10 x 10 x 10) were interpolated to calculate the averages.

All neighboring volumes were evaluated until no neighboring volume with a higher average value was found.

Step 4: Re-measurement of the SAR value at the same location as in Step 1. If the value changed by more than 5%, the evaluation was repeated.

CONDUCTED OUTPUT POWER MEASUREMENT

Provision Applicable

The measured peak output power should be greater and within 5% than EMI measurement.

Test Procedure

The RF output of the transmitter was connected to the input of the EMI Test Receiver through sufficient attenuation.

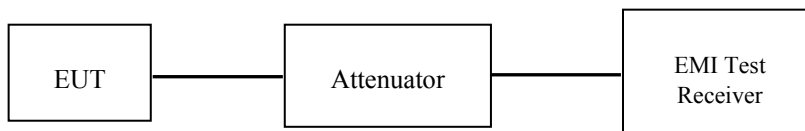

2.4G Band

Maximum Output Power among production units

Max Target Power for Production Unit (dBm)			
Mode/Band	Channel		
	Low	Middle	High
2.4G Band	11	11	11

Test Results:

Band	Frequency (MHz)	Conducted Output Power	
		(dBm)	(mw)
2.4G Band	2410.785	9.46	8.83
	2441.250	9.98	9.95
	2471.625	10.40	10.96

SAR MEASUREMENT RESULTS

This page summarizes the results of the performed dosimetric evaluation.

SAR Test Data

Environmental Conditions

Temperature:	21-24 °C
Relative Humidity:	50-53 %
ATM Pressure:	1001-1002 mbar

Testing was performed by Wilson Chen on 2014-04-28

EUT Position	Frequency (MHz)	Test Mode	Power Drift (%)	Max. Meas. Power (dBm)	Max. Rated Power (dBm)	FCC 1g SAR (W/Kg)		
						Scaled Factor	Meas. SAR	Scaled SAR
Body-Back (0mm)	2410.785	Antenna folded	/	/	/	/	/	/
	2441.250		/	/	/	/	/	/
	2471.625		2.157	10.40	11.00	1.149	0.037	0.043
Body-Back (0mm)	2410.785	Antenna unfolded	/	/	/	/	/	/
	2441.250		/	/	/	/	/	/
	2471.625		-3.995	10.40	11.00	1.149	0.067	0.077

Note:

1. When the 1-g SAR is $\leq 0.8\text{W/Kg}$, testing for other channels are optional.
3. When SAR or MPE is not measured at the maximum power level allowed for production units, the results must be scaled to the maximum tune-up tolerance limit according to the power applied to the individual channels tested to determine compliance.

EUT SCAN RESULTS

Test Laboratory: Bay Area Compliance Lab Corp. (Shenzhen)

Body-Worn-Back (2471.625 MHz); Test Model: Antenna Folded

Measurement Data

Crest Factor : 1
 Scan Type : Complete
 Area Scan : 8x11x1 : Measurement x=10mm, y=10mm, z=4mm
 Zoom Scan : 7x7x7 : Measurement x=5mm, y=5mm, z=5mm
 Power Drift-Start : 0.015 W/kg
 Power Drift-Finish : 0.015 W/kg
 Power Drift (%) : 2.157

Tissue Data

Type : Body
 Frequency : 2471.625 MHz
 Epsilon : 52.80 F/m
 Sigma : 1.98 S/m
 Density : 1000.00 kg/cu. m

Probe Data

Serial No. : 500-00283
 Frequency Band : 2450 MHz
 Duty Cycle Factor : 1
 Conversion Factor : 4.3
 Probe Sensitivity : 1.20 1.20 1.20 $\mu\text{V}/(\text{V}/\text{m})^2$
 Compression Point : 95.00 mV
 Offset : 1.56 mm

1 gram SAR value : 0.037 W/kg
 10 gram SAR value : 0.017 W/kg
 Area Scan Peak SAR : 0.033 W/kg
 Zoom Scan Peak SAR : 0.100 W/kg

Plot 1#

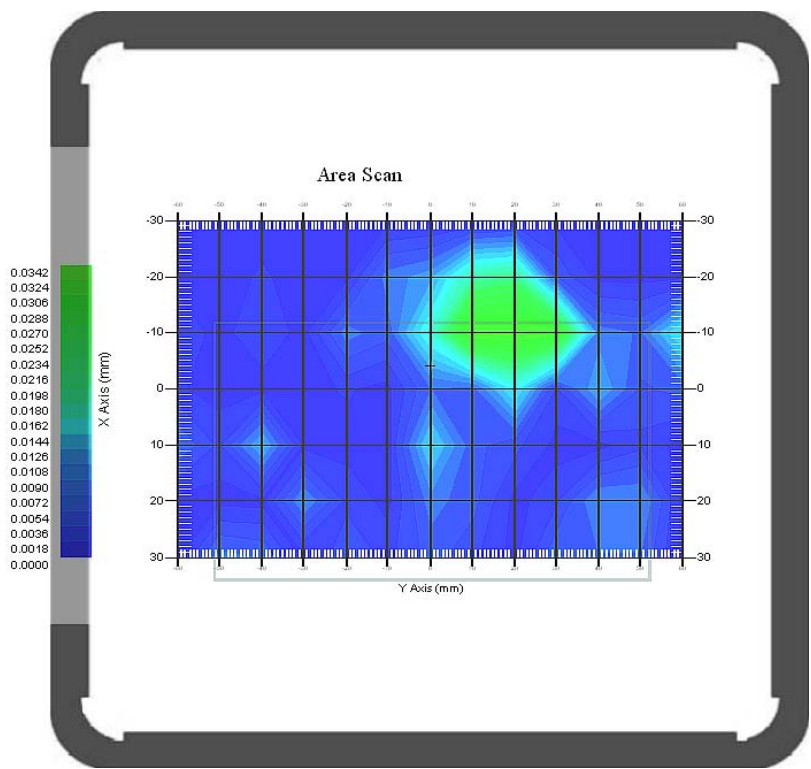

Test Laboratory: Bay Area Compliance Lab Corp. (Shenzhen)

Body-Worn-Back (2471.625 MHz); Test Model: Antenna unfolded

Measurement Data

Crest Factor : 1
 Scan Type : Complete
 Area Scan : 8x11x1 : Measurement x=10mm, y=10mm, z=4mm
 Zoom Scan : 7x7x7 : Measurement x=5mm, y=5mm, z=5mm
 Power Drift-Start : 0.025 W/kg
 Power Drift-Finish : 0.024 W/kg
 Power Drift (%) : -3.995

Tissue Data

Type : Body
 Frequency : 2471.625 MHz
 Epsilon : 52.80 F/m
 Sigma : 1.98 S/m
 Density : 1000.00 kg/cu. m

Probe Data

Serial No. : 500-00283
 Frequency Band : 2450 MHz
 Duty Cycle Factor : 1
 Conversion Factor : 4.3
 Probe Sensitivity : 1.20 1.20 1.20 $\mu\text{V}/(\text{V}/\text{m})^2$
 Compression Point : 95.00 mV
 Offset : 1.56 mm

1 gram SAR value : 0.067 W/kg
 10 gram SAR value : 0.052 W/kg
 Area Scan Peak SAR : 0.064 W/kg
 Zoom Scan Peak SAR : 0.130 W/kg

Plot 2#

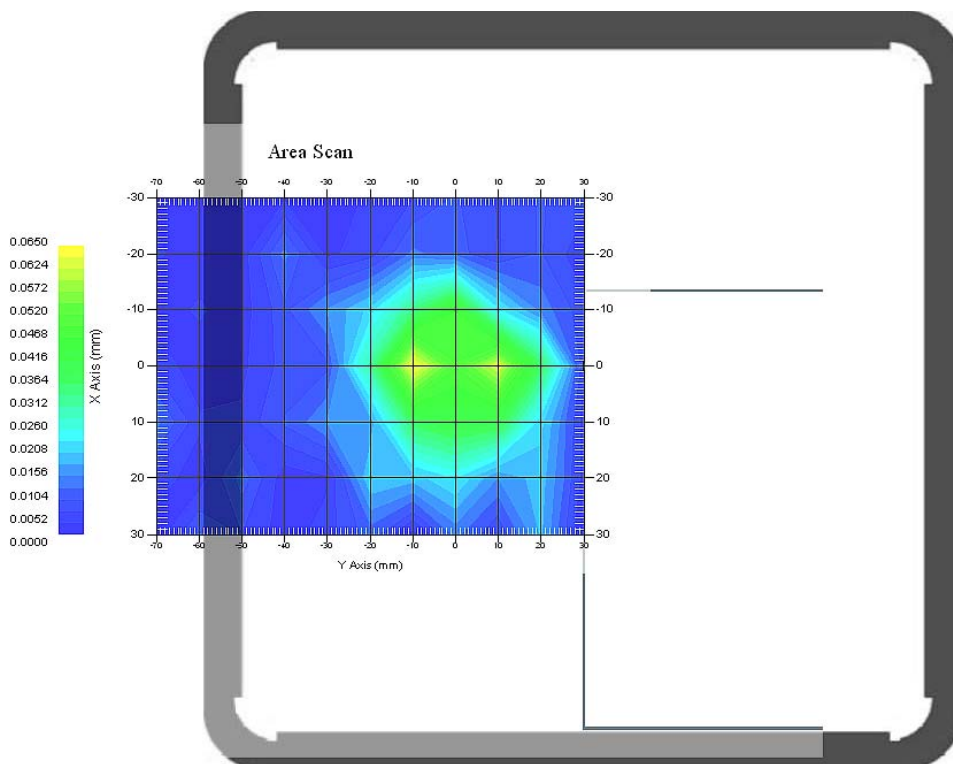

APPENDIX A MEASUREMENT UNCERTAINTY

The uncertainty budget has been determined for the measurement system and is given in the following Table.

Measurement Uncertainty for 300MHz to 3GHz

Source of Uncertainty	Tolerance Value	Probability Distribution	Divisor	c_i^1 (1-g)	c_i^1 (10-g)	Standard Uncertainty (1-g) %	Standard Uncertainty (10-g) %
Measurement System							
Probe Calibration	3.5	normal	1	1	1	3.5	3.5
Axial Isotropy	3.7	rectangular	$\sqrt{3}$	$(1-cp)^{1/2}$	$(\frac{1-cp}{2})^{1/2}$	1.5	1.5
Hemispherical Isotropy	10.9	rectangular	$\sqrt{3}$	\sqrt{cp}	\sqrt{cp}	4.4	4.4
Boundary Effect	1.0	rectangular	$\sqrt{3}$	1	1	0.6	0.6
Linearity	4.7	rectangular	$\sqrt{3}$	1	1	2.7	2.7
Detection Limit	1.0	rectangular	$\sqrt{3}$	1	1	0.6	0.6
Readout Electronics	1.0	normal	1	1	1	1.0	1.0
Response Time	0.8	rectangular	$\sqrt{3}$	1	1	0.5	0.5
Integration Time	1.7	rectangular	$\sqrt{3}$	1	1	1.0	1.0
RF Ambient Condition -Noise	0.006	rectangular	$\sqrt{3}$	1	1	0.003	0.003
RF Ambient Condition - Reflections	3.0	rectangular	$\sqrt{3}$	1	1	1.7	1.7
Probe Positioner Mech. Restrictions	0.4	rectangular	$\sqrt{3}$	1	1	0.2	0.2
Restriction							
Probe Positioning with respect to Phantom Shell	2.9	rectangular	$\sqrt{3}$	1	1	1.7	1.7
Extrapolation and Integration	3.7	rectangular	$\sqrt{3}$	1	1	2.1	2.1
Test Sample Positioning	0.023	normal	1	1	1	0.023	0.023
Device Holder Uncertainty	6.215	normal	1	1	1	6.215	6.215
Drift of Output Power	4.627	rectangular	$\sqrt{3}$	1	1	2.67	2.67
Phantom and Setup							
Phantom Uncertainty(shape & thickness tolerance)	3.4	rectangular	$\sqrt{3}$	1	1	2.0	2.0
Liquid Conductivity(target)	5.0	rectangular	$\sqrt{3}$	0.7	0.5	2.0	1.4
Liquid Conductivity(meas.)	1.938	normal	1	0.7	0.5	1.36	0.97
Liquid Permittivity(target)	5.0	rectangular	$\sqrt{3}$	0.6	0.5	1.7	1.4
Liquid Permittivity(meas.)	3.093	normal	1	0.6	0.5	1.86	1.55
Combined Uncertainty		RSS				10.78	10.55
Expanded uncertainty (coverage factor=2)		Normal(k=2)				21.56	21.10

APPENDIX B – PROBE CALIBRATION CERTIFICATES

NCL CALIBRATION LABORATORIES

Calibration File No.: PC-1537

Task No: BACL-5745

CERTIFICATE OF CALIBRATION

It is certified that the equipment identified below has been calibrated in the **NCL CALIBRATION LABORATORIES** by qualified personnel following recognized procedures and using transfer standards traceable to NRC/NIST.

Equipment: Miniature Isotropic RF Probe

Record of Calibration

Head and Body

Manufacturer: APREL Laboratories

Model No.: E-020

Serial No.: 500-00283

Calibration Procedure: D01-032-E020-V2, D22-012-Tissue, D28-002-Dipole
Project No: BACL-5745

Calibrated: 8th October 2013

Released on: 8th October 2013

This Calibration Certificate is Incomplete Unless Accompanied with the Calibration Results Summary

Released By: _____



Art Brennan, Quality Manager

NCL CALIBRATION LABORATORIES

Suite 102, 303 Terry Fox Dr.
OTTAWA, ONTARIO
CANADA K2K 3J1

Division of APREL Lab.
TEL: (613) 435-8300
FAX: (613) 435-8306

NCL Calibration Laboratories

Division of APREL Inc.

Introduction

This Calibration Report reproduces the results of the calibration performed in line with the references listed below. Calibration is performed using accepted methodologies as per the references listed below. Probes are calibrated for air, and tissue and the values reported are the results from the physical quantification of the probe through meteorological practices.

Calibration Method

Probes are calibrated using the following methods.

<1000MHz

TEM Cell for sensitivity in air

Standard phantom using temperature transfer method for sensitivity in tissue

>1000MHz

Waveguide* method to determine sensitivity in air and tissue

*Waveguide is numerically (simulation) assessed to determine the field distribution and power

The boundary effect for the probe is assessed using a standard flat phantom where the probe output is compared against a numerically simulated series of data points

References

- IEEE Standard 1528
IEEE Recommended Practice for Determining the Peak Spatial-Average Specific Absorption Rate (SAR) in the Human Head from Wireless Communications Devices: Measurement Techniques
- EN 62209-1
Human Exposure to RF Fields from hand-held and body-mounted wireless communication devices - Human models, instrumentation, and procedures-Part 1: Procedure to measure the Specific Absorption Rate (SAR) for hand-held mobile wireless devices
- IEC 62209-2
Human exposure to RF fields from hand-held and body-mounted wireless devices - Human models, instrumentation, and procedures - Part 2: specific absorption rate (SAR) for wireless communication devices (30 MHz - 6 GHz)
- TP-D01-032-E020-V2 E-Field probe calibration procedure
- D22-012-Tissue dielectric tissue calibration procedure
- D28-002-Dipole procedure for validation of SAR system using a dipole
- IEEE 1309 Standard for Calibration of Electromagnetic Field Sensors and Probes, Excluding Antennas, from 9kHz to 40GHz

Page 2 of 10

This page has been reviewed for content and attested to on Page 2 of this document.

NCL Calibration Laboratories

Division of APREL Inc.

Conditions

Probe 500-00283 was a recalibration.

Ambient Temperature of the Laboratory: 22 °C +/- 1.5°C
Temperature of the Tissue: 21 °C +/- 1.5°C
Relative Humidity: < 60%

Primary Measurement Standards

Instrument	Serial Number	Cal due date
Tektronix USB Power Meter	11C940	May 14, 2015
Signal Generator HP 83640B	3844A00689	Feb 12, 2015

Secondary Measurement Standards

Network Analyzer Anritsu 37347C	002106	Feb. 20, 2015
---------------------------------	--------	---------------

Attestation

The below named signatories have conducted the calibration and review of the data which is presented in this calibration report.

We the undersigned attest that to the best of our knowledge the calibration of this subject has been accurately conducted and that all information contained within the results pages have been reviewed for accuracy.



Art Brennan, Quality Manager



Dan Brooks, Test Engineer

NCL Calibration Laboratories

Division of APREL Inc.

Probe Summary

Probe Type:	E-Field Probe E020
Serial Number:	500-00283
Frequency:	As presented on page 5
Sensor Offset:	1.56
Sensor Length:	2.5
Tip Enclosure:	Composite*
Tip Diameter:	< 2.9 mm
Tip Length:	55 mm
Total Length:	289 mm

*Resistive to recommended tissue recipes per IEEE-1528

Sensitivity in Air

Channel X:	1.2 $\mu\text{V}/(\text{V}/\text{m})^2$
Channel Y:	1.2 $\mu\text{V}/(\text{V}/\text{m})^2$
Channel Z:	1.2 $\mu\text{V}/(\text{V}/\text{m})^2$
Diode Compression Point:	95 mV

NCL Calibration Laboratories

Division of APREL Inc.

Calibration for Tissue (Head H, Body B)

Frequency	Tissue Type	Measured Epsilon	Measured Sigma	Standard Uncertainty (%)	Calibration Frequency Range (MHz)	Conversion Factor
450 H	Head	44.29	0.86	3.5	±50	5.7
450 B	Body	56.6	0.94	3.5	±50	5.8
750 H	Head	42.7	0.85	3.5	±50	5.6
750 B	Body	56.6	0.94	3.5	±50	5.5
835 H	Head	42.35	0.938	3.5	±50	5.9
835 B	Body	56.65	1.018	3.5	±50	5.9
900 H	Head	X	X	X	X	X
900 B	Body	X	X	X	X	X
1450 H	Head	X	X	X	X	X
1450 B	Body	X	X	X	X	X
1500 H	Head	X	X	X	X	X
1500 B	Body	X	X	X	X	X
1640 H	Head	X	X	X	X	X
1640 B	Body	X	X	X	X	X
1750 H	Head	38.51	1.36	3.5	±75	5.4
1750 B	Body	51.79	1.53	3.5	±75	5.3
1800 H	Head	38.26	1.41	3.5	±75	5.0
1800 B	Body	51.61	1.58	3.5	±75	5.0
1900 H	Head	38.03	1.36	3.5	±75	4.8
1900 B	Body	53.13	1.58	3.5	±75	4.5
2000 H	Head	X	X	X	X	X
2000 B	Body	X	X	X	X	X
2100 H	Head	X	X	X	X	X
2100 B	Body	X	X	X	X	X
2300 H	Head	X	X	X	X	X
2300 B	Body	X	X	X	X	X
2450 H	Head	37.64	1.88	3.5	±75	4.9
2450 B	Body	50.7	2.03	3.5	±75	4.3
2600 H	Head	X	X	X	X	X
2600 B	Body	X	X	X	X	X
3000 H	Head	X	X	X	X	X
3000 B	Body	X	X	X	X	X
3600 H	Head	X	X	X	X	X
3600 B	Body	X	X	X	X	X
5250 H	Head	34.65	4.8	3.5	±100	2.7
5250 B	Body	47.6	5.3	3.5	±100	2.6
5600 H	Head	33.2	5.15	3.5	±100	2.5
5600 B	Body	45.21	5.57	3.5	±100	2.2
5800 H	Head	32.72	5.38	3.5	±100	3.2
5800 B	Body	44.28	6.04	3.5	±100	2.5

NCL Calibration Laboratories

Division of APREL Inc.

Boundary Effect:

Uncertainty resulting from the boundary effect is less than 2.1% for the distance between the tip of the probe and the tissue boundary, when less than 0.58mm.

Spatial Resolution:

The spatial resolution uncertainty is less than 1.5% for 4.9mm diameter probe.
The spatial resolution uncertainty is less than 1.0% for 2.5mm diameter probe.

DAQ-PAQ Contribution

To minimize the uncertainty calculation all tissue sensitivity values were calculated using a load impedance of 5 M Ω .

Page 6 of 10

This page has been reviewed for content and attested to on Page 2 of this document.

NCL Calibration Laboratories

Division of APREL Inc.

Receiving Pattern Air

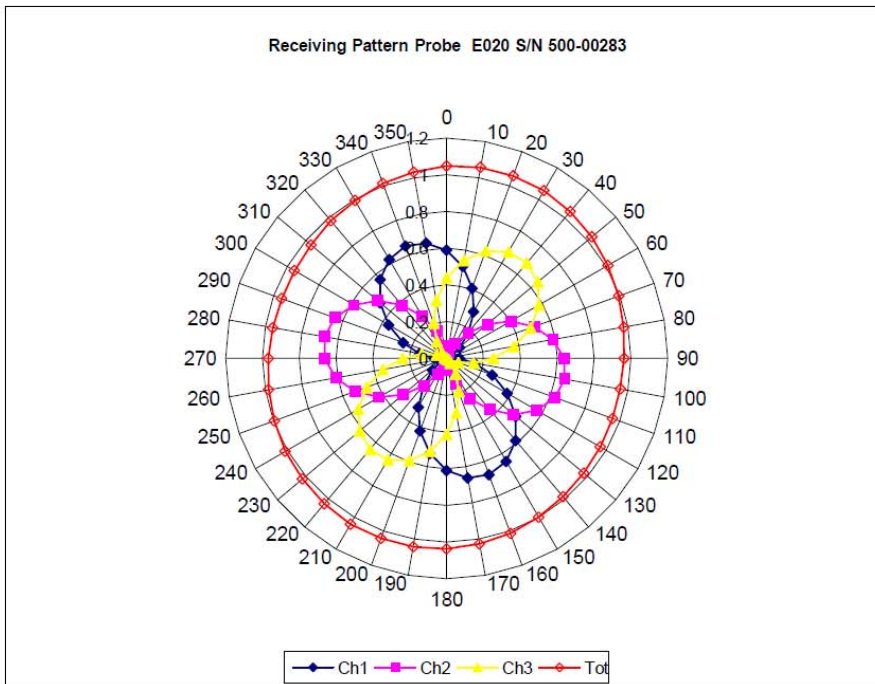

NCL Calibration Laboratories

Division of APREL Inc.

Isotropy Error Air

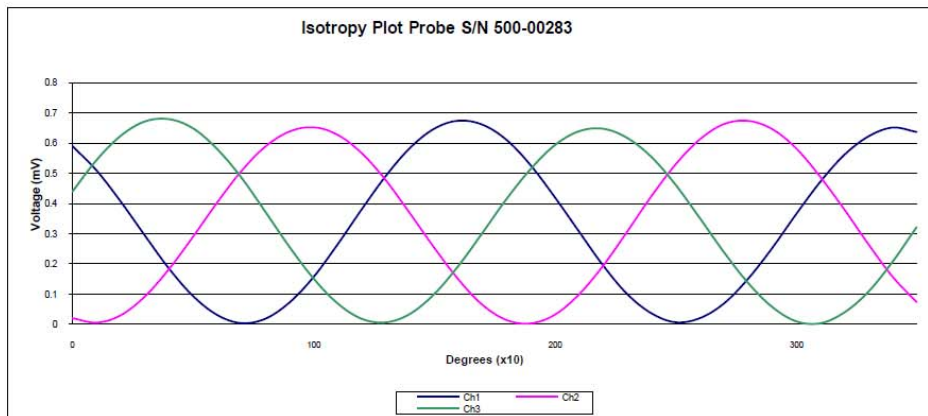
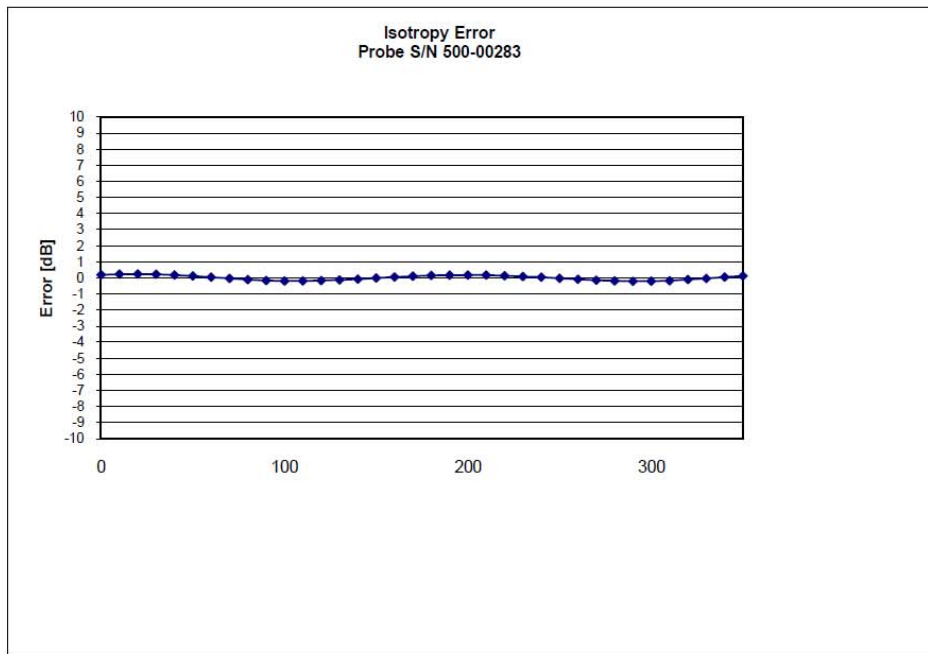

Isotropicity Tissue: 0.10 dB

Page 8 of 10
This page has been reviewed for content and attested to on Page 2 of this document.

NCL Calibration Laboratories

Division of APREL Inc.

Dynamic Range

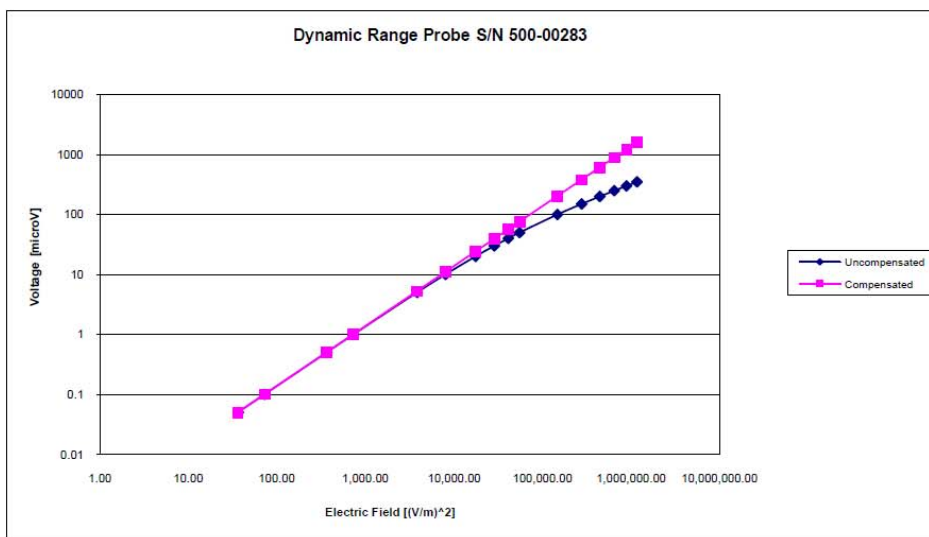

NCL Calibration Laboratories

Division of APREL Inc.

Video Bandwidth

Probe Frequency Characteristics

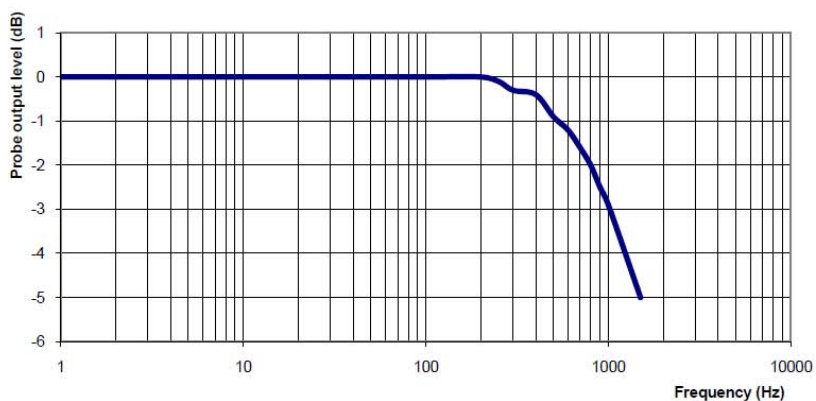

Video Bandwidth at 500 Hz 1 dB
Video Bandwidth at 1.02 KHz: 3 dB

Test Equipment

The test equipment used during Probe Calibration, manufacturer, model number and, current calibration status are listed and located on the main APREL server R:\NCL\Calibration Equipment\Instrument List May 2013.

Page 10 of 10
This page has been reviewed for content and attested to on Page 2 of this document.

APPENDIX C DIPOLE CALIBRATION CERTIFICATES

NCL CALIBRATION LABORATORIES

Calibration File No: DC-1330
Project Number: BAC-dipole-cal-5619

CERTIFICATE OF CALIBRATION

It is certified that the equipment identified below has been calibrated in the
NCL CALIBRATION LABORATORIES by qualified personnel following recognized
procedures and using transfer standards traceable to NRC/NIST.

Validation Dipole (Head & Body)

Manufacturer: APREL Laboratories

Part number: ALS-D-2450-S-2

Frequency: 2450 MHz

Serial No: 220-00758

Customer: Bay Area Compliance Laboratory

Calibrated: 25th August, 2011
Released on: 25th August, 2011

This Calibration Certificate is Incomplete Unless Accompanied with the Calibration Results Summary

Released By: _____

NCL CALIBRATION LABORATORIES

Suite 102, 303 Terry Fox Dr.
Kanata, ONTARIO
CANADA K2K 3J1

Division of APREL Lab.
TEL: (613) 435-8300
FAX: (613)435-8306

NCL Calibration Laboratories

Division of APREL Laboratories.

Conditions

Dipole 220-00758 was received in good condition and was a re-calibration.

Ambient Temperature of the Laboratory: 22 °C +/- 0.5°C

Temperature of the Tissue: 21 °C +/- 0.5°C

We the undersigned attest that to the best of our knowledge the calibration of this device has been accurately conducted and that all information contained within this report has been reviewed for accuracy.

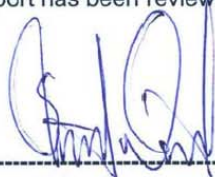

Stuart Nicol



C. Teodorian

Primary Measurement Standards

Instrument	Serial Number	Cal due date
Power meter Anritsu MA2408A	245025437	Nov.4, 2011
Power Sensor Anritsu MA2481D	103555	Nov 4, 2011
Attenuator HP 8495A (70dB) 1	944A10711	Aug.8, 2012
Network Analyzer Agilent E5071C	1334746J	Feb. 8, 2012
Secondary Measurement Standards		
Signal Generator Agilent E4438C	-506 MY55182336	June 7, 2012

This page has been reviewed for content and attested to by signature within this document.

NCL Calibration Laboratories

Division of APREL Laboratories.

Calibration Results Summary

The following results relate the Calibrated Dipole and should be used as a quick reference for the user.

Mechanical Dimensions

Length: 52.4 mm
Height: 30.3 mm

Electrical Specification

Tissue	Frequency	SWR:	Return Loss	Impedance
Head	2450 MHz	1.0459 U	-33.024 dB	48.533 Ω
Body	2450 MHz	1.1159 U	-25.235 dB	46.676 Ω

System Validation Results

Tissue	Frequency	1 Gram	10 Gram	Peak
Head	2450 MHz	52.667	24.518	105.920
Body	2450 MHz	52.561	24.104	108.940

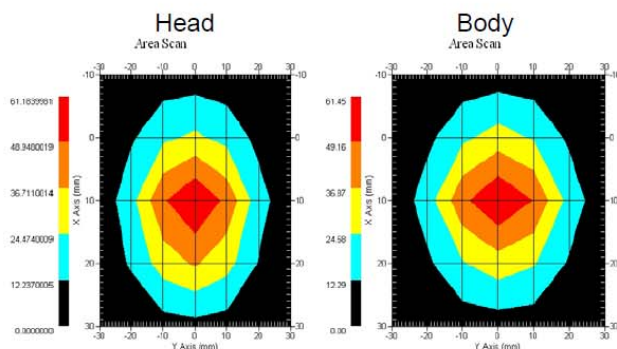

This page has been reviewed for content and attested to by signature within this document.

NCL Calibration Laboratories

Division of APREL Laboratories.

Introduction

This Calibration Report has been produced in line with the SSI Dipole Calibration Procedure SSI-TP-018-ALSAS. The results contained within this report are for Validation Dipole 220-00758. The calibration routine consisted of a three-step process. Step 1 was a mechanical verification of the dipole to ensure that it meets the mechanical specifications. Step 2 was an Electrical Calibration for the Validation Dipole, where the SWR, Impedance, and the Return loss were assessed. Step 3 involved a System Validation using the ALSAS-10U, along with APREL E-020 130 MHz to 26 GHz E-Field Probe Serial Number 212.

References

- SSI-TP-018-ALSAS Dipole Calibration Procedure
- SSI-TP-016 Tissue Calibration Procedure
- IEEE 1528 "Recommended Practice for Determining the Peak Spatial-Average Specific Absorption Rate (SAR) in the Human Body Due to Wireless Communications Devices: Experimental Techniques"
- IEC-62209 "Human exposure to radio frequency fields from hand-held and body-mounted wireless communication devices – Human models, instrumentation, and procedures"
Part 1: "Procedure to determine the Specific Absorption Rate (SAR) for hand-held devices used in close proximity of the ear (frequency range of 300 MHz to 3 GHz)"
- IEC-62209 "Human exposure to radio frequency fields from hand-held and body-mounted wireless communication devices – Human models, instrumentation, and procedures"
Part 2 *Draft*: "Procedure to determine the Specific Absorption Rate (SAR) for hand-held devices used in close proximity of the ear (frequency range of 30 MHz to 6 GHz)"

Conditions

Dipole 220-00758 was a re-calibration.

Ambient Temperature of the Laboratory: 22 °C +/- 0.5°C
Temperature of the Tissue: 20 °C +/- 0.5°C

Dipole Calibration uncertainty

The calibration uncertainty for the dipole is made up of various parameters presented below.

Mechanical	1%
Positioning Error	1.22%
Electrical	1.7%
Tissue	2.2%
Dipole Validation	2.2%
TOTAL	8.32% (16.64% K=2)

This page has been reviewed for content and attested to by signature within this document.

NCL Calibration Laboratories

Division of APREL Laboratories.

Dipole Calibration Results

Mechanical Verification

APREL Length	APREL Height	Measured Length	Measured Height
51.5 mm	30.4 mm	52.4 mm	30.3 mm

Electrical Calibration

Tissue Type	Return Loss:	SWR:	Impedance:
Head	-33.024 dB	1.0459 U	48.533 Ω
Body	-25.235 dB	1.1159 U	46.676 Ω

Tissue Validation

	Dielectric constant, ϵ_r	Conductivity, σ [S/m]
Head Tissue 2450MHz	38.2	1.82
Body Tissue 2450MHz	51.74	1.96

This page has been reviewed for content and attested to by signature within this document.

NCL Calibration Laboratories

Division of APREL Laboratories.

The Following Graphs are the results as displayed on the Vector Network Analyzer.

S11 Parameter Return Loss

Head

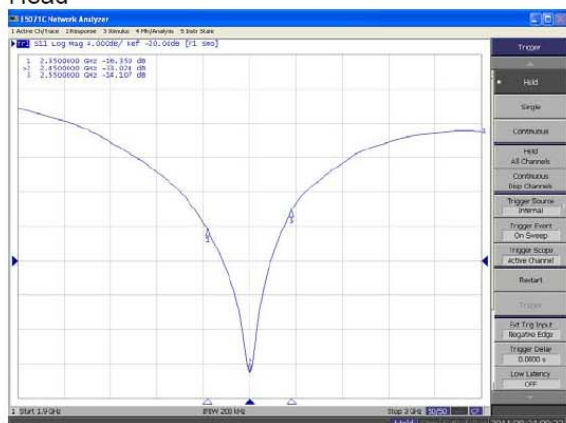

Body

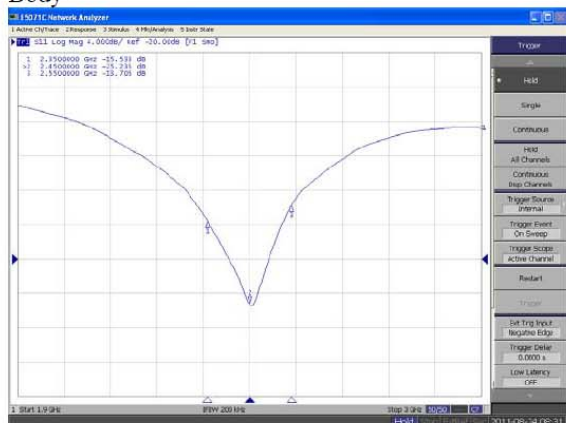

This page has been reviewed for content and attested to by signature within this document.

NCL Calibration Laboratories

Division of APREL Laboratories.

SWR

Head

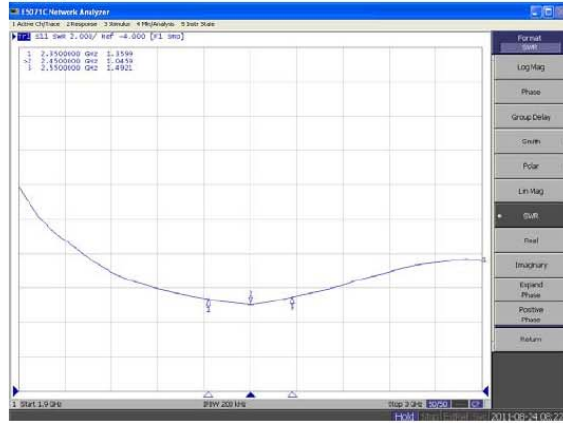

Body

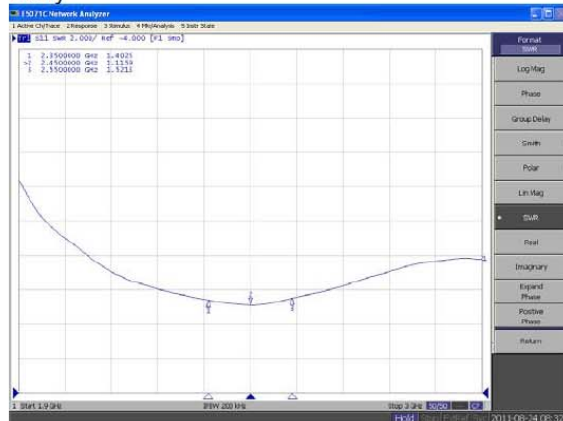

This page has been reviewed for content and attested to by signature within this document.

7

NCL Calibration Laboratories

Division of APREL Laboratories.

Smith Chart Dipole Impedance

Head

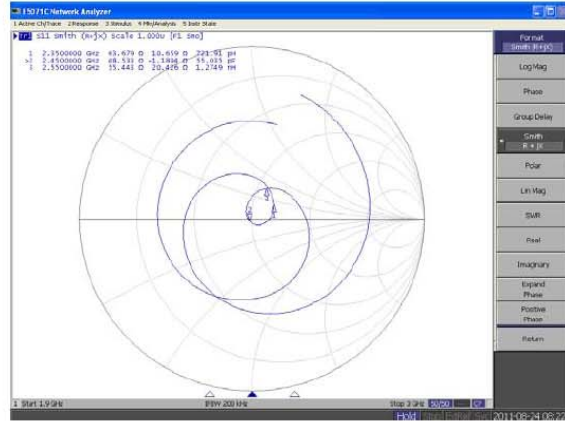

Body

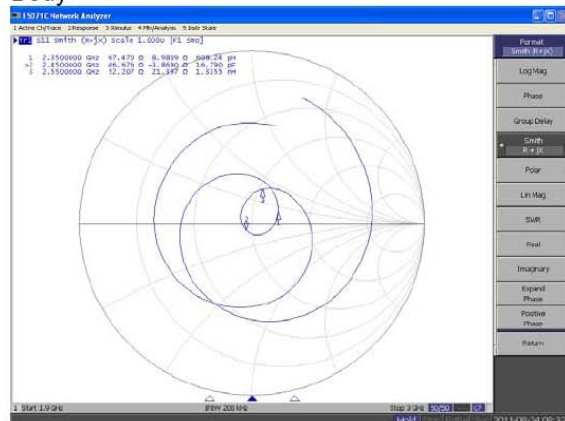

This page has been reviewed for content and attested to by signature within this document.

NCL Calibration Laboratories

Division of APREL Laboratories.

Test Equipment

The test equipment used during Probe Calibration, manufacturer, model number and, current calibration status are listed and located on the main APREL server R:\NCL\Calibration Equipment\Instrument List May 2011.

This page has been reviewed for content and attested to by signature within this document.

9

2450MHz Dipole Calibration By BACL at 2013-12-20

Mechanical Verification

APREL Length	APREL Height	Measured Length	Measured Height
51.5mm	30.4 mm	51.5 mm	30.4 mm

Tissue Type	Measured Return Loss	Measured Impedance
Head	-36.595 dB	51.203 Ω
Body	-27.599 dB	49.186 Ω

Test Graphs:

Head Tissue

Return Loss :

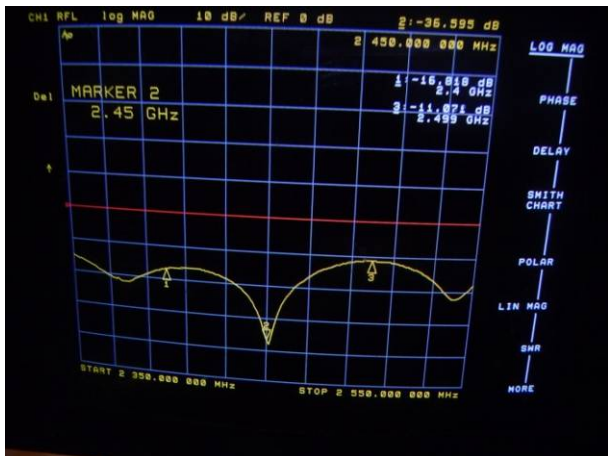

Impedance :



Body Tissue

Return Loss :

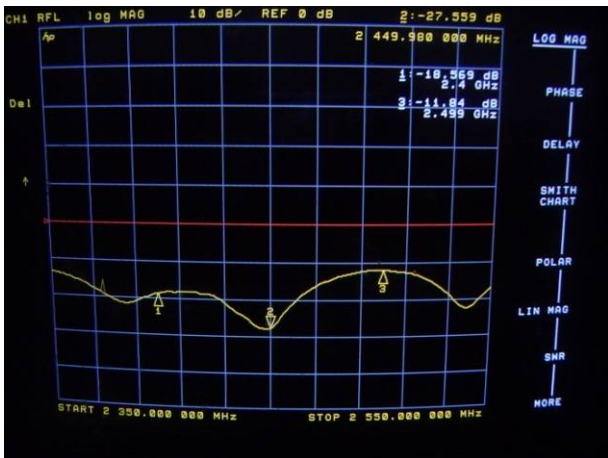

Impedance :



APPENDIX D EUT TEST POSITION PHOTOS

Liquid depth $\geq 15\text{cm}$

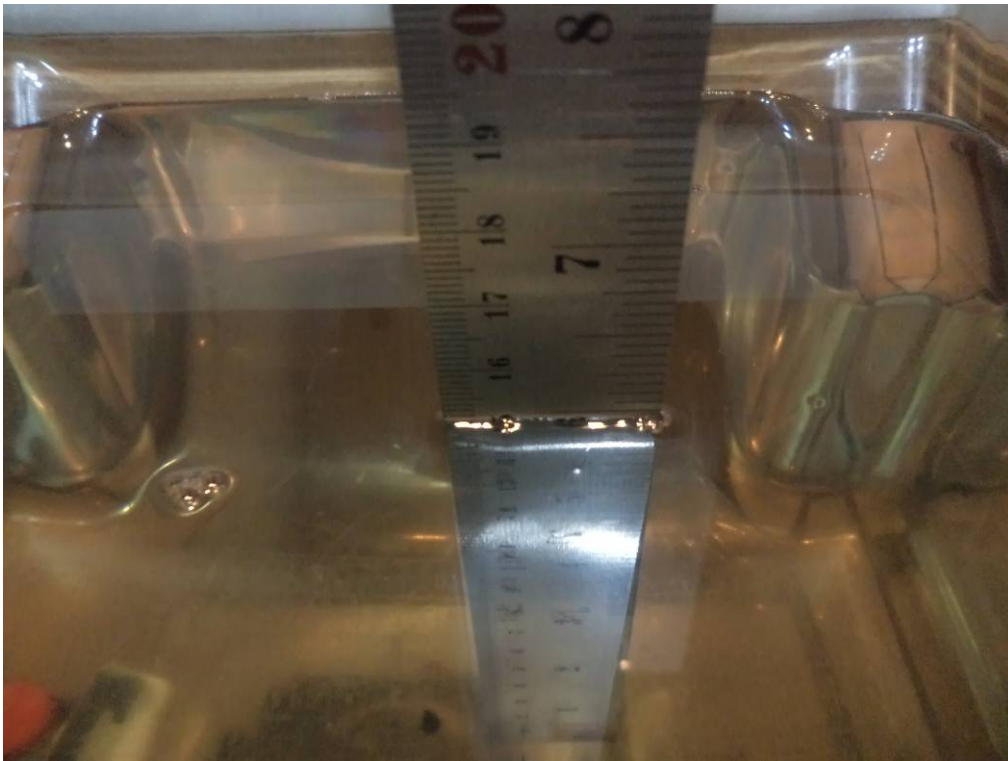

Body-worn Back Setup Photo; Test Model: antenna folded(0.0mm)



Body-worn Back Setup Photo; Test Model: antenna unfolded(0.0mm)

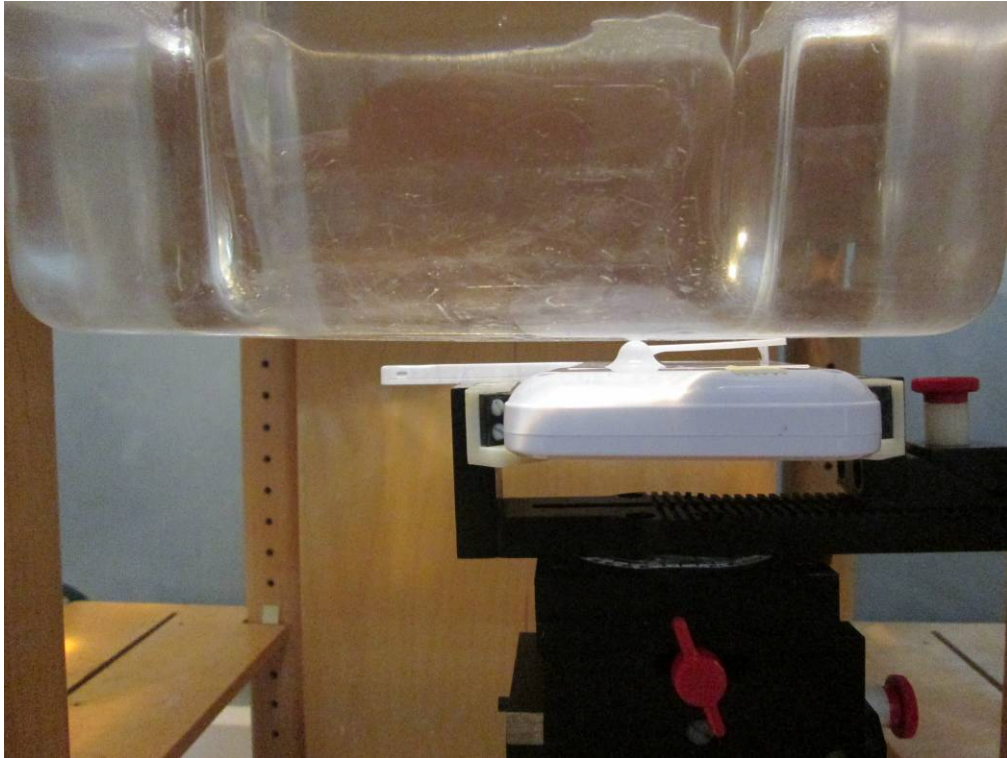

APPENDIX E EUT PHOTOS

EUT – Front View



EUT – Back View (antenna unfolded)



EUT – Back View (antenna folded)



EUT–Top View



EUT-Bottom View



EUT-Left View



EUT-Right View



EUT-Battery off View



PRODUCT SIMILARITY DECLARATION LETTER



Lorex Technology Inc
 250 Royal Crest Court Markham, Ontario L3R 3S1 Canada
 Tel: 905 946 8589 Fax: 905 947 0138

2014-04-28

Product Similarity Declaration Letter

To Whom It May Concern,

We, Lorex Technology Inc. hereby declare that our product 2.4G video baby monitor, the model LB2251, LB251, LB2251AC1 and LB2251AC1B are electrically identical, they have the same PCB layout and schematic, the only difference is the model number for the purpose of market.

Model Number	Description
LB2251/LB251	1 camera + 1 monitor
LB2251AC1/LB2251AC1B	1 camera

Model LB2251 was tested by BACL.

Please contact me if you have any question.

Niles Kanapathipillai
 Director Quality Assurance

APPENDIX G INFORMATIVE REFERENCES

- [1] Federal Communications Commission, \Report and order: Guidelines for evaluating the environmental effects of radiofrequency radiation", Tech. Rep. FCC 96-326, FCC, Washington, D.C. 20554, 1996.
- [2] David L. Means Kwok Chan, Robert F. Cleveland, \Evaluating compliance with FCC guidelines for human exposure to radiofrequency electromagnetic fields", Tech. Rep., Federal Communication Commission, Office of Engineering & Technology, Washington, DC, 1997.
- [3] Thomas Schmid, Oliver Egger, and Niels Kuster, \Automated E-field scanning system for dosimetric assessments", IEEE Transactions on Microwave Theory and Techniques, vol. 44, pp. 105-113, Jan. 1996.
- [4] Niels Kuster, Ralph Kastle, and Thomas Schmid, \Dosimetric evaluation of mobile communications equipment with known precision", IEEE Transactions on Communications, vol. E80-B, no. 5, pp. 645-652, May 1997.
- [5] CENELEC, \Considerations for evaluating of human exposure to electromagnetic fields (EMFs) from mobile telecommunication equipment (MTE) in the frequency range 30MHz - 6GHz", Tech. Rep., CENELEC, European Committee for Electrotechnical Standardization, Brussels, 1997.
- [6] ANSI, ANSI/IEEE C95.1-1992: IEEE Standard for Safety Levels with Respect to Human Exposure to Radio Frequency Electromagnetic Fields, 3 kHz to 300 GHz, The Institute of Electrical and Electronics Engineers, Inc., New York, NY 10017, 1992.
- [7] Katja Pokovic, Thomas Schmid, and Niels Kuster, \Robust setup for precise calibration of E-field probes in tissue simulating liquids at mobile communications frequencies", in ICECOM '97, Dubrovnik, October 15-17, 1997, pp. 120-24.
- [8] Katja Pokovic, Thomas Schmid, and Niels Kuster, \E-field probe with improved isotropy in brain simulating liquids", in Proceedings of the ELMAR, Zadar, Croatia, 23-25 June, 1996, pp. 172-175.
- [9] Volker Hombach, Klaus Meier, Michael Burkhardt, Eberhard Kuhn, and Niels Kuster, \The dependence of EM energy absorption upon human head modeling at 900 MHz", IEEE Transactions on Microwave Theory and Techniques, vol. 44, no. 10, pp. 1865-1873, Oct. 1996.
- [10] Klaus Meier, Ralf Kastle, Volker Hombach, Roger Tay, and Niels Kuster, \The dependence of EM energy absorption upon human head modeling at 1800 MHz", IEEE Transactions on Microwave Theory and Techniques, Oct. 1997, in press.
- [11] W. Gander, Computermathematik, Birkhaeuser, Basel, 1992.
- [12] W. H. Press, S. A. Teukolsky, W. T. Vetterling, and B. P. Flannery, Numerical Recipes in C, The Art of Scientific Computing, Second Edition, Cambridge University Press, 1992. Dosimetric Evaluation of Sample device, month 1998 9
- [13] NIS81 NAMAS, \The treatment of uncertainty in EMC measurement", Tech. Rep., NAMAS Executive, National Physical Laboratory, Teddington, Middlesex, England, 1994.
- [14] Barry N. Taylor and Christ E. Kuyatt, \Guidelines for evaluating and expressing the uncertainty of NIST measurement results", Tech. Rep., National Institute of Standards and Technology, 1994. Dosimetric Evaluation of Sample device, month 1998 10.

***** END OF REPORT *****