



# FCC TEST REPORT

**REPORT NO.:** RF140826E09B

**MODEL NO.:** LNC230-C

**FCC ID:** UCZLNC230-C

**RECEIVED:** Aug. 26, 2014

**TESTED:** Sep. 15 to 16, 2014

**ISSUED:** Apr. 21, 2015

**APPLICANT:** Lorex Technology Inc.

**ADDRESS:** 250 Royal Crest Court, Markham, Ontario,  
Canada L3R 3S1

**ISSUED BY:** Bureau Veritas Consumer Products Services (H.K.)  
Ltd., Taoyuan Branch Hsin Chu Laboratory

**LAB ADDRESS :** No. 81-1, Lu Liao Keng, 9th Ling, Wu Lung Tsuen,  
Chiung Lin Hsiang, Hsin Chu Hsien 307, Taiwan,  
R.O.C.

**TEST LOCATION (1):** No. 81-1, Lu Liao Keng, 9th Ling, Wu Lung Tsuen,  
Chiung Lin Hsiang, Hsin Chu Hsien 307, Taiwan,  
R.O.C.

**TEST LOCATION (2):** No. 49, Ln. 206, Wende Rd., Shangshan Tsuen,  
Chiung Lin Hsiang, Hsin Chu Hsien 307, Taiwan,  
R.O.C.



This report is for your exclusive use. Any copying or replication of this report to or for any other person or entity, or use of our name or trademark, is permitted only with our prior written permission. This report sets forth our findings solely with respect to the test samples identified herein. The results set forth in this report are not indicative or representative of the quality or characteristics of the lot from which a test sample was taken or any similar or identical product unless specifically and expressly noted. Our report includes all of the tests requested by you and the results thereof based upon the information that you provided to us. You have 60 days from date of issuance of this report to notify us of any material error or omission caused by our negligence, provided, however, that such notice shall be in writing and shall specifically address the issue you wish to raise. A failure to raise such issue within the prescribed time shall constitute your unqualified acceptance of the completeness of this report, the tests conducted and the correctness of the report contents. Unless specific mention, the uncertainty of measurement has been explicitly taken into account to declare the compliance or non-compliance to the specification. This report should not be used by the client to claim product certification, approval, or endorsement by TAF or any government agencies.



A D T

## Table of Contents

RELEASE CONTROL RECORD.....	4
1. CERTIFICATION .....	5
2. SUMMARY OF TEST RESULTS.....	6
2.1 MEASUREMENT UNCERTAINTY .....	7
3. GENERAL INFORMATION.....	8
3.1 GENERAL DESCRIPTION OF EUT (WLAN).....	8
3.2 DESCRIPTION OF TEST MODES.....	9
3.2.1 TEST MODE APPLICABILITY AND TESTED CHANNEL DETAIL.....	10
3.3 GENERAL DESCRIPTION OF APPLIED STANDARDS .....	12
3.4 DUTY CYCLE OF TEST SIGNAL.....	13
3.5 DESCRIPTION OF SUPPORT UNITS .....	14
3.6 CONFIGURATION OF SYSTEM UNDER TEST .....	15
4. TEST TYPES AND RESULTS .....	16
4.1 CONDUCTED EMISSION MEASUREMENT .....	16
4.1.1 LIMITS OF CONDUCTED EMISSION MEASUREMENT.....	16
4.1.2 TEST INSTRUMENTS .....	16
4.1.3 TEST PROCEDURES .....	17
4.1.4 DEVIATION FROM TEST STANDARD .....	17
4.1.5 TEST SETUP .....	17
4.1.6 EUT OPERATING CONDITIONS .....	18
4.1.7 TEST RESULTS .....	19
4.2 RADIATED EMISSION AND BANDEDGE MEASUREMENT.....	21
4.2.1 LIMITS OF RADIATED EMISSION AND BANDEDGE MEASUREMENT .....	21
4.2.2 TEST INSTRUMENTS .....	22
4.2.3 TEST PROCEDURES .....	23
4.2.4 DEVIATION FROM TEST STANDARD .....	23
4.2.5 TEST SETUP .....	24
4.2.6 EUT OPERATING CONDITIONS .....	24
4.2.7 TEST RESULTS .....	25
4.3 6DB BANDWIDTH MEASUREMENT.....	38
4.3.1 LIMITS OF 6DB BANDWIDTH MEASUREMENT .....	38
4.3.2 TEST INSTRUMENTS .....	38
4.3.3 TEST PROCEDURE .....	38
4.3.4 DEVIATION FROM TEST STANDARD .....	38
4.3.5 TEST SETUP .....	38
4.3.6 EUT OPERATING CONDITIONS .....	38
4.3.7 TEST RESULTS .....	39
4.4 CONDUCTED OUTPUT POWER MEASUREMENT .....	41
4.4.1 LIMITS OF CONDUCTED OUTPUT POWER MEASUREMENT.....	41
4.4.2 TEST INSTRUMENTS .....	41
4.4.3 TEST PROCEDURES .....	41
4.4.4 DEVIATION FROM TEST STANDARD .....	42
4.4.5 TEST SETUP .....	42
4.4.6 EUT OPERATING CONDITIONS .....	42
4.4.7 TEST RESULTS .....	43
4.5 POWER SPECTRAL DENSITY MEASUREMENT.....	45
4.5.1 LIMITS OF POWER SPECTRAL DENSITY MEASUREMENT .....	45
4.5.2 TEST INSTRUMENTS .....	45
4.5.3 TEST PROCEDURE .....	45
4.5.4 DEVIATION FROM TEST STANDARD .....	45
4.5.5 TEST SETUP .....	45



**A D T**

4.5.6	EUT OPERATING CONDITION .....	45
4.5.7	TEST RESULTS .....	46
4.6	CONDUCTED OUT-BAND EMISSION MEASUREMENT.....	48
4.6.1	LIMITS OF CONDUCTED OUT-BAND EMISSION MEASUREMENT .....	48
4.6.2	TEST INSTRUMENTS .....	48
4.6.3	TEST PROCEDURE .....	48
4.6.4	DEVIATION FROM TEST STANDARD .....	49
4.6.5	TEST SETUP .....	49
4.6.6	EUT OPERATING CONDITION .....	49
4.6.7	TEST RESULTS .....	49
5.	PHOTOGRAPHS OF THE TEST CONFIGURATION.....	54
6.	INFORMATION ON THE TESTING LABORATORIES .....	55
7.	APPENDIX A - MODIFICATIONS RECORDERS FOR ENGINEERING CHANGES TO THE EUT BY THE LAB.....	56



## RELEASE CONTROL RECORD

ISSUE NO.	REASON FOR CHANGE	DATE ISSUED
RF140826E09B	Original release	Apr. 21, 2015



A D T

## 1. CERTIFICATION

**PRODUCT:** HD Wireless Color Network Camera  
**BRAND NAME:** LOREX  
**MODEL NO.:** LNC230-C  
**TEST SAMPLE:** ENGINEERING SAMPLE  
**APPLICANT:** Lorex Technology Inc.  
**TESTED:** Sep. 15 to 16, 2014  
**STANDARDS:** **FCC Part 15, Subpart C (Section 15.247)**  
ANSI C63.10-2009

The above equipment (Model: LNC230-C) has been tested by **Bureau Veritas Consumer Products Services (H.K.) Ltd., Taoyuan Branch**, and found compliance with the requirement of the above standards. The test record, data evaluation & Equipment Under Test (EUT) configurations represented herein are true and accurate accounts of the measurements of the sample's EMC characteristics under the conditions specified in this report.

**Prepared by :**  , **Date:** Apr. 21, 2015  
Claire Kuan / Specialist

**Approved by :**  , **Date:** Apr. 21, 2015  
May Chen / Manager



A D T

## 2. SUMMARY OF TEST RESULTS

The EUT has been tested according to the following specifications:

APPLIED STANDARD: FCC PART 15, SUBPART C (SECTION 15.247)			
STANDARD SECTION	TEST TYPE	RESULT	REMARK
15.207	AC Power Conducted Emission	PASS	Meet the requirement of limit. Minimum passing margin is -13.59dB at 0.45469MHz
15.247(d) 15.209	Radiated Emissions	PASS	Meet the requirement of limit. Minimum passing margin is -0.1dB at 2483.50MHz & 2390.00MHz
15.247(d)	Band Edge Measurement	PASS	Meet the requirement of limit.
15.247(a)(2)	6dB bandwidth	PASS	Meet the requirement of limit.
15.247(b)	Conducted Output power	PASS	Meet the requirement of limit.
15.247(e)	Power Spectral Density	PASS	Meet the requirement of limit.
15.203	Antenna Requirement	PASS	No antenna connector is used.

## 2.1 MEASUREMENT UNCERTAINTY

Where relevant, the following measurement uncertainty levels have been estimated for tests performed on the EUT as specified in CISPR 16-4-2:

This uncertainty represents an expanded uncertainty expressed at approximately the 95% confidence level using a coverage factor of  $k=2$ .

Measurement	Value
Conducted emissions	2.86 dB
Radiated emissions (30MHz-1GHz)	5.43 dB
Radiated emissions (1GHz -6GHz)	3.72 dB
Radiated emissions (6GHz -18GHz)	4.00 dB
Radiated emissions (18GHz -40GHz)	4.11 dB



A D T

### 3. GENERAL INFORMATION

#### 3.1 GENERAL DESCRIPTION OF EUT

<b>PRODUCT</b>	HD Wireless Color Network Camera
<b>MODEL NO.</b>	LNC230-C
<b>POWER SUPPLY</b>	DC 5V from power adapter
<b>MODULATION TYPE</b>	CCK, DQPSK, DBPSK for DSSS 64QAM, 16QAM, QPSK, BPSK for OFDM
<b>MODULATION TECHNOLOGY</b>	DSSS, OFDM
<b>TRANSFER RATE</b>	802.11b: up to 11Mbps 802.11g: up to 54Mbps 802.11n: up to 150Mbps
<b>OPERATING FREQUENCY</b>	2.412 ~ 2.462GHz
<b>NUMBER OF CHANNEL</b>	11 for 802.11b, 802.11g, 802.11n (HT20) 7 for 802.11n (HT40)
<b>MAXIMUM OUTPUT POWER</b>	802.11b: 36.308mW 802.11g: 364.754mW 802.11n (HT20): 299.226mW 802.11n (HT40): 213.796mW
<b>ANTENNA TYPE</b>	Please see NOTE
<b>DATA CABLE</b>	RJ45 cable(Unshielded, 1.8m)
<b>I/O PORTS</b>	Refer to user's manual
<b>ASSOCIATED DEVICES</b>	Adapter x 1

**Note:**

1. The antenna provided to the EUT, please refer to the following table:

Antenna Type	Gain (dBi)	Connector Type	Frequency range (MHz to MHz)
Chip	2	NA	2400 ~ 2500

2. The EUT uses following adapter.

Brand	TEKA
Model	TEKA009-0501500XX
Input Power	AC 100-240V, 0.3A, 50/60Hz
Output Power	DC 5V, 1.5A
Power Line	DC output cable (Unshielded, 3.0m)



3. The EUT incorporates a SISO function.

Modulation Mode	Data Rate (MCS)	Tx & Rx configuration	
802.11b	1 ~ 11Mbps	1TX	1RX
802.11g	6 ~ 54Mbps	1TX	1RX
802.11n (HT20)	MCS 0~7	1TX	1RX
802.11n (HT40)	MCS 0~7	1TX	1RX

4. The above EUT information was declared by manufacturer and for more detailed features description, please refer to the manufacturer's specifications or user's manual.

### 3.2 DESCRIPTION OF TEST MODES

11 channels are provided for 802.11b, 802.11g, 802.11n (HT20):

CHANNEL	FREQUENCY	CHANNEL	FREQUENCY
1	2412MHz	7	2442MHz
2	2417MHz	8	2447MHz
3	2422MHz	9	2452MHz
4	2427MHz	10	2457MHz
5	2432MHz	11	2462MHz
6	2437MHz		

7 channels are provided for 802.11n (HT40):

CHANNEL	FREQUENCY	CHANNEL	FREQUENCY
3	2422MHz	7	2442MHz
4	2427MHz	8	2447MHz
5	2432MHz	9	2452MHz
6	2437MHz		

### 3.2.1 TEST MODE APPLICABILITY AND TESTED CHANNEL DETAIL

EUT CONFIGURE MODE	APPLICABLE TO					DESCRIPTION
	PLC	RE < 1G	RE ≥ 1G	APCM	OB	
-	√	√	√	√	√	-

Where **PLC**: Power Line Conducted Emission      **RE < 1G**: Radiated Emission below 1GHz  
**RE ≥ 1G**: Radiated Emission above 1GHz      **APCM**: Antenna Port Conducted Measurement  
**OB**: Conducted Out-Band Emission Measurement

**NOTE**: The EUT had been pre-tested on the positioned of each 2 axis. The worst case was found when positioned on Y-plane.

#### **POWER LINE CONDUCTED EMISSION TEST:**

- Pre-Scan has been conducted to determine the worst-case mode from all possible combinations between available modulations, data rates and antenna ports (if EUT with antenna diversity architecture).
- Following channel(s) was (were) selected for the final test as listed below.

MODE	AVAILABLE CHANNEL	TESTED CHANNEL	MODULATION TECHNOLOGY	MODULATION TYPE	DATA RATE (Mbps)
802.11g	1 to 11	6	OFDM	BPSK	6

#### **RADIATED EMISSION TEST (BELOW 1 GHz):**

- Pre-Scan has been conducted to determine the worst-case mode from all possible combinations between available modulations, data rates and antenna ports (if EUT with antenna diversity architecture).
- Following channel(s) was (were) selected for the final test as listed below.

MODE	AVAILABLE CHANNEL	TESTED CHANNEL	MODULATION TECHNOLOGY	MODULATION TYPE	DATA RATE (Mbps)
802.11g	1 to 11	6	OFDM	BPSK	6

#### **RADIATED EMISSION TEST (ABOVE 1 GHz):**

- Pre-Scan has been conducted to determine the worst-case mode from all possible combinations between available modulations, data rates and antenna ports (if EUT with antenna diversity architecture).
- Following channel(s) was (were) selected for the final test as listed below.

MODE	AVAILABLE CHANNEL	TESTED CHANNEL	MODULATION TECHNOLOGY	MODULATION TYPE	DATA RATE (Mbps)
802.11b	1 to 11	1, 6, 11	DSSS	DBPSK	1
802.11g	1 to 11	1, 6, 11	OFDM	BPSK	6
802.11n (HT20)	1 to 11	1, 6, 11	OFDM	BPSK	6.5
802.11n (HT40)	3 to 9	3, 6, 9	OFDM	BPSK	13.5



**ANTENNA PORT CONDUCTED MEASUREMENT:**

- Pre-Scan has been conducted to determine the worst-case mode from all possible combinations between available modulations, data rates and antenna ports (if EUT with antenna diversity architecture).
- Following channel(s) was (were) selected for the final test as listed below.

MODE	AVAILABLE CHANNEL	TESTED CHANNEL	MODULATION TECHNOLOGY	MODULATION TYPE	DATA RATE (Mbps)
802.11b	1 to 11	1, 6, 11	DSSS	DBPSK	1
802.11g	1 to 11	1, 6, 11	OFDM	BPSK	6
802.11n (HT20)	1 to 11	1, 6, 11	OFDM	BPSK	6.5
802.11n (HT40)	3 to 9	3, 6, 9	OFDM	BPSK	13.5

**CONDUCTED OUT-BAND EMISSION MEASUREMENT:**

- Pre-Scan has been conducted to determine the worst-case mode from all possible combinations between available modulations, data rates and antenna ports (if EUT with antenna diversity architecture).
- Following channel(s) was (were) selected for the final test as listed below.

MODE	AVAILABLE CHANNEL	TESTED CHANNEL	MODULATION TECHNOLOGY	MODULATION TYPE	DATA RATE (Mbps)
802.11b	1 to 11	1, 6, 11	DSSS	DBPSK	1
802.11g	1 to 11	1, 6, 11	OFDM	BPSK	6
802.11n (HT20)	1 to 11	1, 6, 11	OFDM	BPSK	6.5
802.11n (HT40)	3 to 9	3, 6, 9	OFDM	BPSK	13.5

**TEST CONDITION:**

APPLICABLE TO	ENVIRONMENTAL CONDITIONS	INPUT POWER	TESTED BY
PLC	30deg. C, 70%RH	120Vac, 60Hz	Mike Hsieh
RE<1G	25deg. C, 72%RH	120Vac, 60Hz	Gary Cheng
RE≥1G	22deg. C, 64%RH	120Vac, 60Hz	Tim Ho
APCM	25deg. C, 60%RH	120Vac, 60Hz	Robert Cheng
OB	25deg. C, 60%RH	120Vac, 60Hz	Robert Cheng

### 3.3 GENERAL DESCRIPTION OF APPLIED STANDARDS

The EUT is a RF product. According to the specifications of the manufacturer, it must comply with the requirements of the following standards:

**FCC Part 15, Subpart C (15.247)**

**558074 D01 DTS Meas Guidance v03r02**

ANSI C63.10-2009

All test items have been performed and recorded as per the above standards.

**Note:** The EUT has been verified to comply with the requirements of FCC Part 15, Subpart B, Class B (DoC). The test report has been issued separately.

### 3.4 DUTY CYCLE OF TEST SIGNAL

Duty cycle of test signal is  $\geq 98\%$ , duty factor is not required.

**802.11b**: Duty cycle = 8.675 ms/8.695 ms = 0.998

**802.11g**: Duty cycle = 1.438 ms/1.45 ms = 0.992

**802.11n (HT20)**: Duty cycle = 1.347 ms/1.355 ms = 0.994

**802.11n (HT40)**: Duty cycle = 0.667 ms/0.675 ms = 0.988

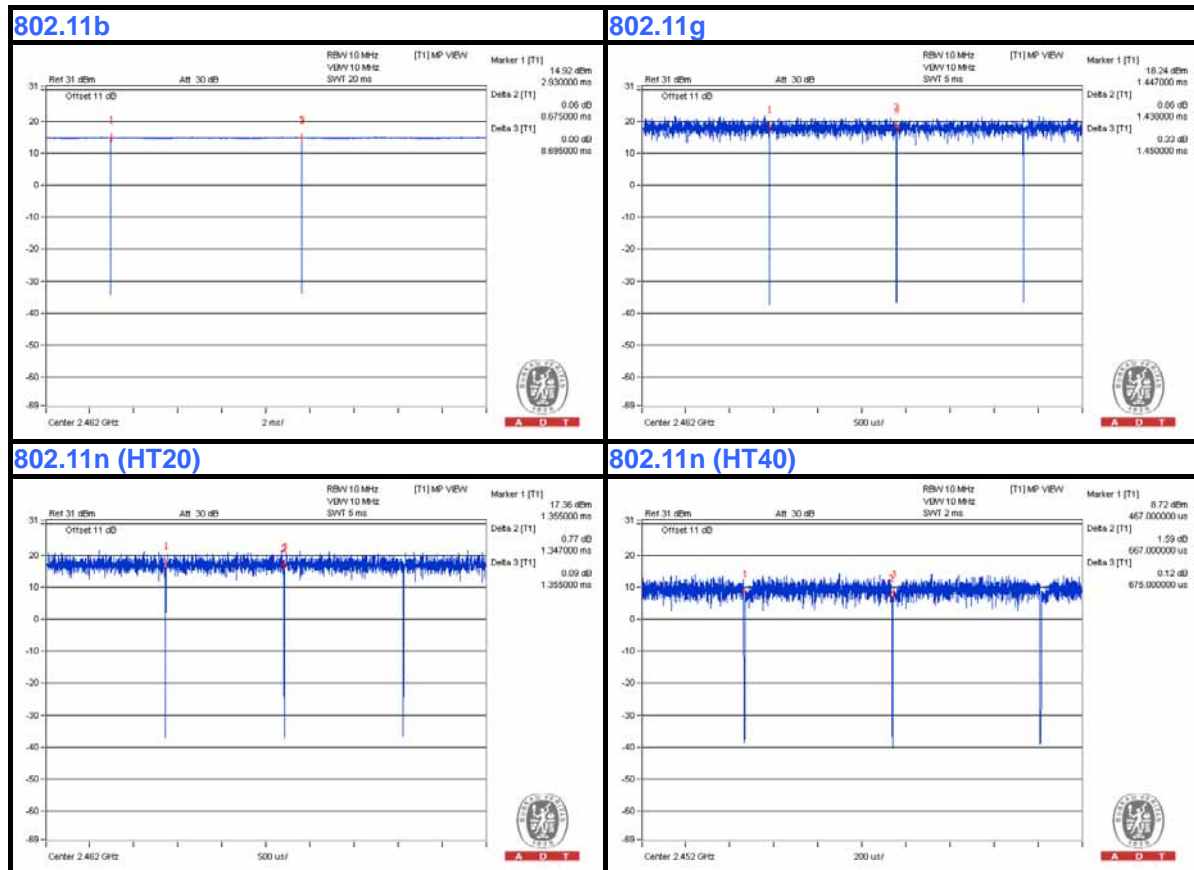



A D T

### 3.5 DESCRIPTION OF SUPPORT UNITS

The EUT has been tested as an independent unit together with other necessary accessories or support units. The following support units or accessories were used to form a representative test configuration during the tests.

No.	Product	Brand	Model No.	Serial No.	FCC ID	Remark
A	Micro SD Card	SDISK	2G	F0520000 043	FCC DoC	Provided by Lab

**NOTE:**

1. All power cords of the above support units are non-shielded (1.8 m).

No.	Cable	Qty.	Length (m)	Shielded (Yes/ No)	Cores (Number)	Remark
1.	DC CABLE	1	3.0	No	0	Supplied by Client

### 3.6 CONFIGURATION OF SYSTEM UNDER TEST

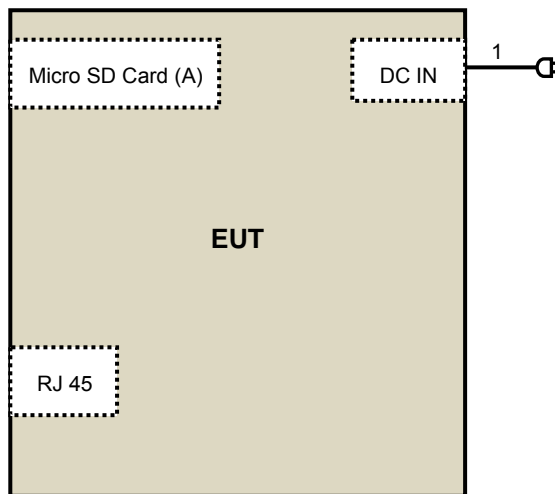



A D T

## 4. TEST TYPES AND RESULTS

### 4.1 CONDUCTED EMISSION MEASUREMENT

#### 4.1.1 LIMITS OF CONDUCTED EMISSION MEASUREMENT

FREQUENCY OF EMISSION (MHz)	CONDUCTED LIMIT (dB $\mu$ V)	
	Quasi-peak	Average
0.15-0.5	66 to 56	56 to 46
0.5-5	56	46
5-30	60	50

- NOTE:**
1. The lower limit shall apply at the transition frequencies.
  2. The limit decreases in line with the logarithm of the frequency in the range of 0.15 to 0.50 MHz.

#### 4.1.2 TEST INSTRUMENTS

DESCRIPTION & MANUFACTURER	MODEL NO.	SERIAL NO.	CALIBRATED DATE	CALIBRATED UNTIL
Test Receiver ROHDE & SCHWARZ	ESCS 30	100375	Apr. 29, 2014	Apr. 28, 2015
Line-Impedance Stabilization Network (for EUT) SCHWARZBECK	NSLK-8127	8127-523	Oct. 02, 2013	Oct. 01, 2014
Line-Impedance Stabilization Network (for Peripheral) ROHDE & SCHWARZ	ENV216	100071	Nov. 13, 2013	Nov. 12, 2014
RF Cable (JYEBAO)	5DFB	COCCAB-001	Mar. 10, 2014	Mar. 09, 2015
50 ohms Terminator	N/A	EMC-03	Sep. 24, 2013	Sep. 23, 2014
50 ohms Terminator	N/A	EMC-02	Oct. 01, 2013	Sep. 30, 2014
Software ADT	BV ADT_Cond_V7.3.7. 3	NA	NA	NA

**Note:**

1. The calibration interval of the above test instruments is 12 months and the calibrations are traceable to NML/ROC and NIST/USA.
2. The test was performed in Shielded Room No. C.
3. The VCCI Con C Registration No. is C-3611.
4. Tested Date: Sep. 16, 2014



### 4.1.3 TEST PROCEDURES

- a. The EUT was placed 0.4 meters from the conducting wall of the shielded room with EUT being connected to the power mains through a line impedance stabilization network (LISN). Other support units were connected to the power mains through another LISN.
- b. The two LISNs provide 50 ohm/ 50uH of coupling impedance for the measuring instrument.
- c. Both lines of the power mains connected to the EUT were checked for maximum conducted interference.
- d. The frequency range from 150kHz to 30MHz was searched. Emission levels under (Limit - 20dB) were not recorded.

#### NOTE:

1. The resolution bandwidth of test receiver is 9kHz for Quasi-peak detection (QP) & Average detection (AV).

### 4.1.4 DEVIATION FROM TEST STANDARD

No deviation

### 4.1.5 TEST SETUP

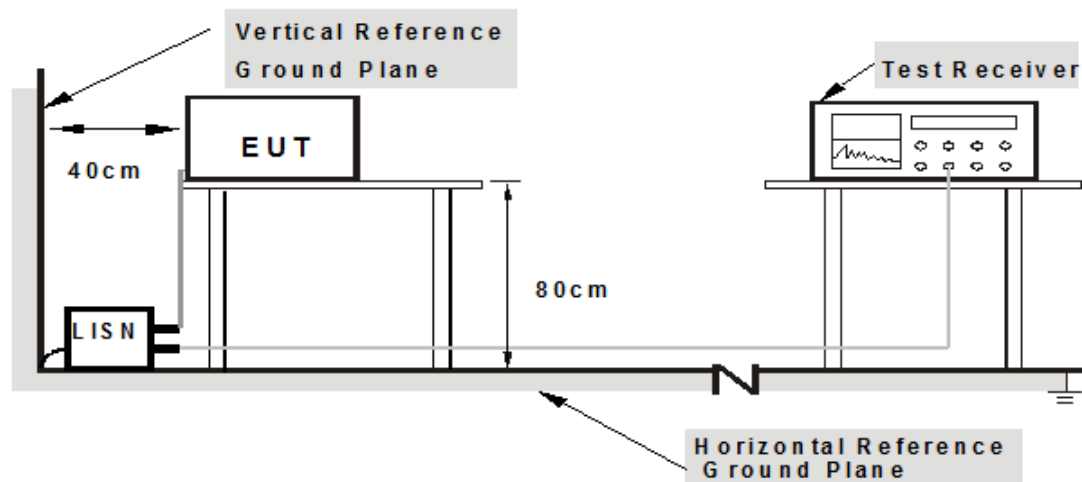

**Note: 1. Support units were connected to second LISN.**

For the actual test configuration, please refer to the related item – Photographs of the Test Configuration.

#### 4.1.6 EUT OPERATING CONDITIONS

1. The EUT which is placed on a testing table.
2. The communication partner run test program “RT5x7xQA.exe” to enable EUT under transmission/receiving condition continuously at specific channel frequency.

### 4.1.7 TEST RESULTS

<b>PHASE</b>	Line (L)	<b>DETECTOR FUNCTION</b>	Quasi-Peak (QP) / Average (AV)
--------------	----------	--------------------------	--------------------------------

No	Freq.	Corr.	Reading Value		Emission Level		Limit		Margin	
	[MHz]	Factor (dB)	Q.P. [dB (uV)]	AV. [dB (uV)]	Q.P. [dB (uV)]	AV. [dB (uV)]	Q.P. [dB (uV)]	AV. [dB (uV)]	Q.P. (dB)	AV. (dB)
	1	0.16172	0.07	39.25	27.52	39.32	27.59	65.38	55.38	-26.06
2	0.27109	0.08	30.98	18.40	31.06	18.48	61.08	51.08	-30.03	-32.61
<b>3</b>	<b>0.45469</b>	<b>0.09</b>	<b>38.66</b>	<b>33.11</b>	<b>38.75</b>	<b>33.20</b>	<b>56.79</b>	<b>46.79</b>	<b>-18.04</b>	<b>-13.59</b>
4	0.90391	0.12	31.54	21.87	31.66	21.99	56.00	46.00	-24.34	-24.01
5	3.23438	0.23	38.74	28.67	38.97	28.90	56.00	46.00	-17.03	-17.10
6	15.05078	0.59	19.13	10.76	19.72	11.35	60.00	50.00	-40.28	-38.65

#### REMARKS:

1. Q.P. and AV. are abbreviations of quasi-peak and average individually.
2. The emission levels of other frequencies were very low against the limit.
3. Margin value = Emission Level – Limit value
4. Correction Factor = Insertion loss + Cable loss
5. Emission Level = Correction Factor + Reading Value

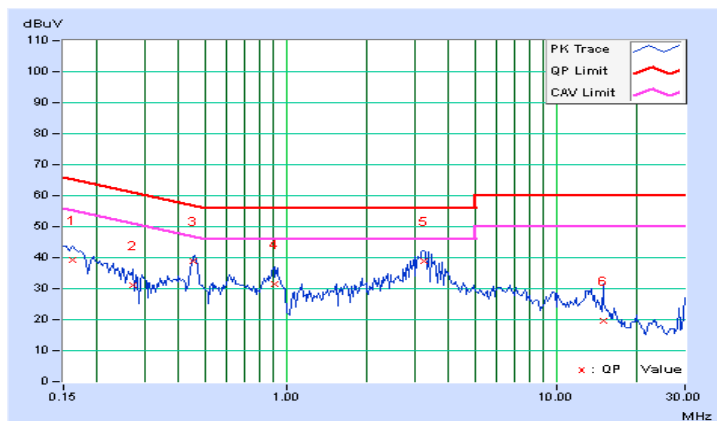

PHASE	Neutral (N)	DETECTOR FUNCTION	Quasi-Peak (QP) / Average (AV)
-------	-------------	-------------------	--------------------------------

No	Freq. [MHz]	Corr. Factor (dB)	Reading Value [dB (uV)]		Emission Level [dB (uV)]		Limit [dB (uV)]		Margin (dB)	
			Q.P.	AV.	Q.P.	AV.	Q.P.	AV.	Q.P.	AV.
1	0.15000	0.08	42.20	28.66	42.28	28.74	66.00	56.00	-23.72	-27.26
2	0.23203	0.07	36.74	20.72	36.81	20.79	62.38	52.38	-25.56	-31.58
3	0.45469	0.09	37.97	28.66	38.06	28.75	56.79	46.79	-18.73	-18.04
4	0.93906	0.13	28.85	16.80	28.98	16.93	56.00	46.00	-27.02	-29.07
5	3.25781	0.23	36.67	27.92	36.90	28.15	56.00	46.00	-19.10	-17.85
6	13.16016	0.54	23.84	12.87	24.38	13.41	60.00	50.00	-35.62	-36.59

**REMARKS:**

1. Q.P. and AV. are abbreviations of quasi-peak and average individually.
2. The emission levels of other frequencies were very low against the limit.
3. Margin value = Emission Level – Limit value
4. Correction Factor = Insertion loss + Cable loss
5. Emission Level = Correction Factor + Reading Value

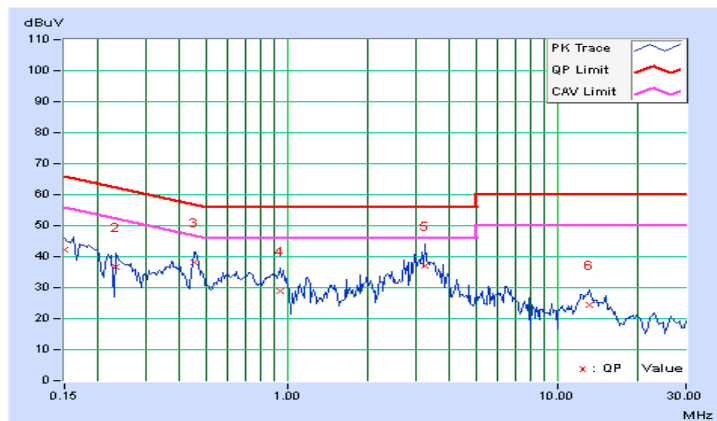

## 4.2 RADIATED EMISSION AND BANDEDGE MEASUREMENT

### 4.2.1 LIMITS OF RADIATED EMISSION AND BANDEDGE MEASUREMENT

Radiated emissions which fall in the restricted bands must comply with the radiated emission limits specified as below table. Other emissions shall be at least 20dB below the highest level of the desired power:

Frequencies (MHz)	Field strength (microvolts/meter)	Measurement distance (meters)
0.009-0.490	2400/F(kHz)	300
0.490-1.705	24000/F(kHz)	30
1.705-30.0	30	30
30-88	100	3
88-216	150	3
216-960	200	3
Above 960	500	3

**NOTE:**

1. The lower limit shall apply at the transition frequencies.
2. Emission level (dBuV/m) = 20 log Emission level (uV/m).
3. For frequencies above 1000MHz, the field strength limits are based on average detector, however, the peak field strength of any emission shall not exceed the maximum permitted average limits, specified above by more than 20dB.



A D T

#### 4.2.2 TEST INSTRUMENTS

DESCRIPTION & MANUFACTURER	MODEL NO.	SERIAL NO.	CALIBRATED DATE	CALIBRATED UNTIL
MXE EMI Receiver Agilent	N9038A	MY50010156	Aug. 11, 2014	Aug. 10, 2015
Pre-Amplifier Mini-Circuits	ZFL-1000VH2 B	AMP-ZFL-04	Nov. 13, 2013	Nov. 12, 2014
Trilog Broadband Antenna SCHWARZBECK	VULB 9168	9168-361	Feb. 27, 2014	Feb. 26, 2015
RF Cable	NA	CHHCAB_001	Oct. 06, 2013	Oct. 05, 2014
Spectrum Analyzer R&S	FSV40	100964	July 05, 2014	July 04, 2015
Horn_Antenna AISI	AIH.8018	0000220091110	Dec. 06, 2013	Dec. 05, 2014
Pre-Amplifier Agilent	8449B	3008A01923	Oct. 29, 2013	Oct. 28, 2014
RF Cable	NA	RF104-205 RF104-207 RF104-202	Dec. 12, 2013	Dec. 11, 2014
Spectrum Analyzer Agilent	E4446A	MY48250253	Aug. 10, 2014	Aug. 09, 2015
Pre-Amplifier SPACEK LABS	SLKKa-48-6	9K16	Nov. 13, 2013	Nov. 12, 2014
Horn_Antenna SCHWARZBECK	BBHA 9170	9170-424	Oct. 08, 2013	Oct. 07, 2014
Software	ADT_Radiated _V8.7.07	NA	NA	NA
Antenna Tower & Turn Table CT	NA	NA	NA	NA

**Note:**

1. The calibration interval of the above test instruments is 12 months and the calibrations are traceable to NML/ROC and NIST/USA.
2. The horn antenna, preamplifier (model: 8449B) are used only for the measurement of emission frequency above 1GHz if tested.
3. The test was performed in 966 Chamber No. H.
4. The FCC Site Registration No. is 797305.
5. The CANADA Site Registration No. is IC 7450H-3.
6. Tested Date: Sep. 15, 2014

### 4.2.3 TEST PROCEDURES

- a. The EUT was placed on the top of a rotating table 0.8 meters above the ground at 3 meter chamber room for test. The table was rotated 360 degrees to determine the position of the highest radiation.
- b. The EUT was set 3 meters away from the interference-receiving antenna, which was mounted on the top of a variable-height antenna tower.
- c. The height of antenna is varied from one meter to four meters above the ground to determine the maximum value of the field strength. Both horizontal and vertical polarizations of the antenna are set to make the measurement.
- d. For each suspected emission, the EUT was arranged to its worst case and then the antenna was tuned to heights from 1 meter to 4 meters and the rotatable table was turned from 0 degrees to 360 degrees to find the maximum reading.
- e. The test-receiver system was set to quasi-peak detect function and specified bandwidth with maximum hold mode when the test frequency is below 1 GHz.
- f. The test-receiver system was set to peak and average detect function and specified bandwidth with maximum hold mode when the test frequency is above 1 GHz. If the peak reading value also meets average limit, measurement with the average detector is unnecessary.

**Note:**

1. The resolution bandwidth and video bandwidth of test receiver/spectrum analyzer is 120kHz for Quasi-peak detection (QP) at frequency below 1GHz.
2. The resolution bandwidth of test receiver/spectrum analyzer is 1 MHz and the video bandwidth is 3 MHz for Peak detection (PK) at frequency above 1GHz.
3. The resolution bandwidth of test receiver/spectrum analyzer is 1MHz and the video bandwidth is 3MHz for RMS Average (Duty cycle < 98%) for Average detection (AV) at frequency above 1GHz, then the measurement results was added to a correction factor ( $10 \log(1/\text{duty cycle})$ ).
4. The resolution bandwidth of test receiver/spectrum analyzer is 1MHz and the video bandwidth is 10Hz (Duty cycle  $\geq 98\%$ ) for Average detection (AV) at frequency above 1GHz.
5. All modes of operation were investigated and the worst-case emissions are reported.

### 4.2.4 DEVIATION FROM TEST STANDARD

No deviation

## 4.2.5 TEST SETUP

### <Frequency Range below 1GHz>

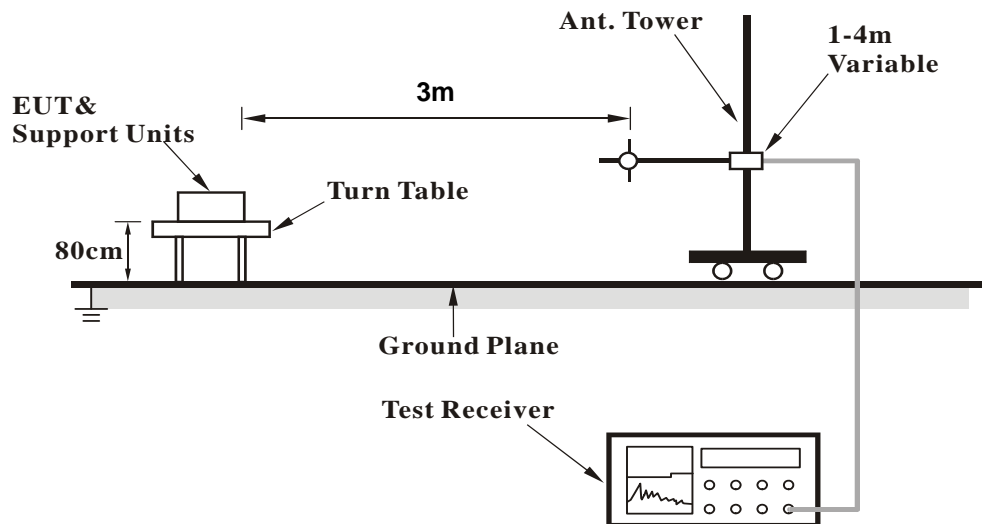

### <Frequency Range above 1GHz>

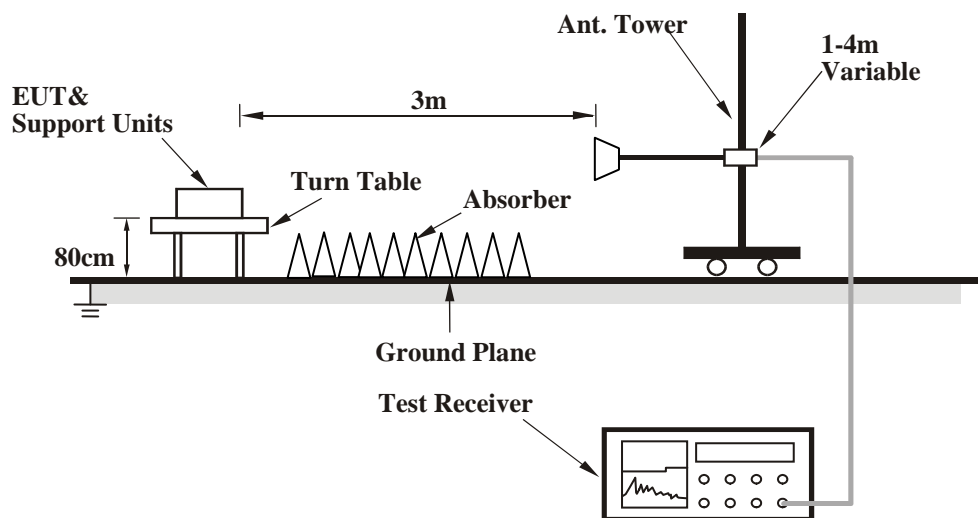

For the actual test configuration, please refer to the related item – Photographs of the Test Configuration.

## 4.2.6 EUT OPERATING CONDITIONS

Same as 4.1.6





A D T

## 4.2.7 TEST RESULTS

### BELOW 1GHz WORST-CASE DATA

#### 802.11g

<b>CHANNEL</b>	TX Channel 6	<b>DETECTOR FUNCTION</b>	Quasi-Peak (QP)
<b>FREQUENCY RANGE</b>	30MHz ~ 1GHz		

ANTENNA POLARITY & TEST DISTANCE: HORIZONTAL AT 3 M								
NO.	FREQ. (MHz)	EMISSION LEVEL (dBuV/m)	LIMIT (dBuV/m)	MARGIN (dB)	ANTENNA HEIGHT (m)	TABLE ANGLE (Degree)	RAW VALUE (dBuV)	CORRECTION FACTOR (dB/m)
1	162.02	35.6 QP	43.5	-7.9	1.50 H	100	49.00	-13.38
2	255.82	36.6 QP	46.0	-9.4	1.00 H	297	50.71	-14.10
3	284.24	36.8 QP	46.0	-9.2	1.00 H	54	49.68	-12.84
4	324.01	37.3 QP	46.0	-8.7	1.00 H	130	48.85	-11.59
5	400.92	38.5 QP	46.0	-7.5	1.00 H	25	48.18	-9.71
6	608.49	40.2 QP	46.0	-5.8	1.50 H	308	44.78	-4.60

ANTENNA POLARITY & TEST DISTANCE: VERTICAL AT 3 M								
NO.	FREQ. (MHz)	EMISSION LEVEL (dBuV/m)	LIMIT (dBuV/m)	MARGIN (dB)	ANTENNA HEIGHT (m)	TABLE ANGLE (Degree)	RAW VALUE (dBuV)	CORRECTION FACTOR (dB/m)
1	249.95	37.3 QP	46.0	-8.7	1.50 V	360	51.61	-14.32
2	270.03	35.1 QP	46.0	-10.9	1.50 V	4	48.54	-13.42
3	284.24	38.5 QP	46.0	-7.6	1.50 V	245	51.29	-12.84
4	324.01	41.4 QP	46.0	-4.6	1.50 V	10	53.00	-11.59
5	400.92	37.3 QP	46.0	-8.7	1.50 V	217	46.98	-9.71
6	611.08	36.2 QP	46.0	-9.8	1.00 V	0	40.70	-4.49

#### REMARKS:

1. Emission Level(dBuV/m) = Raw Value(dBuV) + Correction Factor(dB/m)
2. Correction Factor(dB/m) = Antenna Factor(dB/m) + Cable Factor(dB) – Pre-Amplifier Factor(dB)
3. The other emission levels were very low against the limit.
4. Margin value = Emission Level – Limit value



A D T

## ABOVE 1GHz DATA

## 802.11b

CHANNEL	TX Channel 1	DETECTOR FUNCTION	Peak (PK)
FREQUENCY RANGE	1GHz ~ 25GHz		Average (AV)

ANTENNA POLARITY & TEST DISTANCE: HORIZONTAL AT 3 M								
NO.	FREQ. (MHz)	EMISSION LEVEL (dBuV/m)	LIMIT (dBuV/m)	MARGIN (dB)	ANTENNA HEIGHT (m)	TABLE ANGLE (Degree)	RAW VALUE (dBuV)	CORRECTION FACTOR (dB/m)
1	2390.00	48.5 PK	74.0	-25.5	1.05 H	334	54.10	-5.60
2	2390.00	36.8 AV	54.0	-17.2	1.05 H	334	42.40	-5.60
3	*2412.00	97.2 PK			1.05 H	334	102.73	-5.53
4	*2412.00	94.0 AV			1.05 H	334	99.53	-5.53
5	4824.00	58.1 PK	74.0	-15.9	1.26 H	339	54.24	3.86
6	4824.00	51.6 AV	54.0	-2.4	1.26 H	339	47.74	3.86
ANTENNA POLARITY & TEST DISTANCE: VERTICAL AT 3 M								
NO.	FREQ. (MHz)	EMISSION LEVEL (dBuV/m)	LIMIT (dBuV/m)	MARGIN (dB)	ANTENNA HEIGHT (m)	TABLE ANGLE (Degree)	RAW VALUE (dBuV)	CORRECTION FACTOR (dB/m)
1	2390.00	55.8 PK	74.0	-18.2	1.00 V	77	61.40	-5.60
2	2390.00	37.5 AV	54.0	-16.5	1.00 V	77	43.10	-5.60
3	*2412.00	98.8 PK			1.00 V	77	104.33	-5.53
4	*2412.00	95.9 AV			1.00 V	77	101.43	-5.53
5	4824.00	56.3 PK	74.0	-17.7	1.03 V	8	52.44	3.86
6	4824.00	53.5 AV	54.0	-0.5	1.03 V	8	49.64	3.86

## REMARKS:

1. Emission Level(dBuV/m) = Raw Value(dBuV) + Correction Factor(dB/m)
2. Correction Factor(dB/m) = Antenna Factor(dB/m) + Cable Factor(dB) – Pre-Amplifier Factor(dB)
3. The other emission levels were very low against the limit.
4. Margin value = Emission Level – Limit value
5. " \* ": Fundamental frequency.



A D T

<b>CHANNEL</b>	TX Channel 6	<b>DETECTOR FUNCTION</b>	Peak (PK)
<b>FREQUENCY RANGE</b>	1GHz ~ 25GHz		Average (AV)

**ANTENNA POLARITY & TEST DISTANCE: HORIZONTAL AT 3 M**

NO.	FREQ. (MHz)	EMISSION LEVEL (dBuV/m)	LIMIT (dBuV/m)	MARGIN (dB)	ANTENNA HEIGHT (m)	TABLE ANGLE (Degree)	RAW VALUE (dBuV)	CORRECTION FACTOR (dB/m)
1	*2437.00	98.1 PK			1.03 H	326	103.52	-5.42
2	*2437.00	93.6 AV			1.03 H	326	99.02	-5.42
3	4874.00	58.0 PK	74.0	-16.0	1.21 H	329	54.19	3.81
4	4874.00	51.6 AV	54.0	-2.4	1.21 H	329	47.79	3.81
5	7311.00	54.1 PK	74.0	-19.9	1.02 H	89	45.87	8.23
6	7311.00	41.3 AV	54.0	-12.7	1.02 H	89	33.07	8.23

**ANTENNA POLARITY & TEST DISTANCE: VERTICAL AT 3 M**

NO.	FREQ. (MHz)	EMISSION LEVEL (dBuV/m)	LIMIT (dBuV/m)	MARGIN (dB)	ANTENNA HEIGHT (m)	TABLE ANGLE (Degree)	RAW VALUE (dBuV)	CORRECTION FACTOR (dB/m)
1	*2437.00	99.7 PK			1.16 V	42	105.12	-5.42
2	*2437.00	95.5 AV			1.16 V	42	100.92	-5.42
3	4874.00	56.2 PK	74.0	-17.8	1.02 V	7	52.39	3.81
4	4874.00	53.7 AV	54.0	-0.3	1.02 V	7	49.89	3.81
5	7311.00	53.2 PK	74.0	-20.8	1.01 V	76	44.97	8.23
6	7311.00	41.0 AV	54.0	-13.0	1.01 V	76	32.77	8.23

**REMARKS:**

1. Emission Level(dBuV/m) = Raw Value(dBuV) + Correction Factor(dB/m)
2. Correction Factor(dB/m) = Antenna Factor(dB/m) + Cable Factor(dB) – Pre-Amplifier Factor(dB)
3. The other emission levels were very low against the limit.
4. Margin value = Emission Level – Limit value
5. " \* ": Fundamental frequency.



A D T

<b>CHANNEL</b>	TX Channel 11	<b>DETECTOR FUNCTION</b>	Peak (PK)
<b>FREQUENCY RANGE</b>	1GHz ~ 25GHz		Average (AV)

**ANTENNA POLARITY & TEST DISTANCE: HORIZONTAL AT 3 M**

NO.	FREQ. (MHz)	EMISSION LEVEL (dBuV/m)	LIMIT (dBuV/m)	MARGIN (dB)	ANTENNA HEIGHT (m)	TABLE ANGLE (Degree)	RAW VALUE (dBuV)	CORRECTION FACTOR (dB/m)
1	*2462.00	99.1 PK			1.01 H	318	104.41	-5.31
2	*2462.00	94.6 AV			1.01 H	318	99.91	-5.31
3	2483.50	45.6 PK	74.0	-28.4	1.01 H	318	50.80	-5.20
4	2483.50	37.7 AV	54.0	-16.3	1.01 H	318	42.90	-5.20
5	4924.00	57.8 PK	74.0	-16.2	1.22 H	320	54.00	3.80
6	4924.00	51.3 AV	54.0	-2.7	1.22 H	320	47.50	3.80
7	7386.00	54.3 PK	74.0	-19.7	1.00 H	90	45.75	8.55
8	7386.00	41.4 AV	54.0	-12.6	1.00 H	90	32.85	8.55

**ANTENNA POLARITY & TEST DISTANCE: VERTICAL AT 3 M**

NO.	FREQ. (MHz)	EMISSION LEVEL (dBuV/m)	LIMIT (dBuV/m)	MARGIN (dB)	ANTENNA HEIGHT (m)	TABLE ANGLE (Degree)	RAW VALUE (dBuV)	CORRECTION FACTOR (dB/m)
1	*2462.00	100.7 PK			1.18 V	40	106.01	-5.31
2	*2462.00	96.5 AV			1.18 V	40	101.81	-5.31
3	2483.50	52.9 PK	74.0	-21.1	1.18 V	40	58.10	-5.20
4	2483.50	38.4 AV	54.0	-15.6	1.18 V	40	43.60	-5.20
5	4924.00	56.2 PK	74.0	-17.8	1.00 V	12	52.40	3.80
6	4924.00	53.6 AV	54.0	-0.4	1.00 V	12	49.80	3.80
7	7386.00	53.9 PK	74.0	-20.1	1.00 V	90	45.35	8.55
8	7386.00	41.4 AV	54.0	-12.6	1.00 V	90	32.85	8.55

**REMARKS:**

1. Emission Level(dBuV/m) = Raw Value(dBuV) + Correction Factor(dB/m)
2. Correction Factor(dB/m) = Antenna Factor(dB/m) + Cable Factor(dB) – Pre-Amplifier Factor(dB)
3. The other emission levels were very low against the limit.
4. Margin value = Emission Level – Limit value
5. " \* ": Fundamental frequency.



A D T

802.11g

<b>CHANNEL</b>	TX Channel 1	<b>DETECTOR FUNCTION</b>	Peak (PK)
<b>FREQUENCY RANGE</b>	1GHz ~ 25GHz		Average (AV)

**ANTENNA POLARITY & TEST DISTANCE: HORIZONTAL AT 3 M**

NO.	FREQ. (MHz)	EMISSION LEVEL (dBuV/m)	LIMIT (dBuV/m)	MARGIN (dB)	ANTENNA HEIGHT (m)	TABLE ANGLE (Degree)	RAW VALUE (dBuV)	CORRECTION FACTOR (dB/m)
1	2390.00	71.4 PK	74.0	-2.6	1.02 H	315	77.00	-5.60
2	2390.00	52.0 AV	54.0	-2.0	1.02 H	315	57.60	-5.60
3	*2412.00	103.5 PK			1.02 H	315	109.03	-5.53
4	*2412.00	92.4 AV			1.02 H	315	97.93	-5.53
5	4824.00	60.5 PK	74.0	-13.5	1.47 H	313	56.64	3.86
6	4824.00	46.8 AV	54.0	-7.2	1.47 H	313	42.94	3.86

**ANTENNA POLARITY & TEST DISTANCE: VERTICAL AT 3 M**

NO.	FREQ. (MHz)	EMISSION LEVEL (dBuV/m)	LIMIT (dBuV/m)	MARGIN (dB)	ANTENNA HEIGHT (m)	TABLE ANGLE (Degree)	RAW VALUE (dBuV)	CORRECTION FACTOR (dB/m)
1	2390.00	71.5 PK	74.0	-2.5	1.00 V	78	77.10	-5.60
2	2390.00	53.8 AV	54.0	-0.2	1.00 V	78	59.40	-5.60
3	*2412.00	105.1 PK			1.00 V	78	110.63	-5.53
4	*2412.00	94.3 AV			1.00 V	78	99.83	-5.53
5	4824.00	62.2 PK	74.0	-11.8	1.22 V	79	58.34	3.86
6	4824.00	49.8 AV	54.0	-4.2	1.22 V	79	45.94	3.86

**REMARKS:**

1. Emission Level(dBuV/m) = Raw Value(dBuV) + Correction Factor(dB/m)
2. Correction Factor(dB/m) = Antenna Factor(dB/m) + Cable Factor(dB) – Pre-Amplifier Factor(dB)
3. The other emission levels were very low against the limit.
4. Margin value = Emission Level – Limit value
5. " \* ": Fundamental frequency.



A D T

<b>CHANNEL</b>	TX Channel 6	<b>DETECTOR FUNCTION</b>	Peak (PK)
<b>FREQUENCY RANGE</b>	1GHz ~ 25GHz		Average (AV)

**ANTENNA POLARITY & TEST DISTANCE: HORIZONTAL AT 3 M**

NO.	FREQ. (MHz)	EMISSION LEVEL (dBuV/m)	LIMIT (dBuV/m)	MARGIN (dB)	ANTENNA HEIGHT (m)	TABLE ANGLE (Degree)	RAW VALUE (dBuV)	CORRECTION FACTOR (dB/m)
1	*2437.00	105.9 PK			1.03 H	306	111.32	-5.42
2	*2437.00	95.5 AV			1.03 H	306	100.92	-5.42
3	4874.00	60.8 PK	74.0	-13.2	1.53 H	307	56.99	3.81
4	4874.00	47.4 AV	54.0	-6.6	1.53 H	307	43.59	3.81
5	7311.00	54.6 PK	74.0	-19.4	1.02 H	93	46.37	8.23
6	7311.00	41.6 AV	54.0	-12.4	1.02 H	93	33.37	8.23

**ANTENNA POLARITY & TEST DISTANCE: VERTICAL AT 3 M**

NO.	FREQ. (MHz)	EMISSION LEVEL (dBuV/m)	LIMIT (dBuV/m)	MARGIN (dB)	ANTENNA HEIGHT (m)	TABLE ANGLE (Degree)	RAW VALUE (dBuV)	CORRECTION FACTOR (dB/m)
1	*2437.00	106.9 PK			1.18 V	46	112.32	-5.42
2	*2437.00	96.4 AV			1.18 V	46	101.82	-5.42
3	4874.00	63.5 PK	74.0	-10.5	1.14 V	81	59.69	3.81
4	4874.00	50.5 AV	54.0	-3.5	1.14 V	81	46.69	3.81
5	7311.00	53.4 PK	74.0	-20.6	1.00 V	94	45.17	8.23
6	7311.00	41.1 AV	54.0	-12.9	1.00 V	94	32.87	8.23

**REMARKS:**

1. Emission Level(dBuV/m) = Raw Value(dBuV) + Correction Factor(dB/m)
2. Correction Factor(dB/m) = Antenna Factor(dB/m) + Cable Factor(dB) – Pre-Amplifier Factor(dB)
3. The other emission levels were very low against the limit.
4. Margin value = Emission Level – Limit value
5. " \* ": Fundamental frequency.



A D T

<b>CHANNEL</b>	TX Channel 11	<b>DETECTOR FUNCTION</b>	Peak (PK)
<b>FREQUENCY RANGE</b>	1GHz ~ 25GHz		Average (AV)

**ANTENNA POLARITY & TEST DISTANCE: HORIZONTAL AT 3 M**

NO.	FREQ. (MHz)	EMISSION LEVEL (dBuV/m)	LIMIT (dBuV/m)	MARGIN (dB)	ANTENNA HEIGHT (m)	TABLE ANGLE (Degree)	RAW VALUE (dBuV)	CORRECTION FACTOR (dB/m)
1	*2462.00	104.2 PK			1.02 H	309	109.51	-5.31
2	*2462.00	93.2 AV			1.02 H	309	98.51	-5.31
3	2483.50	72.0 PK	74.0	-2.0	1.02 H	309	77.20	-5.20
4	2483.50	52.0 AV	54.0	-2.0	1.02 H	309	57.20	-5.20
5	4924.00	60.4 PK	74.0	-13.6	1.52 H	306	56.60	3.80
6	4924.00	46.7 AV	54.0	-7.3	1.52 H	306	42.90	3.80
7	7386.00	53.9 PK	74.0	-20.1	1.03 H	79	45.35	8.55
8	7386.00	41.1 AV	54.0	-12.9	1.03 H	79	32.55	8.55

**ANTENNA POLARITY & TEST DISTANCE: VERTICAL AT 3 M**

NO.	FREQ. (MHz)	EMISSION LEVEL (dBuV/m)	LIMIT (dBuV/m)	MARGIN (dB)	ANTENNA HEIGHT (m)	TABLE ANGLE (Degree)	RAW VALUE (dBuV)	CORRECTION FACTOR (dB/m)
1	*2462.00	106.0 PK			1.00 V	78	111.31	-5.31
2	*2462.00	95.1 AV			1.00 V	78	100.41	-5.31
3	2483.50	72.4 PK	74.0	-1.6	1.00 V	78	77.60	-5.20
4	<b>2483.50</b>	<b>53.9 AV</b>	<b>54.0</b>	<b>-0.1</b>	<b>1.00 V</b>	<b>78</b>	<b>59.10</b>	<b>-5.20</b>
5	4924.00	62.1 PK	74.0	-11.9	1.18 V	91	58.30	3.80
6	4924.00	49.4 AV	54.0	-4.6	1.18 V	91	45.60	3.80
7	7386.00	53.4 PK	74.0	-20.6	1.02 V	84	44.85	8.55
8	7386.00	41.1 AV	54.0	-12.9	1.02 V	84	32.55	8.55

**REMARKS:**

1. Emission Level(dBuV/m) = Raw Value(dBuV) + Correction Factor(dB/m)
2. Correction Factor(dB/m) = Antenna Factor(dB/m) + Cable Factor(dB) – Pre-Amplifier Factor(dB)
3. The other emission levels were very low against the limit.
4. Margin value = Emission Level – Limit value
5. " \* ": Fundamental frequency.

**802.11n (HT20)**

<b>CHANNEL</b>	TX Channel 1	<b>DETECTOR FUNCTION</b>	Peak (PK)
<b>FREQUENCY RANGE</b>	1GHz ~ 25GHz		Average (AV)

ANTENNA POLARITY & TEST DISTANCE: HORIZONTAL AT 3 M								
NO.	FREQ. (MHz)	EMISSION LEVEL (dBuV/m)	LIMIT (dBuV/m)	MARGIN (dB)	ANTENNA HEIGHT (m)	TABLE ANGLE (Degree)	RAW VALUE (dBuV)	CORRECTION FACTOR (dB/m)
1	2390.00	71.6 PK	74.0	-2.4	1.07 H	327	77.20	-5.60
2	2390.00	52.0 AV	54.0	-2.0	1.07 H	327	57.60	-5.60
3	*2412.00	102.0 PK			1.07 H	327	107.53	-5.53
4	*2412.00	91.2 AV			1.07 H	327	96.73	-5.53
5	4824.00	60.0 PK	74.0	-14.0	1.52 H	305	56.14	3.86
6	4824.00	46.6 AV	54.0	-7.4	1.52 H	305	42.74	3.86

ANTENNA POLARITY & TEST DISTANCE: VERTICAL AT 3 M								
NO.	FREQ. (MHz)	EMISSION LEVEL (dBuV/m)	LIMIT (dBuV/m)	MARGIN (dB)	ANTENNA HEIGHT (m)	TABLE ANGLE (Degree)	RAW VALUE (dBuV)	CORRECTION FACTOR (dB/m)
1	2390.00	72.9 PK	74.0	-1.1	1.00 V	78	78.50	-5.60
2	<b>2390.00</b>	<b>53.9 AV</b>	<b>54.0</b>	<b>-0.1</b>	<b>1.00 V</b>	<b>78</b>	<b>59.50</b>	<b>-5.60</b>
3	*2412.00	103.6 PK			1.00 V	78	109.13	-5.53
4	*2412.00	93.1 AV			1.00 V	78	98.63	-5.53
5	4824.00	61.9 PK	74.0	-12.1	1.19 V	93	58.04	3.86
6	4824.00	49.6 AV	54.0	-4.4	1.19 V	93	45.74	3.86

**REMARKS:**

1. Emission Level(dBuV/m) = Raw Value(dBuV) + Correction Factor(dB/m)
2. Correction Factor(dB/m) = Antenna Factor(dB/m) + Cable Factor(dB) – Pre-Amplifier Factor(dB)
3. The other emission levels were very low against the limit.
4. Margin value = Emission Level – Limit value
5. " \* ": Fundamental frequency.





A D T

<b>CHANNEL</b>	TX Channel 6	<b>DETECTOR FUNCTION</b>	Peak (PK)
<b>FREQUENCY RANGE</b>	1GHz ~ 25GHz		Average (AV)

**ANTENNA POLARITY & TEST DISTANCE: HORIZONTAL AT 3 M**

NO.	FREQ. (MHz)	EMISSION LEVEL (dBuV/m)	LIMIT (dBuV/m)	MARGIN (dB)	ANTENNA HEIGHT (m)	TABLE ANGLE (Degree)	RAW VALUE (dBuV)	CORRECTION FACTOR (dB/m)
1	*2437.00	105.8 PK			1.05 H	338	111.22	-5.42
2	*2437.00	94.4 AV			1.05 H	338	99.82	-5.42
3	4874.00	60.3 PK	74.0	-13.7	1.47 H	317	56.49	3.81
4	4874.00	46.9 AV	54.0	-7.1	1.47 H	317	43.09	3.81
5	7311.00	54.8 PK	74.0	-19.2	1.02 H	85	46.57	8.23
6	7311.00	41.5 AV	54.0	-12.5	1.02 H	85	33.27	8.23

**ANTENNA POLARITY & TEST DISTANCE: VERTICAL AT 3 M**

NO.	FREQ. (MHz)	EMISSION LEVEL (dBuV/m)	LIMIT (dBuV/m)	MARGIN (dB)	ANTENNA HEIGHT (m)	TABLE ANGLE (Degree)	RAW VALUE (dBuV)	CORRECTION FACTOR (dB/m)
1	*2437.00	106.7 PK			1.14 V	51	112.12	-5.42
2	*2437.00	95.3 AV			1.14 V	51	100.72	-5.42
3	4874.00	62.6 PK	74.0	-11.4	1.14 V	81	58.79	3.81
4	4874.00	49.4 AV	54.0	-4.6	1.14 V	81	45.59	3.81
5	7311.00	53.4 PK	74.0	-20.6	1.02 V	87	45.17	8.23
6	7311.00	40.8 AV	54.0	-13.2	1.02 V	87	32.57	8.23

**REMARKS:**

1. Emission Level(dBuV/m) = Raw Value(dBuV) + Correction Factor(dB/m)
2. Correction Factor(dB/m) = Antenna Factor(dB/m) + Cable Factor(dB) – Pre-Amplifier Factor(dB)
3. The other emission levels were very low against the limit.
4. Margin value = Emission Level – Limit value
5. " \* ": Fundamental frequency.



A D T

<b>CHANNEL</b>	TX Channel 11	<b>DETECTOR FUNCTION</b>	Peak (PK)
<b>FREQUENCY RANGE</b>	1GHz ~ 25GHz		Average (AV)

**ANTENNA POLARITY & TEST DISTANCE: HORIZONTAL AT 3 M**

NO.	FREQ. (MHz)	EMISSION LEVEL (dBuV/m)	LIMIT (dBuV/m)	MARGIN (dB)	ANTENNA HEIGHT (m)	TABLE ANGLE (Degree)	RAW VALUE (dBuV)	CORRECTION FACTOR (dB/m)
1	*2462.00	102.9 PK			1.07 H	327	108.21	-5.31
2	*2462.00	92.1 AV			1.07 H	327	97.41	-5.31
3	2483.50	71.4 PK	74.0	-2.6	1.07 H	327	76.60	-5.20
4	2483.50	51.8 AV	54.0	-2.2	1.07 H	327	57.00	-5.20
5	4924.00	60.4 PK	74.0	-13.6	1.44 H	318	56.60	3.80
6	4924.00	46.8 AV	54.0	-7.2	1.44 H	318	43.00	3.80
7	7386.00	54.7 PK	74.0	-19.3	1.07 H	90	46.15	8.55
8	7386.00	41.1 AV	54.0	-12.9	1.07 H	90	32.55	8.55

**ANTENNA POLARITY & TEST DISTANCE: VERTICAL AT 3 M**

NO.	FREQ. (MHz)	EMISSION LEVEL (dBuV/m)	LIMIT (dBuV/m)	MARGIN (dB)	ANTENNA HEIGHT (m)	TABLE ANGLE (Degree)	RAW VALUE (dBuV)	CORRECTION FACTOR (dB/m)
1	*2462.00	104.5 PK			1.00 V	78	109.81	-5.31
2	*2462.00	94.0 AV			1.00 V	78	99.31	-5.31
3	2483.50	72.9 PK	74.0	-1.1	1.00 V	78	78.10	-5.20
4	<b>2483.50</b>	<b>53.9 AV</b>	<b>54.0</b>	<b>-0.1</b>	<b>1.00 V</b>	<b>78</b>	<b>59.10</b>	<b>-5.20</b>
5	4924.00	61.6 PK	74.0	-12.4	1.18 V	76	57.80	3.80
6	4924.00	49.2 AV	54.0	-4.8	1.18 V	76	45.40	3.80
7	7386.00	52.9 PK	74.0	-21.1	1.05 V	87	44.35	8.55
8	7386.00	40.6 AV	54.0	-13.4	1.05 V	87	32.05	8.55

**REMARKS:**

1. Emission Level(dBuV/m) = Raw Value(dBuV) + Correction Factor(dB/m)
2. Correction Factor(dB/m) = Antenna Factor(dB/m) + Cable Factor(dB) – Pre-Amplifier Factor(dB)
3. The other emission levels were very low against the limit.
4. Margin value = Emission Level – Limit value
5. " \* ": Fundamental frequency.



A D T

802.11n (HT40)

<b>CHANNEL</b>	TX Channel 3	<b>DETECTOR FUNCTION</b>	Peak (PK)
<b>FREQUENCY RANGE</b>	1GHz ~ 25GHz		Average (AV)

**ANTENNA POLARITY & TEST DISTANCE: HORIZONTAL AT 3 M**

NO.	FREQ. (MHz)	EMISSION LEVEL (dBuV/m)	LIMIT (dBuV/m)	MARGIN (dB)	ANTENNA HEIGHT (m)	TABLE ANGLE (Degree)	RAW VALUE (dBuV)	CORRECTION FACTOR (dB/m)
1	2390.00	68.9 PK	74.0	-5.1	1.10 H	312	74.50	-5.60
2	2390.00	52.4 AV	54.0	-1.6	1.10 H	312	58.00	-5.60
3	*2422.00	96.6 PK			1.05 H	314	102.09	-5.49
4	*2422.00	86.7 AV			1.05 H	314	92.19	-5.49
5	4844.00	61.2 PK	74.0	-12.8	1.44 H	320	57.36	3.84
6	4844.00	47.3 AV	54.0	-6.7	1.44 H	320	43.46	3.84
7	7266.00	55.0 PK	74.0	-19.0	1.02 H	98	46.94	8.06
8	7266.00	41.1 AV	54.0	-12.9	1.02 H	98	33.04	8.06

**ANTENNA POLARITY & TEST DISTANCE: VERTICAL AT 3 M**

NO.	FREQ. (MHz)	EMISSION LEVEL (dBuV/m)	LIMIT (dBuV/m)	MARGIN (dB)	ANTENNA HEIGHT (m)	TABLE ANGLE (Degree)	RAW VALUE (dBuV)	CORRECTION FACTOR (dB/m)
1	2390.00	70.4 PK	74.0	-3.6	1.00 V	78	76.00	-5.60
2	2390.00	53.6 AV	54.0	-0.4	1.00 V	78	59.20	-5.60
3	*2422.00	98.2 PK			1.00 V	78	103.69	-5.49
4	*2422.00	88.6 AV			1.00 V	78	94.09	-5.49
5	4844.00	62.2 PK	74.0	-11.8	1.18 V	69	58.36	3.84
6	4844.00	49.5 AV	54.0	-4.5	1.18 V	69	45.66	3.84
7	7266.00	52.5 PK	74.0	-21.5	1.03 V	73	44.44	8.06
8	7266.00	40.1 AV	54.0	-13.9	1.03 V	73	32.04	8.06

**REMARKS:**

1. Emission Level(dBuV/m) = Raw Value(dBuV) + Correction Factor(dB/m)
2. Correction Factor(dB/m) = Antenna Factor(dB/m) + Cable Factor(dB) – Pre-Amplifier Factor(dB)
3. The other emission levels were very low against the limit.
4. Margin value = Emission Level – Limit value
5. " \* ": Fundamental frequency.



A D T

<b>CHANNEL</b>	TX Channel 6	<b>DETECTOR FUNCTION</b>	Peak (PK)
<b>FREQUENCY RANGE</b>	1GHz ~ 25GHz		Average (AV)

ANTENNA POLARITY & TEST DISTANCE: HORIZONTAL AT 3 M								
NO.	FREQ. (MHz)	EMISSION LEVEL (dBuV/m)	LIMIT (dBuV/m)	MARGIN (dB)	ANTENNA HEIGHT (m)	TABLE ANGLE (Degree)	RAW VALUE (dBuV)	CORRECTION FACTOR (dB/m)
1	2390.00	65.9 PK	74.0	-8.1	1.02 H	321	71.50	-5.60
2	2390.00	48.9 AV	54.0	-5.1	1.02 H	321	54.50	-5.60
3	*2437.00	99.8 PK			1.02 H	321	105.22	-5.42
4	*2437.00	89.9 AV			1.02 H	321	95.32	-5.42
5	2483.50	69.6 PK	74.0	-4.4	1.02 H	321	74.80	-5.20
6	2483.50	52.8 AV	54.0	-1.2	1.02 H	321	58.00	-5.20
7	4874.00	61.8 PK	74.0	-12.2	1.50 H	309	57.99	3.81
8	4874.00	47.6 AV	54.0	-6.4	1.50 H	309	43.79	3.81
9	7311.00	55.2 PK	74.0	-18.8	1.04 H	83	46.97	8.23
10	7311.00	41.4 AV	54.0	-12.6	1.04 H	83	33.17	8.23

ANTENNA POLARITY & TEST DISTANCE: VERTICAL AT 3 M								
NO.	FREQ. (MHz)	EMISSION LEVEL (dBuV/m)	LIMIT (dBuV/m)	MARGIN (dB)	ANTENNA HEIGHT (m)	TABLE ANGLE (Degree)	RAW VALUE (dBuV)	CORRECTION FACTOR (dB/m)
1	2390.00	67.4 PK	74.0	-6.6	1.00 V	78	73.00	-5.60
2	2390.00	50.1 AV	54.0	-3.9	1.00 V	78	55.70	-5.60
3	*2437.00	101.4 PK			1.00 V	78	106.82	-5.42
4	*2437.00	91.8 AV			1.00 V	78	97.22	-5.42
5	2483.50	71.5 PK	74.0	-2.5	1.00 V	78	76.70	-5.20
6	<b>2483.50</b>	<b>53.9 AV</b>	<b>54.0</b>	<b>-0.1</b>	<b>1.00 V</b>	<b>78</b>	<b>59.10</b>	<b>-5.20</b>
7	4874.00	62.1 PK	74.0	-11.9	1.15 V	73	58.29	3.81
8	4874.00	49.2 AV	54.0	-4.8	1.15 V	73	45.39	3.81
9	7311.00	52.0 PK	74.0	-22.0	1.01 V	70	43.77	8.23
10	7311.00	39.7 AV	54.0	-14.3	1.01 V	70	31.47	8.23

**REMARKS:**

1. Emission Level(dBuV/m) = Raw Value(dBuV) + Correction Factor(dB/m)
2. Correction Factor(dB/m) = Antenna Factor(dB/m) + Cable Factor(dB) – Pre-Amplifier Factor(dB)
3. The other emission levels were very low against the limit.
4. Margin value = Emission Level – Limit value
5. " \* ": Fundamental frequency.



A D T

<b>CHANNEL</b>	TX Channel 9	<b>DETECTOR FUNCTION</b>	Peak (PK)
<b>FREQUENCY RANGE</b>	1GHz ~ 25GHz		Average (AV)

**ANTENNA POLARITY & TEST DISTANCE: HORIZONTAL AT 3 M**

NO.	FREQ. (MHz)	EMISSION LEVEL (dBuV/m)	LIMIT (dBuV/m)	MARGIN (dB)	ANTENNA HEIGHT (m)	TABLE ANGLE (Degree)	RAW VALUE (dBuV)	CORRECTION FACTOR (dB/m)
1	*2452.00	97.2 PK			1.03 H	323	102.56	-5.36
2	*2452.00	86.7 AV			1.03 H	323	92.06	-5.36
3	2483.50	71.2 PK	74.0	-2.8	1.03 H	323	76.40	-5.20
4	2483.50	52.7 AV	54.0	-1.3	1.03 H	323	57.90	-5.20
5	4904.00	61.4 PK	74.0	-12.6	1.46 H	298	57.61	3.79
6	4904.00	47.2 AV	54.0	-6.8	1.46 H	298	43.41	3.79
7	7356.00	55.2 PK	74.0	-18.8	1.09 H	88	46.77	8.43
8	7356.00	41.4 AV	54.0	-12.6	1.09 H	88	32.97	8.43

**ANTENNA POLARITY & TEST DISTANCE: VERTICAL AT 3 M**

NO.	FREQ. (MHz)	EMISSION LEVEL (dBuV/m)	LIMIT (dBuV/m)	MARGIN (dB)	ANTENNA HEIGHT (m)	TABLE ANGLE (Degree)	RAW VALUE (dBuV)	CORRECTION FACTOR (dB/m)
1	*2452.00	98.8 PK			1.00 V	78	104.16	-5.36
2	*2452.00	88.6 AV			1.00 V	78	93.96	-5.36
3	2483.50	73.1 PK	74.0	-0.9	1.00 V	78	78.30	-5.20
4	<b>2483.50</b>	<b>53.9 AV</b>	<b>54.0</b>	<b>-0.1</b>	<b>1.00 V</b>	<b>78</b>	<b>59.10</b>	<b>-5.20</b>
5	4904.00	62.1 PK	74.0	-11.9	1.18 V	79	58.31	3.79
6	4904.00	49.5 AV	54.0	-4.5	1.18 V	79	45.71	3.79
7	7356.00	52.4 PK	74.0	-21.6	1.03 V	84	43.97	8.43
8	7356.00	40.2 AV	54.0	-13.8	1.03 V	84	31.77	8.43

**REMARKS:**

1. Emission Level(dBuV/m) = Raw Value(dBuV) + Correction Factor(dB/m)
2. Correction Factor(dB/m) = Antenna Factor(dB/m) + Cable Factor(dB) – Pre-Amplifier Factor(dB)
3. The other emission levels were very low against the limit.
4. Margin value = Emission Level – Limit value
5. " \* ": Fundamental frequency.

### 4.3 6dB BANDWIDTH MEASUREMENT

#### 4.3.1 LIMITS OF 6dB BANDWIDTH MEASUREMENT

The minimum of 6dB Bandwidth Measurement is 0.5 MHz.

#### 4.3.2 TEST INSTRUMENTS

DESCRIPTION & MANUFACTURER	MODEL NO.	SERIAL NO.	CALIBRATED DATE	CALIBRATED UNTIL
SPECTRUM ANALYZER R&S	FSV 40	100964	July 05, 2014	July 04, 2015

**Note:**

1. The calibration interval of the above test instruments is 12 months and the calibrations are traceable to NML/ROC and NIST/USA.
2. Tested date : Sep. 16, 2014

#### 4.3.3 TEST PROCEDURE

1. Set resolution bandwidth (RBW) = 100kHz.
2. Set the video bandwidth (VBW)  $\geq 3 \times$  RBW, Detector = Peak.
3. Trace mode = max hold.
4. Sweep = auto couple.
5. Measure the maximum width of the emission that is constrained by the frequencies associated with the two amplitude points (upper and lower) that are attenuated by 6 dB relative to the maximum level measured in the fundamental emission

#### 4.3.4 DEVIATION FROM TEST STANDARD

No deviation

#### 4.3.5 TEST SETUP

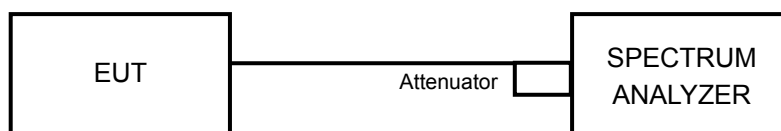

#### 4.3.6 EUT OPERATING CONDITIONS

The software provided by client to enable the EUT under transmission condition continuously at lowest, middle and highest channel frequencies individually.



A D T

### 4.3.7 TEST RESULTS

#### 802.11b

CHANNEL	CHANNEL FREQUENCY (MHz)	6dB BANDWIDTH (MHz)	MINIMUM LIMIT (MHz)	PASS / FAIL
1	2412	12.17	0.5	PASS
6	2437	12.14	0.5	PASS
11	2462	12.16	0.5	PASS

#### 802.11g

CHANNEL	CHANNEL FREQUENCY (MHz)	6dB BANDWIDTH (MHz)	MINIMUM LIMIT (MHz)	PASS / FAIL
1	2412	15.86	0.5	PASS
6	2437	15.87	0.5	PASS
11	2462	16.09	0.5	PASS

#### 802.11n (HT20)

CHANNEL	CHANNEL FREQUENCY (MHz)	6dB BANDWIDTH (MHz)	MINIMUM LIMIT (MHz)	PASS / FAIL
1	2412	15.86	0.5	PASS
6	2437	15.88	0.5	PASS
11	2462	15.89	0.5	PASS

#### 802.11n (HT40)

CHANNEL	CHANNEL FREQUENCY (MHz)	6dB BANDWIDTH (MHz)	MINIMUM LIMIT (MHz)	PASS / FAIL
3	2422	35.29	0.5	PASS
6	2437	35.24	0.5	PASS
9	2452	35.27	0.5	PASS



A D T

### SPECTRUM PLOT OF WORST VALUE

#### 802.11b / CH6

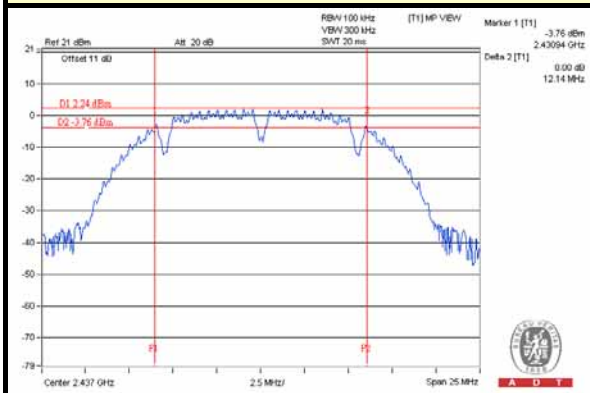

#### 802.11g / CH1

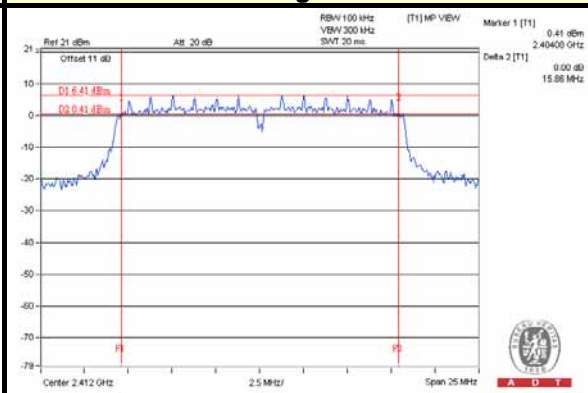

#### 802.11n (HT20) / CH1

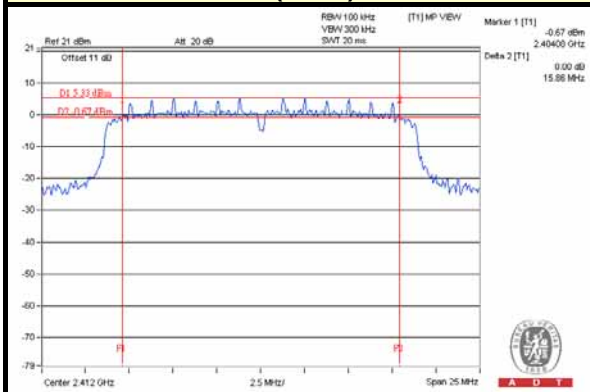

#### 802.11n (HT40) / CH6

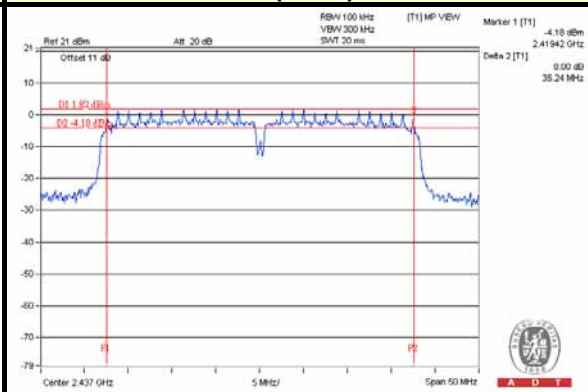





A D T

#### 4.4 CONDUCTED OUTPUT POWER MEASUREMENT

##### 4.4.1 LIMITS OF CONDUCTED OUTPUT POWER MEASUREMENT

For systems using digital modulation in the 2400–2483.5 MHz bands: 1 Watt (30dBm)

##### 4.4.2 TEST INSTRUMENTS

DESCRIPTION & MANUFACTURER	MODEL NO.	SERIAL NO.	CALIBRATED DATE	CALIBRATED UNTIL
Power meter Anritsu	ML2495A	1014008	Apr. 30, 2014	Apr. 29, 2015
Power sensor Anritsu	MA2411B	0917122	Apr. 30, 2014	Apr. 29, 2015

**Note:**

1. The calibration interval of the above test instruments is 12 months and the calibrations are traceable to NML/ROC and NIST/USA.
2. Tested date : Sep. 16, 2014

##### 4.4.3 TEST PROCEDURES

The peak / average power sensor was used on the output port of the EUT. A power meter was used to read the response of the peak / average power sensor. Record the peak power level.

#### 4.4.4 DEVIATION FROM TEST STANDARD

No deviation.

#### 4.4.5 TEST SETUP

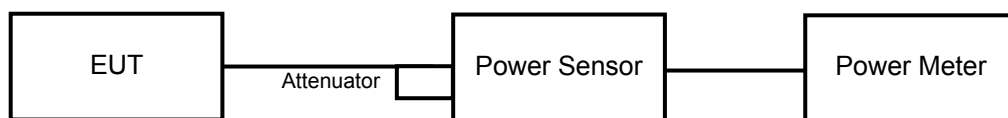

#### 4.4.6 EUT OPERATING CONDITIONS

Same as Item 4.3.6



A D T

#### 4.4.7 TEST RESULTS

##### FOR PEAK POWER

##### 802.11b

CHANNEL	FREQUENCY (MHz)	PEAK POWER (mW)	PEAK POWER (dBm)	LIMIT (dBm)	PASS/FAIL
1	2412	36.308	15.60	30	PASS
6	2437	32.961	15.18	30	PASS
11	2462	36.141	15.58	30	PASS

##### 802.11g

CHANNEL	FREQUENCY (MHz)	PEAK POWER (mW)	PEAK POWER (dBm)	LIMIT (dBm)	PASS/FAIL
1	2412	306.902	24.87	30	PASS
6	2437	364.754	25.62	30	PASS
11	2462	238.232	23.77	30	PASS

##### 802.11n (HT20)

CHANNEL	FREQUENCY (MHz)	PEAK POWER (mW)	PEAK POWER (dBm)	LIMIT (dBm)	PASS/FAIL
1	2412	231.739	23.65	30	PASS
6	2437	299.226	24.76	30	PASS
11	2462	172.584	22.37	30	PASS

##### 802.11n (HT40)

CHANNEL	FREQUENCY (MHz)	PEAK POWER (mW)	PEAK POWER (dBm)	LIMIT (dBm)	PASS/FAIL
3	2422	115.345	20.62	30	PASS
6	2437	213.796	23.30	30	PASS
9	2452	103.992	20.17	30	PASS



A D T

## FOR AVERAGE POWER

### 802.11b

CHANNEL	FREQUENCY (MHz)	AVERAGE POWER (mW)	AVERAGE POWER (dBm)
1	2412	21.281	13.28
6	2437	18.836	12.75
11	2462	20.989	13.22

### 802.11g

CHANNEL	FREQUENCY (MHz)	AVERAGE POWER (mW)	AVERAGE POWER (dBm)
1	2412	55.976	17.48
6	2437	70.958	18.51
11	2462	41.305	16.16

### 802.11n (HT20)

CHANNEL	FREQUENCY (MHz)	AVERAGE POWER (mW)	AVERAGE POWER (dBm)
1	2412	42.073	16.24
6	2437	62.373	17.95
11	2462	32.584	15.13

### 802.11n (HT40)

CHANNEL	FREQUENCY (MHz)	AVERAGE POWER (mW)	AVERAGE POWER (dBm)
3	2422	21.677	13.36
6	2437	43.451	16.38
9	2452	18.450	12.66

## 4.5 POWER SPECTRAL DENSITY MEASUREMENT

### 4.5.1 LIMITS OF POWER SPECTRAL DENSITY MEASUREMENT

The Maximum of Power Spectral Density Measurement is 8dBm.

### 4.5.2 TEST INSTRUMENTS

DESCRIPTION & MANUFACTURER	MODEL NO.	SERIAL NO.	CALIBRATED DATE	CALIBRATED UNTIL
SPECTRUM ANALYZER R&S	FSV 40	100964	July 05, 2014	July 04, 2015

**Note:**

1. The calibration interval of the above test instruments is 12 months and the calibrations are traceable to NML/ROC and NIST/USA.
2. Tested date : Aug. 12, 2014

### 4.5.3 TEST PROCEDURE

1. Set the RBW = 3 kHz, VBW =10 kHz, Detector = peak.
2. Sweep time = auto couple, Trace mode = max hold, allow trace to fully stabilize.
3. Use the peak marker function to determine the maximum amplitude level.

### 4.5.4 DEVIATION FROM TEST STANDARD

No deviation

### 4.5.5 TEST SETUP

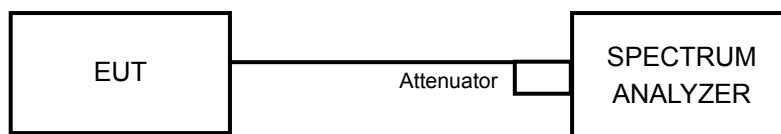

### 4.5.6 EUT OPERATING CONDITION

Same as Item 4.3.6



A D T

## 4.5.7 TEST RESULTS

### 802.11b

CHANNEL	FREQUENCY (MHz)	PSD (dBm)	LIMIT (dBm)	PASS /FAIL
1	2412	-10.84	8	PASS
6	2437	-11.66	8	PASS
11	2462	-11.11	8	PASS

### 802.11g

CHANNEL	FREQUENCY (MHz)	PSD (dBm)	LIMIT (dBm)	PASS /FAIL
1	2412	-9.59	8	PASS
6	2437	-7.94	8	PASS
11	2462	-11.21	8	PASS

### 802.11n (HT20)

CHANNEL	FREQUENCY (MHz)	PSD (dBm)	LIMIT (dBm)	PASS /FAIL
1	2412	-10.25	8	PASS
6	2437	-7.67	8	PASS
11	2462	-10.52	8	PASS

### 802.11n (HT40)

CHANNEL	FREQUENCY (MHz)	PSD (dBm)	LIMIT (dBm)	PASS /FAIL
3	2422	-17.66	8	PASS
6	2437	-13.86	8	PASS
9	2452	-17.83	8	PASS



A D T

### SPECTRUM PLOT OF WORST VALUE

#### 802.11b / CH1

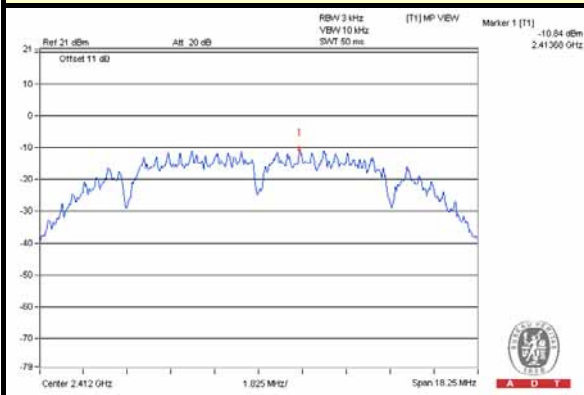

#### 802.11g / CH6

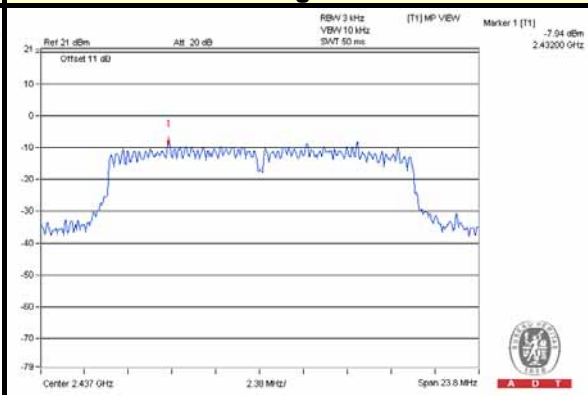

#### 802.11n (HT20) / CH6

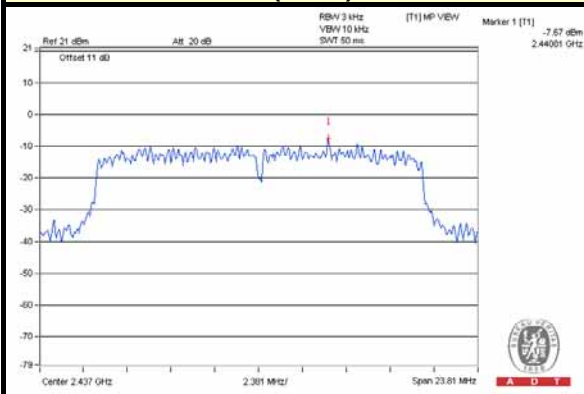

#### 802.11n (HT40) / CH6

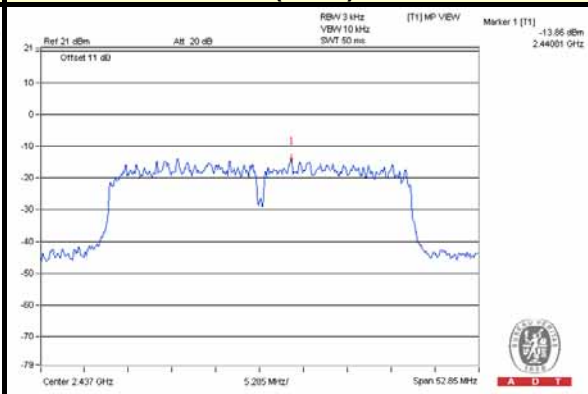

## 4.6 CONDUCTED OUT-BAND EMISSION MEASUREMENT

### 4.6.1 LIMITS OF CONDUCTED OUT-BAND EMISSION MEASUREMENT

Below 20dB of the highest emission level of operating band (in 100kHz Resolution Bandwidth).

### 4.6.2 TEST INSTRUMENTS

DESCRIPTION & MANUFACTURER	MODEL NO.	SERIAL NO.	CALIBRATED DATE	CALIBRATED UNTIL
SPECTRUM ANALYZER R&S	FSV 40	100964	July 05, 2014	July 04, 2015

**Note:**

1. The calibration interval of the above test instruments is 12 months and the calibrations are traceable to NML/ROC and NIST/USA.
2. Tested date : Aug. 12, 2014

### 4.6.3 TEST PROCEDURE

#### Measurement Procedure - Reference Level

1. Set the RBW = 100 kHz.
2. Set the VBW  $\geq$  300 kHz.
3. Detector = peak.
4. Sweep time = auto couple.
5. Trace mode = max hold.
6. Allow trace to fully stabilize.
7. Use the peak marker function to determine the maximum power level in any 100 kHz band segment within the fundamental EBW.

#### Measurement Procedure –Unwanted Emission Level

1. Set RBW = 100 kHz.
2. Set VBW  $\geq$  300 kHz.
3. Detector = peak.
4. Sweep = auto couple.
5. Trace Mode = max hold.
6. Allow trace to fully stabilize.
7. Use the peak marker function to determine the maximum amplitude level.



#### 4.6.4 DEVIATION FROM TEST STANDARD

No deviation

#### 4.6.5 TEST SETUP

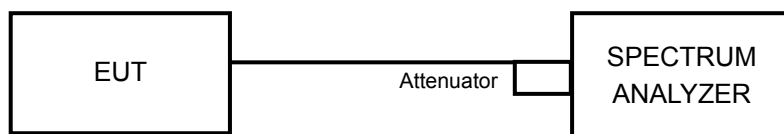

#### 4.6.6 EUT OPERATING CONDITION

Same as Item 4.3.6

#### 4.6.7 TEST RESULTS

The spectrum plots are attached on the following pages. D1 line indicates the highest level, and D2 line indicates the 20dB offset below D1. It shows compliance with the requirement.



A D T

### 802.11b

#### CH 1

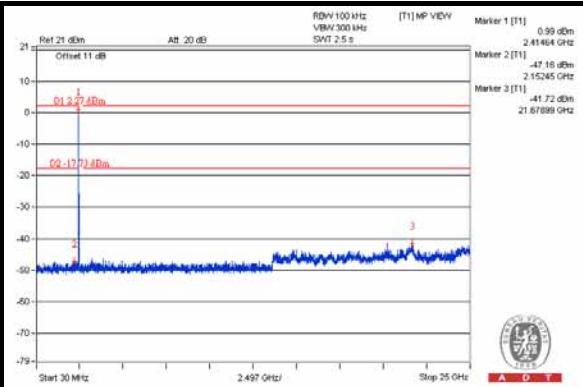
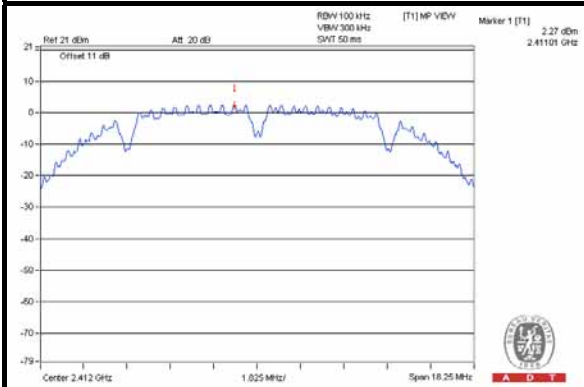

#### CH 6

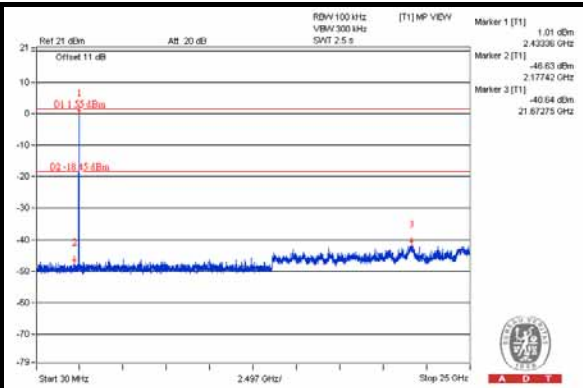
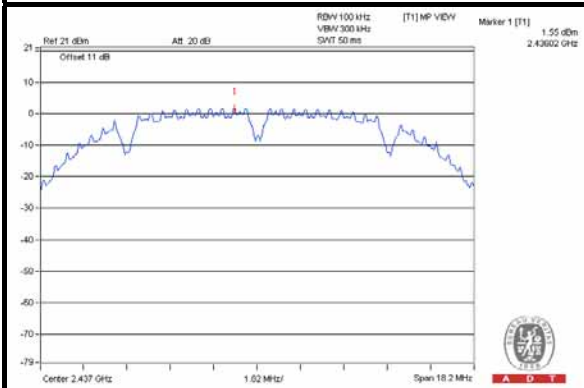

#### CH 11

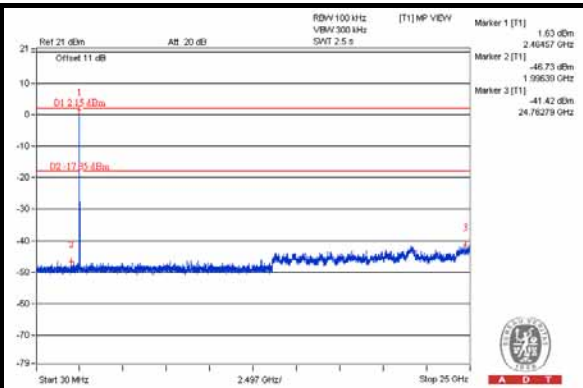
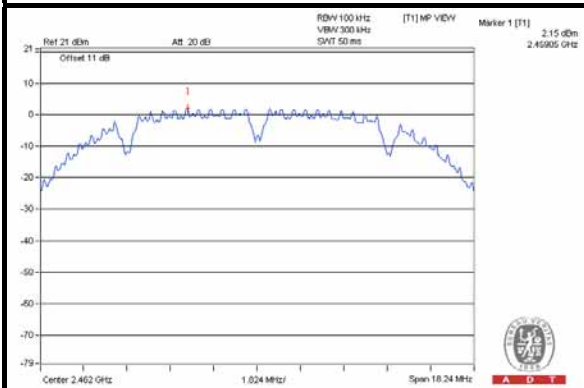

#### CH 1 Band edge

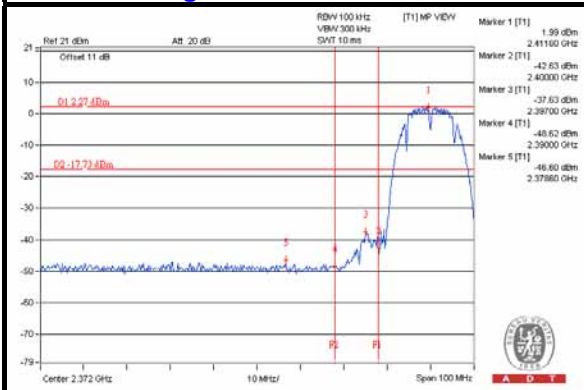

#### CH 11 Band edge

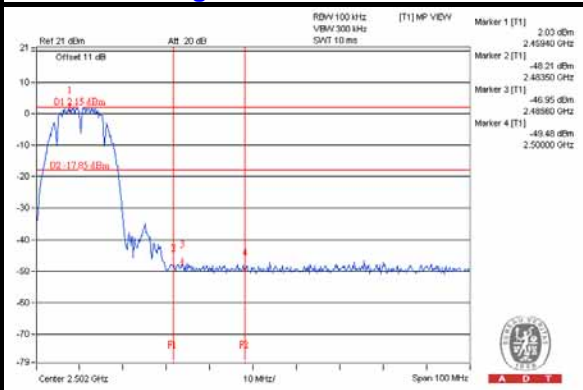



A D T

802.11g

CH 1

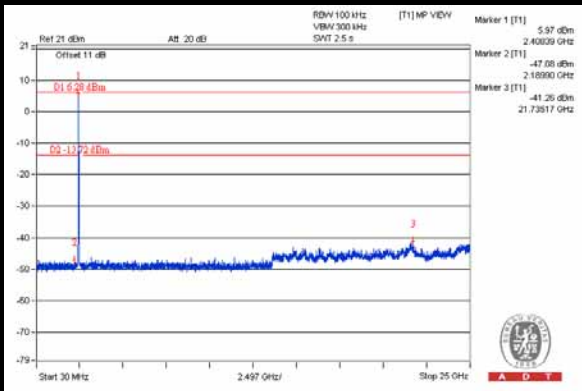
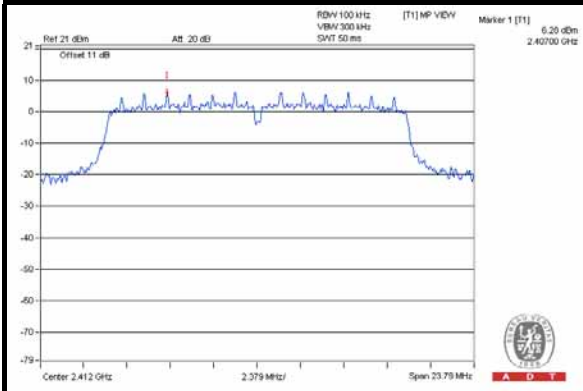

CH 6

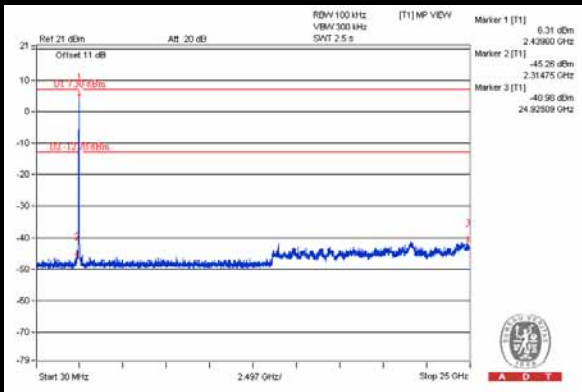
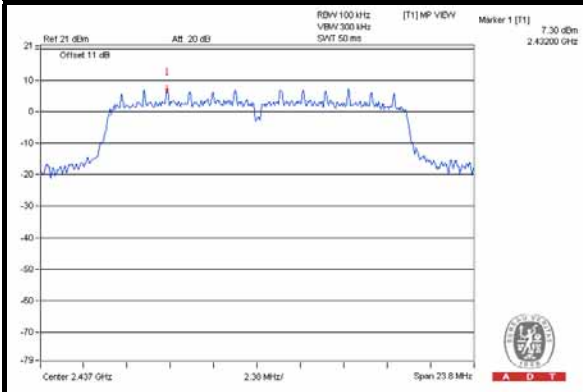

CH 11

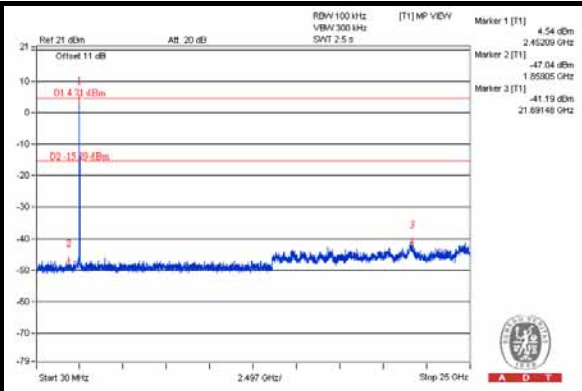
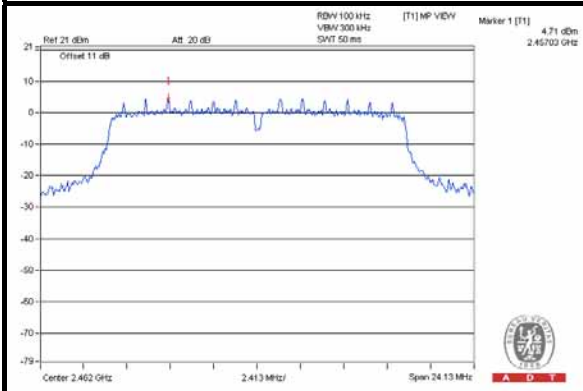

CH 1 Band edge

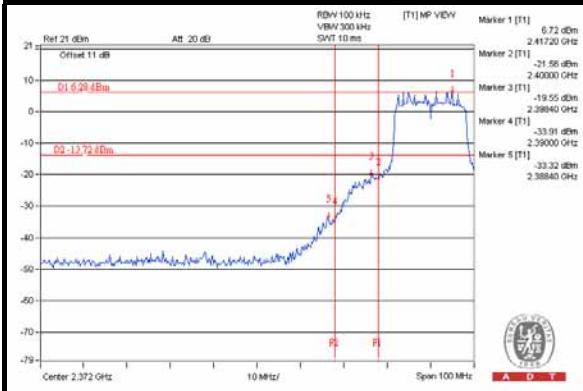

CH 11 Band edge

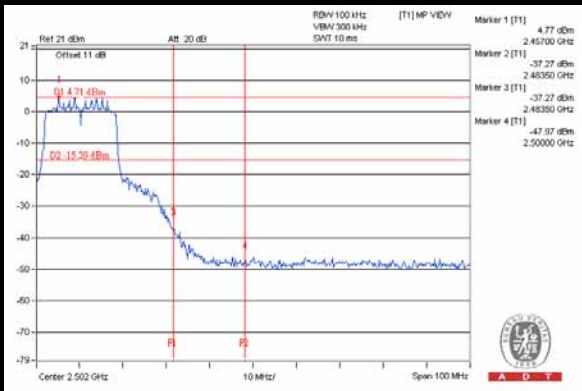



A D T

### 802.11n (HT20)

#### CH 1

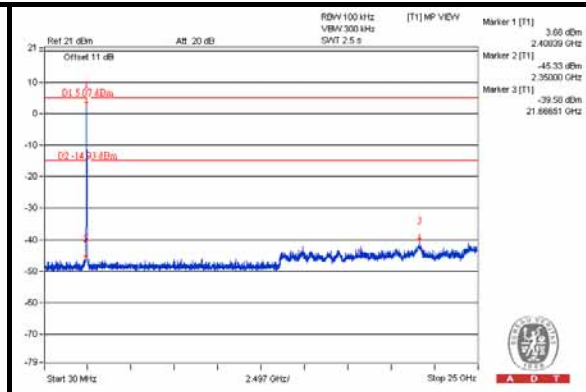
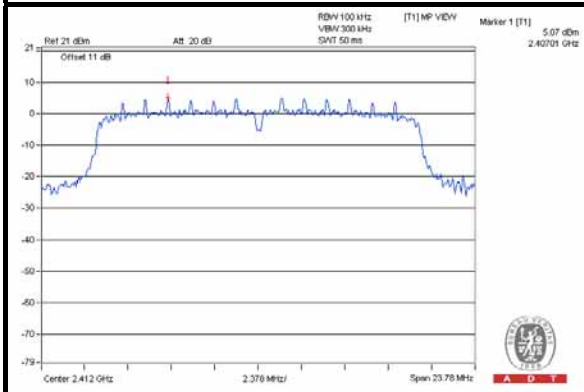

#### CH 6

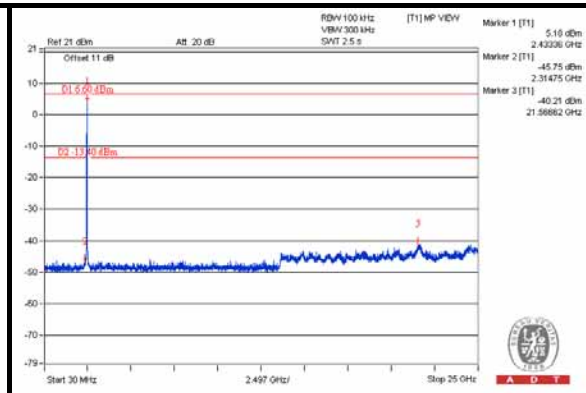
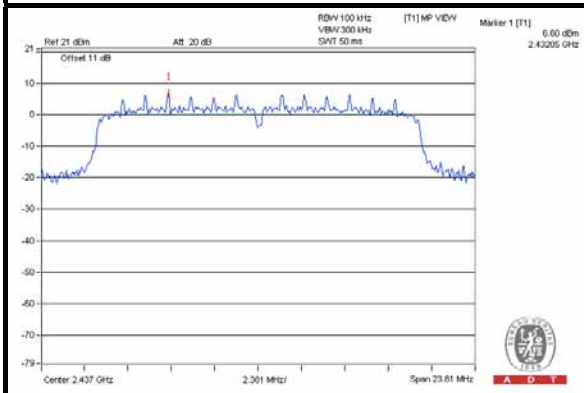

#### CH 11

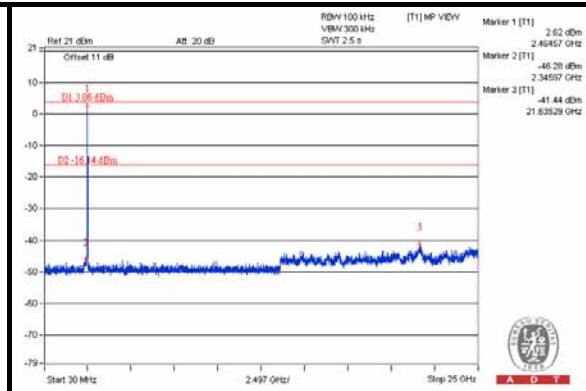
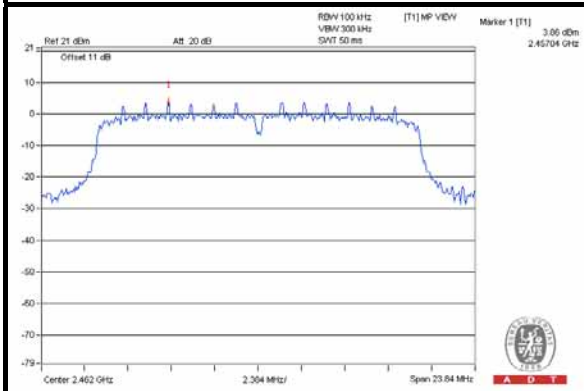

#### CH 1 Band edge

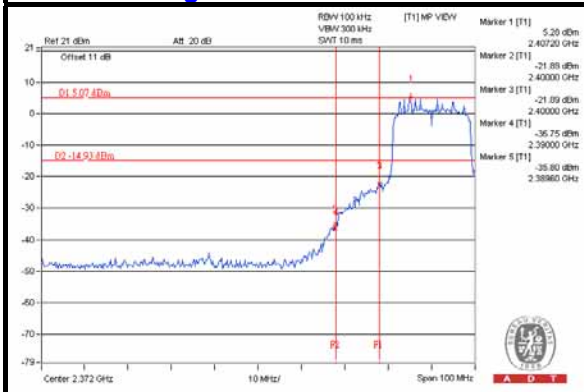

#### CH 11 Band edge

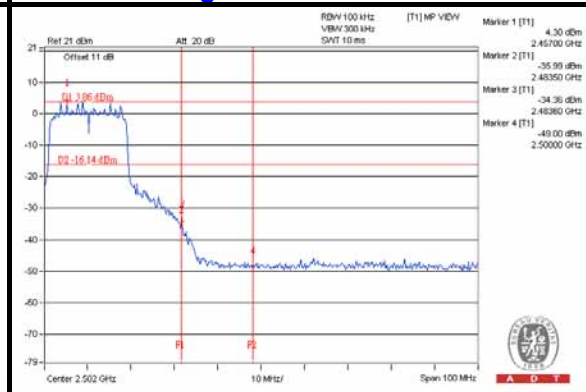



A D T

### 802.11n (HT40)

#### CH 3

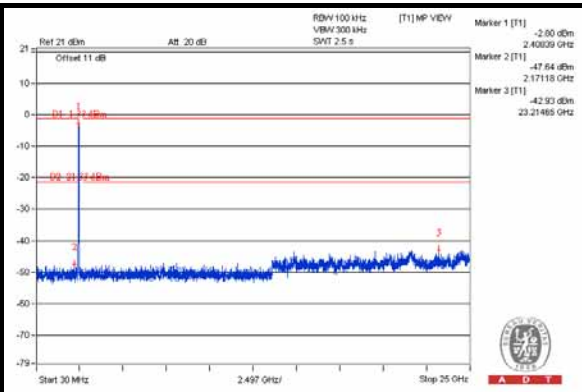
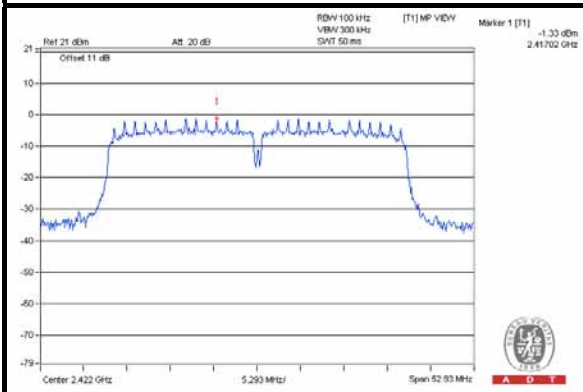

#### CH 6

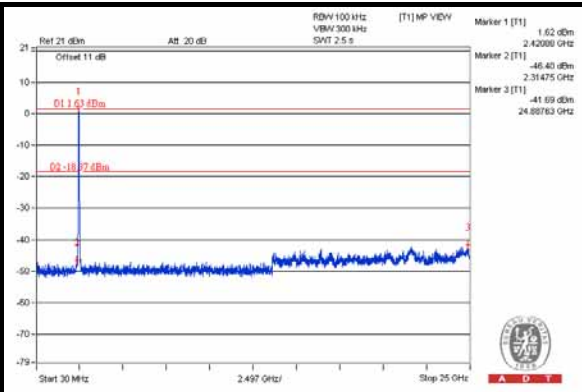
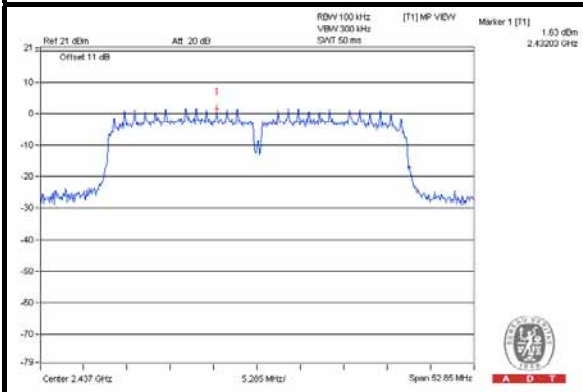

#### CH 9

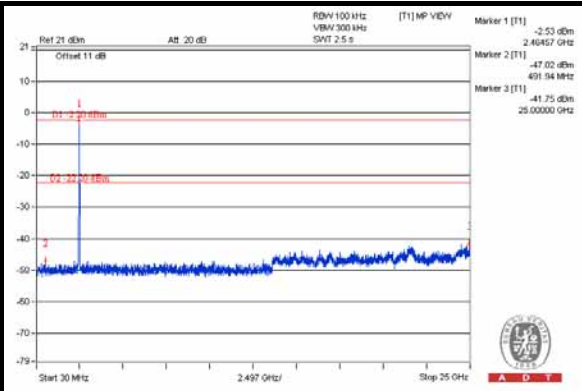
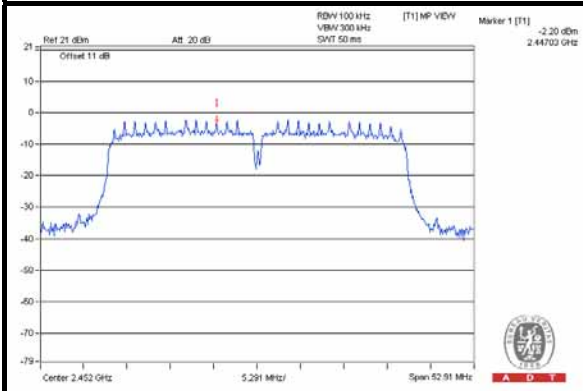

#### CH 3 Band edge

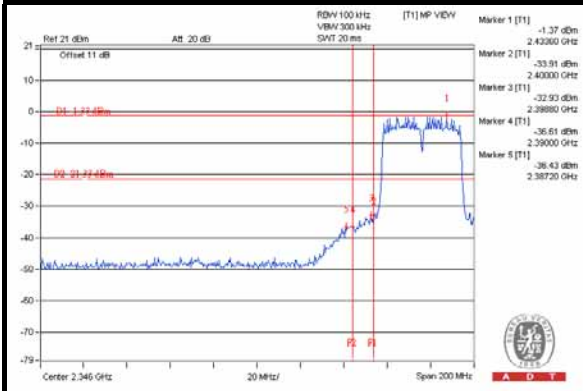

#### CH 9 Band edge

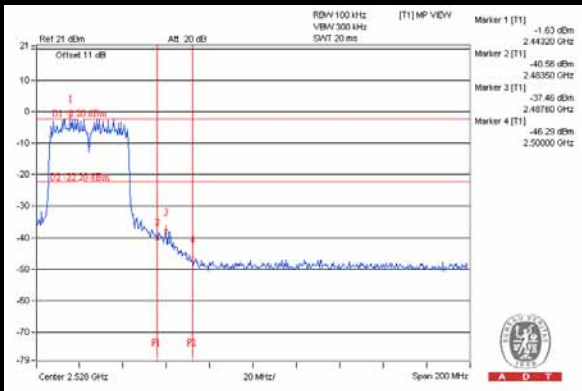

## 5. PHOTOGRAPHS OF THE TEST CONFIGURATION

Please refer to the attached file (Test Setup Photo).





## 6. INFORMATION ON THE TESTING LABORATORIES

We, Bureau Veritas Consumer Products Services (H.K.) Ltd., Taoyuan Branch, were founded in 1988 to provide our best service in EMC, Radio, Telecom and Safety consultation. Our laboratories are accredited and approved according to ISO/IEC 17025.

If you have any comments, please feel free to contact us at the following:

**Linko EMC/RF Lab:**

Tel: 886-2-26052180

Fax: 886-2-26052943

**Hsin Chu EMC/RF/Telecom Lab:**

Tel: 886-3-5935343

Fax: 886-3-5935342

**Hwa Ya EMC/RF/Safety Lab:**

Tel: 886-3-3183232

Fax: 886-3-3270892

**Email:** [service.adt@tw.bureauveritas.com](mailto:service.adt@tw.bureauveritas.com)

**Web Site:** [www.bureauveritas-adt.com](http://www.bureauveritas-adt.com)

The address and road map of all our labs can be found in our web site also.



A D T

## 7. APPENDIX A - MODIFICATIONS RECORDERS FOR ENGINEERING CHANGES TO THE EUT BY THE LAB

No modifications were made to the EUT by the lab during the test.

--- END ---