

FCC RADIO TEST REPORT

according to

47 CFR FCC Part 15 Subpart C § 15.247

Equipment : HP MediaSmart Frame
Model No. : 130
Brand Name : HP
Filing Type : New Application
Applicant : Hon Hai Precision Ind. Co., Ltd.
4F, No. 2, ZihYou St., Tu Cheng City, Taipei County, Taiwan
FCC ID : UCV-OFM130
Manufacturer : HONGFUJIN PRECISION INDUSTRY (SHENZHEN) CO. LTD
No. 2, 2nd Donghuan Road, 10th Yousong Industrial District,
Longhua Community Baoan District, Shenzhen Guangdong
518109 China
Received Date : Jan. 08, 2009
Final Test Date : Feb. 16, 2009

Statement

Test result included is only for the 802.11b/g of the product.

The test result in this report refers exclusively to the presented test model / sample.

Without written approval of SPORTON International Inc., the test report shall not be reproduced except in full.

The measurements and test results shown in this test report were made in accordance with the procedures and found in compliance with the limit given in **ANSI C63.4-2003** and **47 CFR FCC Part 15 Subpart C**.

The test equipment used to perform the test is calibrated and traceable to NML/ROC.



SPORTON International Inc.

6F, No. 106, Sec. 1, Hsin Tai Wu Rd., Hsi Chih, Taipei Hsien, Taiwan, R.O.C.

Table of Contents

1 SUMMARY OF THE TEST RESULT 2

2 GENERAL INFORMATION..... 3

2.1 Product Details 3

2.2 Accessories 3

2.3 Table for Filed Antenna 3

2.4 Table for Carrier Frequencies 3

2.5 Table for Test Modes 4

2.6 Table for Testing Locations 4

2.7 Table for Supporting Units..... 4

2.8 Table for Parameters of Test Software Setting 5

2.9 EUT Operation during Test 5

2.10 Test Configuration 6

3 TEST RESULT 8

3.1 AC Power Line Conducted Emissions Measurement..... 8

3.2 Maximum Conducted Output Power Measurement 12

3.3 Power Spectral Density Measurement 14

3.4 6dB Spectrum Bandwidth Measurement..... 20

3.5 Radiated Emissions Measurement..... 26

3.6 Band Edge and Fundamental Emissions Measurement 44

3.7 Antenna Requirements..... 49

4 LIST OF MEASURING EQUIPMENTS 50

5 TEST LOCATION..... 52

6 TAF CERTIFICATE OF ACCREDITATION 53

APPENDIX A. MAXIMUM PERMISSIBLE EXPOSURE..... A1 ~ A3

APPENDIX B. TEST PHOTOS B1 ~ B6

APPENDIX C. PHOTOGRAPHS OF EUT C1 ~ C19

History of This Test Report

Original Issue Date: Feb. 24, 2009

Report No.: FR920711

- No additional attachment.
- Additional attachment were issued as following record:

Attachment No.	Issue Date	Description

CERTIFICATE OF COMPLIANCE

according to

47 CFR FCC Part 15 Subpart C § 15.247

Equipment : HP MediaSmart Frame
Model No. : 130
Brand Name : HP
Applicant : **Hon Hai Precision Ind. Co., Ltd.**
4F, No. 2, ZihYou St., Tu Cheng City, Taipei
County, Taiwan

Sporton International as requested by the applicant to evaluate the EMC performance of the product sample received on Jan. 08, 2009 would like to declare that the tested sample has been evaluated and found to be in compliance with the tested rule parts. The data recorded as well as the test configuration specified is true and accurate for showing the sample's EMC nature.

Sam Lee / Supervisor

SPORTON International Inc.

6F, No.106, Sec. 1, Hsin Tai Wu Rd., Hsi Chih, Taipei Hsien, Taiwan, R.O.C.

1 SUMMARY OF THE TEST RESULT

Applied Standard: 47 CFR FCC Part 15 Subpart C				
Part	Rule Section	Description of Test	Result	Under Limit
3.1	15.207	AC Power Line Conducted Emissions	Complies	11.96 dB
3.2	15.247(b)(3)	Maximum Conducted Output Power	Complies	13.39 dB
3.3	15.247(e)	Power Spectral Density	Complies	14.38 dB
3.4	15.247(a)(2)	6dB Spectrum Bandwidth	Complies	-
3.5	15.247(d)	Radiated Emissions	Complies	3.08 dB
3.6	15.247(d)	Band Edge Emissions	Complies	2.01 dB
3.7	15.203	Antenna Requirements	Complies	-

Test Items	Uncertainty	Remark
AC Power Line Conducted Emissions	±2.3Db	Confidence levels of 95%
Maximum Peak Conducted Output Power	±0.8Db	Confidence levels of 95%
Power Spectral Density	±0.5Db	Confidence levels of 95%
6Db Spectrum Bandwidth	±8.5×10 ⁻⁸	Confidence levels of 95%
Radiated Emissions (9kHz~30MHz)	±0.8Db	Confidence levels of 95%
Radiated Emissions (30MHz~1000MHz)	±1.9Db	Confidence levels of 95%
Radiated / Band Edge Emissions (1GHz~18GHz)	±1.9Db	Confidence levels of 95%
Radiated Emissions (18GHz~40GHz)	±1.9Db	Confidence levels of 95%
Temperature	±0.7°C	Confidence levels of 95%
Humidity	±3.2%	Confidence levels of 95%
DC / AC Power Source	±1.4%	Confidence levels of 95%

2 GENERAL INFORMATION

2.1 Product Details

Only the radio detail of IEEE 802.11b/g is shown in the table below. For more detailed features description, please refer to the manufacturer’s specifications or user’s manual.

Items	Description
Modulation	DSSS for IEEE 802.11b ; OFDM for IEEE 802.11g
Data Modulation	DSSS (BPSK / QPSK / CCK) ; OFDM (BPSK / QPSK / 16QAM / 64QAM)
Data Rate (Mbps)	DSSS (1/ 2/ 5.5/11) ; OFDM (6/9/12/18/24/36/48/54)
Frequency Range	2400 ~ 2483.5MHz
Channel Number	11b/g: 11
Channel Band Width (99%)	11b: 13.60 MHz ; 11g: 16.52 MHz
Conducted Output Power	11b: 16.61 dBm ; 11g: 14.65 dBm

2.2 Accessories

Power	Brand	Model	Rating
SWITCHING POWER SUPPLY	HP	KPC-024F	INPUT: 100-240Vac, 50-60Hz, 0.8A OUTPUT: 12Vdc, 2.0A

2.3 Table for Filed Antenna

Ant.	Antenna Type	Connector	Gain (dBi)	Remark
A	Printed Antenna	U.FL	2.11	TX / RX

2.4 Table for Carrier Frequencies

Frequency Allocation for 802.11b/g

Frequency Band	Channel No.	Frequency	Channel No.	Frequency
2400~2483.5MHz	1	2412 MHz	7	2442 MHz
	2	2417 MHz	8	2447 MHz
	3	2422 MHz	9	2452 MHz
	4	2427 MHz	10	2457 MHz
	5	2432 MHz	11	2462 MHz
	6	2437 MHz		

2.5 Table for Test Modes

Preliminary tests were performed in different data rate to find the worst radiated emission. The data rate shown in the table below is the worst-case rate with respect to the specific test item. Investigation has been done on the entire possible configuration for searching the worst cases. The following table is a list of the test modes shown in this test report.

Test Items	Mode	Data Rate	Channel
AC Power Line Conducted Emissions	Normal Mode	Auto	-
Maximum Conducted Output Power	11b/CCK	11 Mbps	1/6/11
Power Spectral Density	11g/BPSK	6 Mbps	1/6/11
6Db Spectrum Bandwidth			
Radiated Emissions Above 1GHz			
Band Edge Emissions			
Radiated Emissions Below 1GHz	Normal Mode	Auto	-

2.6 Table for Testing Locations

Test Site No.	Site Category	Location	FCC Reg. No.	IC File No.	VCCI Reg. No
03CH02-HY	SAC	Hwa Ya	101377	IC 4086B-1	-
CO04-HY	Conduction	Hwa Ya	93596	IC 4086B-1	-
TH01-HY	OVEN Room	Hwa Ya	-	-	-

Open Area Test Site (OATS); Semi Anechoic Chamber (SAC); Fully Anechoic Chamber (FAC).

2.7 Table for Supporting Units

Support Unit	Brand	Model	FCC ID
Notebook	DELL	D400	N/A

2.8 Table for Parameters of Test Software Setting

During testing, Channel & Power Controlling Software provided by the customer was used to control the operating channel as well as the output power level. The RF output power selection is for the setting of RF output power expected by the customer and is going to be fixed on the firmware of the final end product.

Power Parameters of IEEE 802.11b/g

Test Software Version	Labtool User Guide		
Frequency	2412 MHz	2437 MHz	2462 MHz
IEEE 802.11b	14	14	14
IEEE 802.11g	12	12	12

2.9 EUT Operation during Test

An executive program, EMCTEST.EXE under WIN XP, which generates a complete line of continuously repeating “H” pattern was used as the test software.

The NB sends “H” messages to the panel, and the panel displays “H” patterns on the screen.

At the same time, the NB following programs was executed:

Executed “Labtool User Guide” to keep transmitting signals at fixed frequency.

2.10 Test Configuration

2.10.1 Radiation Emissions Test Configuration

For radiated emissions 9kHz~1GHz

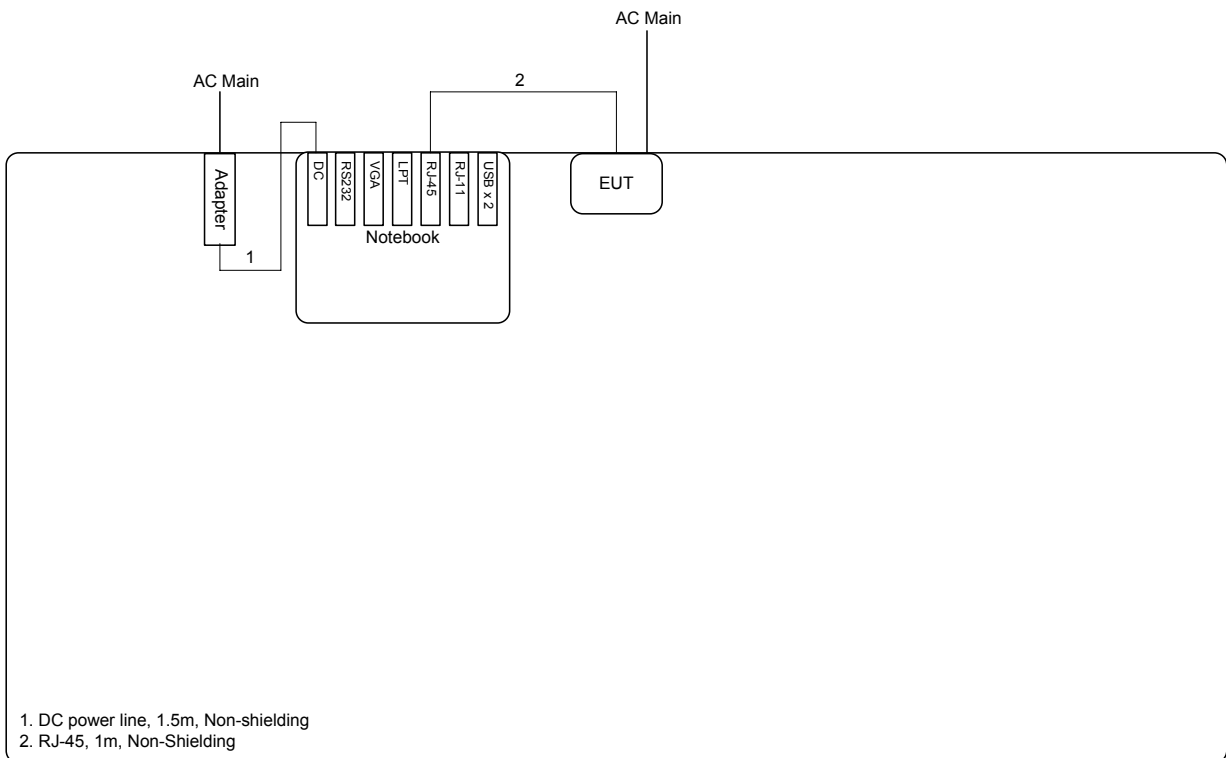

For radiated emissions above 1GHz

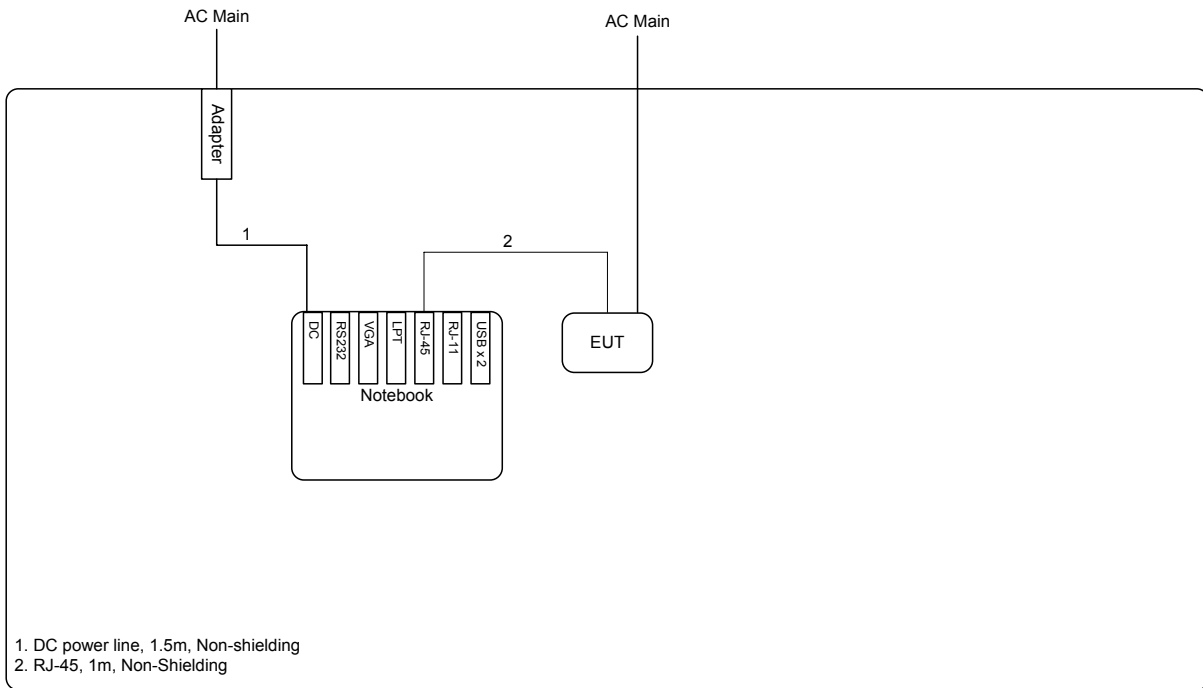

3 TEST RESULT

3.1 AC Power Line Conducted Emissions Measurement

3.1.1 Limit

For this product which is designed to be connected to the AC power line, the radio frequency voltage that is conducted back onto the AC power line on any frequency or frequencies within the band 150 kHz to 30 MHz shall not exceed below limits table.

Class B

Frequency (MHz)	QP Limit (dBuV)	AV Limit (dBuV)
0.15~0.5	66~56	56~46
0.5~5	56	46
5~30	60	50

3.1.2 Measuring Instruments and Setting

Please refer to section 4 of equipments list in this report. The following table is the setting of the receiver.

Receiver Parameters	Setting
Attenuation	10 dB
Start Frequency	0.15 MHz
Stop Frequency	30 MHz
IF Bandwidth	9 KHz

3.1.3 Test Procedures

1. Configure the EUT according to ANSI C63.4. The EUT or host of EUT has to be placed 0.4 meter far from the conducting wall of the shielding room and at least 80 centimeters from any other grounded conducting surface.
2. Connect EUT or host of EUT to the power mains through a line impedance stabilization network (LISN).
3. All the support units are connected to the other LISNs. The LISN should provide 50uH/50ohms coupling impedance.
4. The frequency range from 150 KHz to 30 MHz was searched.
5. Set the test-receiver system to Peak Detect Function and Specified Bandwidth with Maximum Hold Mode.
6. The measurement has to be done between each power line and ground at the power terminal.

3.1.4 Test Setup Layout

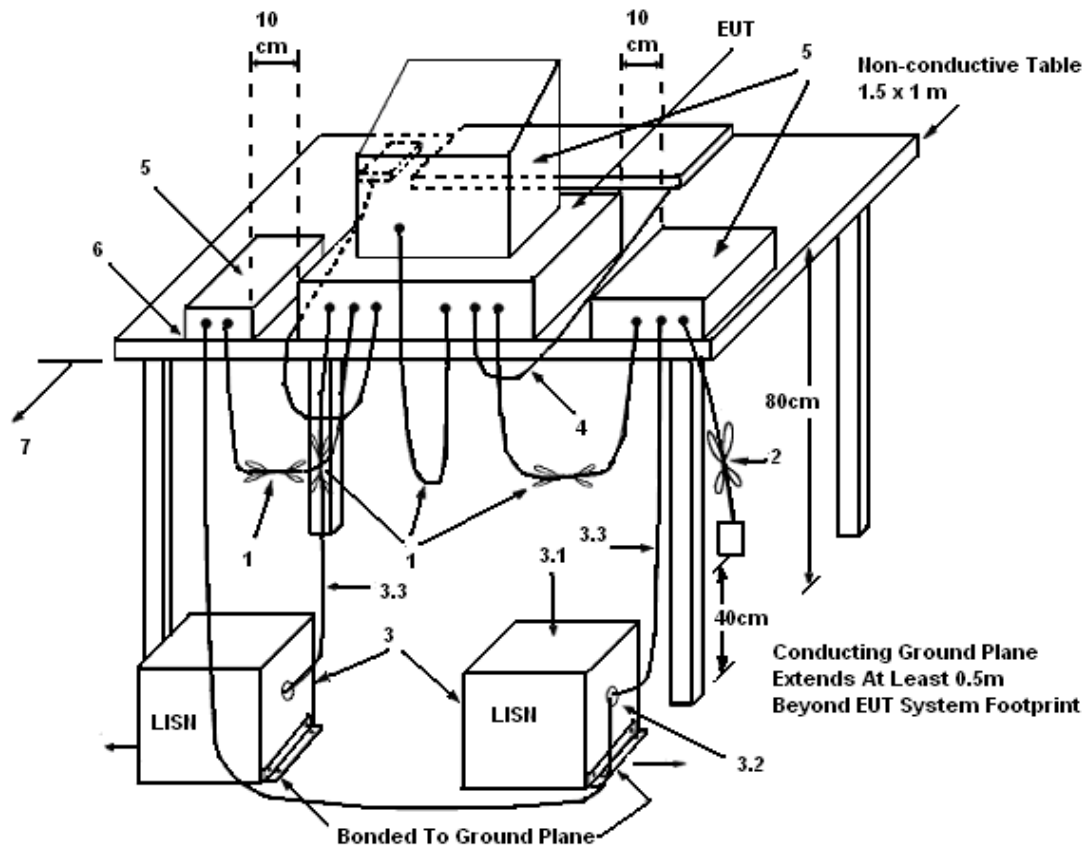

LEGEND:

- (1) Interconnecting cables that hang closer than 40 cm to the ground plane shall be folded back and forth in the center forming a bundle 30 to 40 cm long.
- (2) I/O cables that are not connected to a peripheral shall be bundled in the center. The end of the cable may be terminated, if required, using the correct terminating impedance. The overall length shall not exceed 1 m.
- (3) EUT connected to one LISN. Unused LISN measuring port connectors shall be terminated in 50 Ω. LISN can be placed on top of, or immediately beneath, reference ground plane.
- (3.1) All other equipment powered from additional LISN(s).
- (3.2) Multiple outlet strip can be used for multiple power cords of non-EUT equipment.
- (3.3) LISN at least 80 cm from nearest part of EUT chassis.
- (4) Cables of hand-operated devices, such as keyboards, mice, etc., shall be placed as for normal use.
- (5) Non-EUT components of EUT system being tested.
- (6) Rear of EUT, including peripherals, shall all be aligned and flush with rear of tabletop.
- (7) Rear of tabletop shall be 40 cm removed from a vertical conducting plane that is bonded to the ground plane.

3.1.5 Test Deviation

There is no deviation with the original standard.

3.1.6 EUT Operation during Test

The EUT was placed on the test table and programmed in normal function.

3.1.7 Results of AC Power Line Conducted Emissions Measurement

Test date	Feb. 12, 2009	Test Site No.	CO04-HY
Temperature	25°C	Humidity	55%
Test Engineer	Chris	Configuration	Normal Mode

Line

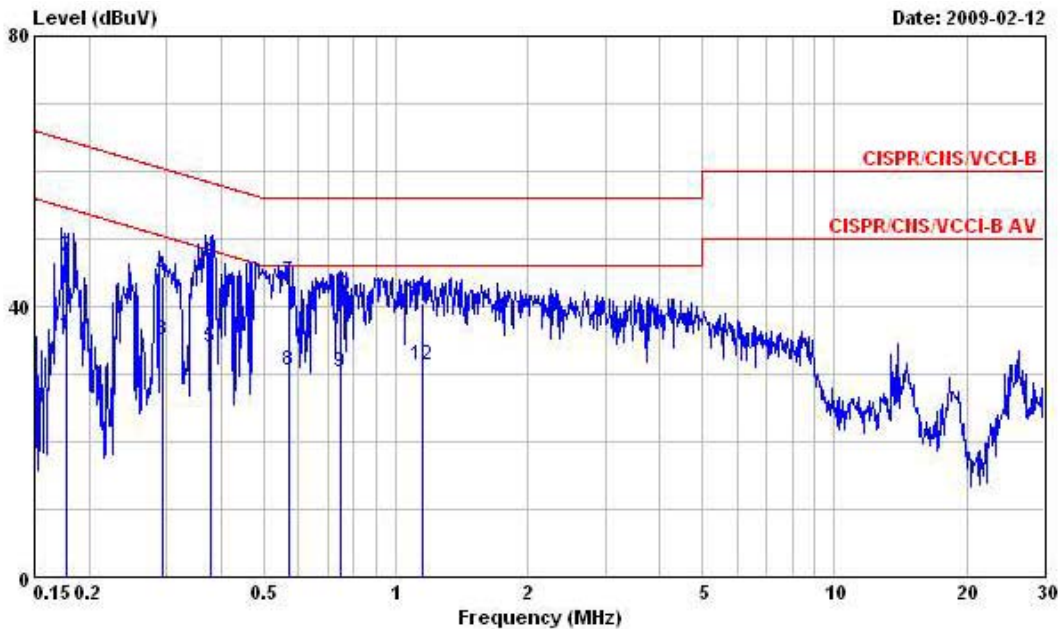

	Freq	Level	Over	Limit	Read	LISN	Cable	Remark
	MHz	dBuV	Limit	Line	Level	Factor	Loss	
			dB	dBuV	dBuV	dB	dB	
1	0.1770890	35.84	-18.78	54.62	35.69	0.09	0.06	Average
2	0.1770890	47.49	-17.13	64.62	47.34	0.09	0.06	QP
3	0.2938770	35.03	-15.38	50.41	34.87	0.10	0.06	Average
4	0.2938770	44.53	-15.88	60.41	44.37	0.10	0.06	QP
5	0.3784800	33.92	-14.39	48.31	33.76	0.10	0.06	Average
6	0.3784800	46.35	-11.96	58.31	46.19	0.10	0.06	QP
7	0.5705780	43.69	-12.31	56.00	43.51	0.10	0.08	QP
8	0.5705780	30.44	-15.56	46.00	30.26	0.10	0.08	Average
9	0.7469700	30.17	-15.83	46.00	29.97	0.11	0.09	Average
10	0.7469700	41.57	-14.43	56.00	41.37	0.11	0.09	QP
11	1.150	40.58	-15.42	56.00	40.35	0.11	0.12	QP
12	1.150	31.33	-14.67	46.00	31.10	0.11	0.12	Average

Neutral

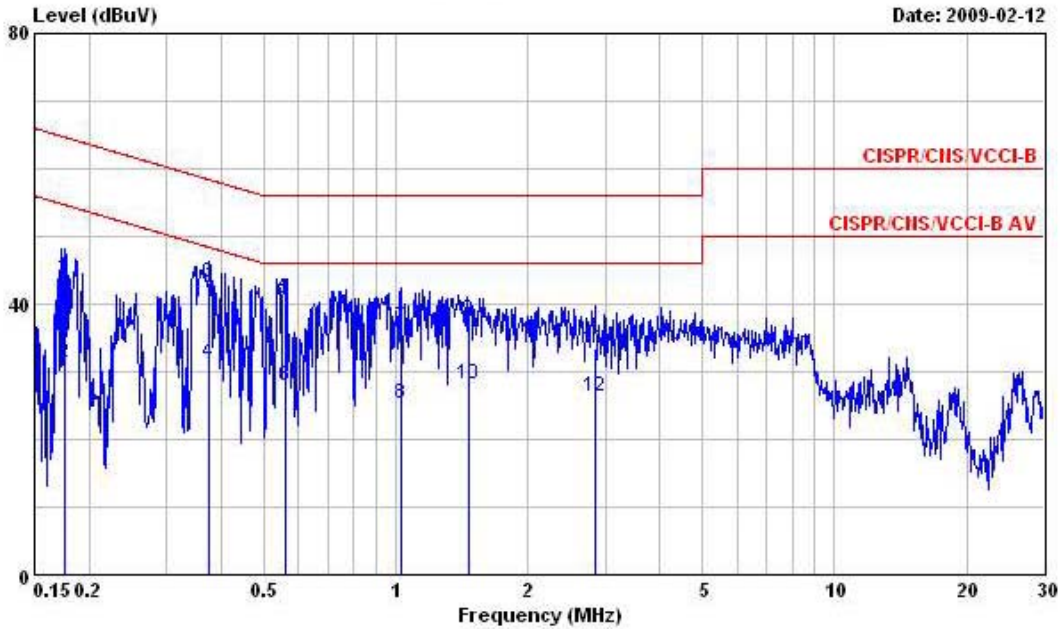

	Freq	Level	Over Limit	Limit Line	Read Level	LISN Factor	Cable Loss	Remark
	MHz	dBuV	dB	dBuV	dBuV	dB	dB	
1	0.1752040	44.02	-20.69	64.71	43.88	0.08	0.06	QP
2	0.1752040	31.25	-23.46	54.71	31.11	0.08	0.06	Average
3	0.3751190	43.20	-15.19	58.39	43.05	0.09	0.06	QP
4	0.3751190	31.32	-17.07	48.39	31.17	0.09	0.06	Average
5	0.5602710	40.90	-15.10	56.00	40.73	0.10	0.07	QP
6	0.5602710	27.97	-18.03	46.00	27.80	0.10	0.07	Average
7	1.030	36.58	-19.42	56.00	36.37	0.11	0.10	QP
8	1.030	25.15	-20.85	46.00	24.94	0.11	0.10	Average
9	1.460	37.58	-18.42	56.00	37.32	0.12	0.14	QP
10	1.460	28.20	-17.80	46.00	27.94	0.12	0.14	Average
11	2.850	33.32	-22.68	56.00	32.98	0.14	0.20	QP
12	2.850	26.45	-19.55	46.00	26.11	0.14	0.20	Average

Note:

Level = Read Level + LISN Factor + Cable Loss.

3.2 Maximum Conducted Output Power Measurement

3.2.1 Limit

For systems using digital modulation in the 2400-2483.5MHz, the limit for peak output power is 30dBm. The limited has to be reduced by the amount in dB that the gain of the antenna exceed 6dBi. In case of point-to-point operation, the limit has to be reduced by 1dB for every 3dB that the directional gain of the antenna exceeds 6dBi.

3.2.2 Measuring Instruments and Setting

Please refer to section 4 of equipments list in this report. The following table is the setting of the spectrum analyzer.

Power Meter Parameter	Setting
Attenuation	Auto
Span Frequency	0.135 s ~ 26 s
RB	1000 kHz
VB	3000 kHz
Detector	rms
Trace	Max Hold
Sweep Time	Auto

3.2.3 Test Procedures

1. The transmitter output (antenna port) was connected to the spectrum analyzer.
2. Test was performed in accordance with Measurement of Digital Transmission Systems Operating under Section 15.247.

3.2.4 Test Setup Layout

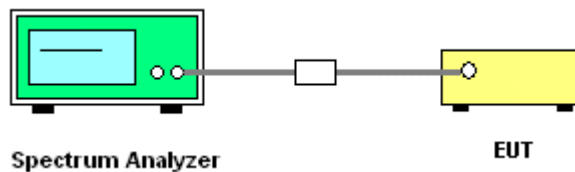

3.2.5 Test Deviation

There is no deviation with the original standard.

3.2.6 EUT Operation during Test

The EUT was programmed to be in continuously transmitting mode.

3.2.7 Test Result of Maximum Conducted Output Power

Test date	Jan. 09, 2009	Test Site No.	TH01-HY
Temperature	28°C	Humidity	56%
Test Engineer	Duncan	Configuration	802.11b/g

Configuration IEEE 802.11b

Channel	Frequency	Conducted Power (dBm)	Max. Limit (dBm)	Result
1	2412 MHz	16.61	30.00	Complies
6	2437 MHz	15.95	30.00	Complies
11	2462 MHz	15.31	30.00	Complies

Configuration IEEE 802.11g

Channel	Frequency	Conducted Power (dBm)	Max. Limit (dBm)	Result
1	2412 MHz	14.65	30.00	Complies
6	2437 MHz	14.10	30.00	Complies
11	2462 MHz	13.90	30.00	Complies

3.3 Power Spectral Density Measurement

3.3.1 Limit

For digitally modulated systems, the power spectral density conducted from the intentional radiator to the antenna shall not be greater than 8 dBm in any 3 kHz band during any time interval of continuous transmission.

3.3.2 Measuring Instruments and Setting

Please refer to section 4 of equipments list in this report. The following table is the setting of the spectrum analyzer.

Spectrum Parameter	Setting
Attenuation	Auto
Span Frequency	1.5MHz
RB	3 kHz
VB	30 kHz
Detector	Peak
Trace	Max Hold
Sweep Time	500s

3.3.3 Test Procedures

1. The transmitter output (antenna port) was connected to the spectrum analyser.
2. Set RBW of spectrum analyzer to 3 kHz and VBW to 30 kHz. Set Detector to Peak, Trace to Max Hold.
3. Mark the frequency with maximum peak power as the center of the display of the spectrum.
4. Set the span to 1.5MHz and the sweep time to 500s and record the maximum peak value.

3.3.4 Test Setup Layout

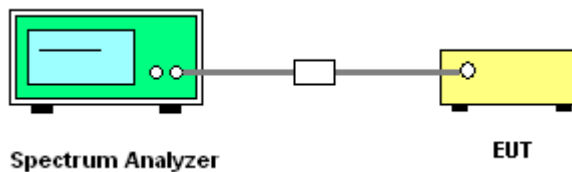

3.3.5 Test Deviation

There is no deviation with the original standard.

3.3.6 EUT Operation during Test

The EUT was programmed to be in continuously transmitting mode.

3.3.7 Test Result of Power Spectral Density

Test date	Jan. 09, 2009	Test Site No.	TH01-HY
Temperature	28°C	Humidity	56%
Test Engineer	Duncan	Configuration	802.11b/g

Configuration IEEE 802.11b

Channel	Frequency	Power Density (dBm)	Max. Limit (dBm)	Result
1	2412 MHz	-6.38	8.00	Complies
6	2437 MHz	-7.19	8.00	Complies
11	2462 MHz	-7.95	8.00	Complies

Configuration IEEE 802.11g

Channel	Frequency	Power Density (dBm)	Max. Limit (dBm)	Result
1	2412 MHz	-9.94	8.00	Complies
6	2437 MHz	-10.40	8.00	Complies
11	2462 MHz	-9.81	8.00	Complies

Power Density Plot on Configuration IEEE 802.11b / 2412 MHz

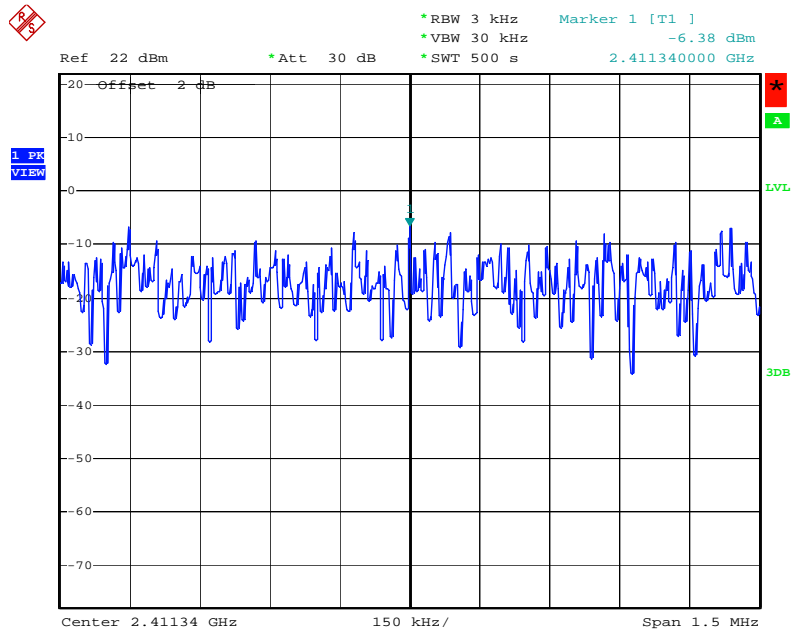

Date: 9.JAN.2009 03:33:43

Power Density Plot on Configuration IEEE 802.11b / 2437 MHz

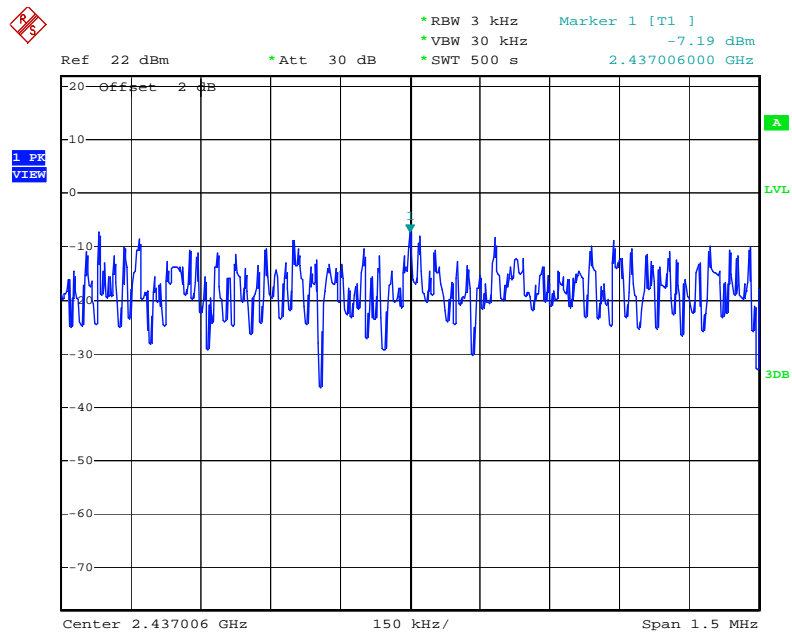

Date: 9.JAN.2009 03:25:27

Power Density Plot on Configuration IEEE 802.11b / 2462 MHz

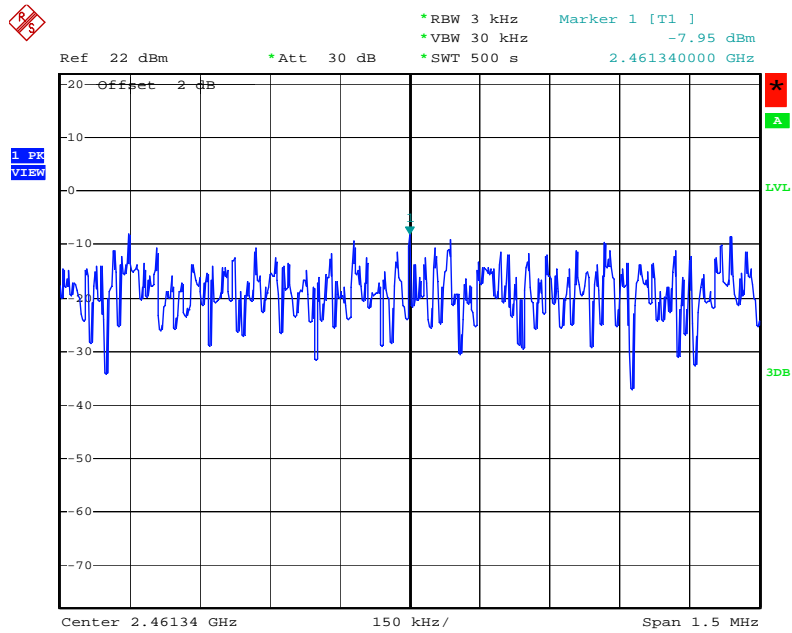

Date: 9.JAN.2009 05:49:00

Power Density Plot on Configuration IEEE 802.11g / 2412 MHz

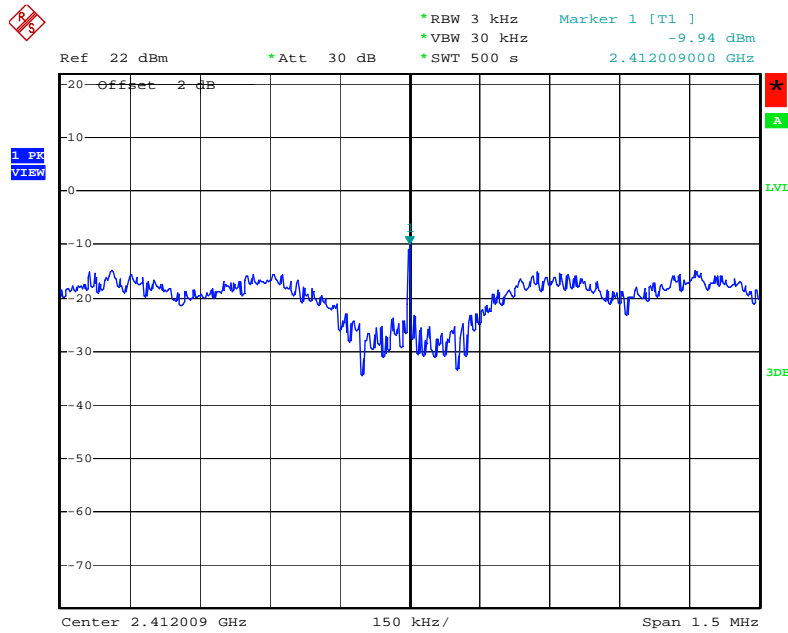

Date: 9.JAN.2009 05:55:39

Power Density Plot on Configuration IEEE 802.11g / 2437 MHz

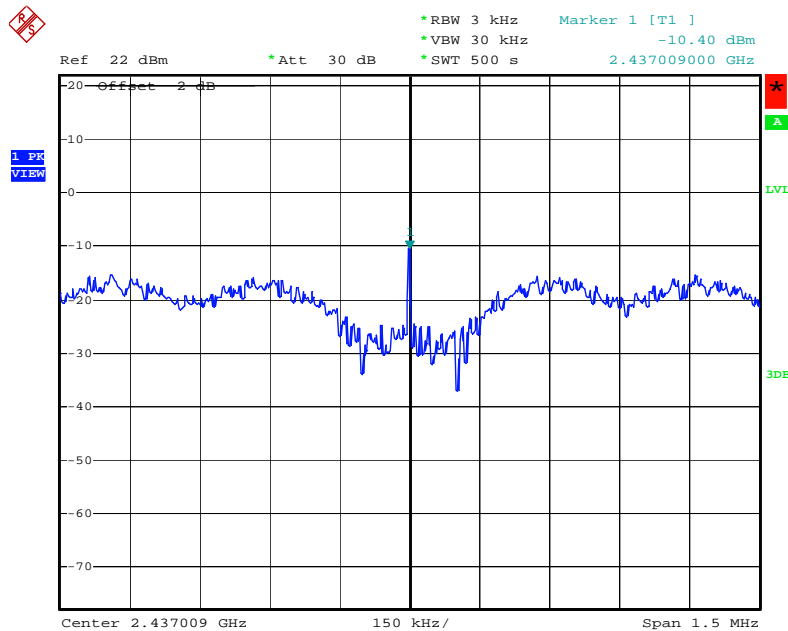

Date: 9.JAN.2009 06:16:50

Power Density Plot on Configuration IEEE 802.11g / 2462 MHz

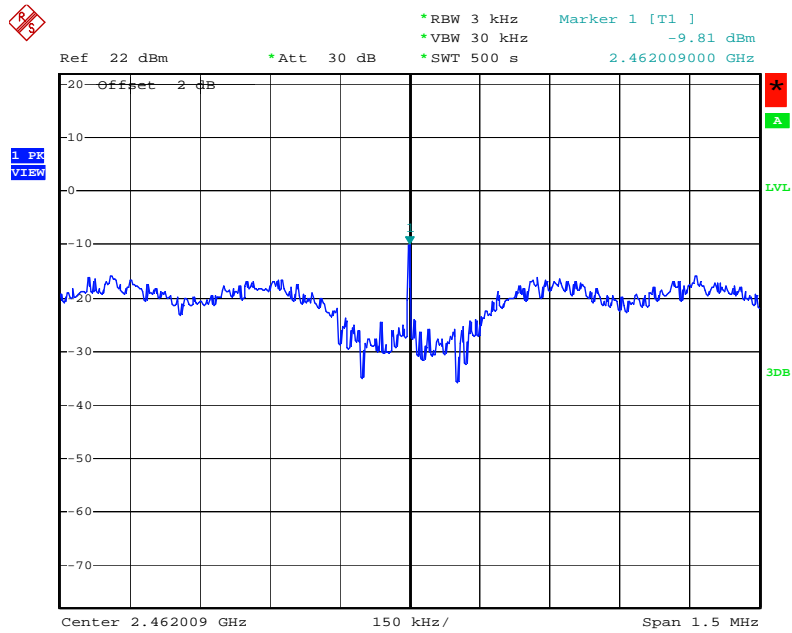

Date: 9.JAN.2009 06:30:17

3.4 6dB Spectrum Bandwidth Measurement

3.4.1 Limit

For digital modulation systems, the minimum 6dB bandwidth shall be at least 500 kHz.

3.4.2 Measuring Instruments and Setting

Please refer to section 4 of equipments list in this report. The following table is the setting of the spectrum analyzer.

Spectrum Parameters	Setting
Attenuation	Auto
Span Frequency	> 6dB Bandwidth
RB	100 kHz
VB	100 kHz
Detector	Peak
Trace	Max Hold
Sweep Time	Auto

3.4.3 Test Procedures

1. The transmitter output (antenna port) was connected to the spectrum analyser in peak hold mode.
2. The resolution bandwidth of 100 kHz and the video bandwidth of 100 kHz were used.
3. Measured the spectrum width with power higher than 6dB below carrier.

3.4.4 Test Setup Layout

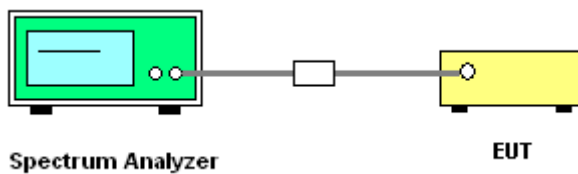

3.4.5 Test Deviation

There is no deviation with the original standard.

3.4.6 EUT Operation during Test

The EUT was programmed to be in continuously transmitting mode.

3.4.7 Test Result of 6dB Spectrum Bandwidth

Test date	Jan. 09, 2009	Test Site No.	TH01-HY
Temperature	28°C	Humidity	56%
Test Engineer	Duncan	Configuration	802.11b/g

Configuration IEEE 802.11b

Channel	Frequency	6dB Bandwidth (MHz)	99% Occupied Bandwidth (MHz)	Min. Limit (kHz)	Test Result
1	2412 MHz	9.52	13.60	500	Complies
6	2437 MHz	9.52	13.60	500	Complies
11	2462 MHz	9.52	13.60	500	Complies

Configuration IEEE 802.11g

Channel	Frequency	6dB Bandwidth (MHz)	99% Occupied Bandwidth (MHz)	Min. Limit (kHz)	Test Result
1	2412 MHz	16.56	16.48	500	Complies
6	2437 MHz	16.56	16.52	500	Complies
11	2462 MHz	16.56	16.52	500	Complies

6 dB Bandwidth Plot on Configuration IEEE 802.11b / 2412 MHz

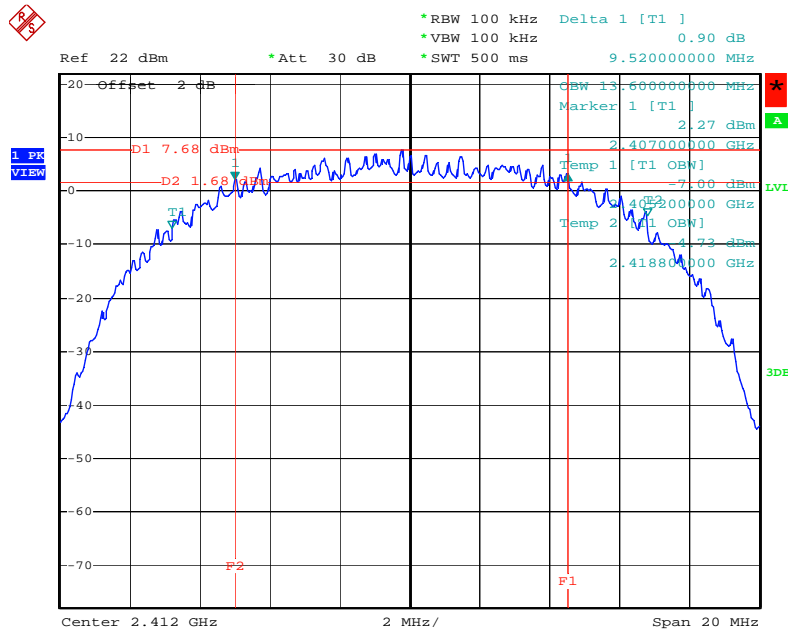

Date: 9.JAN.2009 02:45:35

6 dB Bandwidth Plot on Configuration IEEE 802.11b / 2437 MHz

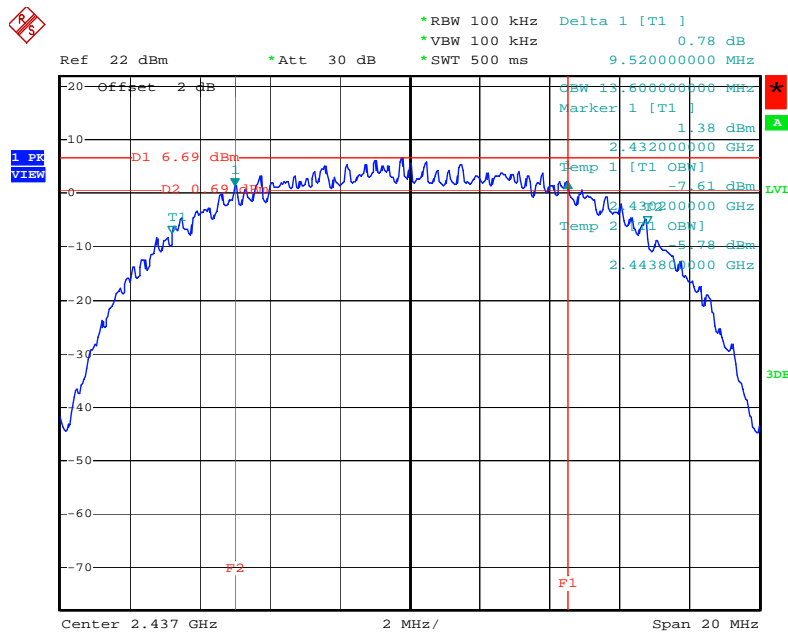

Date: 9.JAN.2009 02:59:16

6 dB Bandwidth Plot on Configuration IEEE 802.11b / 2462 MHz

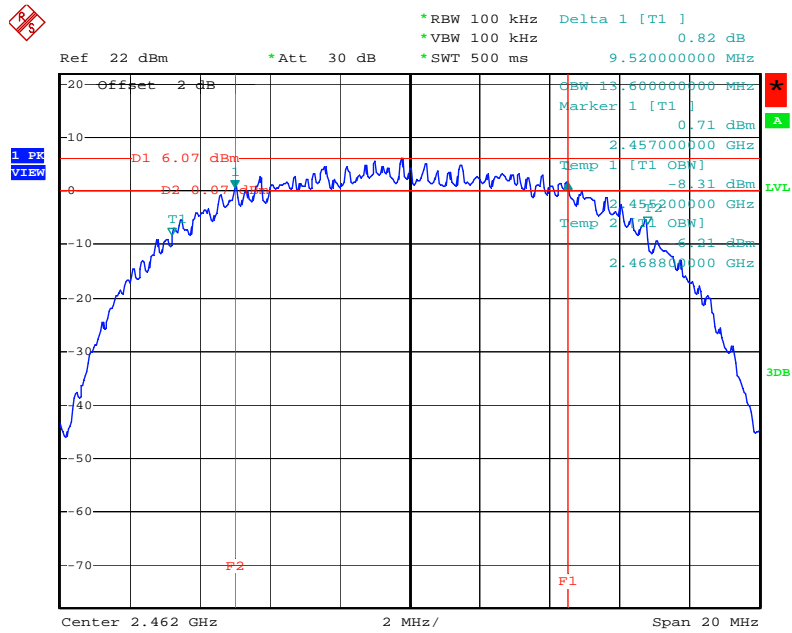

Date: 9.JAN.2009 05:42:06

6 dB Bandwidth Plot on Configuration IEEE 802.11g / 2412 MHz

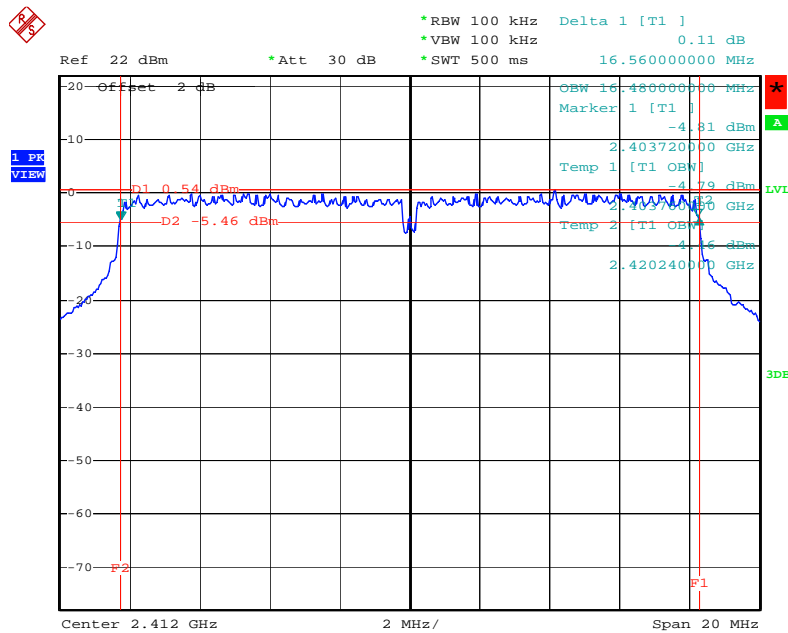

Date: 9.JAN.2009 06:02:48

6 dB Bandwidth Plot on Configuration IEEE 802.11g / 2437 MHz

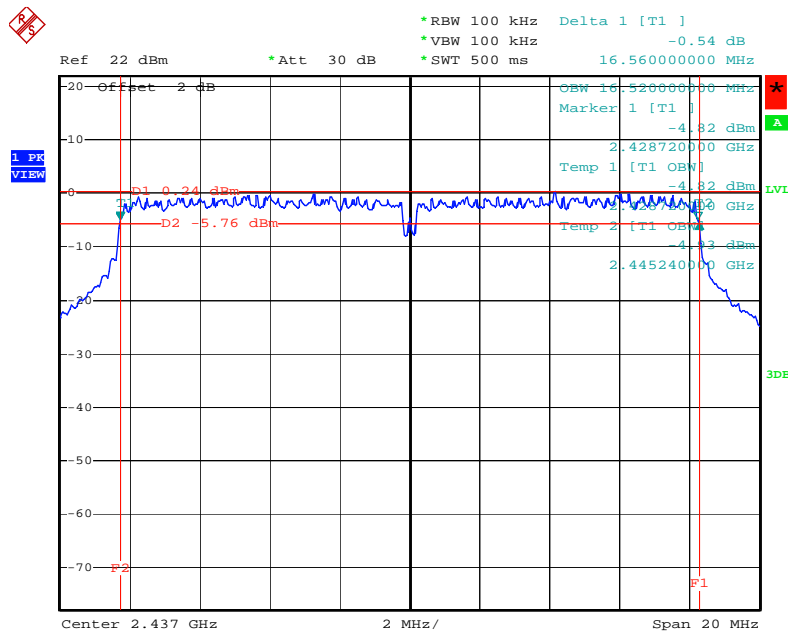

Date: 9.JAN.2009 06:13:41

6 dB Bandwidth Plot on Configuration IEEE 802.11g / 2462 MHz

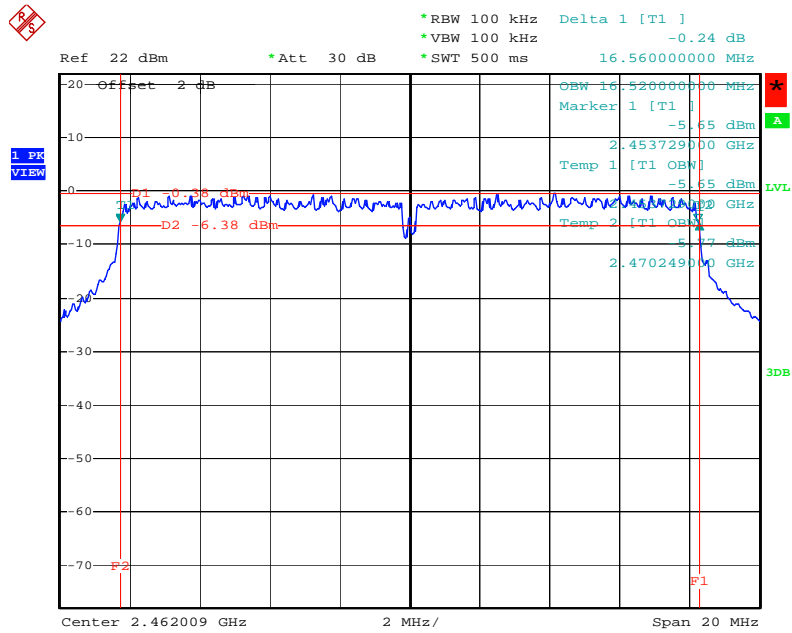

Date: 9.JAN.2009 06:36:45

3.5 Radiated Emissions Measurement

3.5.1 Limit

20dBc in any 100 kHz bandwidth outside the operating frequency band. In case the emission fall within the restricted band specified on 15.205(a), then the 15.209(a) limit in the table below has to be followed.

Frequencies (MHz)	Field Strength (micorvolts/meter)	Measurement Distance (meters)
0.009~0.490	2400/F(KHz)	300
0.490~1.705	24000/F(KHz)	30
1.705~30.0	30	30
30~88	100	3
88~216	150	3
216~960	200	3
Above 960	500	3

3.5.2 Measuring Instruments and Setting

Please refer to section 4 of equipments list in this report. The following table is the setting of spectrum analyzer and receiver.

Spectrum Parameter	Setting
Attenuation	Auto
Start Frequency	1000 MHz
Stop Frequency	10th carrier harmonic
RB / VB (Emission in restricted band)	1MHz / 1MHz for Peak, 1 MHz / 10Hz for Average
RB / VB (Emission in non-restricted band)	100KHz / 100KHz for peak

Receiver Parameter	Setting
Attenuation	Auto
Start ~ Stop Frequency	9kHz~150kHz / RB 200Hz for QP
Start ~ Stop Frequency	150kHz~30MHz / RB 9kHz for QP
Start ~ Stop Frequency	30MHz~1000MHz / RB 120kHz for QP

3.5.3 Test Procedures

1. Configure the EUT according to ANSI C63.4. The EUT was placed on the top of the turntable 0.8 meter above ground. The phase center of the receiving antenna mounted on the top of a height-variable antenna tower was placed 3 meters far away from the turntable.
2. Power on the EUT and all the supporting units. The turntable was rotated by 360 degrees to determine the position of the highest radiation.
3. The height of the broadband receiving antenna was varied between one meter and four meters above ground to find the maximum emissions field strength of both horizontal and vertical polarization.
4. For each suspected emissions, the antenna tower was scan (from 1 M to 4 M) and then the turntable was rotated (from 0 degree to 360 degrees) to find the maximum reading.
5. Set the test-receiver system to Peak or CISPR quasi-peak Detect Function with specified bandwidth under Maximum Hold Mode.
6. For emissions above 1GHz, use 1MHz VBW and RBW for peak reading. Then 1MHz RBW and 10Hz VBW for average reading in spectrum analyzer.
7. When the radiated emissions limits are expressed in terms of the average value of the emissions, and pulsed operation is employed, the measurement field strength shall be determined by averaging over one complete pulse train, including blanking intervals, as long as the pulse train does not exceed 0.1 seconds. As an alternative (provided the transmitter operates for longer than 0.1 seconds) or in cases where the pulse train exceeds 0.1 seconds, the measured field strength shall be determined from the average absolute voltage during a 0.1 second interval during which the field strength is at its maximum value.
8. If the emissions level of the EUT in peak mode was 3 dB lower than the average limit specified, then testing will be stopped and peak values of EUT will be reported, otherwise, the emissions which do not have 3 dB margin will be repeated one by one using the quasi-peak method for below 1GHz.
9. For testing above 1GHz, the emissions level of the EUT in peak mode was lower than average limit (that means the emissions level in peak mode also complies with the limit in average mode), then testing will be stopped and peak values of EUT will be reported, otherwise, the emissions will be measured in average mode again and reported.
10. In case the emission is lower than 30MHz, loop antenna has to be used for measurement and the recorded data should be QP measured by receiver. High – Low scan is not required in this case.

3.5.4 Test Setup Layout

For radiated emissions below 30MHz

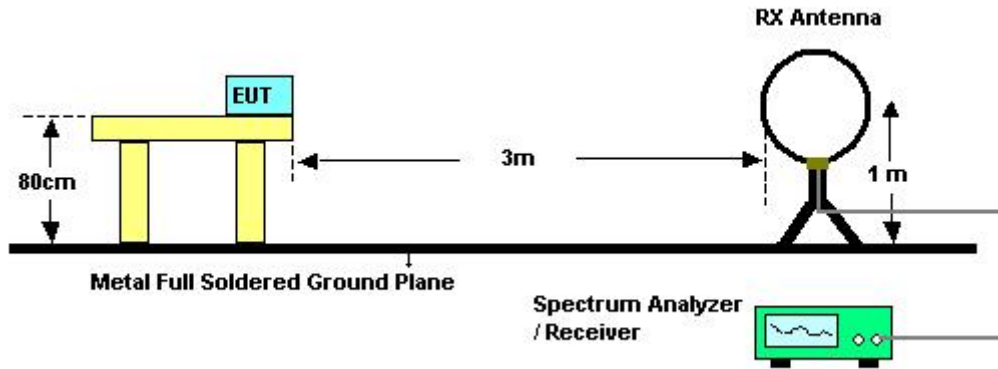

For radiated emissions above 30MHz

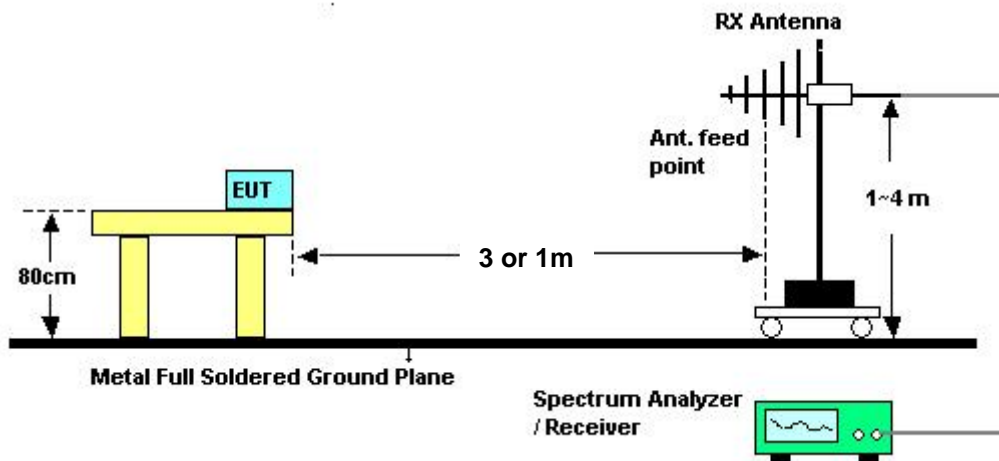

Above 10 GHz shall be extrapolated to the specified distance using an extrapolation factor of 20 dB/decade from 3m to 1m.

Distance extrapolation factor = $20 \log (\text{specific distance [3m]} / \text{test distance [1m]})$ (dB);

Limit line = specific limits (dBuV) + distance extrapolation factor [9.54 dB].

3.5.5 Test Deviation

There is no deviation with the original standard.

3.5.6 EUT Operation during Test

The EUT was programmed to be in continuously transmitting mode.

3.5.7 Results of Radiated Emissions (9kHz~30MHz)

Test date	Jan. 08, 2009	Test Site No.	03CH02HY
Temperature	18°C	Humidity	53%
Test Engineer	David		

Freq. (MHz)	Level (dBuV)	Over Limit (dB)	Limit Line (dBuV)	Remark
-	-	-	-	See Note

Note:

The amplitude of spurious emissions that are attenuated by more than 20 dB below the permissible value has no need to be reported.

Distance extrapolation factor = $40 \log (\text{specific distance} / \text{test distance})$ (dB);

Limit line = specific limits (dBuV) + distance extrapolation factor.

3.5.8 Results of Radiated Emissions (30MHz~1GHz)

Test date	Feb. 16, 2009	Test Site No.	03CH02HY
Temperature	18°C	Humidity	53%
Test Engineer	David	Configuration	Normal Mode

Horizontal

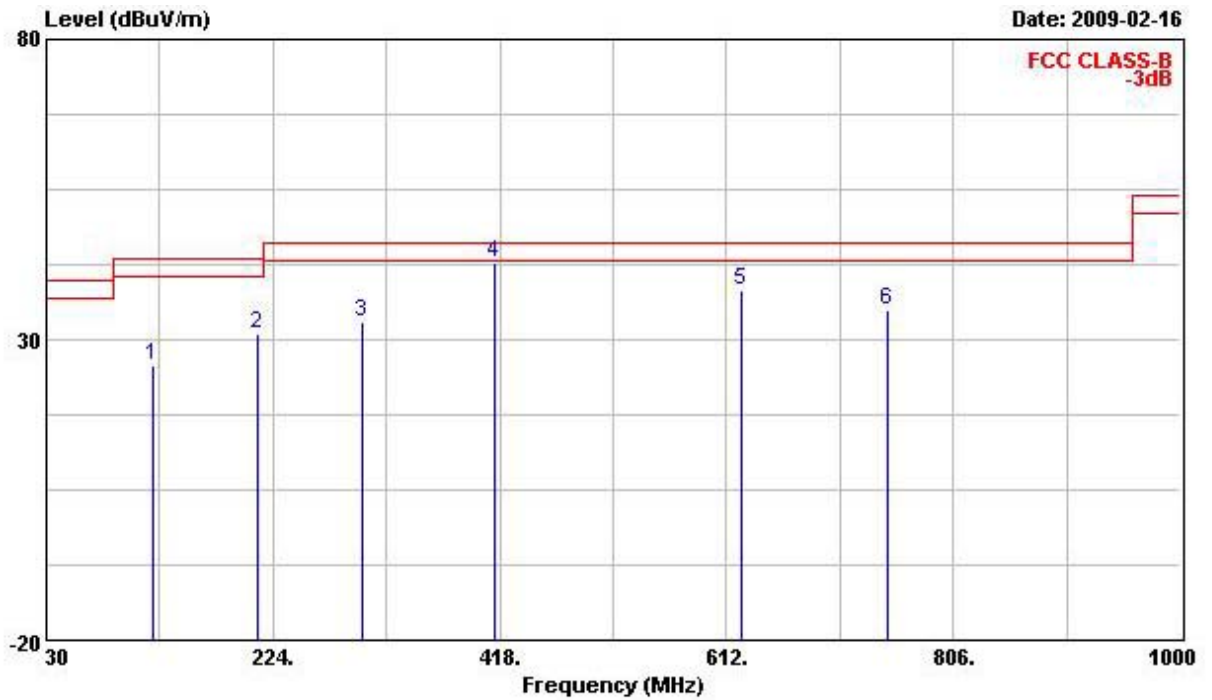

	Freq	Level	Over Limit	Limit Line	ReadAntenna Level	Antenna Factor	Cable Loss	Preamp Factor	Remark
	MHz	dBuV/m	dB	dBuV/m	dBuV	dB/m	dB	dB	
1	121.180	25.71	-17.79	43.50	40.89	13.39	2.18	30.76	Peak
2	211.390	30.96	-12.54	43.50	46.90	11.73	2.91	30.58	Peak
3	299.660	33.01	-12.99	46.00	46.23	13.70	3.48	30.40	Peak
4	414.120	42.92	-3.08	46.00	53.62	15.55	3.92	30.16	Peak
5	625.580	38.22	-7.78	46.00	42.89	19.84	4.99	29.50	Peak
6	749.740	34.90	-11.10	46.00	39.12	19.55	5.33	29.10	Peak

Vertical

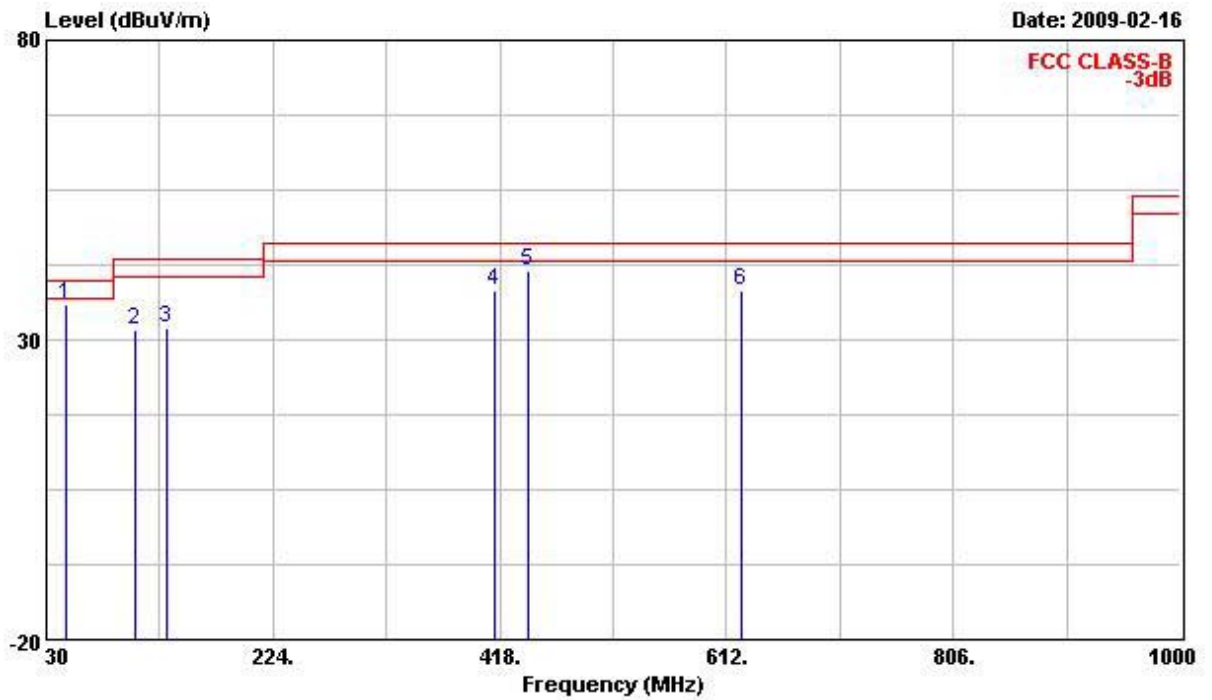

	Freq	Level	Over Limit	Limit Line	ReadAntenna Level	Antenna Factor	Cable Loss	Preamp Factor	Remark
	MHz	dBuV/m	dB	dBuV/m	dBuV	dB/m	dB	dB	
1	47.460	35.83	-4.17	40.00	54.38	10.82	1.44	30.81	Peak
2	105.660	31.59	-11.91	43.50	48.42	11.88	2.09	30.79	Peak
3	133.790	31.93	-11.57	43.50	47.86	12.49	2.31	30.73	Peak
4	413.150	38.27	-7.73	46.00	48.99	15.53	3.92	30.16	Peak
5	442.250	41.41	-4.59	46.00	51.31	16.12	4.06	30.07	Peak
6	625.580	38.29	-7.71	46.00	42.96	19.84	4.99	29.50	Peak

Note:

The amplitude of spurious emissions that are attenuated by more than 20dB below the permissible value has no need to be reported.

Emission level (dBuV/m) = 20 log Emission level (uV/m).

Corrected Reading: Antenna Factor + Cable Loss + Read Level - Preamp Factor = Level.

3.5.9 Results for Radiated Emissions (1GHz~10th Harmonic)

Test date	Jan. 08, 2009	Test Site No.	03CH02HY
Temperature	18°C	Humidity	53%
Test Engineer	David	Configuration	802.11b CH 1

Horizontal

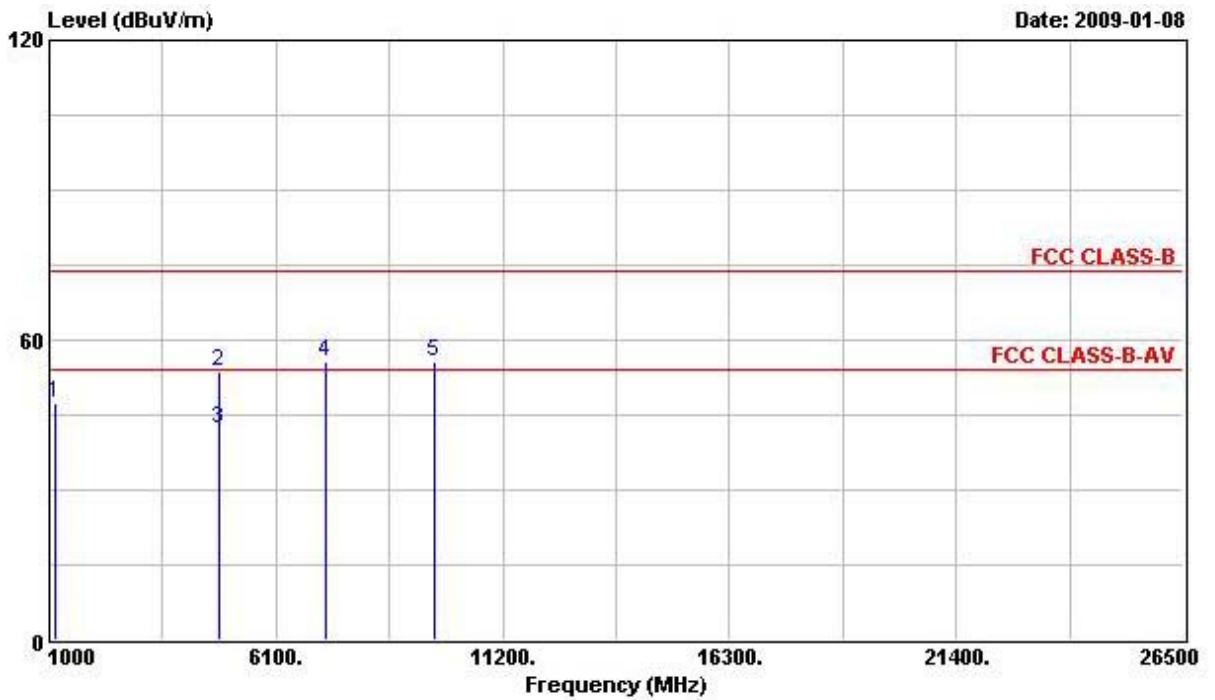

	Freq	Level	Over Limit	Limit Line	ReadAntenna Level	Antenna Factor	Cable Loss	Preamp Factor	Remark
	MHz	dBuV/m	dB	dBuV/m	dBuV	dB/m	dB	dB	
1	1124.000	47.42	-6.58	54.00	53.80	27.20	1.92	35.50	PK
2	4828.000	53.57	-20.43	74.00	48.15	35.76	4.59	34.94	Peak
3	4828.000	42.42	-11.58	54.00	37.00	35.76	4.59	34.94	Average
4	7240.000	55.75			47.52	37.85	5.63	35.25	Peak
5	9652.000	55.75			45.72	39.39	6.34	35.70	Peak

Note: An item 4 and 5 are on un-restricted band, so the limit is 20dB for the field strength of the fundamental emissions (see section 3.6.7).

Vertical

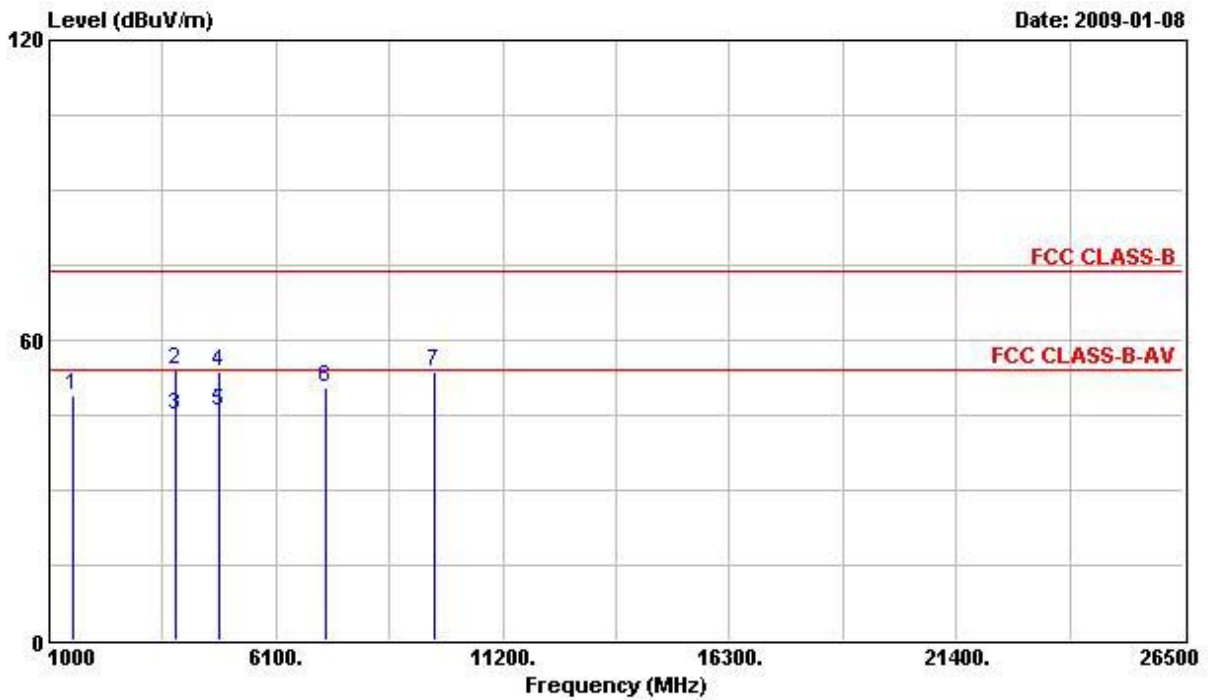

	Freq	Level	Over Limit	Limit Line	ReadAntenna Level	Antenna Factor	Cable Loss	Preamp Factor	Remark
	MHz	dBuV/m	dB	dBuV/m	dBuV	dB/m	dB	dB	
1 @	1516.000	49.01	-4.99	54.00	53.31	28.28	2.32	34.90	PK
2	3840.000	53.91	-20.09	74.00	50.93	33.92	4.06	35.00	Peak
3	3840.000	44.97	-9.03	54.00	41.99	33.92	4.06	35.00	Average
4	4824.000	53.60	-20.40	74.00	48.82	35.13	4.59	34.94	Peak
5	4824.000	45.78	-8.22	54.00	41.00	35.13	4.59	34.94	Average
6	7236.000	50.53	-23.47	74.00	43.26	36.90	5.63	35.25	Peak
7	9648.000	53.71			44.48	38.59	6.34	35.70	Peak

Note: An item 7 is on un-restricted band, so the limit is 20dB for the field strength of the fundamental emissions (see section 3.6.7).

Test date	Jan. 08, 2009	Test Site No.	03CH02HY
Temperature	18°C	Humidity	53%
Test Engineer	David	Configuration	802.11b CH 6

Horizontal

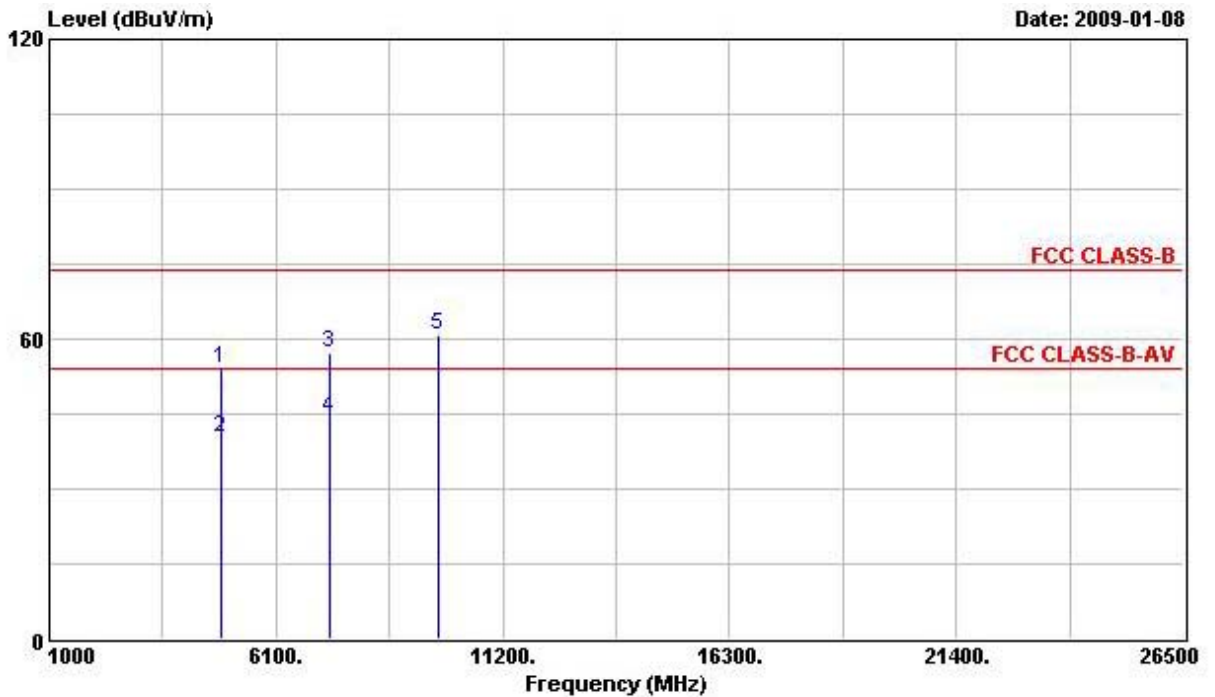

	Freq	Level	Over Limit	Limit Line	ReadAntenna Level	Antenna Factor	Cable Loss	Preamp Factor	Remark
	MHz	dBuV/m	dB	dBuV/m	dBuV	dB/m	dB	dB	
1	4870.000	54.14	-19.86	74.00	48.62	35.83	4.62	34.93	Peak
2	4870.000	40.39	-13.61	54.00	34.87	35.83	4.62	34.93	Average
3	7311.000	57.04	-16.96	74.00	48.80	37.86	5.64	35.26	Peak
4	7311.000	44.25	-9.75	54.00	36.01	37.86	5.64	35.26	Average
5	9748.000	60.87			50.69	39.51	6.36	35.70	Peak

Note: An item 7 is on un-restricted band, so the limit is 20dB for the field strength of the fundamental emissions (see section 3.6.7).

Vertical

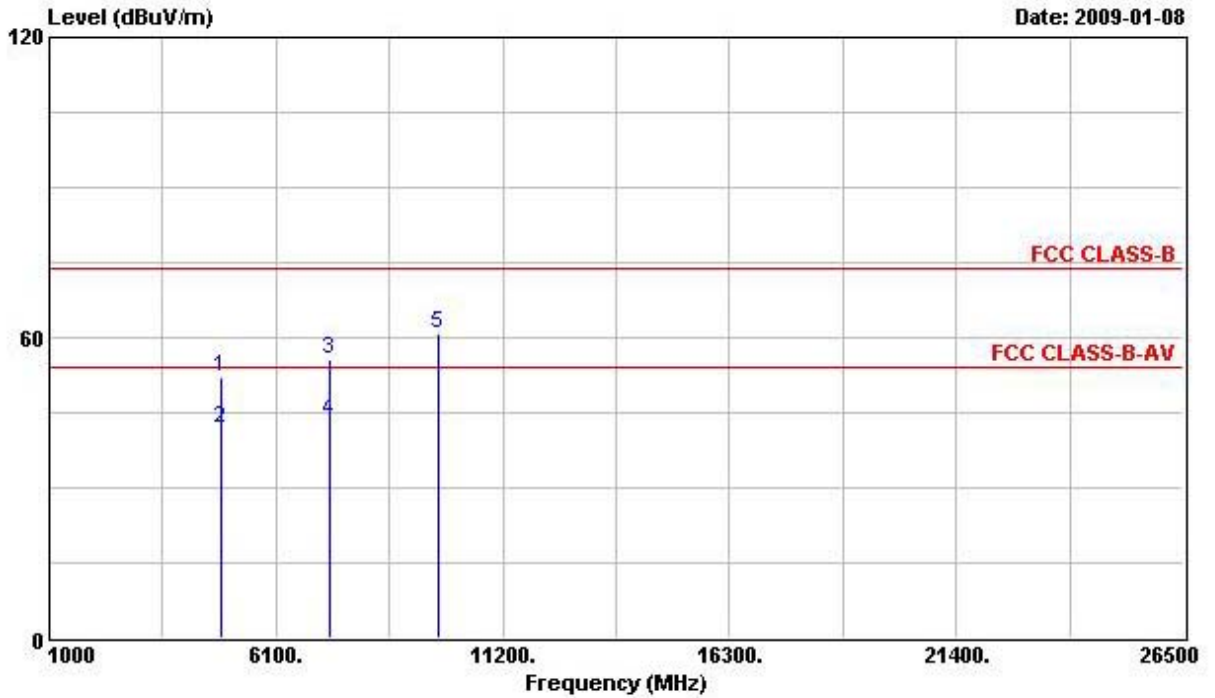

	Freq	Level	Over Limit	Limit Line	ReadAntenna Level	Antenna Factor	Cable Loss	Preamp Factor	Remark
	MHz	dBuV/m	dB	dBuV/m	dBuV	dB/m	dB	dB	
1	4878.000	52.24	-21.76	74.00	47.35	35.18	4.64	34.93	Peak
2	4878.000	41.80	-12.20	54.00	36.90	35.18	4.64	34.93	Average
3	7311.000	55.85	-18.15	74.00	48.55	36.92	5.64	35.26	Peak
4	7311.000	43.26	-10.74	54.00	35.96	36.92	5.64	35.26	Average
5	9748.000	60.93			51.56	38.71	6.36	35.70	Peak

Note: An item 5 is on un-restricted band, so the limit is 20dB for the field strength of the fundamental emissions (see section 3.6.7).

Test date	Jan. 08, 2009	Test Site No.	03CH02HY
Temperature	18°C	Humidity	53%
Test Engineer	David	Configuration	802.11b CH 11

Horizontal

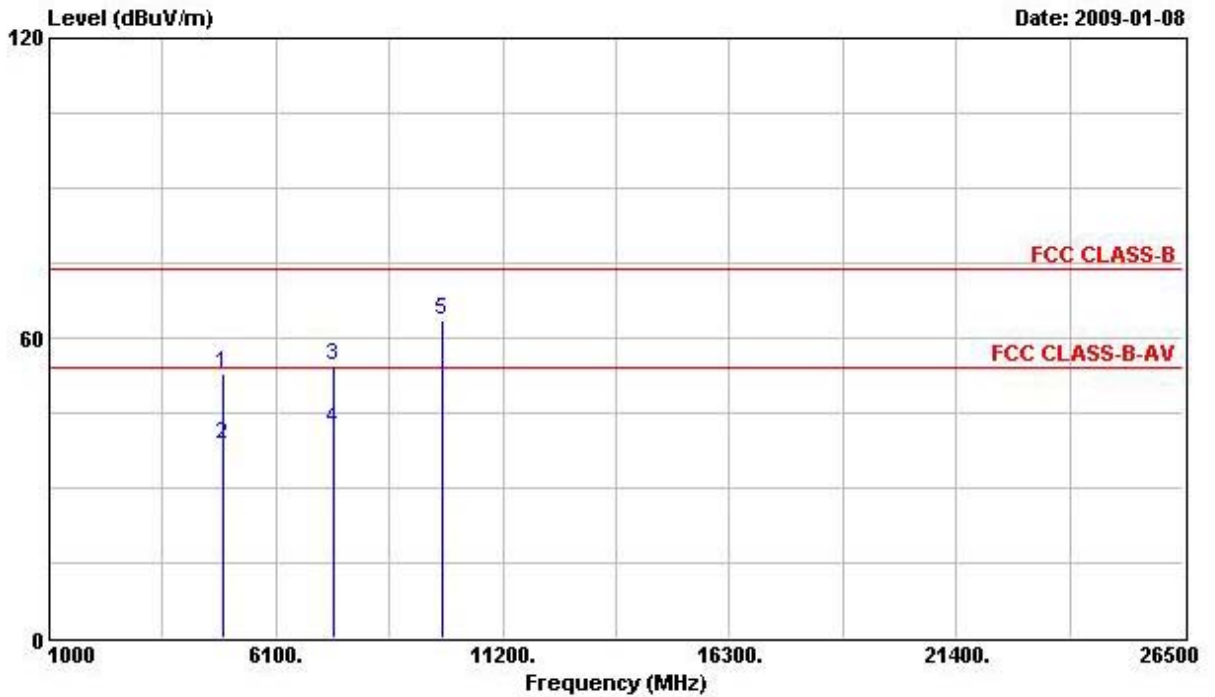

	Freq	Level	Over Limit	Limit Line	ReadAntenna Level	Antenna Factor	Cable Loss	Preamp Factor	Remark
	MHz	dBuV/m	dB	dBuV/m	dBuV	dB/m	dB	dB	
1	4928.000	52.72	-21.28	74.00	47.07	35.90	4.67	34.92	Peak
2	4928.000	38.87	-15.13	54.00	33.22	35.90	4.67	34.92	Average
3	7390.000	54.55	-19.45	74.00	46.30	37.88	5.65	35.28	Peak
4	7390.000	41.73	-12.27	54.00	33.48	37.88	5.65	35.28	Average
5	9848.200	63.72			53.43	39.61	6.38	35.70	Peak

Note: An item 5 is on un-restricted band, so the limit is 20dB for the field strength of the fundamental emissions (see section 3.6.7).

Vertical

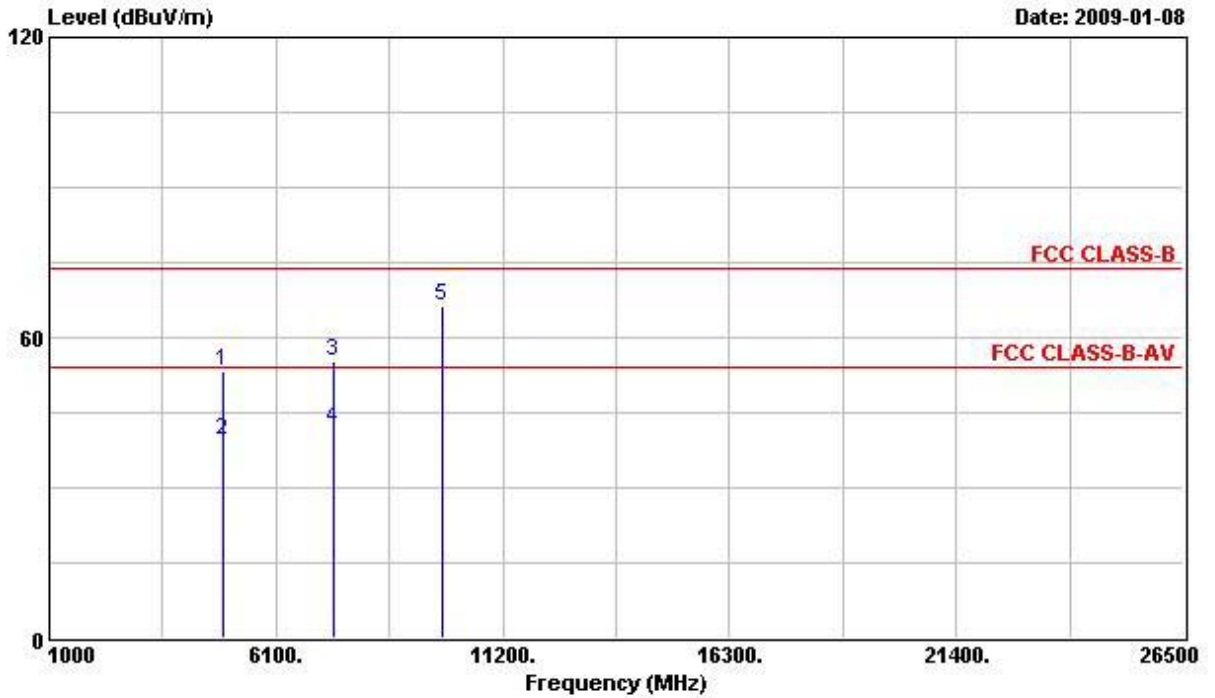

	Freq	Level	Over Limit	Limit Line	ReadAntenna Level	Antenna Factor	Cable Loss	Preamp Factor	Remark
	MHz	dBuV/m	dB	dBuV/m	dBuV	dB/m	dB	dB	
1	4926.480	53.40	-20.60	74.00	48.42	35.23	4.67	34.92	Peak
2	4926.480	39.37	-14.63	54.00	34.39	35.23	4.67	34.92	Average
3	7386.000	55.46	-18.54	74.00	48.13	36.96	5.65	35.28	Peak
4	7386.000	41.88	-12.12	54.00	34.55	36.96	5.65	35.28	Average
5	9848.200	66.15			56.66	38.81	6.38	35.70	Peak

Note: An item 5 is on un-restricted band, so the limit is 20dB for the field strength of the fundamental emissions (see section 3.6.7).

Test date	Jan. 08, 2009	Test Site No.	03CH02HY
Temperature	18°C	Humidity	53%
Test Engineer	David	Configuration	802.11g CH 1

Horizontal

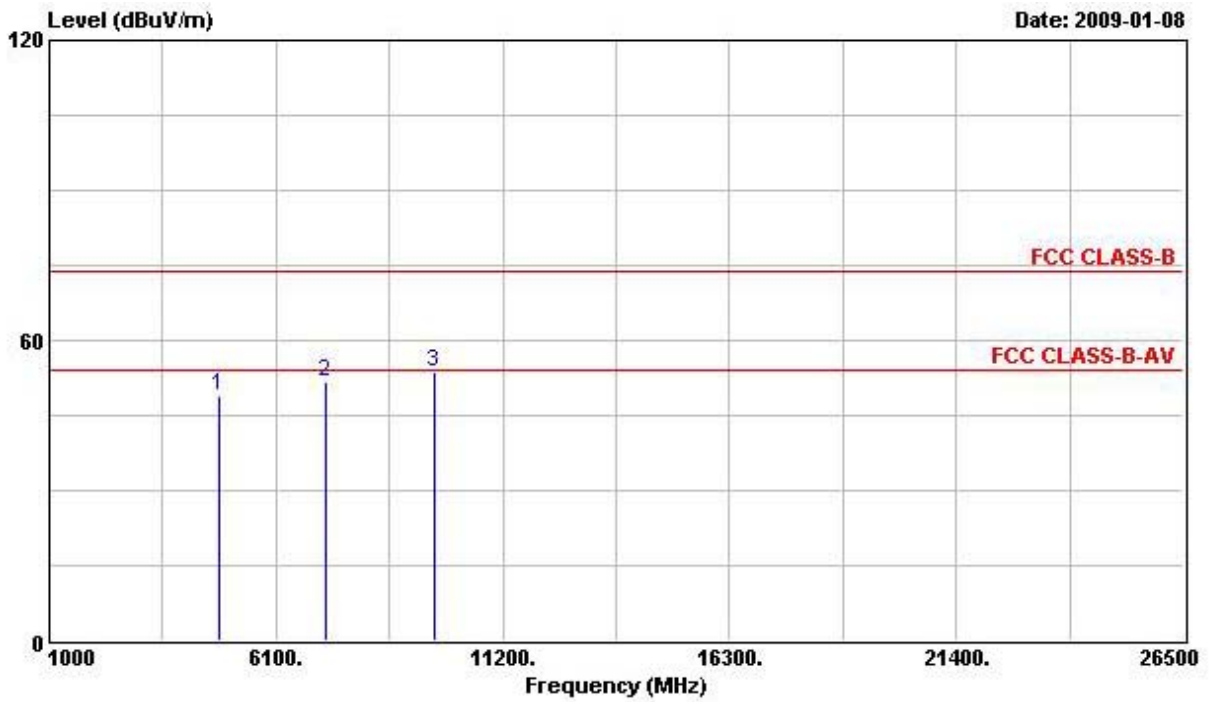

	Freq	Level	Over Limit	Limit Line	ReadAntenna Level	Antenna Factor	Cable Loss	Preamp Factor	Remark
	MHz	dBuV/m	dB	dBuV/m	dBuV	dB/m	dB	dB	
1	4824.000	48.93	-5.07	54.00	43.51	35.76	4.59	34.94	PK
2	7240.000	51.81			43.58	37.85	5.63	35.25	Peak
3	9648.000	53.53			43.50	39.39	6.34	35.70	Peak

Note: An item 2 and 3 are on un-restricted band, so the limit is 20dB for the field strength of the fundamental emissions (see section 3.6.7).

Vertical

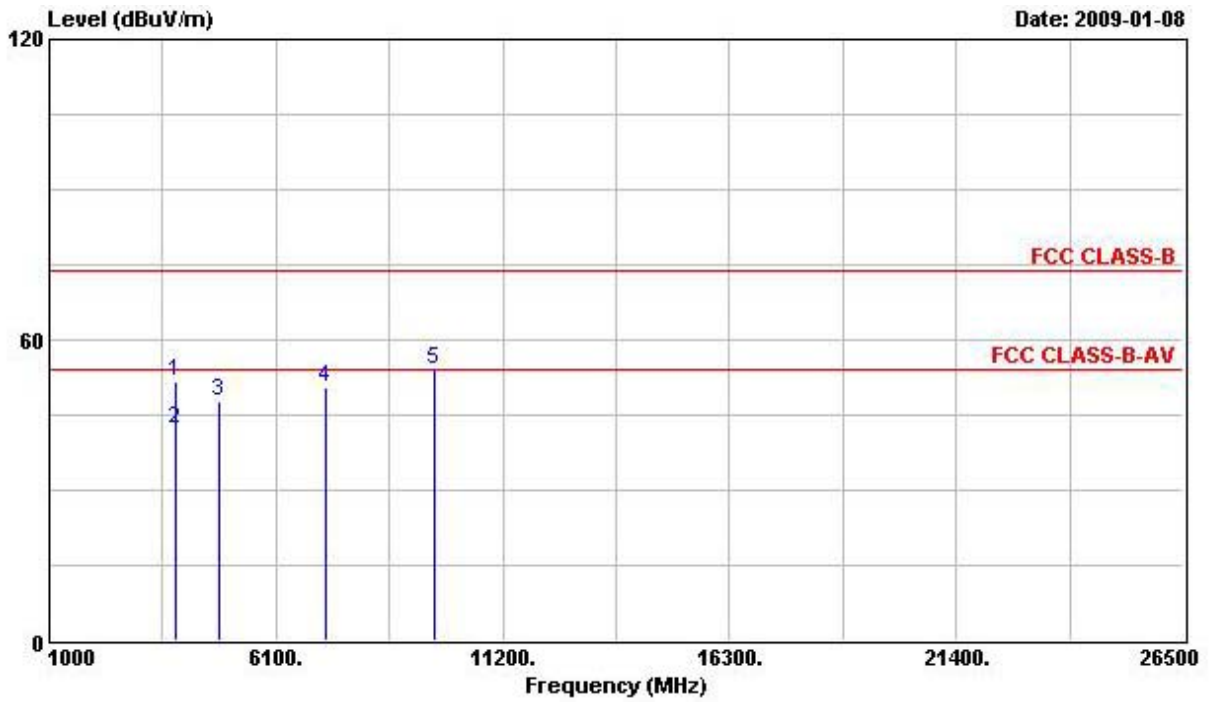

	Freq	Level	Limit	Line	Level	nna	Cable	Preamp	Remark
	MHz	dBuV/m	dB	dBuV/m	dBuV	dB/m	dB	dB	
1	3839.850	51.58	-22.42	74.00	48.60	33.92	4.06	35.00	Peak
2	3839.850	42.34	-11.66	54.00	39.36	33.92	4.06	35.00	Average
3	4828.000	47.73	-6.27	54.00	42.94	35.13	4.59	34.94	PK
4	7232.000	50.48			43.20	36.90	5.63	35.25	Peak
5	9648.000	54.18			44.95	38.59	6.34	35.70	Peak

Note: An item 3, 4 and 5 are on un-restricted band, so the limit is 20dB for the field strength of the fundamental emissions (see section 3.6.7).

Test date	Jan. 08, 2009	Test Site No.	03CH02HY
Temperature	18°C	Humidity	53%
Test Engineer	David	Configuration	802.11g CH 6

Horizontal

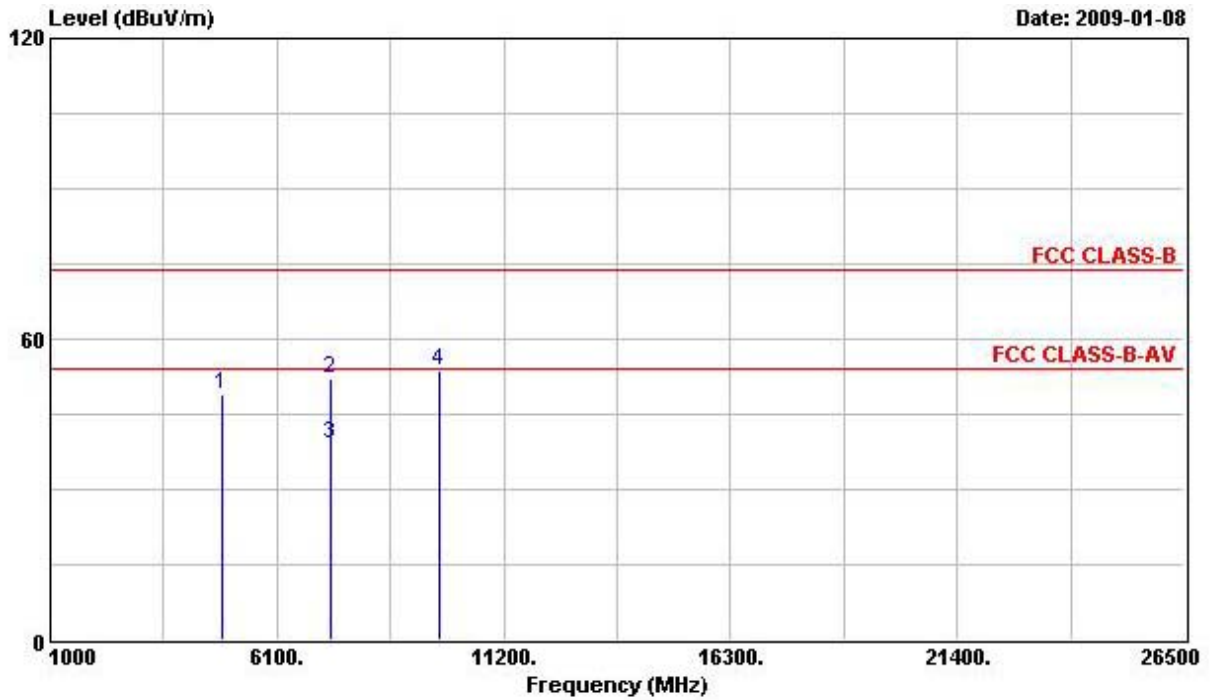

	Freq	Level	Over Limit	Limit Line	ReadAntenna Level	Antenna Factor	Cable Loss	Preamp Factor	Remark
	MHz	dBuV/m	dB	dBuV/m	dBuV	dB/m	dB	dB	
1	4874.000	49.05	-4.95	54.00	43.50	35.83	4.64	34.93	PK
2	7311.000	51.99	-22.01	74.00	43.75	37.86	5.64	35.26	Peak
3	7311.000	39.10	-14.90	54.00	30.86	37.86	5.64	35.26	Average
4	9748.000	53.68			43.51	39.51	6.36	35.70	Peak

Note: An item 4 is on un-restricted band, so the limit is 20dB for the field strength of the fundamental emissions (see section 3.6.7).

Vertical

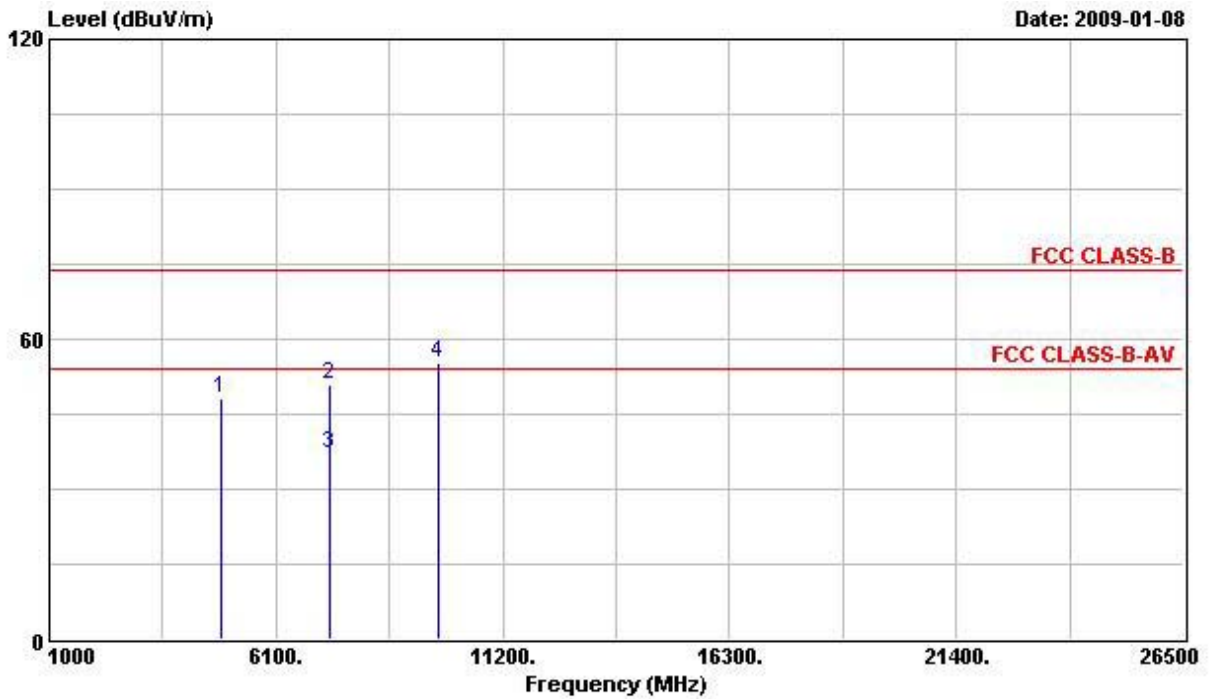

	Freq	Level	Over Limit	Limit Line	ReadAntenna Level	Antenna Factor	Cable Loss	Preamp Factor	Remark
	MHz	dBuV/m	dB	dBuV/m	dBuV	dB/m	dB	dB	
1	4874.000	48.19	-5.81	54.00	43.30	35.18	4.64	34.93	PK
2	7327.000	51.08	-22.92	74.00	43.77	36.93	5.64	35.27	Peak
3	7327.000	36.94	-17.06	54.00	29.64	36.93	5.64	35.27	Average
4	9748.000	55.23			45.86	38.71	6.36	35.70	Peak

Note: An item 4 is on un-restricted band, so the limit is 20dB for the field strength of the fundamental emissions (see section 3.6.7).

Test date	Jan. 08, 2009	Test Site No.	03CH02HY
Temperature	18°C	Humidity	53%
Test Engineer	David	Configuration	802.11g CH 11

Horizontal

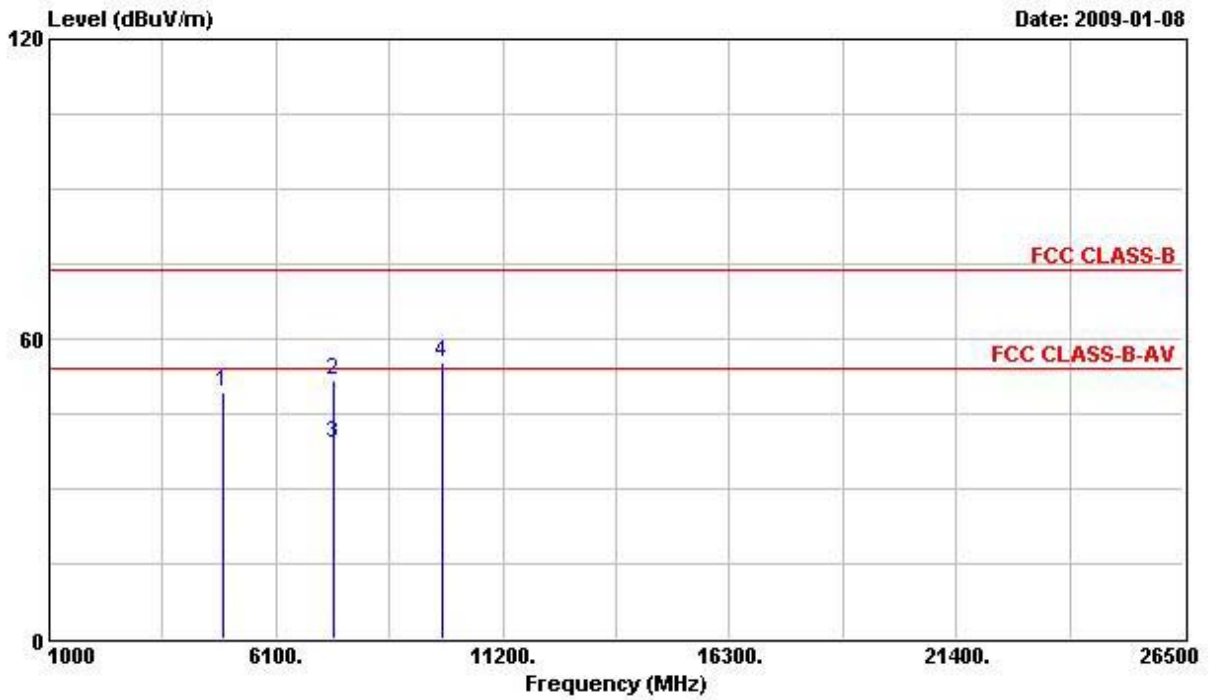

	Freq	Level	Over Limit	Limit Line	ReadAntenna Level	Antenna Factor	Cable Loss	Preamp Factor	Remark
	MHz	dBuV/m	dB	dBuV/m	dBuV	dB/m	dB	dB	
1 @	4920.000	49.48	-4.52	54.00	43.83	35.90	4.67	34.92	PK
2	7382.000	51.83	-22.17	74.00	43.58	37.88	5.65	35.28	Peak
3	7382.000	38.90	-15.10	54.00	30.65	37.88	5.65	35.28	Average
4	9852.000	55.43			45.12	39.63	6.38	35.70	Peak

Note: An item 4 is on un-restricted band, so the limit is 20dB for the field strength of the fundamental emissions (see section 3.6.7).

Vertical

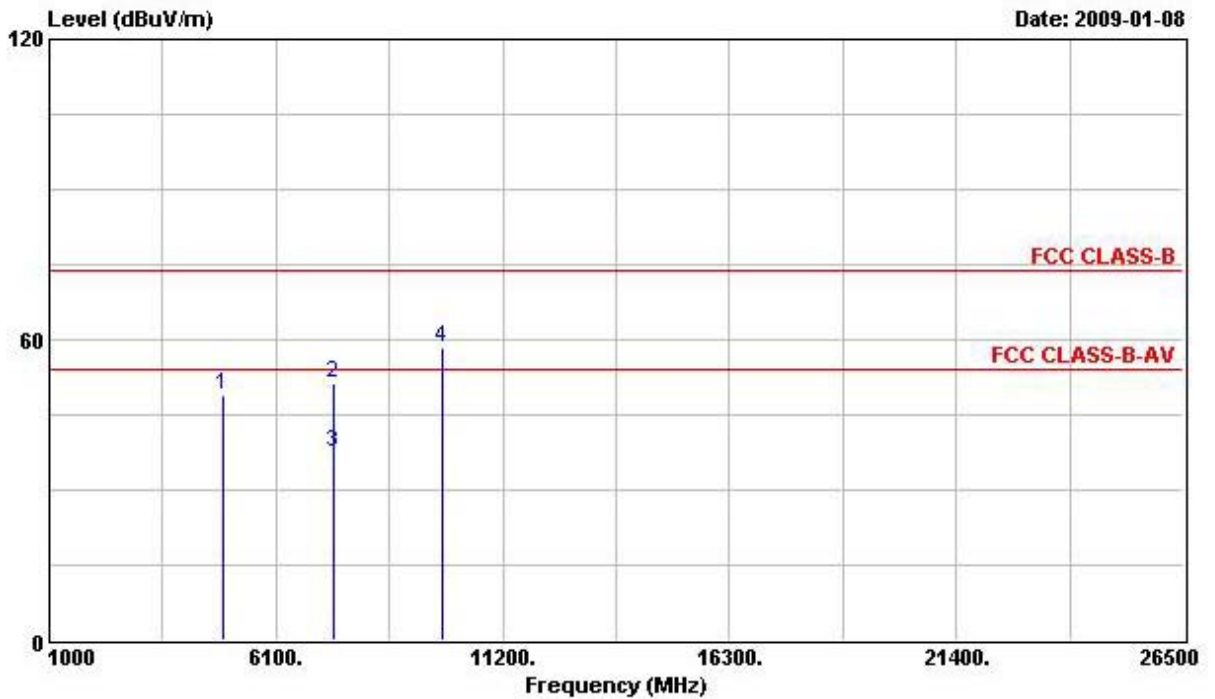

	Freq	Level	Over Limit	Limit Line	ReadAntenna Level	Antenna Factor	Cable Loss	Preamp Factor	Remark
	MHz	dBuV/m	dB	dBuV/m	dBuV	dB/m	dB	dB	
1	4928.000	48.89	-5.11	54.00	43.90	35.23	4.67	34.92	PK
2	7390.000	51.49	-22.51	74.00	44.17	36.96	5.65	35.28	Peak
3	7390.000	37.45	-16.55	54.00	30.13	36.96	5.65	35.28	Average
4	9852.000	58.55			49.04	38.83	6.38	35.70	Peak

Note: An item 4 is on un-restricted band, so the limit is 20dB for the field strength of the fundamental emissions (see section 3.6.7).

The amplitude of spurious emissions that are attenuated by more than 20dB below the permissible value has no need to be reported.

Emission level (dBuV/m) = 20 log Emission level (uV/m).

Corrected Reading: Antenna Factor + Cable Loss + Read Level - Preamp Factor = Level.

3.6 Band Edge and Fundamental Emissions Measurement

3.6.1 Limit

20dBc in any 100 kHz bandwidth outside the operating frequency band. In case the emission fall within the restricted band specified on 15.205(a), then the 15.209(a) limit in the table below has to be followed.

Frequencies (MHz)	Field Strength (micorvolts/meter)	Measurement Distance (meters)
0.009~0.490	2400/F(KHz)	300
0.490~1.705	24000/F(KHz)	30
1.705~30.0	30	30
30~88	100	3
88~216	150	3
216~960	200	3
Above 960	500	3

3.6.2 Measuring Instruments and Setting

Please refer to section 4 of equipments list in this report. The following table is the setting of the spectrum analyzer.

Spectrum Parameter	Setting
Attenuation	Auto
Span Frequency	100 MHz
RB / VB (Emission in restricted band)	1MHz / 1MHz for Peak, 1 MHz / 10Hz for Average
RB / VB (Emission in non-restricted band)	100 KHz /100 KHz for Peak

3.6.3 Test Procedures

The test procedure is the same as section 3.5.3; only the frequency range investigated is limited to 100MHz around band edges.

In case the emission is fail due to the used RB/VB is too wide, marker-delta method of FCC Public Notice DA00-705 will be followed.

3.6.4 Test Setup Layout

This test setup layout is the same as that shown in section 3.5.4.

3.6.5 Test Deviation

There is no deviation with the original standard.

3.6.6 EUT Operation during Test

The EUT was programmed to be in continuously transmitting mode.

3.6.7 Test Result of Band Edge and Fundamental Emissions

Test date	Jan. 08, 2009	Test Site No.	03CH02HY
Temperature	18°C	Humidity	53%
Test Engineer	David	Configuration	802.11b CH 1, 6, 11

Channel 1

	Freq	Level	Over Limit	Limit Line	ReadAntenna Level	Antenna Factor	Cable Loss	Preamp Factor	Remark
	MHz	dBuV/m	dB	dBuV/m	dBuV	dB/m	dB	dB	
1	2390.000	59.96	-14.04	74.00	25.17	31.79	3.00	0.00	Peak
2 @	2413.170	110.35			75.47	31.86	3.02	0.00	Peak
1	2390.000	48.66	-5.34	54.00	13.87	31.79	3.00	0.00	Average
2 @	2413.170	101.57			66.69	31.86	3.02	0.00	Average

An item 2 is Fundamental Emissions.

Channel 6

	Freq	Level	Over Limit	Limit Line	ReadAntenna Level	Antenna Factor	Cable Loss	Preamp Factor	Remark
	MHz	dBuV/m	dB	dBuV/m	dBuV	dB/m	dB	dB	
1 @	2438.250	112.63			77.60	31.99	3.04	0.00	Peak
1 @	2435.970	91.55			56.59	31.92	3.04	0.00	Average

An item 1 is Fundamental Emissions.

Channel 11

	Freq	Level	Over Limit	Limit Line	ReadAntenna Level	Antenna Factor	Cable Loss	Preamp Factor	Remark
	MHz	dBuV/m	dB	dBuV/m	dBuV	dB/m	dB	dB	
1 @	2463.330	112.44			77.34	32.06	3.04	0.00	Peak
2	2486.890	62.58	-11.42	74.00	27.39	32.13	3.06	0.00	Peak
1 @	2463.330	103.36			68.26	32.06	3.04	0.00	Average
2 @	2483.500	50.13	-3.87	54.00	14.94	32.13	3.06	0.00	Average

An item 1 is Fundamental Emissions.

Note:

Emission level (dBuV/m) = 20 log Emission level (uV/m).

Corrected Reading: Antenna Factor + Cable Loss + Read Level - Preamp Factor = Level.

Test date	Jan. 08, 2009	Test Site No.	03CH02HY
Temperature	18°C	Humidity	53%
Test Engineer	David	Configuration	802.11g CH 1, 6, 11

Channel 1

	Freq	Level	Over Limit	Limit Line	ReadAntenna Level	Antenna Factor	Cable Loss	Preamp Factor	Remark
	MHz	dBuV/m	dB	dBuV/m	dBuV	dB/m	dB	dB	
1	2390.000	63.37	-10.63	74.00	28.58	31.79	3.00	0.00	Peak
2 @	2419.060	106.27			71.39	31.86	3.02	0.00	Peak
1	2390.000	49.00	-5.00	54.00	14.21	31.79	3.00	0.00	Average
2 @	2416.970	95.53			60.65	31.86	3.02	0.00	Average

An item 2 is Fundamental Emissions.

Channel 6

	Freq	Level	Over Limit	Limit Line	ReadAntenna Level	Antenna Factor	Cable Loss	Preamp Factor	Remark
	MHz	dBuV/m	dB	dBuV/m	dBuV	dB/m	dB	dB	
1 @	2438.820	107.68			72.65	31.99	3.04	0.00	Peak
1 @	2442.810	96.95			61.92	31.99	3.04	0.00	Average

An item 1 is Fundamental Emissions.

Channel 11

	Freq	Level	Over Limit	Limit Line	ReadAntenna Level	Antenna Factor	Cable Loss	Preamp Factor	Remark
	MHz	dBuV/m	dB	dBuV/m	dBuV	dB/m	dB	dB	
1 @	2464.660	104.57			69.45	32.06	3.06	0.00	Peak
2	2483.500	64.90	-9.10	74.00	29.71	32.13	3.06	0.00	Peak
1 @	2467.890	95.76			60.64	32.06	3.06	0.00	Average
2 @	2483.500	51.99	-2.01	54.00	16.80	32.13	3.06	0.00	Average

An item 1 is Fundamental Emissions.

Note:

Emission level (dBuV/m) = 20 log Emission level (uV/m).

Corrected Reading: Antenna Factor + Cable Loss + Read Level - Preamp Factor = Level.

For Emission not in Restricted Band

Low Band Edge Plot on Configuration IEEE 802.11b / 2412 MHz

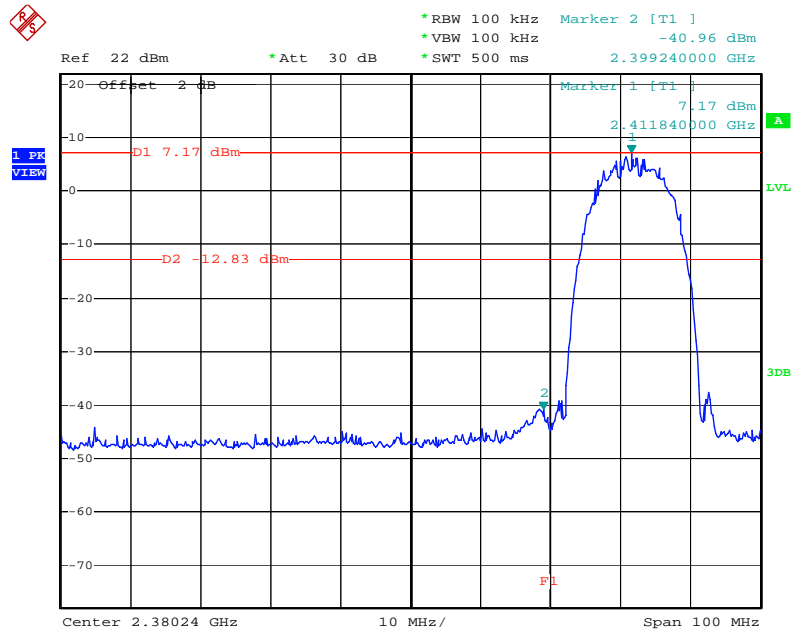

Date: 9.JAN.2009 03:42:06

High Band Edge Plot on Configuration IEEE 802.11b / 2462 MHz

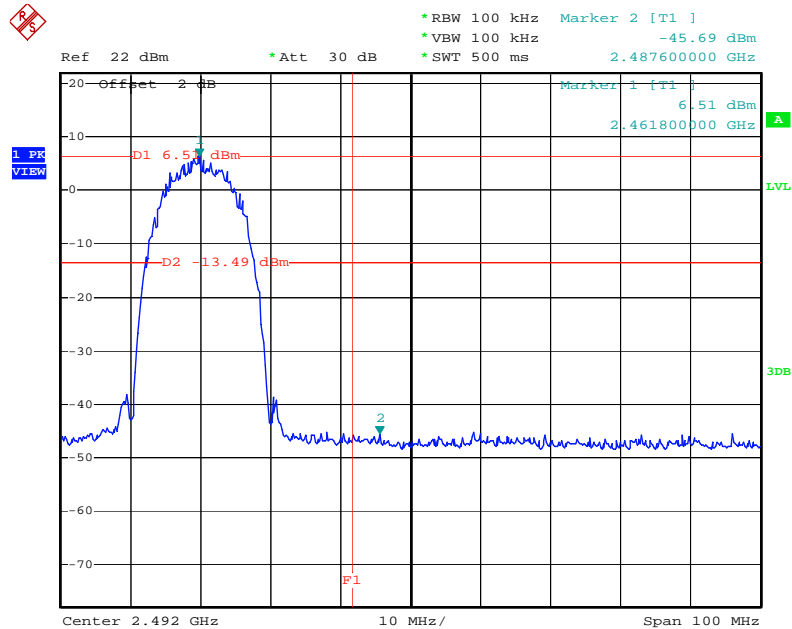

Date: 9.JAN.2009 05:36:56

Low Band Edge Plot on Configuration IEEE 802.11g / 2412 MHz

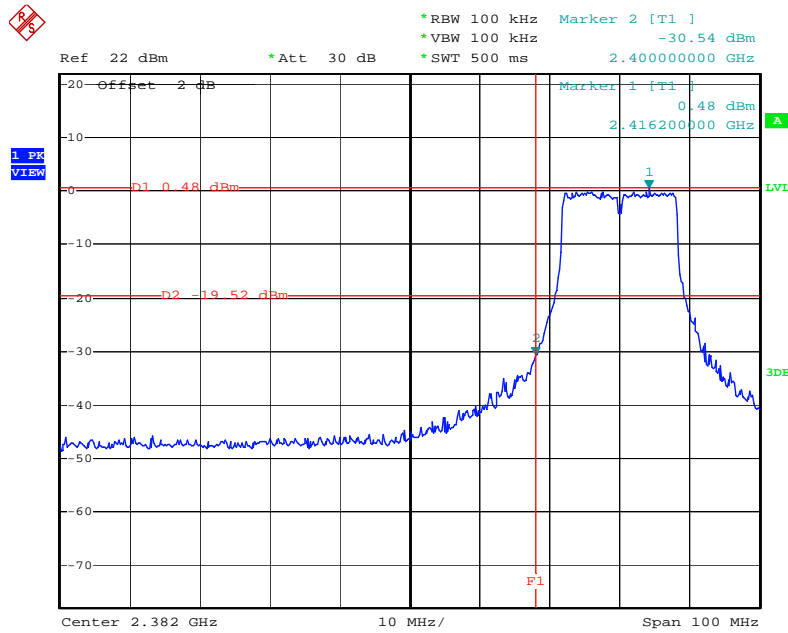

Date: 9.JAN.2009 06:06:56

High Band Edge Plot on Configuration IEEE 802.11g / 2462 MHz

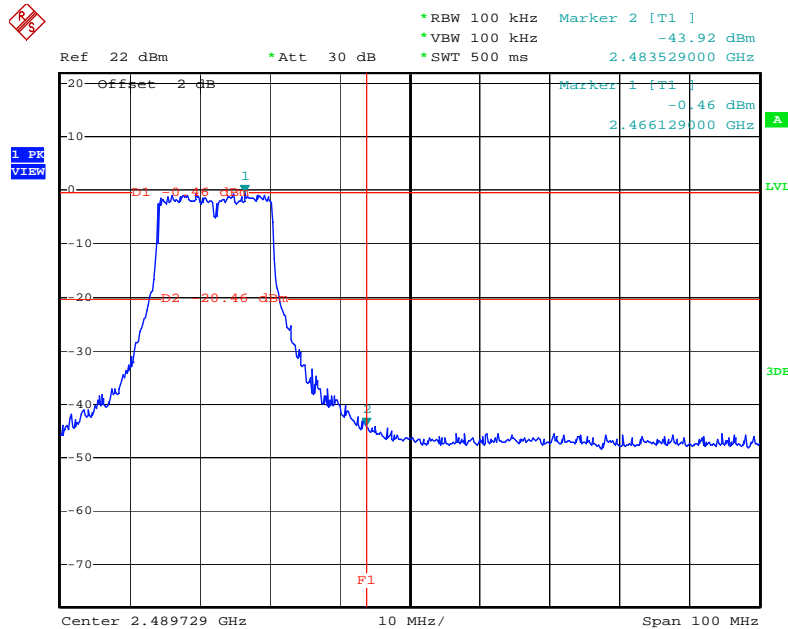

Date: 9.JAN.2009 06:41:38

3.7 Antenna Requirements

3.7.1 Limit

Except for special regulations, the Low-power Radio-frequency Devices must not be equipped with any jacket for installing an antenna with extension cable. An intentional radiator shall be designed to ensure that no antenna other than that furnished by the responsible party shall be used with the device. The use of a permanently attached antenna or of an antenna that uses a unique coupling to the intentional radiator shall be considered sufficient to comply with the provisions of this Section. The manufacturer may design the unit so that the user can replace a broken antenna, but the use of a standard antenna jack or electrical connector is prohibited. Further, this requirement does not apply to intentional radiators that must be professionally installed.

3.7.2 Antenna Connector Construction

Please refer to section 2.2 in this test report; antenna connector complied with the requirements.

4 LIST OF MEASURING EQUIPMENTS

Instrument	Manufacturer	Model No.	Serial No.	Characteristics	Calibration Date	Remark
EMC Receiver	R&S	ESCS 30	100174	9kHz – 2.75GHz	Mar. 03, 2008	Conduction (CO04-HY)
LISN	MessTec	NNB-2/16Z	99079	9kHz – 30MHz	Mar. 31, 2008	Conduction (CO04-HY)
LISN (Support Unit)	EMCO	3810/2NM	9703-1839	9kHz – 30MHz	Mar. 22, 2008	Conduction (CO04-HY)
RF Cable-CON	UTIFLEX	3102-26886-4	CB049	9kHz – 30MHz	Apr. 20, 2008	Conduction (CO04-HY)
EMI Filter	LINDGREN	LRE-2030	2651	< 450 Hz	N/A	Conduction (CO04-HY)

Note: Calibration Interval of instruments listed above is one year.

Instrument	Manufacturer	Model No.	Serial No.	Characteristics	Calibration Date	Remark
3m Semi Anechoic Chamber	SIDT FRANKONIA	SAC-3M	03CH02-HY	30 MHz - 1 GHz 3m	May 12, 2008	Radiation (03CH02-HY)
Amplifier	Agilent	8447D	2944A11146	100 kHz – 1.3 GHz	Jul. 11, 2008	Radiation (03CH02-HY)
Spectrum Analyzer	R&S	FSP40	100305/040	9 kHz - 40GHz	Feb. 04, 2009	Radiation (03CH02-HY)
Bilog Antenna	SCHAFFNER	CBL61128	2723	30 MHz - 2 GHz	Nov. 30, 2008	Radiation (03CH02-HY)
Turn Table	HD	DS 420	420/649/00	0 - 360 degree	N/A	Radiation (03CH02-HY)
Antenna Mast	HD	MA 240	240/559/00	1 m - 4 m	N/A	Radiation (03CH02-HY)
RF Cable-R03m	Jye Bao	RG142	CB020	30 MHz - 1 GHz	Dec. 17, 2008	Radiation (03CH02-HY)
Amplifier	Agilent	8449B	3008A02373	1GHz – 26.5 GHz	Jul. 16, 2008	Radiation (03CH02-HY)
Horn Antenna	ETS-LINDGREN	3117	00091920	1GHz~18GHz	Oct. 22, 2008	Radiation (03CH02-HY)
RF Cable-HIGH	SUHNER	SUCOFLEX106	03CH02-HY	1GHz~40GHz	Dec. 17, 2008	Radiation (03CH02-HY)

Note: Calibration Interval of instruments listed above is one year.

Instrument	Manufacturer	Model No.	Serial No.	Characteristics	Calibration Date	Remark
Spectrum Analyzer	R&S	FSP30	100023	9kHz ~ 30GHz	Jan. 09, 2009	Conducted (TH01-HY)
Power Meter	R&S	NRVS	100444	DC ~ 40GHz	Jul. 11, 2008	Conducted (TH01-HY)
Power Sensor	R&S	NRV-Z51	100458	DC ~ 30GHz	Jul. 11, 2008	Conducted (TH01-HY)
Power Sensor	R&S	NRV-Z32	100057	30MHz ~ 6GHz	Jul. 11, 2008	Conducted (TH01-HY)
DC Power Source	G.W.	GPC-6030D	C671845	DC 1V ~ 60V	Mar. 13, 2008	Conducted (TH01-HY)
Temp. and Humidity Chamber	Giant Force	GTH-225-20-S	MAB0103-001	N/A	Jul. 18, 2008	Conducted (TH01-HY)
RF CABLE-1m	Jye Bao	RG142	CB034-1m	20MHz ~ 7GHz	Dec. 01, 2008	Conducted (TH01-HY)
RF CABLE-2m	Jye Bao	RG142	CB035-2m	20MHz ~ 1GHz	Dec. 01, 2008	Conducted (TH01-HY)
Vector Signal Generator	R&S	SMU200A	102098	100kHz ~ 6GHz	Dec. 14, 2008	Conducted (TH01-HY)
Signal Generator	R&S	SMR40	100116	10MHz ~ 40GHz	Mar. 10, 2008	Conducted (TH01-HY)
Oscilloscope	Tektonix	TDS380	B016197	400MHz/ 2GS/s	Jun. 27, 2008	Conducted (TH01-HY)

Note: Calibration Interval of instruments listed above is one year.

Instrument	Manufacturer	Model No.	Serial No.	Characteristics	Calibration Date	Remark
Loop Antenna	R&S	HFH2-Z2	860004/001	9 kHz - 30 MHz	Jul. 28, 2008*	Radiation (03CH02-HY)
AC Power Source	HPC	HPA-500W	HPA-9100024	AC 0 ~ 300V	May 30, 2008*	Conducted (TH01-HY)

Note: Calibration Interval of instruments listed above is two year.

5 TEST LOCATION

SHIJR	ADD : 6Fl., No. 106, Sec. 1, Shintai 5th Rd., Shijr City, Taipei, Taiwan 221, R.O.C. TEL : 886-2-2696-2468 FAX : 886-2-2696-2255
HWA YA	ADD : No. 52, Hwa Ya 1st Rd., Kwei-Shan Hsiang, Tao Yuan Hsien, Taiwan, R.O.C. TEL : 886-3-327-3456 FAX : 886-3-318-0055
LINKOU	ADD : No. 30-2, Dingfu Tsuen, Linkou Shiang, Taipei, Taiwan 244, R.O.C TEL : 886-2-2601-1640 FAX : 886-2-2601-1695
DUNGHU	ADD : No. 3, Lane 238, Kangle St., Neihu Chiu, Taipei, Taiwan 114, R.O.C. TEL : 886-2-2631-4739 FAX : 886-2-2631-9740
JUNGHE	ADD : 7Fl., No. 758, Jungjeng Rd., Junghe City, Taipei, Taiwan 235, R.O.C. TEL : 886-2-8227-2020 FAX : 886-2-8227-2626
NEIHU	ADD : 4Fl., No. 339, Hsin Hu 2 nd Rd., Taipei 114, Taiwan, R.O.C. TEL : 886-2-2794-8886 FAX : 886-2-2794-9777
JHUBEI	ADD : No.8, Lane 724, Bo-ai St., Jhubei City, HsinChu County 302, Taiwan, R.O.C. TEL : 886-3-656-9065 FAX : 886-3-656-9085

6 TAF CERTIFICATE OF ACCREDITATION



Certificate No. : L1190-070110

財團法人全國認證基金會
Taiwan Accreditation Foundation

Certificate of Accreditation

This is to certify that

Sporton International Inc.
EMC & Wireless Communications Laboratory
No.52, Hwa Ya 1st Rd., Hwa Ya Technology Park, Kwei-Shan Hsiang, Tao Yuan Hsien,
Taiwan, R.O.C.

is accredited in respect of laboratory

Accreditation Criteria	: ISO/IEC 17025:2005
Accreditation Number	: 1190
Originally Accredited	: December 15, 2003
Effective Period	: January 10, 2007 to January 09, 2010
Accredited Scope	: Testing Field, see described in the Appendix
Specific Accreditation Program	: Accreditation Program for Designated Testing Laboratory for Commodities Inspection Accreditation Program for Telecommunication Equipment Testing Laboratory



Jay-San Chen
President, Taiwan Accreditation Foundation
Date : January 10, 2007

PI, total 9 pages

The Appendix forms an integral part of this Certificate, which shall be invalid when used without the Appendix.