

Test Report

Product	Bluetooth LE farm automation communication and control device		
Name and address of the applicant	DeLaval International AB P.O. Box 39 SE-14721 Tumba, Sweden		
Name and address of the manufacturer	DeLaval International AB P.O. Box 39 SE-14721 Tumba, Sweden		
Model	CCM215		
Rating	24 V DC (from AC/DC power supply 100-240 VAC 50-60 Hz)		
Trademark	DeLaval		
Serial number	/		
Additional information	Bluetooth Low Energy		
Tested according to	FCC Part 15.247 Frequency Hopping Transmitters / Digital Transmission Systems Industry Canada RSS-247, Issue 2 Low Power Licence-Exempt Radiocommunications Devices		
Order number	350858		
Tested in period	2018.06.25 to 2018.07.09		
Issue date	2019.09.19		
Name and address of the testing laboratory	 Instituttveien 6 Kjeller, Norway www.nemko.com	CAB Number: FCC: NO0001 ISED: NO0470 TEL: +47 22 96 03 30 FAX: +47 22 96 05 50	  An accredited technical test executed under the Norwegian accreditation scheme
	 Prepared by [Frode Sveisen]	 Approved by [G.Suhanthakumar]	
This report shall not be reproduced except in full without the written approval of Nemko. Opinions and interpretations expressed within this report are not part of the current accreditation. This report was originally distributed electronically with digital signatures. For more information contact Nemko.			

CONTENTS

1	INFORMATION	3
1.1	Test Item	3
1.2	Normal test condition	3
1.3	Test Engineer(s)	4
1.4	Antenna Requirement	4
1.5	Test Configuration	4
1.6	Comments	4
2	TEST REPORT SUMMARY	5
2.1	General	5
2.2	Test Summary	6
3	TEST RESULTS.....	7
3.1	Power Line Conducted Emissions	7
3.2	Occupied Bandwidth (99% BW)	8
3.3	DTS Bandwidth.....	11
3.4	Peak Output Power.....	14
3.5	Conducted Emissions at Antenna Connector.....	18
3.6	Restricted Bands of operation.....	25
3.7	Radiated Emissions, Band Edge.....	26
3.8	Radiated Emissions, 30 – 1000 MHz	28
3.9	Radiated Emissions, 1 – 25 GHz	30
3.10	Power Spectral Density (PSD).....	42
4	Measurement Uncertainty	45
5	LIST OF TEST EQUIPMENT	46
6	BLOCK DIAGRAM	47
6.1	Power Line Conducted Emission	47
6.2	Conducted Tests.....	47
6.3	Test Site Radiated Emission.....	48

1 INFORMATION

1.1 Test Item

Name	DeLaval
FCC ID	UCSCCM215
Industry Canada ID	/
Model/version	CCM215
Serial number	/
Hardware identity and/or version	CCM215 PCBA; 89064582
Software identity and/or version	Thor EMC test SW suite
Frequency Range	2402 – 2480 MHz
Number of Channels	40
Type of Modulation	Digital (GFSK)
User Frequency Adjustment	None
Rated Output Power	0.002 Watts (Conducted)
Type of Power Supply	External DC Supply
Antenna Connector	None
Number of Antennas	1
Antenna Diversity Supported	N/A
Desktop Charger	N/A

Description of Test Item

The CCM215 is one of several units in a family of DeLaval modular farm automation control devices used in milking systems.

1.2 Normal test condition

Temperature:	20 - 24 °C
Relative humidity:	20 - 50 %
Normal test voltage:	24 V _{DC}

The values are the limit registered during the test period.

1.3 Test Engineer(s)

Frode Sveinsen

1.4 Antenna Requirement

Is the antenna detachable? Yes No

If detachable, is the antenna connector non-standard? Yes No

Type of antenna connector: N/A

Ref. FCC §15.203

1.5 Test Configuration

All tests except Power-Line Conducted tests, were performed with the EUT in stand-alone mode and with the EUT powered from a regulated external power supply. The EUT was programmed from Linux Computer that was used to send commands over the Ethernet Interface.

Power-Line Conducted tests were performed with the EUT connected to a test-wall together with other units as shown below.

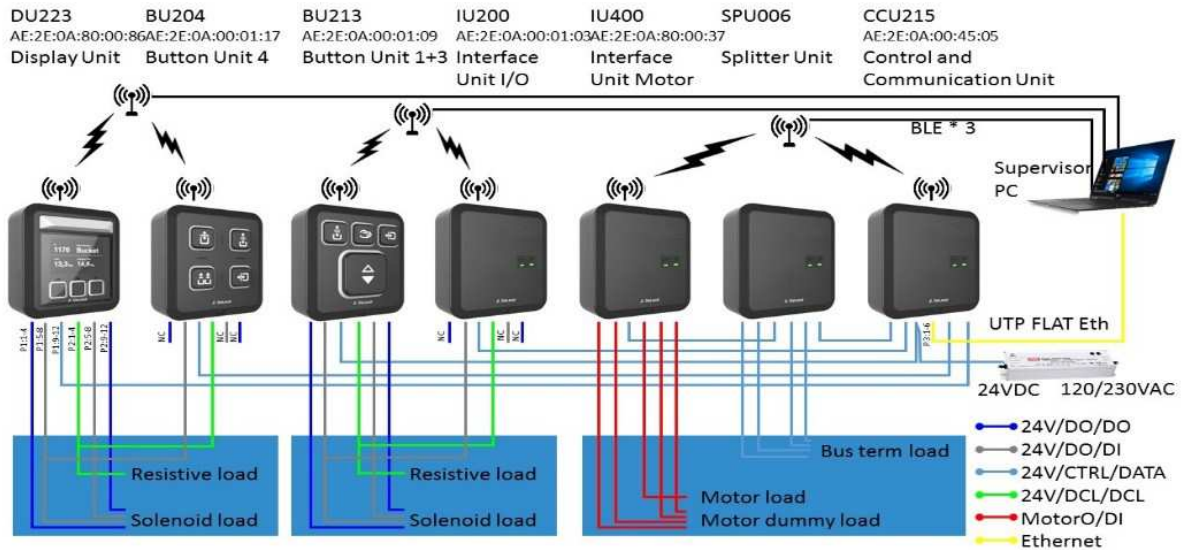

1.6 Comments

All measurements except Power-Line Conducted tests, were performed with the EUT powered by 24 V_{DC} and it was checked that power variations between 85% and 115% did not have any influence on the measurements.

2 TEST REPORT SUMMARY

2.1 General

All measurements are traceable to national standards.

The tests were conducted for demonstrating compliance with FCC CFR 47 Part 15, paragraph 15.247 and Industry Canada RSS-GEN Issue 5 and RSS-247 Issue 2.

Tests were performed in accordance with ANSI C63.4-2014 and and ANSI C63.10-2013.

Radiated tests were made in a semi-anechoic chamber at measuring distances of 1m, 3m and 10m.

A description of the test facility is on file with the FCC and Industry Canada.

New Submission

Production Unit

Class II Permissive Change

Pre-production Unit

DTS Equipment Code

Family Listing



THIS TEST REPORT APPLIES ONLY TO THE ITEM(S) AND CONFIGURATIONS TESTED.

Deviations from, additions to, or exclusions from the test specifications are described in "Summary of Test Data".

Nemko Group authorizes above named company to reproduce this report provided it is reproduced in its entirety and for use by the company's employees only. Any reproduction of parts of this report requires approval in writing from Nemko Group.

Any use that a third party makes of this report, or any reliance on or decisions to be made based on it, are the responsibility of such third parties. Nemko Group accepts no responsibility for damages suffered by any third party because of decisions made or actions based on this report.

2.2 Test Summary

Name of test	FCC Part 15 Reference	RSS-247 Issue 2, RSS-GEN Issue 5 Reference	ANSI C63.10-2013 Reference	Result
Supply Voltage Variations	15.31(e)	6.11 (RSS-GEN)	5.13	Complies
Antenna Requirement	15.203	6.8 (RSS-GEN)	5.8	Complies
Power Line Conducted Emission	15.207(a)	8.8 (RSS-GEN)	6.2	Complies
Occupied Bandwidth (99% BW)	N/A	6.7 (RSS-GEN)	6.9.3	Complies
DTS Bandwidth	15.247(a)(2)	5.2 a)	11.8 Option 2	Complies
Peak Power Output	15.247(b)	5.4 b)	11.9.1.1	Complies
Power Spectral Density	15.247(c)	5.2 b)	11.10.2 PKPSD	Complies
Spurious Emissions (Conducted)	15.247(d)	5.5	11.11	Complies
Spurious Emissions (Radiated)	15.247(c) 15.209(a)	6.13 (RSS-GEN) 8.9 (RSS-GEN)	6.3, 6.5, 6.6, 6.10 11.12, 11.13	Complies

Revision history

Version	Date	Comment	Sign
1.0	2019.09.19	First Edition	FS

3 TEST RESULTS

3.1 Power Line Conducted Emissions

FCC Part 15.207 (a)

ISED Canada RSS-Gen Issue 5, Clause 8.8

Measurement procedure: ANSI C63.4-2014 using 50 μ H/50 ohms LISN

Test Results: Complies

Measurement Data: See attached plot, (Peak detector)

Highest measured value (L1 and N): No frequencies recorded

120V 60Hz:

Full Spectrum

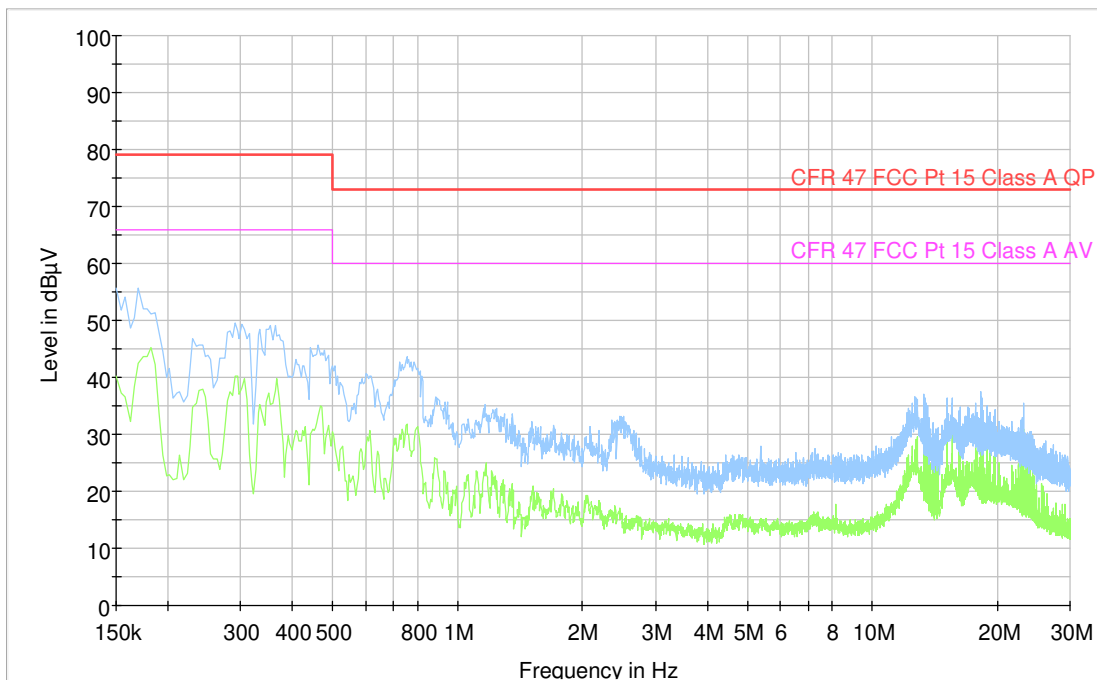

3.2 Occupied Bandwidth (99% BW)

RSS-GEN Issue 5, Clause 6.7

Test Results: **Complies**

Measurement Data:

Carrier Frequency	Occupied Bandwidth (99% BW)
2402 MHz	1.05 MHz
2440 MHz	1.05 MHz
2480 MHz	1.05 MHz

See attached plots.

Requirements:

No limit specified.

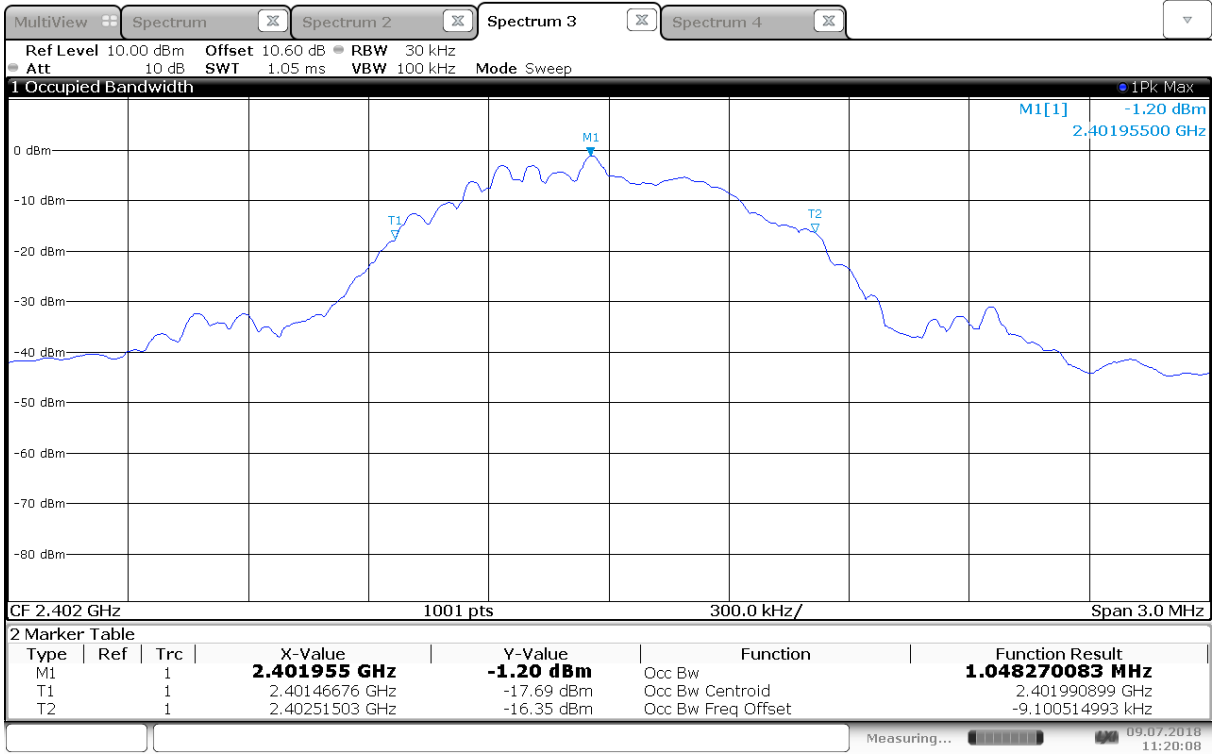

Occupied Bandwidth, 99%, 2402 MHz

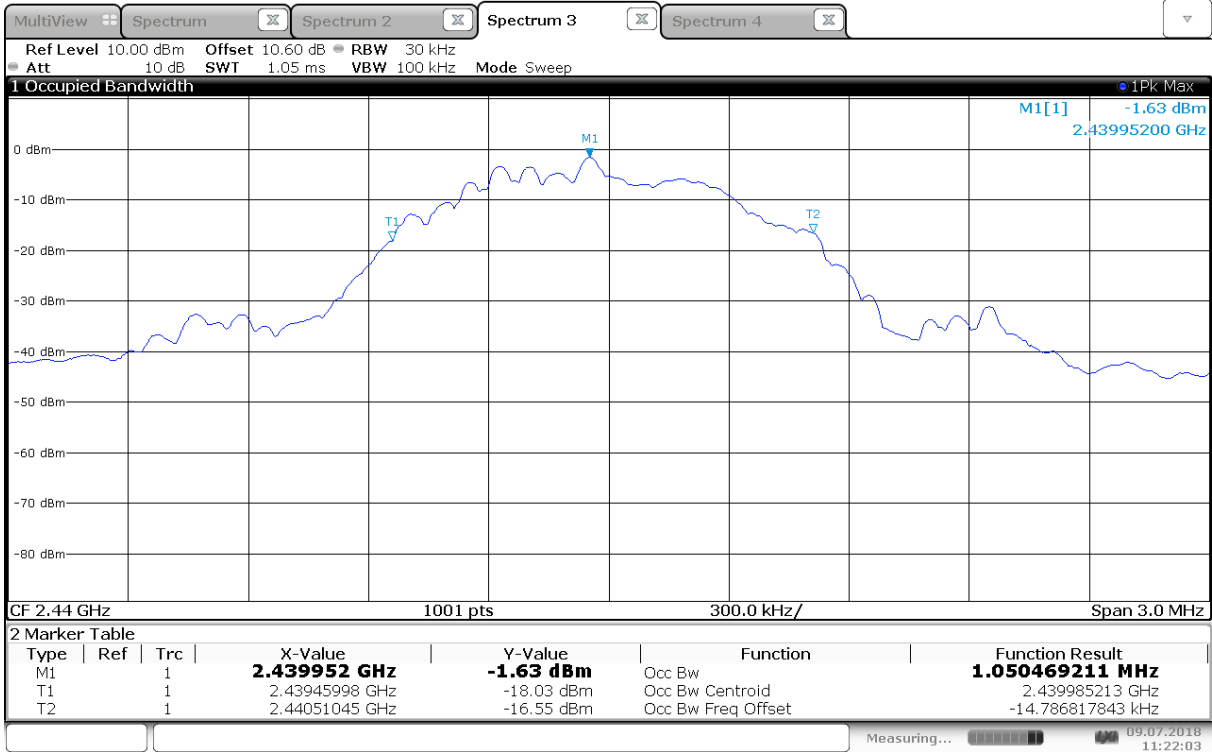

Occupied Bandwidth, 99%, 2440 MHz

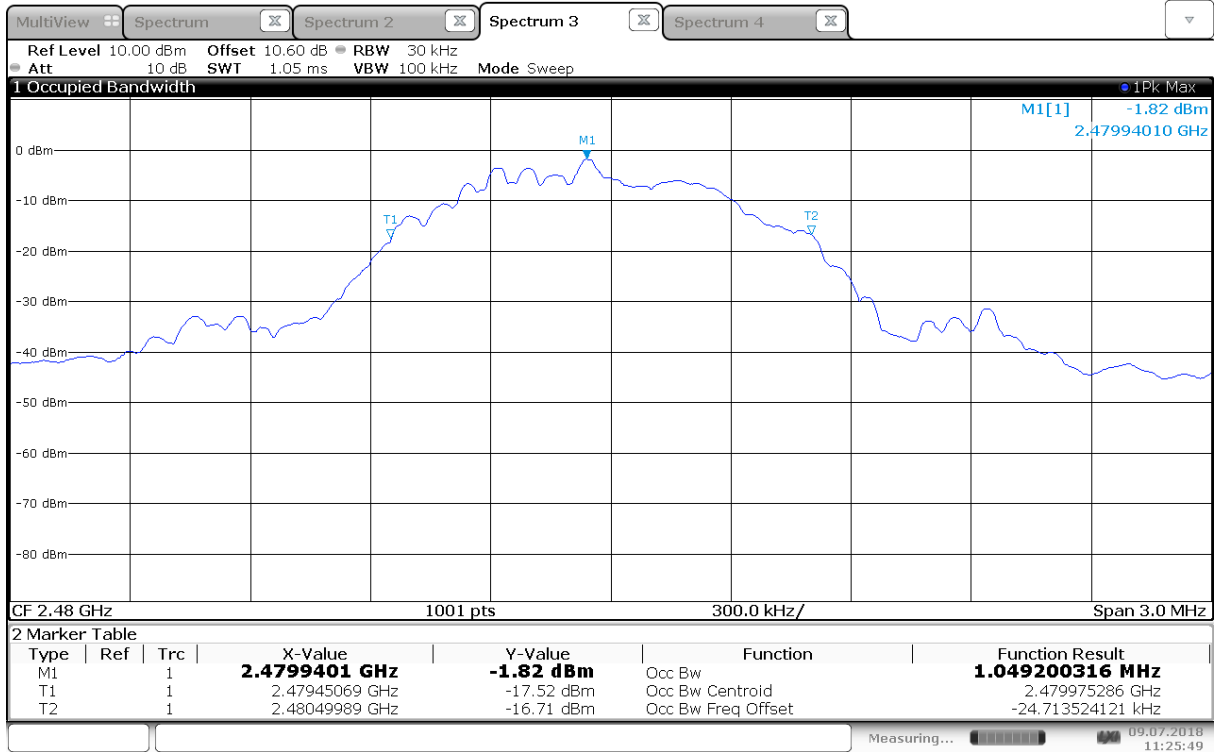

Occupied Bandwidth, 99%, 2480 MHz

3.3 DTS Bandwidth

FCC Part 15.247 (a)(2)

ISED Canada RSS-247 Issue 2, Clause 5.2 (a)

Test Results: Complies

Measurement Data:

Modulation type and bitrate	Measured DTS Bandwidth
2402 MHz	707 kHz
2440 MHz	717 kHz
2480 MHz	721 kHz

Requirements:

For Digital Transmission Systems in the 2400–2483.5 MHz band the minimum 6 dB bandwidth shall be at least 500 kHz.

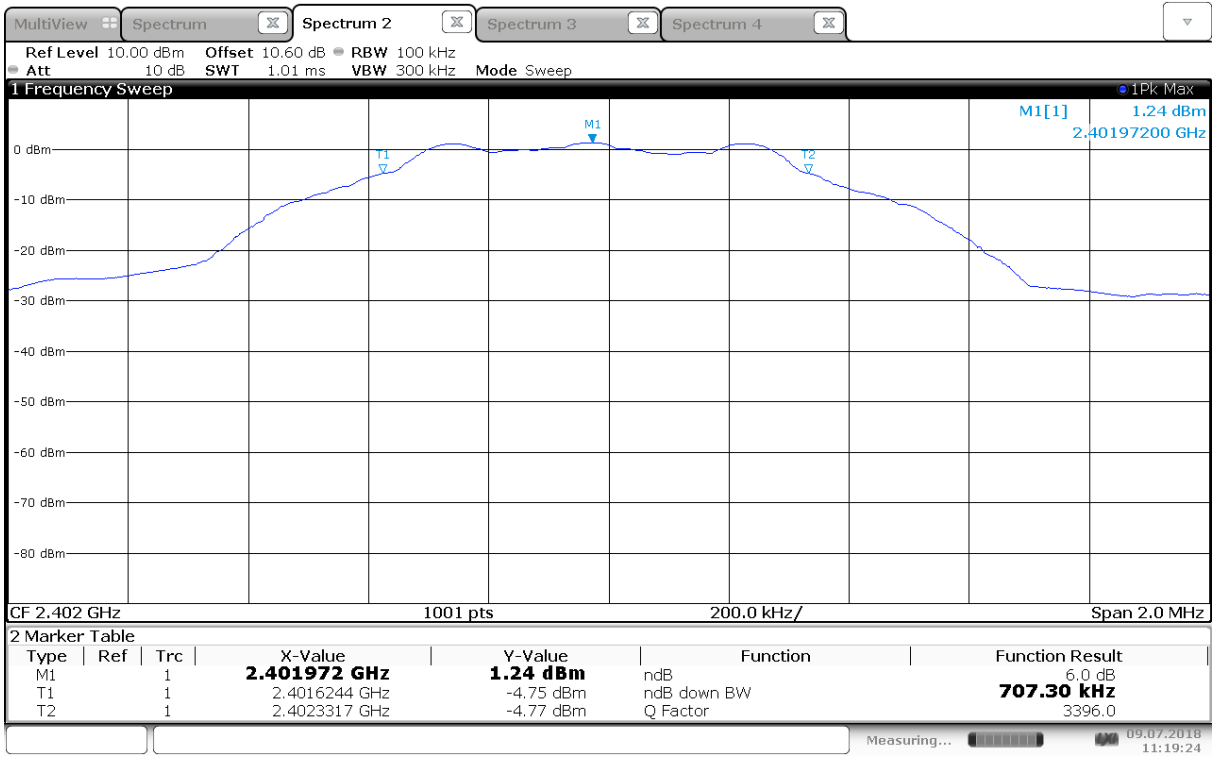

DTS Bandwidth, 2402 MHz

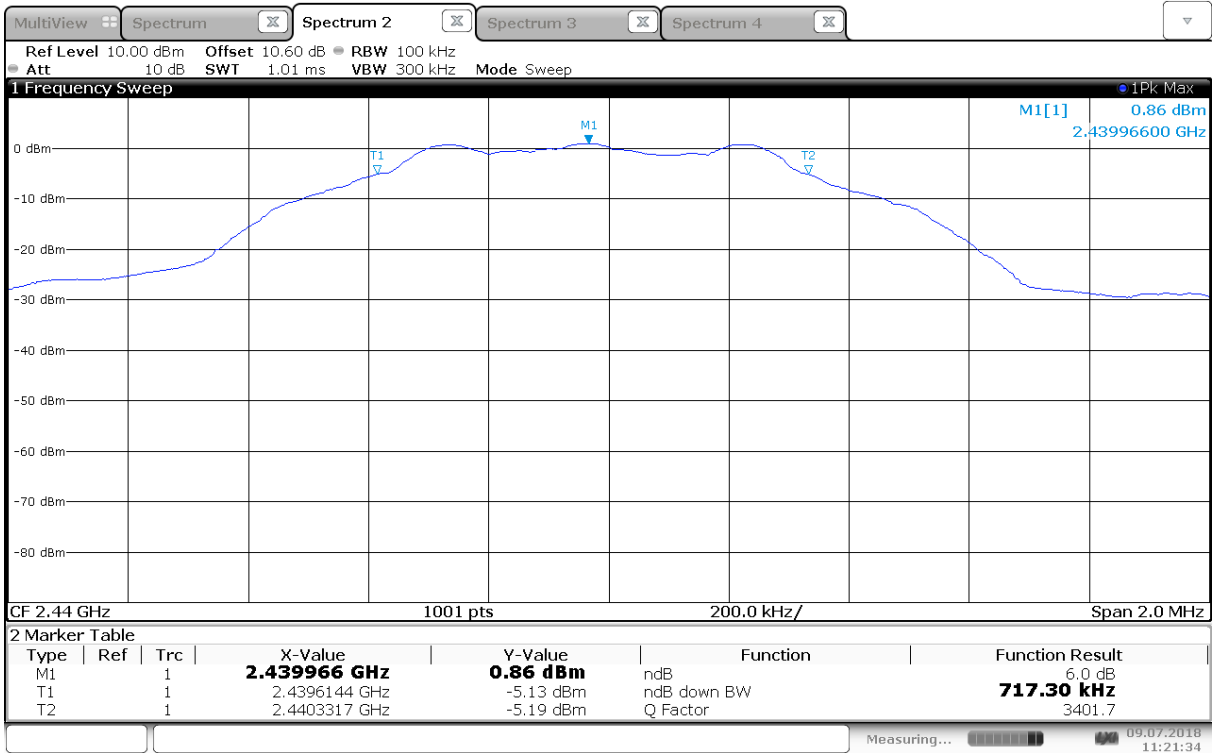

DTS Bandwidth, 2440 MHz

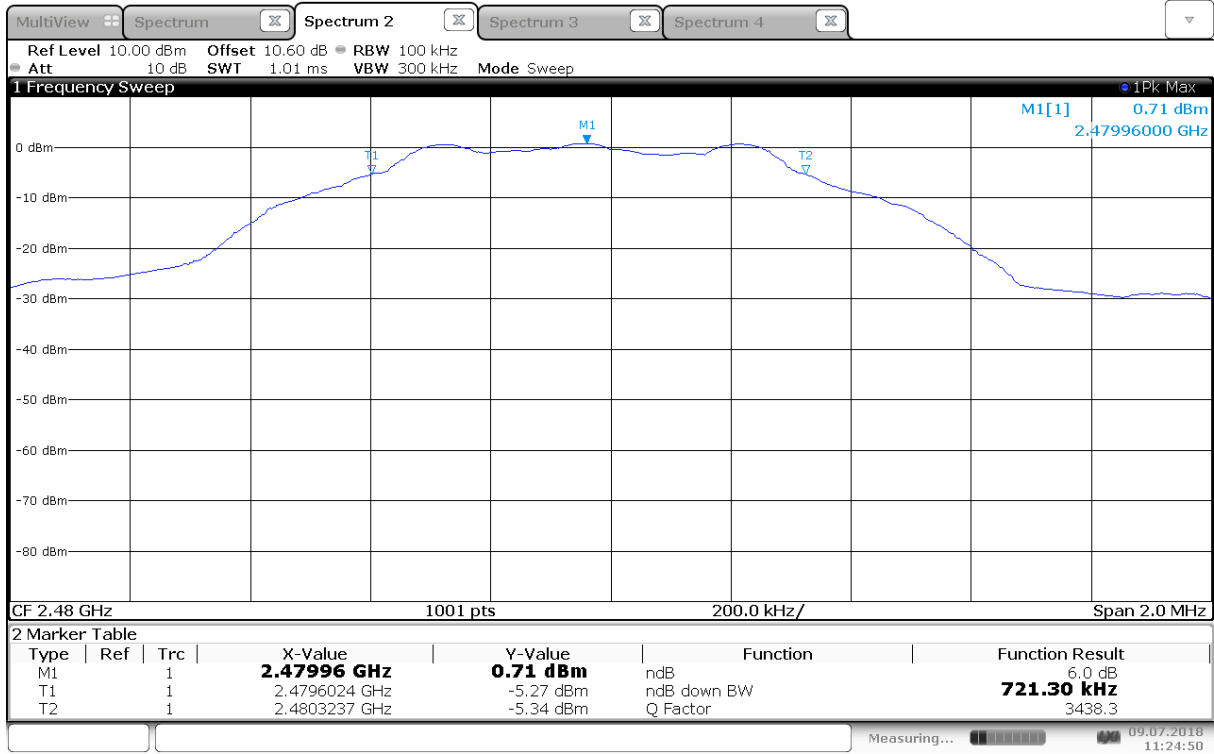

DTS Bandwidth, 2480 MHz

3.4 Peak Output Power

FCC 15.247 (b)

ISED Canada RSS-247 Issue 2, Clause 5.4 (d)

Test Results: Complies

Measurement Data:

Maximum Peak Power			
	2402 MHz	2440 MHz	2480 MHz
Peak Power (dBm)	2.02	1.58	1.44
Peak Power (mW)	1.59	1.44	1.39
Field Strength (dB μ V/m)	91.71	94.52	92.33
EIRP, Calculated (mW)	0.44	0.85	0.51
Antenna Gain (dBi)	-5.5	-2.3	-4.3

EIRP is calculated from measured field strength by the method in KDB 412172 D01.

See attached plots.

Requirements:

The maximum peak output power shall not exceed the following limits:

For Digital Transmission Systems in the 2400–2483.5 MHz band: 1 Watt

If transmitting antennas of directional gain greater than 6 dBi are used, the peak output power from the intentional radiator shall be reduced below the stated value above by the amount in dB that the directional gain of the antenna exceeds 6 dBi.

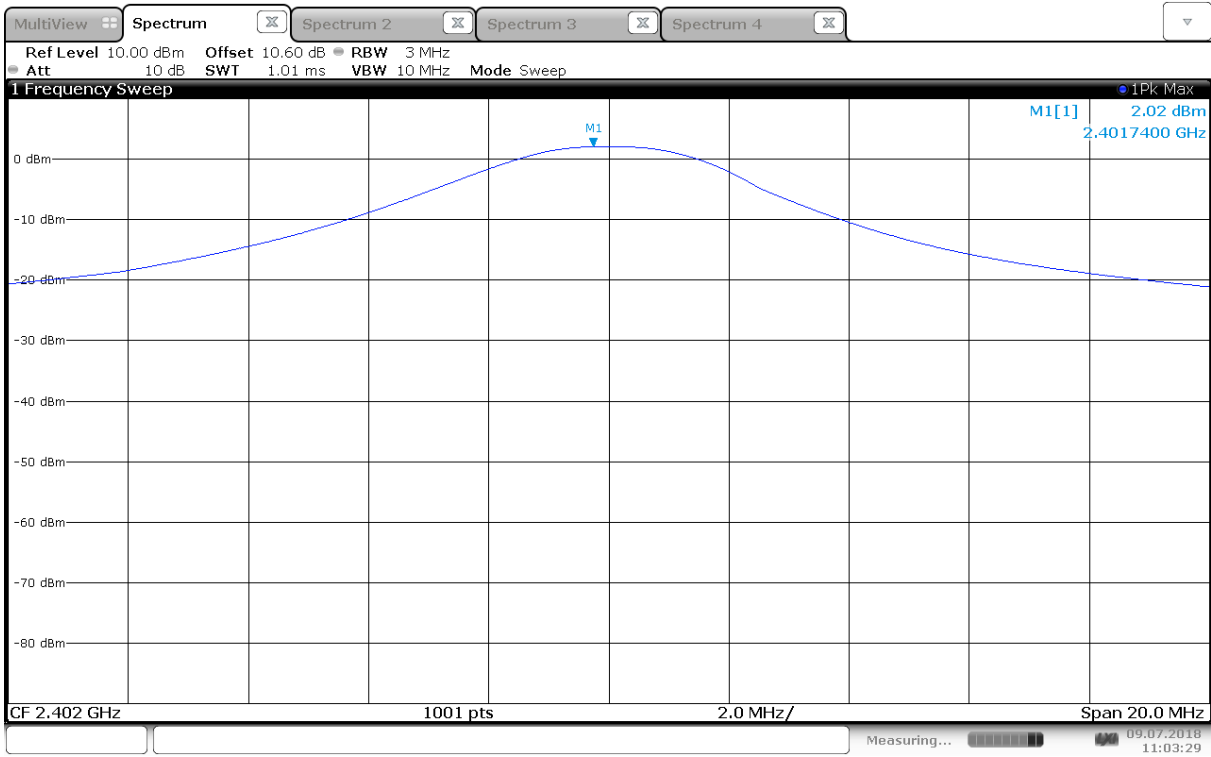

Conducted Output Power, 2402 MHz

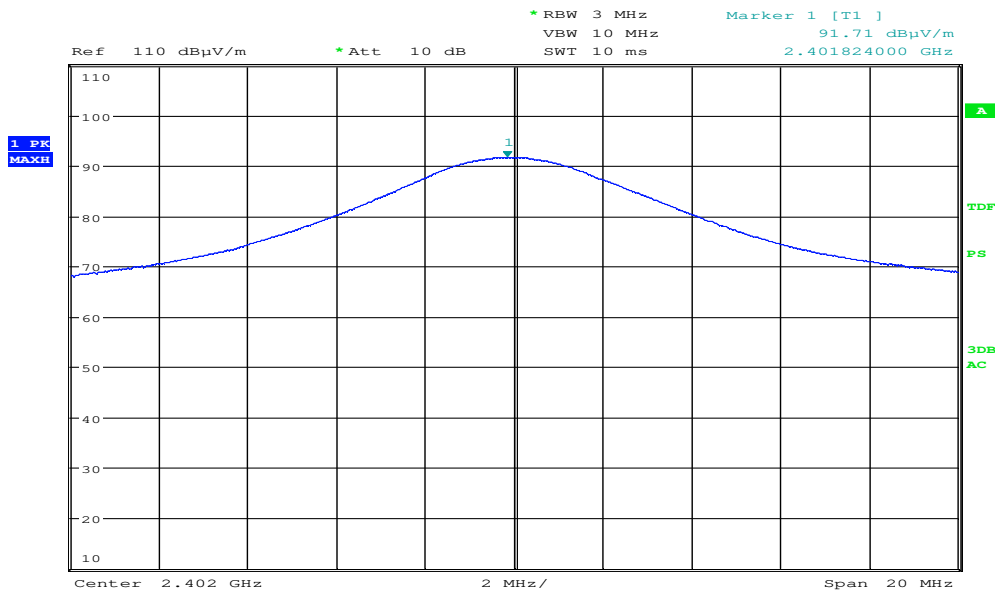

Date: 25.JUN.2018 16:43:41

Radiated Power, 2402 MHz (Max: HP, 102deg, 387cm)

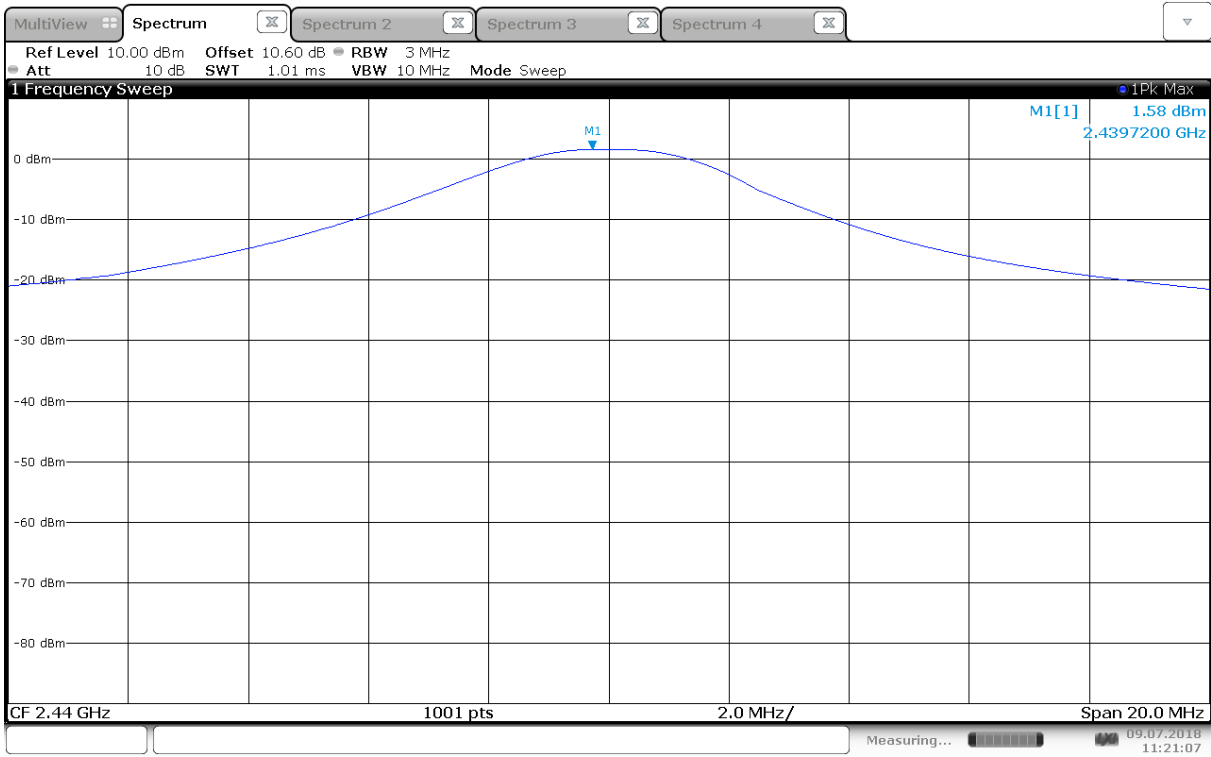

Conducted Output Power, 2440 MHz

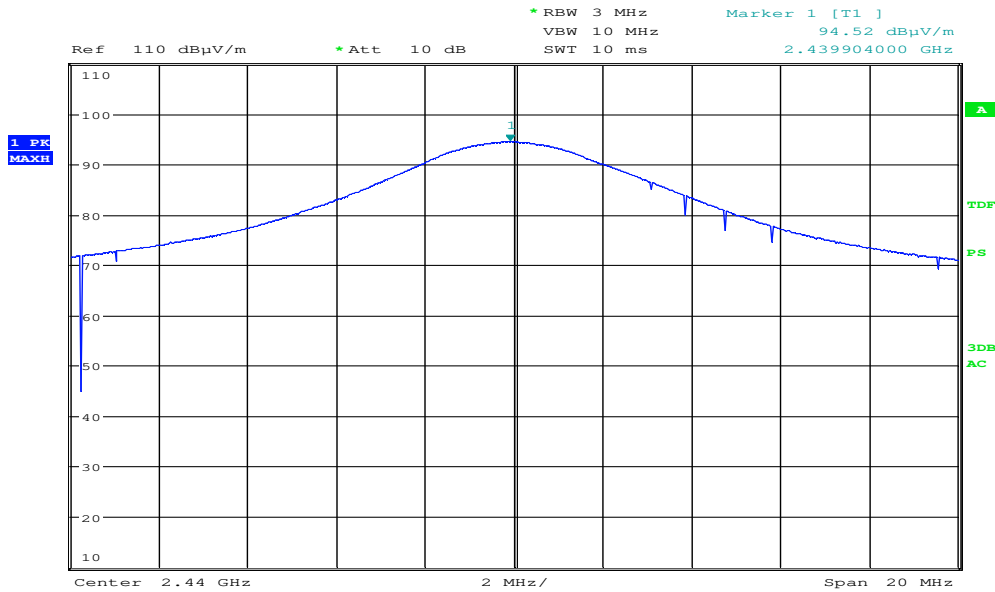

Date: 25.JUN.2018 16:42:13

Radiated Power, 2440 MHz (Max: HP, 102deg, 387cm)

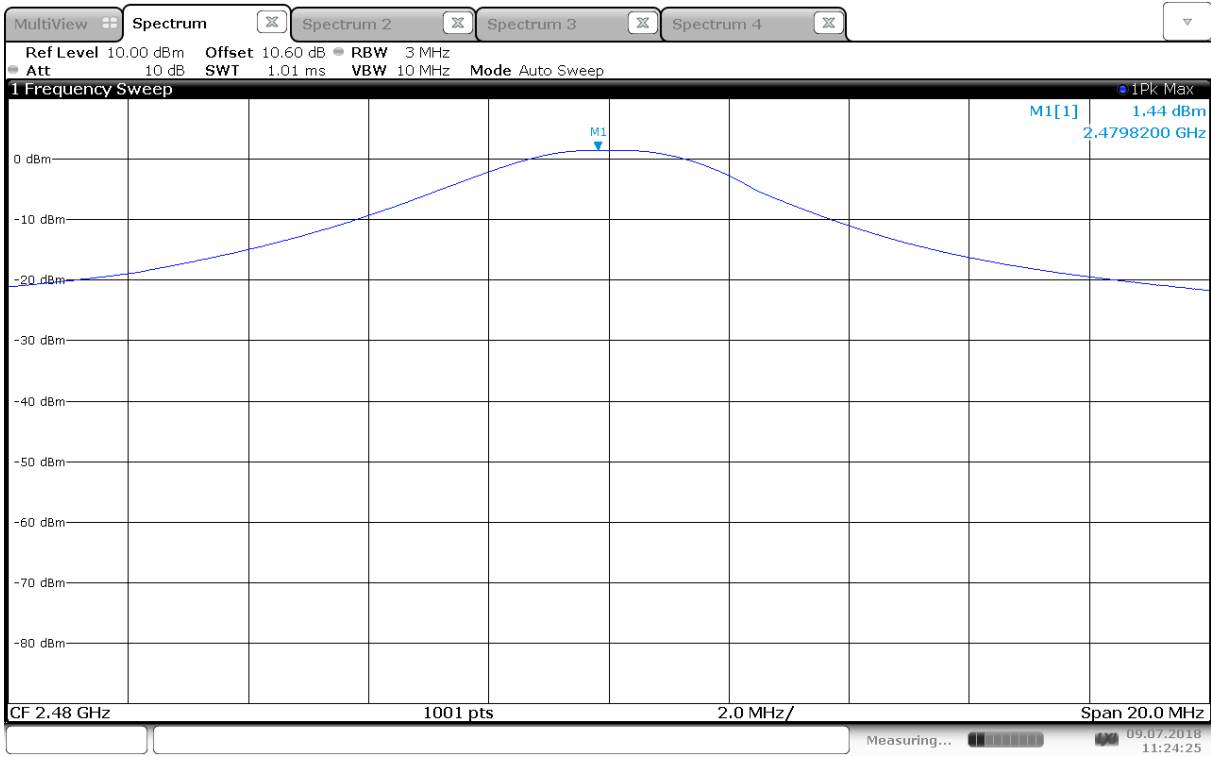

Conducted Output Power, 2480 MHz

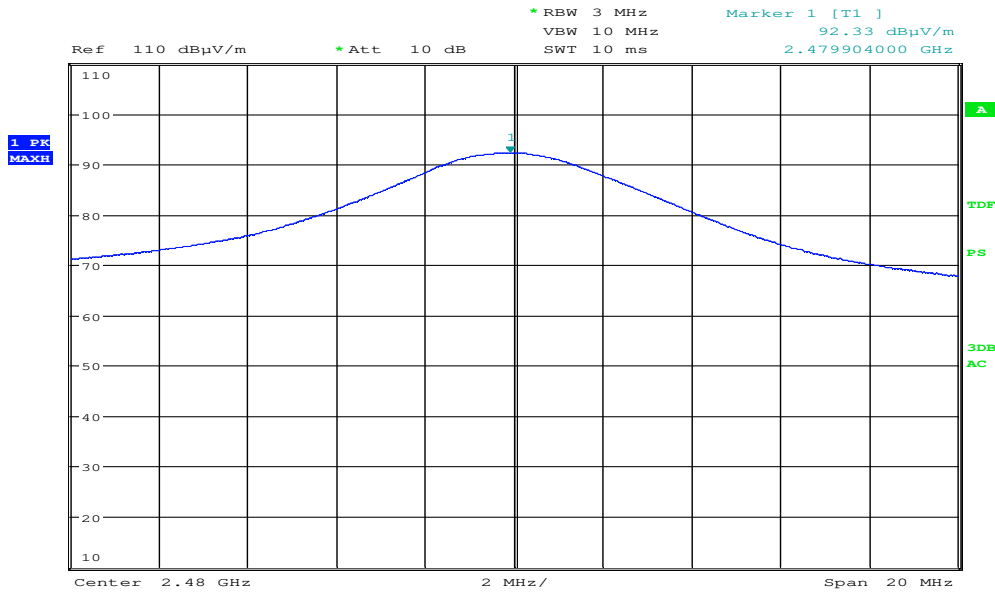

Date: 25.JUN.2018 16:50:38

Radiated Power, 2480 MHz (Max: HP, 102deg, 387cm)

3.5 Conducted Emissions at Antenna Connector

FCC Part 15.247 (d)

RSS-247 Issue 2, Clause 5.5

Test Results: Complies

Measurement Data:

Carrier Frequency	Highest Value (dBc)	Margin (dB)	Verdict
All	> 30	> 10	Pass

Measured with Peak Detector

Out-of-Band emissions were measured with the EUT transmitting at 4 frequencies, 2402, 2440 and 2480 MHz.

RF conducted power to 25 GHz: see attached plots.

Limit

Peak measurement	RMS averaging
20 dBc or more in 100 kHz bandwidth	30 dBc or more in 100 kHz bandwidth

Detector type shall be the same as used for measuring Output Power.

Attenuation below the general limits specified in part 15.209(a) and RSS-GEN Issue 5, clause 8.9, is not required.

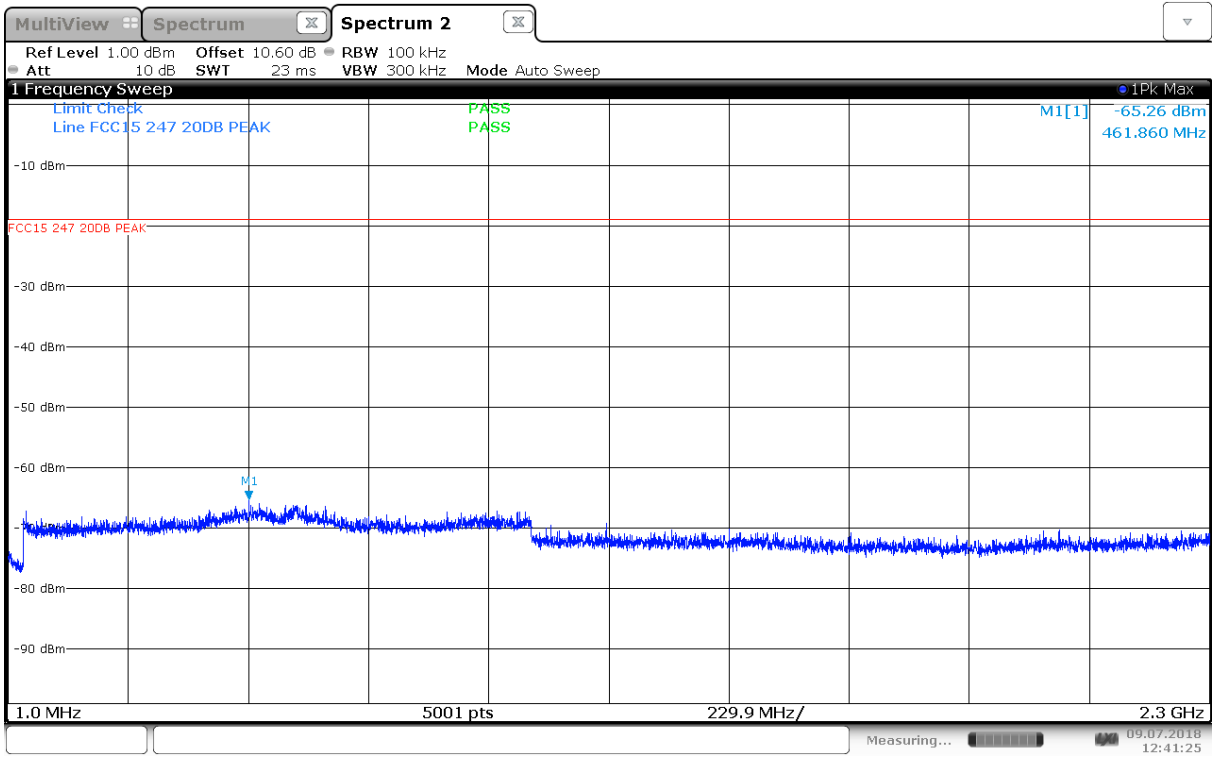

Conducted Emissions, 1 – 2300 MHz, 2402 MHz

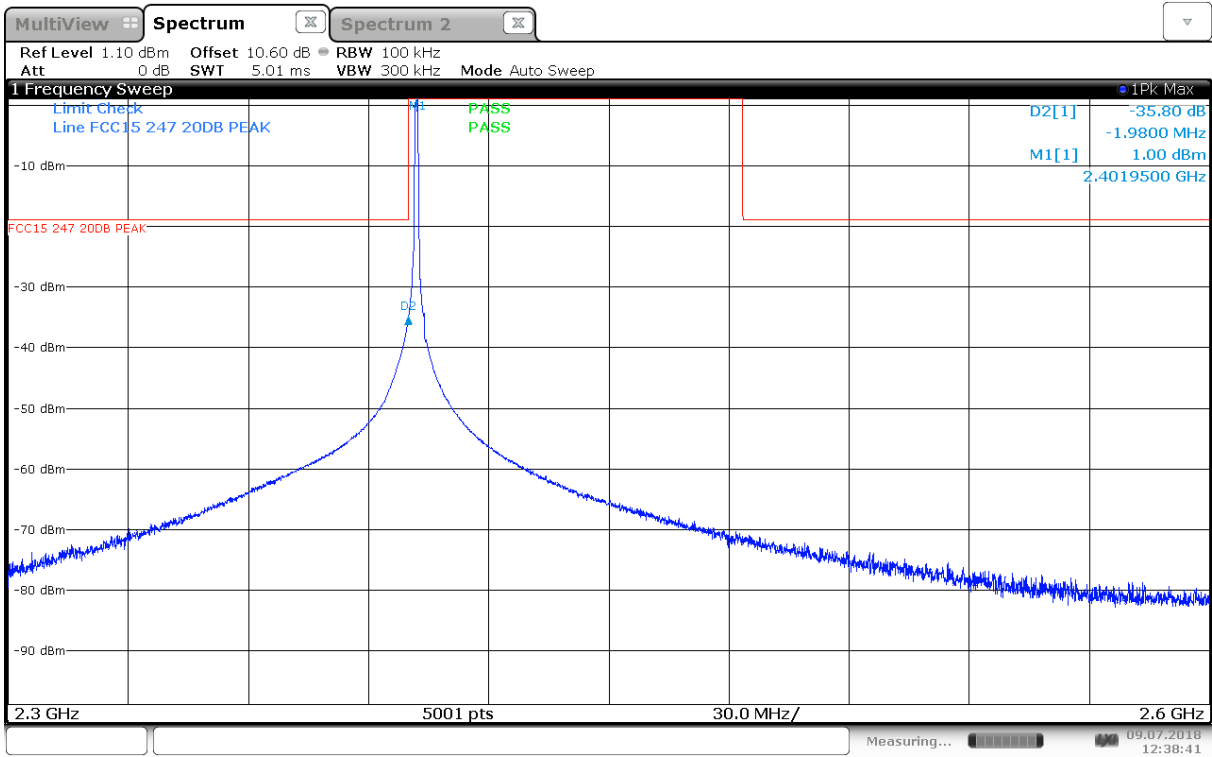

Conducted Emissions, 2300 – 2600 MHz, 2402 MHz

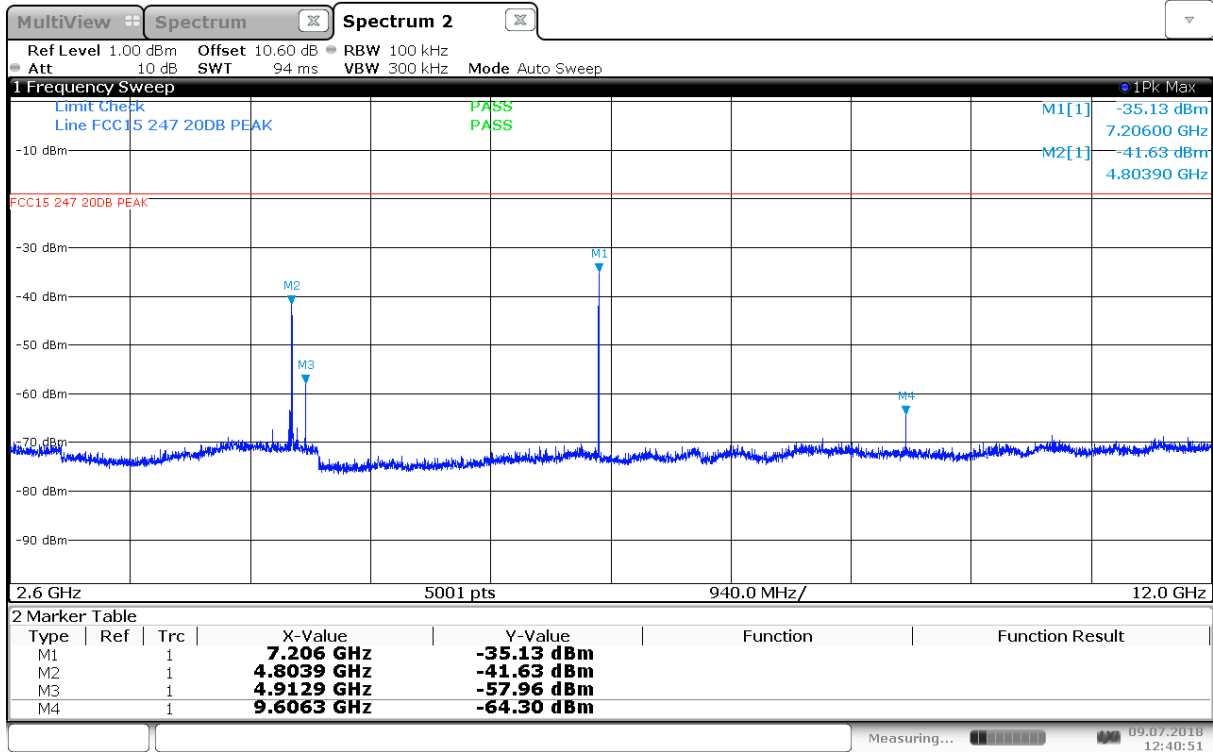

Conducted Emissions, 2600 – 12000 MHz, 2402 MHz

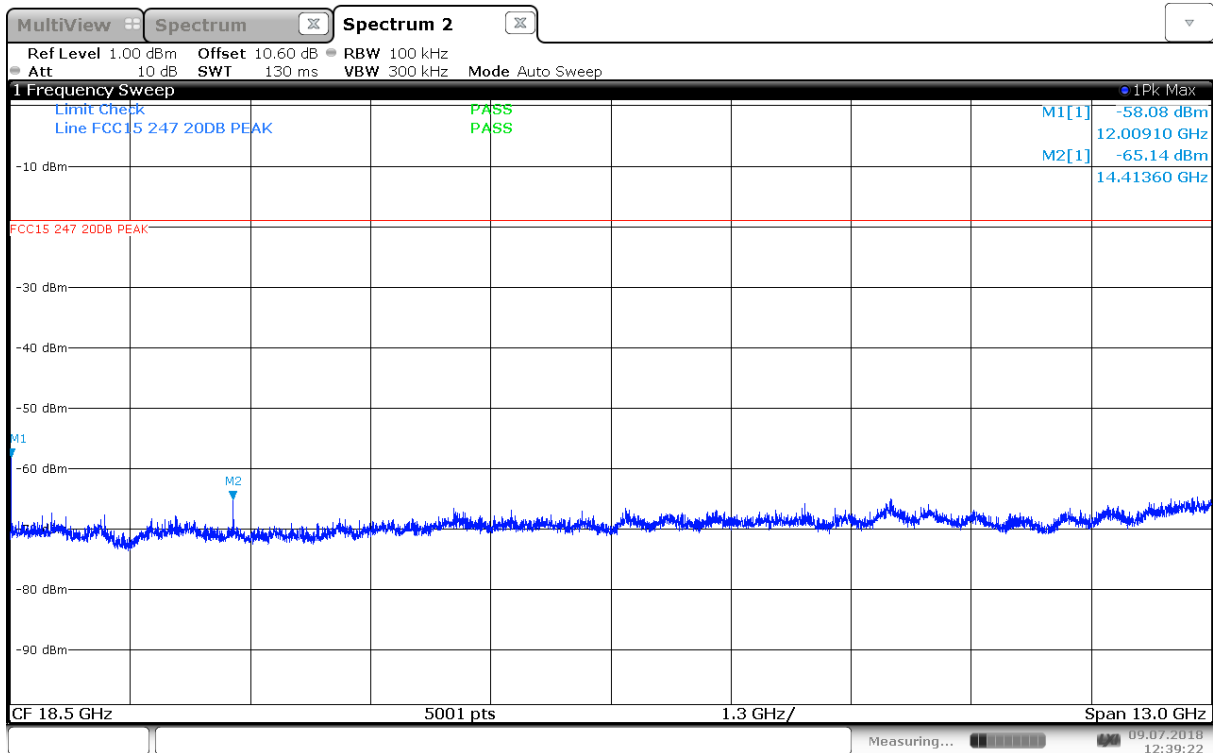

Conducted Emissions, 12000 – 25000 MHz, 2402 MHz

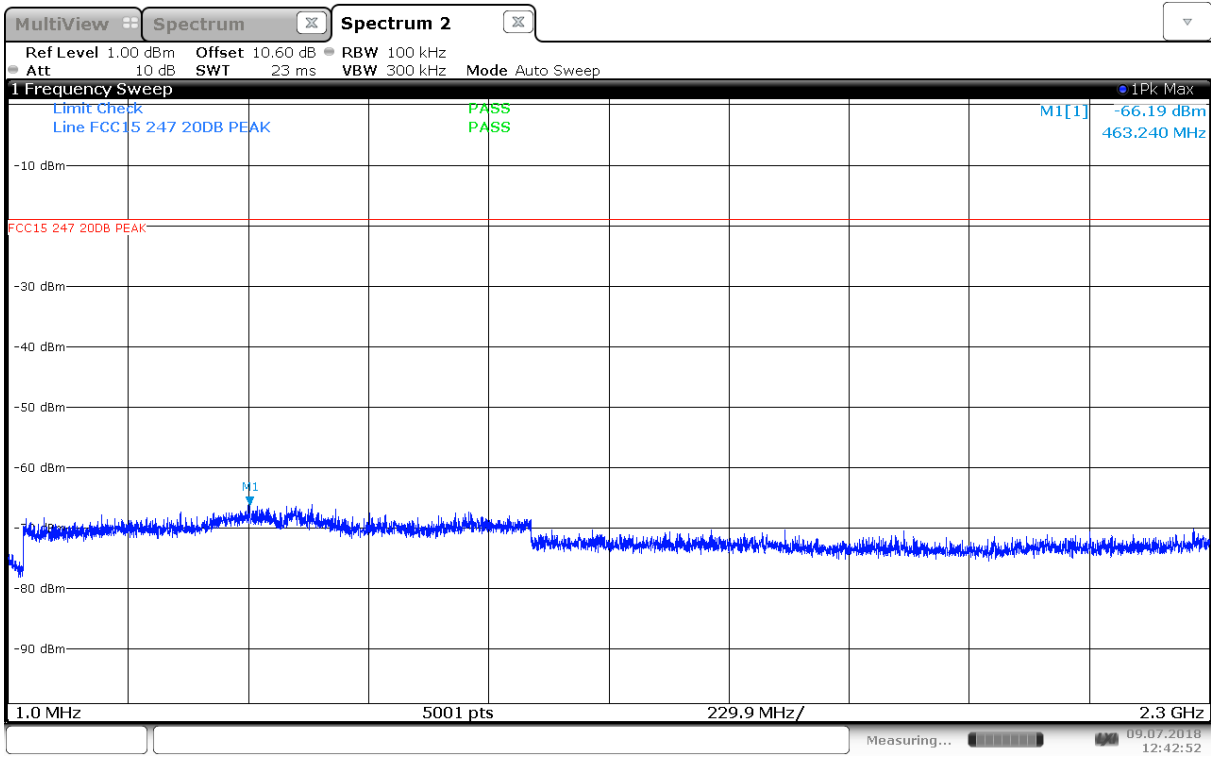

Conducted Emissions, 1 – 2300 MHz, 2440 MHz

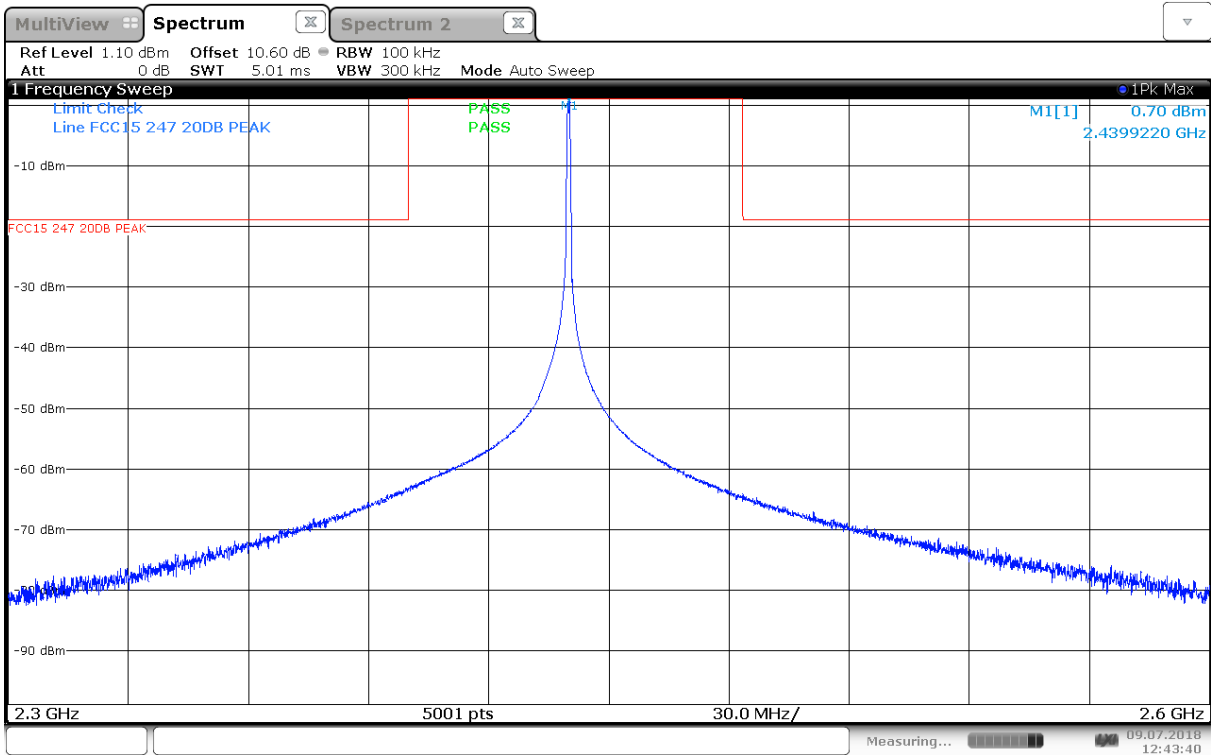

Conducted Emissions, 2300 – 2600 MHz, 2440 MHz

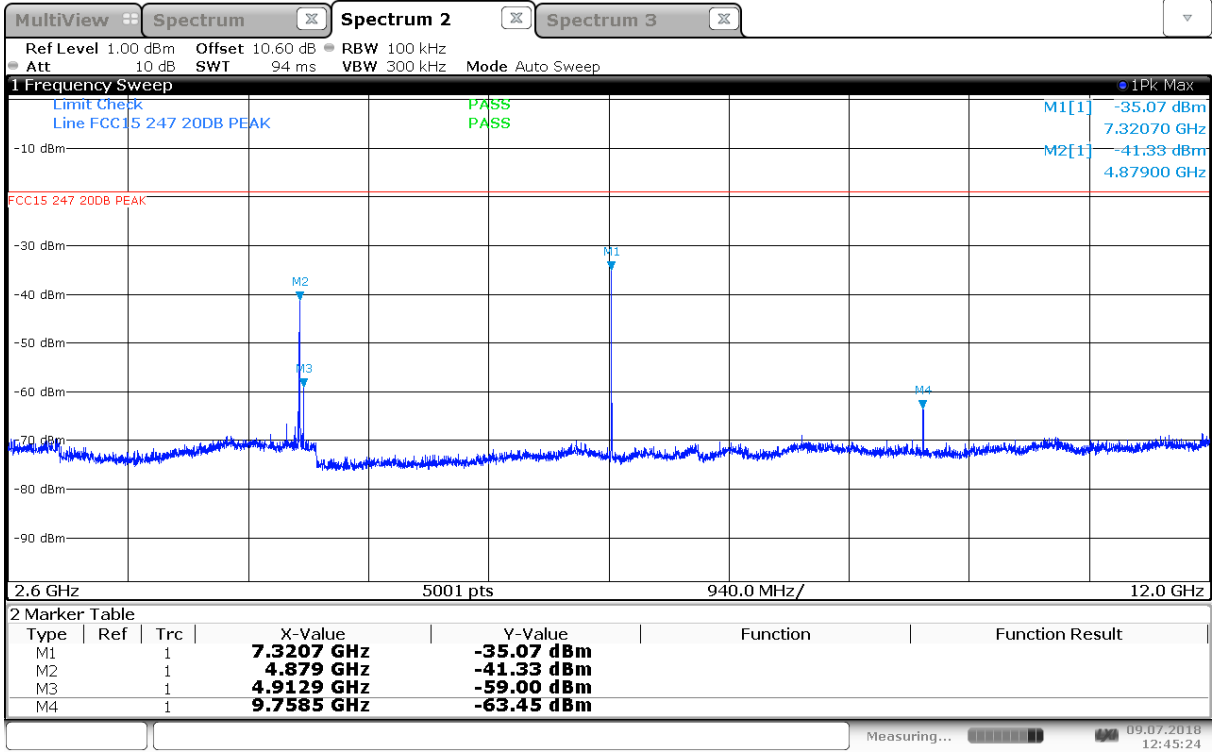

Conducted Emissions, 2600 – 12000 MHz, 2440 MHz

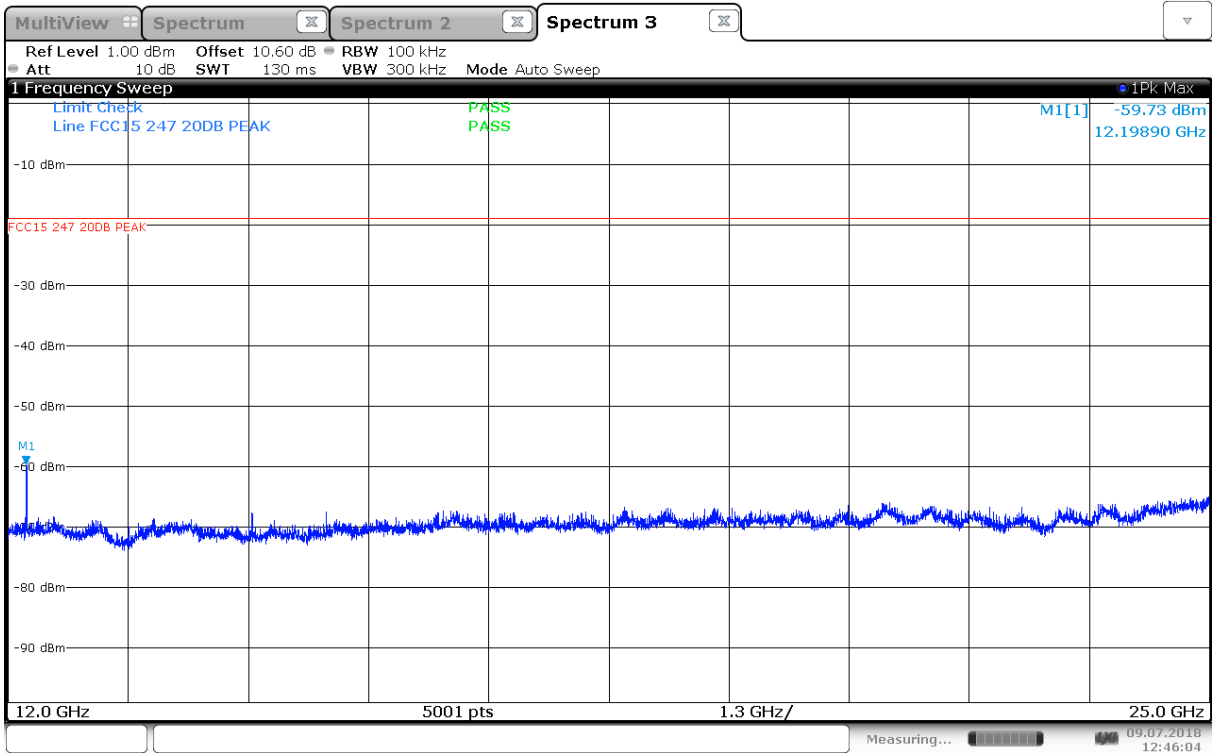

Conducted Emissions, 12000 – 25000 MHz, 2440 MHz

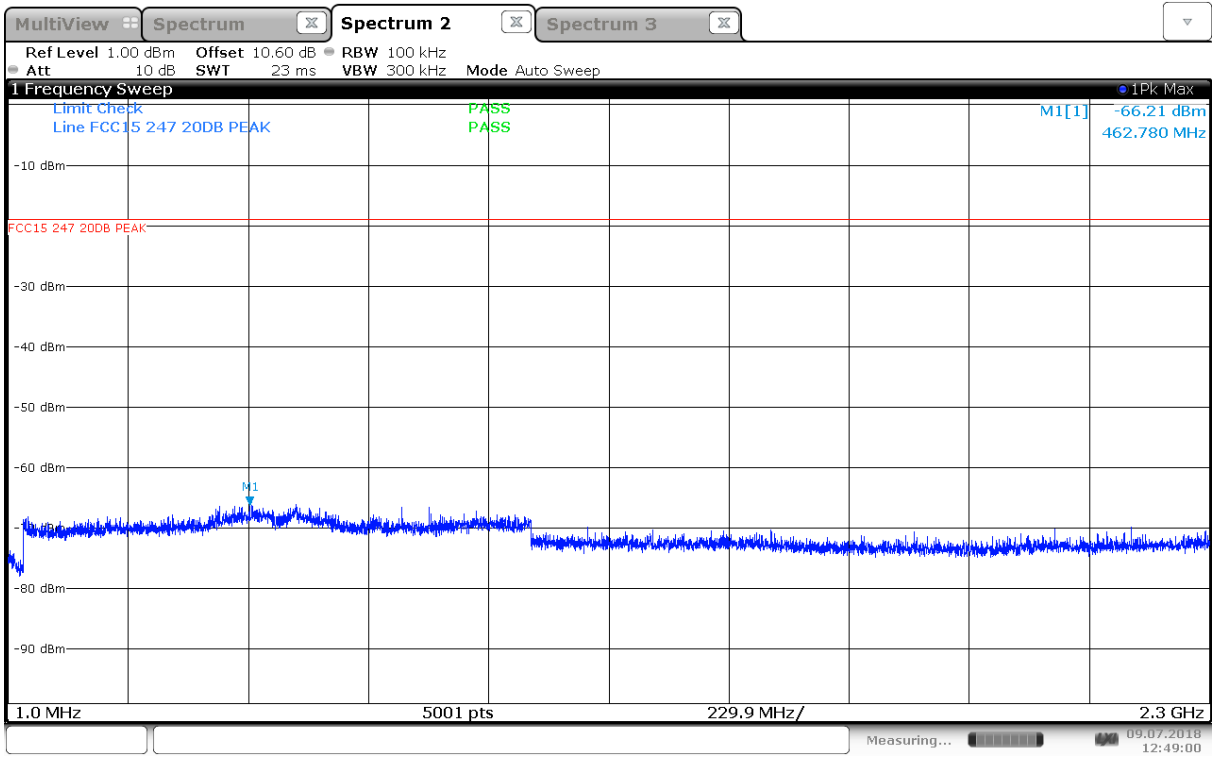

Conducted Emissions, 1 – 2300 MHz, 2480 MHz

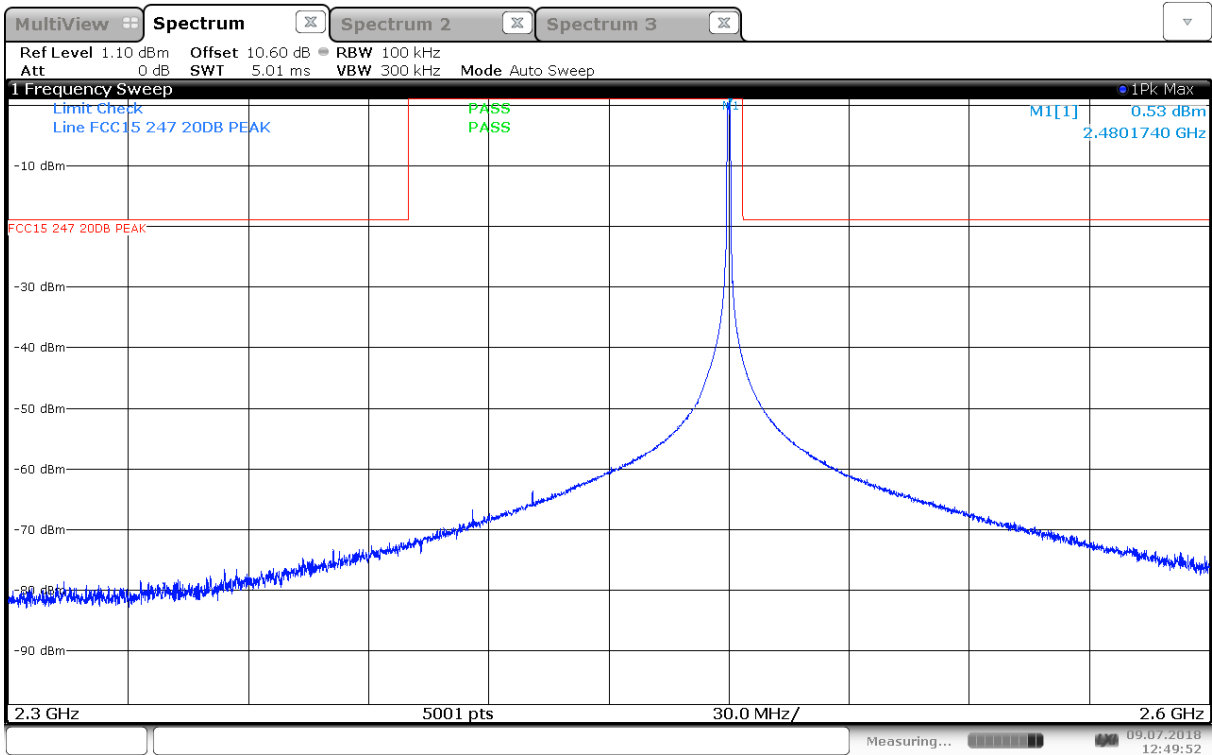

Conducted Emissions, 2300 – 2600 MHz, 2480 MHz

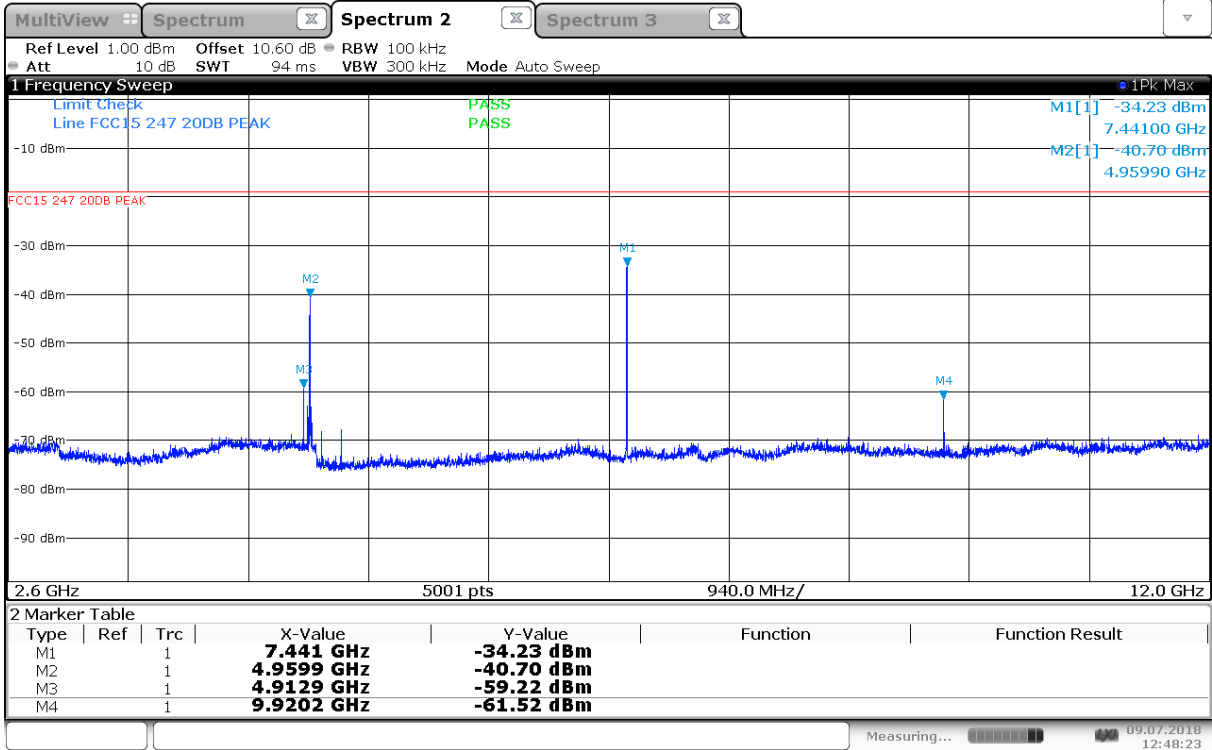

Conducted Emissions, 2600 – 12000 MHz, 2480 MHz

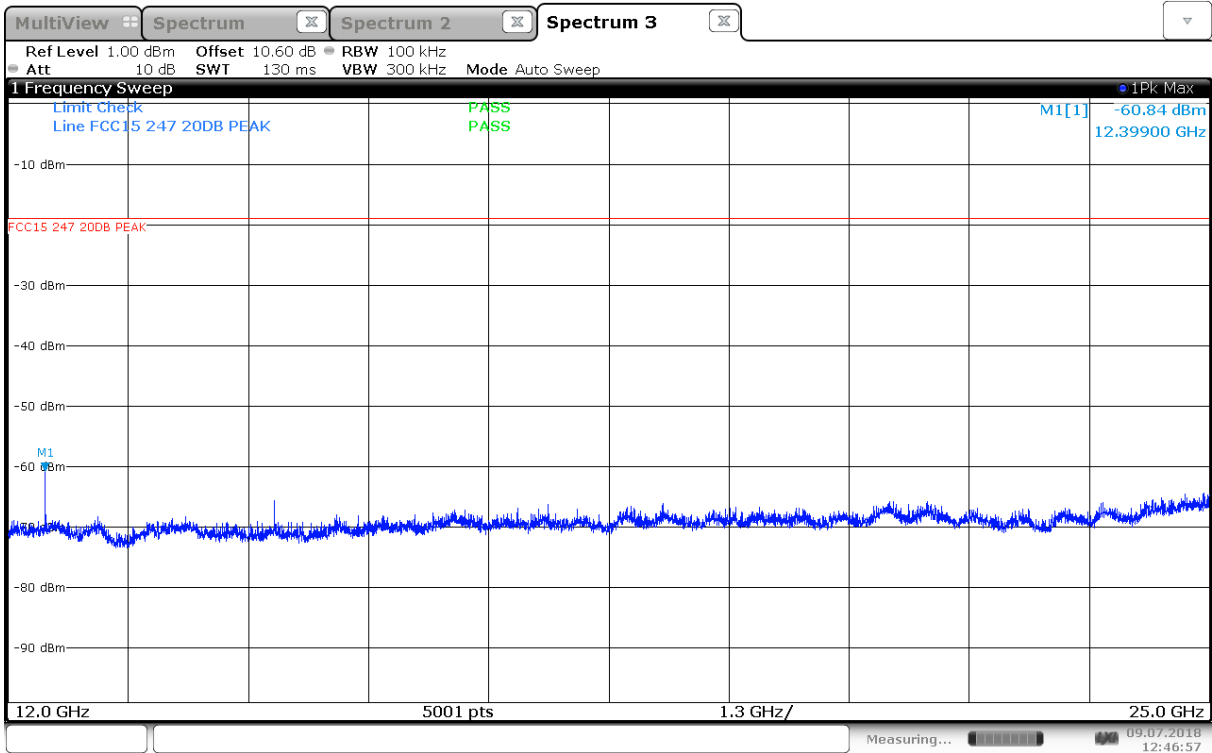

Conducted Emissions, 12000 – 25000 MHz, 2480 MHz

3.6 Restricted Bands of operation

Restricted Bands of operation for FCC and ISED are defined in FCC Part 15.205 and ISED RSS-GEN, Issue 5 clause 8.10.

Generally, no fundamentals are allowed in the restricted bands and all emissions must comply with the limits in FCC 15.209 or RSS-GEN, Issue 5, clause 8.9.

FCC (MHz)	ISED (MHz)	FCC (GHz)	ISED (GHz)
0.090-0.110		0.96-1.24 1.3-1.427	0.96-1.427
0.495-0.505			1.435-1.6265
2.1735-2.1905			1.6455-1.6465
N/A	3.020-3.026		1.660-1.710
4.125-4.128			1.7188-1.7222
4.17725-4.17775			2.2-2.3
4.20725-4.20775			2.31-2.39
N/A	5.677-5.683		2.4835-2.5
6.215-6.218		2.69-2.9	2.655-2.9
6.26775-6.26825			3.26-3.267
6.31175-6.31225			3.332-3.339
8.291-8.294			3.3458-3.358
8.362-8.366		3.6-4.4	3.5-4.4
8.37625-8.38675			4.5-5.15
8.41425-8.41475			5.35-5.46
12.29-12.293			7.25-7.75
12.51975-12.52025			8.025-8.5
12.57675-12.57725			9.0-9.2
13.36-13.41			9.3-9.5
16.42-16.423			10.6-12.7
16.69475-16.69525			13.25-13.4
16.80425-16.80475			14.47-14.5
25.5-25.67			15.35-16.2
37.5-38.25			17.7-21.4
73-74.6			22.01-23.12
74.8-75.2			23.6-24.0
108-121.94 123-138	108-138		31.2-31.8
149.9-150.05			36.43-36.5
156.52475-156.52525			Above 38.6
156.7-156.9			
162.0125-167.17			
167.72-173.2			
240-285			
322-335.4			
399.9-410			
608-614			

3.7 Radiated Emissions, Band Edge

FCC Part 15.209

ISED Canada RSS-GEN Issue 5, Clause 8.9

Test Results: Complies

Measurement Data:

	Measured field strength (dB μ V/m)		Limit (dB μ V/m)	Margin (dB)	
	2390 MHz	2483.5 MHz			
Peak Detector	57.3	68.3	74	16.7	5.7
Average Detector	37.3	48.3	54	16.7	5.7

The EUT was transmitting a modulated signal with constant Duty-Cycle for this measurement.

The EUTs uses BT Low Energy, Duty Cycle Correction Factor 20 dB is used to calculate Average detector values.

See attached plots.

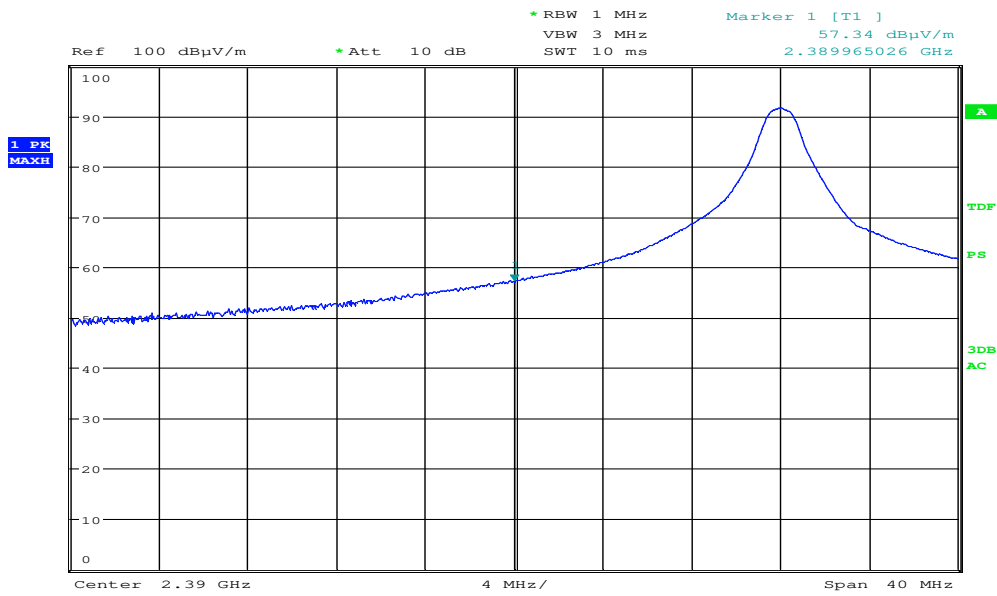

Date: 25.JUN.2018 16:45:25

Band Edge, Lower, Peak, 2402 MHz

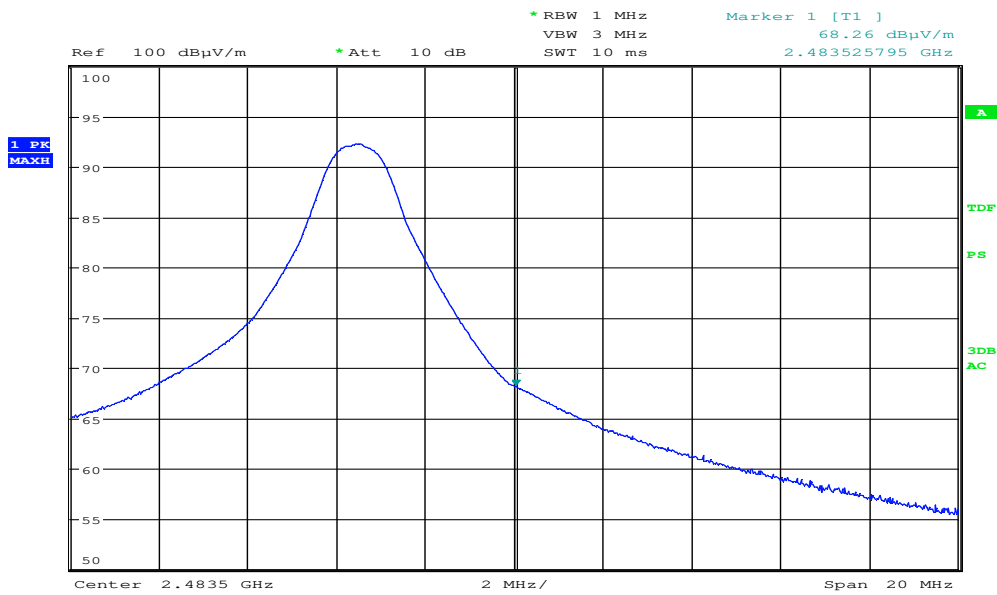

Date: 25.JUN.2018 16:52:15

Band Edge, Upper, Peak, 2480 MHz

3.8 Radiated Emissions, 30 – 1000 MHz

FCC 15.205, 15.209

ISED RSS-GEN, Issue 5, Clause 8.9

Test Results: Complies

Measuring distance 3 m.

Tested in test mode with EUT transmitting on 3 hopping channels.

All measurements were performed with the EUT transmitting at Max Power.

Measured values:

Frequency (MHz)	QuasiPeak (dB μ V/m)	Limit (dB μ V/m)	Margin (dB)	Meas. Time (ms)	Bandwidth (kHz)	Height (cm)	Pol	Azimuth (deg)	Corr. (dB)
50.000450	31.88	40.00	8.12	1000.0	120.000	101.0	V	151.0	-21.4
128.291000	23.16	43.50	20.34	1000.0	120.000	410.0	V	4.0	-17.4
131.881950	16.48	43.50	27.02	1000.0	120.000	300.0	V	139.0	-17.5
141.158200	29.77	43.50	13.73	1000.0	120.000	204.0	H	134.0	-17.7
141.282250	29.78	43.50	13.72	1000.0	120.000	210.0	H	124.0	-17.8
147.397250	24.04	43.50	19.46	1000.0	120.000	203.0	H	45.0	-18.1
152.050400	22.62	43.50	20.88	1000.0	120.000	201.0	H	46.0	-18.3
156.018850	16.41	43.50	27.09	1000.0	120.000	213.0	H	114.0	-18.6
165.048350	18.72	43.50	24.78	1000.0	120.000	301.0	H	265.0	-19.0

See attached plots.

Requirements/Limit

FCC	Part 15.209 @ frequencies defined in §15.205	
ISED	RSS-GEN Issue 5, clause 8.9 @ frequencies defined in clause 8.10	
	Radiated emission limit @3 meters	
Frequency (MHz)	Quasi Peak Limit (μ V/m)	Quasi Peak Limit (dB μ V/m)
30–88	100	40.0
88–216	150	43.5
216–960	200	46.0
960 - 1000	500	54.0

Full Spectrum

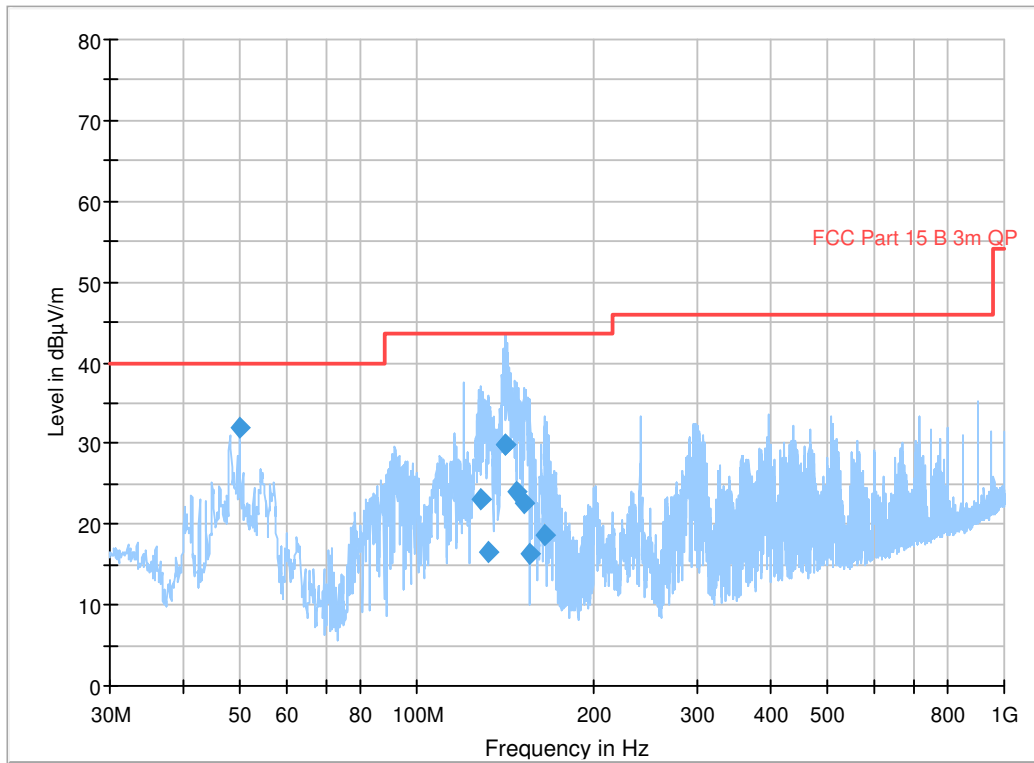

Radiated Emissions, 30–1000 MHz

3.9 Radiated Emissions, 1 – 25 GHz

FCC 15.205, 15.209

ISED RSS-GEN, Issue 5, Clause 8.9

Test Results: Complies

Measurement Data:

Measuring distance: 3 m (1–18 GHz)
 10 cm (18-25 GHz)

A pre-scan at approx. 10 cm was performed above 18 GHz and no spurious emissions were detected.

Measured values:

Frequency (MHz)	Channel	Polarization	Peak (dBµV/m)	Average (dBµV/m)	Peak Margin (dB)	Av Margin (dB)
4804	0	VP	53.5	33.5	20.5	20.5
7206	0	VP	57.0	37.0	17.0	17.0
4880	19	VP	51.0	31.0	23.0	23.0
7320	19	VP	58.5	38.5	15.5	15.5
4960	39	VP	49.3	39.3	24.7	24.7
7440	39	VP	56.8	36.8	17.2	17.2

All values are more than 12 dB below the limit.

Antenna factor, amplifier gain and cable loss are included in spectrum analyzer "Transducer factor".

See plots.

Requirements/Limit

FCC	Part 15.209 @ frequencies defined in §15.205	
ISED	RSS-GEN Issue 5, clause 8.9 @ frequencies defined in clause 8.10	
	Radiated emission limit @3 meters	
Frequency (MHz)	Average Detector Limit (dBµV/m)	Peak Detector Limit (dBµV/m)
Above 1 GHz	54.0	74.0

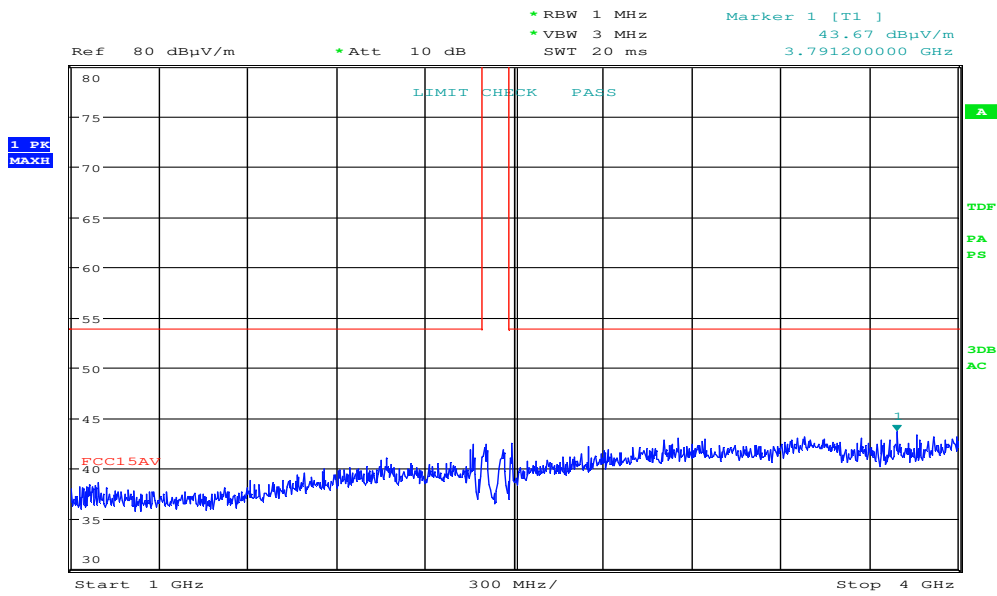

Date: 25.JUN.2018 17:14:53

Radiated Emissions, 1000 – 4000 MHz, 2402 MHz, HP

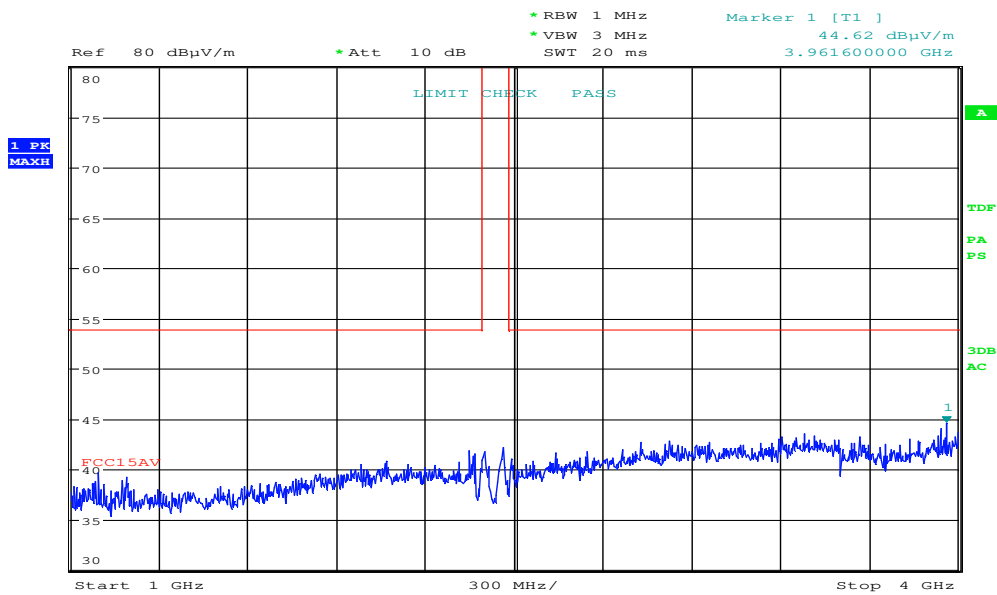

Date: 25.JUN.2018 17:12:59

Radiated Emissions, 1000 – 4000 MHz, 2402 MHz, VP

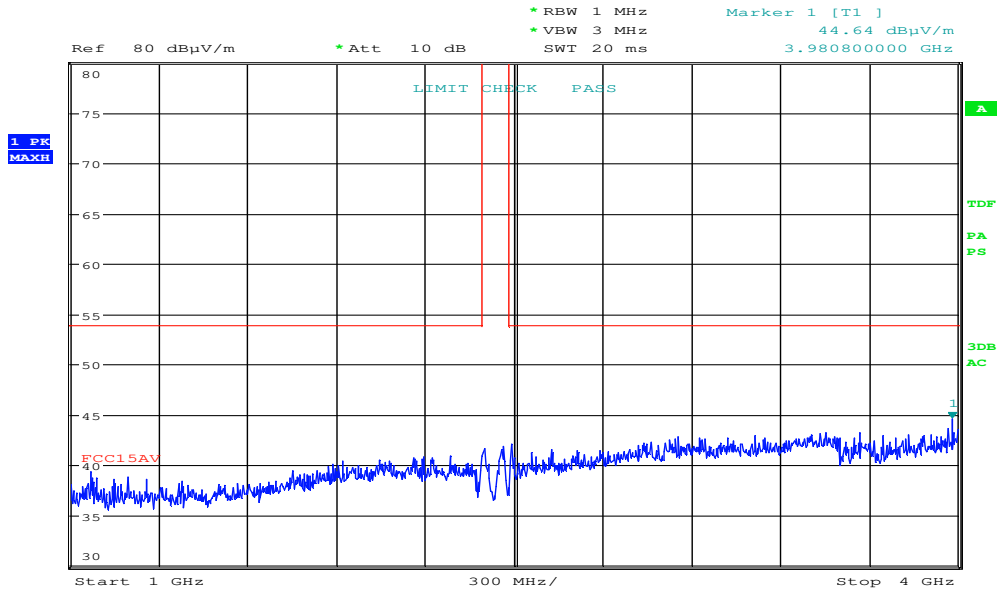

Date: 25.JUN.2018 17:09:50

Radiated Emissions, 1000 – 4000 MHz, 2440 MHz, HP

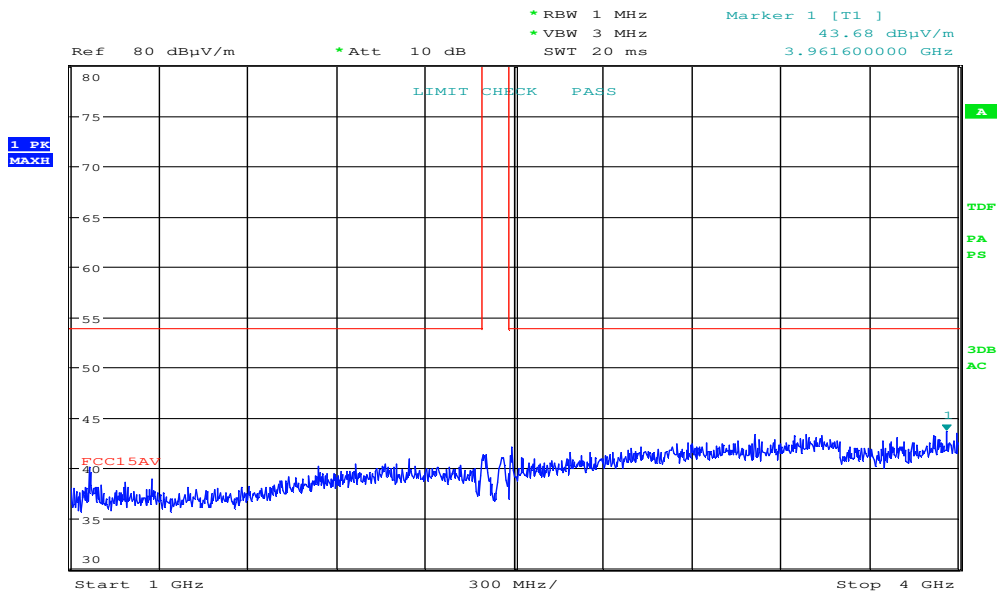

Date: 25.JUN.2018 17:07:56

Radiated Emissions, 1000 – 4000 MHz, 2440 MHz, VP

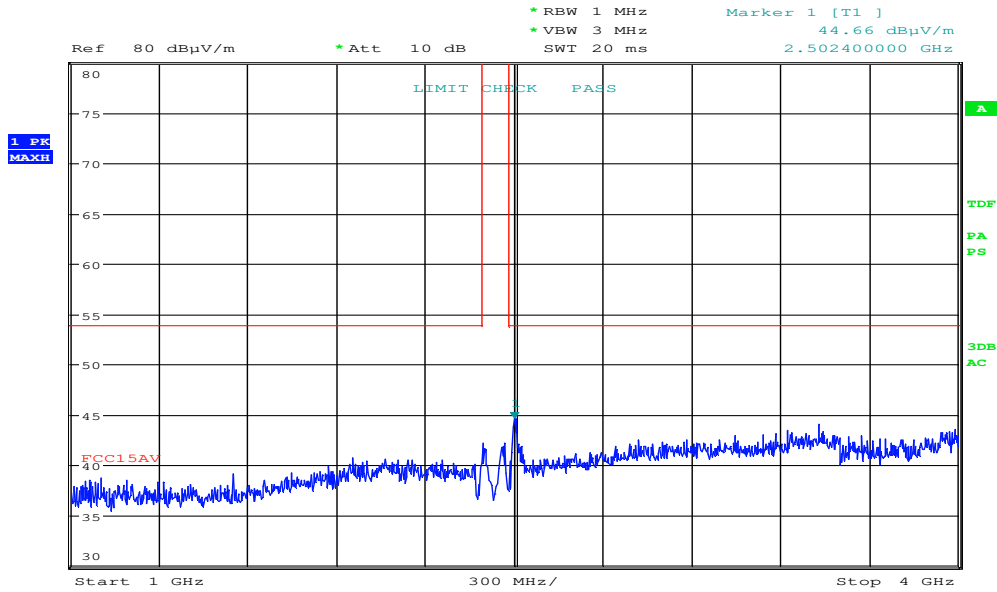

Date: 25.JUN.2018 17:04:52

Radiated Emissions, 1000 – 4000 MHz, 2480 MHz, HP

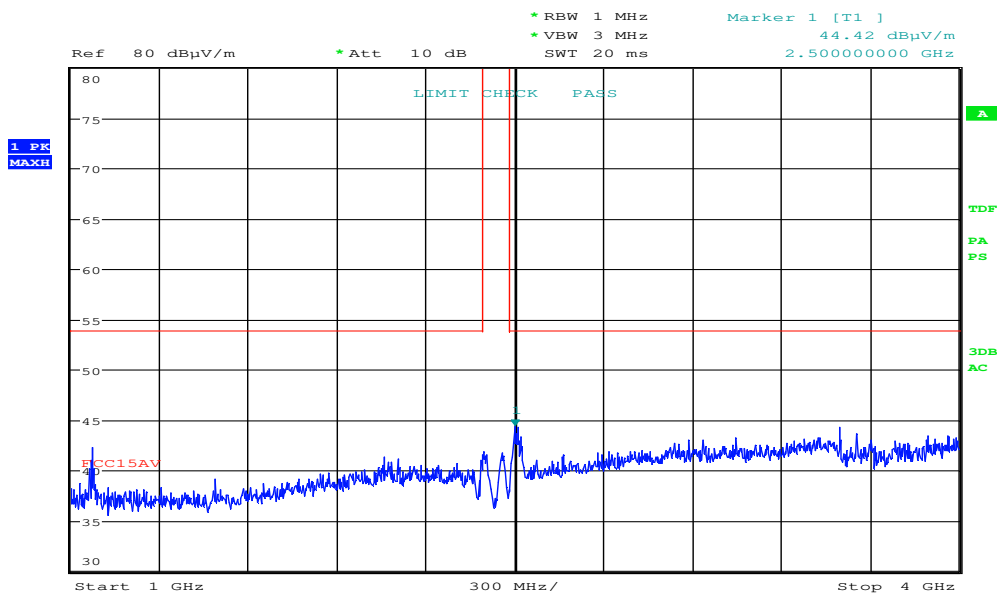

Date: 25.JUN.2018 17:01:05

Radiated Emissions, 1000 – 4000 MHz, 2480 MHz, VP

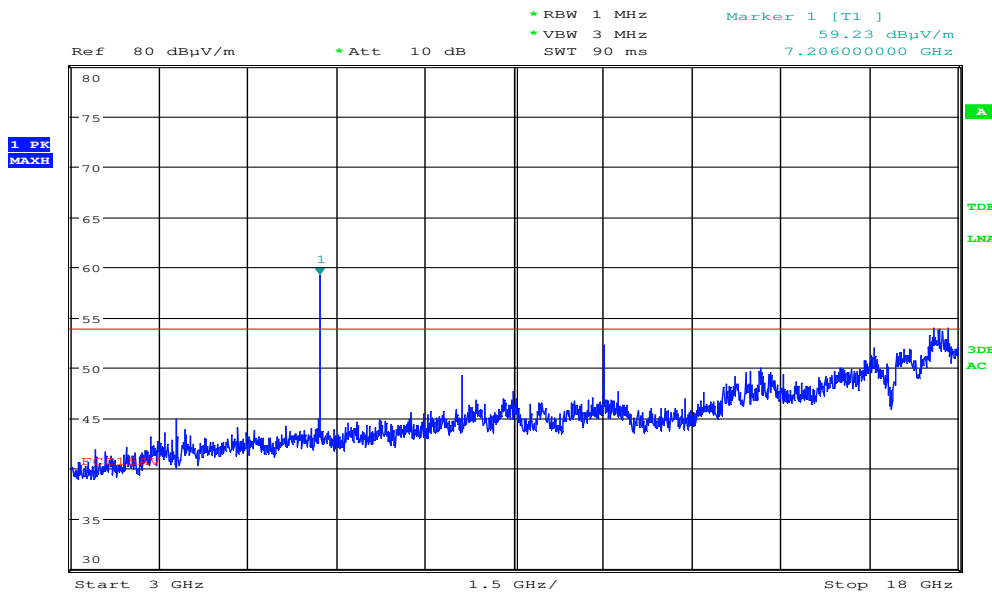

Date: 25.JUN.2018 19:37:52

Radiated Emissions, 3000 – 18000 MHz, 2402 MHz, HP

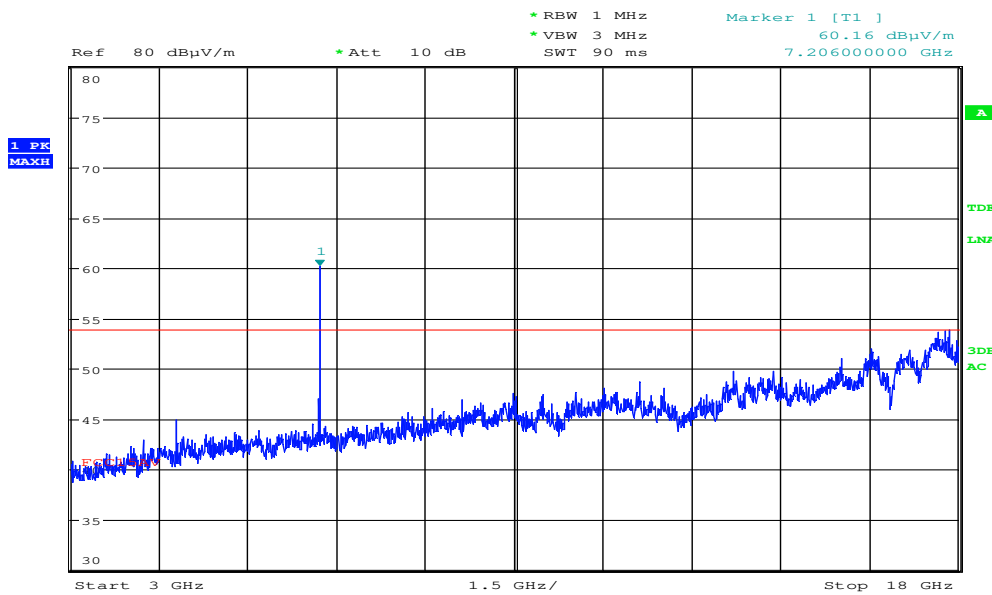

Date: 25.JUN.2018 19:35:58

Radiated Emissions, 3000 – 18000 MHz, 2402 MHz, VP

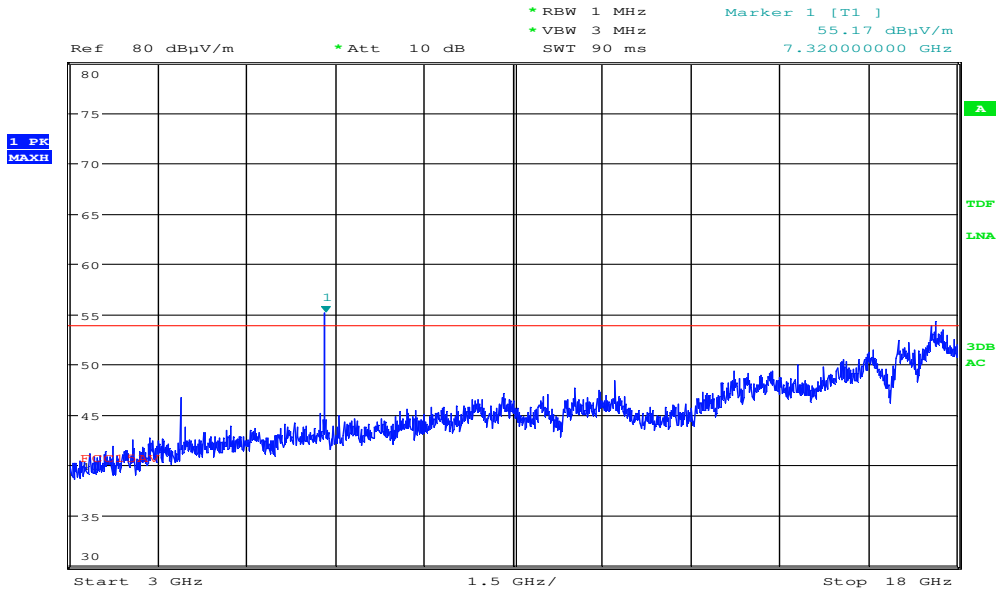

Date: 25.JUN.2018 19:43:37

Radiated Emissions, 3000 – 18000 MHz, 2440 MHz, HP

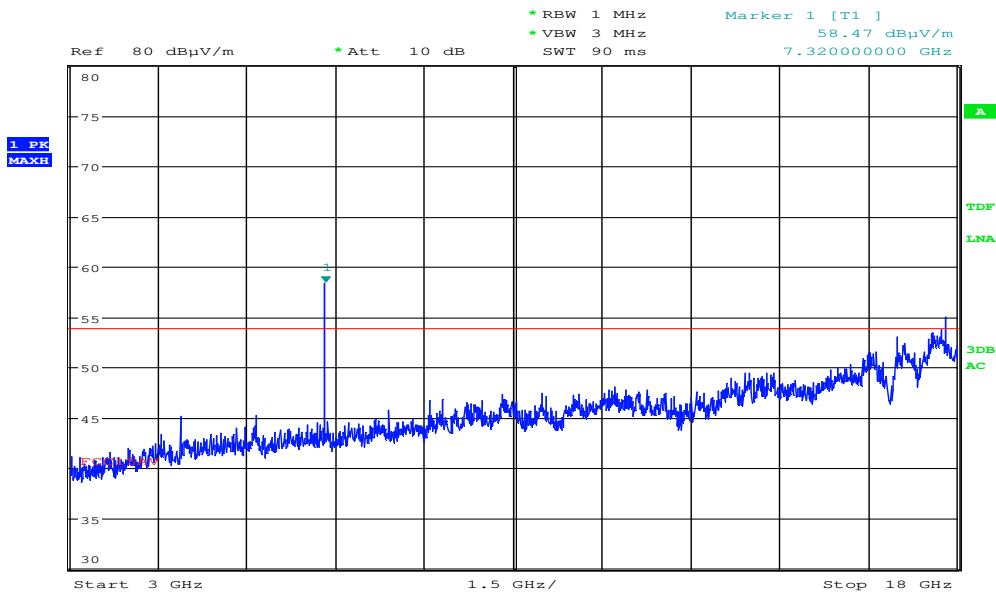

Date: 25.JUN.2018 19:41:43

Radiated Emissions, 3000 – 18000 MHz, 2440 MHz, VP

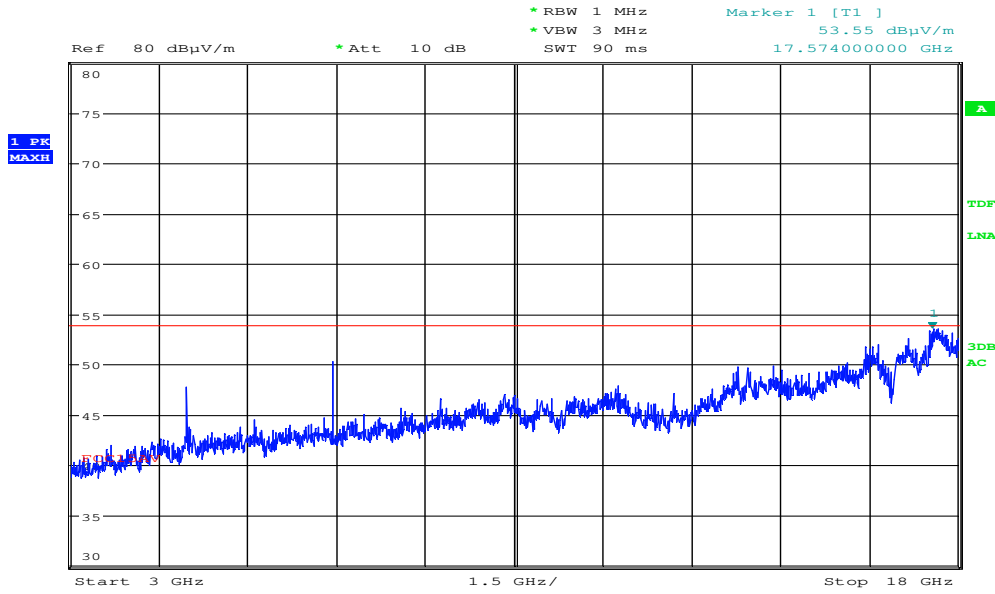

Date: 25.JUN.2018 19:49:20

Radiated Emissions, 3000 – 18000 MHz, 2480 MHz, HP

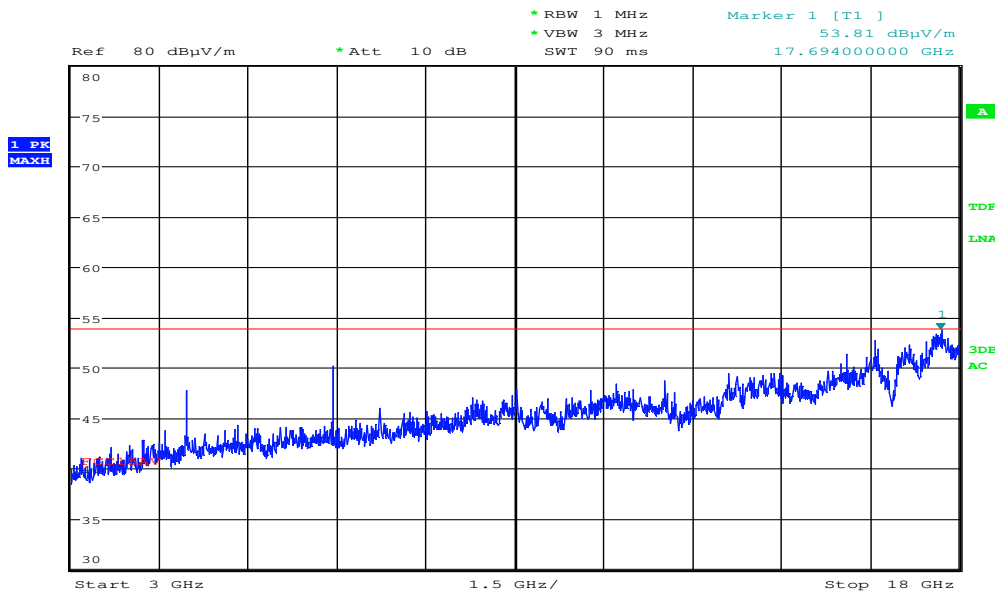

Date: 25.JUN.2018 19:47:26

Radiated Emissions, 3000 – 18000 MHz, 2480 MHz, VP

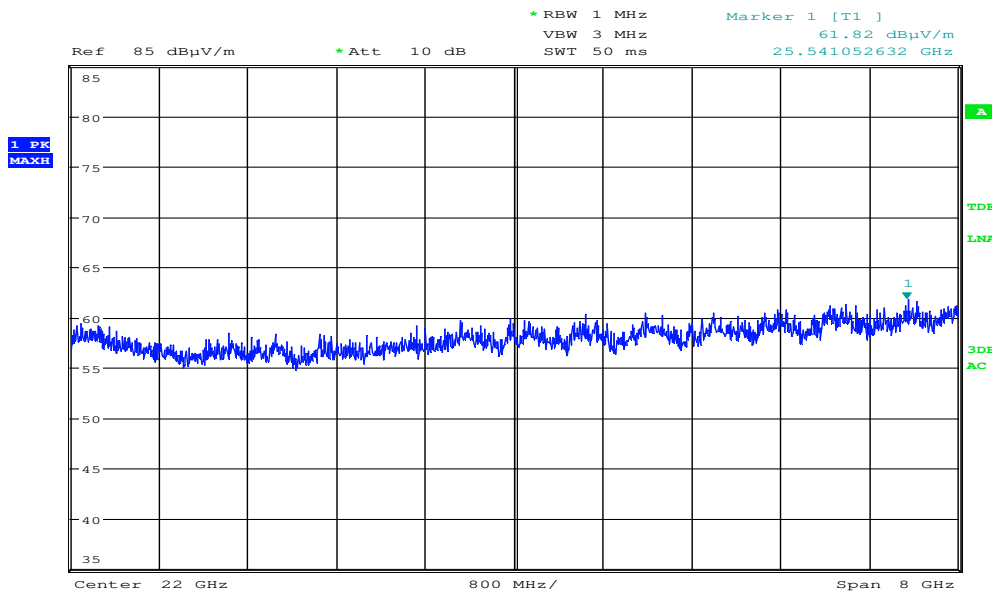

Date: 26.JUN.2018 10:40:08

Pre-scan, 18 – 26 GHz, 2402 MHz, VP/HP, @10cm

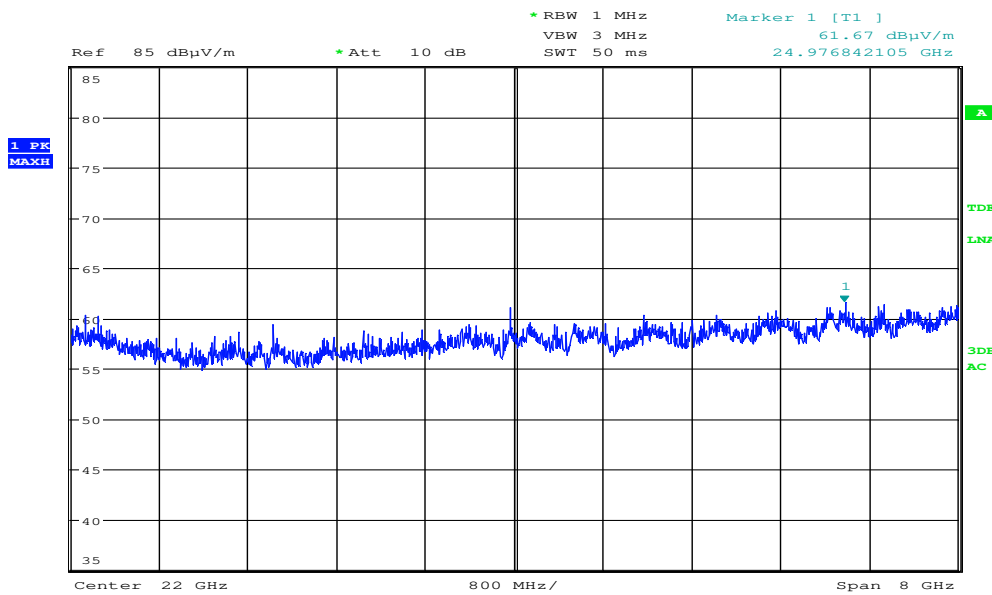

Date: 26.JUN.2018 10:37:54

Pre-scan, 18 – 26 GHz, 2440 MHz, VP/HP, @10cm

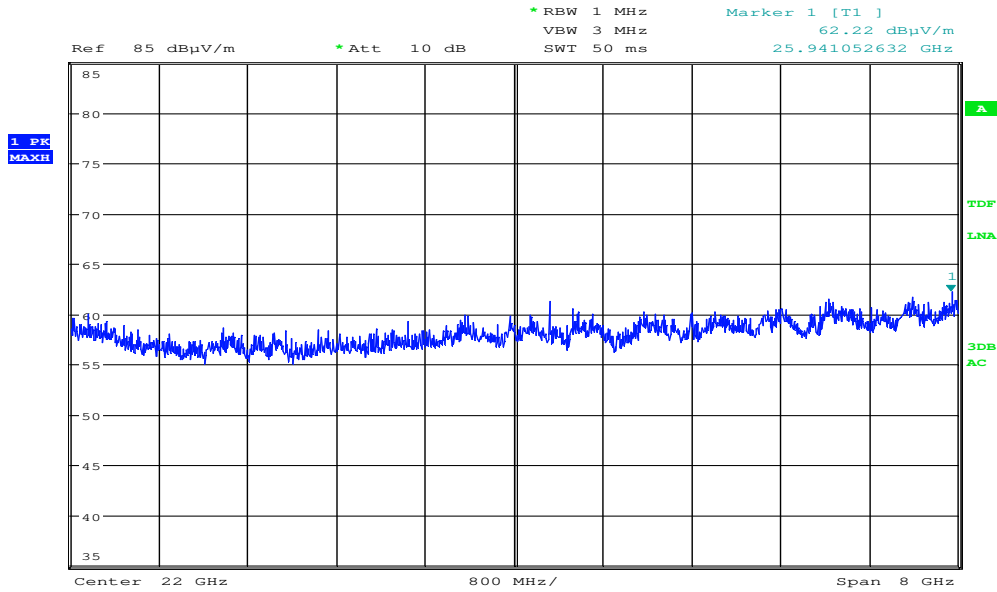

Date: 26.JUN.2018 10:42:08

Pre-scan, 18 – 26 GHz, 2480 MHz, VP/HP, @10cm

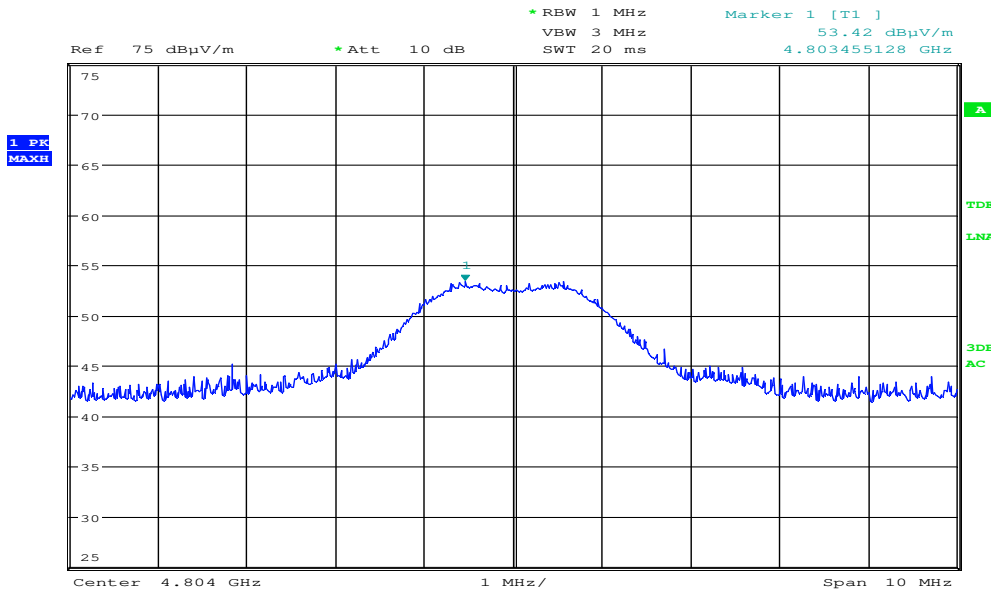

Date: 25.JUN.2018 20:21:13

Radiated Emissions, 4804 MHz, 2402 MHz, Peak (Max: VP)

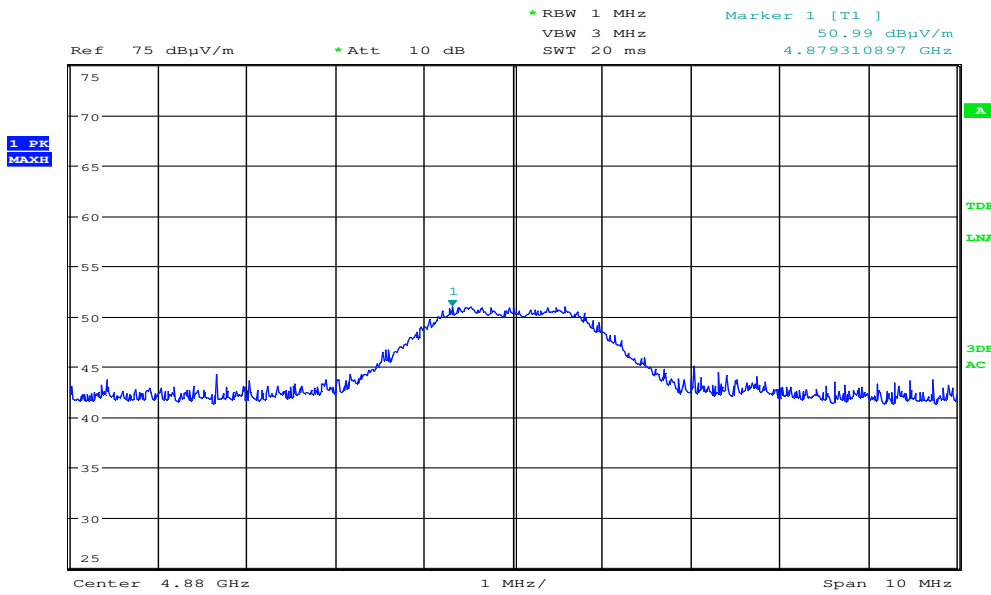

Date: 25.JUN.2018 20:20:29

Radiated Emissions, 4880 MHz, 2440 MHz, Peak (Max: VP)

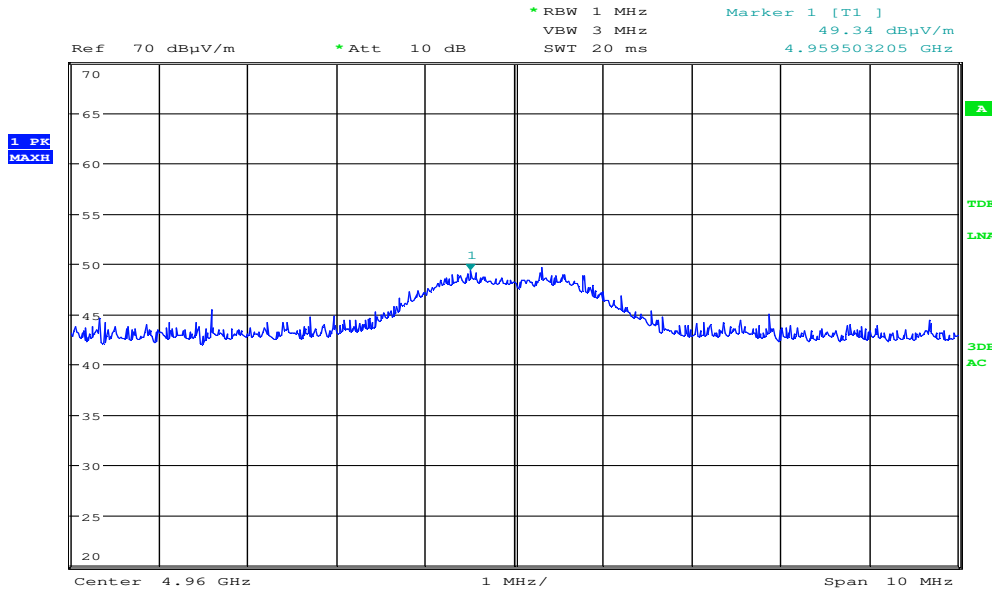

Date: 26.JUN.2018 08:40:35

Radiated Emissions, 4960 MHz, 2480 MHz, Peak (Max: VP)

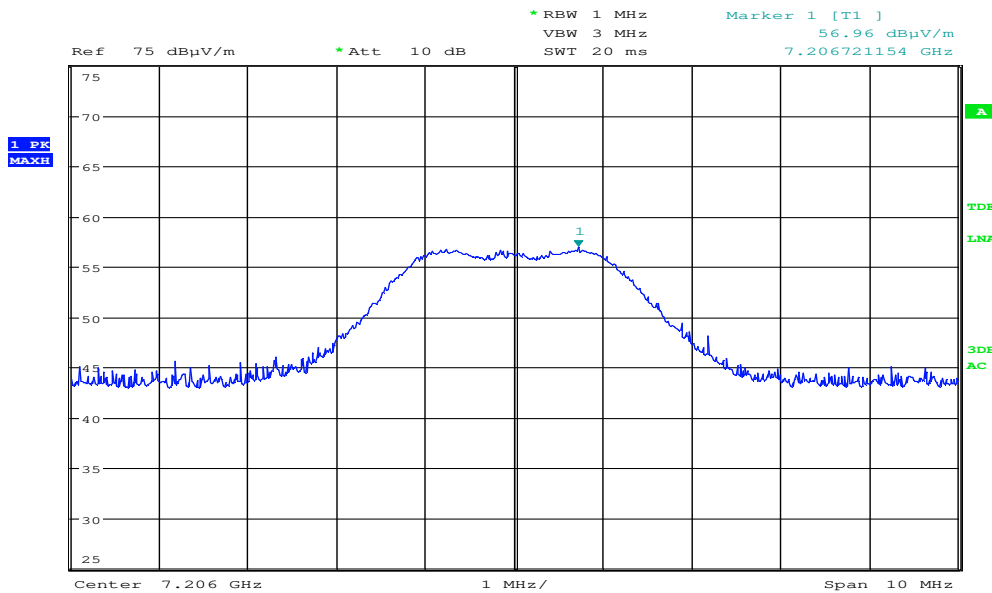

Date: 25.JUN.2018 20:06:24

Radiated Emissions, 7206 MHz, 2402 MHz, Peak (Max: VP)

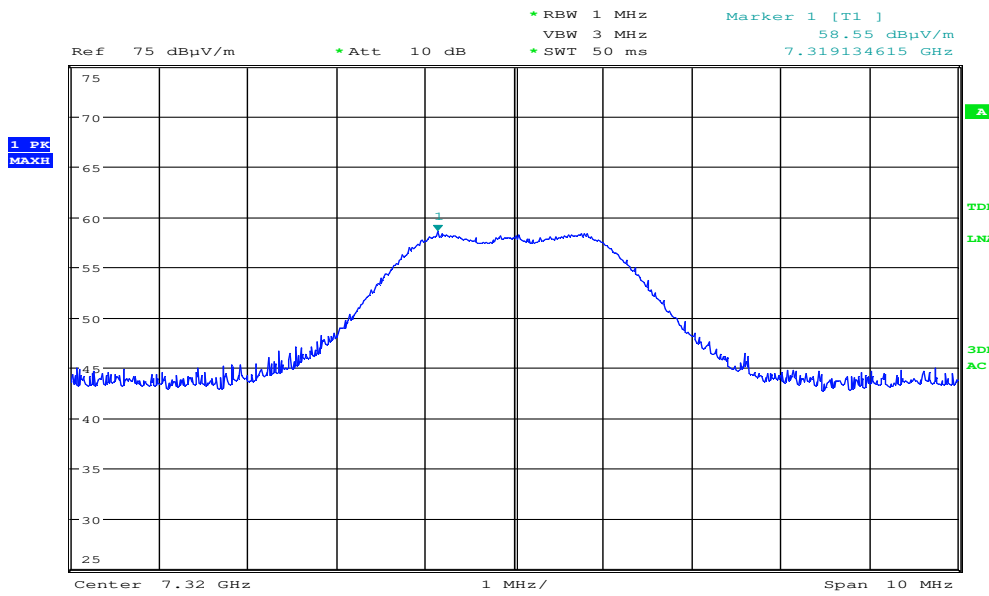

Date: 25.JUN.2018 20:05:12

Radiated Emissions, 7320 MHz, 2440 MHz, Peak (Max: VP)

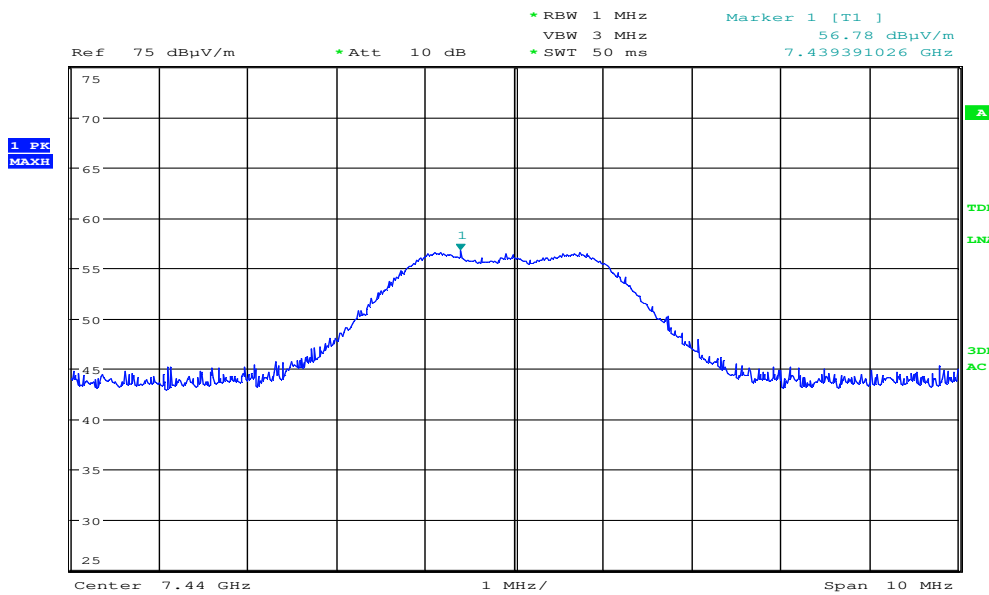

Date: 25.JUN.2018 20:03:23

Radiated Emissions, 7440 MHz, 2480 MHz, Peak (Max: VP)

3.10 Power Spectral Density (PSD)

FCC Part 15.247 (d)

ISED Canada RSS-247 Issue 2, Clause 5.2 (b)

Test Results: Passed

Measured Data:

The measurement procedures PKPSD described in ANSI C63.10-2013 was used.

Carrier Frequency (MHz)	Power Spectral Density (dBm/10 kHz)
2402	-7.5
2440	-8.0
2480	-8.1

Requirements:

The Power Spectral Density of a Digital Transmission System shall be no greater than +8 dBm in any 3 kHz band.

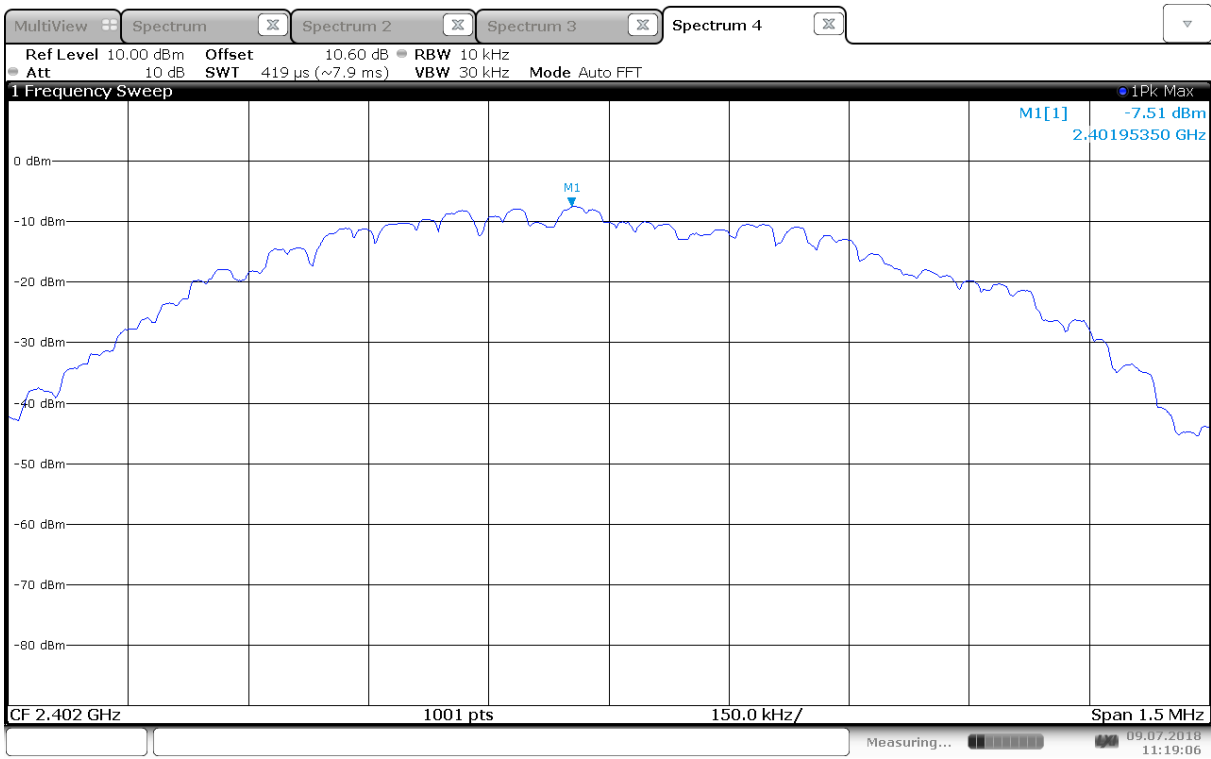

Power Spectral Density, 2402 MHz

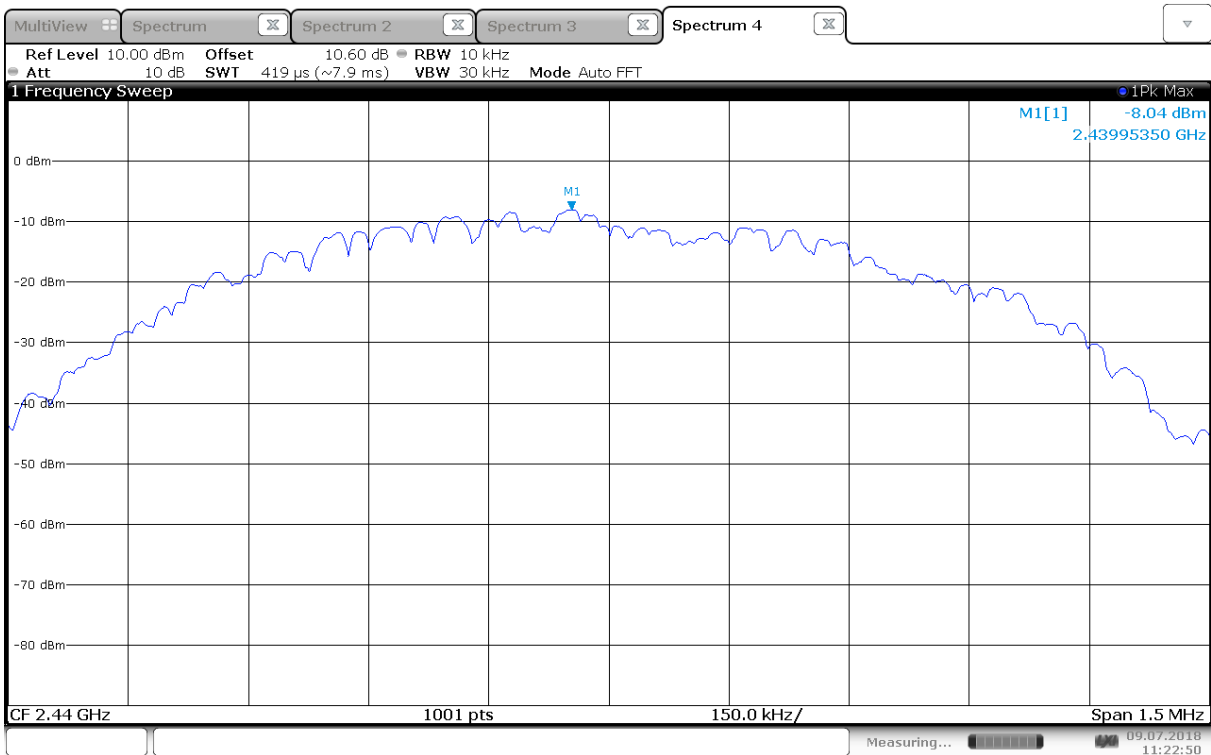

Power Spectral Density, 2440 MHz

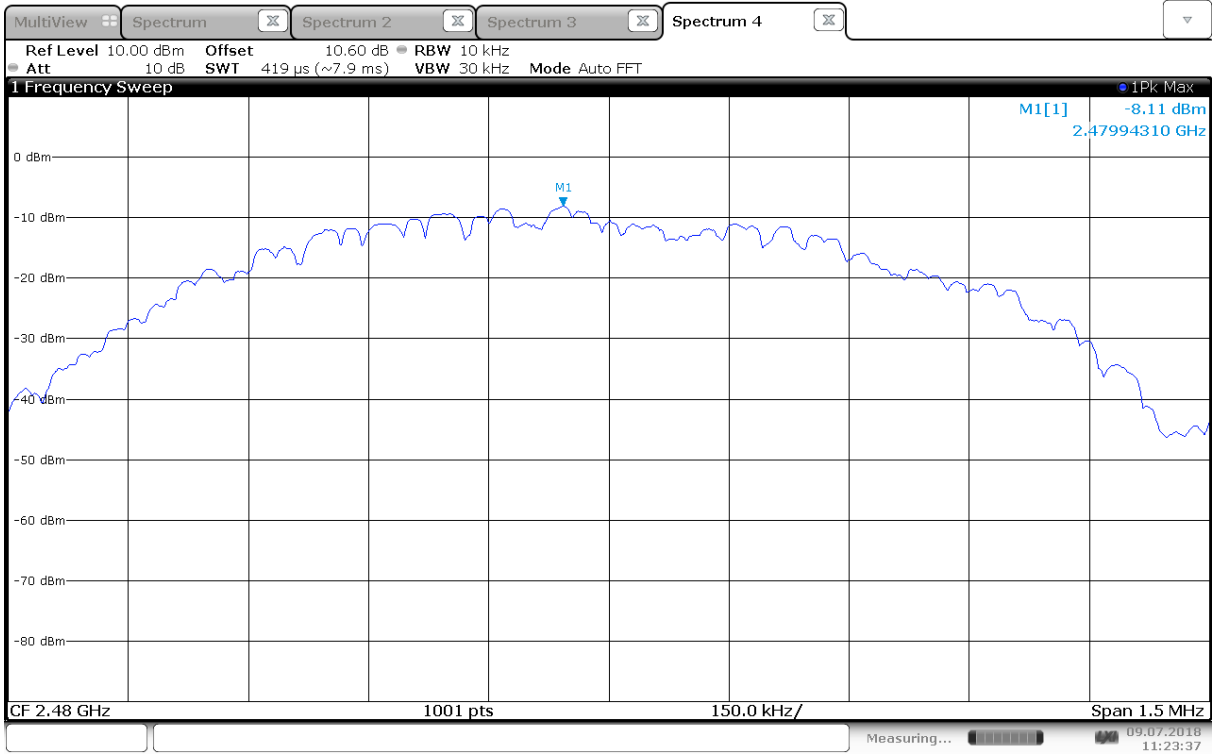

Power Spectral Density, 2480 MHz

4 Measurement Uncertainty

Measurement Uncertainty Values		
Test Item		Uncertainty
Output Power		±0.5 dB
Power Spectral Density		±0.5 dB
Out of Band Emissions, Conducted	< 3.6 GHz	±0.6 dB
	> 3.6 GHz	±0.9 dB
Spurious Emissions, Radiated	< 1 GHz	±2.5 dB
	> 1 GHz	±2.2 dB
Emission Bandwidth		±4 %
Power Line Conducted Emissions		+2.9 / -4.1 dB
Spectrum Mask Measurements	Frequency	±5 %
	Amplitude	±1.0 dB
Frequency Error		±0.6 ppm
Temperature Uncertainty		±1 °C

All uncertainty values are expanded standard uncertainty to give a confidence level of 95%, based on coverage factor k=2

5 LIST OF TEST EQUIPMENT

To facilitate inclusion on each page of the test equipment used for related tests, each item of test equipment and ancillaries are identified (numbered) by the Test Laboratory.

No.	Model number	Description	Manufacturer	Ref. no.	Cal. date	Cal. Due
1	FSW43	Spectrum Analyzer	Rohde & Schwarz	LR 1690	2018.01 2019.01	2019.01 2020.01
2	ESU40	Measuring Receiver	Rohde & Schwarz	LR 1639	2018-01 2019-01	2019-01 2020-01
3	6810.17B	Attenuator	Suhner	LR 1669	COU	
4	6HC3000/18000	Highpass Filter	Trilithic	LR 1614	COU	
5	JB3	BiLog Antenna	Sunol Sciences	N-4525	2016.05	2019.05
6	317	Preamplifier	Sonoma Inst.	LR 1687	2018.07	2019.07
7	8449A	Pre-amplifier	Hewlett Packard	LR 1322	2018.07	2019.07
8	3115	Horn Antenna	EMCO	LR 1330	2016.10	2019.12
9	3117-PA	Horn Antenna +PreAmp	EMCO	LR 1717	2017-12	2019-12
10	638	Antenna Horn	Narda	LR 1480	2010-06	2020-06
11	6032A	Power Supply	Hewlett Packard	LR 1051	COU	
12	CPX400S	Power Supply	TTI	LR 1712	COU	
14	Model 87 V	Multimeter	Fluke	LR 1597	2018-02	2020-02
15	ENV216	Two Line V-Network	Rohde & Schwarz	LR 1665	2017-11	2019-11
16	ESCI3	Measuring Receiver	Rohde & Schwarz	N-4259	2017-10	2019-10
17	ST18/SMA/N/36	RF Cable	Suhner	LR 1627	COU	
18	SF102/1000MM	RF Cable	Suhner	SN 50113/2	COU	
19	SF102/2000MM	RF Cable	Suhner	SN 500100/2	COU	

COU – Calibrate on Use

The software listed below has been used for one or more tests.

No.	Manufacturer	Name	Version	Comment
1	Rohde & Schwarz	EMC32	10.30.10	Power Line Conducted test software
2	Rohde & Schwarz	EMC32	10.30.10	Radiated Emission test software
3	Rohde & Schwarz	GPiBSHOT	2.7	Screenshots from R&S Spectrum Analyzers

6 BLOCK DIAGRAM

6.1 Power Line Conducted Emission

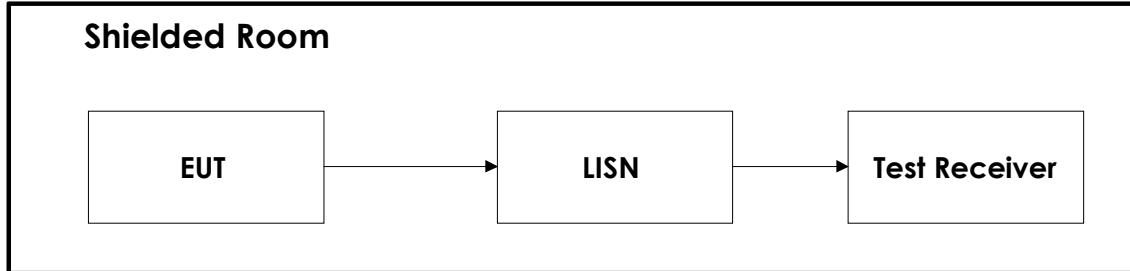

6.2 Conducted Tests

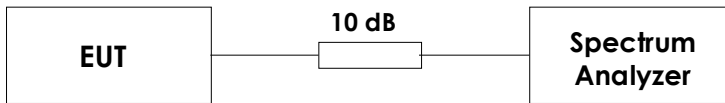

This test set-up is used for all Conducted tests.

6.3 Test Site Radiated Emission

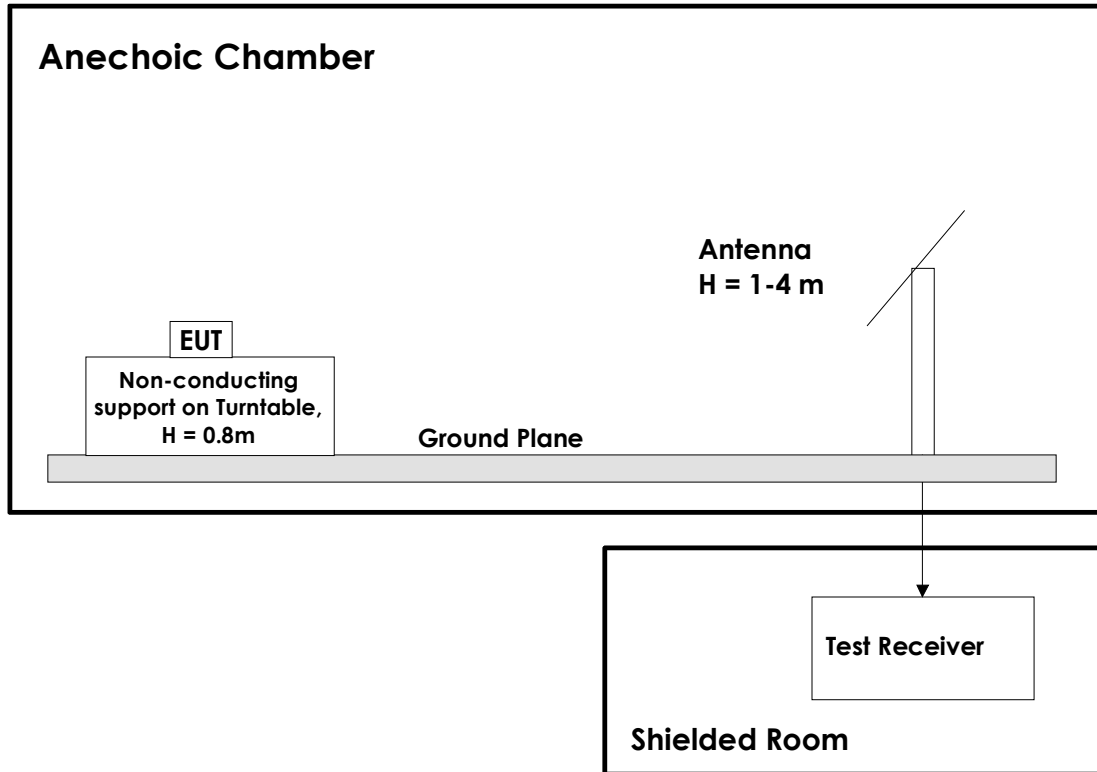

This test setup is used for all radiated emissions tests. Measuring distance is 3m for all frequencies up to 18 GHz. Above 18 GHz measuring distance is 1m.

Emissions above 1 GHz are measured with a Spectrum Analyzer and Horn Antenna.

All measurements at 1 GHz and above were performed with turntable height 1.5m and with the ground plane covered by absorbers.

A pre-amplifier is used for all measurements, and High-Pass filter is used for all harmonics.

Above 18 GHz the test receiver is moved inside the anechoic chamber and located next to the antenna to minimize the cable loss.