

DeLaval activity meter system

Instruction Book

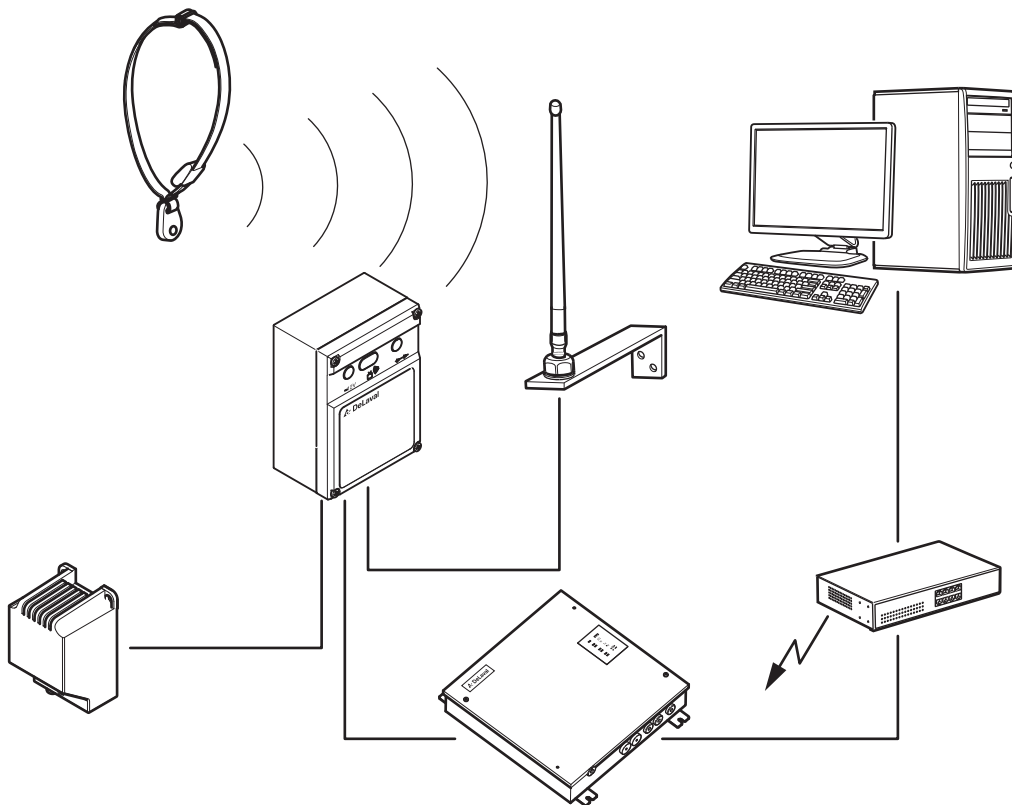

DeLaval activity meter system

Table of contents

EC Declaration of Conformity - DeLaval activity meter system	5
Safety precautions	7
■ DeLaval activity meter system	
■ DeLaval activity meter AM2	
■ DeLaval activity receiver AR2	
1 Foreword.....	7
2 Disclaimer.....	7
3 Note to operator.....	7
4 FCC and IC compliance statement.....	7
4.1 Information to user.....	8
General description	9
■ DeLaval activity meter system	
■ DeLaval activity meter AM2	
■ DeLaval activity receiver AR2	
1 Introduction.....	9
2 Parts of the DeLaval activity meter system.....	10
3 Functional overview.....	11
4 Features of the DeLaval activity meter AM2.....	11
5 Features of the DeLaval activity receiver AR2.....	12
6 Co-existence and compatibility with the previous generation activity meter system.....	13
7 Environmental specification.....	14
Installation	15
■ DeLaval activity meter system	
■ DeLaval activity meter AM2	
■ DeLaval activity receiver AR2	
1 Mounting the DeLaval activity meter on the neckband with B-transponder	15
1.1 Assembling of the neckband without number plates.....	17
1.2 Assembling of the neckband with number plates.....	22
2 Mounting the DeLaval activity meter on the neckband without B-transponder	27
2.1 Assembling the neckband without number plates.....	28
2.2 Assembling of the neckband with number plates.....	33
Start up	36
■ DeLaval activity meter system	
■ DeLaval activity meter AM2	
■ DeLaval activity receiver AR2	
1 Farm management system start up.....	36
2 DeLaval activity meter AM2 start up.....	36
2.1 Manual activation.....	37
2.2 Automatic activation.....	38
3 Matching activity meter ID number to cow number.....	38
4 Confirmation of AM2 start up.....	39
5 Operation.....	39

DeLaval activity meter system

Table of contents

- Troubleshooting..... 40
 - DeLaval activity meter system
 - DeLaval activity meter AM2
 - DeLaval activity receiver AR2
- 1 General..... 40
- 2 DeLaval activity receiver AR2 LED indicators..... 41

EC Declaration of Conformity

Name of product: **DeLaval activity meter system**
Type: DeLaval activity receiver AR2
DeLaval activity meter AM2
Report No. 80009746

The product complies with requirements of the following directives:

Radio and Telecommunication Terminal Equipment Directive - 1999/5/EC

Harmonised standards which have been used:

EN 301 489-3 V1.4.1: 2002

EN 300 220-2 V2.4.1: 2012

Other technical standards and specifications used:

Tumba 2013-08-30

Signed:

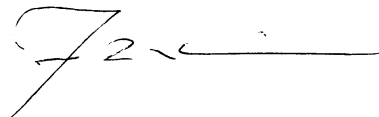

Name: Jan Ove Nilsson

Position: Vice president

Department: BA Capital Goods

Contact: Wiveca Sveen
P.O. Box 39
SE 147 21 TUMBA
Sweden

Name and address of manufacturer:

DeLaval International AB
P.O. Box 39
SE 147 21 TUMBA
Sweden



Safety precautions

DeLaval activity meter system

DeLaval activity meter AM2

DeLaval activity receiver AR2

1 Foreword

Read carefully before using the product!

For best possible performance, continuous satisfactory safe operation, read and understand these instructions thoroughly before operating your equipment.

2 Disclaimer

The information, instructions and parts listed are applicable and current on the date when issued. DeLaval reserves the right to make changes without notice.

3 Note to operator

It is the operator's responsibility to see that any person involved with the use or operation of this equipment follows all safety and operational instructions. Under no circumstances should this equipment be used if the equipment is faulty or the operator does not completely understand the operation of the equipment.

4 FCC and IC compliance statement

This device complies with Part 15 of the FCC Rules and RSS-210 of the IC Rules. Operation is subject to the following two conditions: (1) this device may not cause harmful interference, and (2) this device must accept any interference received, including interferences that may cause undesired operation.

4.1 Information to user

This equipment has been tested and found to comply with the limits for a Class B digital device, pursuant to Part 15 of the FCC Rules. These limits are designed to provide reasonable protection against harmful interference in a residential installation. This equipment generates, uses and can radiate radio frequency energy and, if not installed and used in accordance with the instructions, may cause harmful interference to radio communications. However, there is no guarantee that interference will not occur in a particular installation. If this equipment does cause harmful interference to radio or television reception, which can be determined by turning the equipment off and on, the user is encouraged to try to correct the interference by one or more of the following measures:

- Reorient or relocate the receiving antenna.
- Increase the separation between the equipment and receiver.
- Connect the equipment into an outlet on a circuit different from that to which the receiver is connected.
- Consult the dealer or an experienced radio/TV technician for help.

Note! Changes or modifications not expressly approved by the party responsible for compliance could void the user's authority to operate the equipment.

DeLaval activity meter system

General description

General description

DeLaval activity meter system

DeLaval activity meter AM2

DeLaval activity receiver AR2

1 Introduction

This instruction book covers specifically the DeLaval activity meter AM2 and the DeLaval activity receiver AR2. For information on how to use the activity meter system in the farm management system, please consult the DelPro / ALPRO user manuals.

The DeLaval activity meter system is a wireless, electronic heat detection system for cows and heifers approaching heat. The purpose of the DeLaval activity meter system is to alert the farmer when an animal becomes more active than normal, which usually indicates that the animal is in heat.

The system uses also Low activity to alert the farmer when animals become less active than normal, indicating that the animal may have a health issue and needs to be checked.

DeLaval activity meter system

General description

2 Parts of the DeLaval activity meter system

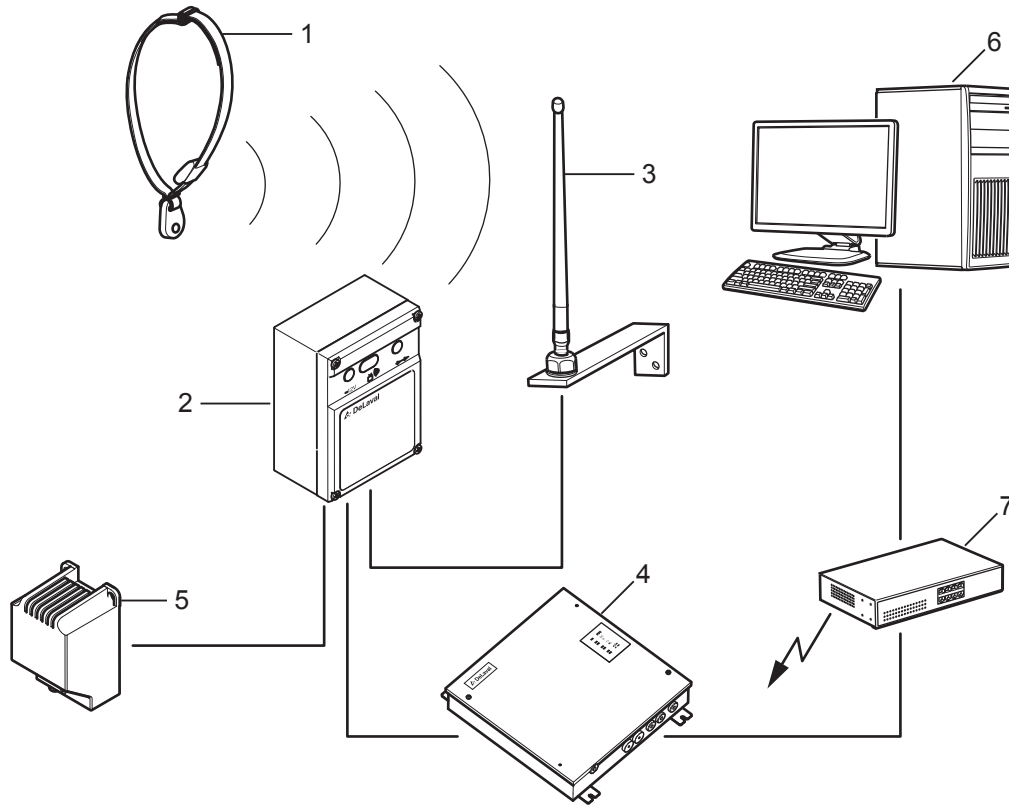

Fig. 1: Parts of the DeLaval activity meter system

- | | | | |
|---|---------------------------------|---|---|
| 1 | DeLaval activity meter AM2 | 5 | Transformer |
| 2 | DeLaval activity receiver AR2 | 6 | PC with DelPro software (or ALPRO Windows software) |
| 3 | Antenna | 7 | Router (optional) |
| 4 | System controller with ALPRO WE | | |

DeLaval activity meter system

General description

3 Functional overview

- The activity meter AM2 contains a sensor which detects movements. The movements are aggregated into an activity level. The activity level data is continuously collected and transmitted to the activity receiver every hour. Every data transmission contains activity data covering the latest 24-hour period.
- The activity receiver AR2 is the link between the activity meters and the ALPRO WE on the system controller, where data from the activity meter is processed. The activity receiver receives the radio signal from the activity meter via the antenna. The received message is checked for validity, and then it is transmitted over the ALCOM bus to the system controller.
- The system controller with ALPRO WE software collects and stores all incoming activity data. Its main task, for heat detection purposes, is to process the activity data into high activity alarms.
- A PC running DelPro / ALPRO Windows software reads and stores the processed activity information from the system controller and presents it in graphs and reports.

4 Features of the DeLaval activity meter AM2

- To distinguish the AM2 from the previous generation activity meters, the cover has a blue/grey colour combination. See Fig. 2.
- Activity sensor: A digital accelerometer provides accurate motion detection. The all-electronic implementation improves reliability and quality of the product.
- RFID-activated start up: The DeLaval activity meter AM2 will be activated (enter ON mode) automatically when exposed to a 131/134 kHz RFID reader signal. Either as the cow passes an RFID reader, or manually by bringing the AM2 close to an RFID reader.
- Automatic shut-off: The AM2 automatically shuts off after 48 hours of inactivity (all zero activity for 48 hours). When an AM2 is temporarily not used, simply put it on the shelf.

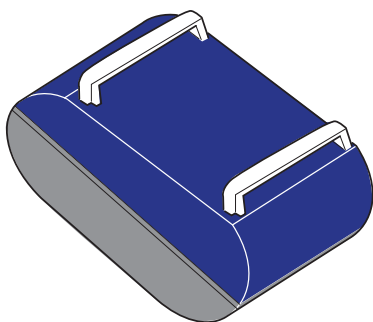

Fig. 2: DeLaval activity meter AM2

DeLaval activity meter system

General description

- RF communication protocol: A high speed, multi-channel RF communication protocol is used to improve system capacity (maximum number of cows with AM2) and to improve immunity to RF noise and interference.
- Internal lithium battery: Battery life time is up to 10 years.

5 Features of the DeLaval activity receiver AR2

- Identification: To visually distinguish the AR2 (see Fig. 3) from the previous generation activity receiver, the front label has a DeLaval logo.
- RF communication protocol: The AR2 supports the AM2 radio protocol.
- RF range: The AM2 to AR2 communication range is typically 200 m line of sight, outdoors.
- Remote software upgrade: software upgrade of the AR2 is supported over the ALCOM bus in DelPro as well as ALPRO systems.

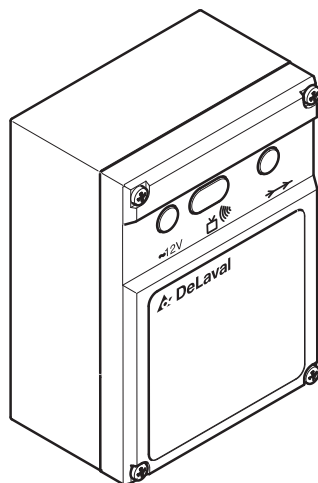

241006

Fig. 3: DeLaval activity receiver AR2

6 Co-existence and compatibility with the previous generation activity meter system

AM2 and the previous generation activity meters can be mixed at the farm, considering a few pre-requisites:

- The activity meter AM2 always requires an AR2 receiver with antenna. When introducing AM2 meters, one or more AR2 receivers must be installed. The AR2 is preferably mounted close to existing activity receivers, to share the existing ALCOM bus and power supply.
- AR2 ALCOM node address ALCOM node addresses for AR2 must be sequential and starting higher than existing receivers. This will enable batch SW upgrade of the AR2.
- A 131/134 kHz RFID reader (any DeLaval ID reader) is required to start up the AM2. If there is no RFID reader available, a Hand-held ID reader could be used for manual start up.
- Radio frequency channels: The AM2 and AR2 use different, multiple radio channels. Thereby AM2 will co-exist with previous generation activity meters without radio interference.
- AR2 compatibility on the ALCOM bus: The AR2 is by default (from the factory) configured in an ALCOM backwards-compatible mode. Activity messages received from AM2 meters will be converted to a legacy message format. The 24-bit unique AM2 serial number is truncated to a 16-bit address (0-65535).
- ALPRO WE/DelPro /ALPRO Windows compatibility: In backwards-compatible mode, the DelPro and ALPRO system will process activity data from the AM2 in the same way as the previous generation system. The management system will not be aware of the activity meter version.

Note! The AR2 does not support previous generation activity meters.

Note! The AR2 does not support download of previous RFI SW versions.

Note! A magnet cannot be used for manual start up.

Note! The Tag tester cannot be used with the AM2.

DeLaval activity meter system

General description

7 Environmental specification

DeLaval activity receiver AR2	
Ideal environment	Outdoors, under roof
Operating temperature	-25 °C to +55 °C
Storage temperature	-40 °C to +70 °C
Humidity	10-100% RH

DeLaval activity meter AM2	
Ideal environment	Outdoors, on animal
Operating temperature	-25 to +55 °C
Storage temperature	-40 to +70 °C
Recommended storage temperature	+5 to +35 °C
Humidity	10-100% RH

Note! Extreme storage temperatures will significantly reduce battery lifetime.

Note! The battery contains lithium. Do not dispose of these items without complying with current environmental laws.

DeLaval activity meter system

Installation

Installation

DeLaval activity meter system

DeLaval activity meter AM2

DeLaval activity receiver AR2

1 Mounting the DeLaval activity meter on the neckband with B-transponder

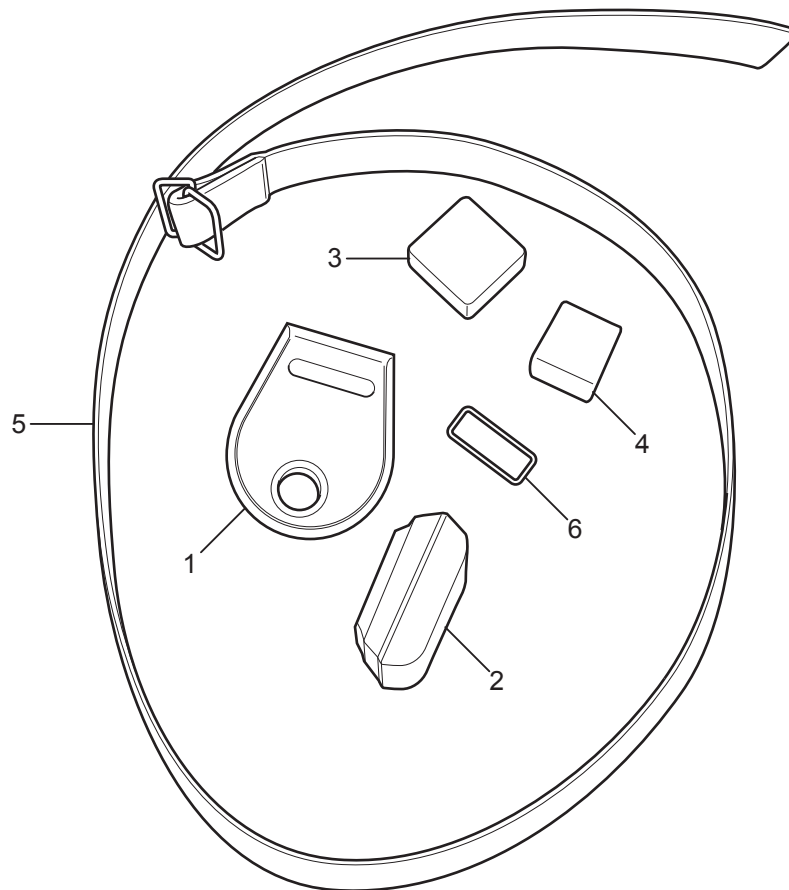

211145

Fig. 4

- 1 B-transponder
- 2 Activity meter
- 3 Activity clip/spacer

- 4 Buckle for the end of the neckband
- 5 Neckband
- 6 Metal ring

When mounting the activity meter (see 2 in Fig. 4) on the neckband (see 5 in Fig. 4) with a B-transponder (see 1 in Fig. 4) an activity clip/

DeLaval activity meter system

Installation

spacer (see 3 in Fig. 4) is needed. The buckle (see 4 in Fig. 4) which is included with the neckband secures the loose end of the neckband. There are two ways of assembling the neckband with the activity meter. It can be assembled with or without the number plates.

DeLaval activity meter system

Installation

1.1 Assembling of the neckband without number plates

1. First place the metal ring on the neckband, and then the B-transponder. See Fig. 5.

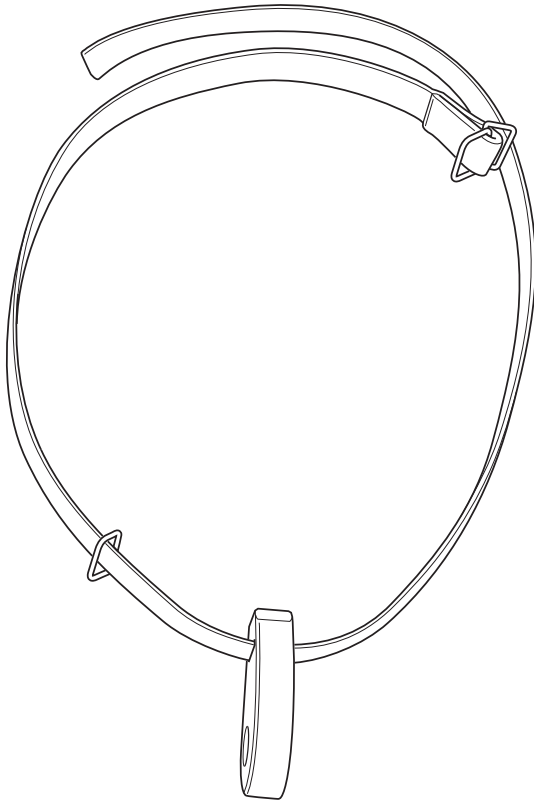

241846

Fig. 5: Neckband with metal ring and B-transponder

DeLaval activity meter system

Installation

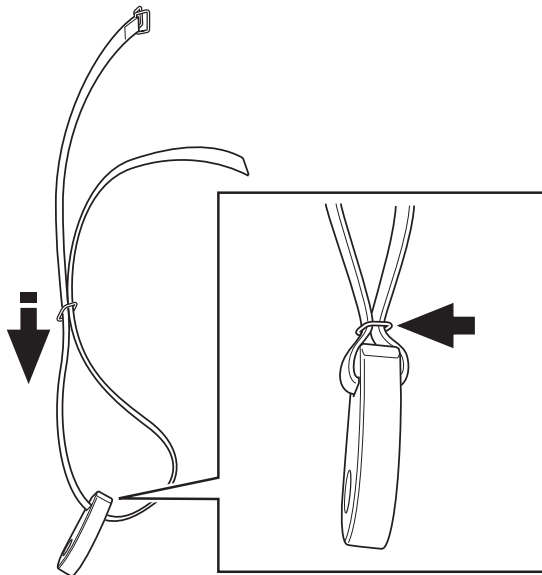

241847

Fig. 6: Securing the B-transponder

2. Pull the neckband through the metal ring to secure the B-transponder on the neckband. See Fig. 6.

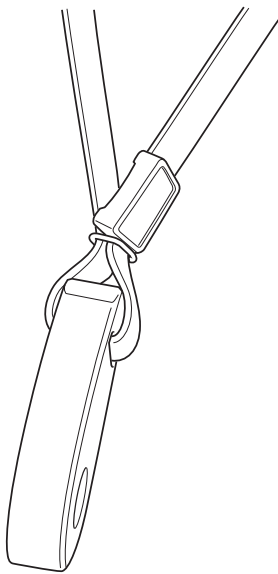

241849

Fig. 7: Threading the activity clip/spacer on the neckband

3. Thread the activity clip/spacer on the neckband. See Fig. 7.

DeLaval activity meter system

Installation

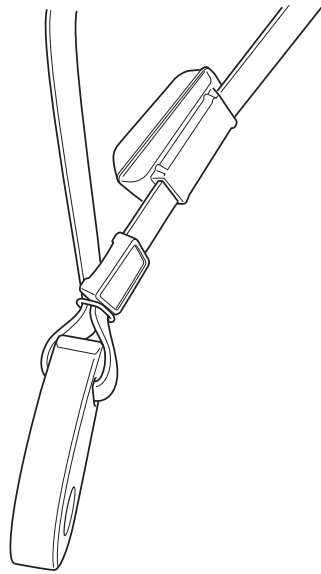

241850

Fig. 8: Threading the activity meter on the neckband

4. Thread the activity meter on the neckband. See Fig. 8.

Note! Make sure that the thickest part of the activity meter is downwards.

Note! Make sure that the activity meter is on the inside of the neckband to prevent being worn out.

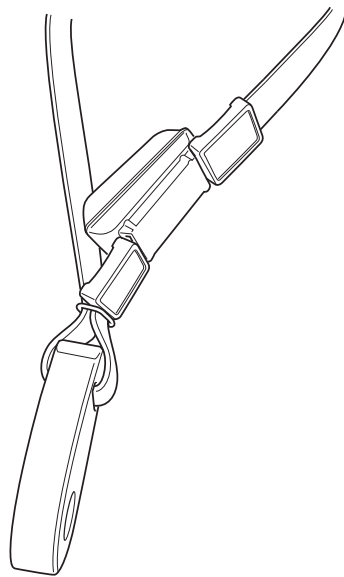

241855

Fig. 9: Thread on the second activity clip/spacer on the neckband

5. A second activity clip/spacer can then be used above the activity meter to prevent it from wandering upwards on the neckband. See Fig. 9.

DeLaval activity meter system

Installation

6. Thread the buckle on the neckband. See Fig. 10.

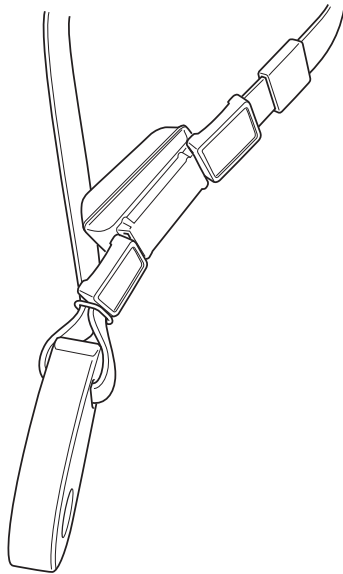

241827

Fig. 10: Threading the buckle on the neckband

DeLaval activity meter system

Installation

7. Fold the end of the neckband through the rings. Make sure the end of the neckband is on the inside. See Fig. 11.

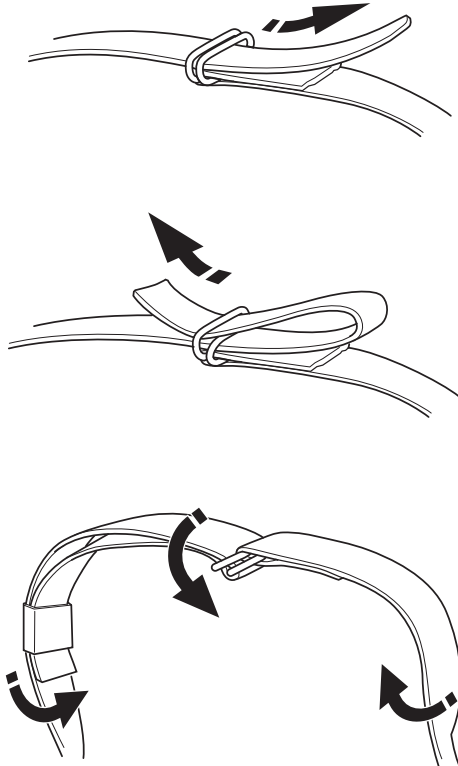

241819

Fig. 11: Folding of the neckband through the rings

DeLaval activity meter system

Installation

1.2 Assembling of the neckband with number plates

1. Thread the number plates on the neckband. See Fig. 12.

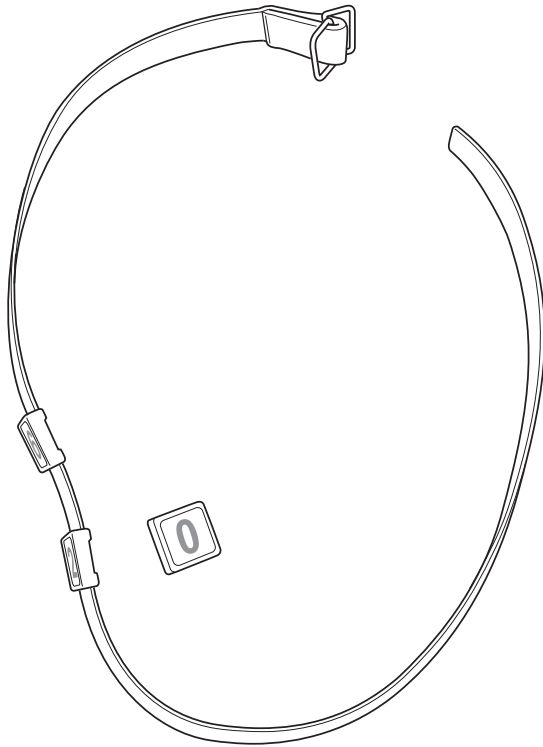

241859

Fig. 12: Threading the number plates on the neckband

DeLaval activity meter system

Installation

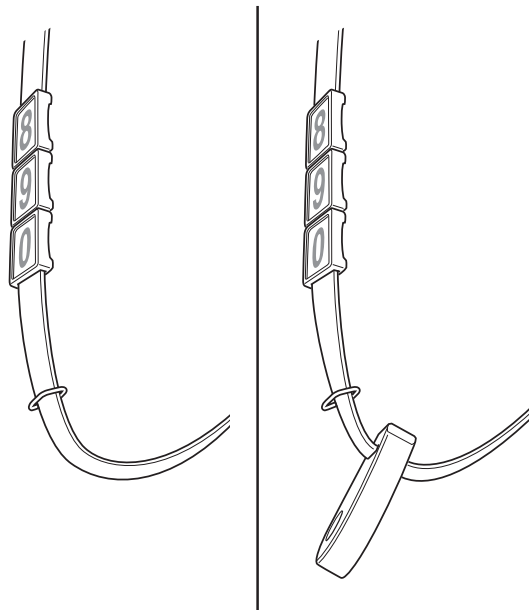

2. Thread the metal ring and then the B transponder on the neckband. See Fig. 13.

Fig. 13: Threading the metal ring and B-transponder on the neckband

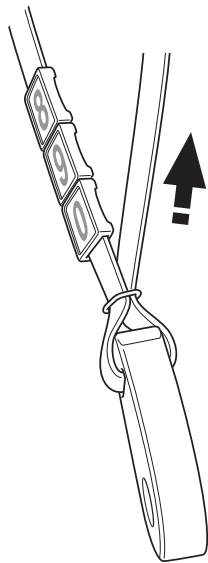

3. Fold the neckband through the metal ring to secure the B-transponder. See Fig. 14.

Fig. 14: Securing the B-transponder

DeLaval activity meter system

Installation

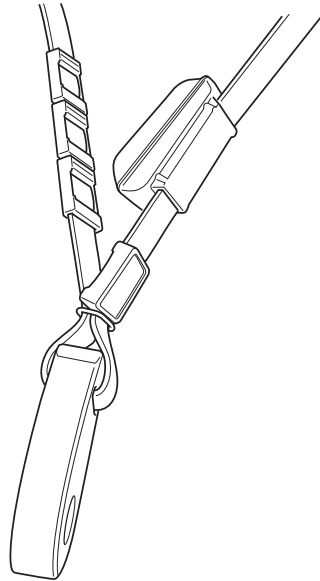

241810

Fig. 15: Threading the activity clip/spacer on the neckband

4. Thread the activity clip/spacer on the neckband. See Fig. 15.

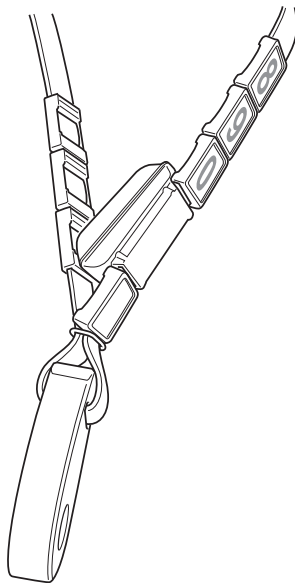

241873

Fig. 16: Threading the number plates on the neckband

5. Thread the number plates on the neckband. See Fig. 16.

DeLaval activity meter system

Installation

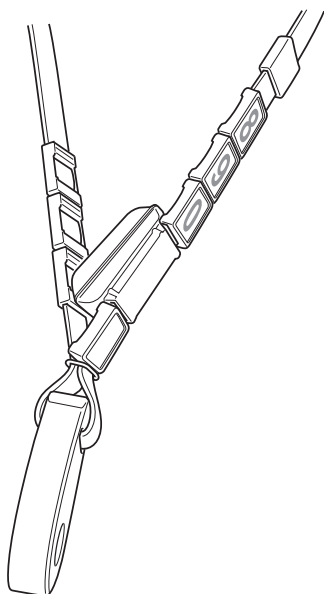

6. Thread the buckle on the neckband. See Fig. 17

241874

Fig. 17: Threading the buckle on the neckband

DeLaval activity meter system

Installation

7. Fold the end of the neckband through the rings. Make sure the end of the neckband is on the inside. See Fig. 11.

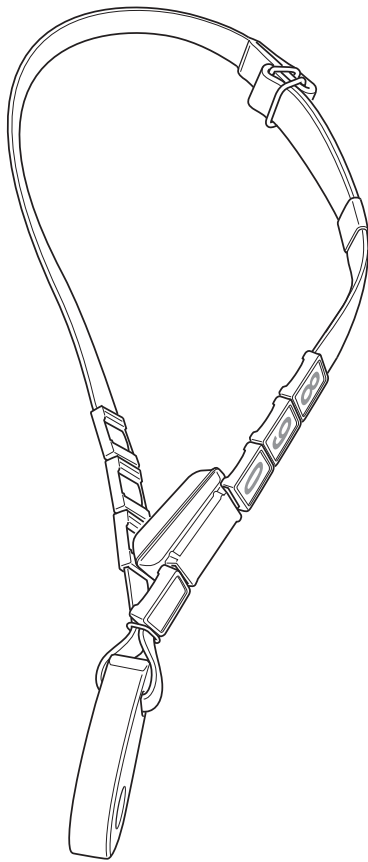

241075

Fig. 18

DeLaval activity meter system

Installation

2 Mounting the DeLaval activity meter on the neckband without B-transponder

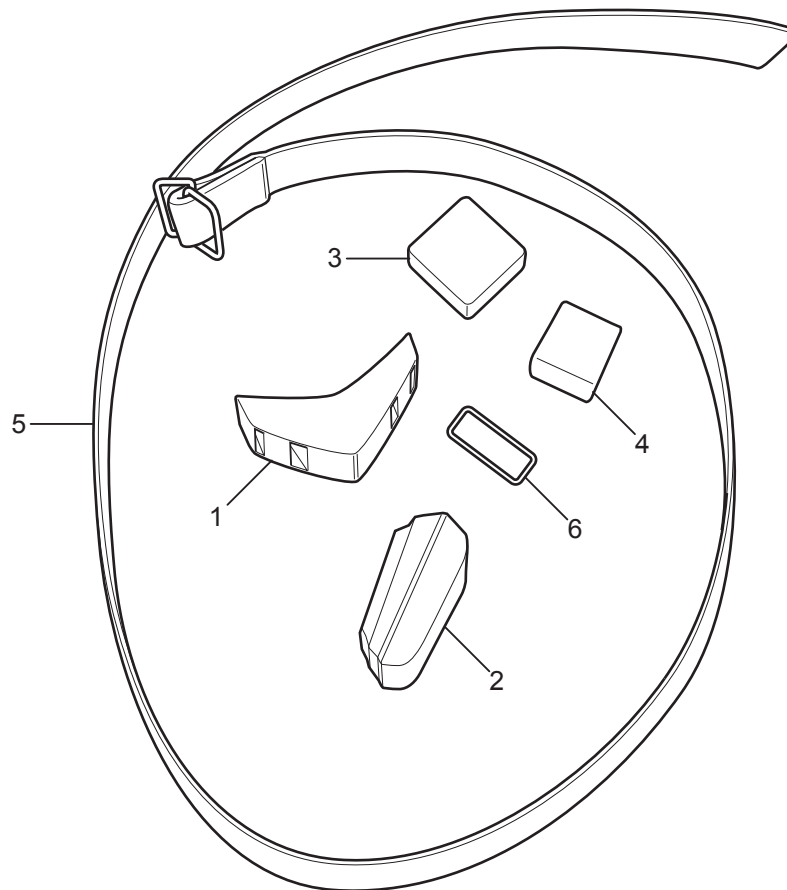

Fig. 19

- 1 Counter weight
- 2 Activity meter
- 3 Activity clip/spacer

- 4 Buckle for the end of the neckband
- 5 Neckband
- 6 Metal ring

The counter weight (see 1 in Fig. 19) should be used on the neckband (see 5 in Fig. 19) when the activity meter (see 2 in Fig. 19) is used without the B-transponder. Its purpose is to hold the activity meter closer to the neck of the cow and to protect the activity meter from wear.

DeLaval activity meter system

Installation

2.1 Assembling the neckband without number plates

1. Pull the neckband through the holes of the counter weight. See Fig. 20.

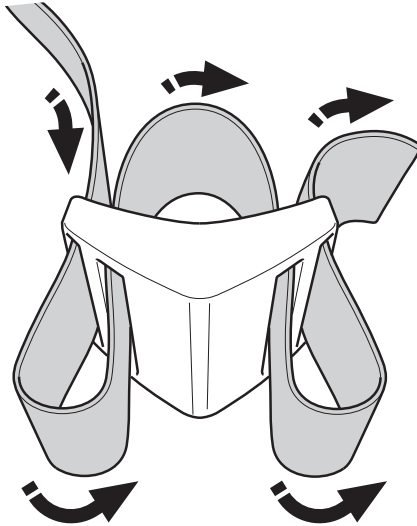

241812

Fig. 20: Pulling the neckband through the counter weight

DeLaval activity meter system

Installation

2. Tighten the neckband on the counter weight. See Fig. 21.

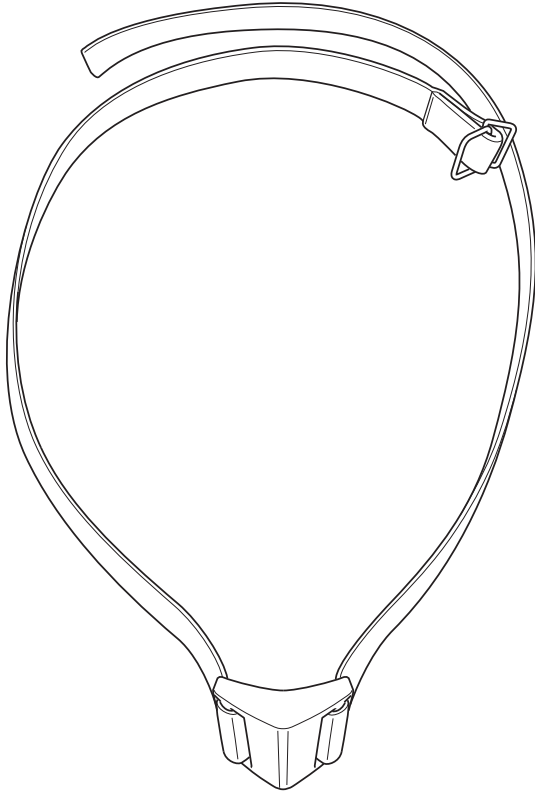

241813

Fig. 21: Neckband tightened on the counter weight

3. Thread the activity clip/spacer on the neckband. See Fig. 22.

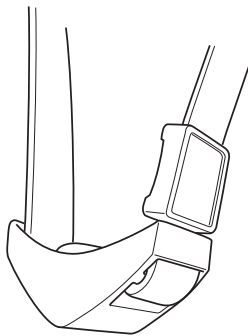

242108

Fig. 22: Threading the activity clip/spacer on the neckband

DeLaval activity meter system

Installation

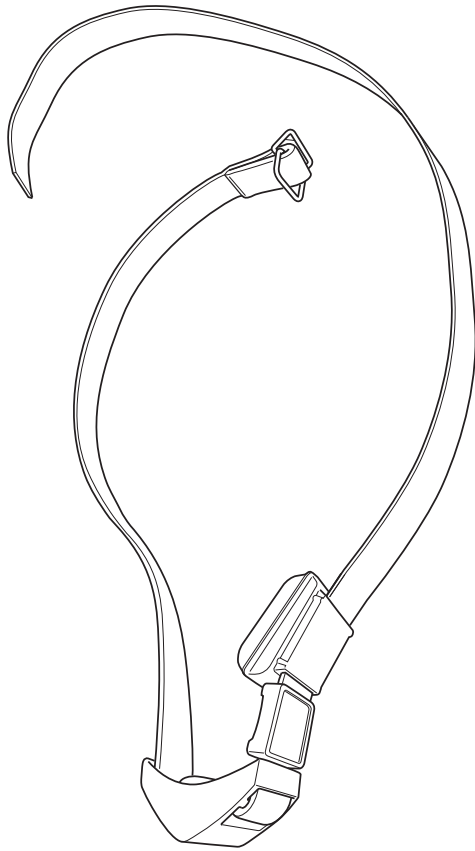

242189

Fig. 23: Threading the activity meter on the neckband

4. Thread the activity meter on the neckband. See Fig. 23.

Note! Make sure that the thickest part of the activity meter is downwards.

Note! Make sure that the activity meter is on the inside of the neckband to prevent wear.

DeLaval activity meter system

Installation

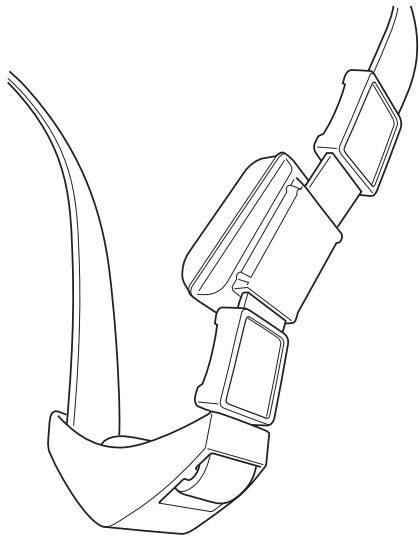

5. A second activity clip/spacer can be added to keep the activity meter from wandering upwards on the neckband. See Fig. 24.

241819

Fig. 24: Threading the second activity clip/spacer on the neckband

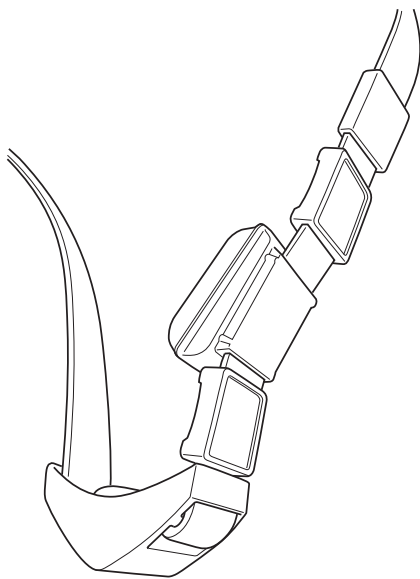

6. Thread the buckle on the neckband. See Fig. 25.

241819

Fig. 25: Threading the buckle on the neckband

DeLaval activity meter system

Installation

7. Fold the end of the neckband through the rings. Make sure that the end of the neckband is on the inside. See Fig. 26.

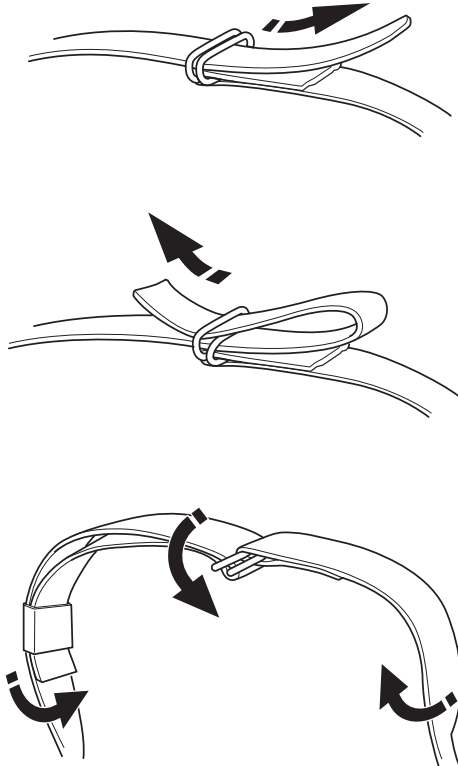

241819

Fig. 26: Folding of the neckband through the rings

DeLaval activity meter system

Installation

2.2 Assembling of the neckband with number plates

1. Thread the number plates on the neckband. See Fig. 27.
2. Thread the counter weight on the neckband. See Fig. 20 and Fig. 21.
3. Thread the activity clip/spacer on the neckband. See Fig. 22.
4. Thread the activity meter on the neckband. See Fig. 23.

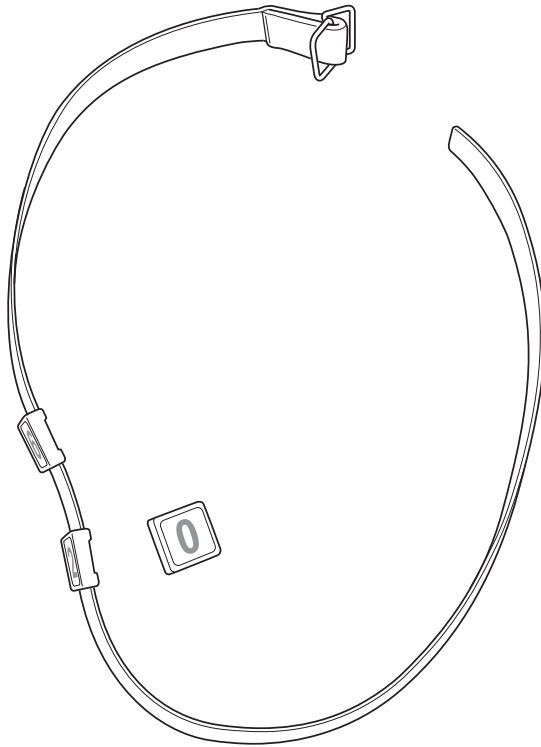

241852

Fig. 27: Threading the number plates on the neckband

DeLaval activity meter system

Installation

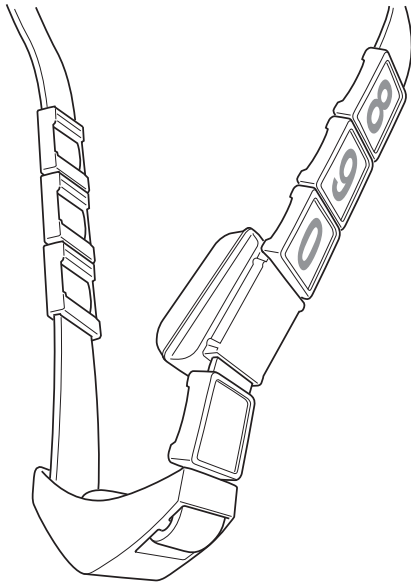

5. Thread the number plates on the neckband after the activity meter. See Fig. 28.
6. Thread the buckle on the neckband. See Fig. 25.

Fig. 28: Threading the number plates on the neckband after the activity meter

DeLaval activity meter system

Installation

7. Fold the end of the neckband through the rings. Make sure the end of the neckband is on the inside. See Fig. 26.



201024

Fig. 29: Neckband with counter weight and number plates

Start up

DeLaval activity meter system

DeLaval activity meter AM2

DeLaval activity receiver AR2

1 Farm management system start up

A general farm management system start up, including the following five steps, should be done before the DeLaval activity meter system start up begins:

1. Farm management software start up.
2. System controller with ALPRO WE start up.
3. Introduction of cows to the system.
4. Checking breeding parameters.
5. Breeding data introduced to the system.

The specific DeLaval activity meter system start up includes:

- To configure the activity receiver in ALPRO/ DelPro.
- To activate the activity meters and mount them on the cows.
- To enter the activity meter numbers to the correct cows in the farm management system.

It is recommended that the activity meter stays permanently mounted on the cow.

2 DeLaval activity meter AM2 start up

Activity meter AM2 is in status OFF when delivered. The activity meter AM2 will be activated (enter ON mode) when exposed to a 131/134 kHz RFID reader signal, for example an ID portal at the milking parlour, a VMS, sort gate or a feeding station with ID reader.

Note! The AM2 does not respond to an RFID reader signal, and will not generate an "unknown" transponder in the herd management system.

DeLaval activity meter system

Start up

Depending on the availability of RFID-readers on the farm, there are two different methods to start up the activity meter: manual or automatic activation.

2.1 Manual activation

For heifers and non-milking animals that will not pass by an RFID reader regularly, the AM2 has to be activated manually before mounting onto the animal. If there is no RFID reader installed on the farm, a Handheld reader (HHR) can be used for activation.

Activation of the AM2

1. Bring the AM2 close to an RFID reader. The activation distance is comparable to ID transponder reading range, approximately 30-40 cm maximum.
2. Keep the AM2 within reading range for about 5 seconds, while slowly turning the activity meter around.

This is to allow successful activation for the activity meters. The RFID sensor of the AM2 is direction sensitive just like any RFID transponder.

There are no restrictions on how many AM2s that can be started within a short time. A random delay at start up will ensure that any number of AM2 does not transmit the hourly activity report at the same time. It means that a full box of 40 AM2 activity meters can all be activated at the same time by bringing the whole box through an RFID reader. The box should be shaken to ensure a successful activation.

As soon as the AM2s are activated but no animal number is yet assigned, these tags will be listed under "Unknown tags" in the herd management system. It is recommended to do a print out and use it to write down the cow numbers while mounting the neckbands with the activity meters on the animals. See [Chapter 3 "Matching activity meter ID number to cow number"](#) on page 38.

Note! *If the AM2 is not moved (not installed) within 48 hours of activation, it will shut off automatically and will have to be activated once again before installation.*

2.2 Automatic activation

This method is convenient for all cows that will pass an RFID reader regularly, for example an ID portal at the milking parlour, a VMS, sort gate or a feeding station with ID reader.

AM2 activity meters are installed on neckbands and mounted onto cows before activation. As the cow then passes an RFID reader, the AM2 will start automatically.

It is recommended to do a print out and use it to write down the cow numbers while mounting the neckbands on the animals. See [Chapter 3 "Matching activity meter ID number to cow number"](#) on page 38.

3 Matching activity meter ID number to cow number

The activity meter serial number is engraved on the grey front part of the AM2. The format is 123 XY 45678. The activity meter ID number used in the system is the 5 digit number (45678) to the right of the two letter date code (XY).

When mounting the activity meters onto the cows the activity meter ID number must be associated with the correct cow. Create a list with the cow numbers and write down the assigned activity meter IDs.

After installation enter the list of activity meter ID numbers in the farm management system.

In DelPro software:

1. Use batch edit "*Animal general*" to add the activity meters to multiple animals, or open the "*Animal card*" for a specific cow and go to the "*General*" tab.
2. Enter the activity meter number in the "*Activity tag number*" field.

In ALPRO Windows:

1. Use "*Batch entry*" and select "*Change Activity Tag*".
2. Enter the activity meter number in the "*Activity tag no*" field.

4 Confirmation of AM2 start up

The activity meter will have status On in the "Activity tag status" field in the "Animal Card → General" after the first activity data message has been received by the herd management system.

An activity meter that has been started but not been correctly matched, or not yet assigned, to a cow will show up as an "Unknown activity meter". For more information see the section [Chapter 1 "General" on page 40](#).

5 Operation

Normal operation of the activity meters involves moving activity meters from one cow to another, replacing faulty or lost activity meters.

The procedures are the same as during system start up.

DeLaval activity meter system

Troubleshooting

Troubleshooting

DeLaval activity meter system

DeLaval activity meter AM2

DeLaval activity receiver AR2

1 General

No.	Symptom	Cause	Action
1	Cow with activity meter does not show any activity data in filters, reports or graphs in the HM software.	The activity meter number has been wrongly entered.	Check the meter number and enter the correct number.
		The cow is out of the range of the antenna.	Move the cow to a group that is closer to the antenna. Move the antenna or install another one to cover the area.
		The activity meter has not been activated and has status OFF in the HM software.	Manual activation by using the Handeld Reader for animals that do not pass by an RFID reader.
		The activity meter is out of battery, or faulty.	Replace the activity meter.
2	Cows showing only zeros in filters, reports and graphs.	The cow has lost the activity meter and will show only zero activity during 48 hours. After 48 hours it will turn the status to OFF.	Replace the activity meter.
3	Several cows do not show activity, or very few activity messages are received.	The activity receiver is not working correctly.	Check status of the AR2 LED indicators: Loss of power or ALCOM bus, no RF messages received can be detected. Replace if necessary.
4	Activity meter number without corresponding cow number will show up in "System → Activity performance".	For one or more cows, the activity meter number has been wrongly entered, or not entered at all.	Check the meter number and enter the correct number.
		The unknown activity meter has not yet been installed.	Install the unknown activity meter.
		The unknown activity meter has been removed from a cow but not yet shut off.	It will automatically shut off after 48 hours of no movements.
		The unknown activity meter belongs to a neighbouring farm.	-

2 DeLaval activity receiver AR2 LED indicators

The LEDs on the front panel indicate what happens:

- Green LED (see A in Fig. 30) is constantly lit when electrical power is on.
- Yellow LED (see C in Fig. 30) is lit when the activity receiver sends or receives a message on the ALCOM bus.
- Red LED (see B in Fig. 30) is lit when there is internal communication in the activity receiver; that is, when a message is received from the antenna.

If the activity receiver receives a message and finds it correct (after validity check), the red LED first flashes once and then the yellow LED flashes once.

There are also messages received that will not be sent on the ALCOM bus. In this case there will be a red LED flash only.

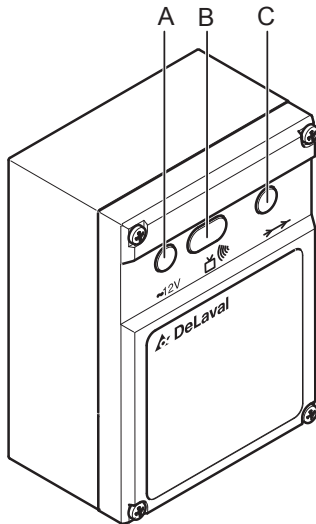

210005

Fig. 30: Front panel LEDs

- A Green LED
- B Red LED
- C Yellow LED

DeLaval activity meter system

Troubleshooting

