

ELECTROMAGNETIC EMISSIONS COMPLIANCE REPORT

INTENTIONAL RADIATOR CERTIFICATION TO FCC PART 22 SUBPART H, PART 24 SUBPART E REQUIREMENT

OF

Applicant: Panasonic Mobile Communications Co., Ltd.
600 Saedo-cho, Tsuzuki-ku, Yokohama-City, Kanagawa,
224-8539, Japan

Product Name: Tablet Computer

Brand Name: Panasonic

Model No.: P-01K

Model Difference: N/A

Report Number: ER/2018/60050

FCC ID: UCE318001A

FCC Rule Part: 2, 22H & 24E

Issue Date: Jun. 29, 2018

Date of Test: Jun. 11, 2018 ~ Jun. 22, 2018

Date of EUT Received: Jun. 11, 2018

We hereby certify that:

The above equipment was tested by SGS Taiwan Ltd. Electronics & Communication Laboratory. The test data, data evaluation, test procedures, and equipment configurations shown in this report were made in accordance with the procedures given in ANSI C63.26-2015 and the energy emitted by the sample EUT tested as described in this report is in compliance with conducted and radiated emission limits.

The test results of this report relate only to the tested sample identified in this report.

Tested By:

Louis Chen / Engineer**Approved By:**

Jim Chang / Asst. Manager

Testing Laboratory

0513

Unless otherwise stated the results shown in this test report refer only to the sample(s) tested and such sample(s) are retained for 90 days only.

除非另有說明，此報告結果僅對測試之樣品負責，同時此樣品僅保留90天。本報告未經本公司書面許可，不可部份複製。

This document is issued by the Company subject to its General Conditions of Service printed overleaf, available on request or accessible at www.sgs.com/terms_and_conditions.htm and, for electronic format documents, subject to Terms and Conditions for Electronic Documents at www.sgs.com/terms_e-document.htm. Attention is drawn to the limitation of liability, indemnification and jurisdiction issues defined therein. Any holder of this document is advised that information contained hereon reflects the Company's findings at the time of its intervention only and within the limits of Client's instructions, if any. The Company's sole responsibility is to its Client and this document does not exonerate parties to a transaction from exercising all their rights and obligations under the transaction documents. This document cannot be reproduced except in full, without prior written approval of the Company. Any unauthorized alteration, forgery or falsification of the content or appearance of this document is unlawful and offenders may be prosecuted to the fullest extent of the law.

SGS Taiwan Ltd.

No. 134, WuKungRoad, NewTaipeiIndustrialPark, WukuDistrict, NewTaipeiCity, Taiwan24803/新北市五股區新北產業園區五工路 134 號

台灣檢驗科技股份有限公司

t (886-2) 2299-3279

f (886-2) 2298-0488

www.tw.sgs.com

Member of SGS Group

Revision History

Report Number	Revision	Description	Effectuated Page	Issue Date	Revised By
ER/2018/60050	Rev.00	Initial creation of document	All	Jun. 29, 2018	Tiffany Kao

Unless otherwise stated the results shown in this test report refer only to the sample(s) tested and such sample(s) are retained for 90 days only.

除非另有說明，此報告結果僅對測試之樣品負責，同時此樣品僅保留90天。本報告未經本公司書面許可，不可部份複製。

This document is issued by the Company subject to its General Conditions of Service printed overleaf, available on request or accessible at www.sgs.com/terms_and_conditions.htm and, for electronic format documents, subject to Terms and Conditions for Electronic Documents at www.sgs.com/terms_e-document.htm. Attention is drawn to the limitation of liability, indemnification and jurisdiction issues defined therein. Any holder of this document is advised that information contained hereon reflects the Company's findings at the time of its intervention only and within the limits of Client's instructions, if any. The Company's sole responsibility is to its Client and this document does not exonerate parties to a transaction from exercising all their rights and obligations under the transaction documents. This document cannot be reproduced except in full, without prior written approval of the Company. Any unauthorized alteration, forgery or falsification of the content or appearance of this document is unlawful and offenders may be prosecuted to the fullest extent of the law.

SGS Taiwan Ltd.

No.134,WuKungRoad,NewTaipeiIndustrialPark,WukuDistrict,NewTaipeiCity,Taiwan24803/新北市五股區新北產業園區五工路 134 號

台灣檢驗科技股份有限公司

t (886-2) 2299-3279

f (886-2) 2298-0488

www.tw.sgs.com

Member of SGS Group

Contents

1. GENERAL PRODUCT INFORMATION	4
2. SYSTEM TEST CONFIGURATION	7
3. SUMMARY OF TEST RESULTS	10
4. DESCRIPTION OF TEST MODES	11
5. MEASUREMENT UNCERTAINTY	14
6. RF CONDUCTED OUTPUT POWER MEASUREMENT	15
7. OCCUPIED BANDWIDTH MEASUREMENT	26
8. OUT OF BAND EMISSION AT ANTENNA TERMINALS	37
9. FIELD STRENGTH OF SPURIOUS RADIATION MEASUREMENT	54
10. FREQUENCY STABILITY MEASUREMENT	81
11. PEAK TO AVERAGE RATIO	85

Unless otherwise stated the results shown in this test report refer only to the sample(s) tested and such sample(s) are retained for 90 days only.

除非另有說明，此報告結果僅對測試之樣品負責，同時此樣品僅保留90天。本報告未經本公司書面許可，不可部份複製。

This document is issued by the Company subject to its General Conditions of Service printed overleaf, available on request or accessible at www.sgs.com/terms_and_conditions.htm and, for electronic format documents, subject to Terms and Conditions for Electronic Documents at www.sgs.com/terms_e-document.htm. Attention is drawn to the limitation of liability, indemnification and jurisdiction issues defined therein. Any holder of this document is advised that information contained hereon reflects the Company's findings at the time of its intervention only and within the limits of Client's instructions, if any. The Company's sole responsibility is to its Client and this document does not exonerate parties to a transaction from exercising all their rights and obligations under the transaction documents. This document cannot be reproduced except in full, without prior written approval of the Company. Any unauthorized alteration, forgery or falsification of the content or appearance of this document is unlawful and offenders may be prosecuted to the fullest extent of the law.

SGS Taiwan Ltd.

No.134,WuKungRoad,NewTaipeiIndustrialPark,WukuDistrict,NewTaipeiCity,Taiwan24803/新北市五股區新北產業園區五工路 134 號

台灣檢驗科技股份有限公司

t (886-2) 2299-3279

f (886-2) 2298-0488

www.tw.sgs.com

Member of SGS Group

1. GENERAL PRODUCT INFORMATION

1.1. Product Description

General:

Product Name:	Tablet Computer	
Brand Name:	Panasonic	
Model No.:	P-01K	
Model Difference:	N/A	
Product SW/HW version:	15-03-021-006 / Rev.C	
Radio SW/HW version:	MSM8909.LA.3.0.1 / Rev.C	
Test SW Version:	N/A	
RF power setting in TEST SW:	N/A	
Power Supply:	3.8V from Rechargeable Li-ion Battery or 5V from AC/DC Adapter	
	Battery:	Model No.: P34, Supplier: Panasonic
	Adapter:	Model No.: 04, Supplier: MITSUMI
Antenna Designation:	PIFA Antenna, Gain: 1.0dBi (GSM 850, LTE B5) 1.5dBi (PCS 1900)	

1.2. GSM / WCDMA / LTE: Standards Frequency Range

Operating Frequency (MHz)	
GSM/GPRS 850	824.2 - 848.8
GSM/GPRS 1900	1850.2 - 1909.8

Operating Frequency (MHz)	
WCDMA / HSPA+ Band V	826.4 - 846.6

LTE Band	BW (MHz)	Operation Frequency (MHz)
5	1.4	824.7 - 848.3
	3	825.5 - 847.5
	5	826.5 - 846.5
	10	829.0 - 844.0

Unless otherwise stated the results shown in this test report refer only to the sample(s) tested and such sample(s) are retained for 90 days only.

除非另有說明，此報告結果僅對測試之樣品負責，同時此樣品僅保留90天。本報告未經本公司書面許可，不可部份複製。

This document is issued by the Company subject to its General Conditions of Service printed overleaf, available on request or accessible at www.sgs.com/terms_and_conditions.htm and, for electronic format documents, subject to Terms and Conditions for Electronic Documents at www.sgs.com/terms_e-document.htm. Attention is drawn to the limitation of liability, indemnification and jurisdiction issues defined therein. Any holder of this document is advised that information contained hereon reflects the Company's findings at the time of its intervention only and within the limits of Client's instructions, if any. The Company's sole responsibility is to its Client and this document does not exonerate parties to a transaction from exercising all their rights and obligations under the transaction documents. This document cannot be reproduced except in full, without prior written approval of the Company. Any unauthorized alteration, forgery or falsification of the content or appearance of this document is unlawful and offenders may be prosecuted to the fullest extent of the law.

1.3. Type of Emission & Max ERP/EIRP Power Measurement Result:

	ERP / EIRP (dBm)		(W)	Type of Emission
GSM 850	33.62	ERP	2.301	246KGXW
GPRS 850	33.62	ERP	2.301	248KGXW
GSM 1900	31.43	EIRP	1.390	250KGXW
GPRS 1900	31.43	EIRP	1.390	248KGXW

	ERP / EIRP (dBm)		(W)	Type of Emission
WCDMA Band V	24.39	ERP	0.275	4M15F9W
HSDPA Band V	23.68	ERP	0.233	4M15F9W
HSUPA Band V	23.47	ERP	0.222	4M14F9W

LTE Band	BW (MHz)	Modulation	ERP (dBm)		(W)	Type of Emission
5	1.4	QPSK	24.68	ERP	0.294	1M10G7D
	1.4	16QAM	23.48	ERP	0.223	1M10W7D
	3	QPSK	24.78	ERP	0.301	2M71G7D
	3	16QAM	23.49	ERP	0.223	2M71W7D
	5	QPSK	24.72	ERP	0.296	4M52G7D
	5	16QAM	22.49	ERP	0.177	4M51W7D
	10	QPSK	24.79	ERP	0.301	9M01G7D
	10	16QAM	23.55	ERP	0.226	8M98W7D

Unless otherwise stated the results shown in this test report refer only to the sample(s) tested and such sample(s) are retained for 90 days only.

除非另有說明，此報告結果僅對測試之樣品負責，同時此樣品僅保留90天。本報告未經本公司書面許可，不可部份複製。

This document is issued by the Company subject to its General Conditions of Service printed overleaf, available on request or accessible at www.sgs.com/terms_and_conditions.htm and, for electronic format documents, subject to Terms and Conditions for Electronic Documents at www.sgs.com/terms_e-document.htm. Attention is drawn to the limitation of liability, indemnification and jurisdiction issues defined therein. Any holder of this document is advised that information contained hereon reflects the Company's findings at the time of its intervention only and within the limits of Client's instructions, if any. The Company's sole responsibility is to its Client and this document does not exonerate parties to a transaction from exercising all their rights and obligations under the transaction documents. This document cannot be reproduced except in full, without prior written approval of the Company. Any unauthorized alteration, forgery or falsification of the content or appearance of this document is unlawful and offenders may be prosecuted to the fullest extent of the law.

SGS Taiwan Ltd.

No.134,WuKungRoad,NewTaipeiIndustrialPark,WukuDistrict,NewTaipeiCity,Taiwan24803/新北市五股區新北產業園區五工路 134 號

台灣檢驗科技股份有限公司

t (886-2) 2299-3279

f (886-2) 2298-0488

www.tw.sgs.com

Member of SGS Group

1.4. Test Methodology of Applied Standards

CC 47 CFR Part 2, 22, 24

ANSI C63.26-2015

KDB971168 D01 Power Meas license Digital System v03

KDB941225 D01 SAR test for 3G devices v03r01 (SAR Measurement Procedures for 3G Devices, WCDMA / HSPA) was used for EUT and Base station setting.

TS 151 010-1 is used to set, and measure the output power.

Note: All test items have been performed and record as per the above standards.

1.5. Test Facility

SGS Taiwan Ltd. Electronics & Communication Laboratory No.134, Wu Kung Road, New Taipei Industrial Park, Wuku District, New Taipei City, Taiwan 24803 code 0513)

FCC Registration Numbers are: 509634 / TW0001

1.6. Special Accessories

No special accessories were used during testing.

1.7. Equipment Modifications

There were no modifications incorporated into the EUT.

Unless otherwise stated the results shown in this test report refer only to the sample(s) tested and such sample(s) are retained for 90 days only.

除非另有說明，此報告結果僅對測試之樣品負責，同時此樣品僅保留90天。本報告未經本公司書面許可，不可部份複製。

This document is issued by the Company subject to its General Conditions of Service printed overleaf, available on request or accessible at www.sgs.com/terms_and_conditions.htm and, for electronic format documents, subject to Terms and Conditions for Electronic Documents at www.sgs.com/terms_e-document.htm. Attention is drawn to the limitation of liability, indemnification and jurisdiction issues defined therein. Any holder of this document is advised that information contained hereon reflects the Company's findings at the time of its intervention only and within the limits of Client's instructions, if any. The Company's sole responsibility is to its Client and this document does not exonerate parties to a transaction from exercising all their rights and obligations under the transaction documents. This document cannot be reproduced except in full, without prior written approval of the Company. Any unauthorized alteration, forgery or falsification of the content or appearance of this document is unlawful and offenders may be prosecuted to the fullest extent of the law.

SGS Taiwan Ltd.

No.134,WuKungRoad,NewTaipeiIndustrialPark,WukuDistrict,NewTaipeiCity,Taiwan24803/新北市五股區新北產業園區五工路 134 號

台灣檢驗科技股份有限公司

t (886-2) 2299-3279

f (886-2) 2298-0488

www.tw.sgs.com

Member of SGS Group

2. SYSTEM TEST CONFIGURATION

2.1. EUT Configuration

The EUT configuration for testing is installed on RF field strength measurement to meet the Commissions requirement and operating in a manner which intends to maximize its emission characteristics in a continuous normal application.

2.2. EUT Exercise

The EUT (Transmitter) was operated in the continuous transmission mode employed with the simulator of the Base Station that fixates at test default channels to fix the Tx frequency which was for the purpose of the measurements.

2.3. Test Procedure

2.3.1 Conducted Measurement at Antenna Port

According to measurement procured ANSI C63.26-2015, the EUT is placed on a turn table which is 0.8 m above ground plane. A low loss of RF cable was used to connect the antenna port of EUT to measurement equipment.

2.3.2 Radiated Emissions (ERP/EIRP)

According to measurement procured ANSI C63.26-2015, The EUT is a placed on as turn table, for emission measurements below 1 GHz is 0.8 m above ground plane, for emission measurements above 1 GHz, the table height shall be 1.5 m. The turn table shall rotate 360 degrees to determine the position of maximum emission level. EUT is set 3m away from the receiving antenna which varied from 1m to 4m to find out the highest emission. And also, each emission was to be maximized by changing the polarization of receiving antenna both Horizontal and Vertical. In order to find out the max. emission, the relative positions of this hand-held transmitter (EUT) was rotated through three orthogonal axes and measurement procedures for electric field radiated emissions above 1 GHz the EUT measurement is to be made "while keeping the antenna in the 'cone of radiation' from that area and pointed at the area both in azimuth and elevation, with polarization oriented for maximum response." is still within the 3dB illumination BW of the measurement antenna according to the requirements in Section 8 and 13.

2.4. Measurement Results Explanation Example

For all conducted test items:

The offset level is set in the spectrum analyzer to compensate the RF cable loss and attenuation factor between EUT conducted port and spectrum analyzer. With the offset compensation, the spectrum analyzer reading level is exactly EUT RF output level.

Unless otherwise stated the results shown in this test report refer only to the sample(s) tested and such sample(s) are retained for 90 days only.

除非另有說明，此報告結果僅對測試之樣品負責，同時此樣品僅保留90天。本報告未經本公司書面許可，不可部份複製。

This document is issued by the Company subject to its General Conditions of Service printed overleaf, available on request or accessible at www.sgs.com/terms_and_conditions.htm and, for electronic format documents, subject to Terms and Conditions for Electronic Documents at www.sgs.com/terms_e-document.htm. Attention is drawn to the limitation of liability, indemnification and jurisdiction issues defined therein. Any holder of this document is advised that information contained hereon reflects the Company's findings at the time of its intervention only and within the limits of Client's instructions, if any. The Company's sole responsibility is to its Client and this document does not exonerate parties to a transaction from exercising all their rights and obligations under the transaction documents. This document cannot be reproduced except in full, without prior written approval of the Company. Any unauthorized alteration, forgery or falsification of the content or appearance of this document is unlawful and offenders may be prosecuted to the fullest extent of the law.

SGS Taiwan Ltd.

台灣檢驗科技股份有限公司

No.134,WuKungRoad,NewTaipeiIndustrialPark,WukuDistrict,NewTaipeiCity,Taiwan24803/新北市五股區新北產業園區五工路 134 號

t (886-2) 2299-3279

f (886-2) 2298-0488

www.tw.sgs.com

Member of SGS Group

Note:

The spectrum analyzer offset is derived from RF cable loss and attenuator factor.
Following shows an offset computation in physical test.

	RF cable loss (dB)	Attenuation factor(dB)	offset(dB)
Low Band (Below 1GHz)	4.8	10	14.8
High Band (Above 1 GHz)	6.2	10	16.2

2.5. Final Amplifier Voltage and Current Information:

Test Mode	DC voltage (V)	DC current (mA)
GSM 850	3.8	833
GPRS 850		842
GSM 1900		824
GPRS 1900		812
WCDMA B5		839
HSDPA B5		805
HSUPA B5		815
LTE Band 5		865

Unless otherwise stated the results shown in this test report refer only to the sample(s) tested and such sample(s) are retained for 90 days only.

除非另有說明，此報告結果僅對測試之樣品負責，同時此樣品僅保留90天。本報告未經本公司書面許可，不可部份複製。

This document is issued by the Company subject to its General Conditions of Service printed overleaf, available on request or accessible at www.sgs.com/terms_and_conditions.htm and, for electronic format documents, subject to Terms and Conditions for Electronic Documents at www.sgs.com/terms_e-document.htm. Attention is drawn to the limitation of liability, indemnification and jurisdiction issues defined therein. Any holder of this document is advised that information contained hereon reflects the Company's findings at the time of its intervention only and within the limits of Client's instructions, if any. The Company's sole responsibility is to its Client and this document does not exonerate parties to a transaction from exercising all their rights and obligations under the transaction documents. This document cannot be reproduced except in full, without prior written approval of the Company. Any unauthorized alteration, forgery or falsification of the content or appearance of this document is unlawful and offenders may be prosecuted to the fullest extent of the law.

SGS Taiwan Ltd.

No.134,WuKungRoad,NewTaipeiIndustrialPark,WukuDistrict,NewTaipeiCity,Taiwan24803/新北市五股區新北產業園區五工路 134 號

台灣檢驗科技股份有限公司

t (886-2) 2299-3279

f (886-2) 2298-0488

www.tw.sgs.com

Member of SGS Group

2.6. Configuration of Tested System

Fig. 2-1 Configuration of Tested System (Fixed Channel-Conducted)

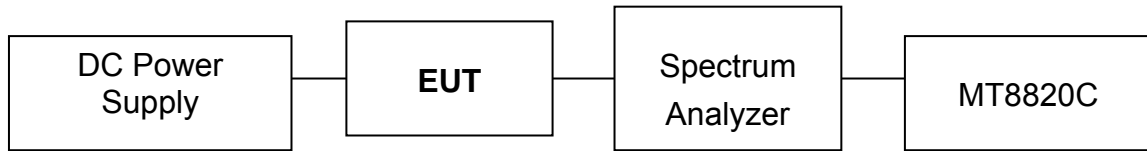

Fig. 2-2 Configuration of Tested System (Fixed Channel-Radiated)

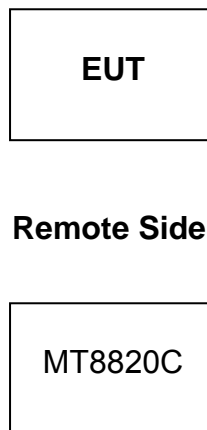

Table 2-1 Equipment Used in

Item	Equipment	Mfr/Brand	Model/ Type No.	Series No.	Data Cable	Power Cord
1.	Radio Communication Analyzer	Anritsu	MT8820C	6201465317	shielded	Un-shielded

Unless otherwise stated the results shown in this test report refer only to the sample(s) tested and such sample(s) are retained for 90 days only.

除非另有說明，此報告結果僅對測試之樣品負責，同時此樣品僅保留90天。本報告未經本公司書面許可，不可部份複製。

This document is issued by the Company subject to its General Conditions of Service printed overleaf, available on request or accessible at www.sgs.com/terms_and_conditions.htm and, for electronic format documents, subject to Terms and Conditions for Electronic Documents at www.sgs.com/terms_e-document.htm. Attention is drawn to the limitation of liability, indemnification and jurisdiction issues defined therein. Any holder of this document is advised that information contained hereon reflects the Company's findings at the time of its intervention only and within the limits of Client's instructions, if any. The Company's sole responsibility is to its Client and this document does not exonerate parties to a transaction from exercising all their rights and obligations under the transaction documents. This document cannot be reproduced except in full, without prior written approval of the Company. Any unauthorized alteration, forgery or falsification of the content or appearance of this document is unlawful and offenders may be prosecuted to the fullest extent of the law.

SGS Taiwan Ltd.

No.134,WuKungRoad,NewTaipeiIndustrialPark,WukuDistrict,NewTaipeiCity,Taiwan24803/新北市五股區新北產業園區五工路 134 號

台灣檢驗科技股份有限公司

t (886-2) 2299-3279

f (886-2) 2298-0488

www.tw.sgs.com

Member of SGS Group

3. SUMMARY OF TEST RESULTS

FCC Rules	Description Of Test	Result
§2.1046(a)	RF Power Output	Compliant
§2.1046(a) §22.913(a)(5) §24.232(c)	ERP/ EIRP measurement	Compliant
§2.1049(h)	99% & 26dB Occupied Bandwidth	Compliant
§2.1051 §22.917(a) §24.238(a)	Out of Band Emissions at Antenna Terminals and Band Edge / Emission mask requirements	Compliant
§2.1053 §22.917(a) §24.238(a)	Field Strength of Spurious Radiation	Compliant
§24.232(d)	Peak to Average Ratio	Compliant
§2.1055(a)(1) §22.355 §24.235	Frequency Stability	Compliant

Unless otherwise stated the results shown in this test report refer only to the sample(s) tested and such sample(s) are retained for 90 days only.

除非另有說明，此報告結果僅對測試之樣品負責，同時此樣品僅保留90天。本報告未經本公司書面許可，不可部份複製。

This document is issued by the Company subject to its General Conditions of Service printed overleaf, available on request or accessible at www.sgs.com/terms_and_conditions.htm and, for electronic format documents, subject to Terms and Conditions for Electronic Documents at www.sgs.com/terms_e-document.htm. Attention is drawn to the limitation of liability, indemnification and jurisdiction issues defined therein. Any holder of this document is advised that information contained hereon reflects the Company's findings at the time of its intervention only and within the limits of Client's instructions, if any. The Company's sole responsibility is to its Client and this document does not exonerate parties to a transaction from exercising all their rights and obligations under the transaction documents. This document cannot be reproduced except in full, without prior written approval of the Company. Any unauthorized alteration, forgery or falsification of the content or appearance of this document is unlawful and offenders may be prosecuted to the fullest extent of the law.

SGS Taiwan Ltd.

No.134,WuKungRoad,NewTaipeiIndustrialPark,WukuDistrict,NewTaipeiCity,Taiwan24803/新北市五股區新北產業園區五工路 134 號

台灣檢驗科技股份有限公司

t (886-2) 2299-3279

f (886-2) 2298-0488

www.tw.sgs.com

Member of SGS Group

4. DESCRIPTION OF TEST MODES

4.1. The Worst Test Modes and Channel Details

1. The EUT has been tested under operating condition.
2. Pre-Scan has been conducted to determine the worst-case mode from all possible combinations between available modulations, data rates, X(E1)Y(E2)Z(H) axis and antenna ports. The worst case was found as listed below. Following channel(s) was (were) selected for the final test as listed below:

BAND	ERP/EIRP	RADIATED EMISSION
GSM/GPRS 850	H-plan	H-plan
GSM/GPRS 1900	H-plan	H-plan
WCDMA/HSPA Band V	H-plan	H-plan
LTE Band 5	H-plan	H-plan

Unless otherwise stated the results shown in this test report refer only to the sample(s) tested and such sample(s) are retained for 90 days only.

除非另有說明，此報告結果僅對測試之樣品負責，同時此樣品僅保留90天。本報告未經本公司書面許可，不可部份複製。

This document is issued by the Company subject to its General Conditions of Service printed overleaf, available on request or accessible at www.sgs.com/terms_and_conditions.htm and, for electronic format documents, subject to Terms and Conditions for Electronic Documents at www.sgs.com/terms_e-document.htm. Attention is drawn to the limitation of liability, indemnification and jurisdiction issues defined therein. Any holder of this document is advised that information contained hereon reflects the Company's findings at the time of its intervention only and within the limits of Client's instructions, if any. The Company's sole responsibility is to its Client and this document does not exonerate parties to a transaction from exercising all their rights and obligations under the transaction documents. This document cannot be reproduced except in full, without prior written approval of the Company. Any unauthorized alteration, forgery or falsification of the content or appearance of this document is unlawful and offenders may be prosecuted to the fullest extent of the law.

SGS Taiwan Ltd.

No.134,WuKungRoad,NewTaipeiIndustrialPark,WukuDistrict,NewTaipeiCity,Taiwan24803/新北市五股區新北產業園區五工路 134 號

台灣檢驗科技股份有限公司

t (886-2) 2299-3279

f (886-2) 2298-0488

www.tw.sgs.com

Member of SGS Group

GSM/GPRS MODE

TEST ITEM	AVAILABLE CHANNEL	TESTED CHANNEL	MODE
ERP	128 to 251	128, 190, 251	GSM/GPRS 850
EIRP	512 to 810	512, 661, 810	GSM/GPRS 1900
FREQUENCY STABILITY	128 to 251 512 to 810	190 661	GPRS 850 GPRS 1900
OCCUPIED BANDWIDTH	128 to 251 512 to 810	190 661	GSM/GPRS 850 GSM/GPRS 1900
PEAK TO AVERAGE RATIO	128 to 251 512 to 810	128, 190, 251 512, 661, 810	GSM/GPRS 850 GSM/GPRS 1900
BAND EDGE	128 to 251 512 to 810	128, 251 512, 810	GSM/GPRS 850 GSM/GPRS 1900
CONDCUDED EMISSION	128 to 251 512 to 810	128, 190, 251 512, 661, 810	GSM/GPRS 850 GSM/GPRS 1900
RADIATED EMISSION	128 to 251 512 to 810	128, 190, 251 512, 661, 810	GSM 850 GSM 1900

WCDMA/HSPA MODE

TEST ITEM	AVAILABLE CHANNEL	TESTED CHANNEL	MODE
ERP	4132 to 4233	4132, 4183, 4233	WCDMA/HSPA Band V
FREQUENCY STABILITY	9262 to 9538	9400	WCDMA Band V
OCCUPIED BANDWIDTH	9262 to 9538	9262, 9400, 9583	WCDMA/HSPA Band V
PEAK TO AVERAGE RATIO	9262 to 9538	9262, 9400, 9583	WCDMA/HSPA Band V
BAND EDGE	9262 to 9538	9262, 9583	WCDMA Band V
CONDCUDED EMISSION	9262 to 9538	9262, 9400, 9583	WCDMA Band V
RADIATED EMISSION	9262 to 9538	9262, 9400, 9583	WCDMA Band V

Unless otherwise stated the results shown in this test report refer only to the sample(s) tested and such sample(s) are retained for 90 days only.

除非另有說明，此報告結果僅對測試之樣品負責，同時此樣品僅保留90天。本報告未經本公司書面許可，不可部份複製。

This document is issued by the Company subject to its General Conditions of Service printed overleaf, available on request or accessible at www.sgs.com/terms_and_conditions.htm and, for electronic format documents, subject to Terms and Conditions for Electronic Documents at www.sgs.com/terms_e-document.htm. Attention is drawn to the limitation of liability, indemnification and jurisdiction issues defined therein. Any holder of this document is advised that information contained hereon reflects the Company's findings at the time of its intervention only and within the limits of Client's instructions, if any. The Company's sole responsibility is to its Client and this document does not exonerate parties to a transaction from exercising all their rights and obligations under the transaction documents. This document cannot be reproduced except in full, without prior written approval of the Company. Any unauthorized alteration, forgery or falsification of the content or appearance of this document is unlawful and offenders may be prosecuted to the fullest extent of the law.

SGS Taiwan Ltd.

No.134,WuKungRoad,NewTaipeiIndustrialPark,WukuDistrict,NewTaipeiCity,Taiwan24803/新北市五股區新北產業園區五工路 134 號

台灣檢驗科技股份有限公司

t (886-2) 2299-3279

f (886-2) 2298-0488

www.tw.sgs.com

Member of SGS Group

LTE Band 5 MODE

TEST ITEM	AVAILABLE CHANNEL	TESTED CHANNEL	CHANNEL BANDWIDTH	MODULATION	MODE
ERP	20470 to 20643	20470, 20525, 20643	1.4MHz	QPSK, 16QAM	1 RB/ 0,5 RB Offest
	20415 to 20635	20415, 20525, 20635	3MHz	QPSK, 16QAM	1 RB/ 0,14 RB Offest
	20425 to 20625	20425, 20525, 20625	5MHz	QPSK, 16QAM	1 RB/ 0,24 RB Offest
	20450 to 20600	20450, 20525, 20600	10MHz	QPSK, 16QAM	1 RB/ 0,49 RB Offest
FREQUENCY STABILITY	20450 to 20600	20525	10MHz	QPSK	Full RB
OCCUPIED BAND-WIDTH	20470 to 20643	20470, 20525, 20643	1.4MHz	QPSK, 16QAM	Full RB
	20415 to 20635	20415, 20525, 20635	3MHz	QPSK, 16QAM	Full RB
	20425 to 20625	20425, 20525, 20625	5MHz	QPSK, 16QAM	Full RB
	20450 to 20600	20450, 20525, 20600	10MHz	QPSK, 16QAM	Full RB
PEAK TO AVERAGE RATIO	20470 to 20643	20470, 20525, 20643	1.4MHz	16QAM	Full RB
	20415 to 20635	20415, 20525, 20635	3MHz	16QAM	Full RB
	20425 to 20625	20425, 20525, 20625	5MHz	16QAM	Full RB
	20450 to 20600	20450, 20525, 20600	10MHz	16QAM	Full RB
BAND EDGE	20470 to 20643	20470, 20643	1.4MHz	QPSK	1 RB/ 0,5 RB Offes Full RB
	20415 to 20635	20415, 20635	3MHz	QPSK	1 RB/ 0,14 RB Offest Full RB
	20425 to 20625	20425, 20625	5MHz	QPSK	1 RB/ 0,24 RB Offest Full RB
	20450 to 20600	20450, 20600	10MHz	QPSK	1 RB/ 0,49 RB Offest Full RB
CONDCUETED EMISSION	20470 to 20643	20470, 20525, 20643	1.4MHz	QPSK	1 RB, 0 RB Offest
	20415 to 20635	20415, 20525, 20635	3MHz	QPSK	1 RB, 0 RB Offest
	20425 to 20625	20425, 20525, 20625	5MHz	QPSK	1 RB, 0 RB Offest
	20450 to 20600	20450, 20525, 20600	10MHz	QPSK	1 RB, 0 RB Offest
RADIATED EMISSION	20450 to 20600	20450, 20525, 20600	10MHz	QPSK	1 RB, 0 RB Offest

Unless otherwise stated the results shown in this test report refer only to the sample(s) tested and such sample(s) are retained for 90 days only.

除非另有說明，此報告結果僅對測試之樣品負責，同時此樣品僅保留90天。本報告未經本公司書面許可，不可部份複製。

This document is issued by the Company subject to its General Conditions of Service printed overleaf, available on request or accessible at www.sgs.com/terms_and_conditions.htm and, for electronic format documents, subject to Terms and Conditions for Electronic Documents at www.sgs.com/terms_e-document.htm. Attention is drawn to the limitation of liability, indemnification and jurisdiction issues defined therein. Any holder of this document is advised that information contained hereon reflects the Company's findings at the time of its intervention only and within the limits of Client's instructions, if any. The Company's sole responsibility is to its Client and this document does not exonerate parties to a transaction from exercising all their rights and obligations under the transaction documents. This document cannot be reproduced except in full, without prior written approval of the Company. Any unauthorized alteration, forgery or falsification of the content or appearance of this document is unlawful and offenders may be prosecuted to the fullest extent of the law.

SGS Taiwan Ltd.

No.134,WuKungRoad,NewTaipeiIndustrialPark,WukuDistrict,NewTaipeiCity,Taiwan24803/新北市五股區新北產業園區五工路 134 號

台灣檢驗科技股份有限公司

t (886-2) 2299-3279

f (886-2) 2298-0488

www.tw.sgs.com

Member of SGS Group

5. MEASUREMENT UNCERTAINTY

Test Items	Uncertainty
RF Power Output	+/- 1.10 dB
ERP/ EIRP measurement	Vertical Polarization = +/- 4.74dB Horizontal Polarization = +/- 4.62dB
99% Occupied Bandwidth	+/- 5.19 Hz
Out of Band Emissions at Antenna Terminals and Band Edge	+/- 0.70 dB
Peak to Average Ratio	+/- 0.70 dB
Frequency Stability vs. Temperature	+/- 5.19 Hz
Frequency Stability vs. Voltage	+/- 5.19 Hz
Temperature	+/- 0.65 °C
Humidity	+/- 4.6 %
DC / AC Power Source	DC= +/- 0.13%, AC= +/- 0.2%

Radiated Spurious Emission:

Measurement uncertainty (Polarization : Vertical)	9kHz – 30MHz: +/- 2.87 dB
	30MHz - 180MHz: +/- 3.37dB
	180MHz -417MHz: +/- 3.19dB
	0.417GHz-1GHz: +/- 3.19dB
	1GHz - 18GHz: +/- 4.04dB
	18GHz - 40GHz: +/- 4.04dB

Measurement uncertainty (Polarization : Horizontal)	9kHz – 30MHz: +/- 2.87 dB
	30MHz - 167MHz: +/- 4.22dB
	167MHz -500MHz: +/- 3.44dB
	0.5GHz-1GHz: +/- 3.39dB
	1GHz - 18GHz: +/- 4.08dB
	18GHz - 40GHz: +/- 4.08dB

This uncertainty represents an expanded uncertainty expressed at approximately the 95% confidence level using a coverage factor of k=2.

Unless otherwise stated the results shown in this test report refer only to the sample(s) tested and such sample(s) are retained for 90 days only.

除非另有說明，此報告結果僅對測試之樣品負責，同時此樣品僅保留90天。本報告未經本公司書面許可，不可部份複製。

This document is issued by the Company subject to its General Conditions of Service printed overleaf, available on request or accessible at www.sgs.com/terms_and_conditions.htm and, for electronic format documents, subject to Terms and Conditions for Electronic Documents at www.sgs.com/terms_e-document.htm. Attention is drawn to the limitation of liability, indemnification and jurisdiction issues defined therein. Any holder of this document is advised that information contained hereon reflects the Company's findings at the time of its intervention only and within the limits of Client's instructions, if any. The Company's sole responsibility is to its Client and this document does not exonerate parties to a transaction from exercising all their rights and obligations under the transaction documents. This document cannot be reproduced except in full, without prior written approval of the Company. Any unauthorized alteration, forgery or falsification of the content or appearance of this document is unlawful and offenders may be prosecuted to the fullest extent of the law.

6. RF CONDUCTED OUTPUT POWER MEASUREMENT

6.1. Standard Applicable

A base station simulator was used to establish communication with the EUT. Its parameters were set to transmit the maximum power on the EUT. The measured power in the radio frequency on the transmitter output terminals.

ERP/EIRP LIMIT

According to FCC §2.1046

FCC 22.913(a) Mobile station is limited to 7W ERP.

FCC 24.232(b) Mobile and portable stations are limited to 2 W EIRP.

6.2. Test Set-up

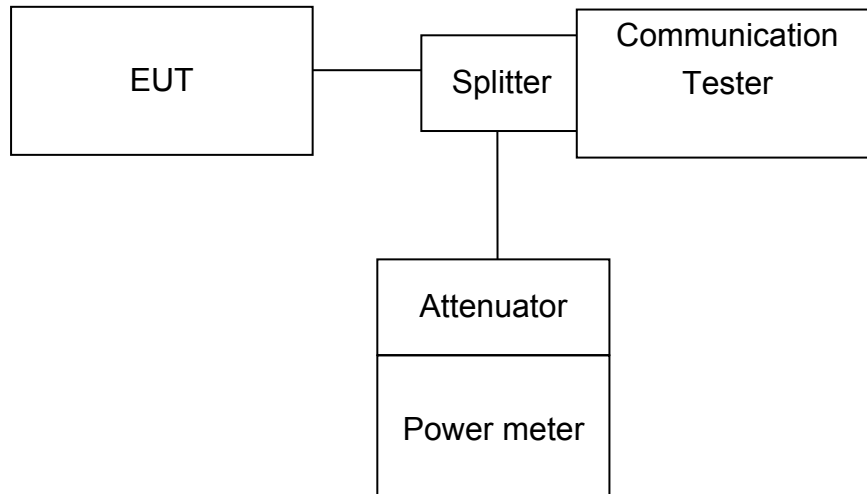

Note: Measurement setup for testing on Antenna connector

Unless otherwise stated the results shown in this test report refer only to the sample(s) tested and such sample(s) are retained for 90 days only.

除非另有說明，此報告結果僅對測試之樣品負責，同時此樣品僅保留90天。本報告未經本公司書面許可，不可部份複製。

This document is issued by the Company subject to its General Conditions of Service printed overleaf, available on request or accessible at www.sgs.com/terms_and_conditions.htm and, for electronic format documents, subject to Terms and Conditions for Electronic Documents at www.sgs.com/terms_e-document.htm. Attention is drawn to the limitation of liability, indemnification and jurisdiction issues defined therein. Any holder of this document is advised that information contained hereon reflects the Company's findings at the time of its intervention only and within the limits of Client's instructions, if any. The Company's sole responsibility is to its Client and this document does not exonerate parties to a transaction from exercising all their rights and obligations under the transaction documents. This document cannot be reproduced except in full, without prior written approval of the Company. Any unauthorized alteration, forgery or falsification of the content or appearance of this document is unlawful and offenders may be prosecuted to the fullest extent of the law.

SGS Taiwan Ltd.

No.134,WuKungRoad,NewTaipeiIndustrialPark,WukuDistrict,NewTaipeiCity,Taiwan24803/新北市五股區新北產業園區五工路 134 號

台灣檢驗科技股份有限公司

t (886-2) 2299-3279

f (886-2) 2298-0488

www.tw.sgs.com

Member of SGS Group

6.3. Measurement Procedure

The transmitter output was connected to a calibrated attenuator, the other end of which was connected to a power meter. Transmitter output was read off the power meter in dBm. The power output at the transmitter antenna port was determined by adding the value of the attenuator to the power meter reading. TS 151 010-1 is reference to conduct the test measurement of output power.

The Procedure of KDB941225 (SAR Measurement Procedures for 3G devices, (WCD-MA/HSPA) was used for EUT and Base station setting. RMC 12.2kps is used for this testing, and KDB 971168 D01 Power Meas License Digital System as the supplemental test methodology to adjust the proper setting obtaining the measurement results

All LTE bands conducted average power is obtained from the simulator telecommunication test set.

The following tests were conducted according to the test requirements outlined in section 6.2 of the 3GPP.

EIRP TEST PROCEDURE:

ANSI C63.26:2015

KDB 971168 Section 5.6

$$ERP/EIRP = P_{Meas} + GT-LC$$

where: ERP/EIRP = effective or equivalent radiated power, respectively (expressed in the same units as P_{Meas} , typically dBW or dBm);

P_{Meas} = measured transmitter output power or PSD, in dBm or dBW;

GT = gain of the transmitting antenna, in dBd (ERP) or dBi (EIRP);

LC = signal attenuation in the connecting cable between the transmitter and antenna, in dB.2

For devices utilizing multiple antennas, KDB 662911 provides guidance for determining the effective array transmit antenna gain term to be used in the above equation.

Unless otherwise stated the results shown in this test report refer only to the sample(s) tested and such sample(s) are retained for 90 days only.

除非另有說明，此報告結果僅對測試之樣品負責，同時此樣品僅保留90天。本報告未經本公司書面許可，不可部份複製。

This document is issued by the Company subject to its General Conditions of Service printed overleaf, available on request or accessible at www.sgs.com/terms_and_conditions.htm and, for electronic format documents, subject to Terms and Conditions for Electronic Documents at www.sgs.com/terms_e-document.htm. Attention is drawn to the limitation of liability, indemnification and jurisdiction issues defined therein. Any holder of this document is advised that information contained hereon reflects the Company's findings at the time of its intervention only and within the limits of Client's instructions, if any. The Company's sole responsibility is to its Client and this document does not exonerate parties to a transaction from exercising all their rights and obligations under the transaction documents. This document cannot be reproduced except in full, without prior written approval of the Company. Any unauthorized alteration, forgery or falsification of the content or appearance of this document is unlawful and offenders may be prosecuted to the fullest extent of the law.

SGS Taiwan Ltd.

台灣檢驗科技股份有限公司

No.134,WuKungRoad,NewTaipeiIndustrialPark,WukuDistrict,NewTaipeiCity,Taiwan24803/新北市五股區新北產業園區五工路 134 號

t (886-2) 2299-3279

f (886-2) 2298-0488

www.tw.sgs.com

Member of SGS Group

6.4. Measurement Equipment Used

EQUIPMENT TYPE	MFR	MODEL NUMBER	SERIAL NUMBER	LAST CAL.	CAL DUE.
Radio Communication Analyser	Anritsu	MT8815B	6200711454	2018/04/05	2019/04/04
Radio Communication Analyser	Anritsu	MT8820C	6200995019	2018/04/05	2019/04/04
DC Power Supply	Anritsu	E3640A	MY52410006	2017/11/28	2018/11/27
Attenuator	Mini-Circuit	BW-S10W2+	2	2018/01/02	2019/01/01
Coaxial Cables	N/A	WK CE Cable	N/A	2018/01/02	2019/01/01

6.5. Measurement Result

RF Conducted Output Power

GSM/GPRS/EDGE (GMSK; 8-PSK) Result:

GSM/GPRS/EDGE (GMSK; 8-PSK) Result:

EUT Mode	Freq. (MHz)	CH	Conducted Avg. Power (dBm)	Antenna Gain (dBi)	ERP / EIRP (dBm)	Limit (dBm)	Margin (dB)
GSM 850	824.2	128	32.42	1	33.42	38.5	-5.08
	836.6	190	32.62	1	33.62	38.5	-4.88
	848.8	251	32.53	1	33.53	38.5	-4.97
GPRS 850	824.2	128	32.42	1	33.42	38.5	-5.08
	836.6	190	32.62	1	33.62	38.5	-4.88
	848.8	251	32.53	1	33.53	38.5	-4.97
GSM 1900	1850.2	512	29.93	1.5	31.43	33	-1.57
	1880.0	661	29.9	1.5	31.4	33	-1.6
	1909.8	810	29.86	1.5	31.36	33	-1.64
GPRS 1900	1850.2	512	29.93	1.5	31.43	34	-2.57
	1880.0	661	29.9	1.5	31.4	35	-3.6
	1909.8	810	29.86	1.5	31.36	36	-4.64

Unless otherwise stated the results shown in this test report refer only to the sample(s) tested and such sample(s) are retained for 90 days only.

除非另有說明，此報告結果僅對測試之樣品負責，同時此樣品僅保留90天。本報告未經本公司書面許可，不可部份複製。

This document is issued by the Company subject to its General Conditions of Service printed overleaf, available on request or accessible at www.sgs.com/terms_and_conditions.htm and, for electronic format documents, subject to Terms and Conditions for Electronic Documents at www.sgs.com/terms_e-document.htm. Attention is drawn to the limitation of liability, indemnification and jurisdiction issues defined therein. Any holder of this document is advised that information contained hereon reflects the Company's findings at the time of its intervention only and within the limits of Client's instructions, if any. The Company's sole responsibility is to its Client and this document does not exonerate parties to a transaction from exercising all their rights and obligations under the transaction documents. This document cannot be reproduced except in full, without prior written approval of the Company. Any unauthorized alteration, forgery or falsification of the content or appearance of this document is unlawful and offenders may be prosecuted to the fullest extent of the law.

SGS Taiwan Ltd.

No.134,WuKungRoad,NewTaipeiIndustrialPark,WukuDistrict,NewTaipeiCity,Taiwan24803/新北市五股區新北產業園區五工路 134 號

台灣檢驗科技股份有限公司

t (886-2) 2299-3279

f (886-2) 2298-0488

www.tw.sgs.com

Member of SGS Group

EUT Mode	Frequency (MHz)	CH	Average Burst Power (1DN 1UP) Class 8 (dBm)	Average Burst Power (1DN 2UP) Class 10 (dBm)	Average Burst Power (1DN 3UP) Class 12 (dBm)	Average Burst Power (1DN 4UP) Class 12 (dBm)
GPRS 850	824.2	128	32.42	30.47	28.72	26.53
	836.6	190	32.62	30.69	28.74	26.8
	848.8	251	32.53	30.64	28.91	26.99
GPRS 1900	1850.2	512	29.93	27.83	25.94	24.48
	1880.0	661	29.9	27.77	25.97	24.39
	1909.8	810	29.86	27.79	25.95	24.45

WCDMA MODE:

The following tests were completed according to the test requirements outlined in section 5.2 of the 3GPP TS34.121-1 V8.4.0 specification. The EUT supports power Class 3, which has a nominal maximum output power of 24 dBm (+1.7/-3.7). RMC 12.2kps is used for this testing.

Results:

WCDMA/HSUPA/HSDPA Band V Result:

EUT Mode	Freq. (MHz)	CH	Conducted Avg. Power (dBm)	Antenna Gain (dBi)	ERP / EIRP (dBm)	Limit (dBm)	Margin (dB)
WCDMA	826.4	4132	23.35	1	24.35	38.5	-14.15
	836.6	4183	23.39	1	24.39	38.5	-14.11
	846.6	4233	23.24	1	24.24	38.5	-14.26
HSDPA	826.4	4132	22.63	1	23.63	38.5	-14.87
	836.6	4183	22.68	1	23.68	38.5	-14.82
	846.6	4233	22.34	1	23.34	38.5	-15.16
HSUPA	826.4	4132	22.44	1	23.44	38.5	-15.06
	836.6	4183	22.47	1	23.47	38.5	-15.03
	846.6	4233	22.31	1	23.31	38.5	-15.19

Unless otherwise stated the results shown in this test report refer only to the sample(s) tested and such sample(s) are retained for 90 days only.

除非另有說明，此報告結果僅對測試之樣品負責，同時此樣品僅保留90天。本報告未經本公司書面許可，不可部份複製。

This document is issued by the Company subject to its General Conditions of Service printed overleaf, available on request or accessible at www.sgs.com/terms_and_conditions.htm and, for electronic format documents, subject to Terms and Conditions for Electronic Documents at www.sgs.com/terms_e-document.htm. Attention is drawn to the limitation of liability, indemnification and jurisdiction issues defined therein. Any holder of this document is advised that information contained hereon reflects the Company's findings at the time of its intervention only and within the limits of Client's instructions, if any. The Company's sole responsibility is to its Client and this document does not exonerate parties to a transaction from exercising all their rights and obligations under the transaction documents. This document cannot be reproduced except in full, without prior written approval of the Company. Any unauthorized alteration, forgery or falsification of the content or appearance of this document is unlawful and offenders may be prosecuted to the fullest extent of the law.

LTE Result:

LTE Band 5

Antenna gain (dBi) 1

LTE Band 5_Uplink frequency band : 824 to 849 MHz									
Bandwidth	UL Channel	Frequency (MHz)	Modulation	RB Size	RB Offset	Conducted Average (dBm)	ERP Average (dBm)	ERP Limit (dBm)	Margin (dB)
1.4	20407	824.7	QPSK	1	0	23.58	24.58	38.45	-13.87
				1	5	23.29	24.29	38.45	-14.16
				3	2	22.54	23.54	38.45	-14.91
				6	0	22.46	23.46	38.45	-14.99
	20525	836.5	QPSK	1	0	23.66	24.66	38.45	-13.79
				1	5	23.42	24.42	38.45	-14.03
				3	2	22.43	23.43	38.45	-15.02
				6	0	22.54	23.54	38.45	-14.91
	20643	848.3	QPSK	1	0	23.68	24.68	38.45	-13.77
				1	5	23.38	24.38	38.45	-14.07
				3	2	22.38	23.38	38.45	-15.07
				6	0	22.55	23.55	38.45	-14.9
	20407	824.7	16QAM	1	0	22.47	23.47	38.45	-14.98
				1	5	22.32	23.32	38.45	-15.13
				3	2	21.54	22.54	38.45	-15.91
				6	0	21.5	22.5	38.45	-15.95
	20525	836.5	16QAM	1	0	22.48	23.48	38.45	-14.97
				1	5	22.24	23.24	38.45	-15.21
				3	2	21.38	22.38	38.45	-16.07
				6	0	21.53	22.53	38.45	-15.92
	20643	848.3	16QAM	1	0	22.29	23.29	38.45	-15.16
				1	5	22.17	23.17	38.45	-15.28
				3	2	21.57	22.57	38.45	-15.88
				6	0	21.45	22.45	38.45	-16

Unless otherwise stated the results shown in this test report refer only to the sample(s) tested and such sample(s) are retained for 90 days only.

除非另有說明，此報告結果僅對測試之樣品負責，同時此樣品僅保留90天。本報告未經本公司書面許可，不可部份複製。

This document is issued by the Company subject to its General Conditions of Service printed overleaf, available on request or accessible at www.sgs.com/terms_and_conditions.htm and, for electronic format documents, subject to Terms and Conditions for Electronic Documents at www.sgs.com/terms_e-document.htm. Attention is drawn to the limitation of liability, indemnification and jurisdiction issues defined therein. Any holder of this document is advised that information contained hereon reflects the Company's findings at the time of its intervention only and within the limits of Client's instructions, if any. The Company's sole responsibility is to its Client and this document does not exonerate parties to a transaction from exercising all their rights and obligations under the transaction documents. This document cannot be reproduced except in full, without prior written approval of the Company. Any unauthorized alteration, forgery or falsification of the content or appearance of this document is unlawful and offenders may be prosecuted to the fullest extent of the law.

SGS Taiwan Ltd.

No.134,WuKungRoad,NewTaipeiIndustrialPark,WukuDistrict,NewTaipeiCity,Taiwan24803/新北市五股區新北產業園區五工路 134 號

台灣檢驗科技股份有限公司

t (886-2) 2299-3279

f (886-2) 2298-0488

www.tw.sgs.com

Member of SGS Group

LTE Band 5

Antenna gain (dBi)

1

LTE Band 5_Uplink frequency band : 824 to 849 MHz									
Bandwidth	UL Channel	Frequency (MHz)	Modulation	RB Size	RB Offset	Conducted Average (dBm)	ERP Average (dBm)	ERP Limit (dBm)	Margin (dB)
3	20415	825.5	QPSK	1	0	23.75	24.75	38.45	-13.7
				1	14	23.23	24.23	38.45	-14.22
				8	4	22.58	23.58	38.45	-14.87
				15	0	22.46	23.46	38.45	-14.99
	20525	836.5	QPSK	1	0	23.78	24.78	38.45	-13.67
				1	14	23.45	24.45	38.45	-14
				8	4	22.55	23.55	38.45	-14.9
				15	0	22.47	23.47	38.45	-14.98
	20635	847.5	QPSK	1	0	23.75	24.75	38.45	-13.7
				1	14	23.38	24.38	38.45	-14.07
				8	4	22.39	23.39	38.45	-15.06
				15	0	22.54	23.54	38.45	-14.91
	20415	825.5	16QAM	1	0	22.45	23.45	38.45	-15
				1	14	22.49	23.49	38.45	-14.96
				8	4	21.41	22.41	38.45	-16.04
				15	0	21.46	22.46	38.45	-15.99
	20525	836.5	16QAM	1	0	22.41	23.41	38.45	-15.04
				1	14	22.31	23.31	38.45	-15.14
				8	4	21.4	22.4	38.45	-16.05
				15	0	21.54	22.54	38.45	-15.91
	20635	847.5	16QAM	1	0	22.27	23.27	38.45	-15.18
				1	14	22.16	23.16	38.45	-15.29
				8	4	21.38	22.38	38.45	-16.07
				15	0	21.51	22.51	38.45	-15.94

Unless otherwise stated the results shown in this test report refer only to the sample(s) tested and such sample(s) are retained for 90 days only.

除非另有說明，此報告結果僅對測試之樣品負責，同時此樣品僅保留90天。本報告未經本公司書面許可，不可部份複製。

This document is issued by the Company subject to its General Conditions of Service printed overleaf, available on request or accessible at www.sgs.com/terms_and_conditions.htm and, for electronic format documents, subject to Terms and Conditions for Electronic Documents at www.sgs.com/terms_e-document.htm. Attention is drawn to the limitation of liability, indemnification and jurisdiction issues defined therein. Any holder of this document is advised that information contained hereon reflects the Company's findings at the time of its intervention only and within the limits of Client's instructions, if any. The Company's sole responsibility is to its Client and this document does not exonerate parties to a transaction from exercising all their rights and obligations under the transaction documents. This document cannot be reproduced except in full, without prior written approval of the Company. Any unauthorized alteration, forgery or falsification of the content or appearance of this document is unlawful and offenders may be prosecuted to the fullest extent of the law.

SGS Taiwan Ltd.

No.134,WuKungRoad,NewTaipeiIndustrialPark,WukuDistrict,NewTaipeiCity,Taiwan24803/新北市五股區新北產業園區五工路 134 號

台灣檢驗科技股份有限公司

t (886-2) 2299-3279

f (886-2) 2298-0488

www.tw.sgs.com

Member of SGS Group

LTE Band 5

Antenna gain (dBi)

1

LTE Band 5_Uplink frequency band : 824 to 849 MHz									
Bandwidth	UL Channel	Frequency (MHz)	Modulation	RB Size	RB Offset	Conducted Average (dBm)	ERP Average (dBm)	ERP Limit (dBm)	Margin (dB)
5	20425	826.5	QPSK	1	0	23.71	24.71	38.45	-13.74
				1	24	23.37	24.37	38.45	-14.08
				12	6	22.47	23.47	38.45	-14.98
				25	0	22.35	23.35	38.45	-15.1
	20525	836.5	QPSK	1	0	23.72	24.72	38.45	-13.73
				1	24	23.58	24.58	38.45	-13.87
				12	6	22.46	23.46	38.45	-14.99
				25	0	22.63	23.63	38.45	-14.82
	20625	846.5	QPSK	1	0	23.67	24.67	38.45	-13.78
				1	24	23.41	24.41	38.45	-14.04
				12	6	22.3	23.3	38.45	-15.15
				25	0	22.36	23.36	38.45	-15.09
	20425	826.5	16QAM	1	0	22.47	23.47	38.45	-14.98
				1	24	22.29	23.29	38.45	-15.16
				12	6	21.49	22.49	38.45	-15.96
				25	0	21.44	22.44	38.45	-16.01
	20525	836.5	16QAM	1	0	22.49	23.49	38.45	-14.96
				1	24	22.42	23.42	38.45	-15.03
				12	6	21.46	22.46	38.45	-15.99
				25	0	21.51	22.51	38.45	-15.94
	20625	846.5	16QAM	1	0	22.34	23.34	38.45	-15.11
				1	24	22.26	23.26	38.45	-15.19
				12	6	21.47	22.47	38.45	-15.98
				25	0	21.47	22.47	38.45	-15.98

Unless otherwise stated the results shown in this test report refer only to the sample(s) tested and such sample(s) are retained for 90 days only.

除非另有說明，此報告結果僅對測試之樣品負責，同時此樣品僅保留90天。本報告未經本公司書面許可，不可部份複製。

This document is issued by the Company subject to its General Conditions of Service printed overleaf, available on request or accessible at www.sgs.com/terms_and_conditions.htm and, for electronic format documents, subject to Terms and Conditions for Electronic Documents at www.sgs.com/terms_e-document.htm. Attention is drawn to the limitation of liability, indemnification and jurisdiction issues defined therein. Any holder of this document is advised that information contained hereon reflects the Company's findings at the time of its intervention only and within the limits of Client's instructions, if any. The Company's sole responsibility is to its Client and this document does not exonerate parties to a transaction from exercising all their rights and obligations under the transaction documents. This document cannot be reproduced except in full, without prior written approval of the Company. Any unauthorized alteration, forgery or falsification of the content or appearance of this document is unlawful and offenders may be prosecuted to the fullest extent of the law.

SGS Taiwan Ltd.

No.134,WuKungRoad,NewTaipeiIndustrialPark,WukuDistrict,NewTaipeiCity,Taiwan24803/新北市五股區新北產業園區五工路 134 號

台灣檢驗科技股份有限公司

t (886-2) 2299-3279

f (886-2) 2298-0488

www.tw.sgs.com

Member of SGS Group

LTE Band 5

Antenna gain (dBi)

1

LTE Band 5_Uplink frequency band : 824 to 849 MHz									
Bandwidth	UL Channel	Frequency (MHz)	Modulation	RB Size	RB Offset	Conducted Average (dBm)	ERP Average (dBm)	ERP Limit (dBm)	Margin (dB)
10	20450	829	QPSK	1	0	23.77	24.77	38.45	-13.68
				1	49	23.38	24.38	38.45	-14.07
				25	12	22.67	23.67	38.45	-14.78
				50	0	22.55	23.55	38.45	-14.9
	20525	836.5	QPSK	1	0	23.79	24.79	38.45	-13.66
				1	49	23.59	24.59	38.45	-13.86
				25	12	22.58	23.58	38.45	-14.87
				50	0	22.66	23.66	38.45	-14.79
	20600	844	QPSK	1	0	23.76	24.76	38.45	-13.69
				1	49	23.41	24.41	38.45	-14.04
				25	12	22.49	23.49	38.45	-14.96
				50	0	22.56	23.56	38.45	-14.89
	20450	829	16QAM	1	0	22.55	23.55	38.45	-14.9
				1	49	22.49	23.49	38.45	-14.96
				25	12	21.57	22.57	38.45	-15.88
				50	0	21.63	22.63	38.45	-15.82
	20525	836.5	16QAM	1	0	22.53	23.53	38.45	-14.92
				1	49	22.43	23.43	38.45	-15.02
				25	12	21.52	22.52	38.45	-15.93
				50	0	21.58	22.58	38.45	-15.87
	20600	844	16QAM	1	0	22.43	23.43	38.45	-15.02
				1	49	22.29	23.29	38.45	-15.16
				25	12	21.58	22.58	38.45	-15.87
				50	0	21.55	22.55	38.45	-15.9

Unless otherwise stated the results shown in this test report refer only to the sample(s) tested and such sample(s) are retained for 90 days only.

除非另有說明，此報告結果僅對測試之樣品負責，同時此樣品僅保留90天。本報告未經本公司書面許可，不可部份複製。

This document is issued by the Company subject to its General Conditions of Service printed overleaf, available on request or accessible at www.sgs.com/terms_and_conditions.htm and, for electronic format documents, subject to Terms and Conditions for Electronic Documents at www.sgs.com/terms_e-document.htm. Attention is drawn to the limitation of liability, indemnification and jurisdiction issues defined therein. Any holder of this document is advised that information contained hereon reflects the Company's findings at the time of its intervention only and within the limits of Client's instructions, if any. The Company's sole responsibility is to its Client and this document does not exonerate parties to a transaction from exercising all their rights and obligations under the transaction documents. This document cannot be reproduced except in full, without prior written approval of the Company. Any unauthorized alteration, forgery or falsification of the content or appearance of this document is unlawful and offenders may be prosecuted to the fullest extent of the law.

SGS Taiwan Ltd.

No.134,WuKungRoad,NewTaipeiIndustrialPark,WukuDistrict,NewTaipeiCity,Taiwan24803/新北市五股區新北產業園區五工路134號

台灣檢驗科技股份有限公司

t (886-2) 2299-3279

f (886-2) 2298-0488

www.tw.sgs.com

Member of SGS Group

HSDPA Release 6 MODE:

The following 4 Sub-Tests were completed according to the test requirements outlined in section 5.2A of the 3GPP TS34.121-1 V8.4.0 specification. All TX RMS power requirements for Power Class 3 were met according to table 5.2AA.5 and 5.2B.5 All UE channels and power ratio's are set according to table C10.1.4 & C11.1.3 in the 3GPP TS34.121-1 V8.4.0. RMC 12.2kps is used for this testing.

HSDPA SUB-TEST Setting

Table C.10.1.4: β values for transmitter characteristics tests with HS-DPCCH(FOR HSDPA)

Sub-test	β_c	β_d	β_d (SF)	β_c/β_d	β_{HS} (Note 1, Note 2)	CM (dB) (Note 3)	MPR (dB) (Note 3)	RMC (Kbps)
1	2/15	15/15	64	2/15	4/15	0.0	0.0	12.2
2	12/15 (Note 4)	15/15 (Note 4)	64	12/15 (Note 4)	24/15	1.0	0.0	12.2
3	15/15	8/15	64	15/8	30/15	1.5	0.5	12.2
4	15/15	4/15	64	15/4	30/15	1.5	0.5	12.2

Note: The recommended HSDPA MPRs are implemented as per following sub-tests.

Results:

Mode	Sub test	Avg. Power (dBm) Channel			Power Class 3 Limitation (dBm)	Comments
		4132	4183	4233		
HSDPA V	1	22.63	22.68	22.34	20.3dBm – 25.7dBm	Pass
	2	22.26	22.36	22.03	20.3dBm – 25.7dBm	Pass
	3	22.20	22.19	21.93	19.8dBm – 25.7dBm	Pass
	4	22.06	22.14	21.76	19.8dBm – 25.7dBm	Pass

Unless otherwise stated the results shown in this test report refer only to the sample(s) tested and such sample(s) are retained for 90 days only.

除非另有說明，此報告結果僅對測試之樣品負責，同時此樣品僅保留90天。本報告未經本公司書面許可，不可部份複製。

This document is issued by the Company subject to its General Conditions of Service printed overleaf, available on request or accessible at www.sgs.com/terms_and_conditions.htm and, for electronic format documents, subject to Terms and Conditions for Electronic Documents at www.sgs.com/terms_e-document.htm. Attention is drawn to the limitation of liability, indemnification and jurisdiction issues defined therein. Any holder of this document is advised that information contained hereon reflects the Company's findings at the time of its intervention only and within the limits of Client's instructions, if any. The Company's sole responsibility is to its Client and this document does not exonerate parties to a transaction from exercising all their rights and obligations under the transaction documents. This document cannot be reproduced except in full, without prior written approval of the Company. Any unauthorized alteration, forgery or falsification of the content or appearance of this document is unlawful and offenders may be prosecuted to the fullest extent of the law.

HSPA (HSDPA & HSUPA) Release 6 MODE

The following 5 Sub-Tests were completed according to the test requirements outlined in section 5.2A of the 3GPP TS34.121-1 V8.4.0 specification. All TX RMS power requirements for Power Class 3 were met according to table 5.2AA.5 and 5.2B.5 All UE channels and power ratio's are set according to table C11.1.3 in the 3GPP TS34.121-1 V8.4.0. RMC 12.2kps is used for this testing

HSPA SUB-TEST Setting

Table C.11.1.3: β values for transmitter characteristics tests with HS-DPCCH and E-DCH(FOR HSUPA)

Sub-test	β_c	β_d	β_d (SF)	β_c/β_d	β_{HS}	β_{ec}	β_{ed}	β_{ed} (SF)	β_{ed} (Code s)	CM (dB)	MPR (dB)	AG Index	E-TFCI	RMC (Kbps)
1	11/15 (Note 3)	15/15 (Note 3)	64	11/15 (Note 3)	22/15	209/225	1309/225	4	1	1.0	0.0	20	75	12.2
2	6/15	15/15	64	6/15	12/15	12/15	94/75	4	1	3.0	2.0	12	67	12.2
3	15/15	9/15	64	15/9	30/15	30/15	$\beta_{ed1}: 47/15$ $\beta_{ed2}: 47/15$	4 4	2	2.0	1.0	15	92	12.2
4	2/15	15/15	64	2/15	4/15	2/15	56/75	4	1	3.0	2.0	17	71	12.2
5	15/15 (Note 4)	15/15 (Note 4)	64	15/15 (Note 4)	30/15	24/15	134/15	4	1	1.0	0.0	21	81	12.2

Note: The recommended HSUPA MPRs are implemented as per following sub-tests.

Results:

Mode	Sub test	Avg. Power (dBm)			Power Class 3 Limitation (dBm)	Comments
		4132	4183	4233		
HSUPA V	1	22.44	22.47	22.31	18.8dBm – 25.7dBm	Pass
	2	21.95	21.83	21.94	16.8dBm – 25.7dBm	Pass
	3	22.34	22.28	22.24	17.8dBm – 25.7dBm	Pass
	4	22.01	22.05	22.14	16.8dBm – 25.7dBm	Pass
	5	22.45	22.49	22.41	18.8dBm – 25.7dBm	Pass

Unless otherwise stated the results shown in this test report refer only to the sample(s) tested and such sample(s) are retained for 90 days only.

除非另有說明，此報告結果僅對測試之樣品負責，同時此樣品僅保留90天。本報告未經本公司書面許可，不可部份複製。

This document is issued by the Company subject to its General Conditions of Service printed overleaf, available on request or accessible at www.sgs.com/terms_and_conditions.htm and, for electronic format documents, subject to Terms and Conditions for Electronic Documents at www.sgs.com/terms_e-document.htm. Attention is drawn to the limitation of liability, indemnification and jurisdiction issues defined therein. Any holder of this document is advised that information contained hereon reflects the Company's findings at the time of its intervention only and within the limits of Client's instructions, if any. The Company's sole responsibility is to its Client and this document does not exonerate parties to a transaction from exercising all their rights and obligations under the transaction documents. This document cannot be reproduced except in full, without prior written approval of the Company. Any unauthorized alteration, forgery or falsification of the content or appearance of this document is unlawful and offenders may be prosecuted to the fullest extent of the law.

Minimum Communications Power Measurement

PCS 1900 band

PCL	0	1	2	3	4	5	6	7	8
Output power (dBm)	29.22	26.32	25.51	23.53	21.83	19.98	18.22	16.14	14.22

PCL	9	10	11	12	13	14	15
Output power (dBm)	12.29	10.14	8.11	6.23	4.02	2.21	0.08

Note: The EUT output power was controlled by simulator. Set Communication Tester [MT8820C](#) PCL as above, and get the mobile phone output power reading.

WCDMA/HSDPA/HSUPA band V

The EUT output power was controlled by simulator. Set Communication Tester MT8820C function key "UE Power Control" and enter max rated power 24dBm. The EUT is going to be set to max output power to 24dBm. Then record the read (see page 15 for measurement data). The min. power was measures by a function key "minimum power" then record the read. It is -52.3dBm. The power variation can be 0.1dB step by setting.

Unless otherwise stated the results shown in this test report refer only to the sample(s) tested and such sample(s) are retained for 90 days only.

除非另有說明，此報告結果僅對測試之樣品負責，同時此樣品僅保留90天。本報告未經本公司書面許可，不可部份複製。

This document is issued by the Company subject to its General Conditions of Service printed overleaf, available on request or accessible at www.sgs.com/terms_and_conditions.htm and, for electronic format documents, subject to Terms and Conditions for Electronic Documents at www.sgs.com/terms_e-document.htm. Attention is drawn to the limitation of liability, indemnification and jurisdiction issues defined therein. Any holder of this document is advised that information contained hereon reflects the Company's findings at the time of its intervention only and within the limits of Client's instructions, if any. The Company's sole responsibility is to its Client and this document does not exonerate parties to a transaction from exercising all their rights and obligations under the transaction documents. This document cannot be reproduced except in full, without prior written approval of the Company. Any unauthorized alteration, forgery or falsification of the content or appearance of this document is unlawful and offenders may be prosecuted to the fullest extent of the law.

SGS Taiwan Ltd.

No.134,WuKungRoad,NewTaipeiIndustrialPark,WukuDistrict,NewTaipeiCity,Taiwan24803/新北市五股區新北產業園區五工路 134 號

台灣檢驗科技股份有限公司

t (886-2) 2299-3279

f (886-2) 2298-0488

www.tw.sgs.com

Member of SGS Group

7. OCCUPIED BANDWIDTH MEASUREMENT

7.1. Standard Applicable

The occupied bandwidth is the frequency bandwidth such that, below its lower and above its upper frequency limits, the mean powers radiated are each equal to 0.5 percent of the total mean power.

7.2. Test Set-up

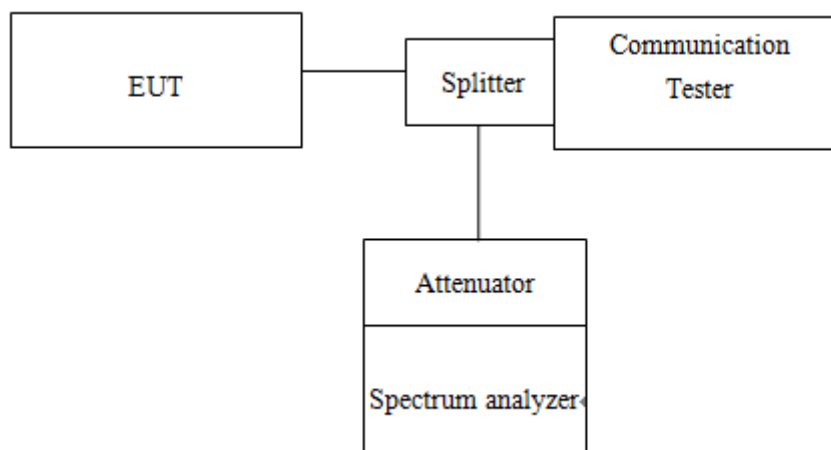

7.3. Measurement Procedure

99% &26dB Bandwidth with detector peak

The EUT's output RF connector was connected with a short cable to the spectrum analyzer, RBW was set to about 1% of emission BW, VBW= 3 times RBW, -26dBc display line was placed on the screen (or 26dB bandwidth), the occupied bandwidth is the delta frequency between the two points where the display line intersects the signal trace. Then set RBW to 99% bandwidth, RBW= 1%, VBW= 3 RBW, with span > 2 * Signal BW, set % Power = 99%.

99% Bandwidth with detector sample

The EUT's output RF connector was connected with a short cable to the spectrum analyzer, RBW was set to about 1% ~ 5% of emission BW, VBW= 3 times RBW, -20dBc display line was placed on the screen (or 20dB bandwidth). Set RBW to 99% bandwidth, RBW= 1% ~ 5%, VBW= 3 RBW, with span > 2 * Signal BW, set % Power = 99%.

Unless otherwise stated the results shown in this test report refer only to the sample(s) tested and such sample(s) are retained for 90 days only.

除非另有說明，此報告結果僅對測試之樣品負責，同時此樣品僅保留90天。本報告未經本公司書面許可，不可部份複製。

This document is issued by the Company subject to its General Conditions of Service printed overleaf, available on request or accessible at www.sgs.com/terms_and_conditions.htm and, for electronic format documents, subject to Terms and Conditions for Electronic Documents at www.sgs.com/terms_e-document.htm. Attention is drawn to the limitation of liability, indemnification and jurisdiction issues defined therein. Any holder of this document is advised that information contained hereon reflects the Company's findings at the time of its intervention only and within the limits of Client's instructions, if any. The Company's sole responsibility is to its Client and this document does not exonerate parties to a transaction from exercising all their rights and obligations under the transaction documents. This document cannot be reproduced except in full, without prior written approval of the Company. Any unauthorized alteration, forgery or falsification of the content or appearance of this document is unlawful and offenders may be prosecuted to the fullest extent of the law.

7.4. Measurement Equipment Used

EQUIPMENT TYPE	MFR	MODEL NUMBER	SERIAL NUMBER	LAST CAL.	CAL DUE.
EXA Spectrum Analyzer	Agilent	N9010A	MY57120290	2018/02/14	2019/02/13
Radio Communication Analyzer	Anritsu	MT8815B	6200711454	2018/04/05	2019/04/04
Radio Communication Analyzer	Anritsu	MT8820C	6200995019	2018/04/05	2019/04/04
DC Power Supply	Anritsu	E3640A	MY52410006	2017/11/28	2018/11/27
Temperature Chamber	TERCHY	MHG-120LF	911009	2018/05/18	2019/05/17
Attenuator	Mini-Circuit	BW-S10W2+	2	2018/01/02	2019/01/01
Splitter	RF-LAMBAD	RFLT2W1G18G	11-JSPF412-018	2018/01/02	2019/01/01
Coaxial Cables	N/A	WK CE Cable	N/A	2018/01/02	2019/01/01

Unless otherwise stated the results shown in this test report refer only to the sample(s) tested and such sample(s) are retained for 90 days only.

除非另有說明，此報告結果僅對測試之樣品負責，同時此樣品僅保留90天。本報告未經本公司書面許可，不可部份複製。

This document is issued by the Company subject to its General Conditions of Service printed overleaf, available on request or accessible at www.sgs.com/terms_and_conditions.htm and, for electronic format documents, subject to Terms and Conditions for Electronic Documents at www.sgs.com/terms_e-document.htm. Attention is drawn to the limitation of liability, indemnification and jurisdiction issues defined therein. Any holder of this document is advised that information contained hereon reflects the Company's findings at the time of its intervention only and within the limits of Client's instructions, if any. The Company's sole responsibility is to its Client and this document does not exonerate parties to a transaction from exercising all their rights and obligations under the transaction documents. This document cannot be reproduced except in full, without prior written approval of the Company. Any unauthorized alteration, forgery or falsification of the content or appearance of this document is unlawful and offenders may be prosecuted to the fullest extent of the law.

SGS Taiwan Ltd.

No.134,WuKungRoad,NewTaipeiIndustrialPark,WukuDistrict,NewTaipeiCity,Taiwan24803/新北市五股區新北產業園區五工路 134 號

台灣檢驗科技股份有限公司

t (886-2) 2299-3279

f (886-2) 2298-0488

www.tw.sgs.com

Member of SGS Group

7.5. Measurement Result

Freq. (MHz)	CH	GSM 850		GPRS 850	
		OBW 26dB	OBW 99%	OBW 26dB	OBW 99%
824.2	128	0.30981	0.24638	0.31429	0.24512
836.6	190	0.31333	0.24363	0.31690	0.24783
848.8	251	0.31490	0.24432	0.31855	0.24689

Freq. (MHz)	CH	GSM 1900		GPRS 1900	
		OBW 26dB	OBW 99%	OBW 26dB	OBW 99%
1850.2	512	0.31647	0.24066	0.31590	0.24473
1880.0	661	0.31447	0.24574	0.31922	0.24807
1909.8	810	0.31741	0.24956	0.31898	0.24397

Freq. (MHz)	CH	WCDMA V		HSDPA V		HSUPA V	
		OBW 26dB	OBW 99%	OBW 26dB	OBW 99%	OBW 26dB	OBW 99%
826.40	4132	4.6884	4.1433	4.7110	4.1434	4.7119	4.1446
836.60	4183	4.6741	4.1260	4.7004	4.1323	4.6858	4.1293
846.60	4233	4.6848	4.1454	4.7120	4.1445	4.6950	4.1354

LTE BAND 5 Channel bandwidth: 1.4MHz					
Freq. (MHz)	CH	99% BW (MHz)		26 dB BW (MHz)	
		QPSK	16QAM	QPSK	16QAM
824.7	20407	1.0977	1.1014	1.2812	1.3032
836.5	20525	1.0979	1.0990	1.2654	1.3056
848.3	20643	1.0985	1.1011	1.2696	1.3032

LTE BAND 5 Channel bandwidth: 3MHz					
Freq. (MHz)	CH	99% BW (MHz)		26 dB BW (MHz)	
		QPSK	16QAM	QPSK	16QAM
825.5	20415	2.7028	2.6990	2.9952	2.9849
836.5	20525	2.7050	2.6998	3.0088	3.0100
847.5	20635	2.7026	2.7053	2.9903	2.9886

LTE BAND 5 Channel bandwidth: 5MHz					
Freq. (MHz)	CH	99% BW (MHz)		26 dB BW (MHz)	
		QPSK	16QAM	QPSK	16QAM
826.5	20425	4.5175	4.5121	5.0554	5.0160
836.5	20525	4.5111	4.5109	5.0574	4.9923
846.5	20625	4.5121	4.5129	5.0562	5.0133

LTE BAND 5 Channel bandwidth: 10MHz					
Freq. (MHz)	CH	99% BW (MHz)		26 dB BW (MHz)	
		QPSK	16QAM	QPSK	16QAM
829.0	20450	9.0032	8.9806	9.959	9.839
836.5	20525	8.9746	8.9421	9.940	9.797
844.0	20600	9.0094	8.9591	9.935	9.814

Unless otherwise stated the results shown in this test report refer only to the sample(s) tested and such sample(s) are retained for 90 days only.

除非另有說明，此報告結果僅對測試之樣品負責，同時此樣品僅保留90天。本報告未經本公司書面許可，不可部份複製。

This document is issued by the Company subject to its General Conditions of Service printed overleaf, available on request or accessible at www.sgs.com/terms_and_conditions.htm and, for electronic format documents, subject to Terms and Conditions for Electronic Documents at www.sgs.com/terms_e-document.htm. Attention is drawn to the limitation of liability, indemnification and jurisdiction issues defined therein. Any holder of this document is advised that information contained hereon reflects the Company's findings at the time of its intervention only and within the limits of Client's instructions, if any. The Company's sole responsibility is to its Client and this document does not exonerate parties to a transaction from exercising all their rights and obligations under the transaction documents. This document cannot be reproduced except in full, without prior written approval of the Company. Any unauthorized alteration, forgery or falsification of the content or appearance of this document is unlawful and offenders may be prosecuted to the fullest extent of the law.

SGS Taiwan Ltd.

No. 134, WuKungRoad, NewTaipeiIndustrialPark, WukuDistrict, NewTaipeiCity, Taiwan24803/新北市五股區新北產業園區五工路 134 號

台灣檢驗科技股份有限公司

t (886-2) 2299-3279

f (886-2) 2298-0488

www.tw.sgs.com

Member of SGS Group

GSM 850MHz LowCH128-824.2

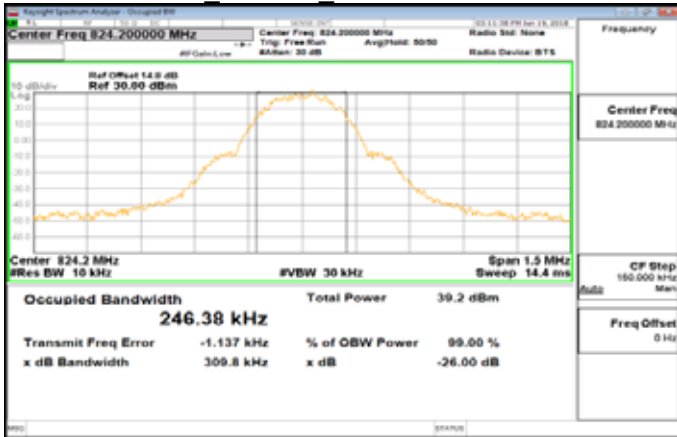

GPRS 850MHz LowCH128-824.2

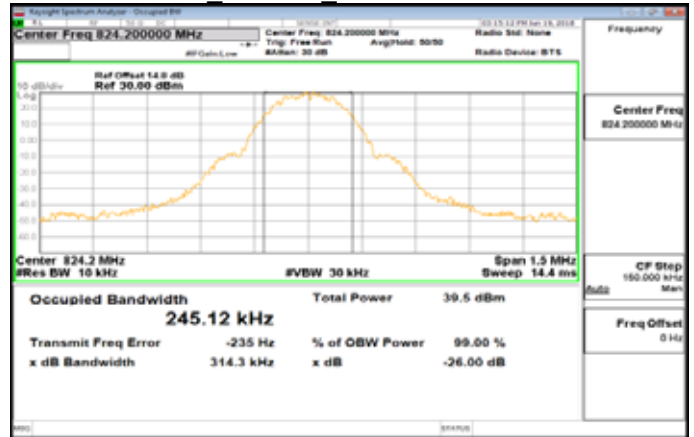

GSM 850MHz MidCH190-836.6

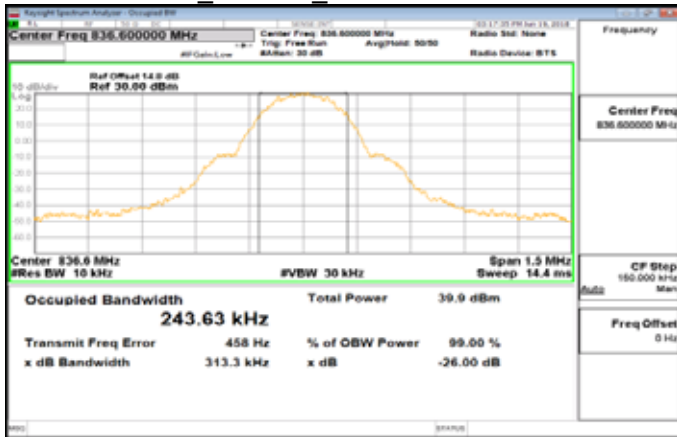

GPRS 850MHz MidCH190-836.6

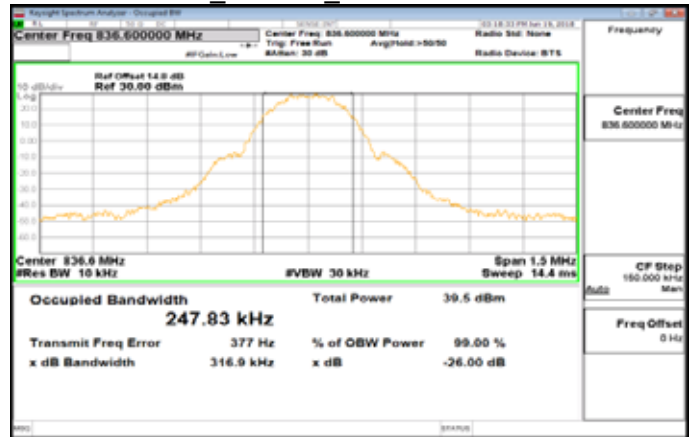

GSM 850MHz HighCH251-848.8

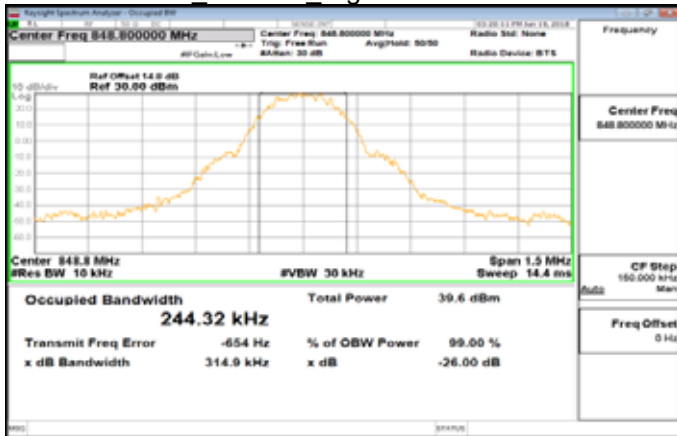

GPRS 850MHz HighCH251-848.8

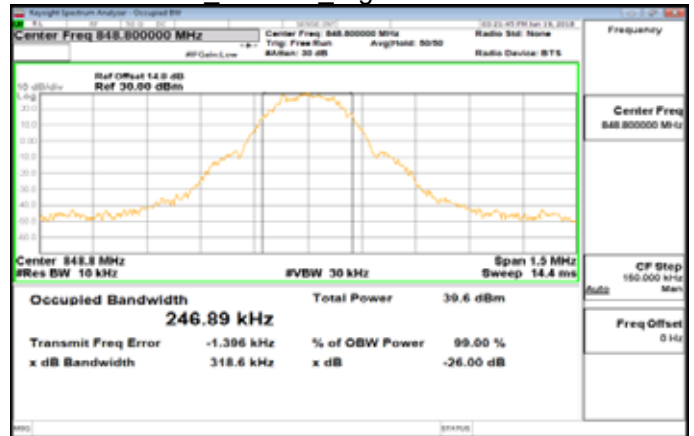

Unless otherwise stated the results shown in this test report refer only to the sample(s) tested and such sample(s) are retained for 90 days only.

除非另有說明，此報告結果僅對測試之樣品負責，同時此樣品僅保留90天。本報告未經本公司書面許可，不可部份複製。

This document is issued by the Company subject to its General Conditions of Service printed overleaf, available on request or accessible at www.sgs.com/terms_and_conditions.htm and, for electronic format documents, subject to Terms and Conditions for Electronic Documents at www.sgs.com/terms_e-document.htm. Attention is drawn to the limitation of liability, indemnification and jurisdiction issues defined therein. Any holder of this document is advised that information contained hereon reflects the Company's findings at the time of its intervention only and within the limits of Client's instructions, if any. The Company's sole responsibility is to its Client and this document does not exonerate parties to a transaction from exercising all their rights and obligations under the transaction documents. This document cannot be reproduced except in full, without prior written approval of the Company. Any unauthorized alteration, forgery or falsification of the content or appearance of this document is unlawful and offenders may be prosecuted to the fullest extent of the law.

SGS Taiwan Ltd.

台灣檢驗科技股份有限公司

No. 134, WuKungRoad, NewTaipeiIndustrialPark, WukuDistrict, NewTaipeiCity, Taiwan24803/新北市五股區新北產業園區五工路 134 號

t (886-2) 2299-3279

f (886-2) 2298-0488

www.tw.sgs.com

Member of SGS Group

WCDMA_B5_LowCH4132-826.4

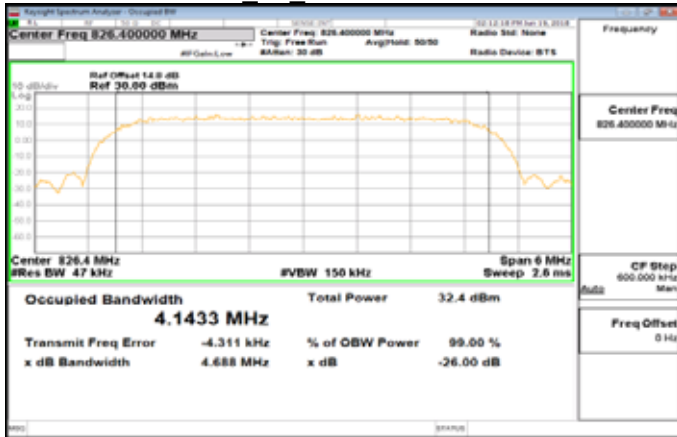

HSDPA_B5_LowCH4132-826.4

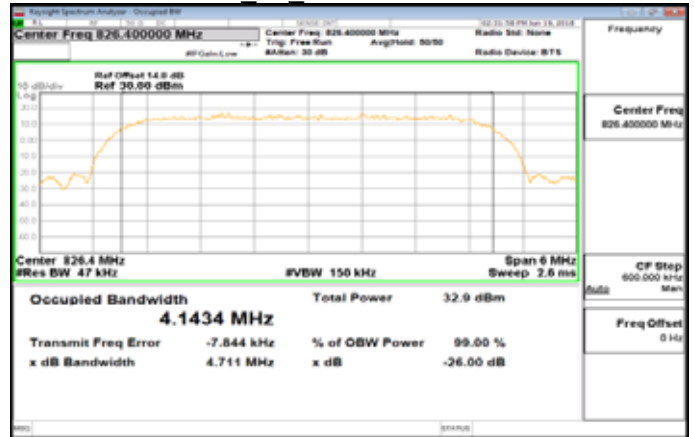

WCDMA_B5_MidCH4183-836.6

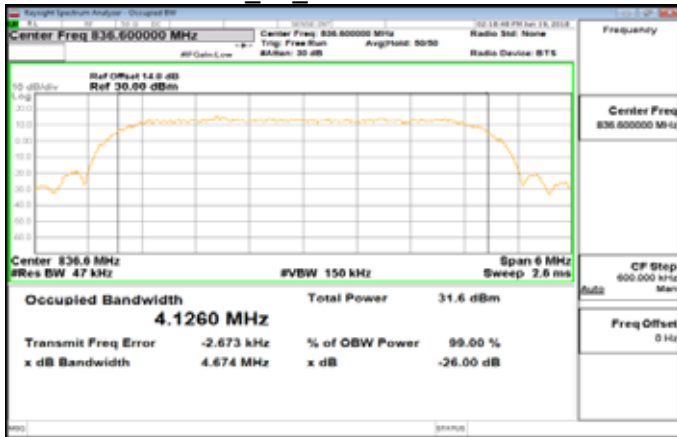

HSDPA_B5_MidCH4183-836.6

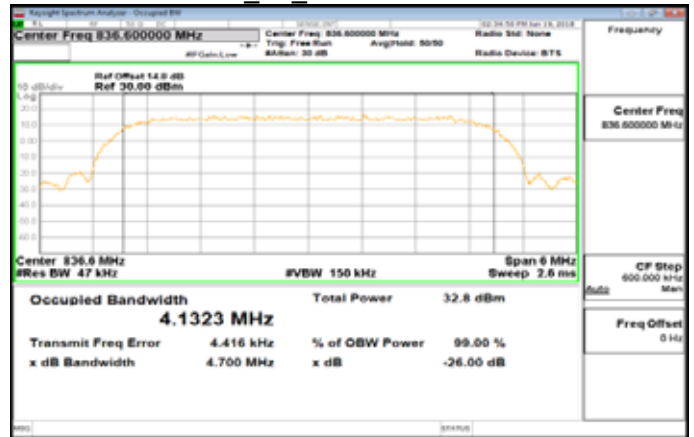

WCDMA_B5_HighCH4233-846.6

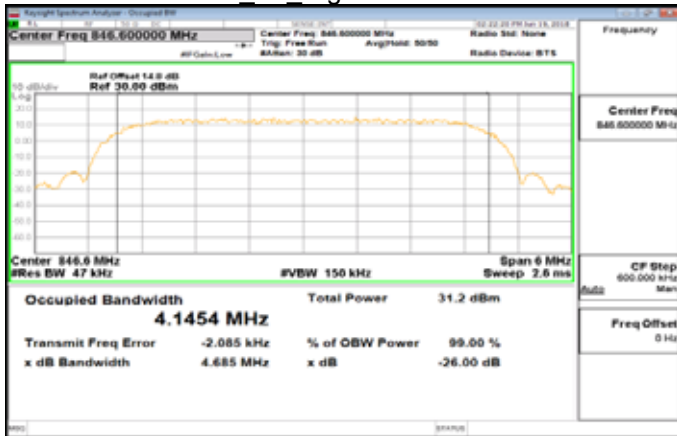

HSDPA_B5_HighCH4233-846.6

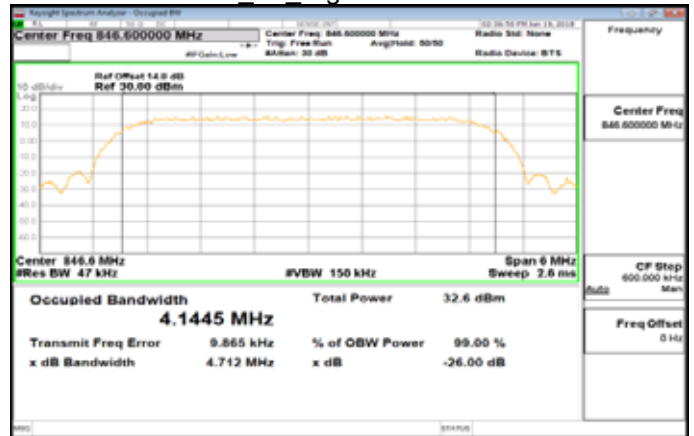

Unless otherwise stated the results shown in this test report refer only to the sample(s) tested and such sample(s) are retained for 90 days only.

除非另有說明，此報告結果僅對測試之樣品負責，同時此樣品僅保留90天。本報告未經本公司書面許可，不可部份複製。

This document is issued by the Company subject to its General Conditions of Service printed overleaf, available on request or accessible at www.sgs.com/terms_and_conditions.htm and, for electronic format documents, subject to Terms and Conditions for Electronic Documents at www.sgs.com/terms_e-document.htm. Attention is drawn to the limitation of liability, indemnification and jurisdiction issues defined therein. Any holder of this document is advised that information contained hereon reflects the Company's findings at the time of its intervention only and within the limits of Client's instructions, if any. The Company's sole responsibility is to its Client and this document does not exonerate parties to a transaction from exercising all their rights and obligations under the transaction documents. This document cannot be reproduced except in full, without prior written approval of the Company. Any unauthorized alteration, forgery or falsification of the content or appearance of this document is unlawful and offenders may be prosecuted to the fullest extent of the law.

HSUPA_B5_LowCH4132-826.4

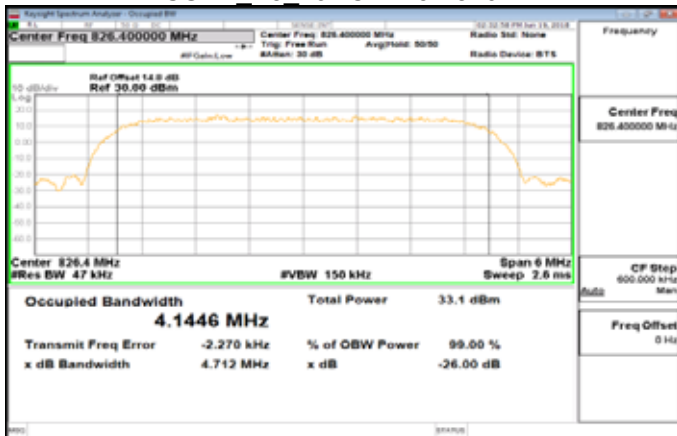

HSUPA_B5_MidCH4183-836.6

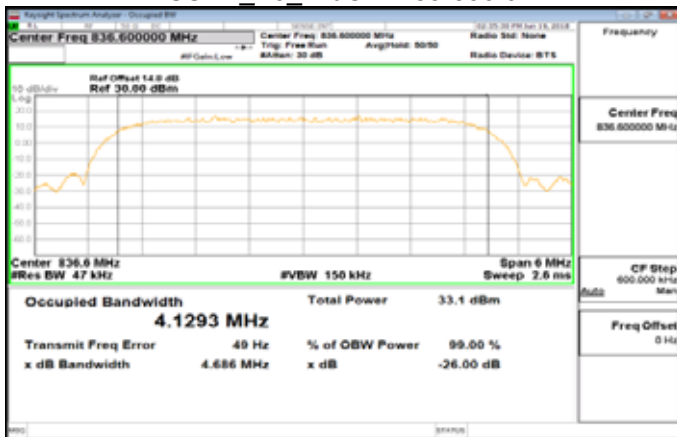

HSUPA_B5_HighCH4233-846.6

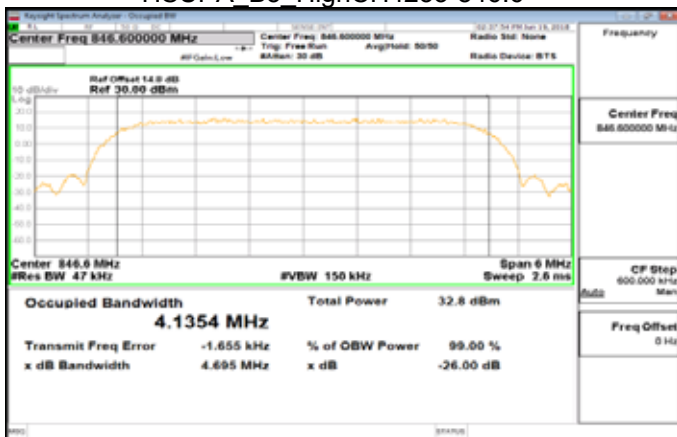

Unless otherwise stated the results shown in this test report refer only to the sample(s) tested and such sample(s) are retained for 90 days only.

除非另有說明，此報告結果僅對測試之樣品負責，同時此樣品僅保留90天。本報告未經本公司書面許可，不可部份複製。

This document is issued by the Company subject to its General Conditions of Service printed overleaf, available on request or accessible at www.sgs.com/terms_and_conditions.htm and, for electronic format documents, subject to Terms and Conditions for Electronic Documents at www.sgs.com/terms_e-document.htm. Attention is drawn to the limitation of liability, indemnification and jurisdiction issues defined therein. Any holder of this document is advised that information contained hereon reflects the Company's findings at the time of its intervention only and within the limits of Client's instructions, if any. The Company's sole responsibility is to its Client and this document does not exonerate parties to a transaction from exercising all their rights and obligations under the transaction documents. This document cannot be reproduced except in full, without prior written approval of the Company. Any unauthorized alteration, forgery or falsification of the content or appearance of this document is unlawful and offenders may be prosecuted to the fullest extent of the law.

SGS Taiwan Ltd.

台灣檢驗科技股份有限公司

No. 134, WuKungRoad, NewTaipeiIndustrialPark, WukuDistrict, NewTaipeiCity, Taiwan24803/新北市五股區新北產業園區五工路 134 號

t (886-2) 2299-3279

f (886-2) 2298-0488

www.tw.sgs.com

Member of SGS Group

Band5 1 4MHz QPSK 6 0 LowCH20407-824.7

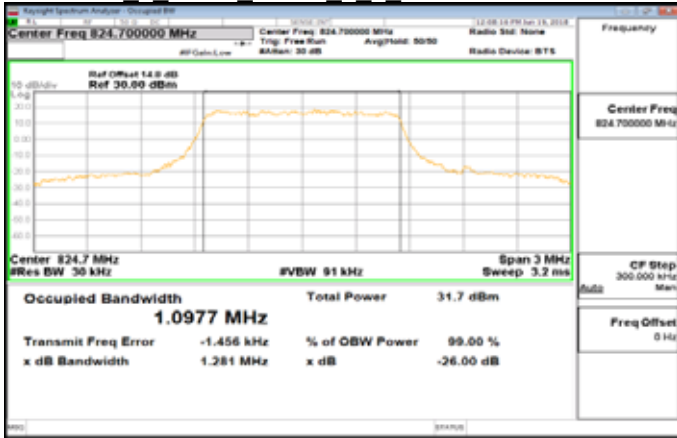

Band5 1 4MHz 16QAM 6 0 LowCH20407-824.7

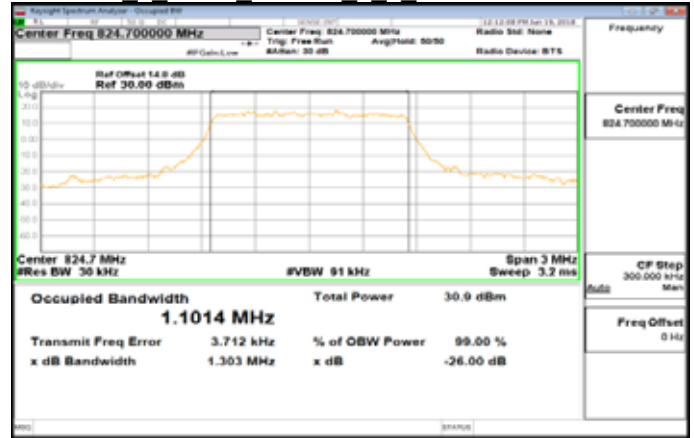

Band5 1 4MHz QPSK 6 0 MidCH20525-836.5

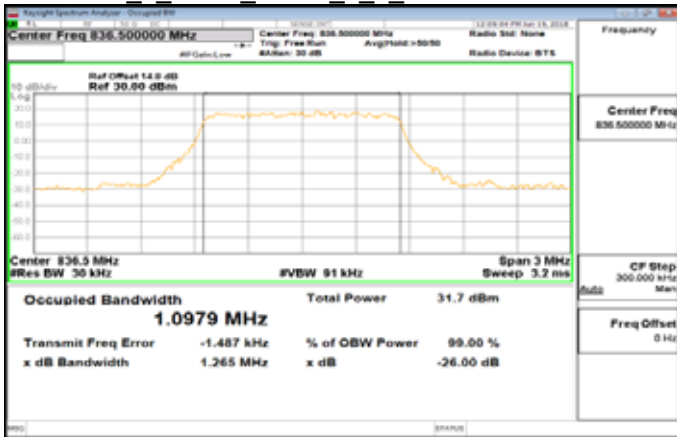

Band5 1 4MHz 16QAM 6 0 MidCH20525-836.5

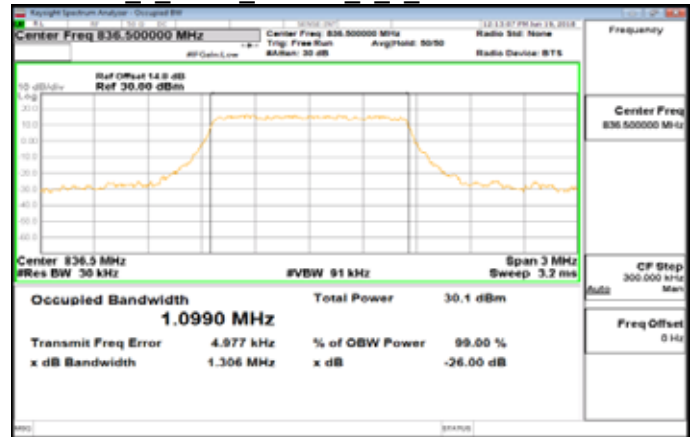

Band5 1 4MHz QPSK 6 0 HighCH20643-848.3

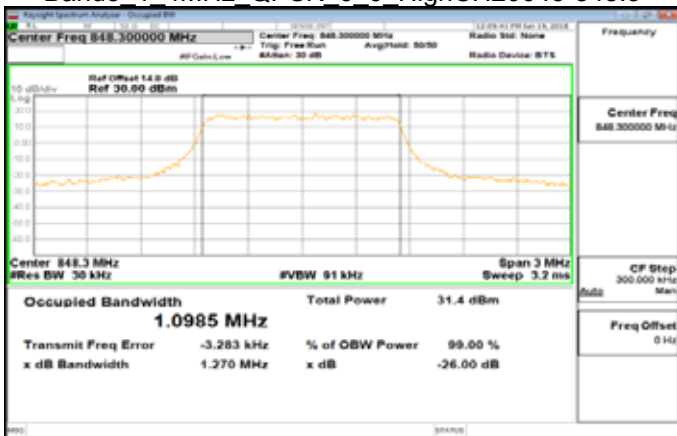

Band5 1 4MHz 16QAM 6 0 HighCH20643-848.3

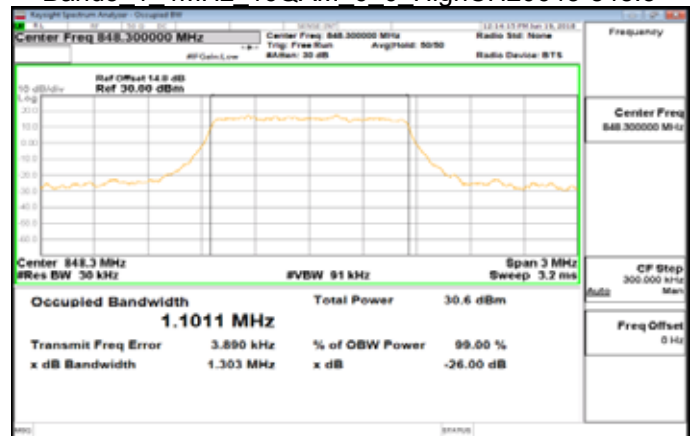

Unless otherwise stated the results shown in this test report refer only to the sample(s) tested and such sample(s) are retained for 90 days only.

除非另有說明，此報告結果僅對測試之樣品負責，同時此樣品僅保留90天。本報告未經本公司書面許可，不可部份複製。

This document is issued by the Company subject to its General Conditions of Service printed overleaf, available on request or accessible at www.sgs.com/terms_and_conditions.htm and, for electronic format documents, subject to Terms and Conditions for Electronic Documents at www.sgs.com/terms_e-document.htm. Attention is drawn to the limitation of liability, indemnification and jurisdiction issues defined therein. Any holder of this document is advised that information contained hereon reflects the Company's findings at the time of its intervention only and within the limits of Client's instructions, if any. The Company's sole responsibility is to its Client and this document does not exonerate parties to a transaction from exercising all their rights and obligations under the transaction documents. This document cannot be reproduced except in full, without prior written approval of the Company. Any unauthorized alteration, forgery or falsification of the content or appearance of this document is unlawful and offenders may be prosecuted to the fullest extent of the law.

SGS Taiwan Ltd.

No. 134, WuKungRoad, NewTaipeiIndustrialPark, WukuDistrict, NewTaipeiCity, Taiwan24803/新北市五股區新北產業園區五工路 134 號

台灣檢驗科技股份有限公司

t (886-2) 2299-3279

f (886-2) 2298-0488

www.tw.sgs.com

Member of SGS Group

Band5 3MHz QPSK 15 0 LowCH20415-825.5

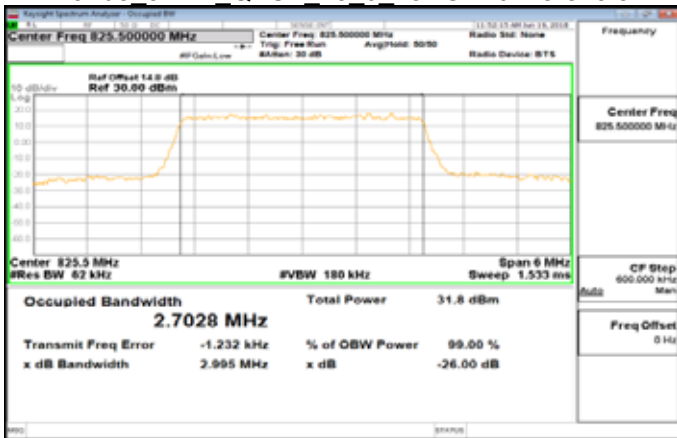

Band5 3MHz 16QAM 15 0 LowCH20415-825.5

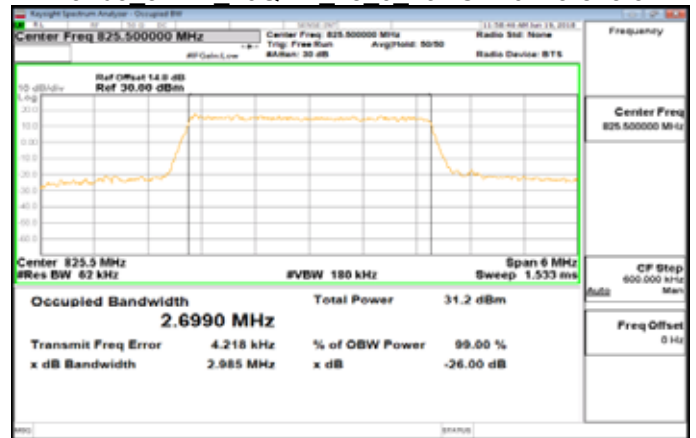

Band5 3MHz QPSK 15 0 MidCH20525-836.5

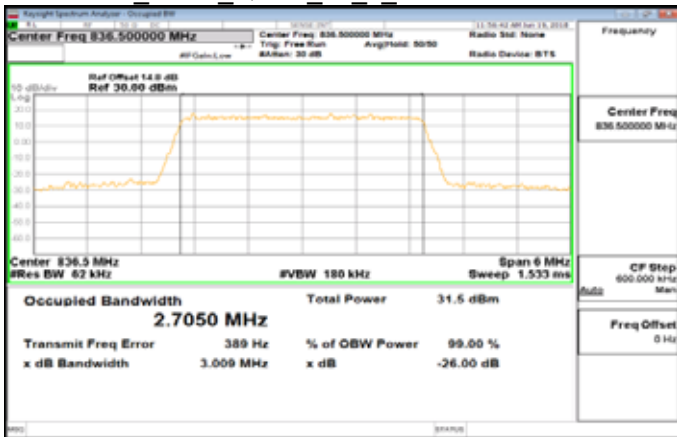

Band5 3MHz 16QAM 15 0 MidCH20525-836.5

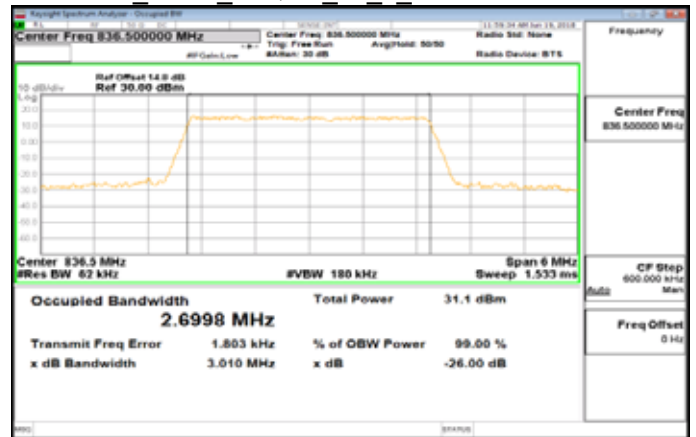

Band5 3MHz QPSK 15 0 HighCH20635-847.5

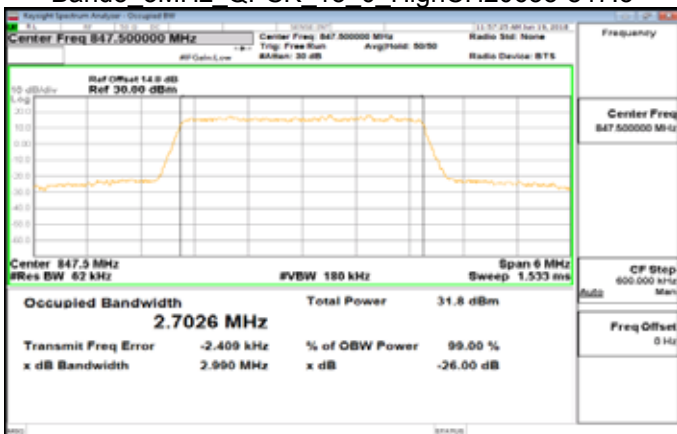

Band5 3MHz 16QAM 15 0 HighCH20635-847.5

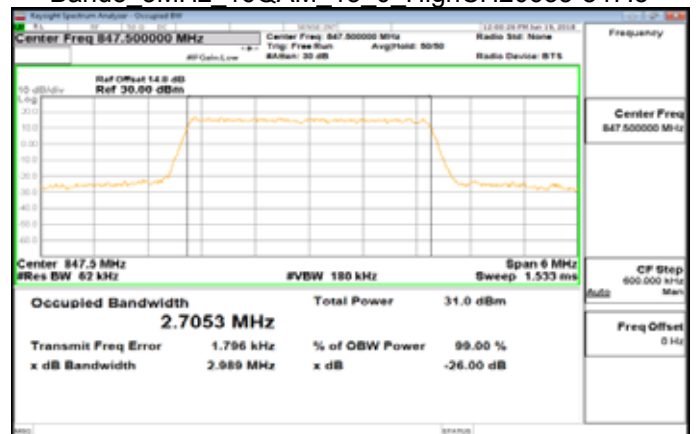

Unless otherwise stated the results shown in this test report refer only to the sample(s) tested and such sample(s) are retained for 90 days only.

除非另有說明，此報告結果僅對測試之樣品負責，同時此樣品僅保留90天。本報告未經本公司書面許可，不可部份複製。

This document is issued by the Company subject to its General Conditions of Service printed overleaf, available on request or accessible at www.sgs.com/terms_and_conditions.htm and, for electronic format documents, subject to Terms and Conditions for Electronic Documents at www.sgs.com/terms_e-document.htm. Attention is drawn to the limitation of liability, indemnification and jurisdiction issues defined therein. Any holder of this document is advised that information contained hereon reflects the Company's findings at the time of its intervention only and within the limits of Client's instructions, if any. The Company's sole responsibility is to its Client and this document does not exonerate parties to a transaction from exercising all their rights and obligations under the transaction documents. This document cannot be reproduced except in full, without prior written approval of the Company. Any unauthorized alteration, forgery or falsification of the content or appearance of this document is unlawful and offenders may be prosecuted to the fullest extent of the law.

SGS Taiwan Ltd.

No.134,WuKungRoad,NewTaipeiIndustrialPark,WukuDistrict,NewTaipeiCity,Taiwan24803/新北市五股區新北產業園區五工路 134 號

台灣檢驗科技股份有限公司

t (886-2) 2299-3279

f (886-2) 2298-0488

www.tw.sgs.com

Member of SGS Group

Band5 5MHz QPSK 25 0 LowCH20425-826.5

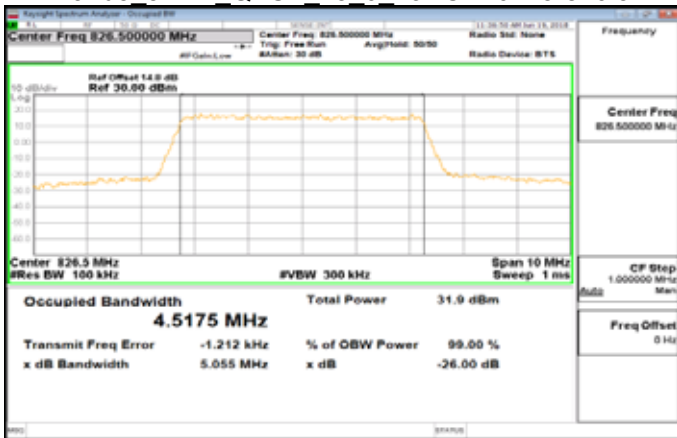

Band5 5MHz 16QAM 25 0 LowCH20425-826.5

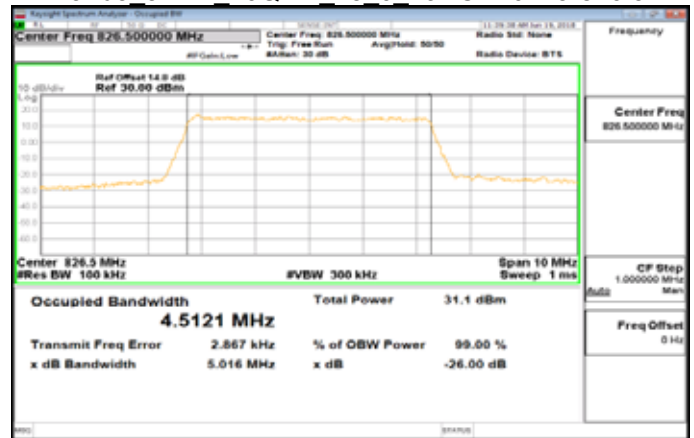

Band5 5MHz QPSK 25 0 MidCH20525-836.5

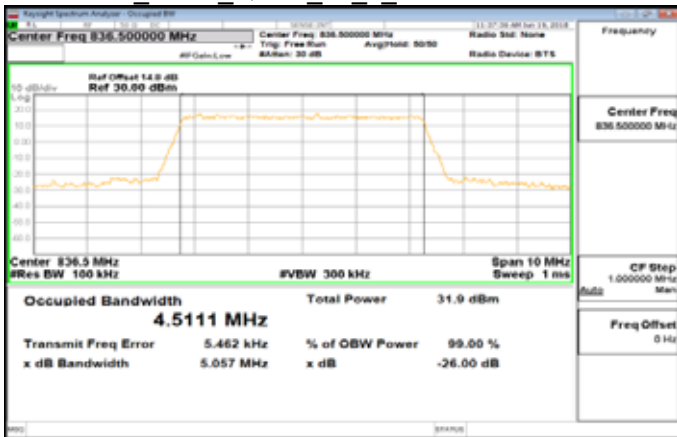

Band5 5MHz 16QAM 25 0 MidCH20525-836.5

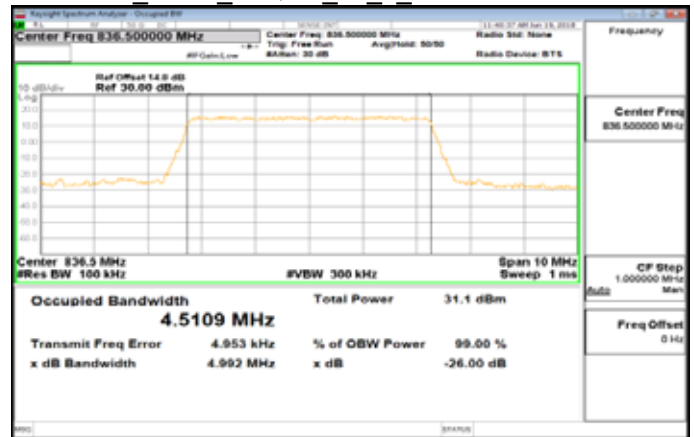

Band5 5MHz QPSK 25 0 HighCH20625-846.5

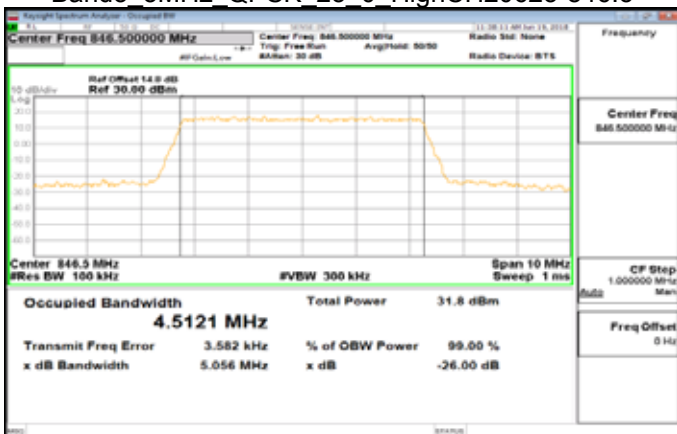

Band5 5MHz 16QAM 25 0 HighCH20625-846.5

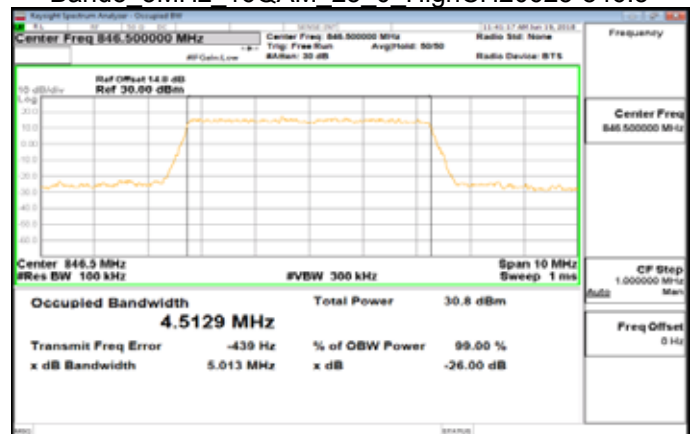

Unless otherwise stated the results shown in this test report refer only to the sample(s) tested and such sample(s) are retained for 90 days only.

除非另有說明，此報告結果僅對測試之樣品負責，同時此樣品僅保留90天。本報告未經本公司書面許可，不可部份複製。

This document is issued by the Company subject to its General Conditions of Service printed overleaf, available on request or accessible at www.sgs.com/terms_and_conditions.htm and, for electronic format documents, subject to Terms and Conditions for Electronic Documents at www.sgs.com/terms_e-document.htm. Attention is drawn to the limitation of liability, indemnification and jurisdiction issues defined therein. Any holder of this document is advised that information contained hereon reflects the Company's findings at the time of its intervention only and within the limits of Client's instructions, if any. The Company's sole responsibility is to its Client and this document does not exonerate parties to a transaction from exercising all their rights and obligations under the transaction documents. This document cannot be reproduced except in full, without prior written approval of the Company. Any unauthorized alteration, forgery or falsification of the content or appearance of this document is unlawful and offenders may be prosecuted to the fullest extent of the law.

SGS Taiwan Ltd.

No. 134, WuKungRoad, NewTaipeiIndustrialPark, WukuDistrict, NewTaipeiCity, Taiwan24803/新北市五股區新北產業園區五工路 134 號

台灣檢驗科技股份有限公司

t (886-2) 2299-3279

f (886-2) 2298-0488

www.tw.sgs.com

Member of SGS Group

Band5_10MHz_QPSK_50_0_LowCH20450-829

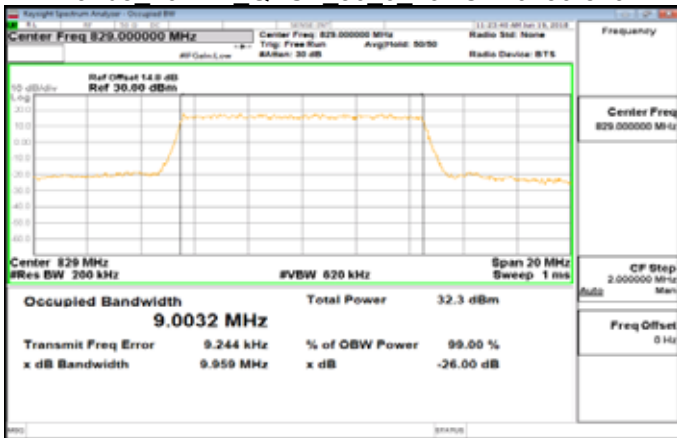

Band5_10MHz_16QAM_50_0_LowCH20450-829

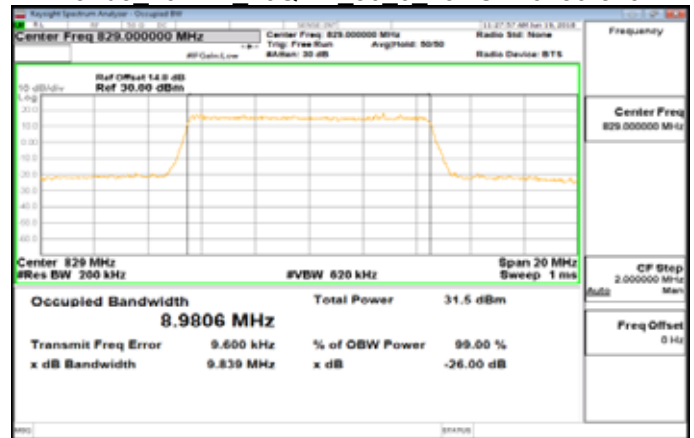

Band5_10MHz_QPSK_50_0_MidCH20525-836.5

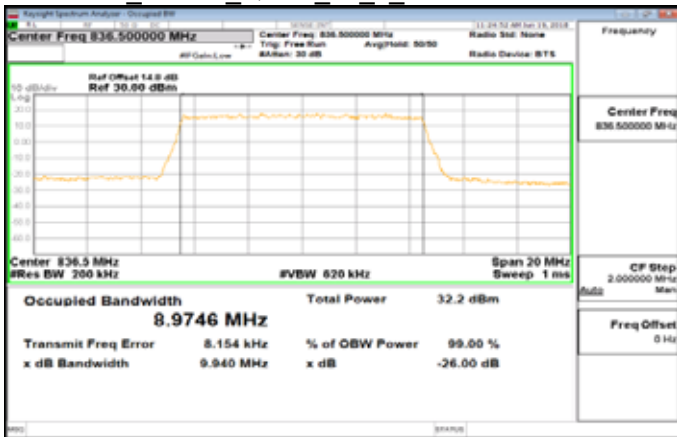

Band5_10MHz_16QAM_50_0_MidCH20525-836.5

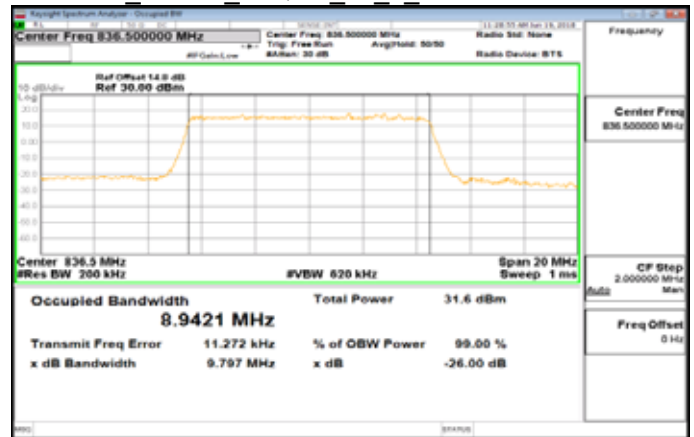

Band5_10MHz_QPSK_50_0_HighCH20600-844

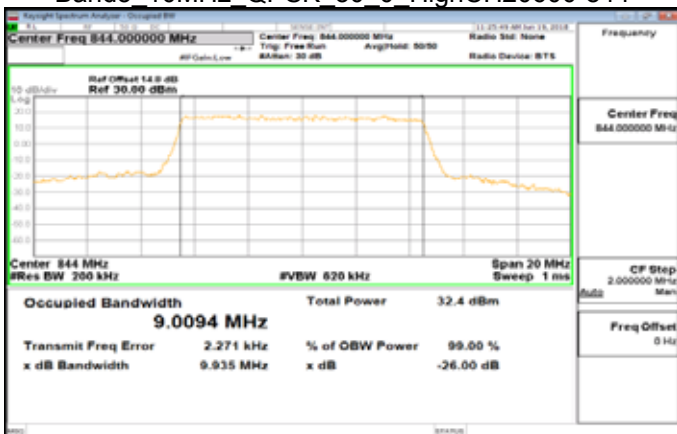

Band5_10MHz_16QAM_50_0_HighCH20600-844

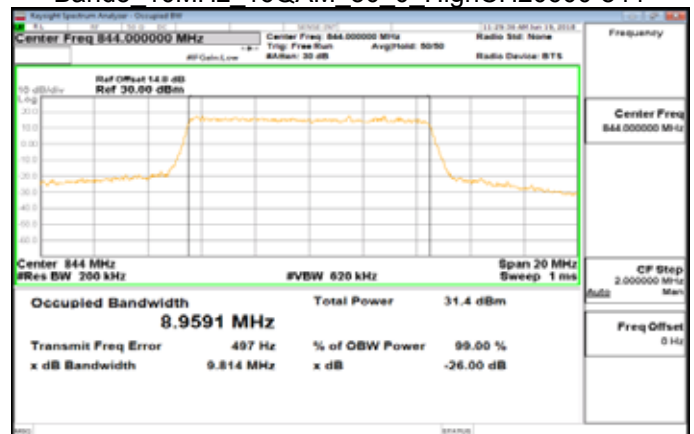

Unless otherwise stated the results shown in this test report refer only to the sample(s) tested and such sample(s) are retained for 90 days only.

除非另有說明，此報告結果僅對測試之樣品負責，同時此樣品僅保留90天。本報告未經本公司書面許可，不可部份複製。

This document is issued by the Company subject to its General Conditions of Service printed overleaf, available on request or accessible at www.sgs.com/terms_and_conditions.htm and, for electronic format documents, subject to Terms and Conditions for Electronic Documents at www.sgs.com/terms_e-document.htm. Attention is drawn to the limitation of liability, indemnification and jurisdiction issues defined therein. Any holder of this document is advised that information contained hereon reflects the Company's findings at the time of its intervention only and within the limits of Client's instructions, if any. The Company's sole responsibility is to its Client and this document does not exonerate parties to a transaction from exercising all their rights and obligations under the transaction documents. This document cannot be reproduced except in full, without prior written approval of the Company. Any unauthorized alteration, forgery or falsification of the content or appearance of this document is unlawful and offenders may be prosecuted to the fullest extent of the law.

8. OUT OF BAND EMISSION AT ANTENNA TERMINALS

8.1. Standard Applicable

FCC §22.917(a), §24.238(a), Out of band emissions. The power of any emission outside of the authorized operating frequency ranges must be attenuated below the transmitting power (P) by a factor of at least $43 + 10 \log(P)$ dB.

8.2. Test SET-UP

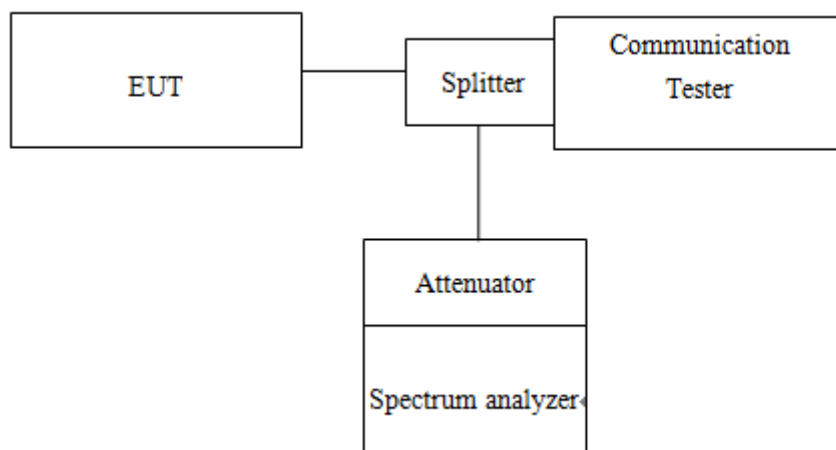

8.3. Measurement Procedure

Conducted Emission

The RF output of the transceiver was connected to a spectrum analyzer through appropriate attenuation. The resolution bandwidth of the spectrum analyzer was set at 1MHz, sufficient scans were taken to show the out of band Emissions if any up to 10th harmonic.

1. To connect Antenna Port of EUT to Spectrum.
2. Set RBW = 1MHz & VBW = 1MHz on Spectrum.
3. Allow trace to fully stabilize
4. Repeat above procedures until all default test channel measured were complete.

Band Edge

1. To connect Antenna Port of EUT to Spectrum.
2. The band edge of low and high channels for the highest RF powers was measured. Setting $RBW \geq 1\% EBW$.
3. Allow trace to fully stabilize
4. Repeat above procedures until all default test channel measured were complete.

Unless otherwise stated the results shown in this test report refer only to the sample(s) tested and such sample(s) are retained for 90 days only.

除非另有說明，此報告結果僅對測試之樣品負責，同時此樣品僅保留90天。本報告未經本公司書面許可，不可部份複製。

This document is issued by the Company subject to its General Conditions of Service printed overleaf, available on request or accessible at www.sgs.com/terms_and_conditions.htm and, for electronic format documents, subject to Terms and Conditions for Electronic Documents at www.sgs.com/terms_e-document.htm. Attention is drawn to the limitation of liability, indemnification and jurisdiction issues defined therein. Any holder of this document is advised that information contained hereon reflects the Company's findings at the time of its intervention only and within the limits of Client's instructions, if any. The Company's sole responsibility is to its Client and this document does not exonerate parties to a transaction from exercising all their rights and obligations under the transaction documents. This document cannot be reproduced except in full, without prior written approval of the Company. Any unauthorized alteration, forgery or falsification of the content or appearance of this document is unlawful and offenders may be prosecuted to the fullest extent of the law.

8.4. Measurement Equipment Used

EQUIPMENT TYPE	MFR	MODEL NUMBER	SERIAL NUMBER	LAST CAL.	CAL DUE.
EXA Spectrum Analyzer	Agilent	N9010A	MY57120290	2018/02/14	2019/02/13
Radio Communication Analyser	Anritsu	MT8815B	6200711454	2018/04/05	2019/04/04
Radio Communication Analyser	Anritsu	MT8820C	6200995019	2018/04/05	2019/04/04
DC Power Supply	Anritsu	E3640A	MY52410006	2017/11/28	2018/11/27
Temperature Chamber	TERCHY	MHG-120LF	911009	2018/05/18	2019/05/17
Attenuator	Mini-Circuit	BW-S10W2+	2	2018/01/02	2019/01/01
Splitter	RF-LAMBAD	RFLT2W1G18G	11-JSPF412-018	2018/01/02	2019/01/01
Coaxial Cables	N/A	WK CE Cable	N/A	2018/01/02	2019/01/01

8.5. Measurement Result:

Refer to next pages.

NOTE: The occurrence of the spike on the conducted emission is the signal of the fundamental emission.

Unless otherwise stated the results shown in this test report refer only to the sample(s) tested and such sample(s) are retained for 90 days only.

除非另有說明，此報告結果僅對測試之樣品負責，同時此樣品僅保留90天。本報告未經本公司書面許可，不可部份複製。

This document is issued by the Company subject to its General Conditions of Service printed overleaf, available on request or accessible at www.sgs.com/terms_and_conditions.htm and, for electronic format documents, subject to Terms and Conditions for Electronic Documents at www.sgs.com/terms_e-document.htm. Attention is drawn to the limitation of liability, indemnification and jurisdiction issues defined therein. Any holder of this document is advised that information contained hereon reflects the Company's findings at the time of its intervention only and within the limits of Client's instructions, if any. The Company's sole responsibility is to its Client and this document does not exonerate parties to a transaction from exercising all their rights and obligations under the transaction documents. This document cannot be reproduced except in full, without prior written approval of the Company. Any unauthorized alteration, forgery or falsification of the content or appearance of this document is unlawful and offenders may be prosecuted to the fullest extent of the law.

SGS Taiwan Ltd.

No.134,WuKungRoad,NewTaipeiIndustrialPark,WukuDistrict,NewTaipeiCity,Taiwan24803/新北市五股區新北產業園區五工路 134 號

台灣檢驗科技股份有限公司

t (886-2) 2299-3279

f (886-2) 2298-0488

www.tw.sgs.com

Member of SGS Group

Band Edge

GSM 850MHz LowCH128-824.2



GSM 1900MHz HighCH810-1909.8



GSM 850MHz HighCH251-848.8



GPRS 850MHz LowCH128-824.2

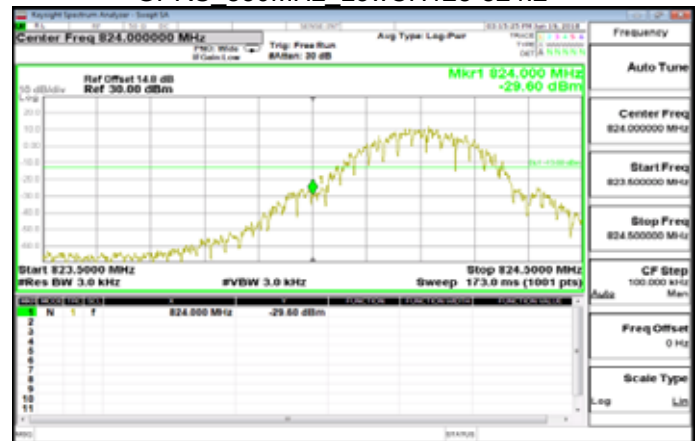

GSM 1900MHz LowCH512-1850.2

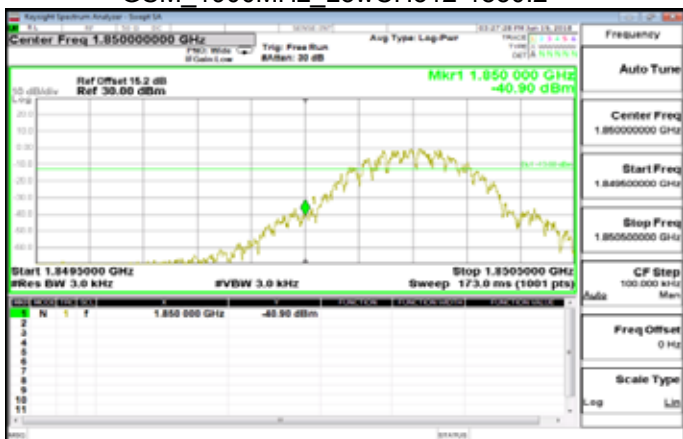

GPRS 850MHz HighCH251-848.8



Unless otherwise stated the results shown in this test report refer only to the sample(s) tested and such sample(s) are retained for 90 days only.

除非另有說明，此報告結果僅對測試之樣品負責，同時此樣品僅保留90天。本報告未經本公司書面許可，不可部份複製。

This document is issued by the Company subject to its General Conditions of Service printed overleaf, available on request or accessible at www.sgs.com/terms_and_conditions.htm and, for electronic format documents, subject to Terms and Conditions for Electronic Documents at www.sgs.com/terms_e-document.htm. Attention is drawn to the limitation of liability, indemnification and jurisdiction issues defined therein. Any holder of this document is advised that information contained hereon reflects the Company's findings at the time of its intervention only and within the limits of Client's instructions, if any. The Company's sole responsibility is to its Client and this document does not exonerate parties to a transaction from exercising all their rights and obligations under the transaction documents. This document cannot be reproduced except in full, without prior written approval of the Company. Any unauthorized alteration, forgery or falsification of the content or appearance of this document is unlawful and offenders may be prosecuted to the fullest extent of the law.

SGS Taiwan Ltd.

No. 134, WuKungRoad, NewTaipeiIndustrialPark, WukuDistrict, NewTaipeiCity, Taiwan24803/新北市五股區新北產業園區五工路 134 號

台灣檢驗科技股份有限公司

t (886-2) 2299-3279

f (886-2) 2298-0488

www.tw.sgs.com

Member of SGS Group

GPRS 1900MHz LowCH512-1850.2

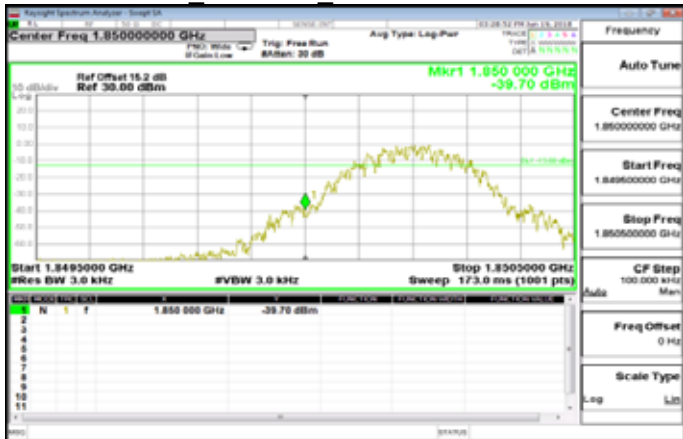

WCDMA B5 HighCH4233-846.6

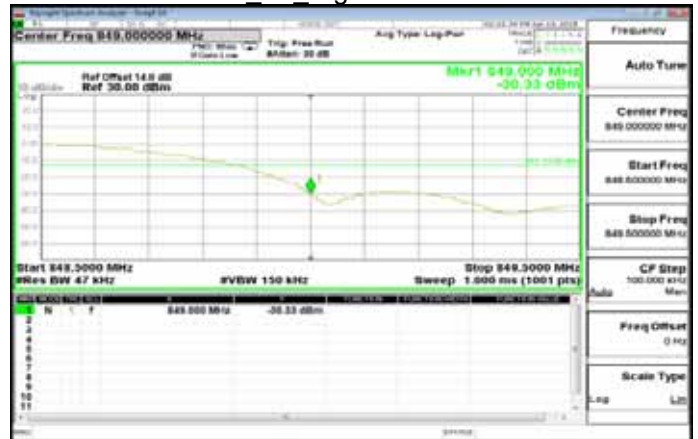

GPRS 1900MHz HighCH810-1909.8



HSDPA B5 LowCH4132-826.4

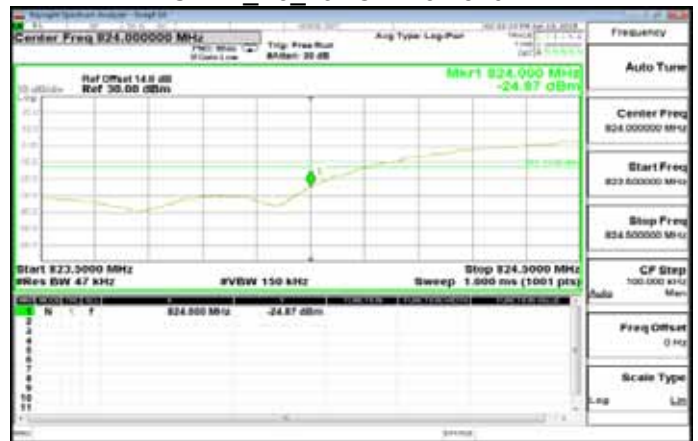

WCDMA B5 LowCH4132-826.4

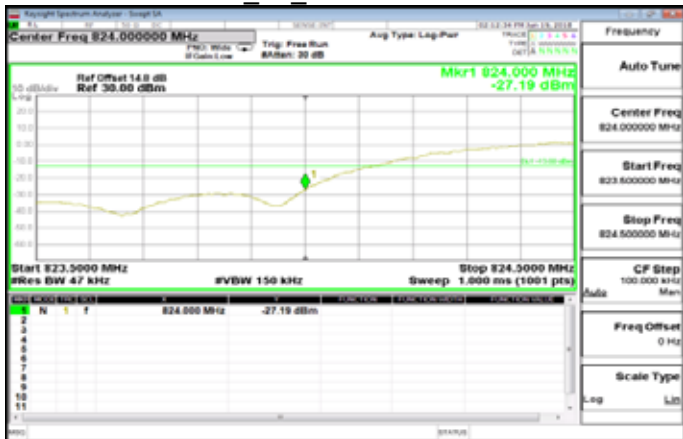

HSDPA B5 HighCH4233-846.6

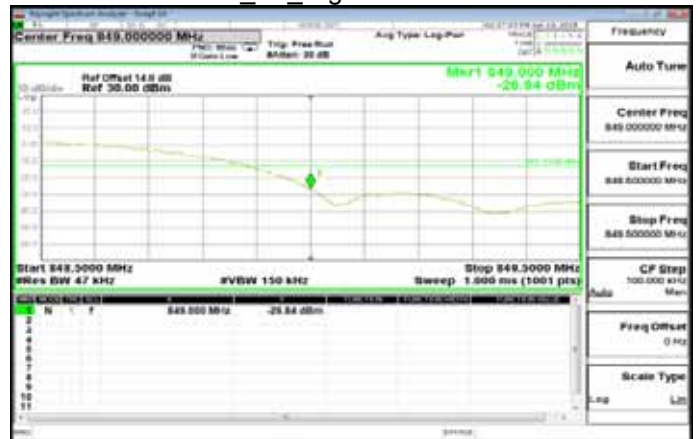

Unless otherwise stated the results shown in this test report refer only to the sample(s) tested and such sample(s) are retained for 90 days only.

除非另有說明，此報告結果僅對測試之樣品負責，同時此樣品僅保留90天。本報告未經本公司書面許可，不可部份複製。

This document is issued by the Company subject to its General Conditions of Service printed overleaf, available on request or accessible at www.sgs.com/terms_and_conditions.htm and, for electronic format documents, subject to Terms and Conditions for Electronic Documents at www.sgs.com/terms_e-document.htm. Attention is drawn to the limitation of liability, indemnification and jurisdiction issues defined therein. Any holder of this document is advised that information contained hereon reflects the Company's findings at the time of its intervention only and within the limits of Client's instructions, if any. The Company's sole responsibility is to its Client and this document does not exonerate parties to a transaction from exercising all their rights and obligations under the transaction documents. This document cannot be reproduced except in full, without prior written approval of the Company. Any unauthorized alteration, forgery or falsification of the content or appearance of this document is unlawful and offenders may be prosecuted to the fullest extent of the law.

SGS Taiwan Ltd.

No. 134, WuKungRoad, NewTaipeiIndustrialPark, WukuDistrict, NewTaipeiCity, Taiwan24803/新北市五股區新北產業園區五工路 134 號

台灣檢驗科技股份有限公司

t (886-2) 2299-3279

f (886-2) 2298-0488

www.tw.sgs.com

Member of SGS Group

HSUPA_B5_LowCH4132-826.4



HSUPA_B5_HighCH4233-846.6



Unless otherwise stated the results shown in this test report refer only to the sample(s) tested and such sample(s) are retained for 90 days only.

除非另有說明，此報告結果僅對測試之樣品負責，同時此樣品僅保留90天。本報告未經本公司書面許可，不可部份複製。

This document is issued by the Company subject to its General Conditions of Service printed overleaf, available on request or accessible at www.sgs.com/terms_and_conditions.htm and, for electronic format documents, subject to Terms and Conditions for Electronic Documents at www.sgs.com/terms_e-document.htm. Attention is drawn to the limitation of liability, indemnification and jurisdiction issues defined therein. Any holder of this document is advised that information contained hereon reflects the Company's findings at the time of its intervention only and within the limits of Client's instructions, if any. The Company's sole responsibility is to its Client and this document does not exonerate parties to a transaction from exercising all their rights and obligations under the transaction documents. This document cannot be reproduced except in full, without prior written approval of the Company. Any unauthorized alteration, forgery or falsification of the content or appearance of this document is unlawful and offenders may be prosecuted to the fullest extent of the law.

SGS Taiwan Ltd.

No. 134, WuKung Road, New Taipei Industrial Park, WuKu District, New Taipei City, Taiwan 24803/新北市五股區新北產業園區五工路 134 號

台灣檢驗科技股份有限公司

t (886-2) 2299-3279

f (886-2) 2298-0488

www.tw.sgs.com

Member of SGS Group

Band5_1_4MHz_QPSK_1_0_LowCH20407-824.7



Band5_1_4MHz_QPSK_6_0_HighCH20643-848.3



Band5_1_4MHz_QPSK_1_5_HighCH20643-848.3



Band5_3MHz_QPSK_1_0_LowCH20415-825.5



Band5_1_4MHz_QPSK_6_0_LowCH20407-824.7

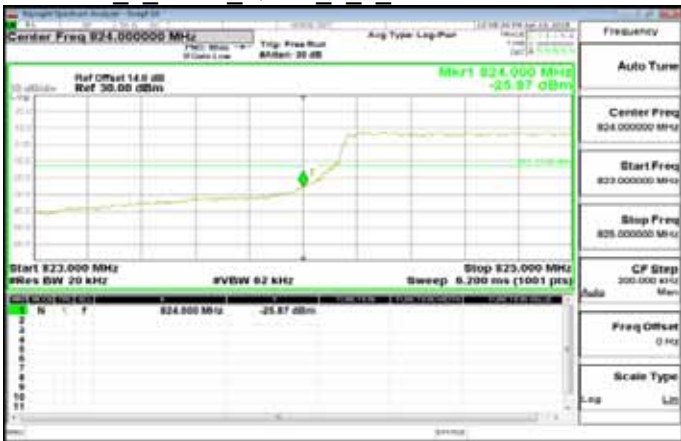

Band5_3MHz_QPSK_1_14_HighCH20635-847.5



Unless otherwise stated the results shown in this test report refer only to the sample(s) tested and such sample(s) are retained for 90 days only.

除非另有說明，此報告結果僅對測試之樣品負責，同時此樣品僅保留90天。本報告未經本公司書面許可，不可部份複製。

This document is issued by the Company subject to its General Conditions of Service printed overleaf, available on request or accessible at www.sgs.com/terms_and_conditions.htm and, for electronic format documents, subject to Terms and Conditions for Electronic Documents at www.sgs.com/terms_e-document.htm. Attention is drawn to the limitation of liability, indemnification and jurisdiction issues defined therein. Any holder of this document is advised that information contained hereon reflects the Company's findings at the time of its intervention only and within the limits of Client's instructions, if any. The Company's sole responsibility is to its Client and this document does not exonerate parties to a transaction from exercising all their rights and obligations under the transaction documents. This document cannot be reproduced except in full, without prior written approval of the Company. Any unauthorized alteration, forgery or falsification of the content or appearance of this document is unlawful and offenders may be prosecuted to the fullest extent of the law.

SGS Taiwan Ltd.

No. 134, WuKungRoad, NewTaipeiIndustrialPark, WukuDistrict, NewTaipeiCity, Taiwan24803/新北市五股區新北產業園區五工路 134 號

台灣檢驗科技股份有限公司

t (886-2) 2299-3279

f (886-2) 2298-0488

www.tw.sgs.com

Member of SGS Group

Band5 3MHz QPSK 15_0 LowCH20415-825.5



Band5 5MHz QPSK 1_24 HighCH20625-846.5



Band5 3MHz QPSK 15_0 HighCH20635-847.5



Band5 5MHz QPSK 25_0 LowCH20425-826.5



Band5 5MHz QPSK 1_0 LowCH20425-826.5



Band5 5MHz QPSK 25_0 HighCH20625-846.5



Unless otherwise stated the results shown in this test report refer only to the sample(s) tested and such sample(s) are retained for 90 days only.

除非另有說明，此報告結果僅對測試之樣品負責，同時此樣品僅保留90天。本報告未經本公司書面許可，不可部份複製。

This document is issued by the Company subject to its General Conditions of Service printed overleaf, available on request or accessible at www.sgs.com/terms_and_conditions.htm and, for electronic format documents, subject to Terms and Conditions for Electronic Documents at www.sgs.com/terms_e-document.htm. Attention is drawn to the limitation of liability, indemnification and jurisdiction issues defined therein. Any holder of this document is advised that information contained hereon reflects the Company's findings at the time of its intervention only and within the limits of Client's instructions, if any. The Company's sole responsibility is to its Client and this document does not exonerate parties to a transaction from exercising all their rights and obligations under the transaction documents. This document cannot be reproduced except in full, without prior written approval of the Company. Any unauthorized alteration, forgery or falsification of the content or appearance of this document is unlawful and offenders may be prosecuted to the fullest extent of the law.

SGS Taiwan Ltd.

No. 134, WuKungRoad, NewTaipeiIndustrialPark, WukuDistrict, NewTaipeiCity, Taiwan24803/新北市五股區新北產業園區五工路 134 號

台灣檢驗科技股份有限公司

t (886-2) 2299-3279

f (886-2) 2298-0488

www.tw.sgs.com

Member of SGS Group

Band5 10MHz QPSK 1 0 LowCH20450-829



Band5 10MHz QPSK 50 0 HighCH20600-844



Band5 10MHz QPSK 1 49 HighCH20600-844



Band5 10MHz QPSK 50 0 LowCH20450-829



Unless otherwise stated the results shown in this test report refer only to the sample(s) tested and such sample(s) are retained for 90 days only.

除非另有說明，此報告結果僅對測試之樣品負責，同時此樣品僅保留90天。本報告未經本公司書面許可，不可部份複製。

This document is issued by the Company subject to its General Conditions of Service printed overleaf, available on request or accessible at www.sgs.com/terms_and_conditions.htm and, for electronic format documents, subject to Terms and Conditions for Electronic Documents at www.sgs.com/terms_e-document.htm. Attention is drawn to the limitation of liability, indemnification and jurisdiction issues defined therein. Any holder of this document is advised that information contained hereon reflects the Company's findings at the time of its intervention only and within the limits of Client's instructions, if any. The Company's sole responsibility is to its Client and this document does not exonerate parties to a transaction from exercising all their rights and obligations under the transaction documents. This document cannot be reproduced except in full, without prior written approval of the Company. Any unauthorized alteration, forgery or falsification of the content or appearance of this document is unlawful and offenders may be prosecuted to the fullest extent of the law.

SGS Taiwan Ltd.

No. 134, WuKung Road, New Taipei Industrial Park, Wuku District, New Taipei City, Taiwan 24803/新北市五股區新北產業園區五工路 134 號

台灣檢驗科技股份有限公司

t (886-2) 2299-3279

f (886-2) 2298-0488

www.tw.sgs.com

Member of SGS Group

Out of Band Emission

30MHz~3GHz GSM 850MHz LowCH128-824.2



3GHz~10GHz GSM 850MHz MidCH190-836.6

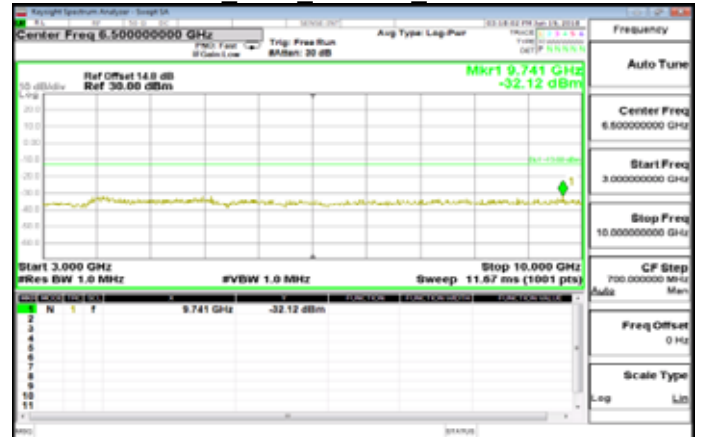

3GHz~10GHz GSM 850MHz LowCH128-824.2

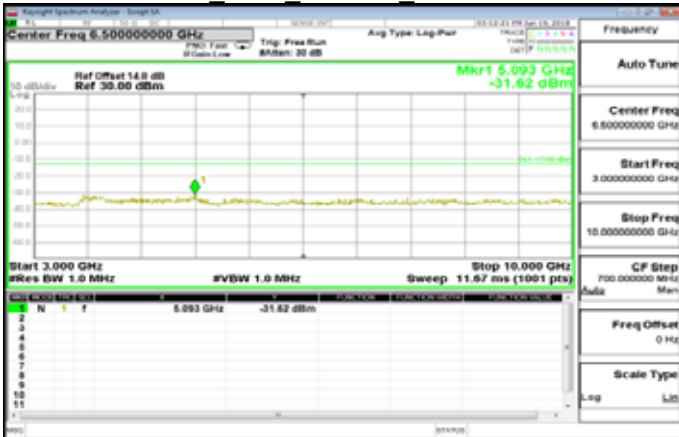

30MHz~3GHz GSM 850MHz HighCH251-848.8



30MHz~3GHz GSM 850MHz MidCH190-836.6



3GHz~10GHz GSM 850MHz HighCH251-848.8



Unless otherwise stated the results shown in this test report refer only to the sample(s) tested and such sample(s) are retained for 90 days only.

除非另有說明，此報告結果僅對測試之樣品負責，同時此樣品僅保留90天。本報告未經本公司書面許可，不可部份複製。

This document is issued by the Company subject to its General Conditions of Service printed overleaf, available on request or accessible at www.sgs.com/terms_and_conditions.htm and, for electronic format documents, subject to Terms and Conditions for Electronic Documents at www.sgs.com/terms_e-document.htm. Attention is drawn to the limitation of liability, indemnification and jurisdiction issues defined therein. Any holder of this document is advised that information contained hereon reflects the Company's findings at the time of its intervention only and within the limits of Client's instructions, if any. The Company's sole responsibility is to its Client and this document does not exonerate parties to a transaction from exercising all their rights and obligations under the transaction documents. This document cannot be reproduced except in full, without prior written approval of the Company. Any unauthorized alteration, forgery or falsification of the content or appearance of this document is unlawful and offenders may be prosecuted to the fullest extent of the law.

SGS Taiwan Ltd.

No. 134, WuKungRoad, NewTaipeiIndustrialPark, WukuDistrict, NewTaipeiCity, Taiwan24803/新北市五股區新北產業園區五工路 134 號

台灣檢驗科技股份有限公司

t (886-2) 2299-3279

f (886-2) 2298-0488

www.tw.sgs.com

Member of SGS Group

30MHz~3GHz_GPRS_850MHz_LowCH128-824.2



3GHz~10GHz_GPRS_850MHz_MidCH190-836.6

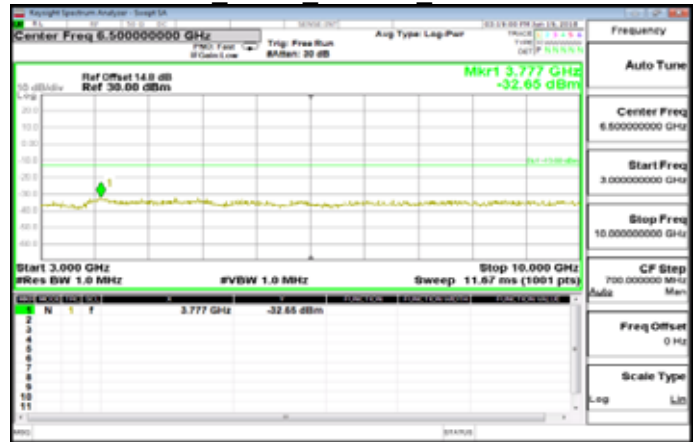

3GHz~10GHz_GPRS_850MHz_LowCH128-824.2



30MHz~3GHz_GPRS_850MHz_HighCH251-848.8



30MHz~3GHz_GPRS_850MHz_MidCH190-836.6



3GHz~10GHz_GPRS_850MHz_HighCH251-848.8



Unless otherwise stated the results shown in this test report refer only to the sample(s) tested and such sample(s) are retained for 90 days only.

除非另有說明，此報告結果僅對測試之樣品負責，同時此樣品僅保留90天。本報告未經本公司書面許可，不可部份複製。

This document is issued by the Company subject to its General Conditions of Service printed overleaf, available on request or accessible at www.sgs.com/terms_and_conditions.htm and, for electronic format documents, subject to Terms and Conditions for Electronic Documents at www.sgs.com/terms_e-document.htm. Attention is drawn to the limitation of liability, indemnification and jurisdiction issues defined therein. Any holder of this document is advised that information contained hereon reflects the Company's findings at the time of its intervention only and within the limits of Client's instructions, if any. The Company's sole responsibility is to its Client and this document does not exonerate parties to a transaction from exercising all their rights and obligations under the transaction documents. This document cannot be reproduced except in full, without prior written approval of the Company. Any unauthorized alteration, forgery or falsification of the content or appearance of this document is unlawful and offenders may be prosecuted to the fullest extent of the law.

SGS Taiwan Ltd.

No. 134, WuKungRoad, NewTaipeiIndustrialPark, WukuDistrict, NewTaipeiCity, Taiwan24803/新北市五股區新北產業園區五工路 134 號

台灣檢驗科技股份有限公司

t (886-2) 2299-3279

f (886-2) 2298-0488

www.tw.sgs.com

Member of SGS Group

30MHz~3GHz GSM_1900MHz LowCH512-1850.2



3GHz~10GHz GSM_1900MHz MidCH661-1880

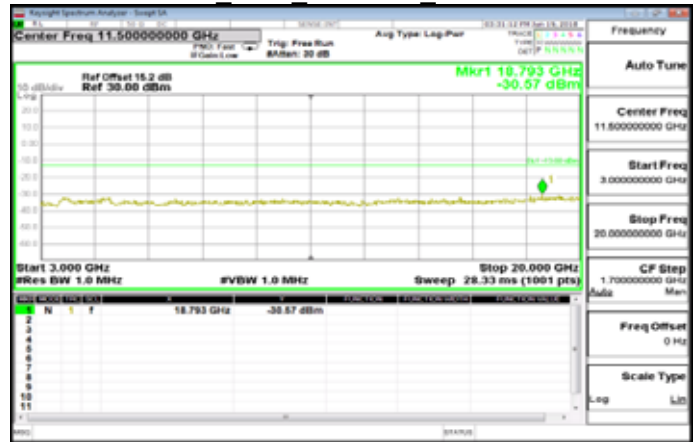

3GHz~10GHz GSM_1900MHz LowCH512-1850.2

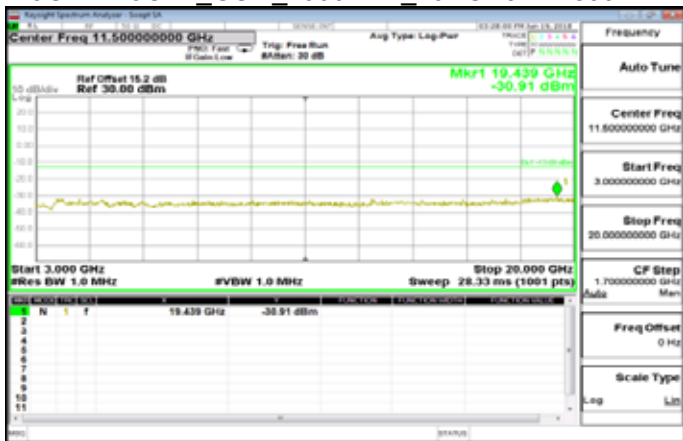

30MHz~3GHz GSM_1900MHz_HighCH810-1909.8



30MHz~3GHz GSM_1900MHz_MidCH661-1880



3GHz~10GHz GSM_1900MHz_HighCH810-1909.8

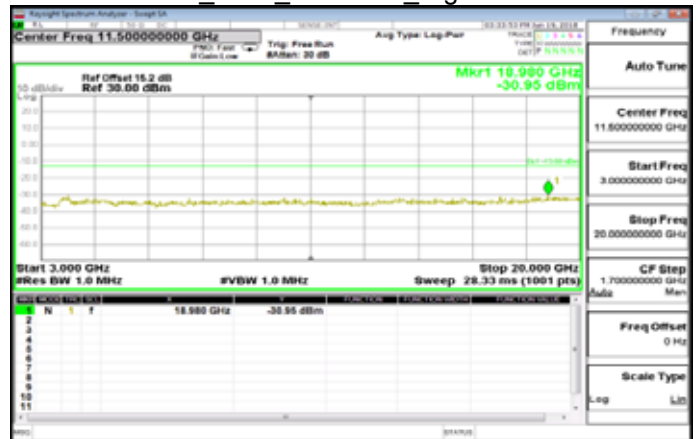

Unless otherwise stated the results shown in this test report refer only to the sample(s) tested and such sample(s) are retained for 90 days only.

除非另有說明，此報告結果僅對測試之樣品負責，同時此樣品僅保留90天。本報告未經本公司書面許可，不可部份複製。

This document is issued by the Company subject to its General Conditions of Service printed overleaf, available on request or accessible at www.sgs.com/terms_and_conditions.htm and, for electronic format documents, subject to Terms and Conditions for Electronic Documents at www.sgs.com/terms_e-document.htm. Attention is drawn to the limitation of liability, indemnification and jurisdiction issues defined therein. Any holder of this document is advised that information contained hereon reflects the Company's findings at the time of its intervention only and within the limits of Client's instructions, if any. The Company's sole responsibility is to its Client and this document does not exonerate parties to a transaction from exercising all their rights and obligations under the transaction documents. This document cannot be reproduced except in full, without prior written approval of the Company. Any unauthorized alteration, forgery or falsification of the content or appearance of this document is unlawful and offenders may be prosecuted to the fullest extent of the law.

SGS Taiwan Ltd.

No. 134, WuKungRoad, NewTaipeiIndustrialPark, WukuDistrict, NewTaipeiCity, Taiwan24803/新北市五股區新北產業園區五工路 134 號

台灣檢驗科技股份有限公司

t (886-2) 2299-3279

f (886-2) 2298-0488

www.tw.sgs.com

Member of SGS Group

30MHz~3GHz_GPRS_1900MHz_LowCH512-1850.2



3GHz~10GHz_GPRS_1900MHz_MidCH661-1880

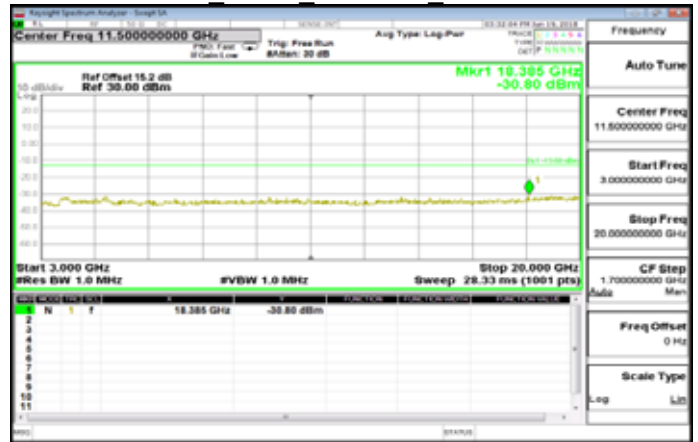

3GHz~10GHz_GPRS_1900MHz_LowCH512-1850.2

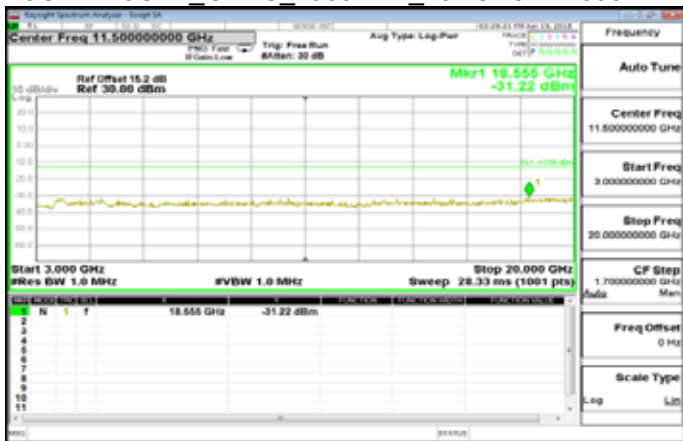

30MHz~3GHz_GPRS_1900MHz_HighCH810-1909.8



30MHz~3GHz_GPRS_1900MHz_MidCH661-1880



3GHz~10GHz_GPRS_1900MHz_HighCH810-1909.8

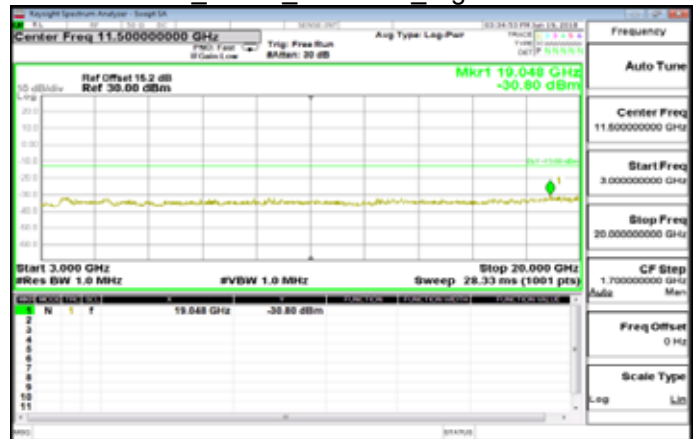

Unless otherwise stated the results shown in this test report refer only to the sample(s) tested and such sample(s) are retained for 90 days only.

除非另有說明，此報告結果僅對測試之樣品負責，同時此樣品僅保留90天。本報告未經本公司書面許可，不可部份複製。

This document is issued by the Company subject to its General Conditions of Service printed overleaf, available on request or accessible at www.sgs.com/terms_and_conditions.htm and, for electronic format documents, subject to Terms and Conditions for Electronic Documents at www.sgs.com/terms_e-document.htm. Attention is drawn to the limitation of liability, indemnification and jurisdiction issues defined therein. Any holder of this document is advised that information contained hereon reflects the Company's findings at the time of its intervention only and within the limits of Client's instructions, if any. The Company's sole responsibility is to its Client and this document does not exonerate parties to a transaction from exercising all their rights and obligations under the transaction documents. This document cannot be reproduced except in full, without prior written approval of the Company. Any unauthorized alteration, forgery or falsification of the content or appearance of this document is unlawful and offenders may be prosecuted to the fullest extent of the law.

SGS Taiwan Ltd.

No. 134, WuKungRoad, NewTaipeiIndustrialPark, WukuDistrict, NewTaipeiCity, Taiwan24803/新北市五股區新北產業園區五工路 134 號

台灣檢驗科技股份有限公司

t (886-2) 2299-3279

f (886-2) 2298-0488

www.tw.sgs.com

Member of SGS Group

30MHz~3GHz_WCDMA_B5_LowCH4132-826.4



3GHz~10GHz_WCDMA_B5_MidCH4183-836.6

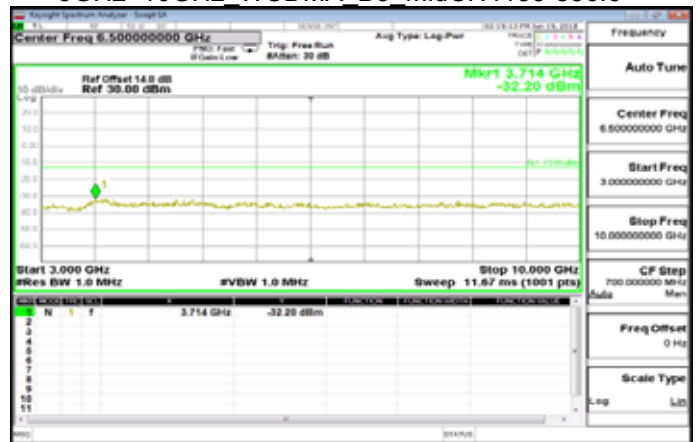

3GHz~10GHz_WCDMA_B5_LowCH4132-826.4

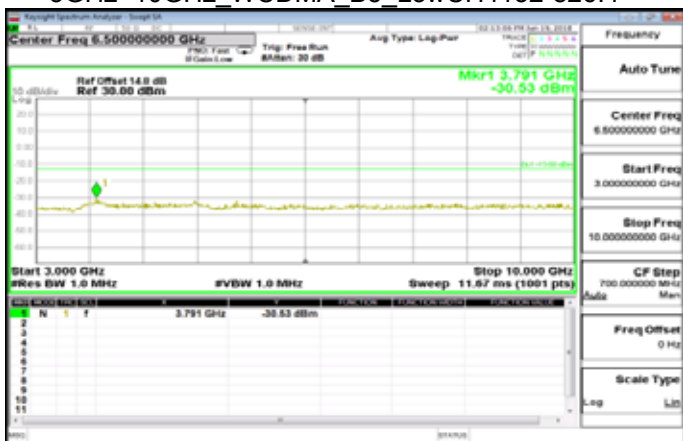

30MHz~3GHz_WCDMA_B5_HighCH4233-846.6



30MHz~3GHz_WCDMA_B5_MidCH4183-836.6



3GHz~10GHz_WCDMA_B5_HighCH4233-846.6



Unless otherwise stated the results shown in this test report refer only to the sample(s) tested and such sample(s) are retained for 90 days only.

除非另有說明，此報告結果僅對測試之樣品負責，同時此樣品僅保留90天。本報告未經本公司書面許可，不可部份複製。

This document is issued by the Company subject to its General Conditions of Service printed overleaf, available on request or accessible at www.sgs.com/terms_and_conditions.htm and, for electronic format documents, subject to Terms and Conditions for Electronic Documents at www.sgs.com/terms_e-document.htm. Attention is drawn to the limitation of liability, indemnification and jurisdiction issues defined therein. Any holder of this document is advised that information contained hereon reflects the Company's findings at the time of its intervention only and within the limits of Client's instructions, if any. The Company's sole responsibility is to its Client and this document does not exonerate parties to a transaction from exercising all their rights and obligations under the transaction documents. This document cannot be reproduced except in full, without prior written approval of the Company. Any unauthorized alteration, forgery or falsification of the content or appearance of this document is unlawful and offenders may be prosecuted to the fullest extent of the law.

SGS Taiwan Ltd.

No. 134, WuKungRoad, NewTaipeiIndustrialPark, WukuDistrict, NewTaipeiCity, Taiwan24803/新北市五股區新北產業園區五工路 134 號

台灣檢驗科技股份有限公司

t (886-2) 2299-3279

f (886-2) 2298-0488

www.tw.sgs.com

Member of SGS Group

30MHz~3GHz_Band5_1_4MHz_QPSK_1_0_LowCH20407
-824.7



3GHz~10GHz_Band5_1_4MHz_QPSK_1_0_MidCH20525
-836.5



3GHz~10GHz_Band5_1_4MHz_QPSK_1_0_LowCH20407
-824.7



30MHz~3GHz_Band5_1_4MHz_QPSK_1_0_HighCH2064
3-848.3



30MHz~3GHz_Band5_1_4MHz_QPSK_1_0_MidCH20525
-836.5



3GHz~10GHz_Band5_1_4MHz_QPSK_1_0_HighCH2064
3-848.3



Unless otherwise stated the results shown in this test report refer only to the sample(s) tested and such sample(s) are retained for 90 days only.
除非另有說明，此報告結果僅對測試之樣品負責，同時此樣品僅保留90天。本報告未經本公司書面許可，不可部份複製。

This document is issued by the Company subject to its General Conditions of Service printed overleaf, available on request or accessible at www.sgs.com/terms_and_conditions.htm and, for electronic format documents, subject to Terms and Conditions for Electronic Documents at www.sgs.com/terms_e-document.htm. Attention is drawn to the limitation of liability, indemnification and jurisdiction issues defined therein. Any holder of this document is advised that information contained hereon reflects the Company's findings at the time of its intervention only and within the limits of Client's instructions, if any. The Company's sole responsibility is to its Client and this document does not exonerate parties to a transaction from exercising all their rights and obligations under the transaction documents. This document cannot be reproduced except in full, without prior written approval of the Company. Any unauthorized alteration, forgery or falsification of the content or appearance of this document is unlawful and offenders may be prosecuted to the fullest extent of the law.

30MHz~3GHz_Band5_3MHz_QPSK_1_0_LowCH20415-8
25.5



3GHz~10GHz_Band5_3MHz_QPSK_1_0_MidCH20525-8
36.5

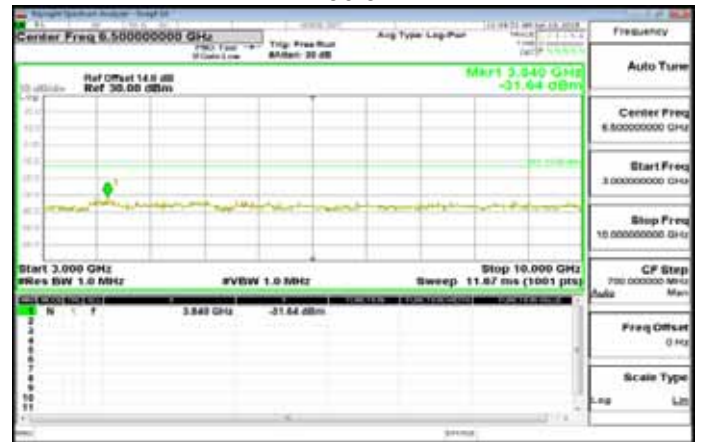

3GHz~10GHz_Band5_3MHz_QPSK_1_0_LowCH20415-8
25.5



30MHz~3GHz_Band5_3MHz_QPSK_1_0_HighCH20635-8
47.5



30MHz~3GHz_Band5_3MHz_QPSK_1_0_MidCH20525-8
36.5



3GHz~10GHz_Band5_3MHz_QPSK_1_0_HighCH20635-8
47.5

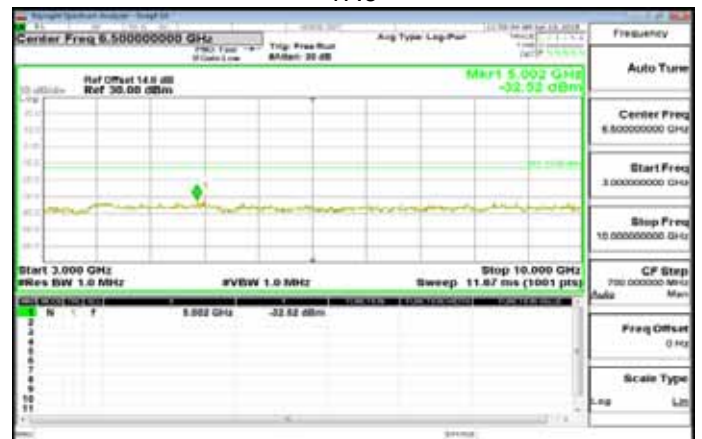

Unless otherwise stated the results shown in this test report refer only to the sample(s) tested and such sample(s) are retained for 90 days only.

除非另有說明，此報告結果僅對測試之樣品負責，同時此樣品僅保留90天。本報告未經本公司書面許可，不可部份複製。

This document is issued by the Company subject to its General Conditions of Service printed overleaf, available on request or accessible at www.sgs.com/terms_and_conditions.htm and, for electronic format documents, subject to Terms and Conditions for Electronic Documents at www.sgs.com/terms_e-document.htm. Attention is drawn to the limitation of liability, indemnification and jurisdiction issues defined therein. Any holder of this document is advised that information contained hereon reflects the Company's findings at the time of its intervention only and within the limits of Client's instructions, if any. The Company's sole responsibility is to its Client and this document does not exonerate parties to a transaction from exercising all their rights and obligations under the transaction documents. This document cannot be reproduced except in full, without prior written approval of the Company. Any unauthorized alteration, forgery or falsification of the content or appearance of this document is unlawful and offenders may be prosecuted to the fullest extent of the law.

SGS Taiwan Ltd.

No. 134, WuKungRoad, NewTaipeiIndustrialPark, WukuDistrict, NewTaipeiCity, Taiwan24803/新北市五股區新北產業園區五工路 134 號

台灣檢驗科技股份有限公司

t (886-2) 2299-3279

f (886-2) 2298-0488

www.tw.sgs.com

Member of SGS Group

30MHz~3GHz_Band5_5MHz_QPSK_1_0_LowCH20425-8
26.5



3GHz~10GHz_Band5_5MHz_QPSK_1_0_MidCH20525-8
36.5



3GHz~10GHz_Band5_5MHz_QPSK_1_0_LowCH20425-8
26.5



30MHz~3GHz_Band5_5MHz_QPSK_1_0_HighCH20625-8
46.5



30MHz~3GHz_Band5_5MHz_QPSK_1_0_MidCH20525-8
36.5

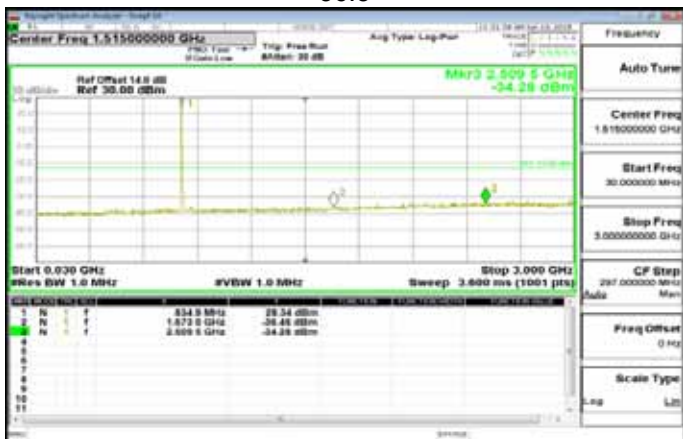

3GHz~10GHz_Band5_5MHz_QPSK_1_0_HighCH20625-8
46.5

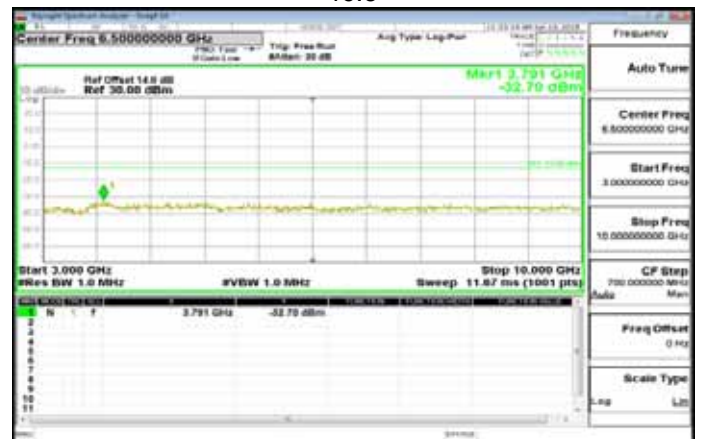

Unless otherwise stated the results shown in this test report refer only to the sample(s) tested and such sample(s) are retained for 90 days only.

除非另有說明，此報告結果僅對測試之樣品負責，同時此樣品僅保留90天。本報告未經本公司書面許可，不可部份複製。

This document is issued by the Company subject to its General Conditions of Service printed overleaf, available on request or accessible at www.sgs.com/terms_and_conditions.htm and, for electronic format documents, subject to Terms and Conditions for Electronic Documents at www.sgs.com/terms_e-document.htm. Attention is drawn to the limitation of liability, indemnification and jurisdiction issues defined therein. Any holder of this document is advised that information contained hereon reflects the Company's findings at the time of its intervention only and within the limits of Client's instructions, if any. The Company's sole responsibility is to its Client and this document does not exonerate parties to a transaction from exercising all their rights and obligations under the transaction documents. This document cannot be reproduced except in full, without prior written approval of the Company. Any unauthorized alteration, forgery or falsification of the content or appearance of this document is unlawful and offenders may be prosecuted to the fullest extent of the law.

SGS Taiwan Ltd.

No. 134, WuKungRoad, NewTaipeiIndustrialPark, WukuDistrict, NewTaipeiCity, Taiwan24803/新北市五股區新北產業園區五工路 134 號

台灣檢驗科技股份有限公司

t (886-2) 2299-3279

f (886-2) 2298-0488

www.tw.sgs.com

Member of SGS Group

30MHz~3GHz_Band5_10MHz_QPSK_1_0_LowCH20450-829



3GHz~10GHz_Band5_10MHz_QPSK_1_0_MidCH20525-836.5

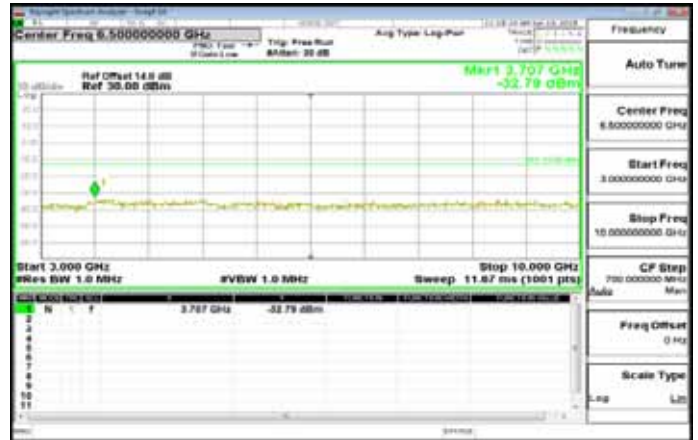

3GHz~10GHz_Band5_10MHz_QPSK_1_0_LowCH20450-829



30MHz~3GHz_Band5_10MHz_QPSK_1_0_HighCH20600-844



30MHz~3GHz_Band5_10MHz_QPSK_1_0_MidCH20525-836.5



3GHz~10GHz_Band5_10MHz_QPSK_1_0_HighCH20600-844

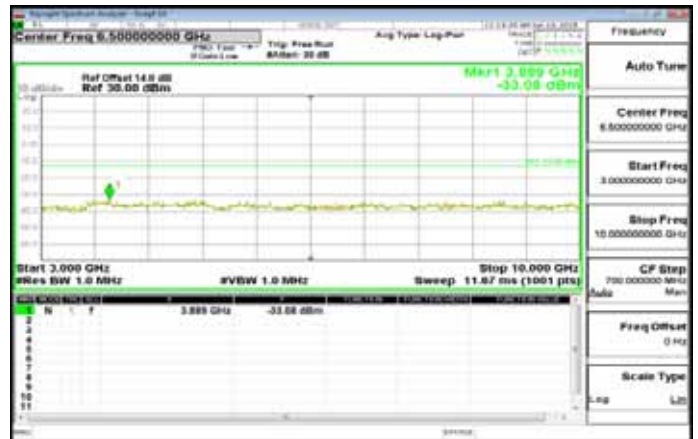

Unless otherwise stated the results shown in this test report refer only to the sample(s) tested and such sample(s) are retained for 90 days only.

除非另有說明，此報告結果僅對測試之樣品負責，同時此樣品僅保留90天。本報告未經本公司書面許可，不可部份複製。

This document is issued by the Company subject to its General Conditions of Service printed overleaf, available on request or accessible at www.sgs.com/terms_and_conditions.htm and, for electronic format documents, subject to Terms and Conditions for Electronic Documents at www.sgs.com/terms_e-document.htm. Attention is drawn to the limitation of liability, indemnification and jurisdiction issues defined therein. Any holder of this document is advised that information contained hereon reflects the Company's findings at the time of its intervention only and within the limits of Client's instructions, if any. The Company's sole responsibility is to its Client and this document does not exonerate parties to a transaction from exercising all their rights and obligations under the transaction documents. This document cannot be reproduced except in full, without prior written approval of the Company. Any unauthorized alteration, forgery or falsification of the content or appearance of this document is unlawful and offenders may be prosecuted to the fullest extent of the law.

SGS Taiwan Ltd.

No. 134, WuKungRoad, NewTaipeiIndustrialPark, WukuDistrict, NewTaipeiCity, Taiwan24803/新北市五股區新北產業園區五工路 134 號

台灣檢驗科技股份有限公司

t (886-2) 2299-3279

f (886-2) 2298-0488

www.tw.sgs.com

Member of SGS Group

9. FIELD STRENGTH OF SPURIOUS RADIATION MEASUREMENT

9.1. Standard Applicable

According to FCC §2.1053,

FCC §22.917(a) , §24.238(a) the magnitude of each spurious and harmonic emission that can be detected when the equipment is operated under the conditions specified in the instruction manual and/ or alignment procedure, shall not be less than $43 + 10 \log$ (mean output power in watts) dBc below the mean power output outside a license's frequency block (-13dBm).

Table 2 — Unwanted Emissions for Mobile, Portable and Low-Power Fixed Subscriber Equipment

Frequency (MHz)	Attenuation (dB)
<2200	$43 + 10 \log_{10}(p)$
2200 - 2288	$70 + 10 \log_{10}(p)$
2288 - 2292	$67 + 10 \log_{10}(p)$
2292 - 2296	$61 + 10 \log_{10}(p)$
2296 - 2300	$55 + 10 \log_{10}(p)$
2300 - 2305	$43 + 10 \log_{10}(p)$
2305 - 2320	$43 + 10 \log_{10}(p)$ ^{Note}
2320 - 2324	$55 + 10 \log_{10}(p)$
2324 - 2328	$61 + 10 \log_{10}(p)$
2328 - 2337	$67 + 10 \log_{10}(p)$
2337 - 2341	$61 + 10 \log_{10}(p)$
2341 - 2345	$55 + 10 \log_{10}(p)$
2345 - 2360	$43 + 10 \log_{10}(p)$ ^{Note}
2360 - 2365	$43 + 10 \log_{10}(p)$
2365 - 2395	$70 + 10 \log_{10}(p)$
>2395	$43 + 10 \log_{10}(p)$

Note: Measured at the edges of the highest and lowest frequency range(s) in which the equipment is designed to operate. See Section 1.2 for the permitted frequency ranges for various equipment types.

Unless otherwise stated the results shown in this test report refer only to the sample(s) tested and such sample(s) are retained for 90 days only.

除非另有說明，此報告結果僅對測試之樣品負責，同時此樣品僅保留90天。本報告未經本公司書面許可，不可部份複製。

This document is issued by the Company subject to its General Conditions of Service printed overleaf, available on request or accessible at www.sgs.com/terms_and_conditions.htm and, for electronic format documents, subject to Terms and Conditions for Electronic Documents at www.sgs.com/terms_e-document.htm. Attention is drawn to the limitation of liability, indemnification and jurisdiction issues defined therein. Any holder of this document is advised that information contained hereon reflects the Company's findings at the time of its intervention only and within the limits of Client's instructions, if any. The Company's sole responsibility is to its Client and this document does not exonerate parties to a transaction from exercising all their rights and obligations under the transaction documents. This document cannot be reproduced except in full, without prior written approval of the Company. Any unauthorized alteration, forgery or falsification of the content or appearance of this document is unlawful and offenders may be prosecuted to the fullest extent of the law.

SGS Taiwan Ltd.

No.134,WuKungRoad,NewTaipeiIndustrialPark,WukuDistrict,NewTaipeiCity,Taiwan24803/新北市五股區新北產業園區五工路 134 號

台灣檢驗科技股份有限公司

t (886-2) 2299-3279

f (886-2) 2298-0488

www.tw.sgs.com

Member of SGS Group

9.2. EUT Setup

Radiated Emission Test Set-Up, Frequency Below 1000MHz

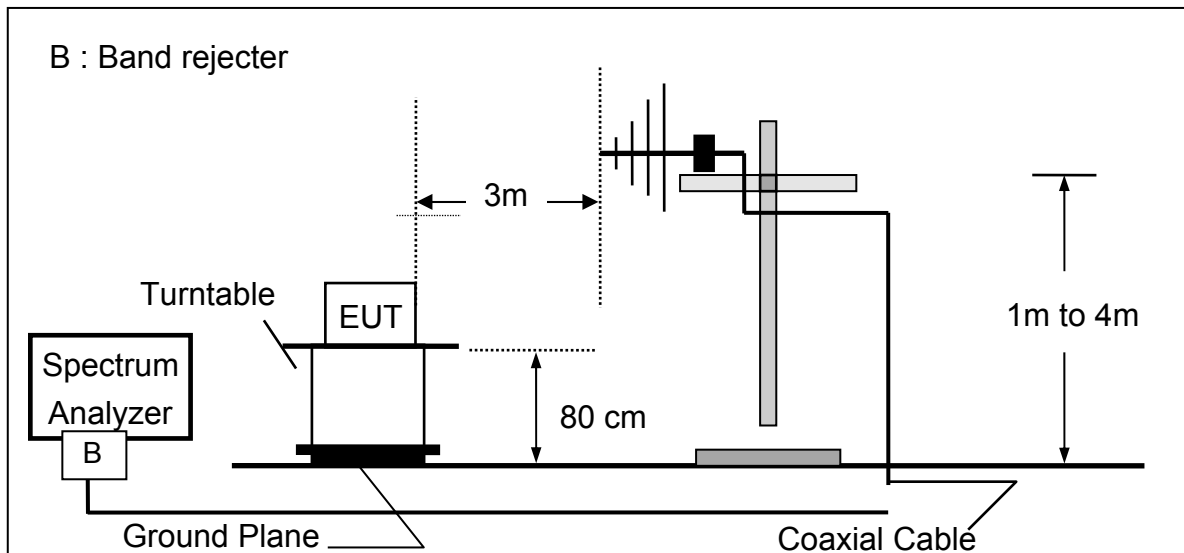

Radiated Emission Test Set-UP Frequency Over 1 GHz

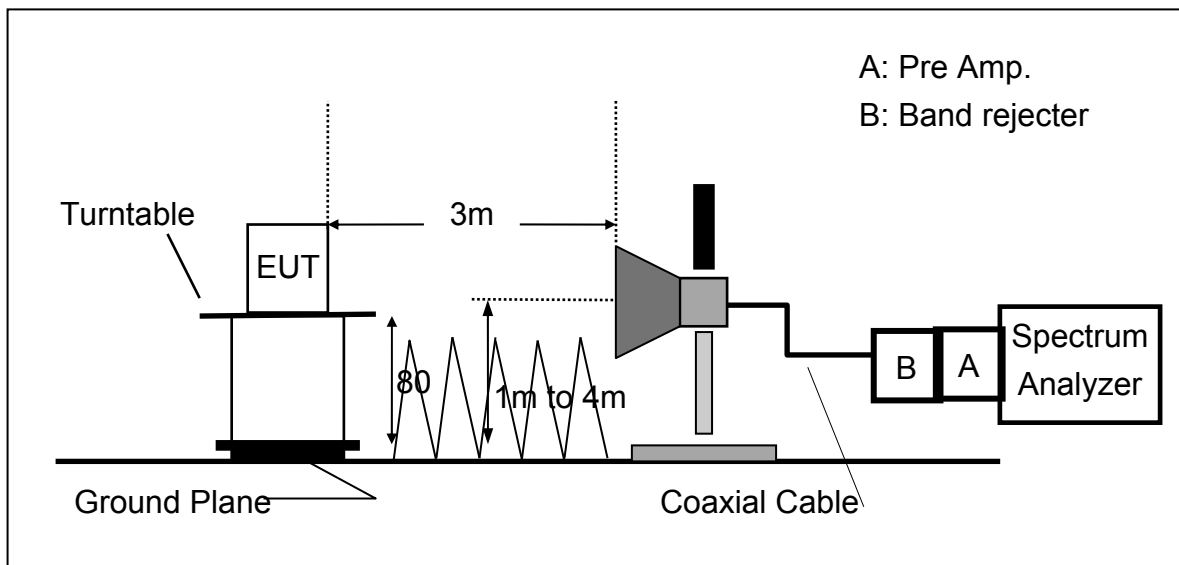

Unless otherwise stated the results shown in this test report refer only to the sample(s) tested and such sample(s) are retained for 90 days only.

除非另有說明，此報告結果僅對測試之樣品負責，同時此樣品僅保留90天。本報告未經本公司書面許可，不可部份複製。

This document is issued by the Company subject to its General Conditions of Service printed overleaf, available on request or accessible at www.sgs.com/terms_and_conditions.htm and, for electronic format documents, subject to Terms and Conditions for Electronic Documents at www.sgs.com/terms_e-document.htm. Attention is drawn to the limitation of liability, indemnification and jurisdiction issues defined therein. Any holder of this document is advised that information contained hereon reflects the Company's findings at the time of its intervention only and within the limits of Client's instructions, if any. The Company's sole responsibility is to its Client and this document does not exonerate parties to a transaction from exercising all their rights and obligations under the transaction documents. This document cannot be reproduced except in full, without prior written approval of the Company. Any unauthorized alteration, forgery or falsification of the content or appearance of this document is unlawful and offenders may be prosecuted to the fullest extent of the law.

9.3. Measurement Procedure:

The EUT was placed on a non-conductive; the measurement antenna was placed at a distance of 3 meters from the EUT. During the tests, the antenna height and the EUT azimuth were varied in order to identify the maximum level of emissions from the EUT. This maximization process was repeated with the EUT positioned in each of its three orthogonal orientations.

The frequency range up to tenth harmonic was investigated for each of three fundamental frequencies (low, middle and high channels). Once spurious emission was identified, the power of the emission was determined using the substitution method.

The spurious emissions attenuation was calculated as the difference between radiated power at the fundamental frequency and the spurious emissions frequency.

$$\text{ERP (dBm)} = \text{SG Level(dBm)} + \text{Antenna Gain(dBd)} + \text{Cable Loss(dB)}$$

$$\text{EIRP (dBm)} = \text{SG Level(dBm)} + \text{Antenna Gain(dBi)} + \text{Cable Loss(dB)}$$

9.4. Measurement Equipment Used:

EQUIPMENT TYPE	MFR	MODEL NUMBER	SERIAL NUMBER	LAST CAL.	CAL DUE.
Bi-log Antenna	SCHWAZBECK	VULB9168	378	2017/12/29	2018/12/28
Bi-log Antenna	SCHWAZBECK	VULB9168	300	2017/12/20	2018/12/19
Horn Antenna	Schwarzbeck	BBHA9120D	603	2018/04/13	2019/04/12
Horn Antenna	Schwarzbeck	BBHA9120D	1441	2017/08/04	2018/08/03
Horn Antenna	Schwarzbeck	BBHA9170	184	2017/12/12	2018/12/11
Horn Antenna	Schwarzbeck	BBHA9170	185	2017/08/01	2018/07/31
3m Site NSA	SGS	966 chamber	N/A	2018/01/02	2019/01/01
Spectrum Analyzer	Agilent	E4446A	MY51100003	2018/05/15	2019/05/14
EMI Test Receiver	R&S	ESCI7	100335	2018/02/02	2019/02/01
Pre-Amplifier	HP	8449B	3008A00578	2018/01/02	2019/01/01
Pre-Amplifier	HP	8447D	2944A07676	2018/01/02	2019/01/01
Pre-Amplifier	EMC Instruments	EMC184045B	980135	2017/10/27	2018/10/26
1GHz High Pass Filter	Micro-Tronics	HPM50108	32	2018/01/02	2019/01/01
2GHz High Pass Filter	Micro-Tronics	HPM50110	36	2018/01/02	2019/01/01
Low Loss Cable	Huber Suhner	966_RX	9	2018/01/02	2019/01/01
Low Loss Cable	Huber Suhner	966 TX	1	2018/01/02	2019/01/01

Unless otherwise stated the results shown in this test report refer only to the sample(s) tested and such sample(s) are retained for 90 days only.

除非另有說明，此報告結果僅對測試之樣品負責，同時此樣品僅保留90天。本報告未經本公司書面許可，不可部份複製。

This document is issued by the Company subject to its General Conditions of Service printed overleaf, available on request or accessible at www.sgs.com/terms_and_conditions.htm and, for electronic format documents, subject to Terms and Conditions for Electronic Documents at www.sgs.com/terms_e-document.htm. Attention is drawn to the limitation of liability, indemnification and jurisdiction issues defined therein. Any holder of this document is advised that information contained hereon reflects the Company's findings at the time of its intervention only and within the limits of Client's instructions, if any. The Company's sole responsibility is to its Client and this document does not exonerate parties to a transaction from exercising all their rights and obligations under the transaction documents. This document cannot be reproduced except in full, without prior written approval of the Company. Any unauthorized alteration, forgery or falsification of the content or appearance of this document is unlawful and offenders may be prosecuted to the fullest extent of the law.

9.5. Measurement Result:

Radiated Spurious Emission Measurement Result: GSM 850 Mode

Operation Band	:GSM 850	Temp./Humi.	:22 deg_C / 53 RH
Fundamental Frequency	:824.2 MHz	Engineer	:Kane
Operation Mode	:TX LOW		
EUT Pol.	:H Plane	Measurement Antenna Pol.	:VERTICAL

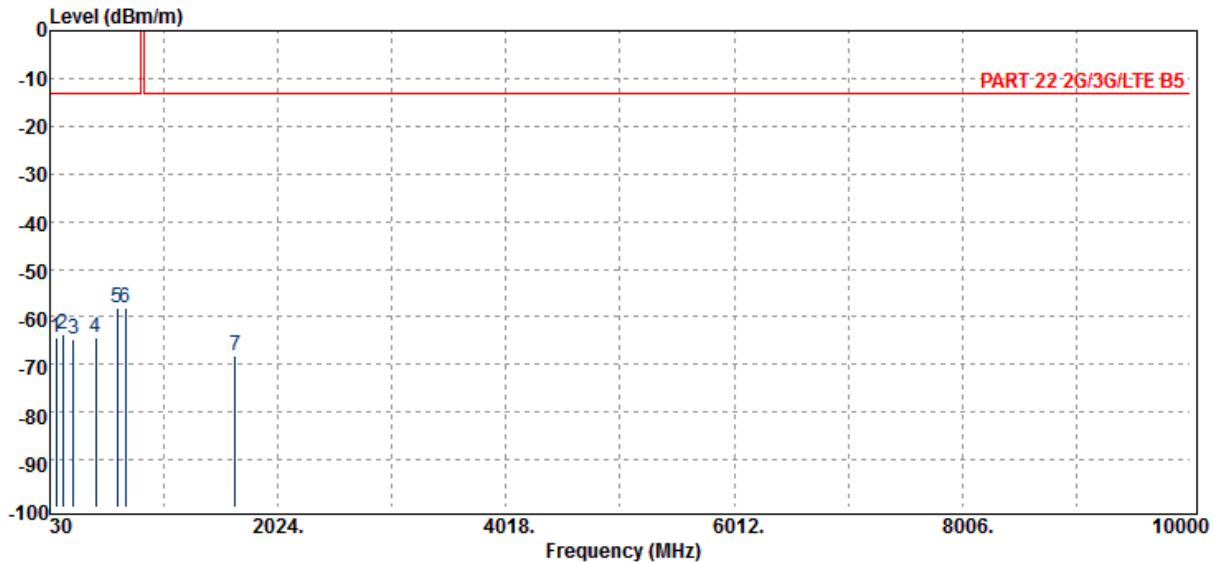

Freq. MHz	ERP/EIRP dBm	SG Output Level dBm	Antenna Gain dBd/dBi	Cable Loss dB	Limit dBm	Margin dB
83.35	-64.24	-61.53	-1.73	-0.98	-13.00	-51.24
138.64	-63.74	-60.23	-2.26	-1.25	-13.00	-50.74
236.61	-64.55	-66.32	3.42	-1.65	-13.00	-51.55
427.70	-64.50	-66.05	3.61	-2.07	-13.00	-51.50
614.91	-58.27	-59.43	3.63	-2.47	-13.00	-45.27
692.51	-58.13	-59.07	3.70	-2.76	-13.00	-45.13
1648.40	-68.08	-63.73	0.00	-4.35	-13.00	-55.08

Unless otherwise stated the results shown in this test report refer only to the sample(s) tested and such sample(s) are retained for 90 days only.

除非另有說明，此報告結果僅對測試之樣品負責，同時此樣品僅保留90天。本報告未經本公司書面許可，不可部份複製。

This document is issued by the Company subject to its General Conditions of Service printed overleaf, available on request or accessible at www.sgs.com/terms_and_conditions.htm and, for electronic format documents, subject to Terms and Conditions for Electronic Documents at www.sgs.com/terms_e-document.htm. Attention is drawn to the limitation of liability, indemnification and jurisdiction issues defined therein. Any holder of this document is advised that information contained hereon reflects the Company's findings at the time of its intervention only and within the limits of Client's instructions, if any. The Company's sole responsibility is to its Client and this document does not exonerate parties to a transaction from exercising all their rights and obligations under the transaction documents. This document cannot be reproduced except in full, without prior written approval of the Company. Any unauthorized alteration, forgery or falsification of the content or appearance of this document is unlawful and offenders may be prosecuted to the fullest extent of the law.

SGS Taiwan Ltd.

No.134,WuKungRoad,NewTaipeiIndustrialPark,WukuDistrict,NewTaipeiCity,Taiwan24803/新北市五股區新北產業園區五工路 134 號

台灣檢驗科技股份有限公司

t (886-2) 2299-3279

f (886-2) 2298-0488

www.tw.sgs.com

Member of SGS Group

Operation Band	:GSM 850	Temp./Humi.	:22 deg_C / 53 RH
Fundamental Frequency	:824.2 MHz	Engineer	:Kane
Operation Mode	:TX LOW		
EUT Pol.	:H Plane	Measurement Antenna Pol.	:HORIZONTAL

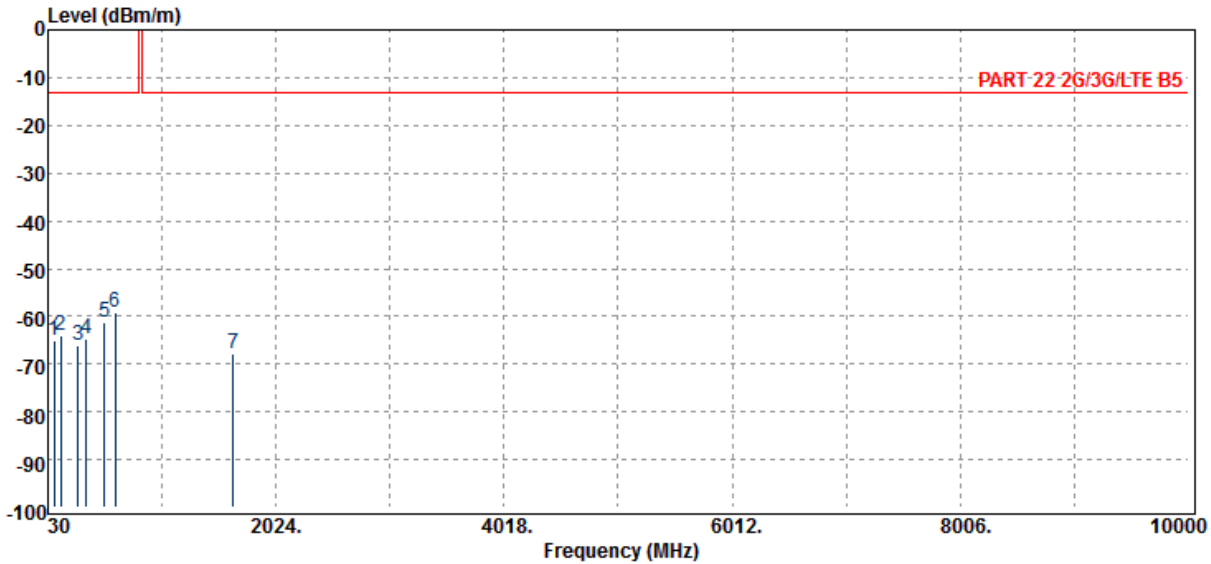

Freq. MHz	ERP/EIRP dBm	SG Output Level dBm	Antenna Gain dBd/dBi	Cable Loss dB	Limit dBm	Margin dB
85.29	-65.15	-62.79	-1.37	-0.99	-13.00	-52.15
140.58	-64.06	-60.52	-2.27	-1.26	-13.00	-51.06
289.96	-65.99	-67.63	3.42	-1.78	-13.00	-52.99
364.65	-64.57	-66.31	3.81	-2.07	-13.00	-51.57
527.61	-61.31	-62.85	4.01	-2.47	-13.00	-48.31
618.79	-59.17	-60.22	3.65	-2.60	-13.00	-46.17
1648.40	-67.67	-63.32	0.00	-4.35	-13.00	-54.67

Unless otherwise stated the results shown in this test report refer only to the sample(s) tested and such sample(s) are retained for 90 days only.

除非另有說明，此報告結果僅對測試之樣品負責，同時此樣品僅保留90天。本報告未經本公司書面許可，不可部份複製。

This document is issued by the Company subject to its General Conditions of Service printed overleaf, available on request or accessible at www.sgs.com/terms_and_conditions.htm and, for electronic format documents, subject to Terms and Conditions for Electronic Documents at www.sgs.com/terms_e-document.htm. Attention is drawn to the limitation of liability, indemnification and jurisdiction issues defined therein. Any holder of this document is advised that information contained hereon reflects the Company's findings at the time of its intervention only and within the limits of Client's instructions, if any. The Company's sole responsibility is to its Client and this document does not exonerate parties to a transaction from exercising all their rights and obligations under the transaction documents. This document cannot be reproduced except in full, without prior written approval of the Company. Any unauthorized alteration, forgery or falsification of the content or appearance of this document is unlawful and offenders may be prosecuted to the fullest extent of the law.

Operation Band	:GSM 850	Temp./Humi.	:22 deg_C / 53 RH
Fundamental Frequency	:836.6 MHz	Engineer	:Kane
Operation Mode	:TX MID		
EUT Pol.	:H Plane	Measurement Antenna Pol.	:VERTICAL

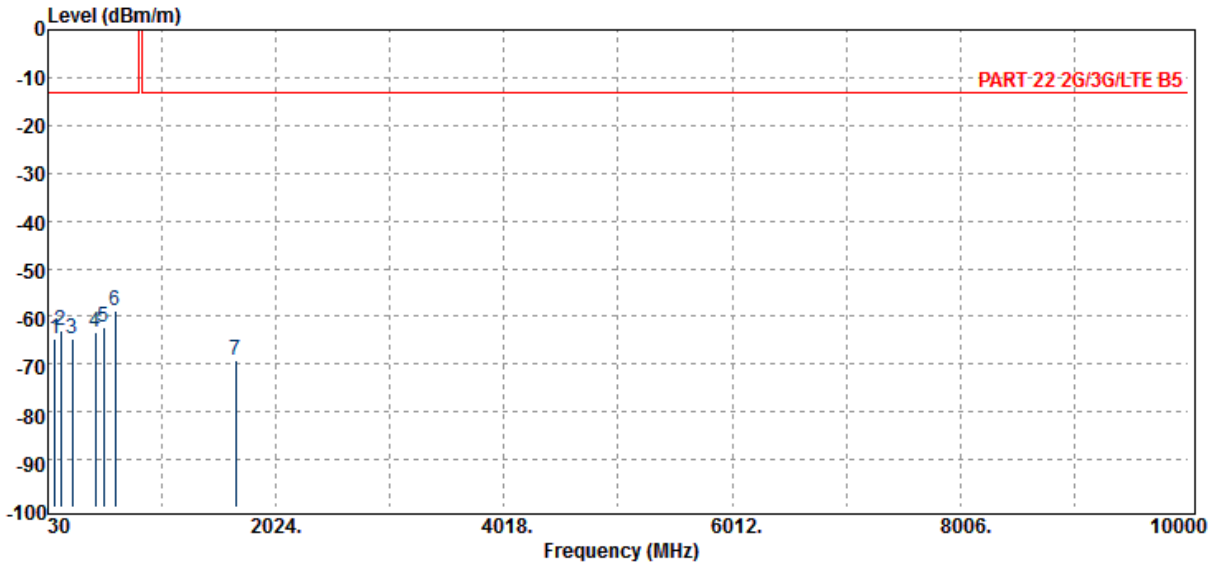

Freq. MHz	ERP/EIRP dBm	SG Output Level dBm	Antenna Gain dBd/dBi	Cable Loss dB	Limit dBm	Margin dB
91.11	-64.55	-62.92	-0.62	-1.01	-13.00	-51.55
139.61	-62.82	-59.27	-2.29	-1.26	-13.00	-49.82
241.46	-64.73	-66.54	3.49	-1.68	-13.00	-51.73
445.16	-63.40	-65.04	3.55	-1.92	-13.00	-50.40
517.91	-62.12	-63.65	4.03	-2.49	-13.00	-49.12
616.85	-58.81	-59.91	3.64	-2.54	-13.00	-45.81
1673.20	-69.04	-64.65	0.00	-4.39	-13.00	-56.04

Unless otherwise stated the results shown in this test report refer only to the sample(s) tested and such sample(s) are retained for 90 days only.

除非另有說明，此報告結果僅對測試之樣品負責，同時此樣品僅保留90天。本報告未經本公司書面許可，不可部份複製。

This document is issued by the Company subject to its General Conditions of Service printed overleaf, available on request or accessible at www.sgs.com/terms_and_conditions.htm and, for electronic format documents, subject to Terms and Conditions for Electronic Documents at www.sgs.com/terms_e-document.htm. Attention is drawn to the limitation of liability, indemnification and jurisdiction issues defined therein. Any holder of this document is advised that information contained hereon reflects the Company's findings at the time of its intervention only and within the limits of Client's instructions, if any. The Company's sole responsibility is to its Client and this document does not exonerate parties to a transaction from exercising all their rights and obligations under the transaction documents. This document cannot be reproduced except in full, without prior written approval of the Company. Any unauthorized alteration, forgery or falsification of the content or appearance of this document is unlawful and offenders may be prosecuted to the fullest extent of the law.

Operation Band	:GSM 850	Temp./Humi.	:22 deg_C / 53 RH
Fundamental Frequency	:836.6 MHz	Engineer	:Kane
Operation Mode	:TX MID		
EUT Pol.	:H Plane	Measurement Antenna Pol.	:HORIZONTAL

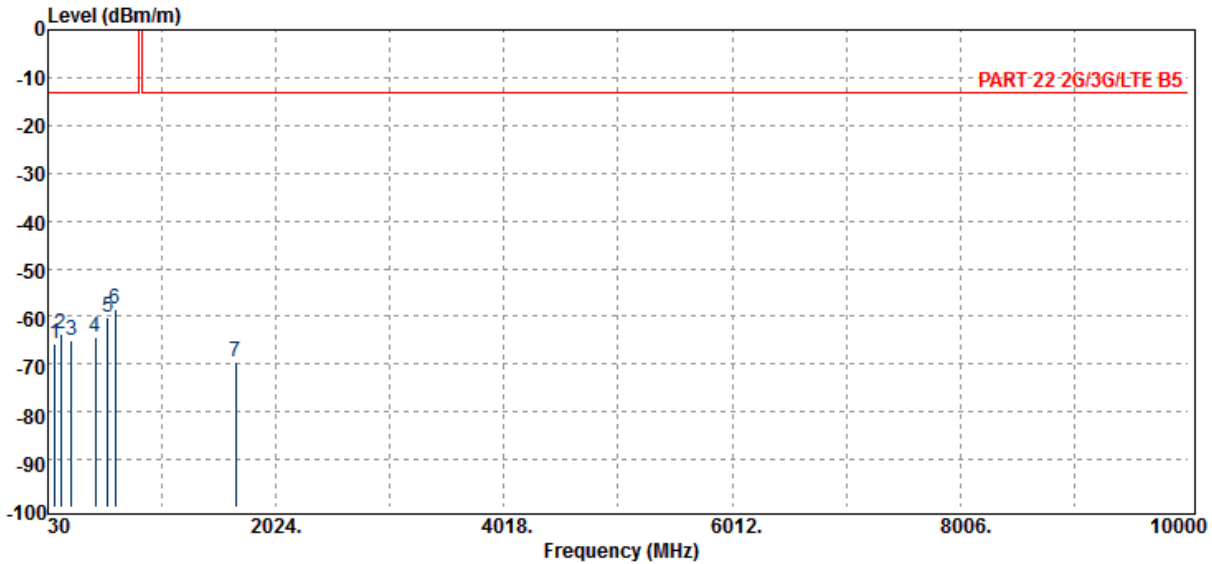

Freq. MHz	ERP/EIRP dBm	SG Output Level dBm	Antenna Gain dBd/dBi	Cable Loss dB	Limit dBm	Margin dB
90.14	-65.81	-64.25	-0.55	-1.01	-13.00	-52.81
143.49	-63.60	-60.20	-2.13	-1.28	-13.00	-50.60
233.70	-65.11	-66.84	3.37	-1.64	-13.00	-52.11
447.10	-64.29	-65.85	3.55	-1.98	-13.00	-51.29
553.80	-60.22	-61.93	3.95	-2.24	-13.00	-47.22
614.91	-58.50	-59.65	3.63	-2.47	-13.00	-45.50
1673.20	-69.40	-65.01	0.00	-4.39	-13.00	-56.40

Unless otherwise stated the results shown in this test report refer only to the sample(s) tested and such sample(s) are retained for 90 days only.

除非另有說明，此報告結果僅對測試之樣品負責，同時此樣品僅保留90天。本報告未經本公司書面許可，不可部份複製。

This document is issued by the Company subject to its General Conditions of Service printed overleaf, available on request or accessible at www.sgs.com/terms_and_conditions.htm and, for electronic format documents, subject to Terms and Conditions for Electronic Documents at www.sgs.com/terms_e-document.htm. Attention is drawn to the limitation of liability, indemnification and jurisdiction issues defined therein. Any holder of this document is advised that information contained hereon reflects the Company's findings at the time of its intervention only and within the limits of Client's instructions, if any. The Company's sole responsibility is to its Client and this document does not exonerate parties to a transaction from exercising all their rights and obligations under the transaction documents. This document cannot be reproduced except in full, without prior written approval of the Company. Any unauthorized alteration, forgery or falsification of the content or appearance of this document is unlawful and offenders may be prosecuted to the fullest extent of the law.

SGS Taiwan Ltd.

No.134,WuKungRoad,NewTaipeiIndustrialPark,WukuDistrict,NewTaipeiCity,Taiwan24803/新北市五股區新北產業園區五工路 134 號

台灣檢驗科技股份有限公司

t (886-2) 2299-3279

f (886-2) 2298-0488

www.tw.sgs.com

Member of SGS Group

Operation Band	:GSM 850	Temp./Humi.	:22 deg_C / 53 RH
Fundamental Frequency	:848.8 MHz	Engineer	:Kane
Operation Mode	:TX HIGH		
EUT Pol.	:H Plane	Measurement Antenna Pol.	:VERTICAL

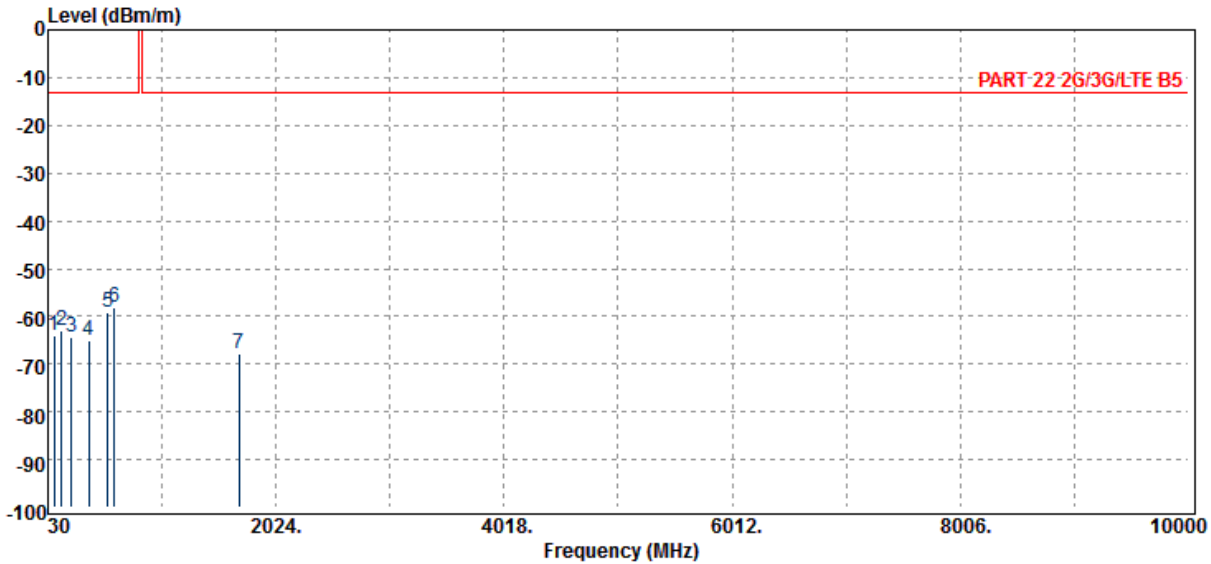

Freq. MHz	ERP/EIRP dBm	SG Output Level dBm	Antenna Gain dBd/dBi	Cable Loss dB	Limit dBm	Margin dB
83.35	-64.07	-61.37	-1.73	-0.98	-13.00	-51.07
146.40	-63.04	-59.77	-1.98	-1.29	-13.00	-50.04
236.61	-64.51	-66.27	3.42	-1.65	-13.00	-51.51
388.90	-65.03	-66.73	3.74	-2.04	-13.00	-52.03
551.86	-59.21	-61.04	3.96	-2.13	-13.00	-46.21
613.94	-58.24	-59.42	3.62	-2.44	-13.00	-45.24
1697.60	-67.91	-63.48	0.00	-4.43	-13.00	-54.91

Unless otherwise stated the results shown in this test report refer only to the sample(s) tested and such sample(s) are retained for 90 days only.

除非另有說明，此報告結果僅對測試之樣品負責，同時此樣品僅保留90天。本報告未經本公司書面許可，不可部份複製。

This document is issued by the Company subject to its General Conditions of Service printed overleaf, available on request or accessible at www.sgs.com/terms_and_conditions.htm and, for electronic format documents, subject to Terms and Conditions for Electronic Documents at www.sgs.com/terms_e-document.htm. Attention is drawn to the limitation of liability, indemnification and jurisdiction issues defined therein. Any holder of this document is advised that information contained hereon reflects the Company's findings at the time of its intervention only and within the limits of Client's instructions, if any. The Company's sole responsibility is to its Client and this document does not exonerate parties to a transaction from exercising all their rights and obligations under the transaction documents. This document cannot be reproduced except in full, without prior written approval of the Company. Any unauthorized alteration, forgery or falsification of the content or appearance of this document is unlawful and offenders may be prosecuted to the fullest extent of the law.

Operation Band	:GSM 850	Temp./Humi.	:22 deg_C / 53 RH
Fundamental Frequency	:848.8 MHz	Engineer	:Kane
Operation Mode	:TX HIGH		
EUT Pol.	:H Plane	Measurement Antenna Pol.	:HORIZONTAL

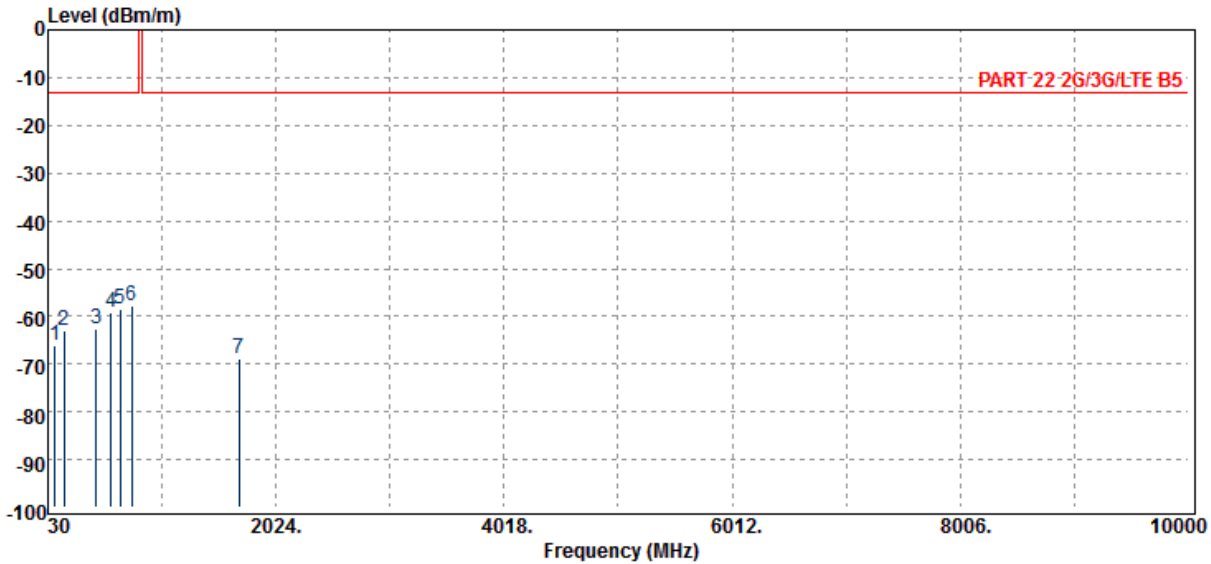

Freq. MHz	ERP/EIRP dBm	SG Output Level dBm	Antenna Gain dBd/dBi	Cable Loss dB	Limit dBm	Margin dB
91.11	-65.99	-64.36	-0.62	-1.01	-13.00	-52.99
167.74	-62.88	-60.81	-0.76	-1.32	-13.00	-49.88
451.95	-62.72	-64.13	3.56	-2.15	-13.00	-49.72
580.96	-59.23	-60.57	3.70	-2.36	-13.00	-46.23
663.41	-58.56	-60.37	3.79	-1.98	-13.00	-45.56
765.26	-57.90	-59.88	3.46	-1.47	-13.00	-44.90
1697.60	-68.76	-64.33	0.00	-4.43	-13.00	-55.76

Unless otherwise stated the results shown in this test report refer only to the sample(s) tested and such sample(s) are retained for 90 days only.

除非另有說明，此報告結果僅對測試之樣品負責，同時此樣品僅保留90天。本報告未經本公司書面許可，不可部份複製。

This document is issued by the Company subject to its General Conditions of Service printed overleaf, available on request or accessible at www.sgs.com/terms_and_conditions.htm and, for electronic format documents, subject to Terms and Conditions for Electronic Documents at www.sgs.com/terms_e-document.htm. Attention is drawn to the limitation of liability, indemnification and jurisdiction issues defined therein. Any holder of this document is advised that information contained hereon reflects the Company's findings at the time of its intervention only and within the limits of Client's instructions, if any. The Company's sole responsibility is to its Client and this document does not exonerate parties to a transaction from exercising all their rights and obligations under the transaction documents. This document cannot be reproduced except in full, without prior written approval of the Company. Any unauthorized alteration, forgery or falsification of the content or appearance of this document is unlawful and offenders may be prosecuted to the fullest extent of the law.

SGS Taiwan Ltd.

No.134,WuKungRoad,NewTaipeiIndustrialPark,WukuDistrict,NewTaipeiCity,Taiwan24803/新北市五股區新北產業園區五工路 134 號

台灣檢驗科技股份有限公司

t (886-2) 2299-3279

f (886-2) 2298-0488

www.tw.sgs.com

Member of SGS Group

Radiated Spurious Emission Measurement Result: GSM 1900 Mode

Operation Band	:GSM 1900	Temp./Humi.	:22 deg_C / 61 RH
Fundamental Frequency	:1850.2 MHz	Engineer	:Kane
Operation Mode	:Tx CH LOW		
EUT Pol.	:H Plane	Measurement Antenna Pol.	:VERTICAL

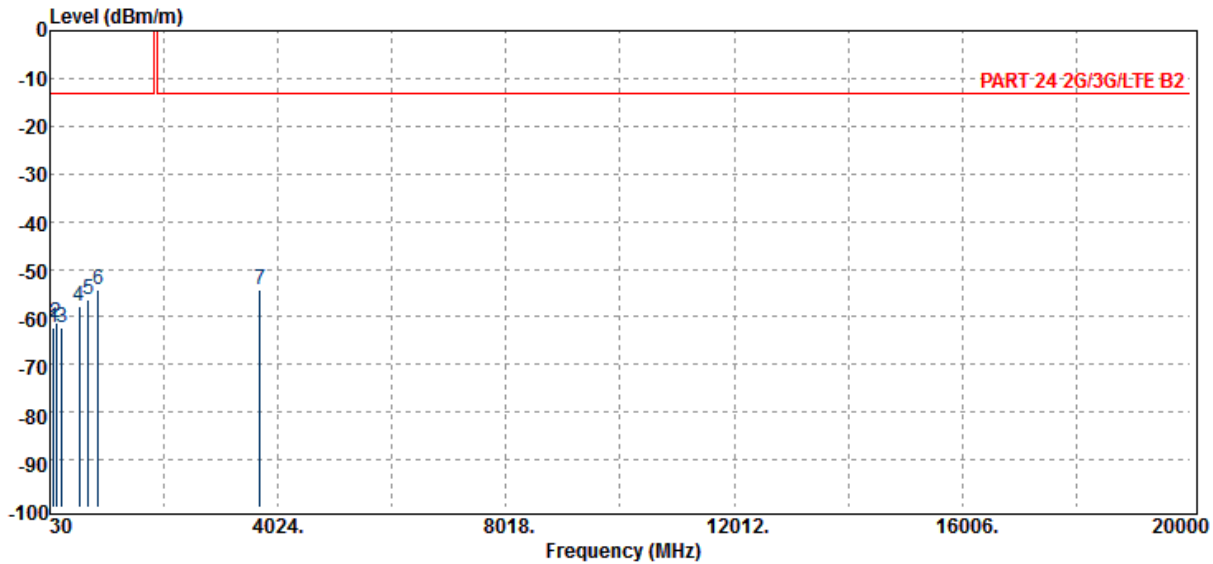

Freq. MHz	ERP/EIRP dBm	SG Output Level dBm	Antenna Gain dBd/dBi	Cable Loss dB	Limit dBm	Margin dB
91.11	-62.28	-60.64	-0.62	-1.01	-13.00	-49.28
139.61	-61.11	-57.56	-2.29	-1.26	-13.00	-48.11
236.61	-62.39	-64.16	3.42	-1.65	-13.00	-49.39
548.95	-57.80	-59.81	3.98	-1.97	-13.00	-44.80
706.09	-56.55	-58.33	3.65	-1.87	-13.00	-43.55
878.75	-54.35	-55.06	3.46	-2.76	-13.00	-41.35
3700.40	-54.16	-59.81	12.57	-6.91	-13.00	-41.16

Unless otherwise stated the results shown in this test report refer only to the sample(s) tested and such sample(s) are retained for 90 days only.

除非另有說明，此報告結果僅對測試之樣品負責，同時此樣品僅保留90天。本報告未經本公司書面許可，不可部份複製。

This document is issued by the Company subject to its General Conditions of Service printed overleaf, available on request or accessible at www.sgs.com/terms_and_conditions.htm and, for electronic format documents, subject to Terms and Conditions for Electronic Documents at www.sgs.com/terms_e-document.htm. Attention is drawn to the limitation of liability, indemnification and jurisdiction issues defined therein. Any holder of this document is advised that information contained hereon reflects the Company's findings at the time of its intervention only and within the limits of Client's instructions, if any. The Company's sole responsibility is to its Client and this document does not exonerate parties to a transaction from exercising all their rights and obligations under the transaction documents. This document cannot be reproduced except in full, without prior written approval of the Company. Any unauthorized alteration, forgery or falsification of the content or appearance of this document is unlawful and offenders may be prosecuted to the fullest extent of the law.

SGS Taiwan Ltd.

No.134,WuKungRoad,NewTaipeiIndustrialPark,WukuDistrict,NewTaipeiCity,Taiwan24803/新北市五股區新北產業園區五工路 134 號

台灣檢驗科技股份有限公司

t (886-2) 2299-3279

f (886-2) 2298-0488

www.tw.sgs.com

Member of SGS Group

Operation Band	:GSM 1900	Temp./Humi.	:22 deg_C / 61 RH
Fundamental Frequency	:1850.2 MHz	Engineer	:Kane
Operation Mode	:Tx CH LOW		
EUT Pol.	:H Plane	Measurement Antenna Pol.	:HORIZONTAL

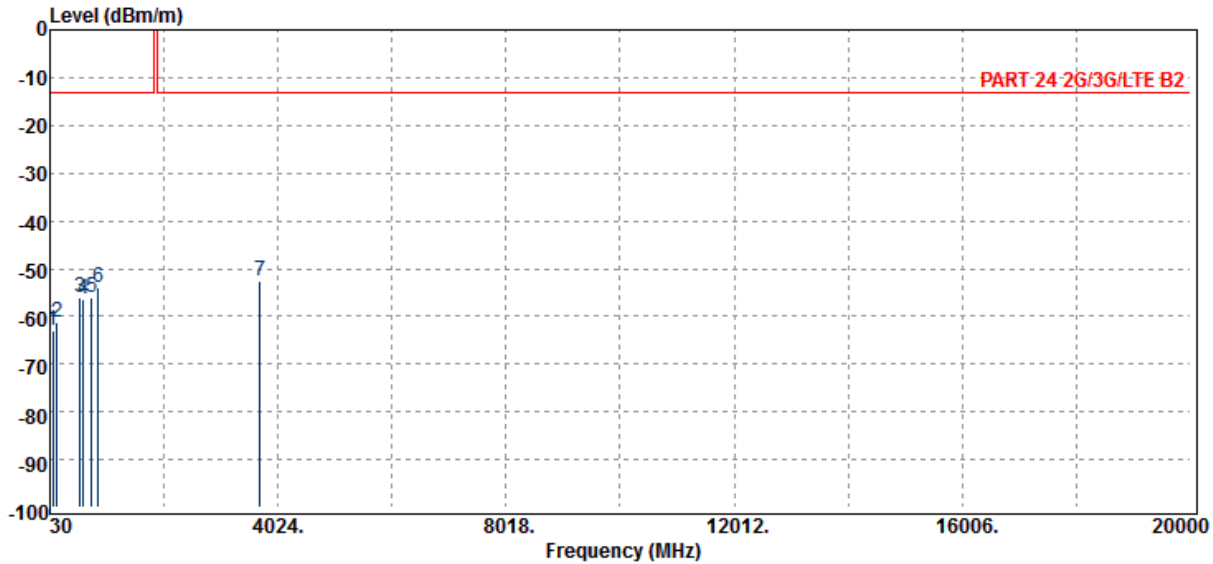

Freq. MHz	ERP/EIRP dBm	SG Output Level dBm	Antenna Gain dBd/dBi	Cable Loss dB	Limit dBm	Margin dB
83.35	-62.81	-60.10	-1.73	-0.98	-13.00	-49.81
146.40	-61.37	-58.10	-1.98	-1.29	-13.00	-48.37
563.50	-56.18	-57.27	3.86	-2.76	-13.00	-43.18
616.85	-56.54	-57.64	3.64	-2.54	-13.00	-43.54
752.65	-56.08	-57.18	3.47	-2.38	-13.00	-43.08
869.05	-54.10	-55.31	3.46	-2.26	-13.00	-41.10
3700.40	-52.65	-58.31	12.57	-6.91	-13.00	-39.65

Unless otherwise stated the results shown in this test report refer only to the sample(s) tested and such sample(s) are retained for 90 days only.

除非另有說明，此報告結果僅對測試之樣品負責，同時此樣品僅保留90天。本報告未經本公司書面許可，不可部份複製。

This document is issued by the Company subject to its General Conditions of Service printed overleaf, available on request or accessible at www.sgs.com/terms_and_conditions.htm and, for electronic format documents, subject to Terms and Conditions for Electronic Documents at www.sgs.com/terms_e-document.htm. Attention is drawn to the limitation of liability, indemnification and jurisdiction issues defined therein. Any holder of this document is advised that information contained hereon reflects the Company's findings at the time of its intervention only and within the limits of Client's instructions, if any. The Company's sole responsibility is to its Client and this document does not exonerate parties to a transaction from exercising all their rights and obligations under the transaction documents. This document cannot be reproduced except in full, without prior written approval of the Company. Any unauthorized alteration, forgery or falsification of the content or appearance of this document is unlawful and offenders may be prosecuted to the fullest extent of the law.

SGS Taiwan Ltd.

No.134,WuKungRoad,NewTaipeiIndustrialPark,WukuDistrict,NewTaipeiCity,Taiwan24803/新北市五股區新北產業園區五工路 134 號

台灣檢驗科技股份有限公司

t (886-2) 2299-3279

f (886-2) 2298-0488

www.tw.sgs.com

Member of SGS Group

Operation Band	:GSM 1900	Temp./Humi.	:22 deg_C / 61 RH
Fundamental Frequency	:1880 MHz	Engineer	:Kane
Operation Mode	:Tx CH MID		
EUT Pol.	:H Plane	Measurement Antenna Pol.	:VERTICAL

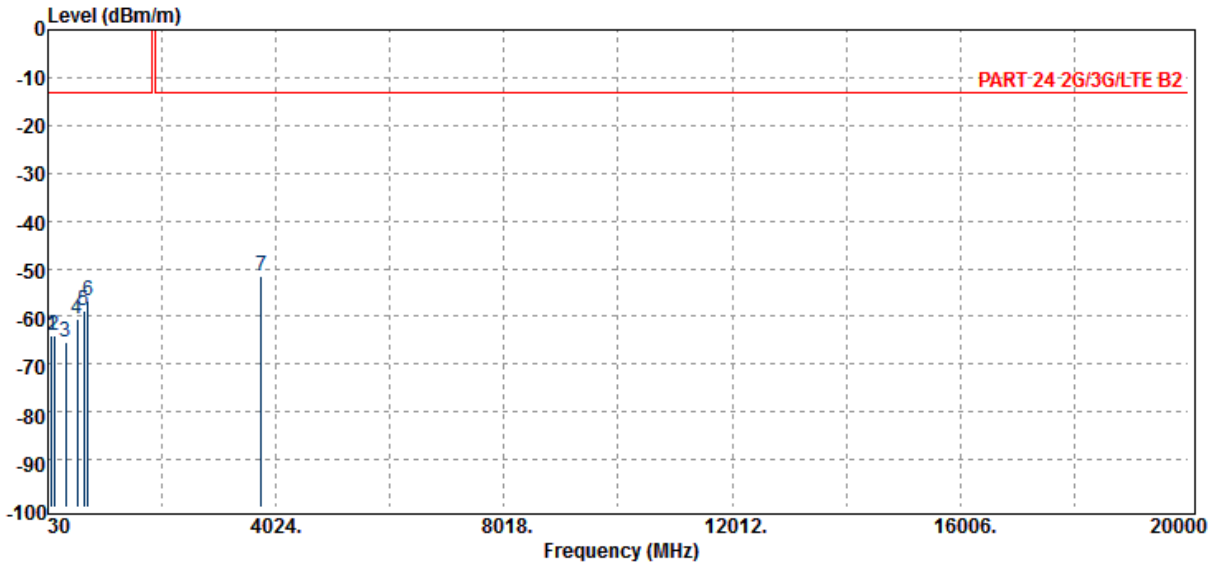

Freq. MHz	ERP/EIRP dBm	SG Output Level dBm	Antenna Gain dBd/dBi	Cable Loss dB	Limit dBm	Margin dB
88.20	-63.97	-62.11	-0.85	-1.00	-13.00	-50.97
143.49	-64.14	-60.74	-2.13	-1.28	-13.00	-51.14
340.40	-65.40	-67.24	3.81	-1.98	-13.00	-52.40
537.31	-60.53	-62.46	4.00	-2.07	-13.00	-47.53
660.50	-58.96	-60.71	3.80	-2.04	-13.00	-45.96
730.34	-56.65	-57.18	3.55	-3.02	-13.00	-43.65
3760.00	-51.59	-57.32	12.61	-6.89	-13.00	-38.59

Unless otherwise stated the results shown in this test report refer only to the sample(s) tested and such sample(s) are retained for 90 days only.

除非另有說明，此報告結果僅對測試之樣品負責，同時此樣品僅保留90天。本報告未經本公司書面許可，不可部份複製。

This document is issued by the Company subject to its General Conditions of Service printed overleaf, available on request or accessible at www.sgs.com/terms_and_conditions.htm and, for electronic format documents, subject to Terms and Conditions for Electronic Documents at www.sgs.com/terms_e-document.htm. Attention is drawn to the limitation of liability, indemnification and jurisdiction issues defined therein. Any holder of this document is advised that information contained hereon reflects the Company's findings at the time of its intervention only and within the limits of Client's instructions, if any. The Company's sole responsibility is to its Client and this document does not exonerate parties to a transaction from exercising all their rights and obligations under the transaction documents. This document cannot be reproduced except in full, without prior written approval of the Company. Any unauthorized alteration, forgery or falsification of the content or appearance of this document is unlawful and offenders may be prosecuted to the fullest extent of the law.

SGS Taiwan Ltd.

No.134,WuKungRoad,NewTaipeiIndustrialPark,WukuDistrict,NewTaipeiCity,Taiwan24803/新北市五股區新北產業園區五工路 134 號

台灣檢驗科技股份有限公司

t (886-2) 2299-3279

f (886-2) 2298-0488

www.tw.sgs.com

Member of SGS Group

Operation Band	:GSM 1900	Temp./Humi.	:22 deg_C / 61 RH
Fundamental Frequency	:1880 MHz	Engineer	:Kane
Operation Mode	:Tx CH MID	Measurement Antenna Pol.	:HORIZONTAL
EUT Pol.	:H Plane		

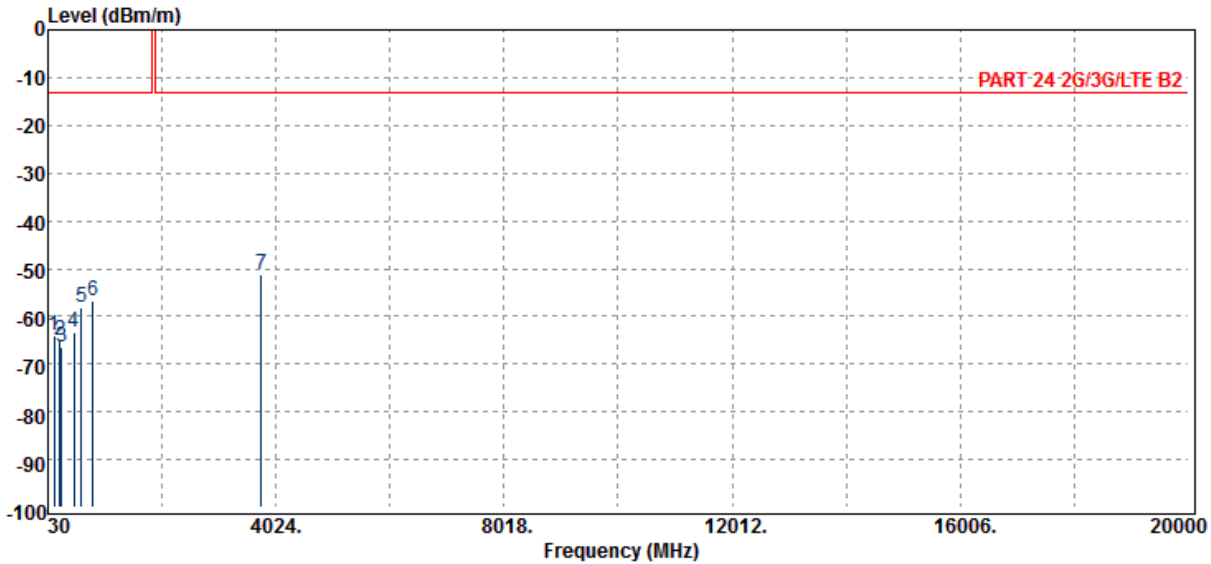

Freq. MHz	ERP/EIRP dBm	SG Output Level dBm	Antenna Gain dBd/dBi	Cable Loss dB	Limit dBm	Margin dB
141.55	-63.98	-60.48	-2.22	-1.27	-13.00	-50.98
240.49	-65.14	-66.95	3.48	-1.67	-13.00	-52.14
272.50	-66.27	-68.02	3.48	-1.73	-13.00	-53.27
483.96	-63.33	-65.37	3.89	-1.85	-13.00	-50.33
614.91	-58.09	-59.25	3.63	-2.47	-13.00	-45.09
813.76	-56.91	-57.85	3.44	-2.50	-13.00	-43.91
3760.00	-51.08	-56.81	12.61	-6.89	-13.00	-38.08

Unless otherwise stated the results shown in this test report refer only to the sample(s) tested and such sample(s) are retained for 90 days only.

除非另有說明，此報告結果僅對測試之樣品負責，同時此樣品僅保留90天。本報告未經本公司書面許可，不可部份複製。

This document is issued by the Company subject to its General Conditions of Service printed overleaf, available on request or accessible at www.sgs.com/terms_and_conditions.htm and, for electronic format documents, subject to Terms and Conditions for Electronic Documents at www.sgs.com/terms_e-document.htm. Attention is drawn to the limitation of liability, indemnification and jurisdiction issues defined therein. Any holder of this document is advised that information contained hereon reflects the Company's findings at the time of its intervention only and within the limits of Client's instructions, if any. The Company's sole responsibility is to its Client and this document does not exonerate parties to a transaction from exercising all their rights and obligations under the transaction documents. This document cannot be reproduced except in full, without prior written approval of the Company. Any unauthorized alteration, forgery or falsification of the content or appearance of this document is unlawful and offenders may be prosecuted to the fullest extent of the law.

SGS Taiwan Ltd.

No.134,WuKungRoad,NewTaipeiIndustrialPark,WukuDistrict,NewTaipeiCity,Taiwan24803/新北市五股區新北產業園區五工路 134 號

台灣檢驗科技股份有限公司

t (886-2) 2299-3279

f (886-2) 2298-0488

www.tw.sgs.com

Member of SGS Group

Operation Band	:GSM 1900	Temp./Humi.	:22 deg_C / 61 RH
Fundamental Frequency	:1909.8 MHz	Engineer	:Kane
Operation Mode	:Tx CH HIGH		
EUT Pol.	:H Plane	Measurement Antenna Pol.	:VERTICAL

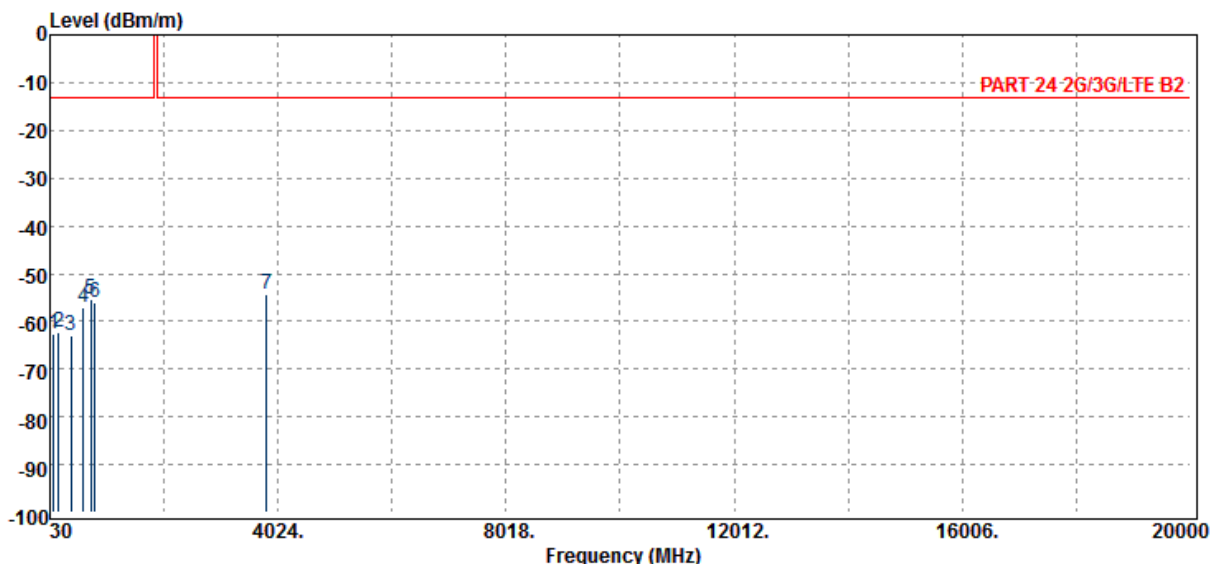

Freq. MHz	ERP/EIRP dBm	SG Output Level dBm	Antenna Gain dBd/dBi	Cable Loss dB	Limit dBm	Margin dB
88.20	-62.51	-60.66	-0.85	-1.00	-13.00	-49.51
178.41	-62.40	-61.76	0.73	-1.37	-13.00	-49.40
400.54	-63.05	-64.64	3.71	-2.12	-13.00	-50.05
610.06	-57.20	-58.49	3.60	-2.31	-13.00	-44.20
740.04	-55.22	-55.74	3.51	-2.99	-13.00	-42.22
810.85	-56.18	-57.29	3.44	-2.33	-13.00	-43.18
3819.60	-54.22	-59.86	12.66	-7.02	-13.00	-41.22

Unless otherwise stated the results shown in this test report refer only to the sample(s) tested and such sample(s) are retained for 90 days only.

除非另有說明，此報告結果僅對測試之樣品負責，同時此樣品僅保留90天。本報告未經本公司書面許可，不可部份複製。

This document is issued by the Company subject to its General Conditions of Service printed overleaf, available on request or accessible at www.sgs.com/terms_and_conditions.htm and, for electronic format documents, subject to Terms and Conditions for Electronic Documents at www.sgs.com/terms_e-document.htm. Attention is drawn to the limitation of liability, indemnification and jurisdiction issues defined therein. Any holder of this document is advised that information contained hereon reflects the Company's findings at the time of its intervention only and within the limits of Client's instructions, if any. The Company's sole responsibility is to its Client and this document does not exonerate parties to a transaction from exercising all their rights and obligations under the transaction documents. This document cannot be reproduced except in full, without prior written approval of the Company. Any unauthorized alteration, forgery or falsification of the content or appearance of this document is unlawful and offenders may be prosecuted to the fullest extent of the law.

SGS Taiwan Ltd.

No.134,WuKungRoad,NewTaipeiIndustrialPark,WukuDistrict,NewTaipeiCity,Taiwan24803/新北市五股區新北產業園區五工路 134 號

台灣檢驗科技股份有限公司

t (886-2) 2299-3279

f (886-2) 2298-0488

www.tw.sgs.com

Member of SGS Group

Operation Band	:GSM 1900	Temp./Humi.	:22 deg_C / 61 RH
Fundamental Frequency	:1909.8 MHz	Engineer	:Kane
Operation Mode	:Tx CH HIGH		
EUT Pol.	:H Plane	Measurement Antenna Pol.	:HORIZONTAL

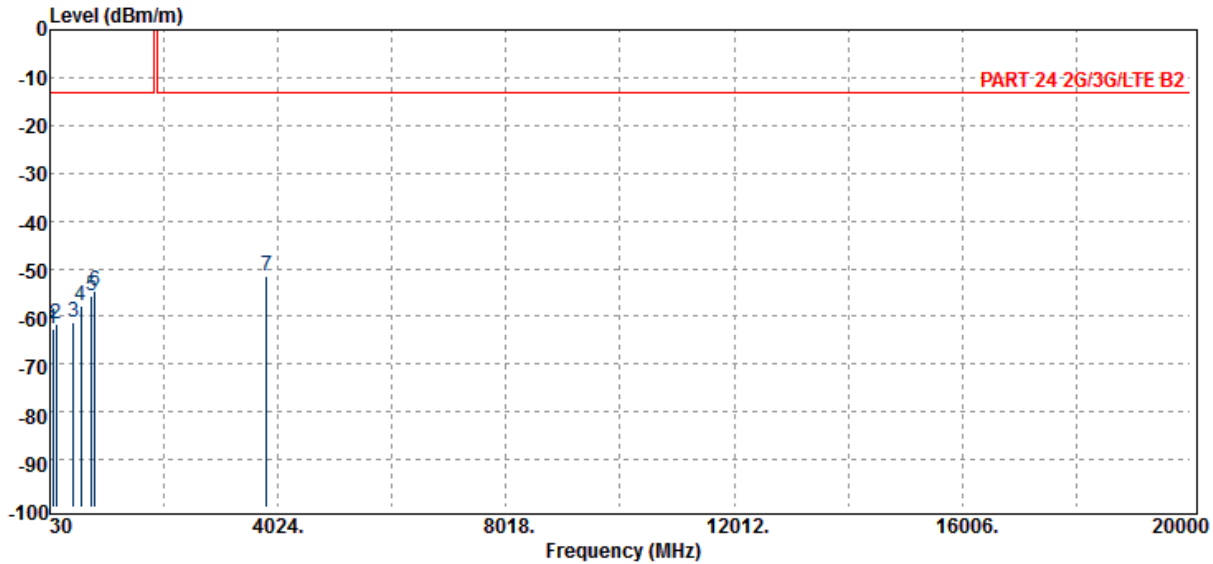

Freq. MHz	ERP/EIRP dBm	SG Output Level dBm	Antenna Gain dBd/dBi	Cable Loss dB	Limit dBm	Margin dB
83.35	-62.79	-60.08	-1.73	-0.98	-13.00	-49.79
140.58	-61.62	-58.08	-2.27	-1.26	-13.00	-48.62
444.19	-61.12	-62.76	3.56	-1.92	-13.00	-48.12
575.14	-57.72	-58.94	3.75	-2.54	-13.00	-44.72
755.56	-55.70	-57.01	3.47	-2.16	-13.00	-42.70
812.79	-54.64	-55.63	3.44	-2.45	-13.00	-41.64
3819.60	-51.67	-57.31	12.66	-7.02	-13.00	-38.67

Unless otherwise stated the results shown in this test report refer only to the sample(s) tested and such sample(s) are retained for 90 days only.

除非另有說明，此報告結果僅對測試之樣品負責，同時此樣品僅保留90天。本報告未經本公司書面許可，不可部份複製。

This document is issued by the Company subject to its General Conditions of Service printed overleaf, available on request or accessible at www.sgs.com/terms_and_conditions.htm and, for electronic format documents, subject to Terms and Conditions for Electronic Documents at www.sgs.com/terms_e-document.htm. Attention is drawn to the limitation of liability, indemnification and jurisdiction issues defined therein. Any holder of this document is advised that information contained hereon reflects the Company's findings at the time of its intervention only and within the limits of Client's instructions, if any. The Company's sole responsibility is to its Client and this document does not exonerate parties to a transaction from exercising all their rights and obligations under the transaction documents. This document cannot be reproduced except in full, without prior written approval of the Company. Any unauthorized alteration, forgery or falsification of the content or appearance of this document is unlawful and offenders may be prosecuted to the fullest extent of the law.

SGS Taiwan Ltd.

No.134,WuKungRoad,NewTaipeiIndustrialPark,WukuDistrict,NewTaipeiCity,Taiwan24803/新北市五股區新北產業園區五工路 134 號

台灣檢驗科技股份有限公司

t (886-2) 2299-3279

f (886-2) 2298-0488

www.tw.sgs.com

Member of SGS Group

Radiated Spurious Emission Measurement Result: WCDMA Band 5 Mode

Operation Band :WCDMA B5 Temp./Humi. :24 deg_C / 61 RH
 Fundamental Frequency :826.4 MHz Engineer :Kane
 Operation Mode :Tx CH LOW
 EUT Pol. :H Plane Measurement Antenna Pol. :VERTICAL

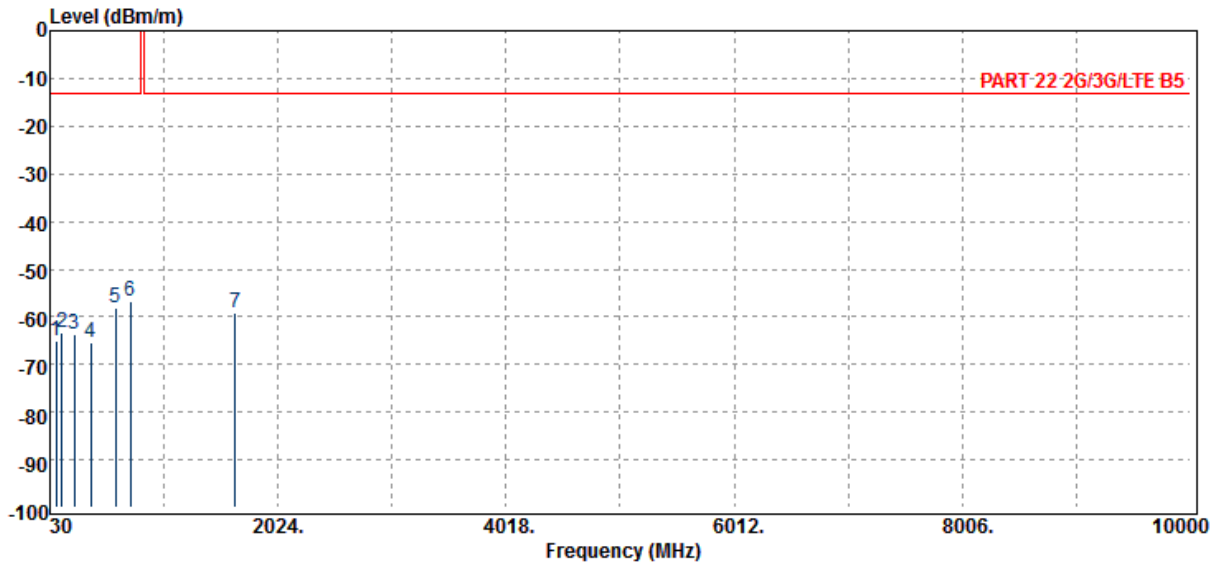

Freq. MHz	ERP/EIRP dBm	SG Output Level dBm	Antenna Gain dBd/dBi	Cable Loss dB	Limit dBm	Margin dB
85.29	-65.19	-62.83	-1.37	-0.99	-13.00	-52.19
136.70	-63.26	-59.82	-2.19	-1.24	-13.00	-50.26
240.49	-63.72	-65.53	3.48	-1.67	-13.00	-50.72
385.99	-65.36	-67.10	3.75	-2.01	-13.00	-52.36
604.24	-58.20	-59.62	3.56	-2.14	-13.00	-45.20
736.16	-56.63	-57.15	3.53	-3.00	-13.00	-43.63
1652.80	-59.19	-63.97	9.14	-4.36	-13.00	-46.19

Unless otherwise stated the results shown in this test report refer only to the sample(s) tested and such sample(s) are retained for 90 days only.

除非另有說明，此報告結果僅對測試之樣品負責，同時此樣品僅保留90天。本報告未經本公司書面許可，不可部份複製。

This document is issued by the Company subject to its General Conditions of Service printed overleaf, available on request or accessible at www.sgs.com/terms_and_conditions.htm and, for electronic format documents, subject to Terms and Conditions for Electronic Documents at www.sgs.com/terms_e-document.htm. Attention is drawn to the limitation of liability, indemnification and jurisdiction issues defined therein. Any holder of this document is advised that information contained hereon reflects the Company's findings at the time of its intervention only and within the limits of Client's instructions, if any. The Company's sole responsibility is to its Client and this document does not exonerate parties to a transaction from exercising all their rights and obligations under the transaction documents. This document cannot be reproduced except in full, without prior written approval of the Company. Any unauthorized alteration, forgery or falsification of the content or appearance of this document is unlawful and offenders may be prosecuted to the fullest extent of the law.

SGS Taiwan Ltd.

No.134,WuKungRoad,NewTaipeiIndustrialPark,WukuDistrict,NewTaipeiCity,Taiwan24803/新北市五股區新北產業園區五工路 134 號

台灣檢驗科技股份有限公司

t (886-2) 2299-3279

f (886-2) 2298-0488

www.tw.sgs.com

Member of SGS Group

Operation Band	:WCDMA B5	Temp./Humi.	:24 deg_C / 61 RH
Fundamental Frequency	:826.4 MHz	Engineer	:Kane
Operation Mode	:Tx CH LOW		
EUT Pol.	:H Plane	Measurement Antenna Pol.	:HORIZONTAL

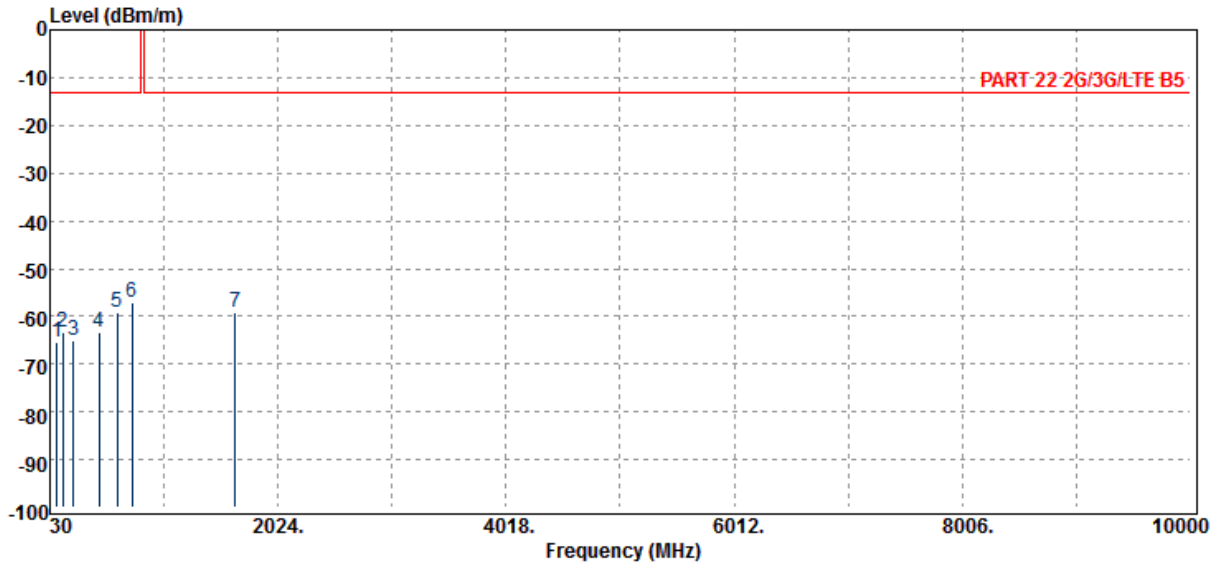

Freq. MHz	ERP/EIRP dBm	SG Output Level dBm	Antenna Gain dBd/dBi	Cable Loss dB	Limit dBm	Margin dB
90.14	-65.28	-63.72	-0.55	-1.01	-13.00	-52.28
143.49	-63.15	-59.75	-2.13	-1.28	-13.00	-50.15
238.55	-64.88	-66.67	3.45	-1.66	-13.00	-51.88
458.74	-63.46	-64.71	3.63	-2.38	-13.00	-50.46
614.91	-59.01	-60.17	3.63	-2.47	-13.00	-46.01
744.89	-57.08	-57.60	3.49	-2.97	-13.00	-44.08
1652.80	-59.13	-63.91	9.14	-4.36	-13.00	-46.13

Unless otherwise stated the results shown in this test report refer only to the sample(s) tested and such sample(s) are retained for 90 days only.

除非另有說明，此報告結果僅對測試之樣品負責，同時此樣品僅保留90天。本報告未經本公司書面許可，不可部份複製。

This document is issued by the Company subject to its General Conditions of Service printed overleaf, available on request or accessible at www.sgs.com/terms_and_conditions.htm and, for electronic format documents, subject to Terms and Conditions for Electronic Documents at www.sgs.com/terms_e-document.htm. Attention is drawn to the limitation of liability, indemnification and jurisdiction issues defined therein. Any holder of this document is advised that information contained hereon reflects the Company's findings at the time of its intervention only and within the limits of Client's instructions, if any. The Company's sole responsibility is to its Client and this document does not exonerate parties to a transaction from exercising all their rights and obligations under the transaction documents. This document cannot be reproduced except in full, without prior written approval of the Company. Any unauthorized alteration, forgery or falsification of the content or appearance of this document is unlawful and offenders may be prosecuted to the fullest extent of the law.

SGS Taiwan Ltd.

No.134,WuKungRoad,NewTaipeiIndustrialPark,WukuDistrict,NewTaipeiCity,Taiwan24803/新北市五股區新北產業園區五工路 134 號

台灣檢驗科技股份有限公司

t (886-2) 2299-3279

f (886-2) 2298-0488

www.tw.sgs.com

Member of SGS Group

Operation Band	:WCDMA B5	Temp./Humi.	:24 deg_C / 61 RH
Fundamental Frequency	:836.6 MHz	Engineer	:Kane
Operation Mode	:Tx CH MID		
EUT Pol.	:H Plane	Measurement Antenna Pol.	:VERTICAL

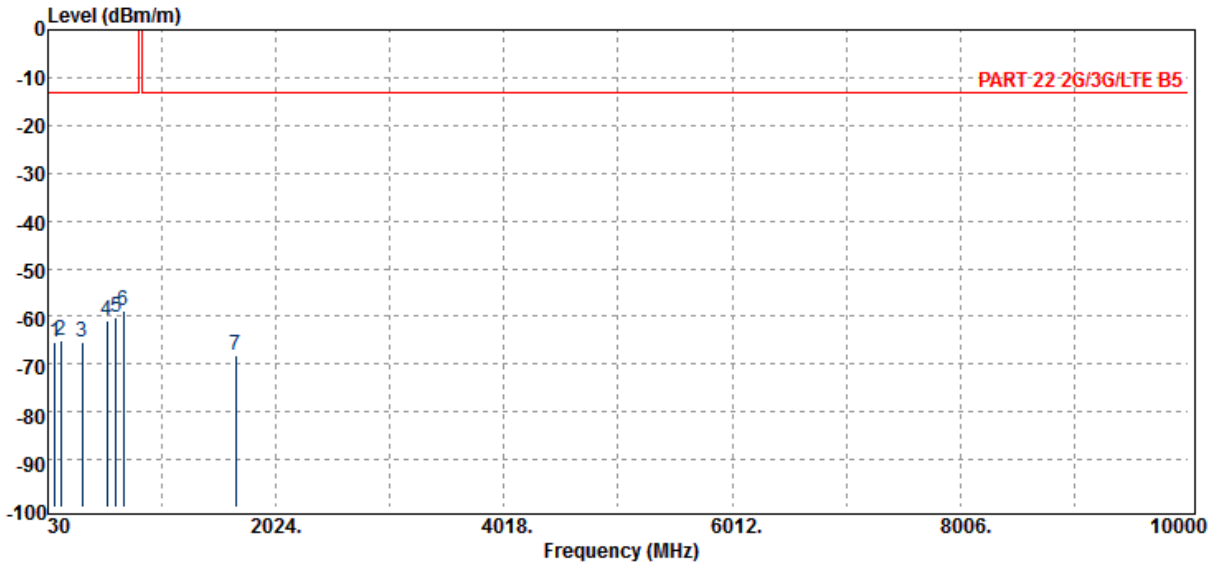

Freq. MHz	ERP/EIRP dBm	SG Output Level dBm	Antenna Gain dBd/dBi	Cable Loss dB	Limit dBm	Margin dB
93.05	-65.53	-63.75	-0.76	-1.02	-13.00	-52.53
140.58	-65.02	-61.48	-2.27	-1.26	-13.00	-52.02
325.85	-65.25	-67.12	3.74	-1.88	-13.00	-52.25
548.95	-60.78	-62.79	3.98	-1.97	-13.00	-47.78
626.55	-60.15	-61.08	3.70	-2.78	-13.00	-47.15
686.69	-58.73	-59.23	3.72	-3.21	-13.00	-45.73
1673.20	-68.21	-63.81	0.00	-4.39	-13.00	-55.21

Unless otherwise stated the results shown in this test report refer only to the sample(s) tested and such sample(s) are retained for 90 days only.

除非另有說明，此報告結果僅對測試之樣品負責，同時此樣品僅保留90天。本報告未經本公司書面許可，不可部份複製。

This document is issued by the Company subject to its General Conditions of Service printed overleaf, available on request or accessible at www.sgs.com/terms_and_conditions.htm and, for electronic format documents, subject to Terms and Conditions for Electronic Documents at www.sgs.com/terms_e-document.htm. Attention is drawn to the limitation of liability, indemnification and jurisdiction issues defined therein. Any holder of this document is advised that information contained hereon reflects the Company's findings at the time of its intervention only and within the limits of Client's instructions, if any. The Company's sole responsibility is to its Client and this document does not exonerate parties to a transaction from exercising all their rights and obligations under the transaction documents. This document cannot be reproduced except in full, without prior written approval of the Company. Any unauthorized alteration, forgery or falsification of the content or appearance of this document is unlawful and offenders may be prosecuted to the fullest extent of the law.

SGS Taiwan Ltd.

No.134,WuKungRoad,NewTaipeiIndustrialPark,WukuDistrict,NewTaipeiCity,Taiwan24803/新北市五股區新北產業園區五工路 134 號

台灣檢驗科技股份有限公司

t (886-2) 2299-3279

f (886-2) 2298-0488

www.tw.sgs.com

Member of SGS Group

Operation Band	:WCDMA B5	Temp./Humi.	:24 deg_C / 61 RH
Fundamental Frequency	:836.6 MHz	Engineer	:Kane
Operation Mode	:Tx CH MID		
EUT Pol.	:H Plane	Measurement Antenna Pol.	:HORIZONTAL

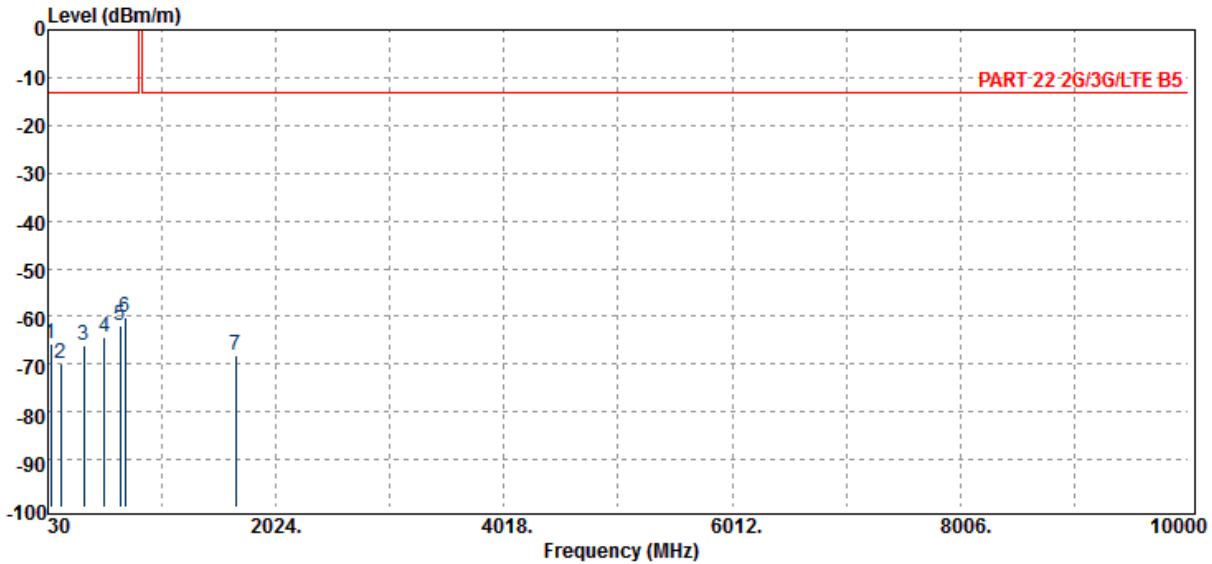

Freq. MHz	ERP/EIRP dBm	SG Output Level dBm	Antenna Gain dBd/dBi	Cable Loss dB	Limit dBm	Margin dB
57.16	-65.82	-55.52	-9.50	-0.80	-13.00	-52.82
144.46	-70.03	-66.67	-2.08	-1.28	-13.00	-57.03
347.19	-66.20	-68.03	3.84	-2.02	-13.00	-53.20
524.70	-64.51	-65.95	4.02	-2.57	-13.00	-51.51
663.41	-61.99	-63.80	3.79	-1.98	-13.00	-48.99
704.15	-60.36	-62.15	3.66	-1.87	-13.00	-47.36
1673.20	-68.05	-63.65	0.00	-4.39	-13.00	-55.05

Unless otherwise stated the results shown in this test report refer only to the sample(s) tested and such sample(s) are retained for 90 days only.

除非另有說明，此報告結果僅對測試之樣品負責，同時此樣品僅保留90天。本報告未經本公司書面許可，不可部份複製。

This document is issued by the Company subject to its General Conditions of Service printed overleaf, available on request or accessible at www.sgs.com/terms_and_conditions.htm and, for electronic format documents, subject to Terms and Conditions for Electronic Documents at www.sgs.com/terms_e-document.htm. Attention is drawn to the limitation of liability, indemnification and jurisdiction issues defined therein. Any holder of this document is advised that information contained hereon reflects the Company's findings at the time of its intervention only and within the limits of Client's instructions, if any. The Company's sole responsibility is to its Client and this document does not exonerate parties to a transaction from exercising all their rights and obligations under the transaction documents. This document cannot be reproduced except in full, without prior written approval of the Company. Any unauthorized alteration, forgery or falsification of the content or appearance of this document is unlawful and offenders may be prosecuted to the fullest extent of the law.

SGS Taiwan Ltd.

No.134,WuKungRoad,NewTaipeiIndustrialPark,WukuDistrict,NewTaipeiCity,Taiwan24803/新北市五股區新北產業園區五工路 134 號

台灣檢驗科技股份有限公司

t (886-2) 2299-3279

f (886-2) 2298-0488

www.tw.sgs.com

Member of SGS Group

Operation Band	:WCDMA B5	Temp./Humi.	:24 deg_C / 61 RH
Fundamental Frequency	:846.6 MHz	Engineer	:Kane
Operation Mode	:Tx CH HIGH		
EUT Pol.	:H Plane	Measurement Antenna Pol.	:VERTICAL

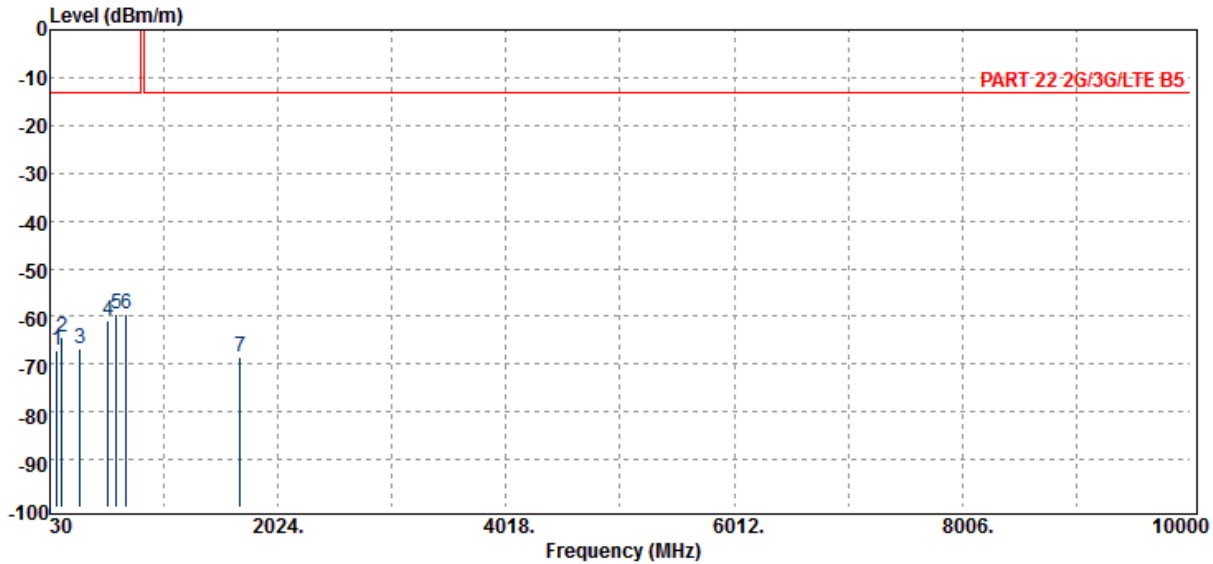

Freq. MHz	ERP/EIRP dBm	SG Output Level dBm	Antenna Gain dBd/dBi	Cable Loss dB	Limit dBm	Margin dB
90.14	-66.97	-65.41	-0.55	-1.01	-13.00	-53.97
136.70	-64.45	-61.01	-2.19	-1.24	-13.00	-51.45
293.84	-66.93	-68.63	3.50	-1.80	-13.00	-53.93
539.25	-60.99	-63.00	4.00	-1.99	-13.00	-47.99
607.15	-59.48	-60.85	3.58	-2.21	-13.00	-46.48
697.36	-59.56	-60.86	3.68	-2.38	-13.00	-46.56
1693.20	-68.67	-64.24	0.00	-4.43	-13.00	-55.67

Unless otherwise stated the results shown in this test report refer only to the sample(s) tested and such sample(s) are retained for 90 days only.

除非另有說明，此報告結果僅對測試之樣品負責，同時此樣品僅保留90天。本報告未經本公司書面許可，不可部份複製。

This document is issued by the Company subject to its General Conditions of Service printed overleaf, available on request or accessible at www.sgs.com/terms_and_conditions.htm and, for electronic format documents, subject to Terms and Conditions for Electronic Documents at www.sgs.com/terms_e-document.htm. Attention is drawn to the limitation of liability, indemnification and jurisdiction issues defined therein. Any holder of this document is advised that information contained hereon reflects the Company's findings at the time of its intervention only and within the limits of Client's instructions, if any. The Company's sole responsibility is to its Client and this document does not exonerate parties to a transaction from exercising all their rights and obligations under the transaction documents. This document cannot be reproduced except in full, without prior written approval of the Company. Any unauthorized alteration, forgery or falsification of the content or appearance of this document is unlawful and offenders may be prosecuted to the fullest extent of the law.

SGS Taiwan Ltd.

No.134,WuKungRoad,NewTaipeiIndustrialPark,WukuDistrict,NewTaipeiCity,Taiwan24803/新北市五股區新北產業園區五工路 134 號

台灣檢驗科技股份有限公司

t (886-2) 2299-3279

f (886-2) 2298-0488

www.tw.sgs.com

Member of SGS Group

Operation Band	:WCDMA B5	Temp./Humi.	:24 deg_C / 61 RH
Fundamental Frequency	:846.6 MHz	Engineer	:Kane
Operation Mode	:Tx CH HIGH		
EUT Pol.	:H Plane	Measurement Antenna Pol.	:HORIZONTAL

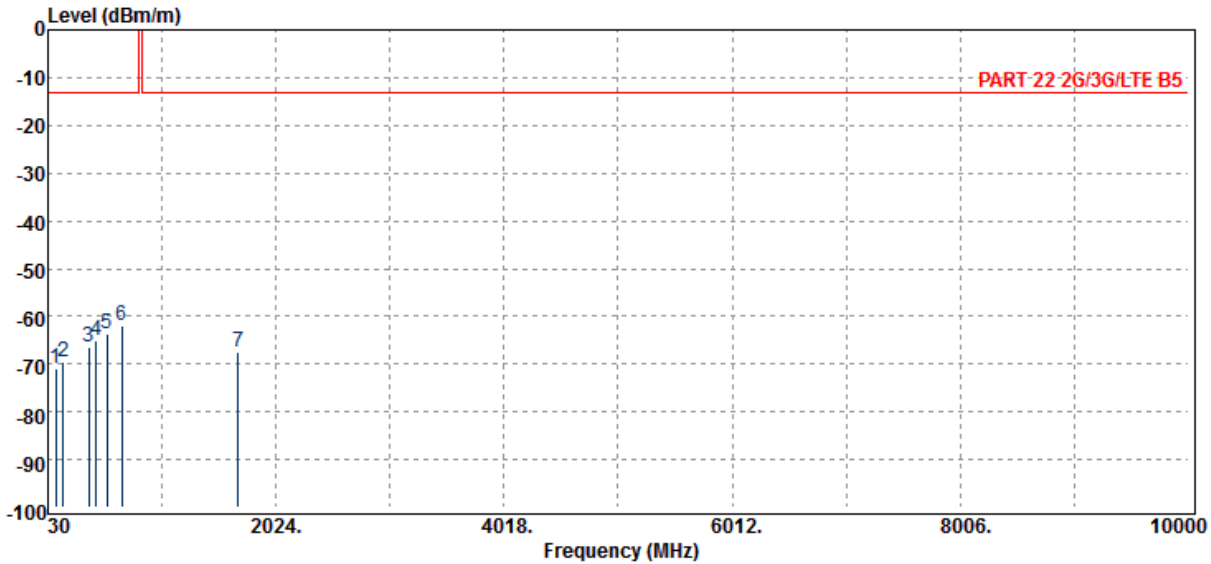

Freq. MHz	ERP/EIRP dBm	SG Output Level dBm	Antenna Gain dBd/dBi	Cable Loss dB	Limit dBm	Margin dB
97.90	-70.97	-68.84	-1.09	-1.04	-13.00	-57.97
162.89	-69.58	-67.22	-1.06	-1.31	-13.00	-56.58
386.96	-66.46	-68.18	3.75	-2.02	-13.00	-53.46
449.04	-65.13	-66.62	3.54	-2.05	-13.00	-52.13
546.04	-63.80	-65.98	3.99	-1.81	-13.00	-50.80
675.05	-61.91	-63.01	3.75	-2.65	-13.00	-48.91
1693.20	-67.33	-62.90	0.00	-4.43	-13.00	-54.33

Unless otherwise stated the results shown in this test report refer only to the sample(s) tested and such sample(s) are retained for 90 days only.

除非另有說明，此報告結果僅對測試之樣品負責，同時此樣品僅保留90天。本報告未經本公司書面許可，不可部份複製。

This document is issued by the Company subject to its General Conditions of Service printed overleaf, available on request or accessible at www.sgs.com/terms_and_conditions.htm and, for electronic format documents, subject to Terms and Conditions for Electronic Documents at www.sgs.com/terms_e-document.htm. Attention is drawn to the limitation of liability, indemnification and jurisdiction issues defined therein. Any holder of this document is advised that information contained hereon reflects the Company's findings at the time of its intervention only and within the limits of Client's instructions, if any. The Company's sole responsibility is to its Client and this document does not exonerate parties to a transaction from exercising all their rights and obligations under the transaction documents. This document cannot be reproduced except in full, without prior written approval of the Company. Any unauthorized alteration, forgery or falsification of the content or appearance of this document is unlawful and offenders may be prosecuted to the fullest extent of the law.

Radiated Spurious Emission Measurement Result: LTE-Band 5 (The Worst Case)

Operation Band	:LTE B5	Temp./Humi.	:24.1 deg_C / 65 RH
Fundamental Frequency	:829 MHz	Engineer	:Kane
Operation Mode	:Tx CH LOW		
EUT Pol.	:H Plane	Measurement Antenna Pol.	:VERTICAL

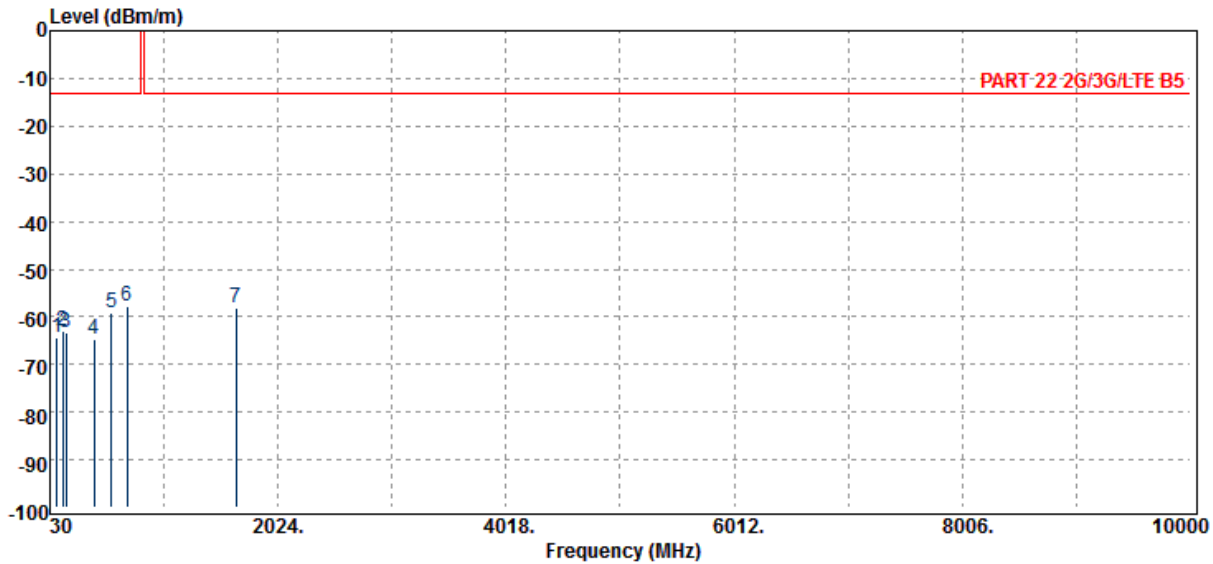

Freq. MHz	ERP/EIRP dBm	SG Output Level dBm	Antenna Gain dBd/dBi	Cable Loss dB	Limit dBm	Margin dB
91.11	-64.36	-62.72	-0.62	-1.01	-13.00	-51.36
141.55	-63.07	-59.58	-2.22	-1.27	-13.00	-50.07
167.74	-63.22	-61.15	-0.76	-1.32	-13.00	-50.22
413.15	-64.54	-66.08	3.67	-2.13	-13.00	-51.54
566.41	-59.32	-60.35	3.83	-2.80	-13.00	-46.32
702.21	-57.92	-59.58	3.67	-2.01	-13.00	-44.92
1658.00	-58.11	-62.90	9.16	-4.37	-13.00	-45.11

Unless otherwise stated the results shown in this test report refer only to the sample(s) tested and such sample(s) are retained for 90 days only.

除非另有說明，此報告結果僅對測試之樣品負責，同時此樣品僅保留90天。本報告未經本公司書面許可，不可部份複製。

This document is issued by the Company subject to its General Conditions of Service printed overleaf, available on request or accessible at www.sgs.com/terms_and_conditions.htm and, for electronic format documents, subject to Terms and Conditions for Electronic Documents at www.sgs.com/terms_e-document.htm. Attention is drawn to the limitation of liability, indemnification and jurisdiction issues defined therein. Any holder of this document is advised that information contained hereon reflects the Company's findings at the time of its intervention only and within the limits of Client's instructions, if any. The Company's sole responsibility is to its Client and this document does not exonerate parties to a transaction from exercising all their rights and obligations under the transaction documents. This document cannot be reproduced except in full, without prior written approval of the Company. Any unauthorized alteration, forgery or falsification of the content or appearance of this document is unlawful and offenders may be prosecuted to the fullest extent of the law.

SGS Taiwan Ltd.

No.134,WuKungRoad,NewTaipeiIndustrialPark,WukuDistrict,NewTaipeiCity,Taiwan24803/新北市五股區新北產業園區五工路 134 號

台灣檢驗科技股份有限公司

t (886-2) 2299-3279

f (886-2) 2298-0488

www.tw.sgs.com

Member of SGS Group

Operation Band	:LTE B5	Temp./Humi.	:24.1 deg_C / 65 RH
Fundamental Frequency	:829 MHz	Engineer	:Kane
Operation Mode	:Tx CH LOW		
EUT Pol.	:H Plane	Measurement Antenna Pol.	:HORIZONTAL

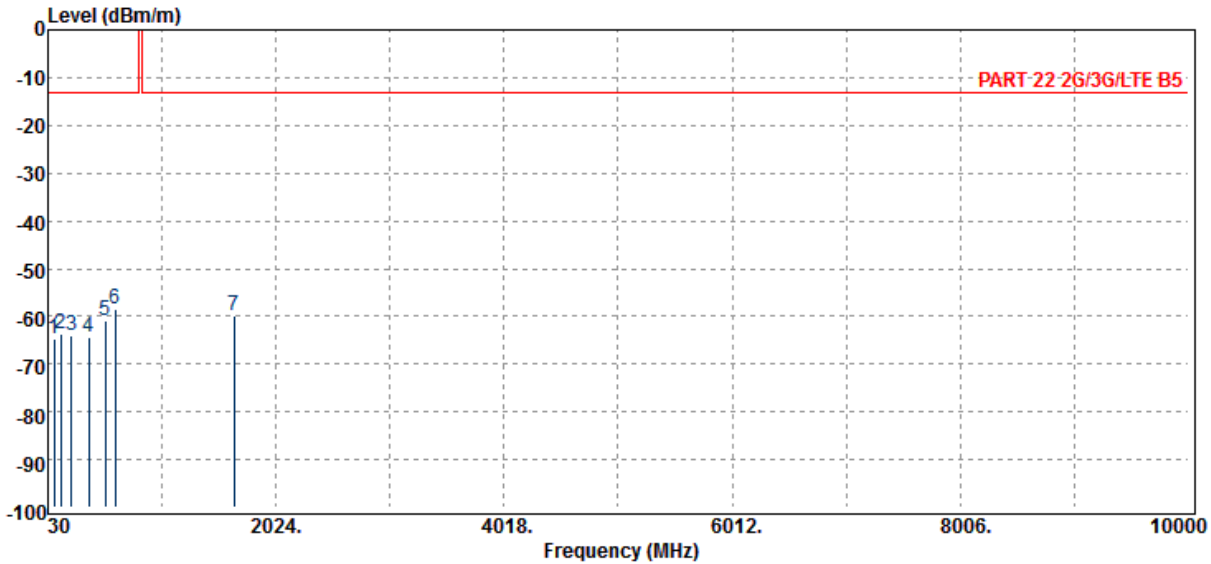

Freq. MHz	ERP/EIRP dBm	SG Output Level dBm	Antenna Gain dBd/dBi	Cable Loss dB	Limit dBm	Margin dB
85.29	-64.83	-62.47	-1.37	-0.99	-13.00	-51.83
139.61	-63.82	-60.27	-2.29	-1.26	-13.00	-50.82
238.55	-64.14	-65.93	3.45	-1.66	-13.00	-51.14
386.96	-64.51	-66.24	3.75	-2.02	-13.00	-51.51
532.46	-60.79	-62.53	4.01	-2.27	-13.00	-47.79
614.91	-58.42	-59.57	3.63	-2.47	-13.00	-45.42
1658.00	-60.00	-64.79	9.16	-4.37	-13.00	-47.00

Unless otherwise stated the results shown in this test report refer only to the sample(s) tested and such sample(s) are retained for 90 days only.

除非另有說明，此報告結果僅對測試之樣品負責，同時此樣品僅保留90天。本報告未經本公司書面許可，不可部份複製。

This document is issued by the Company subject to its General Conditions of Service printed overleaf, available on request or accessible at www.sgs.com/terms_and_conditions.htm and, for electronic format documents, subject to Terms and Conditions for Electronic Documents at www.sgs.com/terms_e-document.htm. Attention is drawn to the limitation of liability, indemnification and jurisdiction issues defined therein. Any holder of this document is advised that information contained hereon reflects the Company's findings at the time of its intervention only and within the limits of Client's instructions, if any. The Company's sole responsibility is to its Client and this document does not exonerate parties to a transaction from exercising all their rights and obligations under the transaction documents. This document cannot be reproduced except in full, without prior written approval of the Company. Any unauthorized alteration, forgery or falsification of the content or appearance of this document is unlawful and offenders may be prosecuted to the fullest extent of the law.

SGS Taiwan Ltd.

No.134,WuKungRoad,NewTaipeiIndustrialPark,WukuDistrict,NewTaipeiCity,Taiwan24803/新北市五股區新北產業園區五工路 134 號

台灣檢驗科技股份有限公司

t (886-2) 2299-3279

f (886-2) 2298-0488

www.tw.sgs.com

Member of SGS Group

Operation Band	:LTE B5	Temp./Humi.	:24.1 deg_C / 65 RH
Fundamental Frequency	:836.5 MHz	Engineer	:Kane
Operation Mode	:Tx CH MID		
EUT Pol.	:H Plane	Measurement Antenna Pol.	:VERTICAL

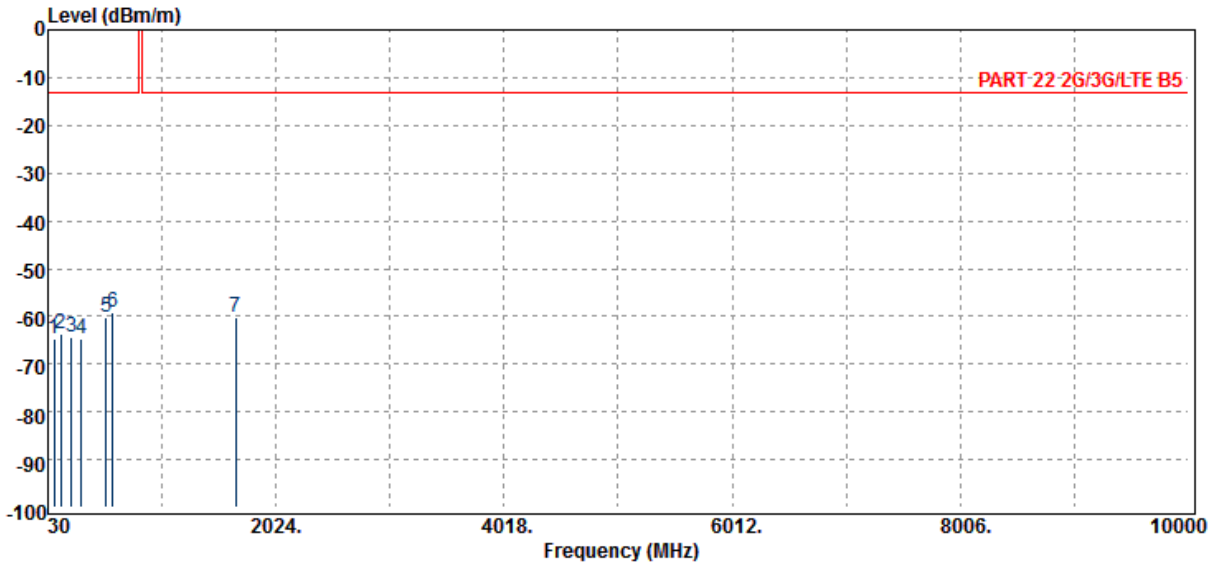

Freq. MHz	ERP/EIRP dBm	SG Output Level dBm	Antenna Gain dBd/dBi	Cable Loss dB	Limit dBm	Margin dB
81.41	-64.74	-61.67	-2.09	-0.97	-13.00	-51.74
141.55	-63.57	-60.08	-2.22	-1.27	-13.00	-50.57
238.55	-64.21	-66.00	3.45	-1.66	-13.00	-51.21
323.91	-64.79	-66.65	3.73	-1.88	-13.00	-51.79
541.19	-60.20	-62.28	3.99	-1.91	-13.00	-47.20
597.45	-59.27	-60.65	3.56	-2.18	-13.00	-46.27
1673.00	-60.19	-65.01	9.21	-4.39	-13.00	-47.19

Unless otherwise stated the results shown in this test report refer only to the sample(s) tested and such sample(s) are retained for 90 days only.

除非另有說明，此報告結果僅對測試之樣品負責，同時此樣品僅保留90天。本報告未經本公司書面許可，不可部份複製。

This document is issued by the Company subject to its General Conditions of Service printed overleaf, available on request or accessible at www.sgs.com/terms_and_conditions.htm and, for electronic format documents, subject to Terms and Conditions for Electronic Documents at www.sgs.com/terms_e-document.htm. Attention is drawn to the limitation of liability, indemnification and jurisdiction issues defined therein. Any holder of this document is advised that information contained hereon reflects the Company's findings at the time of its intervention only and within the limits of Client's instructions, if any. The Company's sole responsibility is to its Client and this document does not exonerate parties to a transaction from exercising all their rights and obligations under the transaction documents. This document cannot be reproduced except in full, without prior written approval of the Company. Any unauthorized alteration, forgery or falsification of the content or appearance of this document is unlawful and offenders may be prosecuted to the fullest extent of the law.

SGS Taiwan Ltd.

No.134,WuKungRoad,NewTaipeiIndustrialPark,WukuDistrict,NewTaipeiCity,Taiwan24803/新北市五股區新北產業園區五工路 134 號

台灣檢驗科技股份有限公司

t (886-2) 2299-3279

f (886-2) 2298-0488

www.tw.sgs.com

Member of SGS Group

Operation Band	:LTE B5	Temp./Humi.	:24.1 deg_C / 65 RH
Fundamental Frequency	:836.5 MHz	Engineer	:Kane
Operation Mode	:Tx CH MID		
EUT Pol.	:H Plane	Measurement Antenna Pol.	:HORIZONTAL

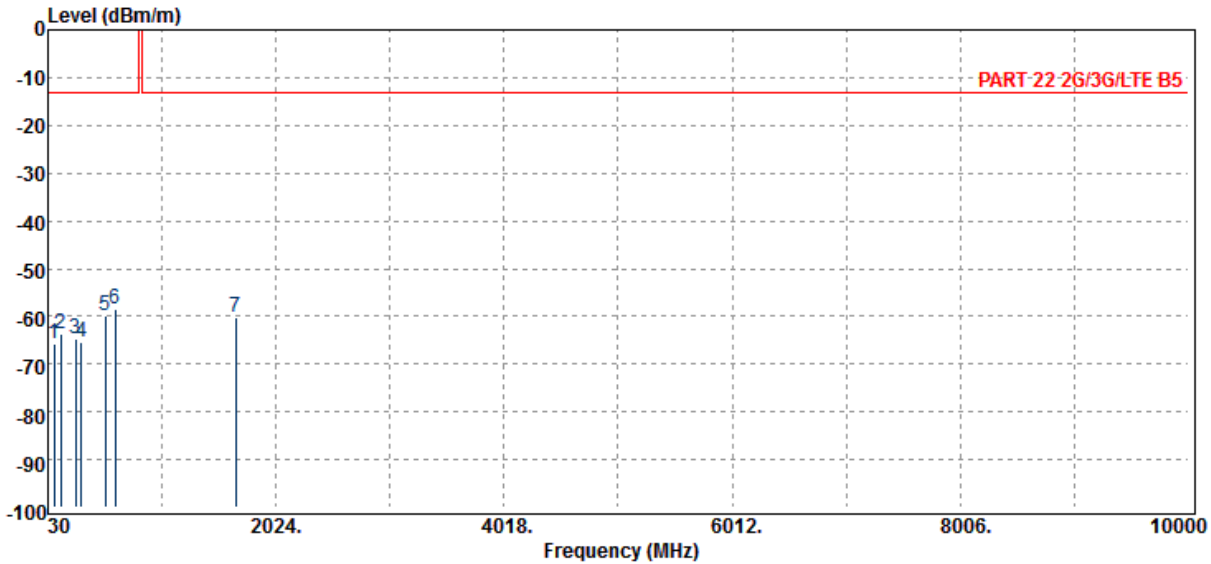

Freq. MHz	ERP/EIRP dBm	SG Output Level dBm	Antenna Gain dBd/dBi	Cable Loss dB	Limit dBm	Margin dB
85.29	-65.61	-63.25	-1.37	-0.99	-13.00	-52.61
139.61	-63.54	-59.99	-2.29	-1.26	-13.00	-50.54
274.44	-64.56	-66.29	3.46	-1.73	-13.00	-51.56
322.94	-65.39	-67.24	3.73	-1.87	-13.00	-52.39
529.55	-60.02	-61.64	4.01	-2.39	-13.00	-47.02
619.76	-58.38	-59.40	3.66	-2.63	-13.00	-45.38
1673.00	-60.21	-65.02	9.21	-4.39	-13.00	-47.21

Unless otherwise stated the results shown in this test report refer only to the sample(s) tested and such sample(s) are retained for 90 days only.

除非另有說明，此報告結果僅對測試之樣品負責，同時此樣品僅保留90天。本報告未經本公司書面許可，不可部份複製。

This document is issued by the Company subject to its General Conditions of Service printed overleaf, available on request or accessible at www.sgs.com/terms_and_conditions.htm and, for electronic format documents, subject to Terms and Conditions for Electronic Documents at www.sgs.com/terms_e-document.htm. Attention is drawn to the limitation of liability, indemnification and jurisdiction issues defined therein. Any holder of this document is advised that information contained hereon reflects the Company's findings at the time of its intervention only and within the limits of Client's instructions, if any. The Company's sole responsibility is to its Client and this document does not exonerate parties to a transaction from exercising all their rights and obligations under the transaction documents. This document cannot be reproduced except in full, without prior written approval of the Company. Any unauthorized alteration, forgery or falsification of the content or appearance of this document is unlawful and offenders may be prosecuted to the fullest extent of the law.

SGS Taiwan Ltd.

No.134,WuKungRoad,NewTaipeiIndustrialPark,WukuDistrict,NewTaipeiCity,Taiwan24803/新北市五股區新北產業園區五工路 134 號

台灣檢驗科技股份有限公司

t (886-2) 2299-3279

f (886-2) 2298-0488

www.tw.sgs.com

Member of SGS Group

Operation Band	:LTE B5	Temp./Humi.	:24.1 deg_C / 65 RH
Fundamental Frequency	:844 MHz	Engineer	:Kane
Operation Mode	:Tx CH HIGH		
EUT Pol.	:H Plane	Measurement Antenna Pol.	:VERTICAL

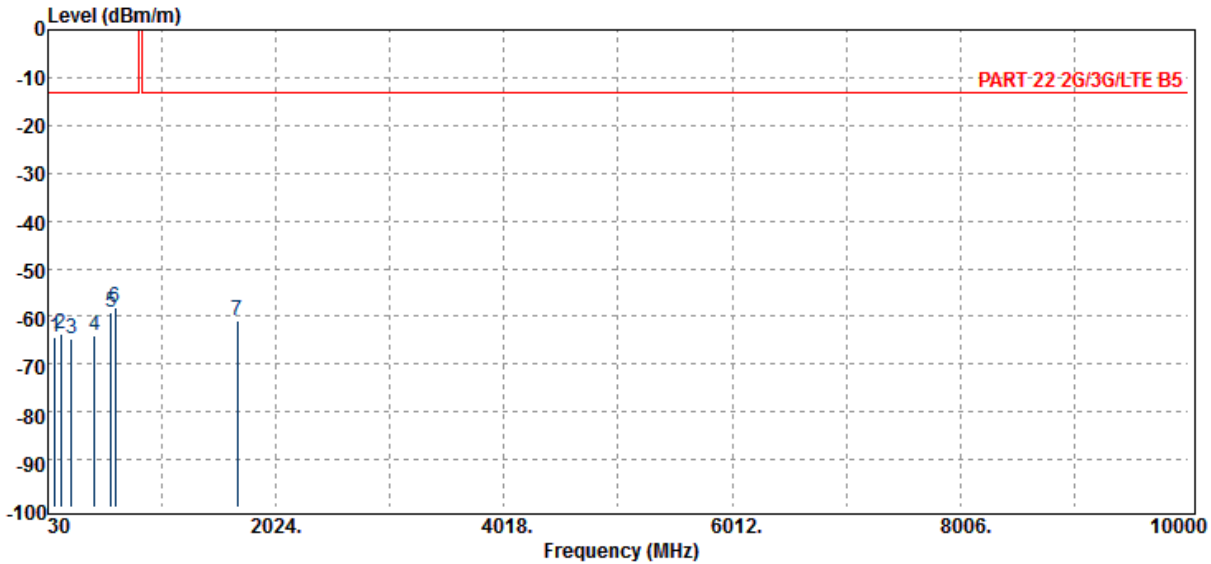

Freq. MHz	ERP/EIRP dBm	SG Output Level dBm	Antenna Gain dBd/dBi	Cable Loss dB	Limit dBm	Margin dB
90.14	-64.27	-62.71	-0.55	-1.01	-13.00	-51.27
144.46	-63.51	-60.14	-2.08	-1.28	-13.00	-50.51
235.64	-64.71	-66.46	3.40	-1.65	-13.00	-51.71
435.46	-64.10	-65.69	3.59	-2.00	-13.00	-51.10
579.99	-59.07	-60.39	3.71	-2.39	-13.00	-46.07
618.79	-58.21	-59.25	3.65	-2.60	-13.00	-45.21
1688.00	-60.78	-63.47	7.11	-4.42	-13.00	-47.78

Unless otherwise stated the results shown in this test report refer only to the sample(s) tested and such sample(s) are retained for 90 days only.

除非另有說明，此報告結果僅對測試之樣品負責，同時此樣品僅保留90天。本報告未經本公司書面許可，不可部份複製。

This document is issued by the Company subject to its General Conditions of Service printed overleaf, available on request or accessible at www.sgs.com/terms_and_conditions.htm and, for electronic format documents, subject to Terms and Conditions for Electronic Documents at www.sgs.com/terms_e-document.htm. Attention is drawn to the limitation of liability, indemnification and jurisdiction issues defined therein. Any holder of this document is advised that information contained hereon reflects the Company's findings at the time of its intervention only and within the limits of Client's instructions, if any. The Company's sole responsibility is to its Client and this document does not exonerate parties to a transaction from exercising all their rights and obligations under the transaction documents. This document cannot be reproduced except in full, without prior written approval of the Company. Any unauthorized alteration, forgery or falsification of the content or appearance of this document is unlawful and offenders may be prosecuted to the fullest extent of the law.

SGS Taiwan Ltd.

No.134,WuKungRoad,NewTaipeiIndustrialPark,WukuDistrict,NewTaipeiCity,Taiwan24803/新北市五股區新北產業園區五工路 134 號

台灣檢驗科技股份有限公司

t (886-2) 2299-3279

f (886-2) 2298-0488

www.tw.sgs.com

Member of SGS Group

Operation Band	:LTE B5	Temp./Humi.	:24.1 deg_C / 65 RH
Fundamental Frequency	:844 MHz	Engineer	:Kane
Operation Mode	:Tx CH HIGH		
EUT Pol.	:H Plane	Measurement Antenna Pol.	:HORIZONTAL

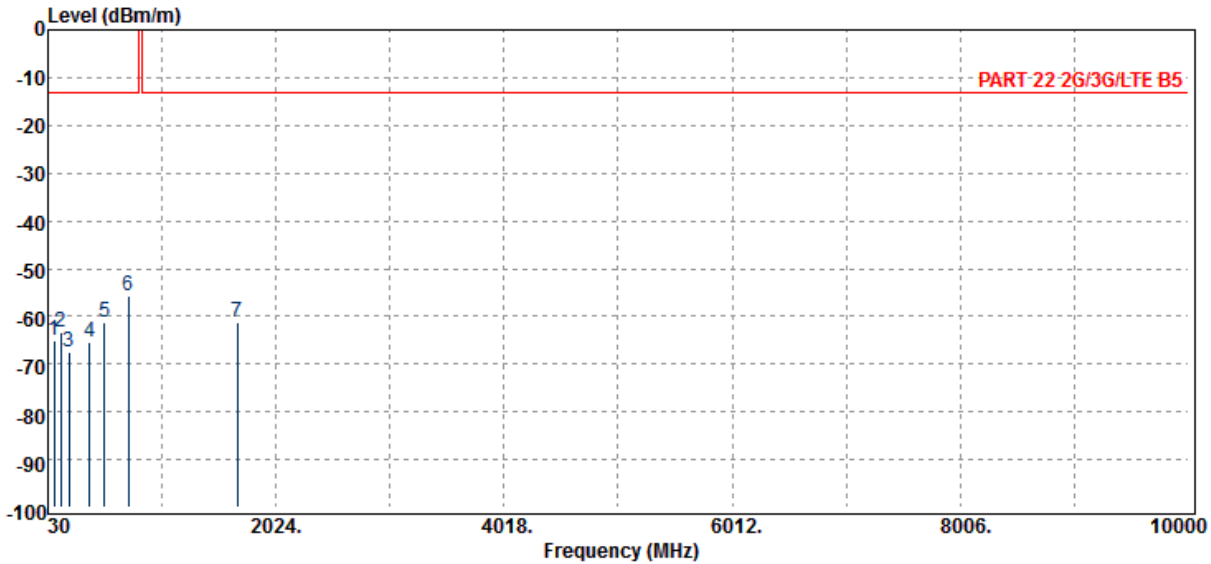

Freq. MHz	ERP/EIRP dBm	SG Output Level dBm	Antenna Gain dBd/dBi	Cable Loss dB	Limit dBm	Margin dB
83.35	-65.16	-62.45	-1.73	-0.98	-13.00	-52.16
140.58	-63.19	-59.65	-2.27	-1.26	-13.00	-50.19
214.30	-67.43	-69.43	3.55	-1.55	-13.00	-54.43
391.81	-65.34	-67.02	3.74	-2.06	-13.00	-52.34
527.61	-61.37	-62.92	4.01	-2.47	-13.00	-48.37
730.34	-55.56	-56.09	3.55	-3.02	-13.00	-42.56
1688.00	-61.41	-64.10	7.11	-4.42	-13.00	-48.41

Unless otherwise stated the results shown in this test report refer only to the sample(s) tested and such sample(s) are retained for 90 days only.

除非另有說明，此報告結果僅對測試之樣品負責，同時此樣品僅保留90天。本報告未經本公司書面許可，不可部份複製。

This document is issued by the Company subject to its General Conditions of Service printed overleaf, available on request or accessible at www.sgs.com/terms_and_conditions.htm and, for electronic format documents, subject to Terms and Conditions for Electronic Documents at www.sgs.com/terms_e-document.htm. Attention is drawn to the limitation of liability, indemnification and jurisdiction issues defined therein. Any holder of this document is advised that information contained hereon reflects the Company's findings at the time of its intervention only and within the limits of Client's instructions, if any. The Company's sole responsibility is to its Client and this document does not exonerate parties to a transaction from exercising all their rights and obligations under the transaction documents. This document cannot be reproduced except in full, without prior written approval of the Company. Any unauthorized alteration, forgery or falsification of the content or appearance of this document is unlawful and offenders may be prosecuted to the fullest extent of the law.

SGS Taiwan Ltd.

No.134,WuKungRoad,NewTaipeiIndustrialPark,WukuDistrict,NewTaipeiCity,Taiwan24803/新北市五股區新北產業園區五工路 134 號

台灣檢驗科技股份有限公司

t (886-2) 2299-3279

f (886-2) 2298-0488

www.tw.sgs.com

Member of SGS Group

10. FREQUENCY STABILITY MEASUREMENT

10.1. Standard Applicable

The frequency stability shall be sufficient to ensure that the fundamental emission stays within the authorized frequency block.

10.2. Test Set-up

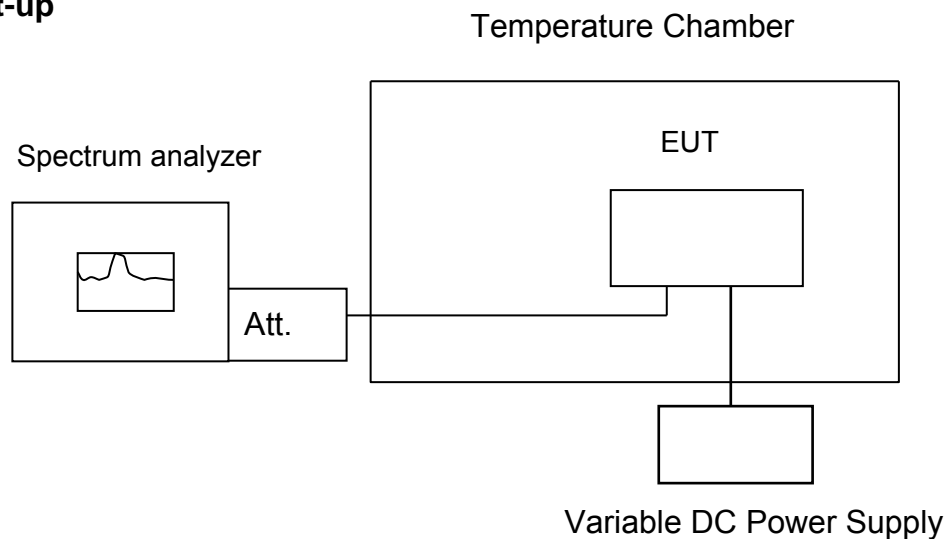

Note: Measurement setup for testing on Antenna connector

10.3. Measurement Procedure

The equipment under test was connected to an external AC or DC power supply and input rated voltage. RF output was connected to a frequency counter or spectrum analyzer via feed through attenuators. The EUT was placed inside the temperature chamber. Set the spectrum analyzer RBW low enough to obtain the desired frequency resolution and measure EUT 25°C operating frequency as reference frequency. Turn EUT off and set the chamber temperature to -30°C. After the temperature stabilized for approximately 30 minutes recorded the frequency. Repeat step measure with 10°C increased per stage until the highest temperature of +50°C reached.

Set chamber temperature to 25 . Use a variable AC power supply / DC power source to power the EUT and set the voltage to rated voltage. Set the spectrum analyzer RBW low enough to obtain the desired frequency resolution and recorded the frequency.

Reduce the input voltage to specify extreme voltage variation (+/- 15%) and endpoint as declared by the manufacturer, record the maximum frequency change.

Unless otherwise stated the results shown in this test report refer only to the sample(s) tested and such sample(s) are retained for 90 days only.

除非另有說明，此報告結果僅對測試之樣品負責，同時此樣品僅保留90天。本報告未經本公司書面許可，不可部份複製。

This document is issued by the Company subject to its General Conditions of Service printed overleaf, available on request or accessible at www.sgs.com/terms_and_conditions.htm and, for electronic format documents, subject to Terms and Conditions for Electronic Documents at www.sgs.com/terms_e-document.htm. Attention is drawn to the limitation of liability, indemnification and jurisdiction issues defined therein. Any holder of this document is advised that information contained hereon reflects the Company's findings at the time of its intervention only and within the limits of Client's instructions, if any. The Company's sole responsibility is to its Client and this document does not exonerate parties to a transaction from exercising all their rights and obligations under the transaction documents. This document cannot be reproduced except in full, without prior written approval of the Company. Any unauthorized alteration, forgery or falsification of the content or appearance of this document is unlawful and offenders may be prosecuted to the fullest extent of the law.

10.4. Measurement Equipment Used

EQUIPMENT TYPE	MFR	MODEL NUMBER	SERIAL NUMBER	LAST CAL.	CAL DUE.
EXA Spectrum Analyzer	Agilent	N9010A	MY57120290	2018/02/14	2019/02/13
Radio Communication Analyer	Anritsu	MT8815B	6200711454	2018/04/05	2019/04/04
Radio Communication Analyer	Anritsu	MT8820C	6200995019	2018/04/05	2019/04/04
DC Power Supply	Anritsu	E3640A	MY52410006	2017/11/28	2018/11/27
Temperature Chamber	TERCHY	MHG-120LF	911009	2018/05/18	2019/05/17
Attenuator	Mini-Circuit	BW-S10W2+	2	2018/01/02	2019/01/01
Splitter	RF-LAMBAD	RFLT2W1G18G	11-JSPF412-018	2018/01/02	2019/01/01
Coaxial Cables	N/A	WK CE Cable	N/A	2018/01/02	2019/01/01

Unless otherwise stated the results shown in this test report refer only to the sample(s) tested and such sample(s) are retained for 90 days only.

除非另有說明，此報告結果僅對測試之樣品負責，同時此樣品僅保留90天。本報告未經本公司書面許可，不可部份複製。

This document is issued by the Company subject to its General Conditions of Service printed overleaf, available on request or accessible at www.sgs.com/terms_and_conditions.htm and, for electronic format documents, subject to Terms and Conditions for Electronic Documents at www.sgs.com/terms_e-document.htm. Attention is drawn to the limitation of liability, indemnification and jurisdiction issues defined therein. Any holder of this document is advised that information contained hereon reflects the Company's findings at the time of its intervention only and within the limits of Client's instructions, if any. The Company's sole responsibility is to its Client and this document does not exonerate parties to a transaction from exercising all their rights and obligations under the transaction documents. This document cannot be reproduced except in full, without prior written approval of the Company. Any unauthorized alteration, forgery or falsification of the content or appearance of this document is unlawful and offenders may be prosecuted to the fullest extent of the law.

SGS Taiwan Ltd.

No.134,WuKungRoad,NewTaipeiIndustrialPark,WukuDistrict,NewTaipeiCity,Taiwan24803/新北市五股區新北產業園區五工路 134 號

台灣檢驗科技股份有限公司

t (886-2) 2299-3279

f (886-2) 2298-0488

www.tw.sgs.com

Member of SGS Group

10.5. Measurement Result

GPRS 850 Mid Channel		836.6	MHz	
Limit: +/- 2.5 ppm				
Vdc	Temp. ()	Freq. (MHz)	Delta (Hz)	Limit (Hz)
FREQUENCY ERROR vs. VOLTAGE				
4.2	20	836.600002	1.999999995	2091
3.8	20	836.599993	-6.999999982	2091
3.4	20	836.599996	-3.99999999	2091
3.34 (End point)	20	836.600008	7.99999998	2091
FREQUENCY ERROR vs. Temp.				
3.8	50	836.599995	-4.999999987	2091
3.8	40	836.600006	5.999999985	2091
3.8	30	836.600005	4.999999987	2091
3.8	20	836.599997	-2.999999992	2091
3.8	10	836.600002	1.999999995	2091
3.8	0	836.599998	-1.999999995	2091
3.8	-10	836.600001	0.999999997	2091
3.8	-20	836.599992	-7.99999998	2091
3.8	-30	836.600006	5.999999985	2091

GPRS 1900 Mid Channel		1880	MHz	
Limit: +/- 2.5 ppm				
Vdc	Temp. ()	Freq. (MHz)	Delta (Hz)	Limit (Hz)
FREQUENCY ERROR vs. VOLTAGE				
4.2	20	1880.000001	1.000000111	4700
3.8	20	1879.999991	-9.000000091	4700
3.4	20	1880.000002	1.999999995	4700
3.34 (End point)	20	1880.000005	5.000000101	4700
FREQUENCY ERROR vs. Temp.				
3.8	50	1879.999992	-7.99999998	4700
3.8	40	1880.000007	7.000000096	4700
3.8	30	1880.000005	5.000000101	4700
3.8	20	1880.000004	3.99999999	4700
3.8	10	1879.999997	-3.000000106	4700
3.8	0	1879.999998	-1.999999995	4700
3.8	-10	1880.000005	5.000000101	4700
3.8	-20	1879.999996	-3.99999999	4700
3.8	-30	1880.000002	1.999999995	4700

Unless otherwise stated the results shown in this test report refer only to the sample(s) tested and such sample(s) are retained for 90 days only.

除非另有說明，此報告結果僅對測試之樣品負責，同時此樣品僅保留90天。本報告未經本公司書面許可，不可部份複製。

This document is issued by the Company subject to its General Conditions of Service printed overleaf, available on request or accessible at www.sgs.com/terms_and_conditions.htm and, for electronic format documents, subject to Terms and Conditions for Electronic Documents at www.sgs.com/terms_e-document.htm. Attention is drawn to the limitation of liability, indemnification and jurisdiction issues defined therein. Any holder of this document is advised that information contained hereon reflects the Company's findings at the time of its intervention only and within the limits of Client's instructions, if any. The Company's sole responsibility is to its Client and this document does not exonerate parties to a transaction from exercising all their rights and obligations under the transaction documents. This document cannot be reproduced except in full, without prior written approval of the Company. Any unauthorized alteration, forgery or falsification of the content or appearance of this document is unlawful and offenders may be prosecuted to the fullest extent of the law.

WCDMA V Mid Channel 836.6 MHz				
Limit: +/- 2.5 ppm				
Vdc	Temp. ()	Freq. (MHz)	Delta (Hz)	Limit (Hz)
FREQUENCY ERROR vs. VOLTAGE				
4.2	20	836.600001	0.999999997	2091
3.8	20	836.599991	-8.999999977	2091
3.4	20	836.600002	1.999999995	2091
3.34 (End point)	20	836.599991	-8.999999977	2091
FREQUENCY ERROR vs. Temp.				
3.8	50	836.599992	-7.999999998	2091
3.8	40	836.600007	6.999999982	2091
3.8	30	836.600005	4.999999987	2091
3.8	20	836.600004	3.999999999	2091
3.8	10	836.599997	-2.999999992	2091
3.8	0	836.599998	-1.999999995	2091
3.8	-10	836.600005	4.999999987	2091
3.8	-20	836.599996	-3.999999999	2091
3.8	-30	836.600002	1.999999995	2091

Reference Freq.: LTE B5 Mid Channel 836.5 MHz 10M QPSK CH 20525				
Power Supply Vdc	Temp. ()	Freq. (MHz)	Delta (Hz)	Limit = +/- 2.5 ppm (Hz)
Freq. ERROR vs. VOLTAGE				
4.2	25	836.500002	2	2091
3.8	25	836.499993	-7	2091
3.4	25	836.499996	-4	2091
3.34 (End Point)	25	836.500001	1	2091
Freq. ERROR vs. Temp.				
3.8	-30	836.499995	-5	2091
3.8	-20	836.500006	6	2091
3.8	-10	836.500005	5	2091
3.8	0	836.499997	-3	2091
3.8	10	836.500002	2	2091
3.8	20	836.499998	-2	2091
3.8	30	836.500001	1	2091
3.8	40	836.499992	-8	2091
3.8	50	836.500006	6	2091

Note: The battery is rated 3.8V dc.

Unless otherwise stated the results shown in this test report refer only to the sample(s) tested and such sample(s) are retained for 90 days only.

除非另有說明，此報告結果僅對測試之樣品負責，同時此樣品僅保留90天。本報告未經本公司書面許可，不可部份複製。

This document is issued by the Company subject to its General Conditions of Service printed overleaf, available on request or accessible at www.sgs.com/terms_and_conditions.htm and, for electronic format documents, subject to Terms and Conditions for Electronic Documents at www.sgs.com/terms_e-document.htm. Attention is drawn to the limitation of liability, indemnification and jurisdiction issues defined therein. Any holder of this document is advised that information contained hereon reflects the Company's findings at the time of its intervention only and within the limits of Client's instructions, if any. The Company's sole responsibility is to its Client and this document does not exonerate parties to a transaction from exercising all their rights and obligations under the transaction documents. This document cannot be reproduced except in full, without prior written approval of the Company. Any unauthorized alteration, forgery or falsification of the content or appearance of this document is unlawful and offenders may be prosecuted to the fullest extent of the law.

11. PEAK TO AVERAGE RATIO

11.1. Standard Applicable

The peak-to-average ratio (PAR) of the transmission may not exceed 13dB.

11.2. Test SET-UP

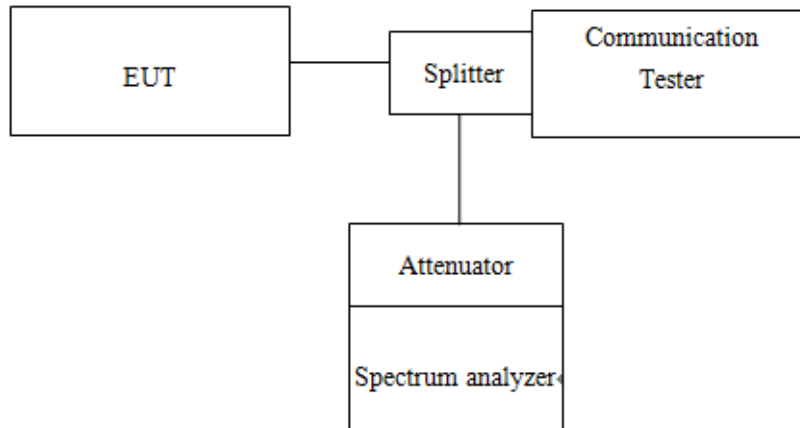

11.3. Measurement Procedure

1. KDB 971168 D01 is employed as the following procedure is proper adjusted accordingly:
2. Set resolution/measurement bandwidth \geq signal's occupied bandwidth; & internal =1ms
3. Set the number of counts to a value that stabilizes the measured CCDF curve.

11.4. Measurement Equipment Used

EQUIPMENT TYPE	MFR	MODEL NUMBER	SERIAL NUMBER	LAST CAL.	CAL DUE.
EXA Spectrum Analyzer	Agilent	N9010A	MY57120290	2018/02/14	2019/02/13
Radio Communication Analyer	Anritsu	MT8815B	6200711454	2018/04/05	2019/04/04
Radio Communication Analyer	Anritsu	MT8820C	6200995019	2018/04/05	2019/04/04
DC Power Supply	Anritsu	E3640A	MY52410006	2017/11/28	2018/11/27
Temperature Chamber	TERCHY	MHG-120LF	911009	2018/05/18	2019/05/17
Attenuator	Mini-Circuit	BW-S10W2+	2	2018/01/02	2019/01/01
Splitter	RF-LAMBAD	RFLT2W1G18G	11-JSPF412-018	2018/01/02	2019/01/01
Coaxial Cables	N/A	WK CE Cable	N/A	2018/01/02	2019/01/01

Unless otherwise stated the results shown in this test report refer only to the sample(s) tested and such sample(s) are retained for 90 days only.

除非另有說明，此報告結果僅對測試之樣品負責，同時此樣品僅保留90天。本報告未經本公司書面許可，不可部份複製。

This document is issued by the Company subject to its General Conditions of Service printed overleaf, available on request or accessible at www.sgs.com/terms_and_conditions.htm and, for electronic format documents, subject to Terms and Conditions for Electronic Documents at www.sgs.com/terms_e-document.htm. Attention is drawn to the limitation of liability, indemnification and jurisdiction issues defined therein. Any holder of this document is advised that information contained hereon reflects the Company's findings at the time of its intervention only and within the limits of Client's instructions, if any. The Company's sole responsibility is to its Client and this document does not exonerate parties to a transaction from exercising all their rights and obligations under the transaction documents. This document cannot be reproduced except in full, without prior written approval of the Company. Any unauthorized alteration, forgery or falsification of the content or appearance of this document is unlawful and offenders may be prosecuted to the fullest extent of the law.

11.5. Measurement Result

Tabular Results:

Freq. (MHz)	CH	Peak-to-Average Ratio (dB)	
		GSM 1900	GPRS 1900
1850.2	512	10.00	9.65
1880	661	9.87	10.38
1909.8	810	8.88	10.15

LTE BAND 5							
Channel bandwidth: 1.4MHz				Channel bandwidth: 3MHz			
Freq. (MHz)	CH	PAPR (dB)		Freq. (MHz)	CH	PAPR (dB)	
		16QAM	Limit			16QAM	Limit
824.7	20407	5.29	13	825.5	20415	5.70	13
836.5	20525	5.78	13	836.5	20525	5.96	13
848.3	20643	5.57	13	847.5	20635	5.84	13

LTE BAND 5							
Channel bandwidth: 5MHz				Channel bandwidth: 10MHz			
Freq. (MHz)	CH	PAPR (dB)		Freq. (MHz)	CH	PAPR (dB)	
		16QAM	Limit			16QAM	Limit
826.5	20425	5.79	13	829.0	20450	5.84	13
836.5	20525	5.87	13	836.5	20525	5.87	13
846.5	20625	5.83	13	844.0	20600	5.87	13

Measurement Results:

Please refer to next page

Unless otherwise stated the results shown in this test report refer only to the sample(s) tested and such sample(s) are retained for 90 days only.

除非另有說明，此報告結果僅對測試之樣品負責，同時此樣品僅保留90天。本報告未經本公司書面許可，不可部份複製。

This document is issued by the Company subject to its General Conditions of Service printed overleaf, available on request or accessible at www.sgs.com/terms_and_conditions.htm and, for electronic format documents, subject to Terms and Conditions for Electronic Documents at www.sgs.com/terms_e-document.htm. Attention is drawn to the limitation of liability, indemnification and jurisdiction issues defined therein. Any holder of this document is advised that information contained hereon reflects the Company's findings at the time of its intervention only and within the limits of Client's instructions, if any. The Company's sole responsibility is to its Client and this document does not exonerate parties to a transaction from exercising all their rights and obligations under the transaction documents. This document cannot be reproduced except in full, without prior written approval of the Company. Any unauthorized alteration, forgery or falsification of the content or appearance of this document is unlawful and offenders may be prosecuted to the fullest extent of the law.

GSM_1900MHz_LowCH512-1850.2

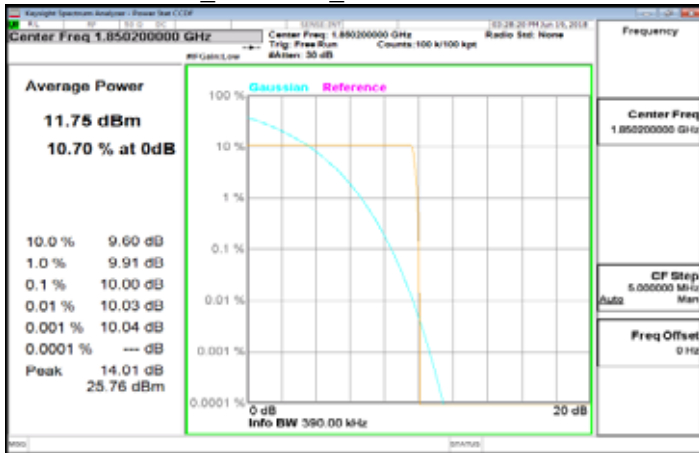

GRS_1900MHz_LowCH512-1850.2

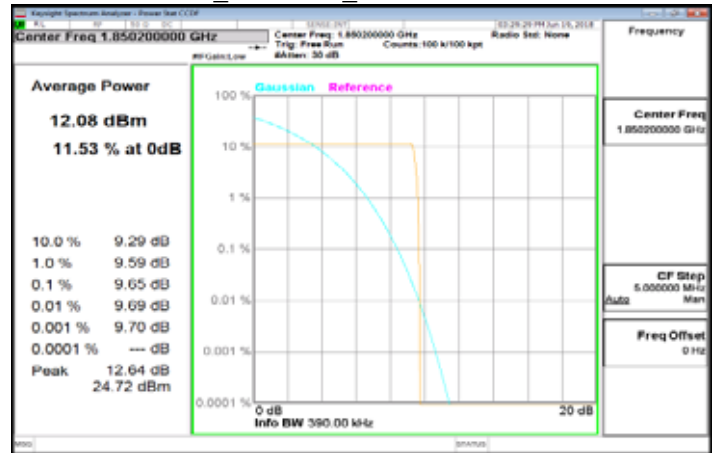

GSM_1900MHz_MidCH661-1880

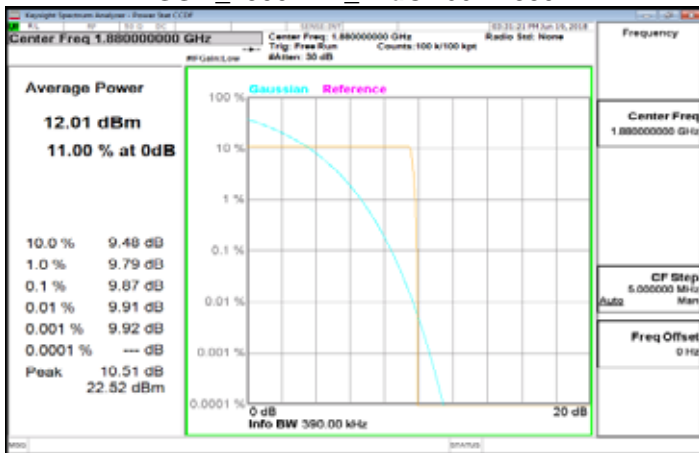

GRS_1900MHz_MidCH661-1880

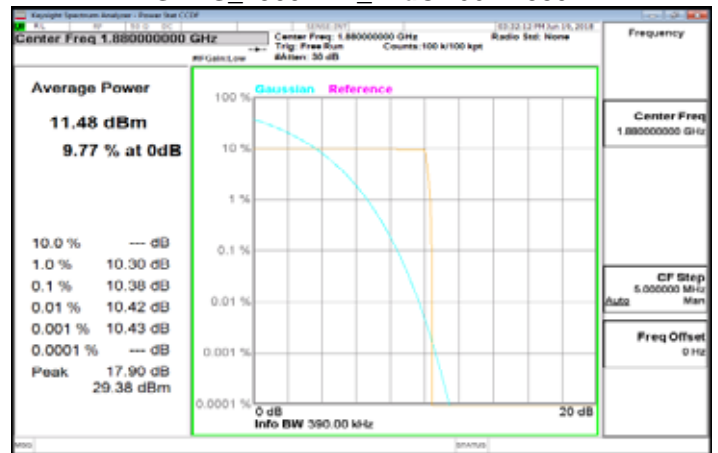

GSM_1900MHz_HighCH810-1909.8

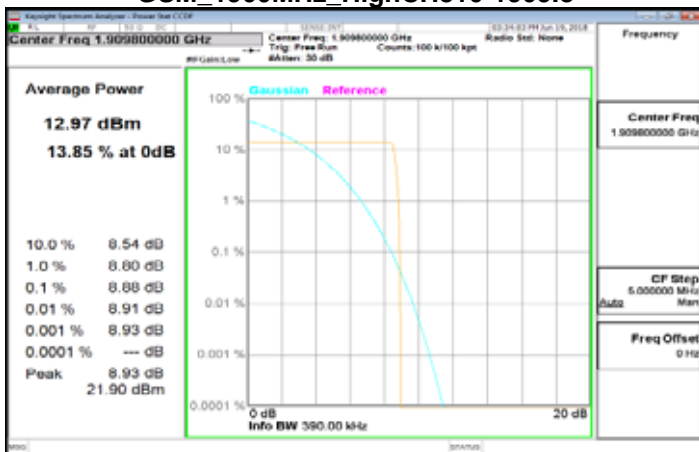

GRS_1900MHz_HighCH810-1909.8

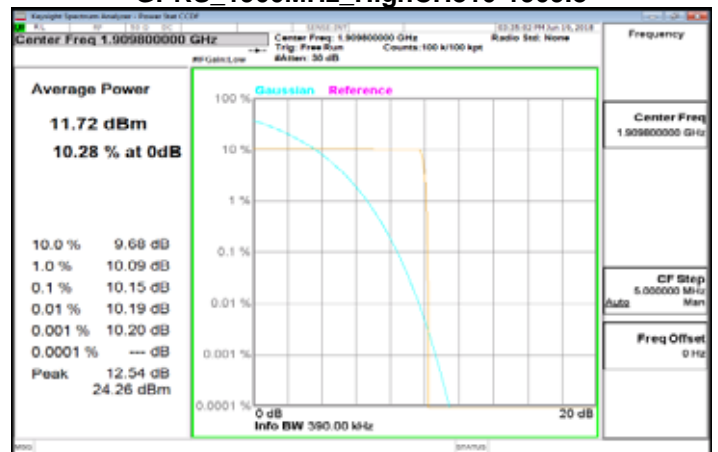

Unless otherwise stated the results shown in this test report refer only to the sample(s) tested and such sample(s) are retained for 90 days only.

除非另有說明，此報告結果僅對測試之樣品負責，同時此樣品僅保留90天。本報告未經本公司書面許可，不可部份複製。

This document is issued by the Company subject to its General Conditions of Service printed overleaf, available on request or accessible at www.sgs.com/terms_and_conditions.htm and, for electronic format documents, subject to Terms and Conditions for Electronic Documents at www.sgs.com/terms_e-document.htm. Attention is drawn to the limitation of liability, indemnification and jurisdiction issues defined therein. Any holder of this document is advised that information contained hereon reflects the Company's findings at the time of its intervention only and within the limits of Client's instructions, if any. The Company's sole responsibility is to its Client and this document does not exonerate parties to a transaction from exercising all their rights and obligations under the transaction documents. This document cannot be reproduced except in full, without prior written approval of the Company. Any unauthorized alteration, forgery or falsification of the content or appearance of this document is unlawful and offenders may be prosecuted to the fullest extent of the law.

SGS Taiwan Ltd.

No. 134, WuKungRoad, NewTaipeiIndustrialPark, WuKuDistrict, NewTaipeiCity, Taiwan24803/新北市五股區新北產業園區五工路 134 號

台灣檢驗科技股份有限公司

t (886-2) 2299-3279

f (886-2) 2298-0488

www.tw.sgs.com

Member of SGS Group

LTE_Band5_1_4MHz_64QAM_6_0_LowCH20407-824.7

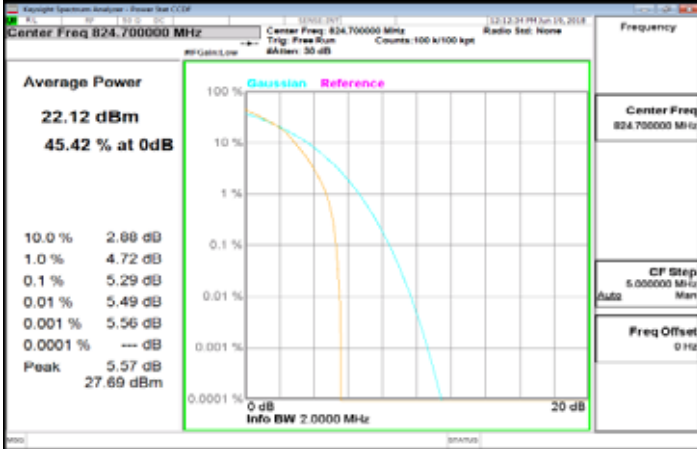

LTE_Band5_3MHz_64QAM_15_0_LowCH20415-825.5

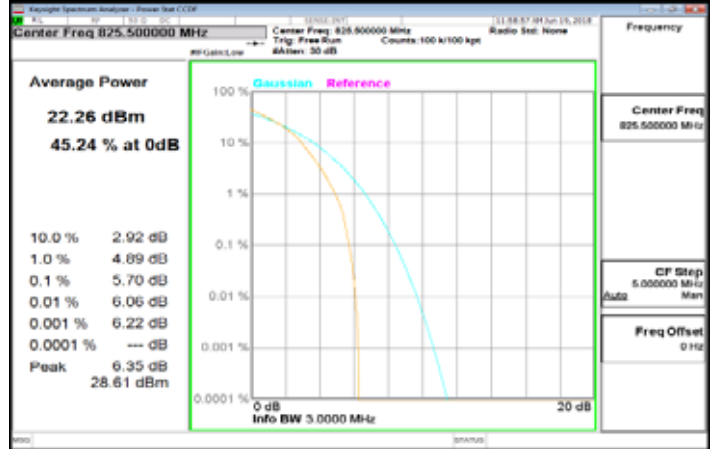

LTE_Band5_1_4MHz_64QAM_6_0_MidCH20525-836.5

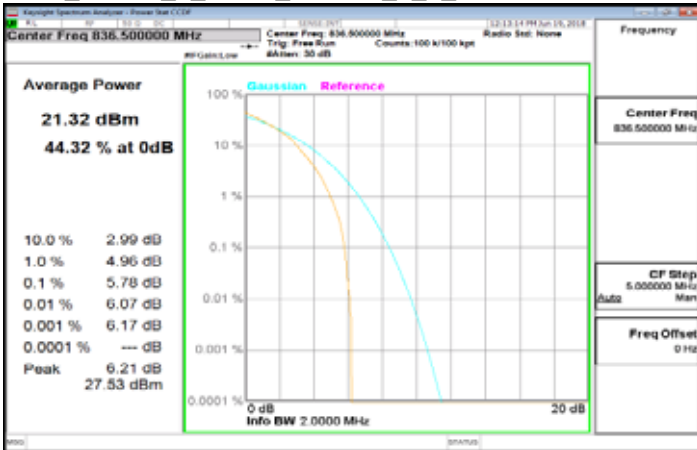

LTE_Band5_3MHz_64QAM_15_0_MidCH20525-836.5

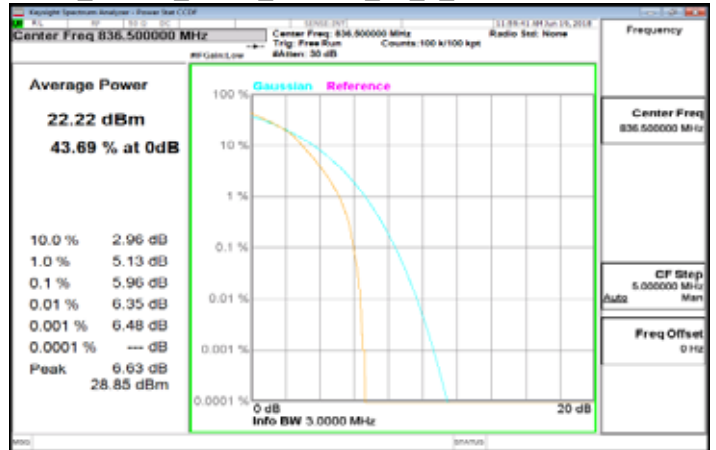

LTE_Band5_1_4MHz_64QAM_6_0_HighCH20643-848.3

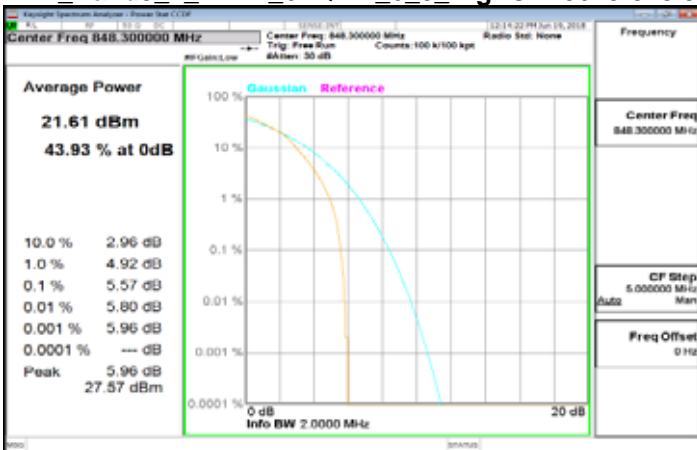

LTE_Band5_3MHz_64QAM_15_0_HighCH20635-847.5

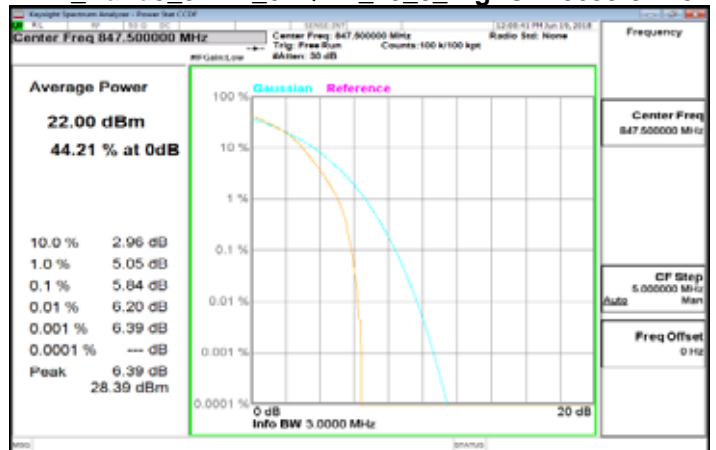

Unless otherwise stated the results shown in this test report refer only to the sample(s) tested and such sample(s) are retained for 90 days only.

除非另有說明，此報告結果僅對測試之樣品負責，同時此樣品僅保留90天。本報告未經本公司書面許可，不可部份複製。

This document is issued by the Company subject to its General Conditions of Service printed overleaf, available on request or accessible at www.sgs.com/terms_and_conditions.htm and, for electronic format documents, subject to Terms and Conditions for Electronic Documents at www.sgs.com/terms_e-document.htm. Attention is drawn to the limitation of liability, indemnification and jurisdiction issues defined therein. Any holder of this document is advised that information contained hereon reflects the Company's findings at the time of its intervention only and within the limits of Client's instructions, if any. The Company's sole responsibility is to its Client and this document does not exonerate parties to a transaction from exercising all their rights and obligations under the transaction documents. This document cannot be reproduced except in full, without prior written approval of the Company. Any unauthorized alteration, forgery or falsification of the content or appearance of this document is unlawful and offenders may be prosecuted to the fullest extent of the law.

SGS Taiwan Ltd.

No. 134, WuKungRoad, NewTaipeiIndustrialPark, WukuDistrict, NewTaipeiCity, Taiwan24803/新北市五股區新北產業園區五工路 134 號

台灣檢驗科技股份有限公司

t (886-2) 2299-3279

f (886-2) 2298-0488

www.tw.sgs.com

Member of SGS Group

LTE_Band5_5MHz_64QAM_25_0_LowCH20425-826.5

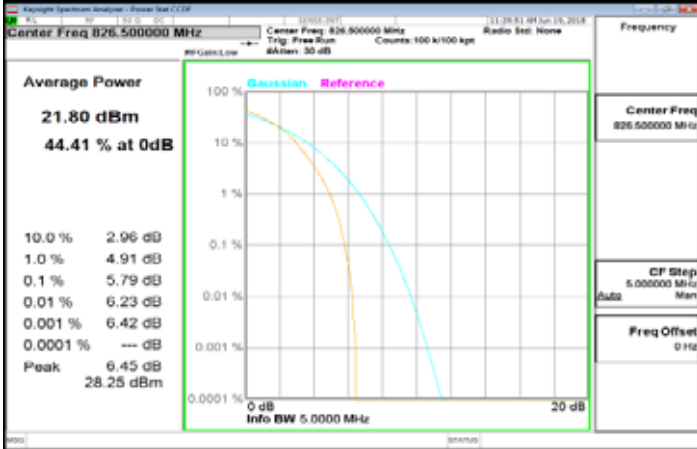

LTE_Band5_10MHz_64QAM_50_0_LowCH20450-829

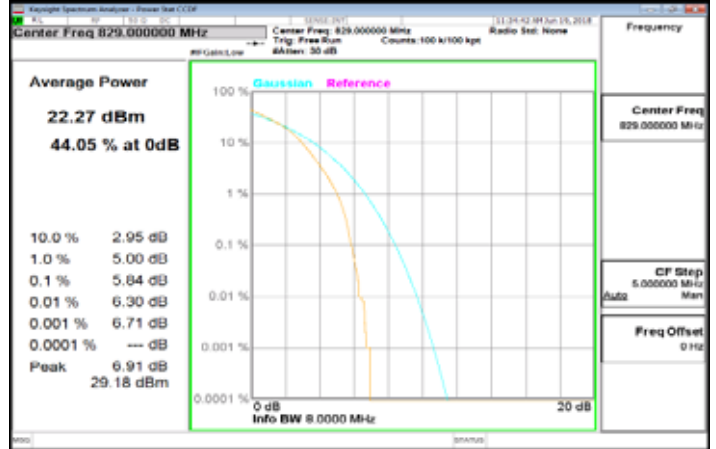

LTE_Band5_5MHz_64QAM_25_0_MidCH20525-836.5

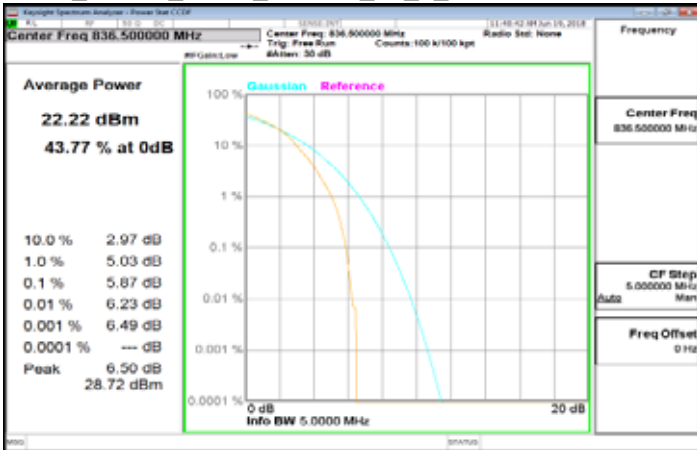

LTE_Band5_10MHz_64QAM_50_0_MidCH20525-836.5

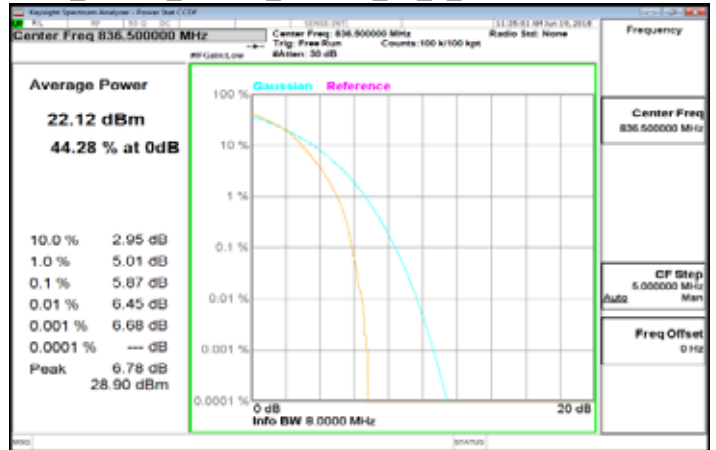

LTE_Band5_5MHz_64QAM_25_0_HighCH20625-846.5

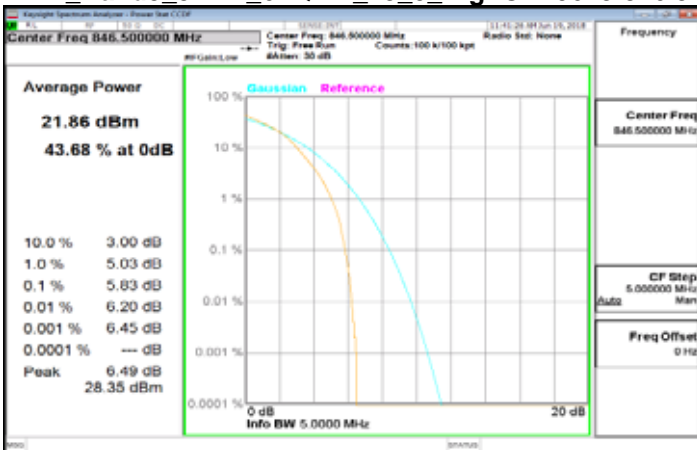

LTE_Band5_10MHz_64QAM_50_0_HighCH20600-844

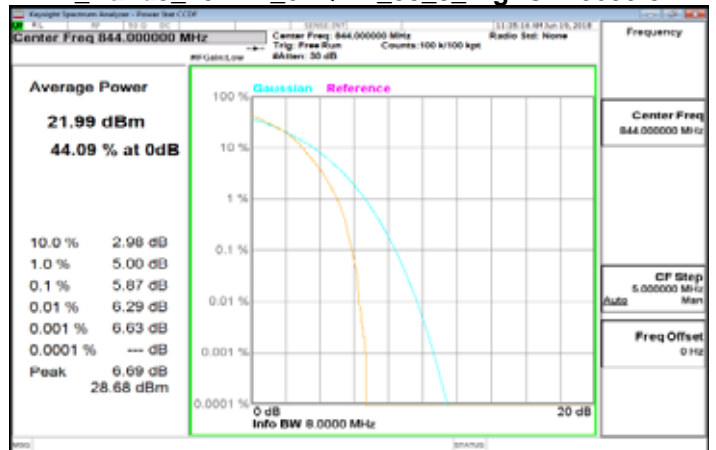

Unless otherwise stated the results shown in this test report refer only to the sample(s) tested and such sample(s) are retained for 90 days only.

除非另有說明，此報告結果僅對測試之樣品負責，同時此樣品僅保留90天。本報告未經本公司書面許可，不可部份複製。

This document is issued by the Company subject to its General Conditions of Service printed overleaf, available on request or accessible at www.sgs.com/terms_and_conditions.htm and, for electronic format documents, subject to Terms and Conditions for Electronic Documents at www.sgs.com/terms_e-document.htm. Attention is drawn to the limitation of liability, indemnification and jurisdiction issues defined therein. Any holder of this document is advised that information contained hereon reflects the Company's findings at the time of its intervention only and within the limits of Client's instructions, if any. The Company's sole responsibility is to its Client and this document does not exonerate parties to a transaction from exercising all their rights and obligations under the transaction documents. This document cannot be reproduced except in full, without prior written approval of the Company. Any unauthorized alteration, forgery or falsification of the content or appearance of this document is unlawful and offenders may be prosecuted to the fullest extent of the law.

SGS Taiwan Ltd.

No. 134, WuKungRoad, NewTaipeiIndustrialPark, WukuDistrict, NewTaipeiCity, Taiwan24803/新北市五股區新北產業園區五工路 134 號

台灣檢驗科技股份有限公司

t (886-2) 2299-3279

f (886-2) 2298-0488

www.tw.sgs.com

Member of SGS Group