



APPLICATION OF CERTIFICATION  
For

Altai Technologies Limited

Altai A2-Ei Dual-band WiFi Access Point

Model Number: WA2011N-E

FCC ID: UCC-WA2011N-E

Prepared for : Altai Technologies Limited  
Units 209, 2/F, Lakeside 2, 10 Science Park West Avenue,  
Hong Kong Science Park, Shatin, Hong Kong, China

Prepared By: Audix Technology (Shenzhen) Co., Ltd.  
No. 6, Ke Feng Rd., 52 Block,  
Shenzhen Science & Industrial Park,  
Nantou, Shenzhen, Guangdong, China

Tel: (0755) 26639496

Fax: (0755) 26632877

Report Number : ACS- F14250  
Date of Test : Jul.01~25, 2014  
Date of Report : Aug.22, 2014

**TABLE OF CONTENTS**

<b>Description</b>	<b>Page</b>
<b>Test Report Certification</b>	
<b>1. SUMMARY OF STANDARDS AND RESULTS .....</b>	<b>1-1</b>
1.1. Description of Standards and Results .....	1-1
<b>2. GENERAL INFORMATION.....</b>	<b>2-1</b>
2.1. Equipment under test (EUT).....	2-1
2.2. Tested Supporting System Details .....	2-2
2.3. Block Diagram of Test Setup.....	2-2
2.4. Test Facility .....	2-3
2.5. Measurement Uncertainty (95% confidence levels, k=2).....	2-3
<b>3. POWER LINE CONDUCTED EMISSION MEASUREMENT .....</b>	<b>3-1</b>
3.1. Test Equipment.....	3-1
3.2. Block Diagram of Test Setup.....	3-1
3.3. Power Line Conducted Emission Test Limits .....	3-1
3.4. Configuration of EUT on Test.....	3-1
3.5. Operating Condition of EUT .....	3-2
3.6. Test Procedure .....	3-2
3.7. Conducted Emission at Mains Terminals Test Results.....	3-2
<b>4. RADIATED EMISSION TEST .....</b>	<b>4-1</b>
4.1. Test Equipment.....	4-1
4.2. Block Diagram of Test Setup.....	4-2
4.3. Radiated Emission Limit .....	4-3
4.4. EUT Configuration on Test .....	4-3
4.5. Operating Condition of EUT .....	4-3
4.6. Test Procedure .....	4-4
4.7. Radiated Disturbance Test Results .....	4-4
<b>5. DEVIATION TO TEST SPECIFICATIONS .....</b>	<b>5-1</b>
<b>6. PHOTOGRAPH .....</b>	<b>6-1</b>
6.1. Photos of Power Line Conducted Emission Test.....	6-1
6.2. Photos of Radiated Emission Test .....	6-2
<b>7. PHOTOS OF THE EUT .....</b>	<b>7-1</b>

## TEST REPORT CERTIFICATION

Applicant : Altai Technologies Limited  
Manufacturer : Altai Technologies Limited  
EUT Description : Altai A2-Ei Dual-band WiFi Access Point  
FCC ID : UCC-WA2011N-E  
(A) Model No. : WA2011N-E  
(B) Power Supply : AC 100V-240V, 50/60Hz  
(C) Test Voltage : DC 56V From POE Input AC 120V/60Hz

## Measurement Standard Used:

FCC Rules and Regulations Part 15 Subpart B Class B 2013

The device described above is tested by AUDIX TECHNOLOGY (SHENZHEN) CO., LTD. to determine the maximum emission levels emanating from the device. The maximum emission levels are compared to the FCC Part 15 Subpart B Class B limits both conducted and radiated emissions. The test results are contained in this test report and AUDIX TECHNOLOGY (SHENZHEN) CO., LTD. is assumed of full responsibility for the accuracy and completeness of these tests. This report contains data that are not covered by the NVLAP accreditation.

After the test, our opinion is that EUT compliance with the requirement of the above standards.

This Report is made under FCC Part 2.1075. No modifications were required during testing to bring this product into compliance.

This report applies to above tested sample only. This report shall not be reproduced in parts without written approval of AUDIX TECHNOLOGY (SHENZHEN) CO., LTD.

The report must not be used by the client to claim product certification, approval, or endorsement by NVLAP, NIST, or any agency of the federal government.

Date of Test : Jul.01~25, 2014 Report of date: Aug.22, 2014

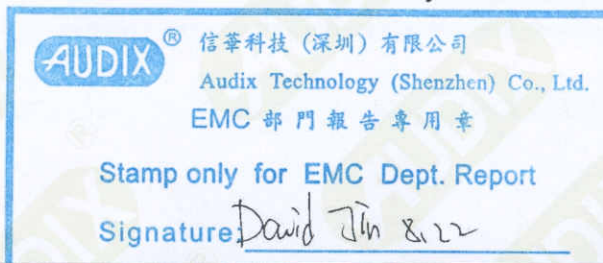
Prepared by : Cindy Zhu / Assistant Reviewed by : Sunny Lu / Assistant ManagerApproved & Authorized Signer : David Jin / Manager

## 1. SUMMARY OF STANDARDS AND RESULTS

### 1.1. Description of Standards and Results

The EUT have been tested according to the applicable standards as referenced below.

EMISSION			
Description of Test Item	Standard	Results	Remarks
Power Line Conducted Emission Test	FCC Part 15: 2013 ANSI C63.4: 2009	PASS	Meets Class B Limit Minimum passing margin is 9.05dB at 0.35800MHz
Radiated Emission Test (30-1000MHz)	FCC Part 15: 2013 ANSI C63.4: 2009	PASS	Meets Class B Limit Minimum passing margin is 3.40dB at 30.000MHz
Radiated Emission Test (1-6GHz)	FCC Part 15: 2013 ANSI C63.4: 2009	PASS	Meets Class B Limit Minimum passing margin is 15.67dB at 11166.000MHz

## 2. GENERAL INFORMATION

### 2.1. Equipment under test (EUT)

Product Name	: Altai A2-Ei Dual-band WiFi Access Point
Model Number	: WA2011N-E
FCC ID	: UCC-WA2011N-E
Radio	: IEEE802.11 a/b/g/n
Operation Frequency	: IEEE 802.11a: 5745MHz—5825MHz IEEE 802.11b: 2412MHz—2462MHz IEEE 802.11g: 2412MHz—2462MHz IEEE 802.11nHT20: 2412MHz—2462MHz, 5745MHz—5825MHz IEEE 802.11nHT40: 2422MHz—2452MHz, 5755MHz—5795MHz
Modulation Technology	: IEEE 802.11b: DSSS(CCK,DQPSK,DBPSK) IEEE 802.11a/g: OFDM(64QAM, 16QAM, QPSK, BPSK) IEEE 802.11n HT20, HT40: OFDM (64QAM, 16QAM, QPSK,BPSK)
Antenna Assembly Gain	: 2.4GHz: Built-in Antenna, 14dBi 5GHz : External Antenna, 15dBi;
Applicant	: Altai Technologies Limited Units 209, 2/F, Lakeside 2, 10 Science Park West Avenue, Hong Kong Science Park, Shatin, Hong Kong, China
Manufacturer	: Altai Technologies Limited Units 209, 2/F, Lakeside 2, 10 Science Park West Avenue, Hong Kong Science Park, Shatin, Hong Kong, China
Date of Test	: Jul.01~25, 2014
Date of Receipt	: Jun.30, 2014
Sample Type	: Prototype production

### 2.2. Tested Supporting System Details

No.	Description	ACS No.	Manufacturer	Model	Serial Number	Approved type
1	Personal Computer	Test PC M	DELL	Studio 540	224XK2X	<input checked="" type="checkbox"/> FCC DoC <input checked="" type="checkbox"/> BSMI ID:R33002
		Power Cord: Unshielded, Detachable, 1.8m Display Card: HD3450 (DVI+VGA+HDMI)				
2	Monitor	ACS-EMC-LM04R	DELL	1907FPt	CN-009759-7161 8-6AP-ACPP	<input checked="" type="checkbox"/> FCC DoC <input checked="" type="checkbox"/> BSMI ID: R3A002
		Power Cord: Unshielded, Detachable, 1.8m VGA Cable: Shielded, Detachable, 2.0m (with two cores) DVI Cable: Shielded, Detachable, 2.0m (with two cores)				
3	USB Mouse	ACS-EMC-M04R	DELL	M0C5UO	512024282	<input checked="" type="checkbox"/> FCC DoC <input checked="" type="checkbox"/> BSMI ID: R41108
		Power Cord: shielded, Undetachable, 1.8m				
4	USB Keyboard	ACS-EMC- K04R	DELL	SK-8115	CN-ODJ313-716 16-6BB-049J	<input checked="" type="checkbox"/> FCC DoC <input checked="" type="checkbox"/> BSMI ID: T3A002
		Power Cord: shielded, Undetachable, 2.0m				

### 2.3. Block Diagram of Test Setup

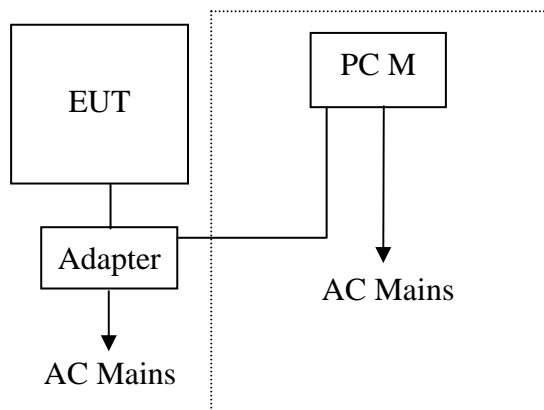

( EUT: Altai A2-Ei Dual-band WiFi Access Point)

### 2.4. Test Facility

Site Description

Name of Firm	:	Audix Technology (Shenzhen) Co., Ltd. No. 6, Ke Feng Rd., 52 Block, Shenzhen Science & Industrial Park, Nantou, Shenzhen, Guangdong, China
3m Anechoic Chamber	:	Certificated by FCC, USA Registration Number: 90454 Valid Date: Feb.22, 2015
3m & 10m Anechoic Chamber	:	Certificated by FCC, USA Registration Number: 794232 Valid Date: Oct.31, 2015
EMC Lab.	:	Certificated by Industry Canada Registration Number: IC 5183A-1 Valid Date: May.14, 2017
	:	Certificated by DAkkS, Germany Registration No: D-PL-12151-01-00 Valid Date: Dec.15, 2016
	:	Accredited by NVLAP, USA NVLAP Code: 200372-0 Valid Date: Mar.31, 2015

### 2.5. Measurement Uncertainty (95% confidence levels, k=2)

Test Item	Uncertainty
Uncertainty for Conduction emission test in No. 1 Conduction	3.10dB (150kHz~30MHz)
Uncertainty for Radiation Emission test in 3m chamber (Distance: 3m)	3.22 dB (30~200MHz, Polarize: H)
	3.23 dB (30~200MHz, Polarize: V)
	3.49 dB (200M~1GHz, Polarize: H)
	3.39 dB (200M~1GHz, Polarize: V)
Uncertainty for Radiation Emission test in 3m chamber (1GHz-18GHz)	4.97 dB (1-6GHz Distance: 3m)
	4.99 dB (6-18GHz Distance: 3m)
Uncertainty for test site temperature and humidity	0.6
	3%

### 3. POWER LINE CONDUCTED EMISSION MEASUREMENT

#### 3.1. Test Equipment

Item	Equipment	Manufacturer	Model No.	Serial No.	Last Cal.	Cal. Interval
1.	1# Shielding Room	AUDIX	N/A	N/A	Apr.17,14	1 Year
2.	Test Receiver	Rohde & Schwarz	ESHS10	838693/001	Oct.31, 13	1 Year
3.	L.I.S.N.#1	Rohde & Schwarz	ESH2-Z5	100429	Jan.22, 14	1 Year
4.	L.I.S.N.#3	Kyoritsu	KNW-242C	8-1920-1	Apr. 28,14	1 Year
5.	Terminator	Hubersuhner	50Ω	No. 1	Apr. 28,14	1 Year
6.	Terminator	Hubersuhner	50Ω	No. 2	Apr. 28,14	1 Year
7.	RF Cable	Hubersuhner	RG58	0100.6954.20#	Jan.22, 14	1 Year
8.	Coaxial Switch	Anritsu	MP59B	6200298346	Apr. 28,14	1 Year
9.	Pulse Limiter	Rohde & Schwarz	ESH3-Z2	101838	Jan.22, 14	1 Year

#### 3.2. Block Diagram of Test Setup

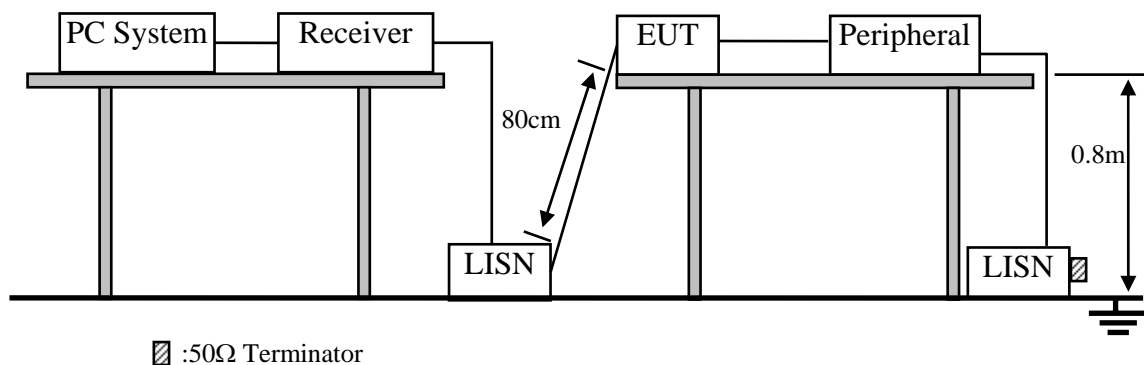

#### 3.3. Power Line Conducted Emission Test Limits

Frequency	Maximum RF Line Voltage	
	Quasi-Peak Level dB(μV)	Average Level dB(μV)
150kHz ~ 500kHz	66 ~ 56*	56 ~ 46*
500kHz ~ 5MHz	56	46
5MHz ~ 30MHz	60	50

- Notes: 1. \* Decreasing linearly with logarithm of frequency.  
 2. The lower limit shall apply at the transition frequencies.

#### 3.4. Configuration of EUT on Test

The following equipment are installed on Power Line Conducted Emission Test to meet the commission requirement and operating regulations in a manner which tends to maximize its emission characteristics in a normal application.

##### 3.4.1. Altai A2-Ei Dual-band WiFi Access Point (EUT)

Model Number : WA2011N-E  
 Serial Number : N/A



3.4.2. Support Equipment : As Tested Supporting System Detail, in Section 2.2.

### 3.5. Operating Condition of EUT

3.5.1. Setup the EUT and simulator as shown as Section 3.2.

3.5.2. Turn on the power of all equipment..

3.5.3. PC run test software to control EUT work in (Running) mode.

### 3.6. Test Procedure

The EUT was placed on a non-metallic table, 80cm above the ground plane. The EUT Power connected to the power mains through a line impedance stabilization network (L.I.S.N. 1#). This provided a 50-ohm coupling impedance for the EUT (Please refer to the block diagram of the test setup and photographs). The other peripheral devices power cord connected to the power mains through a line impedance stabilization network (L.I.S.N.#3). Both sides of power line were checked for maximum conducted interference. In order to find the maximum emission, the relative positions of equipments and all of the interface cables were changed according to ANSI C63.4: 2009 on conducted Emission test.

The bandwidth of test receiver (R&S TEST RECEIVER ESHS10) is set at 9kHz.

The frequency range from 150kHz to 30MHz is checked. The test result are reported on Section 3.7.

### 3.7. Conducted Emission at Mains Terminals Test Results

**PASS.** (All emissions not reported below are too low against the prescribed limits.)

The EUT with the following test modes were tested and selected to read Q.P values and average values, all the test results are listed in next pages.

EUT: Altai A2-Ei Dual-band WiFi Access Point      Model No. : WA2011N-E

Test Date: Jul.25, 2014      Temperature: 26      Humidity: 60%

The details of test mode are as follows :

No.	Test Mode	Reference Test Data No.	
		Line	Neutral
1.	PC LINK	# 22	# 23

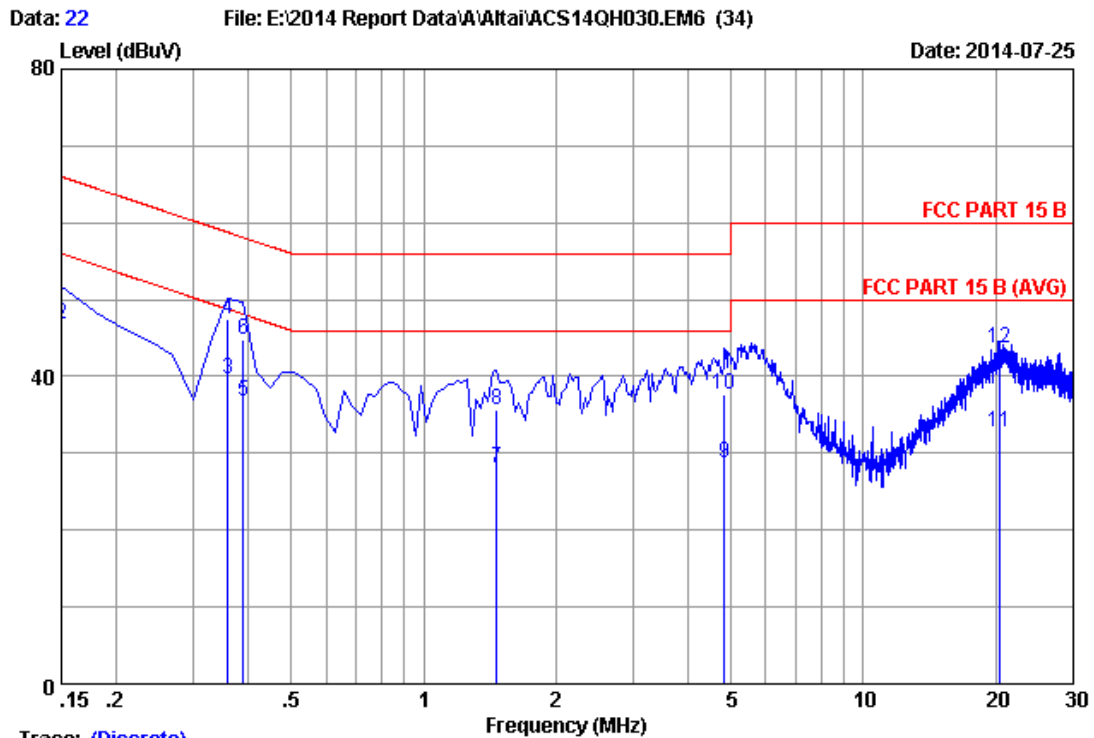

Trace: (Discrete)

Site no :1#conduction Data No :22  
 Dis./Ant. :2014 ESH2-Z5 LINE  
 Limit :FCC PART 15 B  
 Env./Ins. :26°C/60% Engineer :Leo-Li  
 EUT :Altai A2-E1 Dual-band WiFi Access Point  
 Power Rating :DC 56V From POE Input AC 120V/60Hz  
 Test Mode :PC LINK  
 M/N:WA2011N-E

No	Freq (MHz)	LISN Factor (dB)	Cable Loss (dB)	Reading (dBuV)	Emission Level (dBuV)	Limits (dBuV)	Margin (dB)	Remark
1	0.15000	0.12	9.87	27.21	37.20	56.00	18.80	Average
2	0.15000	0.12	9.87	36.70	46.69	66.00	19.31	QP
3	0.35800	0.14	9.88	29.70	39.72	48.77	9.05	Average
4	0.35800	0.14	9.88	37.50	47.52	58.77	11.25	QP
5	0.38880	0.14	9.88	26.69	36.71	48.09	11.38	Average
6	0.38880	0.14	9.88	34.70	44.72	58.09	13.37	QP
7	1.463	0.18	9.90	18.05	28.13	46.00	17.87	Average
8	1.463	0.18	9.90	25.66	35.74	56.00	20.26	QP
9	4.836	0.26	9.95	18.62	28.83	46.00	17.17	Average
10	4.836	0.26	9.95	27.54	37.75	56.00	18.25	QP
11	20.448	0.84	10.08	21.94	32.86	50.00	17.14	Average
12	20.448	0.84	10.08	32.65	43.57	60.00	16.43	QP

Remarks: 1.Emission Level=LISN Factor+Cable Loss(Include 10dB pulse limit)+Reading.  
 2.If the average limit is met when using a quasi-peak detector. the EUT shall be deemed to meet both limits and measurement with average detector is unnecessary.

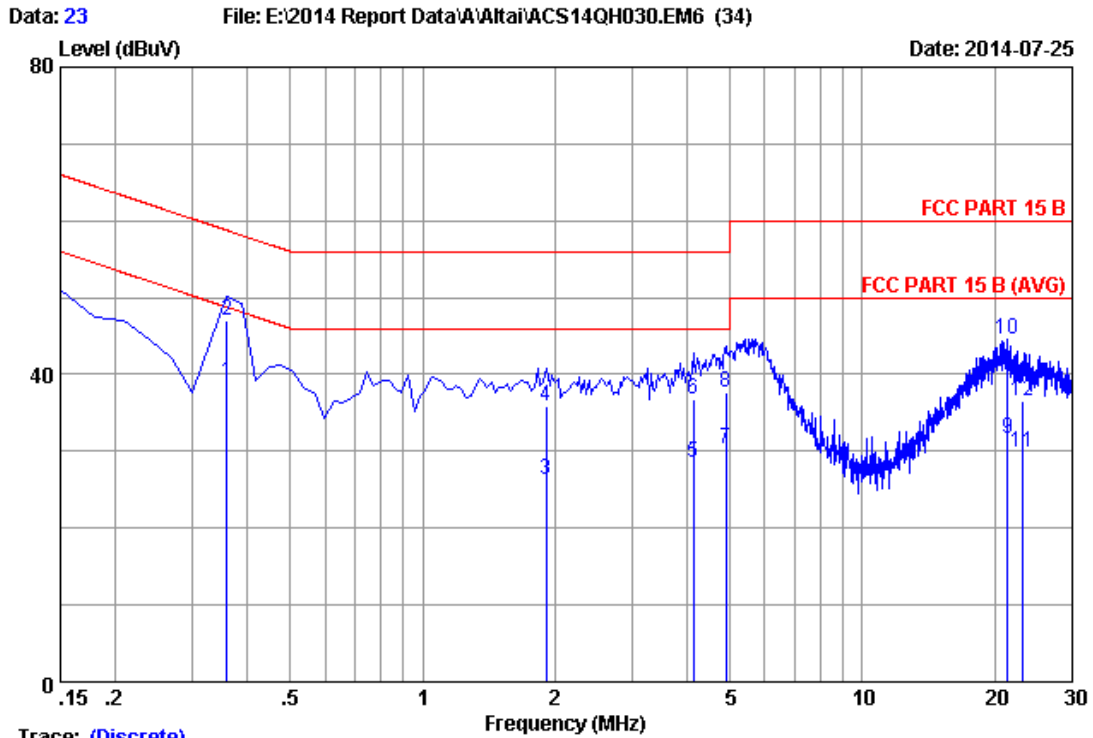

Trace: (Discrete)

Site no :1#conduction Data No :23  
 Dis./Ant. :2014 ESH2-Z5 NEUTRAL  
 Limit :FCC PART 15 B  
 Env./Ins. :26°C/60% Engineer :Leo-Li  
 EUT :Altai A2-E1 Dual-band WiFi Access Point  
 Power Rating :DC 56V From POE Input AC 120V/60Hz  
 Test Mode :PC LINK  
 M/N:WA2011N-E

No	Freq (MHz)	LISN Factor (dB)	Cable Loss (dB)	Reading (dBuV)	Emission Level (dBuV)	Limits (dBuV)	Margin (dB)	Remark
1	0.35800	0.14	9.88	28.90	38.92	48.77	9.85	Average
2	0.35800	0.14	9.88	36.90	46.92	58.77	11.85	QP
3	1.911	0.20	9.91	16.21	26.32	46.00	19.68	Average
4	1.911	0.20	9.91	25.77	35.88	56.00	20.12	QP
5	4.120	0.27	9.94	18.21	28.42	46.00	17.58	Average
6	4.120	0.27	9.94	26.49	36.70	56.00	19.30	QP
7	4.896	0.29	9.95	20.05	30.29	46.00	15.71	Average
8	4.896	0.29	9.95	27.41	37.65	56.00	18.35	QP
9	21.433	1.06	10.10	20.45	31.61	50.00	18.39	Average
10	21.433	1.06	10.10	33.33	44.49	60.00	15.51	QP
11	23.144	1.06	10.11	18.71	29.88	50.00	20.12	Average
12	23.144	1.06	10.11	25.31	36.48	60.00	23.52	QP

Remarks: 1.Emission Level=LISN Factor+Cable Loss(Include 10dB pulse limit)+Reading.  
 2.If the average limit is met when using a quasi-peak detector. the EUT shall be deemed to meet both limits and measurement with average detector is unnecessary.

## 4. RADIATED EMISSION TEST

### 4.1. Test Equipment

#### 4.1.1. For frequency range 30MHz~1000MHz

Item	Equipment	Manufacturer	Model No.	Serial No.	Last Cal.	Cal. Interval
1.	3#Chamber	AUDIX	N/A	N/A	Nov.24, 13	1 Year
2.	EMI Spectrum	Agilent	E4407B	MY41440292	Apr. 28,14	1 Year
3.	Test Receiver	Rohde & Schwarz	ESVS10	834468/011	Apr. 28,14	1 Year
4.	Amplifier	HP	8447D	2648A04738	Apr. 28,14	1 Year
5.	Bilog Antenna	TESEQ	CBL6112D	2598	Jun. 18, 14	1 Year
6.	RF Cable	MIYAZAKI	CFD400-NL	3# Chamber No.1	Apr. 28,14	1 Year
7.	Coaxial Switch	Anritsu	MP59B	6200313662	Apr. 28,14	1 Year

#### 4.1.2. For frequency range 1GHz~6GHz

Item	Equipment	Manufacturer	Model No.	Serial No.	Last Cal.	Cal. Interval
1.	3#Chamber	AUDIX	N/A	N/A	Nov.03, 13	1 Year
2.	Spectrum Analyzer	Agilent	E4407B	MY41440292	Apr. 28,14	1 Year
3.	Horn Antenna	ETS	3115	9607-4877	Aug.27, 13	1 Year
4.	Amplifier	Agilent	8449B	3008A00863	Apr. 28,14	1 Year
5.	RF Cable	Hubersuhner	SUCOFLEX106	77977/6	Apr. 28,14	1 Year
6.	RF Cable	Hubersuhner	SUCOFLEX106	28616/2	Apr. 28,14	1 Year

### 4.2. Block Diagram of Test Setup

For frequency range 30MHz-1000Mz

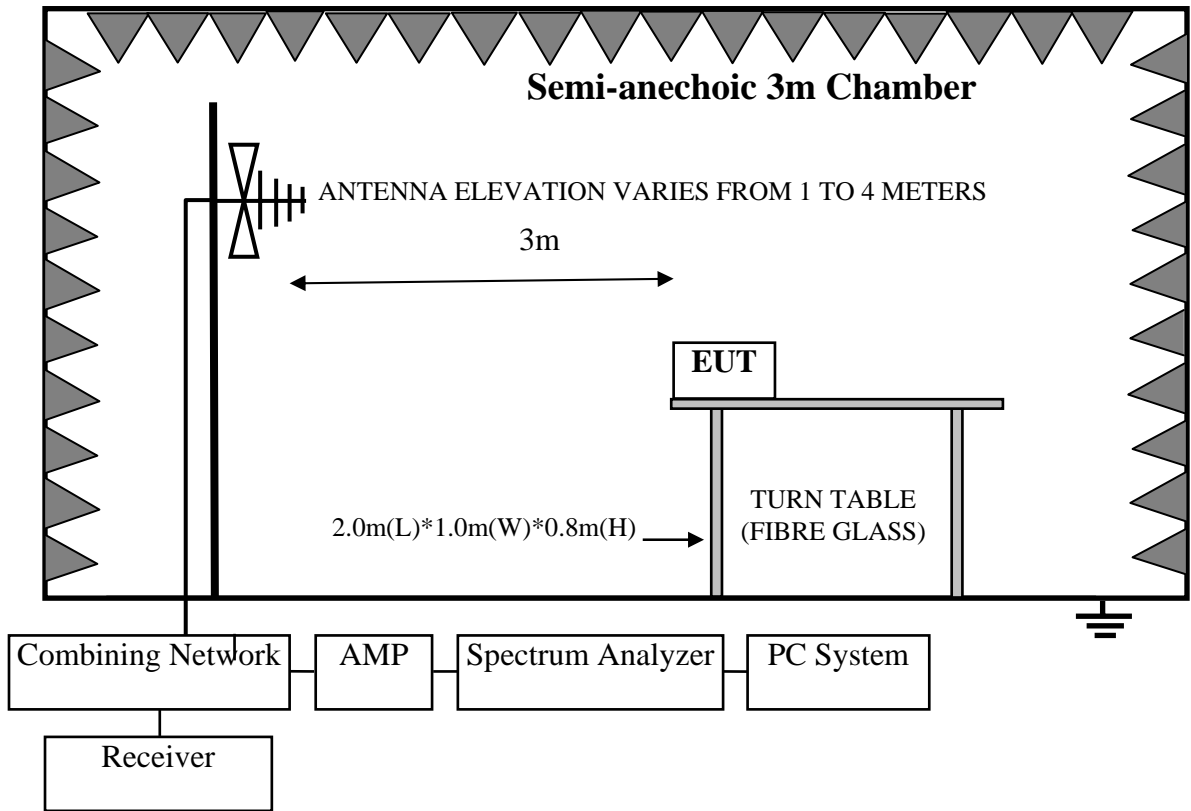

For frequency range 1GHz-6GHz

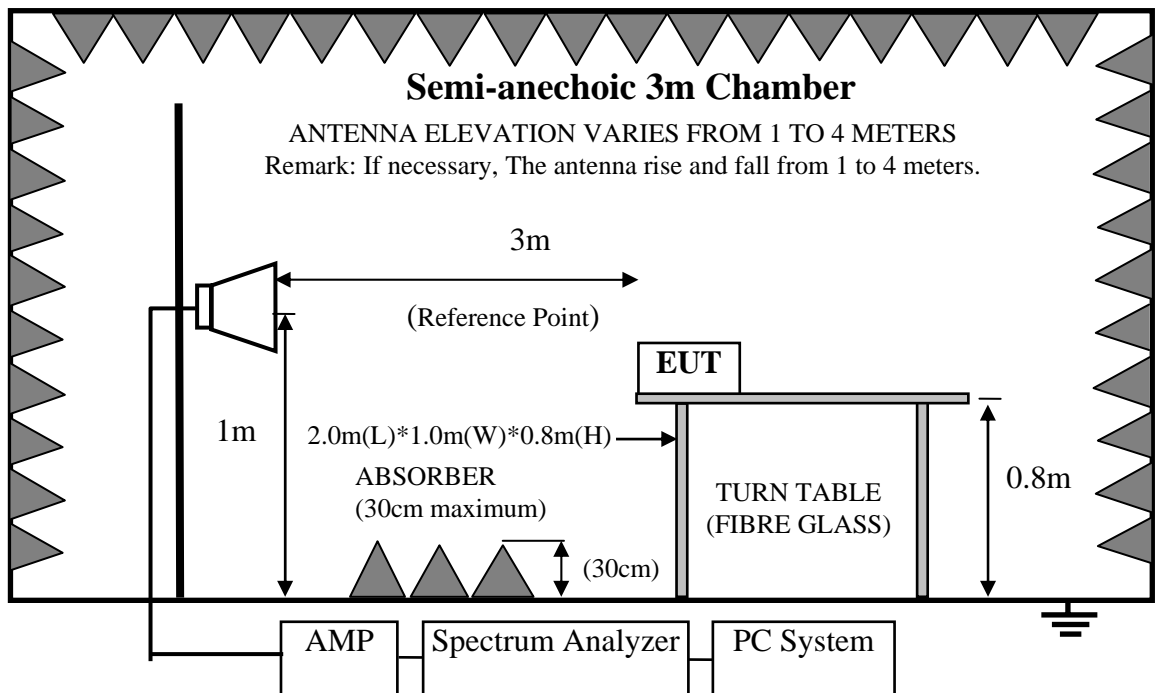

#### 4.3. Radiated Emission Limit

Frequency MHz	Distance (Meters)	Field Strengths Limits dB( $\mu$ V)/m
30 ~ 88	3	40.0
88 ~ 216	3	43.5
216 ~ 960	3	46.0
960 ~ 1000	3	54.0
Above 1000	3	74(Peak)54(Average)

- Remark: (1) Emission level = Antenna Factor + Cable Loss + Reading  
Emission level = Antenna Factor - Amp Factor + Cable Loss + Reading  
(above 1000MHz)
- (2) The smaller limit shall apply at the cross point between two frequency bands.
- (3) Distance is the distance in meters between the measuring instrument, antenna and the closest point of any part of the device or system.

#### 4.4. EUT Configuration on Test

The configurations of EUT are listed in Section 3.4

#### 4.5. Operating Condition of EUT

Same as Conducted Emission test that is listed in Section 3.5. except the test set up replaced by Section 4.2.

#### 4.6. Test Procedure

The EUT was placed on a non-metallic table, 80 cm above the ground plane inside a semi-anechoic chamber. An antenna was located 3m from the EUT on an adjustable mast. A pre-scan was first performed in order to find prominent radiated emissions. For final emissions measurements at each frequency of interest, the EUT were rotated and the antenna height was varied between 1m and 4m in order to maximize the emission. Measurements in both horizontal and vertical polarities were made and the data was recorded. In order to find the maximum emission, the relative positions of equipments and all of the interface cables were changed according to ANSI C63.4: 2009 on Radiated Emission test.

The bandwidth of the EMI test receiver (R&S ESVS10) is set at 120kHz for frequency range from 30MHz to 1000 MHz.

The bandwidth of the Spectrum's RBW is set at 1MHz and VBW is set at 3MHz for peak emissions measurement above 1GHz and 1MHz RBW, 10Hz VBW for average emissions measure above 1GHz.

#### 4.7. Radiated Disturbance Test Results

**PASS.** (All emissions not reported below are too low against the prescribed limits.)

EUT: Altai A2-Ei Dual-band WiFi Access Point  
Model No. : WA2011N-E

##### **For frequency range 30MHz~1000MHz**

The EUT with the following test modes were tested and selected to read Q.P values, all the test results are listed in next pages.

Test Date: Jul.01, 2014      Temperature: 23.4      Humidity: 42%

The details of test mode are as follows :

No.	Test Mode	Reference Test Data No.	
		Horizontal	Vertical
1.	PC LINK	# 4	# 3

##### **For frequency range 1GHz~6GHz**

The EUT with below test mode were measured within Anechoic Chamber and the test results listed in next pages

Note: For all the emissions above 1GHz, the peak measured level comply with peak limit, so the average level were deemed to comply with average limit.

Test Date: Jul.01, 2014      Temperature: 23.4      Humidity: 42%

No.	Test Mode	Reference Test Data No.	
		Horizontal	Vertical
1.	PC LINK	# 5	# 6

30MHz~1000MHz

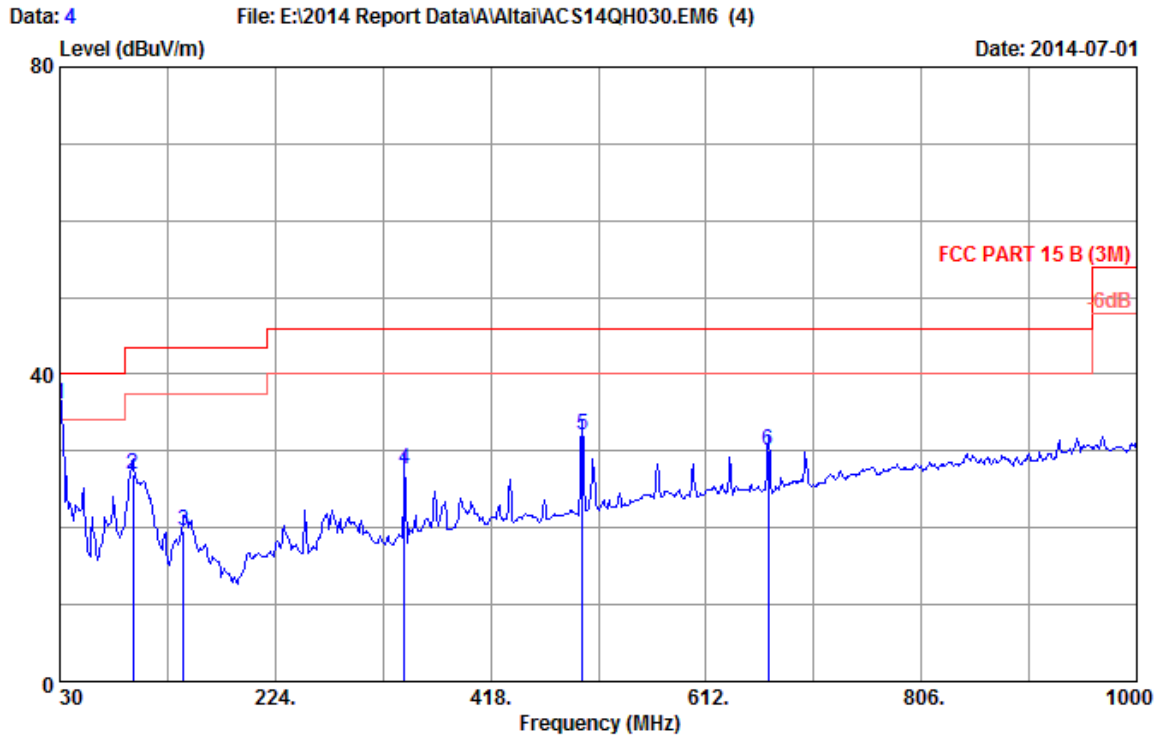

Site no :3m Chamber Data No :4  
 Dis./Ant. :3m 2014 CBL6111C 2598 Ant.pol :HORIZONTAL  
 Limit :FCC PART 15 B (3M)  
 Env./Ins. :23.4\*C/42% Engineer :Leo-Li  
 EUT :Altai A2-Ei Dual-band WiFi Access Point  
 Power Rating :DC 56V From POE Input AC 120V/60Hz  
 Test Mode :PC LINK  
 M/N:WA2011N-E

No	Freq (MHz)	ANT Factor (dB/m)	Cable Loss (dB)	Reading (dBuV)	Emission Level (dBuV/m)	Limits (dBuV/m)	Margin (dB)	Remark
1	30.000	20.10	0.60	15.49	36.19	40.00	3.81	QP
2	95.960	10.20	1.09	15.76	27.05	43.50	16.45	QP
3	141.550	11.60	1.48	6.58	19.66	43.50	23.84	QP
4	340.400	14.92	2.50	10.17	27.59	46.00	18.41	QP
5	500.450	18.30	3.22	10.59	32.11	46.00	13.89	QP
6	668.260	20.50	4.00	5.48	29.98	46.00	16.02	QP

Remarks: 1.Emission Level=Antenna Factor+Cable Loss+Reading.  
 2.The emission Levels that are 20dB below the official limit are not reported



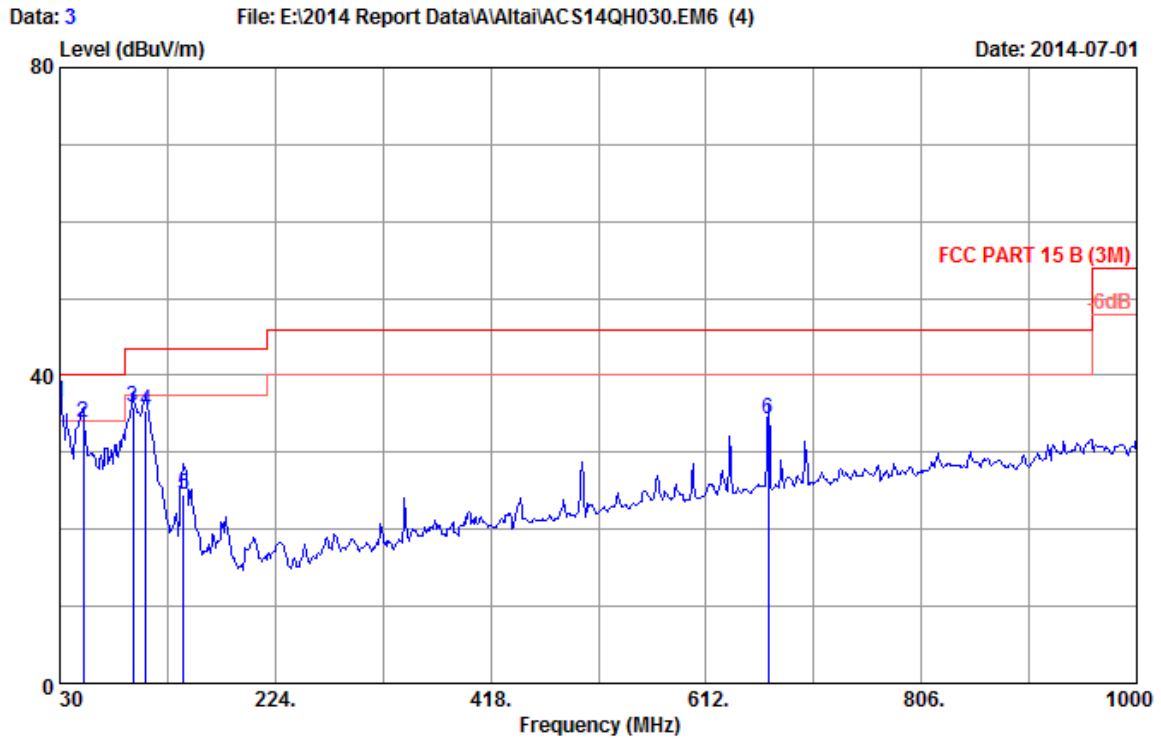

Site no :3m Chamber Data No :3  
 Dis./Ant. :3m 2014 CBL6111C 2598 Ant.pol :VERTICAL  
 Limit :FCC PART 15 B (3M)  
 Env./Ins. :23.4\*C/42% Engineer :Leo-Li  
 EUT :Altai A2-Ei Dual-band WiFi Access Point  
 Power Rating :DC 56V From POE Input AC 120V/60Hz  
 Test Mode :PC LINK  
 M/N:WA2011N-E

No	Freq (MHz)	ANT Factor (dB/m)	Cable Loss (dB)	Reading (dBUV)	Emission Level (dBUV/m)	Limits (dBUV/m)	Margin (dB)	Remark
1	30.000	20.10	0.60	15.90	36.60	40.00	3.40	QP
2	51.340	8.09	0.78	24.96	33.83	40.00	6.17	QP
3	95.960	10.20	1.09	24.58	35.87	43.50	7.63	QP
4	107.600	11.08	1.19	23.14	35.41	43.50	8.09	QP
5	141.550	11.60	1.48	11.51	24.59	43.50	18.91	QP
6	668.260	20.50	4.00	9.82	34.32	46.00	11.68	QP

Remarks: 1.Emission Level=Antenna Factor+Cable Loss+Reading.  
 2.The emission Levels that are 20dB below the official limit are not reported

1GHz~6GHz

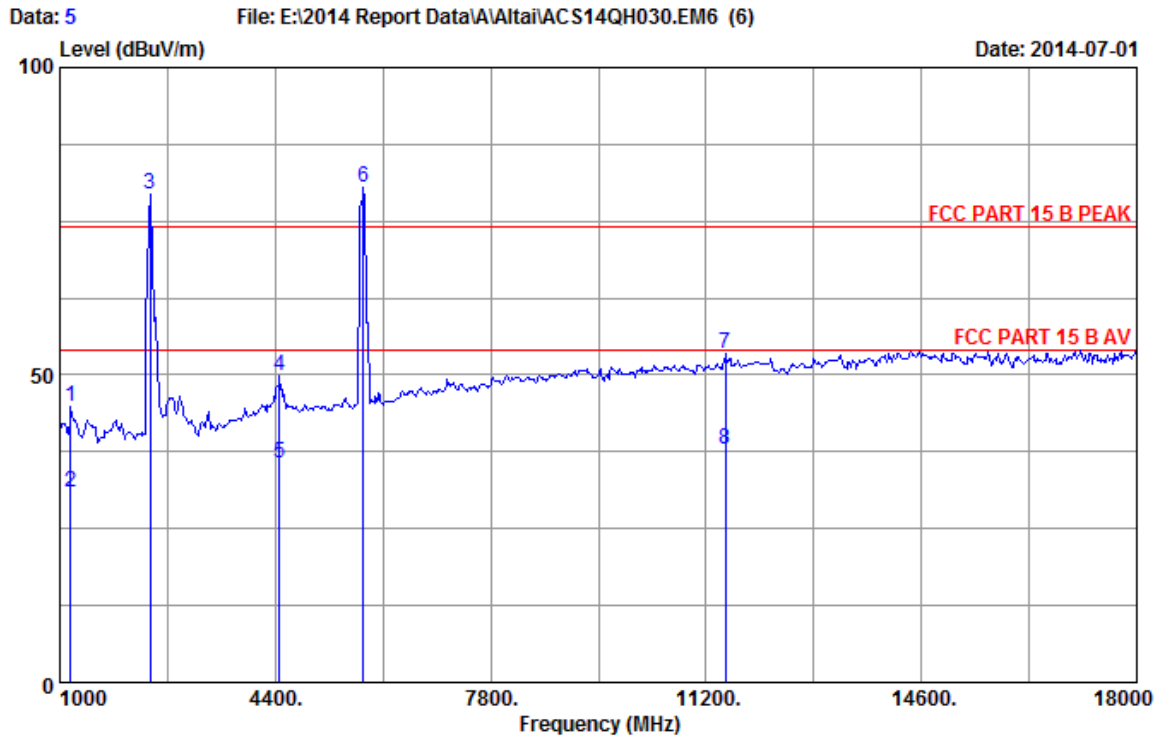

Site no :3m Chamber Data No :5  
 Dis./Ant. :3m 2013 3115 (4877) Ant.pol :HORIZONTAL  
 Limit :FCC PART 15 B PEAK  
 Env./Ins. :23.4\*C/42% Engineer :Leo-Li  
 EUT :Altai A2-Ei Dual-band WiFi Access Point  
 Power Rating :DC 56V From POE Input AC 120V/60Hz  
 Test Mode :PC LINK  
 M/N:WA2011N-E

No	Freq (MHz)	ANT Factor (dB/m)	Cable Loss (dB)	AMP Factor (dB)	Reading (dBuV)	Emission Level (dBuV/m)	Limits (dBuV/m)	Margin (dB)	Remark
1	1170.000	24.15	1.88	35.72	54.63	44.94	74.00	29.06	Peak
2	1170.000	24.15	1.88	35.72	40.65	30.96	54.00	23.04	Average
3	2428.000	27.30	3.46	34.84	83.38	79.30			Peak
4	4468.000	32.29	5.59	34.17	46.04	49.75	74.00	24.25	Peak
5	4468.000	32.29	5.59	34.17	32.01	35.72	54.00	18.28	Average
6	5795.000	34.12	4.43	34.54	76.38	80.39			Peak
7	11506.000	38.71	6.46	34.75	43.11	53.53	74.00	20.47	Peak
8	11506.000	38.71	6.46	34.75	27.58	38.00	54.00	16.00	Average

Remarks: 1.Emission Level=Antenna Factor+Cable Loss+Reading-Amp factor.  
 2.The emission Levels that are 20dB below the official limit are not reported  
 3.2428 MHz and 5795 is the Signal from fundament Frequency. No need to comply with the limit

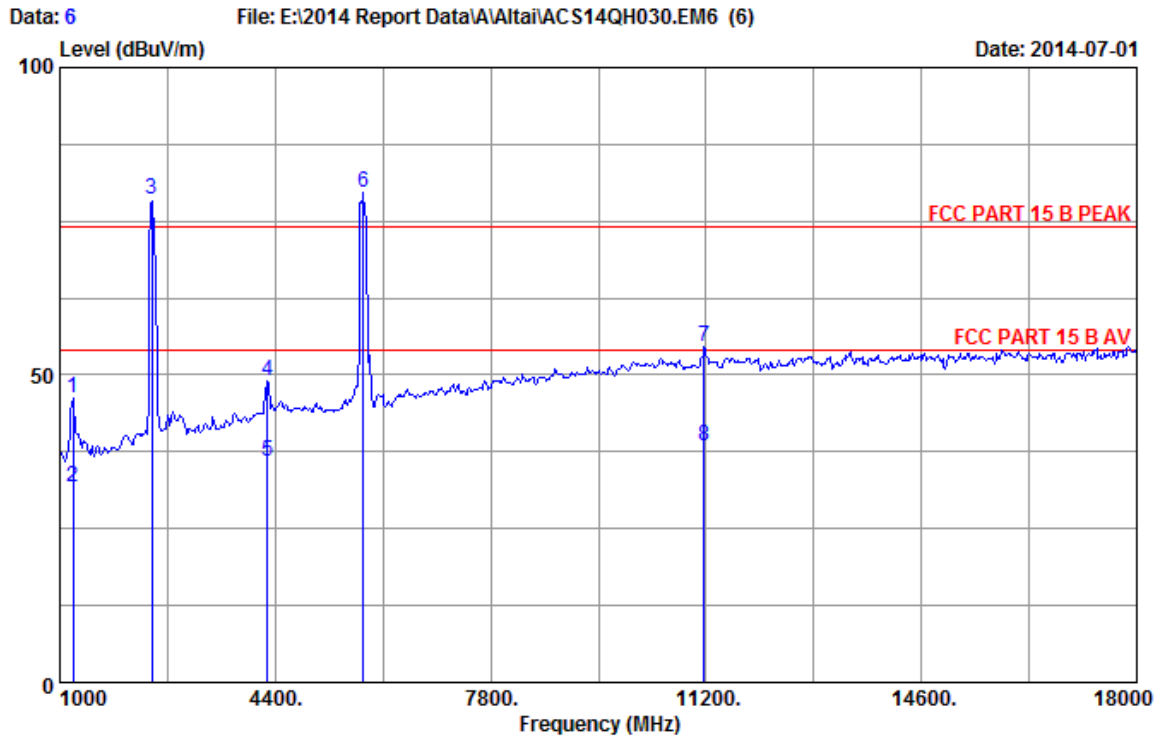

```

Site no      :3m Chamber
Dis./Ant.   :3m 2013 3115 (4877)
Limit       :FCC PART 15 B PEAK
Env./Ins.   :23.4*C/42%
EUT         :Altai A2-Ei Dual-band WiFi Access Point
Power Rating:DC 56V From POE Input AC 120V/60Hz
Test Mode   :PC LINK
M/N:WA2011N-E
Data No     :6
Ant.pol     :VERTICAL
Engineer    :Leo-Li
    
```

No	Freq (MHz)	ANT Factor (dB/m)	Cable Loss (dB)	AMP Factor (dB)	Reading (dBUV)	Emission Level (dBUV/m)	Limits (dBUV/m)	Margin (dB)	Remark
1	1204.000	24.30	1.92	35.67	55.70	46.25	74.00	27.75	Peak
2	1204.000	24.30	1.92	35.67	41.22	31.77	54.00	22.23	Average
3	2450.000	27.36	3.46	34.83	82.48	78.47			Peak
4	4281.000	32.21	5.17	34.15	45.72	48.95	74.00	25.05	Peak
5	4281.000	32.21	5.17	34.15	32.58	35.81	54.00	18.19	Average
6	5790.000	34.12	4.43	34.54	75.54	79.55			Peak
7	11166.000	38.57	6.56	34.81	44.22	54.54	74.00	19.46	Peak
8	11166.000	38.57	6.56	34.81	28.01	38.33	54.00	15.67	Average

Remarks: 1.Emission Level=Antenna Factor+Cable Loss+Reading-Amp factor.  
 2.The emission Levels that are 20dB below the official limit are not reported  
 3.2450 MHz and 5790 is the Signal from fundament Frequency. No need to comply with the limit



## 5. DEVIATION TO TEST SPECIFICATIONS

[NONE]