



APPLICATION OF CERTIFICATION

For

Altai Technologies Limited

Altai A8-Ein (ac) Super WiFi Base Station

Model No: WA8011NAC

FCC ID: UCC-WA8011NAC

Prepared for : Altai Technologies Limited  
Units 209, 2/F, Lakeside 2.10 Science Park West Avenue,  
Hong Kong Science Park, Shatin, Hong Kong, China

Prepared By: Audix Technology (Shenzhen) Co., Ltd.  
No. 6, Ke Feng Rd., 52 Block,  
Shenzhen Science & Industrial Park,  
Nantou, Shenzhen, Guangdong, China

Tel: (0755) 26639496  
Fax: (0755) 26632877

Report Number : ACS- F15309  
Date of Test : Oct.14~Nov.12, 2015  
Date of Report : Dec.14, 2015

**TABLE OF CONTENTS**

<b>Description</b>	<b>Page</b>
<b>Test Report Certification</b>	
<b>1. SUMMARY OF STANDARDS AND RESULTS ..... 1-1</b>	<b>1-1</b>
1.1. Description of Standards and Results ..... 1-1	1-1
<b>2. GENERAL INFORMATION..... 2-1</b>	<b>2-1</b>
2.1. Description of Device (EUT)..... 2-1	2-1
2.2. Tested Supporting System Details ..... 2-2	2-2
2.3. Block Diagram of Connection between the EUT and Simulators ..... 2-2	2-2
2.4. Test Facility ..... 2-3	2-3
2.5. Measurement Uncertainty (95% confidence levels, k=2)..... 2-3	2-3
<b>3. POWER LINE CONDUCTED EMISSION MEASUREMENT ..... 3-1</b>	<b>3-1</b>
3.1. Test Equipment ..... 3-1	3-1
3.2. Block Diagram of Test Setup..... 3-1	3-1
3.3. Power Line Conducted Emission Test Limits(Class B)..... 3-1	3-1
3.4. Configuration of EUT on Test ..... 3-2	3-2
3.5. Operating Condition of EUT ..... 3-2	3-2
3.6. Test Procedure ..... 3-2	3-2
3.7. Conducted Emission at Mains Terminals Test Results..... 3-2	3-2
<b>4. RADIATED EMISSION MEASUREMENT ..... 4-1</b>	<b>4-1</b>
4.1. Test Equipment ..... 4-1	4-1
4.2. Block Diagram of Test Setup..... 4-2	4-2
4.3. Radiated Emission Limit(Class B)..... 4-3	4-3
4.4. EUT Configuration on Test ..... 4-3	4-3
4.5. Operating Condition of EUT ..... 4-3	4-3
4.6. Test Procedure ..... 4-3	4-3
4.7. Radiated Emission Test Results..... 4-4	4-4
<b>5. PHOTOGRAPH ..... 5-1</b>	<b>5-1</b>
5.1. Photos of Power Line Conducted Emission Test..... 5-1	5-1
5.2. Photos of Radiated Emission Test (In 3m Anechoic Chamber) ..... 5-2	5-2
<b>6. PHOTO OF EUT ..... 6-1</b>	<b>6-1</b>

## TEST REPORT CERTIFICATION

Applicant : Altai Technologies Limited  
EUT Description : Altai A8-Ein (ac) Super WiFi Base Station  
FCC ID : UCC-WA8011NAC  
(A) Model No. : WA8011NAC  
(B) Power Supply : DC 56V  
(C) Test Voltage : DC 56V From Adapter Input AC 120V/60Hz

Measurement Standard Used:

FCC CFR 47 Part 15 Subpart B Class B 2014, ICES-003 Issue 5: 2012

The device described above is tested by AUDIX TECHNOLOGY (SHENZHEN) CO., LTD. to determine the maximum emission levels emanating from the device. The maximum emission levels are compared to the FCC Part 15 Subpart B Class B limits both conducted and radiated emissions. The test results are contained in this test report and AUDIX TECHNOLOGY (SHENZHEN) CO., LTD. is assumed of full responsibility for the accuracy and completeness of these tests. This report contains data that are not covered by the NVLAP accreditation.

After the test, our opinion is that EUT compliance with the requirement of the above standards.

This Report is made under FCC Part 2.1075. No modifications were required during testing to bring this product into compliance.

This report applies to above tested sample only. This report shall not be reproduced in parts without written approval of AUDIX TECHNOLOGY (SHENZHEN) CO., LTD.

The report must not be used by the client to claim product certification, approval, or endorsement by NVLAP, NIST, or any agency of the federal government.

Date of Test : Oct.14~Nov.12, 2015 Report of date: Dec.14, 2015

Prepared by : Monica Liu  
Monica Liu / Assistant

Reviewed by : Sunny Lu  
Sunny Lu / Assistant Manager

 信華科技 (深圳) 有限公司  
Audix Technology (Shenzhen) Co., Ltd.  
EMC 部門報告專用章

Stamp only for EMC Dept. Report

Approved & Authorized Signer :

Signature: David Jin  
David Jin / Manager

## 1. SUMMARY OF STANDARDS AND RESULTS

### 1.1. Description of Standards and Results

The EUT have been tested according to the applicable standards as referenced below.

EMISSION			
Description of Test Item	Standard	Results	Remark
Power Line Conducted Emission Test	FCC Part 15: 2014 ANSI C63.4: 2009	PASS	Minimum passing margin is 4.68dB at 23.140MHz
Radiated Emission Test (30-1000MHz)	FCC Part 15: 2014 ANSI C63.4: 2009	PASS	Minimum passing margin is 5.36dB at 83.350MHz
Radiated Emission Test (1-18GHz)	FCC Part 15: 2014 ANSI C63.4: 2009	PASS	Minimum passing margin is 1.39dB at 2445.00MHz

## 2. GENERAL INFORMATION

### 2.1. Description of Device (EUT)

Product Name	: Altai A8-Ein (ac) Super WiFi Base Station
Model Number	: WA8011NAC
FCC ID	: UCC-WA8011NAC
Operation Frequency	: IEEE 802.11a: 5745MHz—5825MHz IEEE 802.11b: 2412MHz—2462MHz IEEE 802.11g: 2412MHz—2462MHz IEEE 802.11n HT20: 2412MHz—2462MHz; 5745MHz—5825MHz IEEE 802.11n HT40: 2422MHz—2452MHz; 5755MHz—5795MHz IEEE 802.11n VHT20: 5745MHz—5825MHz IEEE 802.11n VHT40: 5755MHz—5795MHz IEEE 802.11n VHT80: 5775MHz
Modulation Technology	: IEEE 802.11b: DSSS(CCK,DQPSK,DBPSK) IEEE 802.11a/g: OFDM(64QAM, 16QAM, QPSK, BPSK) IEEE 802.11ac VHT20, VHT40, VHT80: OFDM(16QAM, 64QAM, 256QAM, QPSK, BPSK) IEEE 802.11n HT20, HT40: OFDM (64QAM, 16QAM,QPSK,BPSK)
Antenna Assembly Gain	: Antenna Type: Sector WIFI 2.4GHz:ANT: 19dBi U-NII 5745-5825MHz Band: ANT: 20dBi
Applicant	: Altai Technologies Limited Units 209, 2/F, Lakeside 2.10 Science Park West Avenue, Hong Kong Science Park, Shatin, Hong Kong, China
Manufacturer	: Altai Technologies Limited Units 209, 2/F, Lakeside 2.10 Science Park West Avenue, Hong Kong Science Park, Shatin, Hong Kong, China
Antenna Cable	: Unshielded, Detachable, 2.0m
Date of Test	: Oct.14~Nov.12, 2015
Date of Receipt	: Aug.25, 2015
Sample Type	: Prototype production

2.2. Tested Supporting System Details

No.	Description	ACS No.	Manufacturer	Model	Serial Number
1	Notebook	N/A	DELL	PP09S	N/A
		Power Cord: Unshielded, Detachable, 1.8m Power Adapter: Manufacturer: DELL, M/N: LA65NS1-00 Cable: Unshielded, Detachable, 4.0m(Bond one ferrite core)			

2.3. Block Diagram of Connection between the EUT and Simulators

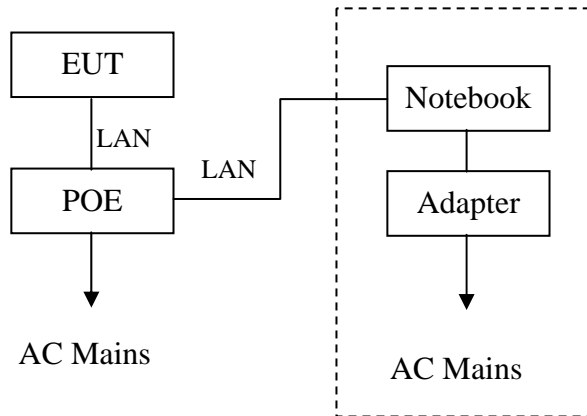

(EUT: Altai A8-Ein (ac) Super WiFi Base Station)

**2.4. Test Facility**

Site Description

Name of Firm : Audix Technology (Shenzhen) Co., Ltd.  
 No. 6, Ke Feng Rd., 52 Block, Shenzhen  
 Science & Industrial Park, Nantou,  
 Shenzhen, Guangdong, China

3m Anechoic Chamber : Certificated by FCC, USA  
 Registration Number: 90454  
 Valid Date: Dec.30, 2017

3m & 10m Anechoic Chamber : Certificated by FCC, USA  
 Registration Number: 794232  
 Valid Date: Jul.12, 2016

EMC Lab. : Accredited by DAkkS, Germany  
 Registration No: D-PL-12151-01-00  
 Valid Date: Dec.15, 2016

: Accredited by NVLAP, USA  
 NVLAP Code: 200372-0  
 Valid Date: Mar.31, 2016

**2.5. Measurement Uncertainty (95% confidence levels, k=2)**

Test Item	Uncertainty
Uncertainty for Conduction emission test in No. 1 Conduction	3.4dB (30MHz~30MHz)
Uncertainty for Radiation Emission test in 3m chamber (Distance: 10m)	2.6dB (30~200MHz, Polarization: H)
	2.6dB (30~200MHz, Polarization: V)
	3.0dB (200M~1GHz, Polarization: H)
	2.8dB (200M~1GHz, Polarization: V)
Uncertainty for Radiation Emission test in 3m chamber (1GHz-18GHz)	6.3dB (1GHz~6GHz, Distance: 3m)
	5.7dB (6GHz~18GHz, Distance: 3m)
Uncertainty for test site temperature and humidity and pressure	0.6°C
	3%
	1kPa

### 3. POWER LINE CONDUCTED EMISSION MEASUREMENT

#### 3.1. Test Equipment

Item	Equipment	Manufacturer	Model No.	Serial No.	Last Cal.	Cal. Interval
1.	1# Shielding Room	AUDIX	N/A	N/A	Apr.17,15	1 Year
2.	Test Receiver	Rohde & Schwarz	ESCI	100842	Apr.28,15	1 Year
3.	L.I.S.N.#1	Rohde & Schwarz	ESH2-Z5	100429	Oct.29,14	1 Year
4.	L.I.S.N.#2	Kyoritsu	K NW-403D	8-1750-2	Apr.28,15	1 Year
5.	Terminator	Hubersuhner	50Ω	No.1	Apr.28,15	1 Year
6.	Terminator	Hubersuhner	50Ω	No.2	Apr.28,15	1 Year
7.	RF Cable	MIYAZAKI	3D-2W	No.1	Apr.28,15	1Year
8.	Coaxial Switch	Anritsu	MP59B	6200766906	Apr.28,15	1 Year
9.	Pulse Limiter	Rohde & Schwarz	ESH3-Z2	101838	Oct.17,15	1 Year
10.	Test Software	AUDIX	E3	6.100913a	N/A	N/A

#### 3.2. Block Diagram of Test Setup

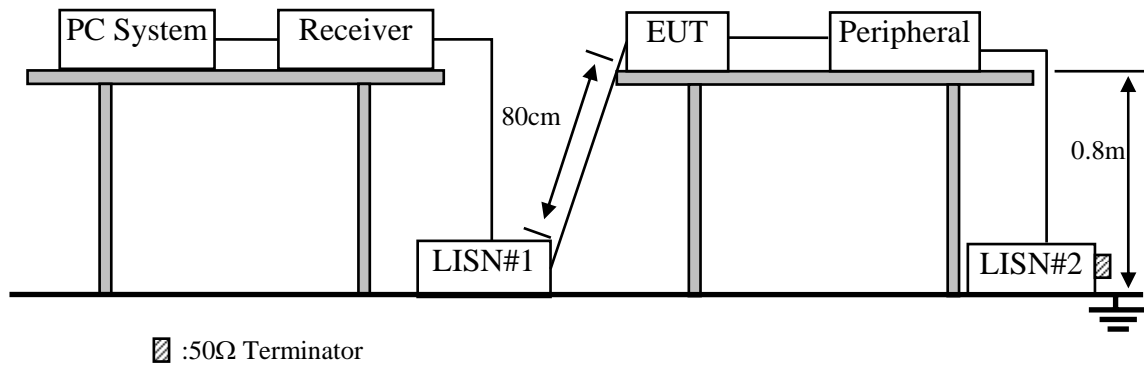

#### 3.3. Power Line Conducted Emission Test Limits(Class B)

Frequency	Maximum RF Line Voltage	
	Quasi-Peak Level dB(μV)	Average Level dB(μV)
150kHz ~ 500kHz	66 ~ 56*	56 ~ 46*
500kHz ~ 5MHz	56	46
5MHz ~ 30MHz	60	50

Notes: 1. \* Decreasing linearly with logarithm of frequency.  
 2. The lower limit shall apply at the transition frequencies.



### 3.4. Configuration of EUT on Test

The following equipment are installed on Power Line Conducted Emission Test to meet the commission requirement and operating regulations in a manner which tends to maximize its emission characteristics in a normal application.

#### 3.4.1. Altai A8-Ein (ac) Super WiFi Base Station (EUT)

Model Number : WA8011NAC  
Serial Number : N/A

#### 3.4.2. Support Equipment: As Tested Supporting System Detail, in Section 2.2.

### 3.5. Operating Condition of EUT

3.5.1. Setup the EUT and simulator as shown as Section 3.2.

3.5.2. Turn on the power of all equipments.

3.5.3. PC run test software to control EUT work in PC Link mode.

### 3.6. Test Procedure

The EUT was placed on a non-metallic table, 80cm above the ground plane. The EUT Power connected to the power mains through a line impedance stabilization network (L.I.S.N. #1 ). This provided a 50-ohm coupling impedance for the EUT (Please refer to the block diagram of the test setup and photographs). The other peripheral devices power cord connected to the power mains through a line impedance stabilization network (L.I.S.N.#2). Both sides of power line were checked for maximum conducted interference. In order to find the maximum emission, the relative positions of equipments and all of the interface cables were changed according to ANSI C63.4: 2009 on conducted Emission test.

The bandwidth of test receiver (R&S TEST RECEIVER ESCI) is set at 9kHz.

The frequency range from 150kHz to 30MHz is checked. The test results are reported on Section 3.7.

### 3.7. Conducted Emission at Mains Terminals Test Results

**PASS.** (All emissions not reported below are too low against the prescribed limits.)

EUT: Altai A8-Ein (ac) Super WiFi Base Station      Model No. : WA8011NAC

The EUT with the following test modes were tested and selected (No.1) to read Q.P and Average values, all the test results are listed in next pages.

Test Date: Oct.14, 2015    Temperature: 25.4°C    Humidity: 55%

The detail of test modes is as follow:

No.	Test Mode	Reference Test Data No.	
		Line	Neutral
1.	PC Link	# 35	# 34

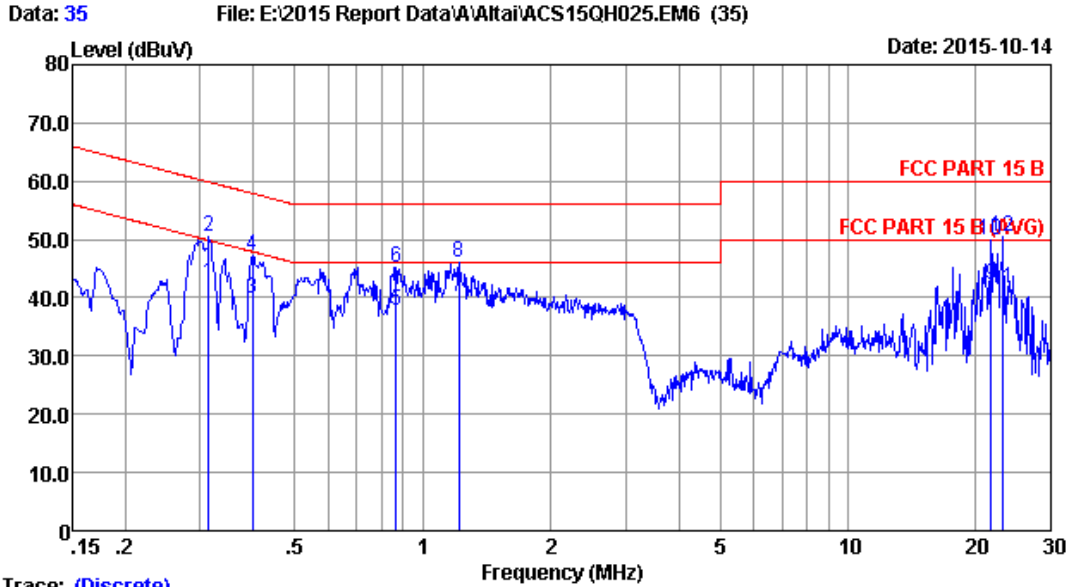

Trace: (Discrete)

Site no :1# Conduction Data No :35

Dis./Lisn :2014 ESH2-25 LINE

Limit :FCC PART 15 B

Env./Ins. :25.4\*C/55% Engineer :Leo-Li

EUT :Altai A8-Ein (ac) Super WiFi Base Station

Power Rating :DC 56V From Adapter Input AC 230V/50Hz

Test Mode :PC LINK

M/N:WA8011NAC

No	Freq (MHz)	LISN Factor (dB)	Cable Loss (dB)	Reading (dBuV)	Emission Level (dBuV)	Limits (dBuV)	Margin (dB)	Remark
1	0.313	0.13	9.94	32.58	42.65	59.88	17.23	Average
2	0.313	0.13	9.94	40.40	50.47	59.88	9.41	QP
3	0.398	0.83	9.94	29.13	39.90	57.90	18.00	Average
4	0.398	0.83	9.94	36.35	47.12	57.90	10.78	QP
5	0.866	0.16	9.95	27.59	37.70	56.00	18.30	Average
6	0.866	0.16	9.95	34.97	45.08	56.00	10.92	QP
7	1.216	0.16	9.96	30.07	40.19	56.00	15.81	Average
8	1.216	0.16	9.96	36.01	46.13	56.00	9.87	QP
9	21.715	0.66	10.16	31.52	42.34	60.00	17.66	Average
10	21.715	0.66	10.16	39.17	49.99	60.00	10.01	QP
11	23.140	0.65	10.17	30.83	41.65	60.00	18.35	Average
12	23.140	0.65	10.17	39.51	50.33	60.00	9.67	QP

Remarks: 1.Emission Level=LISN Factor+Cable Loss(Include 10dB pulse limit)+Reading.  
 2.If the average limit is met when using a quasi-peak detector, the EUT shall be deemed to meet both limits and measurement with average detector is unnecessary.

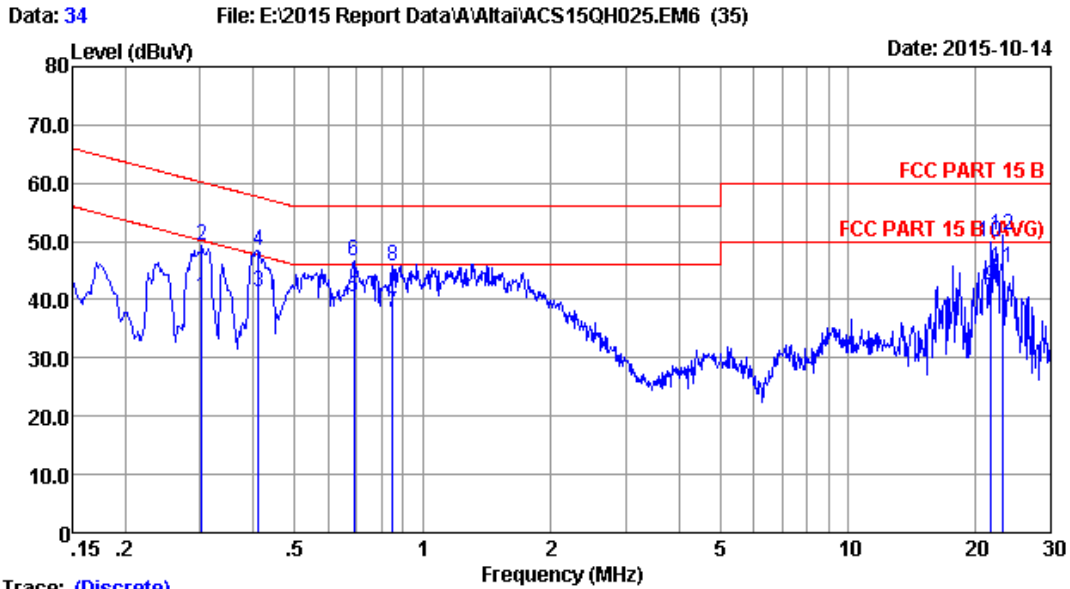

Trace: (Discrete)

Site no :1# Conduction Data No :34  
 Dis./Lisn :2014 ESH2-25 NEUTRAL  
 Limit :FCC PART 15 B  
 Env./Ins. :25.4\*C/55% Engineer :Leo-Li  
 EUT :Altai A8-Ein (ac) Super WiFi Base Station  
 Power Rating :DC 56V From Adapter Input AC 230V/50Hz  
 Test Mode :PC LINK  
 M/N:WA8011NAC

No	Freq (MHz)	LISN Factor (dB)	Cable Loss (dB)	Reading (dBUV)	Emission Level (dBUV)	Limits (dBUV)	Margin (dB)	Remark
1	0.302	0.15	9.94	30.48	40.57	50.19	9.62	Average
2	0.302	0.15	9.94	39.10	49.19	60.19	11.00	QP
3	0.410	0.15	9.94	31.09	41.18	47.64	6.46	Average
4	0.410	0.15	9.94	38.28	48.37	57.64	9.27	QP
5	0.690	0.16	9.95	30.24	40.35	46.00	5.65	Average
6	0.690	0.16	9.95	36.48	46.59	56.00	9.41	QP
7	0.848	0.17	9.95	27.64	37.76	46.00	8.24	Average
8	0.848	0.17	9.95	35.77	45.89	56.00	10.11	QP
9	21.715	0.76	10.16	31.25	42.17	50.00	7.83	Average
10	21.715	0.76	10.16	38.84	49.76	60.00	10.24	QP
11	23.140	0.77	10.17	34.38	45.32	50.00	4.68	Average
12	23.140	0.77	10.17	40.19	51.13	60.00	8.87	QP

Remarks: 1.Emission Level=LISN Factor+Cable Loss(Include 10dB pulse limit)+Reading.  
 2.If the average limit is met when using a quasi-peak detector, the EUT shall be deemed to meet both limits and measurement with average detector is unnecessary.

## 4. RADIATED EMISSION MEASUREMENT

### 4.1. Test Equipment

#### 4.1.1. For frequency range 30MHz~1000MHz (In 3m Anechoic Chamber)

Item	Equipment	Manufacturer	Model No.	Serial No.	Last Cal.	Cal. Interval
1.	3#Chamber	AUDIX	N/A	N/A	Nov.23,14	1 Year
2.	EMI Spectrum	Agilent	E4407B	MY41440292	Apr.28,15	1 Year
3.	Test Receiver	Rohde & Schwarz	ESVS10	834468/011	Apr.28,15	1 Year
4.	Amplifier	HP	8447D	2648A04738	Apr.28,15	1 Year
5.	Trilog-Broadband Antenna	SCHWARZBECK	VULB 9168	9168-493	May.06,15	1 Year
6.	RF Cable	MIYAZAKI	CFD400-N W(3.5M)	No.3	Apr.28,15	1 Year
7.	RF Cable	MIYAZAKI	CFD400-L W(22M)	No.7	Apr.28,15	1 Year
8.	Coaxial Switch	Anritsu	MP59B	6201397222	Apr.28,15	1 Year
9.	Test Software	AUDIX	E3	6.2009-5-21a(n)	N/A	N/A

#### 4.1.2. For frequency range 1GHz~18GHz (In 3m Anechoic Chamber)

Item	Equipment	Manufacturer	Model No.	Serial No.	Last Cal.	Cal. Interval
1.	3#Chamber	AUDIX	N/A	N/A	Mar.22,15	1 Year
2.	Spectrum Analyzer	Agilent	E4407B	MY41440292	Apr.28,15	1 Year
3.	Horn Antenna	ETC	MCTD 1209	DRH15F03007	Feb.03,15	1 Year
4.	Amplifier	Agilent	83017A	MY53270084	May.25,15	1 Year
5.	RF Cable	Hubersuhner	SUCOFLEX106	505238/6+28616/2	Apr.28,15	1 Year
6.	MPEG2 Measurement Generator	ROHDE&SCHWARZ	DVG	100319	Nov.2,15	1 Year
7.	Test Software	AUDIX	E3	6.2009-5-21a(n)	N/A	N/A

### 4.2. Block Diagram of Test Setup

#### 4.2.1. For frequency range 30MHz-1000MHz

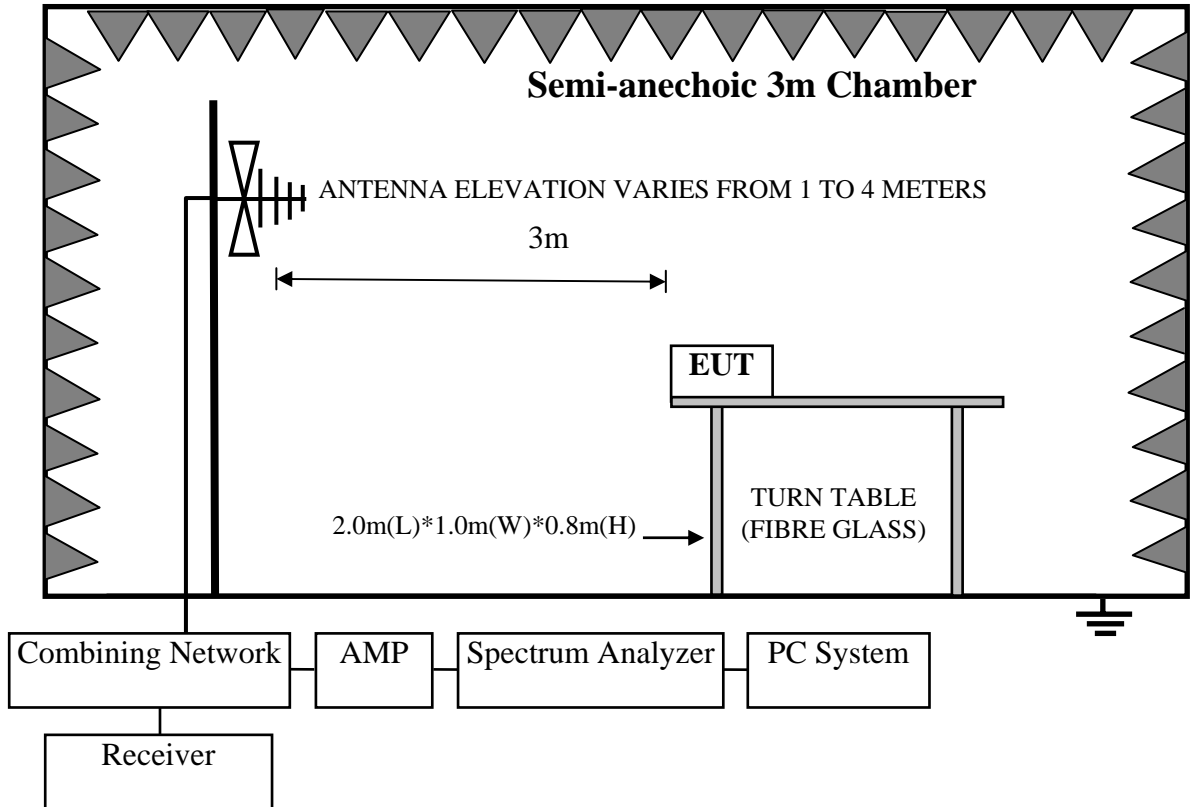

#### 4.2.2. For frequency range 1GHz-18GHz

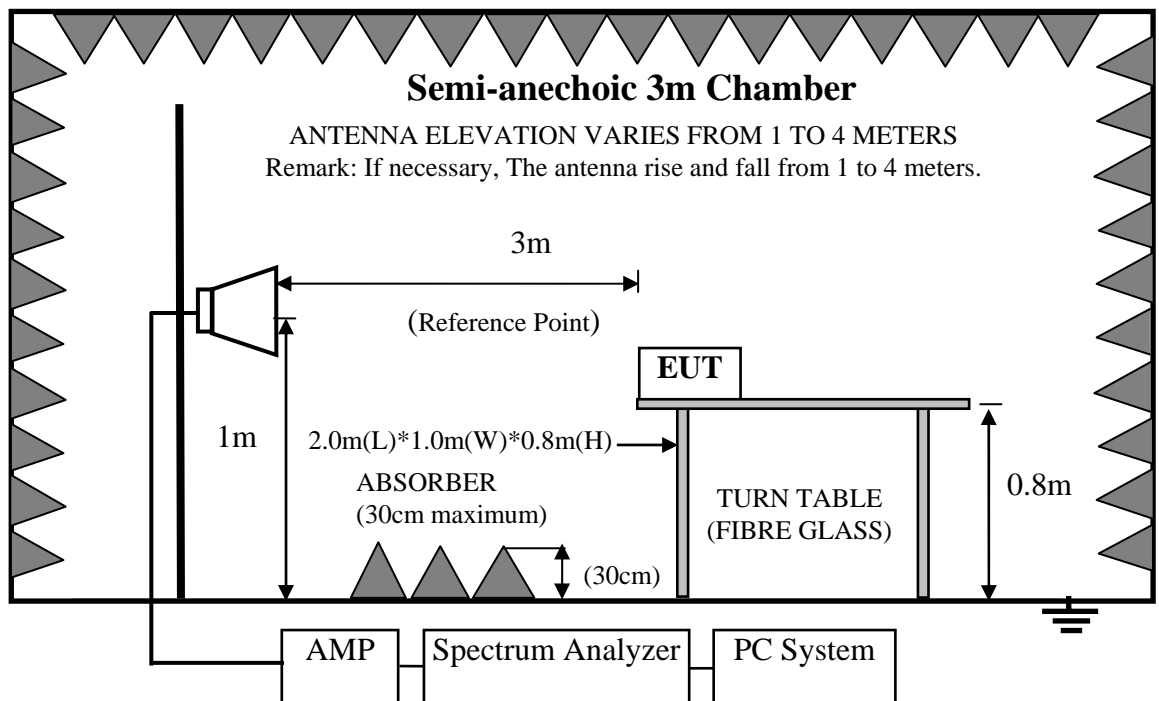

#### 4.3. Radiated Emission Limit(Class B)

FREQUENCY (MHz)	DISTANCE (Meters)	FIELD STRENGTHS LIMITS (dB $\mu$ V/m)
30 ~ 88	3	40.0
88 ~ 216	3	43.5
216~960	3	46.0
960~1000	3	54.0
Above 1000	3	74.0(Peak), 54.0(Average)

- Remark: (1) Emission level = Antenna Factor + Cable Loss + Reading  
Emission level = Antenna Factor - Amp Factor + Cable Loss + Reading  
(above 1000MHz)
- (2) The smaller limit shall apply at the cross point between two frequency bands.
- (3) Distance is the distance in meters between the measuring instrument, antenna and the closest point of any part of the device or system.

#### 4.4. EUT Configuration on Test

The configurations of EUT are listed in Section 3.4

#### 4.5. Operating Condition of EUT

Same as Conducted Emission test that listed in Section 3.5. Except the test set up replaced as Section 4.2.

#### 4.6. Test Procedure

The EUT was placed on a non-metallic table, 80 cm above the ground plane inside a semi-anechoic chamber. An antenna was located 3m from the EUT on an adjustable mast. A pre-scan was first performed in order to find prominent radiated emissions. For final emissions measurements at each frequency of interest, the EUT were rotated and the antenna height was varied between 1m and 4m in order to maximize the emission. Measurements in both horizontal and vertical polarities were made and the data was recorded. In order to find the maximum emission, the relative positions of equipments and all of the interface cables were changed according to ANSI C63.4: 2009 on Radiated Emission test.

The bandwidth setting on the test receiver (R&S TEST RECEIVER ESVS10) is 120 kHz.

The resolution bandwidth of the Agilent Spectrum Analyzer E4407B was set at 1MHz. (For above 1GHz)

The frequency range from 30MHz to 1000MHz was pre-scanned with a peak detector and all final readings of measurement from Test Receiver are Quasi-Peak values.

The frequency range from 1GHz to 18GHz was checked and all final readings of measurement were with Peak and Average detector, measurement distance was 3m at semi-anechoic chamber. The portion of the test volume that was obstructed by absorber placed on the floor (30cm maximum). The EUT were rotated and the antenna height was varied between 1m and 4m in order to maximize the emission.

Finally, selected operating situations at Anechoic Chamber measurement, all the test results are listed in section 4.7.

**4.7. Radiated Emission Test Results**

**PASS.** (All emissions not reported below are too low against the prescribed limits.)

EUT: Altai A8-Ein (ac) Super WiFi Base Station                      Model No. : WA8011NAC

**For frequency range 30MHz~1000MHz**

The EUT with the following test modes were tested and selected to read Q.P values, all the test results are listed in next pages.

Test Date: Oct.14, 2015      Temperature: 25°C      Humidity: 56%

The detail of test modes is as follow:

No.	Test Mode	Reference Test Data No.	
		Horizontal	Vertical
1.	PC Link	# 6	# 5

**For frequency range 1GHz~6GHz**

The EUT with below test mode were measured within anechoic chamber and the test results listed in next pages.

Test Date: Nov.12, 2015      Temperature: 25°C      Humidity: 56%

The detail of test modes is as follow:

No.	Test Mode	Reference Test Data No.	
		Horizontal	Vertical
1.	PC Link	# 7	# 8

30MHz~1000MHz

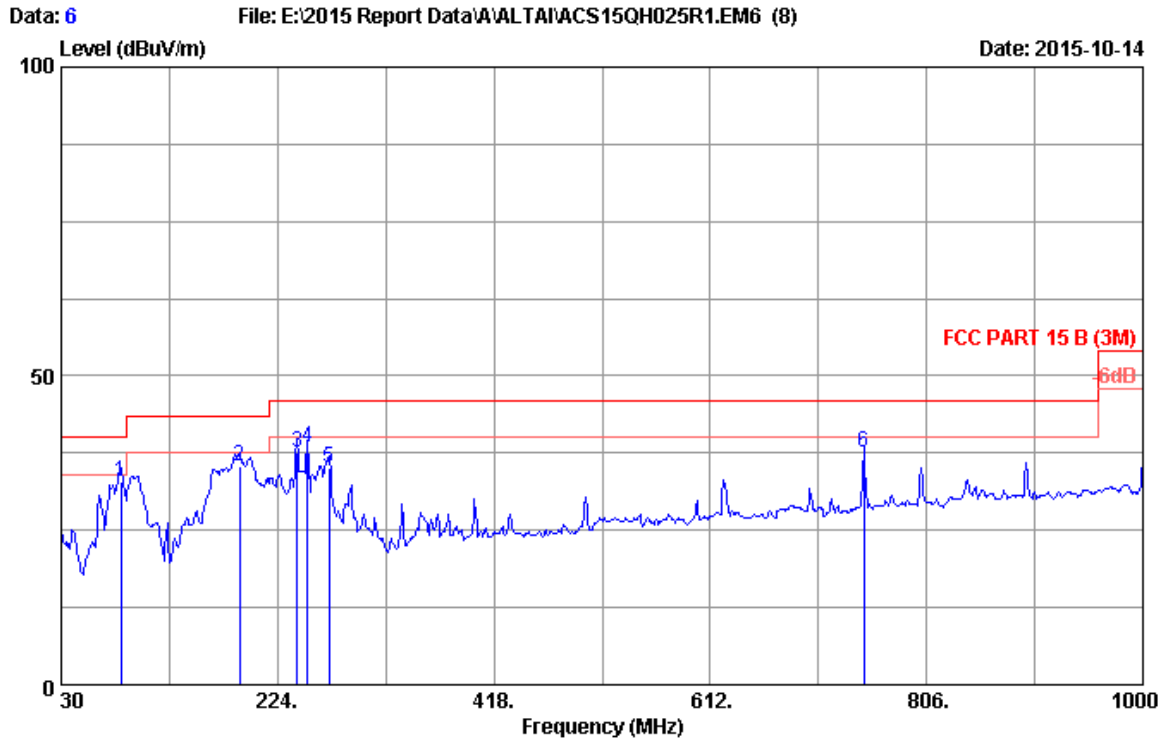

Site no. : 3m Chamber Data no. : 6  
 Dis. / Ant. : 3m 2015 CBL6112D 35375 Ant. pol. : HORIZONTAL  
 Limit : FCC PART 15 B (3M)  
 Env. / Ins. : 24°C/56% Engineer : Leo-Li  
 EUT : Altai A8-Ein (ac) Super WiFi Base Station  
 Power rating : DC 56V From POE Input AC 120V/60Hz  
 Test Mode : PC LINK  
 WA8011NAC

No.	Freq. (MHz)	Ant. Factor (dB/m)	Cable Loss (dB)	Reading (dBUV)	Emission Level (dBUV/m)	Limits (dBUV/m)	Margin (dB)	Remark
1	83.350	8.30	1.02	23.67	32.99	40.00	7.01	QP
2	190.050	10.10	1.46	23.85	35.41	43.50	8.09	QP
3	241.460	12.67	1.65	23.28	37.60	46.00	8.40	QP
4	251.160	13.32	1.71	23.41	38.44	46.00	7.56	QP
5	270.560	13.70	1.79	19.60	35.09	46.00	10.91	QP
6	749.740	20.60	3.14	13.87	37.61	46.00	8.39	QP

- Remarks:
1. Emission Level= Antenna Factor + Cable Loss + Reading.
  2. The emission levels that are 20dB below the official limit are not reported.
  3. The worst emission was detected at 83.350 MHz with corrected signal level 32.99 dBUV/m (Antenna height 1.1m; Turntable degree 218°).
  4. 0° was the table front facing the antenna. Degree is calculated from 0° clockwise facing the antenna.



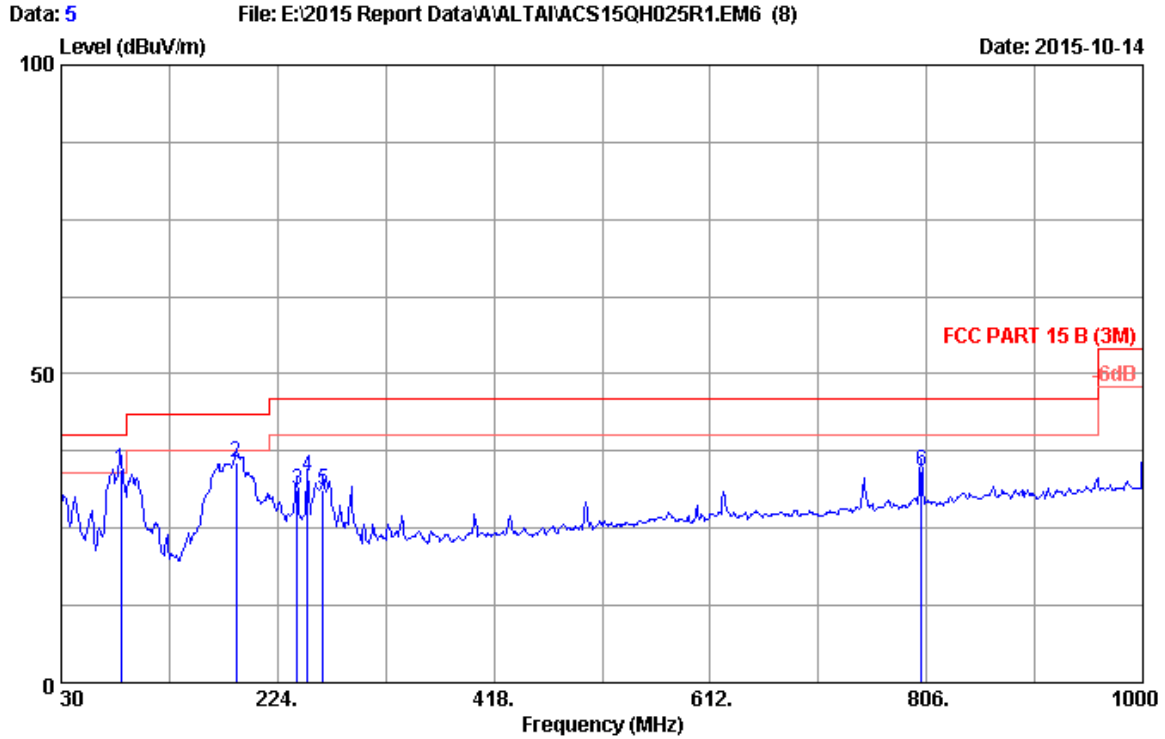

Site no. : 3m Chamber Data no. : 5  
 Dis. / Ant. : 3m 2015 CBL6112D 35375 Ant. pol. : VERTICAL  
 Limit : FCC PART 15 B (3M)  
 Env. / Ins. : 24°C/56% Engineer : Leo-Li  
 EUT : Altai A8-Ein (ac) Super WiFi Base Station  
 Power rating : DC 56V From POE Input AC 120V/60Hz  
 Test Mode : PC LINK  
 WA8011NAC

No.	Freq. (MHz)	Ant. Factor (dB/m)	Cable Loss (dB)	Reading (dBuV)	Emission Level (dBuV/m)	Limits (dBuV/m)	Margin (dB)	Remark
1	83.350	8.30	1.02	25.32	34.64	40.00	5.36	QP
2	187.140	10.10	1.46	24.08	35.64	43.50	7.86	QP
3	241.460	12.67	1.65	16.87	31.19	46.00	14.81	QP
4	251.160	13.32	1.71	18.51	33.54	46.00	12.46	QP
5	264.740	14.23	1.76	15.30	31.29	46.00	14.71	QP
6	801.150	21.09	3.26	9.81	34.16	46.00	11.84	QP

Remarks: 1. Emission Level= Antenna Factor + Cable Loss + Reading.  
 2. The emission levels that are 20dB below the official limit are not reported.  
 3. The worst emission was detected at 83.350 MHz with corrected signal level 34.64 dB $\mu$ V/m (Antenna height 2.0m; Turntable degree 56°).  
 4. 0° was the table front facing the antenna. Degree is calculated from 0° clockwise facing the antenna.

1GHz-18GHz

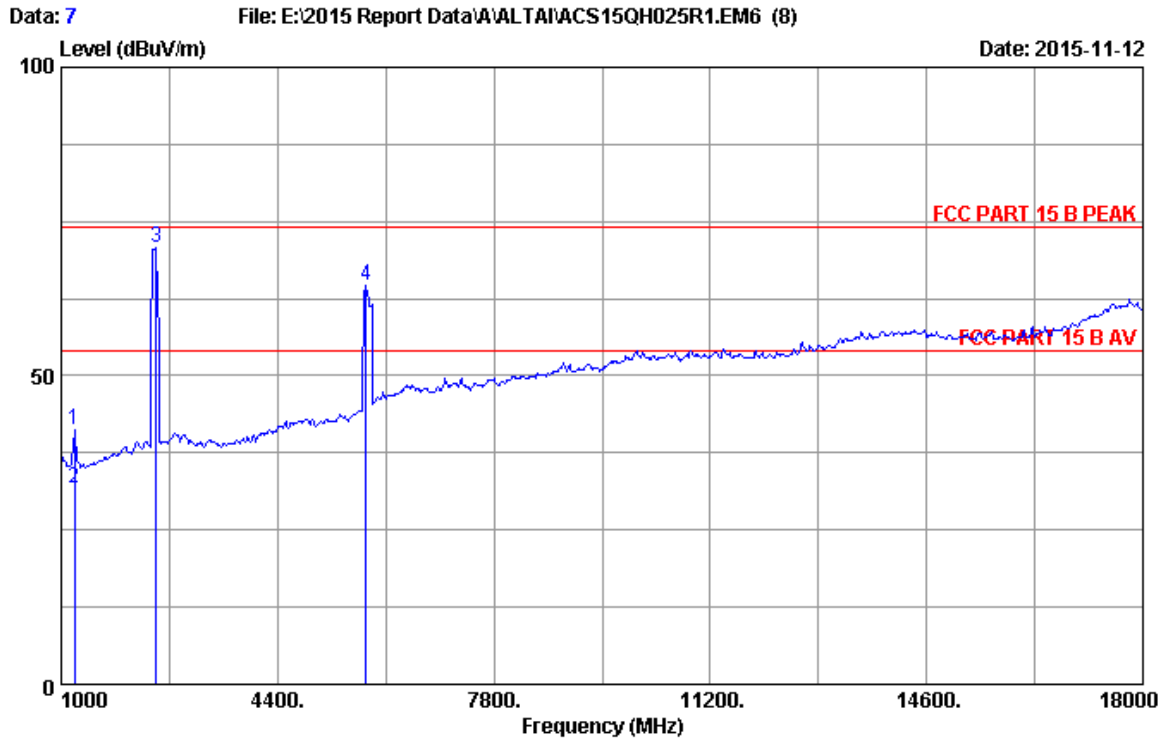

Site no. : 3m Chamber Data no. : 7  
 Dis. / Ant. : 3m 2015 MCTD1209-3007 Ant. pol. : HORIZONTAL  
 Limit : FCC PART 15 B PEAK  
 Env. / Ins. : 24°C/56% Engineer : Leo-Li  
 EUT : Altai A8-Ein (ac) Super WiFi Base Station  
 Power rating : DC 56V From POE Input AC 120V/60Hz  
 Test Mode : PC LINK  
 WA8011NAC

No.	Freq. (MHz)	Ant. Factor (dB/m)	Cable Loss (dB)	Amp factor (dB)	Reading (dBuV)	Emission Level (dBuV/m)	Limits (dBuV/m)	Margin (dB)	Remark
1	1204.00	25.03	1.97	35.63	49.86	41.23	74.00	32.77	Peak
2	1207.40	25.03	1.97	35.60	40.23	31.63	54.00	22.37	Average
3	2446.00	27.99	2.75	34.49	74.56	70.81	74.00	3.19	Peak
4	5794.00	34.00	4.56	33.67	59.86	64.75	74.00	9.25	Peak

- Remarks:
1. Emission Level= Antenna Factor + Cable Loss + Reading -Amp factor.
  2. The emission levels that are 20dB below the official limit are not reported.
  3. 2446MHz & 5794MHz are the signal from fundamental frequency, no need to comply with the limit.

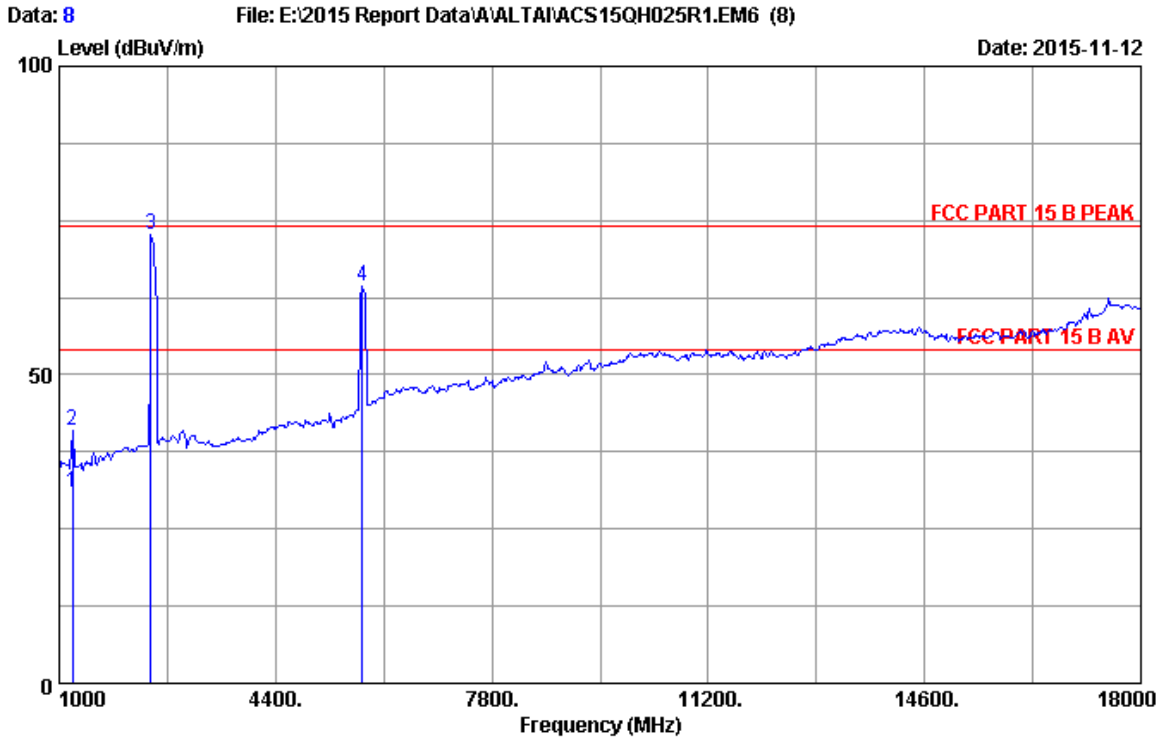

Site no. : 3m Chamber Data no. : 8  
 Dis. / Ant. : 3m 2015 MCTD1209-3007 Ant. pol. : VERTICAL  
 Limit : FCC PART 15 B PEAK  
 Env. / Ins. : 24°C/56% Engineer : Leo-Li  
 EUT : Altai A8-Ein (ac) Super WiFi Base Station  
 Power rating : DC 56V From POE Input AC 120V/60Hz  
 Test Mode : PC LINK  
 WA8011NAC

No.	Freq. (MHz)	Ant. Factor (dB/m)	Cable Loss (dB)	Amp factor (dB)	Reading (dBuV)	Emission Level (dBuV/m)	Limits (dBuV/m)	Margin (dB)	Remark
1	1204.00	25.03	1.97	35.63	39.57	30.94	54.00	23.06	Average
2	1204.00	25.03	1.97	35.63	49.50	40.87	74.00	33.13	Peak
3	2445.00	27.90	2.75	34.51	76.47	72.61	74.00	1.39	Peak
4	5760.00	33.83	4.54	33.70	59.59	64.26	74.00	9.74	Peak

Remarks: 1. Emission Level= Antenna Factor + Cable Loss + Reading -Amp factor.  
 2. The emission levels that are 20dB below the official limit are not reported.  
 3. 2445MHz & 5760MHz are the signal from fundamental frequency, no need to comply with the limit.