

FCC PART 15E TEST REPORT FOR CERTIFICATION  
On Behalf of

Altai Technologies Limited

Altai A8in (ac) Super WiFi Base Station

Model No.: WA8011NAC-H

FCC ID: UCC-WA8011NAC-H

Prepared for : Altai Technologies Limited

Units 209, 2/F, Lakeside 2.10 Science Park West Avenue,  
Hong Kong Science Park, Shatin, Hong Kong, China

Prepared By : Audix Technology (Shenzhen) Co., Ltd.

No. 6, Ke Feng Rd., 52 Block,  
Shenzhen Science & Industrial Park,  
Nantou, Shenzhen, Guangdong, China

Tel: (0755) 26639496

Report Number : ACS-F16075

Date of Test : Feb.01~Mar.14, 2016

Date of Report : Apr.29, 2016

**TABLE OF CONTENTS**

Description	Page
<b>1. SUMMARY OF STANDARDS AND RESULTS .....</b>	<b>1-1</b>
1.1. Description of Standards and Results .....	1-1
<b>2. GENERAL INFORMATION .....</b>	<b>2-1</b>
2.1. Description of Device (EUT) .....	2-1
2.2. Test Information .....	2-2
2.1. Tested Supporting System Details.....	2-3
2.2. Block diagram of connection between the EUT and simulators .....	2-3
2.3. Test Facility .....	2-4
2.4. Measurement Uncertainty (95% confidence levels, k=2).....	2-4
<b>3. POWER LINE CONDUCTED EMISSION TEST.....</b>	<b>3-1</b>
3.1. Test Equipments .....	3-1
3.2. Block Diagram of Test Setup .....	3-1
3.3. Power Line Conducted Emission Test Limits .....	3-1
3.4. Configuration of EUT on Test.....	3-2
3.5. Operating Condition of EUT .....	3-2
3.6. Test Procedure .....	3-2
3.7. Power Line Conducted Emission Test Results .....	3-2
<b>4. RADIATED EMISSION TEST .....</b>	<b>4-1</b>
4.1. Test Equipment.....	4-1
4.2. Block Diagram of Test Setup .....	4-2
4.3. Radiated Emission Limit .....	4-3
4.4. EUT Configuration on Test .....	4-3
4.5. Operating Condition of EUT .....	4-4
4.6. Test Procedure .....	4-4
4.7. Radiated Emission Test Results .....	4-5
<b>5. BAND EDGE COMPLIANCE TEST .....</b>	<b>5-1</b>
5.1. Test Equipment.....	5-1
5.2. Limit .....	5-1
5.3. Test Produce .....	5-1
5.4. Test Results .....	5-1
<b>6. 6dB&amp;26dB Bandwidth Test .....</b>	<b>6-1</b>
6.1. Test Equipment.....	6-1
6.2. Limit .....	6-1
6.3. Test Procedure .....	6-1
6.4. Test Results .....	6-1
<b>7. OUTPUT POWER TEST .....</b>	<b>7-1</b>
7.1. Test Equipment.....	7-1
7.2. Limit .....	7-1
7.3. Test Procedure .....	7-1
7.4. Test Results .....	7-2
<b>8. SPECTRAL DENSITY TEST .....</b>	<b>8-1</b>
8.1. Test Equipment.....	8-1
8.2. Limit .....	8-1
8.3. Test Procedure .....	8-1
8.4. Test Results .....	8-2
<b>9. FREQUENCY STABILITY MEASUREMENT .....</b>	<b>9-1</b>
9.1. Test Equipment.....	9-1
9.2. Limit .....	9-1
9.3. Test Procedure .....	9-1
9.4. Test Result .....	9-1

<b>10.</b>	<b>MPE ESTIMATION .....</b>	<b>10-1</b>
	10.1. Limit for General Population/ Uncontrolled Exposures .....	10-1
	10.2. Estimation Result.....	10-1
<b>11.</b>	<b>ANTENNA REQUIREMENT .....</b>	<b>11-1</b>
	11.1. Standard Applicable .....	11-1
	11.2. Antenna Connected Construction.....	11-1
<b>12.</b>	<b>DEVIATION TO TEST SPECIFICATIONS .....</b>	<b>12-1</b>
<b>13.</b>	<b>PHOTOGRAPH OF TEST.....</b>	<b>13-1</b>
	13.1. Photos of Power Line Conducted Emission Test .....	13-1
	13.2. Photos of Radiated Emission Test .....	13-2
<b>14.</b>	<b>PHOTOS OF THE EUT .....</b>	<b>14-1</b>

## TEST REPORT CERTIFICATION

Applicant : Altai Technologies Limited  
Manufacturer : Altai Technologies Limited  
Product : Altai A8in (ac) Super WiFi Base Station  
FCC ID : UCC-WA8011NAC-H  
(A) Model No. : WA8011NAC-H  
(B) Power Supply : DC 56V  
(C) Test Voltage : DC 56V From POE Input AC 120V/60Hz

Tested for comply with:  
FCC CFR 47 Part 15 Subpart E: 2014

Test procedure used:  
ANSI C63.10: 2013  
KDB789033D01

The device described above is tested by AUDIX TECHNOLOGY (SHENZHEN) CO., LTD. to confirm comply with all the FCC Part 15 Subpart E requirements. The test results are contained in this test report and AUDIX TECHNOLOGY (SHENZHEN) CO., LTD. is assumed full responsibility for the accuracy and completeness of these tests. Also, this report shows that the Equipment Under Test (EUT) is to be technically compliant with the FCC and IC requirements. This report contains data that are not covered by the NVLAP accreditation.

This Report is made under FCC Part 2.1075. No modifications were required during testing to bring this product into compliance.

This report applies to above tested sample only. This report shall not be reproduced in part without written approval of AUDIX TECHNOLOGY (SHENZHEN) CO., LTD.

The report must not be used by the client to claim product certification, approval, or endorsement by NVLAP, NIST, or any agency of the federal government.

Date of Test : Feb.01~Mar.14, 2016 Report of date: Apr.29, 2016

Prepared by : Kayli He Reviewed by : Sunny Lu  
Kayli He / Assistant Sunny Lu / Assistant Manager



Approved & Authorized Signer : David Jin  
David Jin / Manager

## 1. SUMMARY OF STANDARDS AND RESULTS

### 1.1. Description of Standards and Results

The EUT has been tested according to the applicable standards as referenced below.

EMISSION		
Description of Test Item	Standard	Results
Power Line Conducted Emission	FCC Part 15: 15.207	PASS
Radiated Emission	FCC Part 15: 15.209	PASS
Band Edge Compliance	FCC Part 15: 15.407	PASS
6dB&26Bandwidth Test	FCC Part 15: 15.407(a)	PASS
Output Power Test	FCC Part 15: 15.407(a)	PASS
Power Spectral Density Test	FCC Part 15: 15.407(a)	PASS
Frequency Stability	FCC Part 15: 15.407(g)	PASS
Antenna requirement	FCC Part 15: 15.203	PASS

N/A is an abbreviation for Not Applicable.

## 2. GENERAL INFORMATION

### 2.1. Description of Device (EUT)

Product	: Altai A8in (ac) Super WiFi Base Station
Model No.	: WA8011NAC-H
FCC ID	: UCC-WA8011NAC-H
Operation Frequency	: IEEE 802.11a: 5745MHz—5825MHz IEEE 802.11b: 2412MHz—2462MHz IEEE 802.11g: 2412MHz—2462MHz IEEE 802.11n HT20: 2412MHz—2462MHz; 5745MHz—5825MHz IEEE 802.11n HT40: 2422MHz—2452MHz; 5755MHz—5795MHz IEEE 802.11ac VHT20: 5745MHz—5825MHz IEEE 802.11ac VHT40: 5755MHz—5795MHz IEEE 802.11ac VHT80: 5775MHz
Modulation Technology	: IEEE 802.11b: DSSS(CCK,DQPSK,DBPSK) IEEE 802.11a/g: OFDM(64QAM, 16QAM, QPSK, BPSK) IEEE 802.11ac VHT20, VHT40, VHT80: OFDM(16QAM, 64QAM, 256QAM, QPSK, BPSK) IEEE 802.11n HT20, HT40: OFDM (64QAM, 16QAM,QPSK,BPSK)
Antenna Assembly Gain	: Sector Antenna, 2.4GHz: 14dBi gain, Panel Antenna, 5GHz: 20dBi gain
Applicant	: Altai Technologies Limited Units 209, 2/F, Lakeside 2.10 Science Park West Avenue, Hong Kong Science Park, Shatin, Hong Kong, China
Manufacturer	: Altai Technologies Limited Units 209, 2/F, Lakeside 2.10 Science Park West Avenue, Hong Kong Science Park, Shatin, Hong Kong, China
POE	: Manufacturer: FSGREAT;M/N: GRT-560110A INPUT:AC 100-240V 50/60Hz OUTPUT:56V 1100mA
Date of Test	: Feb.01~Mar.14, 2016
Date of Receipt	: Jan.26, 2016
Sample Type	: Prototype production

## 2.2. Test Information

A special test software was used to control EUT work in Continuous TX mode (nearly 100% duty cycle), and select test channel, wireless mode and data rate.

Tested mode, channel, and data rate information			
Mode	data rate (Mbps)(see Note)	Channel	Frequency (MHz)
IEEE 802.11a	6	Low :CH149	5745
	6	Middle: CH157	5785
	6	High: CH165	5825
IEEE 802.11nHT20	MCS0	Low :CH149	5745
	MCS0	Middle: CH157	5785
	MCS0	High: CH165	5825
IEEE 802.11nHT40	MCS0	Low :CH151	5755
	MCS0	High: CH159	5795
IEEE 802.11acVHT20	MCS0	Low :CH149	5745
	MCS0	Middle: CH157	5785
	MCS0	High: CH165	5825
IEEE 802.11acVHT40	MCS0	Low :CH151	5755
	MCS0	High: CH159	5795
IEEE 802.11acVHT80	MCS0	CH155	5775

Note: 1. According exploratory test, EUT will have maximum output power in those data rate, so those data rate were used for all test.

Note: 2. This device use MIMO Mode, test with two antenna transmit simultaneously and comply with KDB662911D01 V02r01.

2.1. Tested Supporting System Details

No.	Description	ACS No.	Manufacturer	Model	Serial Number
1	Notebook	N/A	DELL	PP09S	N/A
		Power Cord: Unshielded, Detachable, 1.8m Power Adapter: Manufacturer: DELL, M/N: LA65NS1-00 Cable: Unshielded, Detachable, 4.0m(Bond one ferrite core)			

2.2. Block diagram of connection between the EUT and simulators

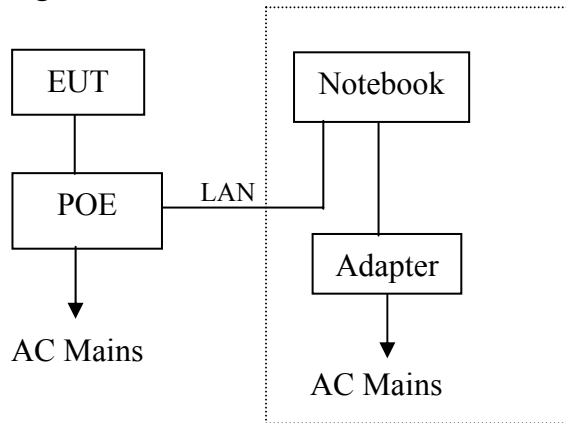

**(EUT: Altai A8in (ac) Super WiFi Base Station)**



**2.3. Test Facility**

Site Description

Name of Firm : Audix Technology (Shenzhen) Co., Ltd.  
 No. 6, Ke Feng Rd., 52 Block, Shenzhen  
 Science & Industrial Park, Nantou, Shenzhen,  
 Guangdong, China

3m Anechoic Chamber : Certificated by FCC, USA  
 Registration Number: 90454  
 Valid Date: Dec.30, 2017

3m & 10m Anechoic Chamber : Certificated by FCC, USA  
 Registration Number: 794232  
 Valid Date: Jul.12, 2016

EMC Lab. : Certificated by Industry Canada  
 Registration Number: IC 5183A-1  
 Valid Date: May.14, 2017

: Certificated by DAkkS, Germany  
 Registration No: D-PL-12151-01-00  
 Valid Date: Dec.15, 2016

: Accredited by NVLAP, USA  
 NVLAP Code: 200372-0  
 Valid Date: Mar.31, 2017

**2.4. Measurement Uncertainty (95% confidence levels, k=2)**

Test Item	Uncertainty
Uncertainty for Conduction emission test in No. 1 Conduction	3.4dB (150KHz to 30MHz)
Uncertainty for Radiation Emission test in 3m chamber	2.6dB (30~200MHz, Polarization: H)
	2.6dB (30~200MHz, Polarization: V)
	3.0dB (200M~1GHz, Polarization: H)
	2.8dB (200M~1GHz, Polarization: V)
Uncertainty for Radiation Emission test in 3m chamber (1GHz-18GHz)	6.3dB (1~6GHz, Distance: 3m)
	5.7dB (6~18GHz, Distance: 3m)
Uncertainty for Radiated Spurious Emission test in RF chamber	3.6dB
Uncertainty for Conduction Spurious emission test	2.0dB
Uncertainty for Output power test	0.8dB
Uncertainty for Bandwidth test	83kHz
Uncertainty for DC power test	0.1%
Uncertainty for test site temperature and humidity	0.6°C
	3%

### 3. POWER LINE CONDUCTED EMISSION TEST

#### 3.1. Test Equipments

Item	Equipment	Manufacturer	Model No.	Serial No.	Last Cal.	Cal. Interval
1.	1# Shielding Room	AUDIX	N/A	N/A	Apr.17,15	1 Year
2.	Test Receiver	Rohde & Schwarz	ESCI	100842	Apr.28,15	1 Year
3.	L.I.S.N.#1	Rohde & Schwarz	ESH2-Z5	100429	Oct.18,15	1 Year
4.	L.I.S.N.#2	Kyoritsu	K NW-403D	8-1750-2	Apr.28,15	1 Year
5.	Terminator	Hubersuhner	50Ω	No.1	Apr.28,15	1 Year
6.	Terminator	Hubersuhner	50Ω	No.2	Apr.28,15	1 Year
7.	RF Cable	MIYAZAKI	3D-2W	No.1	Apr.28,15	1Year
8.	Coaxial Switch	Anritsu	MP59B	6200766906	Apr.28,15	1 Year
9.	Test Software	AUDIX	e3	6.100913a	N/A	N/A

#### 3.2. Block Diagram of Test Setup

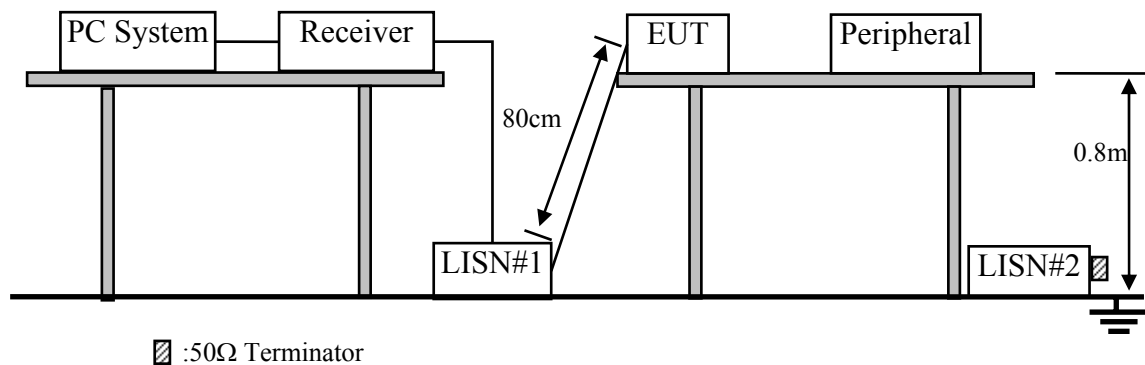

#### 3.3. Power Line Conducted Emission Test Limits

Frequency	Maximum RF Line Voltage	
	Quasi-Peak Level dB(μV)	Average Level dB(μV)
150kHz ~ 500kHz	66 ~ 56*	56 ~ 46*
500kHz ~ 5MHz	56	46
5MHz ~ 30MHz	60	50

Notes: 1. \* Decreasing linearly with logarithm of frequency.

2. The lower limit shall apply at the transition frequencies.

### 3.4. Configuration of EUT on Test

The following equipment are installed on Power Line Conducted Emission Test to meet the commission requirement and operating regulations in a manner which tends to maximize its emission characteristics in a normal application.

#### 3.4.1. Altai A8in (ac) Super WiFi Base Station (EUT)

Model No. : WA8011NAC-H  
Serial No. : N/A

#### 3.4.2. Support Equipment: As Tested Supporting System Details, in Section 2.2.

### 3.5. Operating Condition of EUT

3.5.1. Setup the EUT and simulator as shown as Section 3.2.

3.5.2. Turn on the power of all equipments.

3.5.3. PC run test software to control EUT work in Tx mode.

### 3.6. Test Procedure

The EUT was placed on a non-metallic table, 80cm above the ground plane. The EUT Power Via PC connected to the power mains through a line impedance stabilization network (L.I.S.N. 1#). This provides a 50 ohm coupling impedance for the EUT (Please refer the block diagram of the test setup and photographs). The AC line are checked to find out the maximum conducted emission. In order to find the maximum emission levels, the relative positions of equipment and all of the interface cables shall be changed according to ANSI C63.10: 2013 on Conducted Emission Test.

The bandwidth of test receiver (R & S ESCI) is set at 9kHz.

The frequency range from 150kHz to 30MHz is checked.

### 3.7. Power Line Conducted Emission Test Results

**PASS.** (All emissions not reported below are too low against the prescribed limits.)

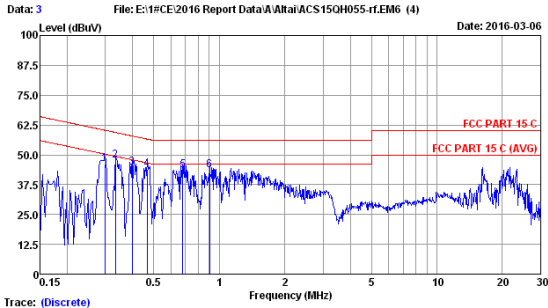

Trace: (Discrete)  
 Site no :1# Conduction Data No :3  
 Dis./Lisn :2015 ESH2-25 LINE  
 Limit :FCC PART 15 C  
 Env./Ins. :25.2°C/53% Engineer :Alvis-Wu  
 EUT :Altai A8in (ac) Super WiFi Base Station  
 Power Rating :DC 56V From POE Input AC 120V/60Hz  
 Test Mode :Tx Mode  
 N/N:WA8011NAC-H

No	Freq (MHz)	LISN Factor (dB)	Cable Loss (dB)	Reading (dBuV)	Emission Level (dBuV)	Limits (dBuV)	Margin (dB)	Remark
1	0.299	0.13	0.05	45.80	45.98	60.28	14.30	QP
2	0.334	0.13	0.06	47.26	47.45	59.35	11.90	QP
3	0.398	0.75	0.06	43.66	44.47	57.90	13.43	QP
4	0.466	0.33	0.06	43.38	43.77	56.58	12.81	QP
5	0.679	0.15	0.06	43.44	43.65	56.00	12.35	QP
6	0.904	0.16	0.07	43.18	43.41	56.00	12.59	QP

Remarks: 1. Emission Level=LISN Factor+Cable Loss+Reading.  
 2. If the average limit is met when using a quasi-peak detector, the EUT shall be deemed to meet both limits and measurement with average detector is unnecessary.

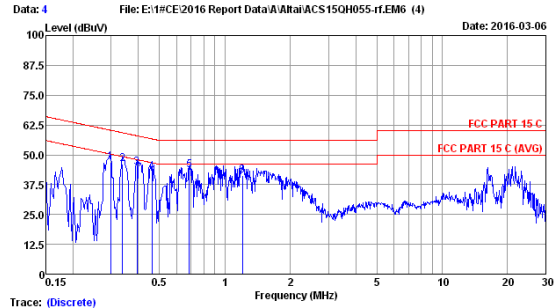

Trace: (Discrete)  
 Site no :1# Conduction Data No :4  
 Dis./Lisn :2015 ESH2-25 NEUTRAL  
 Limit :FCC PART 15 C  
 Env./Ins. :25.2°C/53% Engineer :Alvis-Wu  
 EUT :Altai A8in (ac) Super WiFi Base Station  
 Power Rating :DC 56V From POE Input AC 120V/60Hz  
 Test Mode :Tx Mode  
 N/N:WA8011NAC-H

No	Freq (MHz)	LISN Factor (dB)	Cable Loss (dB)	Reading (dBuV)	Emission Level (dBuV)	Limits (dBuV)	Margin (dB)	Remark
1	0.299	0.13	0.05	46.69	46.87	60.28	13.41	QP
2	0.337	0.13	0.06	45.81	46.00	59.27	13.27	QP
3	0.393	0.14	0.06	44.32	44.52	57.99	13.47	QP
4	0.461	0.14	0.06	42.76	42.96	56.67	13.71	QP
5	0.686	0.15	0.06	43.26	43.47	56.00	12.53	QP
6	1.203	0.17	0.09	41.10	41.36	56.00	14.64	QP

Remarks: 1. Emission Level=LISN Factor+Cable Loss+Reading.  
 2. If the average limit is met when using a quasi-peak detector, the EUT shall be deemed to meet both limits and measurement with average detector is unnecessary.

## 4. RADIATED EMISSION TEST

### 4.1. Test Equipment

#### 4.1.1. For frequency range 30 MHz ~1000MHz (In 3m Anechoic Chamber)

Item	Equipment	Manufacturer	Model No.	Serial No.	Last Cal.	Cal. Interval
1.	3#Chamber	AUDIX	N/A	N/A	Mar.28,15	1 Year
2.	EMI Spectrum	Agilent	E4407B	MY41440292	Apr.28,15	1 Year
3.	Test Receiver	Rohde & Schwarz	ESVS10	834468/011	Apr.28,15	1 Year
4.	Amplifier	HP	8447D	2648A04738	Apr.28,15	1 Year
5.	Bilog Antenna	TESEQ	CBL6112D	35375	Jun.30,15	1 Year
6.	RF Cable	MIYAZAKI	CFD400-NW(3.5M)	No.3	Apr.28,15	1 Year
7.	RF Cable	MIYAZAKI	CFD400-LW(22M)	No.7	Apr.28,15	1 Year
8.	Coaxial Switch	Anritsu	MP59B	6201397222	Apr.28,15	1 Year
9.	Test Software	AUDIX	e3	6.2009-5-21a(n)	N/A	N/A

#### 4.1.2. For frequency range 1GHz~40GHz (In 3m Anechoic Chamber)

Item	Equipment	Manufacturer	Model No.	Serial No.	Last Cal.	Cal. Interval
1.	Spectrum Analyzer	Agilent	E4446A	US44300459	Apr.28,15	1 Year
2.	Horn Antenna	ETS	3115	9510-4877	Oct.15,15	1 Year
3.	Amplifier	Agilent	8449B	3008A02495	Apr.28,15	1 Year
4.	RF Cable	Hubersuhner	SUCOFLEX106	77977/6	Apr.28,15	1 Year
5.	Horn Antenna	ETS	3116	00060088	Nov.18.15	1 Year
6.	Test Software	AUDIX	e3	6.2009-5-21a(n)	N/A	N/A

### 4.2. Block Diagram of Test Setup

For frequency range 30MHz-1000MHz

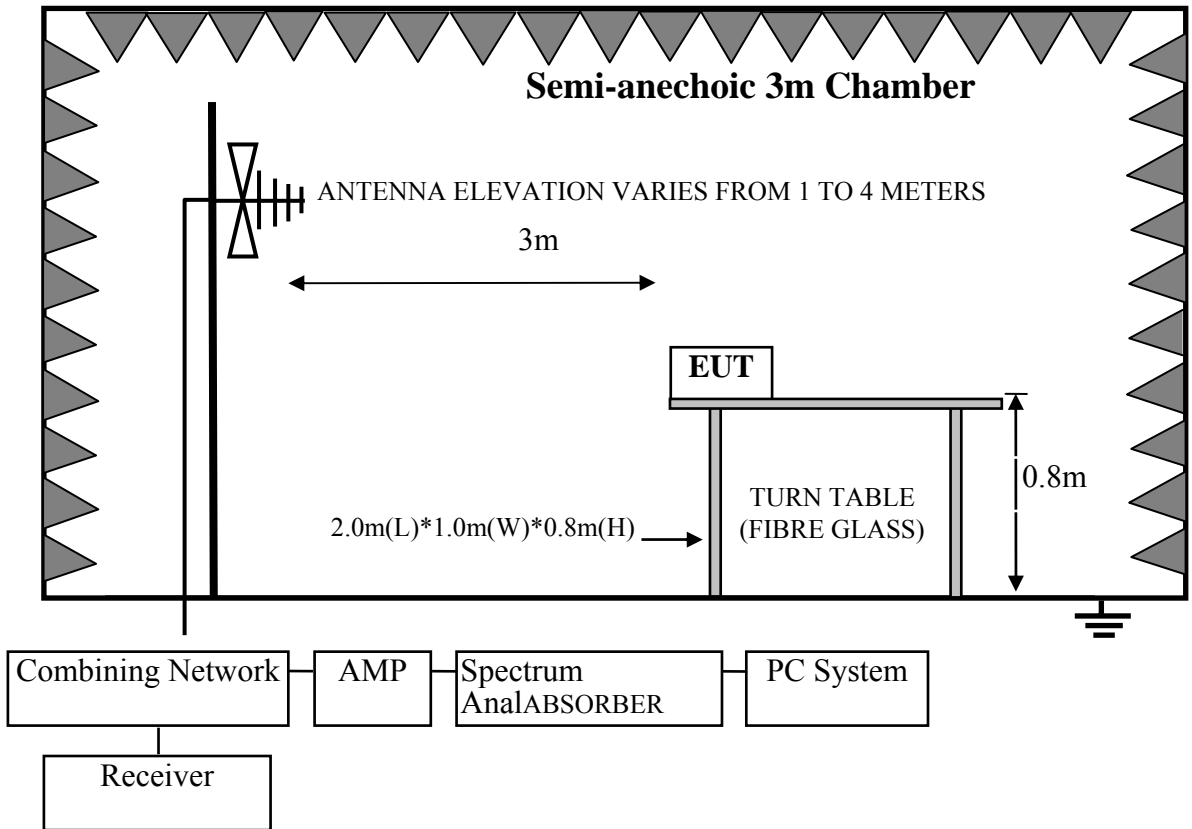

For frequency range 1GHz-40GHz

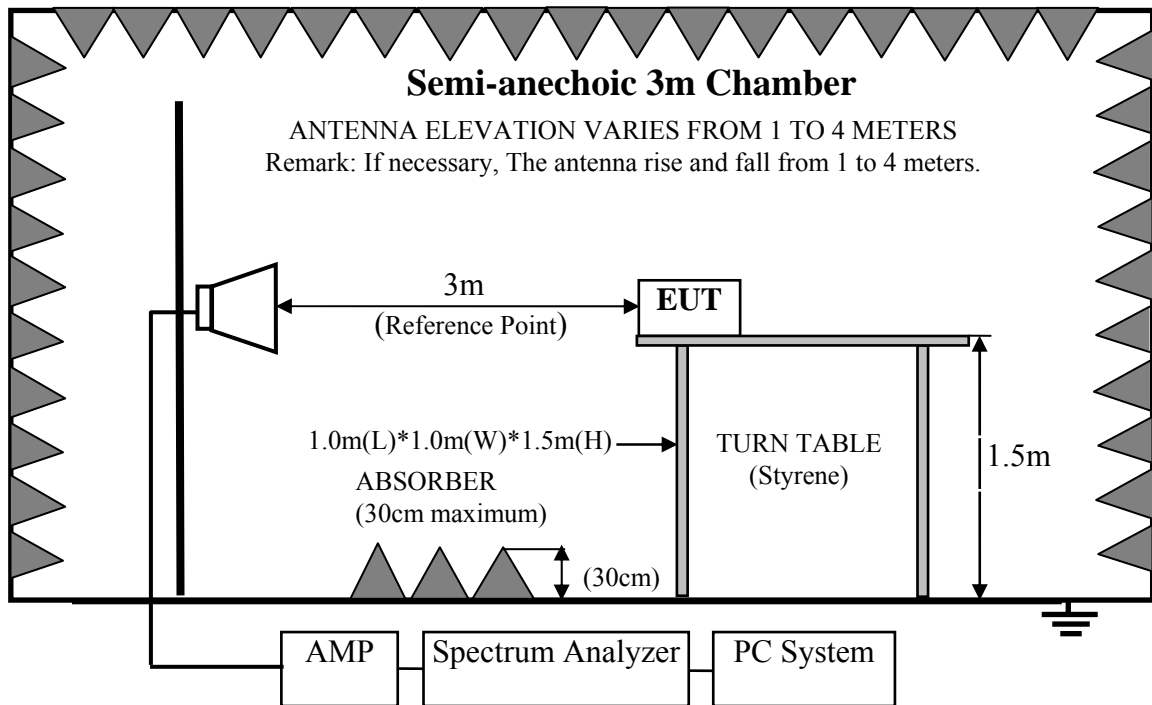

### 4.3. Radiated Emission Limit

For transmitters operating in the 5.15-5.25 GHz; 5.25-5.35GHz; 5.47-5.725GHz, 5.725-5.850GHz band: all emissions outside of those band shall not exceed an EIRP of -27 dBm/MHz. Unwanted emissions below 1 GHz and those emissions appearing within 15.205 restricted frequency bands must comply with the general field strength limits set forth in Section 15.209

#### 4.3.1.15.209 limits

FREQUENCY MHz	DISTANCE Meters	FIELD STRENGTHS LIMIT	
		μV/m	dB(μV)/m
30 ~ 88	3	100	40.0
88 ~ 216	3	150	43.5
216 ~ 960	3	200	46.0
960 ~ 1000	3	500	54.0
Above 1000	3	74.0 dB(μV)/m (Peak) 54.0 dB(μV)/m (Average)	

- Remarks :
- (1) Emission level dBμV = 20 log Emission level μV/m
  - (2) The smaller limit shall apply at the cross point between two frequency bands.
  - (3) Distance is the distance in meters between the measuring instrument, antenna and the closest point of any part of the device or system.

#### 4.3.2.15.205 Restricted bands of operation

MHz	MHz	MHz	GHz
0.090 - 0.110	16.42 - 16.423	399.9 - 410	4.5 - 5.15
<sup>1</sup> 0.495 - 0.505	16.69475 - 16.69525	608 - 614	5.35 - 5.46
2.1735 - 2.1905	16.80425 - 16.80475	960 - 1240	7.25 - 7.75
4.125 - 4.128	25.5 - 25.67	1300 - 1427	8.025 - 8.5
4.17725 - 4.17775	37.5 - 38.25	1435 - 1626.5	9.0 - 9.2
4.20725 - 4.20775	73 - 74.6	1645.5 - 1646.5	9.3 - 9.5
6.215 - 6.218	74.8 - 75.2	1660 - 1710	10.6 - 12.7
6.26775 - 6.26825	108 - 121.94	1718.8 - 1722.2	13.25 - 13.4
6.31175 - 6.31225	123 - 138	2200 - 2300	14.47 - 14.5
8.291 - 8.294	149.9 - 150.05	2310 - 2390	15.35 - 16.2
8.362 - 8.366	156.52475 - 156.52525	2483.5 - 2500	17.7 - 21.4
8.37625 - 8.38675	156.7 - 156.9	2690 - 2900	22.01 - 23.12
8.41425 - 8.41475	162.0125 - 167.17	3260 - 3267	23.6 - 24.0
12.29 - 12.293	167.72 - 173.2	3332 - 3339	31.2 - 31.8
12.51975 - 12.52025	240 - 285	3345.8 - 3358	36.43 - 36.5
12.57675 - 12.57725	322 - 335.4	3600 - 4400	( <sup>2</sup> )

### 4.4. EUT Configuration on Test

The following equipment are installed on Power Line Conducted Emission Test to meet the commission requirement and operating regulations in a manner which tends to maximize its emission characteristics in a normal application.

#### 4.4.1. Altai A8in (ac) Super WiFi Base Station (EUT)

Model Number : WA8011NAC-H  
Serial Number : N/A

#### 4.4.2. Support Equipment: As Tested Supporting System Details, in Section 2.2.

#### 4.5. Operating Condition of EUT

- 4.5.1. Setup the EUT and simulator as shown as Section 4.2.
- 4.5.2. Turn on the power of all equipments.
- 4.5.3. Let EUT work in Tx mode.

#### 4.6. Test Procedure

EUT and its simulators are placed on a turn table, which is 0.8 meter high above ground for frequency 30MHz~1000MHz, 1.5 meter high above ground for frequency above 1GHz and put the absorbing with 2.4m(L)\*2.4m(W)\*0.3m(H) on the ground . The turn table can rotate 360 degrees to determine the position of the maximum emission level. Power on the EUT and let it working in test mode, then test it. EUT is set 3 meters away from the receiving antenna, which is mounted on a antenna tower. The antenna can be moved up and down between 1 meter and 4 meters to find out the maximum emission level. Broadband antenna (calibrated bilog antenna) is used as receiving antenna for frequency 30MHz~1000MHz, and the Horn antenna is used as receiving antenna for frequency above 1GHz. Both horizontal and vertical polarization of the antenna is set on Test. In order to find the maximum emission levels, all of the interface cables must be manipulated according to ANSI C63.10-2013 on radiated emission Test.

For emissions below 1GHz and those emissions appearing within 15.205 restricted frequency bands use below procedure:

The bandwidth of the EMI test receiver (R&S ESVS10) is set at 120kHz for frequency range from 30MHz to 1000 MHz.

The bandwidth of the Spectrum's VBW is set at 1MHz and RBW is set at 1MHz for peak emissions measurement above 1GHz and 1MHz RBW, 10Hz VBW for average emissions measure above 1GHz

For the emissions above 1GHz and not appearing within 15.205 restricted frequency bands use below procedure:

- (1). The maximum emission at 3m distance was measured and recorded with receive antenna in both vertical and horizontal by rotating the turntable and by lowering the receive antenna.
- (2). The EUT was then removed and replaced with a substitution antenna in the same position and the substitution antenna must have the same polarization with the receive antenna.
- (3). A signal which have the same frequency obtained in step 2 was fed to the substitution, the receive antenna was raised and lowered to obtain a maximum reading at the test receiver, the level of the signal generator was adjusted until the measured field strength level in step 2 was obtained, recorded the level of the signal generator.
- (4). Repeated step 4 with both antenna polarizations
- (5). The spurious emissions is equal to the power supplied by the signal generator and corrections due to the gain of the substitution antenna and the cable loss between the signal generator and the substitution antenna. or use procedure (6).
- (6). Per KDB789033 clause H 2)d). if the test distance is 3m, the  $EIRP(dBm) = E(dB\mu v/m) - 95.2$   
Get the result of all unwanted emission outside the restricted band is less than the -27dBm/MHz.

We had checked frequency range that is 30MHz to 10<sup>th</sup> harmonic (40GHz) and no any emissions were found from 18GHz to 40GHz, so the radiated emission from 18GHz to 40GHz were not record.



### 4.7. Radiated Emission Test Results

**PASS.**

All the emissions from 30MHz to 1 GHz were comply with 15.209 limits.  
All other emission comply with 15.407 (b)(1) requirements.

#### Duty cycle

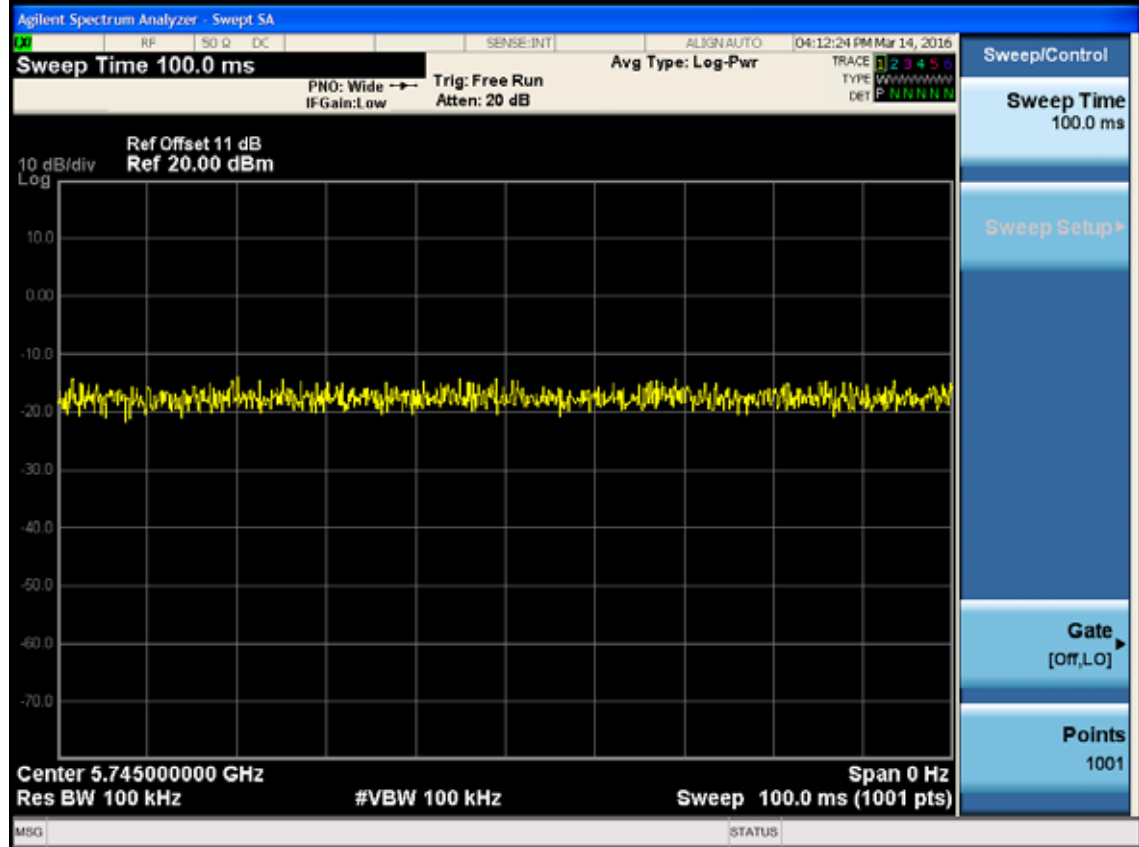

**Note: The Duty Cycle is close to 100%.**

### Frequency: 30MHz~1GHz

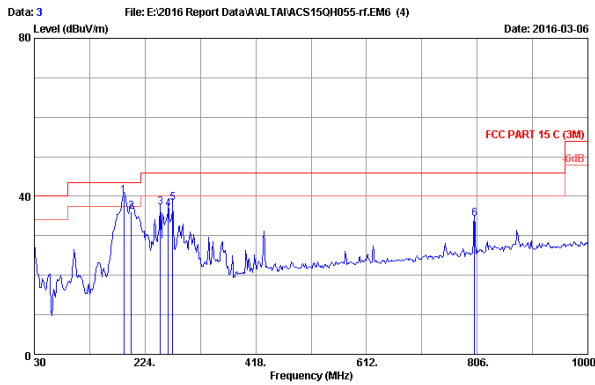

File: E:\2016 Report Data\A\ALTAI\ACS150H055-rf.EM6 (4) Date: 2016-03-06

Site no. : 3m Chamber Data no. : 3  
 Dis. / Ant. : 3m 2015 CBL6112D 35375 Ant. pol. : HORIZONTAL  
 Limit : FCC PART 15 C (3M)  
 Env. / Ins. : 20.6°C/55% Engineer : Donjon  
 EUT : Alcatel 481n (ac) Super WiFi Base Station  
 Power rating : DC 56V From POE Input AC 120V/60Hz  
 Test Mode : Tx Mode  
 WA8011NAC-H

No.	Freq. (MHz)	Ant. Factor (dB/m)	Cable Loss (dB)	Reading (dBuV)	Emission Level (dBuV/m)	Limits (dBuV/m)	Margin (dB)	Remark
1	187.140	10.21	1.46	28.40	40.07	43.50	3.43	QP
2	199.750	10.60	1.51	24.10	36.21	43.50	7.29	QP
3	251.160	13.57	1.71	21.84	37.12	46.00	8.88	QP
4	264.740	14.20	1.76	20.82	36.78	46.00	9.22	QP
5	272.500	14.05	1.79	22.51	38.35	46.00	7.65	QP
6	801.150	21.11	3.26	9.89	34.26	46.00	11.74	QP

Remarks: 1. Emission Level= Antenna Factor + Cable Loss + Reading.  
 2. The emission levels that are 20dB below the official limit are not reported.

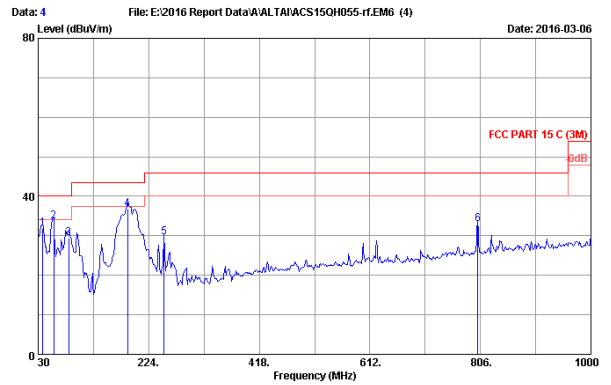

File: E:\2016 Report Data\A\ALTAI\ACS150H055-rf.EM6 (4) Date: 2016-03-06

Site no. : 3m Chamber Data no. : 4  
 Dis. / Ant. : 3m 2015 CBL6112D 35375 Ant. pol. : VERTICAL  
 Limit : FCC PART 15 C (3M)  
 Env. / Ins. : 20.6°C/55% Engineer : Donjon  
 EUT : Alcatel 481n (ac) Super WiFi Base Station  
 Power rating : DC 56V From POE Input AC 120V/60Hz  
 Test Mode : Tx Mode  
 WA8011NAC-H

No.	Freq. (MHz)	Ant. Factor (dB/m)	Cable Loss (dB)	Reading (dBuV)	Emission Level (dBuV/m)	Limits (dBuV/m)	Margin (dB)	Remark
1	37.760	15.34	0.61	15.99	31.94	40.00	8.06	QP
2	57.160	7.64	0.85	25.17	33.66	40.00	6.34	QP
3	83.350	8.43	1.02	20.07	29.52	40.00	10.48	QP
4	187.140	10.21	1.46	25.18	36.85	43.50	6.65	QP
5	251.160	13.57	1.71	14.35	29.63	46.00	16.37	QP
6	801.150	21.11	3.26	8.53	32.90	46.00	13.10	QP

Remarks: 1. Emission Level= Antenna Factor + Cable Loss + Reading.  
 2. The emission levels that are 20dB below the official limit are not reported.

### Frequency: 1GHz~18GHz

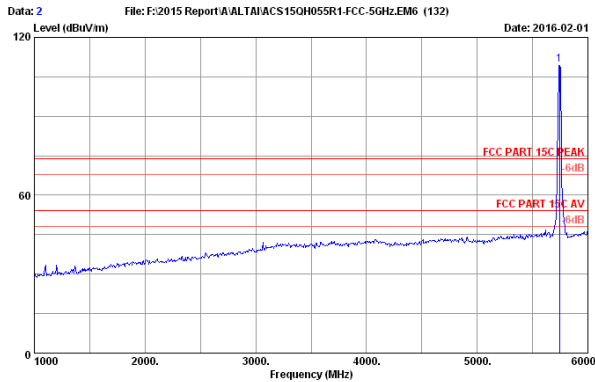

Site no. : 3m Chamber Data no. : 2  
 Dis. / Ant. : 3m 2015 3115-4877 Ant. pol. : HORIZONTAL  
 Limit : FCC PART 15C PEAK  
 Env. / Ins. : 23°C/54%  
 Engineer : Leo-Li  
 EUT : Altai A8in (ac) Super WiFi Base Station  
 Power rating : DC 56V From POE Input AC 120V/60Hz  
 Test Mode : IEEE802.11a 5745MHz Tx  
 WA8011NAC-H

No.	Freq. (MHz)	Ant. Factor (dB/m)	Cable Loss (dB)	AMP factor (dB)	Reading (dBuV)	Emission Level (dBuV/m)	Limits (dBuV/m)	Margin (dB)	Remark
1	5745.000	34.55	9.90	35.11	100.35	109.69	74.00	-35.69	Peak

Remarks: 1. Emission Level= Antenna Factor + Cable Loss + Reading - Amp Factor  
 2. The emission levels that are 20dB below the official limit are not reported.

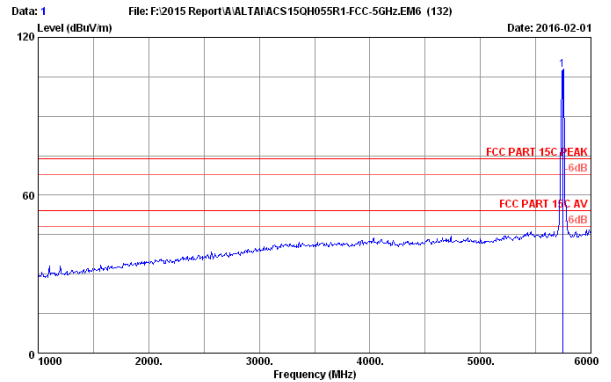

Site no. : 3m Chamber Data no. : 1  
 Dis. / Ant. : 3m 2015 3115-4877 Ant. pol. : VERTICAL  
 Limit : FCC PART 15C PEAK  
 Env. / Ins. : 23°C/54%  
 Engineer : Leo-Li  
 EUT : Altai A8in (ac) Super WiFi Base Station  
 Power rating : DC 56V From POE Input AC 120V/60Hz  
 Test Mode : IEEE802.11a 5745MHz Tx  
 WA8011NAC-H

No.	Freq. (MHz)	Ant. Factor (dB/m)	Cable Loss (dB)	AMP factor (dB)	Reading (dBuV)	Emission Level (dBuV/m)	Limits (dBuV/m)	Margin (dB)	Remark
1	5745.000	34.55	9.90	35.11	98.25	107.59	74.00	-33.59	Peak

Remarks: 1. Emission Level= Antenna Factor + Cable Loss + Reading - Amp Factor  
 2. The emission levels that are 20dB below the official limit are not reported.

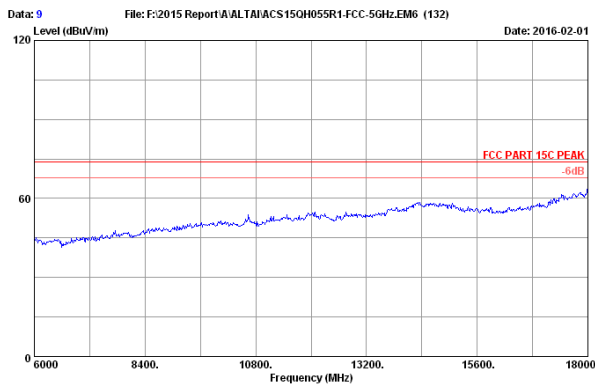

Site no. : 3m Chamber Data no. : 9  
 Dis. / Ant. : 3m 2015 3115-4877 Ant. pol. : HORIZONTAL  
 Limit : FCC PART 15C PEAK  
 Env. / Ins. : 23°C/54%  
 Engineer : Leo-Li  
 EUT : Altai A8in (ac) Super WiFi Base Station  
 Power rating : DC 56V From POE Input AC 120V/60Hz  
 Test Mode : IEEE802.11a 5745MHz Tx  
 WA8011NAC-H

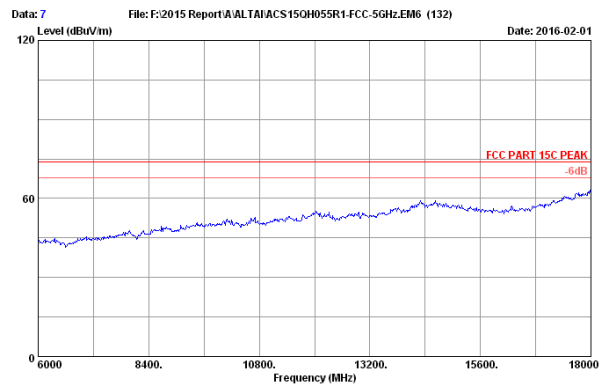

Site no. : 3m Chamber Data no. : 7  
 Dis. / Ant. : 3m 2015 3115-4877 Ant. pol. : VERTICAL  
 Limit : FCC PART 15C PEAK  
 Env. / Ins. : 23°C/54%  
 Engineer : Leo-Li  
 EUT : Altai A8in (ac) Super WiFi Base Station  
 Power rating : DC 56V From POE Input AC 120V/60Hz  
 Test Mode : IEEE802.11a 5745MHz Tx  
 WA8011NAC-H

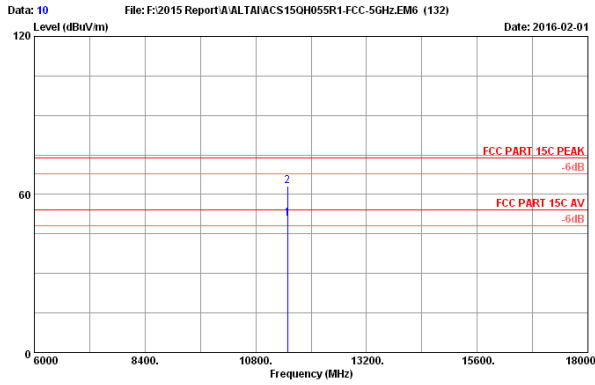

Site no. : 3m Chamber Data no. : 10  
 Dis. / Ant. : 3m 2015 3115-4877 Ant. pol. : HORIZONTAL  
 Limit : FCC PART 15C PEAK  
 Env. / Ins. : 23°C/54%  
 Engineer : Leo-Li  
 EUT : Alcatel A81in (ac) Super WiFi Base Station  
 Power rating : DC 56V From POE Input AC 120V/60Hz  
 Test Mode : IEEE802.11a 5745MHz Tx  
 WA8011NAC-H

No.	Freq. (MHz)	Ant. Factor (dB/m)	Cable Loss (dB)	AMP factor (dB)	Reading (dBuV)	Emission Level (dBuV/m)	Limits (dBuV/m)	Margin (dB)	Remark
1	11490.000	39.09	14.54	35.33	32.46	50.76	54.00	3.24	Average
2	11490.000	39.09	14.54	35.33	44.79	63.09	74.00	10.91	Peak

Remarks: 1. Emission Level= Antenna Factor + Cable Loss + Reading - Amp Factor  
 2. The emission levels that are 20dB below the official limit are not reported.

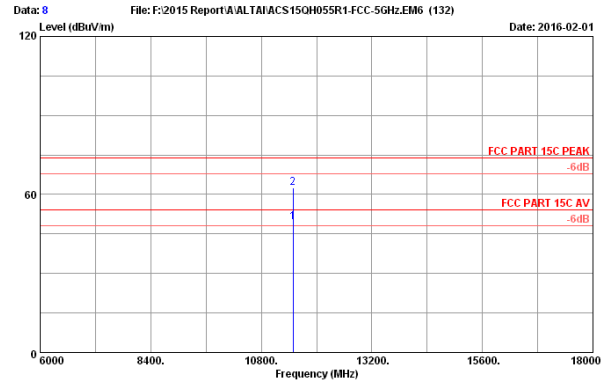

Site no. : 3m Chamber Data no. : 8  
 Dis. / Ant. : 3m 2015 3115-4877 Ant. pol. : VERTICAL  
 Limit : FCC PART 15C PEAK  
 Env. / Ins. : 23°C/54%  
 Engineer : Leo-Li  
 EUT : Alcatel A81in (ac) Super WiFi Base Station  
 Power rating : DC 56V From POE Input AC 120V/60Hz  
 Test Mode : IEEE802.11a 5745MHz Tx  
 WA8011NAC-H

No.	Freq. (MHz)	Ant. Factor (dB/m)	Cable Loss (dB)	AMP factor (dB)	Reading (dBuV)	Emission Level (dBuV/m)	Limits (dBuV/m)	Margin (dB)	Remark
1	11490.000	39.09	14.54	35.33	31.27	49.57	54.00	4.43	Average
2	11490.000	39.09	14.54	35.33	44.19	62.49	74.00	11.51	Peak

Remarks: 1. Emission Level= Antenna Factor + Cable Loss + Reading - Amp Factor  
 2. The emission levels that are 20dB below the official limit are not reported.

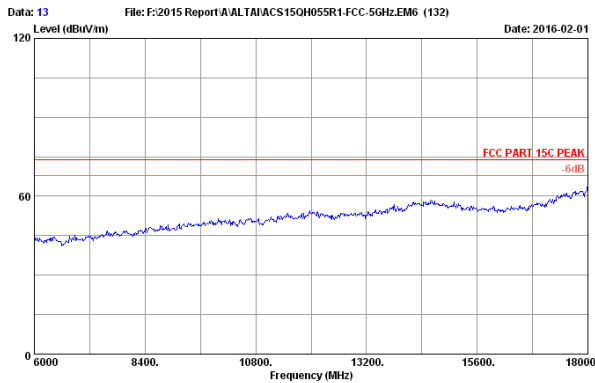

Site no. : 3m Chamber Data no. : 13  
 Dis. / Ant. : 3m 2015 3115-4877 Ant. pol. : HORIZONTAL  
 Limit : FCC PART 15C PEAK  
 Env. / Ins. : 23°C/54%  
 Engineer : Leo-Li  
 EUT : Alcatel A81in (ac) Super WiFi Base Station  
 Power rating : DC 56V From POE Input AC 120V/60Hz  
 Test Mode : IEEE802.11a 5825MHz Tx  
 WA8011NAC-H

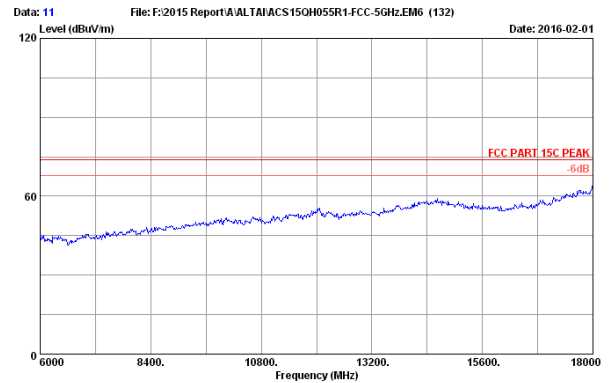

Site no. : 3m Chamber Data no. : 11  
 Dis. / Ant. : 3m 2015 3115-4877 Ant. pol. : VERTICAL  
 Limit : FCC PART 15C PEAK  
 Env. / Ins. : 23°C/54%  
 Engineer : Leo-Li  
 EUT : Alcatel A81in (ac) Super WiFi Base Station  
 Power rating : DC 56V From POE Input AC 120V/60Hz  
 Test Mode : IEEE802.11a 5825MHz Tx  
 WA8011NAC-H

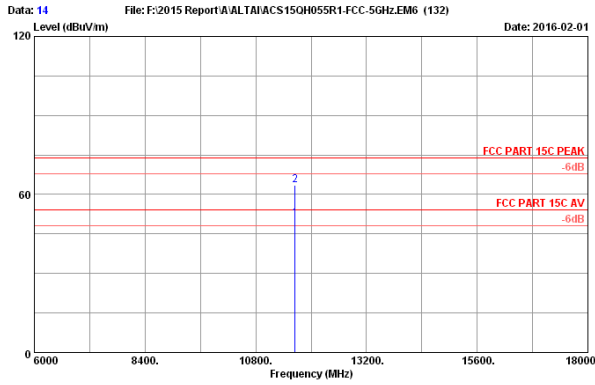

Site no. : 3m Chamber Data no. : 14  
 Dis. / Ant. : 3m 2015 3115-4877 Ant. pol. : HORIZONTAL  
 Limit : FCC PART 15C PEAK  
 Env. / Ins. : 23°C/54%  
 Engineer : Leo-Li  
 EUT : Alcatel ASin (ac) Super WiFi Base Station  
 Power rating : DC 56W From POE Input AC 120V/60Hz  
 Test Mode : IEEE802.11a 5825MHz Tx  
 WA8011NAC-H

No.	Freq. (MHz)	Ant. Factor (dB/m)	Cable Loss (dB)	AMP factor (dB)	Reading (dBuV)	Emission Level (dBuV/m)	Limits (dBuV/m)	Margin (dB)	Remark
1	11650.000	39.19	14.66	35.29	32.36	50.92	54.00	3.08	Average
2	11650.000	39.19	14.66	35.29	44.90	63.46	74.00	10.54	Peak

Remarks: 1. Emission Level= Antenna Factor + Cable Loss + Reading - Amp Factor  
 2. The emission levels that are 20dB below the official limit are not reported.

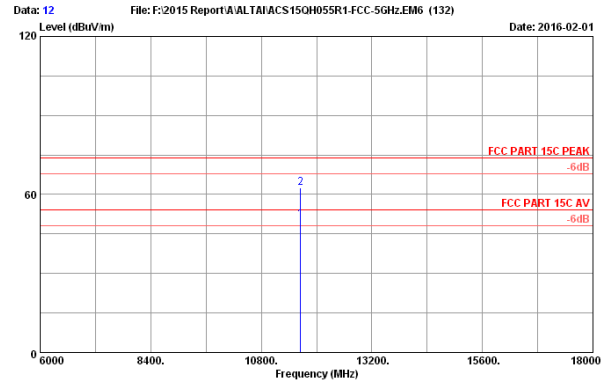

Site no. : 3m Chamber Data no. : 12  
 Dis. / Ant. : 3m 2015 3115-4877 Ant. pol. : VERTICAL  
 Limit : FCC PART 15C PEAK  
 Env. / Ins. : 23°C/54%  
 Engineer : Leo-Li  
 EUT : Alcatel ASin (ac) Super WiFi Base Station  
 Power rating : DC 56W From POE Input AC 120V/60Hz  
 Test Mode : IEEE802.11a 5825MHz Tx  
 WA8011NAC-H

No.	Freq. (MHz)	Ant. Factor (dB/m)	Cable Loss (dB)	AMP factor (dB)	Reading (dBuV)	Emission Level (dBuV/m)	Limits (dBuV/m)	Margin (dB)	Remark
1	11650.000	39.19	14.66	35.29	31.96	50.52	54.00	3.48	Average
2	11650.000	39.19	14.66	35.29	44.03	62.59	74.00	11.41	Peak

Remarks: 1. Emission Level= Antenna Factor + Cable Loss + Reading - Amp Factor  
 2. The emission levels that are 20dB below the official limit are not reported.

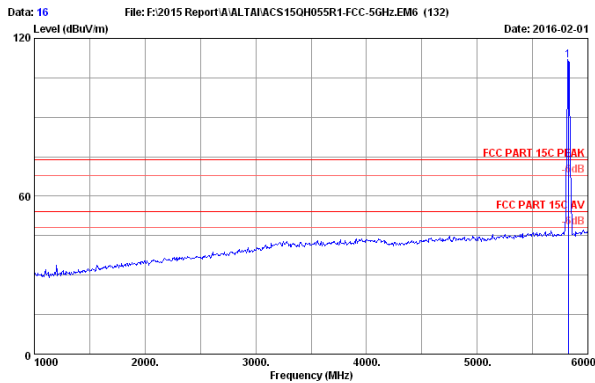

Site no. : 3m Chamber Data no. : 16  
 Dis. / Ant. : 3m 2015 3115-4877 Ant. pol. : HORIZONTAL  
 Limit : FCC PART 15C PEAK  
 Env. / Ins. : 23°C/54%  
 Engineer : Leo-Li  
 EUT : Alcatel ASin (ac) Super WiFi Base Station  
 Power rating : DC 56W From POE Input AC 120V/60Hz  
 Test Mode : IEEE802.11a 5825MHz Tx  
 WA8011NAC-H

No.	Freq. (MHz)	Ant. Factor (dB/m)	Cable Loss (dB)	AMP factor (dB)	Reading (dBuV)	Emission Level (dBuV/m)	Limits (dBuV/m)	Margin (dB)	Remark
1	5825.000	34.60	9.93	35.08	102.26	111.71	74.00	-37.71	Peak

Remarks: 1. Emission Level= Antenna Factor + Cable Loss + Reading - Amp Factor  
 2. The emission levels that are 20dB below the official limit are not reported.

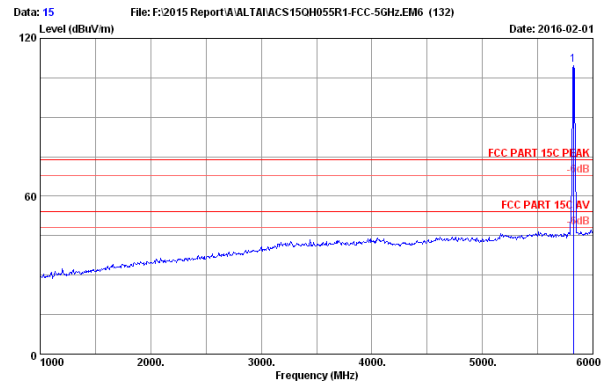

Site no. : 3m Chamber Data no. : 15  
 Dis. / Ant. : 3m 2015 3115-4877 Ant. pol. : VERTICAL  
 Limit : FCC PART 15C PEAK  
 Env. / Ins. : 23°C/54%  
 Engineer : Leo-Li  
 EUT : Alcatel ASin (ac) Super WiFi Base Station  
 Power rating : DC 56W From POE Input AC 120V/60Hz  
 Test Mode : IEEE802.11a 5825MHz Tx  
 WA8011NAC-H

No.	Freq. (MHz)	Ant. Factor (dB/m)	Cable Loss (dB)	AMP factor (dB)	Reading (dBuV)	Emission Level (dBuV/m)	Limits (dBuV/m)	Margin (dB)	Remark
1	5825.000	34.60	9.93	35.08	100.52	109.97	74.00	-35.97	Peak

Remarks: 1. Emission Level= Antenna Factor + Cable Loss + Reading - Amp Factor  
 2. The emission levels that are 20dB below the official limit are not reported.

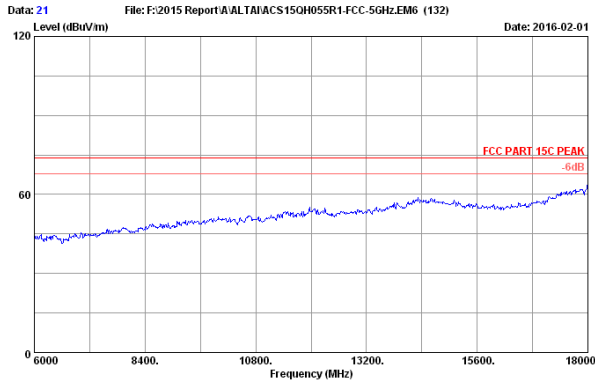

Site no. : 3m Chamber Data no. : 21  
 Dis. / Ant. : 3m 2015 3115-4877 Ant. pol. : HORIZONTAL  
 Limit : FCC PART 15C PEAK  
 Env. / Ins. : 23°C/54%  
 Engineer : Leo-Li  
 EUT : Altai A8in (ac) Super WiFi Base Station  
 Power rating : DC 56V From POE Input AC 120V/60Hz  
 Test Mode : IEEE802.11a 5785MHz Tx  
 WA8011NAC-H

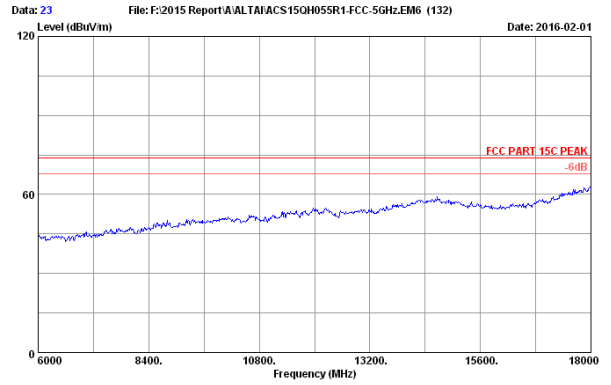

Site no. : 3m Chamber Data no. : 23  
 Dis. / Ant. : 3m 2015 3115-4877 Ant. pol. : VERTICAL  
 Limit : FCC PART 15C PEAK  
 Env. / Ins. : 23°C/54%  
 Engineer : Leo-Li  
 EUT : Altai A8in (ac) Super WiFi Base Station  
 Power rating : DC 56V From POE Input AC 120V/60Hz  
 Test Mode : IEEE802.11a 5785MHz Tx  
 WA8011NAC-H

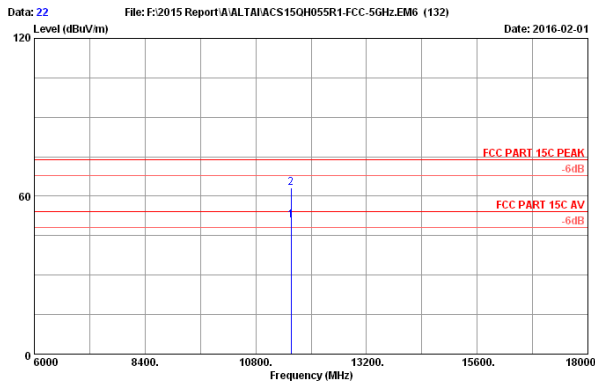

Site no. : 3m Chamber Data no. : 22  
 Dis. / Ant. : 3m 2015 3115-4877 Ant. pol. : HORIZONTAL  
 Limit : FCC PART 15C PEAK  
 Env. / Ins. : 23°C/54%  
 Engineer : Leo-Li  
 EUT : Altai A8in (ac) Super WiFi Base Station  
 Power rating : DC 56V From POE Input AC 120V/60Hz  
 Test Mode : IEEE802.11a 5785MHz Tx  
 WA8011NAC-H

No.	Freq. (MHz)	Ant. Factor (dB/m)	Cable Loss (dB)	AMP factor (dB)	Reading (dBuV)	Emission Level (dBuV/m)	Limits (dBuV/m)	Margin (dB)	Remark
1	11570.000	39.14	14.60	35.31	32.54	50.97	54.00	3.03	Average
2	11570.000	39.14	14.60	35.31	44.85	63.28	74.00	10.72	Peak

Remarks: 1. Emission Level= Antenna Factor + Cable Loss + Reading - Amp Factor  
 2. The emission levels that are 20dB below the official limit are not reported.

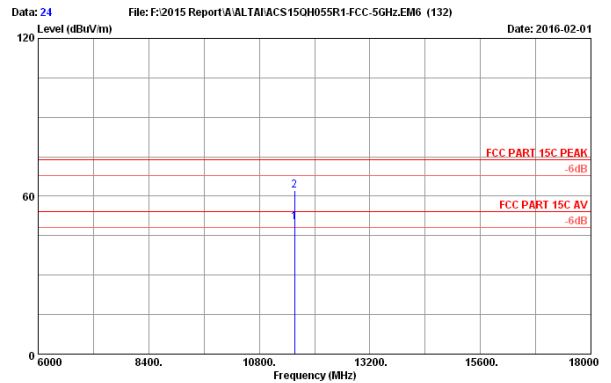

Site no. : 3m Chamber Data no. : 24  
 Dis. / Ant. : 3m 2015 3115-4877 Ant. pol. : VERTICAL  
 Limit : FCC PART 15C PEAK  
 Env. / Ins. : 23°C/54%  
 Engineer : Leo-Li  
 EUT : Altai A8in (ac) Super WiFi Base Station  
 Power rating : DC 56V From POE Input AC 120V/60Hz  
 Test Mode : IEEE802.11a 5785MHz Tx  
 WA8011NAC-H

No.	Freq. (MHz)	Ant. Factor (dB/m)	Cable Loss (dB)	AMP factor (dB)	Reading (dBuV)	Emission Level (dBuV/m)	Limits (dBuV/m)	Margin (dB)	Remark
1	11570.000	39.14	14.60	35.31	31.58	50.01	54.00	3.99	Average
2	11570.000	39.14	14.60	35.31	43.59	62.02	74.00	11.98	Peak

Remarks: 1. Emission Level= Antenna Factor + Cable Loss + Reading - Amp Factor  
 2. The emission levels that are 20dB below the official limit are not reported.

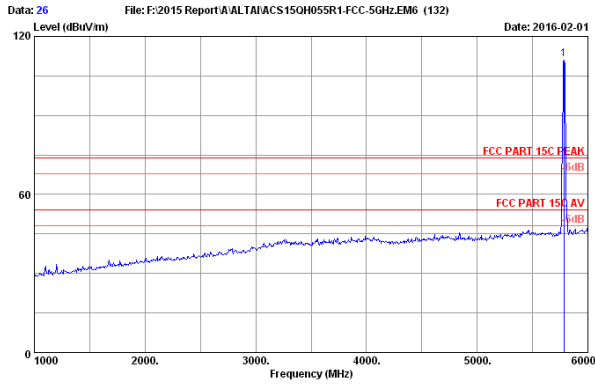

Site no. : 3m Chamber Data no. : 26  
 Dis. / Ant. : 3m 2015 3115-4877 Ant. pol. : HORIZONTAL  
 Limit : FCC PART 15C PEAK  
 Env. / Ins. : 23°C/54%  
 Engineer : Leo-Li  
 EUT : Alcatel ASin (ac) Super WiFi Base Station  
 Power rating : DC 56V From POE Input AC 120V/60Hz  
 Test Mode : IEEE802.11a 5785MHz Tx  
 WA8011NAC-H

No.	Freq. (MHz)	Ant. Factor (dB/m)	Cable Loss (dB)	AMP factor (dB)	Reading (dBuV)	Emission Level (dBuV/m)	Limits (dBuV/m)	Margin (dB)	Remark
1	5785.000	34.57	9.91	35.10	101.98	111.36	74.00	-37.36	Peak

Remarks: 1. Emission Level= Antenna Factor + Cable Loss + Reading - Amp Factor  
 2. The emission levels that are 20dB below the official limit are not reported.

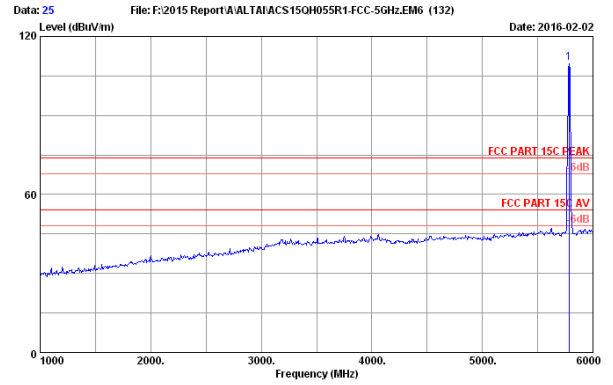

Site no. : 3m Chamber Data no. : 25  
 Dis. / Ant. : 3m 2015 3115-4877 Ant. pol. : VERTICAL  
 Limit : FCC PART 15C PEAK  
 Env. / Ins. : 23°C/54%  
 Engineer : Leo-Li  
 EUT : Alcatel ASin (ac) Super WiFi Base Station  
 Power rating : DC 56V From POE Input AC 120V/60Hz  
 Test Mode : IEEE802.11a 5785MHz Tx  
 WA8011NAC-H

No.	Freq. (MHz)	Ant. Factor (dB/m)	Cable Loss (dB)	AMP factor (dB)	Reading (dBuV)	Emission Level (dBuV/m)	Limits (dBuV/m)	Margin (dB)	Remark
1	5785.000	34.57	9.91	35.10	100.53	109.91	74.00	-35.91	Peak

Remarks: 1. Emission Level= Antenna Factor + Cable Loss + Reading - Amp Factor  
 2. The emission levels that are 20dB below the official limit are not reported.

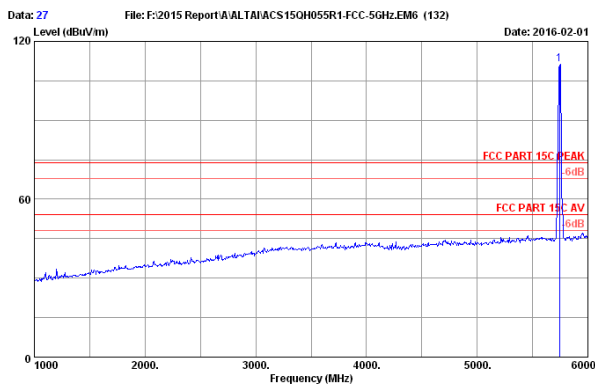

Site no. : 3m Chamber Data no. : 27  
 Dis. / Ant. : 3m 2015 3115-4877 Ant. pol. : HORIZONTAL  
 Limit : FCC PART 15C PEAK  
 Env. / Ins. : 23°C/54%  
 Engineer : Leo-Li  
 EUT : Alcatel ASin (ac) Super WiFi Base Station  
 Power rating : DC 56V From POE Input AC 120V/60Hz  
 Test Mode : IEEE802.11nHT20 5745MHz Tx  
 WA8011NAC-H

No.	Freq. (MHz)	Ant. Factor (dB/m)	Cable Loss (dB)	AMP factor (dB)	Reading (dBuV)	Emission Level (dBuV/m)	Limits (dBuV/m)	Margin (dB)	Remark
1	5745.000	34.55	9.90	35.11	102.04	111.38	74.00	-37.38	Peak

Remarks: 1. Emission Level= Antenna Factor + Cable Loss + Reading - Amp Factor  
 2. The emission levels that are 20dB below the official limit are not reported.

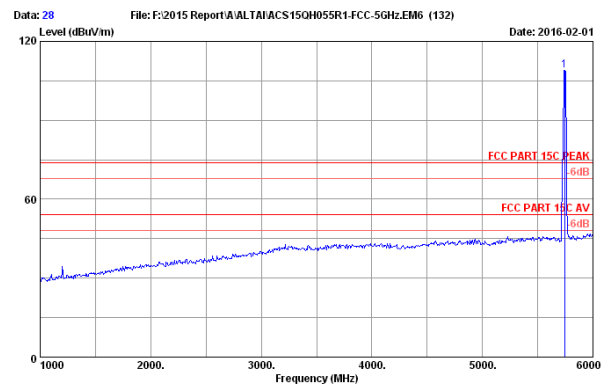

Site no. : 3m Chamber Data no. : 28  
 Dis. / Ant. : 3m 2015 3115-4877 Ant. pol. : VERTICAL  
 Limit : FCC PART 15C PEAK  
 Env. / Ins. : 23°C/54%  
 Engineer : Leo-Li  
 EUT : Alcatel ASin (ac) Super WiFi Base Station  
 Power rating : DC 56V From POE Input AC 120V/60Hz  
 Test Mode : IEEE802.11nHT20 5745MHz Tx  
 WA8011NAC-H

No.	Freq. (MHz)	Ant. Factor (dB/m)	Cable Loss (dB)	AMP factor (dB)	Reading (dBuV)	Emission Level (dBuV/m)	Limits (dBuV/m)	Margin (dB)	Remark
1	5745.000	34.55	9.90	35.11	99.67	109.01	74.00	-35.01	Peak

Remarks: 1. Emission Level= Antenna Factor + Cable Loss + Reading - Amp Factor  
 2. The emission levels that are 20dB below the official limit are not reported.

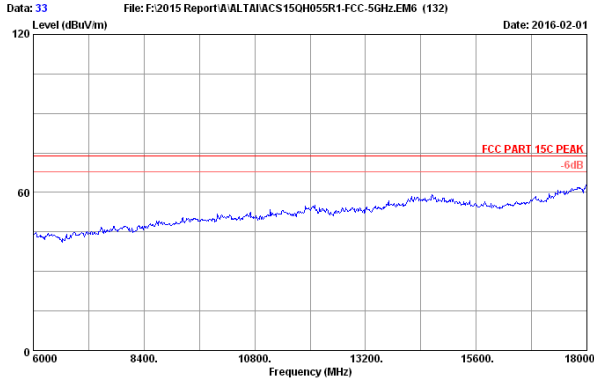

Site no. : 3m Chamber Data no. : 33  
 Dis. / Ant. : 3m 2015 3115-4877 Ant. pol. : HORIZONTAL  
 Limit : FCC PART 15C PEAK  
 Env. / Ins. : 23°C/54%  
 Engineer : Leo-Li  
 EUT : Altai A8in (ac) Super WiFi Base Station  
 Power rating : DC 56V From POE Input AC 120V/60Hz  
 Test Mode : IEEE802.11nHT20 5745MHz Tx  
 WA8011NAC-H

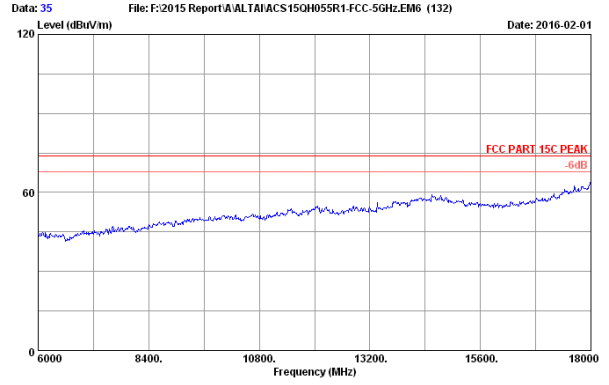

Site no. : 3m Chamber Data no. : 35  
 Dis. / Ant. : 3m 2015 3115-4877 Ant. pol. : VERTICAL  
 Limit : FCC PART 15C PEAK  
 Env. / Ins. : 23°C/54%  
 Engineer : Leo-Li  
 EUT : Altai A8in (ac) Super WiFi Base Station  
 Power rating : DC 56V From POE Input AC 120V/60Hz  
 Test Mode : IEEE802.11nHT20 5745MHz Tx  
 WA8011NAC-H

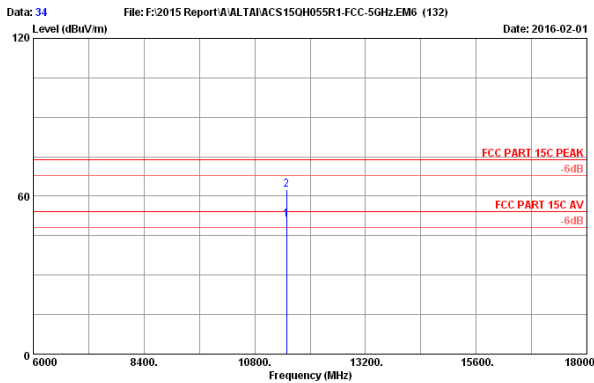

Site no. : 3m Chamber Data no. : 34  
 Dis. / Ant. : 3m 2015 3115-4877 Ant. pol. : HORIZONTAL  
 Limit : FCC PART 15C PEAK  
 Env. / Ins. : 23°C/54%  
 Engineer : Leo-Li  
 EUT : Altai A8in (ac) Super WiFi Base Station  
 Power rating : DC 56V From POE Input AC 120V/60Hz  
 Test Mode : IEEE802.11nHT20 5745MHz Tx  
 WA8011NAC-H

No.	Freq. (MHz)	Ant. Factor (dB/m)	Cable Loss (dB)	AMP factor (dB)	Reading (dBuV)	Emission Level (dBuV/m)	Limits (dBuV/m)	Margin (dB)	Remark
1	11490.000	39.09	14.54	35.33	32.87	51.17	54.00	2.83	Average
2	11490.000	39.09	14.54	35.33	44.13	62.43	74.00	11.57	Peak

Remarks: 1. Emission Level= Antenna Factor + Cable Loss + Reading - Amp Factor  
 2. The emission levels that are 20dB below the official limit are not reported.

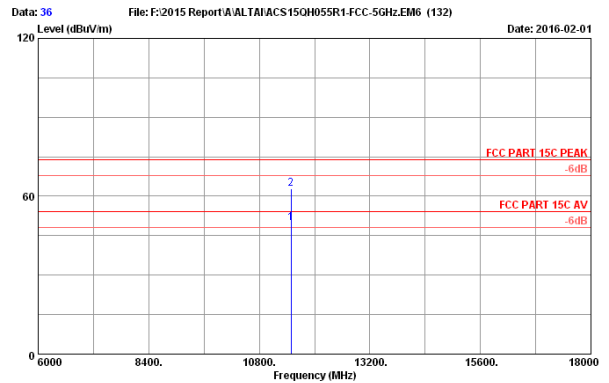

Site no. : 3m Chamber Data no. : 36  
 Dis. / Ant. : 3m 2015 3115-4877 Ant. pol. : VERTICAL  
 Limit : FCC PART 15C PEAK  
 Env. / Ins. : 23°C/54%  
 Engineer : Leo-Li  
 EUT : Altai A8in (ac) Super WiFi Base Station  
 Power rating : DC 56V From POE Input AC 120V/60Hz  
 Test Mode : IEEE802.11nHT20 5745MHz Tx  
 WA8011NAC-H

No.	Freq. (MHz)	Ant. Factor (dB/m)	Cable Loss (dB)	AMP factor (dB)	Reading (dBuV)	Emission Level (dBuV/m)	Limits (dBuV/m)	Margin (dB)	Remark
1	11490.000	39.09	14.54	35.33	31.43	49.73	54.00	4.27	Average
2	11490.000	39.09	14.54	35.33	44.66	62.96	74.00	11.04	Peak

Remarks: 1. Emission Level= Antenna Factor + Cable Loss + Reading - Amp Factor  
 2. The emission levels that are 20dB below the official limit are not reported.



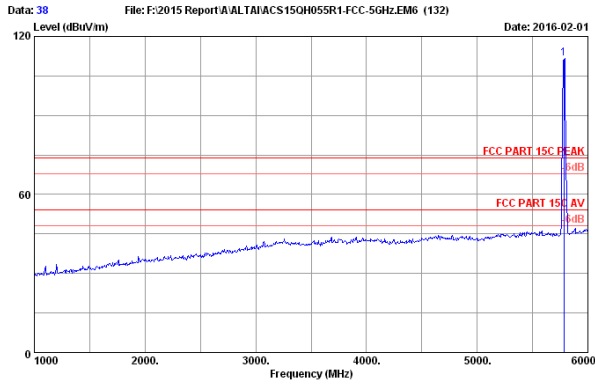

Site no. : 3m Chamber Data no. : 38  
 Dis. / Ant. : 3m 2015 3115-4877 Ant. pol. : HORIZONTAL  
 Limit : FCC PART 15C PEAK  
 Env. / Ins. : 23°C/54%  
 Engineer : Leo-Li  
 EUT : Altel A8in (ac) Super WiFi Base Station  
 Power rating : DC 56V From POE Input AC 120V/60Hz  
 Test Mode : IEEE802.11nHT20 5785MHz Tx  
 WA8011NAC-H

No.	Freq. (MHz)	Ant. Factor (dB/m)	Cable Loss (dB)	AMP factor (dB)	Reading (dBuV)	Emission Level (dBuV/m)	Limits (dBuV/m)	Margin (dB)	Remark
1	5785.000	34.57	9.91	35.10	102.41	111.79	74.00	-37.79	Peak

Remarks: 1. Emission Level= Antenna Factor + Cable Loss + Reading - Amp Factor  
 2. The emission levels that are 20dB below the official limit are not reported.

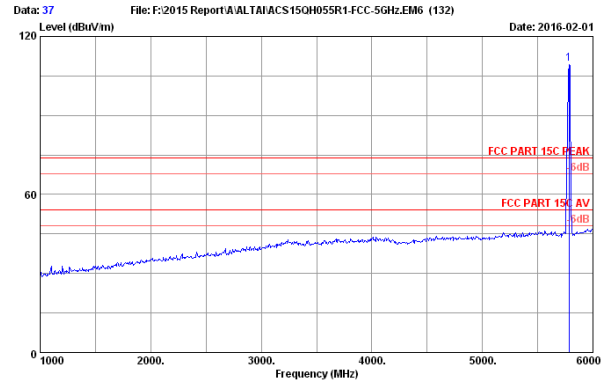

Site no. : 3m Chamber Data no. : 37  
 Dis. / Ant. : 3m 2015 3115-4877 Ant. pol. : VERTICAL  
 Limit : FCC PART 15C PEAK  
 Env. / Ins. : 23°C/54%  
 Engineer : Leo-Li  
 EUT : Altel A8in (ac) Super WiFi Base Station  
 Power rating : DC 56V From POE Input AC 120V/60Hz  
 Test Mode : IEEE802.11nHT20 5785MHz Tx  
 WA8011NAC-H

No.	Freq. (MHz)	Ant. Factor (dB/m)	Cable Loss (dB)	AMP factor (dB)	Reading (dBuV)	Emission Level (dBuV/m)	Limits (dBuV/m)	Margin (dB)	Remark
1	5785.000	34.57	9.91	35.10	100.24	109.62	74.00	-35.62	Peak

Remarks: 1. Emission Level= Antenna Factor + Cable Loss + Reading - Amp Factor  
 2. The emission levels that are 20dB below the official limit are not reported.

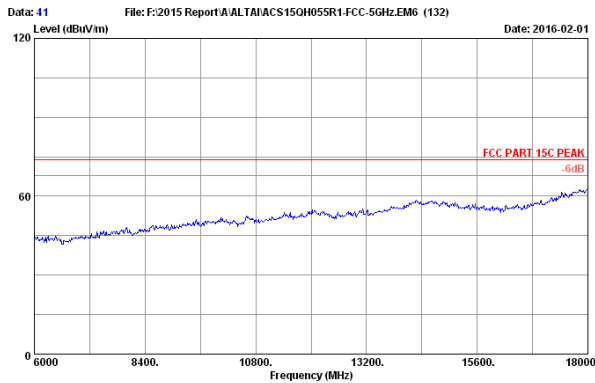

Site no. : 3m Chamber Data no. : 41  
 Dis. / Ant. : 3m 2015 3115-4877 Ant. pol. : HORIZONTAL  
 Limit : FCC PART 15C PEAK  
 Env. / Ins. : 23°C/54%  
 Engineer : Leo-Li  
 EUT : Altel A8in (ac) Super WiFi Base Station  
 Power rating : DC 56V From POE Input AC 120V/60Hz  
 Test Mode : IEEE802.11nHT20 5785MHz Tx  
 WA8011NAC-H

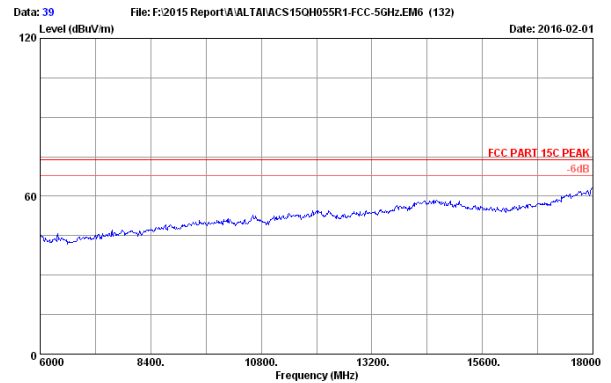

Site no. : 3m Chamber Data no. : 39  
 Dis. / Ant. : 3m 2015 3115-4877 Ant. pol. : VERTICAL  
 Limit : FCC PART 15C PEAK  
 Env. / Ins. : 23°C/54%  
 Engineer : Leo-Li  
 EUT : Altel A8in (ac) Super WiFi Base Station  
 Power rating : DC 56V From POE Input AC 120V/60Hz  
 Test Mode : IEEE802.11nHT20 5785MHz Tx  
 WA8011NAC-H

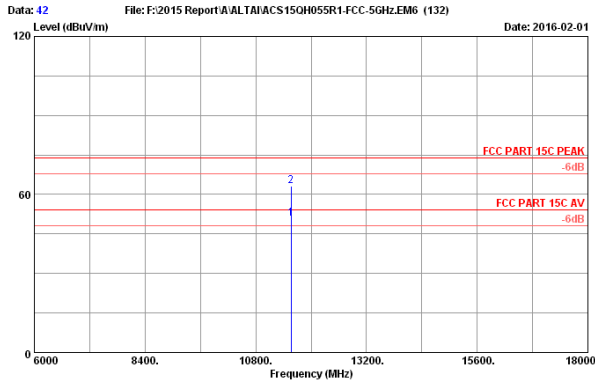

Site no. : 3m Chamber Data no. : 42  
 Dis. / Ant. : 3m 2015 3115-4877 Ant. pol. : HORIZONTAL  
 Limit : FCC PART 15C PEAK  
 Env. / Ins. : 23°C/54%  
 Engineer : Leo-Li  
 EUT : Alcatel A81in (ac) Super WiFi Base Station  
 Power rating : DC 56V From POE Input AC 120V/60Hz  
 Test Mode : IEEE802.11nHT20 5785MHz Tx  
 WA8011NAC-H

No.	Freq. (MHz)	Ant. Factor (dB/m)	Cable Loss (dB)	AMP factor (dB)	Reading (dBuV)	Emission Level (dBuV/m)	Limits (dBuV/m)	Margin (dB)	Remark
1	11570.000	39.14	14.60	35.31	32.54	50.97	54.00	3.03	Average
2	11570.000	39.14	14.60	35.31	44.85	63.28	74.00	10.72	Peak

Remarks: 1. Emission Level= Antenna Factor + Cable Loss + Reading - Amp Factor  
 2. The emission levels that are 20dB below the official limit are not reported.

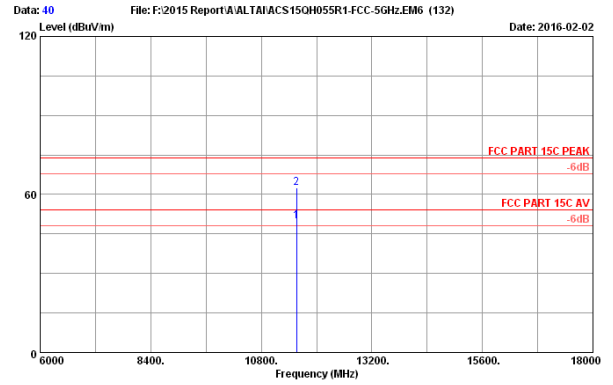

Site no. : 3m Chamber Data no. : 40  
 Dis. / Ant. : 3m 2015 3115-4877 Ant. pol. : VERTICAL  
 Limit : FCC PART 15C PEAK  
 Env. / Ins. : 23°C/54%  
 Engineer : Leo-Li  
 EUT : Alcatel A81in (ac) Super WiFi Base Station  
 Power rating : DC 56V From POE Input AC 120V/60Hz  
 Test Mode : IEEE802.11nHT20 5785MHz Tx  
 WA8011NAC-H

No.	Freq. (MHz)	Ant. Factor (dB/m)	Cable Loss (dB)	AMP factor (dB)	Reading (dBuV)	Emission Level (dBuV/m)	Limits (dBuV/m)	Margin (dB)	Remark
1	11570.000	39.14	14.60	35.31	31.26	49.69	54.00	4.31	Average
2	11570.000	39.14	14.60	35.31	44.03	62.46	74.00	11.54	Peak

Remarks: 1. Emission Level= Antenna Factor + Cable Loss + Reading - Amp Factor  
 2. The emission levels that are 20dB below the official limit are not reported.

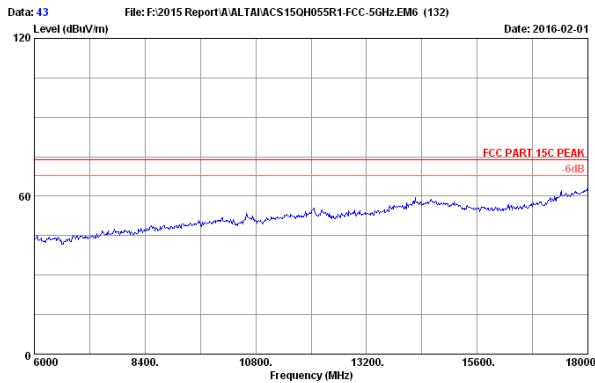

Site no. : 3m Chamber Data no. : 43  
 Dis. / Ant. : 3m 2015 3115-4877 Ant. pol. : HORIZONTAL  
 Limit : FCC PART 15C PEAK  
 Env. / Ins. : 23°C/54%  
 Engineer : Leo-Li  
 EUT : Alcatel A81in (ac) Super WiFi Base Station  
 Power rating : DC 56V From POE Input AC 120V/60Hz  
 Test Mode : IEEE802.11nHT20 5825MHz Tx  
 WA8011NAC-H

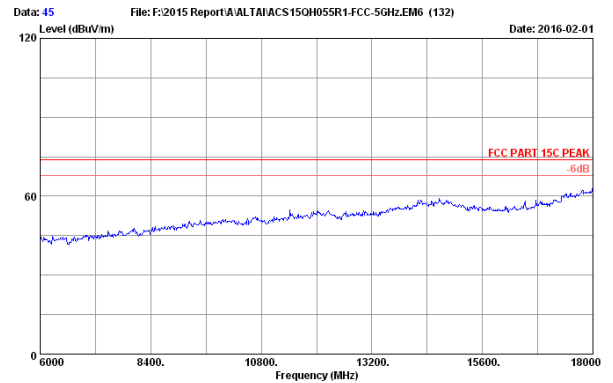

Site no. : 3m Chamber Data no. : 45  
 Dis. / Ant. : 3m 2015 3115-4877 Ant. pol. : VERTICAL  
 Limit : FCC PART 15C PEAK  
 Env. / Ins. : 23°C/54%  
 Engineer : Leo-Li  
 EUT : Alcatel A81in (ac) Super WiFi Base Station  
 Power rating : DC 56V From POE Input AC 120V/60Hz  
 Test Mode : IEEE802.11nHT20 5825MHz Tx  
 WA8011NAC-H

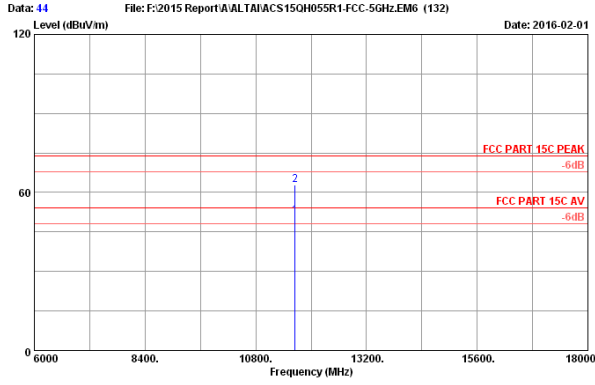

Site no. : 3m Chamber Data no. : 44  
 Dis. / Ant. : 3m 2015 3115-4877 Ant. pol. : HORIZONTAL  
 Limit : FCC PART 15C PEAK  
 Env. / Ins. : 23°C/54%  
 Engineer : Leo-Li  
 EUT : Alcatel A8in (ac) Super WiFi Base Station  
 Power rating : DC 56V From POE Input AC 120V/60Hz  
 Test Mode : IEEE802.11nHT20 5825MHz Tx  
 WA8011NAC-H

No.	Freq. (MHz)	Ant. Factor (dB/m)	Cable Loss (dB)	AMP factor (dB)	Reading (dBuV)	Emission Level (dBuV/m)	Limits (dBuV/m)	Margin (dB)	Remark
1	11650.000	39.19	14.66	35.29	32.65	51.21	54.00	2.79	Average
2	11650.000	39.19	14.66	35.29	44.28	62.84	74.00	11.16	Peak

Remarks: 1. Emission Level= Antenna Factor + Cable Loss + Reading - Amp Factor  
 2. The emission levels that are 20dB below the official limit are not reported.

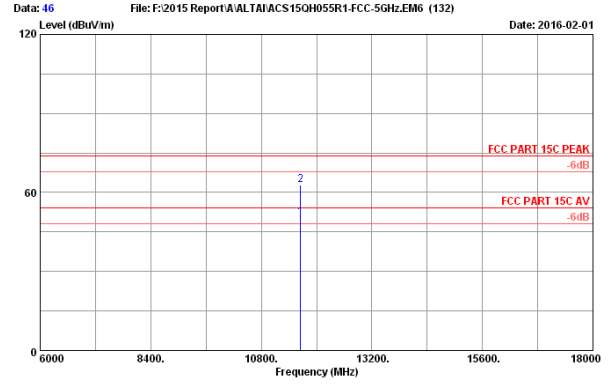

Site no. : 3m Chamber Data no. : 46  
 Dis. / Ant. : 3m 2015 3115-4877 Ant. pol. : VERTICAL  
 Limit : FCC PART 15C PEAK  
 Env. / Ins. : 23°C/54%  
 Engineer : Leo-Li  
 EUT : Alcatel A8in (ac) Super WiFi Base Station  
 Power rating : DC 56V From POE Input AC 120V/60Hz  
 Test Mode : IEEE802.11nHT20 5825MHz Tx  
 WA8011NAC-H

No.	Freq. (MHz)	Ant. Factor (dB/m)	Cable Loss (dB)	AMP factor (dB)	Reading (dBuV)	Emission Level (dBuV/m)	Limits (dBuV/m)	Margin (dB)	Remark
1	11650.000	39.19	14.66	35.29	31.75	50.31	54.00	3.69	Average
2	11650.000	39.19	14.66	35.29	44.24	62.80	74.00	11.20	Peak

Remarks: 1. Emission Level= Antenna Factor + Cable Loss + Reading - Amp Factor  
 2. The emission levels that are 20dB below the official limit are not reported.

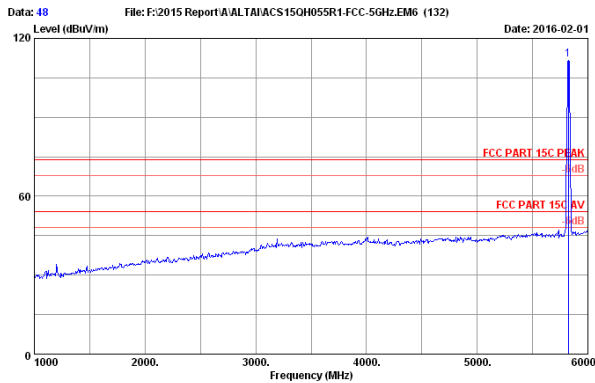

Site no. : 3m Chamber Data no. : 48  
 Dis. / Ant. : 3m 2015 3115-4877 Ant. pol. : HORIZONTAL  
 Limit : FCC PART 15C PEAK  
 Env. / Ins. : 23°C/54%  
 Engineer : Leo-Li  
 EUT : Alcatel A8in (ac) Super WiFi Base Station  
 Power rating : DC 56V From POE Input AC 120V/60Hz  
 Test Mode : IEEE802.11nHT20 5825MHz Tx  
 WA8011NAC-H

No.	Freq. (MHz)	Ant. Factor (dB/m)	Cable Loss (dB)	AMP factor (dB)	Reading (dBuV)	Emission Level (dBuV/m)	Limits (dBuV/m)	Margin (dB)	Remark
1	5825.000	34.60	9.93	35.08	102.39	111.84	74.00	-37.84	Peak

Remarks: 1. Emission Level= Antenna Factor + Cable Loss + Reading - Amp Factor  
 2. The emission levels that are 20dB below the official limit are not reported.

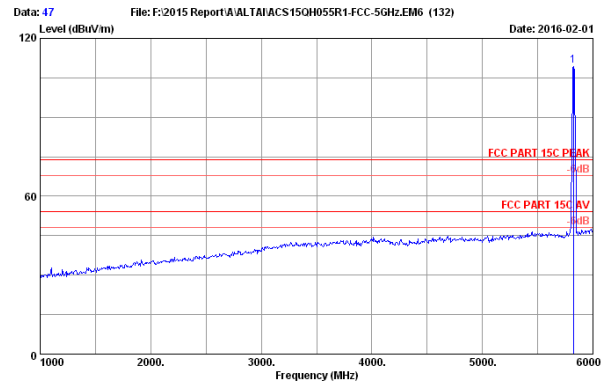

Site no. : 3m Chamber Data no. : 47  
 Dis. / Ant. : 3m 2015 3115-4877 Ant. pol. : VERTICAL  
 Limit : FCC PART 15C PEAK  
 Env. / Ins. : 23°C/54%  
 Engineer : Leo-Li  
 EUT : Alcatel A8in (ac) Super WiFi Base Station  
 Power rating : DC 56V From POE Input AC 120V/60Hz  
 Test Mode : IEEE802.11nHT20 5825MHz Tx  
 WA8011NAC-H

No.	Freq. (MHz)	Ant. Factor (dB/m)	Cable Loss (dB)	AMP factor (dB)	Reading (dBuV)	Emission Level (dBuV/m)	Limits (dBuV/m)	Margin (dB)	Remark
1	5825.000	34.60	9.93	35.08	100.12	109.57	74.00	-35.57	Peak

Remarks: 1. Emission Level= Antenna Factor + Cable Loss + Reading - Amp Factor  
 2. The emission levels that are 20dB below the official limit are not reported.

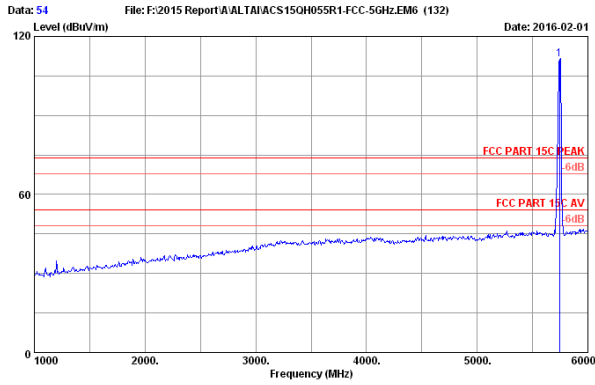

Site no. : 3m Chamber Data no. : 54  
 Dis. / Ant. : 3m 2015 3115-4877 Ant. pol. : HORIZONTAL  
 Limit : FCC PART 15C PEAK  
 Env. / Ins. : 23°C/54%  
 Engineer : Leo-Li  
 EUT : Altel 4Gin (ac) Super WiFi Base Station  
 Power rating : DC 56V From POE Input AC 120V/60Hz  
 Test Mode : IEEE802.11ac VHT20 5745MHz Tx  
 WA8011NAC-H

No.	Freq. (MHz)	Ant. Factor (dB/m)	Cable Loss (dB)	AMP factor (dB)	Reading (dBuV)	Emission Level (dBuV/m)	Limits (dBuV/m)	Margin (dB)	Remark
1	5745.000	34.55	9.90	35.11	101.87	111.21	74.00	-37.21	Peak

Remarks: 1. Emission Level= Antenna Factor + Cable Loss + Reading - Amp Factor  
 2. The emission levels that are 20dB below the official limit are not reported.

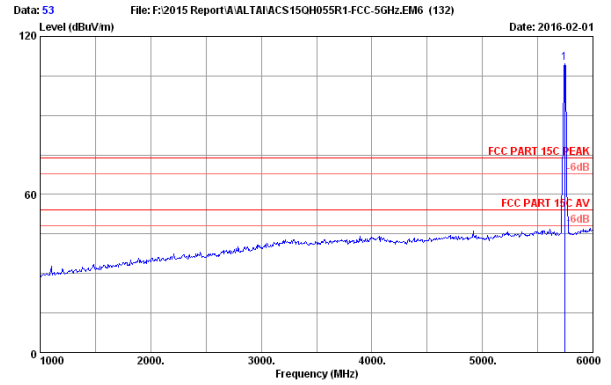

Site no. : 3m Chamber Data no. : 53  
 Dis. / Ant. : 3m 2015 3115-4877 Ant. pol. : VERTICAL  
 Limit : FCC PART 15C PEAK  
 Env. / Ins. : 23°C/54%  
 Engineer : Leo-Li  
 EUT : Altel 4Gin (ac) Super WiFi Base Station  
 Power rating : DC 56V From POE Input AC 120V/60Hz  
 Test Mode : IEEE802.11ac VHT20 5745MHz Tx  
 WA8011NAC-H

No.	Freq. (MHz)	Ant. Factor (dB/m)	Cable Loss (dB)	AMP factor (dB)	Reading (dBuV)	Emission Level (dBuV/m)	Limits (dBuV/m)	Margin (dB)	Remark
1	5745.000	34.55	9.90	35.11	100.57	109.91	74.00	-35.91	Peak

Remarks: 1. Emission Level= Antenna Factor + Cable Loss + Reading - Amp Factor  
 2. The emission levels that are 20dB below the official limit are not reported.

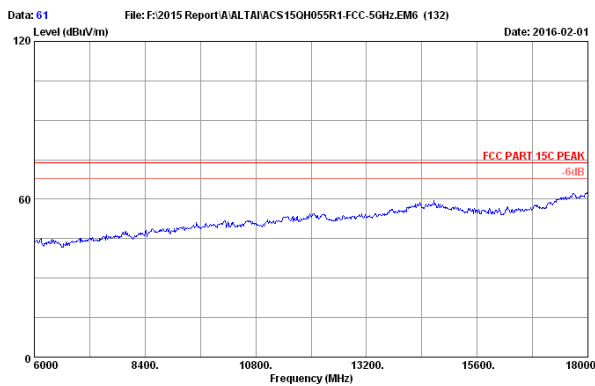

Site no. : 3m Chamber Data no. : 61  
 Dis. / Ant. : 3m 2015 3115-4877 Ant. pol. : HORIZONTAL  
 Limit : FCC PART 15C PEAK  
 Env. / Ins. : 23°C/54%  
 Engineer : Leo-Li  
 EUT : Altel 4Gin (ac) Super WiFi Base Station  
 Power rating : DC 56V From POE Input AC 120V/60Hz  
 Test Mode : IEEE802.11ac VHT20 5745MHz Tx  
 WA8011NAC-H

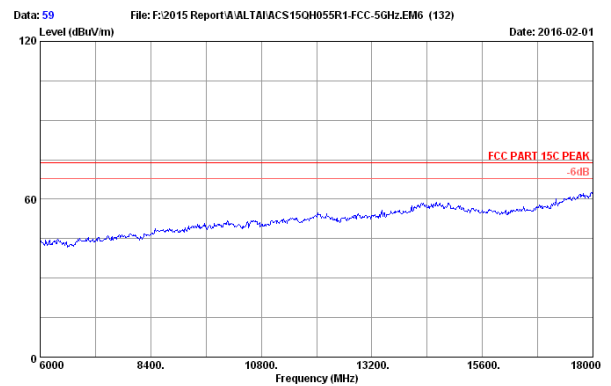

Site no. : 3m Chamber Data no. : 59  
 Dis. / Ant. : 3m 2015 3115-4877 Ant. pol. : VERTICAL  
 Limit : FCC PART 15C PEAK  
 Env. / Ins. : 23°C/54%  
 Engineer : Leo-Li  
 EUT : Altel 4Gin (ac) Super WiFi Base Station  
 Power rating : DC 56V From POE Input AC 120V/60Hz  
 Test Mode : IEEE802.11ac VHT20 5745MHz Tx  
 WA8011NAC-H

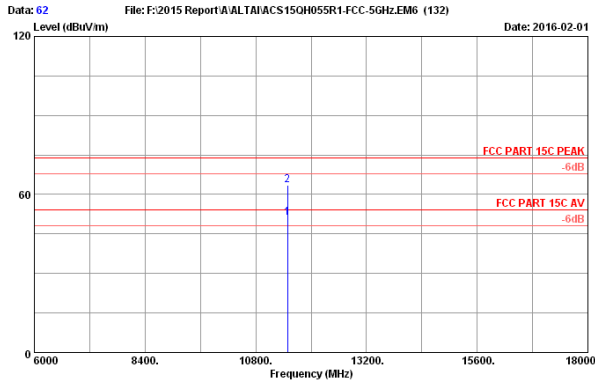

Site no. : 3m Chamber Data no. : 62  
 Dis. / Ant. : 3m 2015 3115-4877 Ant. pol. : HORIZONTAL  
 Limit : FCC PART 15C PEAK  
 Env. / Ins. : 23°C/54%  
 Engineer : Leo-Li  
 EUT : Alcatel A81n (ac) Super WiFi Base Station  
 Power rating : DC 56V From POE Input AC 120V/60Hz  
 Test Mode : IEEE802.11ac VHT20 5745MHz Tx  
 WA8011NAC-H

No.	Freq. (MHz)	Ant. Factor (dB/m)	Cable Loss (dB)	AMP factor (dB)	Reading (dBuV)	Emission Level (dBuV/m)	Limits (dBuV/m)	Margin (dB)	Remark
1	11490.000	39.09	14.54	35.33	32.76	51.06	54.00	2.94	Average
2	11490.000	39.09	14.54	35.33	45.25	63.55	74.00	10.45	Peak

Remarks: 1. Emission Level= Antenna Factor + Cable Loss + Reading - Amp Factor  
 2. The emission levels that are 20dB below the official limit are not reported.

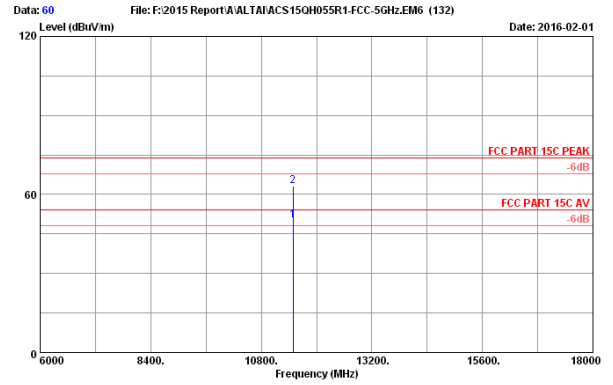

Site no. : 3m Chamber Data no. : 60  
 Dis. / Ant. : 3m 2015 3115-4877 Ant. pol. : VERTICAL  
 Limit : FCC PART 15C PEAK  
 Env. / Ins. : 23°C/54%  
 Engineer : Leo-Li  
 EUT : Alcatel A81n (ac) Super WiFi Base Station  
 Power rating : DC 56V From POE Input AC 120V/60Hz  
 Test Mode : IEEE802.11ac VHT20 5745MHz Tx  
 WA8011NAC-H

No.	Freq. (MHz)	Ant. Factor (dB/m)	Cable Loss (dB)	AMP factor (dB)	Reading (dBuV)	Emission Level (dBuV/m)	Limits (dBuV/m)	Margin (dB)	Remark
1	11490.000	39.09	14.54	35.33	31.90	50.20	54.00	3.80	Average
2	11490.000	39.09	14.54	35.33	44.97	63.27	74.00	10.73	Peak

Remarks: 1. Emission Level= Antenna Factor + Cable Loss + Reading - Amp Factor  
 2. The emission levels that are 20dB below the official limit are not reported.

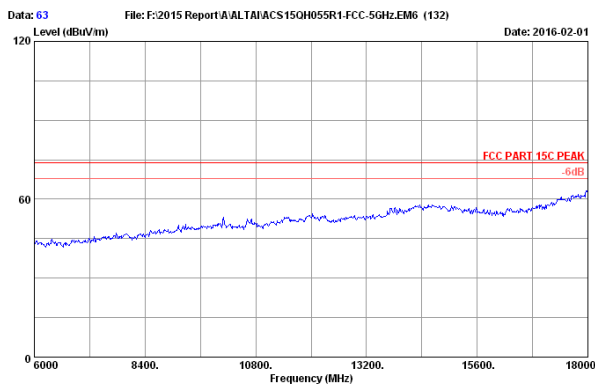

Site no. : 3m Chamber Data no. : 63  
 Dis. / Ant. : 3m 2015 3115-4877 Ant. pol. : HORIZONTAL  
 Limit : FCC PART 15C PEAK  
 Env. / Ins. : 23°C/54%  
 Engineer : Leo-Li  
 EUT : Alcatel A81n (ac) Super WiFi Base Station  
 Power rating : DC 56V From POE Input AC 120V/60Hz  
 Test Mode : IEEE802.11ac VHT20 5825MHz Tx  
 WA8011NAC-H

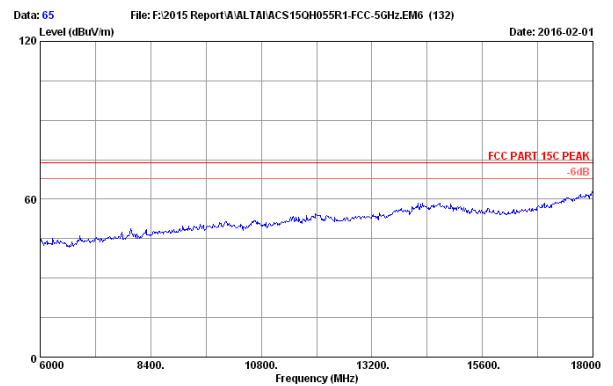

Site no. : 3m Chamber Data no. : 65  
 Dis. / Ant. : 3m 2015 3115-4877 Ant. pol. : VERTICAL  
 Limit : FCC PART 15C PEAK  
 Env. / Ins. : 23°C/54%  
 Engineer : Leo-Li  
 EUT : Alcatel A81n (ac) Super WiFi Base Station  
 Power rating : DC 56V From POE Input AC 120V/60Hz  
 Test Mode : IEEE802.11ac VHT20 5825MHz Tx  
 WA8011NAC-H

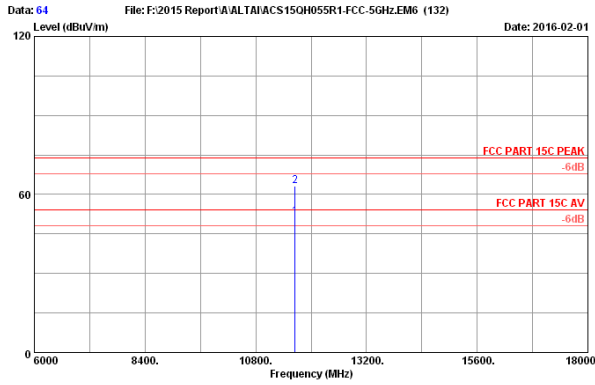

Site no. : 3m Chamber Data no. : 64  
 Dis. / Ant. : 3m 2015 3115-4877 Ant. pol. : HORIZONTAL  
 Limit : FCC PART 15C PEAK  
 Env. / Ins. : 23°C/54%  
 Engineer : Leo-Li  
 EUT : Altai A8in (ac) Super WiFi Base Station  
 Power rating : DC 56V From POE Input AC 120V/60Hz  
 Test Mode : IEEE802.11ac VHT20 5825MHz Tx  
 WA8011NAC-H

No.	Freq. (MHz)	Ant. Factor (dB/m)	Cable Loss (dB)	AMP factor (dB)	Reading (dBuV)	Emission Level (dBuV/m)	Limits (dBuV/m)	Margin (dB)	Remark
1	11650.000	39.19	14.66	35.29	32.85	51.41	54.00	2.59	Average
2	11650.000	39.19	14.66	35.29	44.74	63.30	74.00	10.70	Peak

Remarks: 1. Emission Level= Antenna Factor + Cable Loss + Reading - Amp Factor  
 2. The emission levels that are 20dB below the official limit are not reported.

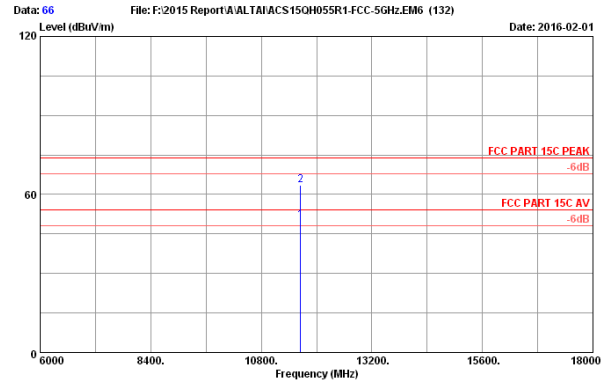

Site no. : 3m Chamber Data no. : 66  
 Dis. / Ant. : 3m 2015 3115-4877 Ant. pol. : VERTICAL  
 Limit : FCC PART 15C PEAK  
 Env. / Ins. : 23°C/54%  
 Engineer : Leo-Li  
 EUT : Altai A8in (ac) Super WiFi Base Station  
 Power rating : DC 56V From POE Input AC 120V/60Hz  
 Test Mode : IEEE802.11ac VHT20 5825MHz Tx  
 WA8011NAC-H

No.	Freq. (MHz)	Ant. Factor (dB/m)	Cable Loss (dB)	AMP factor (dB)	Reading (dBuV)	Emission Level (dBuV/m)	Limits (dBuV/m)	Margin (dB)	Remark
1	11650.000	39.19	14.66	35.29	31.57	50.13	54.00	3.87	Average
2	11650.000	39.19	14.66	35.29	44.89	63.45	74.00	10.55	Peak

Remarks: 1. Emission Level= Antenna Factor + Cable Loss + Reading - Amp Factor  
 2. The emission levels that are 20dB below the official limit are not reported.

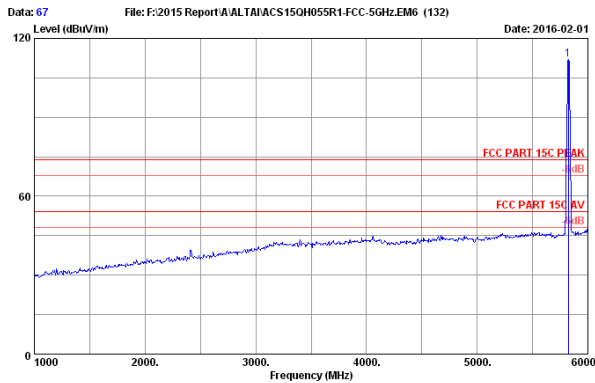

Site no. : 3m Chamber Data no. : 67  
 Dis. / Ant. : 3m 2015 3115-4877 Ant. pol. : HORIZONTAL  
 Limit : FCC PART 15C PEAK  
 Env. / Ins. : 23°C/54%  
 Engineer : Leo-Li  
 EUT : Altai A8in (ac) Super WiFi Base Station  
 Power rating : DC 56V From POE Input AC 120V/60Hz  
 Test Mode : IEEE802.11ac VHT20 5825MHz Tx  
 WA8011NAC-H

No.	Freq. (MHz)	Ant. Factor (dB/m)	Cable Loss (dB)	AMP factor (dB)	Reading (dBuV)	Emission Level (dBuV/m)	Limits (dBuV/m)	Margin (dB)	Remark
1	5825.000	34.60	9.93	35.08	102.58	112.03	74.00	-38.03	Peak

Remarks: 1. Emission Level= Antenna Factor + Cable Loss + Reading - Amp Factor  
 2. The emission levels that are 20dB below the official limit are not reported.

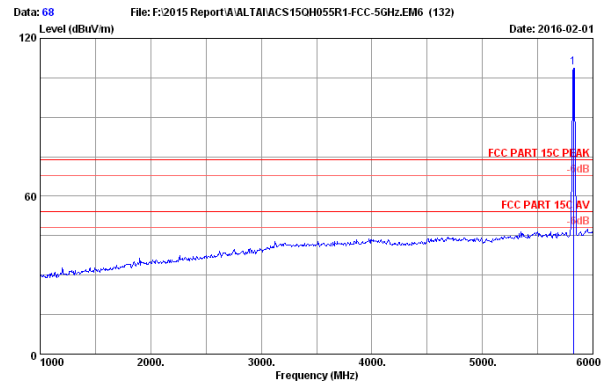

Site no. : 3m Chamber Data no. : 68  
 Dis. / Ant. : 3m 2015 3115-4877 Ant. pol. : VERTICAL  
 Limit : FCC PART 15C PEAK  
 Env. / Ins. : 23°C/54%  
 Engineer : Leo-Li  
 EUT : Altai A8in (ac) Super WiFi Base Station  
 Power rating : DC 56V From POE Input AC 120V/60Hz  
 Test Mode : IEEE802.11ac VHT20 5825MHz Tx  
 WA8011NAC-H

No.	Freq. (MHz)	Ant. Factor (dB/m)	Cable Loss (dB)	AMP factor (dB)	Reading (dBuV)	Emission Level (dBuV/m)	Limits (dBuV/m)	Margin (dB)	Remark
1	5825.000	34.60	9.93	35.08	99.58	109.03	74.00	-35.03	Peak

Remarks: 1. Emission Level= Antenna Factor + Cable Loss + Reading - Amp Factor  
 2. The emission levels that are 20dB below the official limit are not reported.

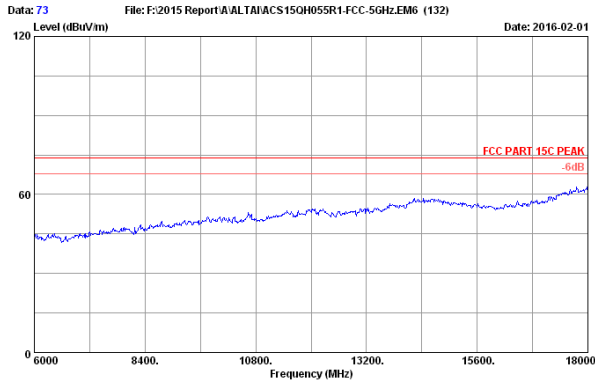

Site no. : 3m Chamber Data no. : 73  
 Dis. / Ant. : 3m 2015 3115-4877 Ant. pol. : HORIZONTAL  
 Limit : FCC PART 15C PEAK  
 Env. / Ins. : 23°C/54%  
 Engineer : Leo-Li  
 EUT : Alcatel A81n (ac) Super WiFi Base Station  
 Power rating : DC 56V From POE Input AC 120V/60Hz  
 Test Mode : IEEE802.11ac VHT20 5785MHz Tx  
 WA8011NAC-H

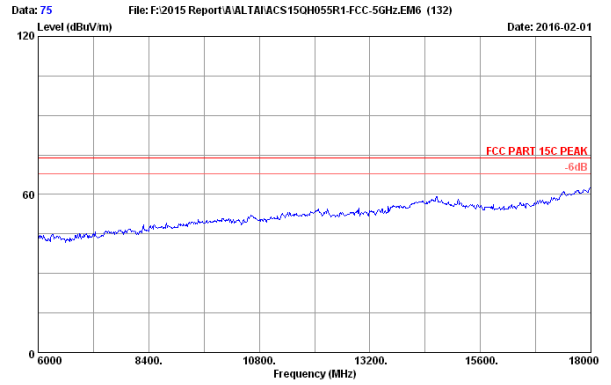

Site no. : 3m Chamber Data no. : 75  
 Dis. / Ant. : 3m 2015 3115-4877 Ant. pol. : VERTICAL  
 Limit : FCC PART 15C PEAK  
 Env. / Ins. : 23°C/54%  
 Engineer : Leo-Li  
 EUT : Alcatel A81n (ac) Super WiFi Base Station  
 Power rating : DC 56V From POE Input AC 120V/60Hz  
 Test Mode : IEEE802.11ac VHT20 5785MHz Tx  
 WA8011NAC-H

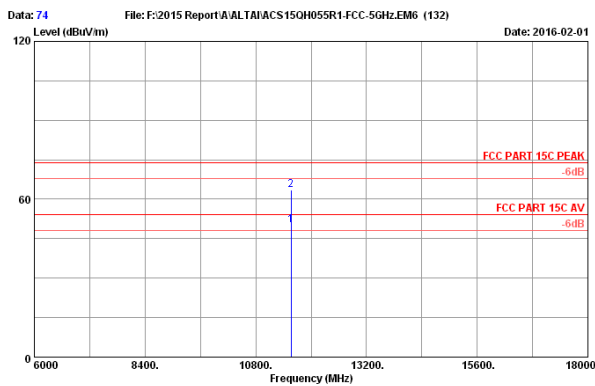

Site no. : 3m Chamber Data no. : 74  
 Dis. / Ant. : 3m 2015 3115-4877 Ant. pol. : HORIZONTAL  
 Limit : FCC PART 15C PEAK  
 Env. / Ins. : 23°C/54%  
 Engineer : Leo-Li  
 EUT : Alcatel A81n (ac) Super WiFi Base Station  
 Power rating : DC 56V From POE Input AC 120V/60Hz  
 Test Mode : IEEE802.11ac VHT20 5785MHz Tx  
 WA8011NAC-H

No.	Freq. (MHz)	Ant. Factor (dB/m)	Cable Loss (dB)	AMP factor (dB)	Reading (dBuV)	Emission Level (dBuV/m)	Limits (dBuV/m)	Margin (dB)	Remark
1	11570.000	39.14	14.60	35.31	31.85	50.28	54.00	3.72	Average
2	11570.000	39.14	14.60	35.31	45.24	63.67	74.00	10.33	Peak

Remarks: 1. Emission Level= Antenna Factor + Cable Loss + Reading - Amp Factor  
 2. The emission levels that are 20dB below the official limit are not reported.

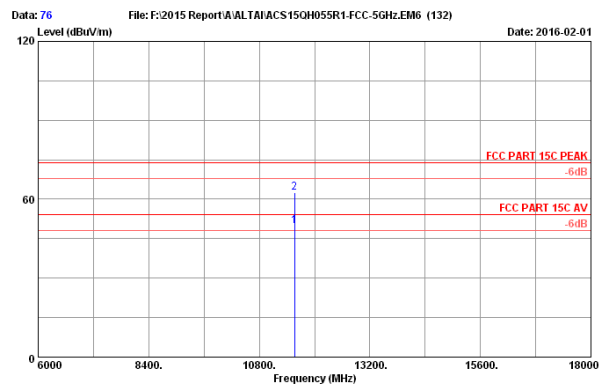

Site no. : 3m Chamber Data no. : 76  
 Dis. / Ant. : 3m 2015 3115-4877 Ant. pol. : VERTICAL  
 Limit : FCC PART 15C PEAK  
 Env. / Ins. : 23°C/54%  
 Engineer : Leo-Li  
 EUT : Alcatel A81n (ac) Super WiFi Base Station  
 Power rating : DC 56V From POE Input AC 120V/60Hz  
 Test Mode : IEEE802.11ac VHT20 5785MHz Tx  
 WA8011NAC-H

No.	Freq. (MHz)	Ant. Factor (dB/m)	Cable Loss (dB)	AMP factor (dB)	Reading (dBuV)	Emission Level (dBuV/m)	Limits (dBuV/m)	Margin (dB)	Remark
1	11570.000	39.14	14.60	35.31	31.44	49.87	54.00	4.13	Average
2	11570.000	39.14	14.60	35.31	44.24	62.67	74.00	11.33	Peak

Remarks: 1. Emission Level= Antenna Factor + Cable Loss + Reading - Amp Factor  
 2. The emission levels that are 20dB below the official limit are not reported.

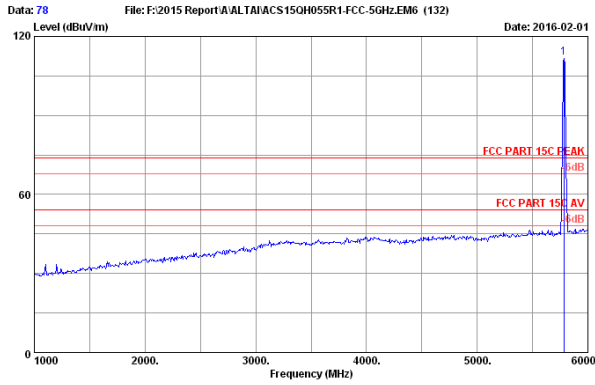

Site no. : 3m Chamber Data no. : 78  
 Dis. / Ant. : 3m 2015 3115-4877 Ant. pol. : HORIZONTAL  
 Limit : FCC PART 15C PEAK  
 Env. / Ins. : 23°C/54%  
 Engineer : Leo-Li  
 EUT : Alcatel A8in (ac) Super WiFi Base Station  
 Power rating : DC 56V From POE Input AC 120V/60Hz  
 Test Mode : IEEE802.11ac VHT20 5785MHz Tx  
 WA8011NAC-H

No.	Freq. (MHz)	Ant. Factor (dB/m)	Cable Loss (dB)	AMP factor (dB)	Reading (dBuV)	Emission Level (dBuV/m)	Limits (dBuV/m)	Margin (dB)	Remark
1	5785.000	34.57	9.91	35.10	102.59	111.97	74.00	-37.97	Peak

Remarks: 1. Emission Level= Antenna Factor + Cable Loss + Reading - Amp Factor  
 2. The emission levels that are 20dB below the official limit are not reported.

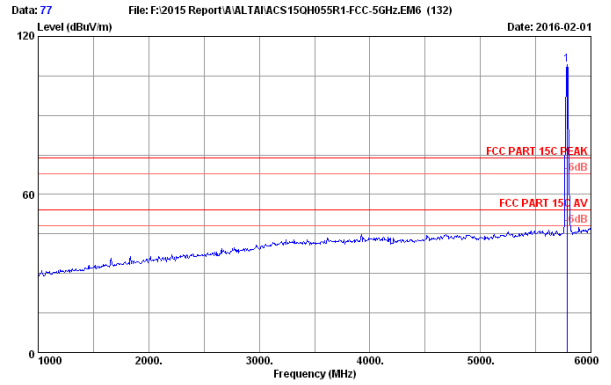

Site no. : 3m Chamber Data no. : 77  
 Dis. / Ant. : 3m 2015 3115-4877 Ant. pol. : VERTICAL  
 Limit : FCC PART 15C PEAK  
 Env. / Ins. : 23°C/54%  
 Engineer : Leo-Li  
 EUT : Alcatel A8in (ac) Super WiFi Base Station  
 Power rating : DC 56V From POE Input AC 120V/60Hz  
 Test Mode : IEEE802.11ac VHT20 5785MHz Tx  
 WA8011NAC-H

No.	Freq. (MHz)	Ant. Factor (dB/m)	Cable Loss (dB)	AMP factor (dB)	Reading (dBuV)	Emission Level (dBuV/m)	Limits (dBuV/m)	Margin (dB)	Remark
1	5785.000	34.57	9.91	35.10	99.89	109.27	74.00	-35.27	Peak

Remarks: 1. Emission Level= Antenna Factor + Cable Loss + Reading - Amp Factor  
 2. The emission levels that are 20dB below the official limit are not reported.

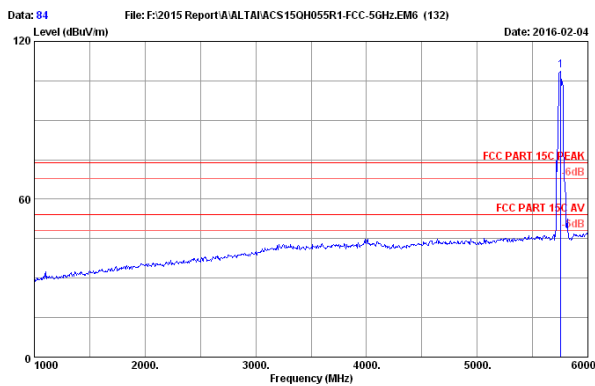

Site no. : 3m Chamber Data no. : 84  
 Dis. / Ant. : 3m 2015 3115-4877 Ant. pol. : HORIZONTAL  
 Limit : FCC PART 15C PEAK  
 Env. / Ins. : 23°C/54%  
 Engineer : Leo-Li  
 EUT : Alcatel A8in (ac) Super WiFi Base Station  
 Power rating : DC 56V From POE Input AC 120V/60Hz  
 Test Mode : IEEE802.11nHT40 5755MHz Tx  
 WA8011NAC-H

No.	Freq. (MHz)	Ant. Factor (dB/m)	Cable Loss (dB)	AMP factor (dB)	Reading (dBuV)	Emission Level (dBuV/m)	Limits (dBuV/m)	Margin (dB)	Remark
1	5755.000	34.55	9.91	35.11	99.58	108.93	74.00	-34.93	Peak

Remarks: 1. Emission Level= Antenna Factor + Cable Loss + Reading - Amp Factor  
 2. The emission levels that are 20dB below the official limit are not reported.

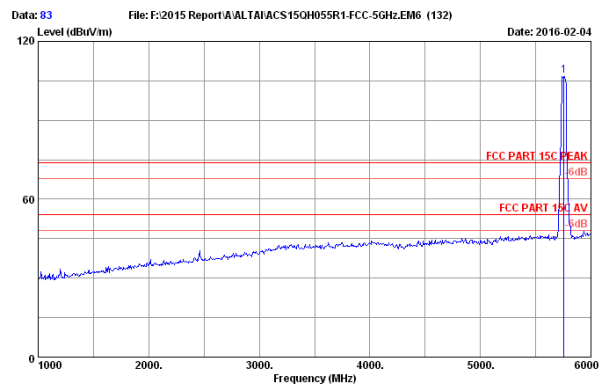

Site no. : 3m Chamber Data no. : 83  
 Dis. / Ant. : 3m 2015 3115-4877 Ant. pol. : VERTICAL  
 Limit : FCC PART 15C PEAK  
 Env. / Ins. : 23°C/54%  
 Engineer : Leo-Li  
 EUT : Alcatel A8in (ac) Super WiFi Base Station  
 Power rating : DC 56V From POE Input AC 120V/60Hz  
 Test Mode : IEEE802.11nHT40 5755MHz Tx  
 WA8011NAC-H

No.	Freq. (MHz)	Ant. Factor (dB/m)	Cable Loss (dB)	AMP factor (dB)	Reading (dBuV)	Emission Level (dBuV/m)	Limits (dBuV/m)	Margin (dB)	Remark
1	5755.000	34.55	9.91	35.11	97.56	106.91	74.00	-32.91	Peak

Remarks: 1. Emission Level= Antenna Factor + Cable Loss + Reading - Amp Factor  
 2. The emission levels that are 20dB below the official limit are not reported.



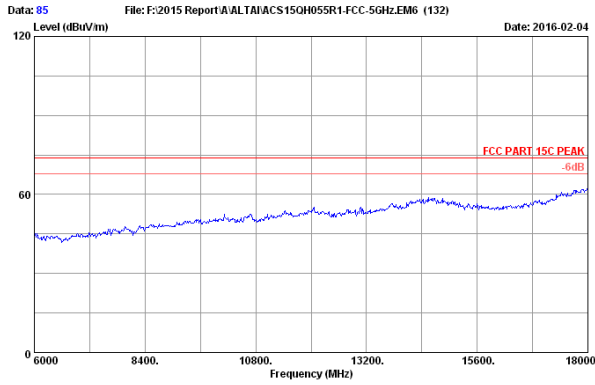

Site no. : 3m Chamber Data no. : 85  
 Dis. / Ant. : 3m 2015 3115-4877 Ant. pol. : HORIZONTAL  
 Limit : FCC PART 15C PEAK  
 Env. / Ins. : 23°C/54%  
 Engineer : Leo-Li  
 EUT : Altai A8in (ac) Super WiFi Base Station  
 Power rating : DC 56V From POE Input AC 120V/60Hz  
 Test Mode : IEEE802.11nHT40 5755MHz Tx  
 WA8011NAC-H

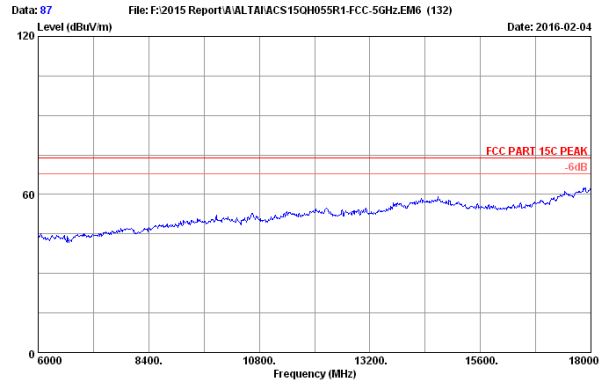

Site no. : 3m Chamber Data no. : 87  
 Dis. / Ant. : 3m 2015 3115-4877 Ant. pol. : VERTICAL  
 Limit : FCC PART 15C PEAK  
 Env. / Ins. : 23°C/54%  
 Engineer : Leo-Li  
 EUT : Altai A8in (ac) Super WiFi Base Station  
 Power rating : DC 56V From POE Input AC 120V/60Hz  
 Test Mode : IEEE802.11nHT40 5755MHz Tx  
 WA8011NAC-H

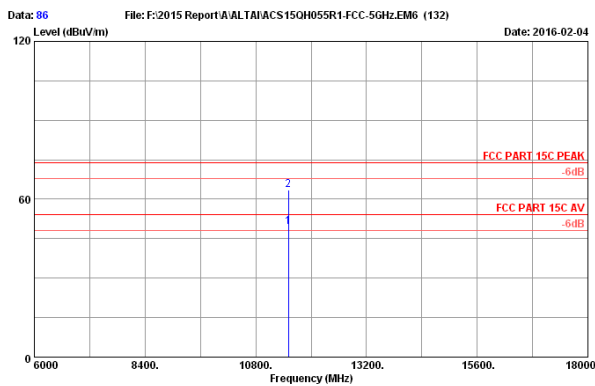

Site no. : 3m Chamber Data no. : 86  
 Dis. / Ant. : 3m 2015 3115-4877 Ant. pol. : HORIZONTAL  
 Limit : FCC PART 15C PEAK  
 Env. / Ins. : 23°C/54%  
 Engineer : Leo-Li  
 EUT : Altai A8in (ac) Super WiFi Base Station  
 Power rating : DC 56V From POE Input AC 120V/60Hz  
 Test Mode : IEEE802.11nHT40 5755MHz Tx  
 WA8011NAC-H

No.	Freq. (MHz)	Ant. Factor (dB/m)	Cable Loss (dB)	AMP factor (dB)	Reading (dBuV)	Emission Level (dBuV/m)	Limits (dBuV/m)	Margin (dB)	Remark
1	11510.000	39.11	14.56	35.33	31.18	49.52	54.00	4.48	Average
2	11510.000	39.11	14.56	35.33	45.20	63.54	74.00	10.46	Peak

Remarks: 1. Emission Level= Antenna Factor + Cable Loss + Reading - Amp Factor  
 2. The emission levels that are 20dB below the official limit are not reported.

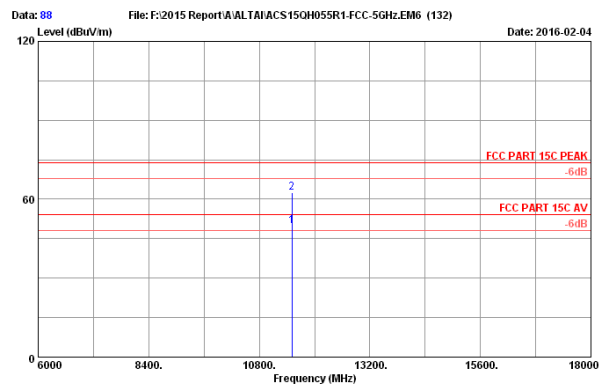

Site no. : 3m Chamber Data no. : 88  
 Dis. / Ant. : 3m 2015 3115-4877 Ant. pol. : VERTICAL  
 Limit : FCC PART 15C PEAK  
 Env. / Ins. : 23°C/54%  
 Engineer : Leo-Li  
 EUT : Altai A8in (ac) Super WiFi Base Station  
 Power rating : DC 56V From POE Input AC 120V/60Hz  
 Test Mode : IEEE802.11nHT40 5755MHz Tx  
 WA8011NAC-H

No.	Freq. (MHz)	Ant. Factor (dB/m)	Cable Loss (dB)	AMP factor (dB)	Reading (dBuV)	Emission Level (dBuV/m)	Limits (dBuV/m)	Margin (dB)	Remark
1	11510.000	39.11	14.56	35.33	31.39	49.73	54.00	4.27	Average
2	11510.000	39.11	14.56	35.33	44.30	62.64	74.00	11.36	Peak

Remarks: 1. Emission Level= Antenna Factor + Cable Loss + Reading - Amp Factor  
 2. The emission levels that are 20dB below the official limit are not reported.

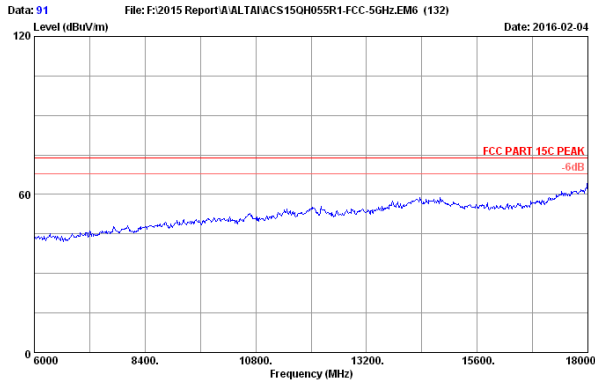

Site no. : 3m Chamber Data no. : 91  
 Dis. / Ant. : 3m 2015 3115-4877 Ant. pol. : HORIZONTAL  
 Limit : FCC PART 15C PEAK  
 Env. / Ins. : 23°C/54%  
 Engineer : Leo-Li  
 EUT : Altai A8in (ac) Super WiFi Base Station  
 Power rating : DC 56V From POE Input AC 120V/60Hz  
 Test Mode : IEEE802.11nHT40 5795MHz Tx  
 WA8011NAC-H

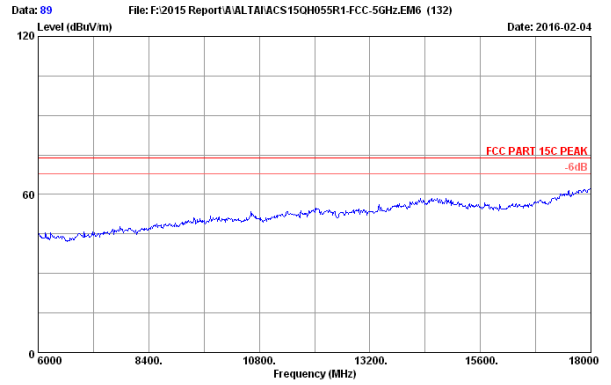

Site no. : 3m Chamber Data no. : 89  
 Dis. / Ant. : 3m 2015 3115-4877 Ant. pol. : VERTICAL  
 Limit : FCC PART 15C PEAK  
 Env. / Ins. : 23°C/54%  
 Engineer : Leo-Li  
 EUT : Altai A8in (ac) Super WiFi Base Station  
 Power rating : DC 56V From POE Input AC 120V/60Hz  
 Test Mode : IEEE802.11nHT40 5795MHz Tx  
 WA8011NAC-H

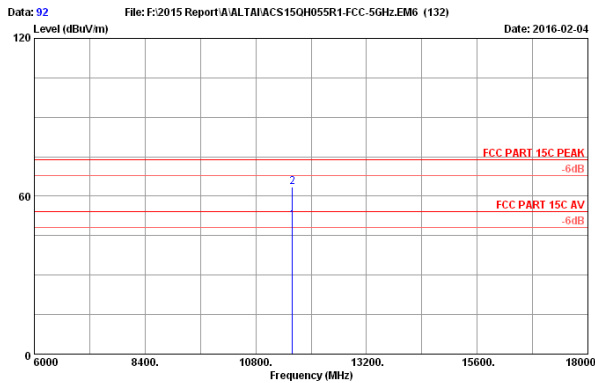

Site no. : 3m Chamber Data no. : 92  
 Dis. / Ant. : 3m 2015 3115-4877 Ant. pol. : HORIZONTAL  
 Limit : FCC PART 15C PEAK  
 Env. / Ins. : 23°C/54%  
 Engineer : Leo-Li  
 EUT : Altai A8in (ac) Super WiFi Base Station  
 Power rating : DC 56V From POE Input AC 120V/60Hz  
 Test Mode : IEEE802.11nHT40 5795MHz Tx  
 WA8011NAC-H

No.	Freq. (MHz)	Ant. Factor (dB/m)	Cable Loss (dB)	AMP factor (dB)	Reading (dBuV)	Emission Level (dBuV/m)	Limits (dBuV/m)	Margin (dB)	Remark
1	11590.000	39.15	14.61	35.30	32.41	50.87	54.00	3.13	Average
2	11590.000	39.15	14.61	35.30	45.01	63.47	74.00	10.53	Peak

Remarks: 1. Emission Level= Antenna Factor + Cable Loss + Reading - Amp Factor  
 2. The emission levels that are 20dB below the official limit are not reported.

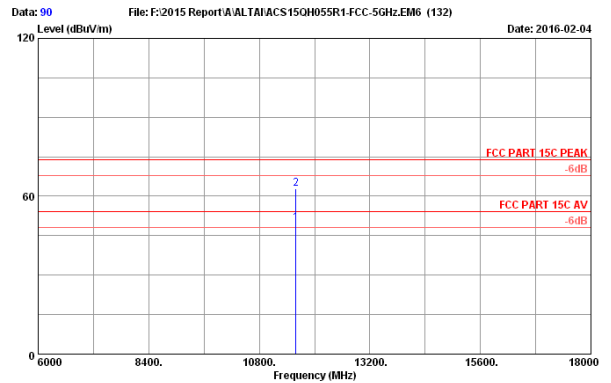

Site no. : 3m Chamber Data no. : 90  
 Dis. / Ant. : 3m 2015 3115-4877 Ant. pol. : VERTICAL  
 Limit : FCC PART 15C PEAK  
 Env. / Ins. : 23°C/54%  
 Engineer : Leo-Li  
 EUT : Altai A8in (ac) Super WiFi Base Station  
 Power rating : DC 56V From POE Input AC 120V/60Hz  
 Test Mode : IEEE802.11nHT40 5795MHz Tx  
 WA8011NAC-H

No.	Freq. (MHz)	Ant. Factor (dB/m)	Cable Loss (dB)	AMP factor (dB)	Reading (dBuV)	Emission Level (dBuV/m)	Limits (dBuV/m)	Margin (dB)	Remark
1	11590.000	39.15	14.61	35.30	31.28	49.74	54.00	4.26	Average
2	11590.000	39.15	14.61	35.30	44.26	62.72	74.00	11.28	Peak

Remarks: 1. Emission Level= Antenna Factor + Cable Loss + Reading - Amp Factor  
 2. The emission levels that are 20dB below the official limit are not reported.

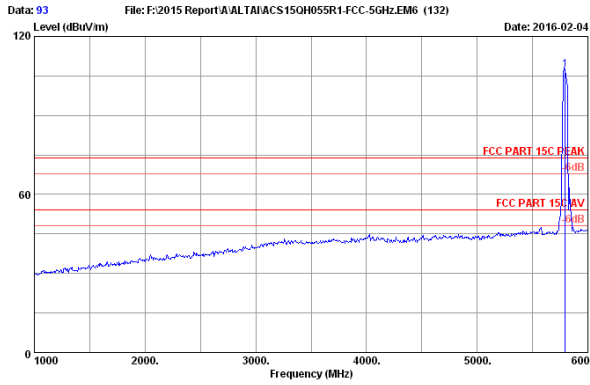

Data: 93 File: F:\2015 Report\A\ALTAI\ACS150H055R1-FCC-5GHz.EM6 (132) Date: 2016-02-04

Site no. : 3m Chamber Data no. : 93  
 Dis. / Ant. : 3m 2015 3115-4877 Ant. pol. : HORIZONTAL  
 Limit : FCC PART 15C PEAK  
 Env. / Ins. : 23°C/54%  
 Engineer : Leo-Li  
 EUT : Altai A8in (ac) Super WiFi Base Station  
 Power rating : DC 56V From POE Input AC 120V/60Hz  
 Test Mode : IEEE802.11nHT40 5795MHz Tx  
 WA8011NAC-H

No.	Freq. (MHz)	Ant. Factor (dB/m)	Cable Loss (dB)	AMP factor (dB)	Reading (dBuV)	Emission Level (dBuV/m)	Limits (dBuV/m)	Margin (dB)	Remark
1	5795.000	34.58	9.92	35.09	97.82	107.23	74.00	-33.23	Peak

Remarks: 1. Emission Level= Antenna Factor + Cable Loss + Reading - Amp Factor  
 2. The emission levels that are 20dB below the official limit are not reported.

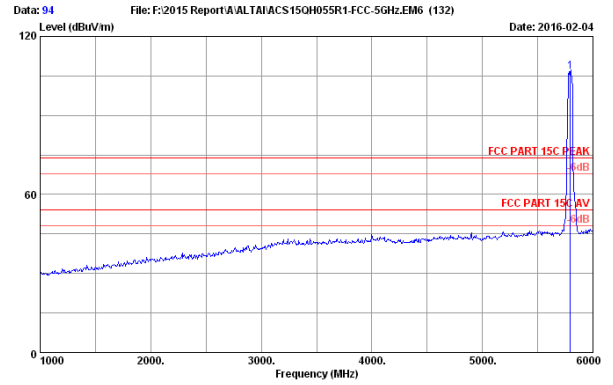

Data: 94 File: F:\2015 Report\A\ALTAI\ACS150H055R1-FCC-5GHz.EM6 (132) Date: 2016-02-04

Site no. : 3m Chamber Data no. : 94  
 Dis. / Ant. : 3m 2015 3115-4877 Ant. pol. : VERTICAL  
 Limit : FCC PART 15C PEAK  
 Env. / Ins. : 23°C/54%  
 Engineer : Leo-Li  
 EUT : Altai A8in (ac) Super WiFi Base Station  
 Power rating : DC 56V From POE Input AC 120V/60Hz  
 Test Mode : IEEE802.11nHT40 5795MHz Tx  
 WA8011NAC-H

No.	Freq. (MHz)	Ant. Factor (dB/m)	Cable Loss (dB)	AMP factor (dB)	Reading (dBuV)	Emission Level (dBuV/m)	Limits (dBuV/m)	Margin (dB)	Remark
1	5795.000	34.58	9.92	35.09	97.26	106.67	74.00	-32.67	Peak

Remarks: 1. Emission Level= Antenna Factor + Cable Loss + Reading - Amp Factor  
 2. The emission levels that are 20dB below the official limit are not reported.

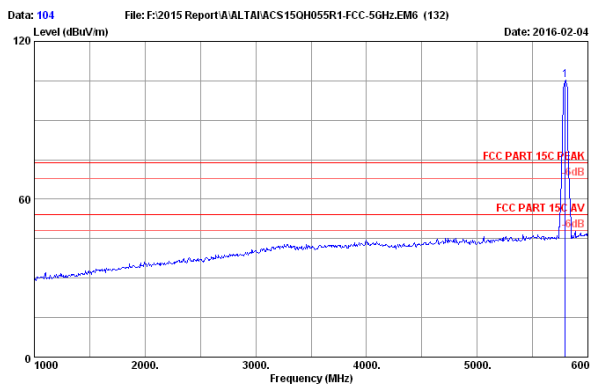

Data: 104 File: F:\2015 Report\A\ALTAI\ACS150H055R1-FCC-5GHz.EM6 (132) Date: 2016-02-04

Site no. : 3m Chamber Data no. : 104  
 Dis. / Ant. : 3m 2015 3115-4877 Ant. pol. : HORIZONTAL  
 Limit : FCC PART 15C PEAK  
 Env. / Ins. : 23°C/54%  
 Engineer : Leo-Li  
 EUT : Altai A8in (ac) Super WiFi Base Station  
 Power rating : DC 56V From POE Input AC 120V/60Hz  
 Test Mode : IEEE802.11ac VHT40 5795MHz Tx  
 WA8011NAC-H

No.	Freq. (MHz)	Ant. Factor (dB/m)	Cable Loss (dB)	AMP factor (dB)	Reading (dBuV)	Emission Level (dBuV/m)	Limits (dBuV/m)	Margin (dB)	Remark
1	5795.000	34.58	9.92	35.09	95.86	105.27	74.00	-31.27	Peak

Remarks: 1. Emission Level= Antenna Factor + Cable Loss + Reading - Amp Factor  
 2. The emission levels that are 20dB below the official limit are not reported.

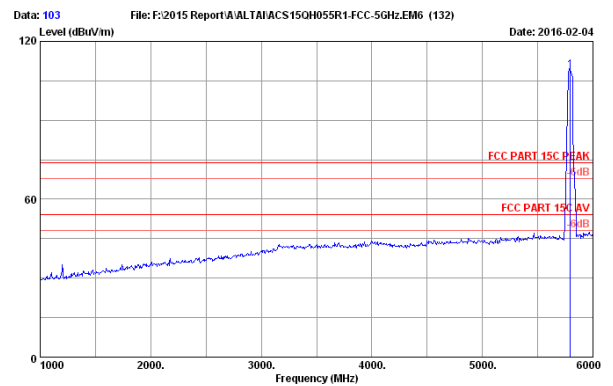

Data: 103 File: F:\2015 Report\A\ALTAI\ACS150H055R1-FCC-5GHz.EM6 (132) Date: 2016-02-04

Site no. : 3m Chamber Data no. : 103  
 Dis. / Ant. : 3m 2015 3115-4877 Ant. pol. : VERTICAL  
 Limit : FCC PART 15C PEAK  
 Env. / Ins. : 23°C/54%  
 Engineer : Leo-Li  
 EUT : Altai A8in (ac) Super WiFi Base Station  
 Power rating : DC 56V From POE Input AC 120V/60Hz  
 Test Mode : IEEE802.11ac VHT40 5795MHz Tx  
 WA8011NAC-H

No.	Freq. (MHz)	Ant. Factor (dB/m)	Cable Loss (dB)	AMP factor (dB)	Reading (dBuV)	Emission Level (dBuV/m)	Limits (dBuV/m)	Margin (dB)	Remark
1	5795.000	34.58	9.92	35.09	99.58	108.99	74.00	-34.99	Peak

Remarks: 1. Emission Level= Antenna Factor + Cable Loss + Reading - Amp Factor  
 2. The emission levels that are 20dB below the official limit are not reported.

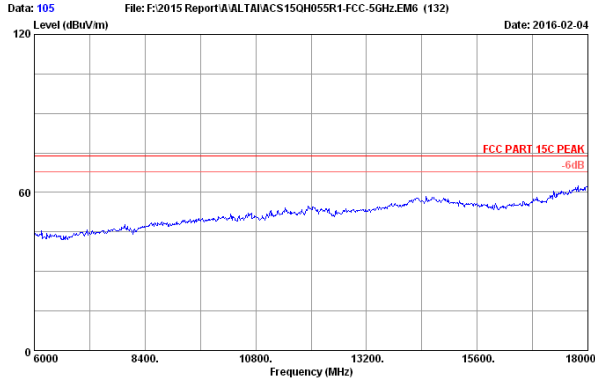

Site no. : 3m Chamber Data no. : 105  
 Dis. / Ant. : 3m 2015 3115-4877 Ant. pol. : HORIZONTAL  
 Limit : FCC PART 15C PEAK  
 Env. / Ins. : 23°C/54%  
 Engineer : Leo-Li  
 EUT : Alcatel A81in (ac) Super WiFi Base Station  
 Power rating : DC 56V From POE Input AC 120V/60Hz  
 Test Mode : IEEE802.11ac VHT40 5795MHz Tx  
 WA8011NAC-H

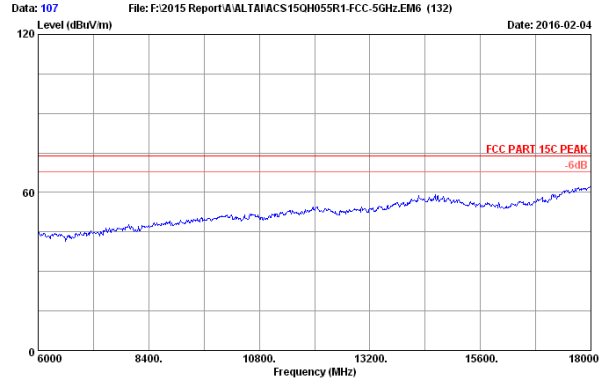

Site no. : 3m Chamber Data no. : 107  
 Dis. / Ant. : 3m 2015 3115-4877 Ant. pol. : VERTICAL  
 Limit : FCC PART 15C PEAK  
 Env. / Ins. : 23°C/54%  
 Engineer : Leo-Li  
 EUT : Alcatel A81in (ac) Super WiFi Base Station  
 Power rating : DC 56V From POE Input AC 120V/60Hz  
 Test Mode : IEEE802.11ac VHT40 5795MHz Tx  
 WA8011NAC-H

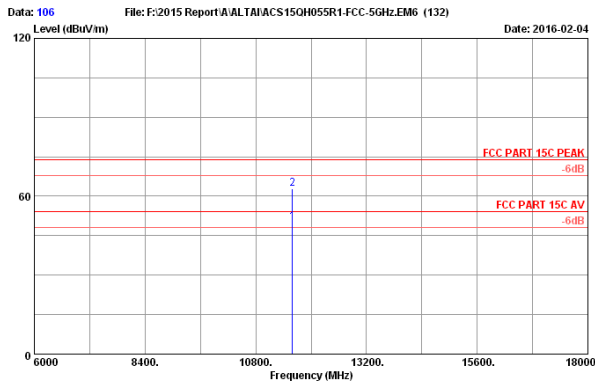

Site no. : 3m Chamber Data no. : 106  
 Dis. / Ant. : 3m 2015 3115-4877 Ant. pol. : HORIZONTAL  
 Limit : FCC PART 15C PEAK  
 Env. / Ins. : 23°C/54%  
 Engineer : Leo-Li  
 EUT : Alcatel A81in (ac) Super WiFi Base Station  
 Power rating : DC 56V From POE Input AC 120V/60Hz  
 Test Mode : IEEE802.11ac VHT40 5795MHz Tx  
 WA8011NAC-H

No.	Freq. (MHz)	Ant. Factor (dB/m)	Cable Loss (dB)	AMP factor (dB)	Reading (dBuV)	Emission Level (dBuV/m)	Limits (dBuV/m)	Margin (dB)	Remark
1	11590.000	39.15	14.61	35.30	31.74	50.20	54.00	3.80	Average
2	11590.000	39.15	14.61	35.30	44.29	62.75	74.00	11.25	Peak

Remarks: 1. Emission Level= Antenna Factor + Cable Loss + Reading - Amp Factor  
 2. The emission levels that are 20dB below the official limit are not reported.

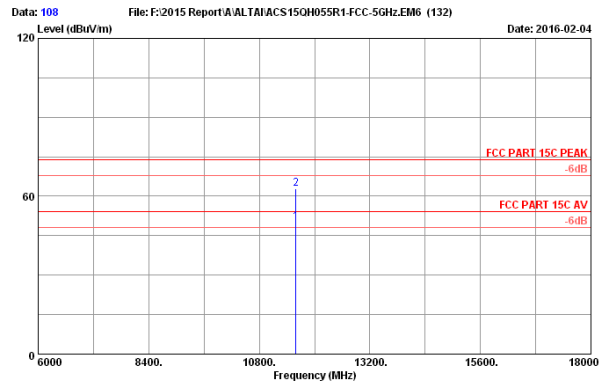

Site no. : 3m Chamber Data no. : 108  
 Dis. / Ant. : 3m 2015 3115-4877 Ant. pol. : VERTICAL  
 Limit : FCC PART 15C PEAK  
 Env. / Ins. : 23°C/54%  
 Engineer : Leo-Li  
 EUT : Alcatel A81in (ac) Super WiFi Base Station  
 Power rating : DC 56V From POE Input AC 120V/60Hz  
 Test Mode : IEEE802.11ac VHT40 5795MHz Tx  
 WA8011NAC-H

No.	Freq. (MHz)	Ant. Factor (dB/m)	Cable Loss (dB)	AMP factor (dB)	Reading (dBuV)	Emission Level (dBuV/m)	Limits (dBuV/m)	Margin (dB)	Remark
1	11590.000	39.15	14.61	35.30	31.55	50.01	54.00	3.99	Average
2	11590.000	39.15	14.61	35.30	44.26	62.72	74.00	11.28	Peak

Remarks: 1. Emission Level= Antenna Factor + Cable Loss + Reading - Amp Factor  
 2. The emission levels that are 20dB below the official limit are not reported.

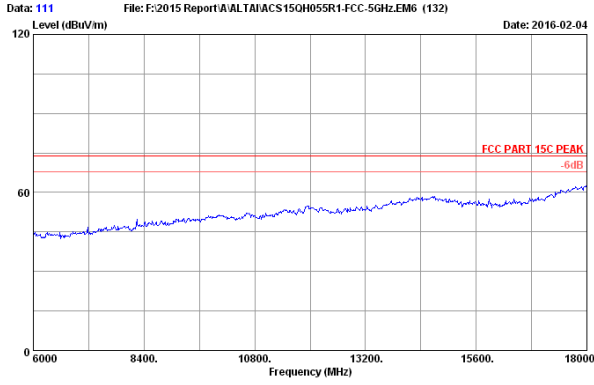

Site no. : 3m Chamber Data no. : 111  
 Dis. / Ant. : 3m 2015 3115-4877 Ant. pol. : HORIZONTAL  
 Limit : FCC PART 15C PEAK  
 Env. / Ins. : 23°C/54%  
 Engineer : Leo-Li  
 EUT : Alcatel A81n (ac) Super WiFi Base Station  
 Power rating : DC 56W From POE Input AC 120V/60Hz  
 Test Mode : IEEE802.11ac VHT40 5755MHz Tx  
 WA8011NAC-H

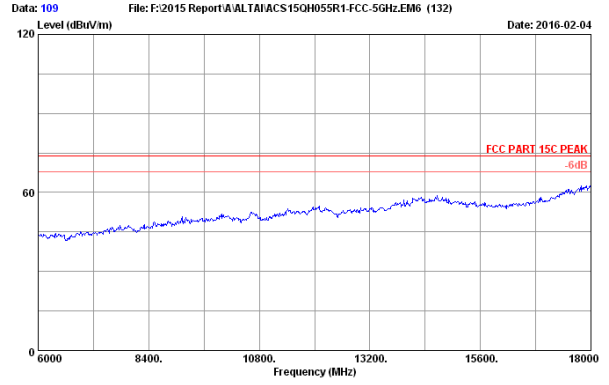

Site no. : 3m Chamber Data no. : 109  
 Dis. / Ant. : 3m 2015 3115-4877 Ant. pol. : VERTICAL  
 Limit : FCC PART 15C PEAK  
 Env. / Ins. : 23°C/54%  
 Engineer : Leo-Li  
 EUT : Alcatel A81n (ac) Super WiFi Base Station  
 Power rating : DC 56W From POE Input AC 120V/60Hz  
 Test Mode : IEEE802.11ac VHT40 5755MHz Tx  
 WA8011NAC-H

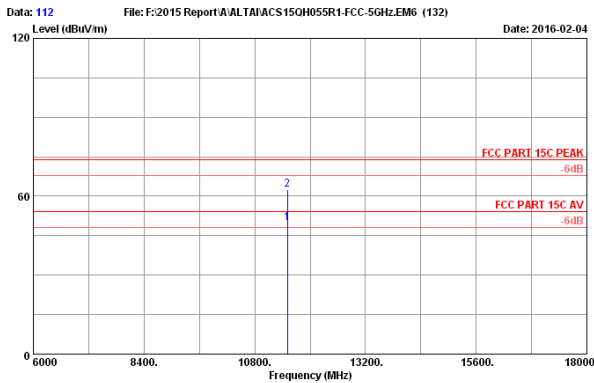

Site no. : 3m Chamber Data no. : 112  
 Dis. / Ant. : 3m 2015 3115-4877 Ant. pol. : HORIZONTAL  
 Limit : FCC PART 15C PEAK  
 Env. / Ins. : 23°C/54%  
 Engineer : Leo-Li  
 EUT : Alcatel A81n (ac) Super WiFi Base Station  
 Power rating : DC 56W From POE Input AC 120V/60Hz  
 Test Mode : IEEE802.11ac VHT40 5755MHz Tx  
 WA8011NAC-H

No.	Freq. (MHz)	Ant. Factor (dB/m)	Cable Loss (dB)	AMP factor (dB)	Reading (dBuV)	Emission Level (dBuV/m)	Limits (dBuV/m)	Margin (dB)	Remark
1	11510.000	39.11	14.56	35.33	31.46	49.80	54.00	4.20	Average
2	11510.000	39.11	14.56	35.33	44.03	62.37	74.00	11.63	Peak

Remarks: 1. Emission Level= Antenna Factor + Cable Loss + Reading - Amp Factor  
 2. The emission levels that are 20dB below the official limit are not reported.

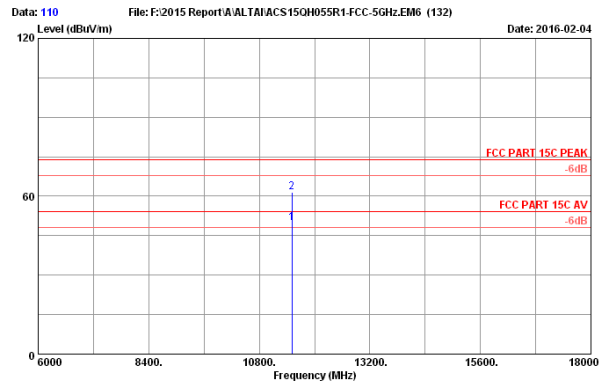

Site no. : 3m Chamber Data no. : 110  
 Dis. / Ant. : 3m 2015 3115-4877 Ant. pol. : VERTICAL  
 Limit : FCC PART 15C PEAK  
 Env. / Ins. : 23°C/54%  
 Engineer : Leo-Li  
 EUT : Alcatel A81n (ac) Super WiFi Base Station  
 Power rating : DC 56W From POE Input AC 120V/60Hz  
 Test Mode : IEEE802.11ac VHT40 5755MHz Tx  
 WA8011NAC-H

No.	Freq. (MHz)	Ant. Factor (dB/m)	Cable Loss (dB)	AMP factor (dB)	Reading (dBuV)	Emission Level (dBuV/m)	Limits (dBuV/m)	Margin (dB)	Remark
1	11510.000	39.11	14.56	35.33	31.56	49.90	54.00	4.10	Average
2	11510.000	39.11	14.56	35.33	43.26	61.60	74.00	12.40	Peak

Remarks: 1. Emission Level= Antenna Factor + Cable Loss + Reading - Amp Factor  
 2. The emission levels that are 20dB below the official limit are not reported.

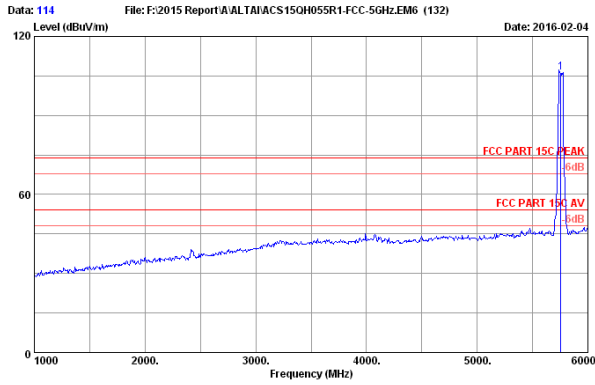

Site no. : 3m Chamber Data no. : 114  
 Dis. / Ant. : 3m 2015 3115-4877 Ant. pol. : HORIZONTAL  
 Limit : FCC PART 15C PEAK  
 Env. / Ins. : 23°C/54%  
 Engineer : Leo-Li  
 EUT : Altai A8in (ac) Super WiFi Base Station  
 Power rating : DC 56V From POE Input AC 120V/60Hz  
 Test Mode : IEEE802.11ac VHT40 5755MHz Tx  
 WA8011NAC-H

No.	Freq. (MHz)	Ant. Factor (dB/m)	Cable Loss (dB)	AMP factor (dB)	Reading (dBuV)	Emission Level (dBuV/m)	Limits (dBuV/m)	Margin (dB)	Remark
1	5755.000	34.55	9.91	35.11	96.85	106.20	74.00	-32.20	Peak

Remarks: 1. Emission Level= Antenna Factor + Cable Loss + Reading - Amp Factor  
 2. The emission levels that are 20dB below the official limit are not reported.

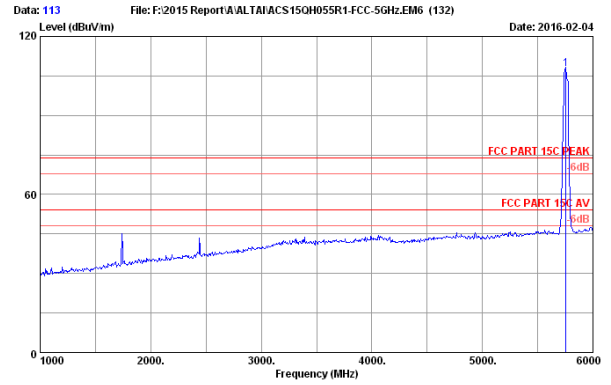

Site no. : 3m Chamber Data no. : 113  
 Dis. / Ant. : 3m 2015 3115-4877 Ant. pol. : VERTICAL  
 Limit : FCC PART 15C PEAK  
 Env. / Ins. : 23°C/54%  
 Engineer : Leo-Li  
 EUT : Altai A8in (ac) Super WiFi Base Station  
 Power rating : DC 56V From POE Input AC 120V/60Hz  
 Test Mode : IEEE802.11ac VHT40 5755MHz Tx  
 WA8011NAC-H

No.	Freq. (MHz)	Ant. Factor (dB/m)	Cable Loss (dB)	AMP factor (dB)	Reading (dBuV)	Emission Level (dBuV/m)	Limits (dBuV/m)	Margin (dB)	Remark
1	5755.000	34.55	9.91	35.11	98.26	107.61	74.00	-33.61	Peak

Remarks: 1. Emission Level= Antenna Factor + Cable Loss + Reading - Amp Factor  
 2. The emission levels that are 20dB below the official limit are not reported.

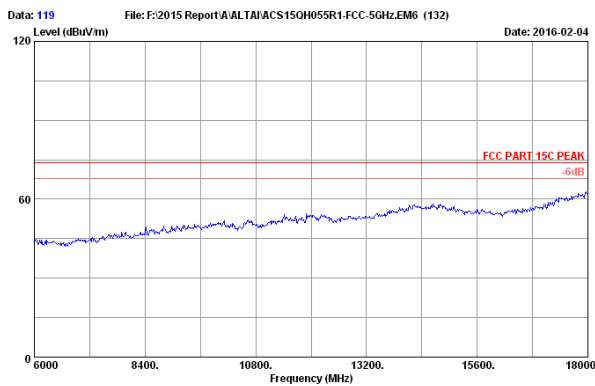

Site no. : 3m Chamber Data no. : 119  
 Dis. / Ant. : 3m 2015 3115-4877 Ant. pol. : HORIZONTAL  
 Limit : FCC PART 15C PEAK  
 Env. / Ins. : 23°C/54%  
 Engineer : Leo-Li  
 EUT : Altai A8in (ac) Super WiFi Base Station  
 Power rating : DC 56V From POE Input AC 120V/60Hz  
 Test Mode : IEEE802.11ac VHT80 5775MHz Tx  
 WA8011NAC-H

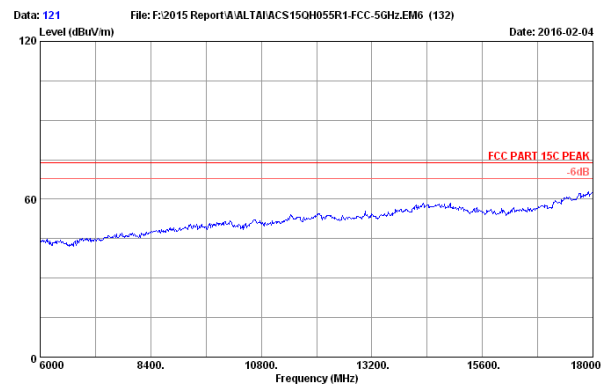

Site no. : 3m Chamber Data no. : 121  
 Dis. / Ant. : 3m 2015 3115-4877 Ant. pol. : VERTICAL  
 Limit : FCC PART 15C PEAK  
 Env. / Ins. : 23°C/54%  
 Engineer : Leo-Li  
 EUT : Altai A8in (ac) Super WiFi Base Station  
 Power rating : DC 56V From POE Input AC 120V/60Hz  
 Test Mode : IEEE802.11ac VHT80 5775MHz Tx  
 WA8011NAC-H

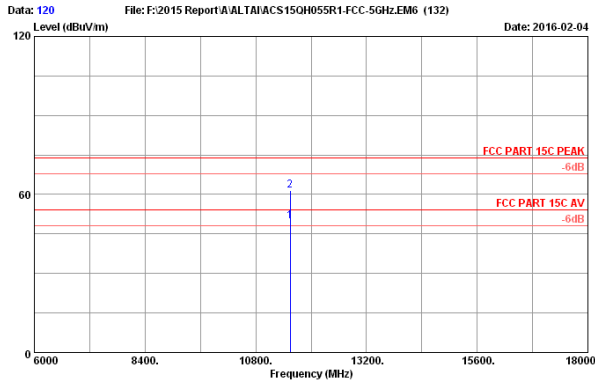

Site no. : 3m Chamber Data no. : 120  
 Dis. / Ant. : 3m 2015 3115-4877 Ant. pol. : HORIZONTAL  
 Limit : FCC PART 15C PEAK  
 Env. / Ins. : 23°C/54%  
 Engineer : Leo-Li  
 EUT : Altai ASin (ac) Super WiFi Base Station  
 Power rating : DC 56V From POE Input AC 120V/60Hz  
 Test Mode : IEEE802.11ac VHT80 5775MHz Tx  
 WA8011NAC-H

No.	Freq. (MHz)	Ant. Factor (dB/m)	Cable Loss (dB)	AMP factor (dB)	Reading (dBuV)	Emission Level (dBuV/m)	Limits (dBuV/m)	Margin (dB)	Remark
1	11550.000	39.13	14.58	35.31	31.26	49.66	54.00	4.34	Average
2	11550.000	39.13	14.58	35.31	43.26	61.66	74.00	12.34	Peak

Remarks: 1. Emission Level= Antenna Factor + Cable Loss + Reading - Amp Factor  
 2. The emission levels that are 20dB below the official limit are not reported.

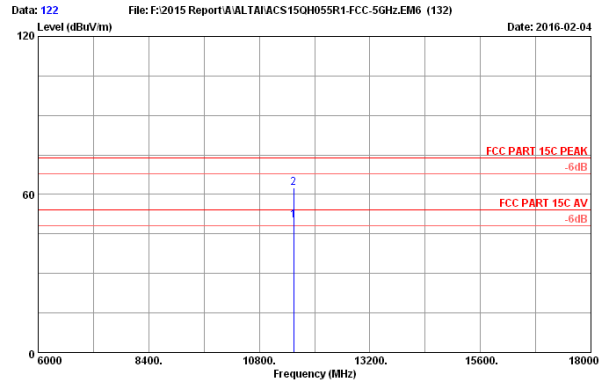

Site no. : 3m Chamber Data no. : 122  
 Dis. / Ant. : 3m 2015 3115-4877 Ant. pol. : VERTICAL  
 Limit : FCC PART 15C PEAK  
 Env. / Ins. : 23°C/54%  
 Engineer : Leo-Li  
 EUT : Altai ASin (ac) Super WiFi Base Station  
 Power rating : DC 56V From POE Input AC 120V/60Hz  
 Test Mode : IEEE802.11ac VHT80 5775MHz Tx  
 WA8011NAC-H

No.	Freq. (MHz)	Ant. Factor (dB/m)	Cable Loss (dB)	AMP factor (dB)	Reading (dBuV)	Emission Level (dBuV/m)	Limits (dBuV/m)	Margin (dB)	Remark
1	11550.000	39.13	14.58	35.31	31.68	50.08	54.00	3.92	Average
2	11550.000	39.13	14.58	35.31	44.06	62.46	74.00	11.54	Peak

Remarks: 1. Emission Level= Antenna Factor + Cable Loss + Reading - Amp Factor  
 2. The emission levels that are 20dB below the official limit are not reported.

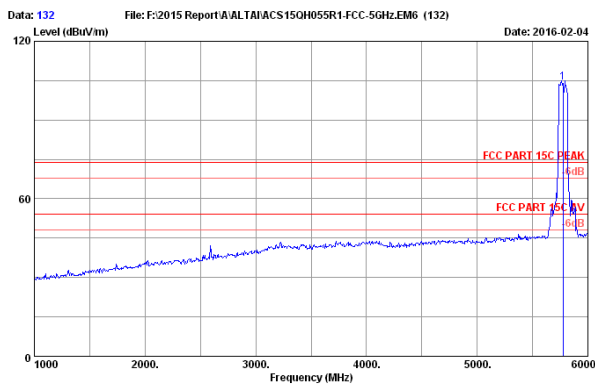

Site no. : 3m Chamber Data no. : 132  
 Dis. / Ant. : 3m 2015 3115-4877 Ant. pol. : HORIZONTAL  
 Limit : FCC PART 15C PEAK  
 Env. / Ins. : 23°C/54%  
 Engineer : Leo-Li  
 EUT : Altai ASin (ac) Super WiFi Base Station  
 Power rating : DC 56V From POE Input AC 120V/60Hz  
 Test Mode : IEEE802.11ac VHT80 5775MHz Tx  
 WA8011NAC-H

No.	Freq. (MHz)	Ant. Factor (dB/m)	Cable Loss (dB)	AMP factor (dB)	Reading (dBuV)	Emission Level (dBuV/m)	Limits (dBuV/m)	Margin (dB)	Remark
1	5775.000	34.57	9.91	35.10	94.85	104.23	74.00	-30.23	Peak

Remarks: 1. Emission Level= Antenna Factor + Cable Loss + Reading - Amp Factor  
 2. The emission levels that are 20dB below the official limit are not reported.

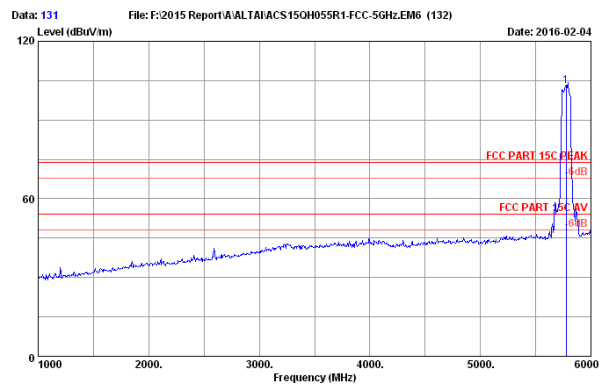

Site no. : 3m Chamber Data no. : 131  
 Dis. / Ant. : 3m 2015 3115-4877 Ant. pol. : VERTICAL  
 Limit : FCC PART 15C PEAK  
 Env. / Ins. : 23°C/54%  
 Engineer : Leo-Li  
 EUT : Altai ASin (ac) Super WiFi Base Station  
 Power rating : DC 56V From POE Input AC 120V/60Hz  
 Test Mode : IEEE802.11ac VHT80 5775MHz Tx  
 WA8011NAC-H

No.	Freq. (MHz)	Ant. Factor (dB/m)	Cable Loss (dB)	AMP factor (dB)	Reading (dBuV)	Emission Level (dBuV/m)	Limits (dBuV/m)	Margin (dB)	Remark
1	5775.000	34.57	9.91	35.10	93.68	103.06	74.00	-29.06	Peak

Remarks: 1. Emission Level= Antenna Factor + Cable Loss + Reading - Amp Factor  
 2. The emission levels that are 20dB below the official limit are not reported.

## 5. BAND EDGE COMPLIANCE TEST

### 5.1. Test Equipment

Item	Equipment	Manufacturer	Model No.	Serial No.	Last Cal.	Cal. Interval
1.	Spectrum	Agilent	E4446A	US44300459	Apr.28,15	1 Year
2.	Amp	HP	8449B	3008A02495	Apr.28,15	1 Year
3.	Horn Antenna	ETS	3115	9510-4877	Oct.15,15	1 Year
4.	HF Cable	Hubersuhner	Sucoflex104	274094/4	Apr.28,15	1 Year

### 5.2. Limit

For transmitters operating in the band 5150-5250 MHz, all emissions outside the band 5150-5350 MHz shall not exceed -27 dBm/MHz e.i.r.p.

For devices with both operating frequencies and channel bandwidths contained within the band 5250-5350 MHz,

All emissions outside the band 5250-5350 MHz shall not exceed -27 dBm/MHz e.i.r.p.

For transmitters operating in the band 5470-5725MHz, Emissions outside the band 5470-5725 MHz shall not exceed -27 dBm/MHz e.i.r.p.

For the band 5725-5850 MHz, emissions at frequencies from the band edges to 10 MHz above or below the band edges shall not exceed -17 dBm/MHz e.i.r.p.

For emissions at frequencies more than 10 MHz above or below the band edges, the emissions power shall not exceed -27 dBm/MHz.

### 5.3. Test Produce

1. The EUT is placed on a turntable, which is 0.8m above the ground plane and worked at highest radiated power.
2. The turntable was rotated for 360 degrees to determine the position of maximum emission level.
3. EUT is set 3m away from the receiving antenna, which is varied from 1m to 4m to find out the highest emission.
4. Set the spectrum analyzer in the following setting in order to capture the lower and upper band-edges of the emission:
  - (a) PEAK: RBW=1MHz; VBW=3MHz; Sweep=AUTO
  - (b) AVERAGE: RBW=1MHz; VBW=10Hz; Sweep=AUTO
5. Per KDB789033 clause H 2)d).if the test distance is 3m, the EIRP(dBm)=E(dBuv/m)-95.2  
Get the final compare with limit.

### 5.4. Test Results

Pass (The testing data was attached in the next pages.)



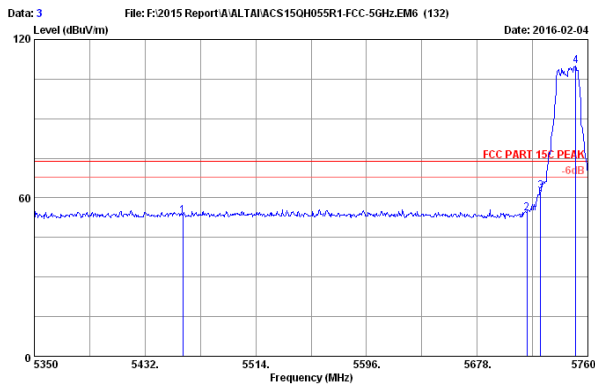

Site no. : 3m Chamber Data no. : 3  
 Dis. / Ant. : 3m 2015 3115-4877 Ant. pol. : HORIZONTAL  
 Limit : FCC PART 15C PEAK  
 Env. / Ins. : 23°C/54%  
 Engineer : Leo-Li  
 EUT : Altai A8in (ac) Super WiFi Base Station  
 Power rating : DC 56V From POE Input AC 120V/60Hz  
 Test Mode : IEEE802.11a 5745MHz Tx  
 WA8011NAC-H

No.	Freq. (MHz)	Ant. Factor (dB/m)	Cable Loss (dB)	AMP factor (dB)	Reading (dBuV)	Emission Level (dBuV/m)	Limits (dBuV/m)	Margin (dB)	Remark
1	5460.000	34.33	9.76	35.25	44.36	53.20	74.00	20.80	Peak
2	5715.000	34.53	9.88	35.12	44.79	54.08	74.00	19.92	Peak
3	5725.000	34.53	9.89	35.12	53.10	62.40	74.00	11.60	Peak
4	5750.980	34.55	9.90	35.11	100.64	109.98	74.00	-35.98	Peak

Remarks: 1. Emission Level= Antenna Factor + Cable Loss + Reading - Amp Factor  
 2. The emission levels that are 20dB below the official limit are not reported.

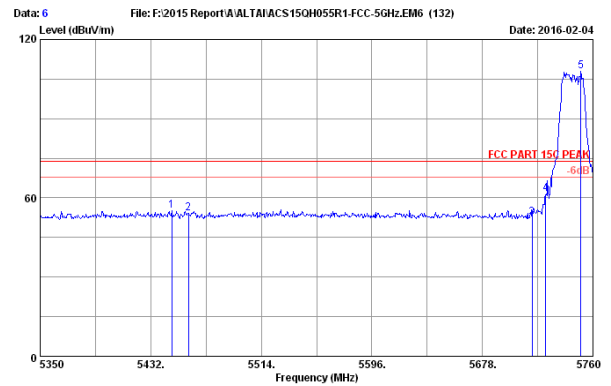

Site no. : 3m Chamber Data no. : 6  
 Dis. / Ant. : 3m 2015 3115-4877 Ant. pol. : VERTICAL  
 Limit : FCC PART 15C PEAK  
 Env. / Ins. : 23°C/54%  
 Engineer : Leo-Li  
 EUT : Altai A8in (ac) Super WiFi Base Station  
 Power rating : DC 56V From POE Input AC 120V/60Hz  
 Test Mode : IEEE802.11a 5745MHz Tx  
 WA8011NAC-H

No.	Freq. (MHz)	Ant. Factor (dB/m)	Cable Loss (dB)	AMP factor (dB)	Reading (dBuV)	Emission Level (dBuV/m)	Limits (dBuV/m)	Margin (dB)	Remark
1	5447.580	34.31	9.75	35.25	46.43	55.24	74.00	18.76	Peak
2	5460.000	34.33	9.76	35.25	45.24	54.08	74.00	19.92	Peak
3	5715.000	34.53	9.88	35.12	43.08	52.37	74.00	21.63	Peak
4	5725.000	34.53	9.89	35.12	52.19	61.49	74.00	12.51	Peak
5	5750.980	34.55	9.90	35.11	98.62	107.96	74.00	-33.96	Peak

Remarks: 1. Emission Level= Antenna Factor + Cable Loss + Reading - Amp Factor  
 2. The emission levels that are 20dB below the official limit are not reported.

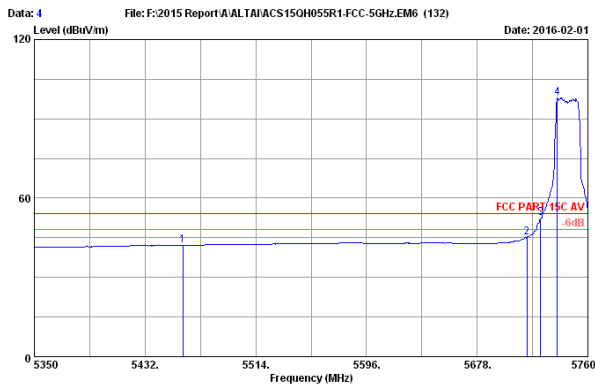

Site no. : 3m Chamber Data no. : 4  
 Dis. / Ant. : 3m 2015 3115-4877 Ant. pol. : HORIZONTAL  
 Limit : FCC PART 15C AV  
 Env. / Ins. : 23°C/54%  
 Engineer : Leo-Li  
 EUT : Altai A8in (ac) Super WiFi Base Station  
 Power rating : DC 56V From POE Input AC 120V/60Hz  
 Test Mode : IEEE802.11a 5745MHz Tx  
 WA8011NAC-H

No.	Freq. (MHz)	Ant. Factor (dB/m)	Cable Loss (dB)	AMP factor (dB)	Reading (dBuV)	Emission Level (dBuV/m)	Limits (dBuV/m)	Margin (dB)	Remark
1	5460.000	34.33	9.76	35.25	33.26	42.10	54.00	11.90	Average
2	5715.000	34.53	9.88	35.12	35.99	45.28	54.00	8.72	Average
3	5725.000	34.53	9.89	35.12	43.17	52.47	54.00	1.53	Average
4	5737.450	34.54	9.90	35.12	60.60	67.92	54.00	-43.92	Average

Remarks: 1. Emission Level= Antenna Factor + Cable Loss + Reading - Amp Factor  
 2. The emission levels that are 20dB below the official limit are not reported.

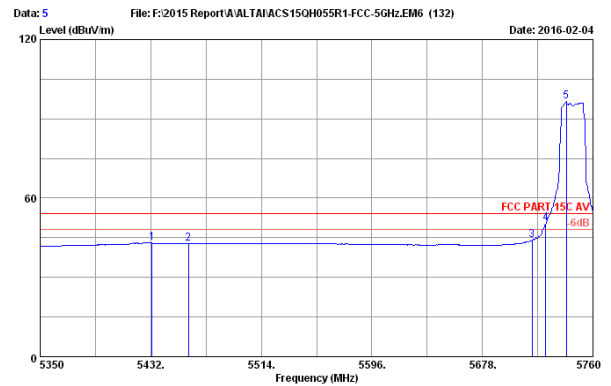

Site no. : 3m Chamber Data no. : 5  
 Dis. / Ant. : 3m 2015 3115-4877 Ant. pol. : VERTICAL  
 Limit : FCC PART 15C AV  
 Env. / Ins. : 23°C/54%  
 Engineer : Leo-Li  
 EUT : Altai A8in (ac) Super WiFi Base Station  
 Power rating : DC 56V From POE Input AC 120V/60Hz  
 Test Mode : IEEE802.11a 5745MHz Tx  
 WA8011NAC-H

No.	Freq. (MHz)	Ant. Factor (dB/m)	Cable Loss (dB)	AMP factor (dB)	Reading (dBuV)	Emission Level (dBuV/m)	Limits (dBuV/m)	Margin (dB)	Remark
1	5432.820	34.28	9.75	35.26	34.35	43.12	54.00	10.88	Average
2	5460.000	34.33	9.76	35.25	33.88	42.72	54.00	11.28	Average
3	5715.000	34.53	9.88	35.12	34.68	43.97	54.00	10.03	Average
4	5725.000	34.53	9.89	35.12	41.03	50.33	54.00	3.67	Average
5	5740.320	34.54	9.90	35.11	87.28	96.61	54.00	-42.61	Average

Remarks: 1. Emission Level= Antenna Factor + Cable Loss + Reading - Amp Factor  
 2. The emission levels that are 20dB below the official limit are not reported.

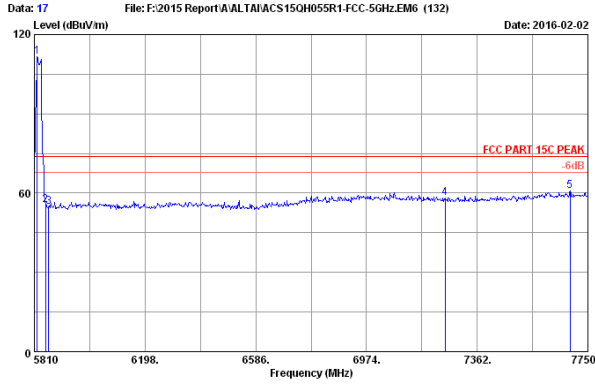

Site no. : 3m Chamber Data no. : 17  
 Dis. / Ant. : 3m 2015 3115-4877 Ant. pol. : HORIZONTAL  
 Limit : FCC PART 15C PEAK  
 Env. / Ins. : 23°C/54%  
 Engineer : Leo-Li  
 EUT : Altai A8in (ac) Super WiFi Base Station  
 Power rating : DC 56V From POE Input AC 120V/60Hz  
 Test Mode : IEEE802.11a 5825MHz Tx  
 WA8011NAC-H

No.	Freq. (MHz)	Ant. Factor (dB/m)	Cable Loss (dB)	AMP factor (dB)	Reading (dBuV)	Emission Level (dBuV/m)	Limits (dBuV/m)	Margin (dB)	Remark
1	5819.700	34.59	9.93	35.08	102.22	111.66	74.00	-37.66	Peak
2	5850.000	34.61	9.95	35.07	45.95	55.44	74.00	18.56	Peak
3	5860.000	34.62	9.95	35.07	45.19	54.69	74.00	19.31	Peak
4	7250.000	36.10	10.74	35.50	46.97	58.31	74.00	15.69	Peak
5	7687.920	36.81	11.16	35.68	48.69	60.98	74.00	13.02	Peak

Remarks: 1. Emission Level= Antenna Factor + Cable Loss + Reading - Amp Factor  
 2. The emission levels that are 20dB below the official limit are not reported.

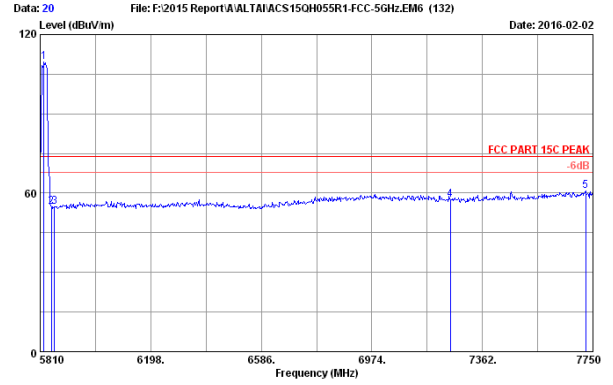

Site no. : 3m Chamber Data no. : 20  
 Dis. / Ant. : 3m 2015 3115-4877 Ant. pol. : VERTICAL  
 Limit : FCC PART 15C PEAK  
 Env. / Ins. : 23°C/54%  
 Engineer : Leo-Li  
 EUT : Altai A8in (ac) Super WiFi Base Station  
 Power rating : DC 56V From POE Input AC 120V/60Hz  
 Test Mode : IEEE802.11a 5825MHz Tx  
 WA8011NAC-H

No.	Freq. (MHz)	Ant. Factor (dB/m)	Cable Loss (dB)	AMP factor (dB)	Reading (dBuV)	Emission Level (dBuV/m)	Limits (dBuV/m)	Margin (dB)	Remark
1	5823.580	34.59	9.93	35.08	100.30	109.74	74.00	-35.74	Peak
2	5850.000	34.61	9.95	35.07	45.43	54.92	74.00	19.08	Peak
3	5860.000	34.62	9.95	35.07	45.23	54.73	74.00	19.27	Peak
4	7250.000	36.10	10.74	35.50	46.06	57.40	74.00	16.60	Peak
5	7724.780	36.83	11.20	35.69	48.41	60.75	74.00	13.25	Peak

Remarks: 1. Emission Level= Antenna Factor + Cable Loss + Reading - Amp Factor  
 2. The emission levels that are 20dB below the official limit are not reported.

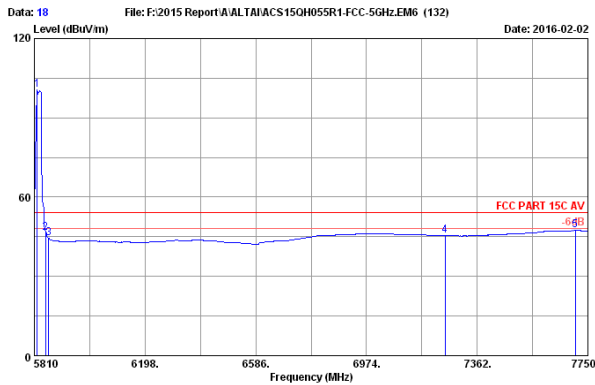

Site no. : 3m Chamber Data no. : 18  
 Dis. / Ant. : 3m 2015 3115-4877 Ant. pol. : HORIZONTAL  
 Limit : FCC PART 15C AV  
 Env. / Ins. : 23°C/54%  
 Engineer : Leo-Li  
 EUT : Altai A8in (ac) Super WiFi Base Station  
 Power rating : DC 56V From POE Input AC 120V/60Hz  
 Test Mode : IEEE802.11a 5825MHz Tx  
 WA8011NAC-H

No.	Freq. (MHz)	Ant. Factor (dB/m)	Cable Loss (dB)	AMP factor (dB)	Reading (dBuV)	Emission Level (dBuV/m)	Limits (dBuV/m)	Margin (dB)	Remark
1	5819.700	34.59	9.93	35.08	91.18	100.62	54.00	-46.62	Average
2	5850.000	34.61	9.95	35.07	36.94	46.43	54.00	7.57	Average
3	5860.000	34.62	9.95	35.07	34.89	44.39	54.00	9.61	Average
4	7250.000	36.10	10.74	35.50	34.16	45.50	54.00	8.50	Average
5	7705.380	36.82	11.18	35.68	35.03	47.35	54.00	6.65	Average

Remarks: 1. Emission Level= Antenna Factor + Cable Loss + Reading - Amp Factor  
 2. The emission levels that are 20dB below the official limit are not reported.

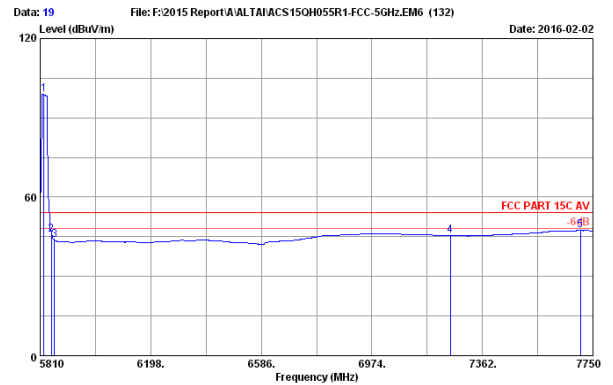

Site no. : 3m Chamber Data no. : 19  
 Dis. / Ant. : 3m 2015 3115-4877 Ant. pol. : VERTICAL  
 Limit : FCC PART 15C AV  
 Env. / Ins. : 23°C/54%  
 Engineer : Leo-Li  
 EUT : Altai A8in (ac) Super WiFi Base Station  
 Power rating : DC 56V From POE Input AC 120V/60Hz  
 Test Mode : IEEE802.11a 5825MHz Tx  
 WA8011NAC-H

No.	Freq. (MHz)	Ant. Factor (dB/m)	Cable Loss (dB)	AMP factor (dB)	Reading (dBuV)	Emission Level (dBuV/m)	Limits (dBuV/m)	Margin (dB)	Remark
1	5823.580	34.59	9.93	35.08	89.56	99.00	54.00	-45.00	Average
2	5850.000	34.61	9.95	35.07	36.25	45.74	54.00	8.26	Average
3	5860.000	34.62	9.95	35.07	34.32	43.82	54.00	10.18	Average
4	7250.000	36.10	10.74	35.50	34.18	45.52	54.00	8.48	Average
5	7705.380	36.82	11.18	35.68	35.04	47.36	54.00	6.64	Average

Remarks: 1. Emission Level= Antenna Factor + Cable Loss + Reading - Amp Factor  
 2. The emission levels that are 20dB below the official limit are not reported.

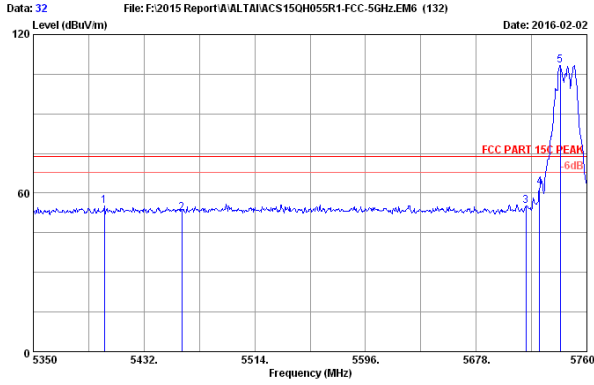

Site no. : 3m Chamber Data no. : 32  
 Dis. / Ant. : 3m 2015 3115-4877 Ant. pol. : HORIZONTAL  
 Limit : FCC PART 15C PEAK  
 Env. / Ins. : 23°C/54%  
 Engineer : Leo-Li  
 EUT : Altai A8in (ac) Super WiFi Base Station  
 Power rating : DC 56V From POE Input AC 120V/60Hz  
 Test Mode : IEEE802.11nHT20 5745MHz Tx  
 WA8011NAC-H

No.	Freq. (MHz)	Ant. Factor (dB/m)	Cable Loss (dB)	AMP factor (dB)	Reading (dBuV)	Emission Level (dBuV/m)	Limits (dBuV/m)	Margin (dB)	Remark
1	5402.480	34.22	9.76	35.27	46.42	55.11	74.00	18.89	Peak
2	5460.000	34.33	9.76	35.25	43.50	52.34	74.00	21.66	Peak
3	5715.000	34.53	9.88	35.12	45.87	55.16	74.00	18.84	Peak
4	5725.000	34.53	9.89	35.12	52.87	62.17	74.00	11.83	Peak
5	5740.320	34.54	9.90	35.11	99.09	108.42	74.00	-34.42	Peak

Remarks: 1. Emission Level= Antenna Factor + Cable Loss + Reading -Amp Factor  
 2. The emission levels that are 20dB below the official limit are not reported.

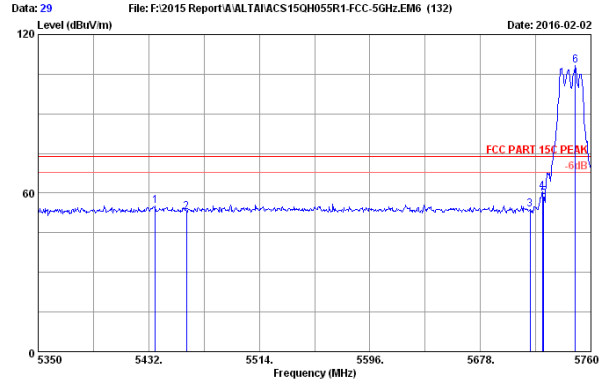

Site no. : 3m Chamber Data no. : 29  
 Dis. / Ant. : 3m 2015 3115-4877 Ant. pol. : VERTICAL  
 Limit : FCC PART 15C PEAK  
 Env. / Ins. : 23°C/54%  
 Engineer : Leo-Li  
 EUT : Altai A8in (ac) Super WiFi Base Station  
 Power rating : DC 56V From POE Input AC 120V/60Hz  
 Test Mode : IEEE802.11nHT20 5745MHz Tx  
 WA8011NAC-H

No.	Freq. (MHz)	Ant. Factor (dB/m)	Cable Loss (dB)	AMP factor (dB)	Reading (dBuV)	Emission Level (dBuV/m)	Limits (dBuV/m)	Margin (dB)	Remark
1	5436.920	34.29	9.75	35.26	46.35	55.13	74.00	18.87	Peak
2	5460.000	34.33	9.76	35.25	44.08	52.92	74.00	21.08	Peak
3	5715.000	34.53	9.88	35.12	44.58	53.87	74.00	20.13	Peak
4	5725.920	34.53	9.89	35.12	51.05	60.35	74.00	13.65	Peak
5	5725.000	34.53	9.89	35.12	49.18	58.48	74.00	15.52	Peak
6	5748.520	34.55	9.90	35.11	99.01	108.35	74.00	-34.35	Peak

Remarks: 1. Emission Level= Antenna Factor + Cable Loss + Reading -Amp Factor  
 2. The emission levels that are 20dB below the official limit are not reported.

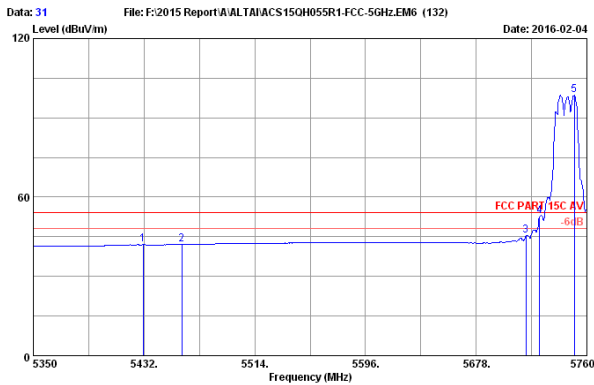

Site no. : 3m Chamber Data no. : 31  
 Dis. / Ant. : 3m 2015 3115-4877 Ant. pol. : HORIZONTAL  
 Limit : FCC PART 15C AV  
 Env. / Ins. : 23°C/54%  
 Engineer : Leo-Li  
 EUT : Altai A8in (ac) Super WiFi Base Station  
 Power rating : DC 56V From POE Input AC 120V/60Hz  
 Test Mode : IEEE802.11nHT20 5745MHz Tx  
 WA8011NAC-H

No.	Freq. (MHz)	Ant. Factor (dB/m)	Cable Loss (dB)	AMP factor (dB)	Reading (dBuV)	Emission Level (dBuV/m)	Limits (dBuV/m)	Margin (dB)	Remark
1	5431.180	34.28	9.75	35.26	33.28	42.05	54.00	11.95	Average
2	5460.000	34.33	9.76	35.25	33.20	42.04	54.00	11.96	Average
3	5715.000	34.53	9.88	35.12	36.14	45.43	54.00	8.57	Average
4	5725.000	34.53	9.89	35.12	43.44	52.74	54.00	1.26	Average
5	5750.570	34.55	9.90	35.11	89.26	98.60	54.00	-44.60	Average

Remarks: 1. Emission Level= Antenna Factor + Cable Loss + Reading -Amp Factor  
 2. The emission levels that are 20dB below the official limit are not reported.

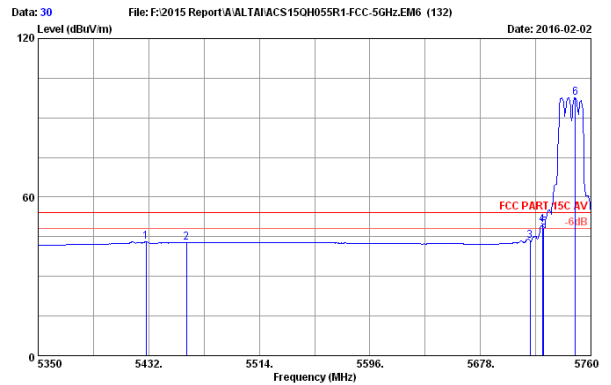

Site no. : 3m Chamber Data no. : 30  
 Dis. / Ant. : 3m 2015 3115-4877 Ant. pol. : VERTICAL  
 Limit : FCC PART 15C AV  
 Env. / Ins. : 23°C/54%  
 Engineer : Leo-Li  
 EUT : Altai A8in (ac) Super WiFi Base Station  
 Power rating : DC 56V From POE Input AC 120V/60Hz  
 Test Mode : IEEE802.11nHT20 5745MHz Tx  
 WA8011NAC-H

No.	Freq. (MHz)	Ant. Factor (dB/m)	Cable Loss (dB)	AMP factor (dB)	Reading (dBuV)	Emission Level (dBuV/m)	Limits (dBuV/m)	Margin (dB)	Remark
1	5429.950	34.27	9.74	35.26	34.34	43.09	54.00	10.91	Average
2	5460.000	34.33	9.76	35.25	33.84	42.68	54.00	11.32	Average
3	5715.000	34.53	9.88	35.12	34.18	43.47	54.00	10.53	Average
4	5723.920	34.53	9.89	35.12	40.03	49.33	54.00	4.67	Average
5	5725.000	34.53	9.89	35.12	39.04	48.34	54.00	5.66	Average
6	5748.520	34.55	9.90	35.11	88.32	97.66	54.00	-43.66	Average

Remarks: 1. Emission Level= Antenna Factor + Cable Loss + Reading -Amp Factor  
 2. The emission levels that are 20dB below the official limit are not reported.

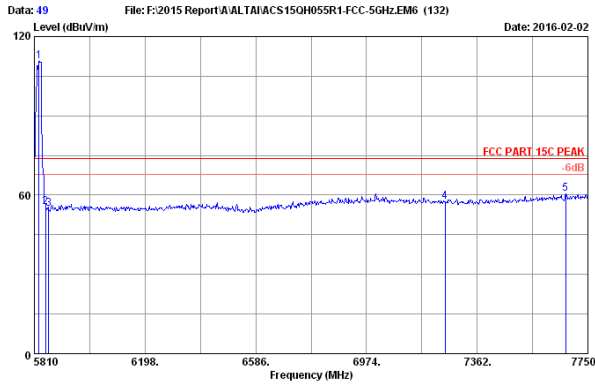

Date: 49 File: F:\2015 Report\A\ALTAIACS15QH055R1-FCC-5GHz.EM6 (132) Date: 2016-02-02

Site no. : 3m Chamber Data no. : 49  
 Dis. / Ant. : 3m 2015 3115-4877 Ant. pol. : HORIZONTAL  
 Limit : FCC PART 15C PEAK  
 Env. / Ins. : 23°C/54%  
 Engineer : Leo-Li  
 EUT : Altai A8in (ac) Super WiFi Base Station  
 Power rating : DC 56V From POE Input AC 120V/60Hz  
 Test Mode : IEEE802.11nHT20 5825MHz Tx  
 WA8011NAC-H

No.	Freq. (MHz)	Ant. Factor (dB/m)	Cable Loss (dB)	AMP factor (dB)	Reading (dBuV)	Emission Level (dBuV/m)	Limits (dBuV/m)	Margin (dB)	Remark
1	5825.520	34.60	9.94	35.08	101.28	110.74	74.00	-36.74	Peak
2	5850.000	34.61	9.95	35.07	46.10	55.59	74.00	18.41	Peak
3	5860.000	34.62	9.95	35.07	45.34	54.84	74.00	19.16	Peak
4	7250.000	36.10	10.74	35.50	46.00	57.34	74.00	16.66	Peak
5	7672.400	36.80	11.15	35.67	48.08	60.36	74.00	13.64	Peak

Remarks: 1. Emission Level= Antenna Factor + Cable Loss + Reading - Amp Factor  
 2. The emission levels that are 20dB below the official limit are not reported.

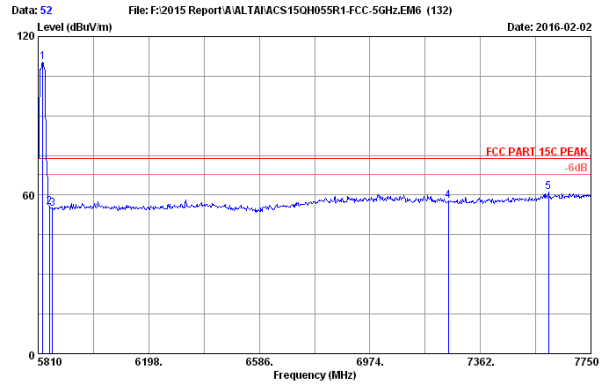

Date: 52 File: F:\2015 Report\A\ALTAIACS15QH055R1-FCC-5GHz.EM6 (132) Date: 2016-02-02

Site no. : 3m Chamber Data no. : 52  
 Dis. / Ant. : 3m 2015 3115-4877 Ant. pol. : VERTICAL  
 Limit : FCC PART 15C PEAK  
 Env. / Ins. : 23°C/54%  
 Engineer : Leo-Li  
 EUT : Altai A8in (ac) Super WiFi Base Station  
 Power rating : DC 56V From POE Input AC 120V/60Hz  
 Test Mode : IEEE802.11nHT20 5825MHz Tx  
 WA8011NAC-H

No.	Freq. (MHz)	Ant. Factor (dB/m)	Cable Loss (dB)	AMP factor (dB)	Reading (dBuV)	Emission Level (dBuV/m)	Limits (dBuV/m)	Margin (dB)	Remark
1	5825.520	34.60	9.94	35.08	100.96	110.42	74.00	-36.42	Peak
2	5850.000	34.61	9.95	35.07	46.07	55.56	74.00	18.44	Peak
3	5860.000	34.62	9.95	35.07	45.45	54.95	74.00	19.05	Peak
4	7250.000	36.10	10.74	35.50	46.43	57.77	74.00	16.23	Peak
5	7600.620	36.76	11.07	35.64	48.97	61.16	74.00	12.84	Peak

Remarks: 1. Emission Level= Antenna Factor + Cable Loss + Reading - Amp Factor  
 2. The emission levels that are 20dB below the official limit are not reported.

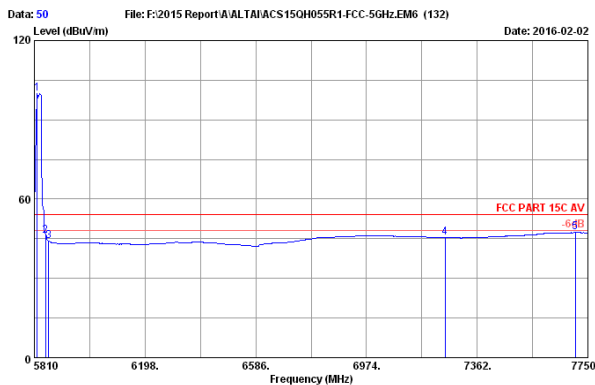

Date: 50 File: F:\2015 Report\A\ALTAIACS15QH055R1-FCC-5GHz.EM6 (132) Date: 2016-02-02

Site no. : 3m Chamber Data no. : 50  
 Dis. / Ant. : 3m 2015 3115-4877 Ant. pol. : HORIZONTAL  
 Limit : FCC PART 15C AV  
 Env. / Ins. : 23°C/54%  
 Engineer : Leo-Li  
 EUT : Altai A8in (ac) Super WiFi Base Station  
 Power rating : DC 56V From POE Input AC 120V/60Hz  
 Test Mode : IEEE802.11nHT20 5825MHz Tx  
 WA8011NAC-H

No.	Freq. (MHz)	Ant. Factor (dB/m)	Cable Loss (dB)	AMP factor (dB)	Reading (dBuV)	Emission Level (dBuV/m)	Limits (dBuV/m)	Margin (dB)	Remark
1	5819.700	34.59	9.93	35.08	90.63	100.07	54.00	-46.07	Average
2	5850.000	34.61	9.95	35.07	36.67	46.16	54.00	7.84	Average
3	5860.000	34.62	9.95	35.07	34.70	44.20	54.00	9.80	Average
4	7250.000	36.10	10.74	35.50	34.15	45.49	54.00	8.51	Average
5	7705.380	36.82	11.18	35.68	35.03	47.35	54.00	6.65	Average

Remarks: 1. Emission Level= Antenna Factor + Cable Loss + Reading - Amp Factor  
 2. The emission levels that are 20dB below the official limit are not reported.

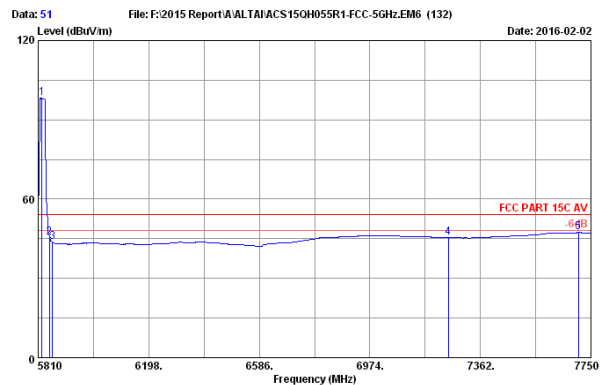

Date: 51 File: F:\2015 Report\A\ALTAIACS15QH055R1-FCC-5GHz.EM6 (132) Date: 2016-02-02

Site no. : 3m Chamber Data no. : 51  
 Dis. / Ant. : 3m 2015 3115-4877 Ant. pol. : VERTICAL  
 Limit : FCC PART 15C AV  
 Env. / Ins. : 23°C/54%  
 Engineer : Leo-Li  
 EUT : Altai A8in (ac) Super WiFi Base Station  
 Power rating : DC 56V From POE Input AC 120V/60Hz  
 Test Mode : IEEE802.11nHT20 5825MHz Tx  
 WA8011NAC-H

No.	Freq. (MHz)	Ant. Factor (dB/m)	Cable Loss (dB)	AMP factor (dB)	Reading (dBuV)	Emission Level (dBuV/m)	Limits (dBuV/m)	Margin (dB)	Remark
1	5823.580	34.59	9.93	35.08	88.92	98.36	54.00	-44.36	Average
2	5850.000	34.61	9.95	35.07	35.90	45.39	54.00	8.61	Average
3	5860.000	34.62	9.95	35.07	34.13	43.63	54.00	10.37	Average
4	7250.000	36.10	10.74	35.50	34.17	45.51	54.00	8.49	Average
5	7705.380	36.82	11.18	35.68	35.01	47.33	54.00	6.67	Average

Remarks: 1. Emission Level= Antenna Factor + Cable Loss + Reading - Amp Factor  
 2. The emission levels that are 20dB below the official limit are not reported.

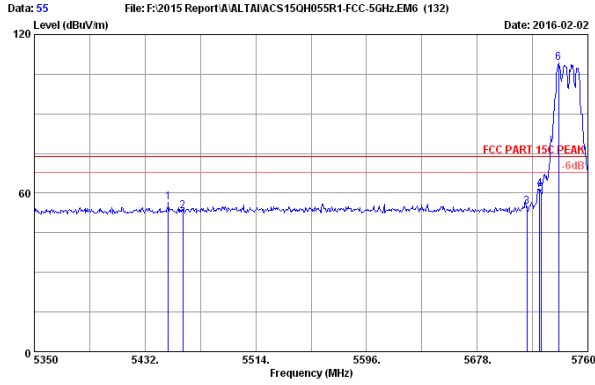

Site no. : 3m Chamber Data no. : 55  
 Dis. / Ant. : 3m 2015 3115-4877 Ant. pol. : HORIZONTAL  
 Limit : FCC PART 15C PEAK  
 Env. / Ins. : 23°C/54%  
 Engineer : Leo-Li  
 EUT : Altai A8in (ac) Super WiFi Base Station  
 Power rating : DC 56V From POE Input AC 120V/60Hz  
 Test Mode : IEEE802.11ac VHT20 5745MHz Tx  
 WA8011NAC-H

No.	Freq. (MHz)	Ant. Factor (dB/m)	Cable Loss (dB)	AMP factor (dB)	Reading (dBuV)	Emission Level (dBuV/m)	Limits (dBuV/m)	Margin (dB)	Remark
1	5449.220	34.31	9.76	35.25	47.65	56.47	74.00	17.53	Peak
2	5460.000	34.33	9.76	35.25	44.18	53.02	74.00	20.98	Peak
3	5715.000	34.53	9.88	35.12	45.53	54.82	74.00	19.18	Peak
4	5724.330	34.53	9.89	35.12	52.19	61.49	74.00	12.51	Peak
5	5725.150	34.54	9.89	35.12	50.65	59.96	74.00	14.04	Peak
6	5738.270	34.54	9.90	35.11	100.06	109.39	74.00	-35.39	Peak

Remarks: 1. Emission Level= Antenna Factor + Cable Loss + Reading -Amp Factor  
 2. The emission levels that are 20dB below the official limit are not reported.

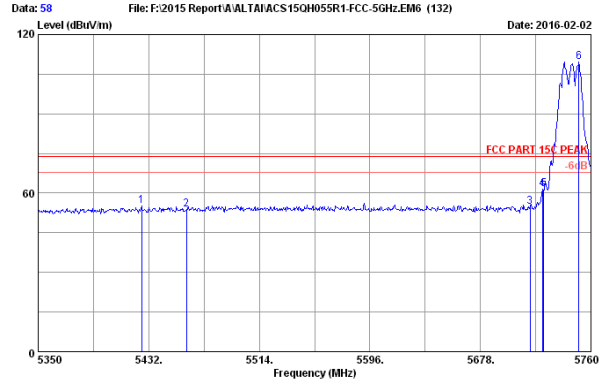

Site no. : 3m Chamber Data no. : 58  
 Dis. / Ant. : 3m 2015 3115-4877 Ant. pol. : VERTICAL  
 Limit : FCC PART 15C PEAK  
 Env. / Ins. : 23°C/54%  
 Engineer : Leo-Li  
 EUT : Altai A8in (ac) Super WiFi Base Station  
 Power rating : DC 56V From POE Input AC 120V/60Hz  
 Test Mode : IEEE802.11ac VHT20 5745MHz Tx  
 WA8011NAC-H

No.	Freq. (MHz)	Ant. Factor (dB/m)	Cable Loss (dB)	AMP factor (dB)	Reading (dBuV)	Emission Level (dBuV/m)	Limits (dBuV/m)	Margin (dB)	Remark
1	5426.670	34.27	9.74	35.26	46.30	55.05	74.00	18.95	Peak
2	5460.000	34.33	9.76	35.25	45.03	53.87	74.00	20.13	Peak
3	5715.000	34.53	9.88	35.12	45.66	54.95	74.00	19.05	Peak
4	5723.920	34.53	9.89	35.12	52.15	61.45	74.00	12.55	Peak
5	5725.000	34.53	9.89	35.12	52.09	61.39	74.00	12.61	Peak
6	5750.980	34.55	9.90	35.11	100.16	109.50	74.00	-35.50	Peak

Remarks: 1. Emission Level= Antenna Factor + Cable Loss + Reading -Amp Factor  
 2. The emission levels that are 20dB below the official limit are not reported.

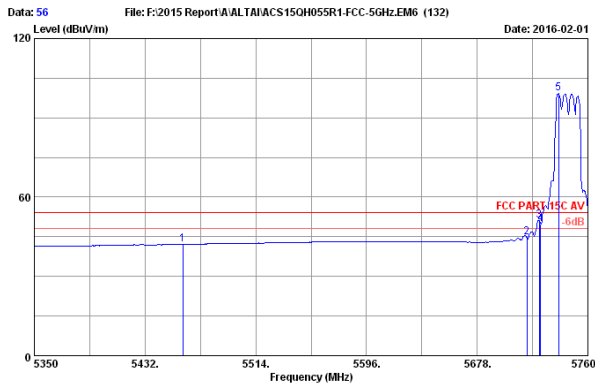

Site no. : 3m Chamber Data no. : 56  
 Dis. / Ant. : 3m 2015 3115-4877 Ant. pol. : HORIZONTAL  
 Limit : FCC PART 15C AV  
 Env. / Ins. : 23°C/54%  
 Engineer : Leo-Li  
 EUT : Altai A8in (ac) Super WiFi Base Station  
 Power rating : DC 56V From POE Input AC 120V/60Hz  
 Test Mode : IEEE802.11ac VHT20 5745MHz Tx  
 WA8011NAC-H

No.	Freq. (MHz)	Ant. Factor (dB/m)	Cable Loss (dB)	AMP factor (dB)	Reading (dBuV)	Emission Level (dBuV/m)	Limits (dBuV/m)	Margin (dB)	Remark
1	5460.000	34.33	9.76	35.25	33.23	42.07	54.00	11.93	Average
2	5715.000	34.53	9.88	35.12	35.34	44.63	54.00	9.37	Average
3	5723.920	34.53	9.89	35.12	41.83	51.13	54.00	2.87	Average
4	5725.000	34.53	9.89	35.12	40.50	49.80	54.00	4.20	Average
5	5738.270	34.54	9.90	35.11	89.78	99.11	54.00	-45.11	Average

Remarks: 1. Emission Level= Antenna Factor + Cable Loss + Reading -Amp Factor  
 2. The emission levels that are 20dB below the official limit are not reported.

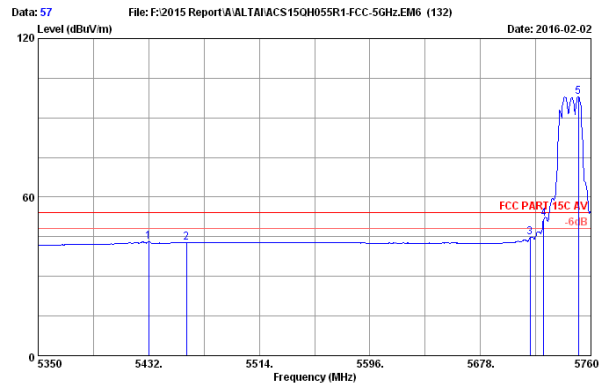

Site no. : 3m Chamber Data no. : 57  
 Dis. / Ant. : 3m 2015 3115-4877 Ant. pol. : VERTICAL  
 Limit : FCC PART 15C AV  
 Env. / Ins. : 23°C/54%  
 Engineer : Leo-Li  
 EUT : Altai A8in (ac) Super WiFi Base Station  
 Power rating : DC 56V From POE Input AC 120V/60Hz  
 Test Mode : IEEE802.11ac VHT20 5745MHz Tx  
 WA8011NAC-H

No.	Freq. (MHz)	Ant. Factor (dB/m)	Cable Loss (dB)	AMP factor (dB)	Reading (dBuV)	Emission Level (dBuV/m)	Limits (dBuV/m)	Margin (dB)	Remark
1	5492.000	34.28	9.75	35.26	34.27	43.04	54.00	10.96	Average
2	5460.000	34.33	9.76	35.25	33.61	42.65	54.00	11.35	Average
3	5715.000	34.53	9.88	35.12	35.42	44.71	54.00	9.29	Average
4	5725.000	34.53	9.89	35.12	42.59	51.89	54.00	2.11	Average
5	5750.980	34.55	9.90	35.11	88.73	98.07	54.00	-44.07	Average

Remarks: 1. Emission Level= Antenna Factor + Cable Loss + Reading -Amp Factor  
 2. The emission levels that are 20dB below the official limit are not reported.

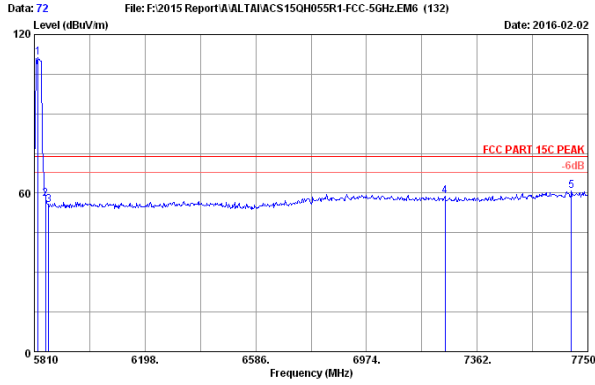

Date: 2016-02-02  
 File: F:\2015 Report\A\ALTAI\ACS150H055R1-FCC-5GHz.EM6 (132)  
 Site no. : 3m Chamber Data no. : 72  
 Dis. / Ant. : 3m 2015 3115-4877 Ant. pol. : HORIZONTAL  
 Limit : FCC PART 15C PEAK  
 Env. / Ins. : 23°C/54%  
 Engineer : Leo-Li  
 EUT : Altai A8in (ac) Super WiFi Base Station  
 Power rating : DC 56V From POE Input AC 120V/60Hz  
 Test Mode : IEEE802.11ac VHT20 5825MHz Tx  
 WA8011NAC-H

No.	Freq. (MHz)	Ant. Factor (dB/m)	Cable Loss (dB)	AMP factor (dB)	Reading (dBuV)	Emission Level (dBuV/m)	Limits (dBuV/m)	Margin (dB)	Remark
1	5823.580	34.59	9.93	35.08	102.01	111.45	74.00	-37.45	Peak
2	5850.000	34.61	9.95	35.07	48.23	57.72	74.00	16.28	Peak
3	5860.000	34.62	9.95	35.07	45.82	55.32	74.00	18.68	Peak
4	7250.000	36.10	10.74	35.50	47.60	58.94	74.00	15.06	Peak
5	7691.800	36.82	11.16	35.68	48.44	60.74	74.00	13.26	Peak

Remarks: 1. Emission Level= Antenna Factor + Cable Loss + Reading - Amp Factor  
 2. The emission levels that are 20dB below the official limit are not reported.

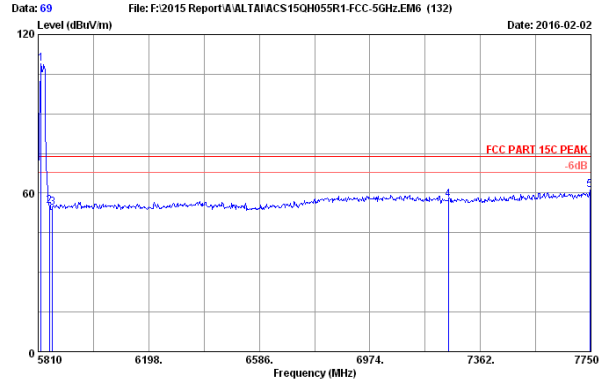

Date: 2016-02-02  
 File: F:\2015 Report\A\ALTAI\ACS150H055R1-FCC-5GHz.EM6 (132)  
 Site no. : 3m Chamber Data no. : 69  
 Dis. / Ant. : 3m 2015 3115-4877 Ant. pol. : VERTICAL  
 Limit : FCC PART 15C PEAK  
 Env. / Ins. : 23°C/54%  
 Engineer : Leo-Li  
 EUT : Altai A8in (ac) Super WiFi Base Station  
 Power rating : DC 56V From POE Input AC 120V/60Hz  
 Test Mode : IEEE802.11ac VHT20 5825MHz Tx  
 WA8011NAC-H

No.	Freq. (MHz)	Ant. Factor (dB/m)	Cable Loss (dB)	AMP factor (dB)	Reading (dBuV)	Emission Level (dBuV/m)	Limits (dBuV/m)	Margin (dB)	Remark
1	5819.700	34.59	9.93	35.08	99.42	108.66	74.00	-34.66	Peak
2	5850.000	34.61	9.95	35.07	45.73	55.22	74.00	18.78	Peak
3	5860.000	34.62	9.95	35.07	45.04	54.54	74.00	19.46	Peak
4	7250.000	36.10	10.74	35.50	46.14	57.48	74.00	16.52	Peak
5	7746.120	36.85	11.22	35.70	48.65	61.02	74.00	12.98	Peak

Remarks: 1. Emission Level= Antenna Factor + Cable Loss + Reading - Amp Factor  
 2. The emission levels that are 20dB below the official limit are not reported.

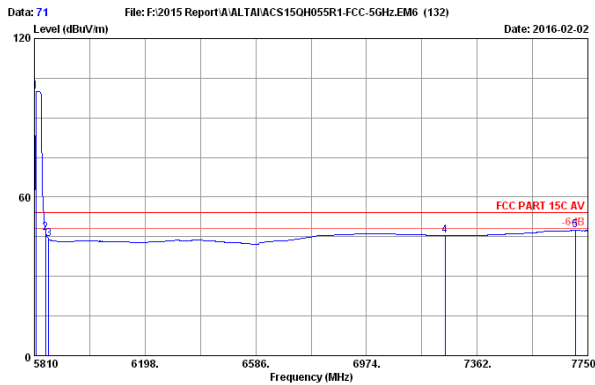

Date: 2016-02-02  
 File: F:\2015 Report\A\ALTAI\ACS150H055R1-FCC-5GHz.EM6 (132)  
 Site no. : 3m Chamber Data no. : 71  
 Dis. / Ant. : 3m 2015 3115-4877 Ant. pol. : HORIZONTAL  
 Limit : FCC PART 15C AV  
 Env. / Ins. : 23°C/54%  
 Engineer : Leo-Li  
 EUT : Altai A8in (ac) Super WiFi Base Station  
 Power rating : DC 56V From POE Input AC 120V/60Hz  
 Test Mode : IEEE802.11ac VHT20 5825MHz Tx  
 WA8011NAC-H

No.	Freq. (MHz)	Ant. Factor (dB/m)	Cable Loss (dB)	AMP factor (dB)	Reading (dBuV)	Emission Level (dBuV/m)	Limits (dBuV/m)	Margin (dB)	Remark
1	5815.820	34.59	9.93	35.08	90.56	100.00	54.00	-46.00	Average
2	5850.000	34.61	9.95	35.07	36.97	46.46	54.00	7.54	Average
3	5860.000	34.62	9.95	35.07	34.75	44.25	54.00	9.75	Average
4	7250.000	36.10	10.74	35.50	34.17	45.51	54.00	8.49	Average
5	7705.380	36.82	11.18	35.68	35.05	47.37	54.00	6.63	Average

Remarks: 1. Emission Level= Antenna Factor + Cable Loss + Reading - Amp Factor  
 2. The emission levels that are 20dB below the official limit are not reported.

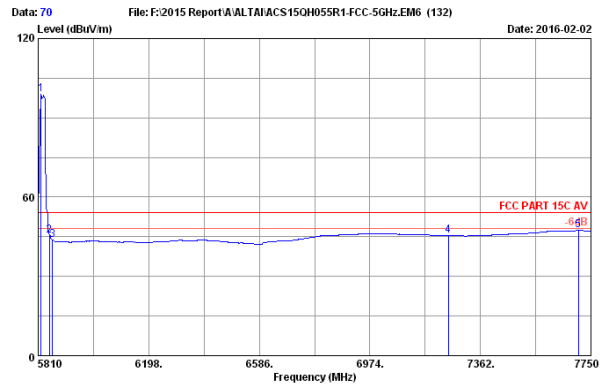

Date: 2016-02-02  
 File: F:\2015 Report\A\ALTAI\ACS150H055R1-FCC-5GHz.EM6 (132)  
 Site no. : 3m Chamber Data no. : 70  
 Dis. / Ant. : 3m 2015 3115-4877 Ant. pol. : VERTICAL  
 Limit : FCC PART 15C AV  
 Env. / Ins. : 23°C/54%  
 Engineer : Leo-Li  
 EUT : Altai A8in (ac) Super WiFi Base Station  
 Power rating : DC 56V From POE Input AC 120V/60Hz  
 Test Mode : IEEE802.11ac VHT20 5825MHz Tx  
 WA8011NAC-H

No.	Freq. (MHz)	Ant. Factor (dB/m)	Cable Loss (dB)	AMP factor (dB)	Reading (dBuV)	Emission Level (dBuV/m)	Limits (dBuV/m)	Margin (dB)	Remark
1	5819.700	34.59	9.93	35.08	89.46	98.90	54.00	-44.90	Average
2	5850.000	34.61	9.95	35.07	35.83	45.32	54.00	8.68	Average
3	5860.000	34.62	9.95	35.07	34.20	43.70	54.00	10.30	Average
4	7250.000	36.10	10.74	35.50	34.17	45.51	54.00	8.49	Average
5	7705.380	36.82	11.18	35.68	35.04	47.36	54.00	6.64	Average

Remarks: 1. Emission Level= Antenna Factor + Cable Loss + Reading - Amp Factor  
 2. The emission levels that are 20dB below the official limit are not reported.

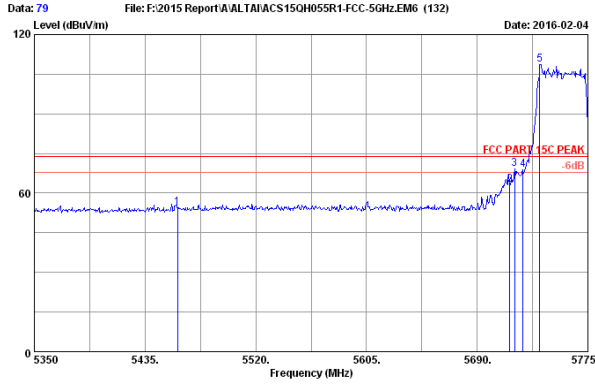

Site no. : 3m Chamber Data no. : 79  
 Dis. / Ant. : 3m 2015 3115-4877 Ant. pol. : HORIZONTAL  
 Limit : FCC PART 15C PEAK  
 Env. / Ins. : 23°C/54%  
 Engineer : Leo-Li  
 EUT : Altai A8in (ac) Super WiFi Base Station  
 Power rating : DC 56V From POE Input AC 120V/60Hz  
 Test Mode : IEEE802.11nHT40 5755MHz Tx  
 WA8011NAC-H

No.	Freq. (MHz)	Ant. Factor (dB/m)	Cable Loss (dB)	AMP factor (dB)	Reading (dBuV)	Emission Level (dBuV/m)	Limits (dBuV/m)	Margin (dB)	Remark
1	5460.000	34.33	9.76	35.25	45.65	54.49	74.00	19.51	Peak
2	5715.000	34.53	9.88	35.12	53.95	63.24	74.00	10.76	Peak
3	5718.900	34.53	9.89	35.12	59.83	69.13	74.00	4.87	Peak
4	5725.000	34.53	9.89	35.12	59.40	68.70	74.00	5.30	Peak
5	5738.025	34.54	9.90	35.11	99.16	108.49	74.00	-34.49	Peak

Remarks: 1. Emission Level= Antenna Factor + Cable Loss + Reading - Amp Factor  
 2. The emission levels that are 20dB below the official limit are not reported.

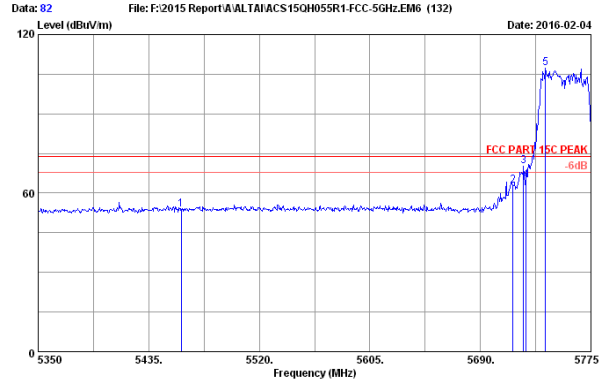

Site no. : 3m Chamber Data no. : 82  
 Dis. / Ant. : 3m 2015 3115-4877 Ant. pol. : VERTICAL  
 Limit : FCC PART 15C PEAK  
 Env. / Ins. : 23°C/54%  
 Engineer : Leo-Li  
 EUT : Altai A8in (ac) Super WiFi Base Station  
 Power rating : DC 56V From POE Input AC 120V/60Hz  
 Test Mode : IEEE802.11nHT40 5755MHz Tx  
 WA8011NAC-H

No.	Freq. (MHz)	Ant. Factor (dB/m)	Cable Loss (dB)	AMP factor (dB)	Reading (dBuV)	Emission Level (dBuV/m)	Limits (dBuV/m)	Margin (dB)	Remark
1	5460.000	34.33	9.76	35.25	44.97	53.61	74.00	20.19	Peak
2	5715.000	34.53	9.88	35.12	53.41	62.70	74.00	11.30	Peak
3	5723.150	34.53	9.89	35.12	61.01	70.31	74.00	3.69	Peak
4	5725.000	34.53	9.89	35.12	55.69	64.99	74.00	9.01	Peak
5	5740.150	34.54	9.90	35.11	97.84	107.17	74.00	-33.17	Peak

Remarks: 1. Emission Level= Antenna Factor + Cable Loss + Reading - Amp Factor  
 2. The emission levels that are 20dB below the official limit are not reported.

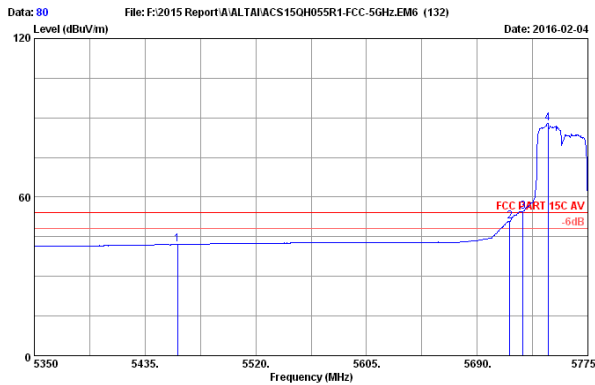

Site no. : 3m Chamber Data no. : 80  
 Dis. / Ant. : 3m 2015 3115-4877 Ant. pol. : HORIZONTAL  
 Limit : FCC PART 15C AV  
 Env. / Ins. : 23°C/54%  
 Engineer : Leo-Li  
 EUT : Altai A8in (ac) Super WiFi Base Station  
 Power rating : DC 56V From POE Input AC 120V/60Hz  
 Test Mode : IEEE802.11nHT40 5755MHz Tx  
 WA8011NAC-H

No.	Freq. (MHz)	Ant. Factor (dB/m)	Cable Loss (dB)	AMP factor (dB)	Reading (dBuV)	Emission Level (dBuV/m)	Limits (dBuV/m)	Margin (dB)	Remark
1	5460.000	34.33	9.76	35.25	33.16	42.00	54.00	12.00	Average
2	5715.000	34.53	9.88	35.12	41.63	50.92	54.00	3.08	Average
3	5725.000	34.53	9.89	35.12	45.09	54.39	54.00	-0.39	Average
4	5744.400	34.55	9.90	35.11	78.64	87.98	54.00	-33.98	Average

Remarks: 1. Emission Level= Antenna Factor + Cable Loss + Reading - Amp Factor  
 2. The emission levels that are 20dB below the official limit are not reported.

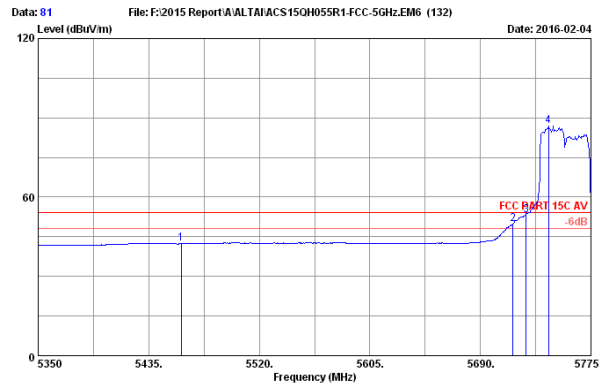

Site no. : 3m Chamber Data no. : 81  
 Dis. / Ant. : 3m 2015 3115-4877 Ant. pol. : VERTICAL  
 Limit : FCC PART 15C AV  
 Env. / Ins. : 23°C/54%  
 Engineer : Leo-Li  
 EUT : Altai A8in (ac) Super WiFi Base Station  
 Power rating : DC 56V From POE Input AC 120V/60Hz  
 Test Mode : IEEE802.11nHT40 5755MHz Tx  
 WA8011NAC-H

No.	Freq. (MHz)	Ant. Factor (dB/m)	Cable Loss (dB)	AMP factor (dB)	Reading (dBuV)	Emission Level (dBuV/m)	Limits (dBuV/m)	Margin (dB)	Remark
1	5460.000	34.33	9.76	35.25	33.47	42.31	54.00	11.69	Average
2	5715.000	34.53	9.88	35.12	40.65	49.94	54.00	4.06	Average
3	5725.000	34.53	9.89	35.12	43.82	53.12	54.00	0.88	Average
4	5742.275	34.55	9.90	35.11	77.65	86.99	54.00	-32.99	Average

Remarks: 1. Emission Level= Antenna Factor + Cable Loss + Reading - Amp Factor  
 2. The emission levels that are 20dB below the official limit are not reported.

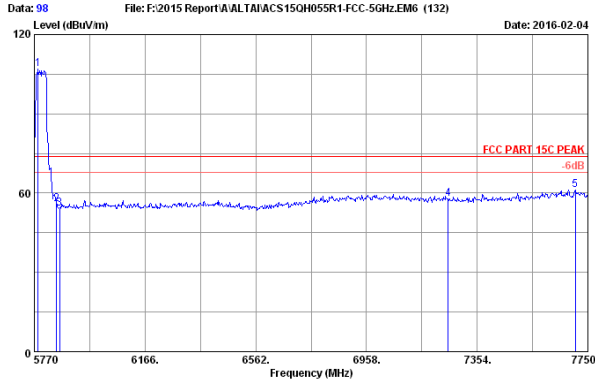

Site no. : 3m Chamber Data no. : 98  
 Dis. / Ant. : 3m 2015 3115-4877 Ant. pol. : HORIZONTAL  
 Limit : FCC PART 15C PEAK  
 Env. / Ins. : 23°C/54%  
 Engineer : Leo-Li  
 EUT : Altai A8in (ac) Super WiFi Base Station  
 Power rating : DC 56V From POE Input AC 120V/60Hz  
 Test Mode : IEEE802.11nHT40 5795MHz Tx  
 WA8011NAC-H

No.	Freq. (MHz)	Ant. Factor (dB/m)	Cable Loss (dB)	AMP factor (dB)	Reading (dBuV)	Emission Level (dBuV/m)	Limits (dBuV/m)	Margin (dB)	Remark
1	5783.860	34.57	9.91	35.10	97.55	106.93	74.00	-32.93	Peak
2	5850.000	34.61	9.95	35.07	46.19	55.68	74.00	18.32	Peak
3	5860.000	34.62	9.95	35.07	44.75	54.25	74.00	19.75	Peak
4	7250.000	36.10	10.74	35.50	46.48	57.82	74.00	16.18	Peak
5	7704.460	36.82	11.18	35.68	48.83	61.15	74.00	12.85	Peak

Remarks: 1. Emission Level= Antenna Factor + Cable Loss + Reading - Amp Factor  
 2. The emission levels that are 20dB below the official limit are not reported.

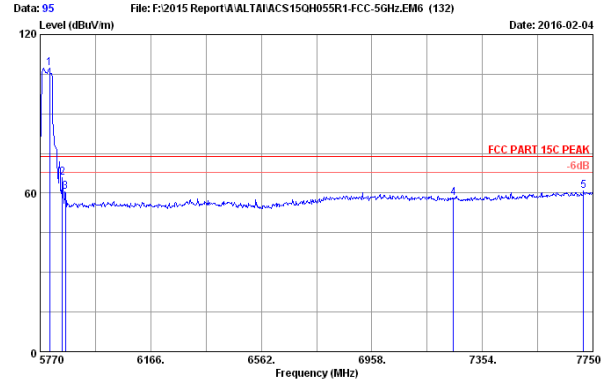

Site no. : 3m Chamber Data no. : 95  
 Dis. / Ant. : 3m 2015 3115-4877 Ant. pol. : VERTICAL  
 Limit : FCC PART 15C PEAK  
 Env. / Ins. : 23°C/54%  
 Engineer : Leo-Li  
 EUT : Altai A8in (ac) Super WiFi Base Station  
 Power rating : DC 56V From POE Input AC 120V/60Hz  
 Test Mode : IEEE802.11nHT40 5795MHz Tx  
 WA8011NAC-H

No.	Freq. (MHz)	Ant. Factor (dB/m)	Cable Loss (dB)	AMP factor (dB)	Reading (dBuV)	Emission Level (dBuV/m)	Limits (dBuV/m)	Margin (dB)	Remark
1	5803.660	34.58	9.92	35.09	97.61	107.22	74.00	-33.22	Peak
2	5850.000	34.61	9.95	35.07	56.20	65.69	74.00	8.31	Peak
3	5860.000	34.62	9.95	35.07	50.90	60.40	74.00	13.60	Peak
4	7250.000	36.10	10.74	35.50	46.89	58.23	74.00	15.77	Peak
5	7716.340	36.83	11.20	35.69	48.57	60.91	74.00	13.09	Peak

Remarks: 1. Emission Level= Antenna Factor + Cable Loss + Reading - Amp Factor  
 2. The emission levels that are 20dB below the official limit are not reported.

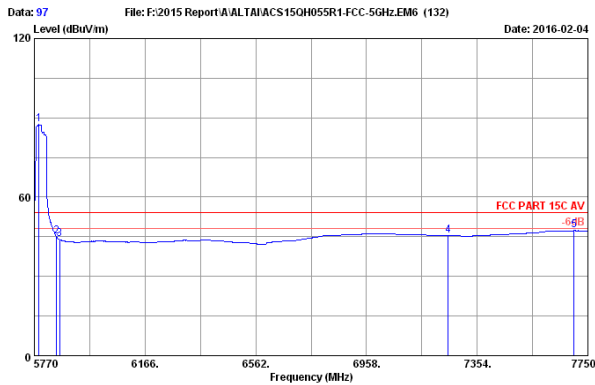

Site no. : 3m Chamber Data no. : 97  
 Dis. / Ant. : 3m 2015 3115-4877 Ant. pol. : HORIZONTAL  
 Limit : FCC PART 15C AV  
 Env. / Ins. : 23°C/54%  
 Engineer : Leo-Li  
 EUT : Altai A8in (ac) Super WiFi Base Station  
 Power rating : DC 56V From POE Input AC 120V/60Hz  
 Test Mode : IEEE802.11nHT40 5795MHz Tx  
 WA8011NAC-H

No.	Freq. (MHz)	Ant. Factor (dB/m)	Cable Loss (dB)	AMP factor (dB)	Reading (dBuV)	Emission Level (dBuV/m)	Limits (dBuV/m)	Margin (dB)	Remark
1	5785.840	34.57	9.91	35.10	78.03	87.41	54.00	-33.41	Average
2	5850.000	34.61	9.95	35.07	35.49	44.98	54.00	9.02	Average
3	5860.000	34.62	9.95	35.07	34.55	44.05	54.00	9.95	Average
4	7250.000	36.10	10.74	35.50	34.12	45.46	54.00	8.54	Average
5	7700.500	36.82	11.18	35.68	35.00	47.32	54.00	6.68	Average

Remarks: 1. Emission Level= Antenna Factor + Cable Loss + Reading - Amp Factor  
 2. The emission levels that are 20dB below the official limit are not reported.

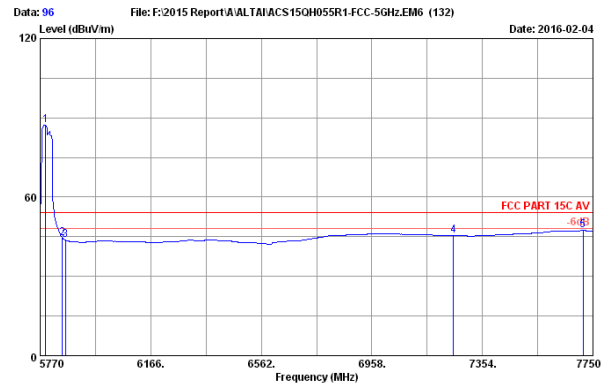

Site no. : 3m Chamber Data no. : 96  
 Dis. / Ant. : 3m 2015 3115-4877 Ant. pol. : VERTICAL  
 Limit : FCC PART 15C AV  
 Env. / Ins. : 23°C/54%  
 Engineer : Leo-Li  
 EUT : Altai A8in (ac) Super WiFi Base Station  
 Power rating : DC 56V From POE Input AC 120V/60Hz  
 Test Mode : IEEE802.11nHT40 5795MHz Tx  
 WA8011NAC-H

No.	Freq. (MHz)	Ant. Factor (dB/m)	Cable Loss (dB)	AMP factor (dB)	Reading (dBuV)	Emission Level (dBuV/m)	Limits (dBuV/m)	Margin (dB)	Remark
1	5789.800	34.57	9.92	35.09	77.84	87.24	54.00	-33.24	Average
2	5850.000	34.61	9.95	35.07	35.08	44.57	54.00	9.43	Average
3	5860.000	34.62	9.95	35.07	34.22	43.72	54.00	10.28	Average
4	7250.000	36.10	10.74	35.50	34.14	45.48	54.00	8.52	Average
5	7714.360	36.83	11.20	35.69	34.99	47.33	54.00	6.67	Average

Remarks: 1. Emission Level= Antenna Factor + Cable Loss + Reading - Amp Factor  
 2. The emission levels that are 20dB below the official limit are not reported.



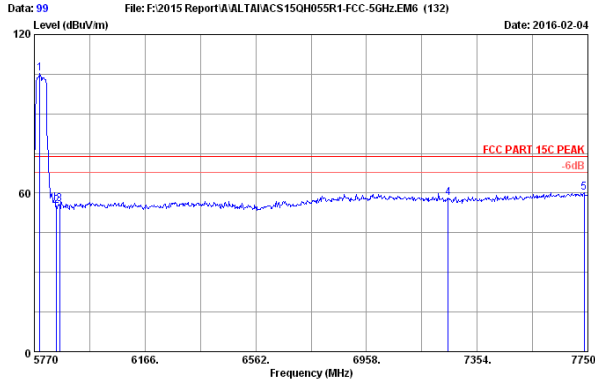

Site no. : 3m Chamber Data no. : 99  
 Dis. / Ant. : 3m 2015 3115-4877 Ant. pol. : HORIZONTAL  
 Limit : FCC PART 15C PEAK  
 Env. / Ins. : 23°C/54%  
 Engineer : Leo-Li  
 EUT : Altai A8in (ac) Super WiFi Base Station  
 Power rating : DC 56V From POE Input AC 120V/60Hz  
 Test Mode : IEEE802.11ac VHT40 5795MHz Tx  
 WA8011NAC-H

No.	Freq. (MHz)	Ant. Factor (dB/m)	Cable Loss (dB)	AMP factor (dB)	Reading (dBuV)	Emission Level (dBuV/m)	Limits (dBuV/m)	Margin (dB)	Remark
1	5789.800	34.57	9.92	35.09	95.81	105.21	74.00	-31.21	Peak
2	5850.000	34.61	9.95	35.07	45.65	55.14	74.00	18.86	Peak
3	5860.000	34.62	9.95	35.07	46.45	55.95	74.00	18.05	Peak
4	7250.000	36.10	10.74	35.50	46.88	58.22	74.00	15.78	Peak
5	7736.140	36.84	11.22	35.69	47.94	60.31	74.00	13.69	Peak

Remarks: 1. Emission Level= Antenna Factor + Cable Loss + Reading - Amp Factor  
 2. The emission levels that are 20dB below the official limit are not reported.

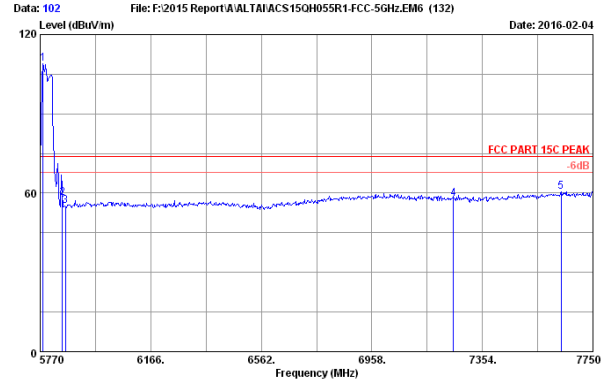

Site no. : 3m Chamber Data no. : 102  
 Dis. / Ant. : 3m 2015 3115-4877 Ant. pol. : VERTICAL  
 Limit : FCC PART 15C PEAK  
 Env. / Ins. : 23°C/54%  
 Engineer : Leo-Li  
 EUT : Altai A8in (ac) Super WiFi Base Station  
 Power rating : DC 56V From POE Input AC 120V/60Hz  
 Test Mode : IEEE802.11ac VHT40 5795MHz Tx  
 WA8011NAC-H

No.	Freq. (MHz)	Ant. Factor (dB/m)	Cable Loss (dB)	AMP factor (dB)	Reading (dBuV)	Emission Level (dBuV/m)	Limits (dBuV/m)	Margin (dB)	Remark
1	5779.900	34.57	9.91	35.10	99.47	108.85	74.00	-34.85	Peak
2	5850.000	34.61	9.95	35.07	48.64	58.13	74.00	15.87	Peak
3	5860.000	34.62	9.95	35.07	45.49	54.99	74.00	19.01	Peak
4	7250.000	36.10	10.74	35.50	46.57	57.91	74.00	16.09	Peak
5	7635.160	36.78	11.11	35.65	48.35	60.59	74.00	13.41	Peak

Remarks: 1. Emission Level= Antenna Factor + Cable Loss + Reading - Amp Factor  
 2. The emission levels that are 20dB below the official limit are not reported.

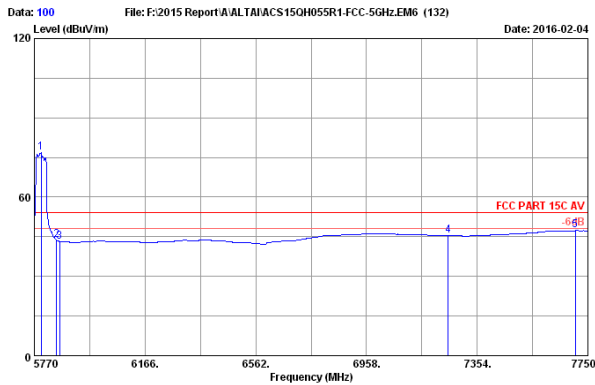

Site no. : 3m Chamber Data no. : 100  
 Dis. / Ant. : 3m 2015 3115-4877 Ant. pol. : HORIZONTAL  
 Limit : FCC PART 15C AV  
 Env. / Ins. : 23°C/54%  
 Engineer : Leo-Li  
 EUT : Altai A8in (ac) Super WiFi Base Station  
 Power rating : DC 56V From POE Input AC 120V/60Hz  
 Test Mode : IEEE802.11ac VHT40 5795MHz Tx  
 WA8011NAC-H

No.	Freq. (MHz)	Ant. Factor (dB/m)	Cable Loss (dB)	AMP factor (dB)	Reading (dBuV)	Emission Level (dBuV/m)	Limits (dBuV/m)	Margin (dB)	Remark
1	5793.760	34.58	9.92	35.09	67.30	76.71	54.00	-22.71	Average
2	5850.000	34.61	9.95	35.07	34.20	43.69	54.00	10.31	Average
3	5860.000	34.62	9.95	35.07	33.73	43.23	54.00	10.77	Average
4	7250.000	36.10	10.74	35.50	34.14	45.48	54.00	8.52	Average
5	7704.460	36.82	11.18	35.68	34.99	47.31	54.00	6.69	Average

Remarks: 1. Emission Level= Antenna Factor + Cable Loss + Reading - Amp Factor  
 2. The emission levels that are 20dB below the official limit are not reported.

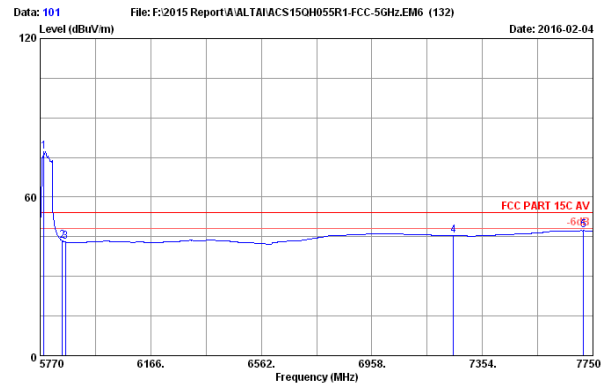

Site no. : 3m Chamber Data no. : 101  
 Dis. / Ant. : 3m 2015 3115-4877 Ant. pol. : VERTICAL  
 Limit : FCC PART 15C AV  
 Env. / Ins. : 23°C/54%  
 Engineer : Leo-Li  
 EUT : Altai A8in (ac) Super WiFi Base Station  
 Power rating : DC 56V From POE Input AC 120V/60Hz  
 Test Mode : IEEE802.11ac VHT40 5795MHz Tx  
 WA8011NAC-H

No.	Freq. (MHz)	Ant. Factor (dB/m)	Cable Loss (dB)	AMP factor (dB)	Reading (dBuV)	Emission Level (dBuV/m)	Limits (dBuV/m)	Margin (dB)	Remark
1	5783.860	34.57	9.91	35.10	67.98	77.36	54.00	-23.36	Average
2	5850.000	34.61	9.95	35.07	33.96	43.45	54.00	10.55	Average
3	5860.000	34.62	9.95	35.07	33.51	43.01	54.00	10.99	Average
4	7250.000	36.10	10.74	35.50	34.15	45.49	54.00	8.51	Average
5	7716.340	36.83	11.20	35.69	34.99	47.33	54.00	6.67	Average

Remarks: 1. Emission Level= Antenna Factor + Cable Loss + Reading - Amp Factor  
 2. The emission levels that are 20dB below the official limit are not reported.

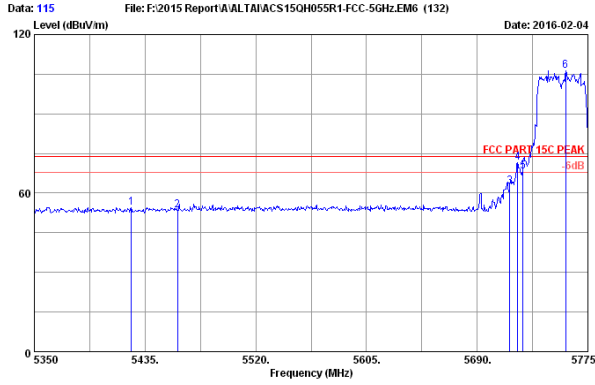

Site no. : 3m Chamber Data no. : 115  
 Dis. / Ant. : 3m 2015 3115-4877 Ant. pol. : HORIZONTAL  
 Limit : FCC PART 15C PEAK  
 Env. / Ins. : 23°C/54%  
 Engineer : Leo-Li  
 EUT : Altai A8in (ac) Super WiFi Base Station  
 Power rating : DC 56V From POE Input AC 120V/60Hz  
 Test Mode : IEEE802.11ac VHT40 5755MHz Tx  
 WA8011NAC-H

No.	Freq. (MHz)	Ant. Factor (dB/m)	Cable Loss (dB)	AMP factor (dB)	Reading (dBuV)	Emission Level (dBuV/m)	Limits (dBuV/m)	Margin (dB)	Remark
1	5424.375	34.25	9.76	35.26	45.85	54.59	74.00	19.41	Peak
2	5460.075	34.33	9.76	35.25	44.70	53.54	74.00	20.46	Peak
3	5715.000	34.53	9.88	35.12	53.38	62.67	74.00	11.33	Peak
4	5721.025	34.53	9.89	35.12	62.08	71.38	74.00	2.62	Peak
5	5725.000	34.53	9.89	35.12	58.94	68.24	74.00	5.76	Peak
6	5758.000	34.55	9.91	35.11	96.86	106.21	74.00	-32.21	Peak

Remarks: 1. Emission Level= Antenna Factor + Cable Loss + Reading - Amp Factor  
 2. The emission levels that are 20dB below the official limit are not reported.

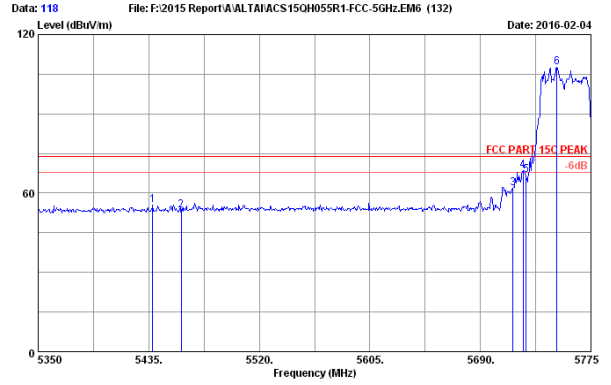

Site no. : 3m Chamber Data no. : 118  
 Dis. / Ant. : 3m 2015 3115-4877 Ant. pol. : VERTICAL  
 Limit : FCC PART 15C PEAK  
 Env. / Ins. : 23°C/54%  
 Engineer : Leo-Li  
 EUT : Altai A8in (ac) Super WiFi Base Station  
 Power rating : DC 56V From POE Input AC 120V/60Hz  
 Test Mode : IEEE802.11ac VHT40 5755MHz Tx  
 WA8011NAC-H

No.	Freq. (MHz)	Ant. Factor (dB/m)	Cable Loss (dB)	AMP factor (dB)	Reading (dBuV)	Emission Level (dBuV/m)	Limits (dBuV/m)	Margin (dB)	Remark
1	5437.975	34.29	9.75	35.25	46.53	55.32	74.00	18.68	Peak
2	5460.000	34.33	9.76	35.25	44.73	53.57	74.00	20.43	Peak
3	5715.000	34.53	9.88	35.12	52.71	62.00	74.00	12.00	Peak
4	5722.725	34.53	9.89	35.12	59.38	68.68	74.00	5.32	Peak
5	5725.000	34.53	9.89	35.12	57.68	66.98	74.00	7.02	Peak
6	5748.650	34.55	9.90	35.11	98.16	107.50	74.00	-33.50	Peak

Remarks: 1. Emission Level= Antenna Factor + Cable Loss + Reading - Amp Factor  
 2. The emission levels that are 20dB below the official limit are not reported.

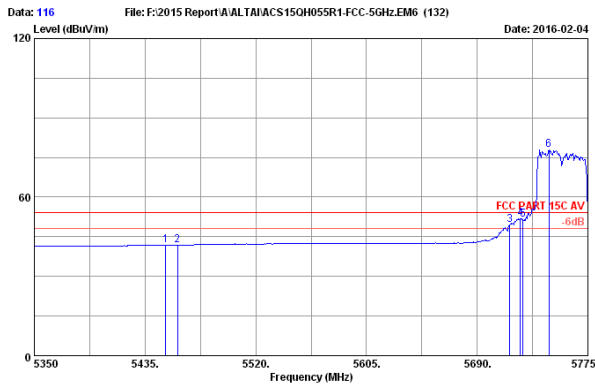

Site no. : 3m Chamber Data no. : 116  
 Dis. / Ant. : 3m 2015 3115-4877 Ant. pol. : HORIZONTAL  
 Limit : FCC PART 15C AV  
 Env. / Ins. : 23°C/54%  
 Engineer : Leo-Li  
 EUT : Altai A8in (ac) Super WiFi Base Station  
 Power rating : DC 56V From POE Input AC 120V/60Hz  
 Test Mode : IEEE802.11ac VHT40 5755MHz Tx  
 WA8011NAC-H

No.	Freq. (MHz)	Ant. Factor (dB/m)	Cable Loss (dB)	AMP factor (dB)	Reading (dBuV)	Emission Level (dBuV/m)	Limits (dBuV/m)	Margin (dB)	Remark
1	5450.725	34.31	9.76	35.25	33.02	41.84	54.00	12.16	Average
2	5460.000	34.33	9.76	35.25	32.98	41.82	54.00	12.18	Average
3	5715.000	34.53	9.88	35.12	40.27	49.56	54.00	4.44	Average
4	5723.150	34.53	9.89	35.12	42.56	51.86	54.00	2.14	Average
5	5725.000	34.53	9.89	35.12	42.18	51.48	54.00	2.52	Average
6	5745.250	34.55	9.90	35.11	68.65	77.99	54.00	-23.99	Average

Remarks: 1. Emission Level= Antenna Factor + Cable Loss + Reading - Amp Factor  
 2. The emission levels that are 20dB below the official limit are not reported.

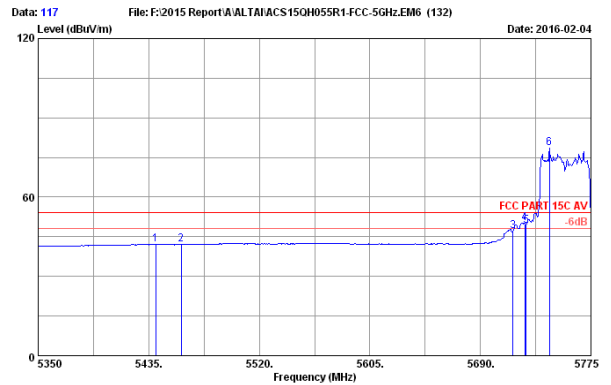

Site no. : 3m Chamber Data no. : 117  
 Dis. / Ant. : 3m 2015 3115-4877 Ant. pol. : VERTICAL  
 Limit : FCC PART 15C AV  
 Env. / Ins. : 23°C/54%  
 Engineer : Leo-Li  
 EUT : Altai A8in (ac) Super WiFi Base Station  
 Power rating : DC 56V From POE Input AC 120V/60Hz  
 Test Mode : IEEE802.11ac VHT40 5755MHz Tx  
 WA8011NAC-H

No.	Freq. (MHz)	Ant. Factor (dB/m)	Cable Loss (dB)	AMP factor (dB)	Reading (dBuV)	Emission Level (dBuV/m)	Limits (dBuV/m)	Margin (dB)	Remark
1	5440.525	34.29	9.75	35.25	33.33	42.12	54.00	11.88	Average
2	5460.000	34.33	9.76	35.25	33.17	42.01	54.00	11.99	Average
3	5715.000	34.53	9.88	35.12	37.71	47.00	54.00	7.00	Average
4	5724.000	34.53	9.89	35.12	40.98	50.28	54.00	3.72	Average
5	5725.000	34.53	9.89	35.12	39.86	49.16	54.00	4.84	Average
6	5743.125	34.55	9.90	35.11	69.05	78.39	54.00	-24.39	Average

Remarks: 1. Emission Level= Antenna Factor + Cable Loss + Reading - Amp Factor  
 2. The emission levels that are 20dB below the official limit are not reported.

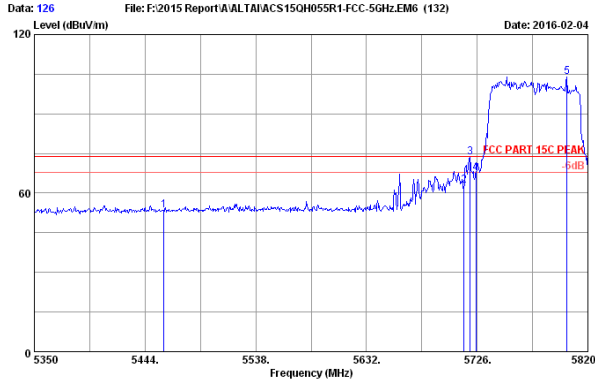

Site no. : 3m Chamber Data no. : 126  
 Dis. / Ant. : 3m 2015 3115-4877 Ant. pol. : HORIZONTAL  
 Limit : FCC PART 15C PEAK  
 Env. / Ins. : 23°C/54%  
 Engineer : Leo-Li  
 EUT : Altai A8in (ac) Super WiFi Base Station  
 Power rating : DC 56V From POE Input AC 120V/60Hz  
 Test Mode : IEEE802.11ac VHT80 5775MHz Tx  
 WA8011NAC-H

No.	Freq. (MHz)	Ant. Factor (dB/m)	Cable Loss (dB)	AMP factor (dB)	Reading (dBuV)	Emission Level (dBuV/m)	Limits (dBuV/m)	Margin (dB)	Remark
1	5459.980	34.33	9.76	35.25	44.49	53.33	74.00	20.67	Peak
2	5715.000	34.53	9.88	35.12	53.54	62.83	74.00	11.17	Peak
3	5719.890	34.53	9.89	35.12	64.28	73.58	74.00	0.42	Peak
4	5725.000	34.53	9.89	35.12	58.13	67.43	74.00	6.57	Peak
5	5802.140	34.58	9.92	35.09	94.67	104.08	74.00	-30.08	Peak

Remarks: 1. Emission Level= Antenna Factor + Cable Loss + Reading - Amp Factor  
 2. The emission levels that are 20dB below the official limit are not reported.

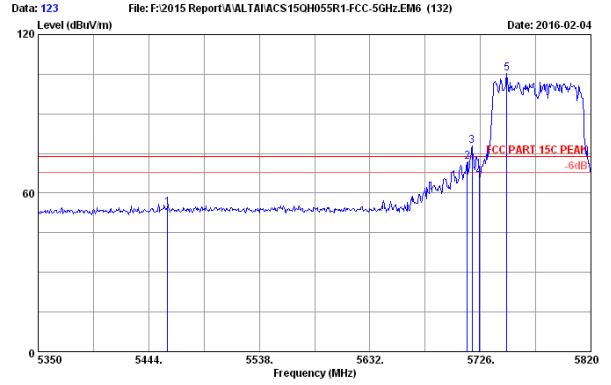

Site no. : 3m Chamber Data no. : 123  
 Dis. / Ant. : 3m 2015 3115-4877 Ant. pol. : VERTICAL  
 Limit : FCC PART 15C PEAK  
 Env. / Ins. : 23°C/54%  
 Engineer : Leo-Li  
 EUT : Altai A8in (ac) Super WiFi Base Station  
 Power rating : DC 56V From POE Input AC 120V/60Hz  
 Test Mode : IEEE802.11ac VHT80 5775MHz Tx  
 WA8011NAC-H

No.	Freq. (MHz)	Ant. Factor (dB/m)	Cable Loss (dB)	AMP factor (dB)	Reading (dBuV)	Emission Level (dBuV/m)	Limits (dBuV/m)	Margin (dB)	Remark
1	5460.000	34.33	9.76	35.25	45.80	54.64	74.00	19.36	Peak
2	5715.000	34.53	9.88	35.12	62.68	71.97	74.00	2.03	Peak
3	5718.950	34.53	9.89	35.12	68.48	77.78	74.00	-3.78	Peak
4	5725.000	34.53	9.89	35.12	56.83	66.13	74.00	7.87	Peak
5	5748.560	34.55	9.90	35.11	95.97	105.31	74.00	-31.31	Peak

Remarks: 1. Emission Level= Antenna Factor + Cable Loss + Reading - Amp Factor  
 2. The emission levels that are 20dB below the official limit are not reported.

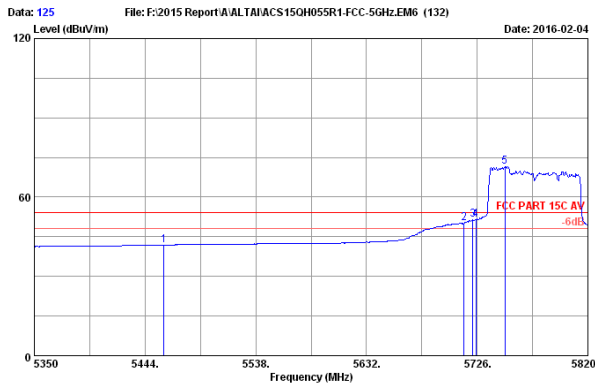

Site no. : 3m Chamber Data no. : 125  
 Dis. / Ant. : 3m 2015 3115-4877 Ant. pol. : HORIZONTAL  
 Limit : FCC PART 15C AV  
 Env. / Ins. : 23°C/54%  
 Engineer : Leo-Li  
 EUT : Altai A8in (ac) Super WiFi Base Station  
 Power rating : DC 56V From POE Input AC 120V/60Hz  
 Test Mode : IEEE802.11ac VHT80 5775MHz Tx  
 WA8011NAC-H

No.	Freq. (MHz)	Ant. Factor (dB/m)	Cable Loss (dB)	AMP factor (dB)	Reading (dBuV)	Emission Level (dBuV/m)	Limits (dBuV/m)	Margin (dB)	Remark
1	5460.000	34.33	9.76	35.25	33.01	41.85	54.00	12.15	Average
2	5715.000	34.53	9.88	35.12	40.75	50.04	54.00	3.96	Average
3	5722.240	34.53	9.89	35.12	42.34	51.64	54.00	2.36	Average
4	5725.000	34.53	9.89	35.12	42.12	51.42	54.00	2.58	Average
5	5749.500	34.55	9.90	35.11	62.22	71.56	54.00	-17.56	Average

Remarks: 1. Emission Level= Antenna Factor + Cable Loss + Reading - Amp Factor  
 2. The emission levels that are 20dB below the official limit are not reported.

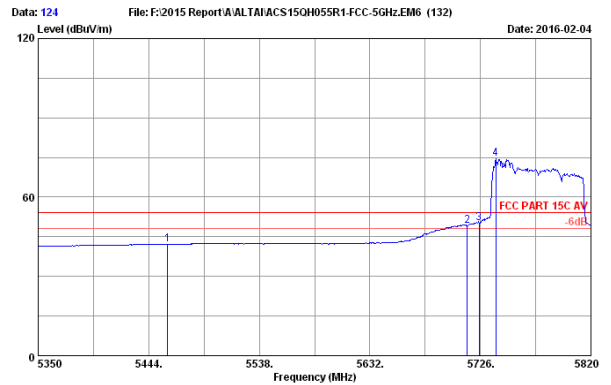

Site no. : 3m Chamber Data no. : 124  
 Dis. / Ant. : 3m 2015 3115-4877 Ant. pol. : VERTICAL  
 Limit : FCC PART 15C AV  
 Env. / Ins. : 23°C/54%  
 Engineer : Leo-Li  
 EUT : Altai A8in (ac) Super WiFi Base Station  
 Power rating : DC 56V From POE Input AC 120V/60Hz  
 Test Mode : IEEE802.11ac VHT80 5775MHz Tx  
 WA8011NAC-H

No.	Freq. (MHz)	Ant. Factor (dB/m)	Cable Loss (dB)	AMP factor (dB)	Reading (dBuV)	Emission Level (dBuV/m)	Limits (dBuV/m)	Margin (dB)	Remark
1	5460.000	34.33	9.76	35.25	33.28	42.12	54.00	11.88	Average
2	5715.000	34.53	9.88	35.12	39.80	49.09	54.00	4.91	Average
3	5725.000	34.53	9.89	35.12	40.81	50.11	54.00	3.89	Average
4	5739.160	34.54	9.90	35.11	65.32	74.65	54.00	-20.65	Average

Remarks: 1. Emission Level= Antenna Factor + Cable Loss + Reading - Amp Factor  
 2. The emission levels that are 20dB below the official limit are not reported.

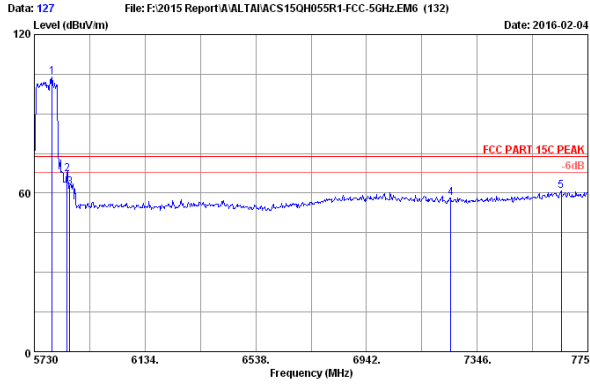

Site no. : 3m Chamber Data no. : 127  
 Dis. / Ant. : 3m 2015 3115-4877 Ant. pol. : HORIZONTAL  
 Limit : FCC PART 15C PEAK  
 Env. / Ins. : 23°C/54%  
 Engineer : Leo-Li  
 EUT : Altai A8in (ac) Super WiFi Base Station  
 Power rating : DC 56V From POE Input AC 120V/60Hz  
 Test Mode : IEEE802.11ac VHT80 5775MHz Tx  
 WA8011NAC-H

No.	Freq. (MHz)	Ant. Factor (dB/m)	Cable Loss (dB)	AMP factor (dB)	Reading (dBuV)	Emission Level (dBuV/m)	Limits (dBuV/m)	Margin (dB)	Remark
1	5794.640	34.55	9.92	35.09	94.45	103.86	74.00	-29.86	Peak
2	5850.000	34.61	9.95	35.07	57.60	67.09	74.00	6.91	Peak
3	5860.000	34.62	9.95	35.07	52.54	62.04	74.00	11.96	Peak
4	7250.000	36.10	10.74	35.50	46.98	58.32	74.00	15.68	Peak
5	7653.040	36.79	11.13	35.66	48.63	60.89	74.00	13.11	Peak

Remarks: 1. Emission Level= Antenna Factor + Cable Loss + Reading - Amp Factor  
 2. The emission levels that are 20dB below the official limit are not reported.

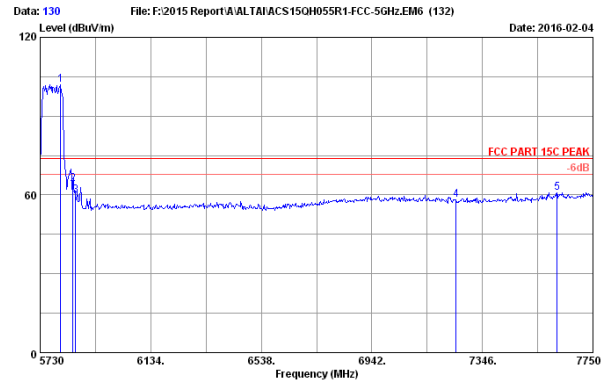

Site no. : 3m Chamber Data no. : 130  
 Dis. / Ant. : 3m 2015 3115-4877 Ant. pol. : VERTICAL  
 Limit : FCC PART 15C PEAK  
 Env. / Ins. : 23°C/54%  
 Engineer : Leo-Li  
 EUT : Altai A8in (ac) Super WiFi Base Station  
 Power rating : DC 56V From POE Input AC 120V/60Hz  
 Test Mode : IEEE802.11ac VHT80 5775MHz Tx  
 WA8011NAC-H

No.	Freq. (MHz)	Ant. Factor (dB/m)	Cable Loss (dB)	AMP factor (dB)	Reading (dBuV)	Emission Level (dBuV/m)	Limits (dBuV/m)	Margin (dB)	Remark
1	5804.740	34.55	9.92	35.09	92.68	102.09	74.00	-28.09	Peak
2	5850.000	34.61	9.95	35.07	54.82	64.31	74.00	9.69	Peak
3	5860.000	34.62	9.95	35.07	50.43	59.93	74.00	14.07	Peak
4	7250.000	36.10	10.74	35.50	46.98	58.32	74.00	15.68	Peak
5	7618.700	36.77	11.09	35.65	48.68	60.89	74.00	13.11	Peak

Remarks: 1. Emission Level= Antenna Factor + Cable Loss + Reading - Amp Factor  
 2. The emission levels that are 20dB below the official limit are not reported.

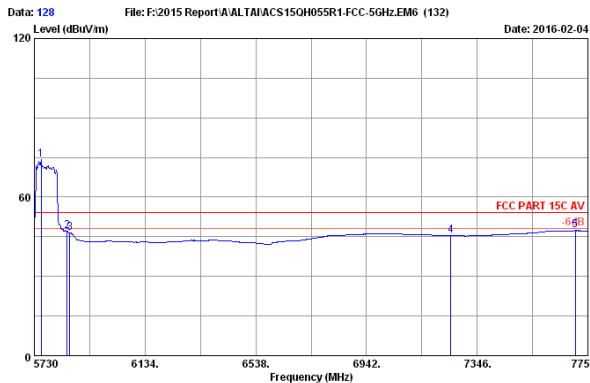

Site no. : 3m Chamber Data no. : 128  
 Dis. / Ant. : 3m 2015 3115-4877 Ant. pol. : HORIZONTAL  
 Limit : FCC PART 15C AV  
 Env. / Ins. : 23°C/54%  
 Engineer : Leo-Li  
 EUT : Altai A8in (ac) Super WiFi Base Station  
 Power rating : DC 56V From POE Input AC 120V/60Hz  
 Test Mode : IEEE802.11ac VHT80 5775MHz Tx  
 WA8011NAC-H

No.	Freq. (MHz)	Ant. Factor (dB/m)	Cable Loss (dB)	AMP factor (dB)	Reading (dBuV)	Emission Level (dBuV/m)	Limits (dBuV/m)	Margin (dB)	Remark
1	5794.240	34.55	9.91	35.11	64.72	74.07	54.00	-20.07	Average
2	5850.000	34.61	9.95	35.07	37.66	47.15	54.00	6.85	Average
3	5860.000	34.62	9.95	35.07	36.89	46.39	54.00	7.61	Average
4	7249.040	36.10	10.74	35.50	34.16	45.50	54.00	8.50	Average
5	7703.540	36.82	11.18	35.68	35.01	47.33	54.00	6.67	Average

Remarks: 1. Emission Level= Antenna Factor + Cable Loss + Reading - Amp Factor  
 2. The emission levels that are 20dB below the official limit are not reported.

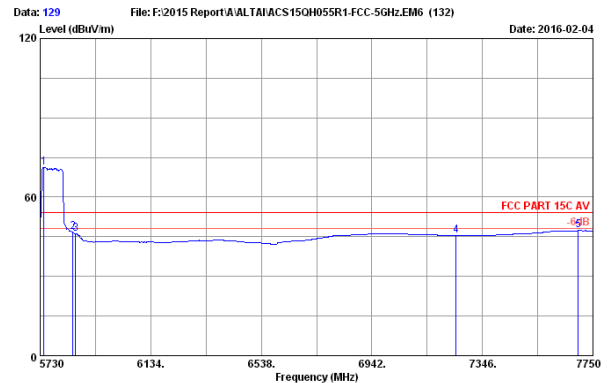

Site no. : 3m Chamber Data no. : 129  
 Dis. / Ant. : 3m 2015 3115-4877 Ant. pol. : VERTICAL  
 Limit : FCC PART 15C AV  
 Env. / Ins. : 23°C/54%  
 Engineer : Leo-Li  
 EUT : Altai A8in (ac) Super WiFi Base Station  
 Power rating : DC 56V From POE Input AC 120V/60Hz  
 Test Mode : IEEE802.11ac VHT80 5775MHz Tx  
 WA8011NAC-H

No.	Freq. (MHz)	Ant. Factor (dB/m)	Cable Loss (dB)	AMP factor (dB)	Reading (dBuV)	Emission Level (dBuV/m)	Limits (dBuV/m)	Margin (dB)	Remark
1	5744.540	34.55	9.90	35.11	62.01	71.95	54.00	-17.35	Average
2	5850.000	34.61	9.95	35.07	37.18	46.67	54.00	7.33	Average
3	5860.000	34.62	9.95	35.07	36.63	46.13	54.00	7.87	Average
4	7250.000	36.10	10.74	35.50	34.16	45.50	54.00	8.50	Average
5	7695.460	36.82	11.18	35.68	35.00	47.32	54.00	6.68	Average

Remarks: 1. Emission Level= Antenna Factor + Cable Loss + Reading - Amp Factor  
 2. The emission levels that are 20dB below the official limit are not reported.

## 6. 6dB&26dB Bandwidth Test

### 6.1. Test Equipment

Item	Equipment	Manufacturer	Model No.	Serial No.	Last Cal.	Cal. Interval
1.	Spectrum	Agilent	N9030A	MY51380221	Oct.18,15	1 Year
2.	Attenuator (20dB)	Agilent	8491B	MY39262165	Apr.28,15	1 Year
3.	RF Cable	Marvelous Microwave Inc	SFL402105FLEX	NO.1	Oct.17.15	1 Year

### 6.2. Limit

6dB Bandwidth should be not less than 500kHz

### 6.3. Test Procedure

#### **6dB Bandwidth:**

The transmitter output was connected to a spectrum analyzer, The bandwidth of the fundamental frequency was measured by spectrum analyzer with 100kHz RBW and 300 KHz VBW for signal width below 20MHz and 300KHz RBW ,1MHz VBW for Above 20MHz signal Bandwidth.

#### **26dB Bandwidth:**

The transmitter output was connected to a spectrum analyzer, The bandwidth of the fundamental frequency was measured by spectrum analyzer with 100kHz RBW and 300 KHz VBW The 26dB bandwidth is defined as the total spectrum the power of which is higher than peak power minus 26dB.

### 6.4. Test Results

**6dB bandwidth**

EUT: Altai A8in (ac) Super WiFi Base Station		
M/N: WA8011NAC-H		
Test date: 2016-02-18	Pressure: 101.3±1.0kPa	Humidity: 50.4±3.0%
Tested by: Donjon_Huang	Test site: RF site	Temperature: 21.3±0.6 °C

Test Mode	CH	6dB bandwidth (MHz)		Limit (KHz)
		ANT1	ANT2	
11a	CH149	16.51	16.44	≧ 500
	CH157	16.49	16.48	≧ 500
	CH165	16.47	16.51	≧ 500
11n HT20	CH149	17.69	17.67	≧ 500
	CH157	17.71	17.71	≧ 500
	CH165	17.73	17.73	≧ 500
11n HT40	CH151	36.32	37.11	≧ 500
	CH159	36.42	36.46	≧ 500
11ac VHT20	CH149	17.73	17.68	≧ 500
	CH157	17.72	17.71	≧ 500
	CH165	17.68	17.57	≧ 500
11ac VHT40	CH151	36.44	35.12	≧ 500
	CH159	35.50	35.85	≧ 500
11ac VHT80	CH155	75.14	72.58	≧ 500
Conclusion : PASS				

**26dB bandwidth**

EUT: Altai A8in (ac) Super WiFi Base Station		
M/N: WA8011NAC-H		
Test date: 2016-02-18	Pressure: 101.3±1.0kPa	Humidity: 50.4±3.0%
Tested by: Donjon_Huang	Test site: RF site	Temperature: 21.3±0.6 °C

Test Mode	CH	26dB bandwidth (MHz)		Limit (KHz)
		ANT1	ANT2	
11a	CH149	20.52	19.43	N/A
	CH157	20.02	19.80	N/A
	CH165	19.84	20.05	N/A
11n HT20	CH149	21.17	20.56	N/A
	CH157	21.13	20.99	N/A
	CH165	20.64	20.91	N/A
11n HT40	CH151	39.86	39.62	N/A
	CH159	39.29	39.62	N/A
11ac VHT20	CH149	20.99	20.75	N/A
	CH157	21.10	21.09	N/A
	CH165	20.80	20.89	N/A
11ac VHT40	CH151	39.03	38.68	N/A
	CH159	38.74	38.74	N/A
11ac VHT80	CH155	78.29	77.79	N/A
Conclusion : PASS				

<p><b>6dB bandwidth</b></p> <p><b>ANT 1</b></p>	
<p><b>11a</b></p> <p>5745MHz</p>	<p><b>11n HT20</b></p> <p>5745MHz</p>
<p>5785MHz</p>	<p>5785MHz</p>
<p>5825MHz</p>	<p>5825MHz</p>



**11n HT40**

**5755MHz**

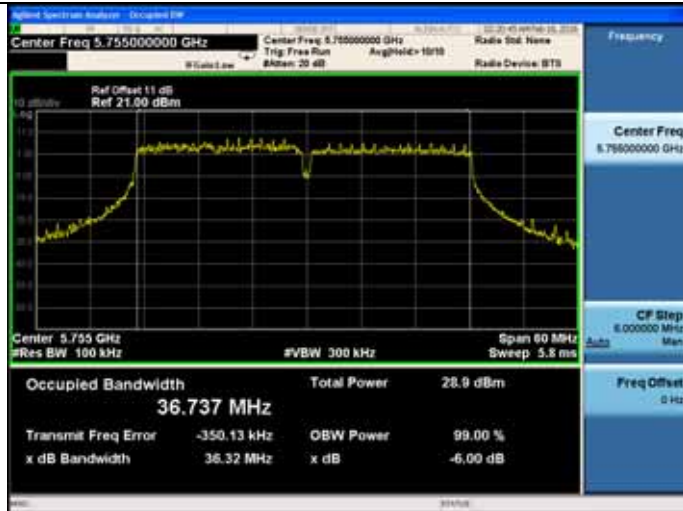

**5785MHz**



**5795MHz**

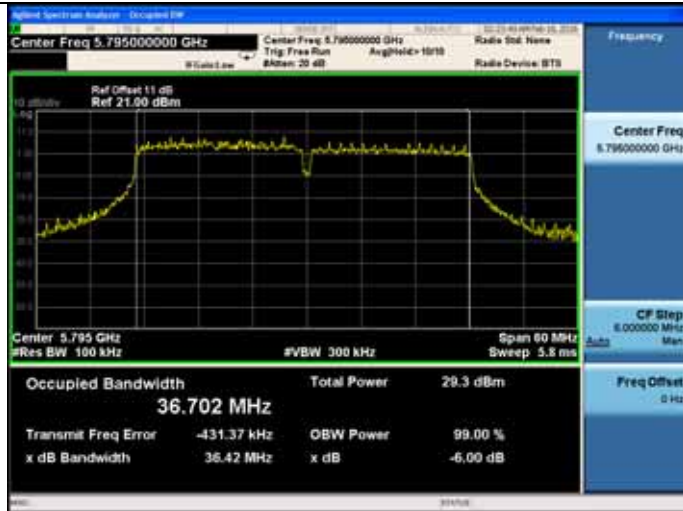

**5825MHz**

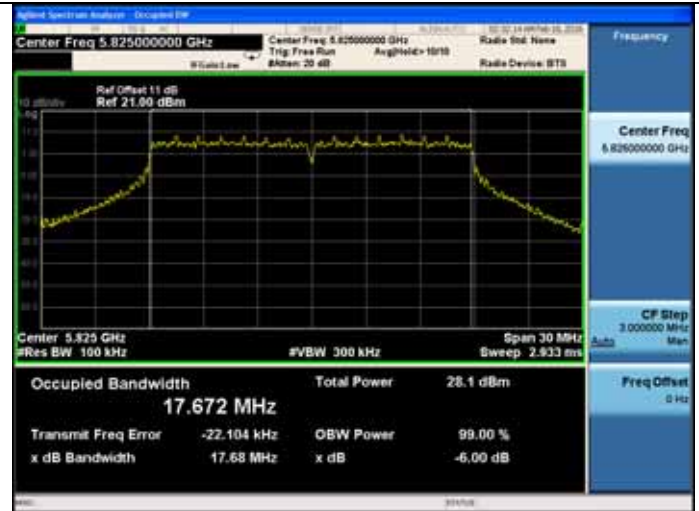

**11ac VHT20**

**5745MHz**

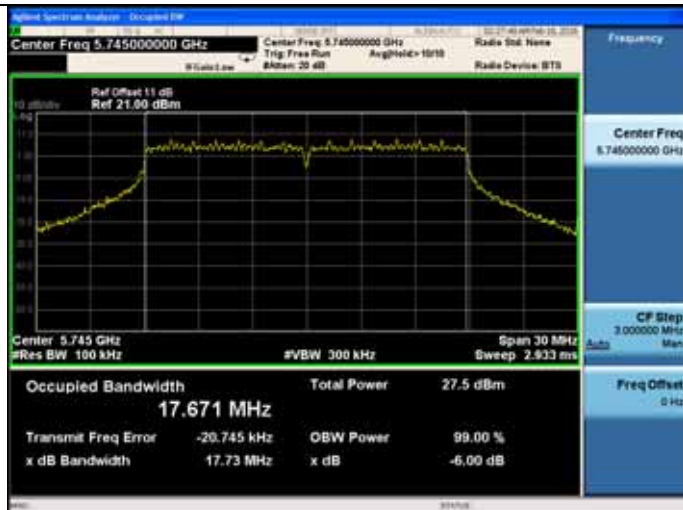

**11ac VHT40**

**5755MHz**

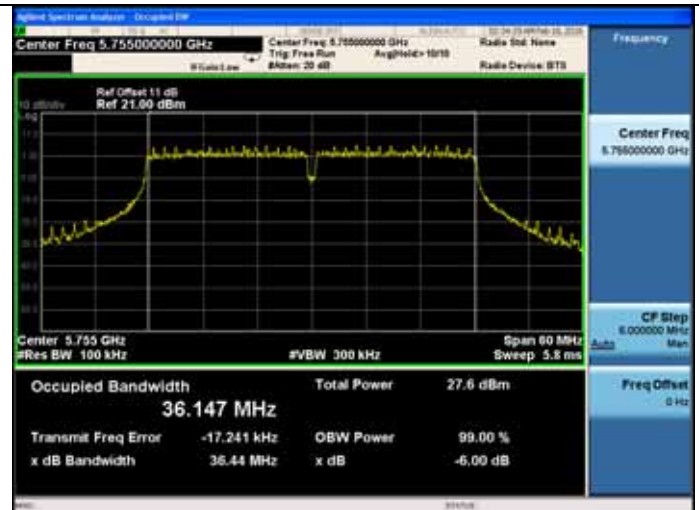

5795MHz

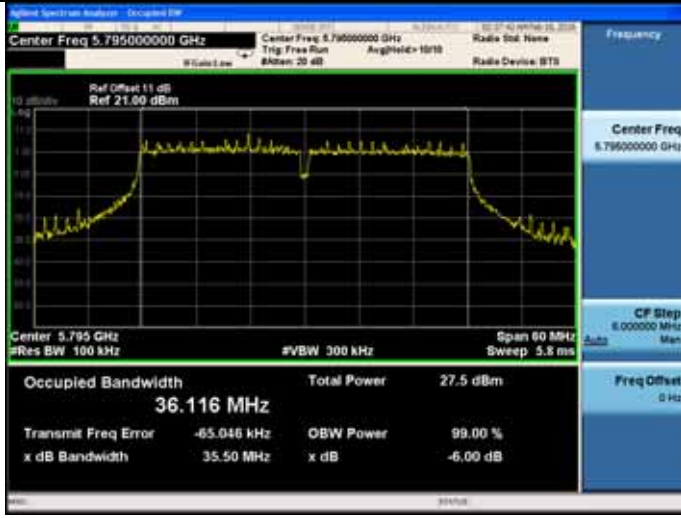

11ac VHT80  
5775MHz

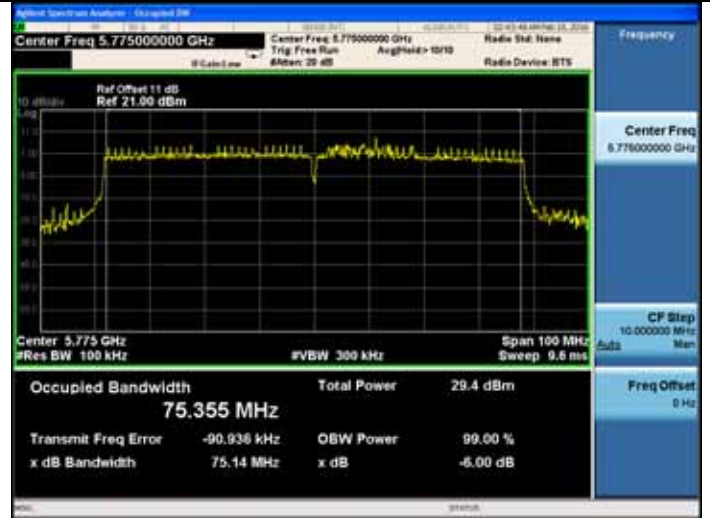

<p><b>6dB bandwidth</b></p> <p><b>ANT 2</b></p>	
<p><b>11a</b></p> <p>5745MHz</p>	<p><b>11n HT20</b></p> <p>5745MHz</p>
<p>5785MHz</p>	<p>5785MHz</p>
<p>5825MHz</p>	<p>5825MHz</p>

**11n HT40**

**5755MHz**

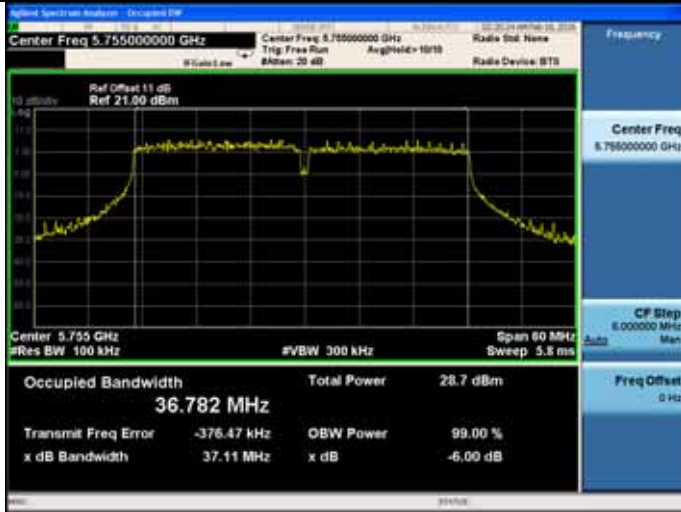

**5785MHz**

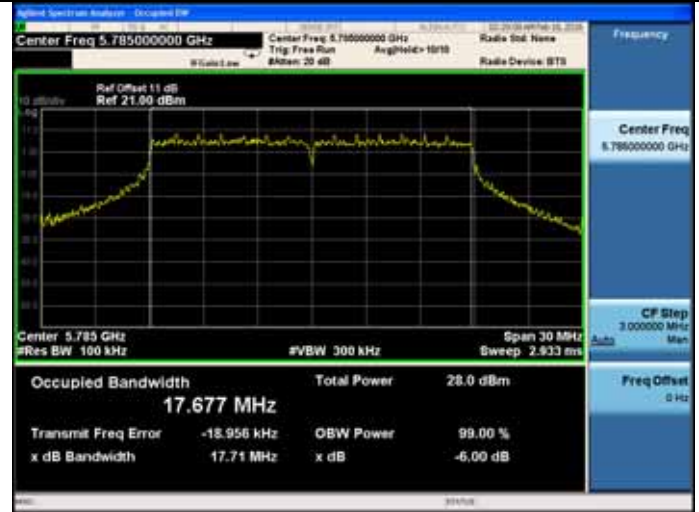

**5795MHz**

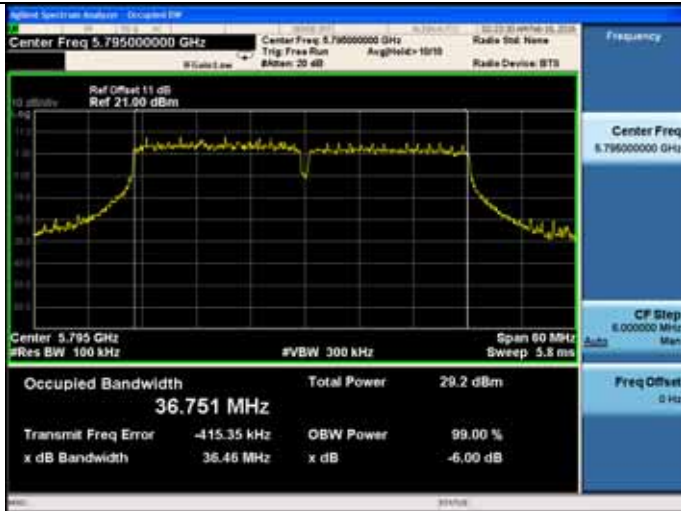

**5825MHz**



**11ac VHT20**

**5745MHz**

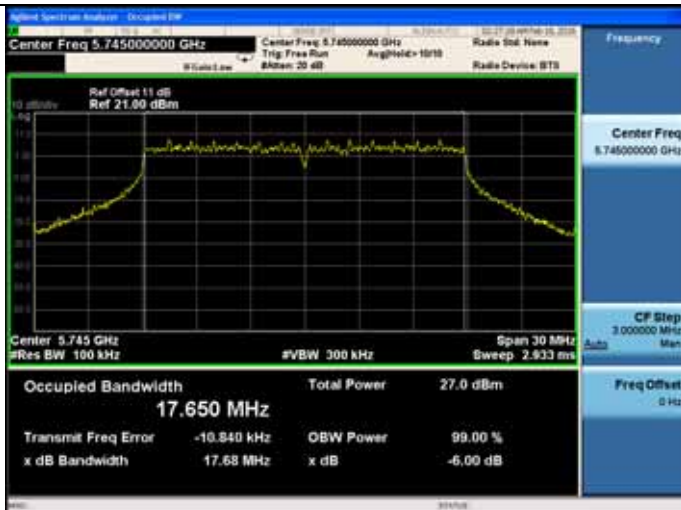

**11ac VHT40**

**5755MHz**

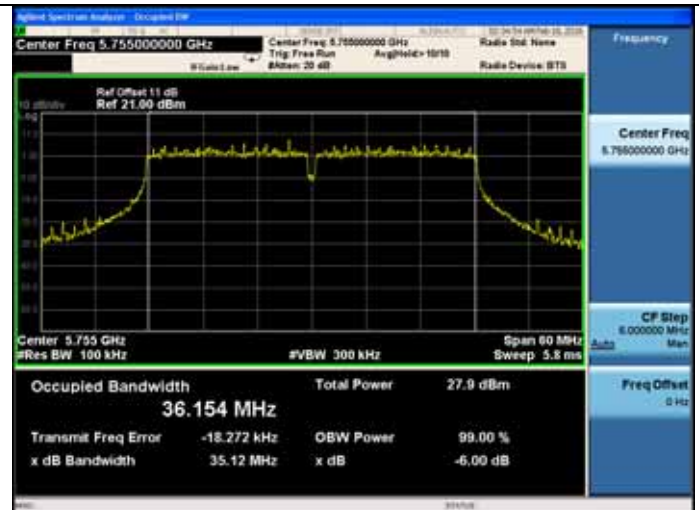

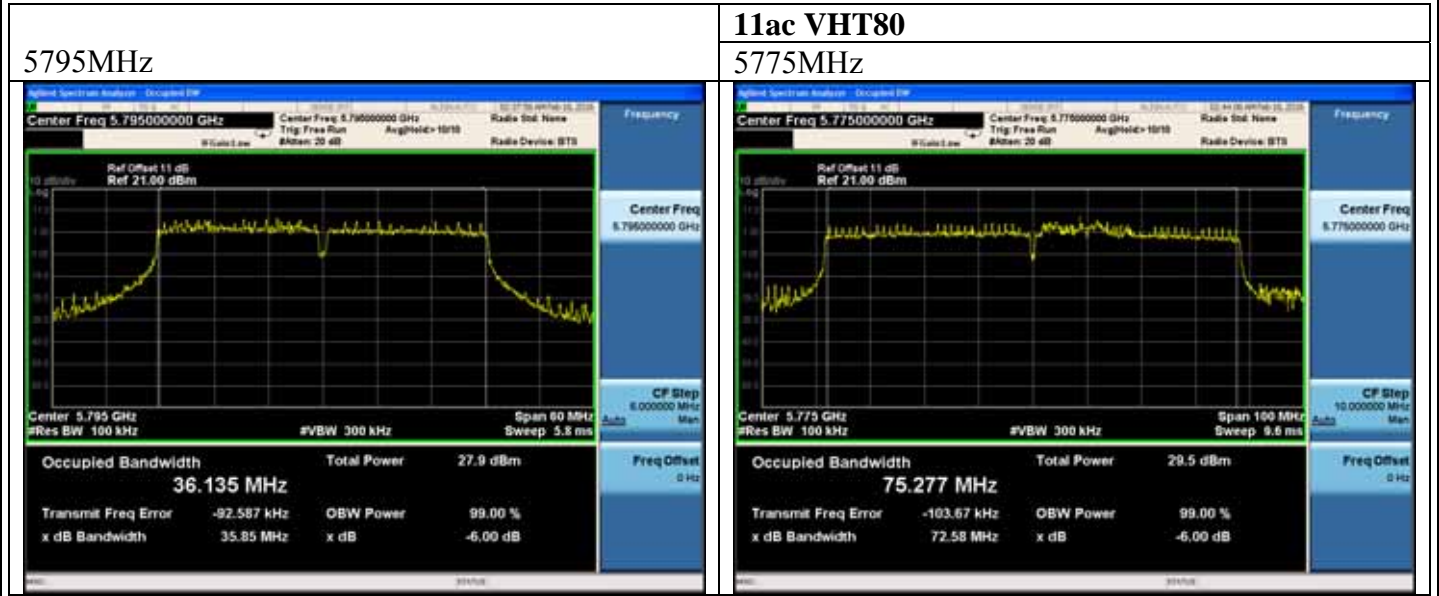

<p><b>26dB bandwidth</b></p> <p><b>ANT 1</b></p>	
<p><b>11a</b></p> <p>5745MHz</p> <p>Occupied Bandwidth: 16.459 MHz Total Power: 26.7 dBm Transmit Freq Error: -16.493 kHz x dB Bandwidth: 20.52 MHz</p>	<p><b>11n HT20</b></p> <p>5745MHz</p> <p>Occupied Bandwidth: 17.663 MHz Total Power: 27.1 dBm Transmit Freq Error: -26.810 kHz x dB Bandwidth: 21.17 MHz</p>
<p>5785MHz</p> <p>Occupied Bandwidth: 16.461 MHz Total Power: 28.3 dBm Transmit Freq Error: -39.417 kHz x dB Bandwidth: 20.02 MHz</p>	<p>5785MHz</p> <p>Occupied Bandwidth: 17.670 MHz Total Power: 28.4 dBm Transmit Freq Error: -31.819 kHz x dB Bandwidth: 21.13 MHz</p>
<p>5825MHz</p> <p>Occupied Bandwidth: 16.456 MHz Total Power: 27.8 dBm Transmit Freq Error: -30.738 kHz x dB Bandwidth: 19.84 MHz</p>	<p>5825MHz</p> <p>Occupied Bandwidth: 17.689 MHz Total Power: 28.1 dBm Transmit Freq Error: -23.541 kHz x dB Bandwidth: 20.64 MHz</p>

**11n HT40**

**5755MHz**

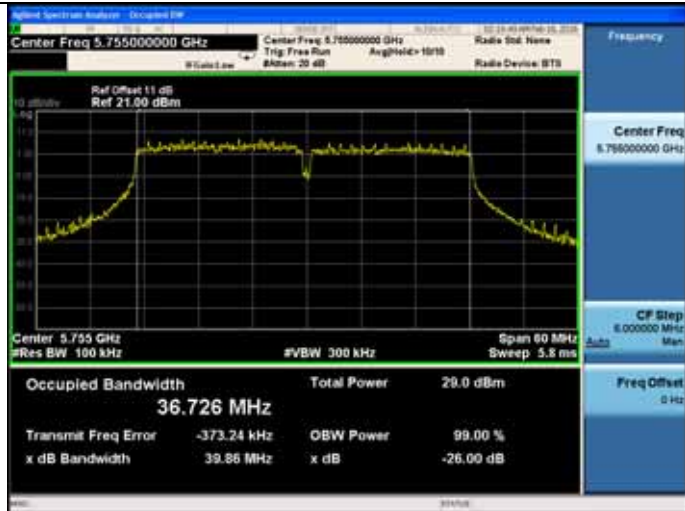

**5785MHz**



**5795MHz**

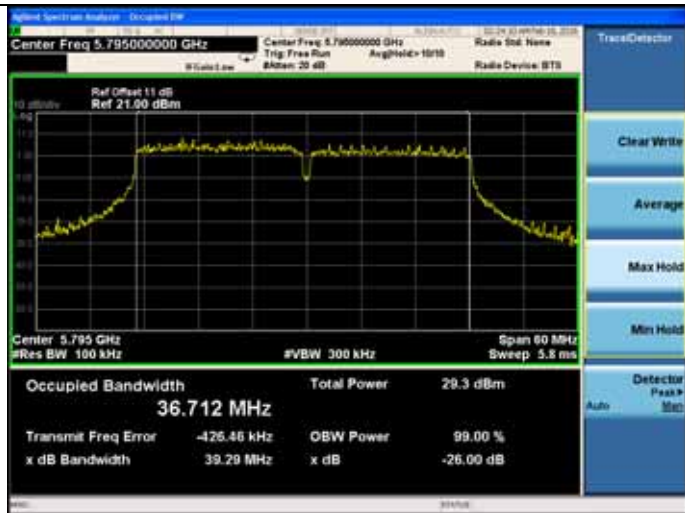

**5825MHz**

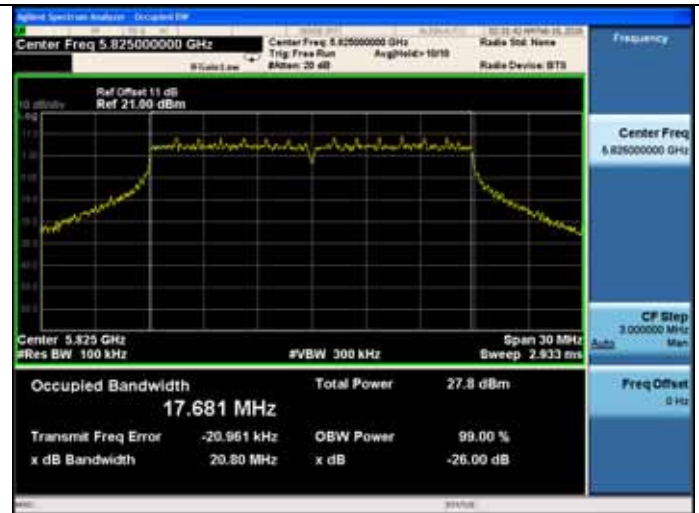

**11ac VHT20**

**5745MHz**

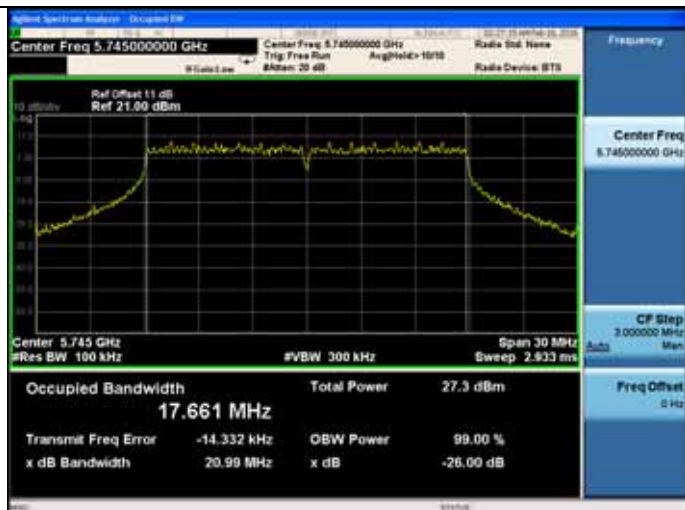

**11ac VHT40**

**5755MHz**

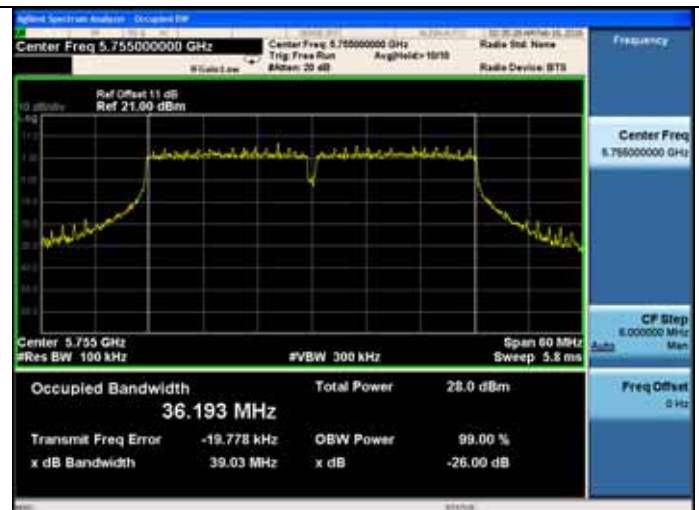

5795MHz

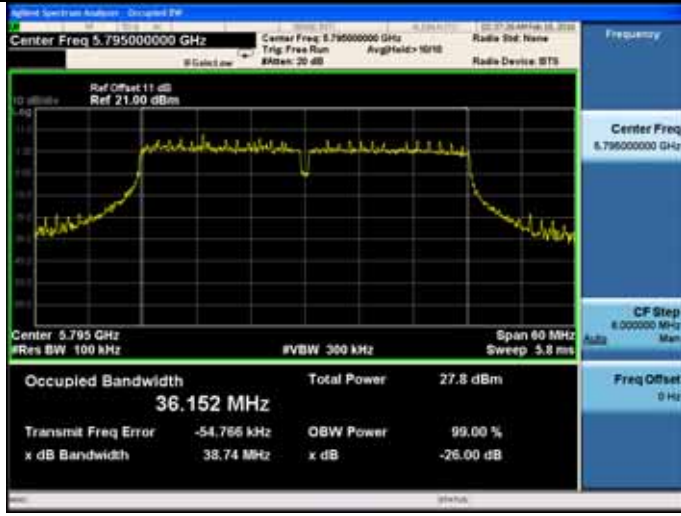

11ac VHT80  
5775MHz

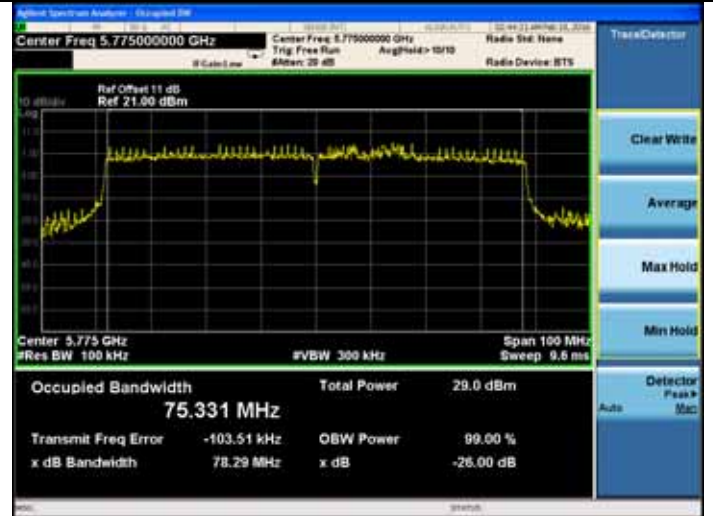



<p><b>26dB bandwidth</b></p> <p><b>ANT 2</b></p>	
<p><b>11a</b></p> <p>5745MHz</p>	<p><b>11n HT20</b></p> <p>5745MHz</p>
<p>5785MHz</p>	<p>5785MHz</p>
<p>5825MHz</p>	<p>5825MHz</p>

<p><b>11n HT40</b> <b>5755MHz</b></p> <p>Center Freq 5.75500000 GHz</p> <p>Center Freq 5.75500000 GHz</p> <p>Ref Offset 11 dB Ref 21.00 dBm</p> <p>Center Freq 5.755 GHz</p> <p>Occupied Bandwidth 36.731 MHz</p> <p>Total Power 28.8 dBm</p> <p>Transmit Freq Error -374.90 kHz</p> <p>OBW Power 99.00 %</p> <p>x dB Bandwidth 39.62 MHz</p> <p>-26.00 dB</p>	<p><b>5785MHz</b></p> <p>Center Freq 5.78500000 GHz</p> <p>Center Freq 5.78500000 GHz</p> <p>Ref Offset 11 dB Ref 21.00 dBm</p> <p>Center Freq 5.785 GHz</p> <p>Occupied Bandwidth 17.657 MHz</p> <p>Total Power 28.1 dBm</p> <p>Transmit Freq Error -31.570 kHz</p> <p>OBW Power 99.00 %</p> <p>x dB Bandwidth 21.09 MHz</p> <p>-26.00 dB</p>
<p><b>5795MHz</b></p> <p>Center Freq 5.79500000 GHz</p> <p>Center Freq 5.79500000 GHz</p> <p>Ref Offset 11 dB Ref 21.00 dBm</p> <p>Center Freq 5.795 GHz</p> <p>Occupied Bandwidth 36.744 MHz</p> <p>Total Power 29.2 dBm</p> <p>Transmit Freq Error -435.62 kHz</p> <p>OBW Power 99.00 %</p> <p>x dB Bandwidth 39.62 MHz</p> <p>-26.00 dB</p>	<p><b>5825MHz</b></p> <p>Center Freq 5.82500000 GHz</p> <p>Center Freq 5.82500000 GHz</p> <p>Ref Offset 11 dB Ref 21.00 dBm</p> <p>Center Freq 5.825 GHz</p> <p>Occupied Bandwidth 17.681 MHz</p> <p>Total Power 28.2 dBm</p> <p>Transmit Freq Error -21.204 kHz</p> <p>OBW Power 99.00 %</p> <p>x dB Bandwidth 20.89 MHz</p> <p>-26.00 dB</p>
<p><b>11ac VHT20</b> <b>5745MHz</b></p> <p>Center Freq 5.74500000 GHz</p> <p>Center Freq 5.74500000 GHz</p> <p>Ref Offset 11 dB Ref 21.00 dBm</p> <p>Center Freq 5.745 GHz</p> <p>Occupied Bandwidth 17.655 MHz</p> <p>Total Power 26.8 dBm</p> <p>Transmit Freq Error -21.508 kHz</p> <p>OBW Power 99.00 %</p> <p>x dB Bandwidth 20.75 MHz</p> <p>-26.00 dB</p>	<p><b>11ac VHT40</b> <b>5755MHz</b></p> <p>Center Freq 5.75500000 GHz</p> <p>Center Freq 5.75500000 GHz</p> <p>Ref Offset 11 dB Ref 21.00 dBm</p> <p>Center Freq 5.755 GHz</p> <p>Occupied Bandwidth 36.214 MHz</p> <p>Total Power 27.9 dBm</p> <p>Transmit Freq Error -33.276 kHz</p> <p>OBW Power 99.00 %</p> <p>x dB Bandwidth 38.68 MHz</p> <p>-26.00 dB</p>

5795MHz

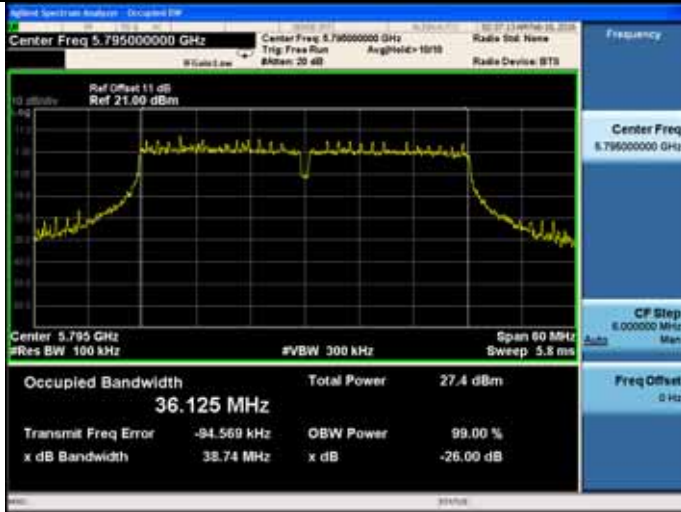

11ac VHT80  
5775MHz

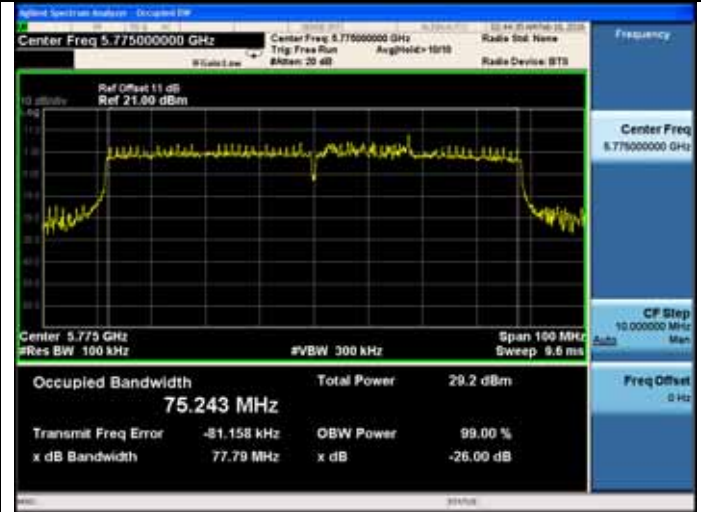

## 7. OUTPUT POWER TEST

### 7.1. Test Equipment

Item	Equipment	Manufacturer	Model No.	Serial No.	Last Cal.	Cal. Interval
1.	Spectrum	Agilent	N9030A	MY51380221	Oct.18,15	1 Year
2.	Power meter	Anritsu	ML2487A	6K00002472	Aug.21,15	1 Year
3.	Power sensor	Anritsu	MA2491A	0033005	Aug.21,15	1 Year
4.	Attenuator (20dB)	Agilent	8491B	MY39262165	Apr.28,15	1 Year
5.	RF Cable	Marvelous Microwave Inc	SFL402105FLEX	NO.1	Oct.17,15	1 Year

### 7.2. Limit

For the band 5.15–5.25 GHz.

For mobile and portable client devices in the 5.15–5.25 GHz band, the maximum conducted output power over the frequency band of operation shall not exceed 250 mW provided the maximum antenna gain does not exceed 6 dBi.

For the 5.25–5.35 GHz and 5.47–5.725 GHz bands, the maximum conducted output power over the frequency bands of operation shall not exceed the lesser of 250 mW or 11 dBm + 10 log B, where B is the 26 dB emission bandwidth in megahertz.

For the band 5.725-5.85 GHz, the maximum conducted output power over the frequency band of operation shall not exceed 1W.

### 7.3. Test Procedure

1. Connected the EUT’s antenna port to measure device by 26dB attenuator.
2. For IEEE 802.11a and IEEE802.11n HT20 and 802.11ac VHT20 mode, use a PK power meter which’s bandwidth is 20MHz and above 26dB bandwidth of signal to measure out each test modes’ PK output power.
3. For IEEE802.11n HT40 mode, because the signal’s bandwidth is about 40MHz and above 20MHz bandwidth of power sensor ML2491A. So use the test method described in KBD789033 clause E Method SA-1
  - 1) Connect the antenna port to the spectrum analyzer and Set span of the spectrum to encompass the entire emission bandwidth (EBW) of the signal.
  - 2) Set the RBW=1MHz and VBW =3MHz
  - 3) Number of points in sweep  $\geq 2$  Span / RBW
  - 4) Detector = RMS
  - 5) Sweep time = auto couple
  - 6) Allow the sweep to “free run” and set the Trace average at least 100 traces in power averaging (i.e., RMS) mode.
  - 7) Compute power by integrating the spectrum across the 26 dB EBW of the signal using the instrument’s band power measurement function with band limits set equal to the EBW band edges.

Note: The cable loss and attenuator loss were offset into measure device as an amplitude offset.

7.4. Test Results

EUT: Altai A8in (ac) Super WiFi Base Station					
M/N: WA8011NAC-H					
Test date: 2016-02-18		Pressure:101.8±1.0kPa		Humidity:50.3±3.0%	
Tested by: Donjon_Huang		Test site: RF site		Temperature:20.2±0.6 °C	
Test Mode	Frequency (MHz)	Maximum Conducted output power (dBm)			Limit (dBm)
		ANT1	ANT2	Total	
11a	5745	11.67	11.57	14.63	13
	5785	12.60	11.78	15.22	13
	5825	12.63	12.03	15.35	13
11n HT20	5745	11.41	11.07	14.25	13
	5785	11.60	11.47	14.55	13
	5825	11.93	10.88	14.45	13
11n HT40	5755	12.49	12.24	15.38	13
	5795	12.43	12.00	15.23	13
11ac VHT20	5745	11.43	11.88	14.67	13
	5785	12.25	11.41	14.86	13
	5825	12.48	11.45	15.01	13
11ac VHT40	5755	11.96	11.76	14.87	13
	5795	12.03	11.87	14.96	13
11ac VHT80	5775	12.35	11.65	15.02	13
Conclusion: PASS					

$$\begin{aligned} \text{Directional Gain} &= G_{\text{ANT}} + 10\log 2(\text{dBi}) \\ &= 20\text{dBi} + 3\text{dBi} \\ &= 23\text{dBi} > 6\text{dBi} \end{aligned}$$

$$\begin{aligned} \text{Output Power Limit} &= 30\text{dBm} - (23\text{dBi} - 6\text{dBi}) \\ &= 13\text{dBm} \end{aligned}$$

<p><b>ANT 1</b></p>	
<p><b>11n HT40</b></p>	
<p><b>5755MHz</b></p>	<p><b>5795MHz</b></p>
<p><b>11ac VHT80</b></p>	
<p><b>5795MHz</b></p>	<p><b>5775MHz</b></p>
<p><b>11acVHT40</b></p>	
<p><b>5755MHz</b></p>	

<p><b>ANT 2</b></p>	
<p><b>11n HT40</b></p>	
<p><b>5755MHz</b></p>	<p><b>5795MHz</b></p>
<p><b>11ac VHT80</b></p>	
<p><b>5795MHz</b></p>	<p><b>5775MHz</b></p>
<p><b>11acVHT40</b></p>	
<p><b>5755MHz</b></p>	

## 8. SPECTRAL DENSITY TEST

### 8.1. Test Equipment

Item	Equipment	Manufacturer	Model No.	Serial No.	Last Cal.	Cal. Interval
1.	Spectrum	Agilent	N9030A	MY51380221	Oct.18,15	1 Year
2.	Attenuator (20dB)	Agilent	8491B	MY39262165	Apr.28,15	1 Year
3.	RF Cable	Marvelous Microwave Inc	SFL402105FLEX	NO.1	Oct.17,15	1 Year

### 8.2. Limit

**Band 5150-5250 MHz:**

The e.i.r.p spectral density shall not exceed 10 dBm in any 1.0 MHz band.

**Band 5250-5350 MHz:**

The power spectral density shall not exceed 11 dBm in any 1.0 MHz band.

**Band 5470-5725 MHz:**

The power spectral density shall not exceed 11 dBm in any 1.0 MHz band.

**Band 5725-5850 MHz:**

The power spectral density shall not exceed 30 dBm in any 500 KHz band.

### 8.3. Test Procedure

For the Band 5.15-5.25GHz:

The transmitter output was connected to a spectrum analyzer. Power density was measured by spectrum analyzer with 1MHz RBW and 3MHz VBW; Detector: RMS mode.

For the band 5.725-5.85 GHz:

The transmitter output was connected to a spectrum analyzer. Power density was measured by spectrum analyzer with 1MHz RBW and 3MHz VBW,RMS Detector.

So use the test method described in KDB789033 clause E

- 1) Set the RBW=100kHz and VBW =3MHz
- 2) Number of points in sweep  $\geq 2$  Span / RBW.(This ensures that bin-to-bin spacing is  $\leq$  RBW/2, so that narrowband signals are not lost between frequency bins.)
- 3) Sweep time = auto
- 4) Detector = RMS (i.e., power averaging), if available. Otherwise, use sample detector mode.
- 5) Use the “peak search” function of spectrum analyzer find the max value, then add  $10\log(500\text{kHz}/\text{RBW})$  to the measured result.

Note: The cable loss and attenuator loss were offset into measure device as an amplitude offset.



### 8.4. Test Results

EUT: Altai A8in (ac) Super WiFi Base Station		
M/N: WA8011NAC-H		
Test date: 2016-02-18	Pressure: 101.8±1.0kPa	Humidity: 50.3±3.0%
Tested by: Donjon_Huang	Test site: RF site	Temperature: 20.2±0.6 °C

Test Mode	Frequency (MHz)	Power density (dBm/500KHz)			Limit (dBm/500KHz)
		ANT1	ANT2	Total	
11a	5745	-9.9473	-10.1673	-7.05	13
	5785	-9.8283	-10.2873	-7.04	13
	5825	-9.9563	-10.5273	-7.22	13
11n HT20	5745	-10.7803	-11.0053	-7.88	13
	5785	-10.7663	-10.8463	-7.80	13
	5825	-10.2723	-11.2683	-7.73	13
11n HT40	5755	-13.9453	-14.0593	-10.99	13
	5795	-13.7463	-13.4163	-10.57	13
11ac VHT20	5745	-10.3513	-10.1923	-7.26	13
	5785	-9.9713	-9.6933	-6.82	13
	5825	-10.0513	-10.1443	-7.09	13
11ac VHT40	5755	-15.7873	-14.9923	-12.36	13
	5795	-14.9973	-15.0123	-11.99	13
11ac VHT80	5775	-19.7583	-19.7523	-16.74	13
Conclusion: PASS					

$$\begin{aligned} \text{Directional Gain} &= G_{\text{ANT}} + 10\log_2(\text{dBi}) \\ &= 20\text{dBi} + 3\text{dBi} \\ &= 23\text{dBi} > 6\text{dBi} \end{aligned}$$

$$\begin{aligned} \text{Output Power Limit} &= 30\text{dBm} - (23\text{dBi} - 6\text{dBi}) \\ &= 13\text{dBm} \end{aligned}$$

<p><b>ANT 1</b></p>	
<p><b>11a</b></p> <p>5745MHz</p>	<p><b>11n HT20</b></p> <p>5745MHz</p>
<p>5785MHz</p>	
<p>5825MHz</p>	

**11n HT40**

5755MHz



5785MHz



5795MHz



5825MHz

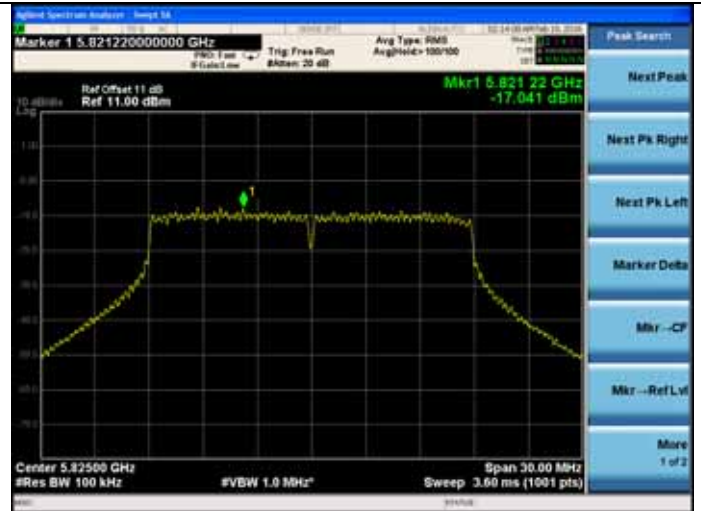

**11ac VHT20**

5745MHz

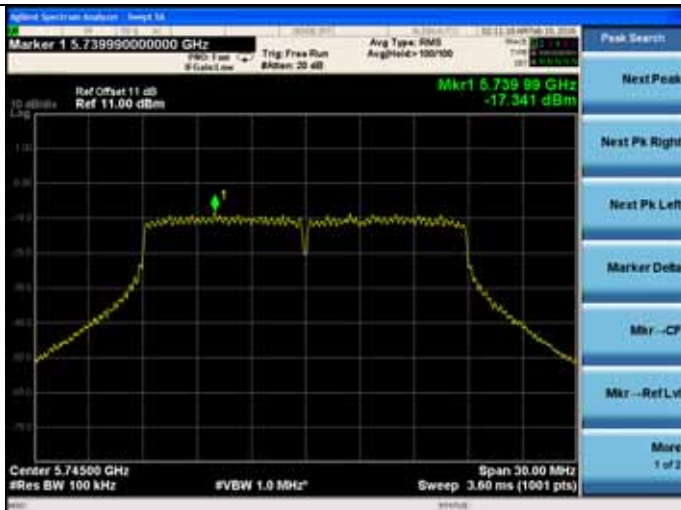

**11ac VHT40**

5755MHz

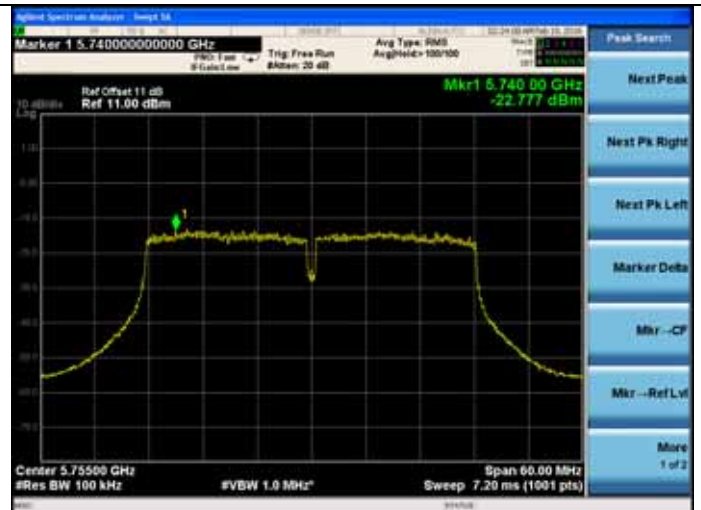

5795MHz

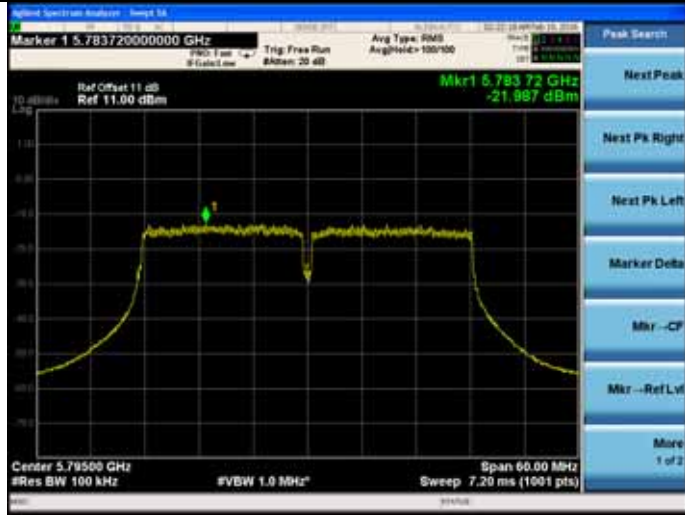

11ac VHT80  
5775MHz



<p><b>ANT 2</b></p>	
<p><b>11a</b></p> <p>5745MHz</p>	<p><b>11n HT20</b></p> <p>5745MHz</p>
<p>5785MHz</p>	<p>5785MHz</p>
<p>5825MHz</p>	<p>5825MHz</p>

**11n HT40**

5755MHz



5785MHz

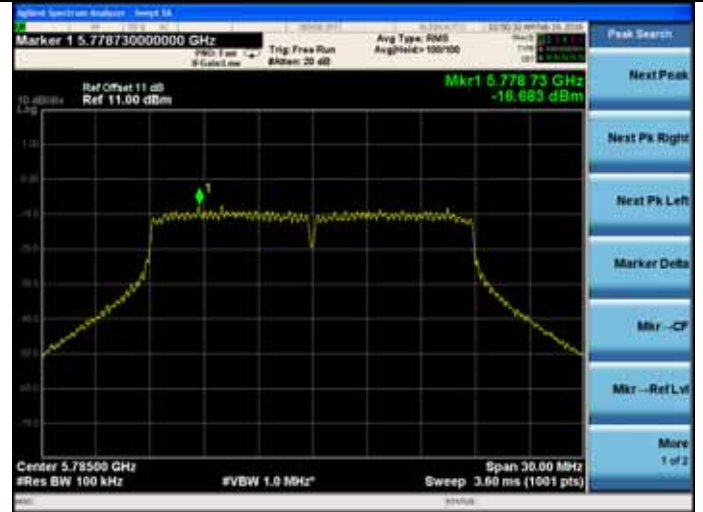

5795MHz



5825MHz

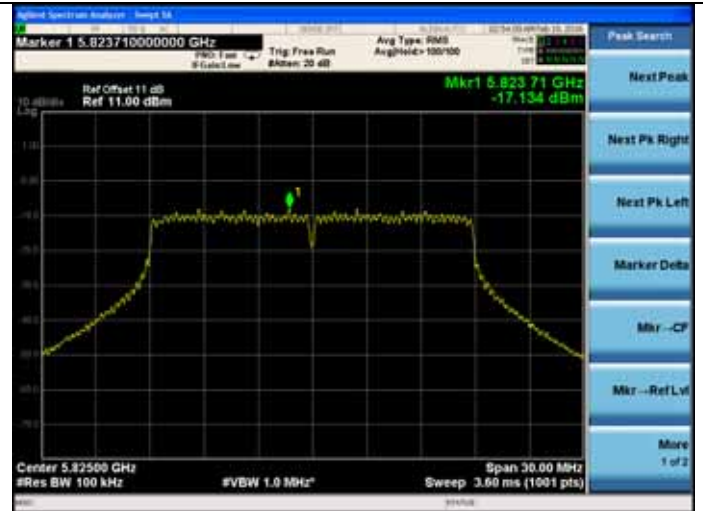

**11ac VHT20**

5745MHz

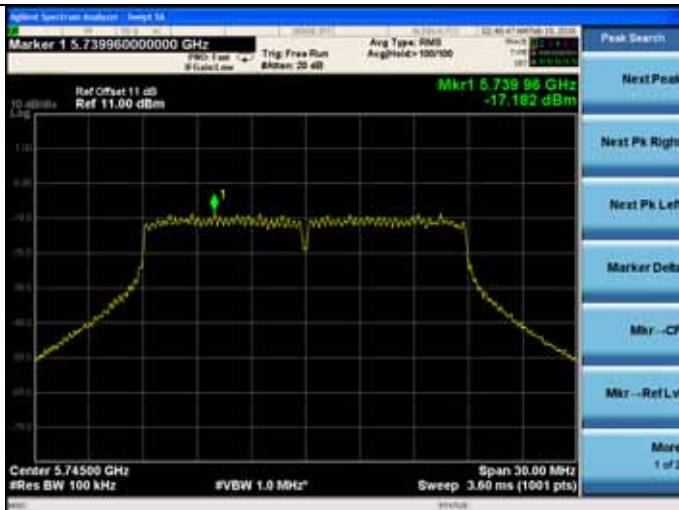

**11ac VHT40**

5755MHz

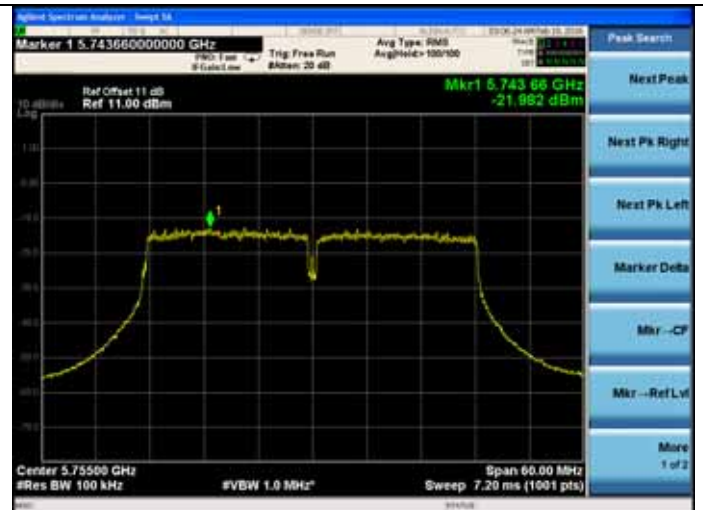

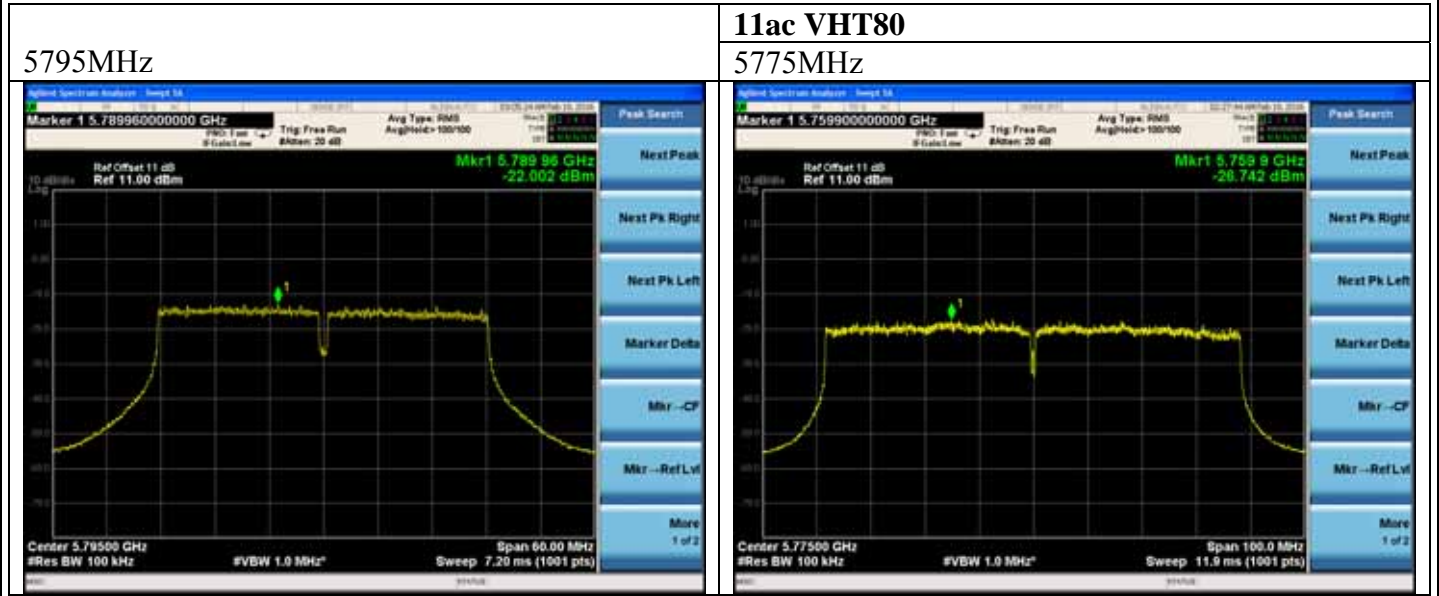

## 9. FREQUENCY STABILITY MEASUREMENT

### 9.1. Test Equipment

Item	Equipment	Manufacturer	Model No.	Serial No.	Last Cal.	Cal. Interval
1.	PXA Signal Analyzer	Agilent	N9030A	MY51380221	Oct.18,15	1 Year
2.	Amplifier	Agilent	8449B	3008A02495	Apr.28,15	1 Year
3.	Horn Antenna	ETS	3115	9510-4877	Oct.15,15	1 Year
4.	HF Cable	Hubersuhner	Sucoflex104	274094/4	Apr.28,15	1 Year

### 9.2. Limit

Manufacturers of U-NII devices are responsible for ensuring frequency stability such that an emissions is maintained within the band of operation under all conditions of normal operation as specified in the user's manual or  $\pm 20$ ppm

### 9.3. Test Procedure

1. The transmitter output (antenna port) was connected to the spectrum analyzer. EUT have transmitted absence of modulation signal and fixed channelise. Set the spectrum analyzer span to view the entire absence of modulation emissions bandwidth. Set RBW = 10 kHz, VBW = 10 kHz with peak detector and maxhold settings.  $f_c$  is declaring of channel frequency. Then the frequency error formula is  $(f_c - f) / f_c \times 10^6$  ppm and the limit is less than  $\pm 20$ ppm The test extreme voltage is to change the primary supply voltage from 85 to 115 percent of the nominal value
2. Extreme temperature rule is  $-30^\circ\text{C} \sim 50^\circ\text{C}$ .

### 9.4. Test Result



EUT: Altai A8in (ac) Super WiFi Base Station		
M/N: WA8011NAC-H		
Test date: 2016-02-26	Pressure:101.8±1.0kPa	Humidity:50.8±3.0%
Tested by: Donjon_Huang	Test site: RF site	Temperature:20.9±0.6 °C

**Frequency Stability vs Voltage:**

Test Voltage (V)	Temp (°C)	CH	Max. Reading (MHz)	Target Frequency (MHz)	Result (ppm)	Limit (ppm)
AC 108V	25°C	CH149	5745.033	5745	5.74	±20
		CH151	5755.029	5755	5.04	±20
		CH155	5775.038	5775	6.58	±20
		CH157	5785.029	5785	5.01	±20
		CH159	5795.025	5795	4.31	±20
		CH165	5825.034	5825	5.84	±20

Conclusion: PASS

Test Voltage (V)	Temp (°C)	CH	Max. Reading (MHz)	Target Frequency (MHz)	Result (ppm)	Limit (ppm)
AC 120V	25°C	CH149	5745.036	5745	6.27	±20
		CH151	5755.031	5755	5.39	±20
		CH155	5775.029	5775	5.02	±20
		CH157	5785.034	5785	5.88	±20
		CH159	5795.036	5795	6.21	±20
		CH165	5825.029	5825	4.98	±20

Conclusion: PASS

Test Voltage (V)	Temp (°C)	CH	Max. Reading (MHz)	Target Frequency (MHz)	Result (ppm)	Limit (ppm)
AC 132V	25°C	CH149	5745.029	5745	5.05	±20
		CH151	5755.030	5755	5.21	±20
		CH155	5775.029	5775	5.02	±20
		CH157	5785.034	5785	5.89	±20
		CH159	5795.028	5795	4.83	±20
		CH165	5825.026	5825	4.46	±20

Conclusion: PASS

Frequency Stability vs. Temperature:

Test Voltage (V)	Temp (°C)	CH	Max. Reading (MHz)	Target Frequency (MHz)	Result (ppm)	Limit (ppm)
AC 120V	-45°C	CH149	5745.022	5745	3.83	±20
		CH151	5755.046	5755	7.99	±20
		CH155	5775.038	5775	6.58	±20
		CH157	5785.026	5785	4.49	±20
		CH159	5795.041	5795	7.08	±20
		CH165	5825.029	5825	4.98	±20

Conclusion: PASS

Test Voltage (V)	Temp (°C)	CH	Max. Reading (MHz)	Target Frequency (MHz)	Result (ppm)	Limit (ppm)
AC 120V	-35°C	CH149	5745.028	5745	4.87	±20
		CH151	5755.039	5755	6.78	±20
		CH155	5775.027	5775	4.68	±20
		CH157	5785.035	5785	6.05	±20
		CH159	5795.042	5795	7.25	±20
		CH165	5825.031	5825	5.32	±20

Conclusion: PASS

Test Voltage (V)	Temp (°C)	CH	Max. Reading (MHz)	Target Frequency (MHz)	Result (ppm)	Limit (ppm)
AC 120V	-25°C	CH149	5745.031	5745	5.40	±20
		CH151	5755.029	5755	5.04	±20
		CH155	5775.036	5775	6.23	±20
		CH157	5785.042	5785	7.26	±20
		CH159	5795.038	5795	6.56	±20
		CH165	5825.052	5825	8.93	±20

Conclusion: PASS

Test Voltage (V)	Temp (°C)	CH	Max. Reading (MHz)	Target Frequency (MHz)	Result (ppm)	Limit (ppm)
AC 120V	-15°C	CH149	5745.026	5745	4.53	±20
		CH151	5755.033	5755	5.73	±20
		CH155	5775.047	5775	8.14	±20
		CH157	5785.035	5785	6.05	±20
		CH159	5795.034	5795	5.87	±20
		CH165	5825.021	5825	3.61	±20

Conclusion: PASS

Test Voltage (V)	Temp (°C)	CH	Max. Reading (MHz)	Target Frequency (MHz)	Result (ppm)	Limit (ppm)
AC 120V	-5°C	CH149	5745.034	5745	5.92	±20
		CH151	5755.027	5755	4.69	±20
		CH155	5775.029	5775	5.02	±20
		CH157	5785.031	5785	5.36	±20
		CH159	5795.037	5795	6.38	±20
		CH165	5825.029	5825	4.98	±20

Conclusion: PASS

Test Voltage (V)	Temp (°C)	CH	Max. Reading (MHz)	Target Frequency (MHz)	Result (ppm)	Limit (ppm)
AC 120V	5°C	CH149	5745.037	5745	6.44	±20
		CH151	5755.041	5755	7.12	±20
		CH155	5775.028	5775	4.85	±20
		CH157	5785.026	5785	4.49	±20
		CH159	5795.051	5795	8.80	±20
		CH165	5825.039	5825	6.70	±20

Conclusion: PASS

Test Voltage (V)	Temp (°C)	CH	Max. Reading (MHz)	Target Frequency (MHz)	Result (ppm)	Limit (ppm)
AC 120V	15°C	CH149	5745.029	5745	5.05	±20
		CH151	5755.035	5755	6.08	±20
		CH155	5775.028	5775	4.85	±20
		CH157	5785.034	5785	5.88	±20
		CH159	5795.026	5795	4.49	±20
		CH165	5825.027	5825	4.64	±20

Conclusion: PASS

Test Voltage (V)	Temp (°C)	CH	Max. Reading (MHz)	Target Frequency (MHz)	Result (ppm)	Limit (ppm)
AC 120V	25°C	CH149	5745.034	5745	5.92	±20
		CH151	5755.029	5755	5.04	±20
		CH155	5775.036	5775	6.23	±20
		CH157	5785.042	5785	7.26	±20
		CH159	5795.039	5795	6.73	±20
		CH165	5825.043	5825	7.38	±20

Conclusion:PASS

Test Voltage (V)	Temp (°C)	CH	Max. Reading (MHz)	Target Frequency (MHz)	Result (ppm)	Limit (ppm)
AC 120V	35°C	CH149	5745.030	5745	5.22	±20
		CH151	5755.031	5755	5.39	±20
		CH155	5775.041	5775	7.10	±20
		CH157	5785.039	5785	6.74	±20
		CH159	5795.028	5795	4.83	±20
		CH165	5825.031	5825	5.32	±20

Conclusion:PASS

Test Voltage (V)	Temp (°C)	CH	Max. Reading (MHz)	Target Frequency (MHz)	Result (ppm)	Limit (ppm)
AC 120V	45°C	CH149	5745.029	5745	5.05	±20
		CH151	5755.031	5755	5.39	±20
		CH155	5775.029	5775	5.02	±20
		CH157	5785.027	5785	4.67	±20
		CH159	5795.034	5795	5.87	±20
		CH165	5825.038	5825	6.52	±20

Conclusion: PASS

Test Voltage (V)	Temp (°C)	CH	Max. Reading (MHz)	Target Frequency (MHz)	Result (ppm)	Limit (ppm)
AC 120V	55°C	CH149	5745.031	5745	5.39	±20
		CH151	5755.036	5755	6.26	±20
		CH155	5775.029	5775	5.02	±20
		CH157	5785.031	5785	5.36	±20
		CH159	5795.042	5795	7.25	±20
		CH165	5825.029	5825	4.98	±20

Conclusion: PASS

Test Voltage (V)	Temp (°C)	CH	Max. Reading (MHz)	Target Frequency (MHz)	Result (ppm)	Limit (ppm)
AC 120V	65°C	CH149	5745.028	5745	4.87	±20
		CH151	5755.036	5755	6.26	±20
		CH155	5775.029	5775	5.02	±20
		CH157	5785.038	5785	6.57	±20
		CH159	5795.036	5795	6.21	±20
		CH165	5825.039	5825	6.70	±20

Conclusion: PASS

## 10. MPE ESTIMATION

### 10.1. Limit for General Population/ Uncontrolled Exposures

Frequency	Power density (mW/ cm <sup>2</sup> )	Averaging time(minutes)
300MHz----1.5GHz	F/1500	30
1.5GHz---100GHz	1.0	30

Note: F= Frequency in MHz

### 10.2. Estimation Result

EUT: Altai A8in (ac) Super WiFi Base Station		
M/N: WA8011NAC-H		
Test date: 2016-02-25	Pressure: 101.3±1.0kPa	Humidity: 50.2±3.0%
Tested by: Donjon_Huang	Test site: RF site	Temperature:20.4±0.6 °C

Test Mode	Frequency (MHz)	Peak Output Power (dBm)	Output Power (mW)	Antenna Gain (dBi)	Antenna Gain (Linear)	MPE
11a	5745	14.63	29.04	20	100.00	0.5780
	5785	15.22	33.27	20	100.00	0.6621
	5825	15.35	34.28	20	100.00	0.6823
11n HT20	5745	14.25	26.61	20	100.00	0.5296
	5785	14.55	28.51	20	100.00	0.5675
	5825	14.45	27.86	20	100.00	0.5546
11n HT40	5755	15.38	34.51	20	100.00	0.6870
	5795	15.23	33.34	20	100.00	0.6637
11ac VHT20	5745	14.67	29.31	20	100.00	0.5834
	5785	14.86	30.62	20	100.00	0.6095
	5825	15.01	31.70	20	100.00	0.6309
11ac VHT40	5755	14.87	30.69	20	100.00	0.6109
	5795	14.96	31.33	20	100.00	0.6237
11ac VHT80	5775	15.02	31.77	20	100.00	0.6323

$$MPE = \frac{PG}{4\pi R^2} \quad (R=20 \text{ cm})$$

## 11. ANTENNA REQUIREMENT

### 11.1. Standard Applicable

For intentional device, according to FCC 47 CFR Section 15.203, an intentional radiator shall be designed to ensure that no antenna other than that furnished by the responsible party shall be used with the device. And according to FCC 47 CFR Section 15.407 (a), if transmitting antennas of directional gain greater than 6dBi are used, the power shall be reduced by the amount in dB that the directional gain of the antenna exceeds 6dBi.

### 11.2. Antenna Connected Construction

The antennas used for this product are Panel antenna that no antenna other than that furnished by the responsible party shall be used with the device, the maximum peak gain of the transmit antenna is 20dBi.

## 12. DEVIATION TO TEST SPECIFICATIONS

[ NONE ]