

RF Test Report

Applicant : Altai Technologies Limited
Product Type : IX500 Indoor 2x2 802.11ac Wave 2 AP
Trade Name : ALTAI
Model Number : IX500
Applicable Standard : FCC 47 CFR PART 15 SUBPART C
ANSI C63.10:2013
Receive Date : Aug. 29, 2017
Test Period : Feb. 01 ~ Mar. 19, 2018
Issue Date : Oct. 05, 2018

Issue by

A Test Lab Techno Corp.
No. 140-1, Changan Street, Bade District,
Taoyuan City 33465, Taiwan (R.O.C)
Tel : +886-3-2710188 / Fax : +886-3-2710190



Taiwan Accreditation Foundation accreditation number: 1330
Test Firm MRA designation number: TW0010

Note: This report shall not be reproduced except in full, without the written approval of A Test Lab Techno Corp. This document may be altered or revised by A Test Lab Techno Corp. personnel only, and shall be noted in the revision section of the document. The client should not use it to claim product endorsement by TAF, or any government agencies. The test results in the report only apply to the tested sample.



Revision History

Rev.	Issue Date	Revisions	Revised By
00	Oct. 05, 2018	Initial Issue	Janet Chao

Verification of Compliance

Issued Date: Oct. 05, 2018

Applicant : Altai Technologies Limited
Product Type : IX500 Indoor 2x2 802.11ac Wave 2 AP
Trade Name : ALTAI
Model Number : IX500
FCC ID : UCC-IX500
EUT Rated Voltage : DC 12V, 1.25A
Test Voltage : 120 Vac / 60 Hz
Applicable Standard : FCC 47 CFR PART 15 SUBPART C
ANSI C63.10:2013

Test Result : Complied

Performing Lab. : A Test Lab Techno Corp.

No. 140-1, Changan Street, Bade District,
Taoyuan City 33465, Taiwan (R.O.C)
Tel : +886-3-2710188 / Fax : +886-3-2710190



Taiwan Accreditation Foundation accreditation number: 1330

<http://www.atl-lab.com.tw/e-index.htm>

A Test Lab Techno Corp. tested the above equipment in accordance with the requirements set forth in the above standards. All indications of Pass/Fail in this report are opinions expressed by A Test Lab Techno Corp. based on interpretations and/or observations of test results. Measurement Uncertainties were not taken into account and are published for informational purposes only. The test results show that the equipment tested is capable of demonstrating compliance with the requirements as documented in this report.

Approved By : Fly Lu Reviewed By : Eric Ou Yang
(Manager) (Fly Lu) (Testing Engineer) (Eric Ou Yang)



TABLE OF CONTENTS

1	General Information	5
2	EUT Description.....	6
3	Test Methodology.....	7
	3.1. Mode of Operation.....	7
	3.2. EUT Exercise Software	11
	3.3. Configuration of Test System Details.....	12
	3.4. Test Instruments	13
	3.5. Test Site Environment.....	14
4	Measurement Procedure.....	15
	4.1. AC Power Line Conducted Emission Measurement.....	15
	4.2. Transmitter Radiated Emissions Measurement.....	17
	4.3. Maximum Conducted Output Power Measurement.....	21
	4.4. 6dB RF Bandwidth Measurement.....	22
	4.5. Maximum Power Density Measurement.....	23
	4.6. Out of Band Conducted Emissions Measurement.....	24
	4.7. Antenna Measurement	25
5	Test Results	26
	Annex A. AC Power Line Conducted Emission Test Results	26
	Annex B. Transmitter Radiated Emissions	32
	Annex C. Conducted Test Results	93
	Annex D. Antenna Requirement	141

1 General Information

1.1 Summary of Test Result

Standard	Item	Result	Remark
15.247			
15.207	AC Power Conducted Emission	PASS	----
Standard	Item	Result	Remark
15.247			
15.247(d)	Transmitter Radiated Emissions	PASS	----
15.247(b)(3)	Max. Output Power	PASS	----
15.247(a)(2)	6dB RF Bandwidth	PASS	----
15.247(e)	Maximum Power Spectral Density	PASS	----
15.247(d)	Out of Band Conducted Spurious Emission	PASS	----
15.203	Antenna Requirement	PASS	----

The test results of this report relate only to the tested sample(s) identified in this report. Manufacturer or whom it may concern should recognize the pass or fail of the test result.

1.2 Measurement Uncertainty

Test Item	Frequency Range	Uncertainty (dB)
Conducted Emission	9kHz ~ 150KHz	2.7
	150kHz ~ 30MHz	2.7
Radiated Emission	9kHz ~ 30MHz	1.7
	30MHz ~ 1000MHz	5.7
	1000MHz ~ 18000MHz	5.5
	18000MHz ~ 26500MHz	4.8
	26500MHz ~ 40000MHz	4.8
Conducted Output Power	+0.27 dB / -0.28 dB	
RF Bandwidth	4.96%	
Power Spectral Density	+0.71 dB / -0.77 dB	



2 EUT Description

Applicant	Altai Technologies Limited Unit 209, 2/F, Lakeside 2, 10 Science Park West Avenue, HK Science Park, Shatin, Hong Kong			
Manufacturer	Altai Technologies Limited Unit 209, 2/F, Lakeside 2, 10 Science Park West Avenue, HK Science Park, Shatin, Hong Kong			
Product Type	IX500 Indoor 2x2 802.11ac Wave 2 AP			
Trade Name	ALTAI			
Model Number	IX500			
FCC ID	UCC-IX500			
Operate Freq. Band	Frequency Range (MHz)	Modulation	Channel Bandwidth	Data Rate 400 / 800 GI (ns)
IEEE 802.11b	2412 ~ 2462	DSSS	20MHz	Up to 11Mbps
IEEE 802.11g	2412 ~ 2462	OFDM	20MHz	Up to 54Mbps
IEEE 802.11n 2.4GHz 20MHz	2412 ~ 2462	OFDM (256QAM)	20MHz	Up to 173.4Mbps
IEEE 802.11n 2.4GHz 40MHz	2422 ~ 2452	OFDM (256QAM)	40MHz	Up to 400Mbps
Antenna information	ANT		Type	Max. Gain (dBi)
	ANT-0		Metal PIFA Antenna	3.38
	ANT-1		Metal PIFA Antenna	4.26
	G _{ANT}			3.84
Antenna Delivery	See section 3.1			
Operate Temp. Range	0 ~ +40 °C			

Frequency Band	Max. RF Output Power (W)
IEEE 802.11b	0.439
IEEE 802.11g	0.354
IEEE 802.11n 2.4GHz 20MHz	0.358
IEEE 802.11n 2.4GHz 40MHz	0.159

3 Test Methodology

3.1. Mode of Operation

Decision of Test ATL has verified the construction and function in typical operation. All the test modes were carried out with the EUT in normal operation, which was shown in this test report and defined as:

Test Mode
Mode 1: Transmit mode
Mode 2: IEEE 802.11b Continuous TX mode
Mode 3: IEEE 802.11g Continuous TX mode
Mode 4: IEEE 802.11n 2.4GHz 20MHz Continuous TX mode
Mode 5: IEEE 802.11n 2.4GHz 40MHz Continuous TX mode

Software used to control the EUT for staying in continuous transmitting mode was programmed.

After verification, all tests were carried out with the worst case test modes as shown below except radiated spurious emission below 1GHz and power line conducted emissions below 30MHz, which worst case was in TX mode only.

By preliminary testing and verifying three axis (X, Y and Z) position of EUT transmitted status, it was found that "X axis" position was the worst, then the final test was executed the worst condition and test data were recorded in this report.

Test Mode	ANT-0	ANT-1	ANT-0+1
Mode 2	V	V	V
Mode 3	V	V	V
Mode 4	V	V	V
Mode 5	V	V	V

Test Mode	Antenna Delivery	Data Rate	Test Channel
Mode 2	2TX (CDD)	1M	1, 6, 11
Mode 3	2TX (CDD)	6M	1, 6, 11
Mode 4	2TX (CDD)	13M	1, 6, 11
Mode 5	2TX (CDD)	27M	3, 6, 9

Duty cycle

Test Mode	Frequency (MHz)	on time (ms)	on+off time (ms)	Duty cycle	Duty Factor (dB)	1/T Minimum VBW (kHz)
Mode 2	2412	12.260	12.280	0.998	0.007	0.010
Mode 3	2412	2.050	2.110	0.972	0.125	0.488
Mode 4	2412	4.995	5.055	0.988	0.052	0.010
Mode 5	2422	2.440	2.510	0.972	0.123	0.410

Duty Cycle Graphs

Mode 2: IEEE 802.11b Continuous TX mode



Mode 3: IEEE 802.11g Continuous TX mode

On time

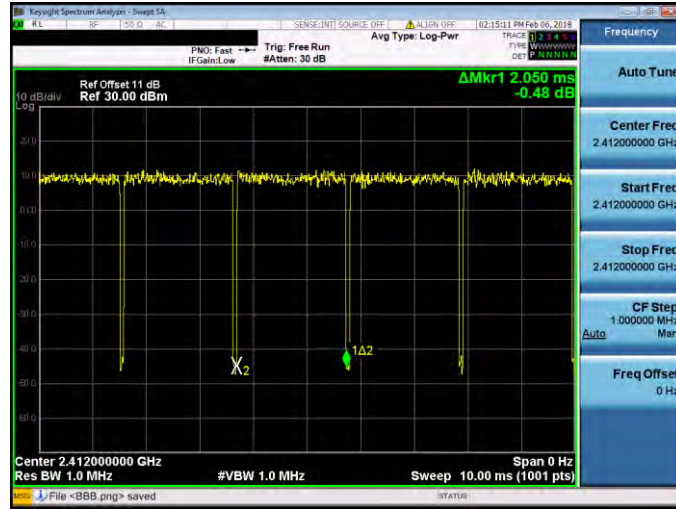

On+off time

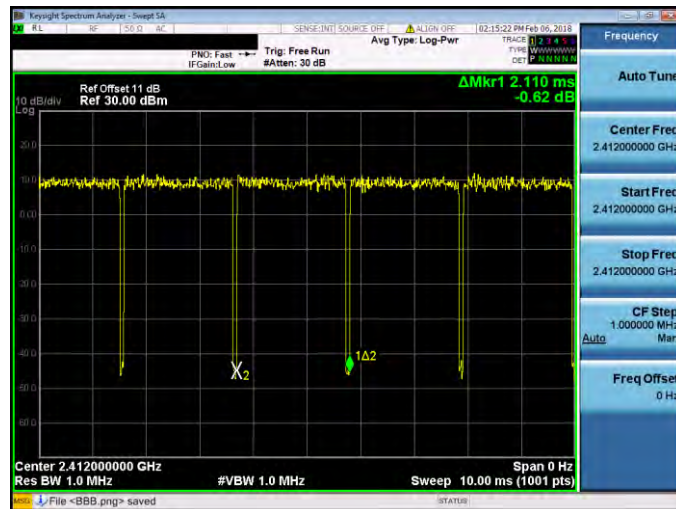

Mode 4: IEEE 802.11n 2.4GHz 20MHz Continuous TX mode

<p>On time</p>	 <p>Key features of the 'On time' screenshot:</p> <ul style="list-style-type: none"> Center Freq: 2.412000000 GHz Start Freq: 2.412000000 GHz Stop Freq: 2.412000000 GHz CF Step: 1.000000 MHz Freq Offset: 0 Hz Ref Offset: 11 dB Ref: 30.00 dBm ΔMkr1: 4.995 ms -0.58 dB Sweep: 15.00 ms (1001 pts)
<p>On+off time</p>	 <p>Key features of the 'On+off time' screenshot:</p> <ul style="list-style-type: none"> Center Freq: 2.412000000 GHz Start Freq: 2.412000000 GHz Stop Freq: 2.412000000 GHz CF Step: 1.000000 MHz Freq Offset: 0 Hz Ref Offset: 11 dB Ref: 30.00 dBm ΔMkr1: 5.055 ms -2.20 dB Sweep: 15.00 ms (1001 pts)

Mode 5: IEEE 802.11n 2.4GHz 40MHz Continuous TX mode	
On time	
On+off time	

3.2. EUT Exercise Software

1.	Setup the EUT shown on “Configuration of Test System Details.”
2.	Turn on the power of all equipment.
3.	Turn Wi-Fi function link to Notebook
4.	EUT run test program.

Measurement Software	
1	EZ-EMC Ver. ATL-03A1-1
2	EZ-EMC Ver ATL-ITC-3A1-1

3.3. Configuration of Test System Details

Conducted Emissions

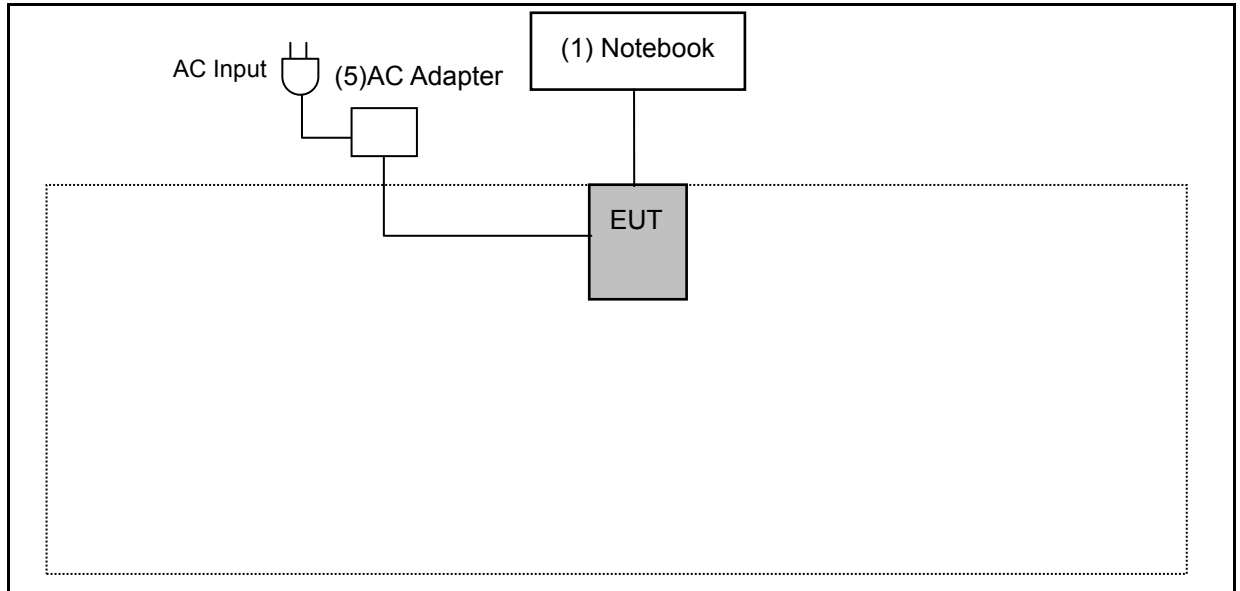

Radiated Emission

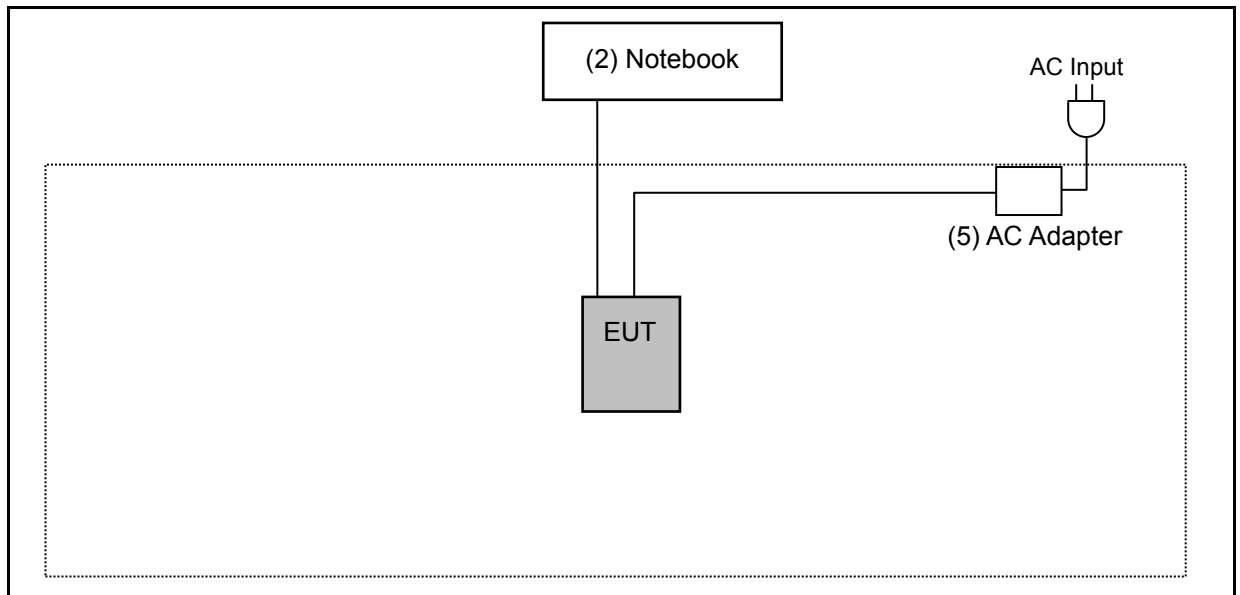

Devices Description					
	Product	Manufacturer	Model Number	Serial Number	Remark
(1)	Notebook	DELL	LAPTITU E5440	6699565657	---
(2)	Notebook	DELL	LATITUDE E6440	5HZBD72	---
(3)	AC Adapter	DEE VAN ENTERPRISE CO., LTD.	DSA-12PFT-12 FUS 120100	---	Input: 100 - 240 V, 50-60Hz, 0.5A Output: 12V, 1A
(4)	AC Adapter	Powertron Electronics Corp.	PA1015-120HUB1 25	---	Input: 100 - 240 V, 50-60Hz, 0.4A Output: 12V, 1.25A
(5)	AC Adapter	Powertron Electronics Corp.	PS1012-120HUB1 00	---	Input: 100 - 240 V, 50-60Hz, 0.4A Output: 12V, 1A

Note: Adapter Model Number: PS1012-120HUB100 is worst case.

3.4. Test Instruments

For Conducted Emission

Equipment	Manufacturer	Model Number	Serial Number	Cal. Date	Cal. Period
Test Receiver	R&S	ESCI	100367	05/18/2017	1 year
LISN	R&S	ENV216	101040	04/01/2017	1 year
RF Cable	Woken	00100D1380194M	TE-02-02	05/19/2017	1 year

For Radiated Emissions

Equipment	Manufacturer	Model Number	Serial Number	Cal. Date	Cal. Period
Spectrum Analyzer (10Hz~44GHz)	Keysight	N9010A	MY52221312	01/15/2018	1 year
Pre Amplifier (1~26.5GHz)	Agilent	8449B	3008A02237	10/16/2017	1 year
Pre Amplifier (100KHz~1.3GHz)	Agilent	8447D	2944A11119	01/10/2018	1 year
Broadband Antenna	Schwarzbeck	VULB9168	416	10/26/2017	1 year
Horn Antenna (1~18GHz)	SCHWARZBECK MESS-ELEKTRONIK	BBHA9120D	9120D-550	06/20/2017	1 year
Horn Antenna (18~40GHz)	ETS	3116	86467	09/19/2017	1 year



For Conducted

Equipment	Manufacturer	Model Number	Serial Number	Cal. Date	Cal. Period
Power Sensor	Anritsu	MA2411B	1126022	08/28/2017	1 year
Power Meter	Anritsu	ML2495A	1135009	08/28/2017	1 year
Spectrum Analyzer (10Hz~44GHz)	Agilent	N9010A	MY52221312	01/16/2018	1 year

3.5. Test Site Environment

Items	Required (IEC 60068-1)	Actual
Temperature (°C)	15-35	26
Humidity (%RH)	25-75	60
Barometric pressure (mbar)	860-1060	950

4 Measurement Procedure

4.1. AC Power Line Conducted Emission Measurement

■ Limit

Frequency (MHz)	Quasi-peak	Average
0.15 - 0.5	66 to 56	56 to 46
0.50 - 5.0	56	46
5.0 - 30.0	60	50

■ Test Setup

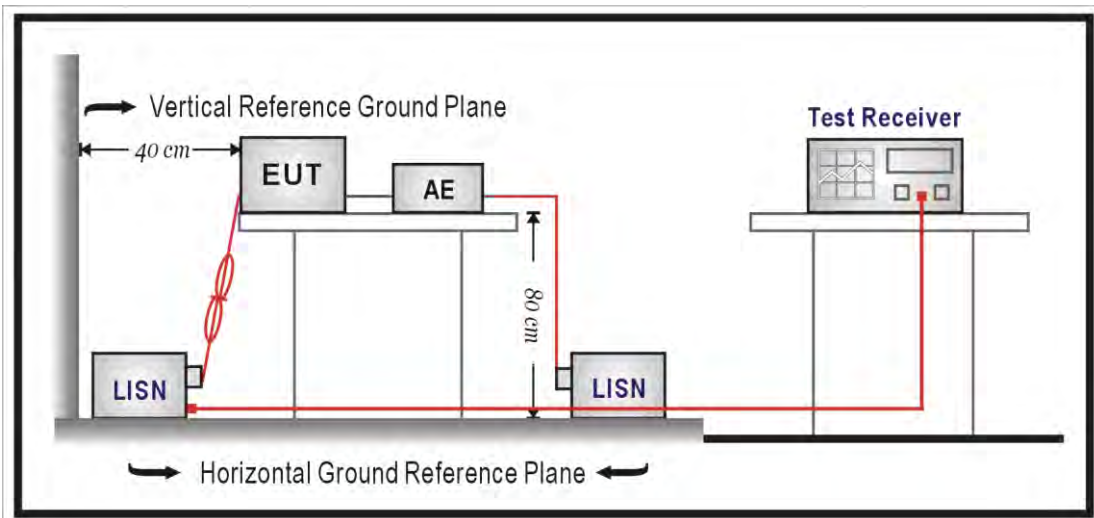

■ Test Procedure

The EUT and simulators are connected to the main power through a line impedance stabilization network (L.I.S.N.). This provides a $50\Omega // 50\mu\text{H}$ coupling impedance for the measuring equipment. The peripheral devices are also connected to the main power through a LISN that provides a $50\Omega // 50\mu\text{H}$ coupling impedance with 50ohm termination.

Tabletop device shall be placed on a non-conducting platform, of nominal size 1 m by 1.5 m, raised 80 cm above the reference ground plane. The wall of screened room shall be located 40cm to the rear of the EUT. Other surfaces of tabletop or floor standing EUT shall be at least 80cm from any other ground conducting surface including one or more LISNs. For floor-standing device shall be placed under the EUT with a 12mm insulating material.

Conducted emissions were investigated over the frequency range from 0.15 MHz to 30 MHz using a resolution bandwidth of 9 kHz. The equipment under test (EUT) shall be meet the limits in section 4.1, as applicable, including the average limit and the quasi-peak limit when using respectively, an average detector and quasi-peak detector measured in accordance with the methods described of related standard. When all of peak value were complied with quasi-peak and average limit from 150kHz to 30MHz then quasi-peak and average measurement was unnecessary.

The AMN shall be placed 0,8 m from the boundary of the unit under test and bonded to a ground reference plane for AMNs mounted on top of the ground reference plane. This distance is between the closest points of the AMN and the EUT. All other units of the EUT and associated equipment shall be at least 0,8 m from the AMN. If the mains power cable is longer than 1m then the cable shall be folded back and forth at the centre of the lead to form a bundle no longer than 0.4m. All of interconnecting cables that hang closer than 40cm to the ground plane shall be folded back and forth in the center forming a bundle 30 cm to 40 cm long. All of EUT and AE shall be separate place more than 0.1m. All 50Ω ports of the LISN shall be resistively terminated into 50Ω loads when not connected to the measuring instrument.

If the reading of the measuring receiver shows fluctuations close to the limit, the reading shall be observed for at least 15 s at each measurement frequency; the higher reading shall be recorded with the exception of any brief isolated high reading which shall be ignored.

4.2. Transmitter Radiated Emissions Measurement

■ Limit

According to §15.209(a), except as provided elsewhere in this subpart, the emissions from an intentional radiator shall not exceed the field strength levels specified in the following table:

Frequency (MHz)	Field Strength ($\mu\text{V}/\text{m}$ at meter)	Measurement Distance (meters)
0.009 – 0.490	$2400 / F$ (kHz)	300
0.490 – 1.705	$24000 / F$ (kHz)	30
1.705 – 30.0	30	30
30 - 88	100**	3
88-216	150**	3
216-960	200**	3
Above 960	500	3

** Except as provided in paragraph (g), fundamental emissions from intentional radiators operating under this Section shall not be located in the frequency bands 54-72 MHz, 76-88 MHz, 174-216 MHz or 470-806 MHz. However, operation within these frequency bands is permitted under other sections of this Part, e.g., Sections 15.231 and 15.241.

■ Setup

9kHz ~ 30MHz

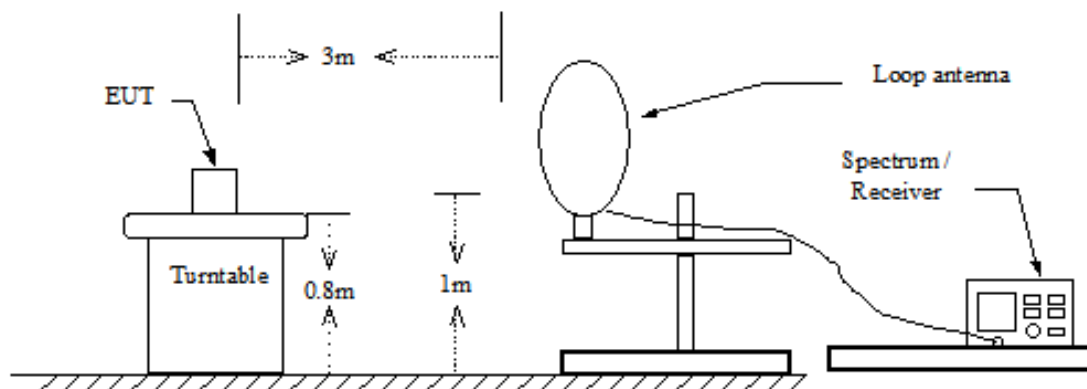

Below 1GHz

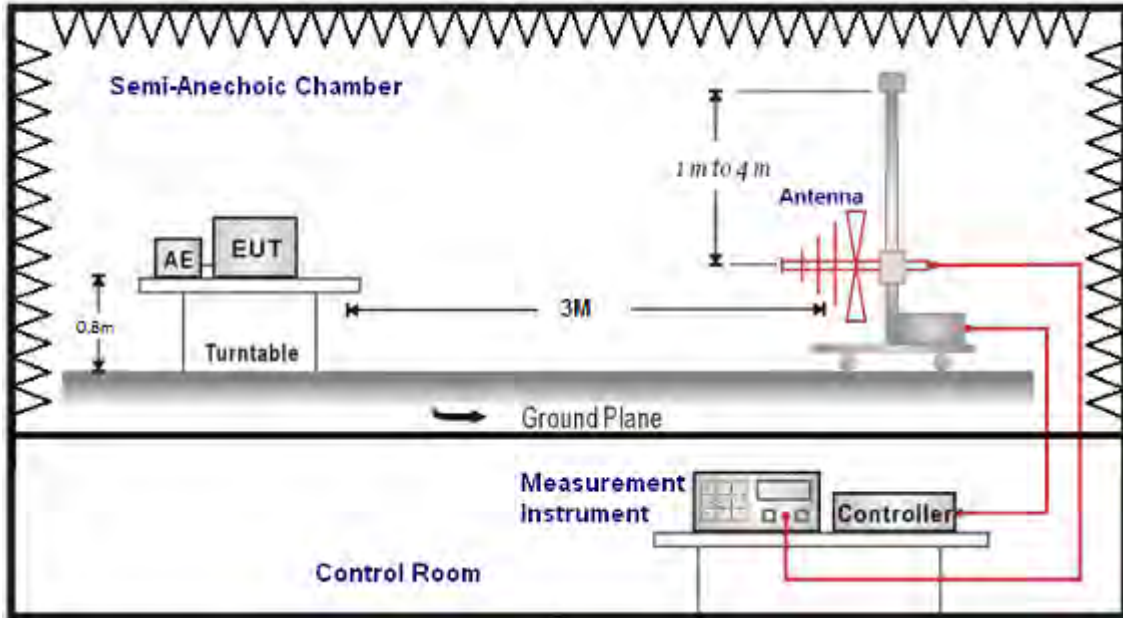

Above 1GHz

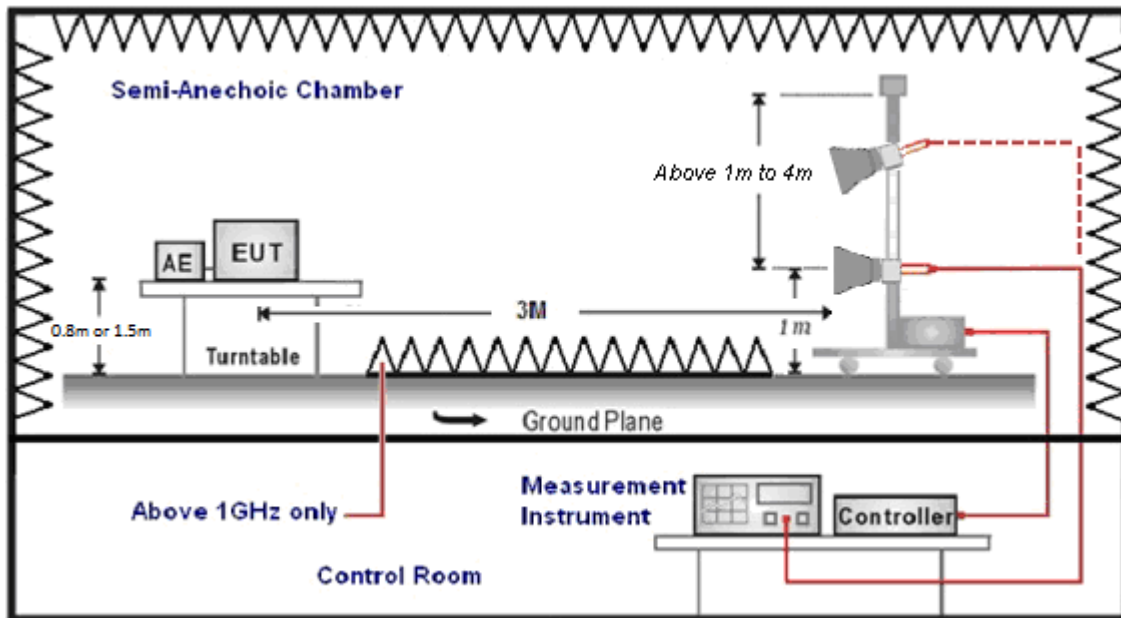

■ Test Procedure

Final radiation measurements were made on a three-meter, Semi Anechoic Chamber. The EUT system was placed on a nonconductive turntable which is 0.8 or 1.5 meters height, top surface 1.0 x 1.5 meter. The spectrum was examined from 250 MHz to 2.5 GHz in order to cover the whole spectrum below 10th harmonic which could generate from the EUT. During the test, EUT was set to transmit continuously & Measurements spectrum range from 9 kHz to 26.5 GHz is investigated.

For measurements below 1 GHz the resolution bandwidth is set to 100 kHz for peak detection measurements or 120 kHz for quasi-peak detection measurements. Peak detection is used unless otherwise noted as quasi-peak.

For measurements above 1 GHz the resolution bandwidth is set to 1 MHz, and then the video bandwidth is set to 1 MHz for peak measurements and 10 Hz for average measurements when Duty cycle >0.98 / $1/T$ for average measurements when Duty cycle <0.98 . A nonconductive material surrounded the EUT to supporting the EUT for standing on three orthogonal planes. At each condition, the EUT was rotated 360 degrees, and the antenna was raised and lowered from one to four meters to find the maximum emission levels. Measurements were taken using both horizontal and vertical antenna polarization.

SCHWARZBECK MESS-ELEKTRONIK Biconilog Antenna at 3 Meter and the SCHWARZBECK Double Ridged Guide Antenna was used in frequencies 1 –26.5 GHz at a distance of 3 meter. The antenna at an angle toward the source of the emission. All test results were extrapolated to equivalent signal at 3 meters utilizing an inverse linear distance extrapolation Factor (20dB/decade).

For testing above 1GHz, the emission level of the EUT in peak mode was 20dB lower than average limit (that means the emission level in peak mode also complies with the limit in average mode), then testing will be stopped and peak values of EUT will be reported, otherwise, the emissions will be measured in average mode again and reported.

Appropriate preamplifiers were used for improving sensitivity and precautions were taken to avoid overloading or desensitizing the spectrum analyzer. No post – detector video filters were used in the test.

The spectrum analyzer's 6 dB bandwidth was set to 1 MHz, and the analyzer was operated in the peak detection mode, for frequencies both below and up 1 GHz. The average levels were obtained by subtracting the duty cycle correction factor from the peak readings.

The following procedures were used to convert the emission levels measured in decibels referenced to 1 microvolt (dBuV) into field intensity in micro volts pre meter (uV/m).

The actual field intensity in decibels referenced to 1 microvolt in to field intensity in micro volts per meter (dBuV/m).



The actual field intensity in referenced to 1 microvolt per meter (dBuV/m) is determined by algebraically adding the measured reading in dBuV, the antenna factor (dB), and cable loss (dB) and Subtracting the gain of preamplifier (dB) is auto calculate in spectrum analyzer.

(1) $\text{Amplitude (dBuV/m)} = \text{FI (dBuV)} + \text{AF (dBuV)} + \text{CL (dBuV)} - \text{Gain (dB)}$

FI= Reading of the field intensity.

AF= Antenna factor.

CL= Cable loss.

P.S Amplitude is auto calculate in spectrum analyzer.

(2) $\text{Actual Amplitude (dBuV/m)} = \text{Amplitude (dBuV)} - \text{Dis(dB)}$

The FCC specified emission limits were calculated according the EUT operating frequency and by following linear interpolation equations:

(a) For fundamental frequency : Transmitter Output < +30dBm

(b) For spurious frequency : Spurious emission limits = fundamental emission limit /10

Data of measurement within this frequency range without mark in the table above means the reading of emissions are attenuated more than 20dB below the permissible limits or the field strength is too small to be measured.

4.3. Maximum Conducted Output Power Measurement

■ Limit

For systems using digital modulation in the 2400-2483.5MHz, the limit for maximum output power is 30dBm.

And According to 15.247 (b), if transmitting antennas of directional gain greater than 6 dBi are used, the power shall be reduced by the amount in dB that the directional gain of the antenna exceeds 6dBi.

■ Test Setup

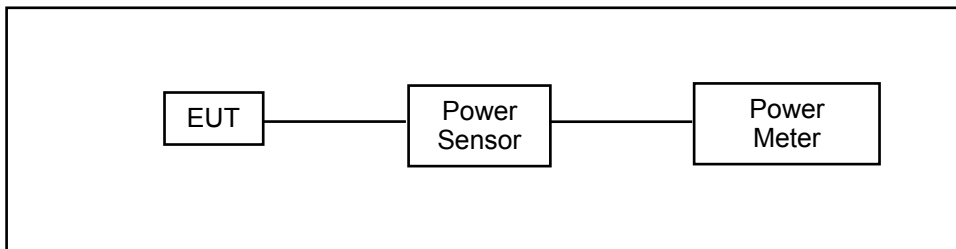

■ Test Procedure

The tests below are run with the EUT's transmitter set at high power in TX mode. The EUT is needed to force selection of output power level and channel number. While testing, EUT was set to transmit continuously. Remove the Subjective device's antenna and connect the RF output port to power sensor.

4.4. 6dB RF Bandwidth Measurement

■ Limit

6dB RF Bandwidth: Systems using digital modulation techniques may operate in the 2400–2483.5 MHz bands. The minimum 6 dB band-width shall be at least 500 kHz.

■ Test Setup

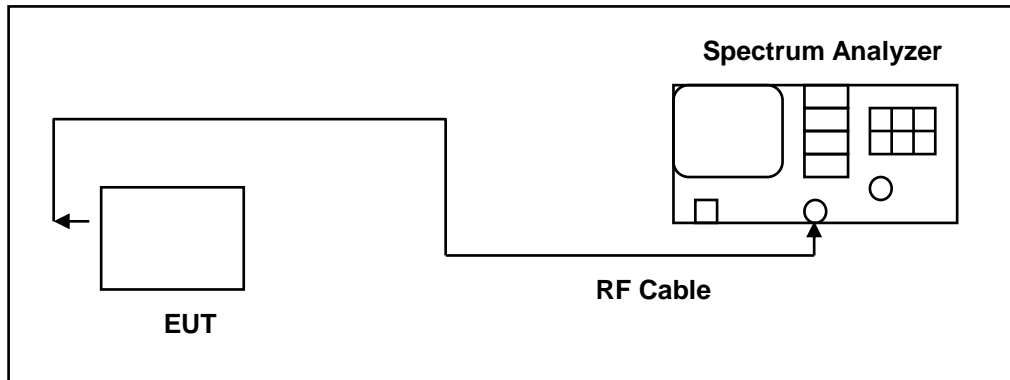

■ Test Procedure

The EUT tested to DTS test procedure of KDB558074D01 for compliance to FCC 47CFR 15.247 requirements.

6dB RF Bandwidth: The antenna port of the EUT was connected to the input of a spectrum analyzer. Analyzer RBW was set to 100 kHz. For each RF output channel investigated, the spectrum analyzer center frequency was set to the channel carrier. A peak output reading was taken, a DISPLAY line was drawn 6 dB lower than peak level. The 6 dB bandwidth was determined from where the channel output spectrum intersected the display line.

The test was performed at 3 channels (Channel low, middle, high)

4.5. Maximum Power Density Measurement

■ Limit

For digitally modulated systems, the power spectral density conducted from the intentional radiator to the antenna shall not be greater than 8 dBm in any 3 kHz band during any time interval of continuous transmission.

* CDD mode : Directional Gain = $10 \cdot \log\{[10^{(G1/20)} + 10^{(G2/20)} + \dots + 10^{(Gn/20)}]^2 / NANT\}$ = 6.84 dBi > 6dBi

* CDD mode power limit shall be reduced = $8 - 0.84 = 7.16$ dBm/ 3KHz

■ Test Setup

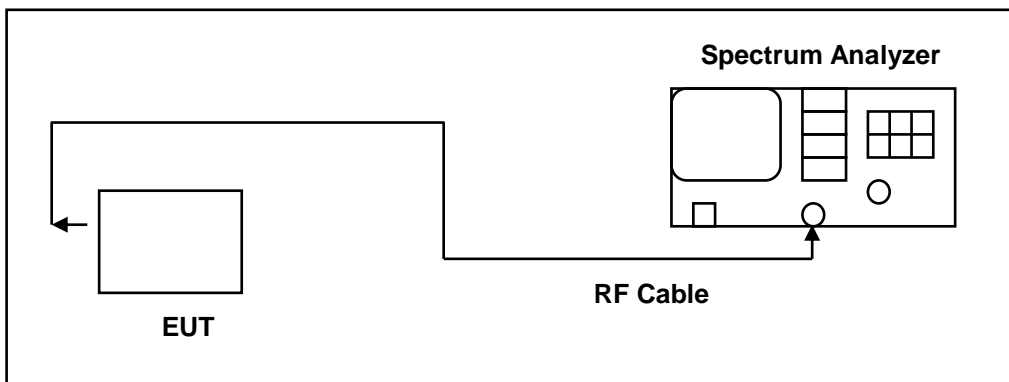

■ Test Procedure

The EUT tested to DTS test procedure of KDB558074D01 for compliance to FCC 47CFR 15.247 requirements.

1. Set analyzer center frequency to DTS channel center frequency.
2. Set the span to 1.5 times the DTS bandwidth.
3. Set the RBW to: $3 \text{ kHz} \leq \text{RBW} \leq 100 \text{ kHz}$.
4. Set the VBW $\geq 3 \times \text{RBW}$.
5. Detector = peak.
6. Sweep time = auto couple.
7. Trace mode = max hold.
8. Allow trace to fully stabilize.
9. Use the peak marker function to determine the maximum amplitude level within the RBW.
10. If measured value exceeds limit, reduce RBW (no less than 3 kHz) and repeat.

4.6. Out of Band Conducted Emissions Measurement

■ Limit

In any 100 kHz bandwidth outside the frequency band in which the spread spectrum or digitally modulated intentional radiator is operating, the radio frequency power that is produced by the intentional radiator shall be at least 20 dB below that in the 100 kHz bandwidth within the band that contains the highest level of the desired power

■ Test Setup

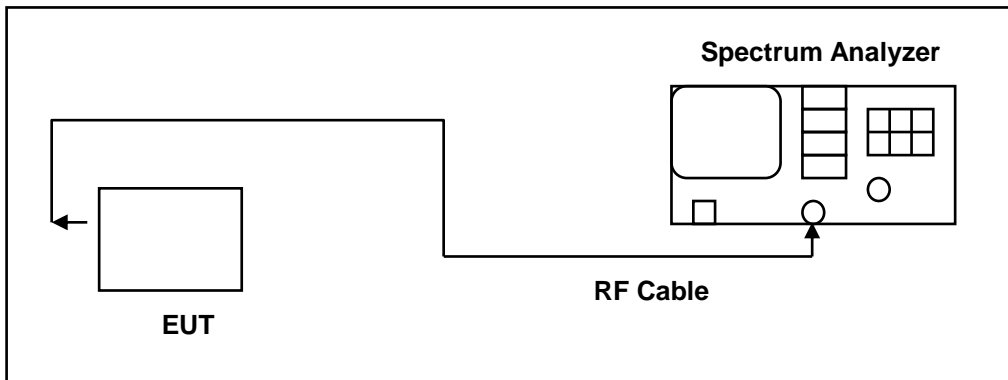

■ Test Procedure

In any 100 kHz bandwidth outside the EUT pass band, the RF power produced by the modulation products of the spreading sequence, the information sequence, and the carrier frequency shall be at least 20 dB below that of the maximum in-band 100 kHz emission, antenna output of the EUT was coupled directly to spectrum analyzer; if an external attenuator and/or cable was used, these losses are compensated for with the analyzer OFFSET function.

All other types of emissions from the EUT shall meet the general limits for radiated frequencies outside the pass band.

The test was performed at 3 channels.



4.7. Antenna Measurement

■ Limit

For intentional device, according to 15.203, an intentional radiator shall be designed to ensure that no antenna other than that furnished by the responsible party shall be used with the device.

And According to 15.247 (b), if transmitting antennas of directional gain greater than 6 dBi are used, the power shall be reduced by the amount in dB that the directional gain of the antenna exceeds 6dBi.

5 Test Results

Annex A. AC Power Line Conducted Emission Test Results

Standard:	FCC Part 15.247	Line:	L1
Test item:	Conducted Emission	Power:	AC 120V/60Hz
Mode:	Mode 1	Temp.(°C)/Hum.(%RH):	26(°C)/60%RH
Description:	Adapter Model Number: DSA-12PFT-12 FUS 120100		

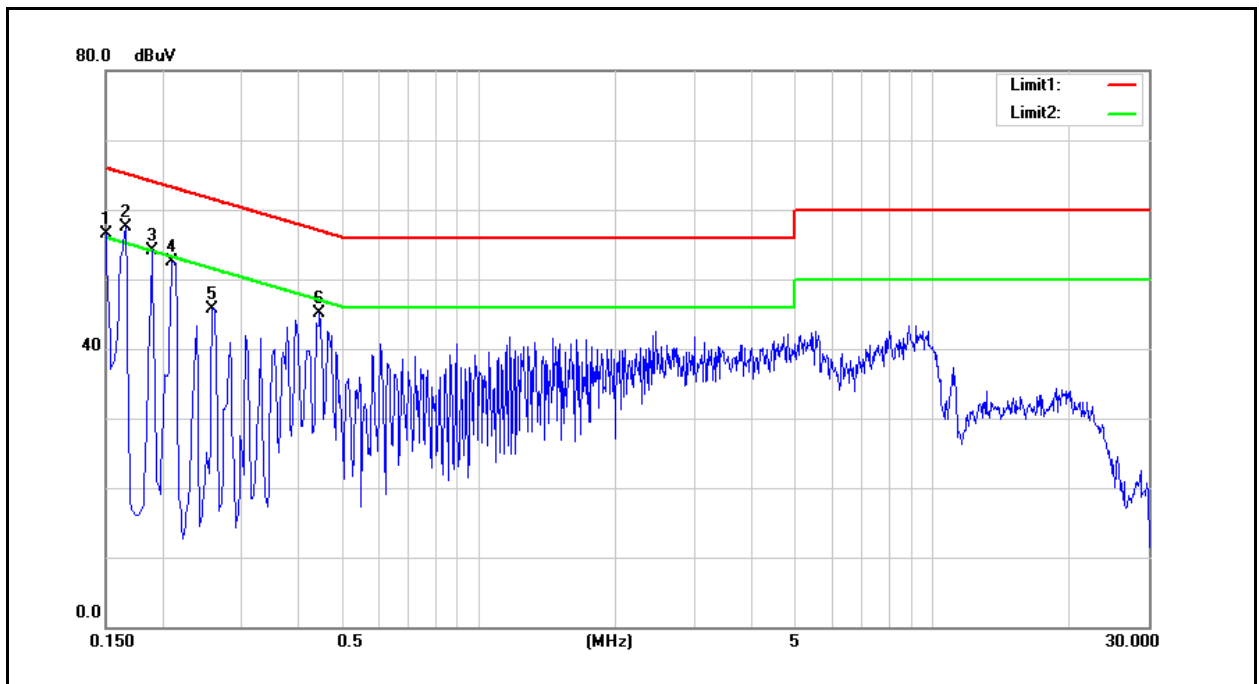

No.	Frequency (MHz)	QP reading (dBuV)	AVG reading (dBuV)	Correction factor (dB)	QP result (dBuV)	AVG result (dBuV)	QP limit (dBuV)	AVG limit (dBuV)	QP margin (dB)	AVG margin (dB)	Remark
1	0.1500	43.07	23.82	9.53	52.60	33.35	66.00	56.00	-13.40	-22.65	Pass
2	0.1660	44.53	27.99	9.54	54.07	37.53	65.16	55.16	-11.09	-17.63	Pass
3	0.1900	31.47	8.09	9.53	41.00	17.62	64.04	54.04	-23.04	-36.42	Pass
4	0.2100	40.52	26.11	9.53	50.05	35.64	63.21	53.21	-13.16	-17.57	Pass
5	0.2580	33.95	17.63	9.53	43.48	27.16	61.50	51.50	-18.02	-24.34	Pass
6	0.4460	28.31	19.13	9.54	37.85	28.67	56.95	46.95	-19.10	-18.28	Pass

Note: 1. Result (dBuV/m) = Correct Factor (dB/m) + Reading(dBuV).

2. Correction factor (dB) = Cable loss (dB) + L.I.S.N. factor (dB).

Standard:	FCC Part 15.247	Line:	N
Test item:	Conducted Emission	Power:	AC 120V/60Hz
Mode:	Mode 1	Temp.(°C)/Hum.(%RH):	26(°C)/60%RH
Description:	Adapter Model Number: DSA-12PFT-12 FUS 120100		

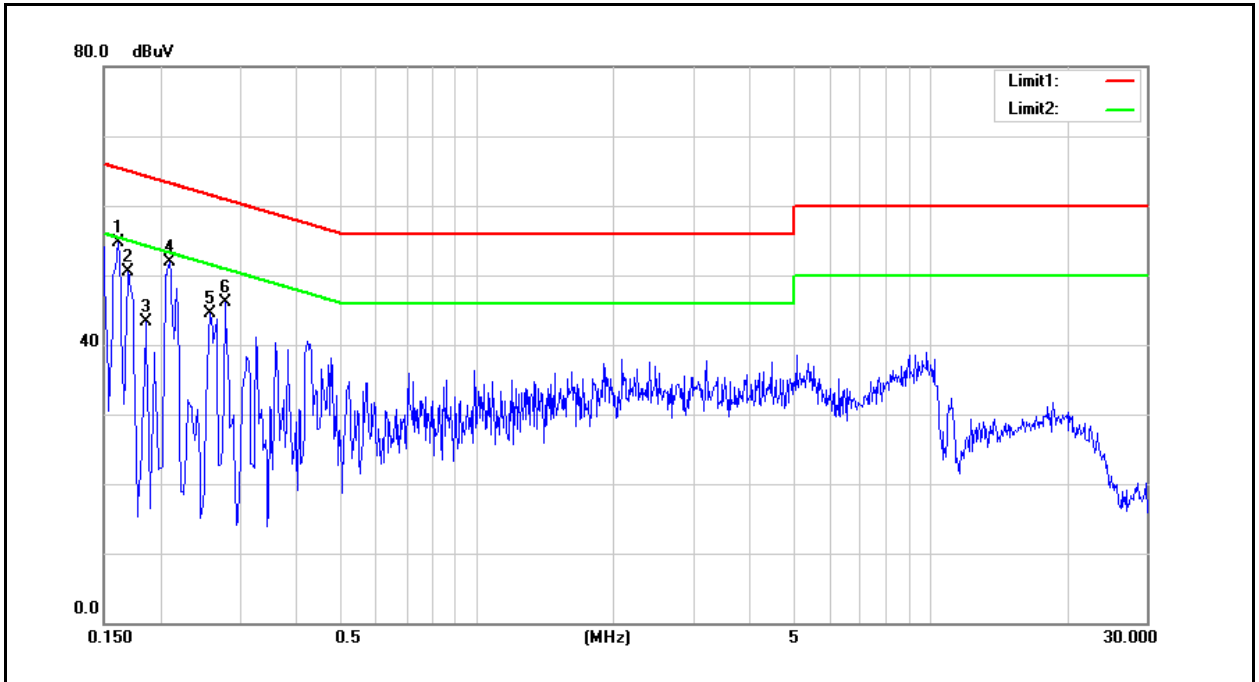

No.	Frequency (MHz)	QP reading (dBuV)	AVG reading (dBuV)	Correction factor (dB)	QP result (dBuV)	AVG result (dBuV)	QP limit (dBuV)	AVG limit (dBuV)	QP margin (dB)	AVG margin (dB)	Remark
1	0.1620	45.17	31.04	9.63	54.80	40.67	65.36	55.36	-10.56	-14.69	Pass
2	0.1700	40.57	20.94	9.63	50.20	30.57	64.96	54.96	-14.76	-24.39	Pass
3	0.1860	30.82	9.79	9.63	40.45	19.42	64.21	54.21	-23.76	-34.79	Pass
4	0.2100	38.94	23.91	9.63	48.57	33.54	63.21	53.21	-14.64	-19.67	Pass
5	0.2580	32.75	16.28	9.63	42.38	25.91	61.50	51.50	-19.12	-25.59	Pass
6	0.2780	29.74	12.64	9.63	39.37	22.27	60.88	50.88	-21.51	-28.61	Pass

Note: 1. Result (dBuV/m) = Correct Factor (dB/m) + Reading(dBuV).

2. Correction factor (dB) = Cable loss (dB) + L.I.S.N. factor (dB).

Standard:	FCC Part 15.247	Line:	L1
Test item:	Conducted Emission	Power:	AC 120V/60Hz
Mode:	Mode 1	Temp.(°C)/Hum.(%RH):	26(°C)/60%RH
Description:		Adapter Model Number: PA1015-120HUB125	

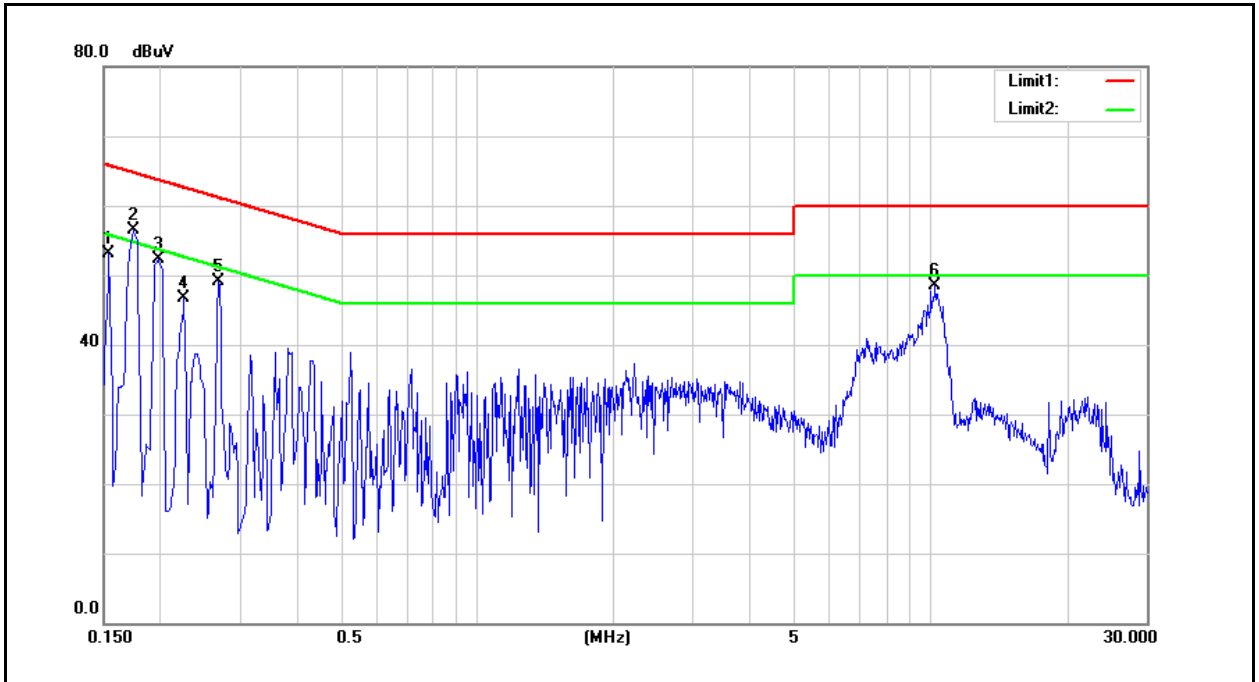

No.	Frequency (MHz)	QP reading (dBuV)	AVG reading (dBuV)	Correction factor (dB)	QP result (dBuV)	AVG result (dBuV)	QP limit (dBuV)	AVG limit (dBuV)	QP margin (dB)	AVG margin (dB)	Remark
1	0.1540	45.99	30.14	9.54	55.53	39.68	65.78	55.78	-10.25	-16.10	Pass
2	0.1740	38.47	18.49	9.54	48.01	28.03	64.77	54.77	-16.76	-26.74	Pass
3	0.1980	40.80	24.01	9.53	50.33	33.54	63.69	53.69	-13.36	-20.15	Pass
4	0.2260	28.51	14.95	9.53	38.04	24.48	62.60	52.60	-24.56	-28.12	Pass
5	0.2700	37.19	23.95	9.53	46.72	33.48	61.12	51.12	-14.40	-17.64	Pass
6	10.2700	33.53	22.93	9.80	43.33	32.73	60.00	50.00	-16.67	-17.27	Pass

Note: 1. Result (dBuV/m) = Correct Factor (dB/m) + Reading(dBuV).
 2. Correction factor (dB) = Cable loss (dB) + L.I.S.N. factor (dB).



Standard:	FCC Part 15.247	Line:	N
Test item:	Conducted Emission	Power:	AC 120V/60Hz
Mode:	Mode 1	Temp.(°C)/Hum.(%RH):	26(°C)/60%RH
Description:		Adapter Model Number: PA1015-120HUB125	

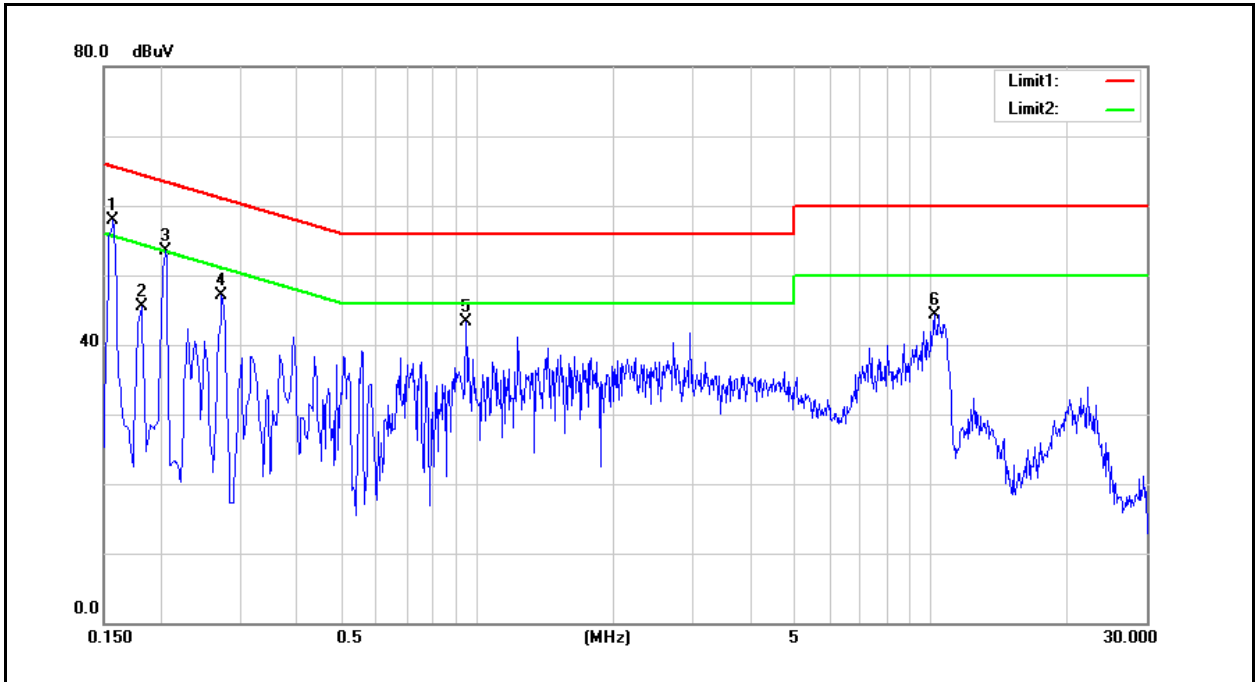

No.	Frequency (MHz)	QP reading (dBuV)	AVG reading (dBuV)	Correction factor (dB)	QP result (dBuV)	AVG result (dBuV)	QP limit (dBuV)	AVG limit (dBuV)	QP margin (dB)	AVG margin (dB)	Remark
1	0.1580	45.96	29.55	9.63	55.59	39.18	65.57	55.57	-9.98	-16.39	Pass
2	0.1820	35.42	19.17	9.63	45.05	28.80	64.39	54.39	-19.34	-25.59	Pass
3	0.2060	33.79	13.93	9.63	43.42	23.56	63.37	53.37	-19.95	-29.81	Pass
4	0.2740	37.54	30.45	9.63	47.17	40.08	61.00	51.00	-13.83	-10.92	Pass
5	0.9460	26.43	18.85	9.67	36.10	28.52	56.00	46.00	-19.90	-17.48	Pass
6	10.2180	28.15	17.54	9.93	38.08	27.47	60.00	50.00	-21.92	-22.53	Pass

Note: 1. Result (dBuV/m) = Correct Factor (dB/m) + Reading(dBuV).

2. Correction factor (dB) = Cable loss (dB) + L.I.S.N. factor (dB).



Standard:	FCC Part 15.247	Line:	L1
Test item:	Conducted Emission	Power:	AC 120V/60Hz
Mode:	Mode 1	Temp.(°C)/Hum.(%RH):	26(°C)/60%RH
Description:		Adapter Model Number: PS1012-120HUB100	

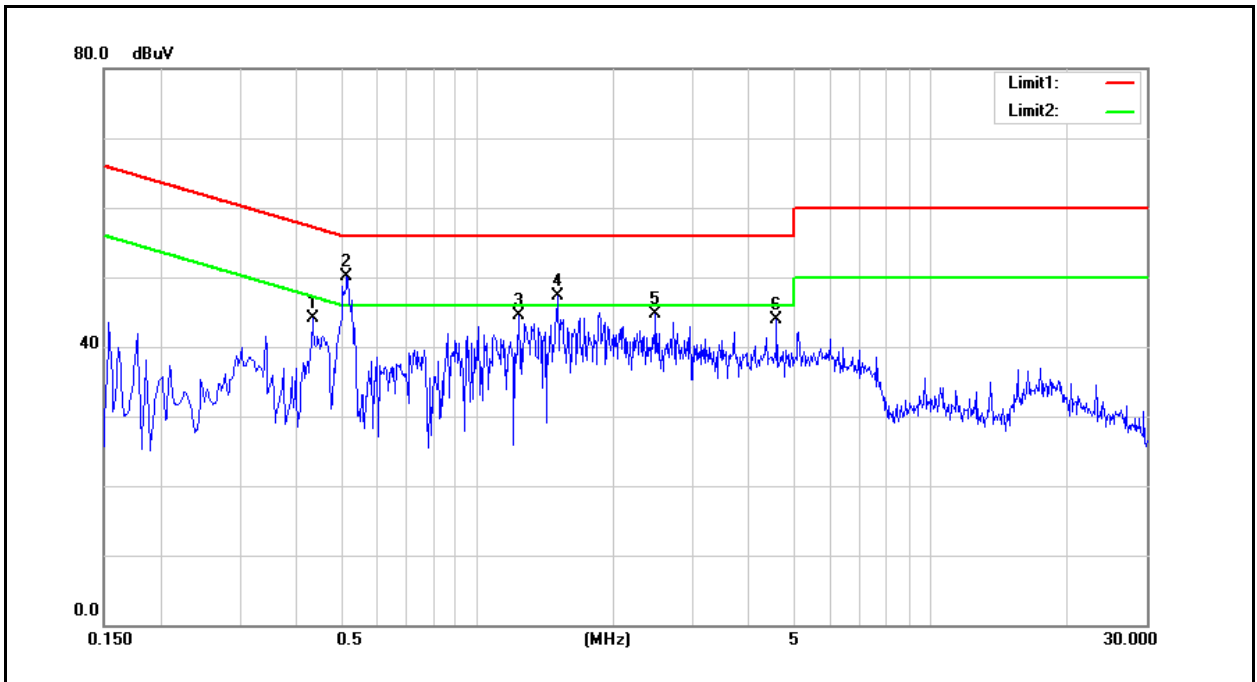

No.	Frequency (MHz)	QP reading (dBuV)	AVG reading (dBuV)	Correction factor (dB)	QP result (dBuV)	AVG result (dBuV)	QP limit (dBuV)	AVG limit (dBuV)	QP margin (dB)	AVG margin (dB)	Remark
1	0.4340	28.52	20.42	9.54	38.06	29.96	57.18	47.18	-19.12	-17.22	Pass
2	0.5180	37.24	29.54	9.54	46.78	39.08	56.00	46.00	-9.22	-6.92	Pass
3	1.2420	29.19	19.25	9.58	38.77	28.83	56.00	46.00	-17.23	-17.17	Pass
4	1.5100	31.86	22.23	9.60	41.46	31.83	56.00	46.00	-14.54	-14.17	Pass
5	2.4860	29.38	20.17	9.62	39.00	29.79	56.00	46.00	-17.00	-16.21	Pass
6	4.5900	25.39	16.90	9.68	35.07	26.58	56.00	46.00	-20.93	-19.42	Pass

Note: 1. Result (dBuV/m) = Correct Factor (dB/m) + Reading(dBuV).
 2. Correction factor (dB) = Cable loss (dB) + L.I.S.N. factor (dB).

Standard:	FCC Part 15.247	Line:	N
Test item:	Conducted Emission	Power:	AC 120V/60Hz
Mode:	Mode 1	Temp.(°C)/Hum.(%RH):	26(°C)/60%RH
Description:		Adapter Model Number: PS1012-120HUB100	

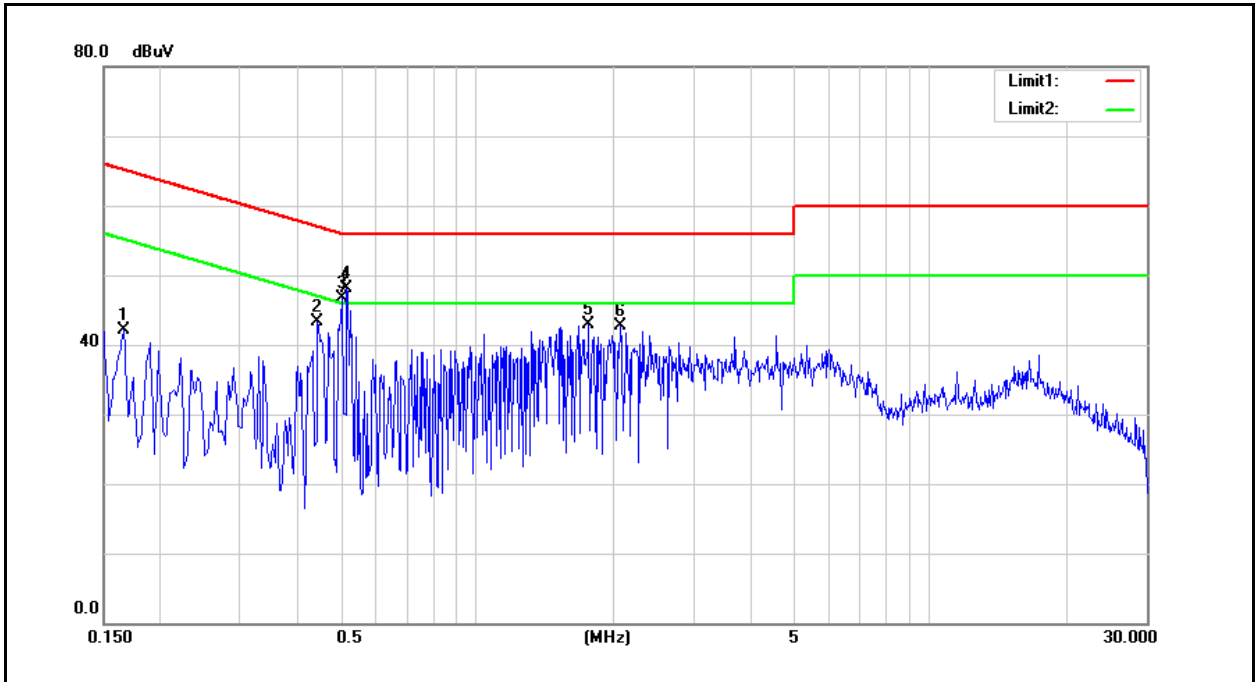

No.	Frequency (MHz)	QP reading (dBuV)	AVG reading (dBuV)	Correction factor (dB)	QP result (dBuV)	AVG result (dBuV)	QP limit (dBuV)	AVG limit (dBuV)	QP margin (dB)	AVG margin (dB)	Remark
1	0.1660	32.51	18.88	9.63	42.14	28.51	65.16	55.16	-23.02	-26.65	Pass
2	0.4460	28.94	15.47	9.64	38.58	25.11	56.95	46.95	-18.37	-21.84	Pass
3	0.5020	33.82	20.48	9.64	43.46	30.12	56.00	46.00	-12.54	-15.88	Pass
4	0.5180	35.82	22.18	9.64	45.46	31.82	56.00	46.00	-10.54	-14.18	Pass
5	1.7700	28.26	16.00	9.70	37.96	25.70	56.00	46.00	-18.04	-20.30	Pass
6	2.0740	26.55	14.12	9.71	36.26	23.83	56.00	46.00	-19.74	-22.17	Pass

Note: 1. Result (dBuV/m) = Correct Factor (dB/m) + Reading(dBuV).
 2. Correction factor (dB) = Cable loss (dB) + L.I.S.N. factor (dB).

Annex B. Transmitter Radiated Emissions

Harmonic

Below 1GHz

Standard:	FCC Part 15.247	Test Distance:	3m				
Test item:	Harmonic	Power:	AC 120V/60Hz				
Mode:	Mode 1	Temp.(°C)/Hum.(%RH):	26(°C)/60%RH				
Description:	Adapter Model Number: DSA-12PFT-12 FUS 120100						
Frequency (MHz)	Reading (dBuV)	Correct Factor (dB/m)	Result (dBuV/m)	Limit (dBuV/m)	Margin (dB)	Remark	Ant.Polar. H / V
140.5800	34.82	-5.77	29.05	43.50	-14.45	QP	H
153.1900	32.48	-5.19	27.29	43.50	-16.21	QP	H
184.2300	31.94	-6.72	25.22	43.50	-18.28	QP	H
265.7100	28.34	-4.45	23.89	46.00	-22.11	QP	H
401.5100	26.81	-1.11	25.70	46.00	-20.30	QP	H
826.3700	26.68	7.05	33.73	46.00	-12.27	QP	H
89.1700	41.76	-11.92	29.84	43.50	-13.66	QP	V
139.6100	36.78	-5.84	30.94	43.50	-12.56	QP	V
184.2300	38.45	-6.72	31.73	43.50	-11.77	QP	V
227.8800	35.58	-6.35	29.23	46.00	-16.77	QP	V
439.3400	30.55	-0.33	30.22	46.00	-15.78	QP	V
714.8200	27.59	5.00	32.59	46.00	-13.41	QP	V

Note:1.Result (dBuV/m) = Correct Factor (dB/m) + Reading(dBuV).

2.Correction factor (dB/m) = Antenna Factor (dB/m) + Cable loss (dB) – Pre-Amplifier gain (dB).

3.When the peak results are less than average limit, so not need to evaluate the average.



Standard:	FCC Part 15.247	Test Distance:	3m				
Test item:	Harmonic	Power:	AC 120V/60Hz				
Mode:	Mode 1	Temp.(°C)/Hum.(%RH):	26(°C)/60%RH				
Description:	Adapter Model Number: PA1015-120HUB125						
Frequency (MHz)	Reading (dBuV)	Correct Factor (dB/m)	Result (dBuV/m)	Limit (dBuV/m)	Margin (dB)	Remark	Ant.Polar. H / V
429.6400	27.94	-0.53	27.41	46.00	-18.59	QP	H
567.3800	27.92	2.03	29.95	46.00	-16.05	QP	H
610.0600	28.15	3.02	31.17	46.00	-14.83	QP	H
745.8600	28.56	5.76	34.32	46.00	-11.68	QP	H
823.4600	27.25	6.99	34.24	46.00	-11.76	QP	H
907.8500	27.78	8.82	36.60	46.00	-9.40	QP	H
368.5300	28.68	-1.86	26.82	46.00	-19.18	QP	V
402.4800	32.93	-1.09	31.84	46.00	-14.16	QP	V
415.0900	29.81	-0.83	28.98	46.00	-17.02	QP	V
516.9400	31.93	0.97	32.90	46.00	-13.10	QP	V
648.8600	28.59	3.56	32.15	46.00	-13.85	QP	V
955.3800	27.78	9.55	37.33	46.00	-8.67	QP	V

Note:1.Result (dBuV/m) = Correct Factor (dB/m) + Reading(dBuV).

2.Correction factor (dB/m) = Antenna Factor (dB/m) + Cable loss (dB) – Pre-Amplifier gain (dB).

3.When the peak results are less than average limit, so not need to evaluate the average.



Standard:	FCC Part 15.247	Test Distance:	3m				
Test item:	Harmonic	Power:	AC 120V/60Hz				
Mode:	Mode 1	Temp.(°C)/Hum.(%RH):	26(°C)/60%RH				
Description:	Adapter Model Number: PS1012-120HUB100						
Frequency (MHz)	Reading (dBuV)	Correct Factor (dB/m)	Result (dBuV/m)	Limit (dBuV/m)	Margin (dB)	Remark	Ant.Polar. H / V
135.7300	38.49	-6.27	32.22	43.50	-11.28	QP	H
184.2300	34.03	-6.72	27.31	43.50	-16.19	QP	H
274.4400	29.96	-4.00	25.96	46.00	-20.04	QP	H
440.3100	27.87	-0.31	27.56	46.00	-18.44	QP	H
643.0400	27.83	3.48	31.31	46.00	-14.69	QP	H
906.8800	26.49	8.80	35.29	46.00	-10.71	QP	H
127.9700	43.24	-7.12	36.12	43.50	-7.38	QP	V
197.8100	41.43	-7.17	34.26	43.50	-9.24	QP	V
224.9700	38.52	-6.47	32.05	46.00	-13.95	QP	V
427.7000	29.86	-0.57	29.29	46.00	-16.71	QP	V
624.6100	29.30	3.23	32.53	46.00	-13.47	QP	V
821.5200	27.17	6.95	34.12	46.00	-11.88	QP	V

Note:1.Result (dBuV/m) = Correct Factor (dB/m) + Reading(dBuV).

2.Correction factor (dB/m) = Antenna Factor (dB/m) + Cable loss (dB) – Pre-Amplifier gain (dB).

3.When the peak results are less than average limit, so not need to evaluate the average.



Above 1GHz

Standard:	FCC Part 15.247	Test Distance:	3m
Test item:	Harmonic	Power:	AC 120V/60Hz
Frequency:	2412MHz	Temp.(°C)/Hum.(%RH):	26(°C)/60%RH
Mode:	Mode 2		
Ant.Polar.:	Horizontal		

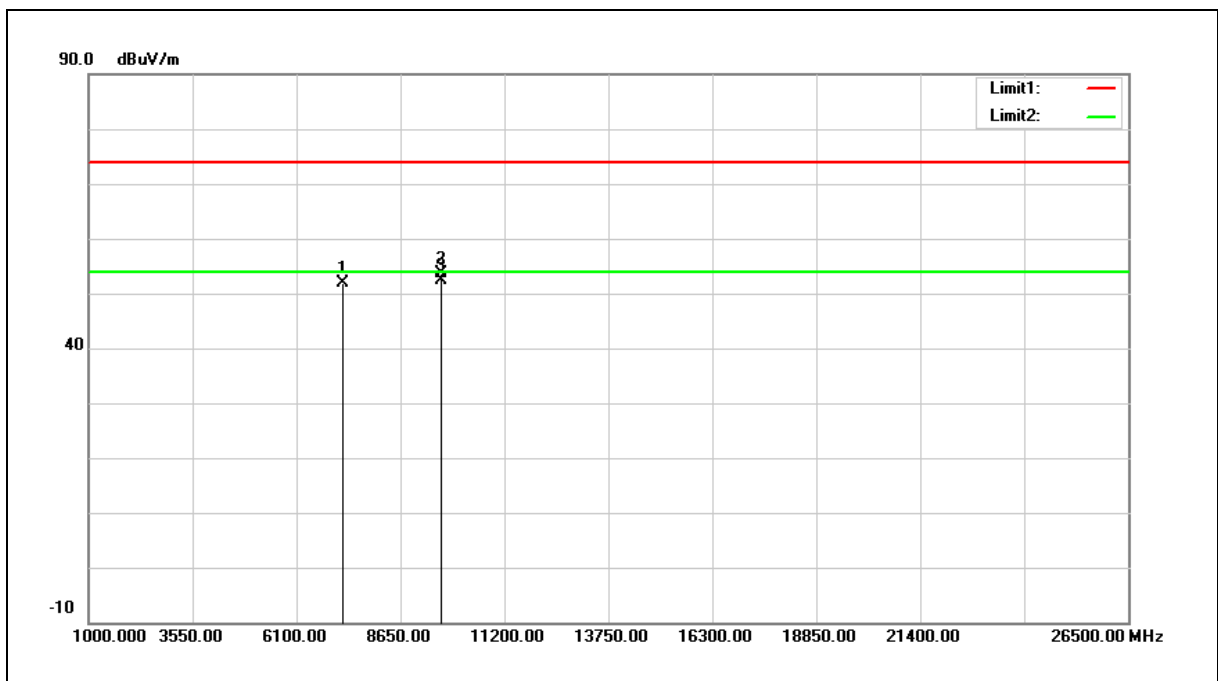

No.	Frequency (MHz)	Reading (dBuV)	Correct Factor (dB/m)	Result (dBuV/m)	Limit (dBuV/m)	Margin (dB)	Remark
1	7236.000	40.59	11.27	51.86	74.00	-22.14	peak
2	9648.000	39.30	14.24	53.54	74.00	-20.46	peak
3	9648.000	38.02	14.24	52.26	54.00	-1.74	AVG

Note:1.Result (dBuV/m) = Correct Factor (dB/m) + Reading(dBuV).

2.Correction factor (dB/m) = Antenna Factor (dB/m) + Cable loss (dB) – Pre-Amplifier gain (dB).

3.When the peak results are less than average limit, so not need to evaluate the average.



Standard:	FCC Part 15.247	Test Distance:	3m
Test item:	Harmonic	Power:	AC 120V/60Hz
Frequency:	2412MHz	Temp.(°C)/Hum.(%RH):	26(°C)/60%RH
Mode:	Mode 2		
Ant.Polar.:	Vertical		

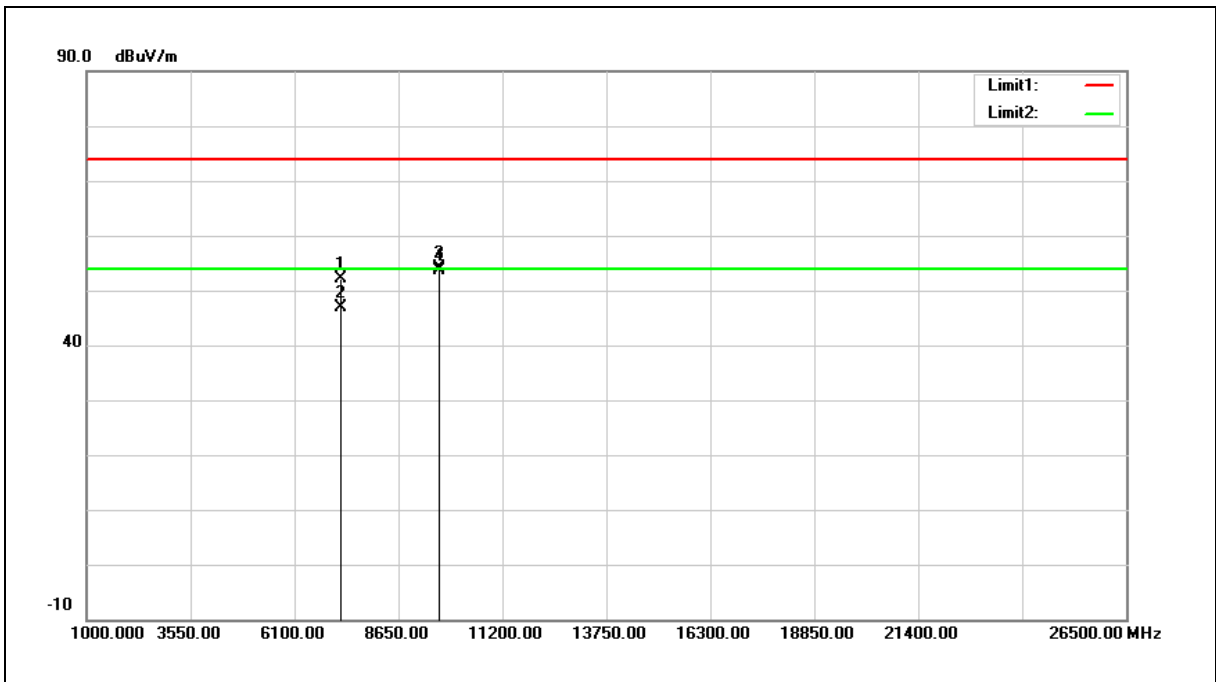

No.	Frequency (MHz)	Reading (dBuV)	Correct Factor (dB/m)	Result (dBuV/m)	Limit (dBuV/m)	Margin (dB)	Remark
1	7236.000	40.96	11.27	52.23	74.00	-21.77	peak
2	7236.000	35.49	11.27	46.76	54.00	-7.24	AVG
3	9648.000	39.93	14.24	54.17	74.00	-19.83	peak
4	9648.000	39.32	14.24	53.56	54.00	-0.44	AVG

Note:1.Result (dBuV/m) = Correct Factor (dB/m) + Reading(dBuV).

2.Correction factor (dB/m) = Antenna Factor (dB/m) + Cable loss (dB) – Pre-Amplifier gain (dB).

3.When the peak results are less than average limit, so not need to evaluate the average.



Standard:	FCC Part 15.247	Test Distance:	3m
Test item:	Harmonic	Power:	AC 120V/60Hz
Frequency:	2437MHz	Temp.(°C)/Hum.(%RH):	26(°C)/60%RH
Mode:	Mode 2		
Ant.Polar.:	Horizontal		

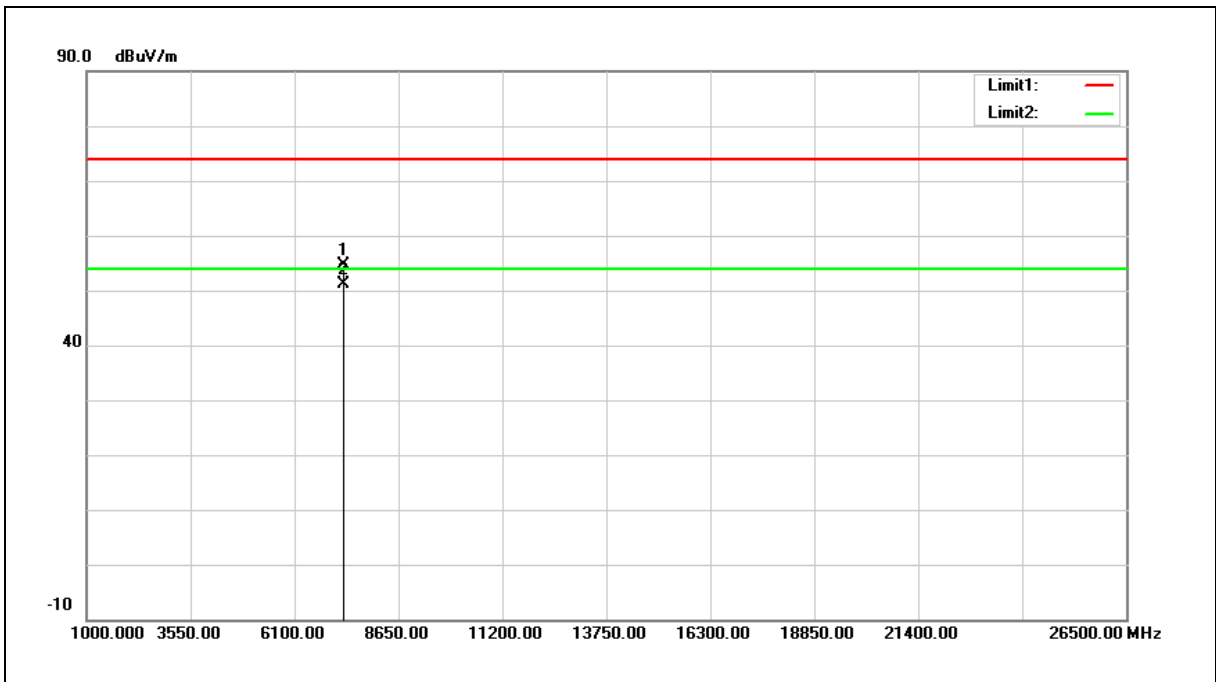

No.	Frequency (MHz)	Reading (dBuV)	Correct Factor (dB/m)	Result (dBuV/m)	Limit (dBuV/m)	Margin (dB)	Remark
1	7311.000	43.06	11.46	54.52	74.00	-19.48	peak
2	7311.000	39.76	11.46	51.22	54.00	-2.78	AVG

Note:1.Result (dBuV/m) = Correct Factor (dB/m) + Reading(dBuV).

2.Correction factor (dB/m) = Antenna Factor (dB/m) + Cable loss (dB) – Pre-Amplifier gain (dB).

3.When the peak results are less than average limit, so not need to evaluate the average.



Standard:	FCC Part 15.247	Test Distance:	3m
Test item:	Harmonic	Power:	AC 120V/60Hz
Frequency:	2437MHz	Temp.(°C)/Hum.(%RH):	26(°C)/60%RH
Mode:	Mode 2		
Ant.Polar.:	Vertical		

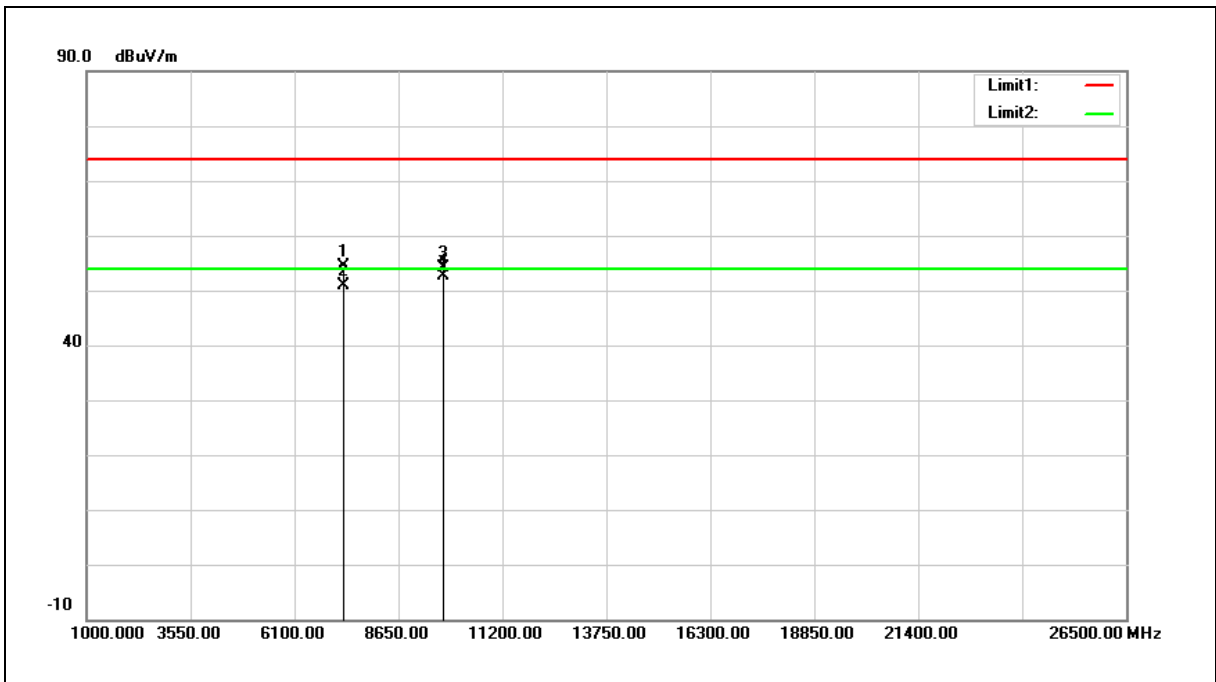

No.	Frequency (MHz)	Reading (dBuV)	Correct Factor (dB/m)	Result (dBuV/m)	Limit (dBuV/m)	Margin (dB)	Remark
1	7311.000	42.87	11.46	54.33	74.00	-19.67	peak
2	7311.000	39.54	11.46	51.00	54.00	-3.00	AVG
3	9748.000	39.62	14.44	54.06	74.00	-19.94	peak
4	9748.000	38.31	14.44	52.75	54.00	-1.25	AVG

Note:1.Result (dBuV/m) = Correct Factor (dB/m) + Reading(dBuV).

2.Correction factor (dB/m) = Antenna Factor (dB/m) + Cable loss (dB) – Pre-Amplifier gain (dB).

3.When the peak results are less than average limit, so not need to evaluate the average.



Standard:	FCC Part 15.247	Test Distance:	3m
Test item:	Harmonic	Power:	AC 120V/60Hz
Frequency:	2462MHz	Temp.(°C)/Hum.(%RH):	26(°C)/60%RH
Mode:	Mode 2		
Ant.Polar.:	Horizontal		

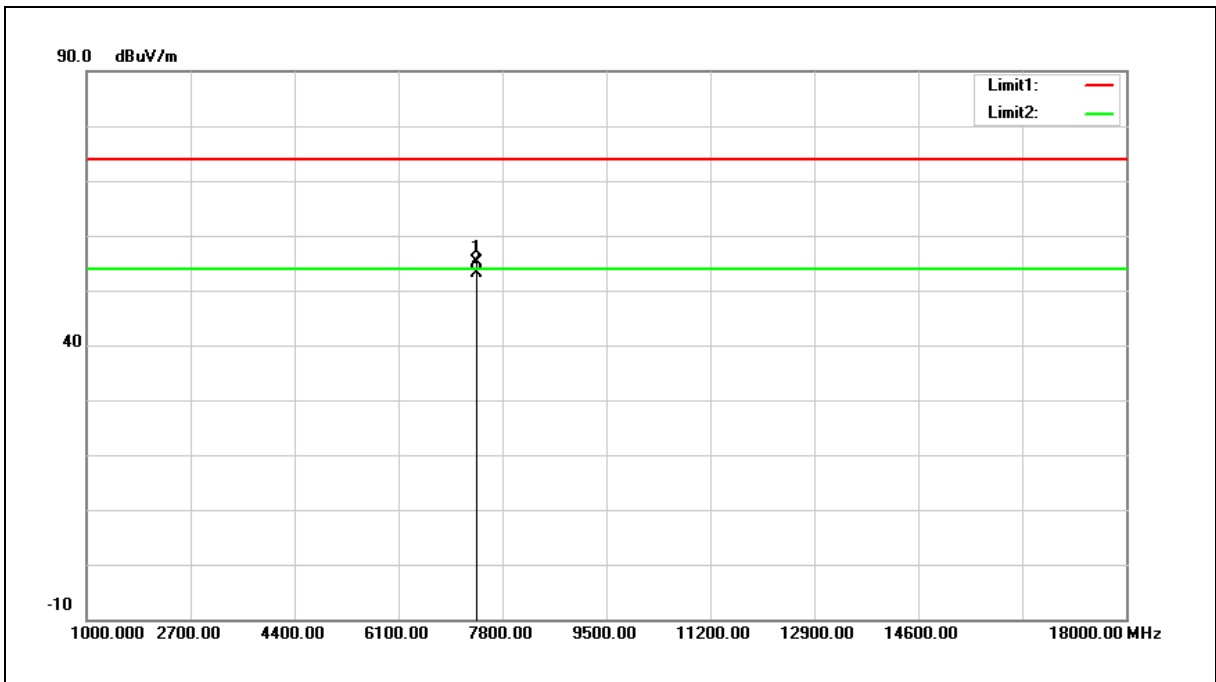

No.	Frequency (MHz)	Reading (dBuV)	Correct Factor (dB/m)	Result (dBuV/m)	Limit (dBuV/m)	Margin (dB)	Remark
1	7386.000	43.48	11.66	55.14	74.00	-18.86	peak
2	7386.000	41.58	11.66	53.24	54.00	-0.76	AVG

Note:1.Result (dBuV/m) = Correct Factor (dB/m) + Reading(dBuV).

2.Correction factor (dB/m) = Antenna Factor (dB/m) + Cable loss (dB) – Pre-Amplifier gain (dB).

3.When the peak results are less than average limit, so not need to evaluate the average.



Standard:	FCC Part 15.247	Test Distance:	3m
Test item:	Harmonic	Power:	AC 120V/60Hz
Frequency:	2462MHz	Temp.(°C)/Hum.(%RH):	26(°C)/60%RH
Mode:	Mode 2		
Ant.Polar.:	Vertical		

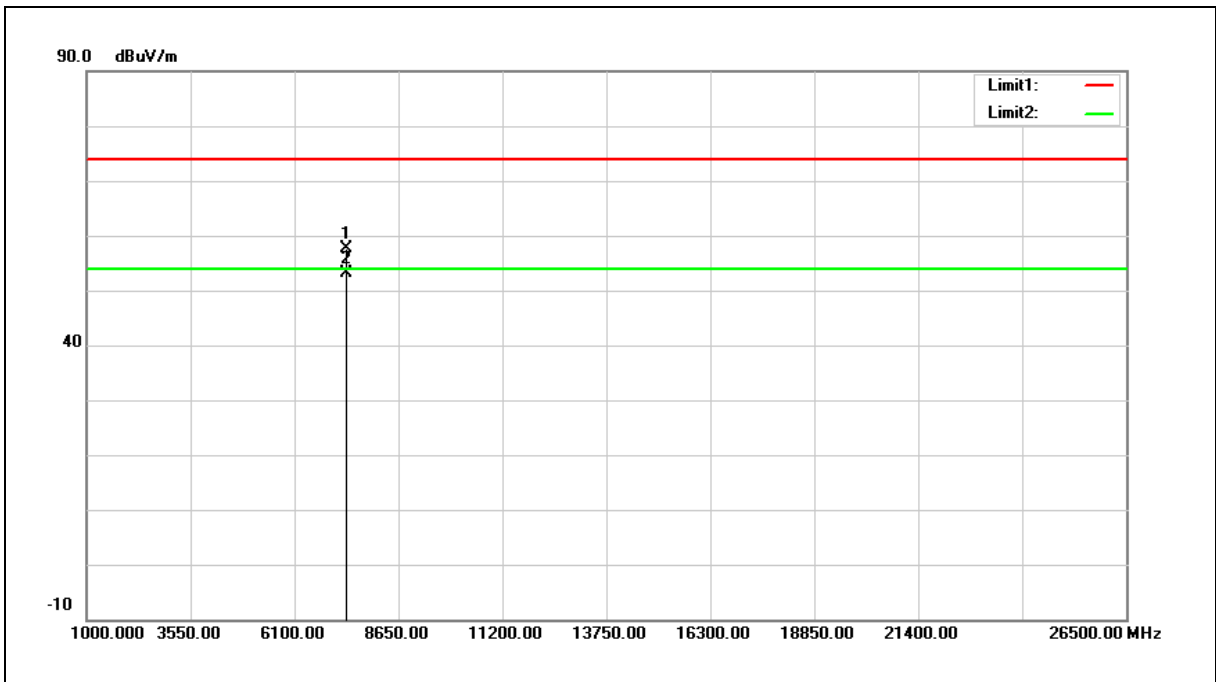

No.	Frequency (MHz)	Reading (dBuV)	Correct Factor (dB/m)	Result (dBuV/m)	Limit (dBuV/m)	Margin (dB)	Remark
1	7386.000	46.05	11.66	57.71	74.00	-16.29	peak
2	7386.000	41.48	11.66	53.14	74.00	-20.86	peak

Note: 1. Result (dBuV/m) = Correct Factor (dB/m) + Reading(dBuV).

2. Correction factor (dB/m) = Antenna Factor (dB/m) + Cable loss (dB) – Pre-Amplifier gain (dB).

3. When the peak results are less than average limit, so not need to evaluate the average.



Standard:	FCC Part 15.247	Test Distance:	3m
Test item:	Harmonic	Power:	AC 120V/60Hz
Frequency:	2412MHz	Temp.(°C)/Hum.(%RH):	26(°C)/60%RH
Mode:	Mode 3		
Ant.Polar.:	Horizontal		

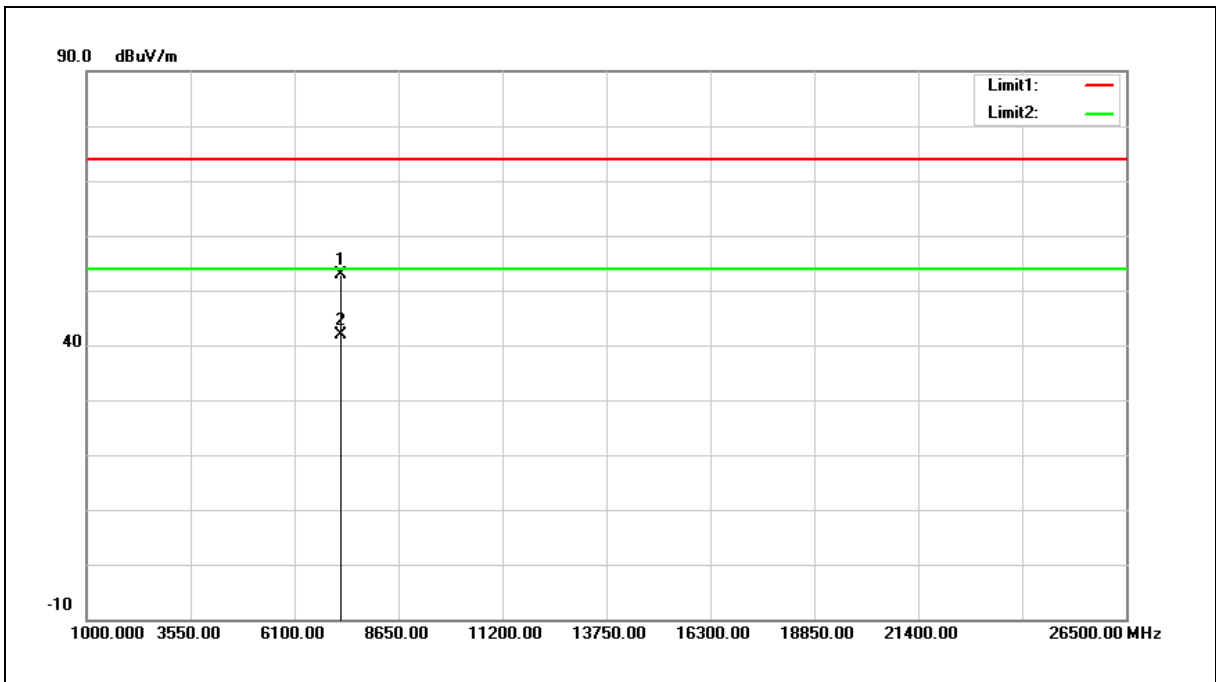

No.	Frequency (MHz)	Reading (dBuV)	Correct Factor (dB/m)	Result (dBuV/m)	Limit (dBuV/m)	Margin (dB)	Remark
1	7236.000	41.65	11.27	52.92	74.00	-21.08	peak
2	7236.000	30.64	11.27	41.91	54.00	-12.09	AVG

Note:1.Result (dBuV/m) = Correct Factor (dB/m) + Reading(dBuV).

2.Correction factor (dB/m) = Antenna Factor (dB/m) + Cable loss (dB) – Pre-Amplifier gain (dB).

3.When the peak results are less than average limit, so not need to evaluate the average.



Standard:	FCC Part 15.247	Test Distance:	3m
Test item:	Harmonic	Power:	AC 120V/60Hz
Frequency:	2412MHz	Temp.(°C)/Hum.(%RH):	26(°C)/60%RH
Mode:	Mode 3		
Ant.Polar.:	Vertical		

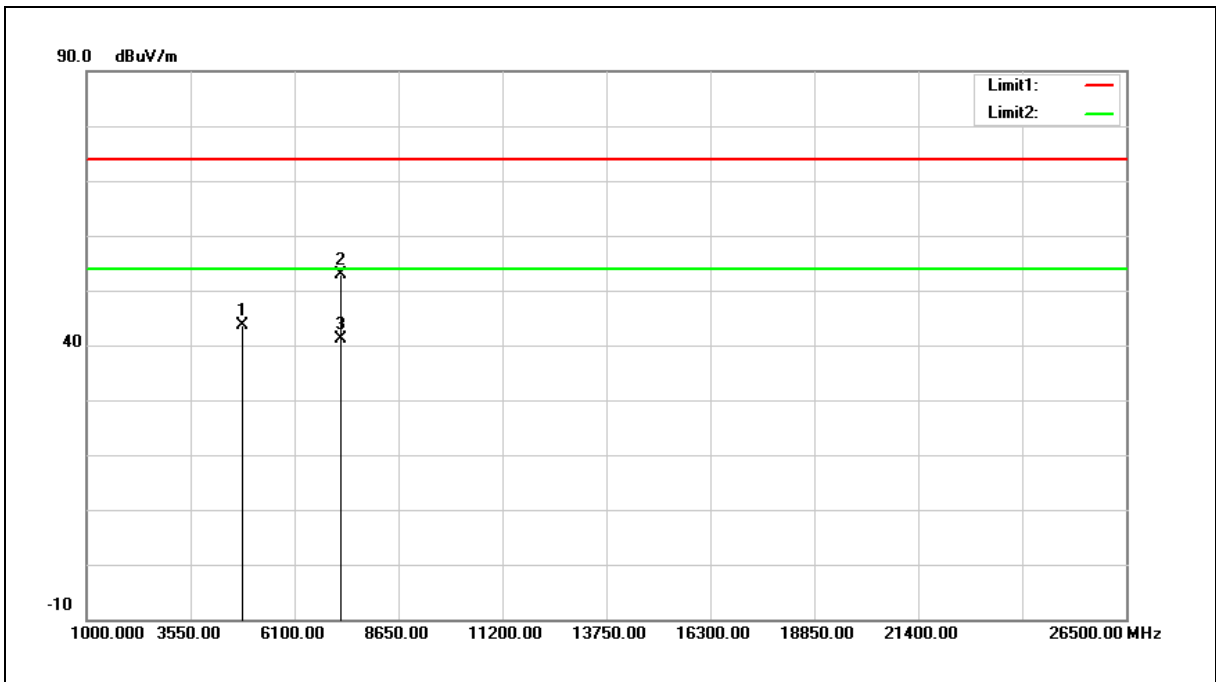

No.	Frequency (MHz)	Reading (dBuV)	Correct Factor (dB/m)	Result (dBuV/m)	Limit (dBuV/m)	Margin (dB)	Remark
1	4824.000	38.59	4.99	43.58	74.00	-30.42	peak
2	7236.000	41.65	11.27	52.92	74.00	-21.08	peak
3	7236.000	29.82	11.27	41.09	54.00	-12.91	AVG

Note:1.Result (dBuV/m) = Correct Factor (dB/m) + Reading(dBuV).

2.Correction factor (dB/m) = Antenna Factor (dB/m) + Cable loss (dB) – Pre-Amplifier gain (dB).

3.When the peak results are less than average limit, so not need to evaluate the average.



Standard:	FCC Part 15.247	Test Distance:	3m
Test item:	Harmonic	Power:	AC 120V/60Hz
Frequency:	2437MHz	Temp.(°C)/Hum.(%RH):	26(°C)/60%RH
Mode:	Mode 3		
Ant.Polar.:	Horizontal		

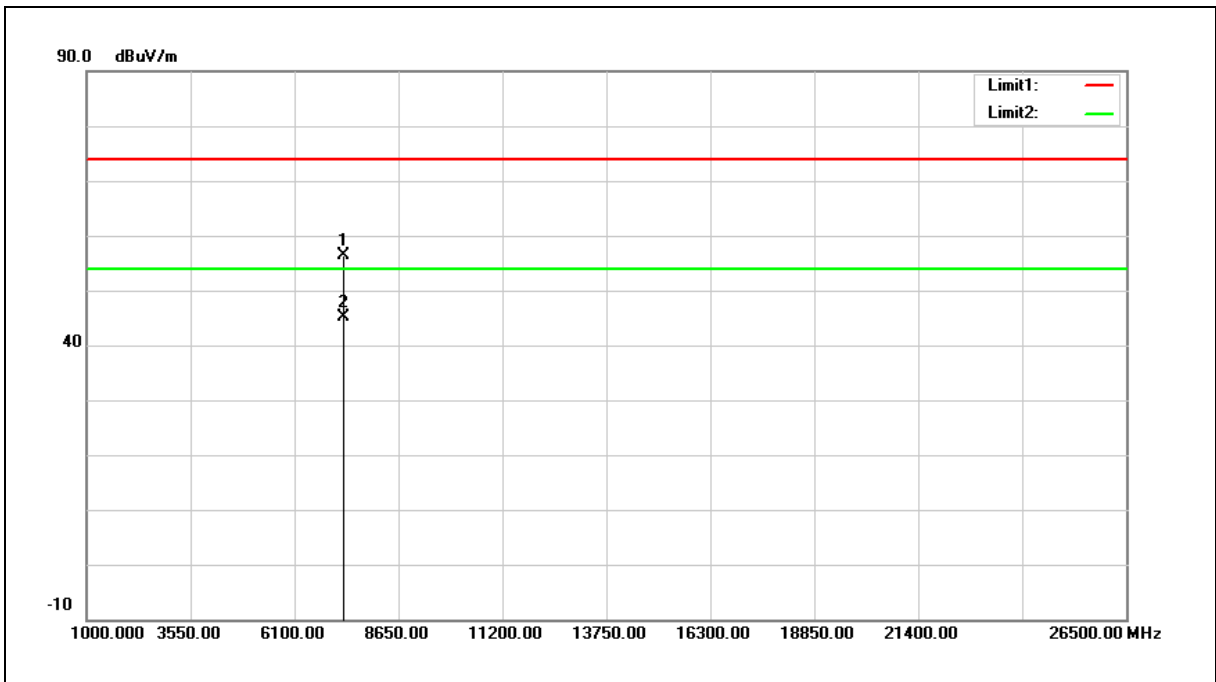

No.	Frequency (MHz)	Reading (dBuV)	Correct Factor (dB/m)	Result (dBuV/m)	Limit (dBuV/m)	Margin (dB)	Remark
1	7311.000	44.90	11.46	56.36	74.00	-17.64	peak
2	7311.000	33.78	11.46	45.24	54.00	-8.76	AVG

Note:1.Result (dBuV/m) = Correct Factor (dB/m) + Reading(dBuV).

2.Correction factor (dB/m) = Antenna Factor (dB/m) + Cable loss (dB) – Pre-Amplifier gain (dB).

3.When the peak results are less than average limit, so not need to evaluate the average.



Standard:	FCC Part 15.247	Test Distance:	3m
Test item:	Harmonic	Power:	AC 120V/60Hz
Frequency:	2437MHz	Temp.(°C)/Hum.(%RH):	26(°C)/60%RH
Mode:	Mode 3		
Ant.Polar.:	Vertical		

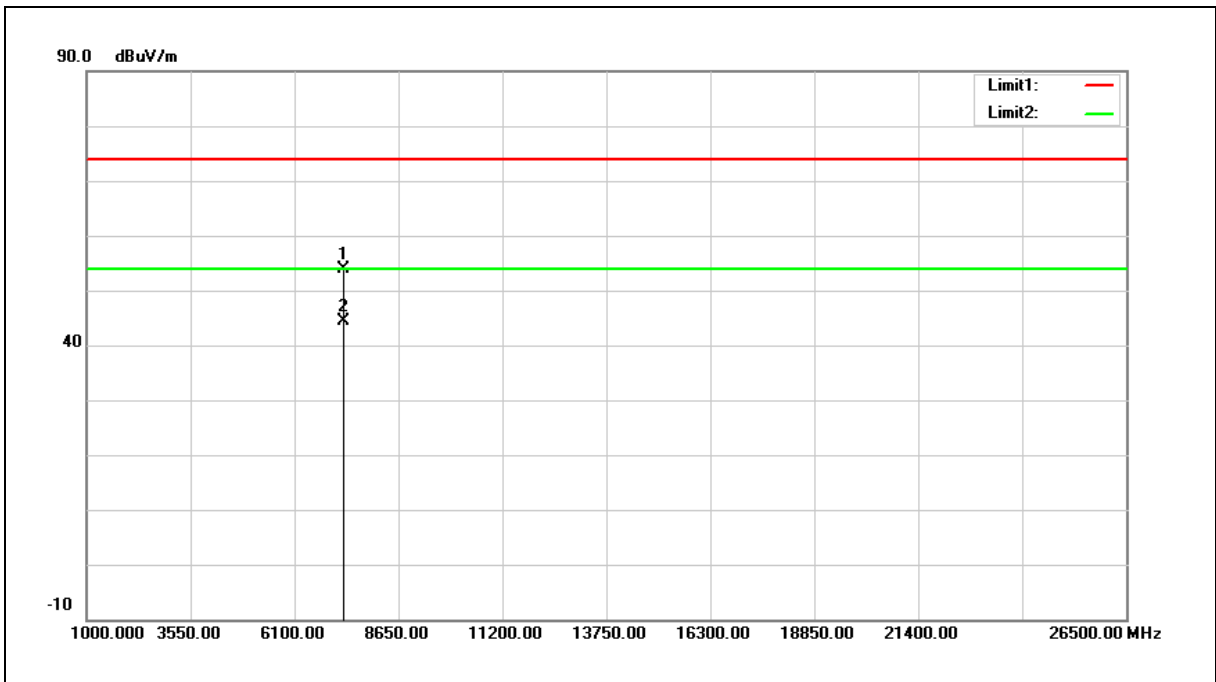

No.	Frequency (MHz)	Reading (dBuV)	Correct Factor (dB/m)	Result (dBuV/m)	Limit (dBuV/m)	Margin (dB)	Remark
1	7311.000	42.48	11.46	53.94	74.00	-20.06	peak
2	7311.000	32.90	11.46	44.36	54.00	-9.64	AVG

Note:1.Result (dBuV/m) = Correct Factor (dB/m) + Reading(dBuV).

2.Correction factor (dB/m) = Antenna Factor (dB/m) + Cable loss (dB) – Pre-Amplifier gain (dB).

3.When the peak results are less than average limit, so not need to evaluate the average.



Standard:	FCC Part 15.247	Test Distance:	3m
Test item:	Harmonic	Power:	AC 120V/60Hz
Frequency:	2462MHz	Temp.(°C)/Hum.(%RH):	26(°C)/60%RH
Mode:	Mode 3		
Ant.Polar.:	Horizontal		

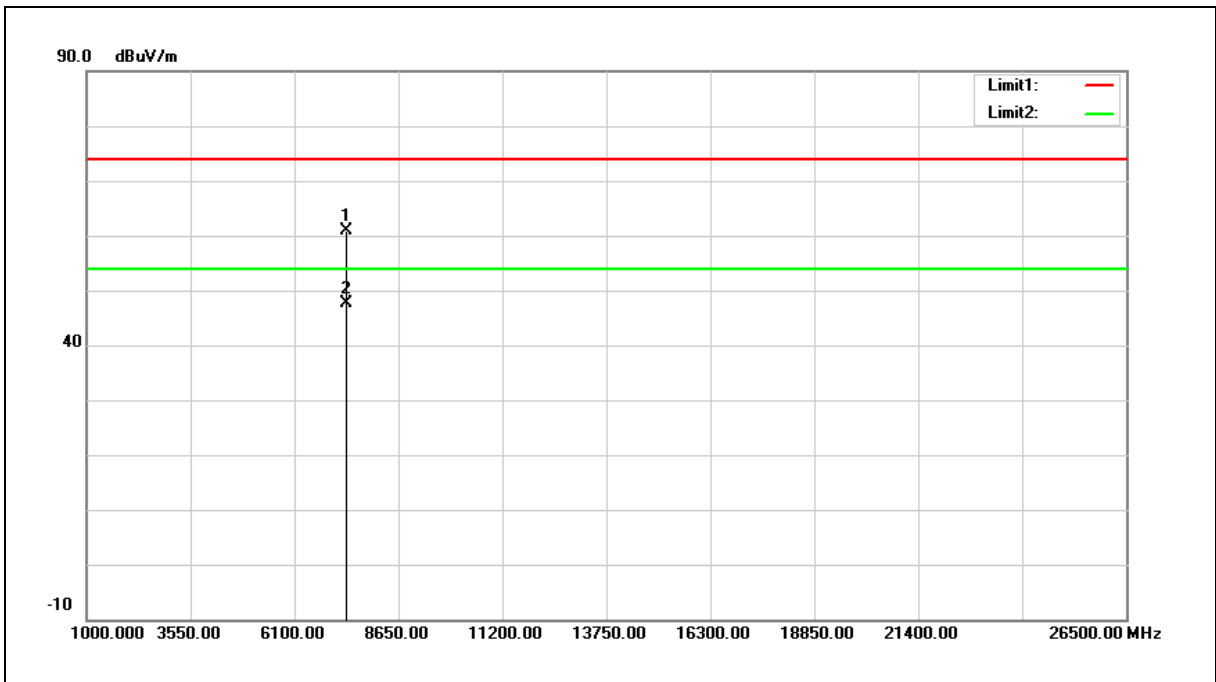

No.	Frequency (MHz)	Reading (dBuV)	Correct Factor (dB/m)	Result (dBuV/m)	Limit (dBuV/m)	Margin (dB)	Remark
1	7386.000	49.15	11.66	60.81	74.00	-13.19	peak
2	7386.000	36.01	11.66	47.67	54.00	-6.33	AVG

Note:1.Result (dBuV/m) = Correct Factor (dB/m) + Reading(dBuV).

2.Correction factor (dB/m) = Antenna Factor (dB/m) + Cable loss (dB) – Pre-Amplifier gain (dB).

3.When the peak results are less than average limit, so not need to evaluate the average.



Standard:	FCC Part 15.247	Test Distance:	3m
Test item:	Harmonic	Power:	AC 120V/60Hz
Frequency:	2462MHz	Temp.(°C)/Hum.(%RH):	26(°C)/60%RH
Mode:	Mode 3		
Ant.Polar.:	Vertical		

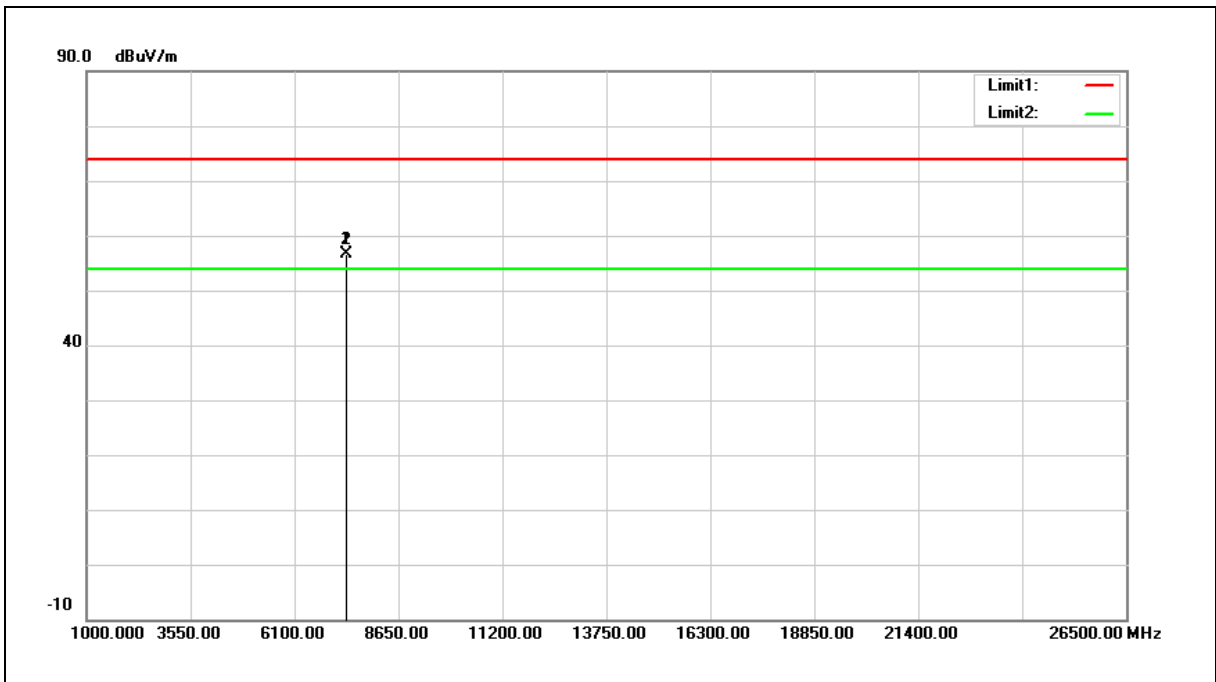

No.	Frequency (MHz)	Reading (dBuV)	Correct Factor (dB/m)	Result (dBuV/m)	Limit (dBuV/m)	Margin (dB)	Remark
1	7386.000	44.89	11.66	56.55	74.00	-17.45	peak
2	7386.000	44.89	11.66	56.55	74.00	-17.45	peak

- Note: 1.Result (dBuV/m) = Correct Factor (dB/m) + Reading(dBuV).
 2.Correction factor (dB/m) = Antenna Factor (dB/m) + Cable loss (dB) – Pre-Amplifier gain (dB).
 3.When the peak results are less than average limit, so not need to evaluate the average.



Standard:	FCC Part 15.247	Test Distance:	3m
Test item:	Harmonic	Power:	AC 120V/60Hz
Frequency:	2412MHz	Temp.(°C)/Hum.(%RH):	26(°C)/60%RH
Mode:	Mode 4		
Ant.Polar.:	Horizontal		

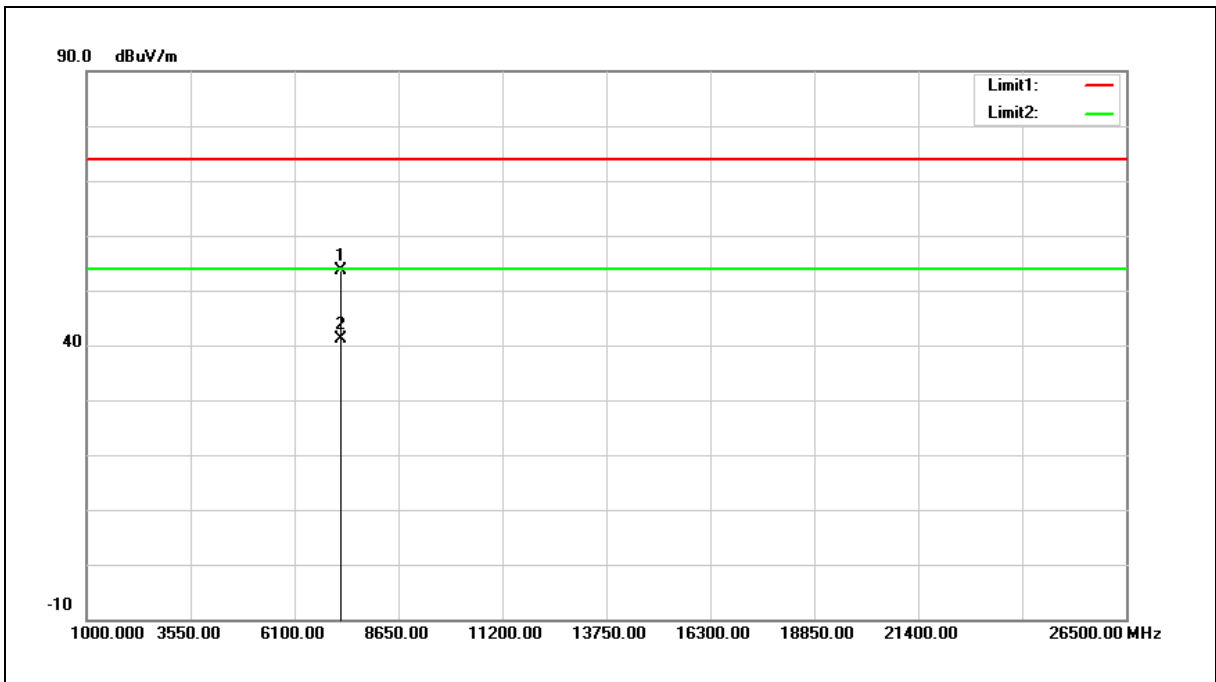

No.	Frequency (MHz)	Reading (dBuV)	Correct Factor (dB/m)	Result (dBuV/m)	Limit (dBuV/m)	Margin (dB)	Remark
1	7236.000	42.27	11.27	53.54	74.00	-20.46	peak
2	7236.000	29.94	11.27	41.21	54.00	-12.79	AVG

Note:1.Result (dBuV/m) = Correct Factor (dB/m) + Reading(dBuV).

2.Correction factor (dB/m) = Antenna Factor (dB/m) + Cable loss (dB) – Pre-Amplifier gain (dB).

3.When the peak results are less than average limit, so not need to evaluate the average.



Standard:	FCC Part 15.247	Test Distance:	3m
Test item:	Harmonic	Power:	AC 120V/60Hz
Frequency:	2412MHz	Temp.(°C)/Hum.(%RH):	26(°C)/60%RH
Mode:	Mode 4		
Ant.Polar.:	Vertical		

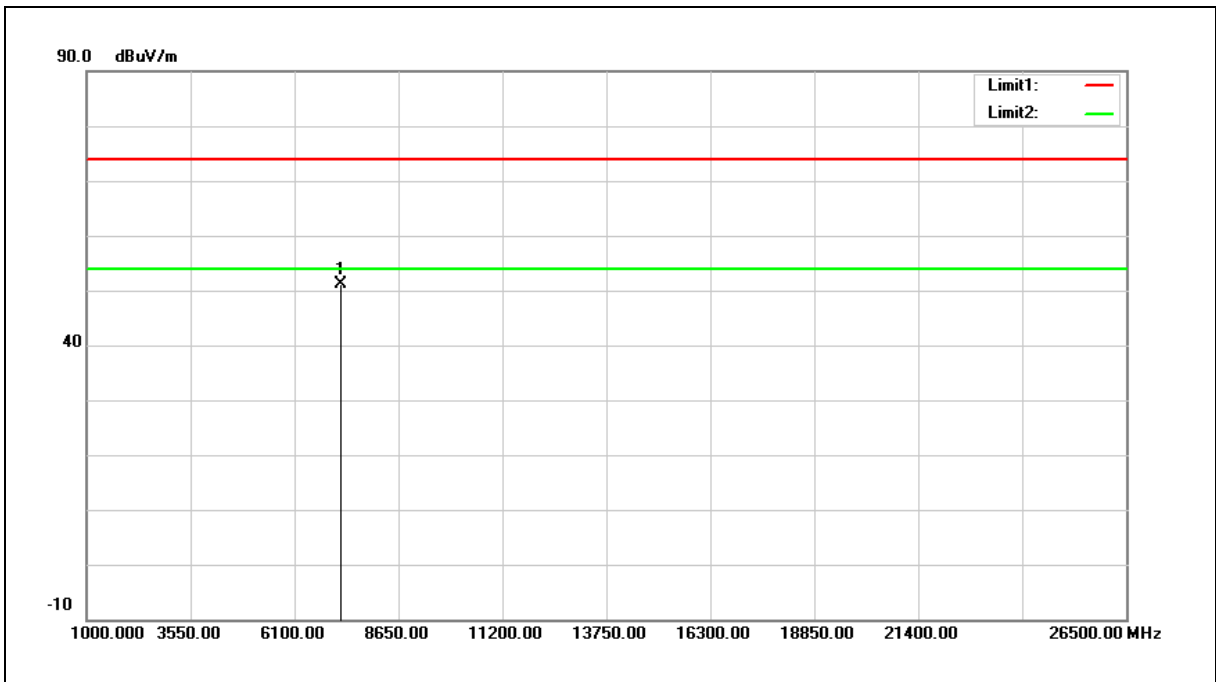

No.	Frequency (MHz)	Reading (dBuV)	Correct Factor (dB/m)	Result (dBuV/m)	Limit (dBuV/m)	Margin (dB)	Remark
1	7236.000	39.94	11.27	51.21	74.00	-22.79	peak

- Note: 1.Result (dBuV/m) = Correct Factor (dB/m) + Reading(dBuV).
 2.Correction factor (dB/m) = Antenna Factor (dB/m) + Cable loss (dB) – Pre-Amplifier gain (dB).
 3.When the peak results are less than average limit, so not need to evaluate the average.



Standard:	FCC Part 15.247	Test Distance:	3m
Test item:	Harmonic	Power:	AC 120V/60Hz
Frequency:	2437MHz	Temp.(°C)/Hum.(%RH):	26(°C)/60%RH
Mode:	Mode 4		
Ant.Polar.:	Horizontal		

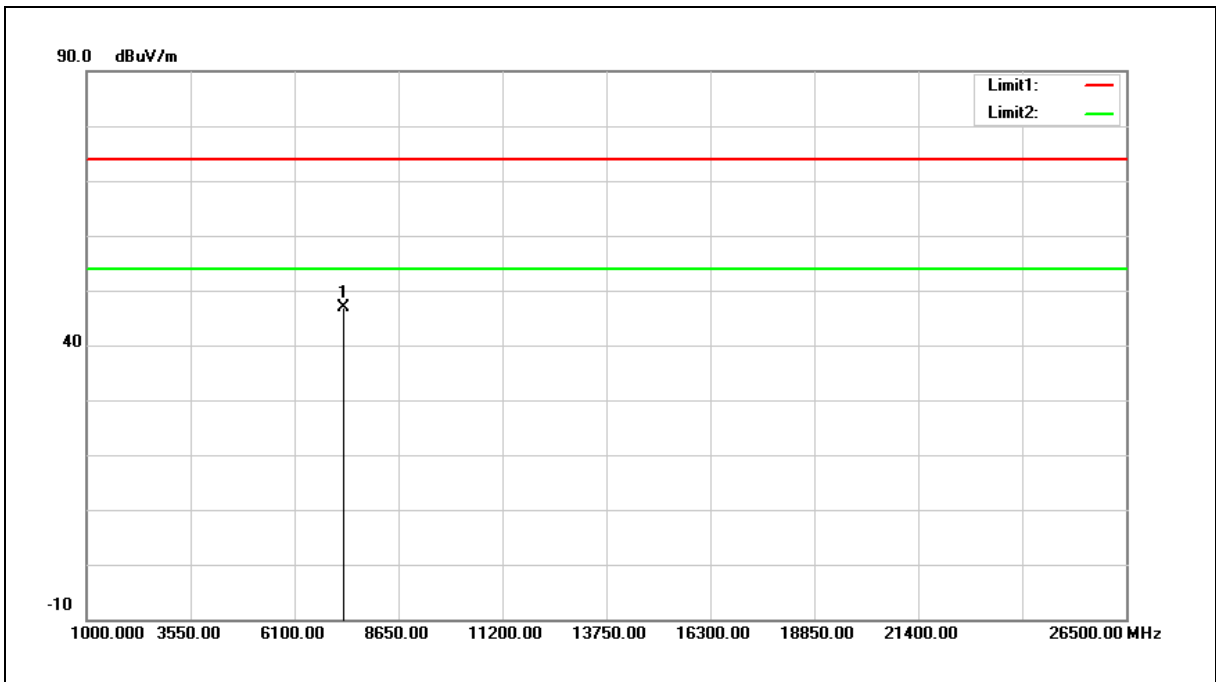

No.	Frequency (MHz)	Reading (dBuV)	Correct Factor (dB/m)	Result (dBuV/m)	Limit (dBuV/m)	Margin (dB)	Remark
1	7311.000	35.36	11.46	46.82	74.00	-27.18	peak

Note: 1.Result (dBuV/m) = Correct Factor (dB/m) + Reading(dBuV).

2.Correction factor (dB/m) = Antenna Factor (dB/m) + Cable loss (dB) – Pre-Amplifier gain (dB).

3.When the peak results are less than average limit, so not need to evaluate the average.



Standard:	FCC Part 15.247	Test Distance:	3m
Test item:	Harmonic	Power:	AC 120V/60Hz
Frequency:	2437MHz	Temp.(°C)/Hum.(%RH):	26(°C)/60%RH
Mode:	Mode 4		
Ant.Polar.:	Vertical		

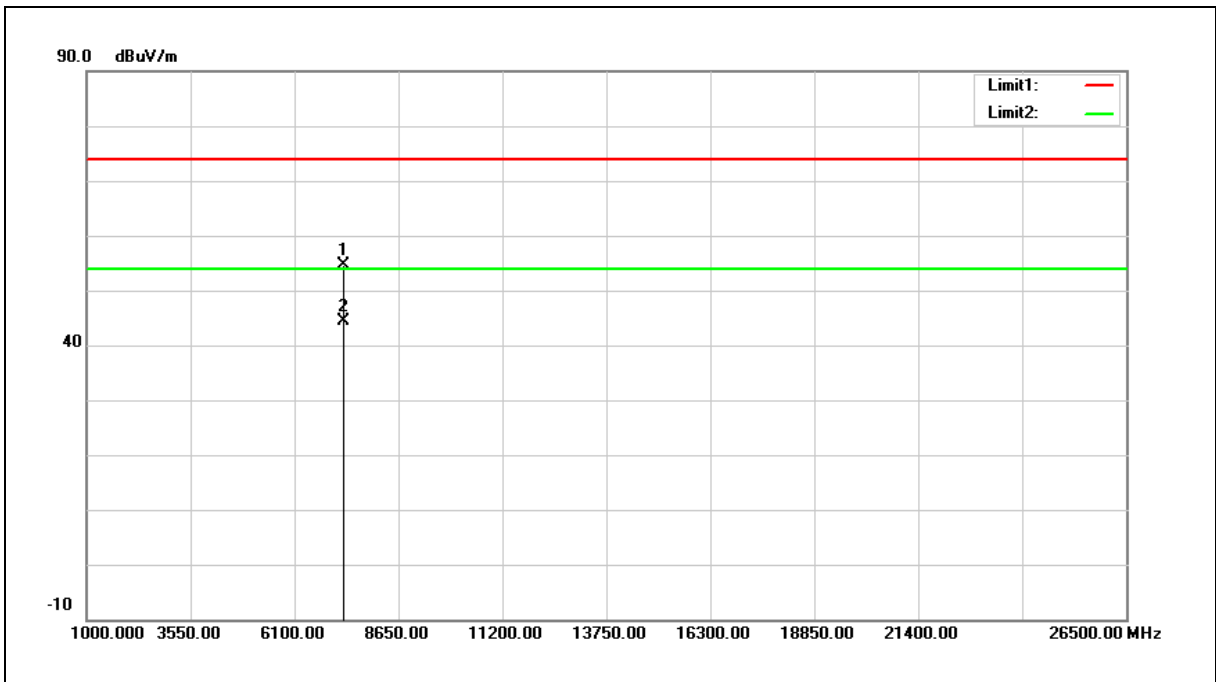

No.	Frequency (MHz)	Reading (dBuV)	Correct Factor (dB/m)	Result (dBuV/m)	Limit (dBuV/m)	Margin (dB)	Remark
1	7311.000	43.05	11.46	54.51	74.00	-19.49	peak
2	7311.000	33.02	11.46	44.48	54.00	-9.52	AVG

Note:1.Result (dBuV/m) = Correct Factor (dB/m) + Reading(dBuV).

2.Correction factor (dB/m) = Antenna Factor (dB/m) + Cable loss (dB) – Pre-Amplifier gain (dB).

3.When the peak results are less than average limit, so not need to evaluate the average.



Standard:	FCC Part 15.247	Test Distance:	3m
Test item:	Harmonic	Power:	AC 120V/60Hz
Frequency:	2462MHz	Temp.(°C)/Hum.(%RH):	26(°C)/60%RH
Mode:	Mode 4		
Ant.Polar.:	Horizontal		

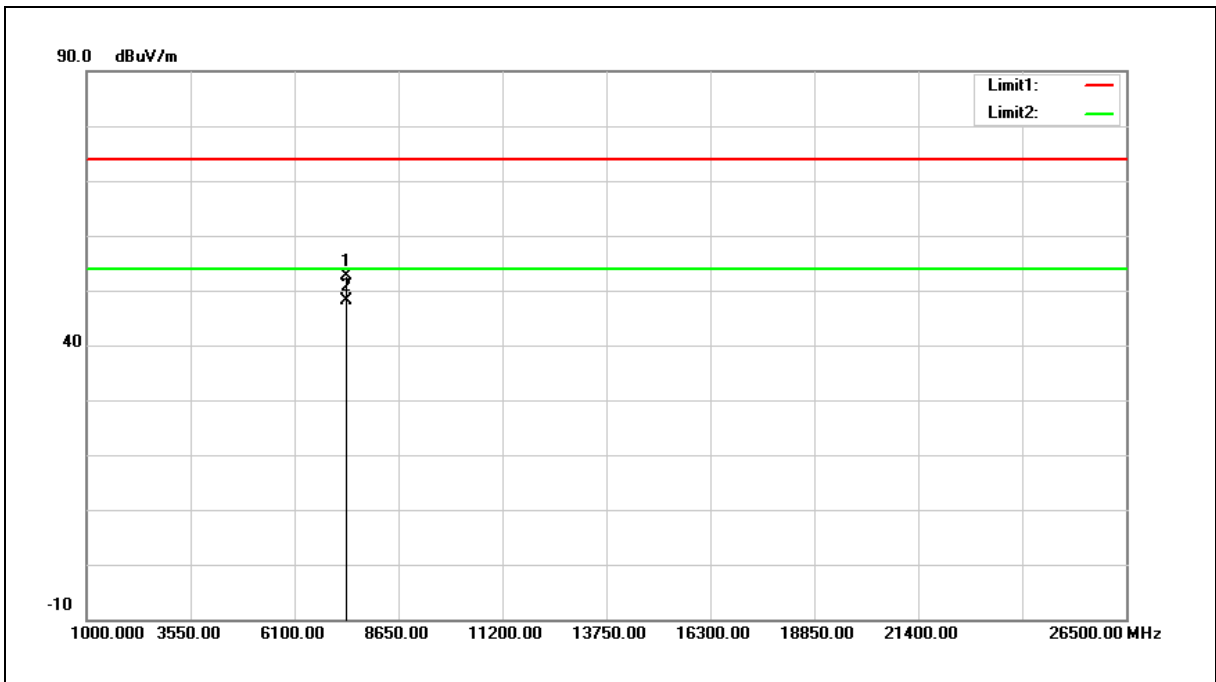

No.	Frequency (MHz)	Reading (dBuV)	Correct Factor (dB/m)	Result (dBuV/m)	Limit (dBuV/m)	Margin (dB)	Remark
1	7386.000	41.03	11.66	52.69	74.00	-21.31	peak
2	7386.000	36.36	11.66	48.02	54.00	-5.98	AVG

Note:1.Result (dBuV/m) = Correct Factor (dB/m) + Reading(dBuV).

2.Correction factor (dB/m) = Antenna Factor (dB/m) + Cable loss (dB) – Pre-Amplifier gain (dB).

3.When the peak results are less than average limit, so not need to evaluate the average.



Standard:	FCC Part 15.247	Test Distance:	3m
Test item:	Harmonic	Power:	AC 120V/60Hz
Frequency:	2462MHz	Temp.(°C)/Hum. (%RH):	26(°C)/60%RH
Mode:	Mode 4		
Ant.Polar.:	Vertical		

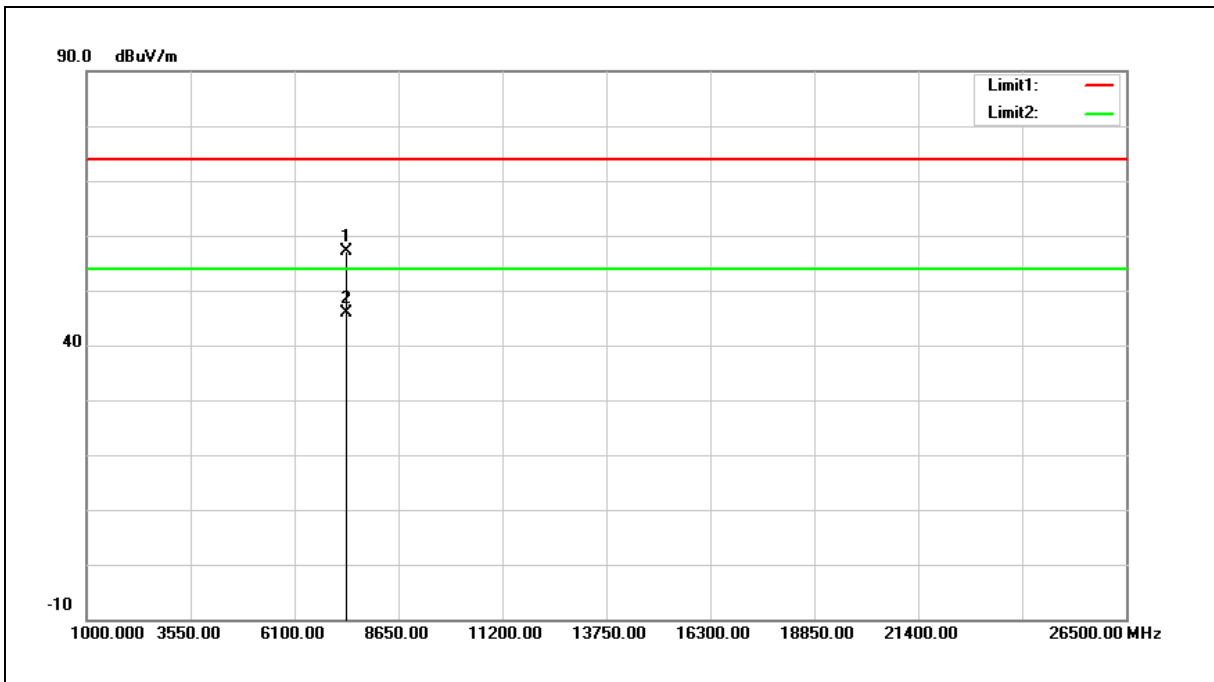

No.	Frequency (MHz)	Reading (dBuV)	Correct Factor (dB/m)	Result (dBuV/m)	Limit (dBuV/m)	Margin (dB)	Remark
1	7386.000	45.40	11.66	57.06	74.00	-16.94	peak
2	7386.000	34.25	11.66	45.91	54.00	-8.09	AVG

Note: 1. Result (dBuV/m) = Correct Factor (dB/m) + Reading(dBuV).

2. Correction factor (dB/m) = Antenna Factor (dB/m) + Cable loss (dB) – Pre-Amplifier gain (dB).

3. When the peak results are less than average limit, so not need to evaluate the average.



Standard:	FCC Part 15.247	Test Distance:	3m
Test item:	Harmonic	Power:	AC 120V/60Hz
Frequency:	2422MHz	Temp.(°C)/Hum.(%RH):	26(°C)/60%RH
Mode:	Mode 5		
Ant.Polar.:	Horizontal		

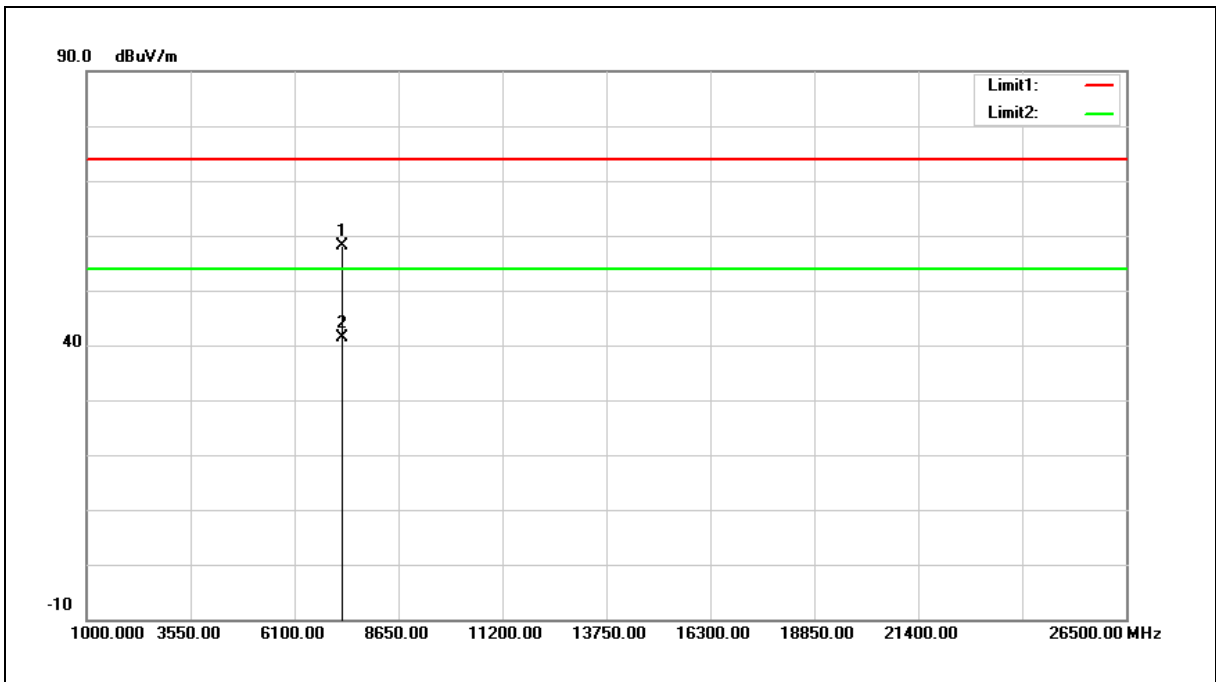

No.	Frequency (MHz)	Reading (dBuV)	Correct Factor (dB/m)	Result (dBuV/m)	Limit (dBuV/m)	Margin (dB)	Remark
1	7266.000	46.88	11.35	58.23	74.00	-15.77	peak
2	7266.000	30.06	11.35	41.41	54.00	-12.59	AVG

Note:1.Result (dBuV/m) = Correct Factor (dB/m) + Reading(dBuV).

2.Correction factor (dB/m) = Antenna Factor (dB/m) + Cable loss (dB) – Pre-Amplifier gain (dB).

3.When the peak results are less than average limit, so not need to evaluate the average.



Standard:	FCC Part 15.247	Test Distance:	3m
Test item:	Harmonic	Power:	AC 120V/60Hz
Frequency:	2422MHz	Temp.(°C)/Hum.(%RH):	26(°C)/60%RH
Mode:	Mode 5		
Ant.Polar.:	Vertical		

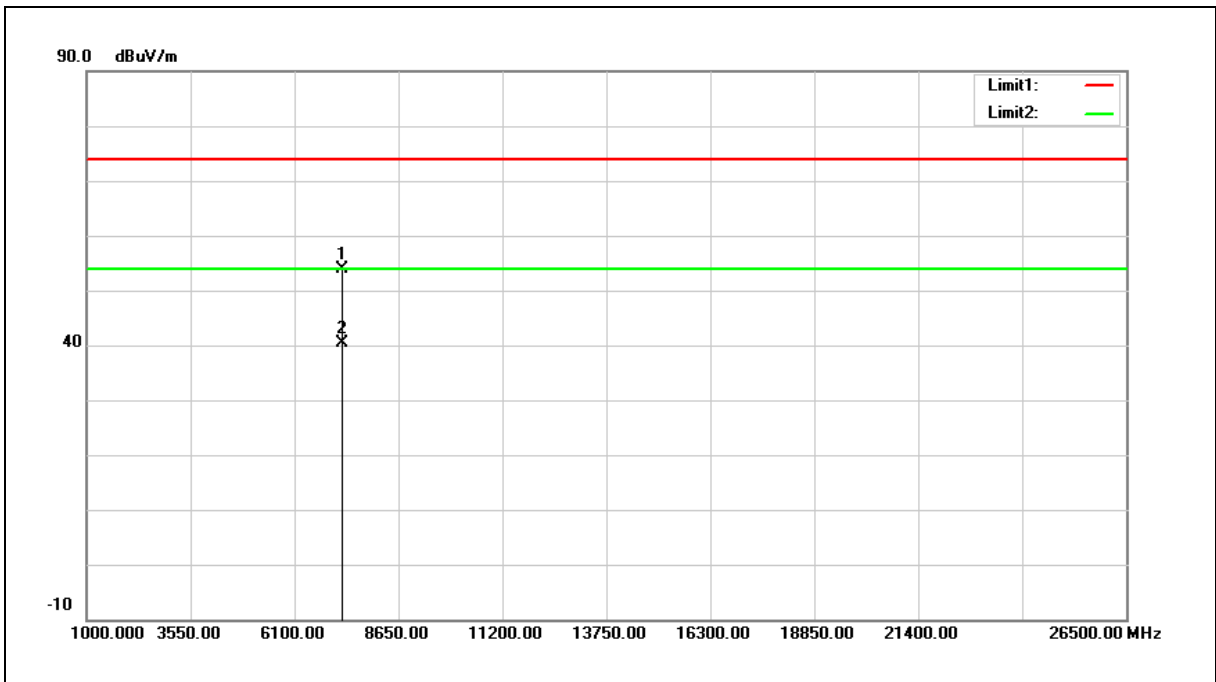

No.	Frequency (MHz)	Reading (dBuV)	Correct Factor (dB/m)	Result (dBuV/m)	Limit (dBuV/m)	Margin (dB)	Remark
1	7266.000	42.63	11.35	53.98	74.00	-20.02	peak
2	7266.000	29.11	11.35	40.46	54.00	-13.54	AVG

Note:1.Result (dBuV/m) = Correct Factor (dB/m) + Reading(dBuV).

2.Correction factor (dB/m) = Antenna Factor (dB/m) + Cable loss (dB) – Pre-Amplifier gain (dB).

3.When the peak results are less than average limit, so not need to evaluate the average.



Standard:	FCC Part 15.247	Test Distance:	3m
Test item:	Harmonic	Power:	AC 120V/60Hz
Frequency:	2437MHz	Temp.(°C)/Hum.(%RH):	26(°C)/60%RH
Mode:	Mode 5		
Ant.Polar.:	Horizontal		

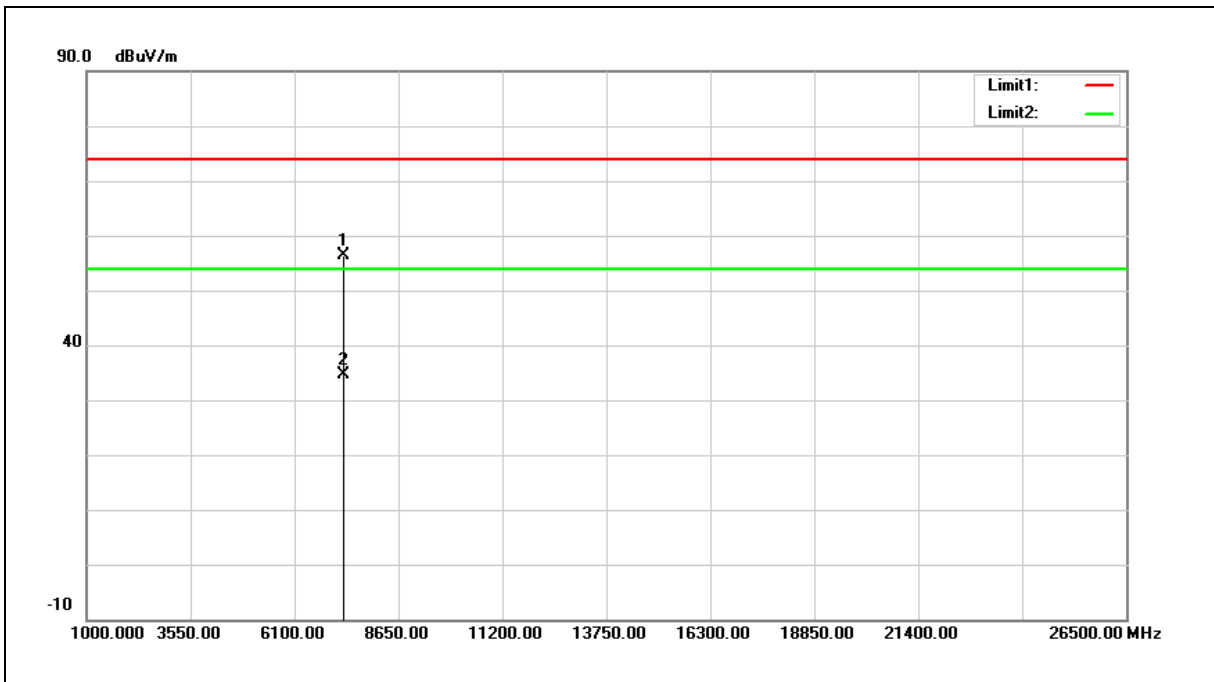

No.	Frequency (MHz)	Reading (dBuV)	Correct Factor (dB/m)	Result (dBuV/m)	Limit (dBuV/m)	Margin (dB)	Remark
1	7311.000	44.97	11.46	56.43	74.00	-17.57	peak
2	7311.000	23.28	11.46	34.74	54.00	-19.26	AVG

Note:1.Result (dBuV/m) = Correct Factor (dB/m) + Reading(dBuV).

2.Correction factor (dB/m) = Antenna Factor (dB/m) + Cable loss (dB) – Pre-Amplifier gain (dB).

3.When the peak results are less than average limit, so not need to evaluate the average.



Standard:	FCC Part 15.247	Test Distance:	3m
Test item:	Harmonic	Power:	AC 120V/60Hz
Frequency:	2437MHz	Temp.(°C)/Hum.(%RH):	26(°C)/60%RH
Mode:	Mode 5		
Ant.Polar.:	Vertical		

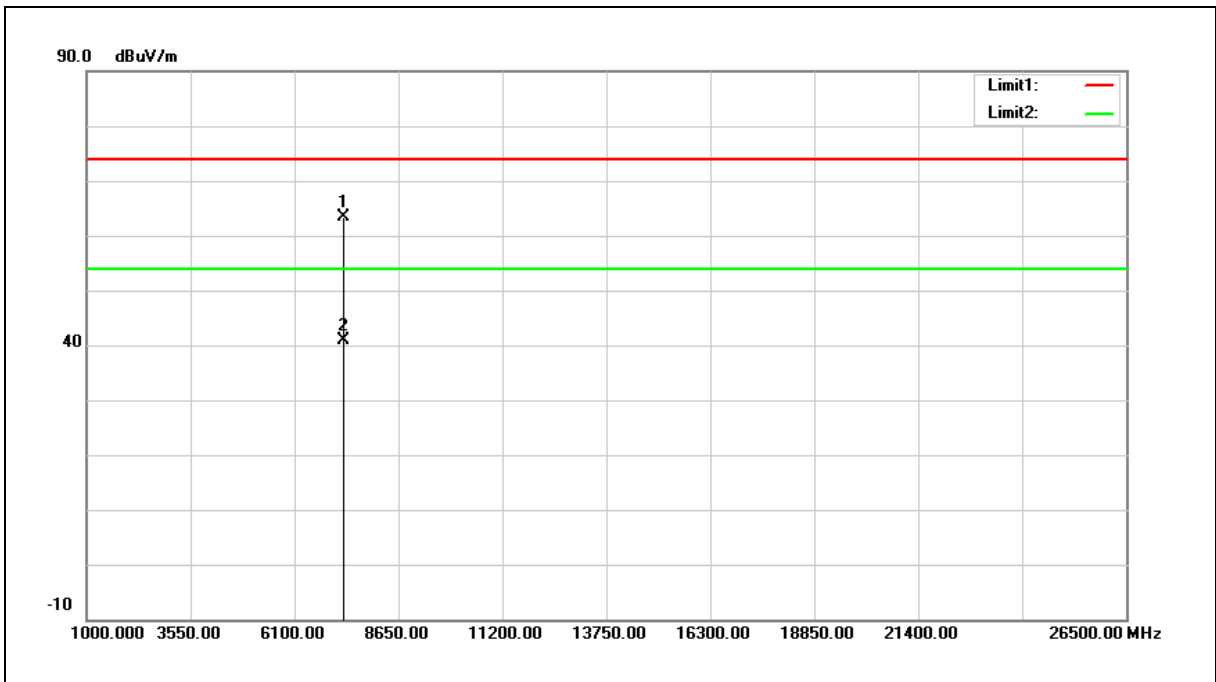

No.	Frequency (MHz)	Reading (dBuV)	Correct Factor (dB/m)	Result (dBuV/m)	Limit (dBuV/m)	Margin (dB)	Remark
1	7311.000	51.95	11.46	63.41	74.00	-10.59	peak
2	7311.000	29.47	11.46	40.93	54.00	-13.07	AVG

Note:1.Result (dBuV/m) = Correct Factor (dB/m) + Reading(dBuV).

2.Correction factor (dB/m) = Antenna Factor (dB/m) + Cable loss (dB) – Pre-Amplifier gain (dB).

3.When the peak results are less than average limit, so not need to evaluate the average.



Standard:	FCC Part 15.247	Test Distance:	3m
Test item:	Harmonic	Power:	AC 120V/60Hz
Frequency:	2452MHz	Temp.(°C)/Hum. (%RH):	26(°C)/60%RH
Mode:	Mode 5		
Ant.Polar.:	Horizontal		

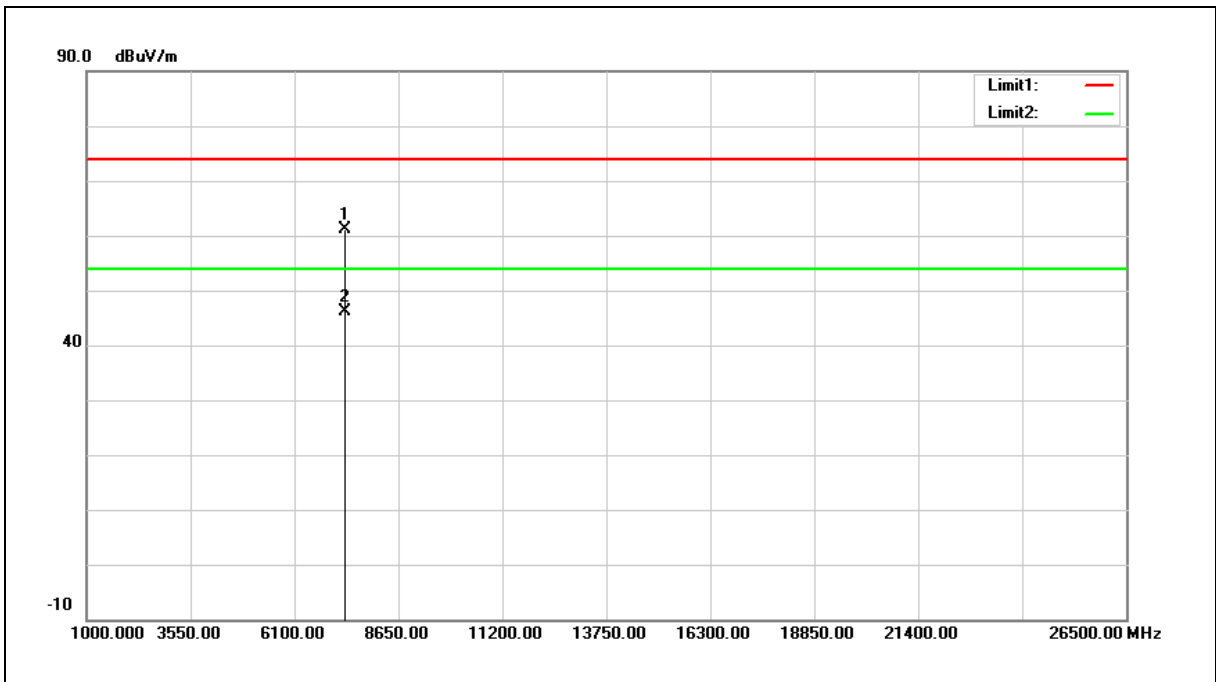

No.	Frequency (MHz)	Reading (dBuV)	Correct Factor (dB/m)	Result (dBuV/m)	Limit (dBuV/m)	Margin (dB)	Remark
1	7356.000	49.53	11.58	61.11	74.00	-12.89	peak
2	7356.000	34.67	11.58	46.25	54.00	-7.75	AVG

Note: 1. Result (dBuV/m) = Correct Factor (dB/m) + Reading(dBuV).

2. Correction factor (dB/m) = Antenna Factor (dB/m) + Cable loss (dB) – Pre-Amplifier gain (dB).

3. When the peak results are less than average limit, so not need to evaluate the average.



Standard:	FCC Part 15.247	Test Distance:	3m
Test item:	Harmonic	Power:	AC 120V/60Hz
Frequency:	2452MHz	Temp.(°C)/Hum.(%RH):	26(°C)/60%RH
Mode:	Mode 5		
Ant.Polar.:	Vertical		

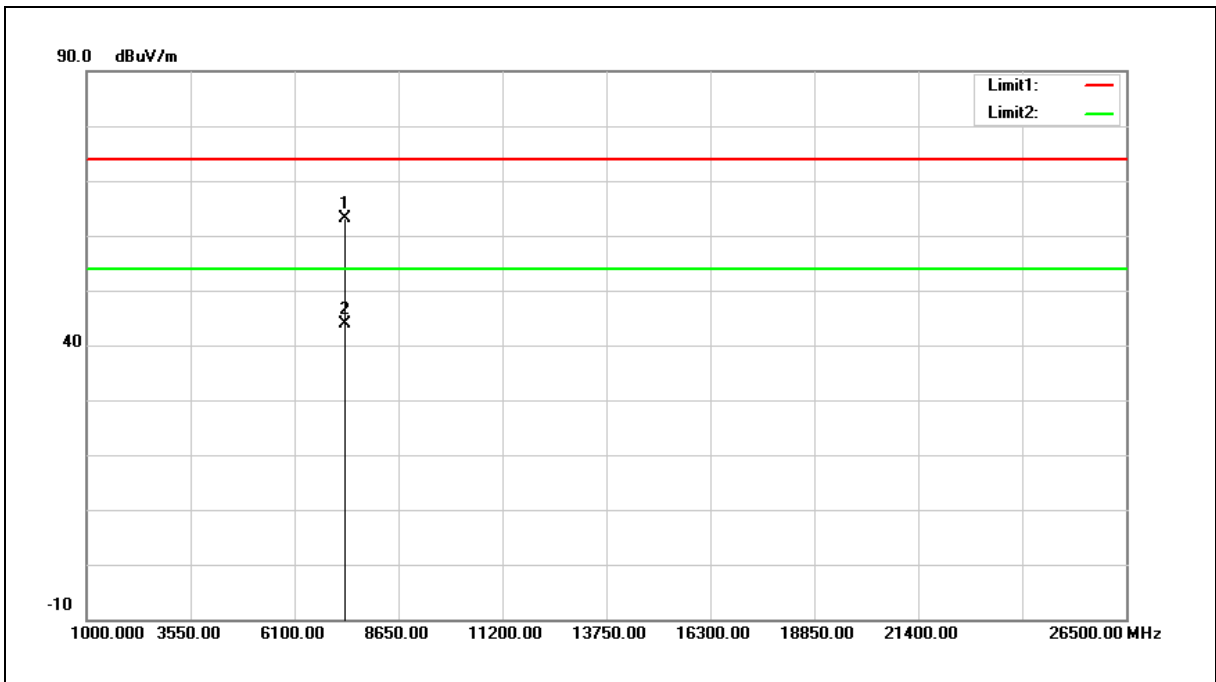

No.	Frequency (MHz)	Reading (dBuV)	Correct Factor (dB/m)	Result (dBuV/m)	Limit (dBuV/m)	Margin (dB)	Remark
1	7356.000	51.54	11.58	63.12	74.00	-10.88	peak
2	7356.000	32.23	11.58	43.81	54.00	-10.19	AVG

Note:1.Result (dBuV/m) = Correct Factor (dB/m) + Reading(dBuV).

2.Correction factor (dB/m) = Antenna Factor (dB/m) + Cable loss (dB) – Pre-Amplifier gain (dB).

3.When the peak results are less than average limit, so not need to evaluate the average.

Standard:	LP0002	Test Distance:	3m
Test item:	Harmonic	Power:	AC 120V/60Hz
Mode:	Simultaneous Transmitting (DTS+NII)	Temp.(°C)/Hum.(%RH):	26(°C)/60%RH
Ant.Polar.:	Horizontal		

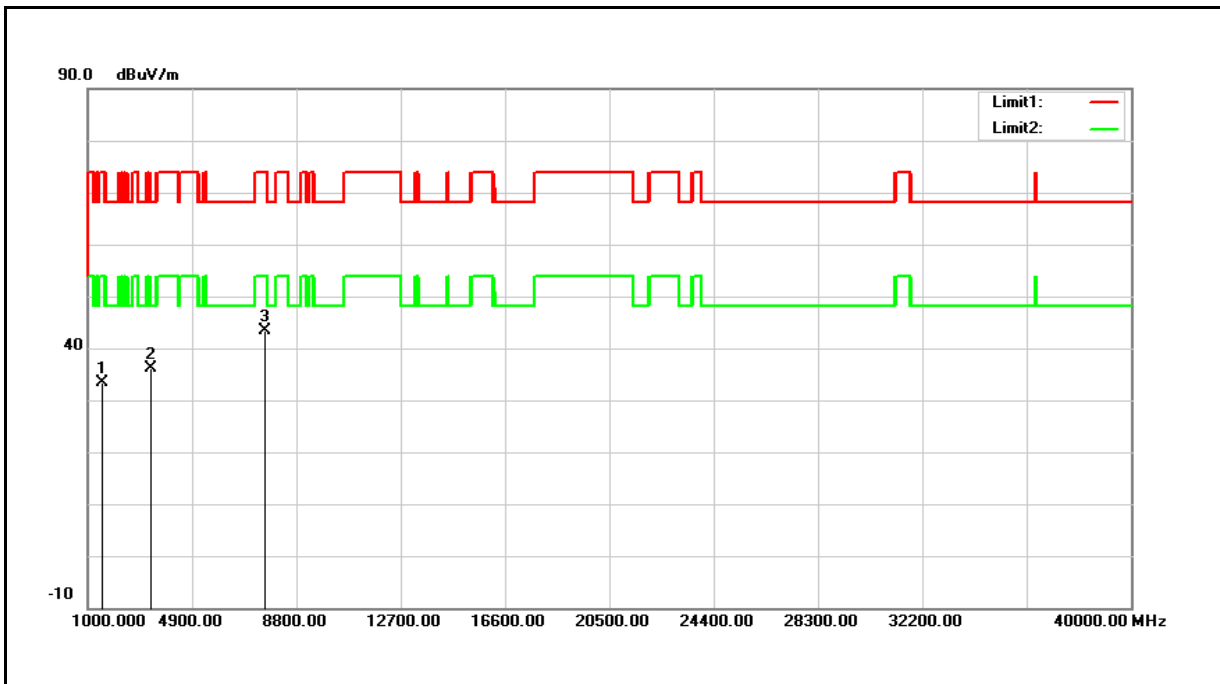

No.	Frequency (MHz)	Reading (dBuV)	Correct Factor (dB/m)	Result (dBuV/m)	Limit (dBuV/m)	Margin (dB)	Remark
1	1510.000	39.05	-5.60	33.45	74.00	-40.55	peak
2	3346.000	35.24	0.78	36.02	74.00	-37.98	peak
3	7613.000	31.36	12.12	43.48	74.00	-30.52	peak

Note:1.Result (dBuV/m) = Correct Factor (dB/m) + Reading(dBuV).

2.Correction factor (dB/m) = Antenna Factor (dB/m) + Cable loss (dB) – Pre-Amplifier gain (dB).

3.When the peak results are less than average limit, so not need to evaluate the average.

Standard:	LP0002	Test Distance:	3m
Test item:	Harmonic	Power:	AC 120V/60Hz
Mode:	Simultaneous Transmitting (DTS+NII)	Temp.(°C)/Hum.(%RH):	26(°C)/60%RH
Ant.Polar.:	Vertical		

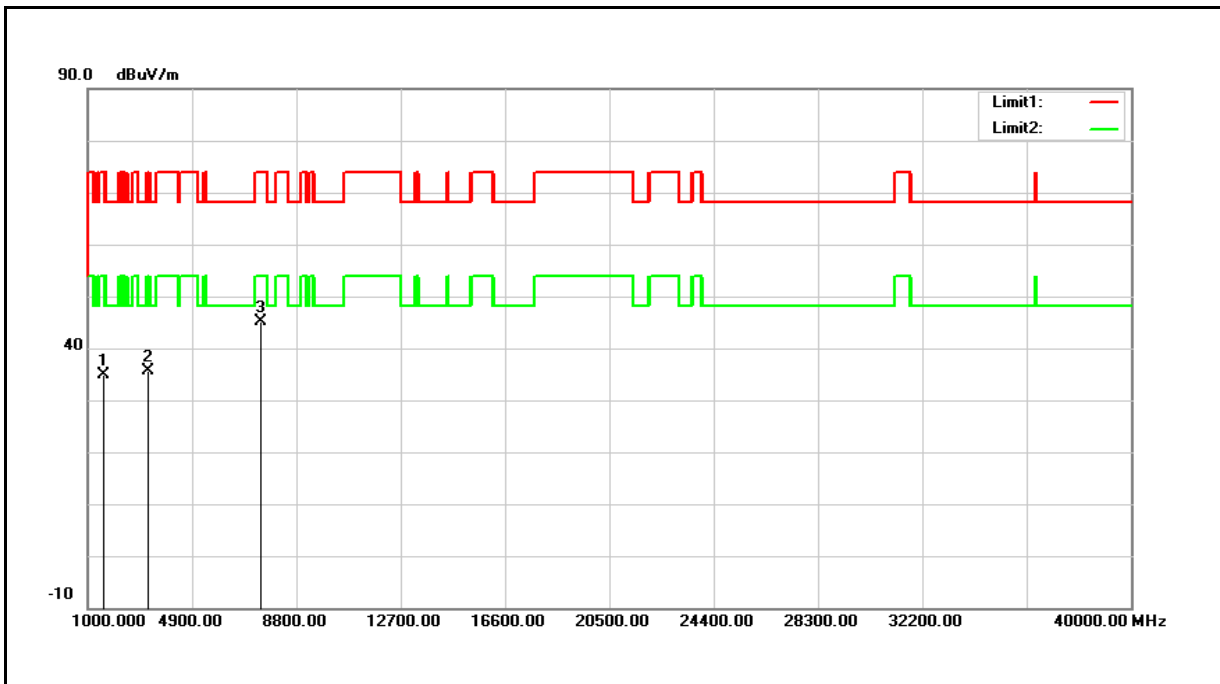

No.	Frequency (MHz)	Reading (dBuV)	Correct Factor (dB/m)	Result (dBuV/m)	Limit (dBuV/m)	Margin (dB)	Remark
1	1561.000	40.21	-5.35	34.86	74.00	-39.14	peak
2	3261.000	35.07	0.61	35.68	74.00	-38.32	peak
3	7443.000	33.24	11.80	45.04	74.00	-28.96	peak

Note:1.Result (dBuV/m) = Correct Factor (dB/m) + Reading(dBuV).

2.Correction factor (dB/m) = Antenna Factor (dB/m) + Cable loss (dB) – Pre-Amplifier gain (dB).

3.When the peak results are less than average limit, so not need to evaluate the average.

Band Edge

Standard:	FCC Part 15.247	Test Distance:	3m
Test item:	Band edge	Power:	AC 120V/60Hz
Frequency:	2412MHz	Temp.(°C)/Hum.(%RH):	26(°C)/60%RH
Mode:	Mode 2		
Ant.Polar.:	Horizontal		

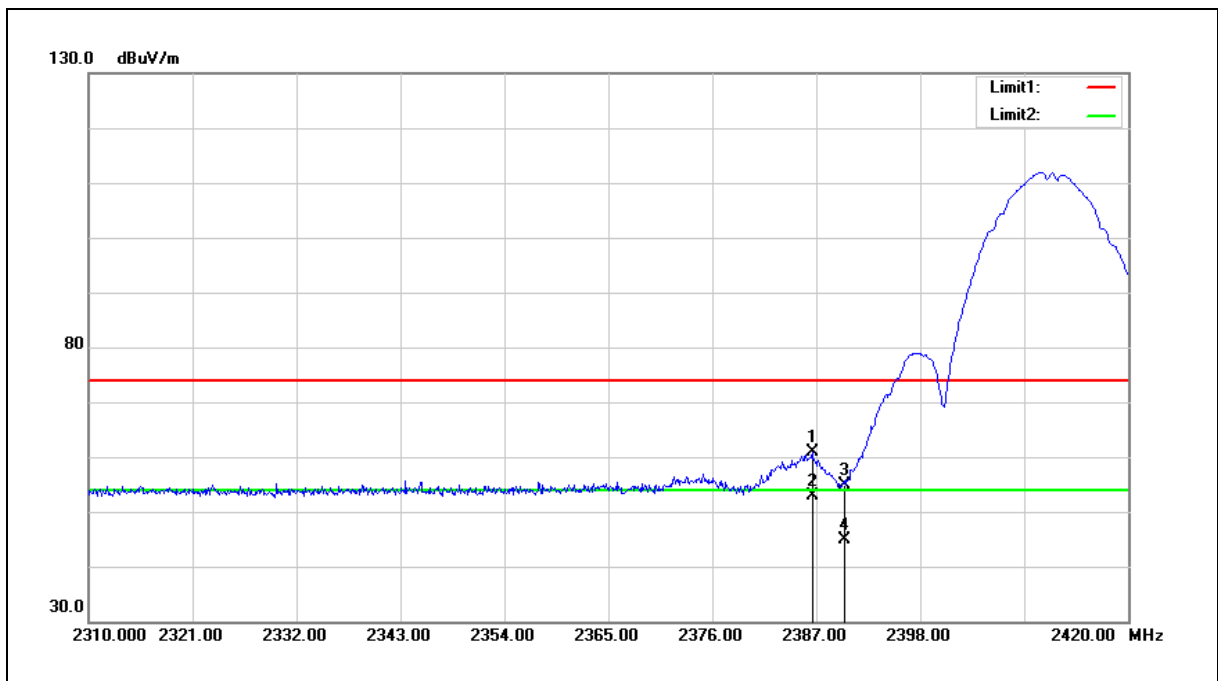

No.	Frequency (MHz)	Reading (dBuV)	Correct Factor (dB/m)	Result (dBuV/m)	Limit (dBuV/m)	Margin (dB)	Remark
1	2386.560	62.65	-1.84	60.81	74.00	-13.19	peak
2	2386.560	54.74	-1.84	52.90	54.00	-1.10	AVG
3	2390.000	56.73	-1.84	54.89	74.00	-19.11	peak
4	2390.000	46.61	-1.84	44.77	54.00	-9.23	AVG

Note:1.Result (dBuV/m) = Correct Factor (dB/m) + Reading(dBuV).

2.Correction factor (dB/m) = Antenna Factor (dB/m) + Cable loss (dB) – Pre-Amplifier gain (dB).

3.When the peak results are less than average limit, so not need to evaluate the average.



Standard:	FCC Part 15.247	Test Distance:	3m
Test item:	Band edge	Power:	AC 120V/60Hz
Frequency:	2412MHz	Temp.(°C)/Hum.(%RH):	26(°C)/60%RH
Mode:	Mode 2		
Ant.Polar.:	Vertical		

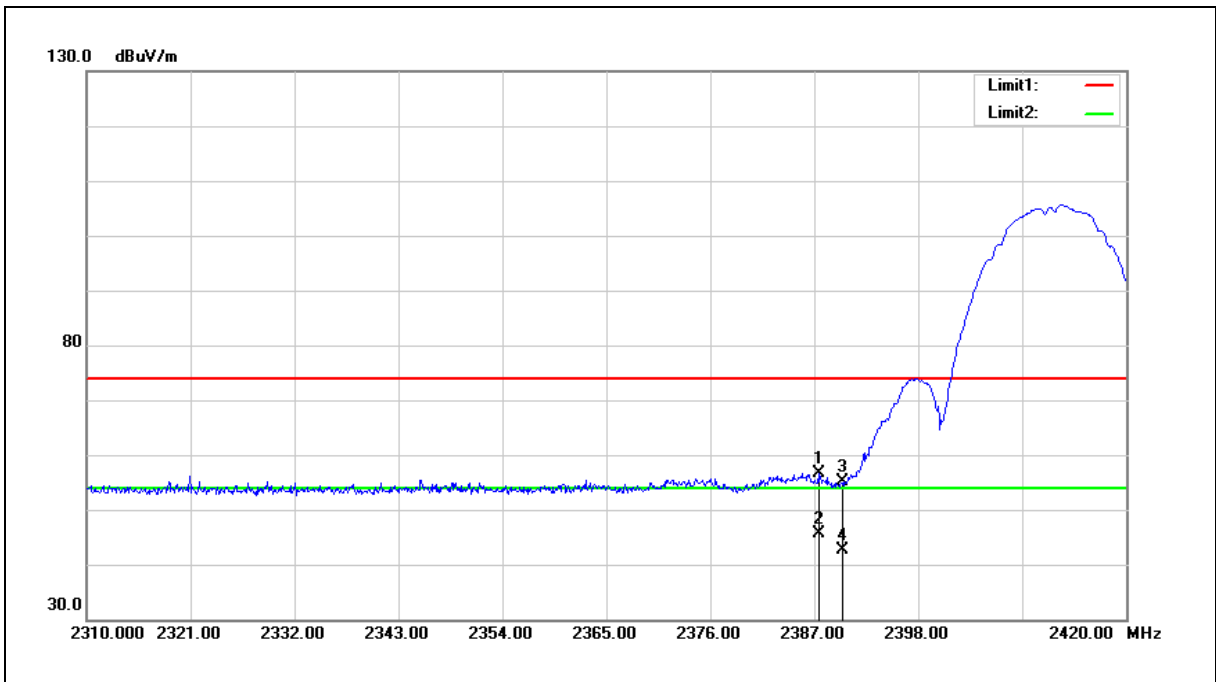

No.	Frequency (MHz)	Reading (dBuV)	Correct Factor (dB/m)	Result (dBuV/m)	Limit (dBuV/m)	Margin (dB)	Remark
1	2387.440	58.47	-1.84	56.63	74.00	-17.37	peak
2	2387.440	47.35	-1.84	45.51	54.00	-8.49	AVG
3	2390.000	56.86	-1.84	55.02	74.00	-18.98	peak
4	2390.000	44.38	-1.84	42.54	54.00	-11.46	AVG

Note:1.Result (dBuV/m) = Correct Factor (dB/m) + Reading(dBuV).

2.Correction factor (dB/m) = Antenna Factor (dB/m) + Cable loss (dB) – Pre-Amplifier gain (dB).

3.When the peak results are less than average limit, so not need to evaluate the average.



Standard:	FCC Part 15.247	Test Distance:	3m
Test item:	Band edge	Power:	AC 120V/60Hz
Frequency:	2437MHz	Temp.(°C)/Hum.(%RH):	26(°C)/60%RH
Mode:	Mode 2		
Ant.Polar.:	Horizontal		

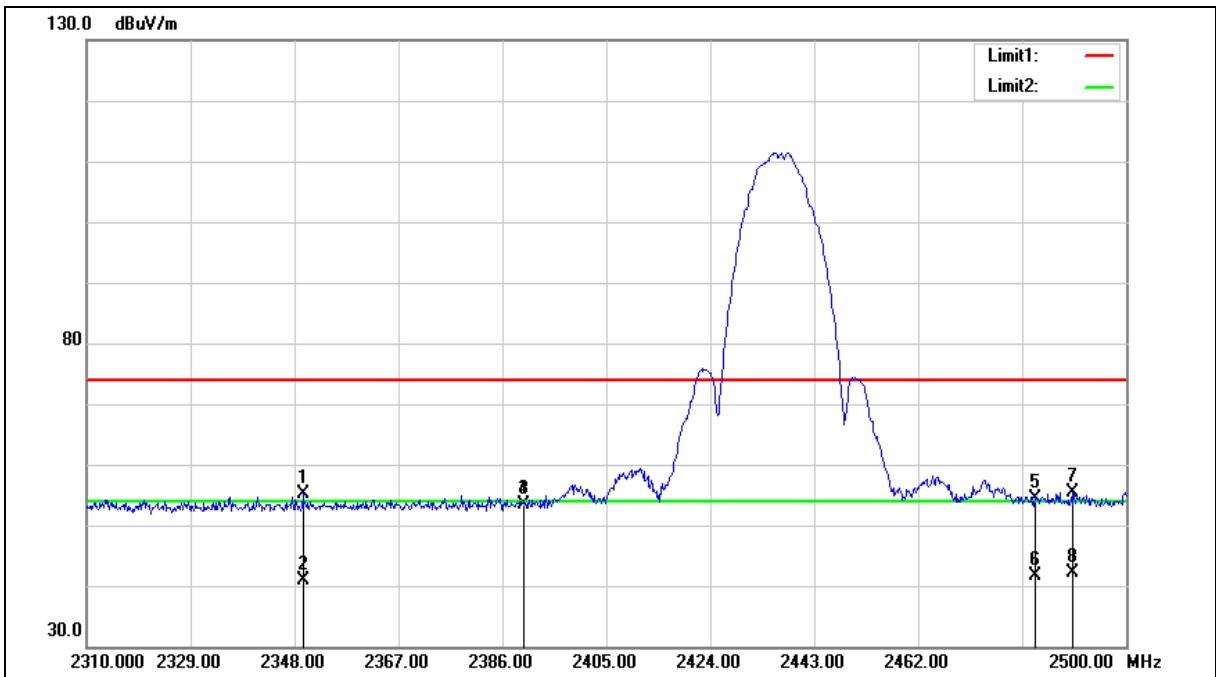



Standard:	FCC Part 15.247	Test Distance:	3m
Test item:	Band edge	Power:	AC 120V/60Hz
Frequency:	2437MHz	Temp.(°C)/Hum.(%RH):	26(°C)/60%RH
Mode:	Mode 2		
Ant.Polar.:	Horizontal		

No.	Frequency (MHz)	Reading (dBuV)	Correct Factor (dB/m)	Result (dBuV/m)	Limit (dBuV/m)	Margin (dB)	Remark
1	2349.520	57.16	-1.98	55.18	74.00	-18.82	peak
2	2349.520	42.93	-1.98	40.95	54.00	-13.05	AVG
3	2390.000	55.25	-1.84	53.41	74.00	-20.59	peak
4	2390.000	55.25	-1.84	53.41	54.00	-0.59	AVG
5	2483.500	55.97	-1.47	54.50	74.00	-19.50	peak
6	2483.500	43.22	-1.47	41.75	54.00	-12.25	AVG
7	2490.120	56.94	-1.44	55.50	74.00	-18.50	peak
8	2490.120	43.52	-1.44	42.08	54.00	-11.92	AVG

Note:1.Result (dBuV/m) = Correct Factor (dB/m) + Reading(dBuV).

2.Correction factor (dB/m) = Antenna Factor (dB/m) + Cable loss (dB) – Pre-Amplifier gain (dB).

3.When the peak results are less than average limit, so not need to evaluate the average.



Standard:	FCC Part 15.247	Test Distance:	3m
Test item:	Band edge	Power:	AC 120V/60Hz
Frequency:	2437MHz	Temp.(°C)/Hum.(%RH):	26(°C)/60%RH
Mode:	Mode 2		
Ant.Polar.:	Vertical		

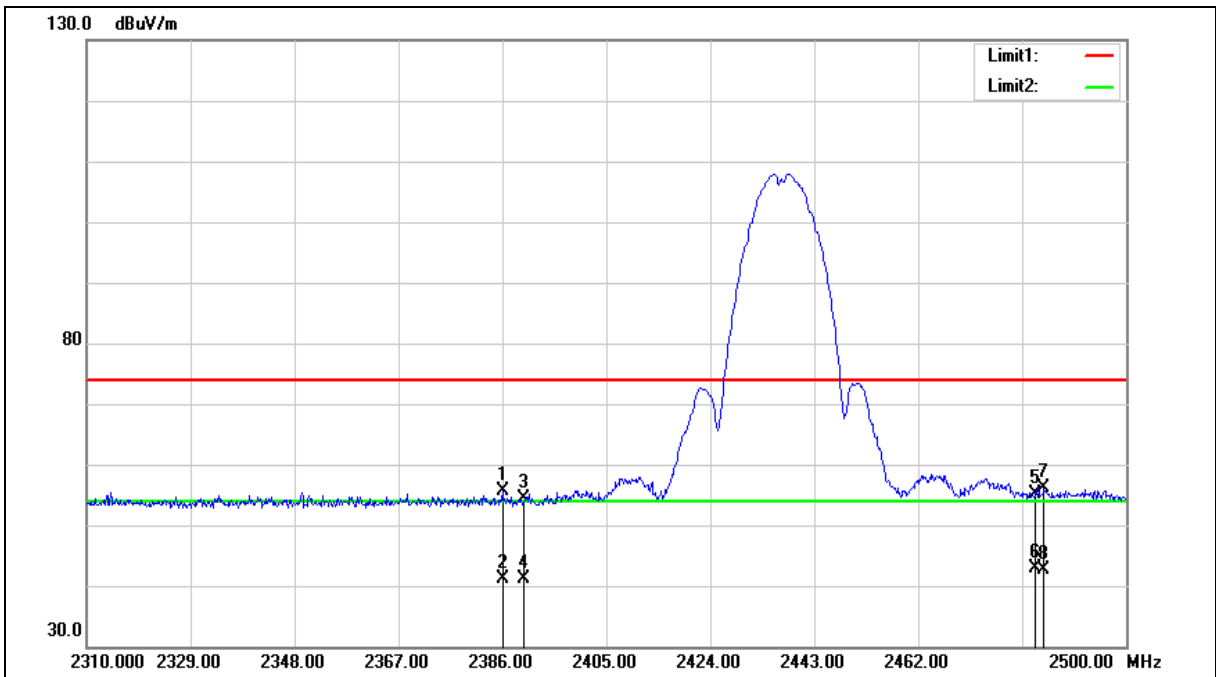



Standard:	FCC Part 15.247	Test Distance:	3m
Test item:	Band edge	Power:	AC 120V/60Hz
Frequency:	2437MHz	Temp.(°C)/Hum.(%RH):	26(°C)/60%RH
Mode:	Mode 2		
Ant.Polar.:	Vertical		

No.	Frequency (MHz)	Reading (dBuV)	Correct Factor (dB/m)	Result (dBuV/m)	Limit (dBuV/m)	Margin (dB)	Remark
1	2386.000	57.37	-1.84	55.53	74.00	-18.47	peak
2	2386.000	42.90	-1.84	41.06	54.00	-12.94	AVG
3	2390.000	56.19	-1.84	54.35	74.00	-19.65	peak
4	2390.000	43.07	-1.84	41.23	54.00	-12.77	AVG
5	2483.500	56.52	-1.47	55.05	74.00	-18.95	peak
6	2483.500	44.27	-1.47	42.80	54.00	-11.20	AVG
7	2484.990	57.60	-1.46	56.14	74.00	-17.86	peak
8	2484.990	44.15	-1.46	42.69	54.00	-11.31	AVG

Note:1.Result (dBuV/m) = Correct Factor (dB/m) + Reading(dBuV).

2.Correction factor (dB/m) = Antenna Factor (dB/m) + Cable loss (dB) – Pre-Amplifier gain (dB).

3.When the peak results are less than average limit, so not need to evaluate the average.



Standard:	FCC Part 15.247	Test Distance:	3m
Test item:	Band edge	Power:	AC 120V/60Hz
Frequency:	2462MHz	Temp.(°C)/Hum.(%RH):	26(°C)/60%RH
Mode:	Mode 2		
Ant.Polar.:	Horizontal		

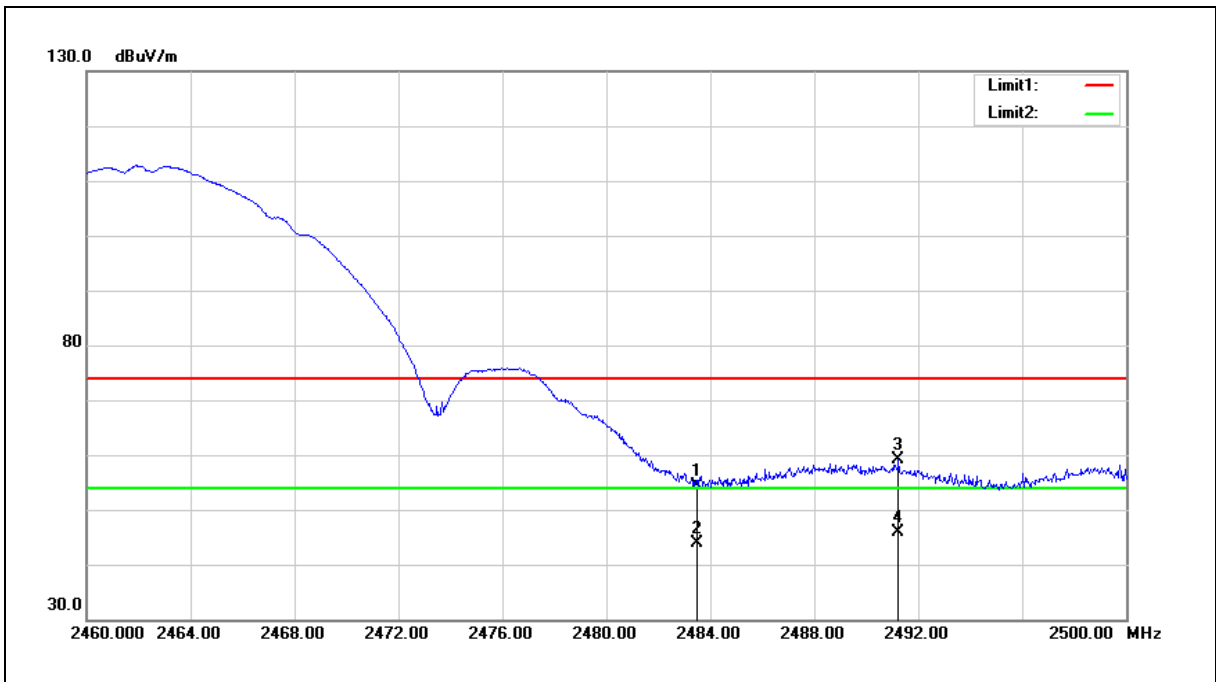

No.	Frequency (MHz)	Reading (dBuV)	Correct Factor (dB/m)	Result (dBuV/m)	Limit (dBuV/m)	Margin (dB)	Remark
1	2483.500	55.94	-1.47	54.47	74.00	-19.53	peak
2	2483.500	45.26	-1.47	43.79	54.00	-10.21	AVG
3	2491.240	60.55	-1.43	59.12	74.00	-14.88	peak
4	2491.240	47.37	-1.43	45.94	54.00	-8.06	AVG

Note:1.Result (dBuV/m) = Correct Factor (dB/m) + Reading(dBuV).

2.Correction factor (dB/m) = Antenna Factor (dB/m) + Cable loss (dB) – Pre-Amplifier gain (dB).

3.When the peak results are less than average limit, so not need to evaluate the average.



Standard:	FCC Part 15.247	Test Distance:	3m
Test item:	Band edge	Power:	AC 120V/60Hz
Frequency:	2462MHz	Temp.(°C)/Hum.(%RH):	26(°C)/60%RH
Mode:	Mode 2		
Ant.Polar.:	Vertical		

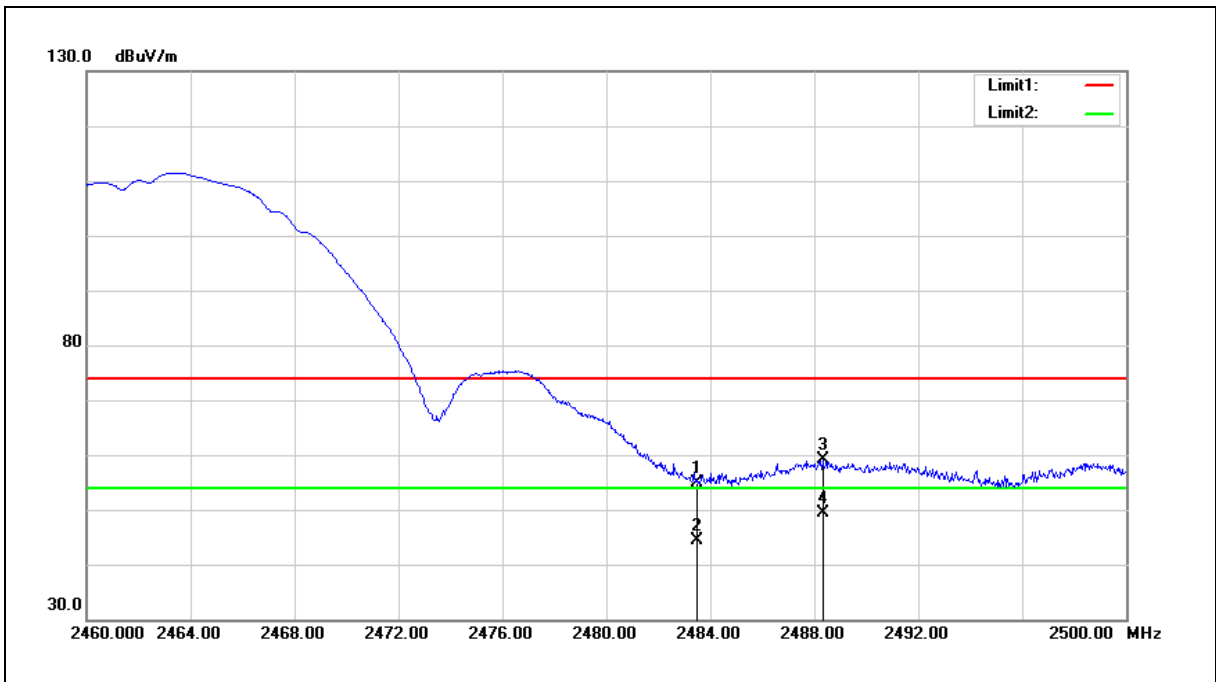

No.	Frequency (MHz)	Reading (dBuV)	Correct Factor (dB/m)	Result (dBuV/m)	Limit (dBuV/m)	Margin (dB)	Remark
1	2483.500	56.31	-1.47	54.84	74.00	-19.16	peak
2	2483.500	45.82	-1.47	44.35	54.00	-9.65	AVG
3	2488.320	60.51	-1.44	59.07	74.00	-14.93	peak
4	2488.320	50.87	-1.44	49.43	54.00	-4.57	AVG

Note:1.Result (dBuV/m) = Correct Factor (dB/m) + Reading(dBuV).

2.Correction factor (dB/m) = Antenna Factor (dB/m) + Cable loss (dB) – Pre-Amplifier gain (dB).

3.When the peak results are less than average limit, so not need to evaluate the average.



Standard:	FCC Part 15.247	Test Distance:	3m
Test item:	Band edge	Power:	AC 120V/60Hz
Frequency:	2412MHz	Temp.(°C)/Hum.(%RH):	26(°C)/60%RH
Mode:	Mode 3		
Ant.Polar.:	Horizontal		

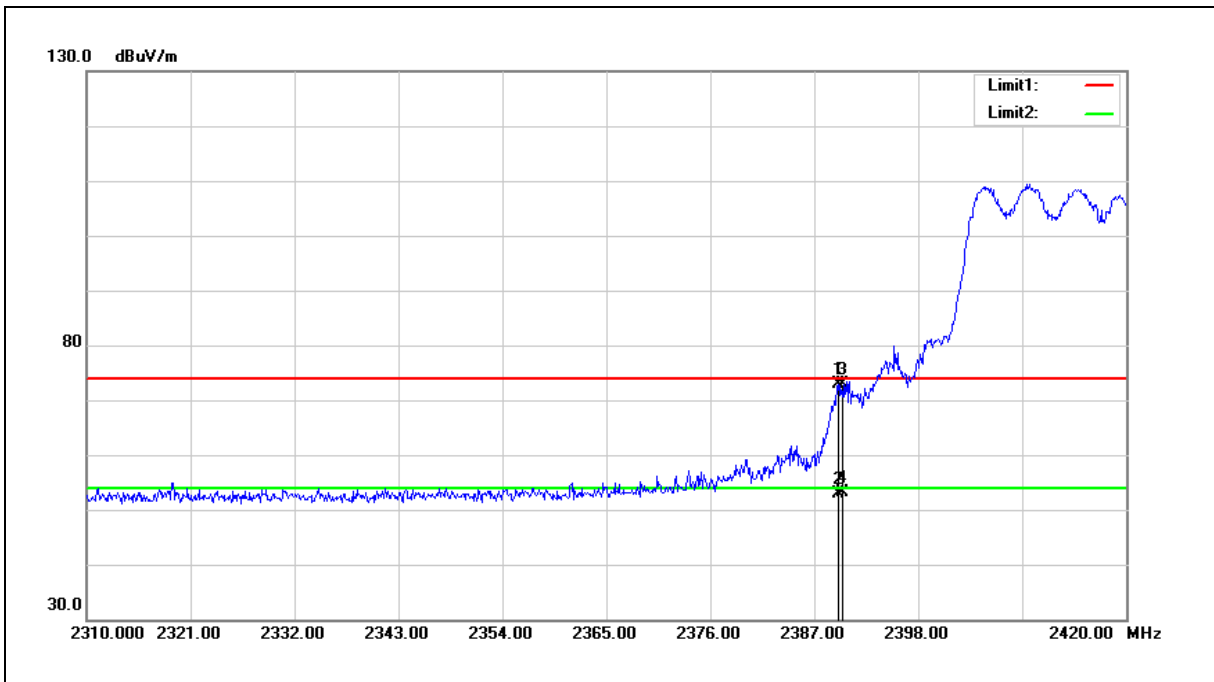

No.	Frequency (MHz)	Reading (dBuV)	Correct Factor (dB/m)	Result (dBuV/m)	Limit (dBuV/m)	Margin (dB)	Remark
1	2389.530	74.71	-1.84	72.87	74.00	-1.13	peak
2	2389.530	54.71	-1.84	52.87	54.00	-1.13	AVG
3	2390.000	74.66	-1.84	72.82	74.00	-1.18	peak
4	2390.000	55.05	-1.84	53.21	54.00	-0.79	AVG

Note:1.Result (dBuV/m) = Correct Factor (dB/m) + Reading(dBuV).

2.Correction factor (dB/m) = Antenna Factor (dB/m) + Cable loss (dB) – Pre-Amplifier gain (dB).

3.When the peak results are less than average limit, so not need to evaluate the average.



Standard:	FCC Part 15.247	Test Distance:	3m
Test item:	Band edge	Power:	AC 120V/60Hz
Frequency:	2412MHz	Temp.(°C)/Hum.(%RH):	26(°C)/60%RH
Mode:	Mode 3		
Ant.Polar.:	Vertical		

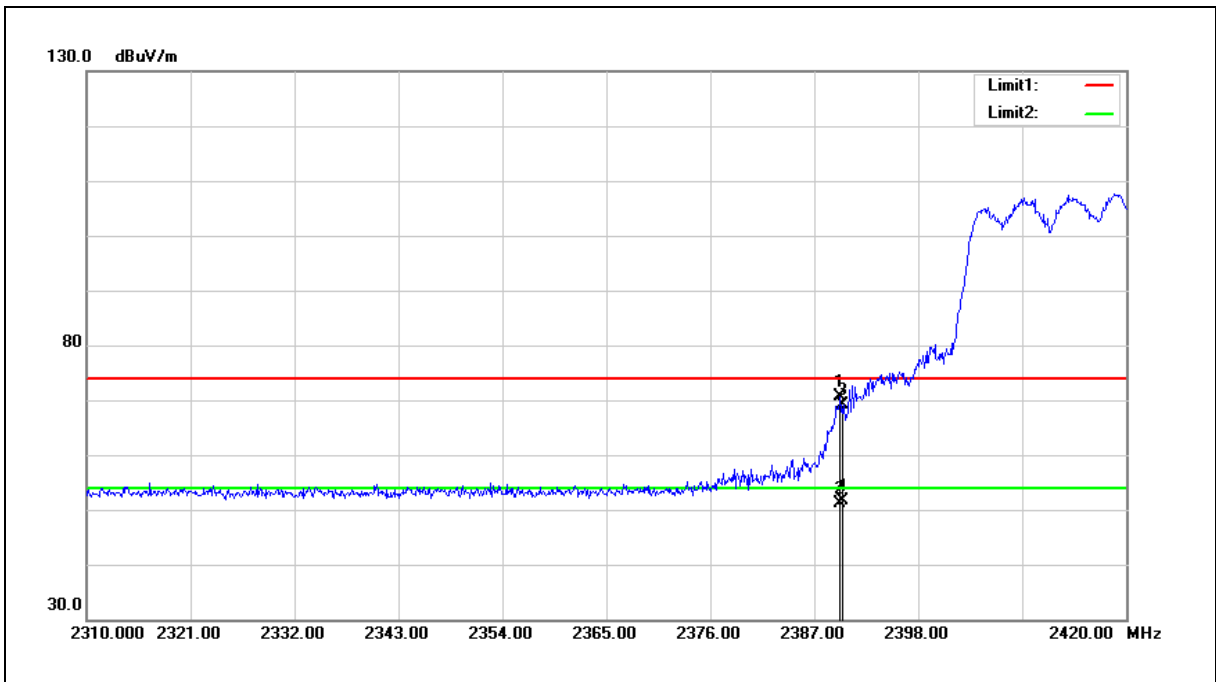

No.	Frequency (MHz)	Reading (dBuV)	Correct Factor (dB/m)	Result (dBuV/m)	Limit (dBuV/m)	Margin (dB)	Remark
1	2389.750	72.46	-1.84	70.62	74.00	-3.38	peak
2	2389.750	53.03	-1.84	51.19	54.00	-2.81	AVG
3	2390.000	71.05	-1.84	69.21	74.00	-4.79	peak
4	2390.000	53.58	-1.84	51.74	54.00	-2.26	AVG

Note:1.Result (dBuV/m) = Correct Factor (dB/m) + Reading(dBuV).

2.Correction factor (dB/m) = Antenna Factor (dB/m) + Cable loss (dB) – Pre-Amplifier gain (dB).

3.When the peak results are less than average limit, so not need to evaluate the average.



Standard:	FCC Part 15.247	Test Distance:	3m
Test item:	Band edge	Power:	AC 120V/60Hz
Frequency:	2437MHz	Temp.(°C)/Hum.(%RH):	26(°C)/60%RH
Mode:	Mode 3		
Ant.Polar.:	Horizontal		

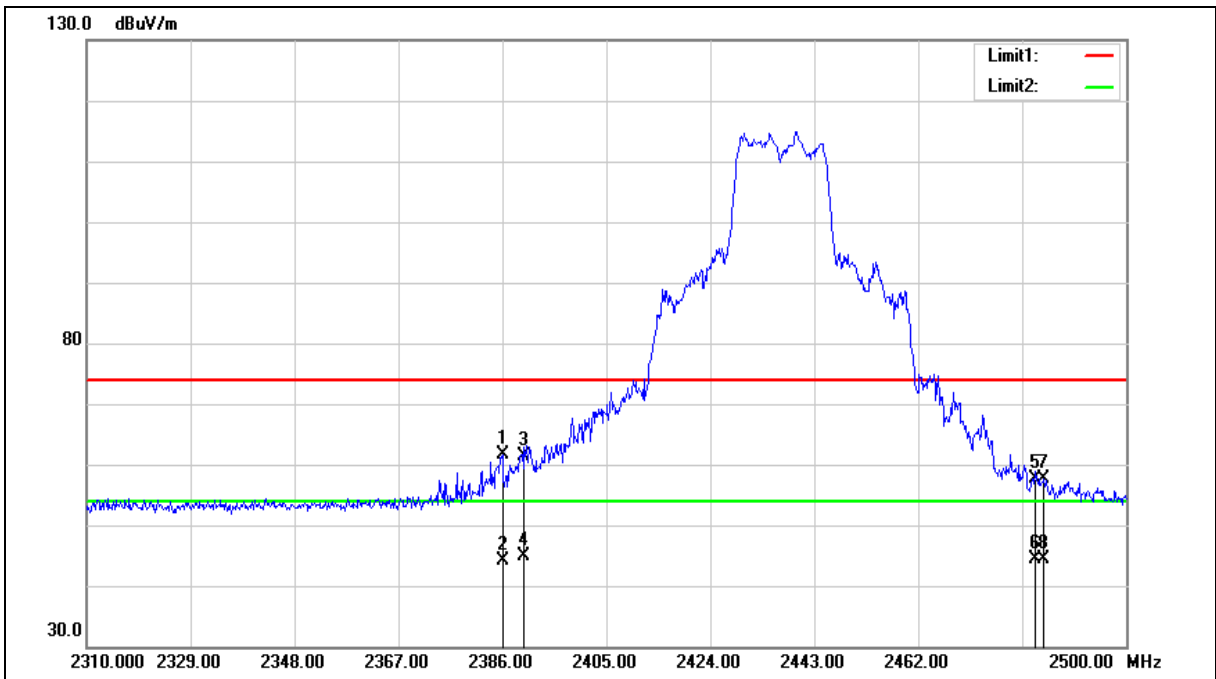



Standard:	FCC Part 15.247	Test Distance:	3m
Test item:	Band edge	Power:	AC 120V/60Hz
Frequency:	2437MHz	Temp.(°C)/Hum.(%RH):	26(°C)/60%RH
Mode:	Mode 3		
Ant.Polar.:	Horizontal		

No.	Frequency (MHz)	Reading (dBuV)	Correct Factor (dB/m)	Result (dBuV/m)	Limit (dBuV/m)	Margin (dB)	Remark
1	2386.000	63.42	-1.84	61.58	74.00	-12.42	peak
2	2386.000	45.88	-1.84	44.04	54.00	-9.96	AVG
3	2390.000	63.17	-1.84	61.33	74.00	-12.67	peak
4	2390.000	46.69	-1.84	44.85	54.00	-9.15	AVG
5	2483.500	59.13	-1.47	57.66	74.00	-16.34	peak
6	2483.500	45.74	-1.47	44.27	54.00	-9.73	AVG
7	2484.990	59.15	-1.46	57.69	74.00	-16.31	peak
8	2484.990	45.95	-1.46	44.49	54.00	-9.51	AVG

Note:1.Result (dBuV/m) = Correct Factor (dB/m) + Reading(dBuV).

2.Correction factor (dB/m) = Antenna Factor (dB/m) + Cable loss (dB) – Pre-Amplifier gain (dB).

3.When the peak results are less than average limit, so not need to evaluate the average.



Standard:	FCC Part 15.247	Test Distance:	3m
Test item:	Band edge	Power:	AC 120V/60Hz
Frequency:	2437MHz	Temp.(°C)/Hum.(%RH):	26(°C)/60%RH
Mode:	Mode 3		
Ant.Polar.:	Vertical		

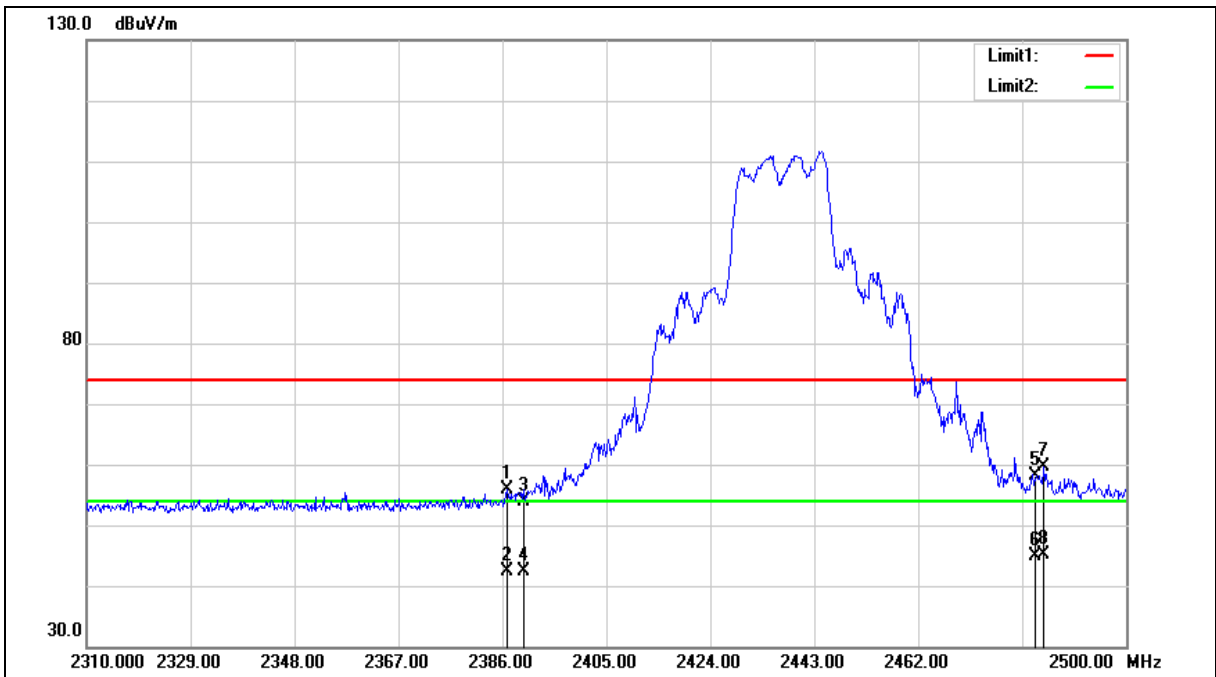



Standard:	FCC Part 15.247	Test Distance:	3m
Test item:	Band edge	Power:	AC 120V/60Hz
Frequency:	2437MHz	Temp.(°C)/Hum.(%RH):	26(°C)/60%RH
Mode:	Mode 3		
Ant.Polar.:	Vertical		

No.	Frequency (MHz)	Reading (dBuV)	Correct Factor (dB/m)	Result (dBuV/m)	Limit (dBuV/m)	Margin (dB)	Remark
1	2386.950	57.72	-1.84	55.88	74.00	-18.12	peak
2	2386.950	44.26	-1.84	42.42	54.00	-11.58	AVG
3	2390.000	55.84	-1.84	54.00	74.00	-20.00	peak
4	2390.000	44.14	-1.84	42.30	54.00	-11.70	AVG
5	2483.500	59.50	-1.47	58.03	74.00	-15.97	peak
6	2483.500	46.42	-1.47	44.95	54.00	-9.05	AVG
7	2484.990	61.06	-1.46	59.60	74.00	-14.40	peak
8	2484.990	46.70	-1.46	45.24	54.00	-8.76	AVG

Note:1.Result (dBuV/m) = Correct Factor (dB/m) + Reading(dBuV).

2.Correction factor (dB/m) = Antenna Factor (dB/m) + Cable loss (dB) – Pre-Amplifier gain (dB).

3.When the peak results are less than average limit, so not need to evaluate the average.



Standard:	FCC Part 15.247	Test Distance:	3m
Test item:	Band edge	Power:	AC 120V/60Hz
Frequency:	2462MHz	Temp.(°C)/Hum.(%RH):	26(°C)/60%RH
Mode:	Mode 3		
Ant.Polar.:	Horizontal		

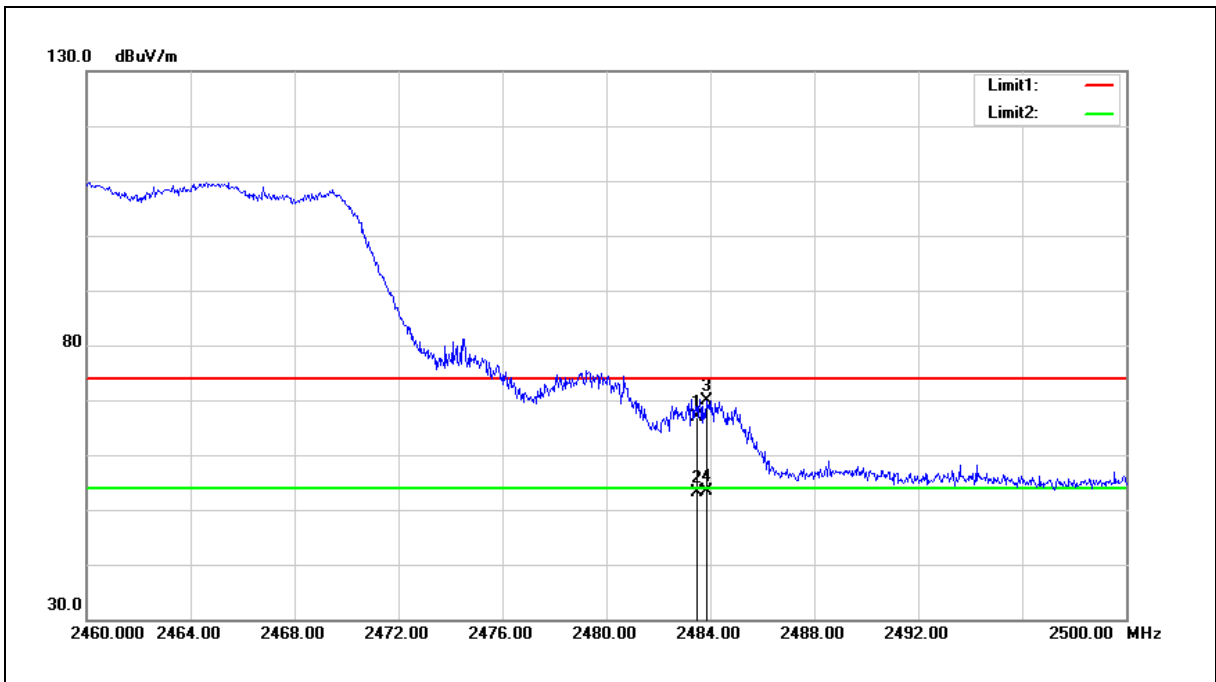

No.	Frequency (MHz)	Reading (dBuV)	Correct Factor (dB/m)	Result (dBuV/m)	Limit (dBuV/m)	Margin (dB)	Remark
1	2483.500	68.38	-1.47	66.91	74.00	-7.09	peak
2	2483.500	54.63	-1.47	53.16	54.00	-0.84	AVG
3	2483.840	71.37	-1.47	69.90	74.00	-4.10	peak
4	2483.840	54.74	-1.47	53.27	54.00	-0.73	AVG

Note:1.Result (dBuV/m) = Correct Factor (dB/m) + Reading(dBuV).

2.Correction factor (dB/m) = Antenna Factor (dB/m) + Cable loss (dB) – Pre-Amplifier gain (dB).

3.When the peak results are less than average limit, so not need to evaluate the average.



Standard:	FCC Part 15.247	Test Distance:	3m
Test item:	Band edge	Power:	AC 120V/60Hz
Frequency:	2462MHz	Temp.(°C)/Hum.(%RH):	26(°C)/60%RH
Mode:	Mode 3		
Ant.Polar.:	Vertical		

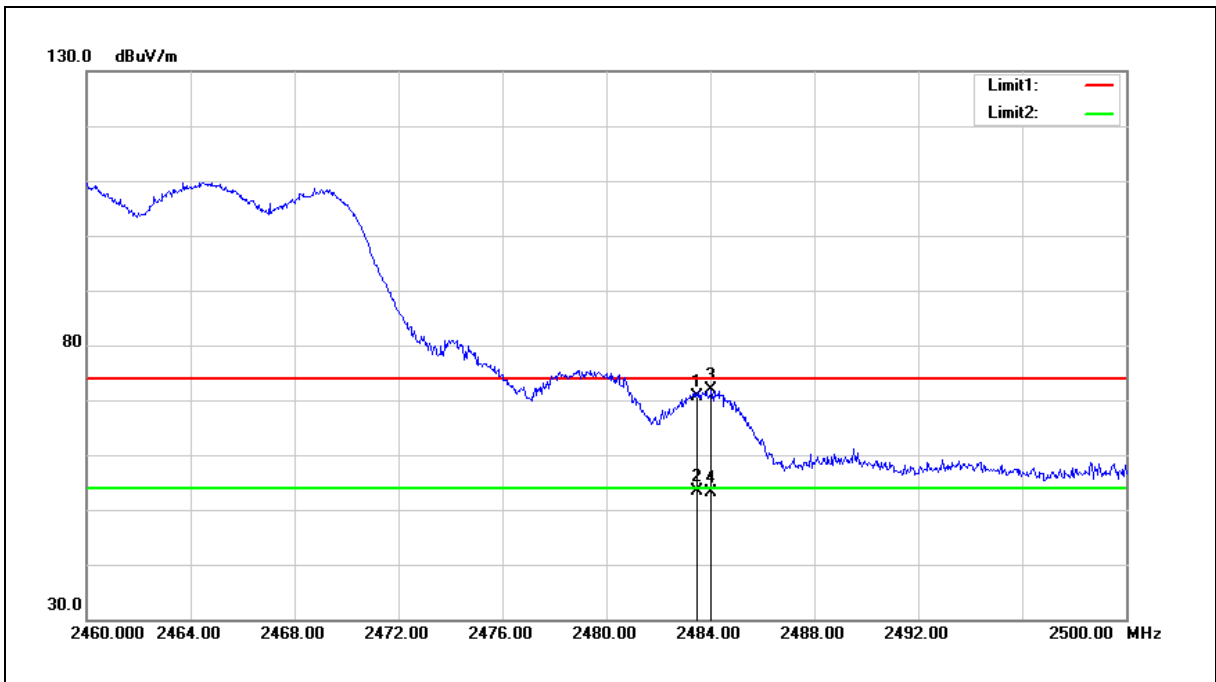

No.	Frequency (MHz)	Reading (dBuV)	Correct Factor (dB/m)	Result (dBuV/m)	Limit (dBuV/m)	Margin (dB)	Remark
1	2483.500	72.22	-1.47	70.75	74.00	-3.25	peak
2	2483.500	54.77	-1.47	53.30	54.00	-0.70	AVG
3	2484.040	73.23	-1.46	71.77	74.00	-2.23	peak
4	2484.040	54.63	-1.46	53.17	54.00	-0.83	AVG

Note:1.Result (dBuV/m) = Correct Factor (dB/m) + Reading(dBuV).

2.Correction factor (dB/m) = Antenna Factor (dB/m) + Cable loss (dB) – Pre-Amplifier gain (dB).

3.When the peak results are less than average limit, so not need to evaluate the average.



Standard:	FCC Part 15.247	Test Distance:	3m
Test item:	Band edge	Power:	AC 120V/60Hz
Frequency:	2412MHz	Temp.(°C)/Hum.(%RH):	26(°C)/60%RH
Mode:	Mode 4		
Ant.Polar.:	Horizontal		

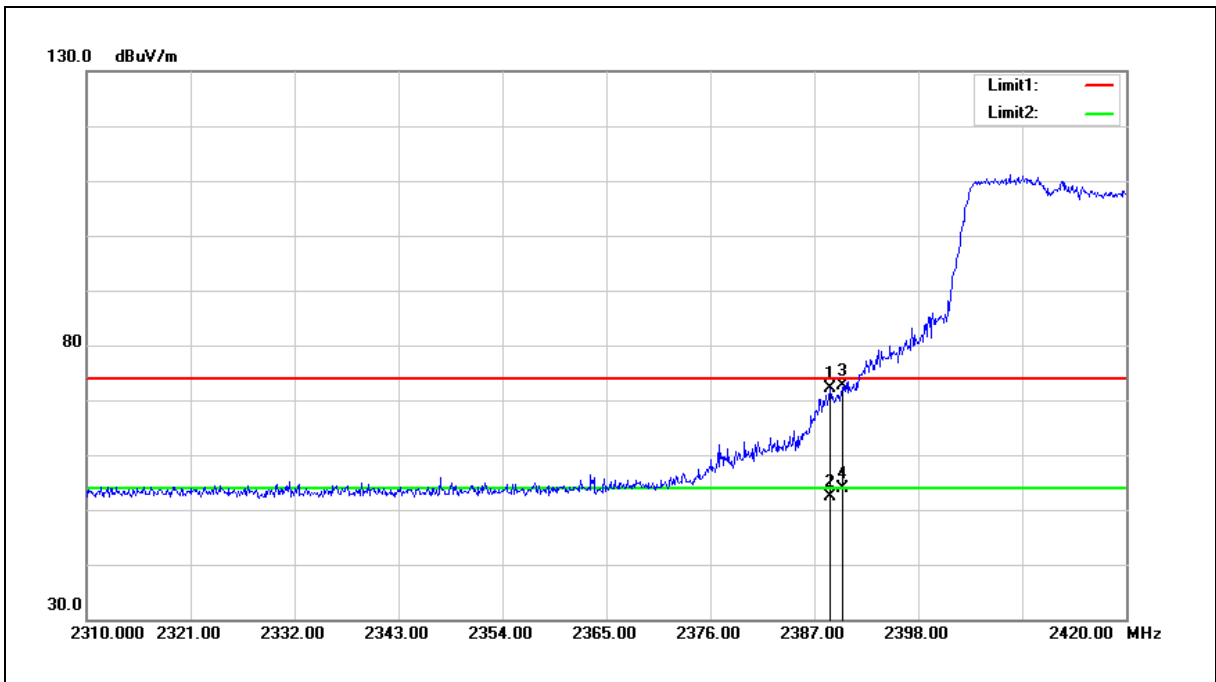

No.	Frequency (MHz)	Reading (dBuV)	Correct Factor (dB/m)	Result (dBuV/m)	Limit (dBuV/m)	Margin (dB)	Remark
1	2388.650	74.07	-1.83	72.24	74.00	-1.76	peak
2	2388.650	54.12	-1.83	52.29	54.00	-1.71	AVG
3	2390.000	74.51	-1.84	72.67	74.00	-1.33	peak
4	2390.000	55.62	-1.84	53.78	54.00	-0.22	AVG

Note:1.Result (dBuV/m) = Correct Factor (dB/m) + Reading(dBuV).

2.Correction factor (dB/m) = Antenna Factor (dB/m) + Cable loss (dB) – Pre-Amplifier gain (dB).

3.When the peak results are less than average limit, so not need to evaluate the average.



Standard:	FCC Part 15.247	Test Distance:	3m
Test item:	Band edge	Power:	AC 120V/60Hz
Frequency:	2412MHz	Temp.(°C)/Hum.(%RH):	26(°C)/60%RH
Mode:	Mode 4		
Ant.Polar.:	Vertical		

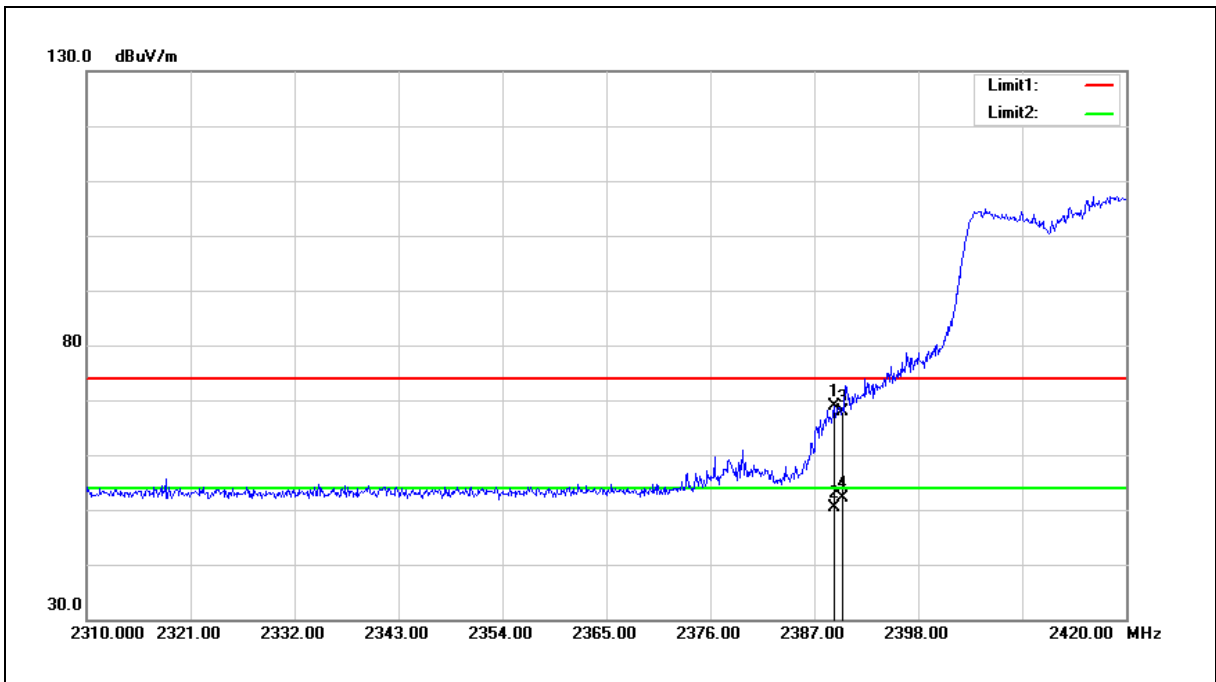

No.	Frequency (MHz)	Reading (dBuV)	Correct Factor (dB/m)	Result (dBuV/m)	Limit (dBuV/m)	Margin (dB)	Remark
1	2389.090	70.63	-1.84	68.79	74.00	-5.21	peak
2	2389.090	52.32	-1.84	50.48	54.00	-3.52	AVG
3	2390.000	69.71	-1.84	67.87	74.00	-6.13	peak
4	2390.000	54.02	-1.84	52.18	54.00	-1.82	AVG

Note:1.Result (dBuV/m) = Correct Factor (dB/m) + Reading(dBuV).

2.Correction factor (dB/m) = Antenna Factor (dB/m) + Cable loss (dB) – Pre-Amplifier gain (dB).

3.When the peak results are less than average limit, so not need to evaluate the average.



Standard:	FCC Part 15.247	Test Distance:	3m
Test item:	Band edge	Power:	AC 120V/60Hz
Frequency:	2437MHz	Temp.(°C)/Hum.(%RH):	26(°C)/60%RH
Mode:	Mode 4		
Ant.Polar.:	Horizontal		

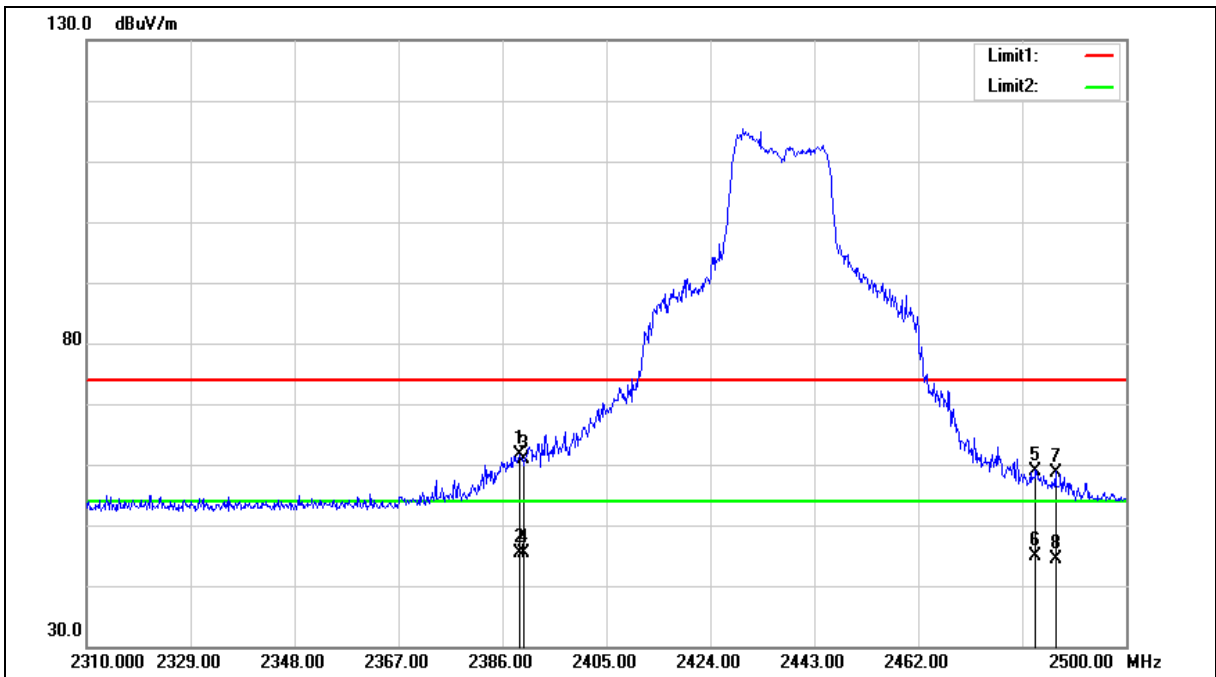



Standard:	FCC Part 15.247	Test Distance:	3m
Test item:	Band edge	Power:	AC 120V/60Hz
Frequency:	2437MHz	Temp.(°C)/Hum.(%RH):	26(°C)/60%RH
Mode:	Mode 4		
Ant.Polar.:	Horizontal		

No.	Frequency (MHz)	Reading (dBuV)	Correct Factor (dB/m)	Result (dBuV/m)	Limit (dBuV/m)	Margin (dB)	Remark
1	2389.230	63.56	-1.84	61.72	74.00	-12.28	peak
2	2389.230	47.13	-1.84	45.29	54.00	-8.71	AVG
3	2390.000	62.77	-1.84	60.93	74.00	-13.07	peak
4	2390.000	47.31	-1.84	45.47	54.00	-8.53	AVG
5	2483.500	60.36	-1.47	58.89	74.00	-15.11	peak
6	2483.500	46.34	-1.47	44.87	54.00	-9.13	AVG
7	2487.080	60.20	-1.45	58.75	74.00	-15.25	peak
8	2487.080	45.78	-1.45	44.33	54.00	-9.67	AVG

Note:1.Result (dBuV/m) = Correct Factor (dB/m) + Reading(dBuV).

2.Correction factor (dB/m) = Antenna Factor (dB/m) + Cable loss (dB) – Pre-Amplifier gain (dB).

3.When the peak results are less than average limit, so not need to evaluate the average.



Standard:	FCC Part 15.247	Test Distance:	3m
Test item:	Band edge	Power:	AC 120V/60Hz
Frequency:	2437MHz	Temp.(°C)/Hum.(%RH):	26(°C)/60%RH
Mode:	Mode 4		
Ant.Polar.:	Vertical		

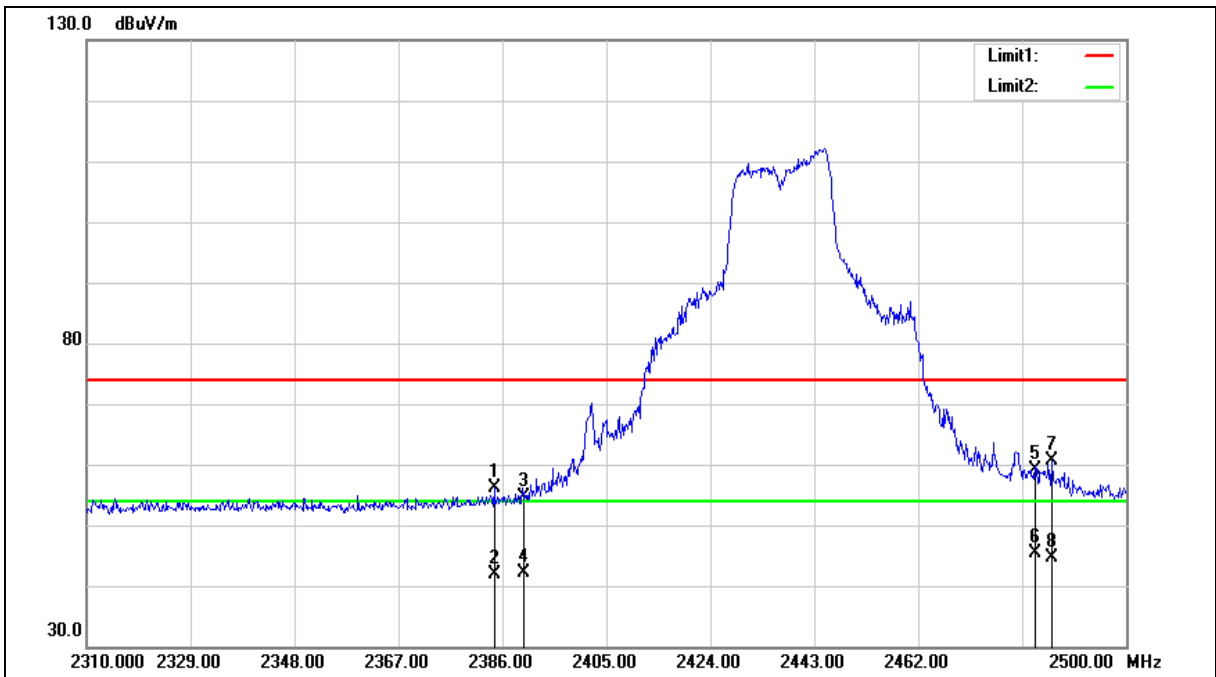



Standard:	FCC Part 15.247	Test Distance:	3m
Test item:	Band edge	Power:	AC 120V/60Hz
Frequency:	2437MHz	Temp.(°C)/Hum.(%RH):	26(°C)/60%RH
Mode:	Mode 4		
Ant.Polar.:	Vertical		

No.	Frequency (MHz)	Reading (dBuV)	Correct Factor (dB/m)	Result (dBuV/m)	Limit (dBuV/m)	Margin (dB)	Remark
1	2384.480	58.05	-1.84	56.21	74.00	-17.79	peak
2	2384.480	43.62	-1.84	41.78	54.00	-12.22	AVG
3	2390.000	56.48	-1.84	54.64	74.00	-19.36	peak
4	2390.000	43.97	-1.84	42.13	54.00	-11.87	AVG
5	2483.500	60.49	-1.47	59.02	74.00	-14.98	peak
6	2483.500	46.93	-1.47	45.46	54.00	-8.54	AVG
7	2486.510	62.12	-1.46	60.66	74.00	-13.34	peak
8	2486.510	46.20	-1.46	44.74	54.00	-9.26	AVG

Note:1.Result (dBuV/m) = Correct Factor (dB/m) + Reading(dBuV).

2.Correction factor (dB/m) = Antenna Factor (dB/m) + Cable loss (dB) – Pre-Amplifier gain (dB).

3.When the peak results are less than average limit, so not need to evaluate the average.



Standard:	FCC Part 15.247	Test Distance:	3m
Test item:	Band edge	Power:	AC 120V/60Hz
Frequency:	2462MHz	Temp.(°C)/Hum.(%RH):	26(°C)/60%RH
Mode:	Mode 4		
Ant.Polar.:	Horizontal		

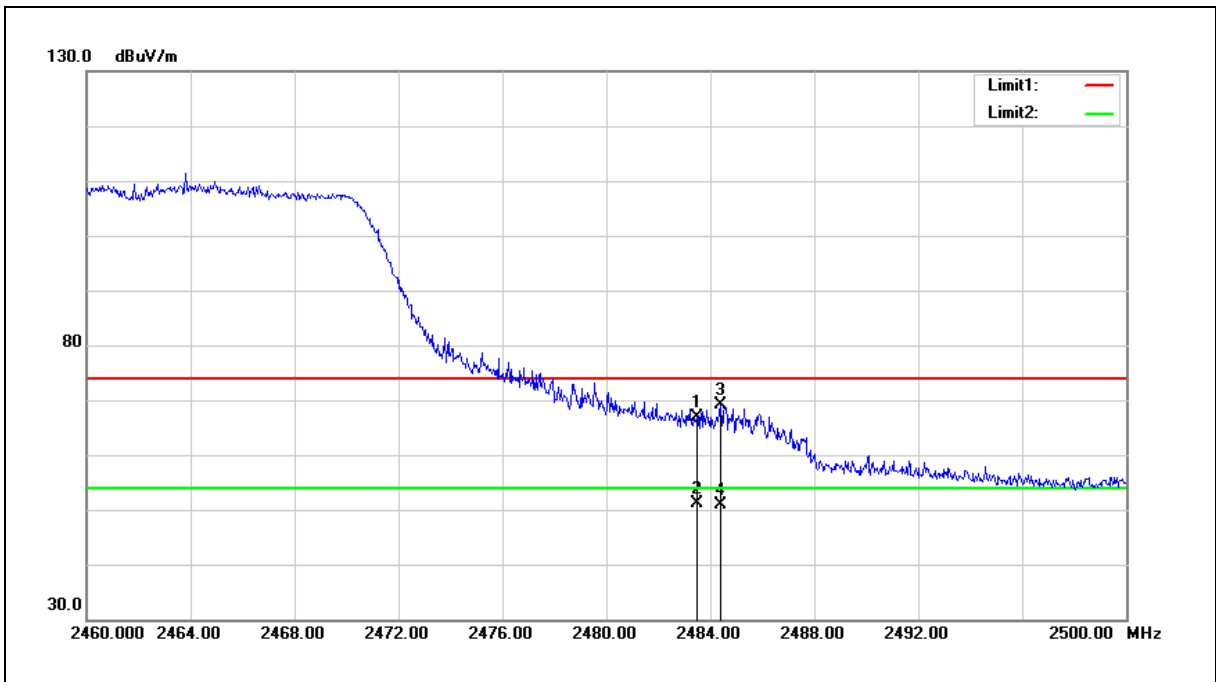

No.	Frequency (MHz)	Reading (dBuV)	Correct Factor (dB/m)	Result (dBuV/m)	Limit (dBuV/m)	Margin (dB)	Remark
1	2483.500	68.30	-1.47	66.83	74.00	-7.17	peak
2	2483.500	52.71	-1.47	51.24	54.00	-2.76	AVG
3	2484.400	70.49	-1.46	69.03	74.00	-4.97	peak
4	2484.400	52.23	-1.46	50.77	54.00	-3.23	AVG

Note:1.Result (dBuV/m) = Correct Factor (dB/m) + Reading(dBuV).

2.Correction factor (dB/m) = Antenna Factor (dB/m) + Cable loss (dB) – Pre-Amplifier gain (dB).

3.When the peak results are less than average limit, so not need to evaluate the average.



Standard:	FCC Part 15.247	Test Distance:	3m
Test item:	Band edge	Power:	AC 120V/60Hz
Frequency:	2462MHz	Temp.(°C)/Hum.(%RH):	26(°C)/60%RH
Mode:	Mode 4		
Ant.Polar.:	Vertical		

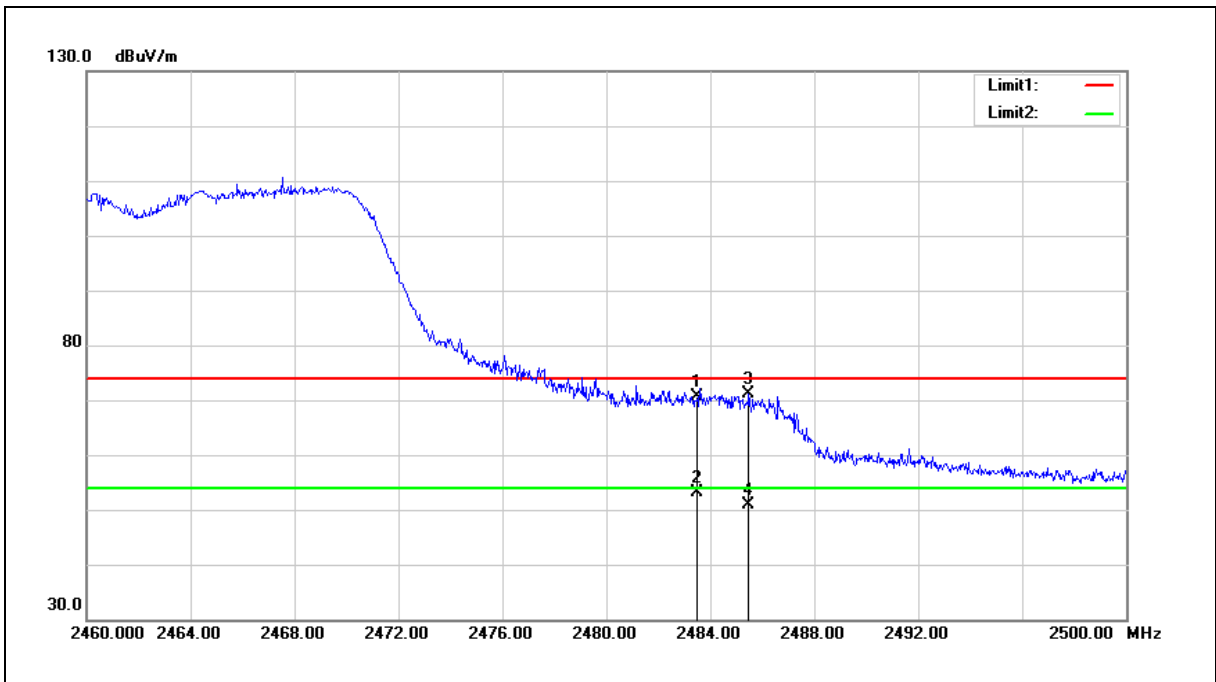

No.	Frequency (MHz)	Reading (dBuV)	Correct Factor (dB/m)	Result (dBuV/m)	Limit (dBuV/m)	Margin (dB)	Remark
1	2483.500	72.06	-1.47	70.59	74.00	-3.41	peak
2	2483.500	54.59	-1.47	53.12	54.00	-0.88	AVG
3	2485.480	72.47	-1.46	71.01	74.00	-2.99	peak
4	2485.480	52.30	-1.46	50.84	54.00	-3.16	AVG

Note:1.Result (dBuV/m) = Correct Factor (dB/m) + Reading(dBuV).

2.Correction factor (dB/m) = Antenna Factor (dB/m) + Cable loss (dB) – Pre-Amplifier gain (dB).

3.When the peak results are less than average limit, so not need to evaluate the average.



Standard:	FCC Part 15.247	Test Distance:	3m
Test item:	Band edge	Power:	AC 120V/60Hz
Frequency:	2422MHz	Temp.(°C)/Hum.(%RH):	26(°C)/60%RH
Mode:	Mode 5		
Ant.Polar.:	Horizontal		

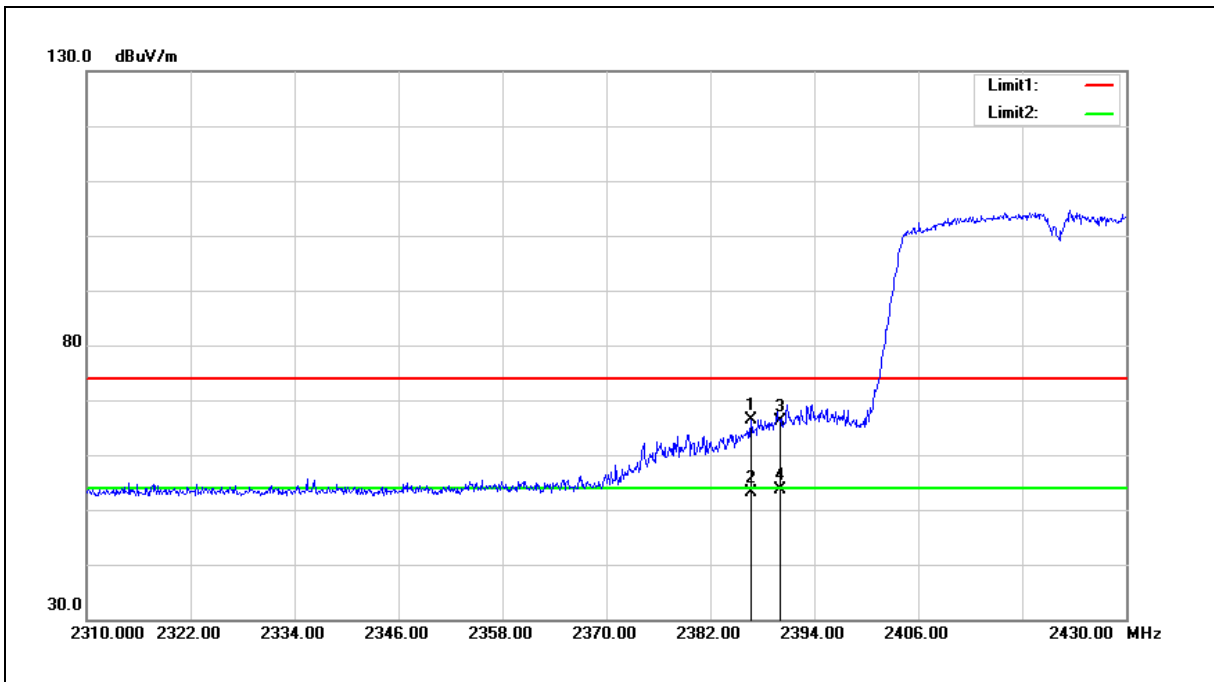

No.	Frequency (MHz)	Reading (dBuV)	Correct Factor (dB/m)	Result (dBuV/m)	Limit (dBuV/m)	Margin (dB)	Remark
1	2386.680	68.30	-1.84	66.46	74.00	-7.54	peak
2	2386.680	54.91	-1.84	53.07	54.00	-0.93	AVG
3	2390.000	67.90	-1.84	66.06	74.00	-7.94	peak
4	2390.000	55.58	-1.84	53.74	54.00	-0.26	AVG

Note:1.Result (dBuV/m) = Correct Factor (dB/m) + Reading(dBuV).

2.Correction factor (dB/m) = Antenna Factor (dB/m) + Cable loss (dB) – Pre-Amplifier gain (dB).

3.When the peak results are less than average limit, so not need to evaluate the average.



Standard:	FCC Part 15.247	Test Distance:	3m
Test item:	Band edge	Power:	AC 120V/60Hz
Frequency:	2422MHz	Temp.(°C)/Hum.(%RH):	26(°C)/60%RH
Mode:	Mode 5		
Ant.Polar.:	Vertical		

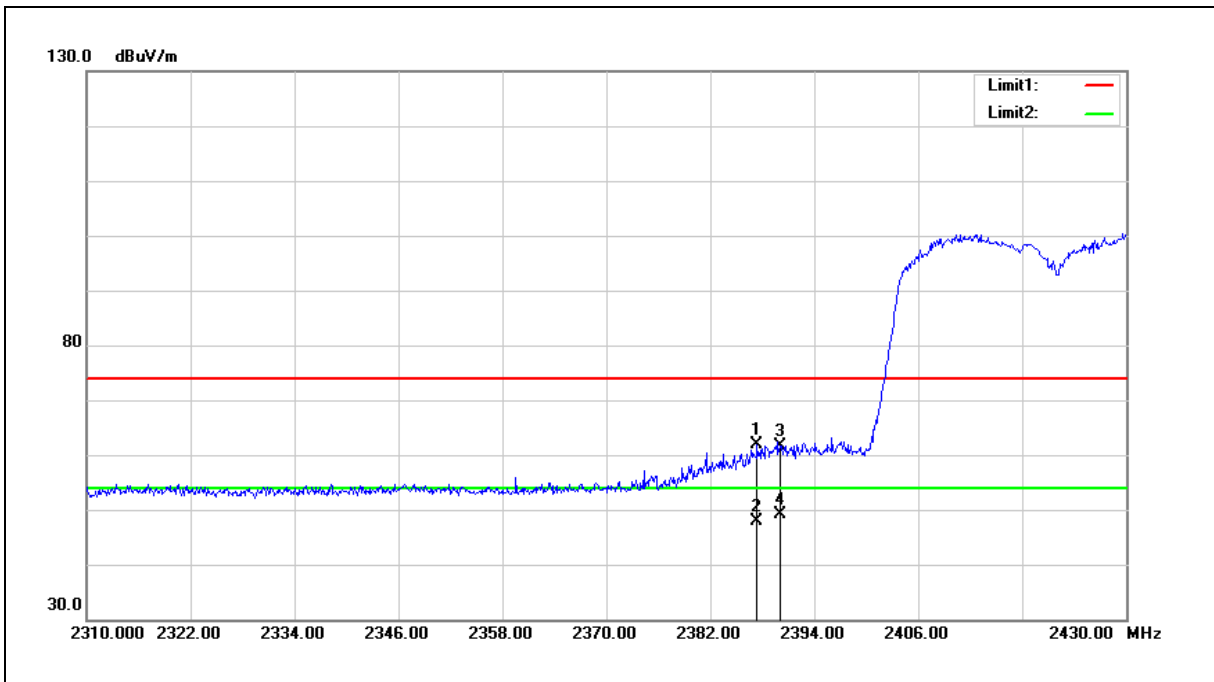

No.	Frequency (MHz)	Reading (dBuV)	Correct Factor (dB/m)	Result (dBuV/m)	Limit (dBuV/m)	Margin (dB)	Remark
1	2387.400	63.75	-1.84	61.91	74.00	-12.09	peak
2	2387.400	49.65	-1.84	47.81	54.00	-6.19	AVG
3	2390.000	63.41	-1.84	61.57	74.00	-12.43	peak
4	2390.000	50.85	-1.84	49.01	54.00	-4.99	AVG

Note:1.Result (dBuV/m) = Correct Factor (dB/m) + Reading(dBuV).

2.Correction factor (dB/m) = Antenna Factor (dB/m) + Cable loss (dB) – Pre-Amplifier gain (dB).

3.When the peak results are less than average limit, so not need to evaluate the average.



Standard:	FCC Part 15.247	Test Distance:	3m
Test item:	Band edge	Power:	AC 120V/60Hz
Frequency:	2437MHz	Temp.(°C)/Hum.(%RH):	26(°C)/60%RH
Mode:	Mode 5		
Ant.Polar.:	Horizontal		

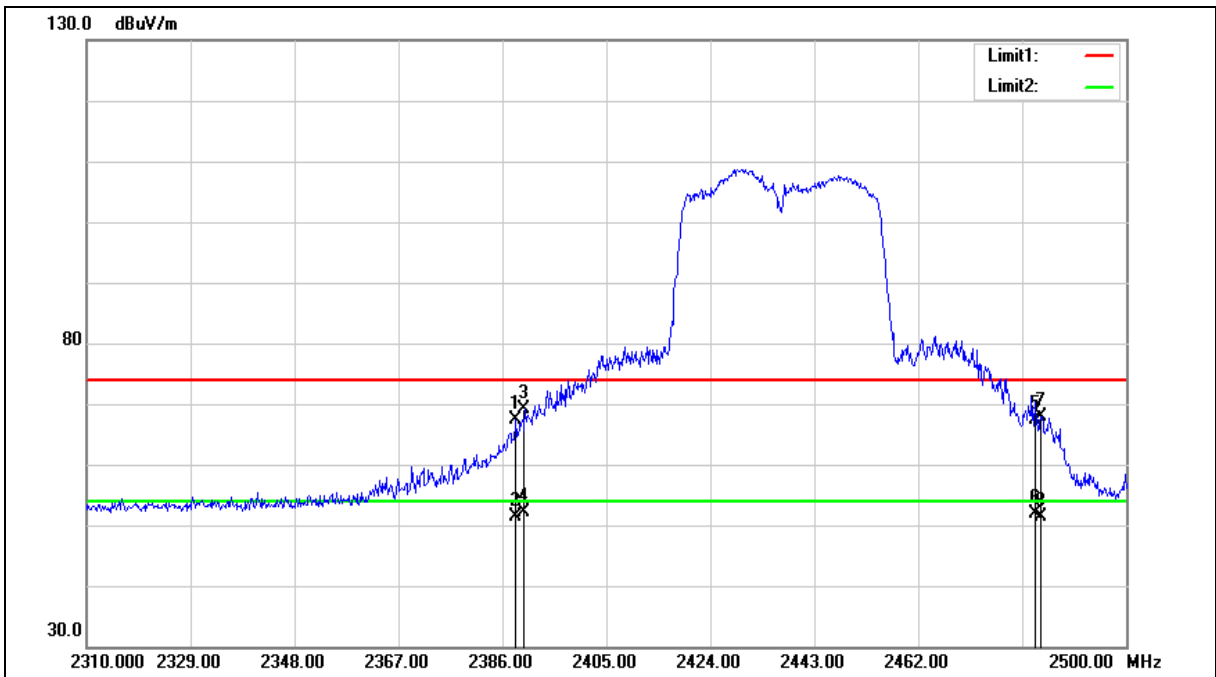



Standard:	FCC Part 15.247	Test Distance:	3m
Test item:	Band edge	Power:	AC 120V/60Hz
Frequency:	2437MHz	Temp.(°C)/Hum.(%RH):	26(°C)/60%RH
Mode:	Mode 5		
Ant.Polar.:	Horizontal		

No.	Frequency (MHz)	Reading (dBuV)	Correct Factor (dB/m)	Result (dBuV/m)	Limit (dBuV/m)	Margin (dB)	Remark
1	2388.470	69.11	-1.83	67.28	74.00	-6.72	peak
2	2388.470	53.15	-1.83	51.32	54.00	-2.68	AVG
3	2390.000	71.08	-1.84	69.24	74.00	-4.76	peak
4	2390.000	54.06	-1.84	52.22	54.00	-1.78	AVG
5	2483.500	68.86	-1.47	67.39	74.00	-6.61	peak
6	2483.500	53.43	-1.47	51.96	54.00	-2.04	AVG
7	2484.420	69.38	-1.46	67.92	74.00	-6.08	peak
8	2484.420	52.87	-1.46	51.41	54.00	-2.59	AVG

Note:1.Result (dBuV/m) = Correct Factor (dB/m) + Reading(dBuV).

2.Correction factor (dB/m) = Antenna Factor (dB/m) + Cable loss (dB) – Pre-Amplifier gain (dB).

3.When the peak results are less than average limit, so not need to evaluate the average.



Standard:	FCC Part 15.247	Test Distance:	3m
Test item:	Band edge	Power:	AC 120V/60Hz
Frequency:	2437MHz	Temp.(°C)/Hum.(%RH):	26(°C)/60%RH
Mode:	Mode 5		
Ant.Polar.:	Vertical		

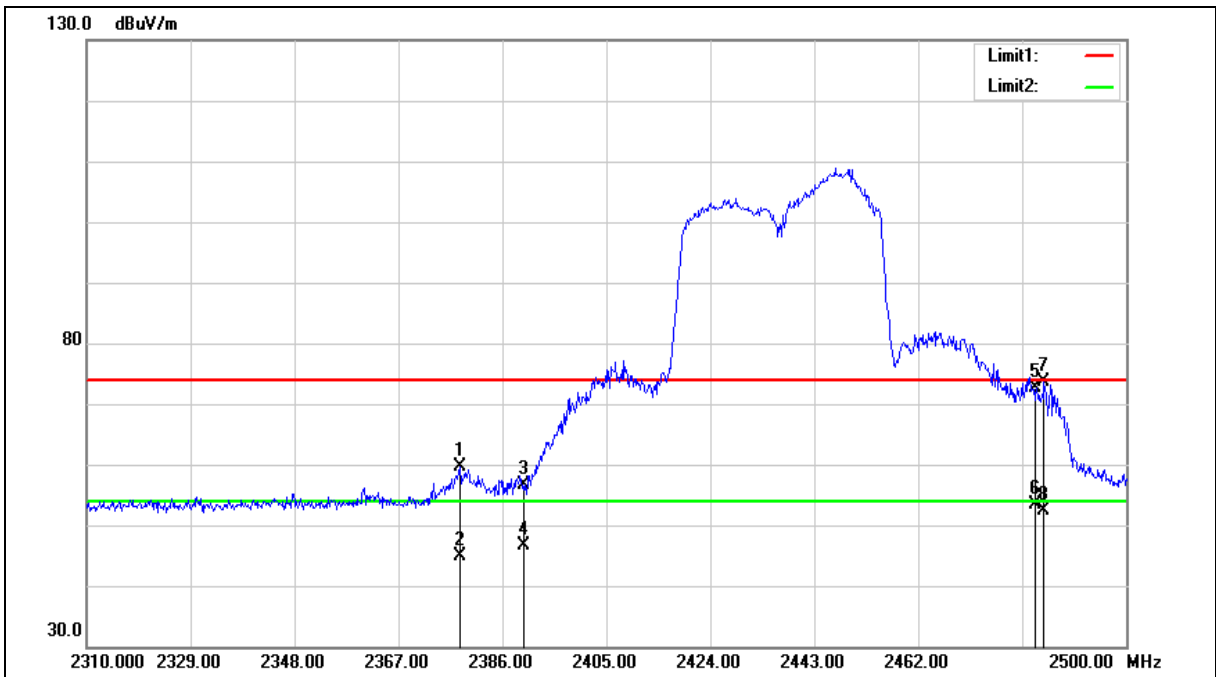



Standard:	FCC Part 15.247	Test Distance:	3m
Test item:	Band edge	Power:	AC 120V/60Hz
Frequency:	2437MHz	Temp.(°C)/Hum.(%RH):	26(°C)/60%RH
Mode:	Mode 5		
Ant.Polar.:	Vertical		

No.	Frequency (MHz)	Reading (dBuV)	Correct Factor (dB/m)	Result (dBuV/m)	Limit (dBuV/m)	Margin (dB)	Remark
1	2378.210	61.49	-1.87	59.62	74.00	-14.38	peak
2	2378.210	46.63	-1.87	44.76	54.00	-9.24	AVG
3	2390.000	58.36	-1.84	56.52	74.00	-17.48	peak
4	2390.000	48.50	-1.84	46.66	54.00	-7.34	AVG
5	2483.500	74.21	-1.47	72.74	74.00	-1.26	peak
6	2483.500	54.93	-1.47	53.46	54.00	-0.54	AVG
7	2484.990	75.13	-1.46	73.67	74.00	-0.33	peak
8	2484.990	53.78	-1.46	52.32	54.00	-1.68	AVG

Note:1.Result (dBuV/m) = Correct Factor (dB/m) + Reading(dBuV).

2.Correction factor (dB/m) = Antenna Factor (dB/m) + Cable loss (dB) – Pre-Amplifier gain (dB).

3.When the peak results are less than average limit, so not need to evaluate the average.



Standard:	FCC Part 15.247	Test Distance:	3m
Test item:	Band edge	Power:	AC 120V/60Hz
Frequency:	2452MHz	Temp.(°C)/Hum.(%RH):	26(°C)/60%RH
Mode:	Mode 5		
Ant.Polar.:	Horizontal		

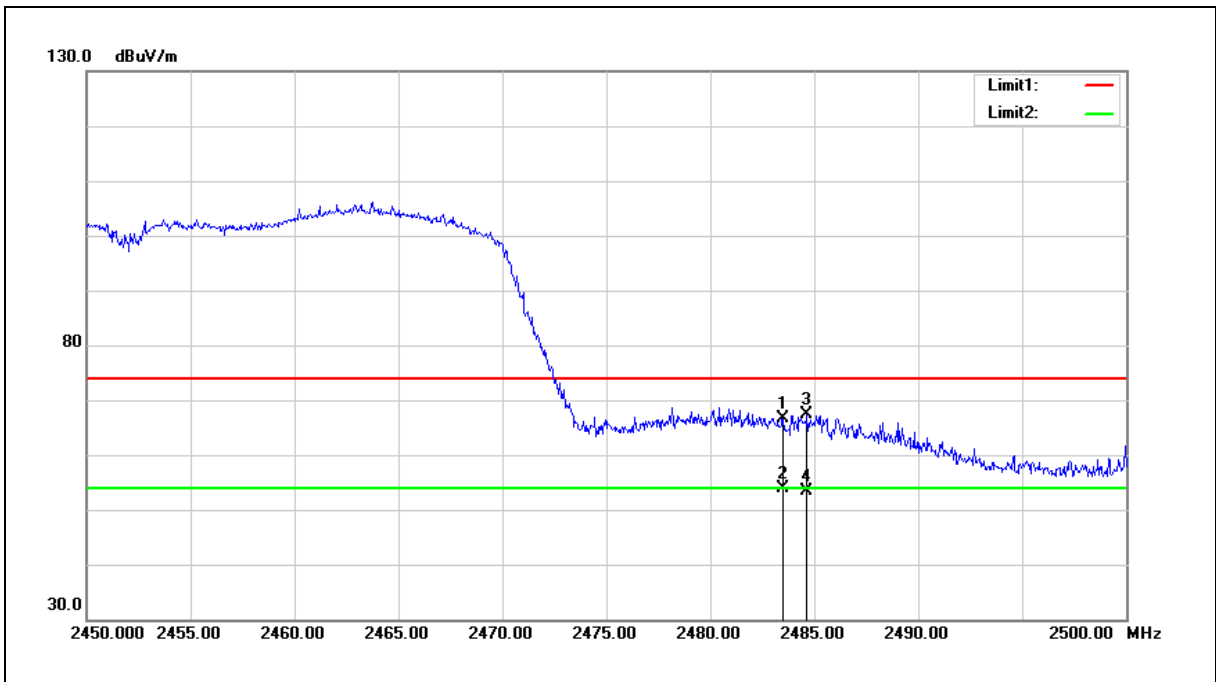

No.	Frequency (MHz)	Reading (dBuV)	Correct Factor (dB/m)	Result (dBuV/m)	Limit (dBuV/m)	Margin (dB)	Remark
1	2483.500	68.06	-1.47	66.59	74.00	-7.41	peak
2	2483.500	55.38	-1.47	53.91	54.00	-0.09	AVG
3	2484.650	68.84	-1.46	67.38	74.00	-6.62	peak
4	2484.650	54.85	-1.46	53.39	54.00	-0.61	AVG

Note:1.Result (dBuV/m) = Correct Factor (dB/m) + Reading(dBuV).

2.Correction factor (dB/m) = Antenna Factor (dB/m) + Cable loss (dB) – Pre-Amplifier gain (dB).

3.When the peak results are less than average limit, so not need to evaluate the average.



Standard:	FCC Part 15.247	Test Distance:	3m
Test item:	Band edge	Power:	AC 120V/60Hz
Frequency:	2452MHz	Temp.(°C)/Hum.(%RH):	26(°C)/60%RH
Mode:	Mode 5		
Ant.Polar.:	Vertical		

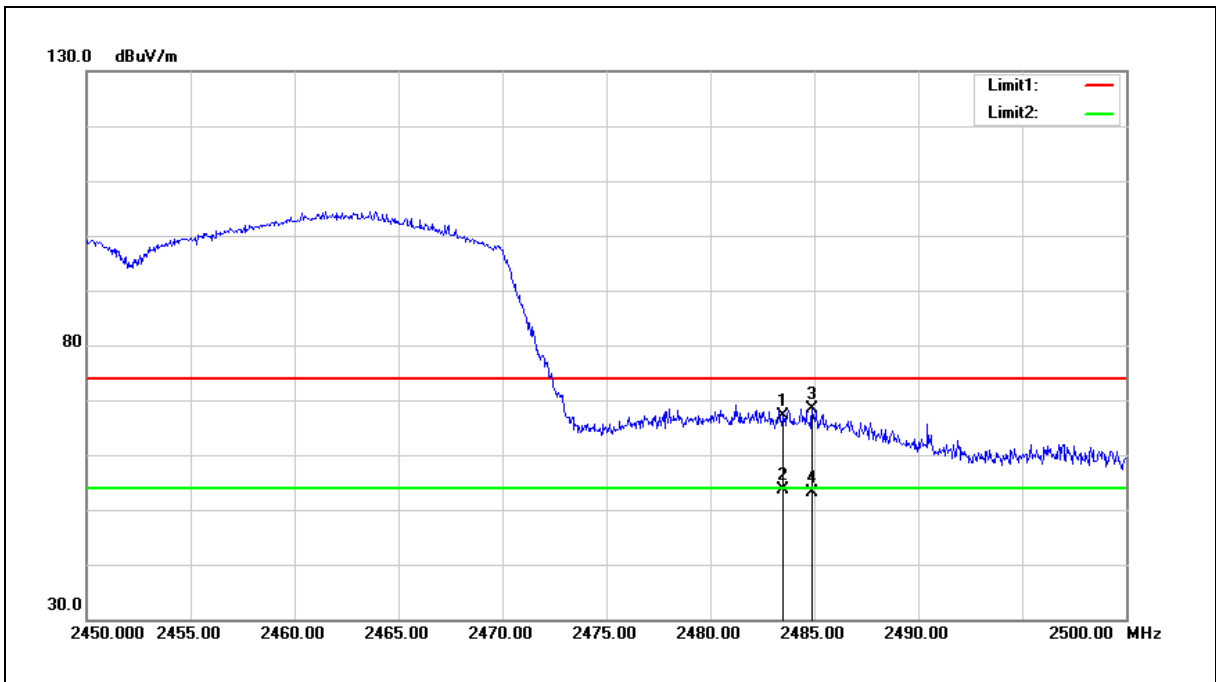

No.	Frequency (MHz)	Reading (dBuV)	Correct Factor (dB/m)	Result (dBuV/m)	Limit (dBuV/m)	Margin (dB)	Remark
1	2483.500	68.54	-1.47	67.07	74.00	-6.93	peak
2	2483.500	55.19	-1.47	53.72	54.00	-0.28	AVG
3	2484.900	69.90	-1.46	68.44	74.00	-5.56	peak
4	2484.900	54.66	-1.46	53.20	54.00	-0.80	AVG

Note:1.Result (dBuV/m) = Correct Factor (dB/m) + Reading(dBuV).

2.Correction factor (dB/m) = Antenna Factor (dB/m) + Cable loss (dB) – Pre-Amplifier gain (dB).

3.When the peak results are less than average limit, so not need to evaluate the average.

Annex C. Conducted Test Results

Maximum Conducted Output Power Measurement

ANT-0					
Test Mode	Frequency (MHz)	Data Rate	Average Output Power		
			Measurement Results		Limit
			dBm	W	dBm
Mode 2	2412	1M	23.56	0.227	< 30
	2437		22.32	0.171	< 30
	2462		22.97	0.198	< 30
	2437	2M	22.28	0.169	< 30
	2437	5.5M	22.20	0.166	< 30
	2437	11M	22.15	0.164	< 30
Mode 3	2412	6M	17.52	0.056	< 30
	2437		22.66	0.185	< 30
	2462		18.12	0.065	< 30
	2437	9M	22.62	0.183	< 30
	2437	12M	22.60	0.182	< 30
	2437	18M	22.57	0.181	< 30
	2437	24M	22.52	0.179	< 30
	2437	36M	22.46	0.176	< 30
	2437	48M	22.42	0.175	< 30
	2437	54M	22.37	0.173	< 30

Note: The relevant measured result has the offset with cable loss already.



ANT-0					
Test Mode	Frequency (MHz)	Data Rate	Average Output Power		
			Measurement Results		Limit
			dBm	W	dBm
Mode 4	2412	13M	17.83	0.061	< 30
	2437		22.71	0.187	< 30
	2462		17.61	0.058	< 30
	2437	28.8M	22.68	0.185	< 30
	2437	43.4M	22.63	0.183	< 30
	2437	57.8M	22.60	0.182	< 30
	2437	86.6M	22.57	0.181	< 30
	2437	115.6M	22.52	0.179	< 30
	2437	130M	22.47	0.177	< 30
	2437	144.4M	22.45	0.176	< 30
	2437	173.4M	22.43	0.175	< 30
Mode 5	2422	27M	15.55	0.036	< 30
	2437		19.04	0.080	< 30
	2452		14.99	0.032	< 30
	2437	60M	19.00	0.079	< 30
	2437	90M	18.97	0.079	< 30
	2437	120M	18.92	0.078	< 30
	2437	180M	18.89	0.077	< 30
	2437	240M	18.85	0.077	< 30
	2437	270M	18.82	0.076	< 30
	2437	300M	18.80	0.076	< 30
	2437	360M	18.77	0.075	< 30
2437	400M	18.74	0.075	< 30	

Note: The relevant measured result has the offset with cable loss already.



ANT-1					
Test Mode	Frequency (MHz)	Data Rate	Average Output Power		
			Measurement Results		Limit
			dBm	W	dBm
Mode 2	2412	1M	23.26	0.212	< 30
	2437		22.68	0.185	< 30
	2462		22.79	0.190	< 30
	2437	2M	22.61	0.182	< 30
	2437	5.5M	22.57	0.181	< 30
	2437	11M	22.53	0.179	< 30
Mode 3	2412	6M	17.15	0.052	< 30
	2437		22.30	0.170	< 30
	2462		18.08	0.064	< 30
	2437	9M	22.25	0.168	< 30
	2437	12M	22.22	0.167	< 30
	2437	18M	22.20	0.166	< 30
	2437	24M	22.17	0.165	< 30
	2437	36M	22.14	0.164	< 30
	2437	48M	22.11	0.163	< 30
	2437	54M	22.08	0.161	< 30

Note: The relevant measured result has the offset with cable loss already.

ANT-1					
Test Mode	Frequency (MHz)	Data Rate	Average Output Power		
			Measurement Results		Limit
			dBm	W	dBm
Mode 4	2412	13M	17.52	0.056	< 30
	2437		22.34	0.171	< 30
	2462		17.24	0.053	< 30
	2437	28.8M	22.31	0.170	< 30
	2437	43.4M	22.28	0.169	< 30
	2437	57.8M	22.24	0.167	< 30
	2437	86.6M	22.21	0.166	< 30
	2437	115.6M	22.17	0.165	< 30
	2437	130M	22.13	0.163	< 30
	2437	144.4M	22.08	0.161	< 30
	2437	173.4M	22.02	0.159	< 30
Mode 5	2422	27M	15.68	0.037	< 30
	2437		18.97	0.079	< 30
	2452		14.92	0.031	< 30
	2437	60M	18.92	0.078	< 30
	2437	90M	18.86	0.077	< 30
	2437	120M	18.83	0.076	< 30
	2437	180M	18.80	0.076	< 30
	2437	240M	18.76	0.075	< 30
	2437	270M	18.74	0.075	< 30
	2437	300M	18.70	0.074	< 30
	2437	360M	18.65	0.073	< 30
2437	400M	18.62	0.073	< 30	

Note: The relevant measured result has the offset with cable loss already.



ANT-0+1					
Test Mode	Frequency (MHz)	Data Rate	Average Output Power		
			Measurement Results		Limit
			dBm	W	dBm
Mode 2	2412	1M	26.42	0.439	< 30
	2437		25.51	0.356	< 30
	2462		25.89	0.388	< 30
	2437	2M	25.46	0.351	< 30
	2437	5.5M	25.40	0.347	< 30
	2437	11M	25.35	0.343	< 30
Mode 3	2412	6M	20.35	0.108	< 30
	2437		25.49	0.354	< 30
	2462		21.11	0.129	< 30
	2437	9M	25.45	0.351	< 30
	2437	12M	25.42	0.349	< 30
	2437	18M	25.40	0.347	< 30
	2437	24M	25.36	0.343	< 30
	2437	36M	25.31	0.340	< 30
	2437	48M	25.28	0.337	< 30
	2437	54M	25.24	0.334	< 30

Note: The relevant measured result has the offset with cable loss already.



ANT-0+1					
Test Mode	Frequency (MHz)	Data Rate	Average Output Power		
			Measurement Results		Limit
			dBm	W	dBm
Mode 4	2412	13M	20.69	0.117	< 30
	2437		25.54	0.358	< 30
	2462		20.44	0.111	< 30
	2437	28.8M	25.51	0.356	< 30
	2437	43.4M	25.47	0.352	< 30
	2437	57.8M	25.43	0.349	< 30
	2437	86.6M	25.40	0.347	< 30
	2437	115.6M	25.36	0.343	< 30
	2437	130M	25.31	0.340	< 30
	2437	144.4M	25.28	0.337	< 30
	2437	173.4M	25.24	0.334	< 30
Mode 5	2422	27M	18.63	0.073	< 30
	2437		22.02	0.159	< 30
	2452		17.97	0.063	< 30
	2437	60M	21.97	0.157	< 30
	2437	90M	21.93	0.156	< 30
	2437	120M	21.89	0.154	< 30
	2437	180M	21.86	0.153	< 30
	2437	240M	21.82	0.152	< 30
	2437	270M	21.79	0.151	< 30
	2437	300M	21.76	0.150	< 30
	2437	360M	21.72	0.149	< 30
2437	400M	21.69	0.148	< 30	

Note: The relevant measured result has the offset with cable loss already.

**6dB RF Bandwidth Measurement**

Test Mode	Frequency (MHz)	Measurement (kHz)		Limit (kHz)
		ANT-0	ANT-1	
Mode 2	2412	9046	9561	> 500
	2437	9036	8087	> 500
	2462	8568	8091	> 500
Mode 3	2412	16360	16360	> 500
	2437	16360	16370	> 500
	2462	16360	16360	> 500
Mode 4	2412	17600	17660	> 500
	2437	17600	17620	> 500
	2462	17610	17600	> 500
Mode 5	2422	35180	35160	> 500
	2437	35350	35180	> 500
	2452	35360	35140	> 500



■ Test Graphs

Mode 2: IEEE 802.11b Continuous TX mode_ANT-0

2412 MHz

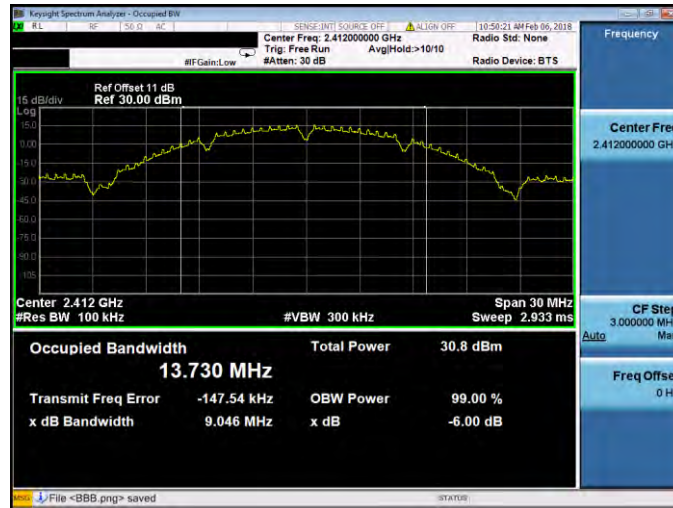

2437 MHz



2462 MHz

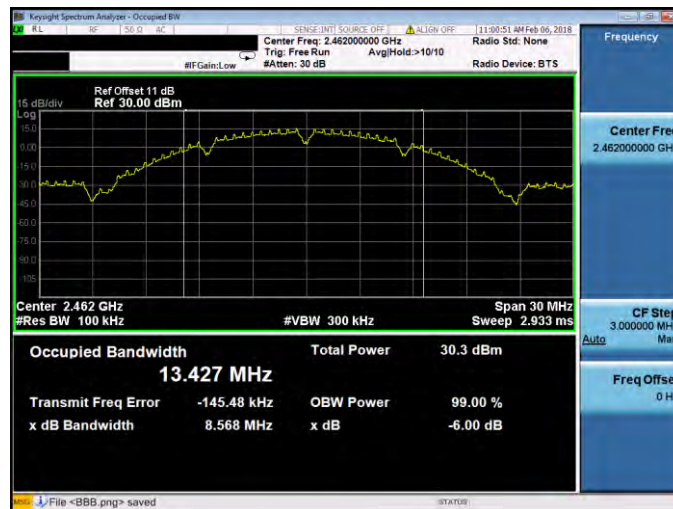



Mode 3: IEEE 802.11g Continuous TX mode_ANT-0

2412 MHz

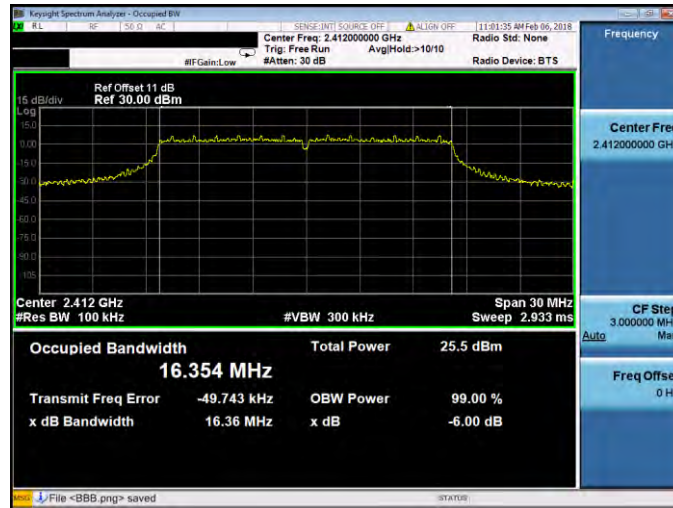

2437 MHz

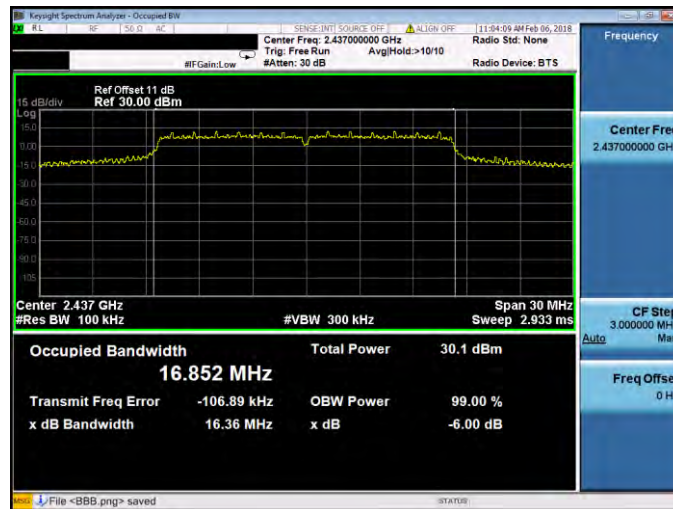

2462 MHz

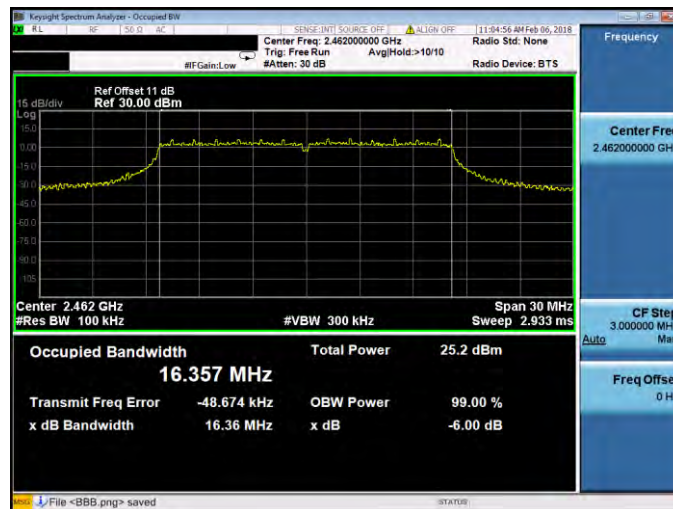



Mode 4: IEEE 802.11n 2.4GHz 20MHz Continuous TX mode_ANT-0

2412 MHz



2437 MHz



2462 MHz

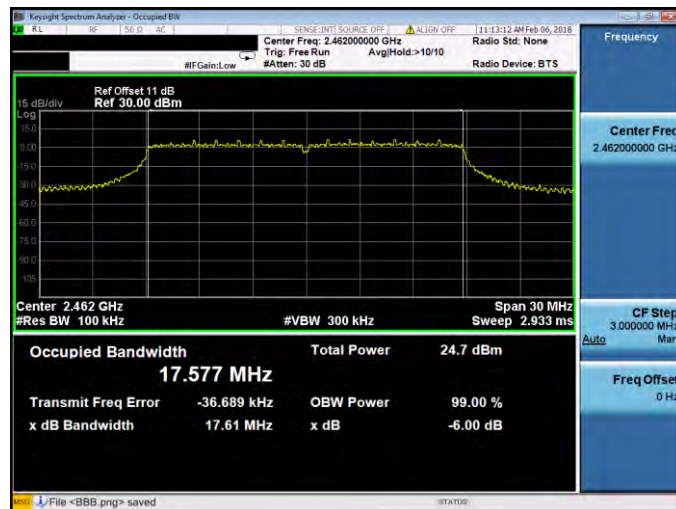



Mode 5: IEEE 802.11n 2.4GHz 40MHz Continuous TX mode_ANT-0

2422 MHz

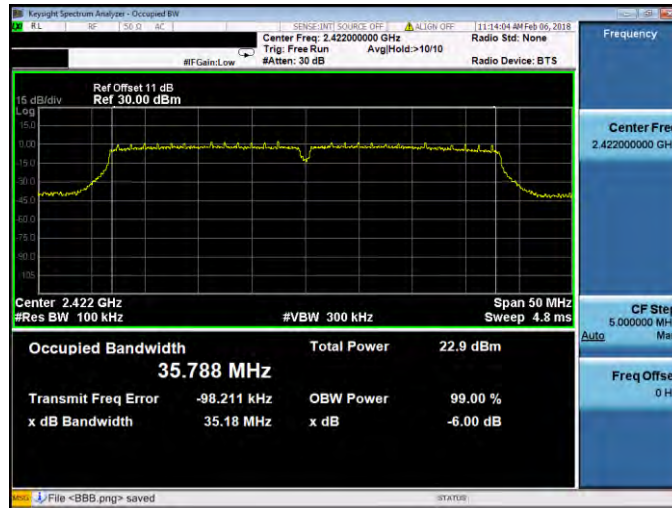

2437 MHz



2452 MHz

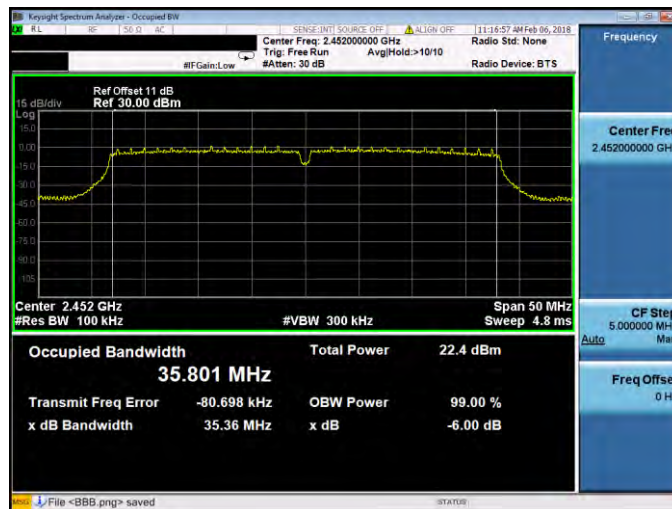



Mode 2: IEEE 802.11b Continuous TX mode_ANT-1

2412 MHz



2437 MHz



2462 MHz

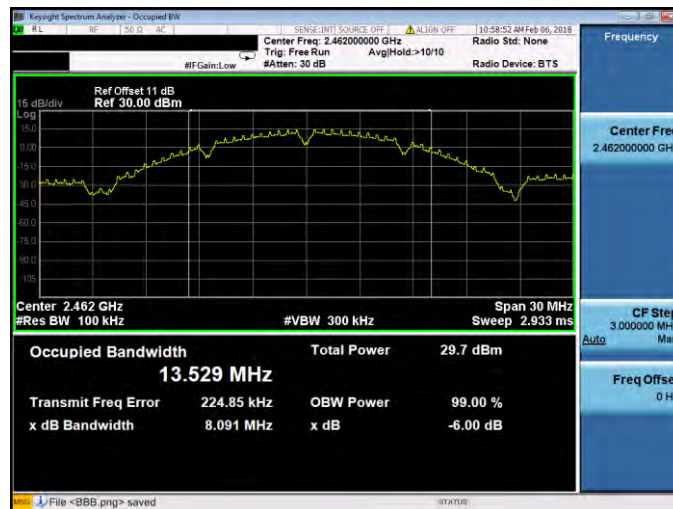



Mode 3: IEEE 802.11g Continuous TX mode_ANT-1

2412 MHz

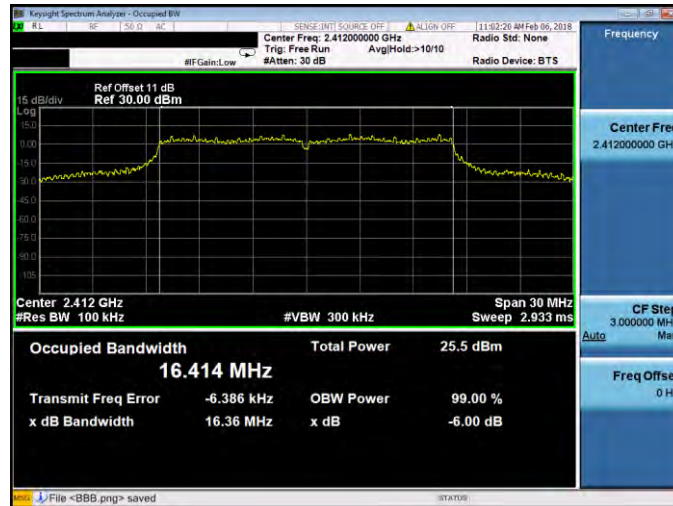

2437 MHz

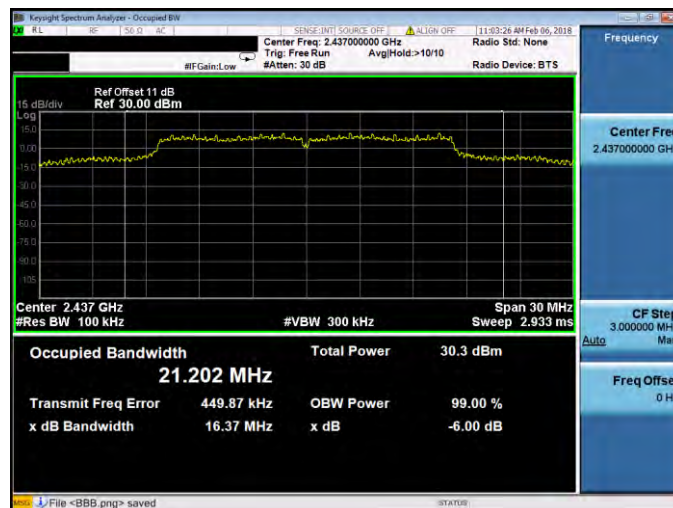

2462 MHz

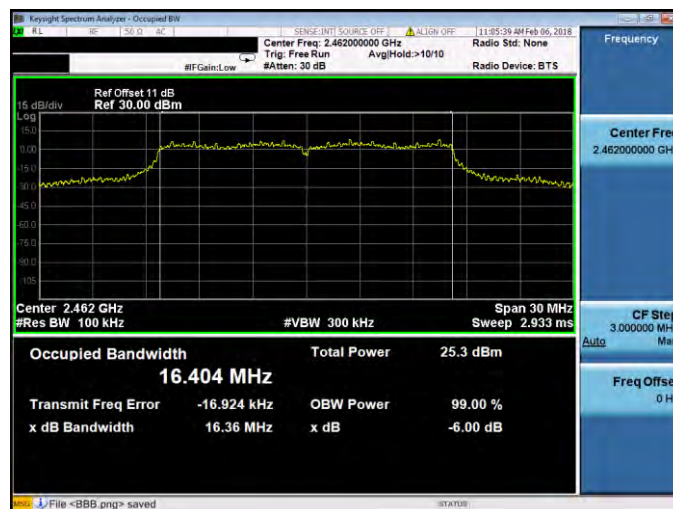



Mode 4: IEEE 802.11n 2.4GHz 20MHz Continuous TX mode_ANT-1

2412 MHz

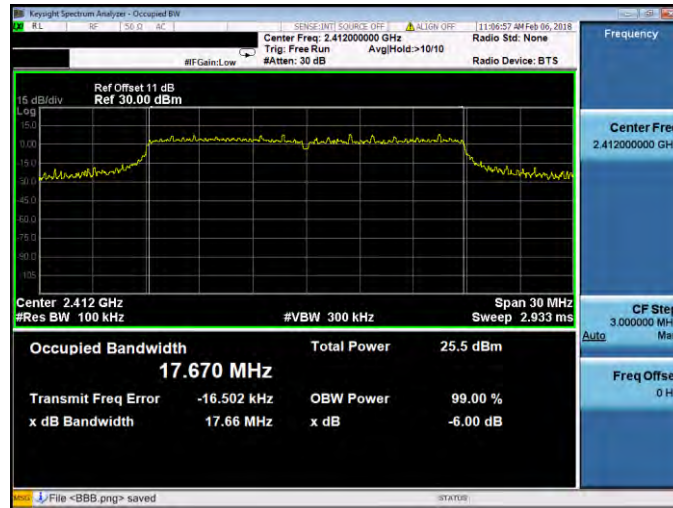

2437 MHz

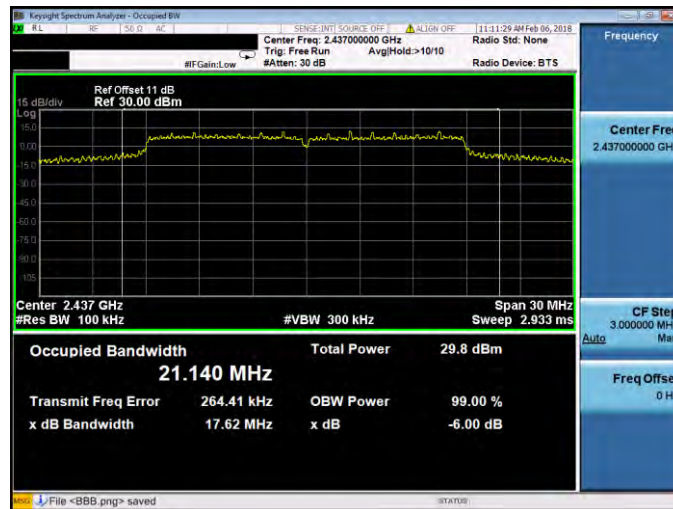

2462 MHz

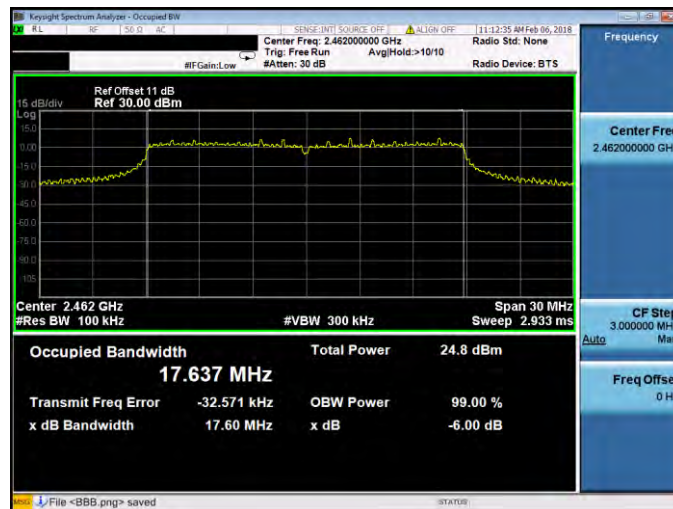



Mode 5: IEEE 802.11n 2.4GHz 40MHz Continuous TX mode_ANT-1

2422 MHz

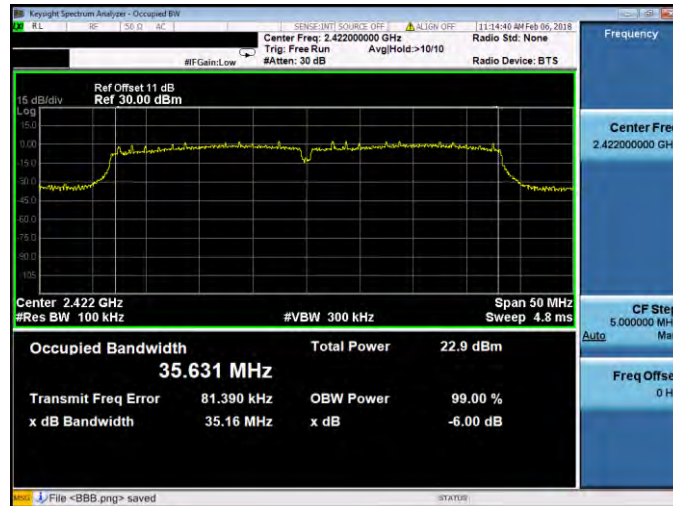

2437 MHz

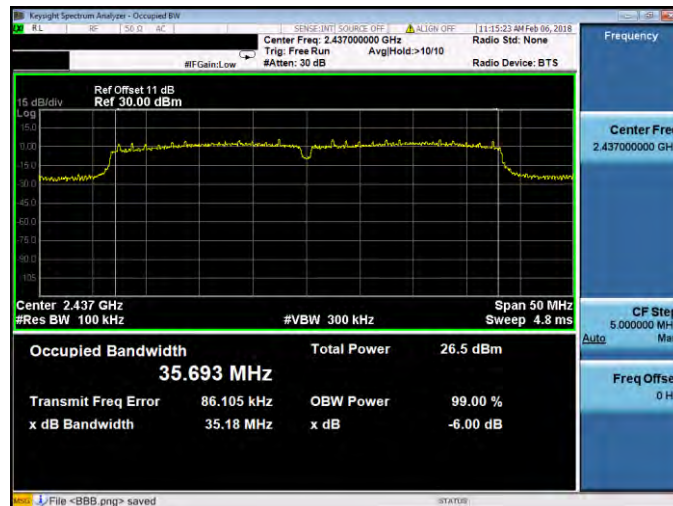

2452 MHz

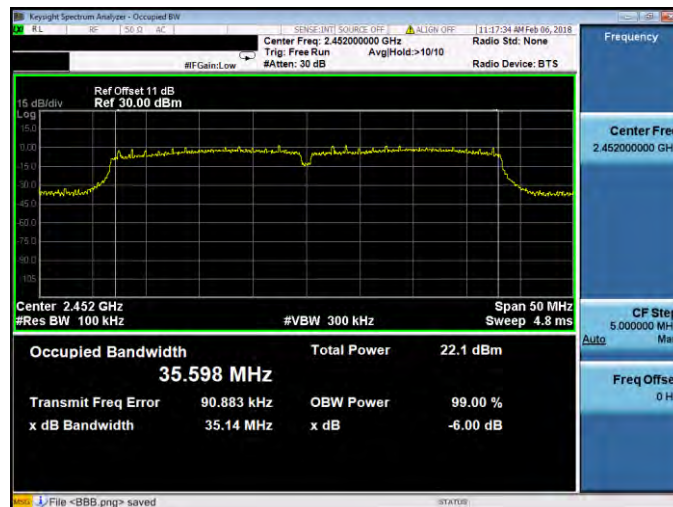

**Maximum Power Density Measurement**

Test Mode	Frequency (MHz)	Measurement (dBm/3KHz)			Limit (dBm/3KHz)
		ANT-0	ANT-1	ANT-0+1	
Mode 2	2412	1.867	2.235	5.065	< 7.16
	2437	1.692	1.521	4.618	< 7.16
	2462	2.473	1.716	5.121	< 7.16
Mode 3	2412	-5.792	-6.030	-2.899	< 7.16
	2437	-0.313	-0.951	2.390	< 7.16
	2462	-4.733	-5.294	-1.994	< 7.16
Mode 4	2412	-6.149	-5.995	-3.061	< 7.16
	2437	-1.522	-0.752	1.890	< 7.16
	2462	-6.488	-6.256	-3.360	< 7.16
Mode 5	2422	-10.795	-10.206	-7.480	< 7.16
	2437	-6.967	-7.134	-4.039	< 7.16
	2452	-11.040	-11.066	-8.043	< 7.16



■ Test Graphs

Mode 2: IEEE 802.11b Continuous TX mode_ANT-0	
2412 MHz	
2437 MHz	
2462 MHz	



Mode 3: IEEE 802.11g Continuous TX mode_ANT-0

2412 MHz

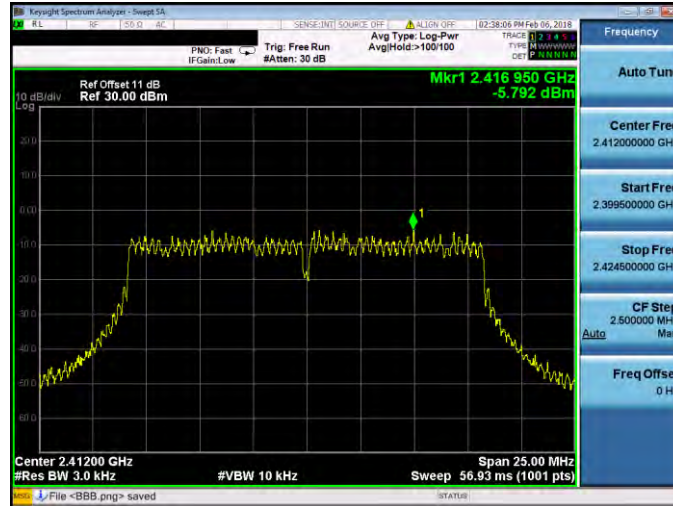

2437 MHz

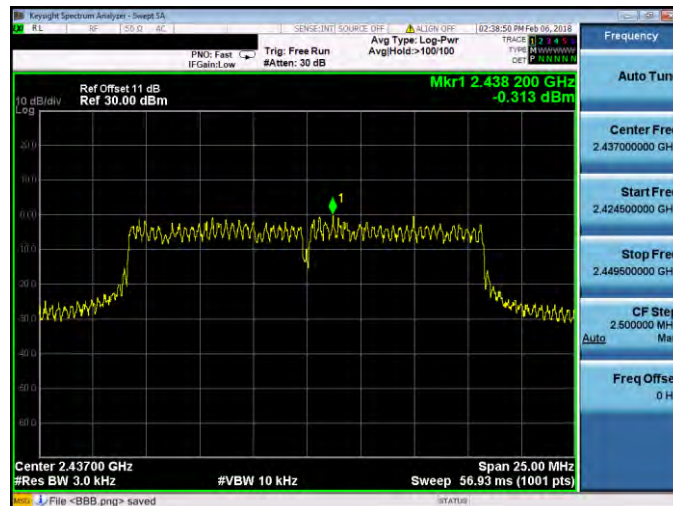

2462 MHz

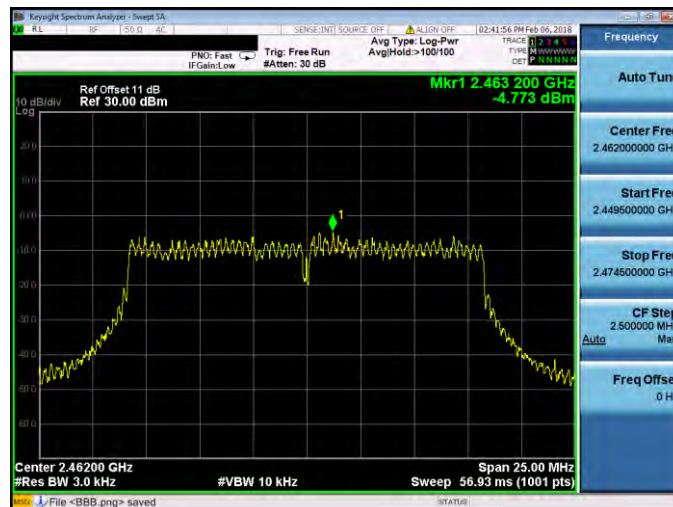



Mode 4: IEEE 802.11n 2.4GHz 20MHz Continuous TX mode_ANT-0

2412 MHz

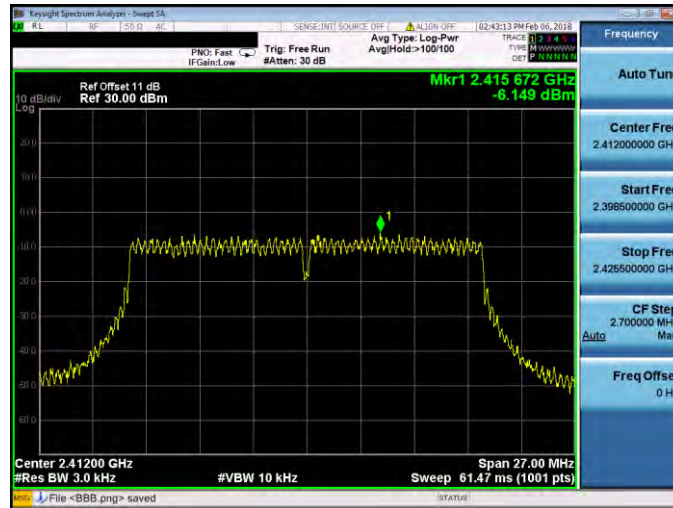

2437 MHz

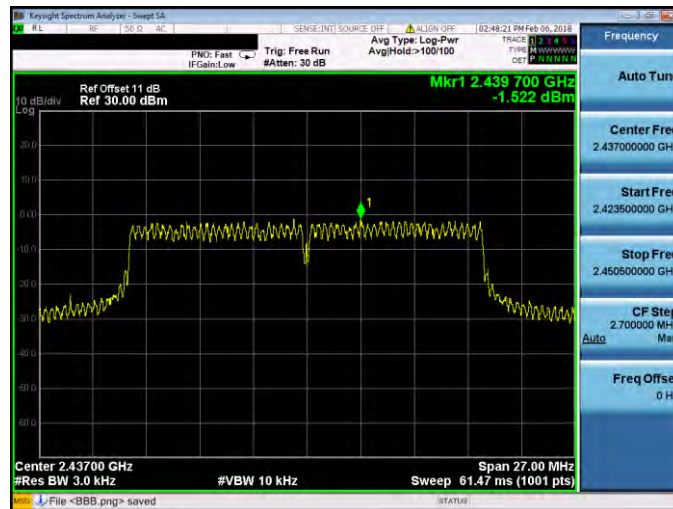

2462 MHz

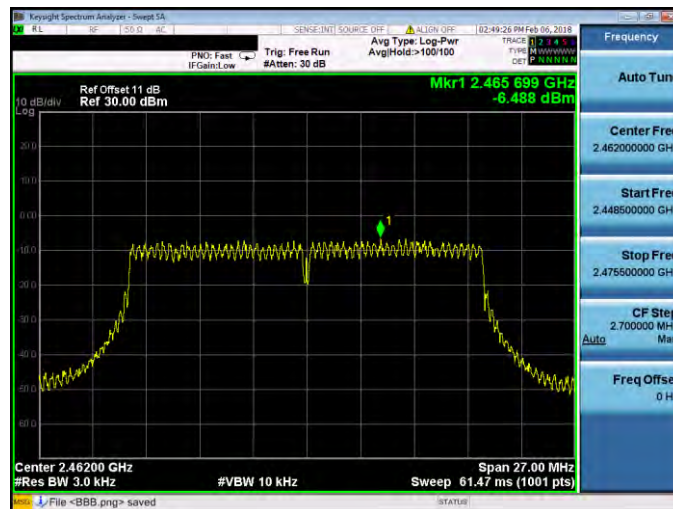



Mode 5: IEEE 802.11n 2.4GHz 40MHz Continuous TX mode_ANT-0

2422 MHz

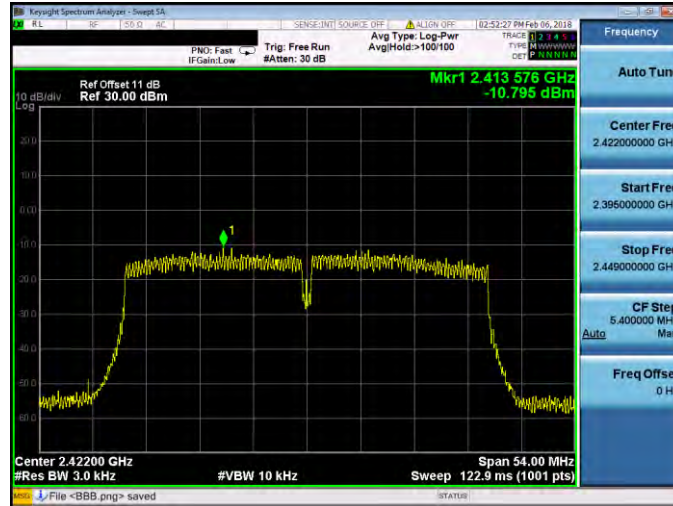

2437 MHz

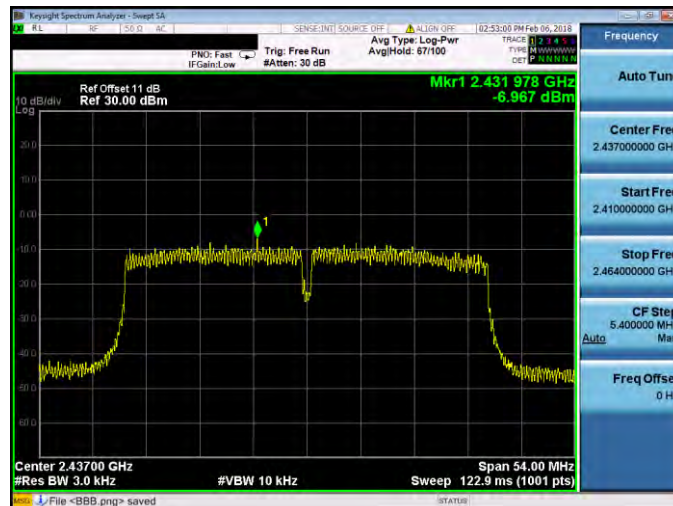

2452 MHz

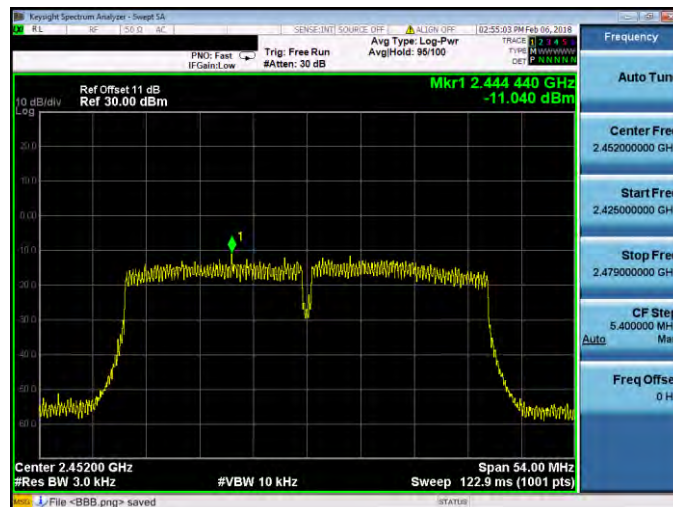



Mode 2: IEEE 802.11b Continuous TX mode_ANT-1

2412 MHz



2437 MHz



2462 MHz





Mode 3: IEEE 802.11g Continuous TX mode_ANT-1

2412 MHz

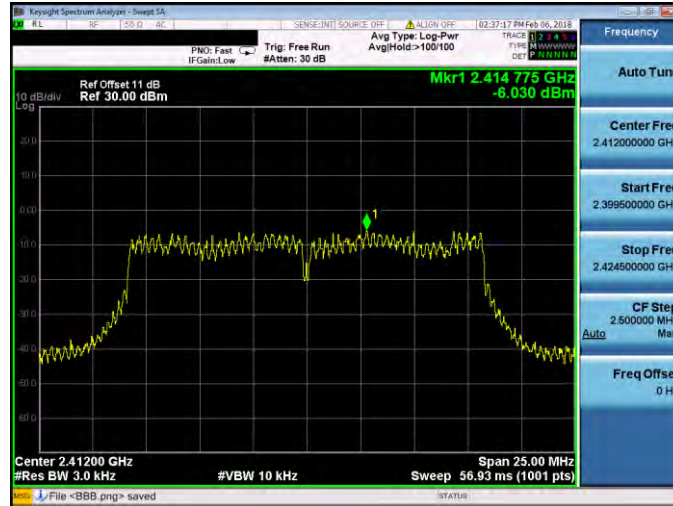

2437 MHz



2462 MHz

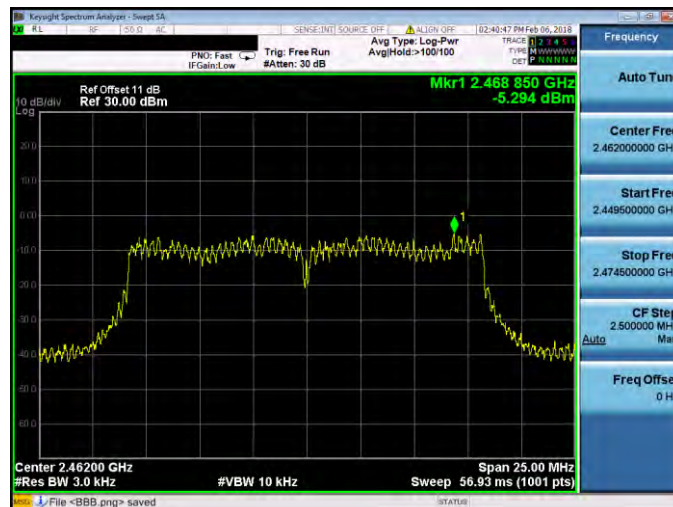



Mode 4: IEEE 802.11n 2.4GHz 20MHz Continuous TX mode_ANT-1

2412 MHz

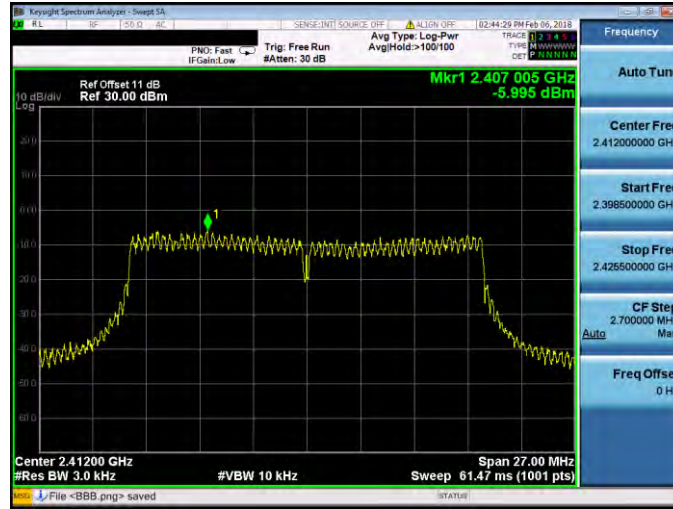

2437 MHz

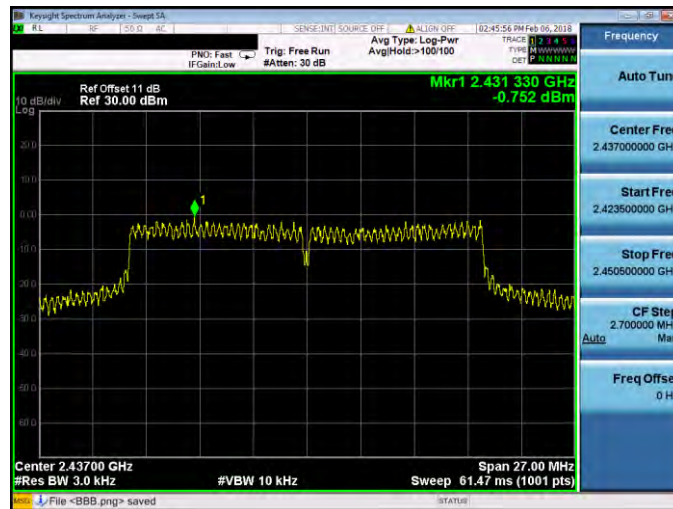

2462 MHz

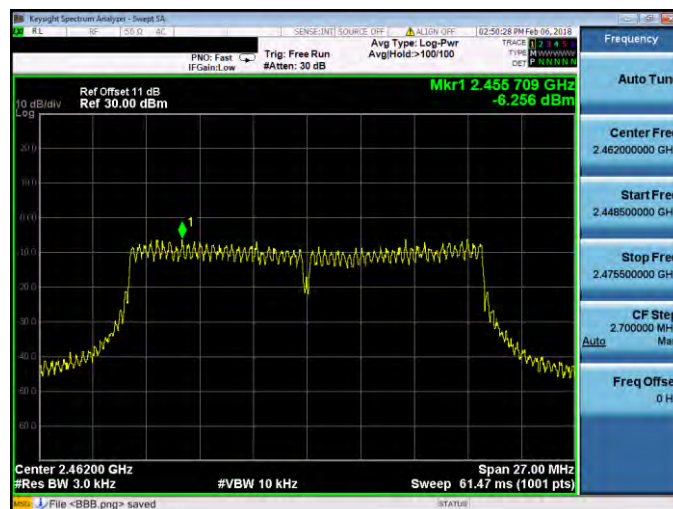



Out of Band Conducted Emissions Measurement

■ Test Graphs

Reference level

Mode 2: IEEE 802.11b Continuous TX mode_ANT-0

2412 MHz



2437 MHz

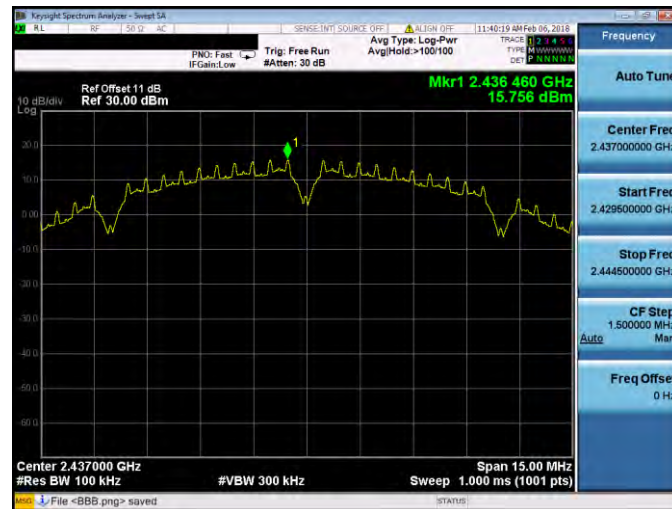

2462 MHz

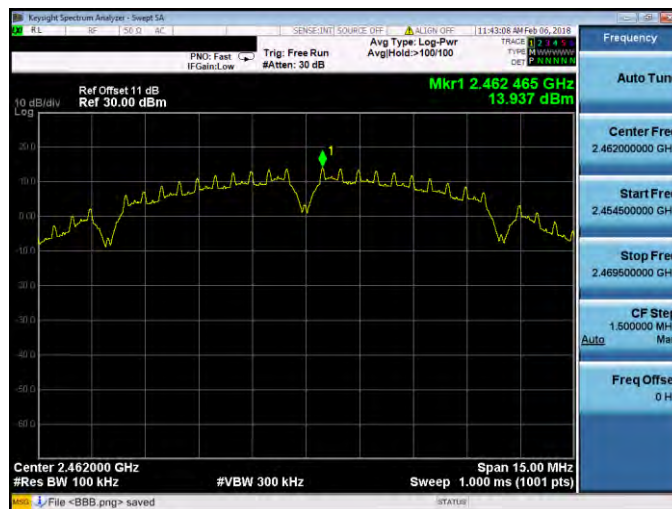



Mode 4: IEEE 802.11n 2.4GHz 20MHz Continuous TX mode_ANT-0

2412 MHz

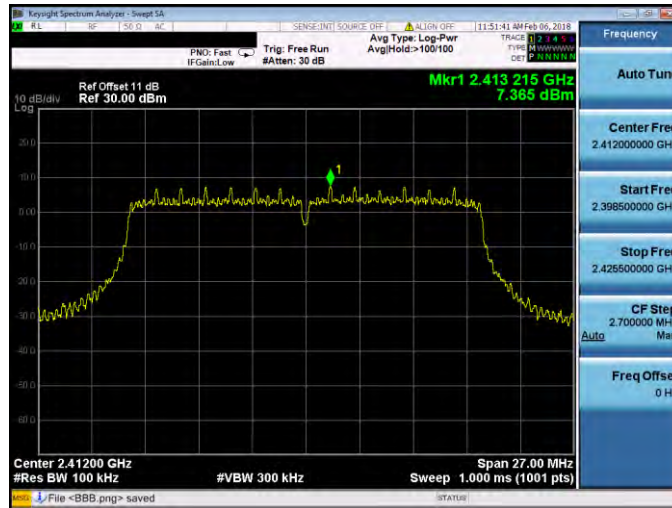

2437 MHz

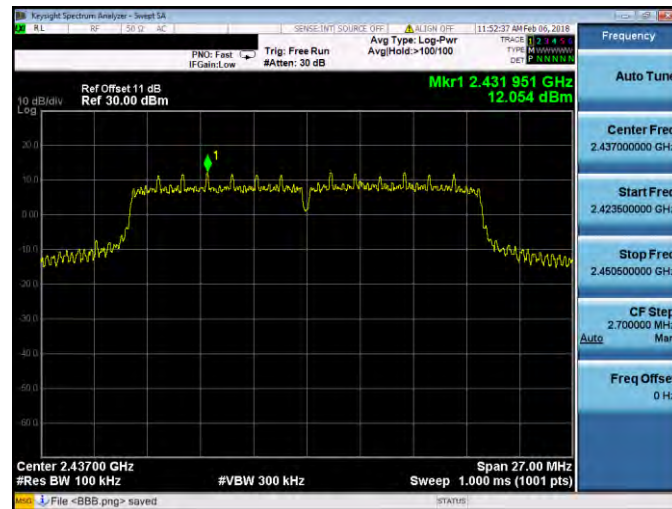

2462 MHz

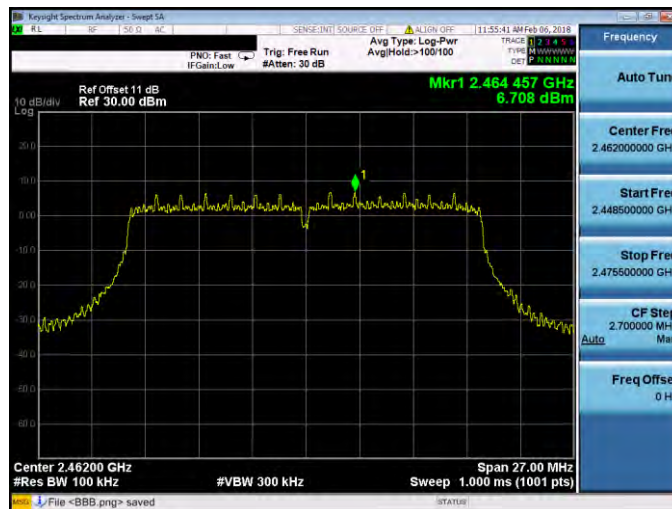



Mode 5: IEEE 802.11n 2.4GHz 40MHz Continuous TX mode_ANT-0

2422 MHz

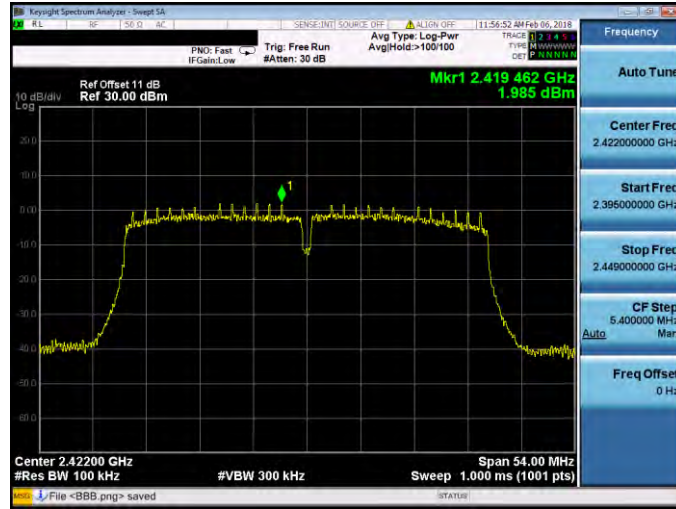

2437 MHz

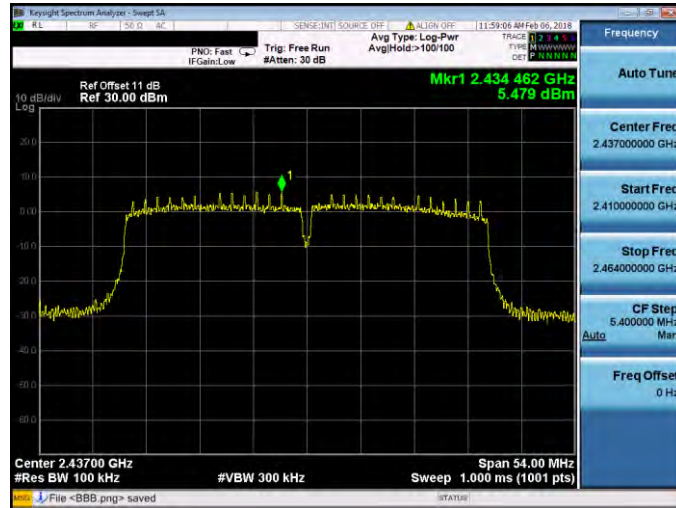

2452 MHz

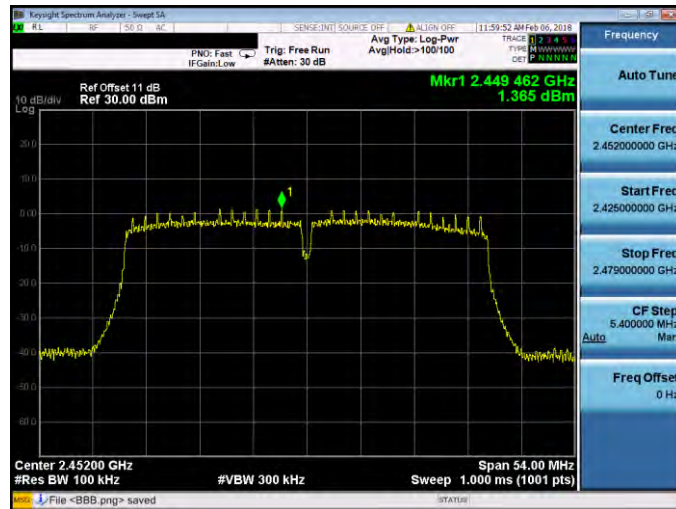



Mode 2: IEEE 802.11b Continuous TX mode_ANT-1

2412 MHz

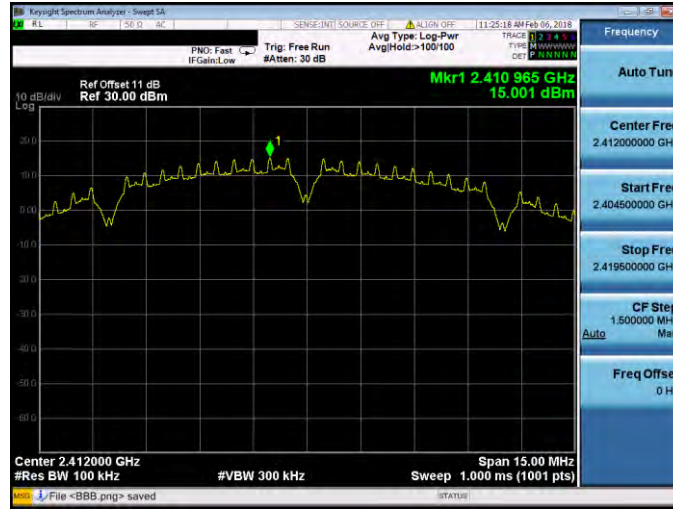

2437 MHz

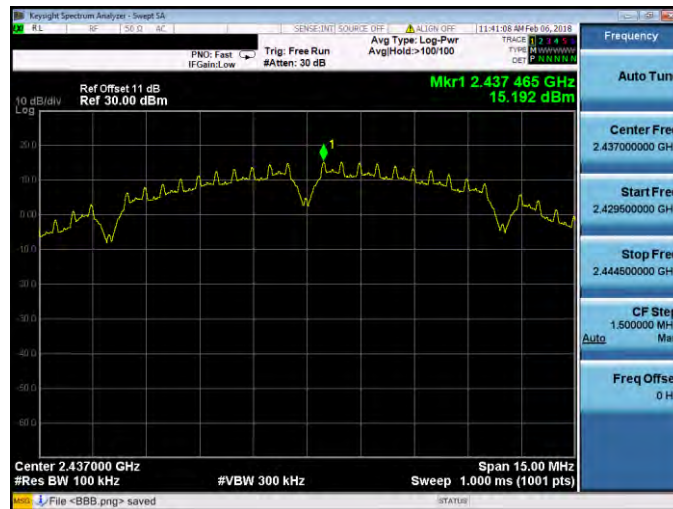

2462 MHz

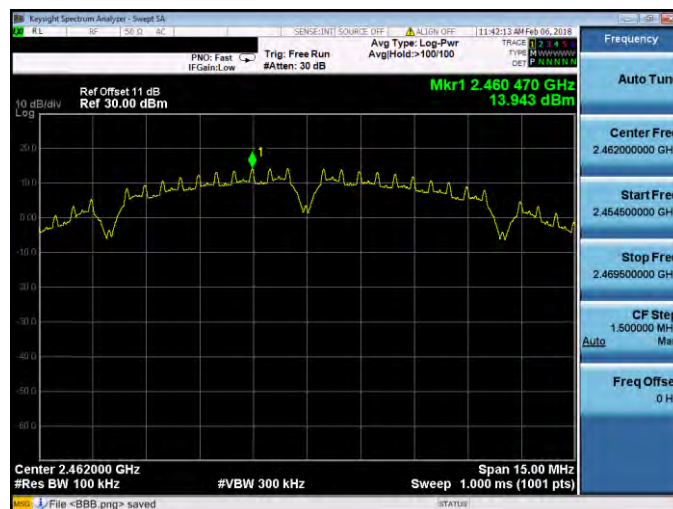



Mode 3: IEEE 802.11g Continuous TX mode_ANT-1

2412 MHz

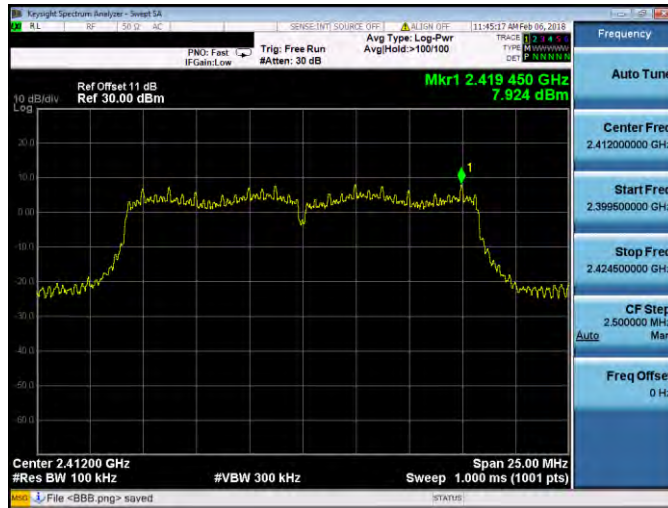

2437 MHz

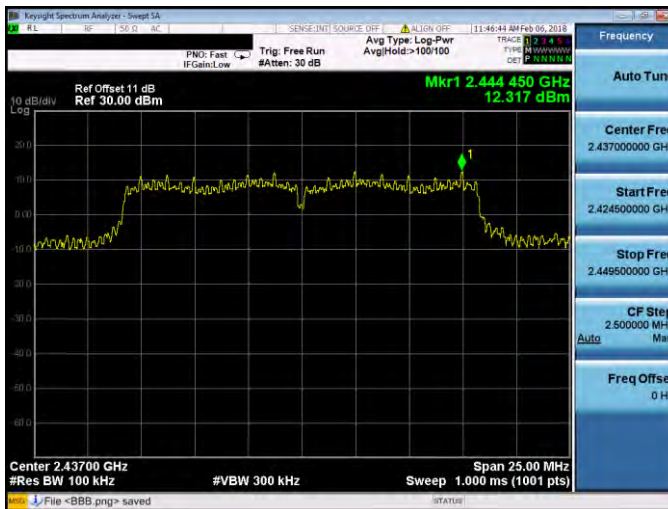

2462 MHz

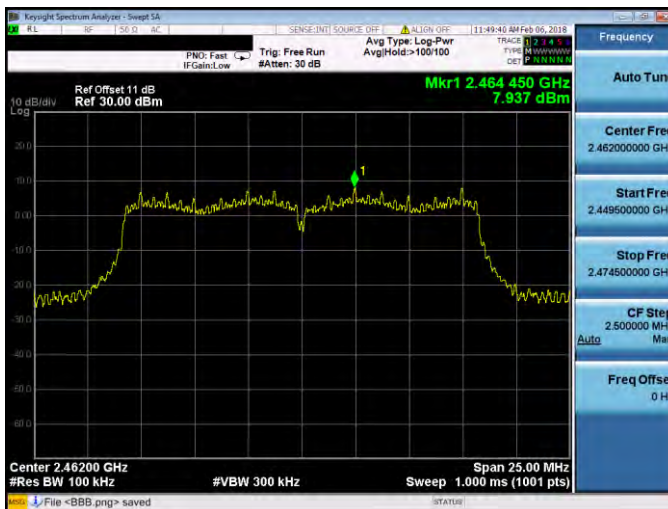

Mode 4: IEEE 802.11n 2.4GHz 20MHz Continuous TX mode_ANT-1

2412 MHz

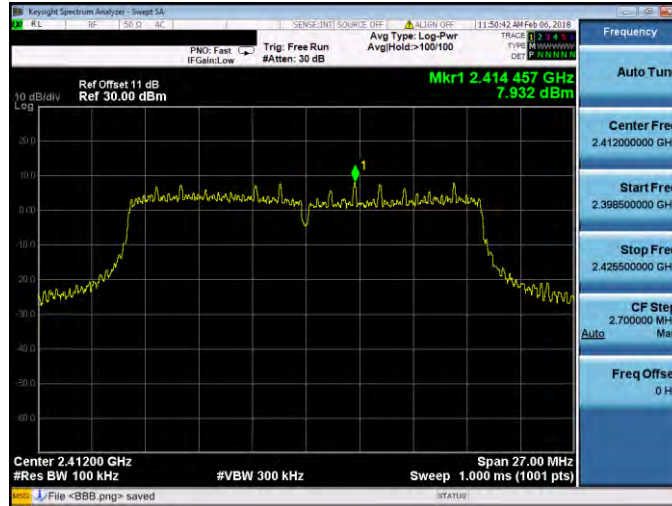

2437 MHz

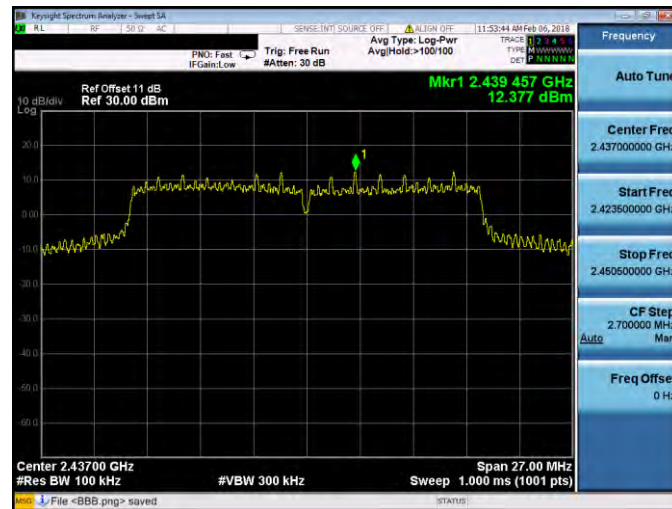

2462 MHz

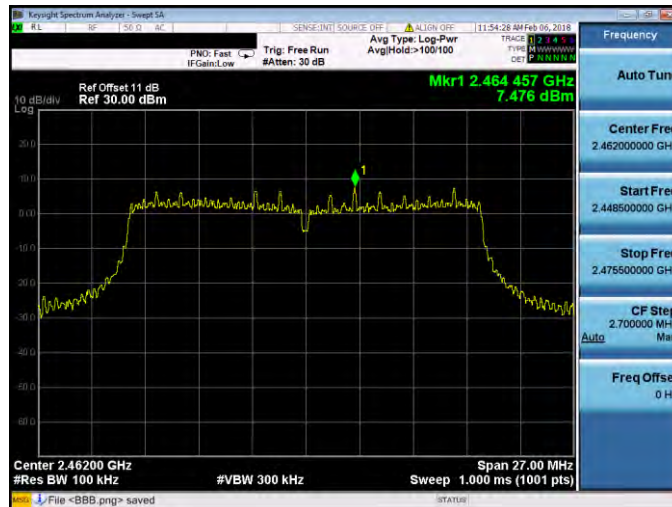



Mode 3: IEEE 802.11g Continuous TX mode_ANT-0

2412 MHz

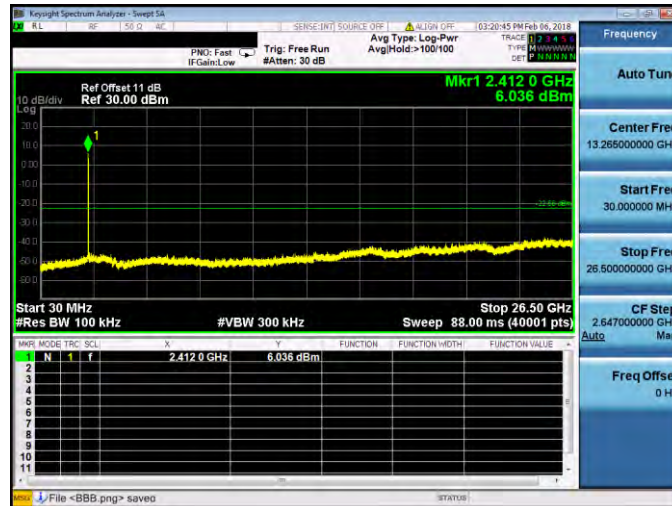

2437 MHz

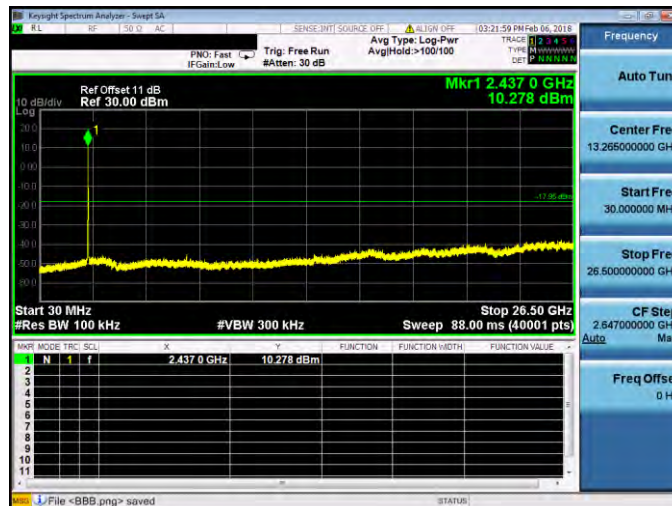

2462 MHz

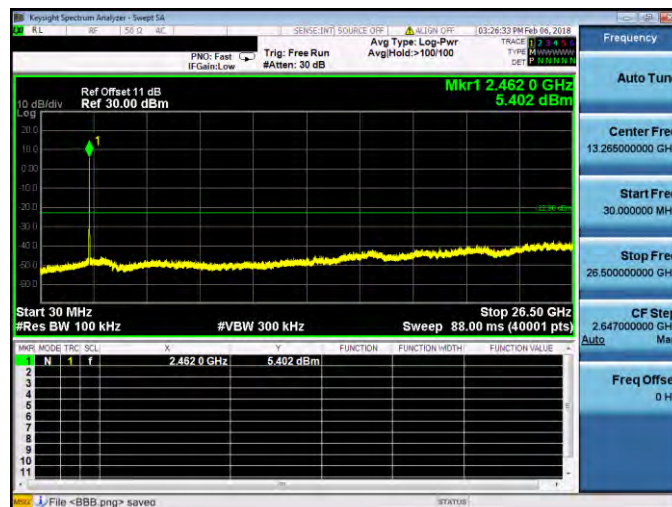



Mode 4: IEEE 802.11n 2.4GHz 20MHz Continuous TX mode_ANT-0

2412 MHz

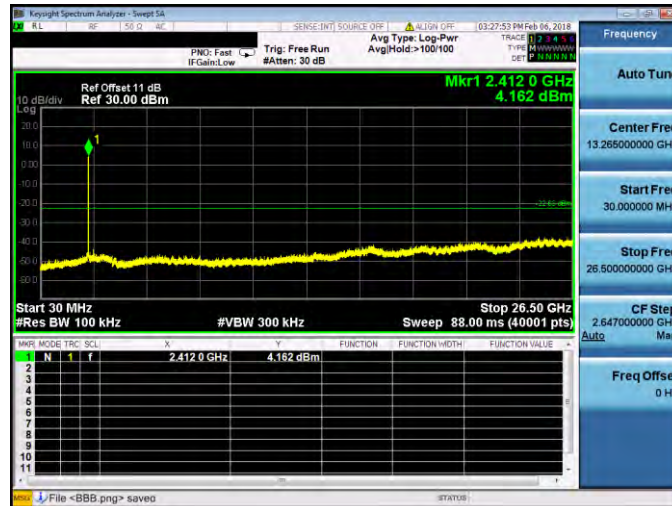

2437 MHz

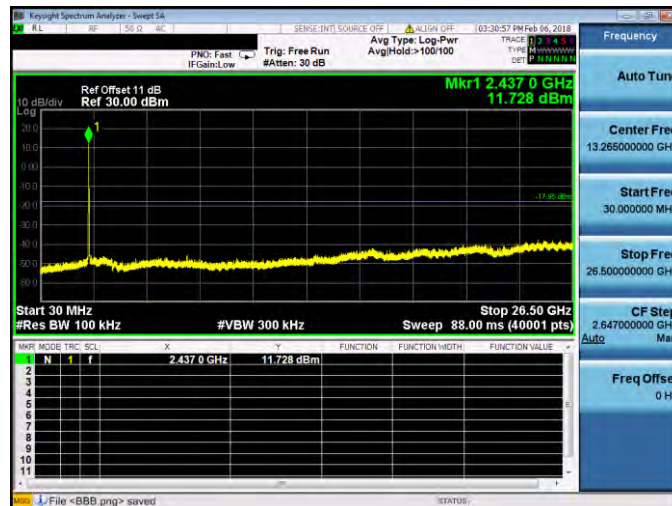

2462 MHz

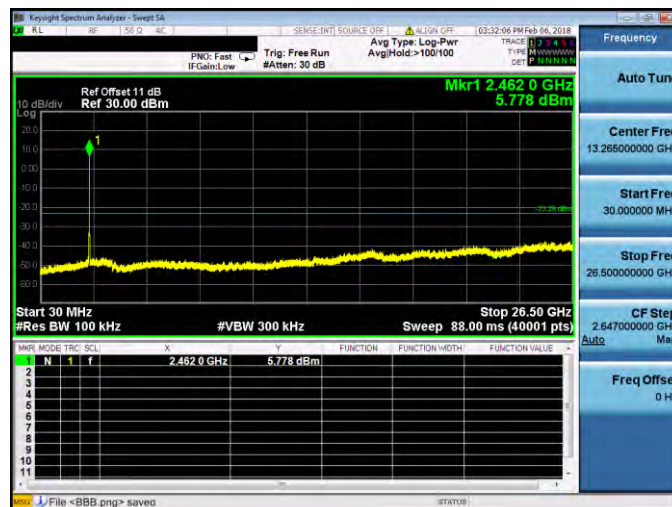



Mode 5: IEEE 802.11n 2.4GHz 40MHz Continuous TX mode_ANT-0

2422 MHz

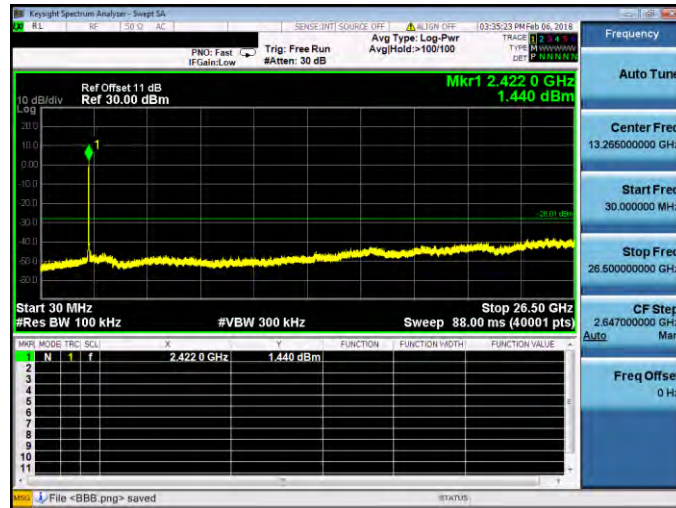

2437 MHz

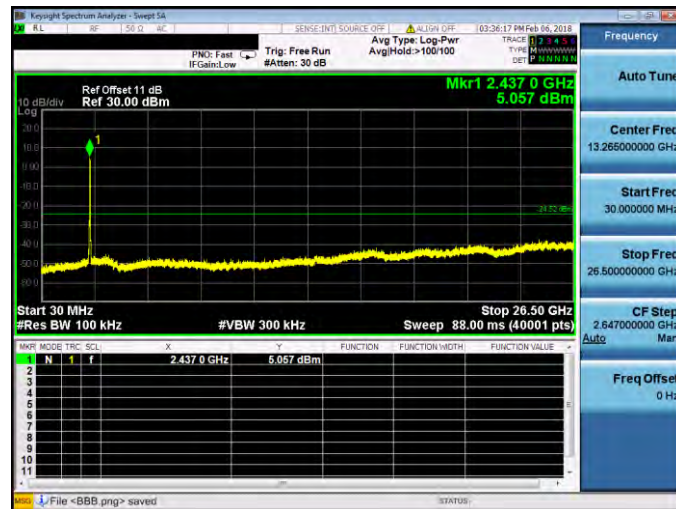

2452 MHz

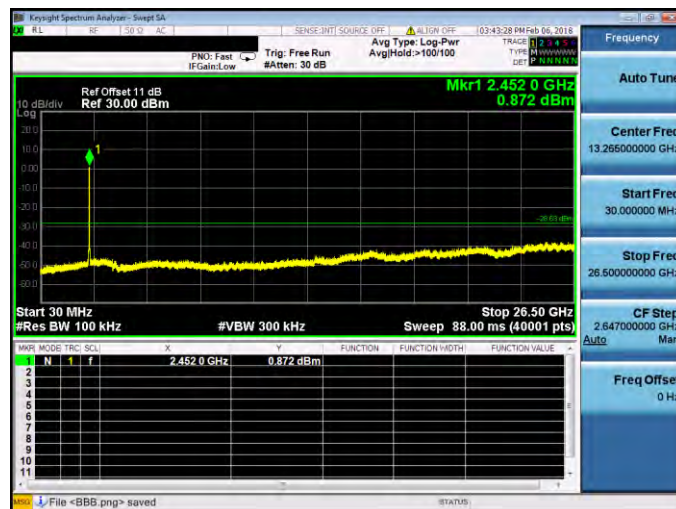



Mode 2: IEEE 802.11b Continuous TX mode_ANT-1

2412 MHz

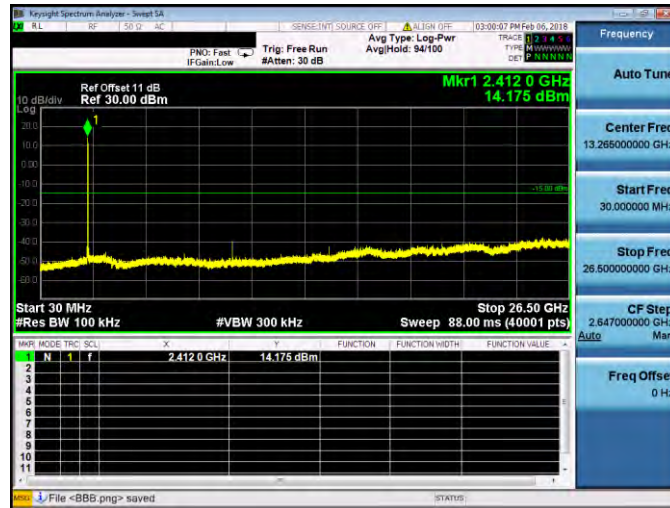

2437 MHz

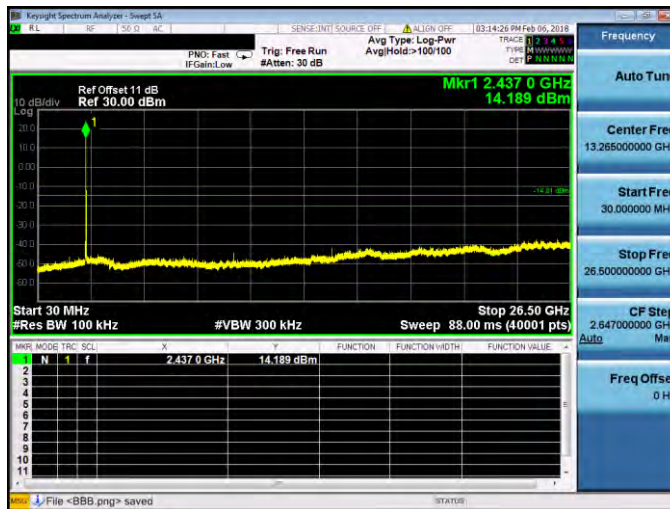

2462 MHz

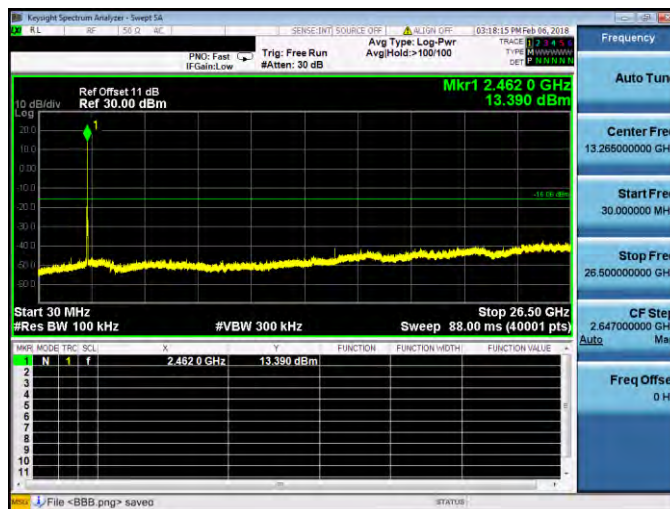



Mode 3: IEEE 802.11g Continuous TX mode_ANT-1

2412 MHz

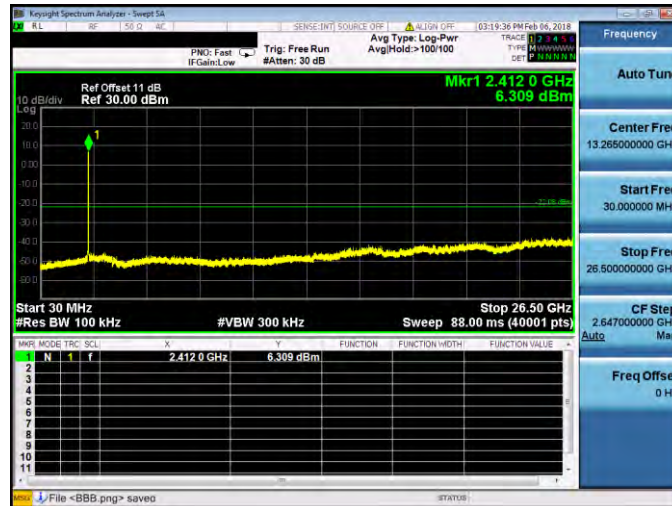

2437 MHz

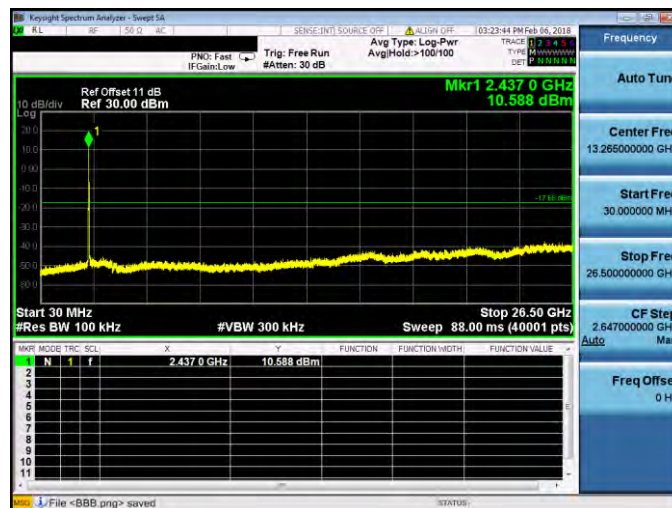

2462 MHz

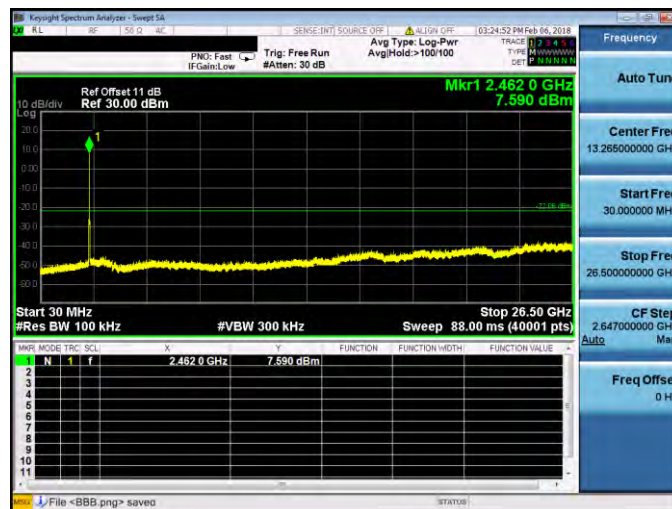



Mode 4: IEEE 802.11n 2.4GHz 20MHz Continuous TX mode_ANT-1

2412 MHz

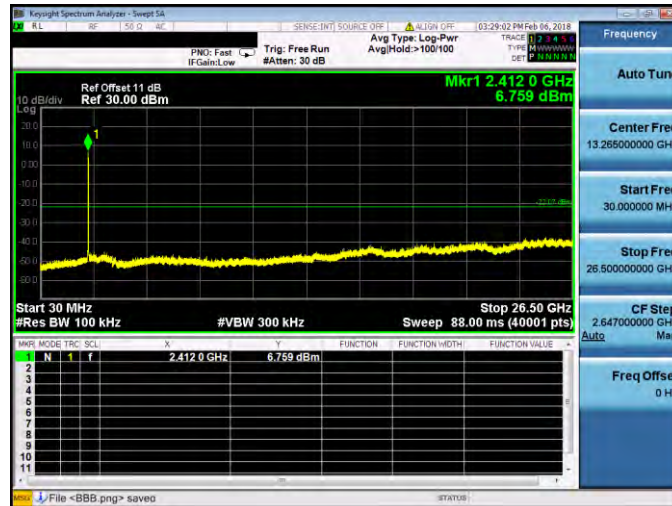

2437 MHz

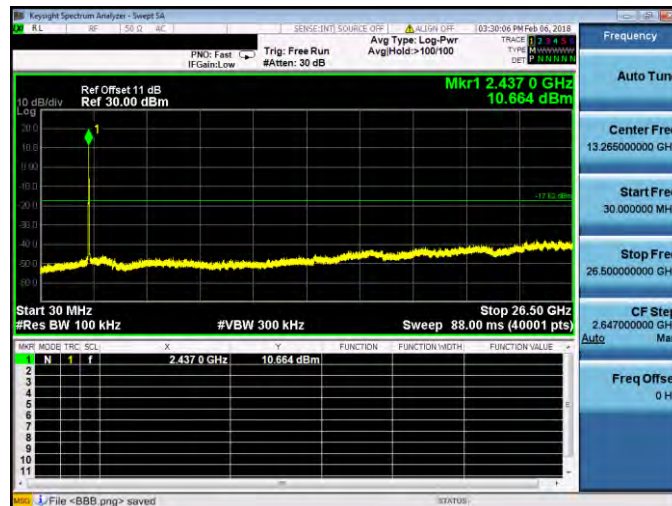

2462 MHz

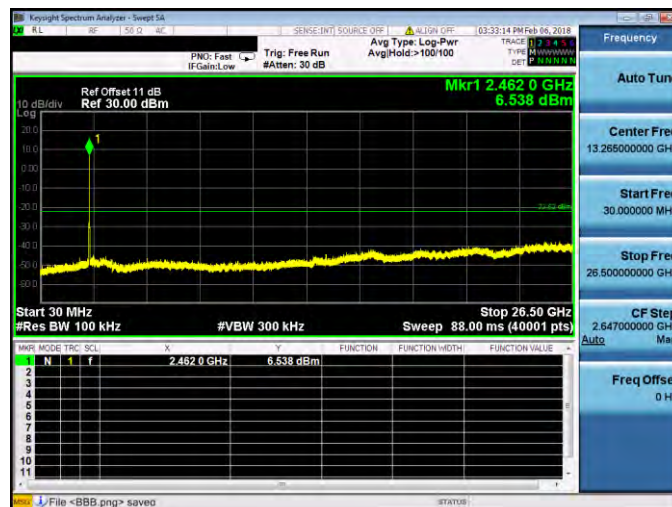



Mode 5: IEEE 802.11n 2.4GHz 40MHz Continuous TX mode_ANT-1

2422 MHz

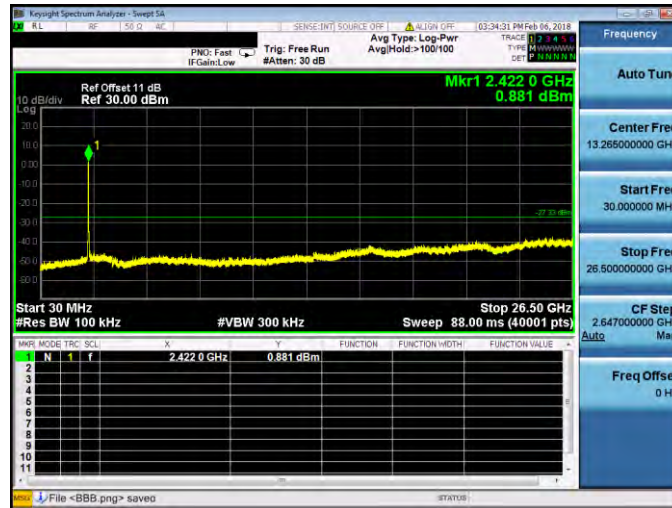

2437 MHz

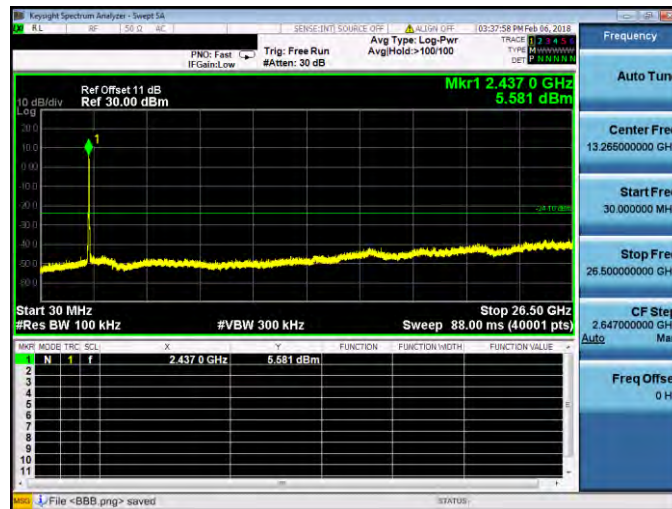

2452 MHz

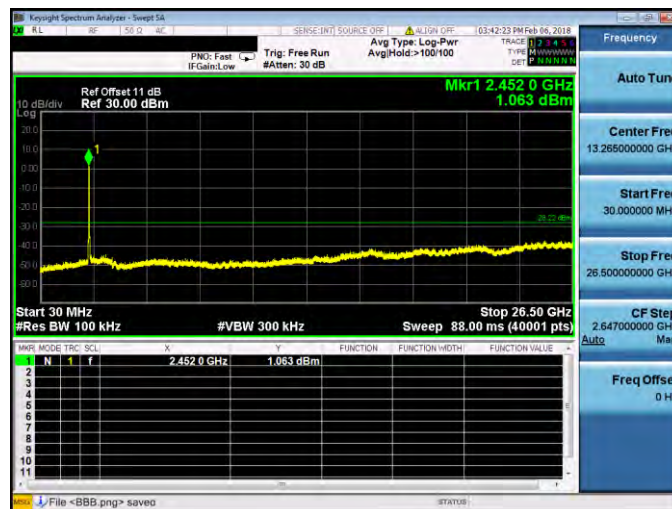

Conducted Band Edge

Mode 2: IEEE 802.11b Continuous TX mode_ANT-0

2412 MHz

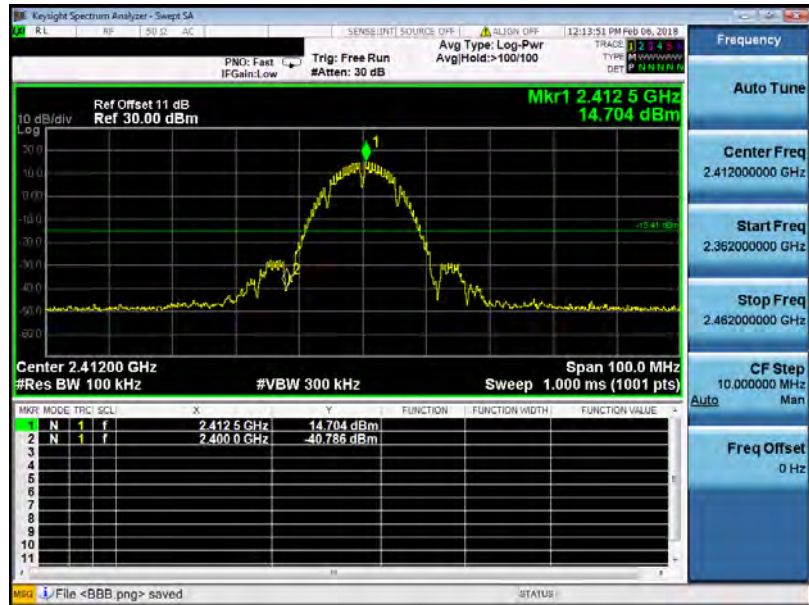

2462 MHz

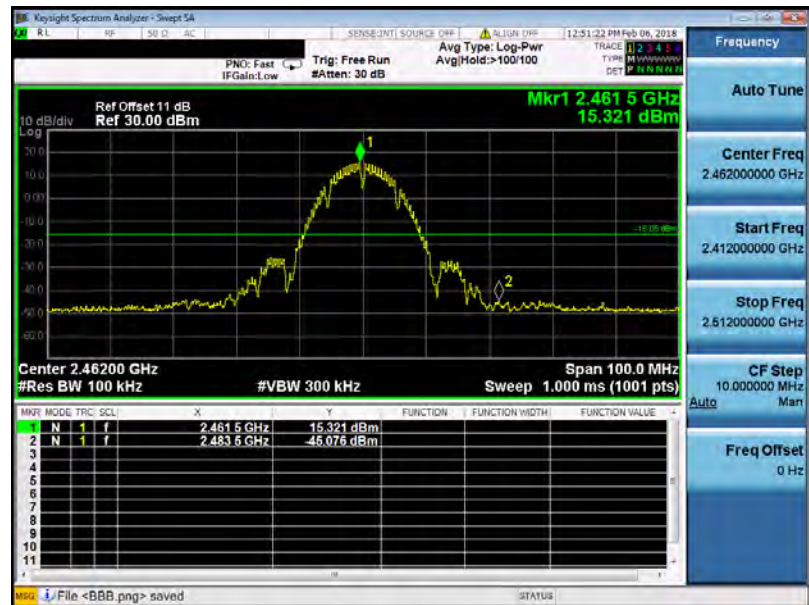

Mode 3: IEEE 802.11g Continuous TX mode_ANT-0

2412 MHz

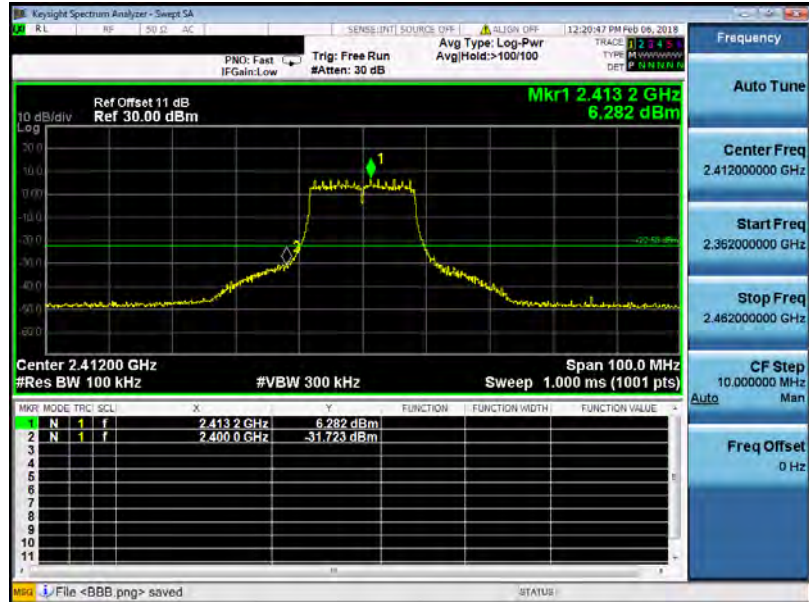

2462 MHz

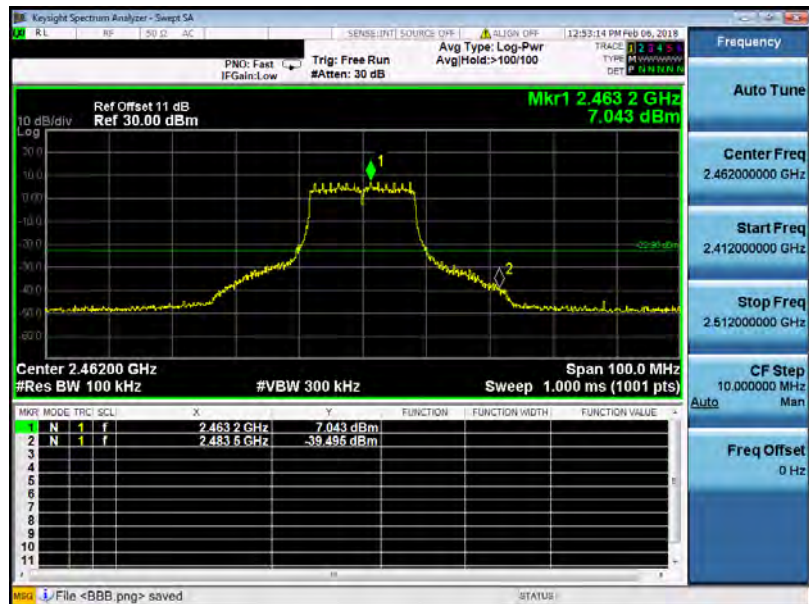

Mode 4: IEEE 802.11n 2.4GHz 20MHz Continuous TX mode_ANT-0

2412 MHz

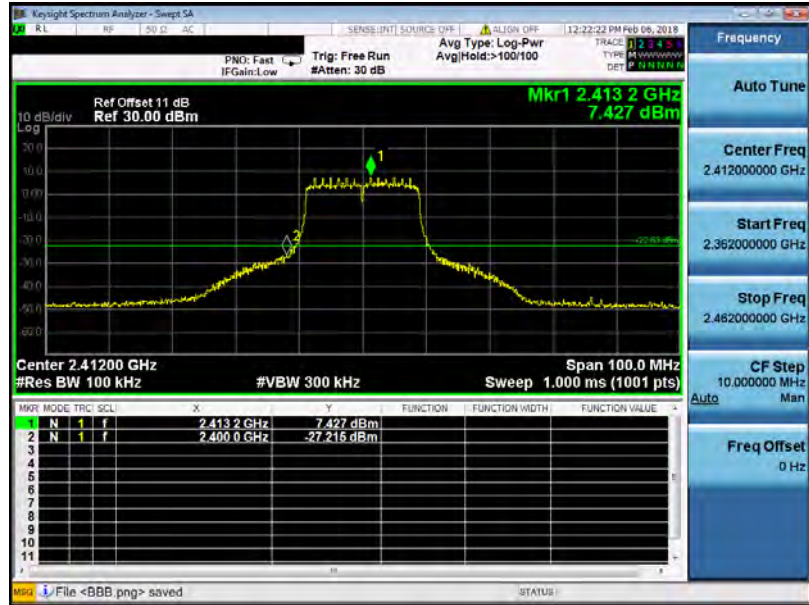

2462 MHz

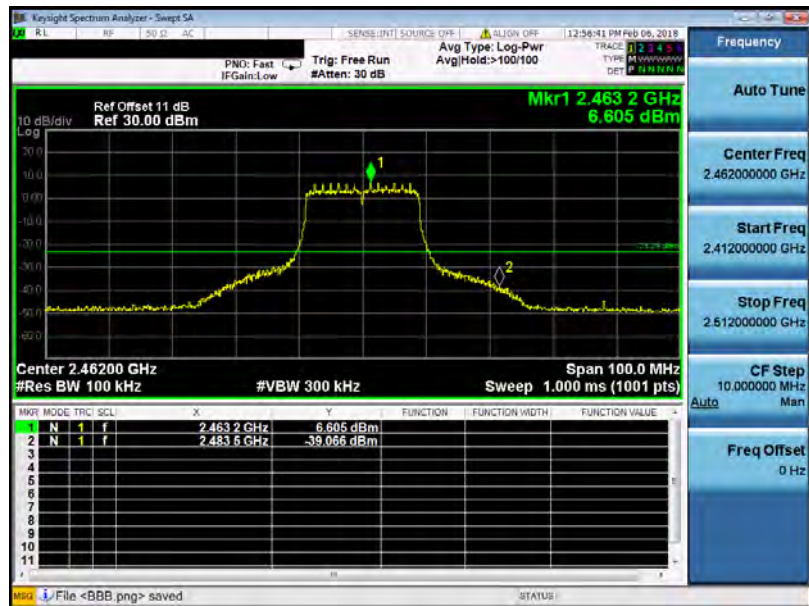



Mode 5: IEEE 802.11n 2.4GHz 40MHz Continuous TX mode_ANT-0

2422 MHz

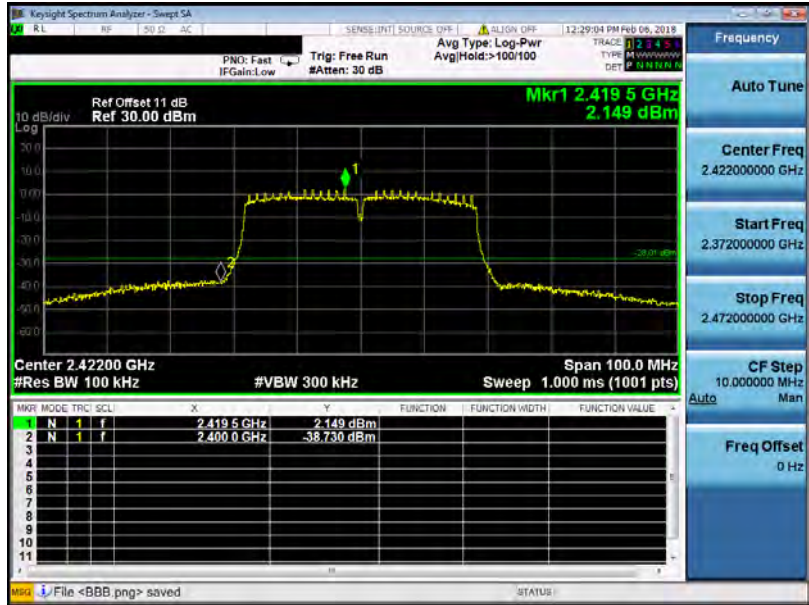

2452 MHz

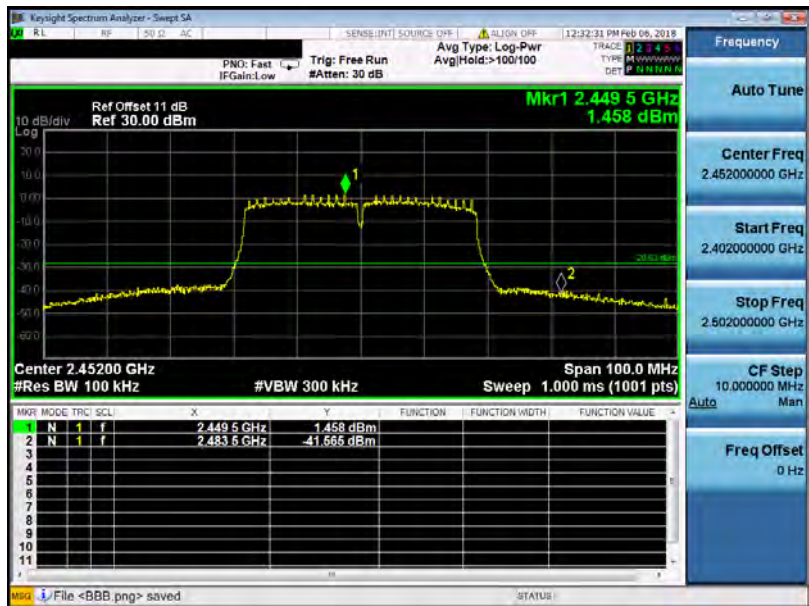

Mode 2: IEEE 802.11b Continuous TX mode_ANT-1

2412 MHz

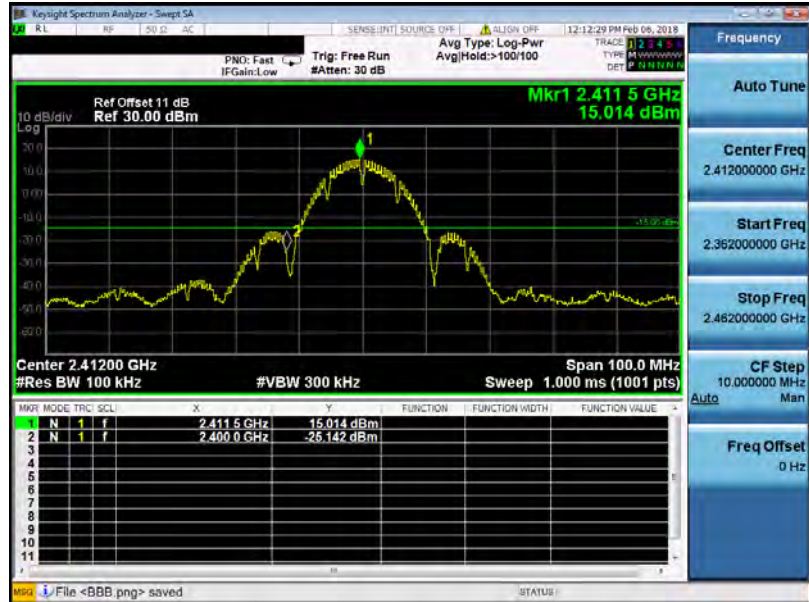

2462 MHz

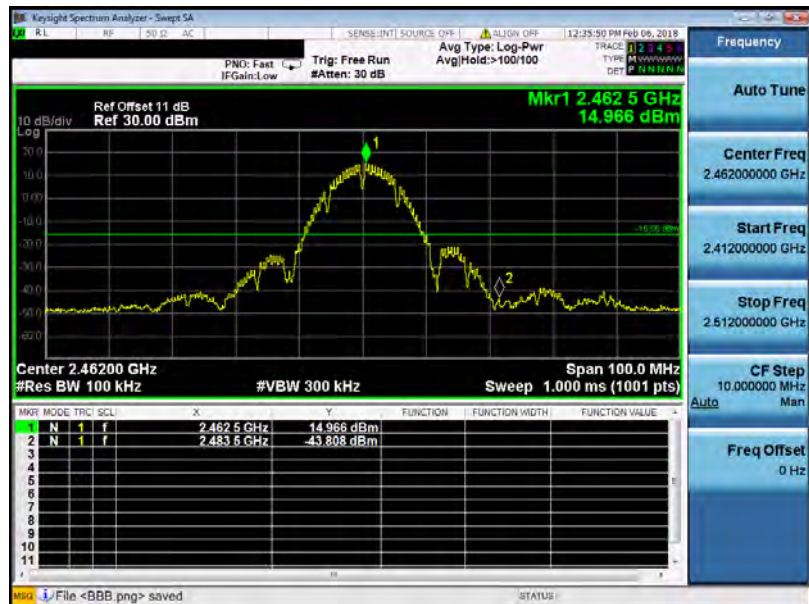

Mode 3: IEEE 802.11g Continuous TX mode_ANT-1

2412 MHz

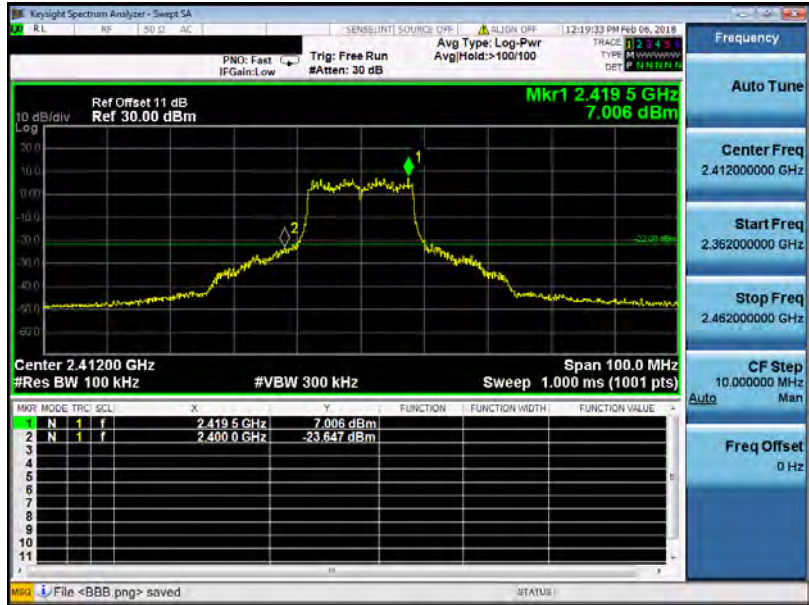

2462 MHz

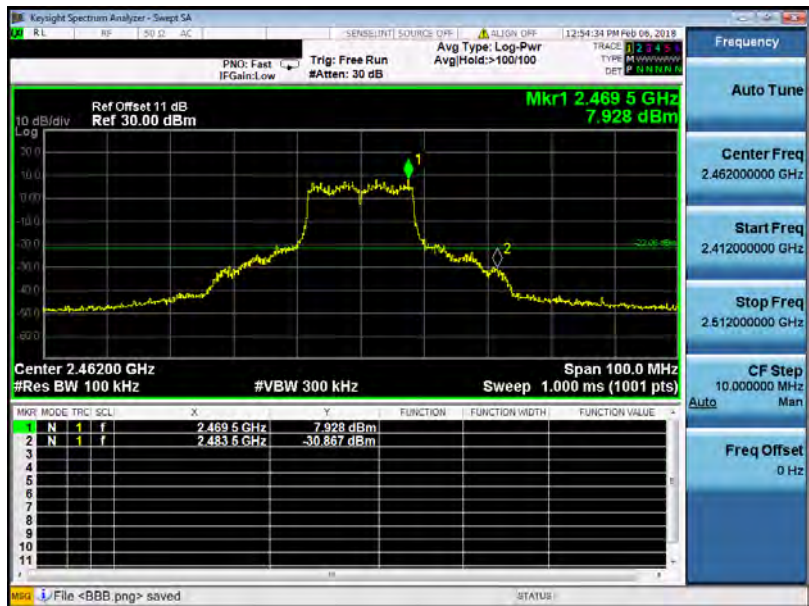

Mode 4: IEEE 802.11n 2.4GHz 20MHz Continuous TX mode_ANT-1

2412 MHz

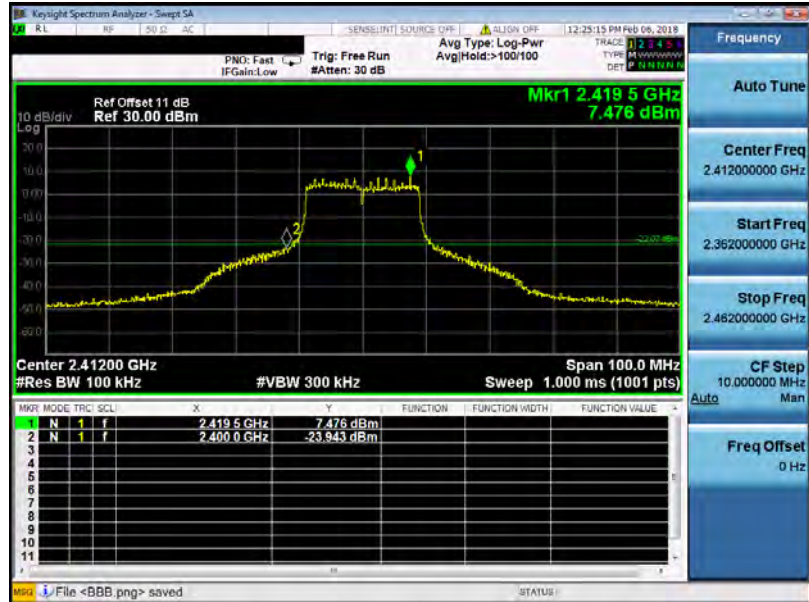

2462 MHz

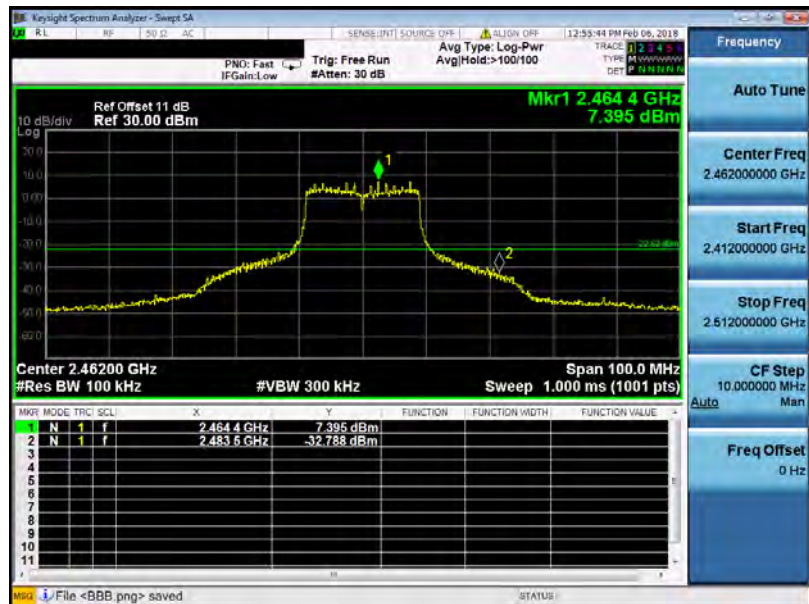

Mode 5: IEEE 802.11n 2.4GHz 40MHz Continuous TX mode_ANT-1

2422 MHz

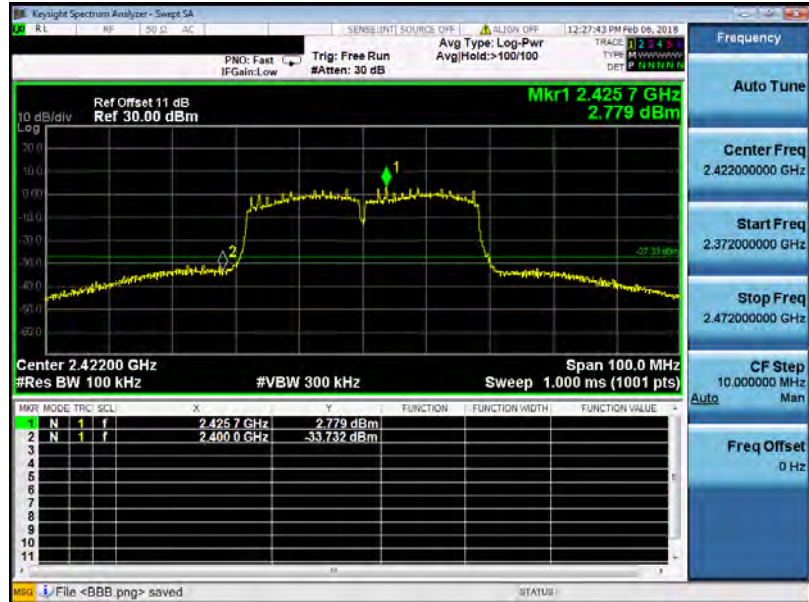

2452 MHz





Annex D. Antenna Requirement

■ Antenna Description

See section 2 – antenna information.

■ Directional Gain Calculated

For Maximum Power Density

* Directional Gain = $10 \cdot \log\{[10^{(G1/20)} + 10^{(G2/20)} + \dots + 10^{(Gn/20)}]^2 / NANT\}$ = 6.84 dBi > 6dBi

Operate Freq. Band	Directional Gain (dBi)
IEEE 802.11b	6.84
IEEE 802.11g	6.84
IEEE 802.11n 2.4GHz 20MHz	6.84
IEEE 802.11n 2.4GHz 40MHz	6.84