

11n(HT20)

CH149

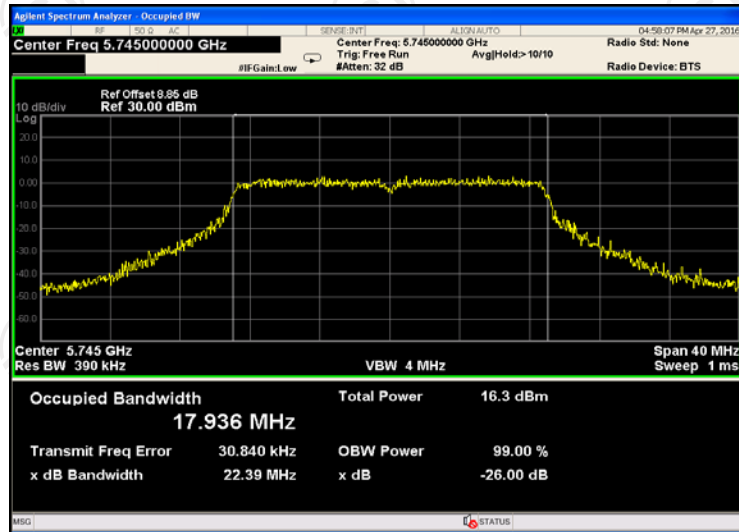

CH157

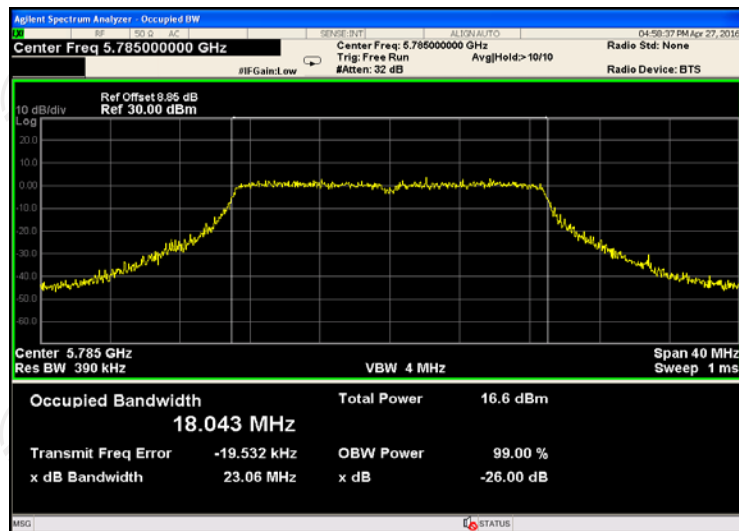

CH161

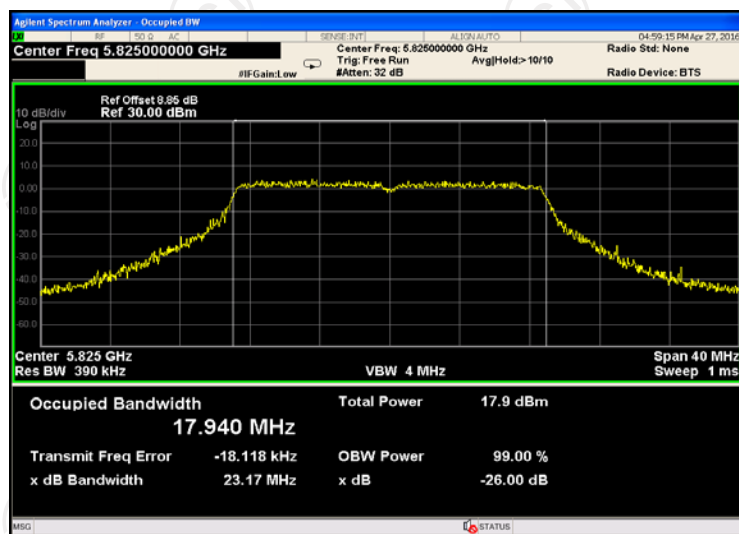

11n(HT40)

CH151

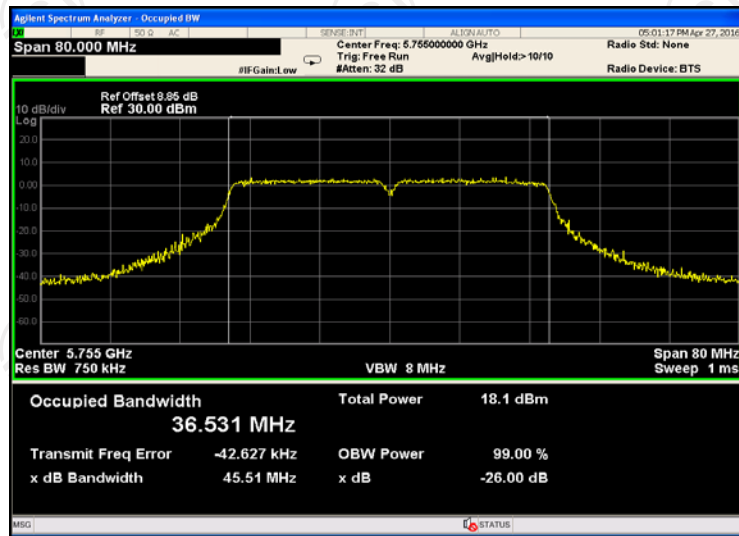

CH159

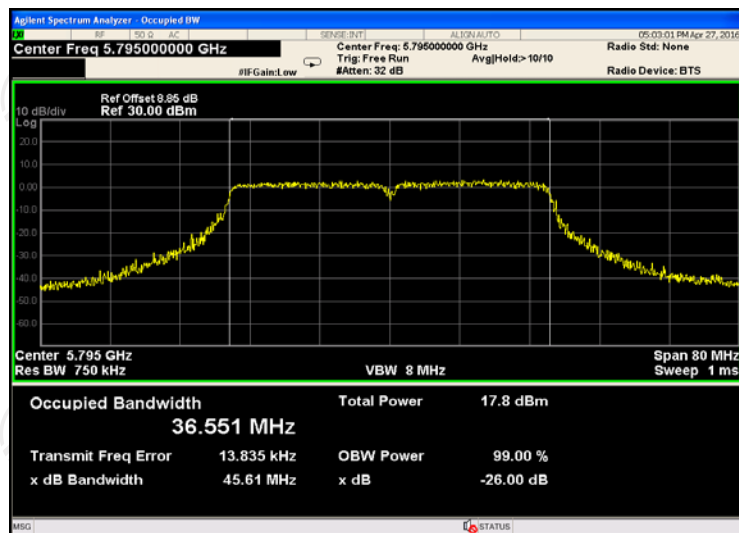

11ac(HT20)

CH149

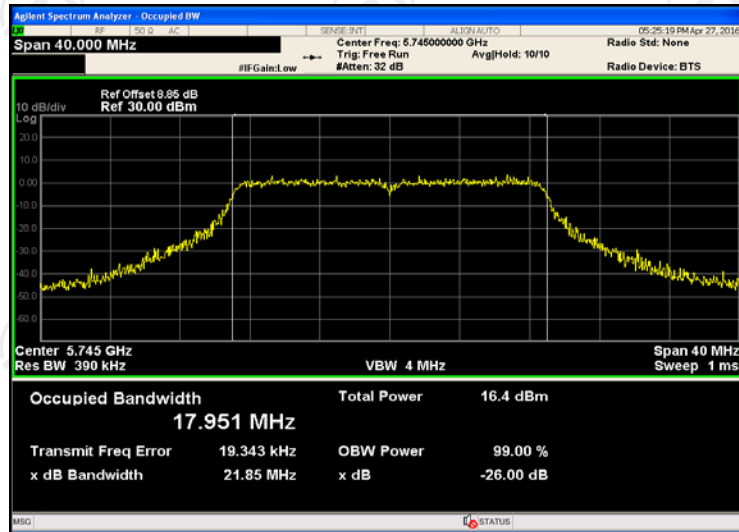

CH157

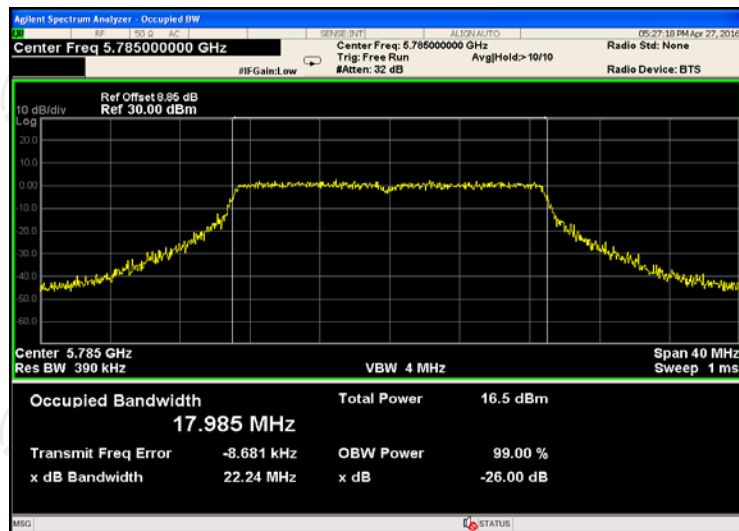

CH161

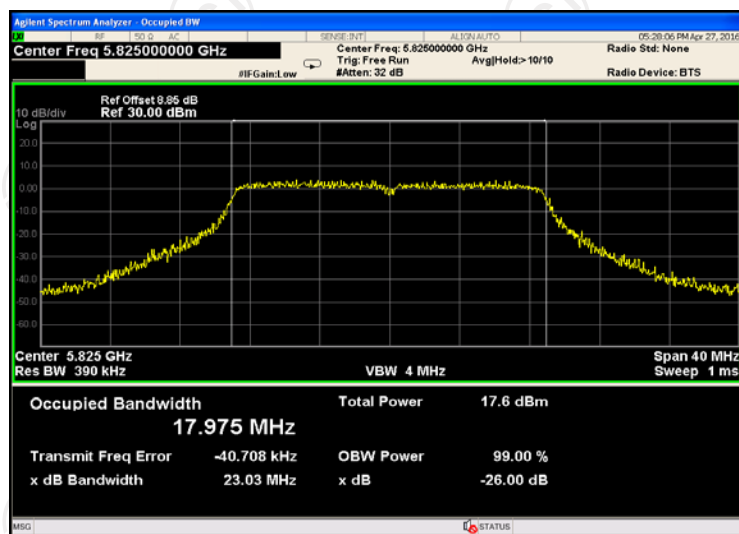

11ac(HT40)

CH151

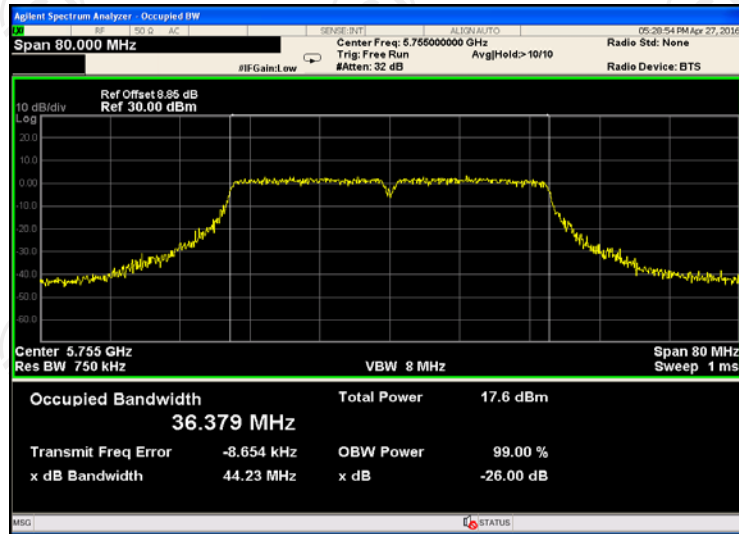

CH159

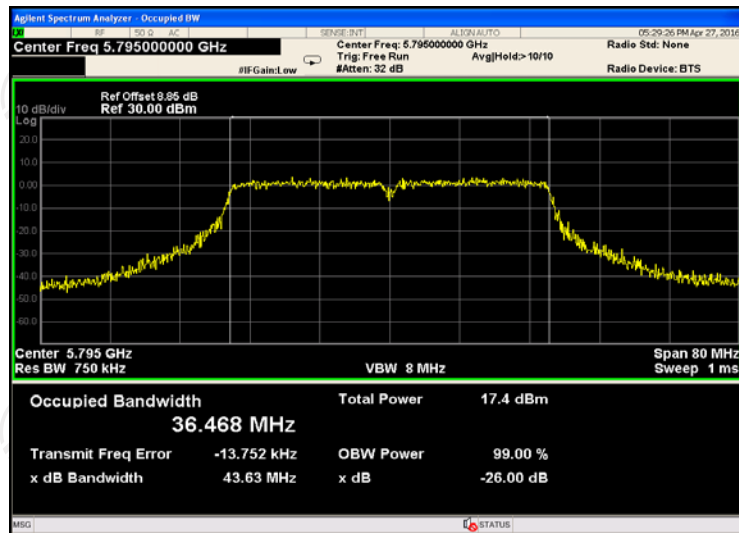

11ac(HT80)

CH155

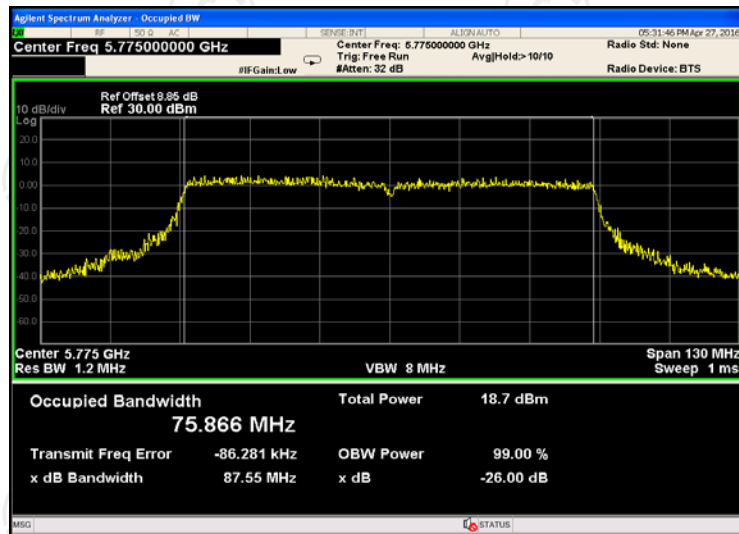

6.6. Power Spectral Density

6.6.1. Test Specification

Test Requirement:	FCC Part15 E Section 15.407 (a)
Test Method:	KDB662911 D01 Multiple Transmitter Output v02r01 KDB789033 D02 General U-NII Test Procedures New Rules v01r02 Section F
Limit:	$\leq 11.00\text{dBm/MHz}$ for Band I 5150MHz-5250MHz $\leq 11.00\text{dBm/MHz}$ for Band II 5250MHz-5350MHz $\leq 11.00\text{dBm/MHz}$ for Band III 5450MHz-5725MHz $\leq 30.00\text{dBm/500KHz}$ for Band IV 5725MHz-5850MHz
Test Setup:	 <p style="text-align: center;">Spectrum Analyzer EUT</p>
Test Mode:	Transmitting mode with modulation
Test Procedure:	<ol style="list-style-type: none"> 1. Set the spectrum analyzer or EMI receiver span to view the entire emission bandwidth. 1. Set RBW = 510 kHz/1 MHz, VBW $\geq 3 \times$ RBW, Sweep time = Auto, Detector = RMS. 2. Allow the sweeps to continue until the trace stabilizes. 3. Use the peak marker function to determine the maximum amplitude level.
Test Result:	PASS

6.6.2. Test Instruments

RF Test Room				
Equipment	Manufacturer	Model	Serial Number	Calibration Due
Spectrum Analyzer	Agilent	N9020A	MY49100060	Sep. 12, 2016
RF cable	TCT	RE-06	N/A	Sep. 12, 2016
Antenna Connector	TCT	RFC-01	N/A	Sep. 12, 2016

Note: The calibration interval of the above test instruments is 12 months and the calibrations are traceable to international system unit (SI).

6.6.3. Test data

Configuration Band IV (5725 - 5850 MHz) / Output 0+Output 1

Mode	Test channel	Power Spectral Density			Limit (dBm/MHz)	Result
		Output 0	Output 1	Total		
11a	CH149	8.61	8.33	11.48	24.00	PASS
11a	CH157	7.70	8.47	11.11	24.00	PASS
11a	CH161	7.30	8.62	11.02	24.00	PASS
11n (HT20)	CH149	8.61	8.03	11.34	24.00	PASS
11n (HT20)	CH157	8.47	8.74	11.62	24.00	PASS
11n (HT20)	CH161	8.44	8.62	11.54	24.00	PASS
11n (HT40)	CH151	6.64	6.74	9.70	24.00	PASS
11n (HT40)	CH159	6.90	7.15	10.04	24.00	PASS
11ac (HT20)	CH149	8.46	8.55	11.52	24.00	PASS
11ac (HT20)	CH157	8.73	8.76	11.76	24.00	PASS
11ac (HT20)	CH161	8.80	8.45	11.64	24.00	PASS
11ac (HT40)	CH151	6.91	6.75	9.84	24.00	PASS
11ac (HT40)	CH159	6.69	6.78	9.75	24.00	PASS
11ac(HT80)	CH155	4.75	6.78	8.89	24.00	PASS

Note: 1. $Directional\ gain = GANT + 10\ log(NANT)\ dBi = 9 + 10\ log(2) = 12\ dBi$
So limit = $30 - (12 - 6) = 24\ dBm/MHz$

2. The total PSD method used the sum spectra maxima across the outputs.

Test plots as follows:

Output 0
Band IV (5725 – 5850 MHz)

11a

CH149

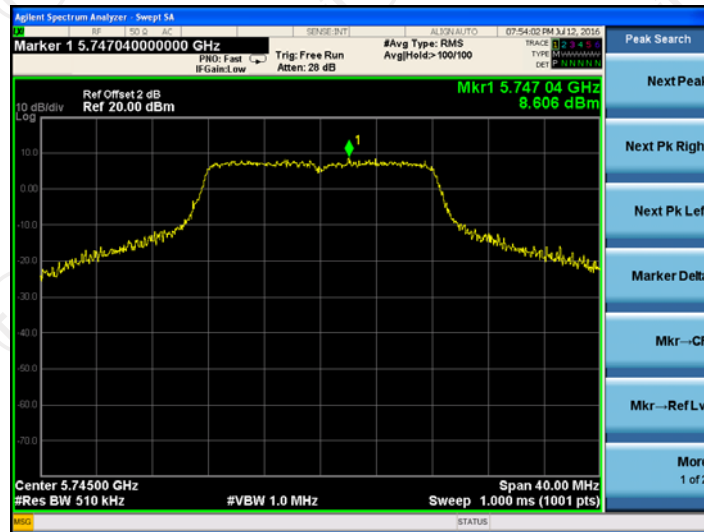

CH157

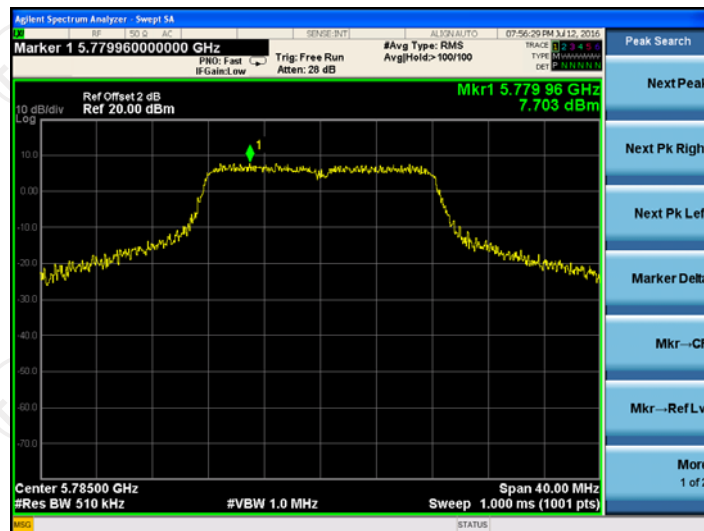

CH161

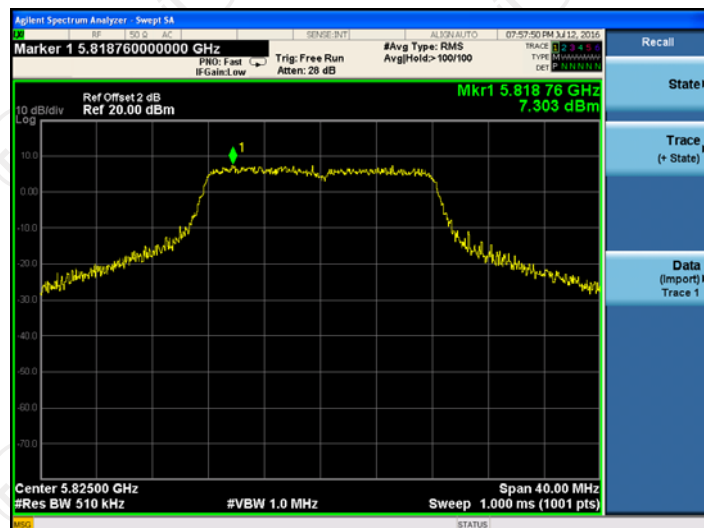

11n(HT20)

CH149

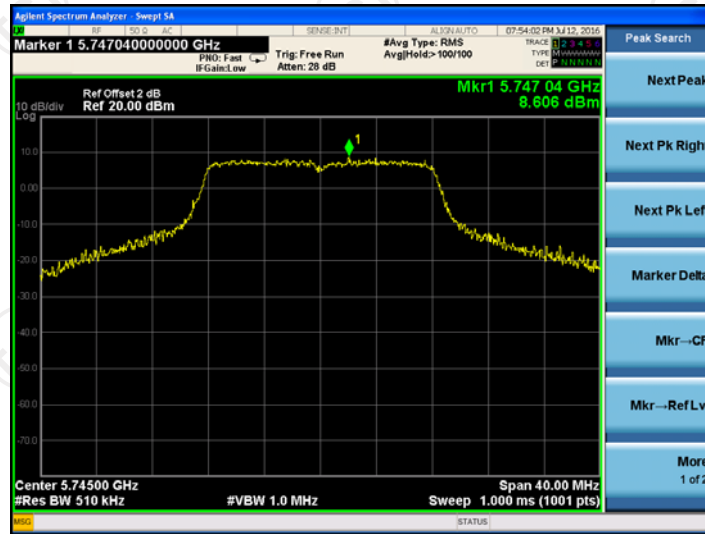

CH157

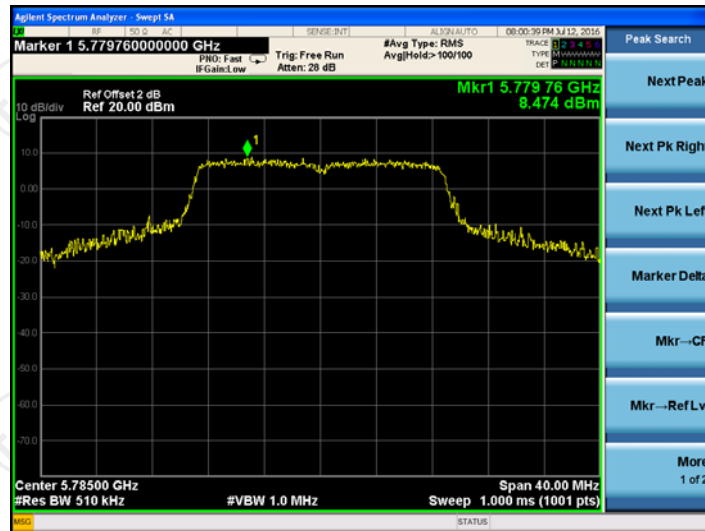

CH161

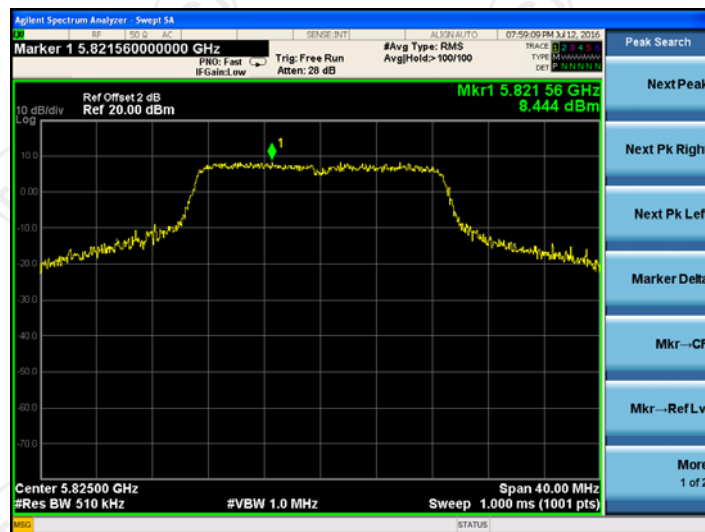

11n(HT40)

CH151



CH159



11ac(HT20)

CH149



CH157

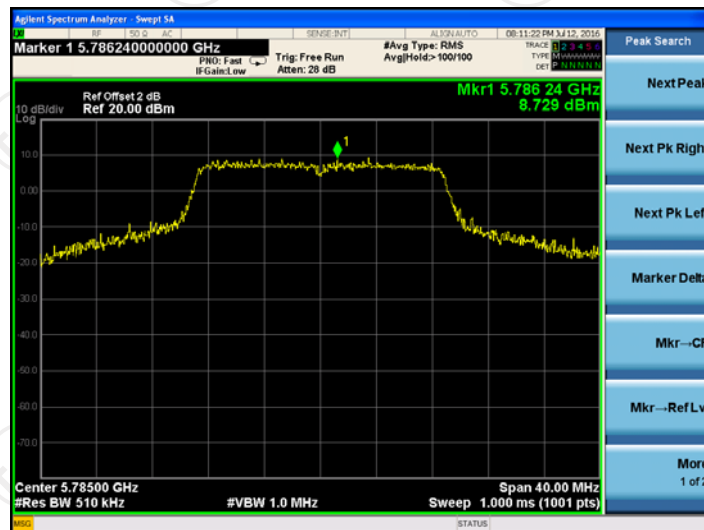

CH161

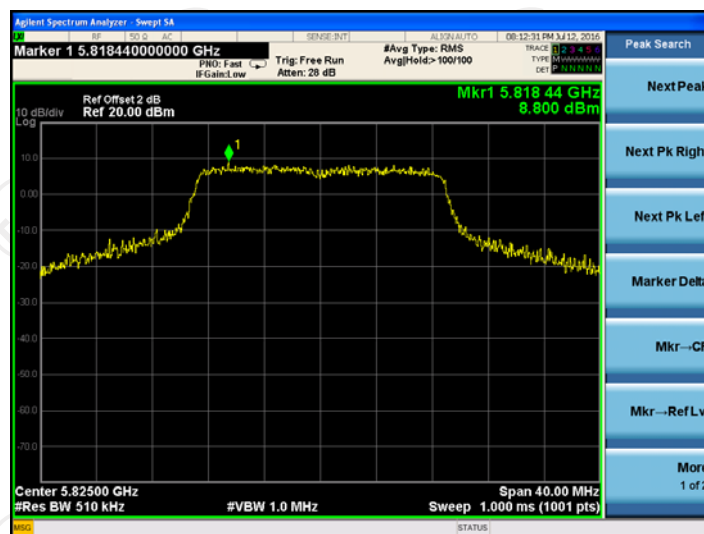

11ac(HT40)

CH151



CH159



11ac(HT80)

CH155



Output 1
Band IV (5725 – 5850 MHz)

11a

CH149

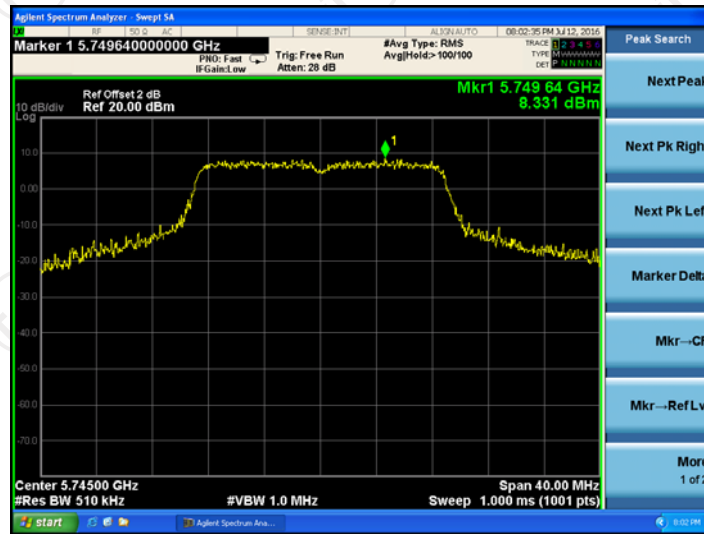

CH157

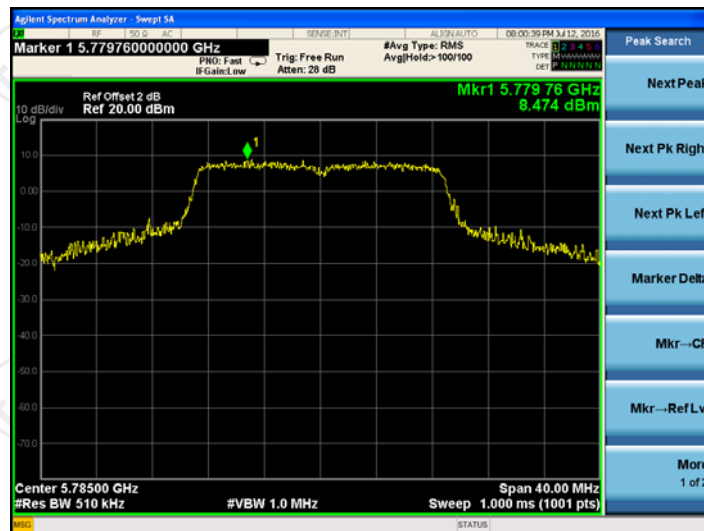

CH161

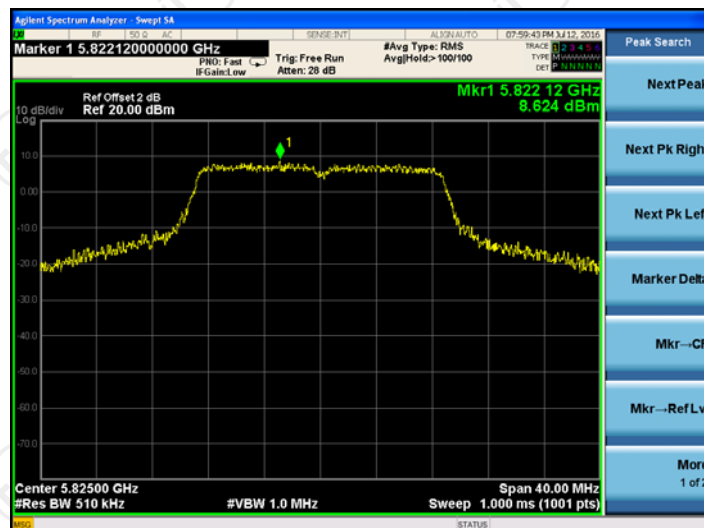

11n(HT20)

CH149



CH157

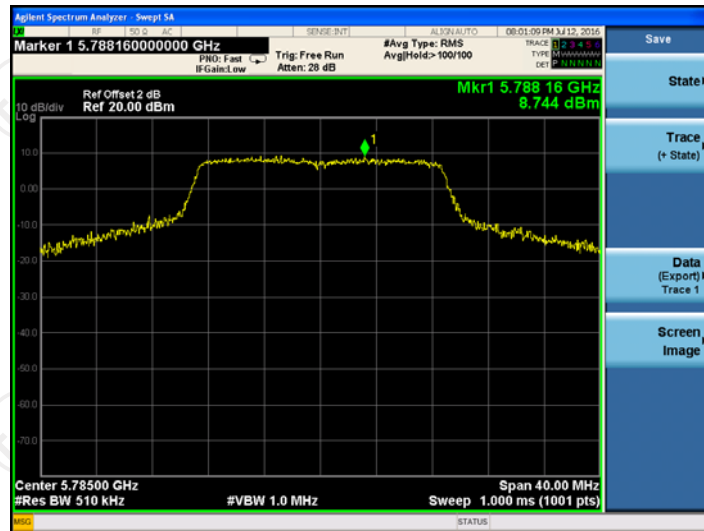

CH161



11n(HT40)

CH151

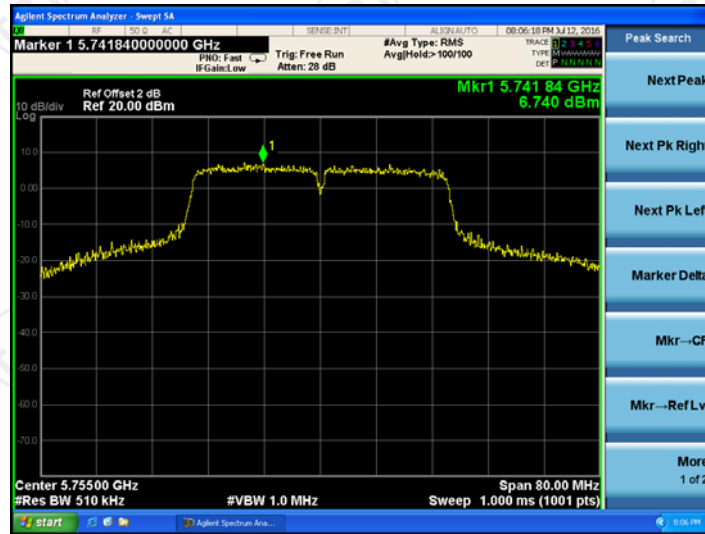

CH159



11ac(HT20)

CH149

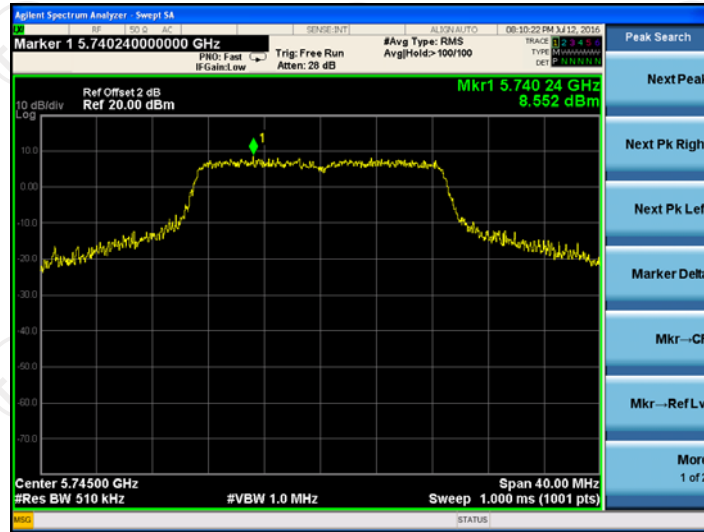

CH157



CH161



11ac(HT40)

CH151



CH159

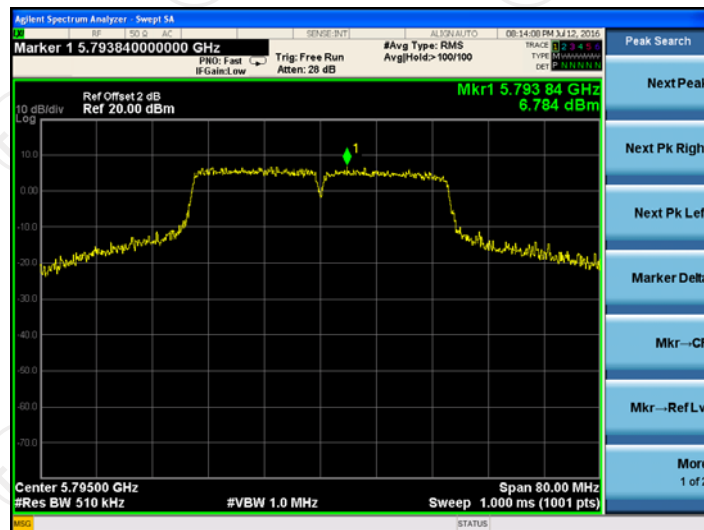

11ac(HT80)

CH155

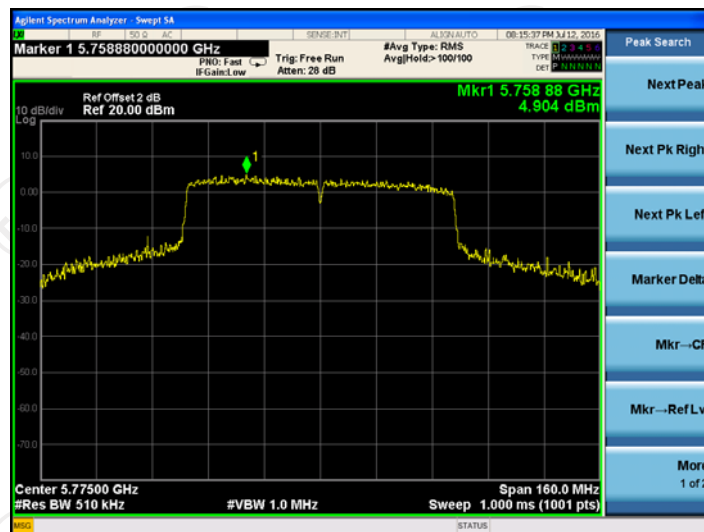

6.7. Band edge

6.7.1. Test Specification

Test Requirement:	FCC CFR47 Part 15E Section 15.407/Part2 J Section 2.1051
Test Method:	ANSI C63.10 2013
Limit:	<p>Outside of the 5.15-5.35GHz Band : e.i.r.p -27 dBm Outside of the 5.15-5.35 GHz band: e.i.r.p. -27 dBm Outside of the 5.47-5.725 GHz band: e.i.r.p. -27 dBm Outside of the 5.725-5.850 GHz band: shall be limited to a level of -27 dBm/MHz at 75 MHz or more above or below the band edge increasing linearly to 10 dBm/MHz at 25 MHz above or below the band edge, and from 25 MHz above or below the band edge increasing linearly to a level of 15.6 dBm/MHz at 5 MHz above or below the band edge, and from 5 MHz above or below the band edge increasing linearly to a level of 27 dBm/MHz at the band edge.</p>
Test Setup:	 <p style="text-align: center;">Spectrum Analyzer EUT</p>
Test Mode:	Transmitting mode with modulation
Test Procedure:	<p>Use the following spectrum analyzer settings:</p> <ol style="list-style-type: none"> Span = wide enough to capture the peak level of the in-band emission and all spurious emissions (e.g., harmonics) from the lowest frequency generated in the EUT up through the 10th harmonic. Typically, several plots are required to cover this entire span. RBW = 1 MHz for $f \geq 1$ GHz, 100 kHz for $f < 1$ GHz VBW \geq RBW Sweep = auto Detector function = peak Trace = max hold.
Test Result:	PASS

6.7.2. Test Instruments

RF Test Room				
Equipment	Manufacturer	Model	Serial Number	Calibration Due
Spectrum Analyzer	Agilent	N9020A	MY49100060	Sep. 12, 2016
RF cable	TCT	RE-06	N/A	Sep. 12, 2016
Antenna Connector	TCT	RFC-01	N/A	Sep. 12, 2016

Note: The calibration interval of the above test instruments is 12 months and the calibrations are traceable to international system unit (SI).

6.7.3. Test Data

Output 0

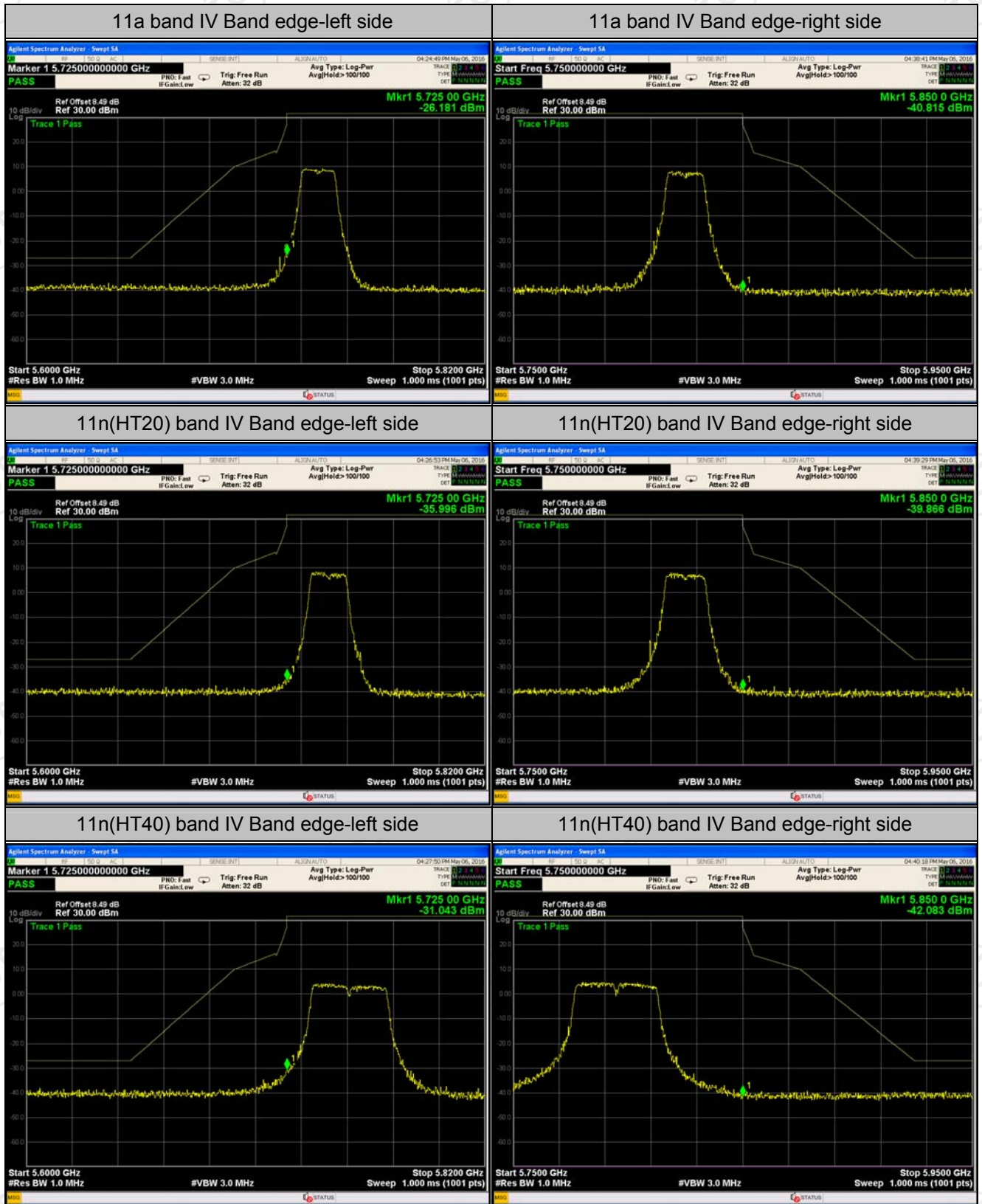

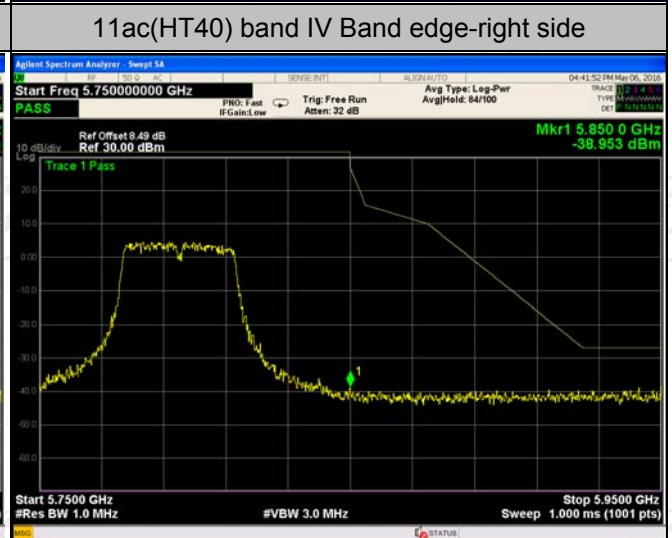
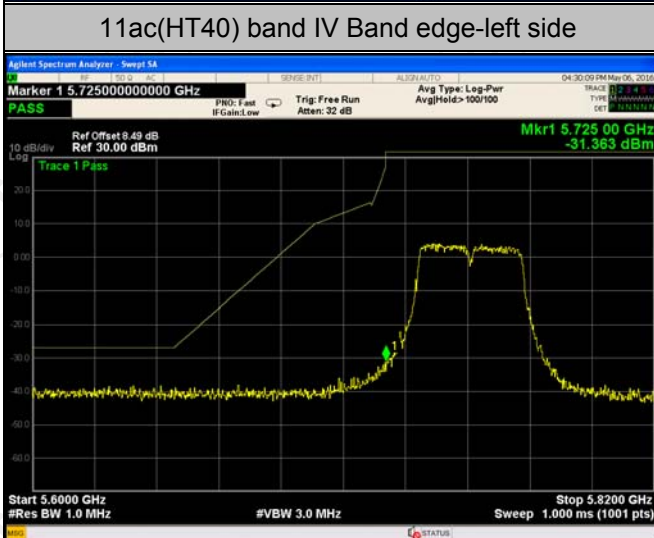
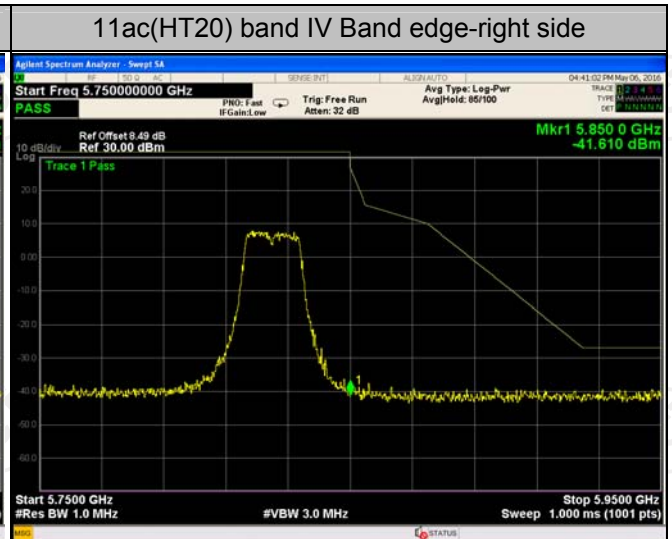
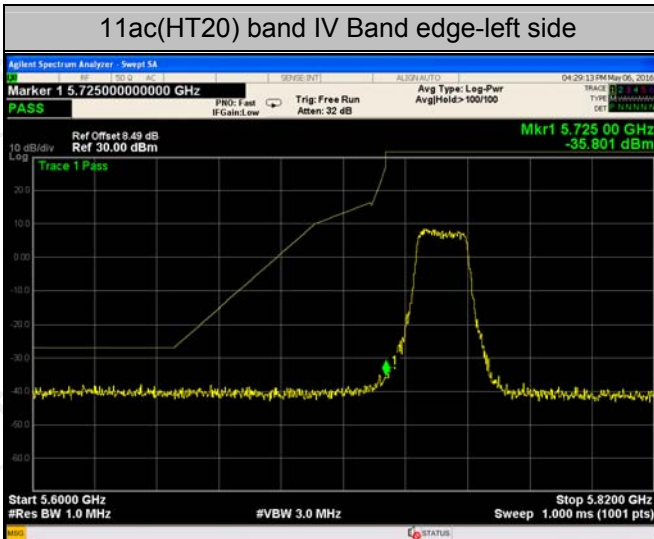

Output 1

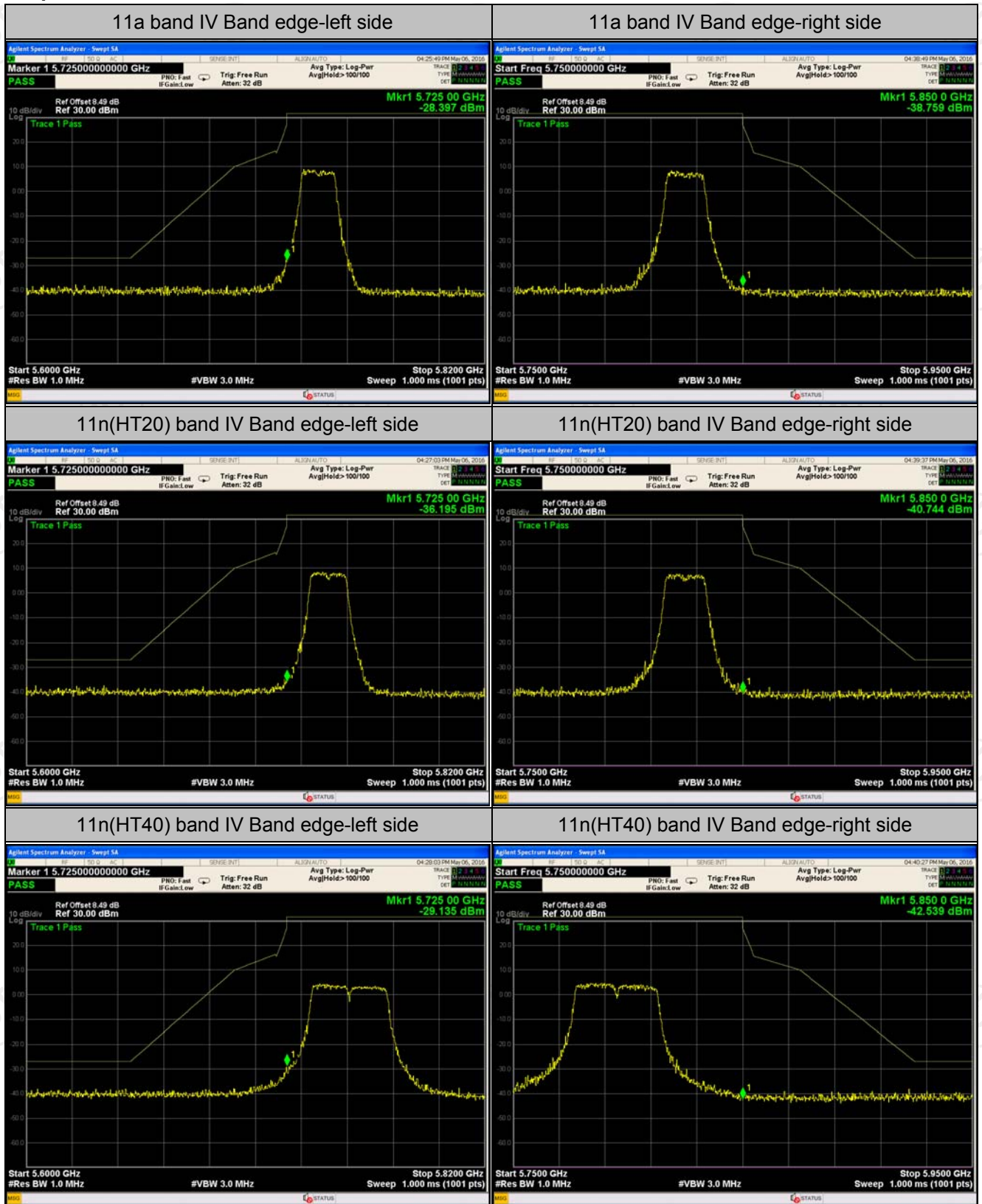

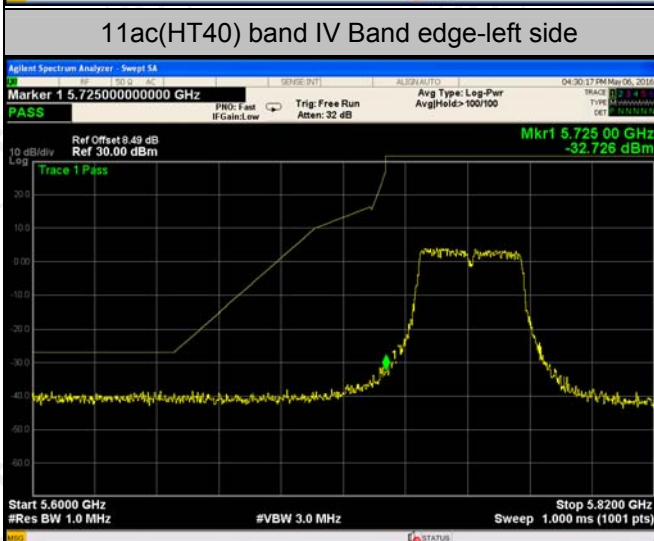
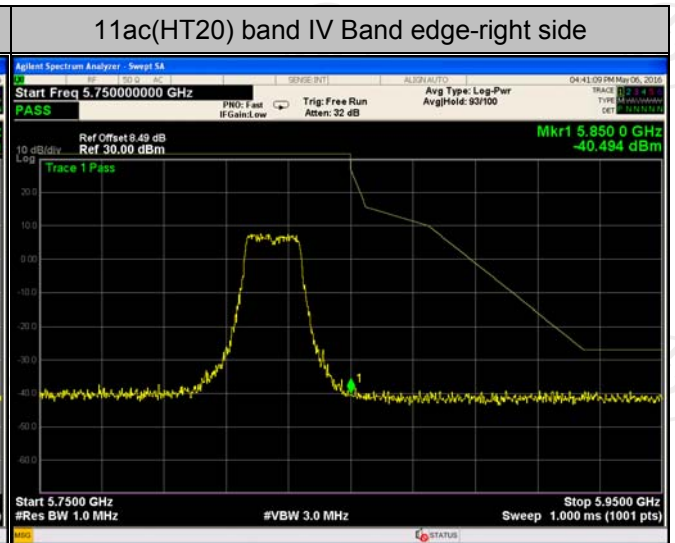
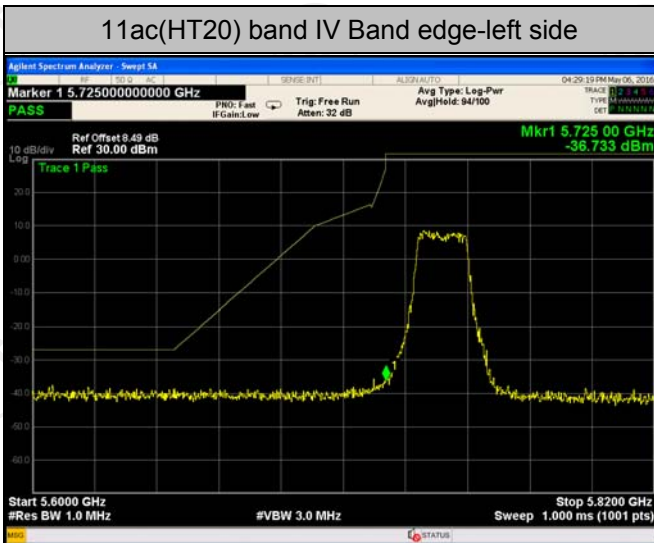

6.8. Unwanted Emission Measurement

6.8.1. Test Specification

Test Requirement:	FCC CFR47 Part 15 Section 15.407 & 15.209 & 15.205 Part2 J Section 2.1053				
Test Method:	KDB 789033 D02 v01				
Frequency Range:	9 kHz to 40GHz				
Measurement Distance:	3 m				
Antenna Polarization:	Horizontal & Vertical				
Operation mode:	Transmitting mode with modulation				
Receiver Setup:	Frequency	Detector	RBW	VBW	Remark
	9kHz- 150kHz	Quasi-peak	200Hz	1kHz	Quasi-peak Value
	150kHz- 30MHz	Quasi-peak	9kHz	30kHz	Quasi-peak Value
	30MHz-1GHz	Quasi-peak	100kHz	300kHz	Quasi-peak Value
	Above 1GHz	Peak	1MHz	3MHz	Peak Value
Peak		1MHz	10Hz	Average Value	
Limit:	(1) For transmitters operating in the 5725-5850 MHz band: all emissions within the frequency range from the band edge to 10 MHz above or below the band edge shall not exceed an EIRP of -17dBm/MHz (78.3dBu V/m); for frequencies 10 MHz or greater above or below the band edge, emissions shall not exceed an EIRP of -27 dBm/MHz (68.3dBuV/m).				
	(2) Unwanted spurious emissions fallen in restricted bands per FCC Part15.205 shall comply with the general field strength limits set forth in § 15.209 as below table,				
	Frequency	Field Strength (microvolts/meter)	Measurement Distance (meters)		
	0.009-0.490	2400/F(KHz)	300		
	0.490-1.705	24000/F(KHz)	30		
	1.705-30	30	30		
	30-88	100	3		
	88-216	150	3		
	216-960	200	3		
	Above 960	500	3		

Test setup:

Note: The following formula is used to convert the EIRP to field strength.

$$E = \frac{1000000\sqrt{30P}}{3} \quad \mu\text{V/m, where P is the eirp (Watts)}$$

EIRP(dBm)	Field Strength at 3m (dBuV/m)
-17	78.3
-27	68.3

(3) KDB789033 v01r02 H)2)c(i) As specified in 15.407(b), emissions above 1000 MHz that are outside of the restricted bands are subject to a peak emission limit of -27 dBm/MHz (or -17dBm/MHz as specified in 15.407(b)(4)). However, an out-of-band emission that complies with both the average and peak limits of 15.209 is not required to satisfy the -27 dBm/MHz or -17dBm/MHz peak emission limit.

For radiated emissions below 30MHz

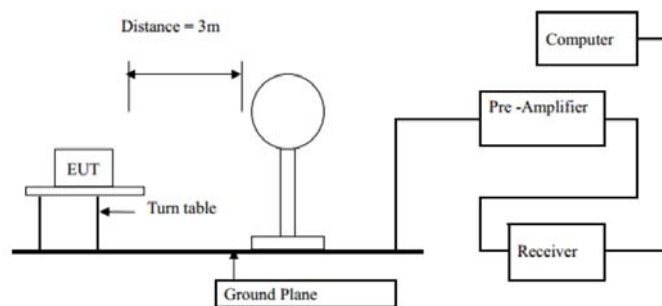

30MHz to 1GHz

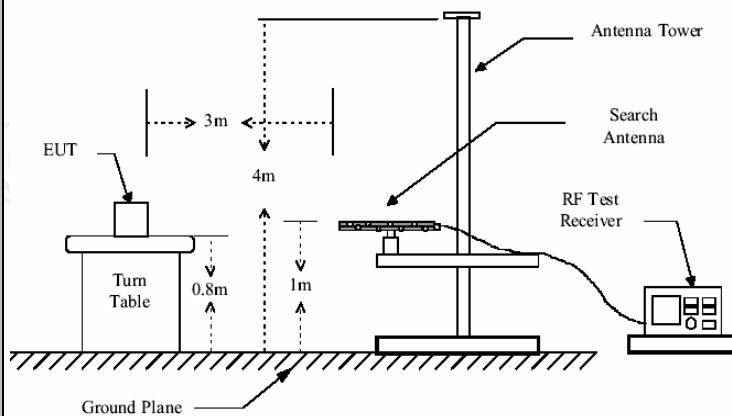

Above 1GHz

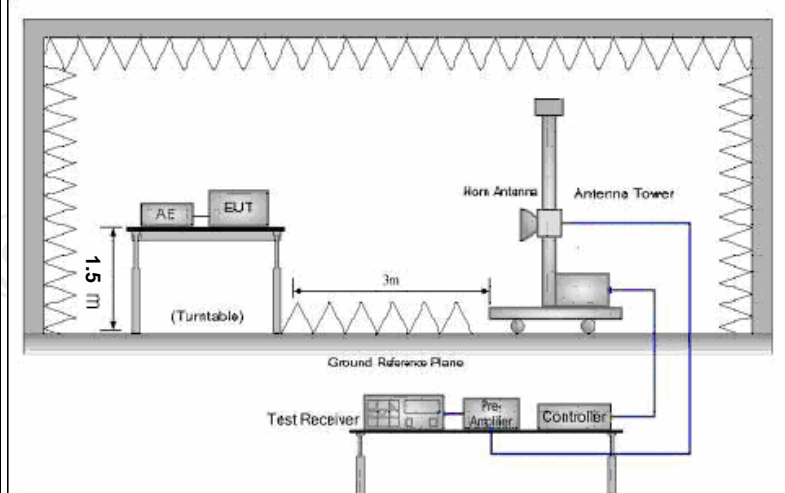

Test Procedure:

1. The testing follows FCC KDB Publication No. 789033 D02 General UNII Test Procedures New Rules v01. Section G) Unwanted emissions measurement.
2. For the radiated emission test below 1GHz:
The EUT was placed on a turntable with 0.8 meter above ground. The EUT was set 3 meters from the interference receiving antenna, which was mounted on the top of a variable height antenna tower. The EUT was arranged to its worst case and then tune the antenna tower (from 1 m to 4 m) and turntable (from 0 degree to 360 degrees) to find the maximum reading. A pre-amp and a high PASS filter are used for the test in order to get better signal level.
For the radiated emission test above 1GHz:
Place the measurement antenna on a turntable with 1.5 meter above ground, which is away from each area of the EUT determined to be a source of emissions at the specified measurement distance, while keeping the measurement antenna aimed at the source of emissions at each frequency of significant emissions, with polarization oriented for maximum response. The measurement antenna may have to be higher or lower than the EUT, depending on the radiation pattern of the emission and staying aimed at the emission source for receiving the maximum signal. The final measurement antenna elevation shall be that which maximizes the emissions. The measurement antenna elevation for maximum emissions shall be restricted to a range of heights of from 1 m to 4 m above the ground or reference ground plane.
3. Corrected Reading: $\text{Antenna Factor} + \text{Cable Loss} + \text{Read Level} - \text{Preamp Factor} = \text{Level}$
4. For measurement below 1GHz, If the emission level of the EUT measured by the peak detector is 3 dB

	<p>lower than the applicable limit, the peak emission level will be reported. Otherwise, the emission measurement will be repeated using the quasi-peak detector and reported.</p> <p>5. Use the following spectrum analyzer settings:</p> <p>(1) Span shall wide enough to fully capture the emission being measured;</p> <p>(2) Set RBW=100 kHz for $f < 1$ GHz; $VBW \geq RBW$; Sweep = auto; Detector function = peak; Trace = max hold;</p> <p>(3) Set RBW = 1 MHz, VBW= 3MHz for $f > 1$ GHz for peak measurement.</p> <p>For average measurement: VBW = 10 Hz, when duty cycle is no less than 98 percent. $VBW \geq 1/T$, when duty cycle is less than 98 percent where T is the minimum transmission duration over which the transmitter is on and is transmitting at its maximum power control level for the tested mode of operation.</p> <p>(4) A 5.8GHz high -PASS filter is used during radiated emissions above 1GHz measurement.</p>
Test results:	PASS

6.8.2. Test Instruments

Radiated Emission Test Site (966)				
Name of Equipment	Manufacturer	Model	Serial Number	Calibration Due
ESPI Test Receiver	ROHDE&SCHW ARZ	ESVD	100008	Sep. 11, 2016
Spectrum Analyzer	ROHDE&SCHW ARZ	FSEM	848597/001	Sep. 11, 2016
Spectrum Analyzer	Agilent	N9020A	MY49100060	Sep. 12, 2016
Spectrum Analyzer	ROHDE&SCHW ARZ	FSP40	100056	Sep. 11, 2016
Pre-amplifier	EM Electronics Corporation CO.,LTD	EM30265	07032613	Sep. 11, 2016
Pre-amplifier	HP	8447D	2727A05017	Sep. 11, 2016
Loop antenna	ZHINAN	ZN30900A	12024	Sep. 13, 2016
Broadband Antenna	Schwarzbeck	VULB9163	340	Sep. 13, 2016
Horn Antenna	Schwarzbeck	BBHA 9120D	631	Sep. 13, 2016
Horn Antenna	Schwarzbeck	BBHA 9170	373	Sep. 13, 2016
Coax cable	TCT	RE-low-01	N/A	Sep. 11, 2016
Coax cable	TCT	RE-high-02	N/A	Sep. 11, 2016
Coax cable	TCT	RE-low-03	N/A	Sep. 11, 2016
Coax cable	TCT	RE-High-04	N/A	Sep. 11, 2016
Antenna Mast	CCS	CC-A-4M	N/A	Sep. 12, 2016
EMI Test Software	Shurple Technology	EZ-EMC	N/A	N/A

Note: The calibration interval of the above test instruments is 12 months and the calibrations are traceable to international system unit (SI).

6.8.3. Test Data

Please refer to following diagram for individual
Below 1GHz

Horizontal:

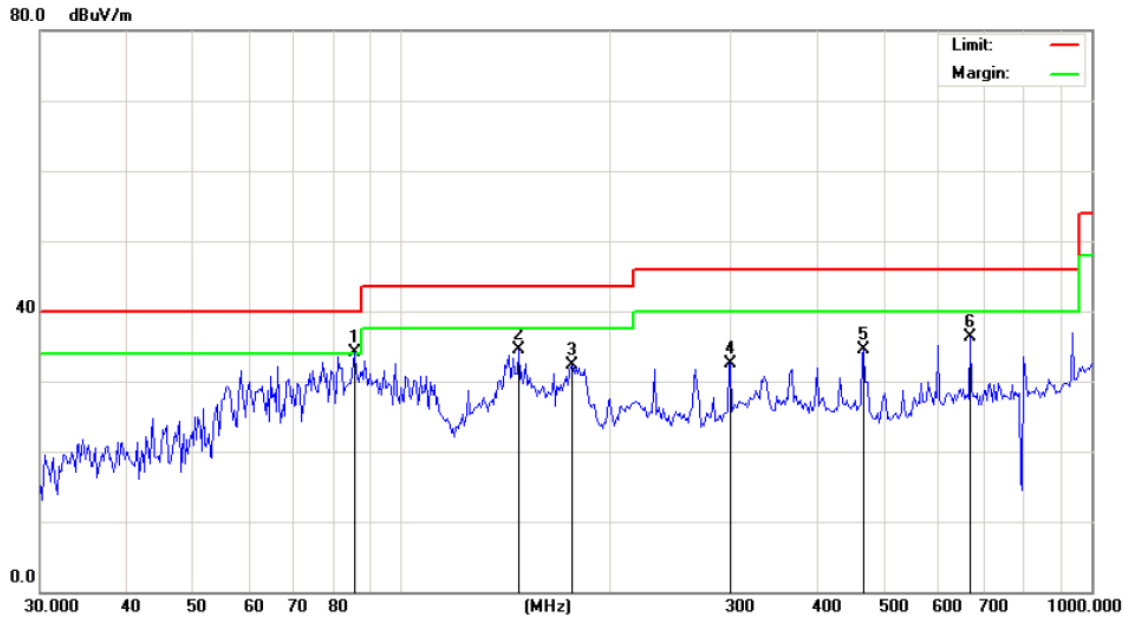

Site: Polarization: **Horizontal** Temperature: 25
Limit: FCC Part 15B Class B RE_3 m Power: AC 120V/60Hz Humidity: 54 %

No.	Mk.	Freq.	Reading Level	Correct Factor	Measurement	Limit	Over	Antenna Height	Table Degree	Comment
		MHz	dBuV	dB	dBuV/m	dBuV/m	dB	Detector	cm	degree
1	*	85.8020	48.45	-14.39	34.06	40.00	-5.94	peak		0
2		147.9875	49.65	-15.20	34.45	43.50	-9.05	peak		0
3		177.1425	45.54	-13.26	32.28	43.50	-11.22	peak		0
4		300.4211	40.82	-8.24	32.58	46.00	-13.42	peak		0
5		468.3072	38.50	-3.99	34.51	46.00	-11.49	peak		0
6		667.2418	36.92	-0.54	36.38	46.00	-9.62	peak		0

Vertical:

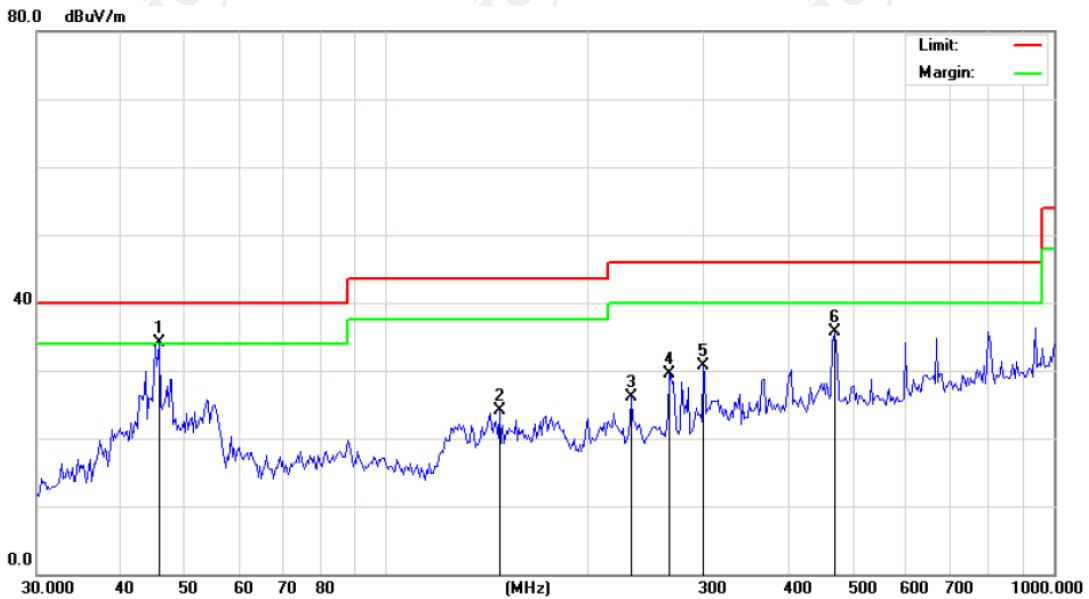

Site: Polarization: **Vertical** Temperature: 25
 Limit: FCC Part 15B Class B RE_3 m Power: AC 120V/60Hz Humidity: 54 %

No.	Mk.	Freq.	Reading Level	Correct Factor	Measurement	Limit	Over	Antenna Height	Table Degree	
		MHz	dBuV	dB	dBuV/m	dBuV/m	dB	cm	degree	Comment
1	*	45.7255	46.36	-12.22	34.14	40.00	-5.86	peak	0	
2		147.9876	39.23	-15.20	24.03	43.50	-19.47	peak	0	
3		233.2960	36.71	-10.54	26.17	46.00	-19.83	peak	0	
4		265.4846	39.01	-9.43	29.58	46.00	-16.42	peak	0	
5		298.7377	38.94	-8.29	30.65	46.00	-15.35	peak	0	
6		470.9465	39.61	-3.91	35.70	46.00	-10.30	peak	0	

Note: 1. The low frequency, which started from 9KHz~30MHz, was pre-scanned and the result which was 20dB lower than the limit line per 15.31(o) was not reported

2. Measurements were conducted in all three channels (high, middle, low) and all modulation (802.11a, 802.11n, 802.11ac), and the worst case Mode (middle channel and 802.11a) was submitted only.

Modulation Type: Band IV

11a CH149: 5745MHz

Frequency (MHz)	Ant. Pol. H/V	Peak reading (dBμV)	AV reading (dBuV)	Correction Factor (dB/m)	Emission Level		Peak limit (dBμV/m)	AV limit (dBμV/m)	Margin (dB)
					Peak (dBμV/m)	AV (dBμV/m)			
11490	H	51.96	---	0.66	52.62	---	74	54	1.38
17235	H	45.53	---	9.5	55.03	---	74	54	1.03
---	H	---	---	---	---	---	---	---	---
11490	V	50.69	---	0.66	51.35	---	74	54	2.65
17235	V	43.34	---	9.5	52.84	---	74	54	1.16
---	V	---	---	---	---	---	---	---	---

11a CH157: 5785MHz

Frequency (MHz)	Ant. Pol. H/V	Peak reading (dBμV)	AV reading (dBuV)	Correction Factor (dB/m)	Emission Level		Peak limit (dBμV/m)	AV limit (dBμV/m)	Margin (dB)
					Peak (dBμV/m)	AV (dBμV/m)			
11570	H	51.51	---	0.99	52.5	---	74	54	1.5
17355	H	45.6	---	9.85	55.45	---	74	54	1.45
---	H	---	---	---	---	---	---	---	---
11570	V	50.77	---	0.99	51.76	---	74	54	2.24
17355	V	42.68	---	9.85	52.53	---	74	54	1.47
---	V	---	---	---	---	---	---	---	---

11a CH161: 5825MHz

Frequency (MHz)	Ant. Pol. H/V	Peak reading (dBμV)	AV reading (dBuV)	Correction Factor (dB/m)	Emission Level		Peak limit (dBμV/m)	AV limit (dBμV/m)	Margin (dB)
					Peak (dBμV/m)	AV (dBμV/m)			
11650	H	53.41	---	1.33	54.74	---	74	54	0.74
17475	H	43.91	---	10.22	54.13	---	74	54	0.13
---	H	---	---	---	---	---	---	---	---
11650	V	51.48	---	1.33	52.81	---	74	54	1.19
17475	V	42.08	---	10.22	52.3	---	74	54	1.7
---	V	---	---	---	---	---	---	---	---

11n(HT20) CH149: 5745MHz

Frequency (MHz)	Ant. Pol. H/V	Peak reading (dBμV)	AV reading (dBuV)	Correction Factor (dB/m)	Emission Level		Peak limit (dBμV/m)	AV limit (dBμV/m)	Margin (dB)
					Peak (dBμV/m)	AV (dBμV/m)			
11490	H	52.42	---	0.66	53.08	---	74	54	0.92
17235	H	44.31	---	9.5	53.81	---	74	54	0.19
---	H	---	---	---	---	---	---	---	---
11490	V	51.79	---	0.66	52.45	---	74	54	1.55
17235	V	43.5	---	9.5	53	---	74	54	1
---	V	---	---	---	---	---	---	---	---

11n(HT20) CH157: 5785MHz

Frequency (MHz)	Ant. Pol. H/V	Peak reading (dBμV)	AV reading (dBμV)	Correction Factor (dB/m)	Emission Level		Peak limit (dBμV/m)	AV limit (dBμV/m)	Margin (dB)
					Peak (dBμV/m)	AV (dBμV/m)			
11570	H	54.38	---	0.66	55.04	---	74	54	1.04
17355	H	42.66	---	9.5	52.16	---	74	54	1.84
---	H	---	---	---	---	---	---	---	---
11570	V	53.53	---	0.66	54.19	---	74	54	0.19
17355	V	44.1	---	9.5	53.6	---	74	54	0.4
---	V	---	---	---	---	---	---	---	---

11n(HT20) CH161: 5825MHz

Frequency (MHz)	Ant. Pol. H/V	Peak reading (dBμV)	AV reading (dBμV)	Correction Factor (dB/m)	Emission Level		Peak limit (dBμV/m)	AV limit (dBμV/m)	Margin (dB)
					Peak (dBμV/m)	AV (dBμV/m)			
11650	H	52.67	---	0.99	53.66	---	74	54	0.34
17475	H	44.89	---	9.85	54.74	---	74	54	0.74
---	H	---	---	---	---	---	---	---	---
11650	V	53.37	---	0.99	54.36	---	74	54	0.36
17475	V	44.21	---	9.85	54.06	---	74	54	0.06
---	V	---	---	---	---	---	---	---	---

11n(HT40) CH151: 5755MHz

Frequency (MHz)	Ant. Pol. H/V	Peak reading (dBμV)	AV reading (dBμV)	Correction Factor (dB/m)	Emission Level		Peak limit (dBμV/m)	AV limit (dBμV/m)	Margin (dB)
					Peak (dBμV/m)	AV (dBμV/m)			
11510	H	54.16	---	1.33	55.49	---	74	54	1.49
17265	H	44.2	---	10.22	54.42	---	74	54	0.42
---	H	---	---	---	---	---	---	---	---
11510	V	53.05	---	1.33	54.38	---	74	54	0.38
17265	V	42.28	---	10.22	52.5	---	74	54	1.5
---	V	---	---	---	---	---	---	---	---

11n(HT40) CH159: 5795MHz

Frequency (MHz)	Ant. Pol. H/V	Peak reading (dBμV)	AV reading (dBμV)	Correction Factor (dB/m)	Emission Level		Peak limit (dBμV/m)	AV limit (dBμV/m)	Margin (dB)
					Peak (dBμV/m)	AV (dBμV/m)			
11590	H	55.3	---	0.66	55.96	---	74	54	1.96
17385	H	44.75	---	9.5	54.25	---	74	54	0.25
---	H	---	---	---	---	---	---	---	---
11590	V	53.17	---	0.66	53.83	---	74	54	0.17
17385	V	43.55	---	9.5	53.05	---	74	54	0.95
---	V	---	---	---	---	---	---	---	---

11ac(HT20) CH149: 5745MHz

Frequency (MHz)	Ant. Pol. H/V	Peak reading (dBμV)	AV reading (dBμV)	Correction Factor (dB/m)	Emission Level		Peak limit (dBμV/m)	AV limit (dBμV/m)	Margin (dB)
					Peak (dBμV/m)	AV (dBμV/m)			
11490	H	51.95	---	0.66	52.61	---	74	54	1.39
17235	H	42.4	---	9.5	51.9	---	74	54	2.1
---	H	---	---	---	---	---	---	---	---
11490	V	52.61	---	0.66	53.27	---	74	54	0.73
17235	V	43.19	---	9.5	52.69	---	74	54	1.31
---	V	---	---	---	---	---	---	---	---

11ac(HT20) CH157: 5785MHz

Frequency (MHz)	Ant. Pol. H/V	Peak reading (dBμV)	AV reading (dBμV)	Correction Factor (dB/m)	Emission Level		Peak limit (dBμV/m)	AV limit (dBμV/m)	Margin (dB)
					Peak (dBμV/m)	AV (dBμV/m)			
11570	H	52.43	---	0.99	53.42	---	74	54	0.58
17355	H	40.98	---	9.85	50.83	---	74	54	3.17
---	H	---	---	---	---	---	---	---	---
11570	V	50.87	---	0.99	51.86	---	74	54	2.14
17355	V	42.36	---	9.85	52.21	---	74	54	1.79
---	V	---	---	---	---	---	---	---	---

11ac(HT20) CH161: 5825MHz

Frequency (MHz)	Ant. Pol. H/V	Peak reading (dBμV)	AV reading (dBμV)	Correction Factor (dB/m)	Emission Level		Peak limit (dBμV/m)	AV limit (dBμV/m)	Margin (dB)
					Peak (dBμV/m)	AV (dBμV/m)			
11650	H	51.76	---	1.33	53.09	---	74	54	0.91
17475	H	41.37	---	10.22	51.59	---	74	54	2.41
---	H	---	---	---	---	---	---	---	---
11650	V	53.45	---	1.33	54.78	---	74	54	0.78
17475	V	42.63	---	10.22	52.85	---	74	54	1.15
---	V	---	---	---	---	---	---	---	---

11ac(HT40) CH151: 5755MHz

Frequency (MHz)	Ant. Pol. H/V	Peak reading (dBμV)	AV reading (dBμV)	Correction Factor (dB/m)	Emission Level		Peak limit (dBμV/m)	AV limit (dBμV/m)	Margin (dB)
					Peak (dBμV/m)	AV (dBμV/m)			
11510	H	50.84	---	0.66	51.5	---	74	54	2.5
17265	H	44.56	---	9.5	54.06	---	74	54	0.06
---	H	---	---	---	---	---	---	---	---
11510	V	51.69	---	0.66	52.35	---	74	54	1.65
17265	V	42.74	---	9.5	52.24	---	74	54	1.76
---	V	---	---	---	---	---	---	---	---

11ac(HT40) CH159: 5795MHz

Frequency (MHz)	Ant. Pol. H/V	Peak reading (dBμV)	AV reading (dBμV)	Correction Factor (dB/m)	Emission Level		Peak limit (dBμV/m)	AV limit (dBμV/m)	Margin (dB)
					Peak (dBμV/m)	AV (dBμV/m)			
11590	H	52.6	---	0.99	53.59	---	74	54	0.41
17385	H	43.39	---	9.85	53.24	---	74	54	0.76
---	H	---	---	---	---	---	---	---	---
11590	V	51.25	---	0.99	52.24	---	74	54	1.76
17385	V	42.81	---	9.85	52.66	---	74	54	1.34
---	V	---	---	---	---	---	---	---	---

11ac(HT80) CH155: 5775MHz

Frequency (MHz)	Ant. Pol. H/V	Peak reading (dBμV)	AV reading (dBμV)	Correction Factor (dB/m)	Emission Level		Peak limit (dBμV/m)	AV limit (dBμV/m)	Margin (dB)
					Peak (dBμV/m)	AV (dBμV/m)			
11550	H	53.11	---	1.33	54.44	---	74	54	0.44
17325	H	42.88	---	10.22	53.1	---	74	54	0.9
---	H	---	---	---	---	---	---	---	---
11550	V	52.29	---	1.33	53.62	---	74	54	0.38
17325	V	44.66	---	10.22	54.88	---	74	54	0.88
---	V	---	---	---	---	---	---	---	---

Note:

1. Emission Level=Peak Reading + Correction Factor; Correction Factor= Antenna Factor + Cable loss – Pre-amplifier
2. Margin (dB) = Emission Level (Peak) (dBμV/m)-Average limit (dBμV/m)
3. The emission levels of other frequencies are very lower than the limit and not show in test report.
4. Measurements were conducted from 1 GHz to the 10th harmonic of highest fundamental frequency. The highest test frequency is 40GHz.
5. Data of measurement shown “---“in the above table mean that the reading of emissions is attenuated more than 20 dB below the limits or the field strength is too small to be measured.

6.9. Frequency Stability Measurement

6.9.1. Test Specification

Test Requirement:	FCC Part15 Section 15.407(g) &Part2 J Section 2.1055
Test Method:	ANSI C63.10: 2013
Limit:	The frequency tolerance shall be maintained within the band of operation frequency over a temperature variation of 0 degrees to 35 degrees C at normal supply voltage, and for a variation in the primary supply voltage from 85% to 115% of the rated supply voltage at a temperature of 20 degrees C.
Test Setup:	<pre> graph LR SA[Spectrum Analyzer] --- EUT[EUT] subgraph TC [Temperature Chamber] EUT end P[AC/DC Power supply] --- EUT </pre>
Test Procedure:	The EUT was placed inside the environmental test chamber and powered by nominal AC/DC voltage. b. Turn the EUT on and couple its output to a spectrum analyzer. c. Turn the EUT off and set the chamber to the highest temperature specified. d. Allow sufficient time (approximately 30 min) for the temperature of the chamber to stabilize. e. Repeat step 2 and 3 with the temperature chamber set to the lowest temperature. f. The test chamber was allowed to stabilize at +20 degree C for a minimum of 30 minutes. The supply voltage was then adjusted on the EUT from 85% to 115% and the frequency record.
Test Result:	PASS
Remark:	Pre-scan was performed at Output 0, Output port 1, no worst case was found. Only the test data of Output 0 was shown in this report.

6.9.2. Test Instruments

RF Test Room				
Equipment	Manufacturer	Model	Serial Number	Calibration Due
Spectrum Analyzer	Agilent	N9020A	MY49100060	Sep. 12, 2016
RF cable	TCT	RE-06	N/A	Sep. 12, 2016
Antenna Connector	TCT	RFC-01	N/A	Sep. 12, 2016
DC Power	GWINSTEK	GPR-3060D	EL864290	Sep. 12, 2016

Test plots as follows:

Test mode:		802.11a	Frequency(MHz):	5745
Temperature (°C)	Voltage(VAC)	Measurement Frequency(MHz)	Delta Frequency(Hz)	Result
45	24	5745.0118	11800	PASS
35		5745.0081	8100	PASS
25		5745.0078	7800	PASS
15		5745.0042	4200	PASS
5		5744.9963	-3700	PASS
0		5744.9982	-1800	PASS
20	27.6	5745.0013	1300	PASS
	24	5745.0016	1600	PASS
	20.4	5745.0025	2500	PASS

Test mode:		802.11a	Frequency(MHz):	5785
Temperature (°C)	Voltage(VAC)	Measurement Frequency(MHz)	Delta Frequency(Hz)	Result
45	24	5785.0088	8800	PASS
35		5785.0029	2900	PASS
25		5785.0034	3400	PASS
15		5785.0008	800	PASS
5		5785.0028	2800	PASS
0		5785.0036	3600	PASS
20	27.6	5785.0021	2100	PASS
	24	5785.0014	1400	PASS
	20.4	5784.9976	-2400	PASS

Test mode:		802.11a	Frequency(MHz):	5825
Temperature (°C)	Voltage(VAC)	Measurement Frequency(MHz)	Delta Frequency(Hz)	Result
45	24	5825.0085	8500	PASS
35		5825.0042	4200	PASS
25		5825.0021	2100	PASS
15		5824.9989	-1100	PASS
5		5824.9973	-2700	PASS
0		5824.9964	-3600	PASS
20	27.6	5825.0046	4600	PASS
	24	5825.0014	1400	PASS
	20.4	5825.0054	5400	PASS

Test mode:		802.11n(HT20)	Frequency(MHz):	5745
Temperature (°C)	Voltage(VAC)	Measurement Frequency(MHz)	Delta Frequency(Hz)	Result
45	24	5745.0082	8200	PASS
35		5745.0021	2100	PASS
25		5745.0035	3500	PASS
15		5745.0024	2400	PASS
5		5745.0016	1600	PASS
0		5745.0034	3400	PASS
20		27.6	5745.0045	4500
	24	5744.9980	-2000	PASS
	20.4	5745.0035	3500	PASS

Test mode:		802.11n(HT20)	Frequency(MHz):	5785
Temperature (°C)	Voltage(VAC)	Measurement Frequency(MHz)	Delta Frequency(Hz)	Result
45	24	5785.0108	10800	PASS
35		5785.0019	1900	PASS
25		5785.0029	2900	PASS
15		5784.9987	-1300	PASS
5		5784.9957	-4300	PASS
0		5785.0024	2400	PASS
20		27.6	5785.0039	3900
	24	5785.0021	2100	PASS
	20.4	5785.0051	5100	PASS

Test mode:		802.11n(HT20)	Frequency(MHz):	5825
Temperature (°C)	Voltage(VAC)	Measurement Frequency(MHz)	Delta Frequency(Hz)	Result
45	24	5824.9815	-18500	PASS
35		5824.9952	-4800	PASS
25		5824.9953	-4700	PASS
15		5824.9985	-1500	PASS
5		5825.0016	1600	PASS
0		5825.0085	8500	PASS
20		27.6	5825.0032	3200
	24	5824.9987	-1300	PASS
	20.4	5825.0029	2900	PASS

Test mode:		802.11n(HT40)	Frequency(MHz):	5755
Temperature (°C)	Voltage(VAC)	Measurement Frequency(MHz)	Delta Frequency(Hz)	Result
45	24	5755.0041	4100	PASS
35		5755.0012	1200	PASS
25		5755.0026	2600	PASS
15		5755.0023	2300	PASS
5		5755.0031	3100	PASS
0		5755.0009	900	PASS
20		27.6	5755.0032	3100
	24	5755.0039	3900	PASS
	20.4	5755.0026	2600	PASS

Test mode:		802.11n(HT40)	Frequency(MHz):	5795
Temperature (°C)	Voltage(VAC)	Measurement Frequency(MHz)	Delta Frequency(Hz)	Result
45	24	5755.0012	1200	PASS
35		5755.0032	3200	PASS
25		5755.0067	6700	PASS
15		5755.0042	4200	PASS
5		5755.0071	7100	PASS
0		5755.0032	3200	PASS
20		27.6	5755.0017	1700
	24	5755.0081	8100	PASS
	20.4	5755.0038	3800	PASS

Test mode:		802.11ac(HT20)	Frequency(MHz):	5745
Temperature (°C)	Voltage(VAC)	Measurement Frequency(MHz)	Delta Frequency(Hz)	Result
45	24	5745.0010	1000	PASS
35		5745.0024	2400	PASS
25		5744.9960	-4000	PASS
15		5744.9955	-4500	PASS
5		5745.0048	4800	PASS
0		5745.0041	4100	PASS
20		27.6	5745.0076	7600
	24	5745.0012	1200	PASS
	20.4	5745.0069	6900	PASS

Test mode:		802.11ac(HT20)	Frequency(MHz):	5785
Temperature (°C)	Voltage(VAC)	Measurement Frequency(MHz)	Delta Frequency(Hz)	Result
45	24	5785.0046	4600	PASS
35		5785.0030	3000	PASS
25		5785.0024	2400	PASS
15		5785.0006	600	PASS
5		5785.0025	2500	PASS
0		5785.0043	4300	PASS
20		27.6	5785.0060	6000
	24	5785.0026	2600	PASS
	20.4	5784.9973	-2700	PASS

Test mode:		802.11ac(HT20)	Frequency(MHz):	5825
Temperature (°C)	Voltage(VAC)	Measurement Frequency(MHz)	Delta Frequency(Hz)	Result
45	24	5805.0051	5100	PASS
35		5805.0052	5200	PASS
25		5805.0029	2900	PASS
15		5805.0011	1100	PASS
5		5805.0085	8500	PASS
0		5805.0064	6400	PASS
20		27.6	5805.0018	1800
	24	5805.0076	7600	PASS
	20.4	5804.9995	-500	PASS

Test mode:		802.11ac(HT40)	Frequency(MHz):	5755
Temperature (°C)	Voltage(VAC)	Measurement Frequency(MHz)	Delta Frequency(Hz)	Result
45	24	5755.0027	4100	PASS
35		5755.0031	1200	PASS
25		5755.0044	2600	PASS
15		5755.0082	2300	PASS
5		5755.0042	3100	PASS
0		5755.0016	900	PASS
20		27.6	5755.0073	3100
	24	5755.0021	3900	PASS
	20.4	5755.0022	2600	PASS

Test mode:		802.11ac(HT40)	Frequency(MHz):	5795
Temperature (°C)	Voltage(VAC)	Measurement Frequency(MHz)	Delta Frequency(Hz)	Result
45	24	5755.0021	2100	PASS
35		5755.0024	2400	PASS
25		5755.0033	3300	PASS
15		5755.0051	5100	PASS
5		5755.0063	6300	PASS
0		5755.0024	2400	PASS
20		27.6	5755.0021	2100
	24	5755.0011	1100	PASS
	20.4	5755.0019	1900	PASS

Test mode:		802.11ac(HT80)	Frequency(MHz):	5775
Temperature (°C)	Voltage(VAC)	Measurement Frequency(MHz)	Delta Frequency(Hz)	Result
45	24	5775.0158	15800	PASS
35		5775.0084	8400	PASS
25		5775.0042	4200	PASS
15		5775.0025	2500	PASS
5		5775.0036	3600	PASS
0		5774.9983	-1700	PASS
20		27.6	5775.0021	2100
	24	5775.0030	3000	PASS
	20.4	5775.0066	6600	PASS

*****END OF REPORT*****

Appendix A: Photographs of Test Setup

Refer to test report TCT160413E007

Appendix B: Photographs of EUT

Refer to test report TCT160413E007