

FCC Test Report

Report No.: RF150318C33G

FCC ID: UCC-A22221000

Test Model: A2-2221-000

Received Date: Mar. 18, 2015

Test Date: Mar. 19 ~ Apr. 07, 2015

Issued Date: Nov. 03, 2016

Applicant: Altai Technologies Limited

Address: Unit 209, 2/F, Lakeside 2, 10 Science Park West Avenue, HK Science Park, Shatin, Hong Kong

Issued By: Bureau Veritas Consumer Products Services (H.K.) Ltd., Taoyuan Branch

Lab Address: No. 47-2, 14th Ling, Chia Pau Vil., Lin Kou Dist., New Taipei City, Taiwan

Test Location: No. 19, Hwa Ya 2nd Rd., Wen Hwa Vil., Kwei Shan Dist., Taoyuan City 33383, TAIWAN (R.O.C.)



This report is for your exclusive use. Any copying or replication of this report to or for any other person or entity, or use of our name or trademark, is permitted only with our prior written permission. This report sets forth our findings solely with respect to the test samples identified herein. The results set forth in this report are not indicative or representative of the quality or characteristics of the lot from which a test sample was taken or any similar or identical product unless specifically and expressly noted. Our report includes all of the tests requested by you and the results thereof based upon the information that you provided to us. You have 60 days from date of issuance of this report to notify us of any material error or omission caused by our negligence, provided, however, that such notice shall be in writing and shall specifically address the issue you wish to raise. A failure to raise such issue within the prescribed time shall constitute your unqualified acceptance of the completeness of this report, the tests conducted and the correctness of the report contents. Unless specific mention, the uncertainty of measurement has been explicitly taken into account to declare the compliance or non-compliance to the specification. The report must not be used by the client to claim product certification, approval, or endorsement by TAF or any government agencies.

Table of Contents

Release Control Record	4
1 Certificate of Conformity	5
2 Summary of Test Results	6
2.1 Measurement Uncertainty.....	6
2.2 Modification Record.....	6
3 General Information	7
3.1 General Description of EUT.....	7
3.2 Description of Test Modes.....	8
3.2.1 Test Mode Applicability and Tested Channel Detail.....	9
3.3 Duty Cycle of Test Signal.....	11
3.4 Description of Support Units.....	12
3.4.1 Configuration of System under Test.....	13
3.5 General Description of Applied Standards.....	14
4 Test Types and Results	15
4.1 Radiated Emission and Bandedge Measurement.....	15
4.1.1 Limits of Radiated Emission and Bandedge Measurement.....	15
4.1.2 Test Instruments.....	16
4.1.3 Test Procedures.....	17
4.1.4 Deviation from Test Standard.....	17
4.1.5 Test Set Up.....	18
4.1.6 EUT Operating Conditions.....	19
4.1.7 Test Results.....	20
4.2 Conducted Emission Measurement.....	34
4.2.1 Limits of Conducted Emission Measurement.....	34
4.2.2 Test Instruments.....	34
4.2.3 Test Procedures.....	34
4.2.4 Deviation from Test Standard.....	34
4.2.5 Test Setup.....	35
4.2.6 EUT Operating Conditions.....	35
4.2.7 Test Results.....	36
4.3 6dB Bandwidth Measurement.....	40
4.3.1 Limits of 6dB Bandwidth Measurement.....	40
4.3.2 Test Setup.....	40
4.3.3 Test Instruments.....	40
4.3.4 Test Procedure.....	40
4.3.5 Deviation from Test Standard.....	40
4.3.6 EUT Operating Conditions.....	40
4.3.7 Test Result.....	41
4.4 Conducted Output Power Measurement.....	43
4.4.1 Limits of Conducted Output Power Measurement.....	43
4.4.2 Test Setup.....	43
4.4.3 Test Instruments.....	43
4.4.4 Test Procedures.....	43
4.4.5 Deviation from Test Standard.....	43
4.4.6 EUT Operating Conditions.....	43
4.4.7 Test Results.....	44
4.5 Power Spectral Density Measurement.....	45
4.5.1 Limits of Power Spectral Density Measurement.....	45
4.5.2 Test Setup.....	45
4.5.3 Test Instruments.....	45
4.5.4 Test Procedure.....	45
4.5.5 Deviation from Test Standard.....	45
4.5.6 EUT Operating Condition.....	45

4.5.7 Test Results	46
4.6 Conducted Out of Band Emission Measurement.....	49
4.6.1 Limits of Conducted Out of Band Emission Measurement	49
4.6.2 Test Setup.....	49
4.6.3 Test Instruments	49
4.6.4 Test Procedure	49
4.6.5 Deviation from Test Standard	49
4.6.6 EUT Operating Condition	49
4.6.7 Test Results	49
5 Pictures of Test Arrangements.....	58
Appendix – Information on the Testing Laboratories	59

Release Control Record

Issue No.	Description	Date Issued
RF150318C33G	Original release.	Nov. 03, 2016

1 Certificate of Conformity

Product: A2c Indoor Dual-Band 2X2 802.11ac AP

Brand: ALTAI

Test Model: A2-2221-000

Sample Status: Engineering sample

Applicant: Altai Technologies Limited

Test Date: Mar. 19 ~ Apr. 07, 2015

Standards: 47 CFR FCC Part 15, Subpart C (Section 15.247)
ANSI C63.10:2013

The above equipment has been tested by **Bureau Veritas Consumer Products Services (H.K.) Ltd., Taoyuan Branch**, and found compliance with the requirement of the above standards. The test record, data evaluation & Equipment Under Test (EUT) configurations represented herein are true and accurate accounts of the measurements of the sample's EMC characteristics under the conditions specified in this report.

Prepared by :  , **Date:** Nov. 03, 2016
Pettie Chen / Senior Specialist

Approved by :  , **Date:** Nov. 03, 2016
Ken Liu / Senior Manager

2 Summary of Test Results

47 CFR FCC Part 15, Subpart C (SECTION 15.247)			
FCC Clause	Test Item	Result	Remarks
15.207	AC Power Conducted Emission	PASS	Meet the requirement of limit. Minimum passing margin is -7.11dB at 0.15000MHz.
15.205 / 15.209 / 15.247(d)	Radiated Emissions and Band Edge Measurement	PASS	Meet the requirement of limit. Minimum passing margin is -1.1dB at 2390.0MHz.
15.247(d)	Antenna Port Emission	PASS	Meet the requirement of limit.
15.247(a)(2)	6dB bandwidth	PASS	Meet the requirement of limit.
15.247(b)	Conducted power	PASS	Meet the requirement of limit.
15.247(e)	Power Spectral Density	PASS	Meet the requirement of limit.
15.203	Antenna Requirement	PASS	No antenna connector is used.

2.1 Measurement Uncertainty

Where relevant, the following measurement uncertainty levels have been estimated for tests performed on the EUT as specified in CISPR 16-4-2:

Measurement	Frequency	Expanded Uncertainty (k=2) (\pm)
Conducted Emissions at mains ports	150kHz ~ 30MHz	2.44 dB
Radiated Emissions up to 1 GHz	30MHz ~ 200MHz	3.86 dB
	200MHz ~ 1000MHz	3.87 dB
Radiated Emissions above 1 GHz	1GHz ~ 18GHz	2.29 dB
	18GHz ~ 40GHz	2.29 dB

2.2 Modification Record

There were no modifications required for compliance.

3 General Information

3.1 General Description of EUT

Product	A2c Indoor Dual-Band 2X2 802.11ac AP
Brand	ALTAI
Test Model	A2-2221-000
Status of EUT	Engineering sample
Power Supply Rating	12Vdc from adapter 48Vdc from PoE
Modulation Type	CCK, DQPSK, DBPSK for DSSS 64QAM, 16QAM, QPSK, BPSK for OFDM
Modulation Technology	DSSS, OFDM
Transfer Rate	802.11b:11.0/ 5.5/ 2.0/ 1.0Mbps 802.11g: 54.0/ 48.0/ 36.0/ 24.0/ 18.0/ 12.0/ 9.0/ 6.0Mbps 802.11n: up to 300.0Mbps
Operating Frequency	2412 ~ 2462MHz
Number of Channel	11 for 802.11b, 802.11g, 802.11n (20MHz) 7 for 802.11n (40MHz)
Output Power	780.051mW
Antenna Type	Refer to Note
Antenna Connector	NA
Accessory Device	Adapter
Data Cable Supplied	0.5m RJ45 non-shielded cable without core

Note:

- The EUT incorporates a MIMO function. Physically, the EUT provides two completed transmitters and two receivers.

Modulation Mode	TX Function
802.11b	2TX
802.11g	2TX
802.11n (HT20)	2TX
802.11n (HT40)	2TX

- The EUT uses following adapter and PoE.

Adapter	
Brand	Powertron Electronics Corp.
Model	PA1024-2HUB PA1024-120HUB200
Input Power	100-240Vac~50-60Hz 0.6A
Output Power	12Vdc / 2.0A 24W Max
Power Line	1.5m cable with 1 core

PoE (Support unit)	
Brand	EnGenius
Model	EPE-48GR
Rating	48Vdc / 0.38A 18.24W

Adapter of PoE (Support unit)	
Brand	Powertron Electronics Corp.
Model	PA1040-480IB080
Input Power	100-240Vac~50-60Hz 1.5A
Output Power	48Vdc / 0.8A 38.4W Max
Power Line	1.6m cable with 1 core

3. The following antennas were provided to the EUT.

Antenna Type	Printed		
Antenna Connector	NA		
Gain (dBi)	Frequency (MHz)		
	2400	2450	2500
Ant. 1	2.49	2.67	3.52
Ant. 2	2.76	3.01	3.16

4. The above EUT information is declared by manufacturer and for more detailed features description, please refer to the manufacturer's specifications or user's manual.

3.2 Description of Test Modes

11 channels are provided for 802.11b, 802.11g and 802.11n (HT20):

Channel	Frequency	Channel	Frequency
1	2412MHz	7	2442MHz
2	2417MHz	8	2447MHz
3	2422MHz	9	2452MHz
4	2427MHz	10	2457MHz
5	2432MHz	11	2462MHz
6	2437MHz		

7 channels are provided for 802.11n (HT40):

Channel	Frequency	Channel	Frequency
3	2422MHz	7	2442MHz
4	2427MHz	8	2447MHz
5	2432MHz	9	2452MHz
6	2437MHz		

3.2.1 Test Mode Applicability and Tested Channel Detail

EUT CONFIGURE MODE	APPLICABLE TO				DESCRIPTION
	RE \geq 1G	RE<1G	PLC	APCM	
A	√	√	√	√	Power from adapter
B	√	√	√	-	Power from PoE

Where **RE \geq 1G**: Radiated Emission above 1GHz & Bandedge Measurement **RE<1G**: Radiated Emission below 1GHz
PLC: Power Line Conducted Emission **APCM**: Antenna Port Conducted Measurement

NOTE: 1. The EUT had been pre-tested on the positioned of each 3 axis. The worst case was found when positioned on **Y-plane**.
2. "-" means no effect.

Radiated Emission Test (Above 1GHz):

- Pre-Scan has been conducted to determine the worst-case mode from all possible combinations between available modulations, data rates and antenna ports (if EUT with antenna diversity architecture).
- Following channel(s) was (were) selected for the final test as listed below.

EUT CONFIGURE MODE	MODE	AVAILABLE CHANNEL	TESTED CHANNEL	MODULATION TECHNOLOGY	MODULATION TYPE	DATA RATE (Mbps)
A	802.11b	1 to 11	1, 6, 11	DSSS	DBPSK	1.0
A	802.11g	1 to 11	1, 6, 11	OFDM	BPSK	6.0
A	802.11n (HT20)	1 to 11	1, 6, 11	OFDM	BPSK	7.2
A	802.11n (HT40)	3 to 9	3, 6, 9	OFDM	BPSK	15.0

Radiated Emission Test (Below 1GHz):

- Pre-Scan has been conducted to determine the worst-case mode from all possible combinations between available modulations, data rates and antenna ports (if EUT with antenna diversity architecture).
- Following channel(s) was (were) selected for the final test as listed below.

EUT CONFIGURE MODE	MODE	AVAILABLE CHANNEL	TESTED CHANNEL	MODULATION TECHNOLOGY	MODULATION TYPE	DATA RATE (Mbps)
A, B	802.11b	1 to 11	6	DSSS	DBPSK	1.0

Power Line Conducted Emission Test:

- Pre-Scan has been conducted to determine the worst-case mode from all possible combinations between available modulations, data rates and antenna ports (if EUT with antenna diversity architecture).
- Following channel(s) was (were) selected for the final test as listed below.

EUT CONFIGURE MODE	MODE	AVAILABLE CHANNEL	TESTED CHANNEL	MODULATION TECHNOLOGY	MODULATION TYPE	DATA RATE (Mbps)
A, B	802.11b	1 to 11	6	DSSS	DBPSK	1.0

Antenna Port Conducted Measurement:

- This item includes all test value of each mode, but only includes spectrum plot of worst value of each mode.
- Pre-Scan has been conducted to determine the worst-case mode from all possible combinations between available modulations, data rates and antenna ports (if EUT with antenna diversity architecture).
- Following channel(s) was (were) selected for the final test as listed below.

EUT CONFIGURE MODE	MODE	AVAILABLE CHANNEL	TESTED CHANNEL	MODULATION TECHNOLOGY	MODULATION TYPE	DATA RATE (Mbps)
A	802.11b	1 to 11	1, 6, 11	DSSS	DBPSK	1.0
A	802.11g	1 to 11	1, 6, 11	OFDM	BPSK	6.0
A	802.11n (HT20)	1 to 11	1, 6, 11	OFDM	BPSK	7.2
A	802.11n (HT40)	3 to 9	3, 6, 9	OFDM	BPSK	15.0

Test Condition:

APPLICABLE TO	ENVIRONMENTAL CONDITIONS	INPUT POWER	TESTED BY
RE≥1G	18deg. C, 70%RH	120Vac, 60Hz	Nick Hsu
RE<1G	18deg. C, 70%RH	120Vac, 60Hz 48Vdc	Nick Hsu
PLC	17deg. C, 69%RH	120Vac, 60Hz 48Vdc	Nick Hsu
APCM	25deg. C, 60%RH	120Vac, 60Hz	Nick Chen

3.3 Duty Cycle of Test Signal

802.11b: Duty cycle of test signal is $\geq 98\%$, duty factor is not required.

802.11g, 802.11n (HT20), 802.11n (HT40):

Duty cycle of test signal is $< 98\%$, duty factor shall be considered.

802.11g: Duty cycle = $2.019/2.074 = 0.973$, Duty factor = $10 * \log(1/0.973) = 0.12$

802.11n (HT20): Duty cycle = $1.885/1.939 = 0.972$, Duty factor = $10 * \log(1/0.972) = 0.12$

802.11n (HT40): Duty cycle = $0.925/0.967 = 0.957$, Duty factor = $10 * \log(1/0.957) = 0.19$

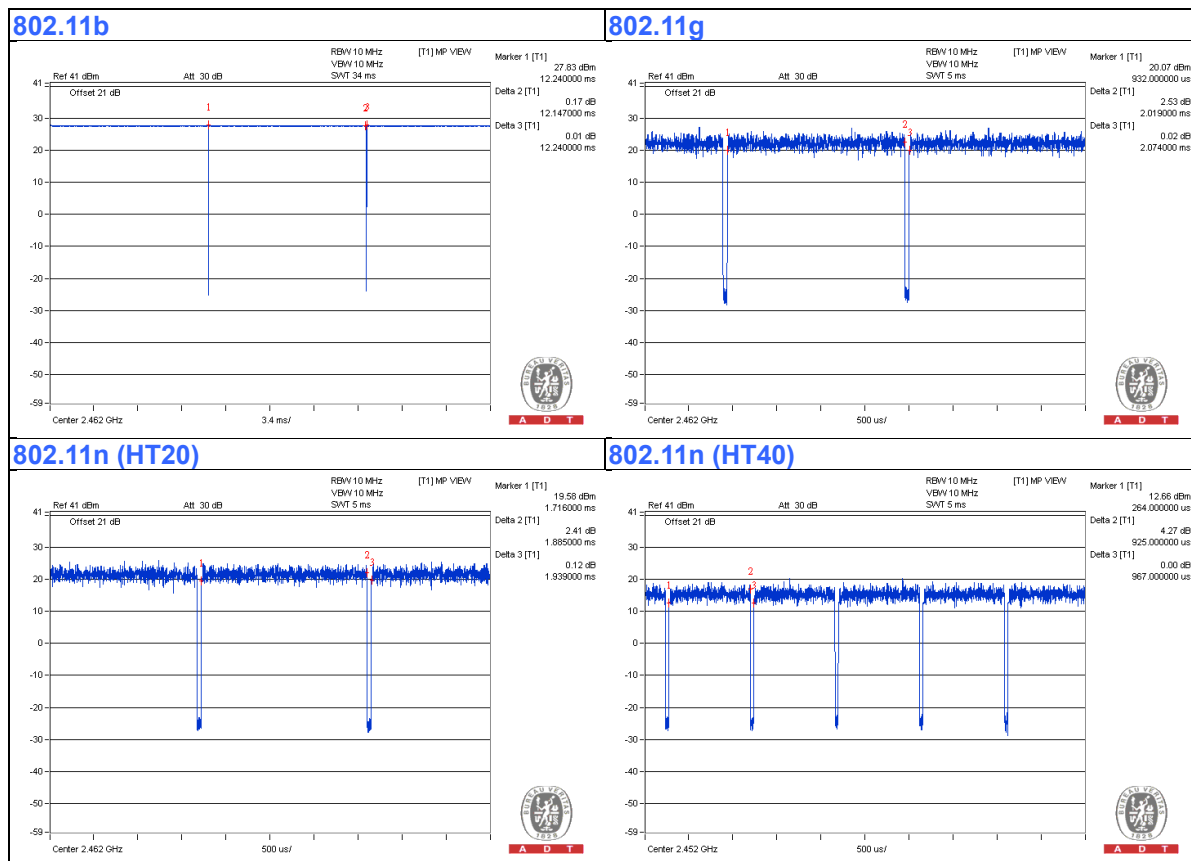

3.4 Description of Support Units

The EUT has been tested as an independent unit together with other necessary accessories or support units. The following support units or accessories were used to form a representative test configuration during the tests.

ID	Product	Brand	Model No.	Serial No.	FCC ID	Remarks
A.	Notebook	DELL	E5410	1HC2XM1	FCC DoC Approved	-
B.	PoE	EnGenius	EPE-48GR	-	-	Provided by client
C.	Adapter of PoE	Powertron Electronics Corp.	PA1040-480IB080	-	-	Provided by client

Note:

1. All power cords of the above support units are non-shielded (1.8m).
2. Items A~C acted as communication partners to transfer data.

ID	Descriptions	Qty.	Length (m)	Shielding (Yes/No)	Cores (Qty.)	Remarks
1.	LAN cable	1	3	N	0	-
2.	DC cable	1	1.6	N	1	Provided by client
3.	LAN cable	1	0.5	N	0	-

Note: The core(s) is(are) originally attached to the cable(s).

3.4.1 Configuration of System under Test

Test Mode A

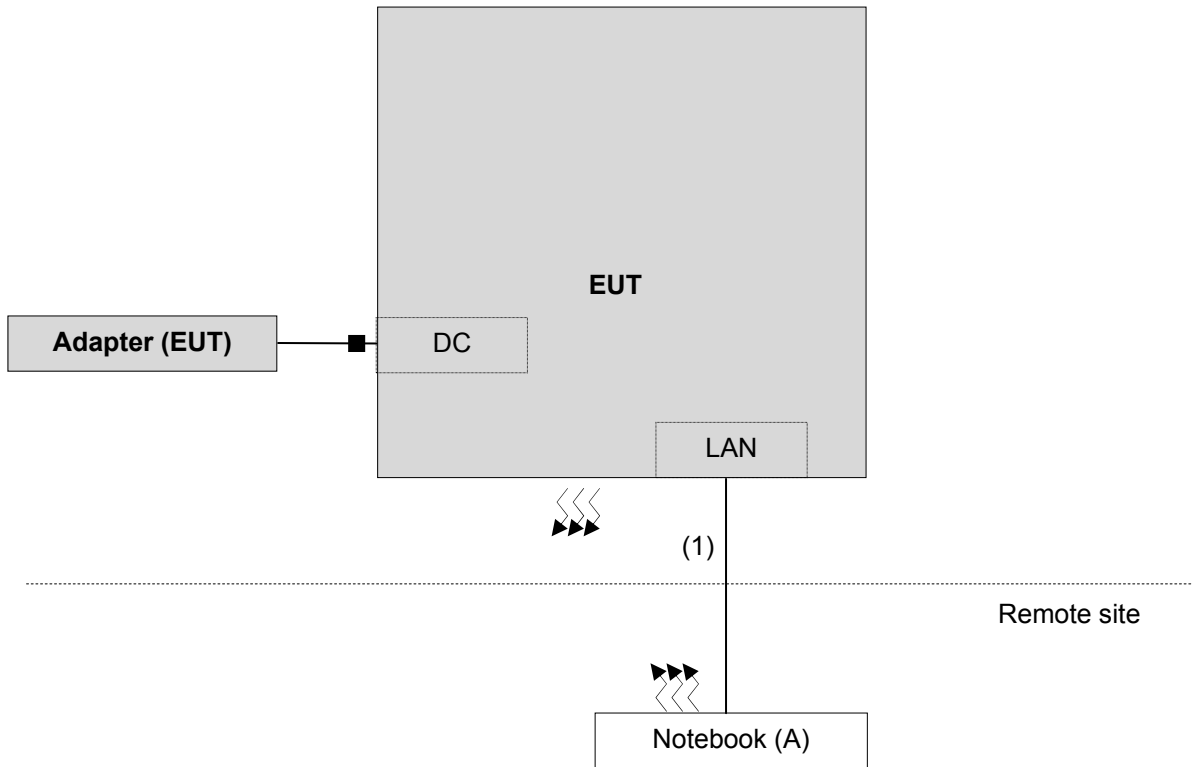

Test Mode B

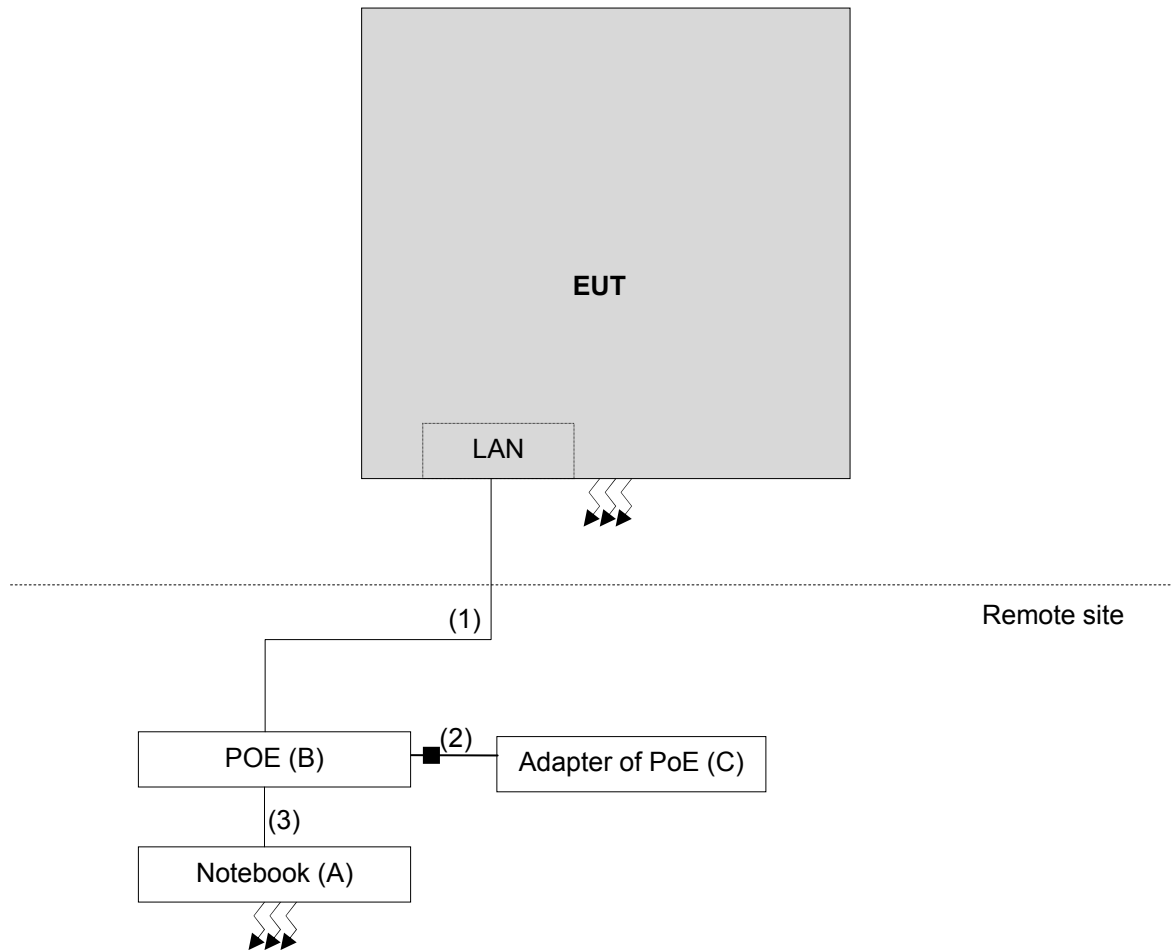

3.5 General Description of Applied Standards

The EUT is a RF Product. According to the specifications of the manufacturer, it must comply with the requirements of the following standards:

FCC Part 15, Subpart C (15.247)
KDB 558074 D01 DTS Meas Guidance v03r05
KDB 662911 D01 Multiple Transmitter Output v02r01
 ANSI C63.10-2013

All test items have been performed and recorded as per the above standards.

NOTE: The EUT has been verified to comply with the requirements of FCC Part 15, Subpart B, Class B (DoC). The test report has been issued separately.

4 Test Types and Results

4.1 Radiated Emission and Bandedge Measurement

4.1.1 Limits of Radiated Emission and Bandedge Measurement

Radiated emissions which fall in the restricted bands must comply with the radiated emission limits specified as below table. Other emissions shall be at least 30dB below the highest level of the desired power:

Frequencies (MHz)	Field Strength (microvolts/meter)	Measurement Distance (meters)
0.009 ~ 0.490	2400/F(kHz)	300
0.490 ~ 1.705	24000/F(kHz)	30
1.705 ~ 30.0	30	30
30 ~ 88	100	3
88 ~ 216	150	3
216 ~ 960	200	3
Above 960	500	3

NOTE:

1. The lower limit shall apply at the transition frequencies.
2. Emission level (dBuV/m) = 20 log Emission level (uV/m).
3. For frequencies above 1000MHz, the field strength limits are based on average detector, however, the peak field strength of any emission shall not exceed the maximum permitted average limits, specified above by more than 30dB under any condition of modulation.

4.1.2 Test Instruments

DESCRIPTION & MANUFACTURER	MODEL NO.	SERIAL NO.	DATE OF CALIBRATION	DUE DATE OF CALIBRATION
Test Receiver ROHDE & SCHWARZ	ESCI	100424	Oct. 06, 2014	Oct. 05, 2015
Spectrum Analyzer ROHDE & SCHWARZ	FSP40	100040	Jul. 25, 2014	Jul. 24, 2015
BILOG Antenna SCHWARZBECK	VULB9168	9168-160	Feb. 05, 2015	Feb. 04, 2016
HORN Antenna SCHWARZBECK	9120D	209	Feb. 09, 2015	Feb. 08, 2016
HORN Antenna SCHWARZBECK	BBHA 9170	BBHA9170241	Feb. 09, 2015	Feb. 08, 2016
Loop Antenna	EM-6879	269	Jun. 24, 2014	Jun. 23, 2015
Preamplifier Agilent	8447D	2944A10738	Oct. 18, 2014	Oct. 17, 2015
Preamplifier Agilent	8449B	3008A01964	Aug. 22, 2014	Aug. 21, 2015
RF signal cable HUBER+SUHNNER	SUCOFLEX 104	214378/4	Aug. 22, 2014	Aug. 21, 2015
RF signal cable HUBER+SUHNNER	SUCOFLEX 106	12738/6 +309224/4	Aug. 22, 2014	Aug. 21, 2015
Software BV ADT	ADT_Radiated_ V7.6.15.9.4	NA	NA	NA
Antenna Tower inn-co GmbH	MA 4000	013303	NA	NA
Antenna Tower Controller inn-co GmbH	CO2000	017303	NA	NA
Turn Table BV ADT	TT100	TT93021703	NA	NA
Turn Table Controller BV ADT	SC100	SC93021703	NA	NA
High Speed Peak Power Meter	ML2495A	0824011	Jul. 26, 2014	Jul. 25, 2015
Power Sensor	MA2411B	0738171	Jul. 26, 2014	Jul. 25, 2015

- NOTE:**
1. The calibration interval of the above test instruments is 12 months and the calibrations are traceable to NML/ROC and NIST/USA.
 2. The test was performed in HwaYa Chamber 4.
 3. The horn antenna and HP preamplifier (model: 8449B) are used only for the measurement of emission frequency above 1GHz if tested.
 4. The FCC Site Registration No. is 460141.
 5. The IC Site Registration No. is IC7450F-4.

4.1.3 Test Procedures

For Radiated emission below 30MHz

- a. The EUT was placed on the top of a rotating table 0.8 meters above the ground at a 3 meter chamber room. The table was rotated 360 degrees to determine the position of the highest radiation.
- b. The EUT was set 3 meters away from the interference-receiving antenna, which was mounted on the top of a variable-height antenna tower.
- c. Both X and Y axes of the antenna are set to make the measurement.
- d. For each suspected emission, the EUT was arranged to its worst case and the rotatable table was turned from 0 degrees to 360 degrees to find the maximum reading.
- e. The test-receiver system was set to Quasi-Peak Detect Function and Specified Bandwidth with Maximum Hold Mode.

NOTE:

1. The resolution bandwidth and video bandwidth of test receiver/spectrum analyzer is 9kHz at frequency below 30MHz.

For Radiated emission above 30MHz

- a. The EUT was placed on the top of a rotating table 0.8 meters (for 30MHz ~ 1GHz) / 1.5 meters (for above 1GHz) above the ground at 3 meter chamber room for test. The table was rotated 360 degrees to determine the position of the highest radiation.
- b. The EUT was set 3 meters away from the interference-receiving antenna, which was mounted on the top of a variable-height antenna tower.
- c. The height of antenna is varied from one meter to four meters above the ground to determine the maximum value of the field strength. Both horizontal and vertical polarizations of the antenna are set to make the measurement.
- d. For each suspected emission, the EUT was arranged to its worst case and then the antenna was tuned to heights from 1 meter to 4 meters and the rotatable table was turned from 0 degrees to 360 degrees to find the maximum reading.
- e. The test-receiver system was set to quasi-peak detect function and specified bandwidth with maximum hold mode when the test frequency is below 1 GHz.
- f. The test-receiver system was set to peak and average detect function and specified bandwidth with maximum hold mode when the test frequency is above 1 GHz. If the peak reading value also meets average limit, measurement with the average detector is unnecessary.

Note:

1. The resolution bandwidth and video bandwidth of test receiver/spectrum analyzer is 120kHz for Quasi-peak detection (QP) at frequency below 1GHz.
2. The resolution bandwidth of test receiver/spectrum analyzer is 1 MHz and the video bandwidth is 3 MHz for Peak detection (PK) at frequency above 1GHz.
3. The resolution bandwidth of test receiver/spectrum analyzer is 1MHz and the video bandwidth is $\geq 1/T$ (Duty cycle < 98%) or 10Hz (Duty cycle $\geq 98\%$) for Average detection (AV) at frequency above 1GHz.
4. All modes of operation were investigated and the worst-case emissions are reported.

4.1.4 Deviation from Test Standard

No deviation.

4.1.5 Test Set Up

For Radiated emission below 30MHz

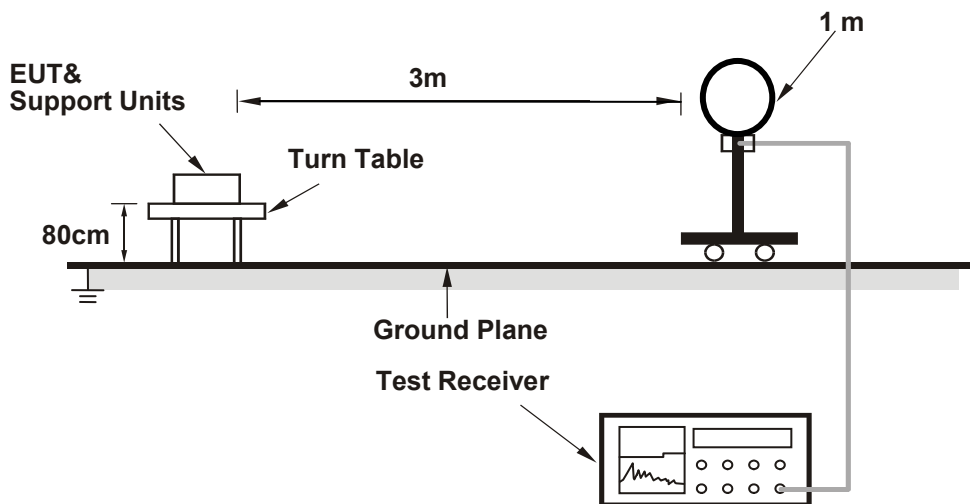

For Radiated emission 30MHz to 1GHz

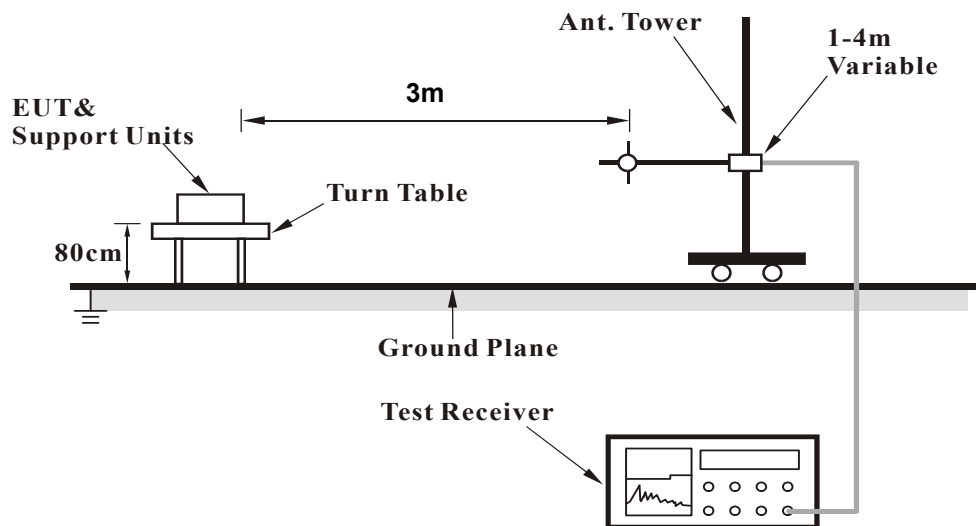

For Radiated emission above 1GHz

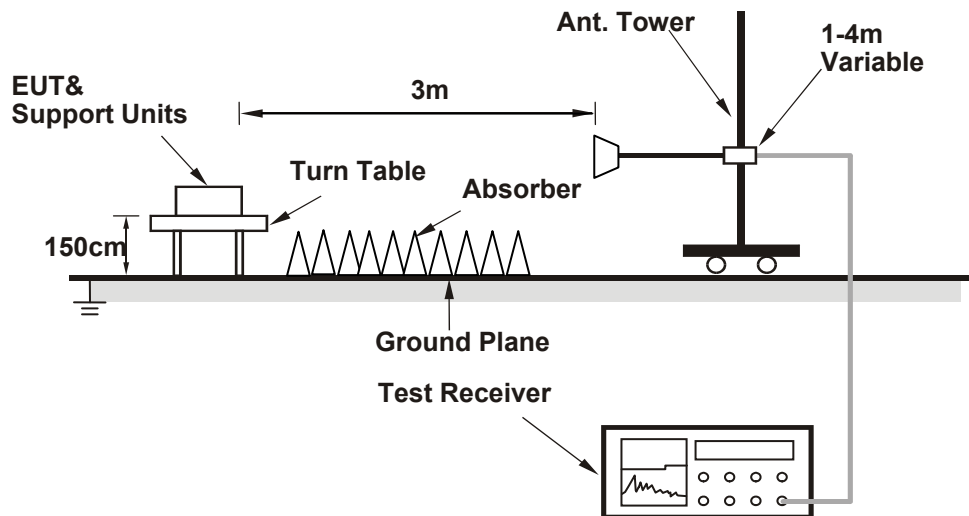

For the actual test configuration, please refer to the attached file (Test Setup Photo).

4.1.6 EUT Operating Conditions

- a. Placed the EUT on the testing table.
- b. Prepared notebook to act as a communication partner and placed it outside of testing area.
- c. The communication partner connected with EUT via a RJ45 cable and ran a test program (provided by manufacturer) to enable EUT under transmission condition continuously at specific channel frequency.
- d. The communication partner sent data to EUT by command "PING".
- e. The necessary accessories enable the system in full functions.

4.1.7 Test Results

Above 1GHz Data :

802.11b

CHANNEL	TX Channel 1	DETECTOR FUNCTION	Peak (PK)
FREQUENCY RANGE	1GHz ~ 25GHz		Average (AV)

ANTENNA POLARITY & TEST DISTANCE: HORIZONTAL AT 3 M								
NO.	FREQ. (MHz)	EMISSION LEVEL (dBuV/m)	LIMIT (dBuV/m)	MARGIN (dB)	ANTENNA HEIGHT (m)	TABLE ANGLE (Degree)	RAW VALUE (dBuV)	CORRECTION FACTOR (dB/m)
1	2390.00	61.8 PK	74.0	-12.2	1.00 H	51	29.30	32.50
2	2390.00	52.2 AV	54.0	-1.8	1.00 H	51	19.70	32.50
3	*2412.00	118.6 PK			1.00 H	42	86.00	32.60
4	*2412.00	115.0 AV			1.00 H	42	82.40	32.60
5	4824.00	47.8 PK	74.0	-26.2	1.00 H	345	41.90	5.90
6	4824.00	36.6 AV	54.0	-17.4	1.00 H	345	30.70	5.90
ANTENNA POLARITY & TEST DISTANCE: VERTICAL AT 3 M								
NO.	FREQ. (MHz)	EMISSION LEVEL (dBuV/m)	LIMIT (dBuV/m)	MARGIN (dB)	ANTENNA HEIGHT (m)	TABLE ANGLE (Degree)	RAW VALUE (dBuV)	CORRECTION FACTOR (dB/m)
1	2390.00	61.4 PK	74.0	-12.6	1.12 V	166	28.90	32.50
2	2390.00	52.4 AV	54.0	-1.6	1.12 V	166	19.90	32.50
3	*2412.00	117.1 PK			1.27 V	166	84.50	32.60
4	*2412.00	113.4 AV			1.27 V	166	80.80	32.60
5	4824.00	46.8 PK	74.0	-27.2	1.25 V	0	40.90	5.90
6	4824.00	35.2 AV	54.0	-18.8	1.25 V	0	29.30	5.90

REMARKS:

1. Emission Level(dBuV/m) = Raw Value(dBuV) + Correction Factor(dB/m)
2. Correction Factor(dB/m) = Antenna Factor(dB/m) + Cable Factor(dB)– Pre-Amplifier Factor(dB)
3. The other emission levels were very low against the limit.
4. Margin value = Emission Level – Limit value
5. " * ": Fundamental frequency.

CHANNEL	TX Channel 6	DETECTOR FUNCTION	Peak (PK)
FREQUENCY RANGE	1GHz ~ 25GHz		Average (AV)

ANTENNA POLARITY & TEST DISTANCE: HORIZONTAL AT 3 M

NO.	FREQ. (MHz)	EMISSION LEVEL (dBuV/m)	LIMIT (dBuV/m)	MARGIN (dB)	ANTENNA HEIGHT (m)	TABLE ANGLE (Degree)	RAW VALUE (dBuV)	CORRECTION FACTOR (dB/m)
1	*2437.00	120.2 PK			1.00 H	45	87.50	32.70
2	*2437.00	116.6 AV			1.00 H	45	83.90	32.70
3	4874.00	49.5 PK	74.0	-24.5	1.62 H	190	43.60	5.90
4	4874.00	40.0 AV	54.0	-14.0	1.62 H	190	34.10	5.90
5	7311.00	55.1 PK	74.0	-18.9	1.24 H	39	43.40	11.70
6	7311.00	47.2 AV	54.0	-6.8	1.24 H	39	35.50	11.70

ANTENNA POLARITY & TEST DISTANCE: VERTICAL AT 3 M

NO.	FREQ. (MHz)	EMISSION LEVEL (dBuV/m)	LIMIT (dBuV/m)	MARGIN (dB)	ANTENNA HEIGHT (m)	TABLE ANGLE (Degree)	RAW VALUE (dBuV)	CORRECTION FACTOR (dB/m)
1	*2437.00	119.5 PK			1.60 V	312	86.80	32.70
2	*2437.00	115.8 AV			1.60 V	312	83.10	32.70
3	4874.00	49.4 PK	74.0	-24.6	2.03 V	85	43.50	5.90
4	4874.00	40.2 AV	54.0	-13.8	2.03 V	85	34.30	5.90
5	7311.00	55.4 PK	74.0	-18.6	1.54 V	179	43.70	11.70
6	7311.00	46.9 AV	54.0	-7.1	1.54 V	179	35.20	11.70

REMARKS:

1. Emission Level(dBuV/m) = Raw Value(dBuV) + Correction Factor(dB/m)
2. Correction Factor(dB/m) = Antenna Factor(dB/m) + Cable Factor(dB)– Pre-Amplifier Factor(dB)
3. The other emission levels were very low against the limit.
4. Margin value = Emission Level – Limit value
5. " * ": Fundamental frequency.

CHANNEL	TX Channel 11	DETECTOR FUNCTION	Peak (PK)
FREQUENCY RANGE	1GHz ~ 25GHz		Average (AV)

ANTENNA POLARITY & TEST DISTANCE: HORIZONTAL AT 3 M

NO.	FREQ. (MHz)	EMISSION LEVEL (dBuV/m)	LIMIT (dBuV/m)	MARGIN (dB)	ANTENNA HEIGHT (m)	TABLE ANGLE (Degree)	RAW VALUE (dBuV)	CORRECTION FACTOR (dB/m)
1	*2462.00	118.1 PK			1.00 H	85	85.50	32.60
2	*2462.00	114.6 AV			1.00 H	85	82.00	32.60
3	2483.50	62.4 PK	74.0	-11.6	1.72 H	41	29.70	32.70
4	2483.50	52.2 AV	54.0	-1.8	1.72 H	41	19.50	32.70
5	4924.00	48.5 PK	74.0	-25.5	1.62 H	311	42.50	6.00
6	4924.00	37.3 AV	54.0	-16.7	1.62 H	311	31.30	6.00

ANTENNA POLARITY & TEST DISTANCE: VERTICAL AT 3 M

NO.	FREQ. (MHz)	EMISSION LEVEL (dBuV/m)	LIMIT (dBuV/m)	MARGIN (dB)	ANTENNA HEIGHT (m)	TABLE ANGLE (Degree)	RAW VALUE (dBuV)	CORRECTION FACTOR (dB/m)
1	*2462.00	115.0 PK			1.01 V	257	82.40	32.60
2	*2462.00	111.5 AV			1.01 V	257	78.90	32.60
3	2483.50	61.5 PK	74.0	-12.5	1.56 V	310	28.80	32.70
4	2483.50	51.8 AV	54.0	-2.2	1.56 V	310	19.10	32.70
5	4924.00	50.4 PK	74.0	-23.6	1.49 V	175	44.40	6.00
6	4924.00	42.4 AV	54.0	-11.6	1.49 V	175	36.40	6.00

REMARKS:

1. Emission Level(dBuV/m) = Raw Value(dBuV) + Correction Factor(dB/m)
2. Correction Factor(dB/m) = Antenna Factor(dB/m) + Cable Factor(dB)– Pre-Amplifier Factor(dB)
3. The other emission levels were very low against the limit.
4. Margin value = Emission Level – Limit value
5. " * ": Fundamental frequency.

802.11g

CHANNEL	TX Channel 1	DETECTOR FUNCTION	Peak (PK)
FREQUENCY RANGE	1GHz ~ 25GHz		Average (AV)

ANTENNA POLARITY & TEST DISTANCE: HORIZONTAL AT 3 M

NO.	FREQ. (MHz)	EMISSION LEVEL (dBuV/m)	LIMIT (dBuV/m)	MARGIN (dB)	ANTENNA HEIGHT (m)	TABLE ANGLE (Degree)	RAW VALUE (dBuV)	CORRECTION FACTOR (dB/m)
1	2390.00	71.5 PK	74.0	-2.5	1.31 H	41	39.00	32.50
2	2390.00	52.9 AV	54.0	-1.1	1.31 H	41	20.40	32.50
3	*2412.00	112.9 PK			1.00 H	43	80.30	32.60
4	*2412.00	103.7 AV			1.00 H	43	71.10	32.60
5	4824.00	46.9 PK	74.0	-27.1	1.18 H	116	41.00	5.90
6	4824.00	33.5 AV	54.0	-20.5	1.18 H	116	27.60	5.90

ANTENNA POLARITY & TEST DISTANCE: VERTICAL AT 3 M

NO.	FREQ. (MHz)	EMISSION LEVEL (dBuV/m)	LIMIT (dBuV/m)	MARGIN (dB)	ANTENNA HEIGHT (m)	TABLE ANGLE (Degree)	RAW VALUE (dBuV)	CORRECTION FACTOR (dB/m)
1	2390.00	70.4 PK	74.0	-3.6	1.11 V	167	37.90	32.50
2	2390.00	51.3 AV	54.0	-2.7	1.11 V	167	18.80	32.50
3	*2412.00	111.3 PK			1.00 V	167	78.70	32.60
4	*2412.00	101.4 AV			1.00 V	167	68.80	32.60
5	4824.00	46.8 PK	74.0	-27.2	1.34 V	246	40.90	5.90
6	4824.00	33.7 AV	54.0	-20.3	1.34 V	246	27.80	5.90

REMARKS:

1. Emission Level(dBuV/m) = Raw Value(dBuV) + Correction Factor(dB/m)
2. Correction Factor(dB/m) = Antenna Factor(dB/m) + Cable Factor(dB)– Pre-Amplifier Factor(dB)
3. The other emission levels were very low against the limit.
4. Margin value = Emission Level – Limit value
5. " * ": Fundamental frequency.

CHANNEL	TX Channel 6	DETECTOR FUNCTION	Peak (PK)
FREQUENCY RANGE	1GHz ~ 25GHz		Average (AV)

ANTENNA POLARITY & TEST DISTANCE: HORIZONTAL AT 3 M

NO.	FREQ. (MHz)	EMISSION LEVEL (dBuV/m)	LIMIT (dBuV/m)	MARGIN (dB)	ANTENNA HEIGHT (m)	TABLE ANGLE (Degree)	RAW VALUE (dBuV)	CORRECTION FACTOR (dB/m)
1	2390.00	69.9 PK	74.0	-4.1	1.02 H	41	37.40	32.50
2	2390.00	52.7 AV	54.0	-1.3	1.02 H	41	20.20	32.50
3	*2437.00	118.0 PK			1.00 H	47	85.30	32.70
4	*2437.00	109.3 AV			1.00 H	47	76.60	32.70
5	4874.00	47.5 PK	74.0	-26.5	1.29 H	176	41.60	5.90
6	4874.00	33.6 AV	54.0	-20.4	1.29 H	176	27.70	5.90

ANTENNA POLARITY & TEST DISTANCE: VERTICAL AT 3 M

NO.	FREQ. (MHz)	EMISSION LEVEL (dBuV/m)	LIMIT (dBuV/m)	MARGIN (dB)	ANTENNA HEIGHT (m)	TABLE ANGLE (Degree)	RAW VALUE (dBuV)	CORRECTION FACTOR (dB/m)
1	2390.00	65.1 PK	74.0	-8.9	1.64 V	321	32.60	32.50
2	2390.00	51.1 AV	54.0	-2.9	1.64 V	321	18.60	32.50
3	*2437.00	118.0 PK			1.26 V	314	85.30	32.70
4	*2437.00	108.2 AV			1.26 V	314	75.50	32.70
5	4874.00	47.0 PK	74.0	-27.0	1.16 V	219	41.10	5.90
6	4874.00	33.8 AV	54.0	-20.2	1.16 V	219	27.90	5.90

REMARKS:

1. Emission Level(dBuV/m) = Raw Value(dBuV) + Correction Factor(dB/m)
2. Correction Factor(dB/m) = Antenna Factor(dB/m) + Cable Factor(dB)– Pre-Amplifier Factor(dB)
3. The other emission levels were very low against the limit.
4. Margin value = Emission Level – Limit value
5. " * ": Fundamental frequency.

CHANNEL	TX Channel 11	DETECTOR FUNCTION	Peak (PK)
FREQUENCY RANGE	1GHz ~ 25GHz		Average (AV)

ANTENNA POLARITY & TEST DISTANCE: HORIZONTAL AT 3 M

NO.	FREQ. (MHz)	EMISSION LEVEL (dBuV/m)	LIMIT (dBuV/m)	MARGIN (dB)	ANTENNA HEIGHT (m)	TABLE ANGLE (Degree)	RAW VALUE (dBuV)	CORRECTION FACTOR (dB/m)
1	*2462.00	113.1 PK			1.00 H	74	80.50	32.60
2	*2462.00	103.8 AV			1.00 H	74	71.20	32.60
3	2483.50	72.5 PK	74.0	-1.5	1.00 H	298	39.80	32.70
4	2483.50	50.6 AV	54.0	-3.4	1.00 H	298	17.90	32.70
5	4924.00	46.7 PK	74.0	-27.3	1.28 H	174	40.70	6.00
6	4924.00	34.1 AV	54.0	-19.9	1.28 H	174	28.10	6.00

ANTENNA POLARITY & TEST DISTANCE: VERTICAL AT 3 M

NO.	FREQ. (MHz)	EMISSION LEVEL (dBuV/m)	LIMIT (dBuV/m)	MARGIN (dB)	ANTENNA HEIGHT (m)	TABLE ANGLE (Degree)	RAW VALUE (dBuV)	CORRECTION FACTOR (dB/m)
1	*2462.00	112.7 PK			1.40 V	315	80.10	32.60
2	*2462.00	102.3 AV			1.40 V	315	69.70	32.60
3	4924.00	47.0 PK	74.0	-27.0	1.07 V	244	41.00	6.00
4	4924.00	47.3 PK	74.0	-26.7	1.34 V	221	41.30	6.00
5	4924.00	34.2 AV	54.0	-19.8	1.07 V	244	28.20	6.00
6	4924.00	34.4 AV	54.0	-19.6	1.34 V	221	28.40	6.00

REMARKS:

1. Emission Level(dBuV/m) = Raw Value(dBuV) + Correction Factor(dB/m)
2. Correction Factor(dB/m) = Antenna Factor(dB/m) + Cable Factor(dB)– Pre-Amplifier Factor(dB)
3. The other emission levels were very low against the limit.
4. Margin value = Emission Level – Limit value
5. " * ": Fundamental frequency.

802.11n (HT20)

CHANNEL	TX Channel 1	DETECTOR FUNCTION	Peak (PK)
FREQUENCY RANGE	1GHz ~ 25GHz		Average (AV)

ANTENNA POLARITY & TEST DISTANCE: HORIZONTAL AT 3 M								
NO.	FREQ. (MHz)	EMISSION LEVEL (dBuV/m)	LIMIT (dBuV/m)	MARGIN (dB)	ANTENNA HEIGHT (m)	TABLE ANGLE (Degree)	RAW VALUE (dBuV)	CORRECTION FACTOR (dB/m)
1	2390.00	64.7 PK	74.0	-9.3	2.16 H	340	32.20	32.50
2	2390.00	52.2 AV	54.0	-1.8	2.16 H	340	19.70	32.50
3	*2412.00	112.1 PK			1.02 H	55	79.50	32.60
4	*2412.00	102.4 AV			1.02 H	55	69.80	32.60
5	4824.00	47.1 PK	74.0	-26.9	1.27 H	146	41.20	5.90
6	4824.00	33.9 AV	54.0	-20.1	1.27 H	146	28.00	5.90

ANTENNA POLARITY & TEST DISTANCE: VERTICAL AT 3 M								
NO.	FREQ. (MHz)	EMISSION LEVEL (dBuV/m)	LIMIT (dBuV/m)	MARGIN (dB)	ANTENNA HEIGHT (m)	TABLE ANGLE (Degree)	RAW VALUE (dBuV)	CORRECTION FACTOR (dB/m)
1	2390.00	65.0 PK	74.0	-9.0	1.12 V	169	32.50	32.50
2	2390.00	50.4 AV	54.0	-3.6	1.12 V	169	17.90	32.50
3	*2412.00	110.2 PK			1.27 V	167	77.60	32.60
4	*2412.00	100.7 AV			1.27 V	167	68.10	32.60
5	4824.00	47.5 PK	74.0	-26.5	1.01 V	226	41.60	5.90
6	4824.00	33.9 AV	54.0	-20.1	1.01 V	226	28.00	5.90

REMARKS:

1. Emission Level(dBuV/m) = Raw Value(dBuV) + Correction Factor(dB/m)
2. Correction Factor(dB/m) = Antenna Factor(dB/m) + Cable Factor(dB)– Pre-Amplifier Factor(dB)
3. The other emission levels were very low against the limit.
4. Margin value = Emission Level – Limit value
5. " * ": Fundamental frequency.

CHANNEL	TX Channel 6	DETECTOR FUNCTION	Peak (PK)
FREQUENCY RANGE	1GHz ~ 25GHz		Average (AV)

ANTENNA POLARITY & TEST DISTANCE: HORIZONTAL AT 3 M

NO.	FREQ. (MHz)	EMISSION LEVEL (dBuV/m)	LIMIT (dBuV/m)	MARGIN (dB)	ANTENNA HEIGHT (m)	TABLE ANGLE (Degree)	RAW VALUE (dBuV)	CORRECTION FACTOR (dB/m)
1	2390.00	69.0 PK	74.0	-5.0	2.38 H	9	36.50	32.50
2	2390.00	52.3 AV	54.0	-1.7	2.38 H	9	19.80	32.50
3	*2437.00	118.9 PK			1.00 H	45	86.20	32.70
4	*2437.00	109.6 AV			1.00 H	45	76.90	32.70
5	4874.00	47.5 PK	74.0	-26.5	1.29 H	360	41.60	5.90
6	4874.00	34.1 AV	54.0	-19.9	1.29 H	360	28.20	5.90

ANTENNA POLARITY & TEST DISTANCE: VERTICAL AT 3 M

NO.	FREQ. (MHz)	EMISSION LEVEL (dBuV/m)	LIMIT (dBuV/m)	MARGIN (dB)	ANTENNA HEIGHT (m)	TABLE ANGLE (Degree)	RAW VALUE (dBuV)	CORRECTION FACTOR (dB/m)
1	2390.00	61.5 PK	74.0	-12.5	1.00 V	341	29.00	32.50
2	2390.00	51.8 AV	54.0	-2.2	1.00 V	341	19.30	32.50
3	*2437.00	119.0 PK			1.25 V	313	86.30	32.70
4	*2437.00	108.3 AV			1.25 V	313	75.60	32.70
5	4874.00	47.9 PK	74.0	-26.1	1.33 V	198	42.00	5.90
6	4874.00	35.0 AV	54.0	-19.0	1.33 V	198	29.10	5.90

REMARKS:

1. Emission Level(dBuV/m) = Raw Value(dBuV) + Correction Factor(dB/m)
2. Correction Factor(dB/m) = Antenna Factor(dB/m) + Cable Factor(dB)– Pre-Amplifier Factor(dB)
3. The other emission levels were very low against the limit.
4. Margin value = Emission Level – Limit value
5. " * " : Fundamental frequency.

CHANNEL	TX Channel 11	DETECTOR FUNCTION	Peak (PK)
FREQUENCY RANGE	1GHz ~ 25GHz		Average (AV)

ANTENNA POLARITY & TEST DISTANCE: HORIZONTAL AT 3 M

NO.	FREQ. (MHz)	EMISSION LEVEL (dBuV/m)	LIMIT (dBuV/m)	MARGIN (dB)	ANTENNA HEIGHT (m)	TABLE ANGLE (Degree)	RAW VALUE (dBuV)	CORRECTION FACTOR (dB/m)
1	*2462.00	113.0 PK			1.00 H	63	80.40	32.60
2	*2462.00	103.1 AV			1.00 H	63	70.50	32.60
3	2483.50	72.3 PK	74.0	-1.7	1.00 H	298	39.60	32.70
4	2483.50	51.3 AV	54.0	-2.7	1.00 H	298	18.60	32.70
5	4924.00	47.7 PK	74.0	-26.3	1.24 H	73	41.70	6.00
6	4924.00	34.2 AV	54.0	-19.8	1.24 H	73	28.20	6.00

ANTENNA POLARITY & TEST DISTANCE: VERTICAL AT 3 M

NO.	FREQ. (MHz)	EMISSION LEVEL (dBuV/m)	LIMIT (dBuV/m)	MARGIN (dB)	ANTENNA HEIGHT (m)	TABLE ANGLE (Degree)	RAW VALUE (dBuV)	CORRECTION FACTOR (dB/m)
1	*2462.00	112.1 PK			1.39 V	311	79.50	32.60
2	*2462.00	102.5 AV			1.39 V	311	69.90	32.60
3	2483.50	71.5 PK	74.0	-2.5	1.55 V	327	38.80	32.70
4	2483.50	51.4 AV	54.0	-2.6	1.55 V	327	18.70	32.70
5	4924.00	47.5 PK	74.0	-26.5	1.21 V	72	41.50	6.00
6	4924.00	34.4 AV	54.0	-19.6	1.21 V	72	28.40	6.00

REMARKS:

1. Emission Level(dBuV/m) = Raw Value(dBuV) + Correction Factor(dB/m)
2. Correction Factor(dB/m) = Antenna Factor(dB/m) + Cable Factor(dB)– Pre-Amplifier Factor(dB)
3. The other emission levels were very low against the limit.
4. Margin value = Emission Level – Limit value
5. " * ": Fundamental frequency.

802.11n (HT40)

CHANNEL	TX Channel 3	DETECTOR FUNCTION	Peak (PK)
FREQUENCY RANGE	1GHz ~ 25GHz		Average (AV)

ANTENNA POLARITY & TEST DISTANCE: HORIZONTAL AT 3 M

NO.	FREQ. (MHz)	EMISSION LEVEL (dBuV/m)	LIMIT (dBuV/m)	MARGIN (dB)	ANTENNA HEIGHT (m)	TABLE ANGLE (Degree)	RAW VALUE (dBuV)	CORRECTION FACTOR (dB/m)
1	2390.00	67.4 PK	74.0	-6.6	1.99 H	22	34.90	32.50
2	2390.00	52.7 AV	54.0	-1.3	1.99 H	22	20.20	32.50
3	*2422.00	105.9 PK			2.31 H	54	73.30	32.60
4	*2422.00	96.3 AV			2.31 H	54	63.70	32.60
5	4844.00	46.9 PK	74.0	-27.1	1.87 H	114	41.00	5.90
6	4844.00	34.6 AV	54.0	-19.4	1.87 H	114	28.70	5.90

ANTENNA POLARITY & TEST DISTANCE: VERTICAL AT 3 M

NO.	FREQ. (MHz)	EMISSION LEVEL (dBuV/m)	LIMIT (dBuV/m)	MARGIN (dB)	ANTENNA HEIGHT (m)	TABLE ANGLE (Degree)	RAW VALUE (dBuV)	CORRECTION FACTOR (dB/m)
1	2390.00	64.2 PK	74.0	-9.8	1.75 V	353	31.70	32.50
2	2390.00	50.0 AV	54.0	-4.0	1.75 V	353	17.50	32.50
3	*2422.00	104.5 PK			1.51 V	327	71.90	32.60
4	*2422.00	95.2 AV			1.51 V	327	62.60	32.60
5	4844.00	47.2 PK	74.0	-26.8	1.27 V	227	41.30	5.90
6	4844.00	35.1 AV	54.0	-18.9	1.27 V	227	29.20	5.90

REMARKS:

1. Emission Level(dBuV/m) = Raw Value(dBuV) + Correction Factor(dB/m)
2. Correction Factor(dB/m) = Antenna Factor(dB/m) + Cable Factor(dB)– Pre-Amplifier Factor(dB)
3. The other emission levels were very low against the limit.
4. Margin value = Emission Level – Limit value
5. " * ": Fundamental frequency.

CHANNEL	TX Channel 6	DETECTOR FUNCTION	Peak (PK)
FREQUENCY RANGE	1GHz ~ 25GHz		Average (AV)

ANTENNA POLARITY & TEST DISTANCE: HORIZONTAL AT 3 M

NO.	FREQ. (MHz)	EMISSION LEVEL (dBuV/m)	LIMIT (dBuV/m)	MARGIN (dB)	ANTENNA HEIGHT (m)	TABLE ANGLE (Degree)	RAW VALUE (dBuV)	CORRECTION FACTOR (dB/m)
1	2390.00	65.7 PK	74.0	-8.3	1.00 H	29	33.20	32.50
2	2390.00	52.2 AV	54.0	-1.8	1.00 H	29	19.70	32.50
3	*2437.00	109.7 PK			1.01 H	85	77.00	32.70
4	*2437.00	101.1 AV			1.01 H	85	68.40	32.70
5	4874.00	47.0 PK	74.0	-27.0	1.26 H	158	41.10	5.90
6	4874.00	35.4 AV	54.0	-18.6	1.26 H	158	29.50	5.90

ANTENNA POLARITY & TEST DISTANCE: VERTICAL AT 3 M

NO.	FREQ. (MHz)	EMISSION LEVEL (dBuV/m)	LIMIT (dBuV/m)	MARGIN (dB)	ANTENNA HEIGHT (m)	TABLE ANGLE (Degree)	RAW VALUE (dBuV)	CORRECTION FACTOR (dB/m)
1	2390.00	63.6 PK	74.0	-10.4	1.63 V	313	31.10	32.50
2	2390.00	51.0 AV	54.0	-3.0	1.63 V	313	18.50	32.50
3	*2437.00	109.2 PK			1.27 V	315	76.50	32.70
4	*2437.00	100.6 AV			1.27 V	315	67.90	32.70
5	4874.00	46.9 PK	74.0	-27.1	1.11 V	241	41.00	5.90
6	4874.00	35.0 AV	54.0	-19.0	1.11 V	241	29.10	5.90

REMARKS:

1. Emission Level(dBuV/m) = Raw Value(dBuV) + Correction Factor(dB/m)
2. Correction Factor(dB/m) = Antenna Factor(dB/m) + Cable Factor(dB)– Pre-Amplifier Factor(dB)
3. The other emission levels were very low against the limit.
4. Margin value = Emission Level – Limit value
5. " * ": Fundamental frequency.

CHANNEL	TX Channel 9	DETECTOR FUNCTION	Peak (PK)
FREQUENCY RANGE	1GHz ~ 25GHz		Average (AV)

ANTENNA POLARITY & TEST DISTANCE: HORIZONTAL AT 3 M

NO.	FREQ. (MHz)	EMISSION LEVEL (dBuV/m)	LIMIT (dBuV/m)	MARGIN (dB)	ANTENNA HEIGHT (m)	TABLE ANGLE (Degree)	RAW VALUE (dBuV)	CORRECTION FACTOR (dB/m)
1	*2452.00	106.6 PK			1.00 H	60	73.90	32.70
2	*2452.00	98.2 AV			1.00 H	60	65.50	32.70
3	2483.50	67.5 PK	74.0	-6.5	1.01 H	295	34.80	32.70
4	2483.50	52.2 AV	54.0	-1.8	1.01 H	295	19.50	32.70
5	4904.00	47.0 PK	74.0	-27.0	1.31 H	119	41.20	5.80
6	4904.00	35.0 AV	54.0	-19.0	1.31 H	119	29.20	5.80

ANTENNA POLARITY & TEST DISTANCE: VERTICAL AT 3 M

NO.	FREQ. (MHz)	EMISSION LEVEL (dBuV/m)	LIMIT (dBuV/m)	MARGIN (dB)	ANTENNA HEIGHT (m)	TABLE ANGLE (Degree)	RAW VALUE (dBuV)	CORRECTION FACTOR (dB/m)
1	*2452.00	105.9 PK			1.42 V	313	73.20	32.70
2	*2452.00	96.4 AV			1.42 V	313	63.70	32.70
3	2483.50	64.0 PK	74.0	-10.0	1.08 V	312	31.30	32.70
4	2483.50	50.9 AV	54.0	-3.1	1.08 V	312	18.20	32.70
5	4904.00	47.3 PK	74.0	-26.7	1.02 V	244	41.50	5.80
6	4904.00	34.9 AV	54.0	-19.1	1.02 V	244	29.10	5.80

REMARKS:

1. Emission Level(dBuV/m) = Raw Value(dBuV) + Correction Factor(dB/m)
2. Correction Factor(dB/m) = Antenna Factor(dB/m) + Cable Factor(dB)– Pre-Amplifier Factor(dB)
3. The other emission levels were very low against the limit.
4. Margin value = Emission Level – Limit value
5. " * ": Fundamental frequency.

Below 1GHz Data:

802.11b

CHANNEL	TX Channel 6	DETECTOR FUNCTION	Quasi-Peak (QP)
FREQUENCY RANGE	9kHz ~ 1GHz	TEST MODE	A

ANTENNA POLARITY & TEST DISTANCE: HORIZONTAL AT 3 M

NO.	FREQ. (MHz)	EMISSION LEVEL (dBuV/m)	LIMIT (dBuV/m)	MARGIN (dB)	ANTENNA HEIGHT (m)	TABLE ANGLE (Degree)	RAW VALUE (dBuV)	CORRECTION FACTOR (dB/m)
1	389.59	43.1 QP	46.0	-2.9	1.00 H	112	53.70	-10.60
2	655.96	41.0 QP	46.0	-5.0	1.00 H	278	46.30	-5.30
3	689.01	41.7 QP	46.0	-4.3	1.00 H	117	46.40	-4.70
4	706.85	42.5 QP	46.0	-3.5	1.00 H	124	46.80	-4.30
5	730.02	42.5 QP	46.0	-3.5	1.00 H	123	46.20	-3.70
6	743.45	41.3 QP	46.0	-4.7	1.03 H	120	44.70	-3.40

ANTENNA POLARITY & TEST DISTANCE: VERTICAL AT 3 M

NO.	FREQ. (MHz)	EMISSION LEVEL (dBuV/m)	LIMIT (dBuV/m)	MARGIN (dB)	ANTENNA HEIGHT (m)	TABLE ANGLE (Degree)	RAW VALUE (dBuV)	CORRECTION FACTOR (dB/m)
1	57.12	29.5 QP	40.0	-10.5	1.49 V	226	44.10	-14.60
2	86.28	29.5 QP	40.0	-10.5	1.49 V	162	49.10	-19.60
3	107.67	29.6 QP	43.5	-13.9	1.49 V	87	47.40	-17.80
4	195.16	34.8 QP	43.5	-8.7	1.00 V	48	51.60	-16.80
5	395.43	40.4 QP	46.0	-5.6	1.00 V	164	51.10	-10.70
6	694.85	40.7 QP	46.0	-5.3	1.49 V	136	45.30	-4.60

REMARKS:

1. Emission Level(dBuV/m) = Raw Value(dBuV) + Correction Factor(dB/m)
2. Correction Factor(dB/m) = Antenna Factor(dB/m) + Cable Factor(dB)– Pre-Amplifier Factor(dB)
3. The other emission levels were very low against the limit.
4. Margin value = Emission Level – Limit value

CHANNEL	TX Channel 6	DETECTOR FUNCTION	Quasi-Peak (QP)
FREQUENCY RANGE	9kHz ~ 1GHz	TEST MODE	B

ANTENNA POLARITY & TEST DISTANCE: HORIZONTAL AT 3 M

NO.	FREQ. (MHz)	EMISSION LEVEL (dBuV/m)	LIMIT (dBuV/m)	MARGIN (dB)	ANTENNA HEIGHT (m)	TABLE ANGLE (Degree)	RAW VALUE (dBuV)	CORRECTION FACTOR (dB/m)
1	57.12	29.4 QP	40.0	-10.6	2.00 H	44	44.00	-14.60
2	125.17	24.6 QP	43.5	-18.9	1.50 H	251	40.70	-16.10
3	387.65	24.5 QP	46.0	-21.5	1.00 H	131	35.20	-10.70
4	500.42	29.3 QP	46.0	-16.7	1.50 H	132	37.70	-8.40
5	624.85	30.8 QP	46.0	-15.2	1.00 H	124	36.40	-5.60
6	751.23	34.6 QP	46.0	-11.4	1.00 H	142	37.80	-3.20

ANTENNA POLARITY & TEST DISTANCE: VERTICAL AT 3 M

NO.	FREQ. (MHz)	EMISSION LEVEL (dBuV/m)	LIMIT (dBuV/m)	MARGIN (dB)	ANTENNA HEIGHT (m)	TABLE ANGLE (Degree)	RAW VALUE (dBuV)	CORRECTION FACTOR (dB/m)
1	37.68	32.3 QP	40.0	-7.7	2.00 V	77	47.60	-15.30
2	57.12	28.5 QP	40.0	-11.5	2.00 V	106	43.10	-14.60
3	109.62	21.8 QP	43.5	-21.7	1.00 V	87	39.20	-17.40
4	624.85	32.8 QP	46.0	-13.2	1.49 V	172	38.40	-5.60
5	714.29	31.8 QP	46.0	-14.2	1.00 V	350	36.10	-4.30
6	900.94	35.5 QP	46.0	-10.5	1.49 V	14	36.10	-0.60

REMARKS:

1. Emission Level(dBuV/m) = Raw Value(dBuV) + Correction Factor(dB/m)
2. Correction Factor(dB/m) = Antenna Factor(dB/m) + Cable Factor(dB)– Pre-Amplifier Factor(dB)
3. The other emission levels were very low against the limit.
4. Margin value = Emission Level – Limit value

4.2 Conducted Emission Measurement

4.2.1 Limits of Conducted Emission Measurement

Frequency (MHz)	Conducted Limit (dBuV)	
	Quasi-peak	Average
0.15 - 0.5	66 - 56	56 - 46
0.50 - 5.0	56	46
5.0 - 30.0	60	50

Note: 1. The lower limit shall apply at the transition frequencies.

2. The limit decreases in line with the logarithm of the frequency in the range of 0.15 to 0.50MHz.

4.2.2 Test Instruments

Description & Manufacturer	Model No.	Serial No.	Date Of Calibration	Due Date Of Calibration
Test Receiver ROHDE & SCHWARZ	ESCI	100613	Nov. 11, 2014	Nov. 10, 2015
RF signal cable Woken	5D-FB	Cable-HYC01-01	Dec. 26, 2014	Dec. 25, 2015
LISN ROHDE & SCHWARZ (EUT)	ESH3-Z5	835239/001	Mar. 02, 2015	Mar. 01, 2016
LISN ROHDE & SCHWARZ (Peripheral)	ESH3-Z5	100311	Jul. 21, 2014	Jul. 20, 2015
Software ADT	BV ADT_Cond_ V7.3.7.3	NA	NA	NA

NOTE: 1. The calibration interval of the above test instruments is 12 months and the calibrations are traceable to NML/ROC and NIST/USA.

2. The test was performed in HwaYa Shielded Room 1.

3. The VCCI Site Registration No. is C-2040.

4.2.3 Test Procedures

- The EUT was placed 0.4 meters from the conducting wall of the shielded room with EUT being connected to the power mains through a line impedance stabilization network (LISN). Other support units were connected to the power mains through another LISN. The two LISNs provide 50 ohm/ 50uH of coupling impedance for the measuring instrument.
- Both lines of the power mains connected to the EUT were checked for maximum conducted interference.
- The frequency range from 150kHz to 30MHz was searched. Emission levels under (Limit - 20dB) was not recorded.

NOTE: The resolution bandwidth and video bandwidth of test receiver is 9kHz for quasi-peak detection (QP) and average detection (AV) at frequency 0.15MHz-30MHz.

4.2.4 Deviation from Test Standard

No deviation.

4.2.5 Test Setup

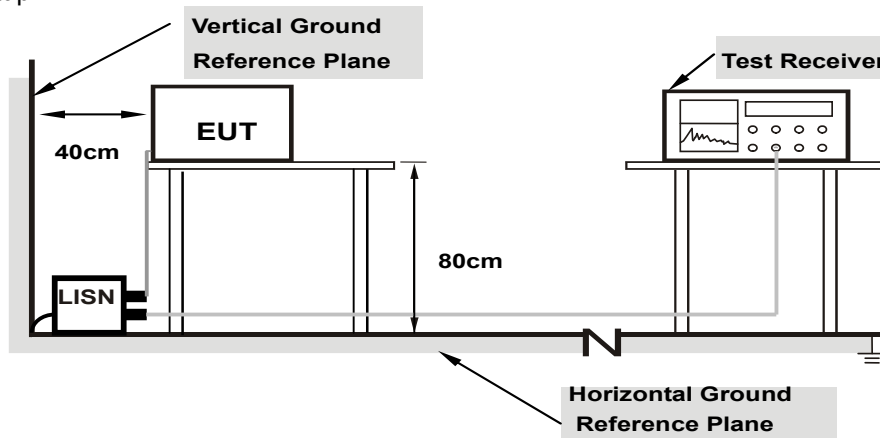

Note: 1.Support units were connected to second LISN.

For the actual test configuration, please refer to the attached file (Test Setup Photo).

4.2.6 EUT Operating Conditions

Same as 4.1.6.

4.2.7 Test Results

Phase	Line (L)	Detector Function	Quasi-Peak (QP) / Average (AV)
Test Mode	A		

No	Freq. [MHz]	Corr. Factor (dB)	Reading Value		Emission Level		Limit		Margin	
			[dB (uV)]		[dB (uV)]		[dB (uV)]		(dB)	
			Q.P.	AV.	Q.P.	AV.	Q.P.	AV.	Q.P.	AV.
1	0.15391	0.08	54.05	41.36	54.13	41.44	65.79	55.79	-11.66	-14.35
2	0.20865	0.15	51.07	35.33	51.22	35.48	63.26	53.26	-12.04	-17.78
3	0.25166	0.13	46.28	32.89	46.41	33.02	61.70	51.70	-15.29	-18.68
4	0.29429	0.12	41.79	28.30	41.91	28.42	60.40	50.40	-18.50	-21.99
5	0.52927	0.10	43.34	36.78	43.44	36.88	56.00	46.00	-12.56	-9.12
6	10.83212	0.52	42.08	37.27	42.60	37.79	60.00	50.00	-17.40	-12.21

REMARKS:

1. Q.P. and AV. are abbreviations of quasi-peak and average individually.
2. The emission levels of other frequencies were very low against the limit.
3. Margin value = Emission level - Limit value
4. Correction factor = Insertion loss + Cable loss
5. Emission Level = Correction Factor + Reading Value.

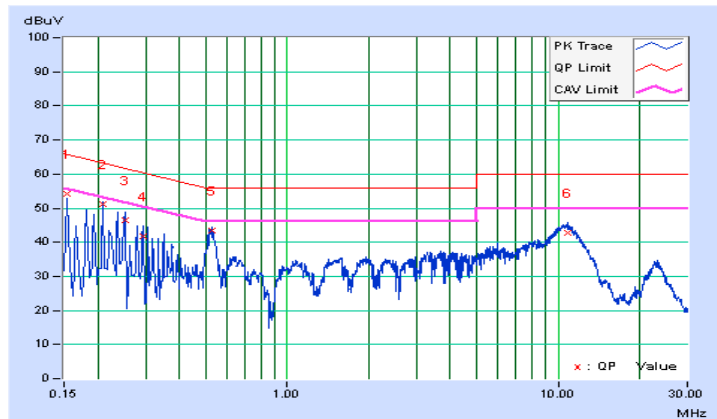

Phase	Neutral (N)	Detector Function	Quasi-Peak (QP) / Average (AV)
Test Mode	A		

No	Freq. [MHz]	Corr. Factor (dB)	Reading Value [dB (uV)]		Emission Level [dB (uV)]		Limit [dB (uV)]		Margin (dB)	
			Q.P.	AV.	Q.P.	AV.	Q.P.	AV.	Q.P.	AV.
			1	0.15000	0.12	58.77	42.25	58.89	42.37	66.00
2	0.15782	0.14	57.75	39.81	57.89	39.95	65.58	55.58	-7.69	-15.63
3	0.18508	0.21	53.97	36.93	54.18	37.14	64.25	54.25	-10.07	-17.11
4	0.21256	0.24	49.87	34.50	50.11	34.74	63.10	53.10	-12.99	-18.36
5	0.25557	0.23	45.25	31.50	45.48	31.73	61.57	51.57	-16.10	-19.85
6	0.52536	0.17	44.36	38.04	44.53	38.21	56.00	46.00	-11.47	-7.79
7	10.84781	0.56	35.01	30.52	35.57	31.08	60.00	50.00	-24.43	-18.92

REMARKS:

1. Q.P. and AV. are abbreviations of quasi-peak and average individually.
2. The emission levels of other frequencies were very low against the limit.
3. Margin value = Emission level - Limit value
4. Correction factor = Insertion loss + Cable loss
5. Emission Level = Correction Factor + Reading Value.

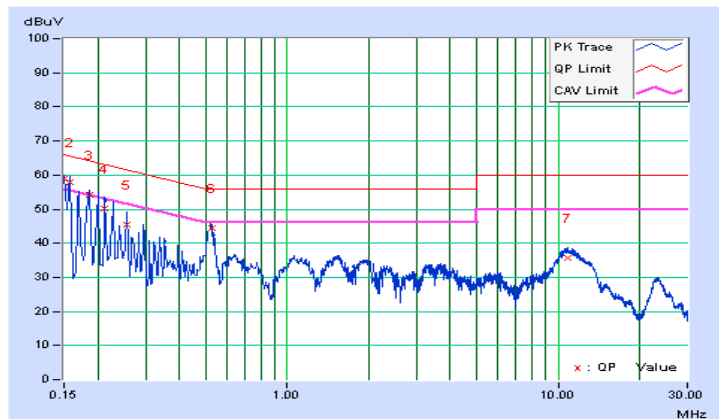

Phase	Line (L)	Detector Function	Quasi-Peak (QP) / Average (AV)
Test Mode	B		

No	Freq. [MHz]	Corr. Factor (dB)	Reading Value [dB (uV)]		Emission Level [dB (uV)]		Limit [dB (uV)]		Margin (dB)	
			Q.P.	AV.	Q.P.	AV.	Q.P.	AV.	Q.P.	AV.
			1	0.15391	0.08	45.64	33.48	45.72	33.56	65.79
2	0.18519	0.13	40.88	26.82	41.01	26.95	64.25	54.25	-23.24	-27.30
3	0.27120	0.13	33.00	20.64	33.13	20.77	61.08	51.08	-27.96	-30.32
4	0.49017	0.10	32.15	24.92	32.25	25.02	56.16	46.16	-23.92	-21.15
5	13.70988	0.66	30.83	29.92	31.49	30.58	60.00	50.00	-28.51	-19.42
6	22.87883	1.04	26.44	19.22	27.48	20.26	60.00	50.00	-32.52	-29.74

REMARKS:

1. Q.P. and AV. are abbreviations of quasi-peak and average individually.
2. The emission levels of other frequencies were very low against the limit.
3. Margin value = Emission level - Limit value
4. Correction factor = Insertion loss + Cable loss
5. Emission Level = Correction Factor + Reading Value.

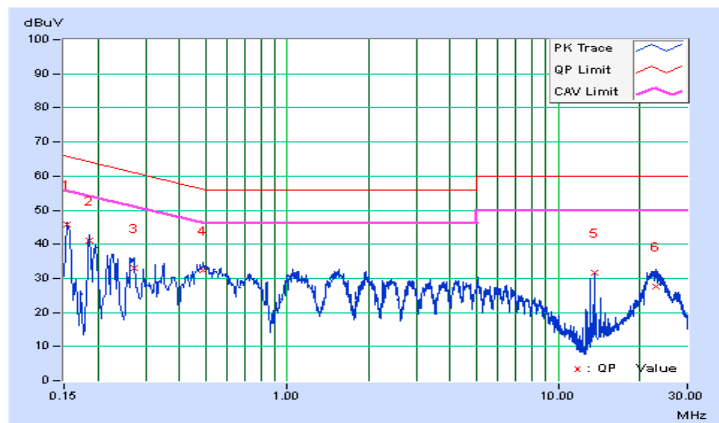

Phase	Neutral (N)	Detector Function	Quasi-Peak (QP) / Average (AV)
Test Mode	B		

No	Freq. [MHz]	Corr. Factor (dB)	Reading Value [dB (uV)]		Emission Level [dB (uV)]		Limit [dB (uV)]		Margin (dB)	
			Q.P.	AV.	Q.P.	AV.	Q.P.	AV.	Q.P.	AV.
			1	0.19301	0.23	40.57	28.39	40.80	28.62	63.91
2	0.23216	0.24	36.15	24.52	36.39	24.76	62.37	52.37	-25.98	-27.61
3	0.55273	0.17	32.86	25.21	33.03	25.38	56.00	46.00	-22.97	-20.62
4	1.40120	0.19	29.66	25.55	29.85	25.74	56.00	46.00	-26.15	-20.26
5	13.70988	0.65	31.78	30.84	32.43	31.49	60.00	50.00	-27.57	-18.51
6	22.22977	0.89	27.56	20.18	28.45	21.07	60.00	50.00	-31.55	-28.93

REMARKS:

1. Q.P. and AV. are abbreviations of quasi-peak and average individually.
2. The emission levels of other frequencies were very low against the limit.
3. Margin value = Emission level - Limit value
4. Correction factor = Insertion loss + Cable loss
5. Emission Level = Correction Factor + Reading Value.

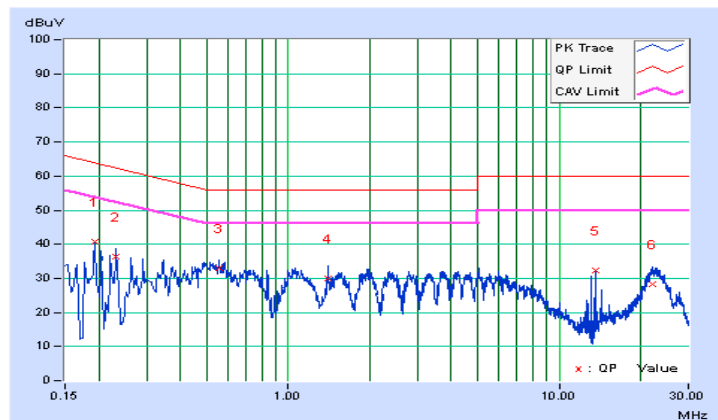

4.3 6dB Bandwidth Measurement

4.3.1 Limits of 6dB Bandwidth Measurement

The minimum of 6dB Bandwidth Measurement is 0.5 MHz.

4.3.2 Test Setup

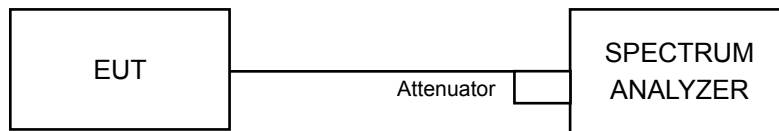

4.3.3 Test Instruments

Refer to section 4.1.2 to get information of above instrument.

4.3.4 Test Procedure

- a. Set resolution bandwidth (RBW) = 100kHz
- b. Set the video bandwidth (VBW) $\geq 3 \times$ RBW, Detector = Peak.
- c. Trace mode = max hold.
- d. Sweep = auto couple.
- e. Measure the maximum width of the emission that is constrained by the frequencies associated with the two amplitude points (upper and lower) that are attenuated by 6 dB relative to the maximum level measured in the fundamental emission

4.3.5 Deviation from Test Standard

No deviation.

4.3.6 EUT Operating Conditions

The software provided by client to enable the EUT under transmission condition continuously at lowest, middle and highest channel frequencies individually.

4.3.7 Test Result

802.11b

Channel	Frequency (MHz)	6dB Bandwidth (MHz)		Minimum Limit (MHz)	Pass / Fail
		Chain 0	Chain 1		
1	2412	8.02	7.10	0.5	PASS
6	2437	7.10	7.11	0.5	PASS
11	2462	7.10	7.07	0.5	PASS

802.11g

Channel	Frequency (MHz)	6dB Bandwidth (MHz)		Minimum Limit (MHz)	Pass / Fail
		Chain 0	Chain 1		
1	2412	16.42	16.41	0.5	PASS
6	2437	16.40	16.37	0.5	PASS
11	2462	16.40	16.38	0.5	PASS

802.11n (HT20)

Channel	Frequency (MHz)	6dB Bandwidth (MHz)		Minimum Limit (MHz)	Pass / Fail
		Chain 0	Chain 1		
1	2412	17.63	17.63	0.5	PASS
6	2437	17.60	17.57	0.5	PASS
11	2462	17.56	17.61	0.5	PASS

802.11n (HT40)

Channel	Frequency (MHz)	6dB Bandwidth (MHz)		Minimum Limit (MHz)	Pass / Fail
		Chain 0	Chain 1		
3	2422	35.86	36.18	0.5	PASS
6	2437	36.34	36.38	0.5	PASS
9	2452	35.98	35.93	0.5	PASS



Spectrum Plot of Worst Value

802.11b

802.11g

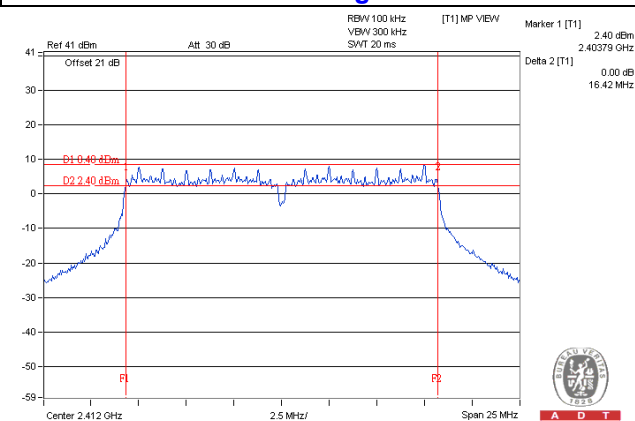
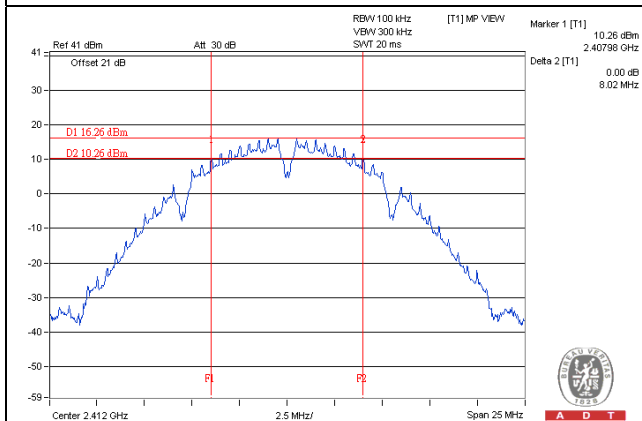

802.11n (HT20)

802.11n (HT40)

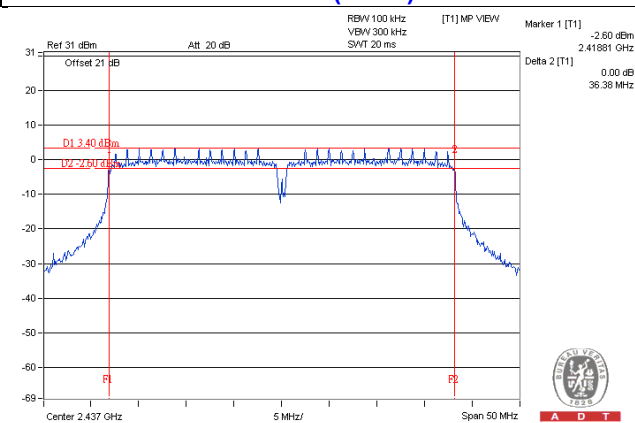
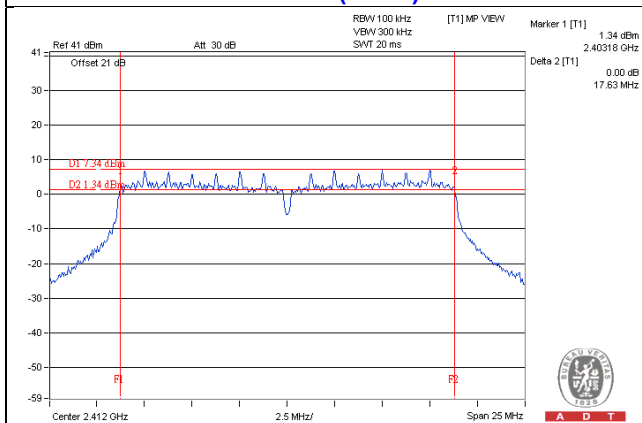

4.4 Conducted Output Power Measurement

4.4.1 Limits of Conducted Output Power Measurement

For systems using digital modulation in the 2400–2483.5 MHz bands: 1 Watt (30dBm)

Per KDB 662911 D01 Multiple Transmitter Output Method of conducted output power measurement on IEEE 802.11 devices,

Array Gain = 0 dB (i.e., no array gain) for $N_{ANT} \leq 4$;

Array Gain = 0 dB (i.e., no array gain) for channel widths ≥ 40 MHz for any N_{ANT} ;

Array Gain = $5 \log(N_{ANT}/N_{SS})$ dB or 3 dB, whichever is less for 20-MHz channel widths with $N_{ANT} \geq 5$.

For power measurements on all other devices: Array Gain = $10 \log(N_{ANT}/N_{SS})$ dB.

4.4.2 Test Setup

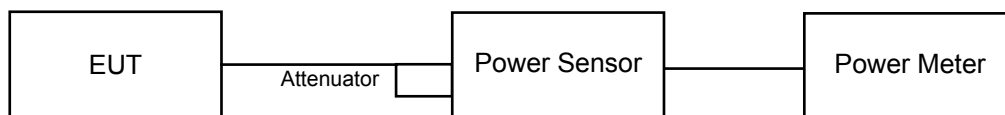

4.4.3 Test Instruments

Refer to section 4.1.2 to get information of above instrument.

4.4.4 Test Procedures

An average power sensor was used on the output port of the EUT. A power meter was used to read the response of the average power sensor. Record the power level.

4.4.5 Deviation from Test Standard

No deviation.

4.4.6 EUT Operating Conditions

Same as Item 4.3.6.

4.4.7 Test Results

FOR AVERAGE POWER

802.11b

Chan.	Freq. (MHz)	Avg. Power (dBm)		Total Power (mW)	Total Power (dBm)	Limit (dBm)	Pass / Fail
		Chain 0	Chain 1				
1	2412	24.21	24.68	557.398	27.46	30	Pass
6	2437	25.82	26.00	780.051	28.92	30	Pass
11	2462	24.54	24.65	576.189	27.61	30	Pass

802.11g

Chan.	Freq. (MHz)	Avg. Power (dBm)		Total Power (mW)	Total Power (dBm)	Limit (dBm)	Pass / Fail
		Chain 0	Chain 1				
1	2412	18.75	19.12	156.647	21.95	30	Pass
6	2437	24.07	24.15	515.286	27.12	30	Pass
11	2462	18.80	19.10	157.141	21.96	30	Pass

802.11n (HT20)

Chan.	Freq. (MHz)	Avg. Power (dBm)		Total Power (mW)	Total Power (dBm)	Limit (dBm)	Pass / Fail
		Chain 0	Chain 1				
1	2412	17.57	17.89	118.666	20.74	30	Pass
6	2437	24.00	24.26	517.875	27.14	30	Pass
11	2462	18.23	18.65	139.809	21.46	30	Pass

802.11n (HT40)

Chan.	Freq. (MHz)	Avg. Power (dBm)		Total Power (mW)	Total Power (dBm)	Limit (dBm)	Pass / Fail
		Chain 0	Chain 1				
3	2422	13.24	13.64	44.207	16.45	30	Pass
6	2437	17.95	18.41	131.716	21.20	30	Pass
9	2452	14.72	15.16	62.458	17.96	30	Pass

4.5 Power Spectral Density Measurement

4.5.1 Limits of Power Spectral Density Measurement

The Maximum of Power Spectral Density Measurement is 8dBm.

4.5.2 Test Setup

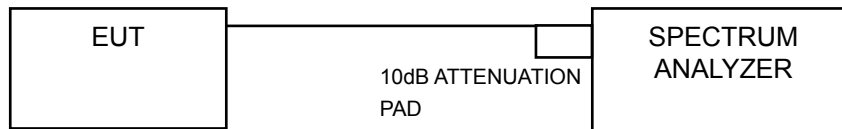

4.5.3 Test Instruments

Refer to section 4.1.2 to get information of above instrument.

4.5.4 Test Procedure

For AVG. power (duty cycle $\geq 98\%$)

- Set instrument center frequency to DTS channel center frequency.
- Set span to at least 1.5 times the OBW.
- Set RBW to: $3 \text{ kHz} \leq \text{RBW} \leq 100 \text{ kHz}$.
- Set VBW $\geq 3 \times \text{RBW}$.
- Detector = power averaging (RMS) or sample detector (when RMS not available).
- Ensure that the number of measurement points in the sweep $\geq 2 \times \text{span}/\text{RBW}$.
- Sweep time = auto couple.
- Employ trace averaging (RMS) mode over a minimum of 100 traces.
- Use the peak marker function to determine the maximum amplitude level.

For AVG. power (duty cycle $< 98\%$)

- Measure the duty cycle (x).
- Set instrument center frequency to DTS channel center frequency.
- Set span to at least 1.5 times the OBW.
- Set RBW to: $3 \text{ kHz} \leq \text{RBW} \leq 100 \text{ kHz}$.
- Set VBW $\geq 3 \times \text{RBW}$.
- Detector = power averaging (RMS) or sample detector (when RMS not available).
- Ensure that the number of measurement points in the sweep $\geq 2 \times \text{span}/\text{RBW}$.
- Sweep time = auto couple.
- Do not use sweep triggering. Allow sweep to "free run".
- Employ trace averaging (RMS) mode over a minimum of 100 traces.
- Use the peak marker function to determine the maximum amplitude level.
- Add $10 \log (1/x)$, where x is the duty cycle measured in step (a), to the measured PSD to compute the average PSD during the actual transmission time.

4.5.5 Deviation from Test Standard

No deviation.

4.5.6 EUT Operating Condition

Same as Item 4.3.6

4.5.7 Test Results

802.11b

TX chain	Channel	Freq. (MHz)	PSD (dBm)	10 log (N=2) dB	Total PSD (dBm)	Limit (dBm)	Pass /Fail
0	1	2412	-3.53	3.01	-0.52	7.65	Pass
	6	2437	-0.46	3.01	2.55	7.65	Pass
	11	2462	-2.30	3.01	0.71	7.65	Pass
1	1	2412	-2.93	3.01	0.08	7.65	Pass
	6	2437	-0.90	3.01	2.11	7.65	Pass
	11	2462	-2.40	3.01	0.61	7.65	Pass

NOTE: Directional gain = $10 \log[(10^{G1/20} + 10^{G2/20} + \dots + 10^{GN/20})^2/2] = 6.35 \text{ dBi} > 6 \text{ dBi}$, so the power density limit shall be reduced to $8 - (6.35 - 6) = 7.65 \text{ dBm}$.

802.11g

TX chain	Channel	Freq. (MHz)	PSD (dBm)	10 log (N=2) dB	Duty Factor	Total PSD with Duty Factor (dBm)	Limit (dBm)	Pass /Fail
0	1	2412	-11.33	3.01	0.12	-8.20	7.65	Pass
	6	2437	-5.91	3.01	0.12	-2.78	7.65	Pass
	11	2462	-11.73	3.01	0.12	-8.60	7.65	Pass
1	1	2412	-7.95	3.01	0.12	-4.82	7.65	Pass
	6	2437	-6.35	3.01	0.12	-3.22	7.65	Pass
	11	2462	-10.92	3.01	0.12	-7.79	7.65	Pass

NOTE:

- Method 1 of power density measurement of KDB 662911 is using for calculating total power density. Total power density is summing entire spectra across corresponding frequency bins on the various outputs by computer.
- Directional gain = $10 \log[(10^{G1/20} + 10^{G2/20} + \dots + 10^{GN/20})^2/2] = 6.35 \text{ dBi} > 6 \text{ dBi}$, so the power density limit shall be reduced to $8 - (6.35 - 6) = 7.65 \text{ dBm}$.
- Refer to section 3.3 for duty cycle spectrum plot.

802.11n (HT20)

TX chain	Channel	Freq. (MHz)	PSD (dBm)	10 log (N=2) dB	Duty Factor	Total PSD with Duty Factor (dBm)	Limit (dBm)	Pass /Fail
0	1	2412	-12.68	3.01	0.12	-9.55	7.65	Pass
	6	2437	-6.42	3.01	0.12	-3.29	7.65	Pass
	11	2462	-12.19	3.01	0.12	-9.06	7.65	Pass
1	1	2412	-13.33	3.01	0.12	-10.20	7.65	Pass
	6	2437	-7.17	3.01	0.12	-4.04	7.65	Pass
	11	2462	-12.34	3.01	0.12	-9.21	7.65	Pass

NOTE:

- Method 1 of power density measurement of KDB 662911 is using for calculating total power density. Total power density is summing entire spectra across corresponding frequency bins on the various outputs by computer.
- Directional gain = $10 \log[(10^{G1/20} + 10^{G2/20} + \dots + 10^{GN/20})^2/2] = 6.35 \text{ dBi} > 6 \text{ dBi}$, so the power density limit shall be reduced to $8 - (6.35 - 6) = 7.65 \text{ dBm}$.
- Refer to section 3.3 for duty cycle spectrum plot.

802.11n (HT40)

TX chain	Channel	Freq. (MHz)	PSD (dBm)	10 log (N=2) dB	Duty Factor	Total PSD with Duty Factor (dBm)	Limit (dBm)	Pass /Fail
0	3	2422	-18.97	3.01	0.19	-15.77	7.65	Pass
	6	2437	-14.81	3.01	0.19	-11.61	7.65	Pass
	9	2452	-17.25	3.01	0.19	-14.05	7.65	Pass
1	3	2422	-19.70	3.01	0.19	-16.50	7.65	Pass
	6	2437	-14.60	3.01	0.19	-11.40	7.65	Pass
	9	2452	-18.33	3.01	0.19	-15.13	7.65	Pass

NOTE:

- Method 1 of power density measurement of KDB 662911 is using for calculating total power density. Total power density is summing entire spectra across corresponding frequency bins on the various outputs by computer.
- Directional gain = $10 \log[(10^{G1/20} + 10^{G2/20} + \dots + 10^{GN/20})^2/2] = 6.35 \text{ dBi} > 6 \text{ dBi}$, so the power density limit shall be reduced to $8 - (6.35 - 6) = 7.65 \text{ dBm}$.
- Refer to section 3.3 for duty cycle spectrum plot.

Spectrum Plot of Worst Value

802.11b

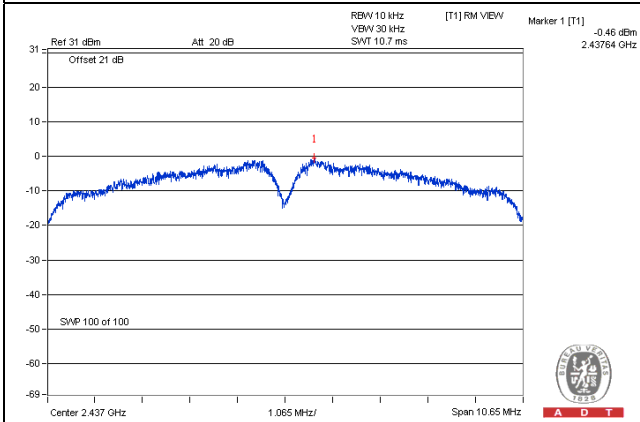

802.11g

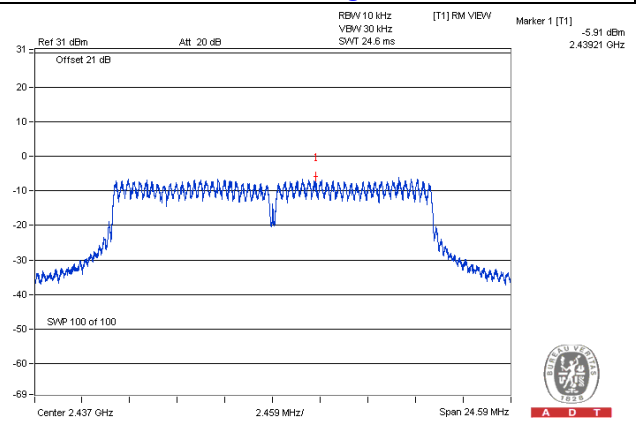

802.11n (HT20)

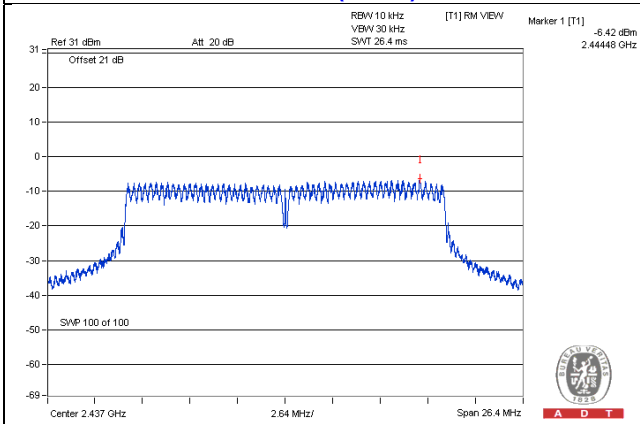

802.11n (HT40)

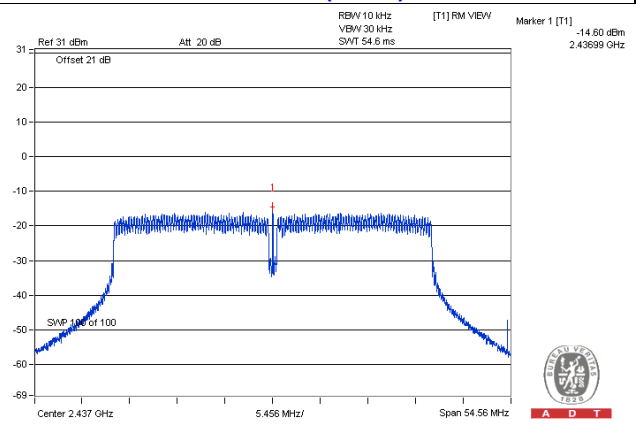

4.6 Conducted Out of Band Emission Measurement

4.6.1 Limits of Conducted Out of Band Emission Measurement

Below 30dB of the highest emission level of operating band (in 100kHz Resolution Bandwidth).

4.6.2 Test Setup

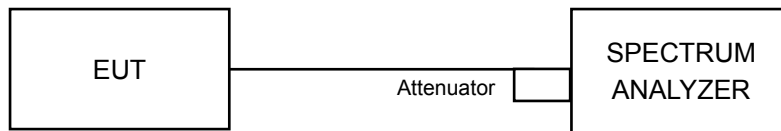

4.6.3 Test Instruments

Refer to section 4.1.2 to get information of above instrument.

4.6.4 Test Procedure

MEASUREMENT PROCEDURE REF

1. Set the RBW = 100 kHz.
2. Set the VBW \geq 300 kHz.
3. Detector = peak.
4. Sweep time = auto couple.
5. Trace mode = max hold.
6. Allow trace to fully stabilize.
7. Use the peak marker function to determine the maximum power level in any 100 kHz band segment within the fundamental EBW.

MEASUREMENT PROCEDURE OOBE

1. Set RBW = 100 kHz.
2. Set VBW \geq 300 kHz.
3. Detector = peak.
4. Sweep = auto couple.
5. Trace Mode = max hold.
6. Allow trace to fully stabilize.
7. Use the peak marker function to determine the maximum amplitude level.

4.6.5 Deviation from Test Standard

No deviation.

4.6.6 EUT Operating Condition

Same as Item 4.3.6

4.6.7 Test Results

The spectrum plots are attached on the following pages. D1 line indicates the highest level, and D2 line indicates the 30dB offset below D1. It shows compliance with the requirement.

802.11b
CHAIN 0

CH 1

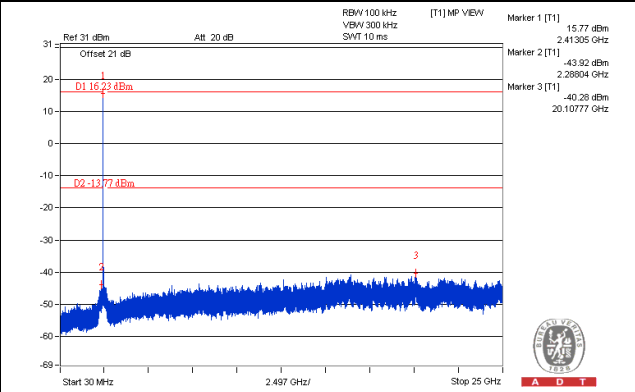
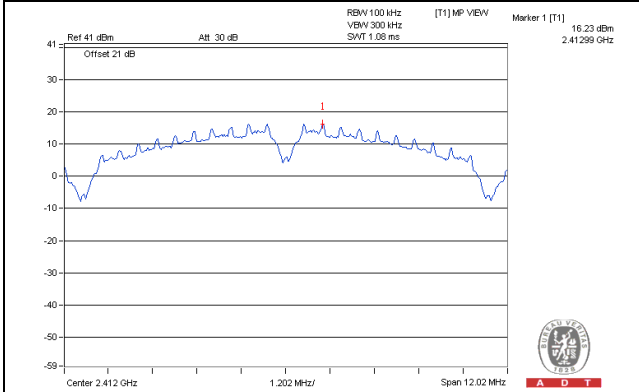

CH 6

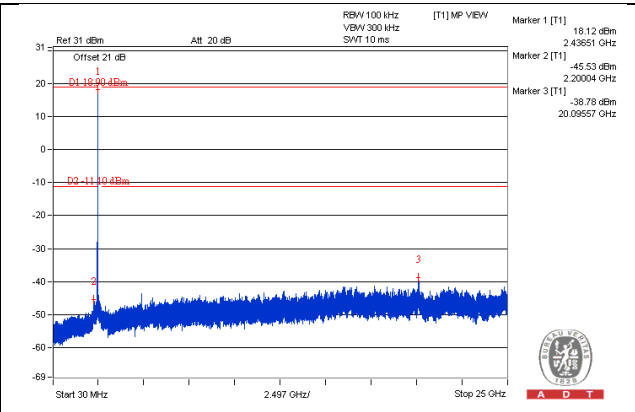
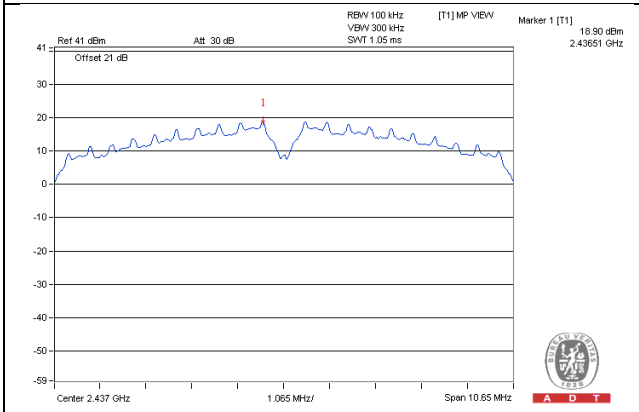

CH 11

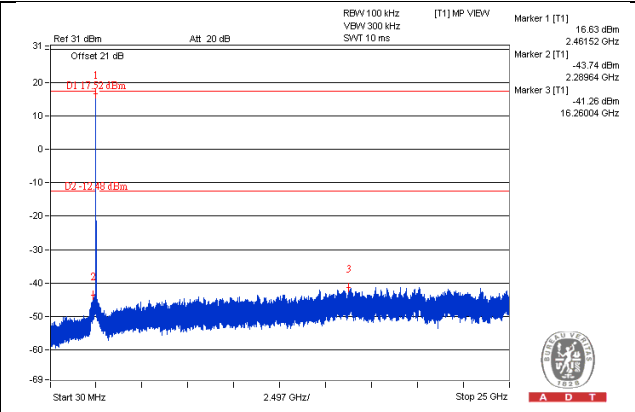
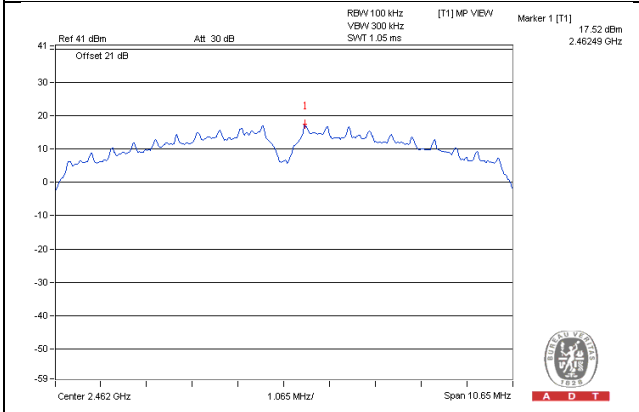

CH 1 Band edge

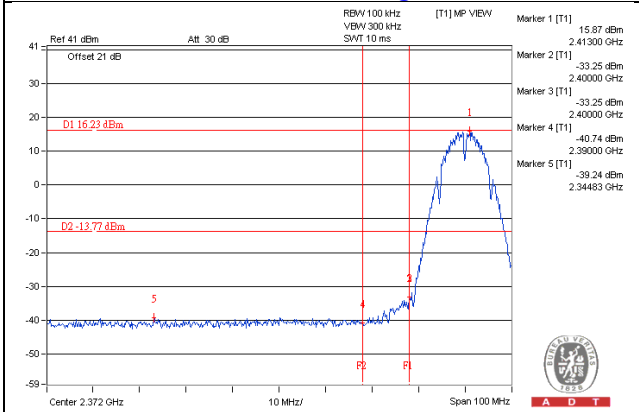

CH 11 Band edge

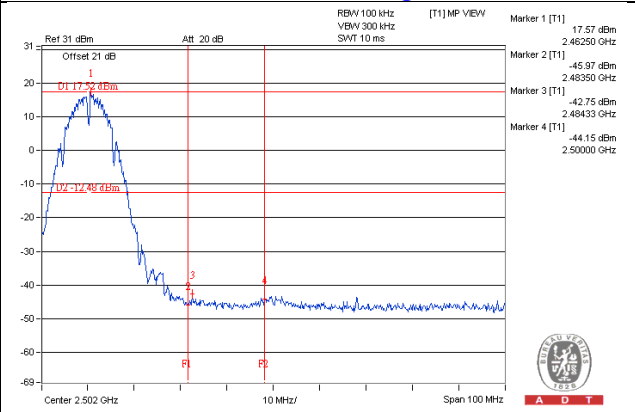

CHAIN 1

CH 1

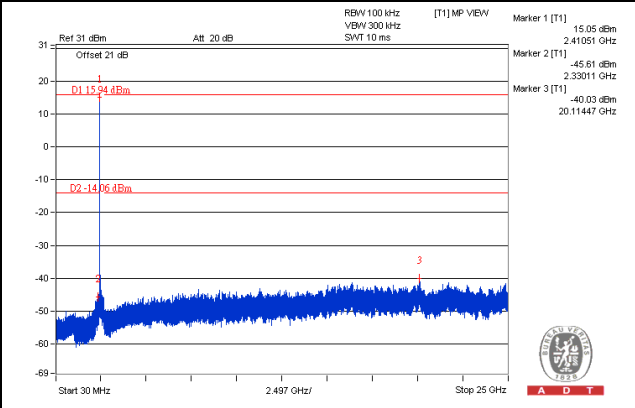
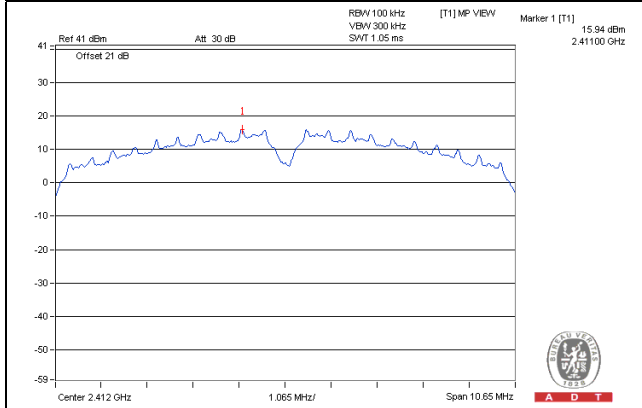

CH 6

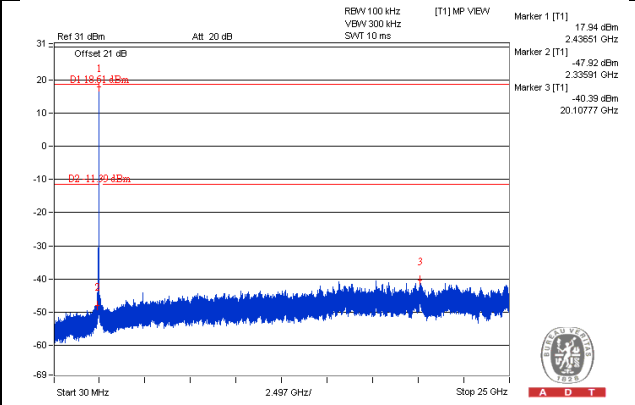
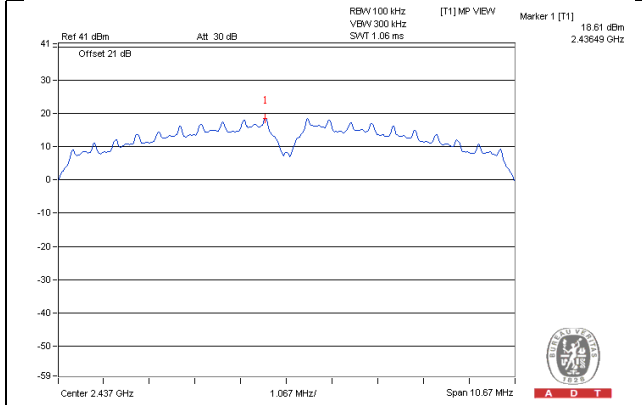

CH 11

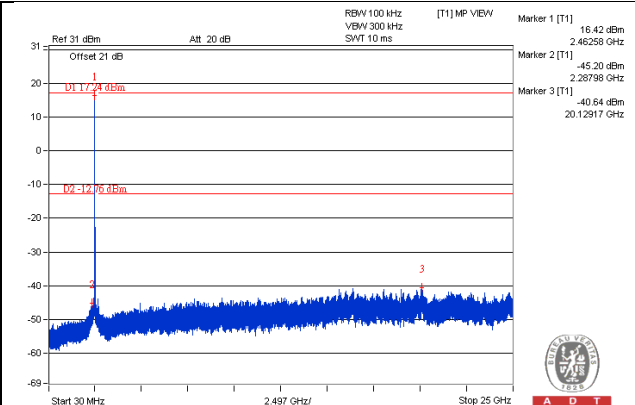
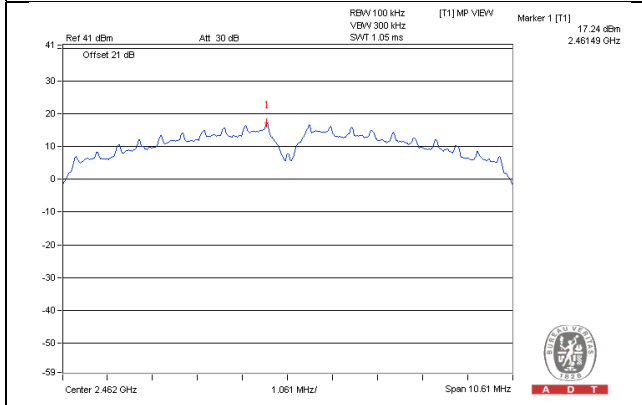

CH 1 Band edge

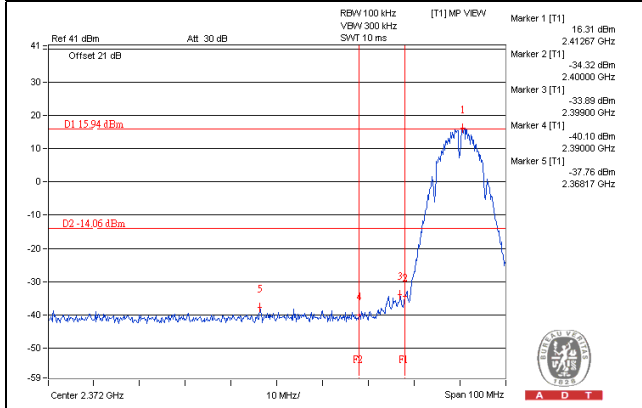

CH 11 Band edge

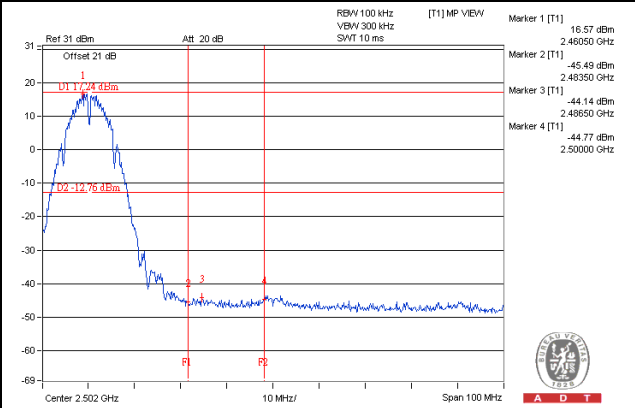

802.11g
CHAIN 0

CH 1

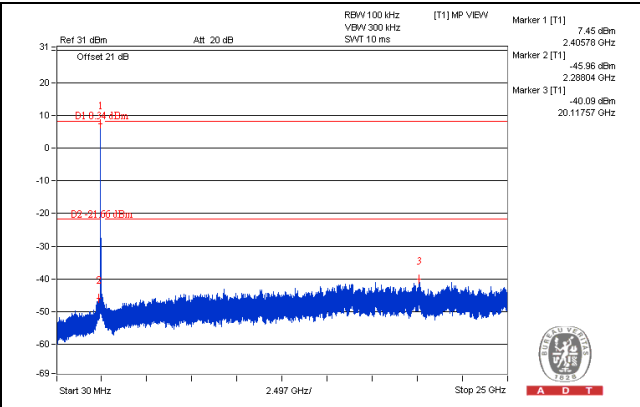
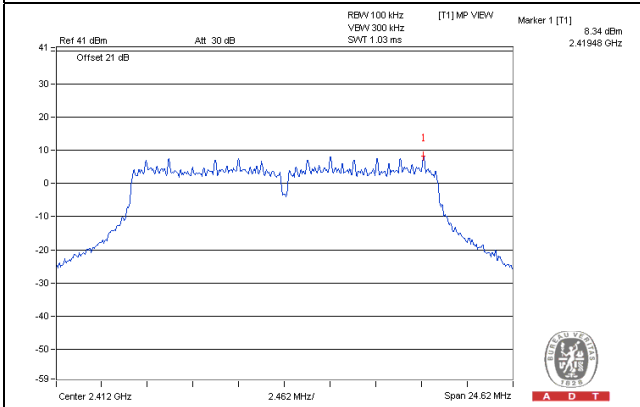

CH 6

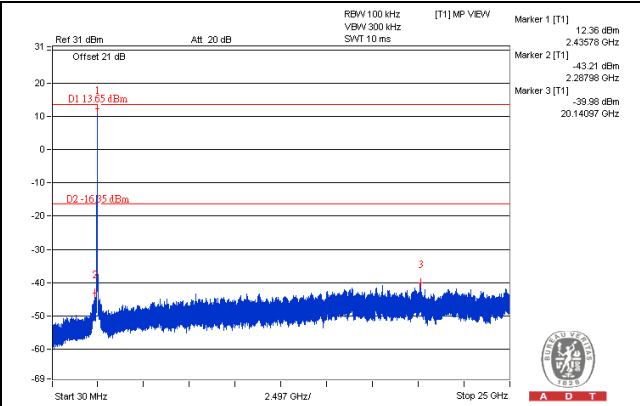
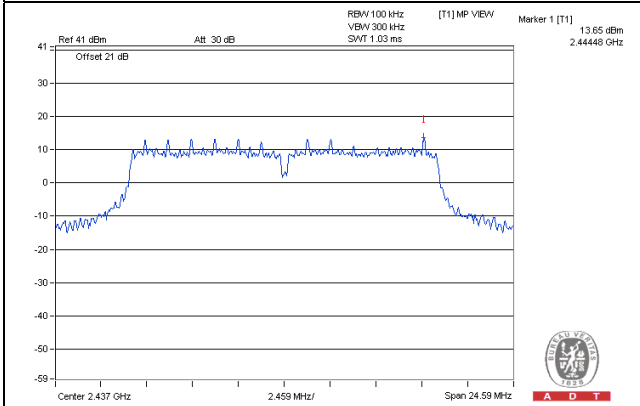

CH 11

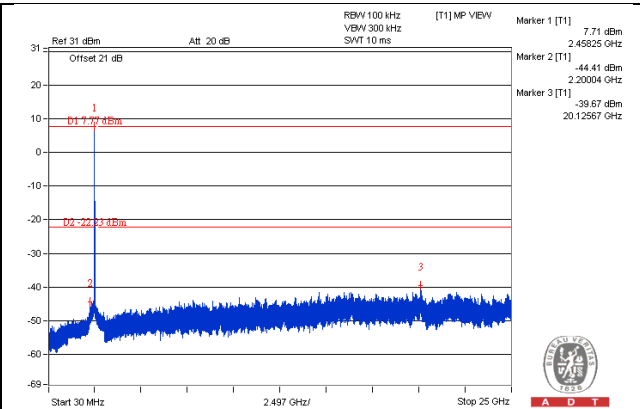
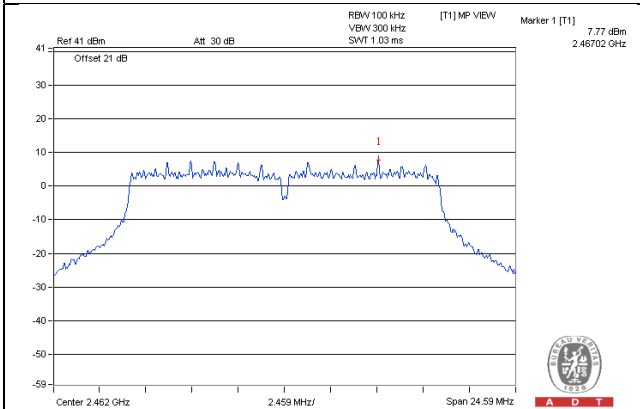

CH 1 Band edge

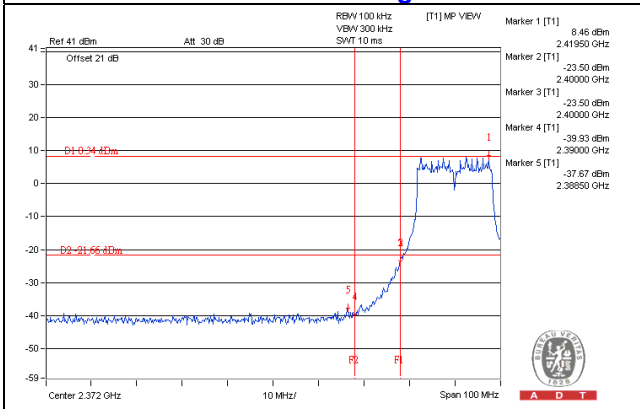

CH 11 Band edge

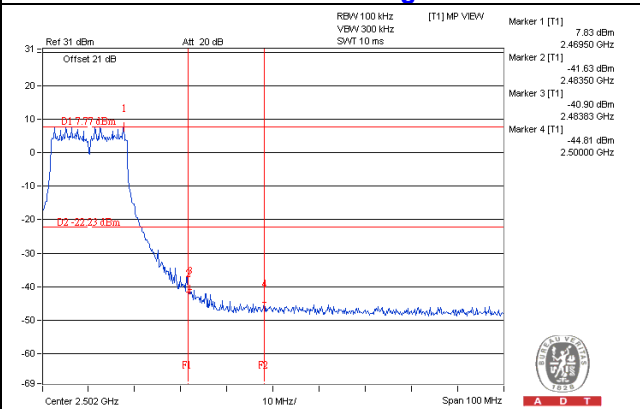

CHAIN 1

CH 1

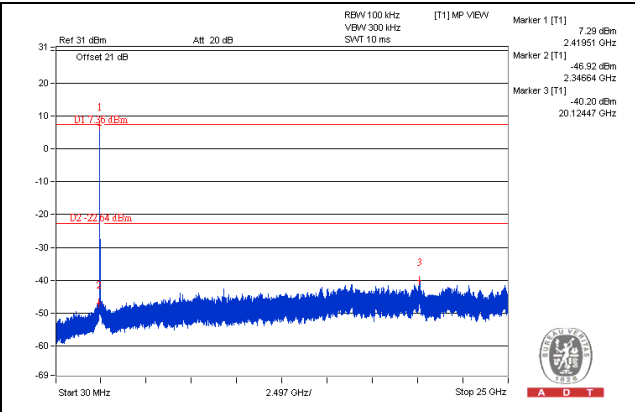
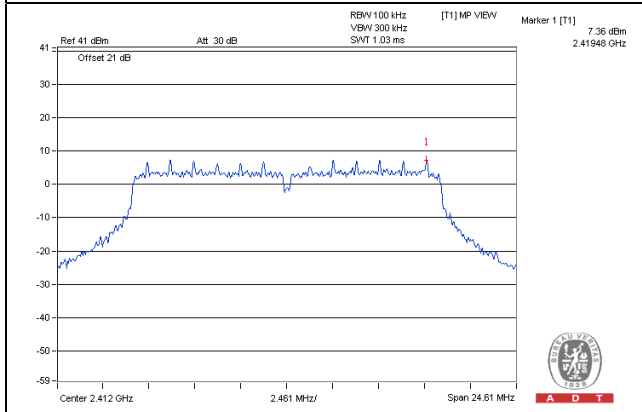

CH 6

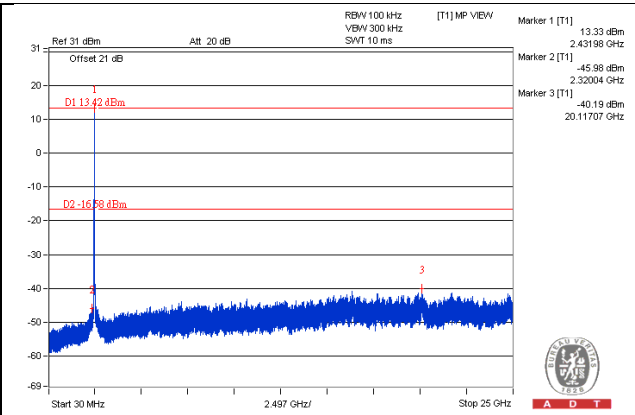
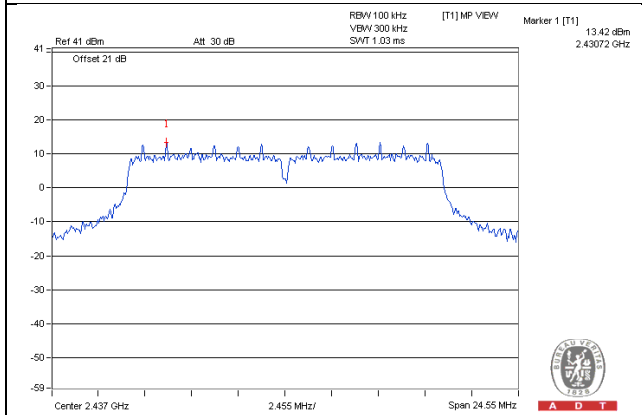

CH 11

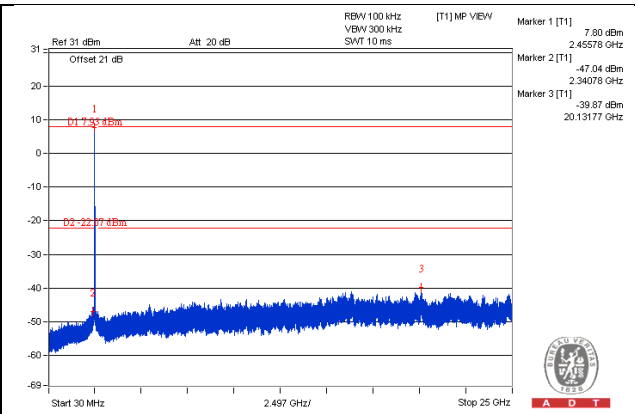
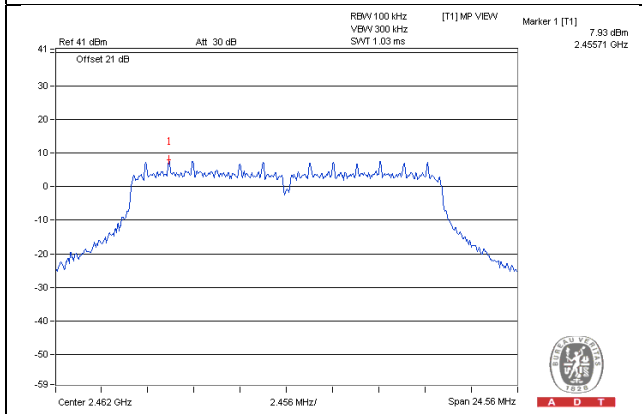

CH 1 Band edge

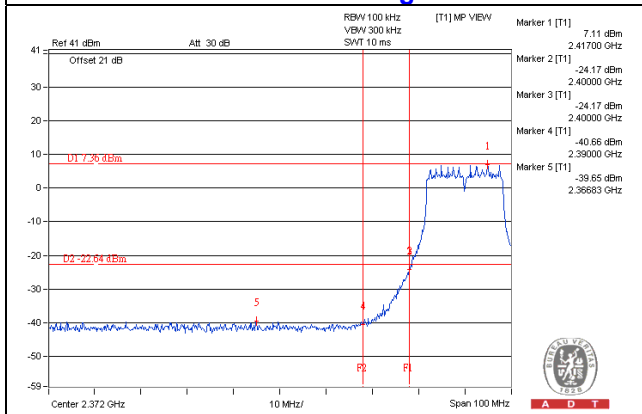

CH 11 Band edge

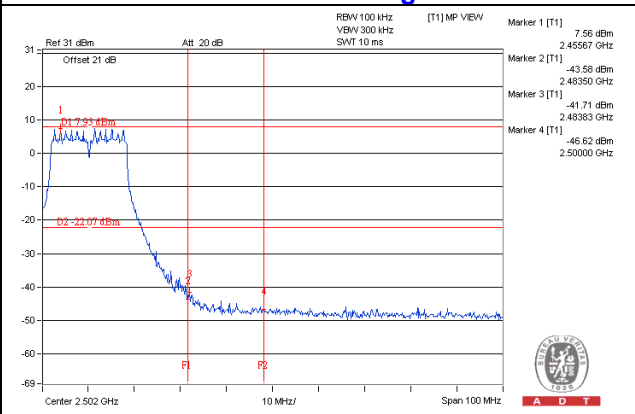

802.11n (HT20)
CHAIN 0

CH 1

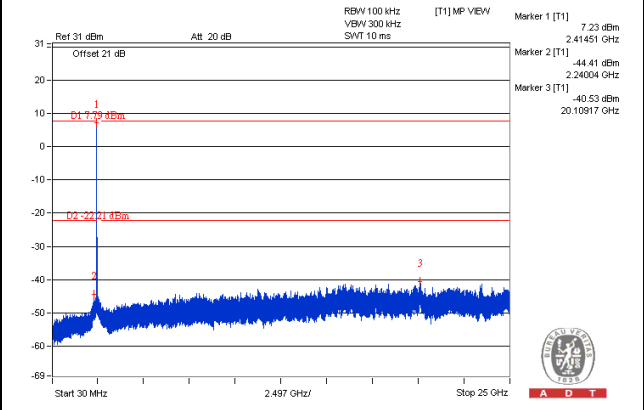
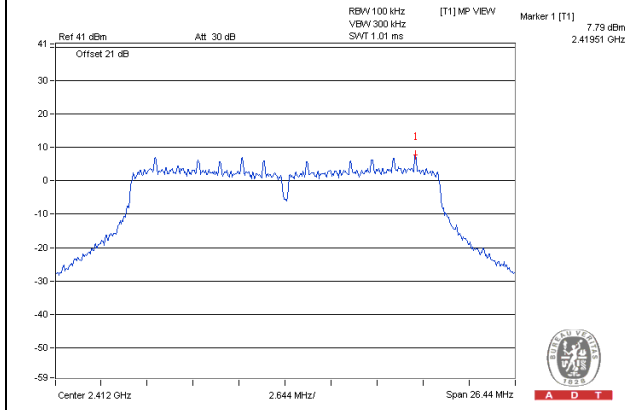

CH 6

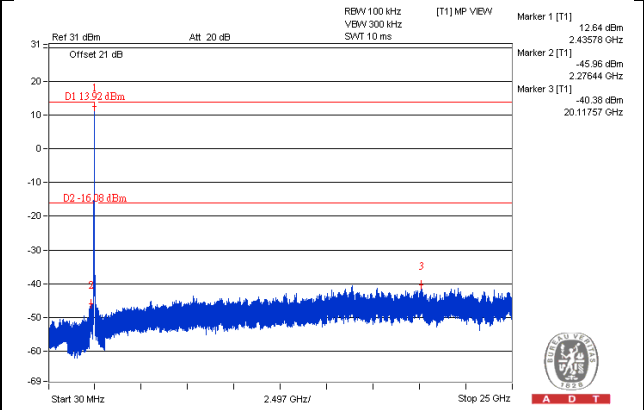
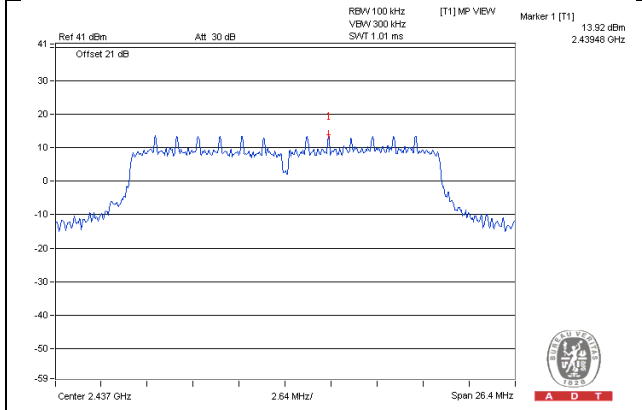

CH 11

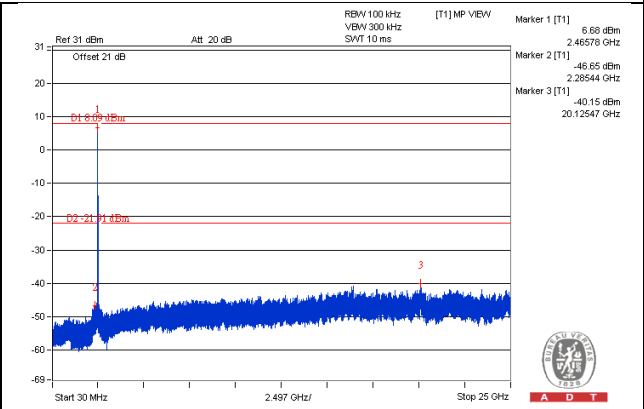
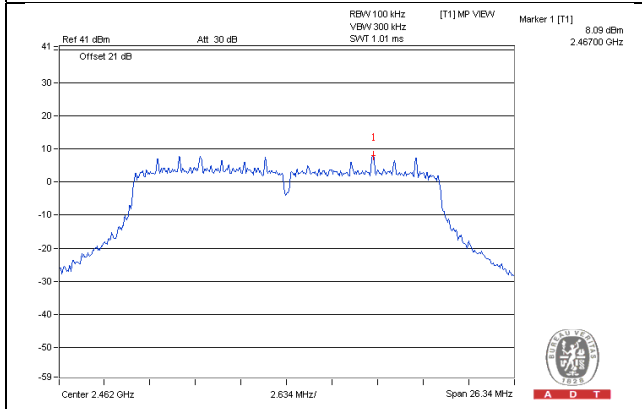

CH 1 Band edge

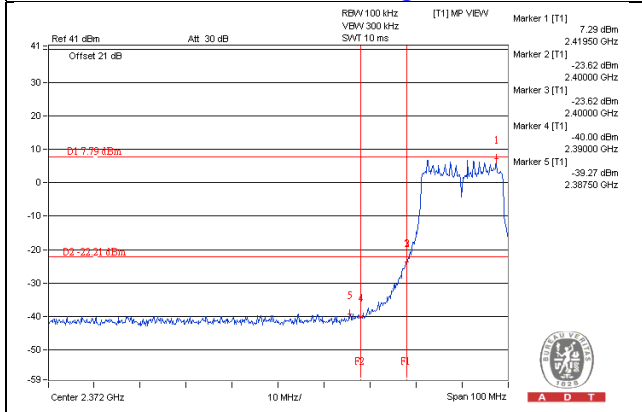

CH 11 Band edge

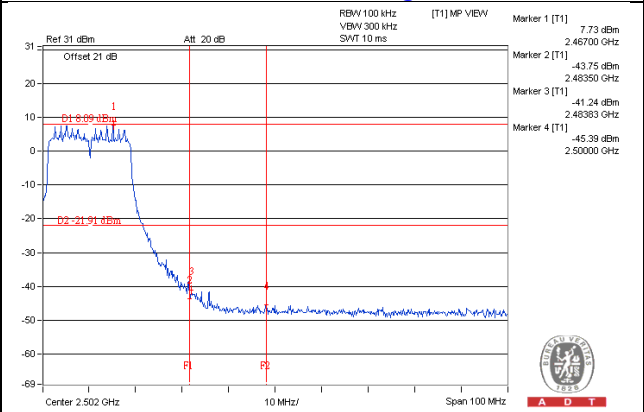

CHAIN 1

CH 1

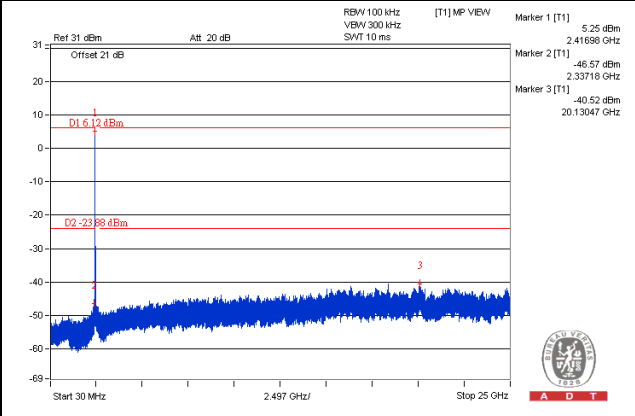
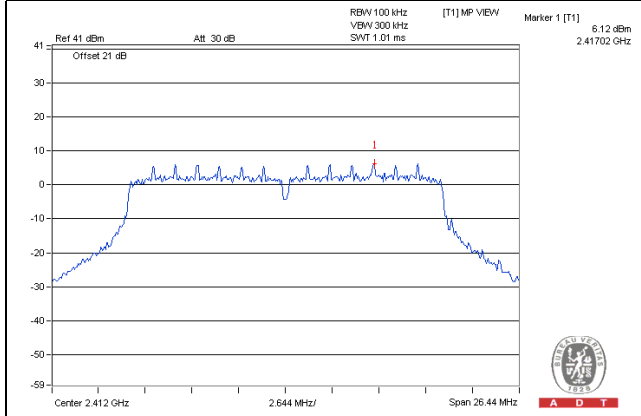

CH 6

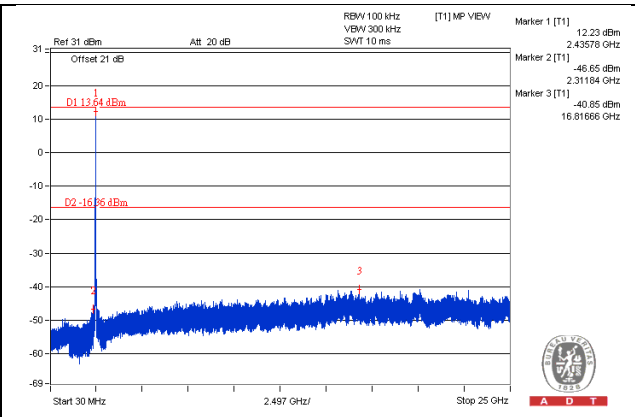
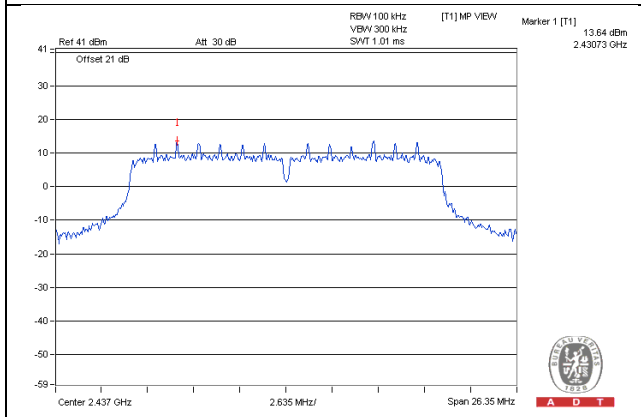

CH 11

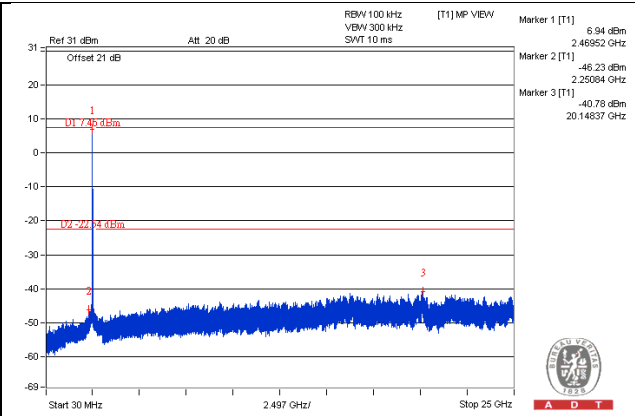
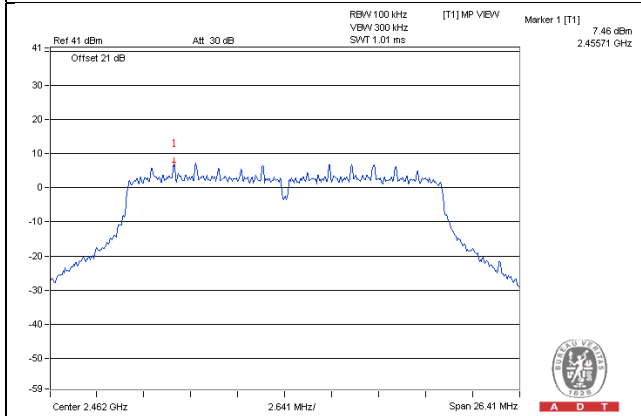

CH 1 Band edge

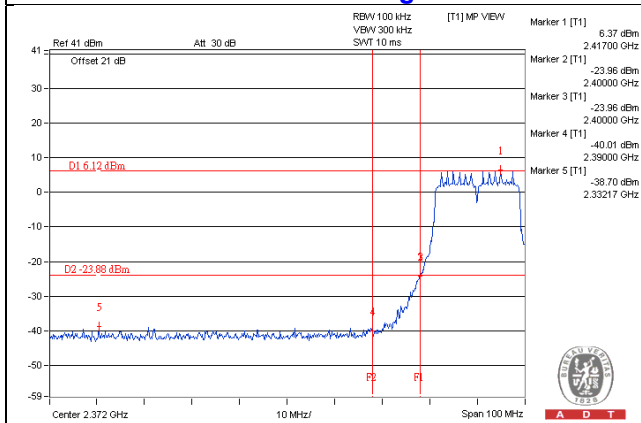

CH 11 Band edge

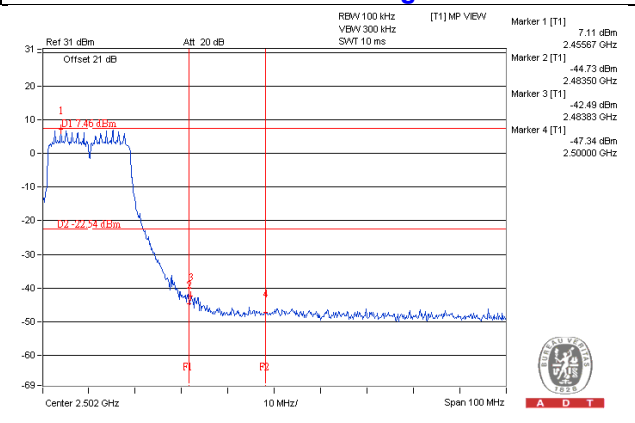

802.11n (HT40)
CHAIN 0

CH 3

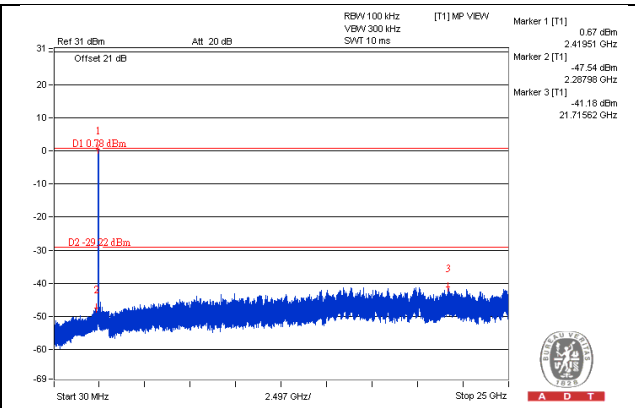
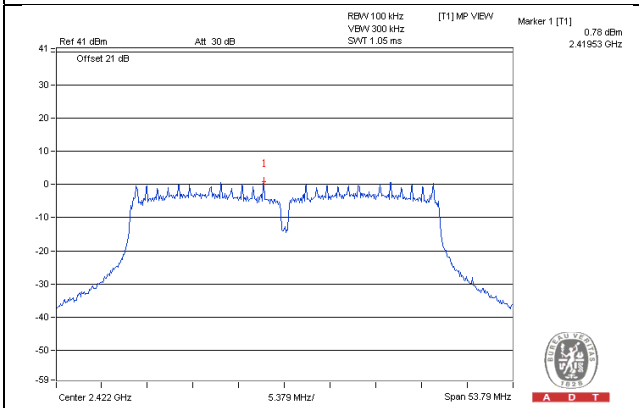

CH 6

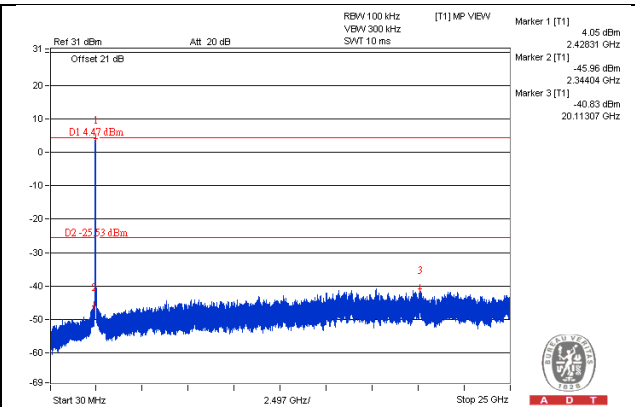
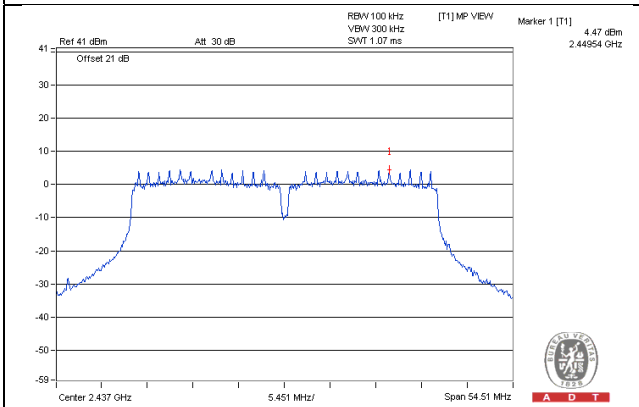

CH 9

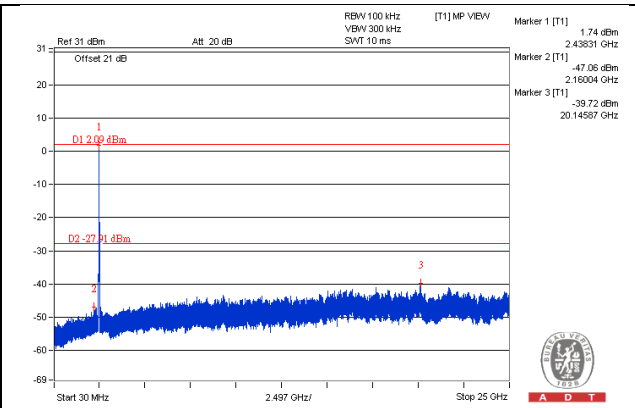
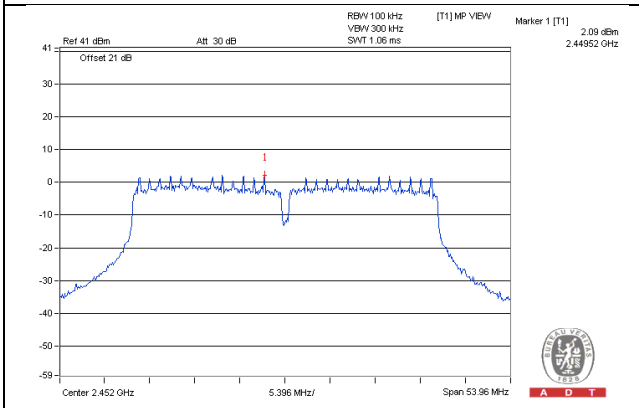

CH 3 Band edge

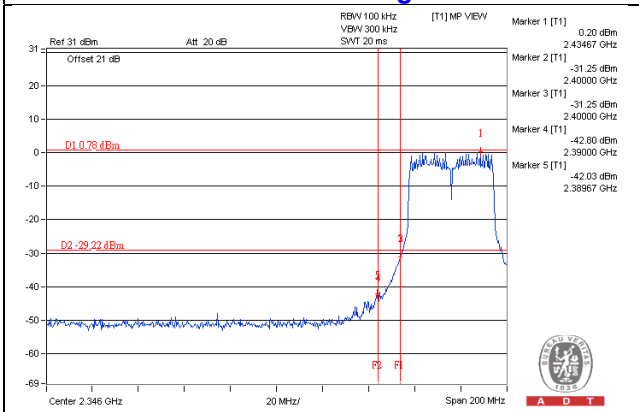

CH 9 Band edge

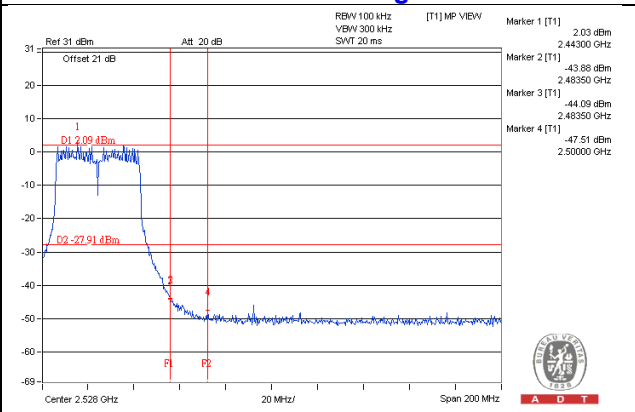

CHAIN 1

CH 3

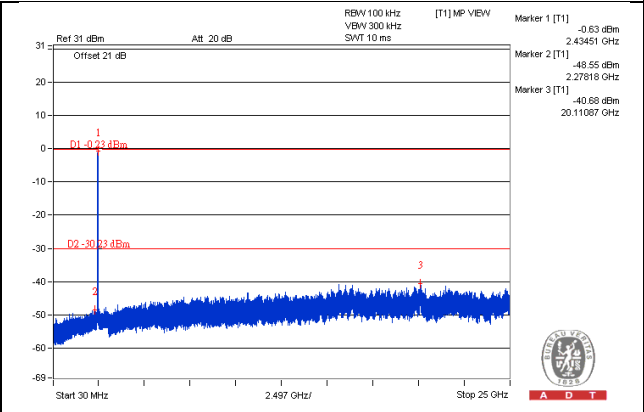
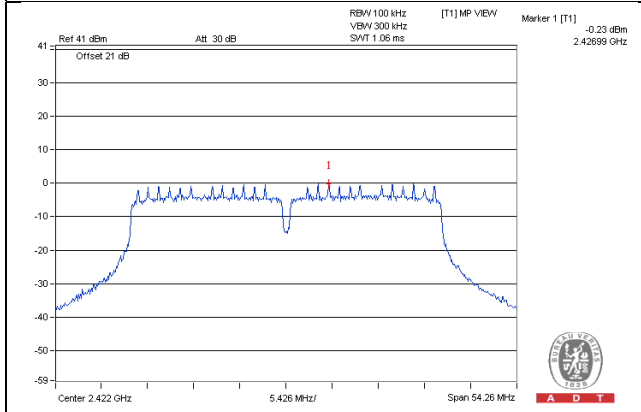

CH 6

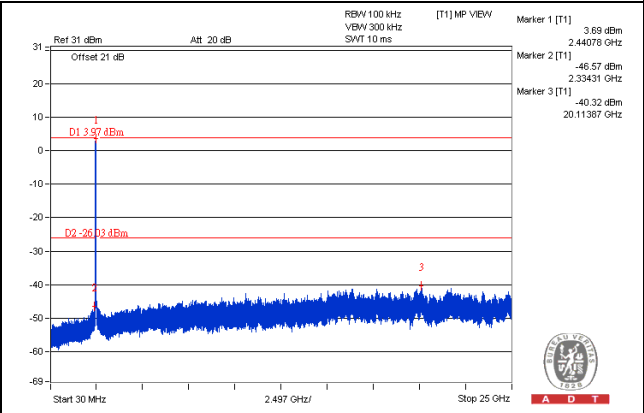
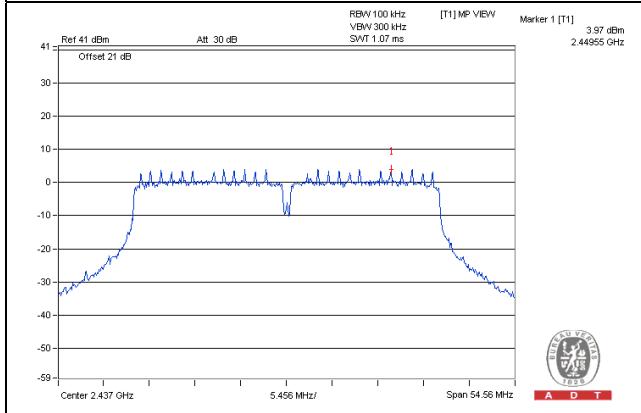

CH 9

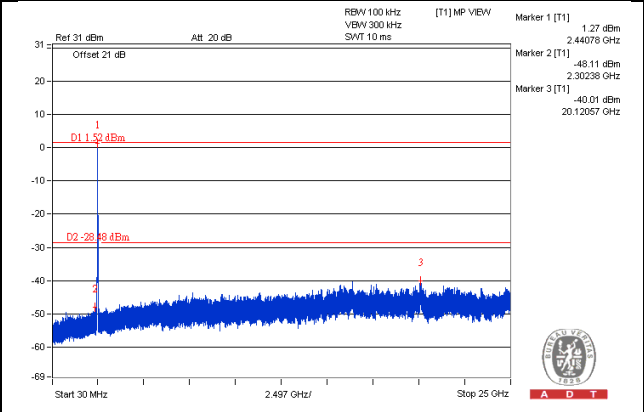
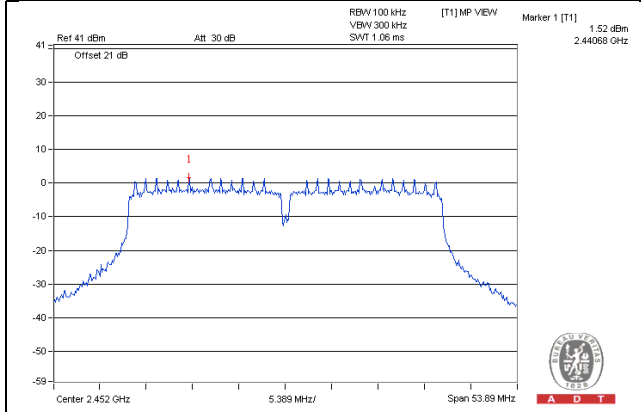

CH 3 Band edge

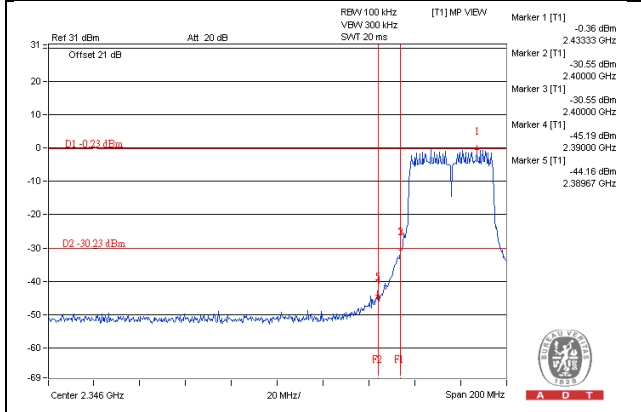

CH 9 Band edge

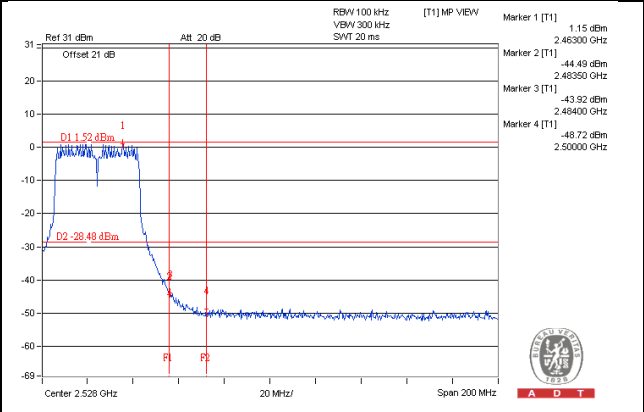

5 Pictures of Test Arrangements

Please refer to the attached file (Test Setup Photo).

Appendix – Information on the Testing Laboratories

We, Bureau Veritas Consumer Products Services (H.K.) Ltd., Taoyuan Branch, were founded in 1988 to provide our best service in EMC, Radio, Telecom and Safety consultation. Our laboratories are accredited and approved according to ISO/IEC 17025.

If you have any comments, please feel free to contact us at the following:

Linko EMC/RF Lab

Tel: 886-2-26052180

Fax: 886-2-26051924

Hsin Chu EMC/RF/Telecom Lab

Tel: 886-3-6668565

Fax: 886-3-6668323

Hwa Ya EMC/RF/Safety Lab

Tel: 886-3-3183232

Fax: 886-3-3270892

Email: service.adt@tw.bureauveritas.com

Web Site: www.bureauveritas-adt.com

The address and road map of all our labs can be found in our web site also.

--- END ---