



REPORT No. : SZ15070092E01

FCC TEST REPORT

APPLICANT : CONVERGENCE SYSTEMS LIMITED
PRODUCT NAME : Intelligent Integrated RFID Reader with 3G/GSM and GPS
MODEL NAME : CS208-3G-2
TRADE NAME : CSL
BRAND NAME : CSL
FCC ID : UB4CS2083G
STANDARD(S) : 47 CFR Part 15 Subpart B
TEST DATE : 2015-10-28 to 2015-11-11
ISSUE DATE : 2015-11-11



SHENZHEN MORLAB COMMUNICATIONS TECHNOLOGY Co., Ltd.

NOTE: This document is issued by MORLAB, the test report shall not be reproduced except in full without prior written permission of the company. The test results apply only to the particular sample(s) tested and to the specific tests carried out which is available on request for validation and information confirmed at our website.

MORLAB GROUP

FL1-3, Building A, FeiYang Science Park, No.8 LongChang Road,
Block67, BaoAn District, ShenZhen , GuangDong Province, P. R. China

Tel: 86-755-36698555 Fax: 86-755-36698525
Http://www.morlab.cn E-mail: service@morlab.cn



DIRECTORY

1. TECHNICAL INFORMATION	5
1.1. APPLICANT INFORMATION	5
1.2. EQUIPMENT UNDER TEST (EUT) DESCRIPTION	5
2. TEST RESULTS	6
2.1. APPLIED REFERENCE DOCUMENTS	6
3. TEST CONDITIONS SETTING	7
3.1. TEST MODE	7
3.2. TEST SETUP AND EQUIPMENTS LIST	8
3.2.1. CONDUCTED EMISSION	8
3.2.2. RADIATED EMISSION	10
4. 47 CFR PART 15B REQUIREMENTS	12
4.1. CONDUCTED EMISSION	12
4.1.1. REQUIREMENT	12
4.1.2. TEST DESCRIPTION	12
4.1.3. TEST RESULT	12
4.2. RADIATED EMISSION	15
4.2.1. REQUIREMENT	15
4.2.2. TEST DESCRIPTION	15
4.2.3. FREQUENCY RANGE OF MEASUREMENT	16
4.2.4. TEST RESULT	16
ANNEX A TEST UNCERTAINTY	19
ANNEX B TESTING LABORATORY INFORMATION	20
1. IDENTIFICATION OF THE RESPONSIBLE TESTING LABORATORY	20
2. IDENTIFICATION OF THE RESPONSIBLE TESTING LOCATION	20



REPORT No. : SZ15070092E01

- 3. ACCREDITATION CERTIFICATE20
- 4. TEST ENVIRONMENT CONDITIONS20

Change History		
Issue	Date	Reason for change
1.0	2015-11-11	First edition



Test Report Declaration

Applicant	CONVERGENCE SYSTEMS LIMITED
Applicant Address	20/F, Chung Nam Building, No.1 Lockhart Road, Wanchai, Hong Kong
Manufacturer	DongGuan DongHongXingYe Electronics Science and Technology Limited
Manufacturer Address	1 Jianxiang Street, Hanxishui, Chashan Town, Dongguan, Guangdong, China
Product Name	Intelligent Integrated RFID Reader with 3G/GSM and GPS
Model Name	CS208-3G-2
Brand Name	CSL
HW Version	Main board (V1.9); GSM board (V4.0); RFID board (V9.0)
SW Version	12.00.006(HE910); 1.5.28(RFID); WinCE6.0(OS)
Test Standards	47 CFR Part 15 Subpart B
Test Result	PASS

Tested by : He Shiling
He Shiling (Test Engineer)

Reviewed by : Xiao Xiong
Xiao Xiong (EMC Manager)

Approved by : Zeng Dexin
Zeng Dexin (Chief Engineer)



1. Technical Information

Note: Provide by applicant.

1.1. Applicant Information

Company: CONVERGENCE SYSTEMS LIMITED
Address: 20/F, Chung Nam Building, No.1 Lockhart Road, Wanchai, Hong Kong

1.2. Equipment under Test (EUT) Description

EUT Type:	Intelligent Integrated RFID Reader with 3G/GSM and GPS
Serial No:	(n.a., marked #1 by test site)
Hardware Version:	Main board (V1.9); GSM board (V4.0); RFID board (V9.0)
Software Version:	12.00.006(HE910); 1.5.28(RFID); WinCE6.0(OS)

Ancillary Equipment:	AC Adapter	
	Brand Name:	Yunsheng
	Model No.:	YS06-120500D
	Serial No.:	(n.a. marked #1 by test site)
	Rated Input:	~ 100-240V, 50/60Hz, 1500mA
	Rated Output:	≡ 12V, 5000mA

NOTE:

1. The EUT is an Intelligent Integrated RFID Reader with 3G/GSM and GPS. It is equipped with an Ethernet port for data transmitting, a USB port which is used for the configuration and firmware upgrading, not for data transferring.
2. For a more detailed description, please refer to Specification or User's Manual supplied by the applicant and/or manufacturer.



2. Test Results

2.1. Applied Reference Documents

The objective of the report is to perform testing according to 47 CFR Part 15 Subpart B:

No.	Identity	Document Title
1	47 CFR Part 15(10-1-13 Edition)	Radio Frequency Devices

Test detailed items/section required by FCC rules and results are as below:

No.	Section	Description	Test Date	Result
1	15.107	Conducted Emission	2015.11.02	PASS
2	15.109	Radiated Emission	2015.11.02	PASS

NOTE: The tests were performed according to the method of measurements prescribed in ANSI C63.4-2014.



3. Test Conditions Setting

3.1. Test Mode

1	<p>The EUT configuration of the emission tests is EUT +Adapter + PC. In this test mode, the EUT was powered by its adapter and turned on. Meanwhile, the EUT was connected to a PC via the Ethernet port. During the measurement, the data was transmitting between the PC and the EUT through the Ethernet port.</p>
---	---

3.2. Test Setup and Equipments List

3.2.1. Conducted Emission

A. Test Setup:

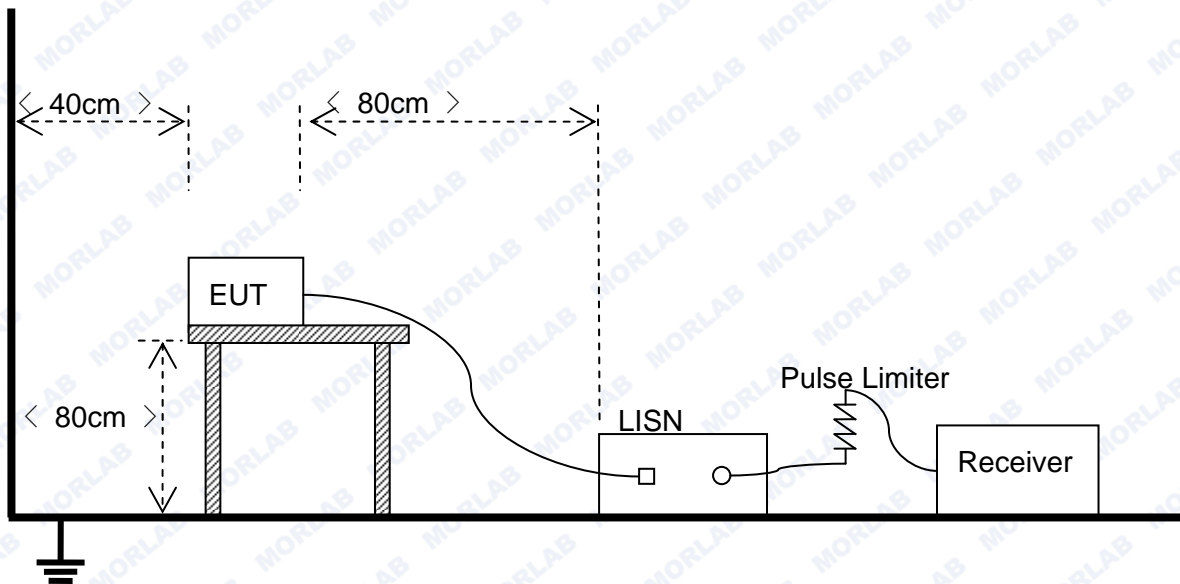

The EUT is placed on a 0.8m high insulating table, which stands on the grounded conducting floor, and keeps 0.4m away from the grounded conducting wall. The EUT is connected to the power mains through a LISN which provides $50\Omega/50\mu\text{H}$ of coupling impedance for the measuring instrument. A Pulse Limiter is used to protect the measuring instrument. The factors of the whole test system are calibrated to correct the reading.

The power strip or extension cord has been investigated to make sure that the LISN integrity is maintained with respect to the impedance characteristics as prescribed in ANSI C63.4-2014 at Clause 4.3.

B. Equipments List:

Description	Manufacturer	Model	Serial No.	Cal. Date	Due. Date
Receiver	Narda	PMM 9010	595WX11007	2015.2.21	2016.2.20
Receiver	Narda	PMM 9060	001WX11001	2015.2.21	2016.2.20
LISN	Schwarzbeck	NSLK 8127	812744	2015.2.24	2016.2.23
Pulse Limiter (20dB)	Schwarzbeck	VTSD 9561-D	9391	(n.a.)	(n.a.)



REPORT No. : SZ15070092E01

Description	Manufacturer	Model	Serial No.	Cal. Date	Due. Date
System Simulator	Agilent	E5515C	GB43130131	2015.2.21	2016.2.20
PC	Lenovo	ThinkPadT61	ZZF3077	(n.a.)	(n.a.)

3.2.2. Radiated Emission

A. Test Setup:

1. For radiated emissions from 30MHz to1GHz

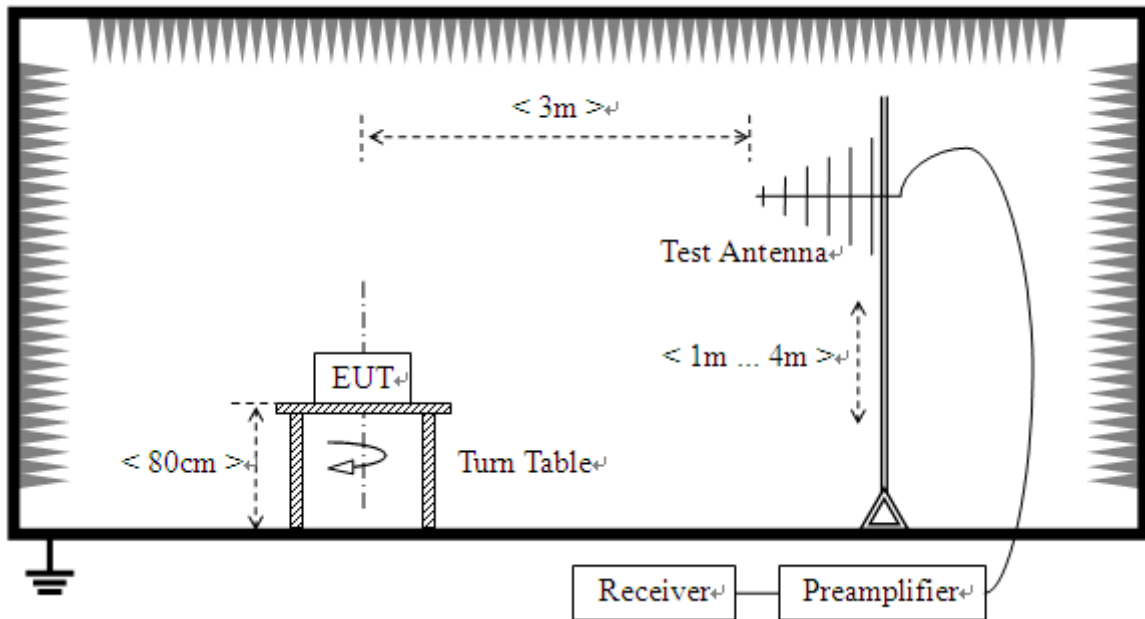

2. For radiated emissions above 1GHz

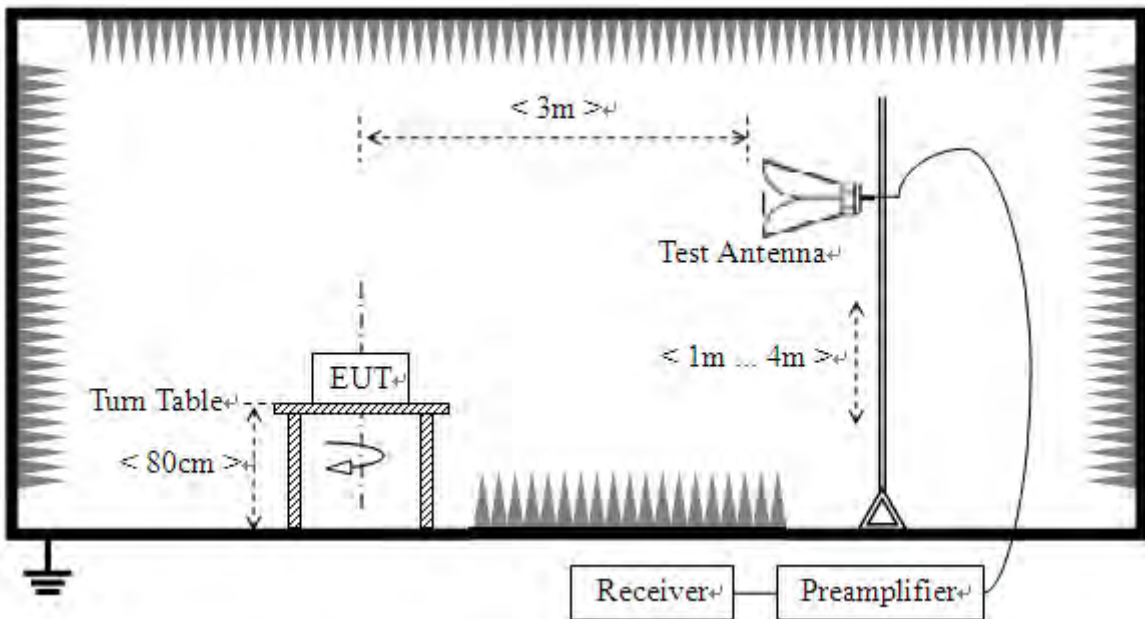



The test is performed in a 3m Semi-Anechoic Chamber; the antenna factor, cable loss and so on of the site (factors) is calculated to correct the reading. The EUT is placed on a 0.8m high insulating Turn Table, and keeps 3m away from the Test Antenna, which is mounted on a variable-height antenna master tower.

For the test Antenna:

In the frequency range above 30MHz, Bi-Log Test Antenna (30MHz to 1GHz) and Horn Test Antenna (above 1GHz) are used. Test Antenna is 3m away from the EUT. Test Antenna height is varied from 1m to 4m above the ground to determine the maximum value of the field strength. The emission levels at both horizontal and vertical polarizations should be tested.

B. Equipments List:

Description	Manufacturer	Model	Serial No.	Cal. Date	Due. Date
MXE EMI Receiver	Agilent	N9038A	MY54130016	2015.2.21	2016.2.20
Semi-Anechoic Chamber	Albatross	9m*6m*6m	(n.a.)	2015.2.21	2016.2.20
Test Antenna - Bi-Log	Schwarzbeck	VULB 9163	9163-274	2015.2.25	2016.2.24
Test Antenna - Horn	Schwarzbeck	BBHA 9120D	9120D-963	2015.2.25	2016.2.24
PC	Lenovo	ThinkPadT61	ZZF3077	(n.a.)	(n.a.)



4. 47 CFR Part 15B Requirements

4.1. Conducted Emission

4.1.1. Requirement

According to FCC section 15.107, the radio frequency voltage that is conducted back onto the AC power line on any frequency within the band 150kHz to 30MHz shall not exceed the limits in the following table, as measured using a 50 μ H/50 Ω line impedance stabilization network (LISN).

Frequency range (MHz)	Conducted Limit (dB μ V)	
	Quasi-peak	Average
0.15 - 0.50	66 to 56	56 to 46
0.50 - 5	56	46
5 - 30	60	50

NOTE:

- The limit subjects to the Class B digital device.
- The lower limit shall apply at the band edges.
- The limit decreases linearly with the logarithm of the frequency in the range 0.15 - 0.50MHz.

4.1.2. Test Description

See section 3.2.1 of this report.

4.1.3. Test Result

The maximum conducted interference is searched using Peak (PK), Quasi-peak (QP) and Average (AV) detectors; the emission levels more than the AV and QP limits, and that have narrow margins from the AV and QP limits will be re-measured with AV and QP detectors. Tests for both L phase and N phase lines of the power mains connected to the EUT are performed. All test modes are considered, refer to recorded points and plots below.

A. Test Plot and Suspicious Points:

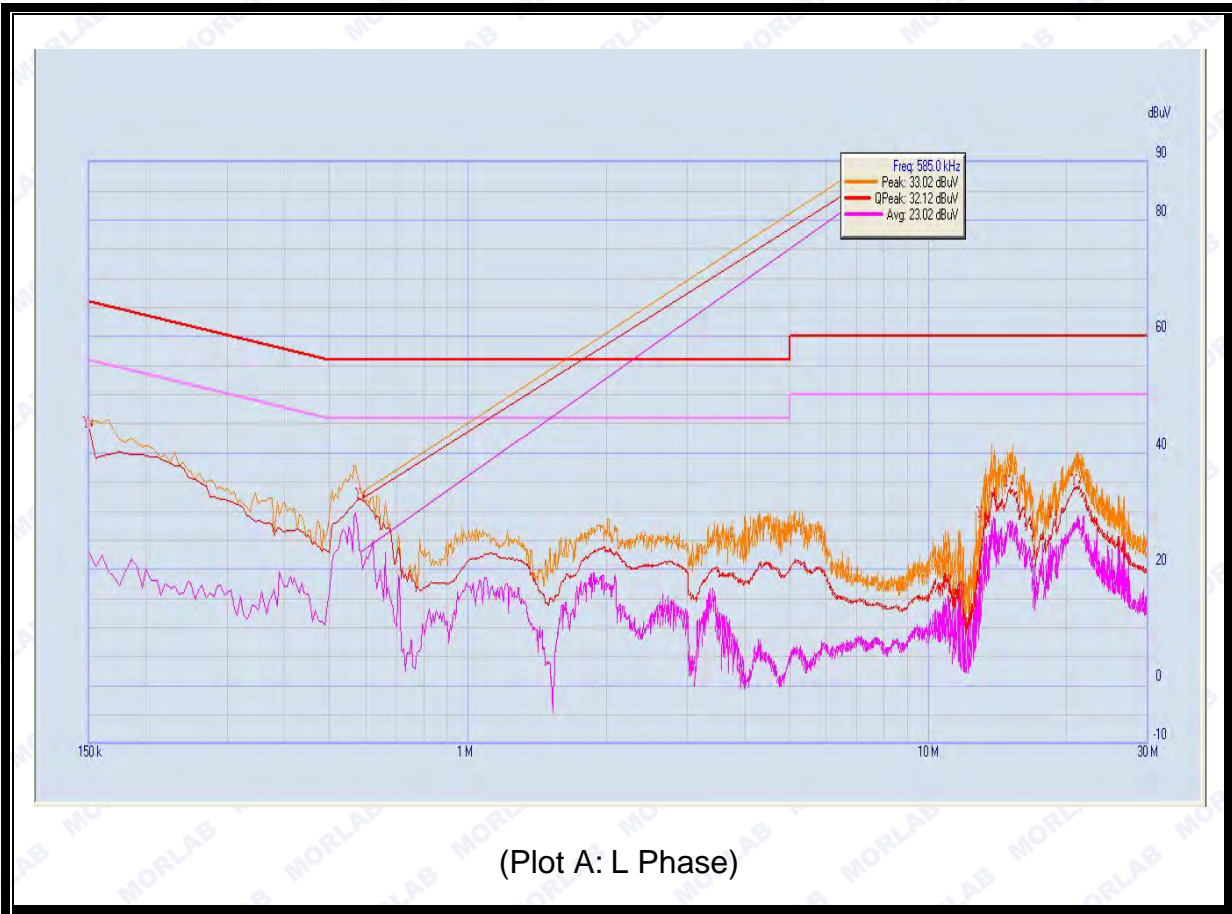

NO.	Fre. (MHz)	Emission Level (dBμV)		Limit (dBμV)		Power-line	Verdict
		Quai-peak	Average	Quai-peak	Average		
1	0.15	44.36	23.00	66.00	56.00	Line	PASS
2	0.585	32.12	23.02	56.00	46.00		PASS
3	13.145	27.87	21.37	60.00	50.00		PASS
4	14.995	33.71	26.76	60.00	50.00		PASS
5	18.715	28.38	22.58	60.00	50.00		PASS
6	21.025	33.91	27.39	60.00	50.00		PASS

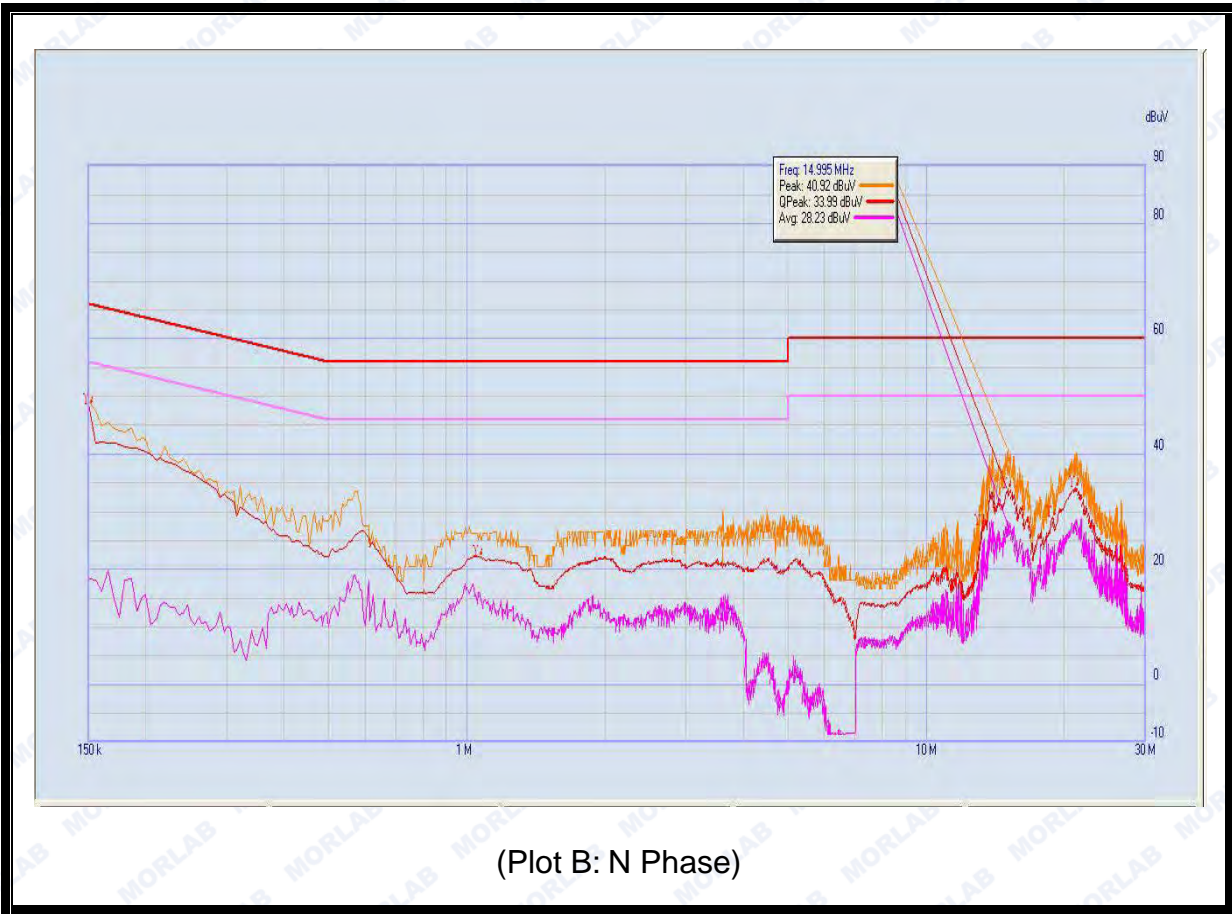

NO.	Fre. (MHz)	Emission Level (dBμV)		Limit (dBμV)		Power-line	Verdict
		Quai-peak	Average	Quai-peak	Average		
1	0.15	48.51	18.23	66.00	56.00	Neutral	PASS
2	1.06	22.28	16.02	56.00	46.00		PASS
3	13.14	26.65	21.50	60.00	50.00		PASS
4	14.995	33.99	28.23	60.00	50.00		PASS
5	18.835	28.00	20.58	60.00	50.00		PASS
6	21.055	33.72	27.92	60.00	50.00		PASS

Test Result: PASS



4.2. Radiated Emission

4.2.1. Requirement

According to FCC section 15.109(a), the field strength of radiated emissions from unintentional radiators at a distance of 3 meters shall not exceed the following values:

Frequency range (MHz)	Field Strength Limitation at 3m Measurement Dist	
	($\mu\text{V/m}$)	($\text{dB}\mu\text{V/m}$)
30.0 - 88.0	100	20log 100
88.0 - 216.0	150	20log 150
216.0 - 960.0	200	20log 200
Above 960.0	500	20log 500

As shown in FCC section 15.35(b), for frequencies above 1000MHz, the field strength limits are based on average detector. When average radiated emission measurements are specified in this part, including emission measurements below 1000MHz, there also is a limit on the radio frequency emissions, as measured using instrumentation with a peak detector function, corresponding to 20dB above the maximum permitted average limit for the frequency being investigated unless a different peak emission limit is otherwise specified in the rules.

Note:

- 1) The tighter limit shall apply at the boundary between two frequency range.
- 2) Limitation expressed in $\text{dB}\mu\text{V/m}$ is calculated by $20\log$ Emission Level($\mu\text{V/m}$).
- 3) If measurement is made at 3m distance, then F.S Limitation at 3m distance is adjusted by using the formula of $L_{d1} = L_{d2} * (d_2/d_1)^2$.

Example:

F.S Limit at 30m distance is $30\mu\text{V/m}$, then F.S Limitation at 3m distance is adjusted as

$$L_{d1} = L_1 = 30\mu\text{V/m} * (10)^2 = 100 * 30\mu\text{V/m}$$

4.2.2. Test Description

See section 3.2.2 of this report.



4.2.3. Frequency range of measurement

Highest frequency generated or used in the device is the highest speed of the processor, lowest frequency generated or used in the device is the lowest frequency of the oscillator. According to 15.33(b)(1), the frequency range of radiated measurement for the EUT is listed in the following table:

Frequency	Frequency generated or used in the device	Frequency range of radiated measurement in the report
Highest	532MHz	5GHz

4.2.4. Test Result

The maximum radiated emission is searched using PK, QP and AV detectors; the emission levels more than the limits, and that have narrow margins from the limits will be re-measured with AV and QP detectors. Both the vertical and the horizontal polarizations of the Test Antenna are considered to perform the tests. All test modes are considered, refer to recorded points and plots below.

The amplitude of spurious emissions which are attenuated more than 20 dB below the permissible value need not be reported.

Note: All radiated emission tests were performed in X, Y, Z axis direction, and only the worst axis test condition was recorded in this test report.

A. Test Plots and Suspicious Points:

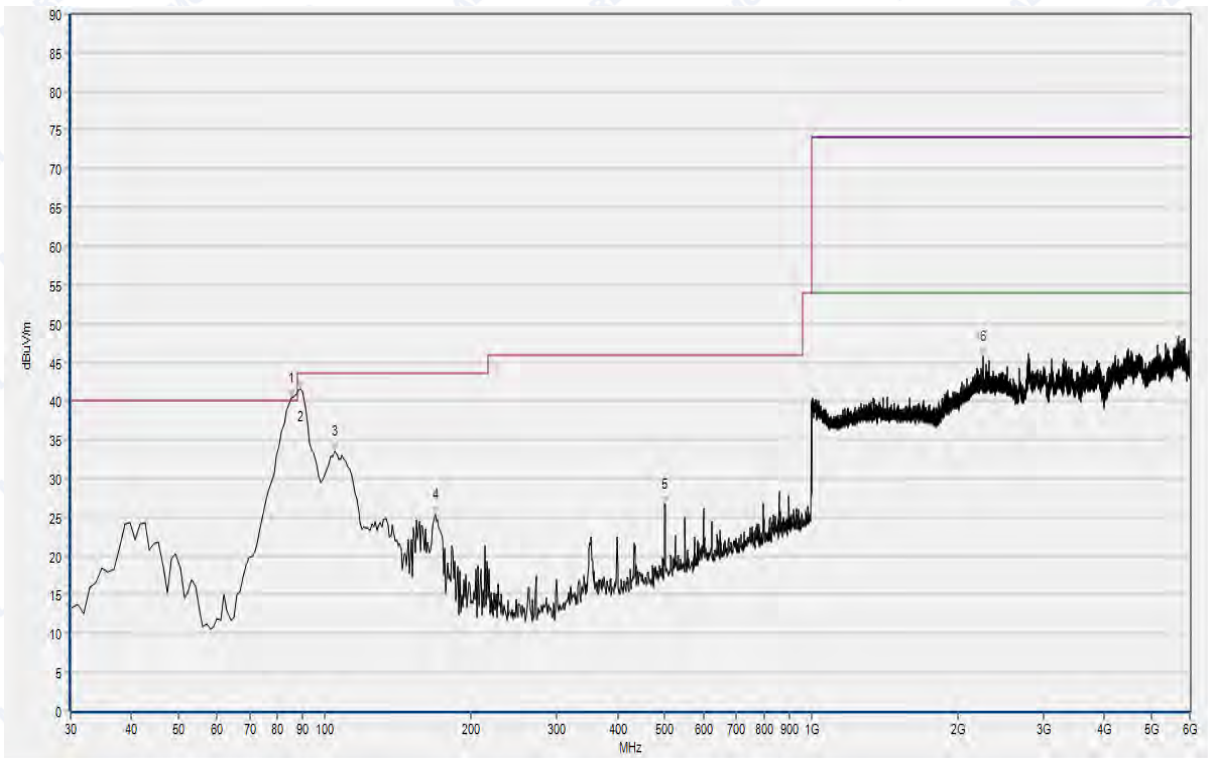

(Plot A: 30MHz – 6GHz, Test Antenna Vertical)

No.	Fre. MHz	Pk dBµV/m	QP dBµV/m	AV dBµV/m	Limit-PK dBµV/m	Limit-QP dBµV/m	Limit-AV dBµV/m	ANT	Verdict
1	85.290	N.A	37.23	N.A	N.A	40.00	N.A	V	Pass
2	89.170	N.A	38.10	N.A	N.A	43.50	N.A	V	Pass
3	104.690	N.A	33.48	N.A	N.A	43.50	N.A	V	Pass
4	168.710	N.A	25.30	N.A	N.A	43.50	N.A	V	Pass
5	499.480	N.A	26.58	N.A	N.A	46.00	N.A	V	Pass
6	2253.867	45.84	N.A	36.18	74.0	N.A	54.0	V	Pass

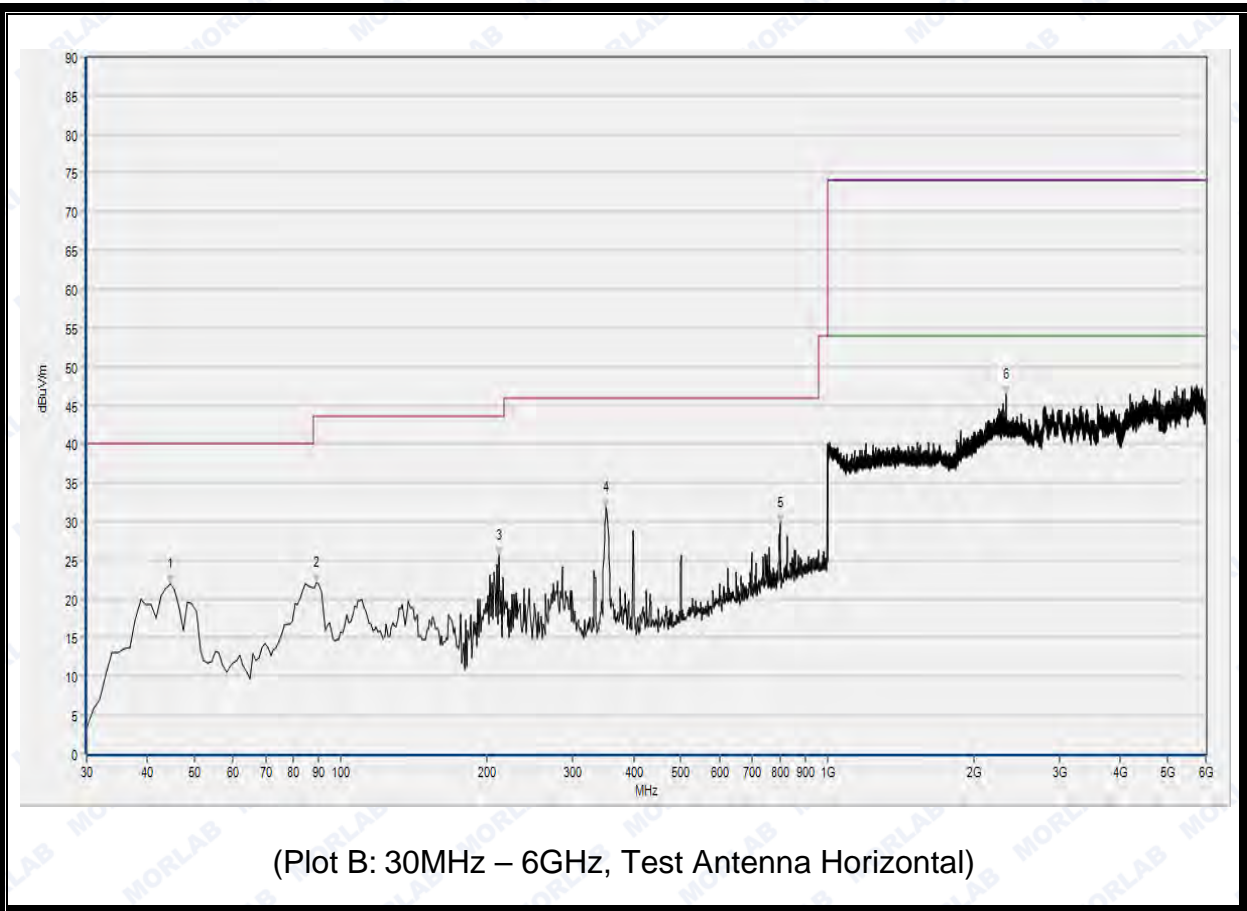

No.	Fre. MHz	Pk dBµV/m	QP dBµV/m	AV dBµV/m	Limit-PK dBµV/m	Limit-QP dBµV/m	Limit-AV dBµV/m	ANT	Verdict
1	44.550	N.A	22.00	N.A	N.A	40.00	N.A	H	Pass
2	89.170	N.A	22.06	N.A	N.A	43.50	N.A	H	Pass
3	211.390	N.A	25.57	N.A	N.A	43.50	N.A	H	Pass
4	351.070	N.A	31.87	N.A	N.A	46.00	N.A	H	Pass
5	799.210	N.A	29.81	N.A	N.A	46.00	N.A	H	Pass
6	2336.00	46.49	N.A	34.93	74.0	N.A	54.0	H	Pass

Test Result: PASS



Annex A Test Uncertainty

The uncertainty is calculated using the methods suggested in the "Guide to the Expression of Uncertainty in Measurement" (GUM) published by ISO.

Uncertainty of Conducted Emission:	$\pm 1.8\text{dB}$
Uncertainty of Radiated Emission:	$\pm 3.1\text{dB}$



Annex B Testing Laboratory Information

1. Identification of the Responsible Testing Laboratory

Company Name:	Shenzhen Morlab Communications Technology Co., Ltd.
Department:	Morlab Laboratory
Address:	FL.3, Building A, FeiYang Science Park, No.8 LongChang Road, Block 67, BaoAn District, ShenZhen, GuangDong Province, P. R. China
Responsible Test Lab Manager:	Mr. Su Feng
Telephone:	+86 755 36698555
Facsimile:	+86 755 36698525

2. Identification of the Responsible Testing Location

Name:	Shenzhen Morlab Communications Technology Co., Ltd. Morlab Laboratory
Address:	FL.3, Building A, FeiYang Science Park, No.8 LongChang Road, Block 67, BaoAn District, ShenZhen, GuangDong Province, P. R. China

3. Accreditation Certificate

Accredited Testing Laboratory: The FCC registration number is 695796.
(Shenzhen Morlab Communications Technology Co., Ltd.)

4. Test Environment Conditions

During the measurement, the environmental conditions were within the listed ranges:

Temperature (°C):	15 - 35
Relative Humidity (%):	30 - 60
Atmospheric Pressure (kPa):	86 - 106

***** END OF REPORT *****