

Convergence Systems Limited

Model: CS203X-2

Product Label Position

Note: Dimension in mm.

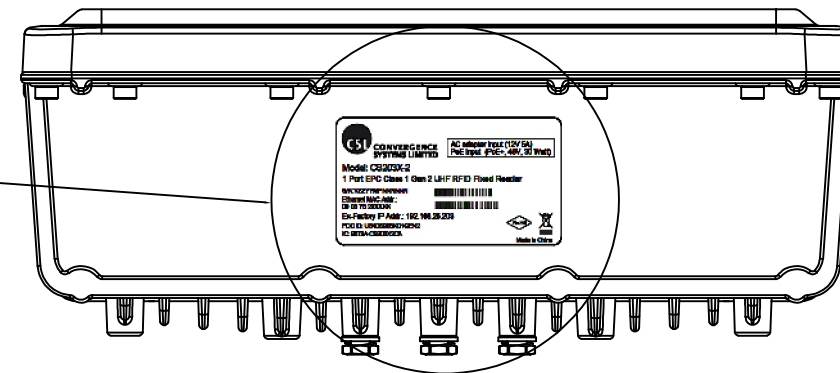
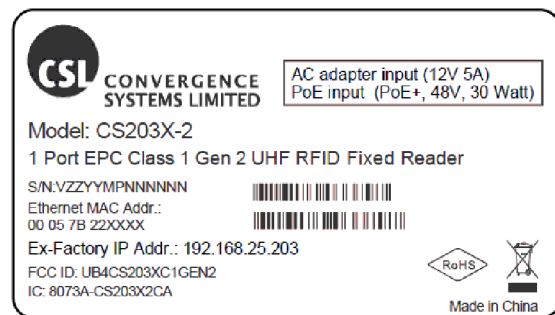
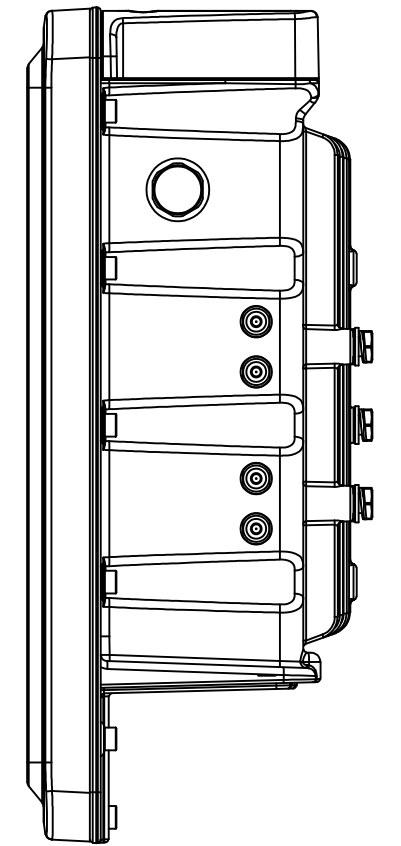
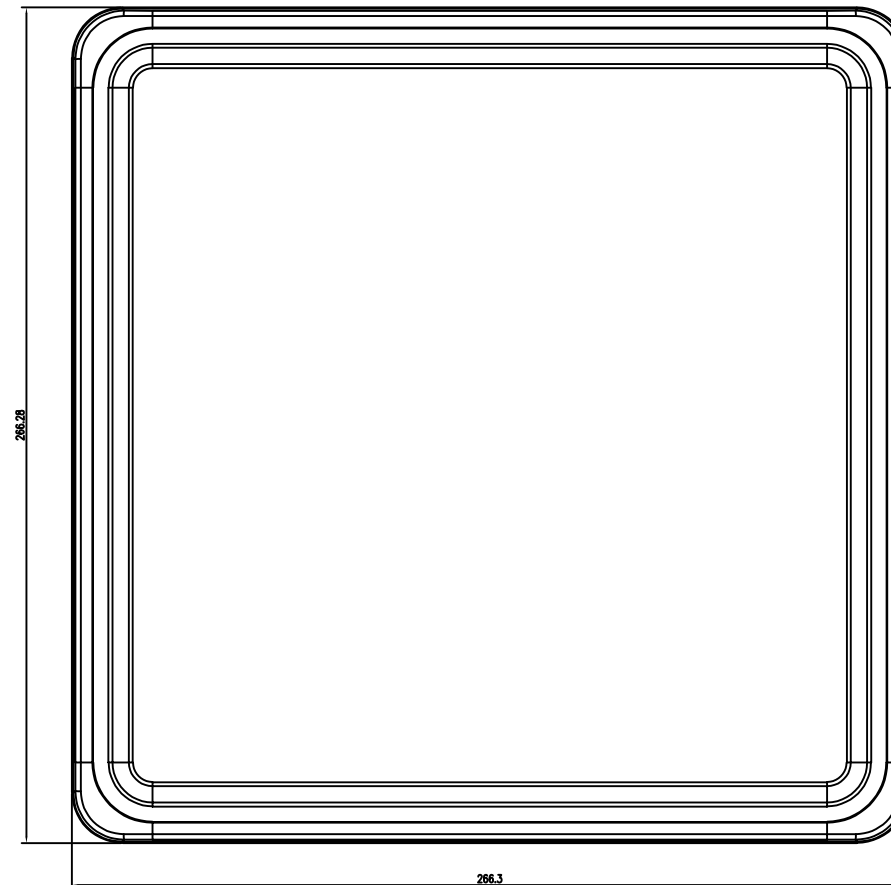
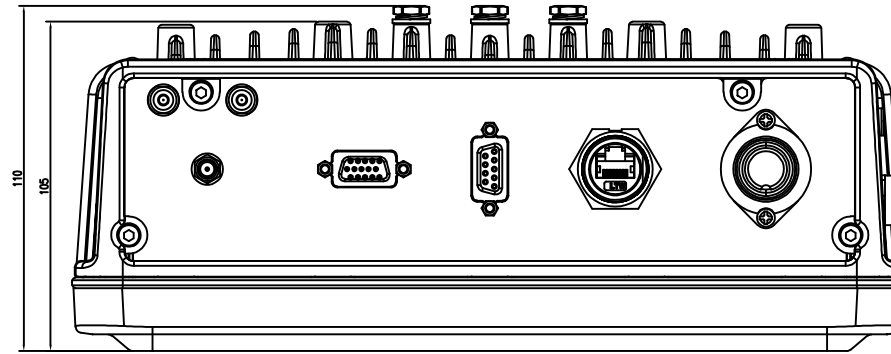
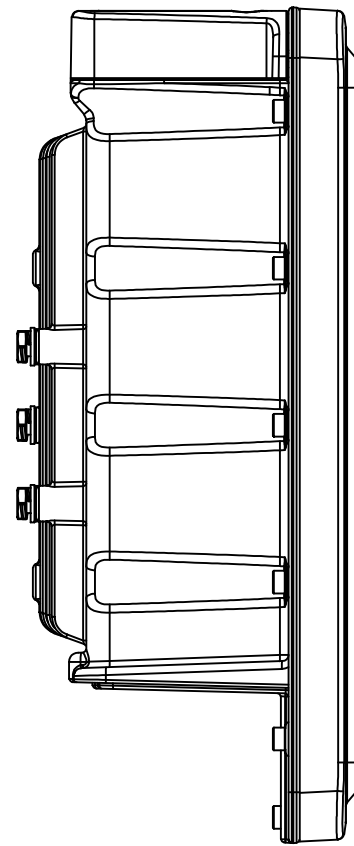
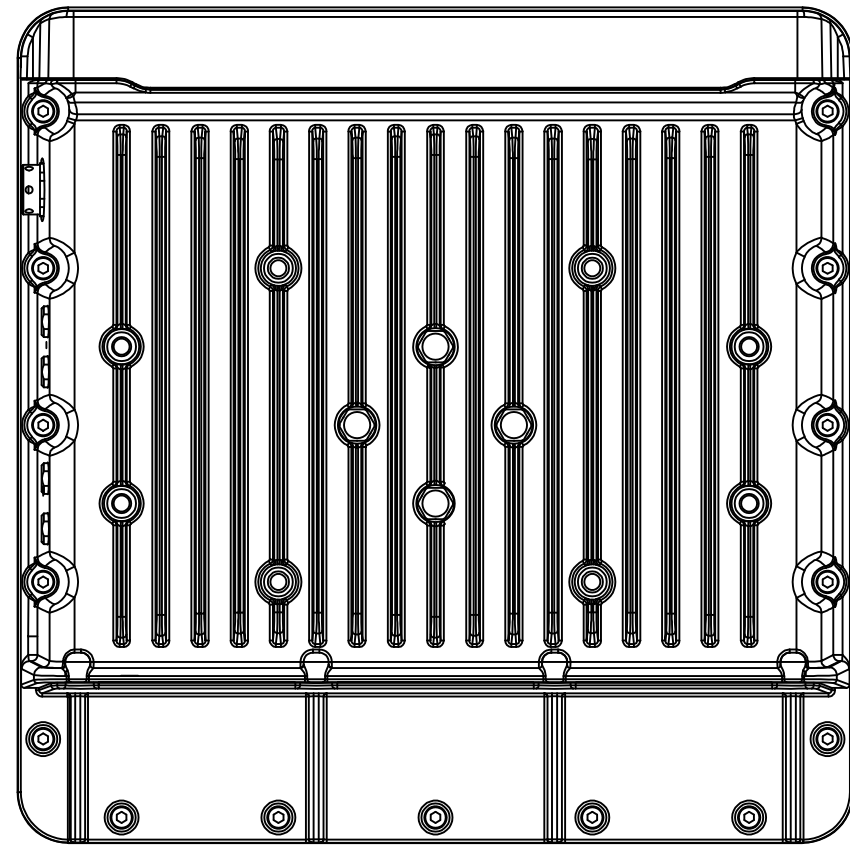

REVISIONS				
ZONE	REV	DESCRIPTION	APPD	DATE
	A	initial release	NELY NING	

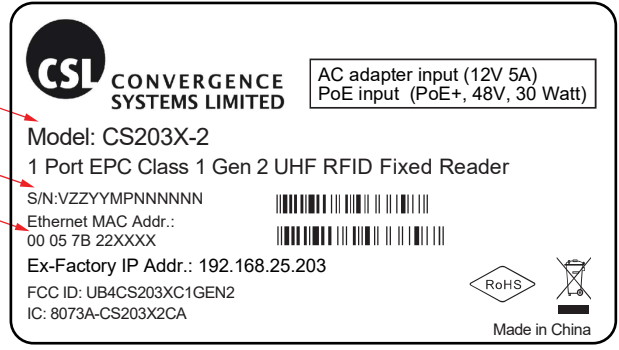

Scale 1:1

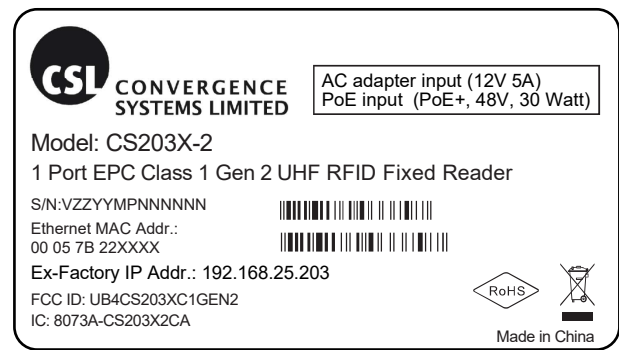

Scale 1:1

ITEM	NOTES	REMARK
1	Model: CS203X-2	FCC version.
2	S/N format: refer to REMCSL-8001X	X--- the latest version.
3	Ethernet Mac Addr.: = 00 05 7B 22xxxx(CS203X MODEL)	XXXX is hexadecimal digital number. it starts from XXX1 to FFFF for a model(CSXXX)

NOTES

- Label material : Matt white Polyester 3M7816 or 3M7814 or 3M7815 or 3M7878 high strength adhesive #310 Acrylic, UL approved.
- Barcode type: 128#.
- Character height, refer to drawing or sample provided by engineering.
- Printing, Black color on white background.
- The font of text: Arial
- Label roll is fit for transfer Ribbon MH10H.
- Part must be free of dirt, damage, notching, scratch, and any surface imperfection.
- Dimensions are in mm
- Tolerance: ±0.3mm

<p>TOLERANCES UNLESS OTHERWISE SPECIFIED DIMENSIONS ARE IN MM</p> <p>DECIMALS ANGULAR</p> <p>. ± 0.50</p> <p>.X ± 0.25</p> <p>.XX ± 0.13</p> <p>DO NOT SCALE IF IN DOUBT ASK</p> <p>WARNING THIS DOCUMENT IS THE PROPERTY OF CSL OR ITS CLIENTS AND CONTAINS CONFIDENTIAL AND TRADE SECRET INFORMATION OF CSL OR ITS CLIENTS.</p>	MODEL NO	CS203X-2			
	PART NO				
	DWN	DATE	NELY NING 20-Nov-2020		
	CKD	DATE			
	APPD	DATE			
	CAD FILENAME:		SCALE	<b>Product Label, FCC, CS203X-2</b>	
	Product Label-CS203X-2(fcc-01).pdf		FIT		
		DWG NO	SHEET 1 OF 1	REV A	