

FCC Test Report (WLAN)

Report No.: RF161216E08H

FCC ID: UAY-W8997-M1216

Test Model: W8997-M1216

Received Date: Aug. 15, 2019

Test Date: Sep. 06 to 07, 2019

Issued Date: Sep. 16, 2019

Applicant: Marvell Semiconductor, Inc.

Address: 5488 Marvell Lane, Santa Clara CA95054 USA

Issued By: Bureau Veritas Consumer Products Services (H.K.) Ltd., Taoyuan Branch
Hsin Chu Laboratory

Lab Address: E-2, No.1, Li Hsin 1st Road, Hsinchu Science Park, Hsinchu City 300,
Taiwan R.O.C.

Test Location: E-2, No.1, Li Hsin 1st Road, Hsinchu Science Park, Hsinchu City 300,
Taiwan R.O.C.

**FCC Registration /
Designation Number:** 723255 / TW2022



This report is for your exclusive use. Any copying or replication of this report to or for any other person or entity, or use of our name or trademark, is permitted only with our prior written permission. This report sets forth our findings solely with respect to the test samples identified herein. The results set forth in this report are not indicative or representative of the quality or characteristics of the lot from which a test sample was taken or any similar or identical product unless specifically and expressly noted. Our report includes all of the tests requested by you and the results thereof based upon the information that you provided to us. You have 60 days from date of issuance of this report to notify us of any material error or omission caused by our negligence, provided, however, that such notice shall be in writing and shall specifically address the issue you wish to raise. A failure to raise such issue within the prescribed time shall constitute your unqualified acceptance of the completeness of this report, the tests conducted and the correctness of the report contents. Unless specific mention, the uncertainty of measurement has been explicitly taken into account to declare the compliance or non-compliance to the specification. The report must not be used by the client to claim product certification, approval, or endorsement by TAF or any government agencies.

Table of Contents

Release Control Record	4
1 Certificate of Conformity	5
2 Summary of Test Results	6
2.1 Measurement Uncertainty	6
2.2 Modification Record	6
3 General Information	7
3.1 General Description of EUT (WLAN)	7
3.2 Description of Test Modes	10
3.2.1 Test Mode Applicability and Tested Channel Detail	11
3.3 Duty Cycle of Test Signal	13
3.4 Description of Support Units	14
3.4.1 Configuration of System under Test	15
3.5 General Description of Applied Standards	16
4 Test Types and Results	17
4.1 Radiated Emission and Bandedge Measurement	17
4.1.1 Limits of Radiated Emission and Bandedge Measurement	17
4.1.2 Test Instruments	18
4.1.3 Test Procedures	19
4.1.4 Deviation from Test Standard	19
4.1.5 Test Setup	20
4.1.6 EUT Operating Conditions	21
4.1.7 Test Results (PCB antenna)	22
4.1.8 Test Results (Dipole antenna)	36
4.2 6dB Bandwidth Measurement	50
4.2.1 Limits of 6dB Bandwidth Measurement	50
4.2.2 Test Setup	50
4.2.3 Test Instruments	50
4.2.4 Test Procedure	50
4.2.5 Deviation from Test Standard	50
4.2.6 EUT Operating Conditions	50
4.2.7 Test Result	51
4.3 Conducted Output Power Measurement	53
4.3.1 Limits of Conducted Output Power Measurement	53
4.3.2 Test Setup	53
4.3.3 Test Instruments	53
4.3.4 Test Procedures	53
4.3.5 Deviation from Test Standard	53
4.3.6 EUT Operating Conditions	53
4.3.7 Test Results	54
4.4 Power Spectral Density Measurement	56
4.4.1 Limits of Power Spectral Density Measurement	56
4.4.2 Test Setup	56
4.4.3 Test Instruments	56
4.4.4 Test Procedure	56
4.4.5 Deviation from Test Standard	56
4.4.6 EUT Operating Condition	56
4.4.7 Test Results	57
4.5 Conducted Out of Band Emission Measurement	60
4.5.1 Limits of Conducted Out of Band Emission Measurement	60
4.5.2 Test Setup	60
4.5.3 Test Instruments	60
4.5.4 Test Procedure	60
4.5.5 Deviation from Test Standard	60

4.5.6 EUT Operating Condition	60
4.5.7 Test Results	60
5 Pictures of Test Arrangements.....	69
Appendix – Information of the Testing Laboratories	70

Release Control Record

Issue No.	Description	Date Issued
RF161216E08H	Original release.	Sep. 16, 2019

1 Certificate of Conformity

Product: IEEE 802.11 2X2 MU-MIMO ac/a/b/g/n Wireless LAN + Bluetooth NGFF Module

Brand: Marvell

Test Model: W8997-M1216

Sample Status: ENGINEERING SAMPLE

Applicant: Marvell Semiconductor, Inc.

Test Date: Sep. 06 to 07, 2019

Standards: 47 CFR FCC Part 15, Subpart C (Section 15.247)
ANSI C63.10: 2013

The above equipment has been tested by **Bureau Veritas Consumer Products Services (H.K.) Ltd., Taoyuan Branch**, and found compliance with the requirement of the above standards. The test record, data evaluation & Equipment Under Test (EUT) configurations represented herein are true and accurate accounts of the measurements of the sample's EMC characteristics under the conditions specified in this report.

Prepared by : Wendy Wu , **Date:** Sep. 16, 2019
Wendy Wu / Specialist

Approved by : May Chen , **Date:** Sep. 16, 2019
May Chen / Manager

2 Summary of Test Results

47 CFR FCC Part 15, Subpart C (Section 15.247)			
FCC Clause	Test Item	Result	Remarks
15.205 / 15.209 / 15.247(d)	Radiated Emissions and Band Edge Measurement	PASS	Meet the requirement of limit. Minimum passing margin is -0.2dB at 12310.00MHz.
15.247(d)	Antenna Port Emission	PASS	Meet the requirement of limit.
15.247(a)(2)	6dB bandwidth	PASS	Meet the requirement of limit.
15.247(b)	Conducted power	PASS	Meet the requirement of limit.
15.247(e)	Power Spectral Density	PASS	Meet the requirement of limit.
15.203	Antenna Requirement	PASS	Antenna connector is i-pex(MHF), RP-SMA, I-pex not a standard connector.

Note:

Determining compliance based on the results of the compliance measurement, not taking into account measurement instrumentation uncertainty.

2.1 Measurement Uncertainty

Where relevant, the following measurement uncertainty levels have been estimated for tests performed on the EUT as specified in CISPR 16-4-2:

Measurement	Frequency	Expanded Uncertainty (k=2) (\pm)
Radiated Emissions up to 1 GHz	9kHz ~ 30MHz	3.0 dB
	30MHz ~ 1GHz	5.1 dB
Radiated Emissions above 1 GHz	1GHz ~ 6GHz	5.1 dB
	6GHz ~ 18GHz	5.0 dB
	18GHz ~ 40GHz	5.2 dB

2.2 Modification Record

There were no modifications required for compliance.

3 General Information

3.1 General Description of EUT (WLAN)

Product	IEEE 802.11 2X2 MU-MIMO ac/a/b/g/n Wireless LAN + Bluetooth NGFF Module
Brand	Marvell
Test Model	W8997-M1216
Status of EUT	ENGINEERING SAMPLE
Power Supply Rating	DC 3.3V from host equipment
Modulation Type	CCK, DQPSK, DBPSK for DSSS 64QAM, 16QAM, QPSK, BPSK for OFDM 256QAM for OFDM in 11ac mode
Modulation Technology	DSSS, OFDM
Transfer Rate	802.11b: up to 11Mbps 802.11a/g: up to 54Mbps 802.11n: up to 300Mbps 802.11ac: up to 866.7Mbps
Operating Frequency	2.4GHz: 2.412 ~ 2.462GHz 5GHz: 5.18~5.24GHz, 5.26~5.32GHz, 5.50~5.70GHz, 5.745~5.825GHz
Number of Channel	2.4GHz: 802.11b, 802.11g, 802.11n (HT20): 11 802.11n (HT40): 7 5GHz: 802.11a, 802.11n (HT20), 802.11ac (VHT20): 24 802.11n (HT40), 802.11ac (VHT40): 11 802.11ac (VHT80): 5
Output Power	2.4GHz: 885.515mW 5.18GHz ~ 5.24GHz: 129.286mW 5.26~5.32GHz: 131.893mW 5.50~5.70GHz: 134.915mW 5.745GHz ~ 5.825GHz: 178.919mW
Antenna Type	Refer to Note
Antenna Connector	Refer to Note
Accessory Device	NA
Data Cable Supplied	NA

Note:

1. This report is prepared for FCC class II permissive change. The difference compared with the Report No.: RF161216E08C as the following:

◆ Add new antennas as following table:

Original								
Antenna Set.	Brand	Model	Chain No.	Antenna Net. Gain(dBi)	Frequency range (MHz)	Antenna Type	Connector Type	Cable Length
1	MAG.LAYERS	MSA-4008-25GC1-A1	Chain 0(Aux)	2.98	2400~2500	PIFA	i-pex(MHF)	15cm
				5.16	4900~5900			
			Chain 1(Main)	2.98	2400~2500			15cm
				5.16	4900~5900			
2	Bondale	G-RA0K10090176-1436B	Chain 0(Aux)	1.9	2400~2500	Dipole	RP-SMA	120mm
				3.6	4900~5800			
			Chain 1(Main)	1.9	2400~2500			120mm
				3.6	4900~5800			
3	San Jose	UEN-201	Chain 0(Aux)	2.4	2400~2500	Dipole	RP-SMA	120mm
				4.4	4900~5800			
			Chain 1(Main)	2.4	2400~2500			120mm
				4.4	4900~5800			
Newly								
Antenna Set.	Brand	Model	chain no.	Antenna Net Gain(dBi) included cable loss	Frequency range	Antenna Type	Connector Type	Cable Length
4	Unictron	H2B1PC1A1C175L	Chain 0(Aux)	1.6	2400-2500	PCB	I-pex	100±5mm
				4.8	5150~5850			
			Chain 1(Main)	1.6	2400-2500			100±5mm
				4.8	5150~5850			
5	LSR	001-0012	Chain 0(Aux)	2	2400-2500	Dipole	RP-SMA	100mm
				2	5150~5850			
			Chain 1(Main)	2	2400-2500			100mm
				2	5150~5850			
6	Laird	MAF94051	Chain 0(Aux)	2.4	2400-2500	Dipole	RP-SMA	100mm
				3.4	5150~5850			
			Chain 1(Main)	2.4	2400-2500			100mm
				3.4	5150~5850			
7	Taoglas	GW.59.3153	Chain 0(Aux)	2.86	2400-2500	Dipole	RP-SMA	100mm
				4.74	5150~5850			
			Chain 1(Main)	2.86	2400-2500			100mm
				4.74	5150~5850			
8	Chang Hong	DA-2458-02-SMR	Chain 0(Aux)	2.85	2400-2500	Dipole	RP-SMA	100mm
				2.17	5150~5850			
			Chain 1(Main)	2.85	2400-2500			100mm
				3.13	5150~5850			
9	Unictron	H2B1PD1A1C385L	Chain 0(Aux)	2.8	2400-2500	PCB	I-pex	100mm
				4.2	5150~5850			
			Chain 1(Main)	2.8	2400-2500			100mm
				4.2	5150~5850			

10	Molex	2042811100	Chain 0(Aux)	2.562	2400-2500	PCB	I-pex	100mm
				3.094	5150~5850			
			Chain 1(Main)	2.562	2400-2500	PCB	I-pex	100mm
				3.094	5150~5850			
11	Molex	1461531100	Chain 0(Aux)	1.829	2400-2500	PCB	I-pex	100mm
				2.485	5150~5850			
			Chain 1(Main)	1.829	2400-2500	PCB	I-pex	100mm
				2.485	5150~5850			
12	MAG.LAYERS	MSA-4008-25GC1-A2	Chain 0(Aux)	2.98	2400-2500	PIFA	i-pex(MHF)	NA
				5.16	5150~5850			
			Chain 1(Main)	2.98	2400-2500	PIFA	i-pex(MHF)	
				5.16	5150~5850			

Note:

1. Max. gain was selected for Antenna Port Conducted Measurement test.
2. Antenna Set. 4, 7 were selected for radiated emissions test.

2. According to above condition, all test items (Except AC Power Conducted Emissions and Frequency Stability) need to be performed. And all data were verified to meet the requirements.
3. There are WLAN, BT technology used for the EUT.
4. Simultaneously transmission condition.

Condition	Technology	
1	WLAN (2.4GHz)	Bluetooth
2	WLAN (5GHz)	Bluetooth

Note: The emission of the simultaneous operation has been evaluated and no non-compliance was found.

5. The EUT incorporates a MIMO function.

2.4GHz Band		
MODULATION MODE	TX & RX CONFIGURATION	
802.11b	2TX	2RX
802.11g	2TX	2RX
802.11n (HT20)	2TX	2RX
802.11n (HT40)	2TX	2RX
5GHz Band		
MODULATION MODE	TX & RX CONFIGURATION	
802.11a	2TX	2RX
802.11n (HT20)	2TX	2RX
802.11n (HT40)	2TX	2RX
802.11ac (VHT20)	2TX	2RX
802.11ac (VHT40)	2TX	2RX
802.11ac (VHT80)	2TX	2RX

Note: The modulation and bandwidth are similar for 802.11n mode for 20MHz (40MHz) and 802.11ac mode for 20MHz (40MHz), therefore investigated worst case to representative mode in test report. (Final test mode refer section 3.2.1)

6. The above EUT information is declared by manufacturer and for more detailed features description, please refers to the manufacturer's specifications or user's manual.

3.2 Description of Test Modes

11 channels are provided for 802.11b, 802.11g and 802.11n (HT20):

Channel	Frequency	Channel	Frequency
1	2412MHz	7	2442MHz
2	2417MHz	8	2447MHz
3	2422MHz	9	2452MHz
4	2427MHz	10	2457MHz
5	2432MHz	11	2462MHz
6	2437MHz		

7 channels are provided for 802.11n (HT40):

Channel	Frequency	Channel	Frequency
3	2422MHz	7	2442MHz
4	2427MHz	8	2447MHz
5	2432MHz	9	2452MHz
6	2437MHz		

3.2.1 Test Mode Applicability and Tested Channel Detail

EUT Configure Mode	Applicable To			Description
	RE \geq 1G	RE $<$ 1G	APCM	
1	-	-	√	PIFA antenna
2	√	√	-	PCB antenna
3	√	√	-	Dipole antenna

RE \geq 1G: Radiated Emission above 1GHz

RE $<$ 1G: Radiated Emission below 1GHz

APCM: Antenna Port Conducted Measurement

NOTE: The EUT's PCB antenna had been pre-tested on the positioned of each 3 axis. The worst case was found when positioned on **X-plane**.

Radiated Emission Test (Above 1GHz):

- Pre-Scan has been conducted to determine the worst-case mode from all possible combinations between available modulations, data rates and antenna ports (if EUT with antenna diversity architecture).
- Following channel(s) was (were) selected for the final test as listed below.

MODE	AVAILABLE CHANNEL	TESTED CHANNEL	MODULATION TECHNOLOGY	MODULATION TYPE	DATA RATE (Mbps)
802.11b	1 to 11	1, 6, 11	DSSS	DBPSK	1
802.11g	1 to 11	1, 6, 11	OFDM	BPSK	6
802.11n (HT20)	1 to 11	1, 6, 11	OFDM	BPSK	6.5
802.11n (HT40)	3 to 9	3, 6, 9	OFDM	BPSK	13.5

Radiated Emission Test (Below 1GHz):

- Pre-Scan has been conducted to determine the worst-case mode from all possible combinations between available modulations, data rates and antenna ports (if EUT with antenna diversity architecture).
- Following channel(s) was (were) selected for the final test as listed below.

MODE	AVAILABLE CHANNEL	TESTED CHANNEL	MODULATION TECHNOLOGY	MODULATION TYPE	DATA RATE (Mbps)
802.11n (HT20)	1 to 11	6	OFDM	BPSK	6

Antenna Port Conducted Measurement:

- This item includes all test value of each mode, but only includes spectrum plot of worst value of each mode.
- Pre-Scan has been conducted to determine the worst-case mode from all possible combinations between available modulations, data rates and antenna ports (if EUT with antenna diversity architecture).
- Following channel(s) was (were) selected for the final test as listed below.

MODE	AVAILABLE CHANNEL	TESTED CHANNEL	MODULATION TECHNOLOGY	MODULATION TYPE	DATA RATE (Mbps)
802.11b	1 to 11	1, 6, 11	DSSS	DBPSK	1
802.11g	1 to 11	1, 2, 6, 10, 11	OFDM	BPSK	6
802.11n (HT20)	1 to 11	1, 2, 6, 10, 11	OFDM	BPSK	6.5
802.11n (HT40)	3 to 9	3, 4, 6, 8, 9	OFDM	BPSK	13.5

Test Condition:

APPLICABLE TO	ENVIRONMENTAL CONDITIONS	INPUT POWER (System)	TESTED BY
RE \geq 1G	24deg. C, 65%RH	120Vac, 60Hz	Nelson Teng
RE<1G	22deg. C, 67%RH	120Vac, 60Hz	Tom Yang
APCM	25deg. C, 60%RH	120Vac, 60Hz	Jyunchun Lin

3.3 Duty Cycle of Test Signal

Duty cycle of test signal is 100 %, duty factor is not required.

802.11b

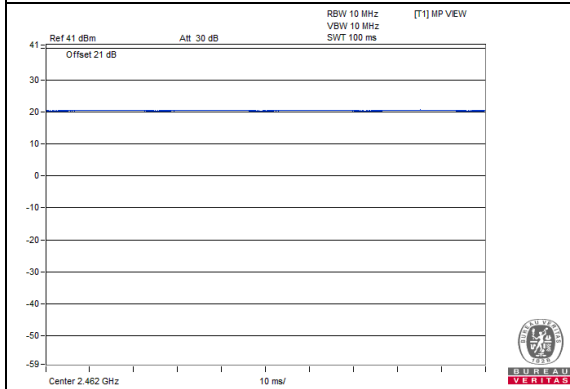

802.11g

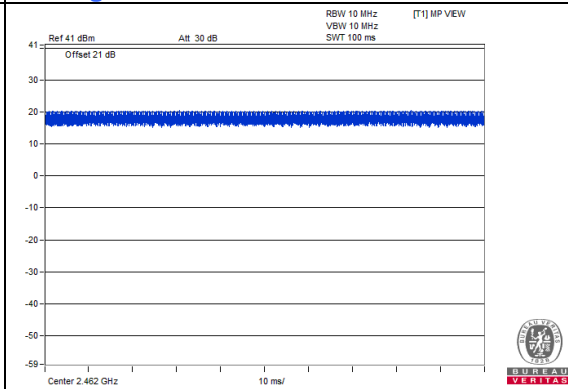

802.11n (HT20)

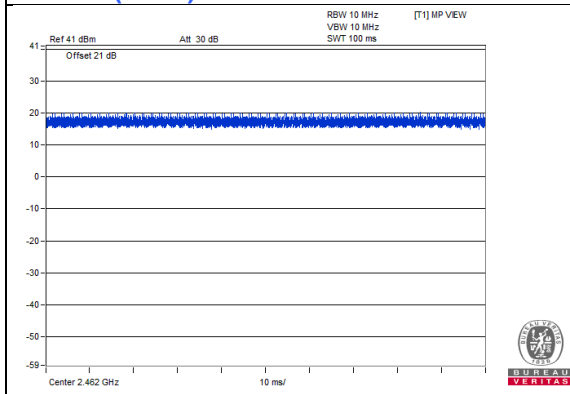

802.11n (HT40)

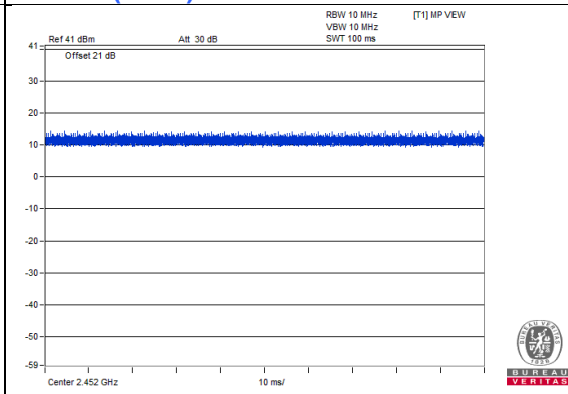

3.4 Description of Support Units

The EUT has been tested as an independent unit together with other necessary accessories or support units. The following support units or accessories were used to form a representative test configuration during the tests.

ID	Product	Brand	Model No.	Serial No.	FCC ID	Remarks
A.	Laptop	DELL	E6420	482T3R1	FCC DoC	Provided by Lab
B.	USB Dongle	AzureWave	USB Dongle	NA	NA	Supplied by client
C.	PCIE Card	AzureWave	PCIE Card	NA	NA	Supplied by client
D.	Test Tool	AzureWave	Test Tool	NA	NA	Supplied by client
E.	Adapter	DELL	LA65NS2-01	NA	NA	Provided by Lab
F.	Laptop	DELL	P88G	G1WJL42	PD93165NG	Provided by Lab

Note:

1. All power cords of the above support units are non-shielded (1.8m).

ID	Descriptions	Qty.	Length (m)	Shielding (Yes/No)	Cores (Qty.)	Remarks
1.	RJ-45 Cable	1	10	No	0	Provided by Lab
2.	DC Cable	1	1.8	No	1	Provided by Lab
3.	AC Cable	1	1	No	0	Provided by Lab
4.	Type C Cable	1	1.5	Yes	0	Provided by Lab

3.4.1 Configuration of System under Test

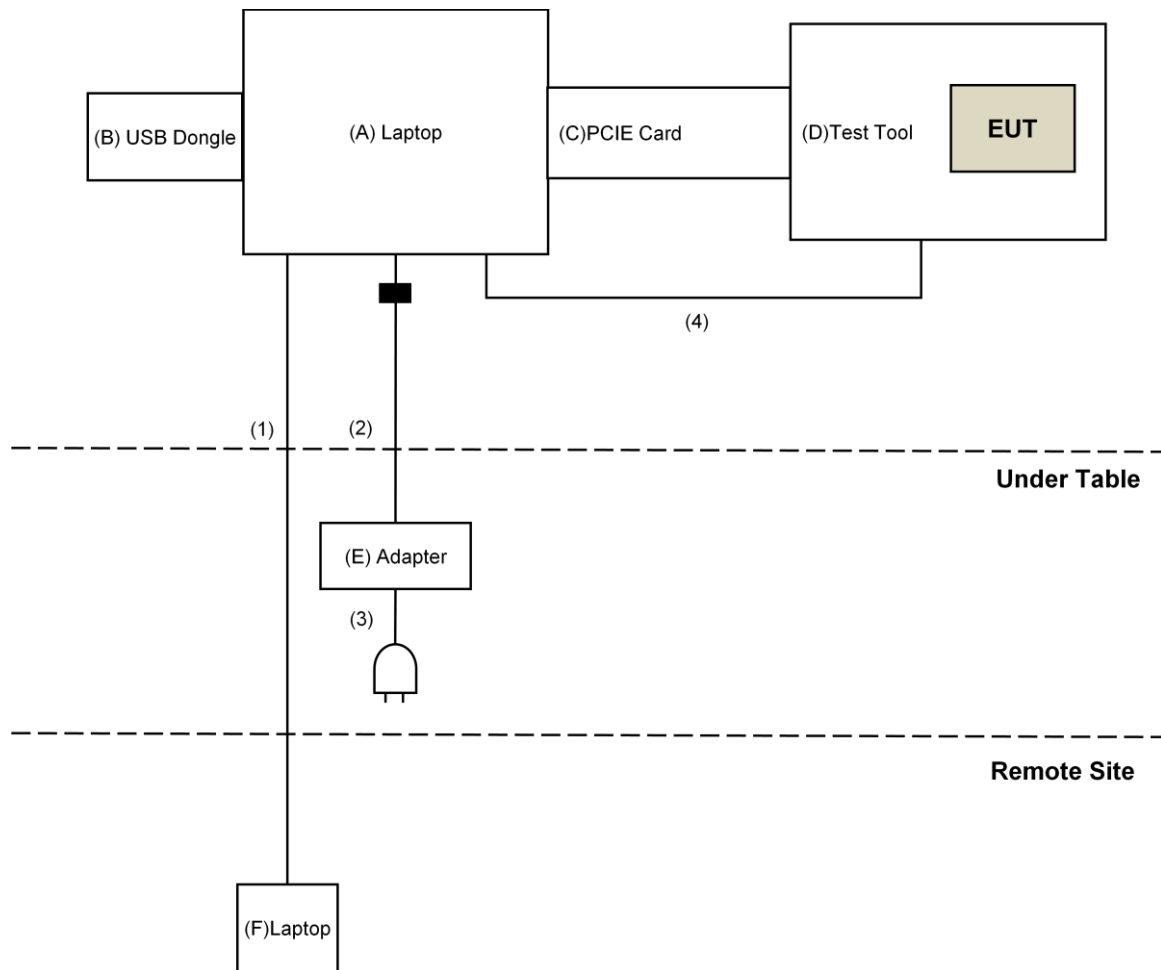

3.5 General Description of Applied Standards

The EUT is a RF Product. According to the specifications of the manufacturer, it must comply with the requirements of the following standards:

FCC Part 15, Subpart C (15.247)
KDB 558074 D01 15.247 Meas Guidance v05r02
KDB 662911 D01 Multiple Transmitter Output v02r01
ANSI C63.10-2013

All test items have been performed and recorded as per the above standards.

4 Test Types and Results

4.1 Radiated Emission and Bandedge Measurement

4.1.1 Limits of Radiated Emission and Bandedge Measurement

Radiated emissions which fall in the restricted bands must comply with the radiated emission limits specified as below table. Other emissions shall be at least 20dB below the highest level of the desired power:

Frequencies (MHz)	Field Strength (microvolts/meter)	Measurement Distance (meters)
0.009 ~ 0.490	2400/F(kHz)	300
0.490 ~ 1.705	24000/F(kHz)	30
1.705 ~ 30.0	30	30
30 ~ 88	100	3
88 ~ 216	150	3
216 ~ 960	200	3
Above 960	500	3

NOTE:

1. The lower limit shall apply at the transition frequencies.
2. Emission level (dBuV/m) = 20 log Emission level (uV/m).
3. For frequencies above 1000MHz, the field strength limits are based on average detector, however, the peak field strength of any emission shall not exceed the maximum permitted average limits, specified above by more than 20dB under any condition of modulation.

4.1.2 Test Instruments

DESCRIPTION & MANUFACTURER	MODEL NO.	SERIAL NO.	CALIBRATED DATE	CALIBRATED UNTIL
Test Receiver Agilent	N9038A	MY50010156	July 17, 2019	July 16, 2020
Pre-Amplifier EMCI	EMC001340	980142	May 30, 2019	May 29, 2020
Loop Antenna Electro-Metrics	EM-6879	264	Jan. 22, 2019	Jan. 21, 2020
RF Cable	NA	LOOPCAB-001	Jan. 14, 2019	Jan. 13, 2020
RF Cable	NA	LOOPCAB-002	Jan. 14, 2019	Jan. 13, 2020
Pre-Amplifier Mini-Circuits	ZFL-1000VH2B	AMP-ZFL-05	Apr. 30, 2019	Apr. 29, 2020
Trilog Broadband Antenna SCHWARZBECK	VULB 9168	9168-361	Nov. 22, 2018	Nov. 21, 2019
RF Cable	8D	966-3-1	Mar. 18, 2019	Mar. 17, 2020
RF Cable	8D	966-3-2	Mar. 18, 2019	Mar. 17, 2020
RF Cable	8D	966-3-3	Mar. 18, 2019	Mar. 17, 2020
Fixed attenuator Mini-Circuits	UNAT-5+	PAD-3m-3-01	Sep. 27, 2018	Sep. 26, 2019
Horn_Antenna SCHWARZBECK	BBHA9120-D	9120D-406	Nov. 25, 2018	Nov. 24, 2019
Pre-Amplifier EMCI	EMC12630SE	980384	Jan. 28, 2019	Jan. 27, 2020
RF Cable	EMC104-SM-SM-1200	160922	Jan. 28, 2019	Jan. 27, 2020
RF Cable	EMC104-SM-SM-2000	180601	June 10, 2019	June 09, 2020
RF Cable	EMC104-SM-SM-6000	180602	June 10, 2019	June 09, 2020
Spectrum Analyzer Keysight	N9030A	MY54490679	July 17, 2019	July 16, 2020
Pre-Amplifier EMCI	EMC184045SE	980387	Jan. 28, 2019	Jan. 27, 2020
Horn_Antenna SCHWARZBECK	BBHA 9170	BBHA9170519	Nov. 25, 2018	Nov. 24, 2019
RF Cable	EMC102-KM-KM-1200	160924	Jan. 28, 2019	Jan. 27, 2020
RF Cable	EMC102-KM-KM-1200	160925	Jan. 28, 2019	Jan. 27, 2020
Software	ADT_Radiated_V8.7.08	NA	NA	NA
Antenna Tower & Turn Table Max-Full	MF-7802	MF780208406	NA	NA
Boresight Antenna Fixture	FBA-01	FBA-SIP01	NA	NA
Spectrum Analyzer R&S	FSV40	100964	June 04, 2019	June 03, 2020
Power meter Anritsu	ML2495A	1014008	May 13, 2019	May 12, 2020
Power sensor Anritsu	MA2411B	0917122	May 13, 2019	May 12, 2020
Fixed Attenuator Mini-Circuits	MDCS18N-10	MDCS18N-10-01	Apr. 15, 2019	Apr. 14, 2020

Note:

1. The calibration interval of the above test instruments is 12 months and the calibrations are traceable to NML/ROC and NIST/USA.
2. The test was performed in 966 Chamber No. 3.
3. Loop antenna was used for all emissions below 30 MHz.
4. Tested Date: Sep. 06 to 07, 2019

4.1.3 Test Procedures

For Radiated emission below 30MHz

- a. The EUT was placed on the top of a rotating table 0.8 meters above the ground at a 3 meter chamber room. The table was rotated 360 degrees to determine the position of the highest radiation.
- b. The EUT was set 3 meters away from the interference-receiving antenna, which was mounted on the top of a variable-height antenna tower.
- c. Parallel, perpendicular, and ground-parallel orientations of the antenna are set to make the measurement.
- d. For each suspected emission, the EUT was arranged to its worst case and the rotatable table was turned from 0 degrees to 360 degrees to find the maximum reading.
- e. The test-receiver system was set to Quasi-Peak Detect Function and Specified Bandwidth with Maximum Hold Mode.

NOTE:

1. The resolution bandwidth and video bandwidth of test receiver/spectrum analyzer is 9kHz at frequency below 30MHz.

For Radiated emission above 30MHz

- a. The EUT was placed on the top of a rotating table 0.8 meters (for 30MHz ~ 1GHz) / 1.5 meters (for above 1GHz) above the ground at 3 meter chamber room for test. The table was rotated 360 degrees to determine the position of the highest radiation.
- b. The EUT was set 3 meters away from the interference-receiving antenna, which was mounted on the top of a variable-height antenna tower.
- c. The height of antenna is varied from one meter to four meters above the ground to determine the maximum value of the field strength. Both horizontal and vertical polarizations of the antenna are set to make the measurement.
- d. For each suspected emission, the EUT was arranged to its worst case and then the antenna was tuned to heights from 1 meter to 4 meters and the rotatable table was turned from 0 degrees to 360 degrees to find the maximum reading.
- e. The test-receiver system was set to quasi-peak detect function and specified bandwidth with maximum hold mode when the test frequency is below 1 GHz.
- f. The test-receiver system was set to peak and average detects function and specified bandwidth with maximum hold mode when the test frequency is above 1 GHz. If the peak reading value also meets average limit, measurement with the average detector is unnecessary.

Note:

1. The resolution bandwidth and video bandwidth of test receiver/spectrum analyzer is 120kHz for Quasi-peak detection (QP) at frequency below 1GHz.
2. The resolution bandwidth of test receiver/spectrum analyzer is 1 MHz and the video bandwidth is 3 MHz for Peak detection (PK) at frequency above 1GHz.
3. The resolution bandwidth of test receiver/spectrum analyzer is 1MHz and the video bandwidth is $\geq 1/T$ (Duty cycle $< 98\%$) or 10Hz (Duty cycle $\geq 98\%$) for Average detection (AV) at frequency above 1GHz.
4. All modes of operation were investigated and the worst-case emissions are reported.

4.1.4 Deviation from Test Standard

No deviation.

4.1.5 Test Setup

For Radiated emission below 30MHz

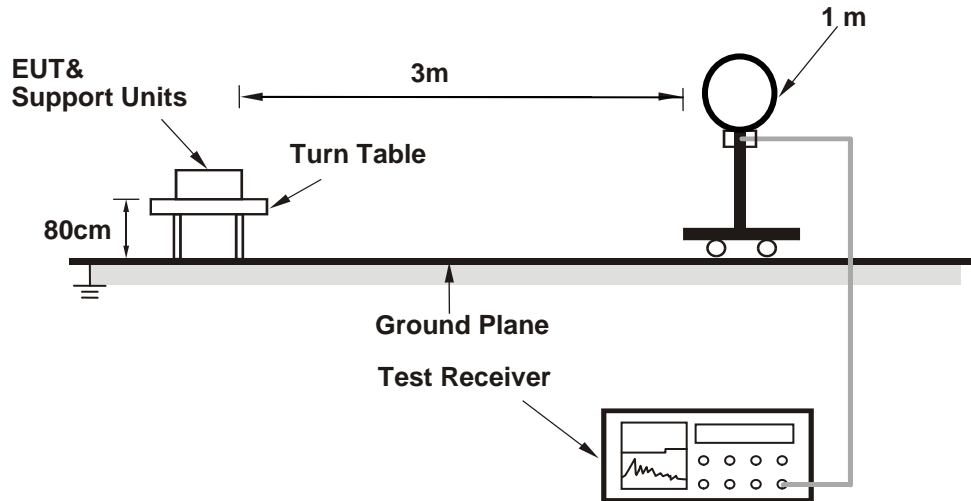

For Radiated emission 30MHz to 1GHz

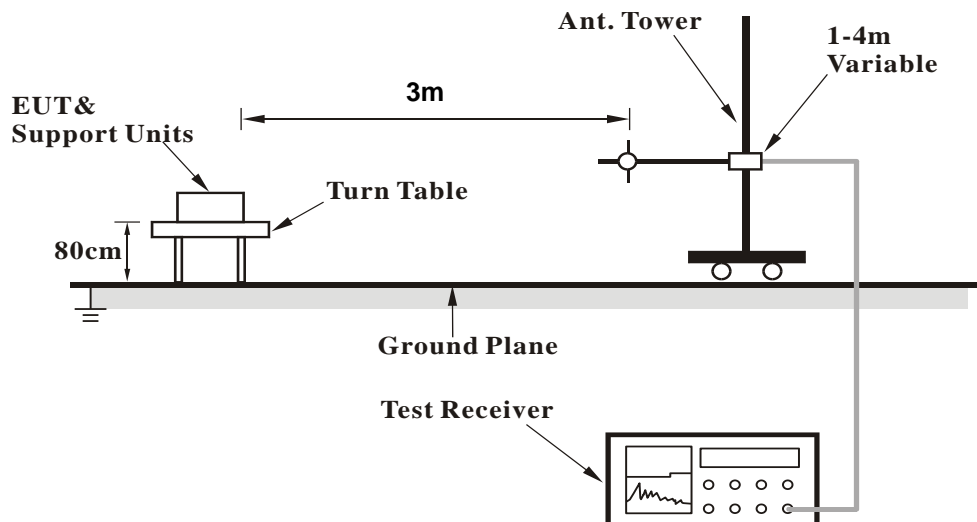

For Radiated emission above 1GHz

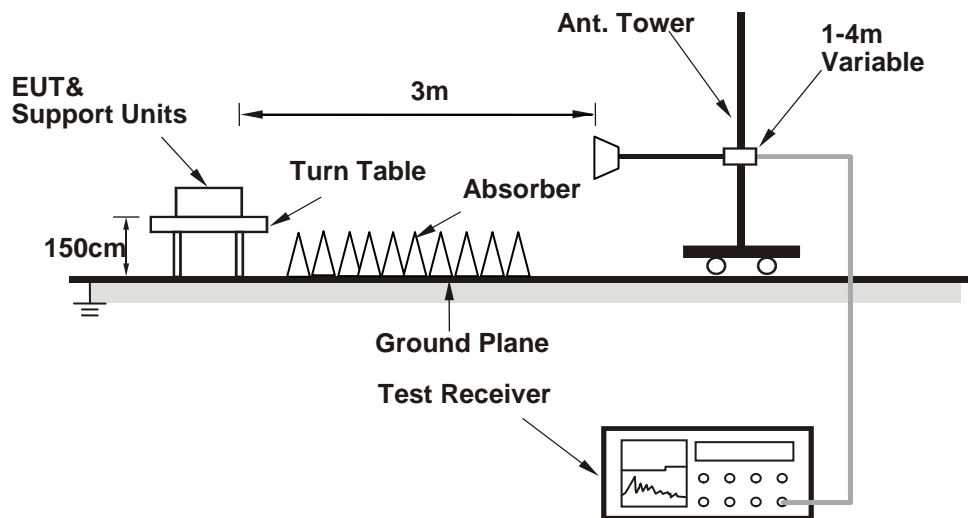

For the actual test configuration, please refer to the attached file (Test Setup Photo).

4.1.6 EUT Operating Conditions

- a. Connected the EUT with the Laptop Computer which is placed on remote site.
- b. Controlling software (DUT labtool (1.0.0.109)) has been activated to set the EUT under transmission condition continuously at specific channel frequency.

4.1.7 Test Results (PCB antenna)

Above 1GHz Data:

802.11b

CHANNEL	TX Channel 1	DETECTOR FUNCTION	Peak (PK)
FREQUENCY RANGE	1GHz ~ 25GHz		Average (AV)

ANTENNA POLARITY & TEST DISTANCE: HORIZONTAL AT 3 M

NO.	FREQ. (MHz)	EMISSION LEVEL (dBuV/m)	LIMIT (dBuV/m)	MARGIN (dB)	ANTENNA HEIGHT (m)	TABLE ANGLE (Degree)	RAW VALUE (dBuV)	CORRECTION FACTOR (dB/m)
1	2386.22	61.6 PK	74.0	-12.4	1.03 H	243	63.6	-2.0
2	2386.22	53.5 AV	54.0	-0.5	1.03 H	243	55.5	-2.0
3	2390.00	61.3 PK	74.0	-12.7	1.03 H	243	63.3	-2.0
4	2390.00	53.2 AV	54.0	-0.8	1.03 H	243	55.2	-2.0
5	*2412.00	111.9 PK			1.03 H	243	113.9	-2.0
6	*2412.00	109.7 AV			1.03 H	243	111.7	-2.0
7	4824.00	50.0 PK	74.0	-24.0	1.01 H	228	47.7	2.3
8	4824.00	47.4 AV	54.0	-6.6	1.01 H	228	45.1	2.3
9	12060.00	57.7 PK	74.0	-16.3	1.12 H	190	45.3	12.4
10	12060.00	53.5 AV	54.0	-0.5	1.12 H	190	41.1	12.4
11	14472.00	56.8 PK	74.0	-17.2	1.05 H	318	41.3	15.5
12	14472.00	51.2 AV	54.0	-2.8	1.05 H	318	35.7	15.5

ANTENNA POLARITY & TEST DISTANCE: VERTICAL AT 3 M

NO.	FREQ. (MHz)	EMISSION LEVEL (dBuV/m)	LIMIT (dBuV/m)	MARGIN (dB)	ANTENNA HEIGHT (m)	TABLE ANGLE (Degree)	RAW VALUE (dBuV)	CORRECTION FACTOR (dB/m)
1	2386.22	58.5 PK	74.0	-15.5	3.36 V	352	60.5	-2.0
2	2386.22	51.1 AV	54.0	-2.9	3.36 V	352	53.1	-2.0
3	2390.00	58.1 PK	74.0	-15.9	3.36 V	352	60.1	-2.0
4	2390.00	51.0 AV	54.0	-3.0	3.36 V	352	53.0	-2.0
5	*2412.00	108.3 PK			3.36 V	352	110.3	-2.0
6	*2412.00	106.1 AV			3.36 V	352	108.1	-2.0
7	4824.00	49.7 PK	74.0	-24.3	2.75 V	161	47.4	2.3
8	4824.00	46.4 AV	54.0	-7.6	2.75 V	161	44.1	2.3
9	12060.00	53.2 PK	74.0	-20.8	3.84 V	183	40.8	12.4
10	12060.00	46.6 AV	54.0	-7.4	3.84 V	183	34.2	12.4
11	14472.00	57.4 PK	74.0	-16.6	3.80 V	5	41.9	15.5
12	14472.00	51.9 AV	54.0	-2.1	3.80 V	5	36.4	15.5

REMARKS:

1. Emission Level(dBuV/m) = Raw Value(dBuV) + Correction Factor(dB/m)
2. Correction Factor(dB/m) = Antenna Factor(dB/m) + Cable Factor(dB) – Pre-Amplifier Factor(dB)
3. Margin value = Emission Level – Limit value
4. The other emission levels were very low against the limit.
5. " * ": Fundamental frequency.

CHANNEL	TX Channel 6	DETECTOR FUNCTION	Peak (PK)
FREQUENCY RANGE	1GHz ~ 25GHz		Average (AV)

ANTENNA POLARITY & TEST DISTANCE: HORIZONTAL AT 3 M

NO.	FREQ. (MHz)	EMISSION LEVEL (dBuV/m)	LIMIT (dBuV/m)	MARGIN (dB)	ANTENNA HEIGHT (m)	TABLE ANGLE (Degree)	RAW VALUE (dBuV)	CORRECTION FACTOR (dB/m)
1	2390.00	59.8 PK	74.0	-14.2	1.04 H	240	61.8	-2.0
2	2390.00	49.8 AV	54.0	-4.2	1.04 H	240	51.8	-2.0
3	*2437.00	111.4 PK			1.04 H	240	113.5	-2.1
4	*2437.00	109.4 AV			1.04 H	240	111.5	-2.1
5	2483.50	59.6 PK	74.0	-14.4	1.04 H	240	61.8	-2.2
6	2483.50	49.5 AV	54.0	-4.5	1.04 H	240	51.7	-2.2
7	4874.00	54.8 PK	74.0	-19.2	1.06 H	288	52.5	2.3
8	4874.00	52.6 AV	54.0	-1.4	1.06 H	288	50.3	2.3
9	7311.00	51.3 PK	74.0	-22.7	3.60 H	310	43.0	8.3
10	7311.00	46.2 AV	54.0	-7.8	3.60 H	310	37.9	8.3
11	12185.00	57.9 PK	74.0	-16.1	1.06 H	190	45.4	12.5
12	12185.00	53.4 AV	54.0	-0.6	1.06 H	190	40.9	12.5

ANTENNA POLARITY & TEST DISTANCE: VERTICAL AT 3 M

NO.	FREQ. (MHz)	EMISSION LEVEL (dBuV/m)	LIMIT (dBuV/m)	MARGIN (dB)	ANTENNA HEIGHT (m)	TABLE ANGLE (Degree)	RAW VALUE (dBuV)	CORRECTION FACTOR (dB/m)
1	2390.00	57.4 PK	74.0	-16.6	3.28 V	354	59.4	-2.0
2	2390.00	44.8 AV	54.0	-9.2	3.28 V	354	46.8	-2.0
3	*2437.00	108.2 PK			3.28 V	354	110.3	-2.1
4	*2437.00	106.1 AV			3.28 V	354	108.2	-2.1
5	2483.50	57.2 PK	74.0	-16.8	3.28 V	354	59.4	-2.2
6	2483.50	45.1 AV	54.0	-8.9	3.28 V	354	47.3	-2.2
7	4874.00	48.6 PK	74.0	-25.4	2.80 V	164	46.3	2.3
8	4874.00	45.6 AV	54.0	-8.4	2.80 V	164	43.3	2.3
9	7311.00	53.6 PK	74.0	-20.4	2.91 V	163	45.3	8.3
10	7311.00	49.6 AV	54.0	-4.4	2.91 V	163	41.3	8.3
11	12185.00	53.2 PK	74.0	-20.8	3.87 V	167	40.7	12.5
12	12185.00	46.9 AV	54.0	-7.1	3.87 V	167	34.4	12.5

REMARKS:

1. Emission Level(dBuV/m) = Raw Value(dBuV) + Correction Factor(dB/m)
2. Correction Factor(dB/m) = Antenna Factor(dB/m) + Cable Factor(dB) – Pre-Amplifier Factor(dB)
3. Margin value = Emission Level – Limit value
4. The other emission levels were very low against the limit.
5. " * ": Fundamental frequency.

CHANNEL	TX Channel 11	DETECTOR FUNCTION	Peak (PK)
FREQUENCY RANGE	1GHz ~ 25GHz		Average (AV)

ANTENNA POLARITY & TEST DISTANCE: HORIZONTAL AT 3 M

NO.	FREQ. (MHz)	EMISSION LEVEL (dBuV/m)	LIMIT (dBuV/m)	MARGIN (dB)	ANTENNA HEIGHT (m)	TABLE ANGLE (Degree)	RAW VALUE (dBuV)	CORRECTION FACTOR (dB/m)
1	*2462.00	111.9 PK			1.01 H	251	114.1	-2.2
2	*2462.00	109.7 AV			1.01 H	251	111.9	-2.2
3	2483.50	60.2 PK	74.0	-13.8	1.01 H	251	62.4	-2.2
4	2483.50	53.0 AV	54.0	-1.0	1.01 H	251	55.2	-2.2
5	2488.68	60.4 PK	74.0	-13.6	1.01 H	251	62.6	-2.2
6	2488.68	53.2 AV	54.0	-0.8	1.01 H	251	55.4	-2.2
7	4924.00	54.1 PK	74.0	-19.9	1.00 H	291	51.6	2.5
8	4924.00	52.1 AV	54.0	-1.9	1.00 H	291	49.6	2.5
9	7386.00	51.3 PK	74.0	-22.7	3.56 H	320	43.0	8.3
10	7386.00	46.3 AV	54.0	-7.7	3.56 H	320	38.0	8.3
11	12310.00	57.9 PK	74.0	-16.1	1.11 H	206	45.4	12.5
12	12310.00	53.8 AV	54.0	-0.2	1.11 H	206	41.3	12.5

ANTENNA POLARITY & TEST DISTANCE: VERTICAL AT 3 M

NO.	FREQ. (MHz)	EMISSION LEVEL (dBuV/m)	LIMIT (dBuV/m)	MARGIN (dB)	ANTENNA HEIGHT (m)	TABLE ANGLE (Degree)	RAW VALUE (dBuV)	CORRECTION FACTOR (dB/m)
1	*2462.00	107.2 PK			3.20 V	356	109.4	-2.2
2	*2462.00	104.9 AV			3.20 V	356	107.1	-2.2
3	2483.50	59.0 PK	74.0	-15.0	3.20 V	356	61.2	-2.2
4	2483.50	48.7 AV	54.0	-5.3	3.20 V	356	50.9	-2.2
5	2488.28	58.4 PK	74.0	-15.6	3.20 V	356	60.6	-2.2
6	2488.28	48.8 AV	54.0	-5.2	3.20 V	356	51.0	-2.2
7	4924.00	49.3 PK	74.0	-24.7	2.75 V	159	46.8	2.5
8	4924.00	46.1 AV	54.0	-7.9	2.75 V	159	43.6	2.5
9	7386.00	53.7 PK	74.0	-20.3	2.88 V	165	45.4	8.3
10	7386.00	49.5 AV	54.0	-4.5	2.88 V	165	41.2	8.3
11	12310.00	52.7 PK	74.0	-21.3	3.79 V	189	40.2	12.5
12	12310.00	46.4 AV	54.0	-7.6	3.79 V	189	33.9	12.5

REMARKS:

1. Emission Level(dBuV/m) = Raw Value(dBuV) + Correction Factor(dB/m)
2. Correction Factor(dB/m) = Antenna Factor(dB/m) + Cable Factor(dB) – Pre-Amplifier Factor(dB)
3. Margin value = Emission Level – Limit value
4. The other emission levels were very low against the limit.
5. " * ": Fundamental frequency.

802.11g

CHANNEL	TX Channel 1	DETECTOR FUNCTION	Peak (PK)
FREQUENCY RANGE	1GHz ~ 25GHz		Average (AV)

ANTENNA POLARITY & TEST DISTANCE: HORIZONTAL AT 3 M

NO.	FREQ. (MHz)	EMISSION LEVEL (dBuV/m)	LIMIT (dBuV/m)	MARGIN (dB)	ANTENNA HEIGHT (m)	TABLE ANGLE (Degree)	RAW VALUE (dBuV)	CORRECTION FACTOR (dB/m)
1	2390.00	70.7 PK	74.0	-3.3	2.71 H	276	72.7	-2.0
2	2390.00	52.6 AV	54.0	-1.4	2.71 H	276	54.6	-2.0
3	*2412.00	109.1 PK			2.71 H	276	111.1	-2.0
4	*2412.00	99.8 AV			2.71 H	276	101.8	-2.0
5	4824.00	44.2 PK	74.0	-29.8	3.18 H	91	41.9	2.3
6	4824.00	31.5 AV	54.0	-22.5	3.18 H	91	29.2	2.3

ANTENNA POLARITY & TEST DISTANCE: VERTICAL AT 3 M

NO.	FREQ. (MHz)	EMISSION LEVEL (dBuV/m)	LIMIT (dBuV/m)	MARGIN (dB)	ANTENNA HEIGHT (m)	TABLE ANGLE (Degree)	RAW VALUE (dBuV)	CORRECTION FACTOR (dB/m)
1	2390.00	62.7 PK	74.0	-11.3	3.78 V	358	64.7	-2.0
2	2390.00	47.1 AV	54.0	-6.9	3.78 V	358	49.1	-2.0
3	*2412.00	107.1 PK			3.78 V	358	109.1	-2.0
4	*2412.00	97.3 AV			3.78 V	358	99.3	-2.0
5	4824.00	46.2 PK	74.0	-27.8	1.08 V	211	43.9	2.3
6	4824.00	32.5 AV	54.0	-21.5	1.08 V	211	30.2	2.3

REMARKS:

1. Emission Level(dBuV/m) = Raw Value(dBuV) + Correction Factor(dB/m)
2. Correction Factor(dB/m) = Antenna Factor(dB/m) + Cable Factor(dB) – Pre-Amplifier Factor(dB)
3. Margin value = Emission Level – Limit value
4. The other emission levels were very low against the limit.
5. " * ": Fundamental frequency.

CHANNEL	TX Channel 6	DETECTOR FUNCTION	Peak (PK)
FREQUENCY RANGE	1GHz ~ 25GHz		Average (AV)

ANTENNA POLARITY & TEST DISTANCE: HORIZONTAL AT 3 M

NO.	FREQ. (MHz)	EMISSION LEVEL (dBuV/m)	LIMIT (dBuV/m)	MARGIN (dB)	ANTENNA HEIGHT (m)	TABLE ANGLE (Degree)	RAW VALUE (dBuV)	CORRECTION FACTOR (dB/m)
1	2390.00	73.0 PK	74.0	-1.0	2.93 H	288	75.0	-2.0
2	2390.00	49.0 AV	54.0	-5.0	2.93 H	288	51.0	-2.0
3	*2437.00	114.0 PK			2.93 H	288	116.1	-2.1
4	*2437.00	104.9 AV			2.93 H	288	107.0	-2.1
5	2483.50	72.0 PK	74.0	-2.0	2.93 H	288	74.2	-2.2
6	2483.50	48.4 AV	54.0	-5.6	2.93 H	288	50.6	-2.2
7	4874.00	51.9 PK	74.0	-22.1	3.12 H	81	49.6	2.3
8	4874.00	38.8 AV	54.0	-15.2	3.12 H	81	36.5	2.3
9	7311.00	55.1 PK	74.0	-18.9	1.06 H	290	46.8	8.3
10	7311.00	41.0 AV	54.0	-13.0	1.06 H	290	32.7	8.3
11	12185.00	55.5 PK	74.0	-18.5	1.06 H	98	43.0	12.5
12	12185.00	41.3 AV	54.0	-12.7	1.06 H	98	28.8	12.5

ANTENNA POLARITY & TEST DISTANCE: VERTICAL AT 3 M

NO.	FREQ. (MHz)	EMISSION LEVEL (dBuV/m)	LIMIT (dBuV/m)	MARGIN (dB)	ANTENNA HEIGHT (m)	TABLE ANGLE (Degree)	RAW VALUE (dBuV)	CORRECTION FACTOR (dB/m)
1	2390.00	57.0 PK	74.0	-17.0	3.67 V	360	59.0	-2.0
2	2390.00	44.5 AV	54.0	-9.5	3.67 V	360	46.5	-2.0
3	*2437.00	111.2 PK			3.67 V	360	113.3	-2.1
4	*2437.00	101.0 AV			3.67 V	360	103.1	-2.1
5	2483.50	56.8 PK	74.0	-17.2	3.67 V	360	59.0	-2.2
6	2483.50	45.0 AV	54.0	-9.0	3.67 V	360	47.2	-2.2
7	4874.00	53.0 PK	74.0	-21.0	1.10 V	200	50.7	2.3
8	4874.00	39.3 AV	54.0	-14.7	1.10 V	200	37.0	2.3
9	7311.00	50.4 PK	74.0	-23.6	1.20 V	191	42.1	8.3
10	7311.00	37.4 AV	54.0	-16.6	1.20 V	191	29.1	8.3
11	12185.00	57.6 PK	74.0	-16.4	1.05 V	204	45.1	12.5
12	12185.00	47.8 AV	54.0	-6.2	1.05 V	204	35.3	12.5

REMARKS:

1. Emission Level(dBuV/m) = Raw Value(dBuV) + Correction Factor(dB/m)
2. Correction Factor(dB/m) = Antenna Factor(dB/m) + Cable Factor(dB) – Pre-Amplifier Factor(dB)
3. Margin value = Emission Level – Limit value
4. The other emission levels were very low against the limit.
5. " * ": Fundamental frequency.

CHANNEL	TX Channel 11	DETECTOR FUNCTION	Peak (PK)
FREQUENCY RANGE	1GHz ~ 25GHz		Average (AV)

ANTENNA POLARITY & TEST DISTANCE: HORIZONTAL AT 3 M

NO.	FREQ. (MHz)	EMISSION LEVEL (dBuV/m)	LIMIT (dBuV/m)	MARGIN (dB)	ANTENNA HEIGHT (m)	TABLE ANGLE (Degree)	RAW VALUE (dBuV)	CORRECTION FACTOR (dB/m)
1	*2462.00	109.9 PK			2.92 H	275	112.1	-2.2
2	*2462.00	100.4 AV			2.92 H	275	102.6	-2.2
3	2483.50	69.2 PK	74.0	-4.8	2.92 H	275	71.4	-2.2
4	2483.50	53.5 AV	54.0	-0.5	2.92 H	275	55.7	-2.2
5	4924.00	44.4 PK	74.0	-29.6	3.12 H	102	41.9	2.5
6	4924.00	31.6 AV	54.0	-22.4	3.12 H	102	29.1	2.5
7	7386.00	50.6 PK	74.0	-23.4	1.09 H	307	42.3	8.3
8	7386.00	37.1 AV	54.0	-16.9	1.09 H	307	28.8	8.3

ANTENNA POLARITY & TEST DISTANCE: VERTICAL AT 3 M

NO.	FREQ. (MHz)	EMISSION LEVEL (dBuV/m)	LIMIT (dBuV/m)	MARGIN (dB)	ANTENNA HEIGHT (m)	TABLE ANGLE (Degree)	RAW VALUE (dBuV)	CORRECTION FACTOR (dB/m)
1	*2462.00	108.6 PK			3.98 V	34	110.8	-2.2
2	*2462.00	98.7 AV			3.98 V	34	100.9	-2.2
3	2483.50	59.5 PK	74.0	-14.5	3.98 V	34	61.7	-2.2
4	2483.50	46.6 AV	54.0	-7.4	3.98 V	34	48.8	-2.2
5	4924.00	45.9 PK	74.0	-28.1	1.15 V	185	43.4	2.5
6	4924.00	32.0 AV	54.0	-22.0	1.15 V	185	29.5	2.5
7	7386.00	48.6 PK	74.0	-25.4	1.31 V	208	40.3	8.3
8	7386.00	35.5 AV	54.0	-18.5	1.31 V	208	27.2	8.3

REMARKS:

1. Emission Level(dBuV/m) = Raw Value(dBuV) + Correction Factor(dB/m)
2. Correction Factor(dB/m) = Antenna Factor(dB/m) + Cable Factor(dB) – Pre-Amplifier Factor(dB)
3. Margin value = Emission Level – Limit value
4. The other emission levels were very low against the limit.
5. " * ": Fundamental frequency.

802.11n (HT20)

CHANNEL	TX Channel 1	DETECTOR FUNCTION	Peak (PK)
FREQUENCY RANGE	1GHz ~ 25GHz		Average (AV)

ANTENNA POLARITY & TEST DISTANCE: HORIZONTAL AT 3 M

NO.	FREQ. (MHz)	EMISSION LEVEL (dBuV/m)	LIMIT (dBuV/m)	MARGIN (dB)	ANTENNA HEIGHT (m)	TABLE ANGLE (Degree)	RAW VALUE (dBuV)	CORRECTION FACTOR (dB/m)
1	2390.00	70.7 PK	74.0	-3.3	2.73 H	278	72.7	-2.0
2	2390.00	52.9 AV	54.0	-1.1	2.73 H	278	54.9	-2.0
3	*2412.00	109.3 PK			2.73 H	278	111.3	-2.0
4	*2412.00	100.2 AV			2.73 H	278	102.2	-2.0
5	4824.00	43.7 PK	74.0	-30.3	3.16 H	95	41.4	2.3
6	4824.00	30.9 AV	54.0	-23.1	3.16 H	95	28.6	2.3

ANTENNA POLARITY & TEST DISTANCE: VERTICAL AT 3 M

NO.	FREQ. (MHz)	EMISSION LEVEL (dBuV/m)	LIMIT (dBuV/m)	MARGIN (dB)	ANTENNA HEIGHT (m)	TABLE ANGLE (Degree)	RAW VALUE (dBuV)	CORRECTION FACTOR (dB/m)
1	2390.00	62.4 PK	74.0	-11.6	3.83 V	38	64.4	-2.0
2	2390.00	46.7 AV	54.0	-7.3	3.83 V	38	48.7	-2.0
3	*2412.00	106.7 PK			3.83 V	38	108.7	-2.0
4	*2412.00	97.2 AV			3.83 V	38	99.2	-2.0
5	4824.00	45.9 PK	74.0	-28.1	1.14 V	214	43.6	2.3
6	4824.00	32.0 AV	54.0	-22.0	1.14 V	214	29.7	2.3

REMARKS:

1. Emission Level(dBuV/m) = Raw Value(dBuV) + Correction Factor(dB/m)
2. Correction Factor(dB/m) = Antenna Factor(dB/m) + Cable Factor(dB) – Pre-Amplifier Factor(dB)
3. Margin value = Emission Level – Limit value
4. The other emission levels were very low against the limit.
5. " * ": Fundamental frequency.

CHANNEL	TX Channel 6	DETECTOR FUNCTION	Peak (PK)
FREQUENCY RANGE	1GHz ~ 25GHz		Average (AV)

ANTENNA POLARITY & TEST DISTANCE: HORIZONTAL AT 3 M

NO.	FREQ. (MHz)	EMISSION LEVEL (dBuV/m)	LIMIT (dBuV/m)	MARGIN (dB)	ANTENNA HEIGHT (m)	TABLE ANGLE (Degree)	RAW VALUE (dBuV)	CORRECTION FACTOR (dB/m)
1	2390.00	73.0 PK	74.0	-1.0	2.95 H	286	75.0	-2.0
2	2390.00	48.8 AV	54.0	-5.2	2.95 H	286	50.8	-2.0
3	*2437.00	113.7 PK			2.95 H	286	115.8	-2.1
4	*2437.00	104.6 AV			2.95 H	286	106.7	-2.1
5	2483.50	72.3 PK	74.0	-1.7	2.95 H	286	74.5	-2.2
6	2483.50	48.5 AV	54.0	-5.5	2.95 H	286	50.7	-2.2
7	4874.00	44.1 PK	74.0	-29.9	3.10 H	77	41.8	2.3
8	4874.00	31.4 AV	54.0	-22.6	3.10 H	77	29.1	2.3
9	7311.00	50.9 PK	74.0	-23.1	1.02 H	291	42.6	8.3
10	7311.00	37.2 AV	54.0	-16.8	1.02 H	291	28.9	8.3

ANTENNA POLARITY & TEST DISTANCE: VERTICAL AT 3 M

NO.	FREQ. (MHz)	EMISSION LEVEL (dBuV/m)	LIMIT (dBuV/m)	MARGIN (dB)	ANTENNA HEIGHT (m)	TABLE ANGLE (Degree)	RAW VALUE (dBuV)	CORRECTION FACTOR (dB/m)
1	2390.00	56.7 PK	74.0	-17.3	3.62 V	31	58.7	-2.0
2	2390.00	44.2 AV	54.0	-9.8	3.62 V	31	46.2	-2.0
3	*2437.00	111.4 PK			3.62 V	31	113.5	-2.1
4	*2437.00	101.1 AV			3.62 V	31	103.2	-2.1
5	2483.50	57.8 PK	74.0	-16.2	3.62 V	31	60.0	-2.2
6	2483.50	45.6 AV	54.0	-8.4	3.62 V	31	47.8	-2.2
7	4874.00	45.6 PK	74.0	-28.4	1.10 V	205	43.3	2.3
8	4874.00	32.0 AV	54.0	-22.0	1.10 V	205	29.7	2.3
9	7311.00	48.3 PK	74.0	-25.7	1.21 V	193	40.0	8.3
10	7311.00	35.2 AV	54.0	-18.8	1.21 V	193	26.9	8.3

REMARKS:

1. Emission Level(dBuV/m) = Raw Value(dBuV) + Correction Factor(dB/m)
2. Correction Factor(dB/m) = Antenna Factor(dB/m) + Cable Factor(dB) – Pre-Amplifier Factor(dB)
3. Margin value = Emission Level – Limit value
4. The other emission levels were very low against the limit.
5. " * ": Fundamental frequency.

CHANNEL	TX Channel 11	DETECTOR FUNCTION	Peak (PK)
FREQUENCY RANGE	1GHz ~ 25GHz		Average (AV)

ANTENNA POLARITY & TEST DISTANCE: HORIZONTAL AT 3 M

NO.	FREQ. (MHz)	EMISSION LEVEL (dBuV/m)	LIMIT (dBuV/m)	MARGIN (dB)	ANTENNA HEIGHT (m)	TABLE ANGLE (Degree)	RAW VALUE (dBuV)	CORRECTION FACTOR (dB/m)
1	*2462.00	109.8 PK			2.92 H	279	112.0	-2.2
2	*2462.00	100.4 AV			2.92 H	279	102.6	-2.2
3	2483.50	69.2 PK	74.0	-4.8	2.92 H	279	71.4	-2.2
4	2483.50	53.7 AV	54.0	-0.3	2.92 H	279	55.9	-2.2
5	4924.00	43.7 PK	74.0	-30.3	3.13 H	76	41.2	2.5
6	4924.00	31.1 AV	54.0	-22.9	3.13 H	76	28.6	2.5
7	7386.00	50.6 PK	74.0	-23.4	1.10 H	312	42.3	8.3
8	7386.00	36.8 AV	54.0	-17.2	1.10 H	312	28.5	8.3

ANTENNA POLARITY & TEST DISTANCE: VERTICAL AT 3 M

NO.	FREQ. (MHz)	EMISSION LEVEL (dBuV/m)	LIMIT (dBuV/m)	MARGIN (dB)	ANTENNA HEIGHT (m)	TABLE ANGLE (Degree)	RAW VALUE (dBuV)	CORRECTION FACTOR (dB/m)
1	*2462.00	108.9 PK			3.99 V	35	111.1	-2.2
2	*2462.00	98.7 AV			3.99 V	35	100.9	-2.2
3	2483.50	58.8 PK	74.0	-15.2	3.99 V	35	61.0	-2.2
4	2483.50	46.2 AV	54.0	-7.8	3.99 V	35	48.4	-2.2
5	4924.00	46.0 PK	74.0	-28.0	1.06 V	197	43.5	2.5
6	4924.00	32.5 AV	54.0	-21.5	1.06 V	197	30.0	2.5
7	7386.00	47.8 PK	74.0	-26.2	1.27 V	181	39.5	8.3
8	7386.00	35.2 AV	54.0	-18.8	1.27 V	181	26.9	8.3

REMARKS:

1. Emission Level(dBuV/m) = Raw Value(dBuV) + Correction Factor(dB/m)
2. Correction Factor(dB/m) = Antenna Factor(dB/m) + Cable Factor(dB) – Pre-Amplifier Factor(dB)
3. Margin value = Emission Level – Limit value
4. The other emission levels were very low against the limit.
5. " * ": Fundamental frequency.

802.11n (HT40)

CHANNEL	TX Channel 3	DETECTOR FUNCTION	Peak (PK)
FREQUENCY RANGE	1GHz ~ 25GHz		Average (AV)

ANTENNA POLARITY & TEST DISTANCE: HORIZONTAL AT 3 M

NO.	FREQ. (MHz)	EMISSION LEVEL (dBuV/m)	LIMIT (dBuV/m)	MARGIN (dB)	ANTENNA HEIGHT (m)	TABLE ANGLE (Degree)	RAW VALUE (dBuV)	CORRECTION FACTOR (dB/m)
1	2390.00	66.6 PK	74.0	-7.4	2.74 H	269	68.6	-2.0
2	2390.00	53.6 AV	54.0	-0.4	2.74 H	269	55.6	-2.0
3	*2422.00	103.0 PK			2.74 H	269	105.0	-2.0
4	*2422.00	94.1 AV			2.74 H	269	96.1	-2.0
5	4844.00	44.2 PK	74.0	-29.8	3.13 H	104	41.9	2.3
6	4844.00	31.2 AV	54.0	-22.8	3.13 H	104	28.9	2.3
7	7266.00	50.7 PK	74.0	-23.3	1.11 H	313	42.3	8.4
8	7266.00	37.3 AV	54.0	-16.7	1.11 H	313	28.9	8.4

ANTENNA POLARITY & TEST DISTANCE: VERTICAL AT 3 M

NO.	FREQ. (MHz)	EMISSION LEVEL (dBuV/m)	LIMIT (dBuV/m)	MARGIN (dB)	ANTENNA HEIGHT (m)	TABLE ANGLE (Degree)	RAW VALUE (dBuV)	CORRECTION FACTOR (dB/m)
1	2390.00	57.1 PK	74.0	-16.9	4.00 V	27	59.1	-2.0
2	2390.00	45.0 AV	54.0	-9.0	4.00 V	27	47.0	-2.0
3	*2422.00	101.1 PK			4.00 V	27	103.1	-2.0
4	*2422.00	92.1 AV			4.00 V	27	94.1	-2.0
5	4844.00	46.1 PK	74.0	-27.9	1.05 V	186	43.8	2.3
6	4844.00	32.5 AV	54.0	-21.5	1.05 V	186	30.2	2.3
7	7266.00	48.0 PK	74.0	-26.0	1.26 V	191	39.6	8.4
8	7266.00	35.2 AV	54.0	-18.8	1.26 V	191	26.8	8.4

REMARKS:

1. Emission Level(dBuV/m) = Raw Value(dBuV) + Correction Factor(dB/m)
2. Correction Factor(dB/m) = Antenna Factor(dB/m) + Cable Factor(dB) – Pre-Amplifier Factor(dB)
3. Margin value = Emission Level – Limit value
4. The other emission levels were very low against the limit.
5. " * ": Fundamental frequency.

CHANNEL	TX Channel 6	DETECTOR FUNCTION	Peak (PK)
FREQUENCY RANGE	1GHz ~ 25GHz		Average (AV)

ANTENNA POLARITY & TEST DISTANCE: HORIZONTAL AT 3 M

NO.	FREQ. (MHz)	EMISSION LEVEL (dBuV/m)	LIMIT (dBuV/m)	MARGIN (dB)	ANTENNA HEIGHT (m)	TABLE ANGLE (Degree)	RAW VALUE (dBuV)	CORRECTION FACTOR (dB/m)
1	2390.00	66.2 PK	74.0	-7.8	3.04 H	294	68.2	-2.0
2	2390.00	52.1 AV	54.0	-1.9	3.04 H	294	54.1	-2.0
3	*2437.00	107.7 PK			3.04 H	294	109.8	-2.1
4	*2437.00	98.7 AV			3.04 H	294	100.8	-2.1
5	2483.50	66.4 PK	74.0	-7.6	3.04 H	294	68.6	-2.2
6	2483.50	52.6 AV	54.0	-1.4	3.04 H	294	54.8	-2.2
7	4874.00	44.5 PK	74.0	-29.5	3.15 H	79	42.2	2.3
8	4874.00	31.7 AV	54.0	-22.3	3.15 H	79	29.4	2.3
9	7311.00	51.1 PK	74.0	-22.9	1.04 H	310	42.8	8.3
10	7311.00	37.4 AV	54.0	-16.6	1.04 H	310	29.1	8.3

ANTENNA POLARITY & TEST DISTANCE: VERTICAL AT 3 M

NO.	FREQ. (MHz)	EMISSION LEVEL (dBuV/m)	LIMIT (dBuV/m)	MARGIN (dB)	ANTENNA HEIGHT (m)	TABLE ANGLE (Degree)	RAW VALUE (dBuV)	CORRECTION FACTOR (dB/m)
1	2390.00	56.9 PK	74.0	-17.1	3.98 V	25	58.9	-2.0
2	2390.00	44.6 AV	54.0	-9.4	3.98 V	25	46.6	-2.0
3	*2437.00	104.9 PK			3.98 V	25	107.0	-2.1
4	*2437.00	95.9 AV			3.98 V	25	98.0	-2.1
5	2483.50	57.1 PK	74.0	-16.9	3.98 V	25	59.3	-2.2
6	2483.50	45.1 AV	54.0	-8.9	3.98 V	25	47.3	-2.2
7	4874.00	46.0 PK	74.0	-28.0	1.10 V	182	43.7	2.3
8	4874.00	32.3 AV	54.0	-21.7	1.10 V	182	30.0	2.3
9	7311.00	48.2 PK	74.0	-25.8	1.28 V	169	39.9	8.3
10	7311.00	35.4 AV	54.0	-18.6	1.28 V	169	27.1	8.3

REMARKS:

1. Emission Level(dBuV/m) = Raw Value(dBuV) + Correction Factor(dB/m)
2. Correction Factor(dB/m) = Antenna Factor(dB/m) + Cable Factor(dB) – Pre-Amplifier Factor(dB)
3. Margin value = Emission Level – Limit value
4. The other emission levels were very low against the limit.
5. " * ": Fundamental frequency.

CHANNEL	TX Channel 9	DETECTOR FUNCTION	Peak (PK)
FREQUENCY RANGE	1GHz ~ 25GHz		Average (AV)

ANTENNA POLARITY & TEST DISTANCE: HORIZONTAL AT 3 M

NO.	FREQ. (MHz)	EMISSION LEVEL (dBuV/m)	LIMIT (dBuV/m)	MARGIN (dB)	ANTENNA HEIGHT (m)	TABLE ANGLE (Degree)	RAW VALUE (dBuV)	CORRECTION FACTOR (dB/m)
1	*2452.00	103.4 PK			3.22 H	290	105.6	-2.2
2	*2452.00	94.7 AV			3.22 H	290	96.9	-2.2
3	2483.50	66.0 PK	74.0	-8.0	3.22 H	290	68.2	-2.2
4	2483.50	53.1 AV	54.0	-0.9	3.22 H	290	55.3	-2.2
5	4904.00	44.8 PK	74.0	-29.2	3.07 H	104	42.4	2.4
6	4904.00	31.7 AV	54.0	-22.3	3.07 H	104	29.3	2.4
7	7356.00	50.3 PK	74.0	-23.7	1.00 H	295	42.1	8.2
8	7356.00	36.8 AV	54.0	-17.2	1.00 H	295	28.6	8.2

ANTENNA POLARITY & TEST DISTANCE: VERTICAL AT 3 M

NO.	FREQ. (MHz)	EMISSION LEVEL (dBuV/m)	LIMIT (dBuV/m)	MARGIN (dB)	ANTENNA HEIGHT (m)	TABLE ANGLE (Degree)	RAW VALUE (dBuV)	CORRECTION FACTOR (dB/m)
1	*2452.00	100.8 PK			3.98 V	24	103.0	-2.2
2	*2452.00	92.1 AV			3.98 V	24	94.3	-2.2
3	2483.50	57.0 PK	74.0	-17.0	3.98 V	24	59.2	-2.2
4	2483.50	44.9 AV	54.0	-9.1	3.98 V	24	47.1	-2.2
5	4904.00	45.9 PK	74.0	-28.1	1.05 V	189	43.5	2.4
6	4904.00	32.7 AV	54.0	-21.3	1.05 V	189	30.3	2.4
7	7356.00	47.4 PK	74.0	-26.6	1.21 V	192	39.2	8.2
8	7356.00	35.0 AV	54.0	-19.0	1.21 V	192	26.8	8.2

REMARKS:

1. Emission Level(dBuV/m) = Raw Value(dBuV) + Correction Factor(dB/m)
2. Correction Factor(dB/m) = Antenna Factor(dB/m) + Cable Factor(dB) – Pre-Amplifier Factor(dB)
3. Margin value = Emission Level – Limit value
4. The other emission levels were very low against the limit.
5. " * ": Fundamental frequency.

Below 1GHz Data:

802.11n (HT20)

CHANNEL	TX Channel 6	DETECTOR FUNCTION	Quasi-Peak (QP)
FREQUENCY RANGE	9kHz ~ 1GHz		

ANTENNA POLARITY & TEST DISTANCE: HORIZONTAL AT 3 M								
NO.	FREQ. (MHz)	EMISSION LEVEL (dBuV/m)	LIMIT (dBuV/m)	MARGIN (dB)	ANTENNA HEIGHT (m)	TABLE ANGLE (Degree)	RAW VALUE (dBuV)	CORRECTION FACTOR (dB/m)
1	48.89	29.1 QP	40.0	-10.9	1.50 H	133	37.7	-8.6
2	161.58	27.4 QP	43.5	-16.1	1.00 H	195	35.5	-8.1
3	250.12	30.0 QP	46.0	-16.0	1.50 H	237	38.3	-8.3
4	323.13	27.3 QP	46.0	-18.7	1.00 H	194	32.9	-5.6
5	451.03	27.7 QP	46.0	-18.3	1.00 H	272	30.7	-3.0
6	538.09	29.0 QP	46.0	-17.0	1.00 H	360	30.0	-1.0

REMARKS:

1. Emission Level(dBuV/m) = Raw Value(dBuV) + Correction Factor(dB/m)
2. Correction Factor(dB/m) = Antenna Factor(dB/m) + Cable Factor(dB) – Pre-Amplifier Factor(dB)
3. Margin value = Emission Level – Limit value
4. The other emission levels were very low against the limit of frequency range 30MHz~1000MHz.
5. The emission levels were very low against the limit of frequency range 9kHz~30MHz: the amplitude of spurious emissions attenuated more than 20 dB below the permissible value to be report.

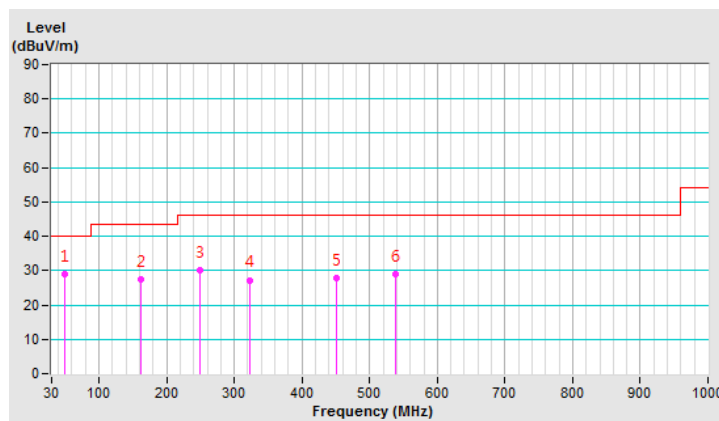

CHANNEL	TX Channel 6	DETECTOR FUNCTION	Quasi-Peak (QP)
FREQUENCY RANGE	9kHz ~ 1GHz		

ANTENNA POLARITY & TEST DISTANCE: VERTICAL AT 3 M								
NO.	FREQ. (MHz)	EMISSION LEVEL (dBuV/m)	LIMIT (dBuV/m)	MARGIN (dB)	ANTENNA HEIGHT (m)	TABLE ANGLE (Degree)	RAW VALUE (dBuV)	CORRECTION FACTOR (dB/m)
1	50.10	30.8 QP	40.0	-9.2	2.00 V	234	39.3	-8.5
2	93.92	28.3 QP	43.5	-15.2	1.00 V	283	41.2	-12.9
3	137.67	26.6 QP	43.5	-16.9	3.00 V	245	35.0	-8.4
4	257.44	30.6 QP	46.0	-15.4	1.00 V	215	38.7	-8.1
5	456.97	29.1 QP	46.0	-16.9	2.00 V	354	31.8	-2.7
6	558.46	31.0 QP	46.0	-15.0	2.00 V	224	31.4	-0.4

REMARKS:

1. Emission Level(dBuV/m) = Raw Value(dBuV) + Correction Factor(dB/m)
2. Correction Factor(dB/m) = Antenna Factor(dB/m) + Cable Factor(dB) – Pre-Amplifier Factor(dB)
3. Margin value = Emission Level – Limit value
4. The other emission levels were very low against the limit of frequency range 30MHz~1000MHz.
5. The emission levels were very low against the limit of frequency range 9kHz~30MHz: the amplitude of spurious emissions attenuated more than 20 dB below the permissible value to be report.

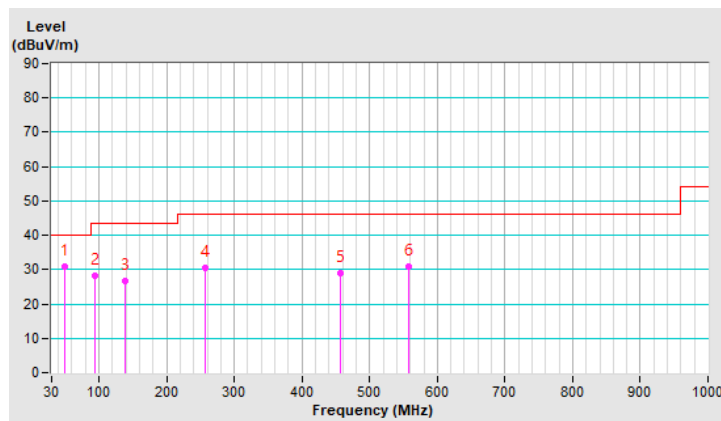

4.1.8 Test Results (Dipole antenna)

Above 1GHz Data:

802.11b

CHANNEL	TX Channel 1	DETECTOR FUNCTION	Peak (PK)
FREQUENCY RANGE	1GHz ~ 25GHz		Average (AV)

ANTENNA POLARITY & TEST DISTANCE: HORIZONTAL AT 3 M								
NO.	FREQ. (MHz)	EMISSION LEVEL (dBuV/m)	LIMIT (dBuV/m)	MARGIN (dB)	ANTENNA HEIGHT (m)	TABLE ANGLE (Degree)	RAW VALUE (dBuV)	CORRECTION FACTOR (dB/m)
1	2386.22	58.2 PK	74.0	-15.8	1.26 H	39	60.2	-2.0
2	2386.22	46.6 AV	54.0	-7.4	1.26 H	39	48.6	-2.0
3	2390.00	58.2 PK	74.0	-15.8	1.26 H	39	60.2	-2.0
4	2390.00	46.3 AV	54.0	-7.7	1.26 H	39	48.3	-2.0
5	*2412.00	105.3 PK			1.26 H	39	107.3	-2.0
6	*2412.00	100.2 AV			1.26 H	39	102.2	-2.0
7	4824.00	45.6 PK	74.0	-28.4	1.15 H	318	43.3	2.3
8	4824.00	41.4 AV	54.0	-12.6	1.15 H	318	39.1	2.3
9	12060.00	52.9 PK	74.0	-21.1	1.47 H	292	40.5	12.4
10	12060.00	46.3 AV	54.0	-7.7	1.47 H	292	33.9	12.4
11	14472.00	53.2 PK	74.0	-20.8	1.44 H	354	37.7	15.5
12	14472.00	46.1 AV	54.0	-7.9	1.44 H	354	30.6	15.5

ANTENNA POLARITY & TEST DISTANCE: VERTICAL AT 3 M								
NO.	FREQ. (MHz)	EMISSION LEVEL (dBuV/m)	LIMIT (dBuV/m)	MARGIN (dB)	ANTENNA HEIGHT (m)	TABLE ANGLE (Degree)	RAW VALUE (dBuV)	CORRECTION FACTOR (dB/m)
1	2386.22	60.5 PK	74.0	-13.5	1.28 V	296	62.5	-2.0
2	2386.22	53.2 AV	54.0	-0.8	1.28 V	296	55.2	-2.0
3	2390.00	60.3 PK	74.0	-13.7	1.28 V	296	62.3	-2.0
4	2390.00	53.1 AV	54.0	-0.9	1.28 V	296	55.1	-2.0
5	*2412.00	111.6 PK			1.28 V	296	113.6	-2.0
6	*2412.00	109.4 AV			1.28 V	296	111.4	-2.0
7	4824.00	47.3 PK	74.0	-26.7	2.54 V	150	45.0	2.3
8	4824.00	43.4 AV	54.0	-10.6	2.54 V	150	41.1	2.3
9	12060.00	57.9 PK	74.0	-16.1	2.44 V	71	45.5	12.4
10	12060.00	53.7 AV	54.0	-0.3	2.44 V	71	41.3	12.4
11	14472.00	55.7 PK	74.0	-18.3	2.40 V	66	40.2	15.5
12	14472.00	52.2 AV	54.0	-1.8	2.40 V	66	36.7	15.5

REMARKS:

1. Emission Level(dBuV/m) = Raw Value(dBuV) + Correction Factor(dB/m)
2. Correction Factor(dB/m) = Antenna Factor(dB/m) + Cable Factor(dB) – Pre-Amplifier Factor(dB)
3. Margin value = Emission Level – Limit value
4. The other emission levels were very low against the limit.
5. " * ": Fundamental frequency.

CHANNEL	TX Channel 6	DETECTOR FUNCTION	Peak (PK)
FREQUENCY RANGE	1GHz ~ 25GHz		Average (AV)

ANTENNA POLARITY & TEST DISTANCE: HORIZONTAL AT 3 M

NO.	FREQ. (MHz)	EMISSION LEVEL (dBuV/m)	LIMIT (dBuV/m)	MARGIN (dB)	ANTENNA HEIGHT (m)	TABLE ANGLE (Degree)	RAW VALUE (dBuV)	CORRECTION FACTOR (dB/m)
1	2388.19	56.4 PK	74.0	-17.6	1.21 H	26	58.4	-2.0
2	2388.19	43.7 AV	54.0	-10.3	1.21 H	26	45.7	-2.0
3	2390.00	56.1 PK	74.0	-17.9	1.21 H	26	58.1	-2.0
4	2390.00	43.6 AV	54.0	-10.4	1.21 H	26	45.6	-2.0
5	*2437.00	106.6 PK			1.21 H	26	108.7	-2.1
6	*2437.00	104.4 AV			1.21 H	26	106.5	-2.1
7	2483.50	57.2 PK	74.0	-16.8	1.21 H	26	59.4	-2.2
8	2483.50	44.2 AV	54.0	-9.8	1.21 H	26	46.4	-2.2
9	4874.00	45.5 PK	74.0	-28.5	1.01 H	344	43.2	2.3
10	4874.00	41.3 AV	54.0	-12.7	1.01 H	344	39.0	2.3
11	7311.00	50.4 PK	74.0	-23.6	1.27 H	56	42.1	8.3
12	7311.00	44.7 AV	54.0	-9.3	1.27 H	56	36.4	8.3
13	12185.00	53.5 PK	74.0	-20.5	1.42 H	288	41.0	12.5
14	12185.00	46.7 AV	54.0	-7.3	1.42 H	288	34.2	12.5

ANTENNA POLARITY & TEST DISTANCE: VERTICAL AT 3 M

NO.	FREQ. (MHz)	EMISSION LEVEL (dBuV/m)	LIMIT (dBuV/m)	MARGIN (dB)	ANTENNA HEIGHT (m)	TABLE ANGLE (Degree)	RAW VALUE (dBuV)	CORRECTION FACTOR (dB/m)
1	2388.19	59.7 PK	74.0	-14.3	1.23 V	265	61.7	-2.0
2	2388.19	49.5 AV	54.0	-4.5	1.23 V	265	51.5	-2.0
3	2390.00	59.6 PK	74.0	-14.4	1.23 V	265	61.6	-2.0
4	2390.00	49.3 AV	54.0	-4.7	1.23 V	265	51.3	-2.0
5	*2437.00	117.2 PK			1.23 V	265	119.3	-2.1
6	*2437.00	115.0 AV			1.23 V	265	117.1	-2.1
7	2483.50	59.9 PK	74.0	-14.1	1.23 V	265	62.1	-2.2
8	2483.50	49.6 AV	54.0	-4.4	1.23 V	265	51.8	-2.2
9	4874.00	51.3 PK	74.0	-22.7	2.78 V	154	49.0	2.3
10	4874.00	49.2 AV	54.0	-4.8	2.78 V	154	46.9	2.3
11	7311.00	52.3 PK	74.0	-21.7	2.59 V	242	44.0	8.3
12	7311.00	48.0 AV	54.0	-6.0	2.59 V	242	39.7	8.3
13	12185.00	58.0 PK	74.0	-16.0	2.38 V	61	45.5	12.5
14	12185.00	53.7 AV	54.0	-0.3	2.38 V	61	41.2	12.5

REMARKS:

1. Emission Level(dBuV/m) = Raw Value(dBuV) + Correction Factor(dB/m)
2. Correction Factor(dB/m) = Antenna Factor(dB/m) + Cable Factor(dB) – Pre-Amplifier Factor(dB)
3. Margin value = Emission Level – Limit value
4. The other emission levels were very low against the limit.
5. " * ": Fundamental frequency.

CHANNEL	TX Channel 11	DETECTOR FUNCTION	Peak (PK)
FREQUENCY RANGE	1GHz ~ 25GHz		Average (AV)

ANTENNA POLARITY & TEST DISTANCE: HORIZONTAL AT 3 M

NO.	FREQ. (MHz)	EMISSION LEVEL (dBuV/m)	LIMIT (dBuV/m)	MARGIN (dB)	ANTENNA HEIGHT (m)	TABLE ANGLE (Degree)	RAW VALUE (dBuV)	CORRECTION FACTOR (dB/m)
1	*2462.00	104.9 PK			1.15 H	36	107.1	-2.2
2	*2462.00	99.7 AV			1.15 H	36	101.9	-2.2
3	2483.50	56.4 PK	74.0	-17.6	1.15 H	36	58.6	-2.2
4	2483.50	46.1 AV	54.0	-7.9	1.15 H	36	48.3	-2.2
5	2485.83	56.7 PK	74.0	-17.3	1.15 H	36	58.9	-2.2
6	2485.83	46.2 AV	54.0	-7.8	1.15 H	36	48.4	-2.2
7	4924.00	46.1 PK	74.0	-27.9	1.17 H	331	43.6	2.5
8	4924.00	41.8 AV	54.0	-12.2	1.17 H	331	39.3	2.5
9	7386.00	51.2 PK	74.0	-22.8	1.29 H	63	42.9	8.3
10	7386.00	45.4 AV	54.0	-8.6	1.29 H	63	37.1	8.3
11	12310.00	52.8 PK	74.0	-21.2	1.41 H	279	40.3	12.5
12	12310.00	46.2 AV	54.0	-7.8	1.41 H	279	33.7	12.5

ANTENNA POLARITY & TEST DISTANCE: VERTICAL AT 3 M

NO.	FREQ. (MHz)	EMISSION LEVEL (dBuV/m)	LIMIT (dBuV/m)	MARGIN (dB)	ANTENNA HEIGHT (m)	TABLE ANGLE (Degree)	RAW VALUE (dBuV)	CORRECTION FACTOR (dB/m)
1	*2462.00	111.8 PK			1.26 V	262	114.0	-2.2
2	*2462.00	109.6 AV			1.26 V	262	111.8	-2.2
3	2483.50	60.8 PK	74.0	-13.2	1.26 V	262	63.0	-2.2
4	2483.50	52.5 AV	54.0	-1.5	1.26 V	262	54.7	-2.2
5	2485.83	60.8 PK	74.0	-13.2	1.26 V	262	63.0	-2.2
6	2485.83	52.6 AV	54.0	-1.4	1.26 V	262	54.8	-2.2
7	4924.00	50.6 PK	74.0	-23.4	2.80 V	164	48.1	2.5
8	4924.00	48.7 AV	54.0	-5.3	2.80 V	164	46.2	2.5
9	7386.00	52.4 PK	74.0	-21.6	2.61 V	231	44.1	8.3
10	7386.00	48.0 AV	54.0	-6.0	2.61 V	231	39.7	8.3
11	12310.00	58.0 PK	74.0	-16.0	2.39 V	68	45.5	12.5
12	12310.00	53.6 AV	54.0	-0.4	2.39 V	68	41.1	12.5

REMARKS:

1. Emission Level(dBuV/m) = Raw Value(dBuV) + Correction Factor(dB/m)
2. Correction Factor(dB/m) = Antenna Factor(dB/m) + Cable Factor(dB) – Pre-Amplifier Factor(dB)
3. Margin value = Emission Level – Limit value
4. The other emission levels were very low against the limit.
5. " * ": Fundamental frequency.

802.11g

CHANNEL	TX Channel 1	DETECTOR FUNCTION	Peak (PK)
FREQUENCY RANGE	1GHz ~ 25GHz		Average (AV)

ANTENNA POLARITY & TEST DISTANCE: HORIZONTAL AT 3 M

NO.	FREQ. (MHz)	EMISSION LEVEL (dBuV/m)	LIMIT (dBuV/m)	MARGIN (dB)	ANTENNA HEIGHT (m)	TABLE ANGLE (Degree)	RAW VALUE (dBuV)	CORRECTION FACTOR (dB/m)
1	2390.00	65.7 PK	74.0	-8.3	1.21 H	26	67.7	-2.0
2	2390.00	47.7 AV	54.0	-6.3	1.21 H	26	49.7	-2.0
3	*2412.00	103.5 PK			1.21 H	26	105.5	-2.0
4	*2412.00	93.4 AV			1.21 H	26	95.4	-2.0
5	4824.00	40.1 PK	74.0	-33.9	1.19 H	324	37.8	2.3
6	4824.00	35.6 AV	54.0	-18.4	1.19 H	324	33.3	2.3

ANTENNA POLARITY & TEST DISTANCE: VERTICAL AT 3 M

NO.	FREQ. (MHz)	EMISSION LEVEL (dBuV/m)	LIMIT (dBuV/m)	MARGIN (dB)	ANTENNA HEIGHT (m)	TABLE ANGLE (Degree)	RAW VALUE (dBuV)	CORRECTION FACTOR (dB/m)
1	2390.00	71.2 PK	74.0	-2.8	1.27 V	248	73.2	-2.0
2	2390.00	53.2 AV	54.0	-0.8	1.27 V	248	55.2	-2.0
3	*2412.00	109.2 PK			1.27 V	248	111.2	-2.0
4	*2412.00	100.2 AV			1.27 V	248	102.2	-2.0
5	4824.00	43.6 PK	74.0	-30.4	2.74 V	160	41.3	2.3
6	4824.00	38.5 AV	54.0	-15.5	2.74 V	160	36.2	2.3

REMARKS:

1. Emission Level(dBuV/m) = Raw Value(dBuV) + Correction Factor(dB/m)
2. Correction Factor(dB/m) = Antenna Factor(dB/m) + Cable Factor(dB) – Pre-Amplifier Factor(dB)
3. Margin value = Emission Level – Limit value
4. The other emission levels were very low against the limit.
5. " * ": Fundamental frequency.

CHANNEL	TX Channel 6	DETECTOR FUNCTION	Peak (PK)
FREQUENCY RANGE	1GHz ~ 25GHz		Average (AV)

ANTENNA POLARITY & TEST DISTANCE: HORIZONTAL AT 3 M

NO.	FREQ. (MHz)	EMISSION LEVEL (dBuV/m)	LIMIT (dBuV/m)	MARGIN (dB)	ANTENNA HEIGHT (m)	TABLE ANGLE (Degree)	RAW VALUE (dBuV)	CORRECTION FACTOR (dB/m)
1	2390.00	67.4 PK	74.0	-6.6	1.28 H	37	69.4	-2.0
2	2390.00	46.4 AV	54.0	-7.6	1.28 H	37	48.4	-2.0
3	*2437.00	109.2 PK			1.28 H	37	111.3	-2.1
4	*2437.00	97.6 AV			1.28 H	37	99.7	-2.1
5	2483.50	67.1 PK	74.0	-6.9	1.28 H	37	69.3	-2.2
6	2483.50	45.7 AV	54.0	-8.3	1.28 H	37	47.9	-2.2
7	4874.00	44.1 PK	74.0	-29.9	1.23 H	317	41.8	2.3
8	4874.00	39.6 AV	54.0	-14.4	1.23 H	317	37.3	2.3
9	7311.00	50.0 PK	74.0	-24.0	1.16 H	65	41.7	8.3
10	7311.00	41.2 AV	54.0	-12.8	1.16 H	65	32.9	8.3

ANTENNA POLARITY & TEST DISTANCE: VERTICAL AT 3 M

NO.	FREQ. (MHz)	EMISSION LEVEL (dBuV/m)	LIMIT (dBuV/m)	MARGIN (dB)	ANTENNA HEIGHT (m)	TABLE ANGLE (Degree)	RAW VALUE (dBuV)	CORRECTION FACTOR (dB/m)
1	2390.00	72.6 PK	74.0	-1.4	1.27 V	261	74.6	-2.0
2	2390.00	51.5 AV	54.0	-2.5	1.27 V	261	53.5	-2.0
3	*2437.00	114.8 PK			1.27 V	261	116.9	-2.1
4	*2437.00	105.9 AV			1.27 V	261	108.0	-2.1
5	2483.50	72.9 PK	74.0	-1.1	1.27 V	261	75.1	-2.2
6	2483.50	51.0 AV	54.0	-3.0	1.27 V	261	53.2	-2.2
7	4874.00	50.0 PK	74.0	-24.0	2.78 V	158	47.7	2.3
8	4874.00	46.3 AV	54.0	-7.7	2.78 V	158	44.0	2.3
9	7311.00	51.6 PK	74.0	-22.4	2.60 V	231	43.3	8.3
10	7311.00	44.2 AV	54.0	-9.8	2.60 V	231	35.9	8.3

REMARKS:

1. Emission Level(dBuV/m) = Raw Value(dBuV) + Correction Factor(dB/m)
2. Correction Factor(dB/m) = Antenna Factor(dB/m) + Cable Factor(dB) – Pre-Amplifier Factor(dB)
3. Margin value = Emission Level – Limit value
4. The other emission levels were very low against the limit.
5. " * ": Fundamental frequency.

CHANNEL	TX Channel 11	DETECTOR FUNCTION	Peak (PK)
FREQUENCY RANGE	1GHz ~ 25GHz		Average (AV)

ANTENNA POLARITY & TEST DISTANCE: HORIZONTAL AT 3 M

NO.	FREQ. (MHz)	EMISSION LEVEL (dBuV/m)	LIMIT (dBuV/m)	MARGIN (dB)	ANTENNA HEIGHT (m)	TABLE ANGLE (Degree)	RAW VALUE (dBuV)	CORRECTION FACTOR (dB/m)
1	*2462.00	103.7 PK			1.18 H	46	105.9	-2.2
2	*2462.00	93.7 AV			1.18 H	46	95.9	-2.2
3	2483.50	65.2 PK	74.0	-8.8	1.18 H	46	67.4	-2.2
4	2483.50	49.7 AV	54.0	-4.3	1.18 H	46	51.9	-2.2
5	4924.00	41.2 PK	74.0	-32.8	1.33 H	309	38.7	2.5
6	4924.00	36.4 AV	54.0	-17.6	1.33 H	309	33.9	2.5
7	7386.00	45.0 PK	74.0	-29.0	1.20 H	70	36.7	8.3
8	7386.00	39.1 AV	54.0	-14.9	1.20 H	70	30.8	8.3

ANTENNA POLARITY & TEST DISTANCE: VERTICAL AT 3 M

NO.	FREQ. (MHz)	EMISSION LEVEL (dBuV/m)	LIMIT (dBuV/m)	MARGIN (dB)	ANTENNA HEIGHT (m)	TABLE ANGLE (Degree)	RAW VALUE (dBuV)	CORRECTION FACTOR (dB/m)
1	*2462.00	109.1 PK			1.26 V	245	111.3	-2.2
2	*2462.00	99.5 AV			1.26 V	245	101.7	-2.2
3	2483.50	69.5 PK	74.0	-4.5	1.26 V	245	71.7	-2.2
4	2483.50	53.4 AV	54.0	-0.6	1.26 V	245	55.6	-2.2
5	4924.00	44.2 PK	74.0	-29.8	2.67 V	163	41.7	2.5
6	4924.00	40.3 AV	54.0	-13.7	2.67 V	163	37.8	2.5
7	7386.00	45.6 PK	74.0	-28.4	2.57 V	225	37.3	8.3
8	7386.00	38.7 AV	54.0	-15.3	2.57 V	225	30.4	8.3

REMARKS:

1. Emission Level(dBuV/m) = Raw Value(dBuV) + Correction Factor(dB/m)
2. Correction Factor(dB/m) = Antenna Factor(dB/m) + Cable Factor(dB) – Pre-Amplifier Factor(dB)
3. Margin value = Emission Level – Limit value
4. The other emission levels were very low against the limit.
5. " * ": Fundamental frequency.

802.11n (HT20)

CHANNEL	TX Channel 1	DETECTOR FUNCTION	Peak (PK)
FREQUENCY RANGE	1GHz ~ 25GHz		Average (AV)

ANTENNA POLARITY & TEST DISTANCE: HORIZONTAL AT 3 M

NO.	FREQ. (MHz)	EMISSION LEVEL (dBuV/m)	LIMIT (dBuV/m)	MARGIN (dB)	ANTENNA HEIGHT (m)	TABLE ANGLE (Degree)	RAW VALUE (dBuV)	CORRECTION FACTOR (dB/m)
1	2389.27	65.5 PK	74.0	-8.5	1.26 H	39	67.5	-2.0
2	2389.27	47.1 AV	54.0	-6.9	1.26 H	39	49.1	-2.0
3	2390.00	65.5 PK	74.0	-8.5	1.32 H	53	67.5	-2.0
4	2390.00	46.3 AV	54.0	-7.7	1.32 H	53	48.3	-2.0
5	*2412.00	102.2 PK			1.26 H	39	104.2	-2.0
6	*2412.00	93.3 AV			1.26 H	39	95.3	-2.0
7	4824.00	40.4 PK	74.0	-33.6	1.14 H	316	38.1	2.3
8	4824.00	36.1 AV	54.0	-17.9	1.14 H	316	33.8	2.3

ANTENNA POLARITY & TEST DISTANCE: VERTICAL AT 3 M

NO.	FREQ. (MHz)	EMISSION LEVEL (dBuV/m)	LIMIT (dBuV/m)	MARGIN (dB)	ANTENNA HEIGHT (m)	TABLE ANGLE (Degree)	RAW VALUE (dBuV)	CORRECTION FACTOR (dB/m)
1	2389.27	70.5 PK	74.0	-3.5	1.30 V	248	72.5	-2.0
2	2389.27	52.8 AV	54.0	-1.2	1.30 V	248	54.8	-2.0
3	2390.00	70.5 PK	74.0	-3.5	1.35 V	236	72.5	-2.0
4	2390.00	52.5 AV	54.0	-1.5	1.35 V	236	54.5	-2.0
5	*2412.00	109.2 PK			1.30 V	248	111.2	-2.0
6	*2412.00	100.3 AV			1.30 V	248	102.3	-2.0
7	4824.00	44.2 PK	74.0	-29.8	2.71 V	161	41.9	2.3
8	4824.00	39.0 AV	54.0	-15.0	2.71 V	161	36.7	2.3

REMARKS:

1. Emission Level(dBuV/m) = Raw Value(dBuV) + Correction Factor(dB/m)
2. Correction Factor(dB/m) = Antenna Factor(dB/m) + Cable Factor(dB) – Pre-Amplifier Factor(dB)
3. Margin value = Emission Level – Limit value
4. The other emission levels were very low against the limit.
5. " * ": Fundamental frequency.

CHANNEL	TX Channel 6	DETECTOR FUNCTION	Peak (PK)
FREQUENCY RANGE	1GHz ~ 25GHz		Average (AV)

ANTENNA POLARITY & TEST DISTANCE: HORIZONTAL AT 3 M

NO.	FREQ. (MHz)	EMISSION LEVEL (dBuV/m)	LIMIT (dBuV/m)	MARGIN (dB)	ANTENNA HEIGHT (m)	TABLE ANGLE (Degree)	RAW VALUE (dBuV)	CORRECTION FACTOR (dB/m)
1	2390.00	66.7 PK	74.0	-7.3	1.24 H	50	68.7	-2.0
2	2390.00	46.3 AV	54.0	-7.7	1.24 H	50	48.3	-2.0
3	*2437.00	108.9 PK			1.24 H	50	111.0	-2.1
4	*2437.00	98.2 AV			1.24 H	50	100.3	-2.1
5	2483.50	69.5 PK	74.0	-4.5	1.24 H	50	71.7	-2.2
6	2483.50	47.1 AV	54.0	-6.9	1.24 H	50	49.3	-2.2
7	4874.00	44.5 PK	74.0	-29.5	1.24 H	309	42.2	2.3
8	4874.00	40.0 AV	54.0	-14.0	1.24 H	309	37.7	2.3
9	7311.00	50.7 PK	74.0	-23.3	1.21 H	80	42.4	8.3
10	7311.00	41.6 AV	54.0	-12.4	1.21 H	80	33.3	8.3

ANTENNA POLARITY & TEST DISTANCE: VERTICAL AT 3 M

NO.	FREQ. (MHz)	EMISSION LEVEL (dBuV/m)	LIMIT (dBuV/m)	MARGIN (dB)	ANTENNA HEIGHT (m)	TABLE ANGLE (Degree)	RAW VALUE (dBuV)	CORRECTION FACTOR (dB/m)
1	2390.00	72.0 PK	74.0	-2.0	1.26 V	250	74.0	-2.0
2	2390.00	51.1 AV	54.0	-2.9	1.26 V	250	53.1	-2.0
3	*2437.00	114.9 PK			1.26 V	250	117.0	-2.1
4	*2437.00	105.8 AV			1.26 V	250	107.9	-2.1
5	2483.50	73.2 PK	74.0	-0.8	1.26 V	250	75.4	-2.2
6	2483.50	51.3 AV	54.0	-2.7	1.26 V	250	53.5	-2.2
7	4874.00	50.2 PK	74.0	-23.8	2.82 V	153	47.9	2.3
8	4874.00	46.4 AV	54.0	-7.6	2.82 V	153	44.1	2.3
9	7311.00	51.1 PK	74.0	-22.9	2.66 V	219	42.8	8.3
10	7311.00	42.8 AV	54.0	-11.2	2.66 V	219	34.5	8.3

REMARKS:

1. Emission Level(dBuV/m) = Raw Value(dBuV) + Correction Factor(dB/m)
2. Correction Factor(dB/m) = Antenna Factor(dB/m) + Cable Factor(dB) – Pre-Amplifier Factor(dB)
3. Margin value = Emission Level – Limit value
4. The other emission levels were very low against the limit.
5. " * ": Fundamental frequency.

CHANNEL	TX Channel 11	DETECTOR FUNCTION	Peak (PK)
FREQUENCY RANGE	1GHz ~ 25GHz		Average (AV)

ANTENNA POLARITY & TEST DISTANCE: HORIZONTAL AT 3 M

NO.	FREQ. (MHz)	EMISSION LEVEL (dBuV/m)	LIMIT (dBuV/m)	MARGIN (dB)	ANTENNA HEIGHT (m)	TABLE ANGLE (Degree)	RAW VALUE (dBuV)	CORRECTION FACTOR (dB/m)
1	*2462.00	103.4 PK			1.19 H	164	105.6	-2.2
2	*2462.00	93.9 AV			1.19 H	164	96.1	-2.2
3	2483.50	64.8 PK	74.0	-9.2	1.19 H	164	67.0	-2.2
4	2483.50	49.7 AV	54.0	-4.3	1.19 H	164	51.9	-2.2
5	4924.00	41.1 PK	74.0	-32.9	1.30 H	315	38.6	2.5
6	4924.00	36.2 AV	54.0	-17.8	1.30 H	315	33.7	2.5
7	7386.00	45.1 PK	74.0	-28.9	1.14 H	72	36.8	8.3
8	7386.00	39.0 AV	54.0	-15.0	1.14 H	72	30.7	8.3

ANTENNA POLARITY & TEST DISTANCE: VERTICAL AT 3 M

NO.	FREQ. (MHz)	EMISSION LEVEL (dBuV/m)	LIMIT (dBuV/m)	MARGIN (dB)	ANTENNA HEIGHT (m)	TABLE ANGLE (Degree)	RAW VALUE (dBuV)	CORRECTION FACTOR (dB/m)
1	*2462.00	109.0 PK			1.28 V	242	111.2	-2.2
2	*2462.00	99.7 AV			1.28 V	242	101.9	-2.2
3	2483.50	69.2 PK	74.0	-4.8	1.28 V	242	71.4	-2.2
4	2483.50	53.6 AV	54.0	-0.4	1.28 V	242	55.8	-2.2
5	4924.00	44.3 PK	74.0	-29.7	2.71 V	171	41.8	2.5
6	4924.00	40.4 AV	54.0	-13.6	2.71 V	171	37.9	2.5
7	7386.00	45.7 PK	74.0	-28.3	2.60 V	214	37.4	8.3
8	7386.00	38.6 AV	54.0	-15.4	2.60 V	214	30.3	8.3

REMARKS:

1. Emission Level(dBuV/m) = Raw Value(dBuV) + Correction Factor(dB/m)
2. Correction Factor(dB/m) = Antenna Factor(dB/m) + Cable Factor(dB) – Pre-Amplifier Factor(dB)
3. Margin value = Emission Level – Limit value
4. The other emission levels were very low against the limit.
5. " * ": Fundamental frequency.

802.11n (HT40)

CHANNEL	TX Channel 3	DETECTOR FUNCTION	Peak (PK)
FREQUENCY RANGE	1GHz ~ 25GHz		Average (AV)

ANTENNA POLARITY & TEST DISTANCE: HORIZONTAL AT 3 M

NO.	FREQ. (MHz)	EMISSION LEVEL (dBuV/m)	LIMIT (dBuV/m)	MARGIN (dB)	ANTENNA HEIGHT (m)	TABLE ANGLE (Degree)	RAW VALUE (dBuV)	CORRECTION FACTOR (dB/m)
1	2388.75	61.3 PK	74.0	-12.7	1.24 H	48	63.3	-2.0
2	2388.75	47.1 AV	54.0	-6.9	1.24 H	48	49.1	-2.0
3	2390.00	61.3 PK	74.0	-12.7	1.29 H	46	63.3	-2.0
4	2390.00	47.2 AV	54.0	-6.8	1.29 H	46	49.2	-2.0
5	*2422.00	97.7 PK			1.24 H	48	99.7	-2.0
6	*2422.00	89.5 AV			1.24 H	48	91.5	-2.0
7	4844.00	38.9 PK	74.0	-35.1	1.21 H	320	36.6	2.3
8	4844.00	33.1 AV	54.0	-20.9	1.21 H	320	30.8	2.3
9	7266.00	36.4 PK	74.0	-37.6	1.25 H	67	28.0	8.4
10	7266.00	31.9 AV	54.0	-22.1	1.25 H	67	23.5	8.4

ANTENNA POLARITY & TEST DISTANCE: VERTICAL AT 3 M

NO.	FREQ. (MHz)	EMISSION LEVEL (dBuV/m)	LIMIT (dBuV/m)	MARGIN (dB)	ANTENNA HEIGHT (m)	TABLE ANGLE (Degree)	RAW VALUE (dBuV)	CORRECTION FACTOR (dB/m)
1	2388.75	67.7 PK	74.0	-6.3	1.28 V	247	69.7	-2.0
2	2388.75	53.5 AV	54.0	-0.5	1.28 V	247	55.5	-2.0
3	2390.00	67.2 PK	74.0	-6.8	1.23 V	247	69.2	-2.0
4	2390.00	53.2 AV	54.0	-0.8	1.23 V	247	55.2	-2.0
5	*2422.00	104.5 PK			1.28 V	247	106.5	-2.0
6	*2422.00	95.9 AV			1.28 V	247	97.9	-2.0
7	4844.00	44.0 PK	74.0	-30.0	2.75 V	152	41.7	2.3
8	4844.00	35.9 AV	54.0	-18.1	2.75 V	152	33.6	2.3
9	7266.00	42.3 PK	74.0	-31.7	2.62 V	200	33.9	8.4
10	7266.00	32.5 AV	54.0	-21.5	2.62 V	200	24.1	8.4

REMARKS:

1. Emission Level(dBuV/m) = Raw Value(dBuV) + Correction Factor(dB/m)
2. Correction Factor(dB/m) = Antenna Factor(dB/m) + Cable Factor(dB) – Pre-Amplifier Factor(dB)
3. Margin value = Emission Level – Limit value
4. The other emission levels were very low against the limit.
5. " * ": Fundamental frequency.

CHANNEL	TX Channel 6	DETECTOR FUNCTION	Peak (PK)
FREQUENCY RANGE	1GHz ~ 25GHz		Average (AV)

ANTENNA POLARITY & TEST DISTANCE: HORIZONTAL AT 3 M

NO.	FREQ. (MHz)	EMISSION LEVEL (dBuV/m)	LIMIT (dBuV/m)	MARGIN (dB)	ANTENNA HEIGHT (m)	TABLE ANGLE (Degree)	RAW VALUE (dBuV)	CORRECTION FACTOR (dB/m)
1	2390.00	60.7 PK	74.0	-13.3	1.20 H	164	62.7	-2.0
2	2390.00	46.9 AV	54.0	-7.1	1.20 H	164	48.9	-2.0
3	*2437.00	101.8 PK			1.20 H	164	103.9	-2.1
4	*2437.00	93.2 AV			1.20 H	164	95.3	-2.1
5	2483.50	61.7 PK	74.0	-12.3	1.20 H	164	63.9	-2.2
6	2483.50	48.0 AV	54.0	-6.0	1.20 H	164	50.2	-2.2
7	4874.00	43.2 PK	74.0	-30.8	1.27 H	320	40.9	2.3
8	4874.00	37.5 AV	54.0	-16.5	1.27 H	320	35.2	2.3
9	7311.00	40.3 PK	74.0	-33.7	1.22 H	93	32.0	8.3
10	7311.00	35.2 AV	54.0	-18.8	1.22 H	93	26.9	8.3

ANTENNA POLARITY & TEST DISTANCE: VERTICAL AT 3 M

NO.	FREQ. (MHz)	EMISSION LEVEL (dBuV/m)	LIMIT (dBuV/m)	MARGIN (dB)	ANTENNA HEIGHT (m)	TABLE ANGLE (Degree)	RAW VALUE (dBuV)	CORRECTION FACTOR (dB/m)
1	2390.00	68.3 PK	74.0	-5.7	1.28 V	249	70.3	-2.0
2	2390.00	53.7 AV	54.0	-0.3	1.28 V	249	55.7	-2.0
3	*2437.00	108.6 PK			1.28 V	249	110.7	-2.1
4	*2437.00	99.6 AV			1.28 V	249	101.7	-2.1
5	2483.50	67.0 PK	74.0	-7.0	1.28 V	249	69.2	-2.2
6	2483.50	52.2 AV	54.0	-1.8	1.28 V	249	54.4	-2.2
7	4874.00	47.2 PK	74.0	-26.8	2.75 V	148	44.9	2.3
8	4874.00	40.2 AV	54.0	-13.8	2.75 V	148	37.9	2.3
9	7311.00	45.9 PK	74.0	-28.1	2.62 V	192	37.6	8.3
10	7311.00	37.1 AV	54.0	-16.9	2.62 V	192	28.8	8.3

REMARKS:

1. Emission Level(dBuV/m) = Raw Value(dBuV) + Correction Factor(dB/m)
2. Correction Factor(dB/m) = Antenna Factor(dB/m) + Cable Factor(dB) – Pre-Amplifier Factor(dB)
3. Margin value = Emission Level – Limit value
4. The other emission levels were very low against the limit.
5. " * ": Fundamental frequency.

CHANNEL	TX Channel 9	DETECTOR FUNCTION	Peak (PK)
FREQUENCY RANGE	1GHz ~ 25GHz		Average (AV)

ANTENNA POLARITY & TEST DISTANCE: HORIZONTAL AT 3 M

NO.	FREQ. (MHz)	EMISSION LEVEL (dBuV/m)	LIMIT (dBuV/m)	MARGIN (dB)	ANTENNA HEIGHT (m)	TABLE ANGLE (Degree)	RAW VALUE (dBuV)	CORRECTION FACTOR (dB/m)
1	*2452.00	104.6 PK			1.31 H	155	106.8	-2.2
2	*2452.00	89.4 AV			1.31 H	155	91.6	-2.2
3	2483.50	60.3 PK	74.0	-13.7	1.31 H	155	62.5	-2.2
4	2483.50	46.8 AV	54.0	-7.2	1.31 H	155	49.0	-2.2
5	4904.00	39.2 PK	74.0	-34.8	2.74 H	329	36.8	2.4
6	4904.00	33.5 AV	54.0	-20.5	2.74 H	329	31.1	2.4
7	7356.00	36.9 PK	74.0	-37.1	1.46 H	53	28.7	8.2
8	7356.00	32.3 AV	54.0	-21.7	1.46 H	53	24.1	8.2

ANTENNA POLARITY & TEST DISTANCE: VERTICAL AT 3 M

NO.	FREQ. (MHz)	EMISSION LEVEL (dBuV/m)	LIMIT (dBuV/m)	MARGIN (dB)	ANTENNA HEIGHT (m)	TABLE ANGLE (Degree)	RAW VALUE (dBuV)	CORRECTION FACTOR (dB/m)
1	*2452.00	104.4 PK			1.28 V	242	106.6	-2.2
2	*2452.00	95.5 AV			1.28 V	242	97.7	-2.2
3	2483.50	64.8 PK	74.0	-9.2	1.28 V	242	67.0	-2.2
4	2483.50	53.2 AV	54.0	-0.8	1.28 V	242	55.4	-2.2
5	4904.00	43.6 PK	74.0	-30.4	2.69 V	163	41.2	2.4
6	4904.00	35.8 AV	54.0	-18.2	2.69 V	163	33.4	2.4
7	7356.00	42.5 PK	74.0	-31.5	2.57 V	185	34.3	8.2
8	7356.00	32.5 AV	54.0	-21.5	2.57 V	185	24.3	8.2

REMARKS:

1. Emission Level(dBuV/m) = Raw Value(dBuV) + Correction Factor(dB/m)
2. Correction Factor(dB/m) = Antenna Factor(dB/m) + Cable Factor(dB) – Pre-Amplifier Factor(dB)
3. Margin value = Emission Level – Limit value
4. The other emission levels were very low against the limit.
5. " * ": Fundamental frequency.

Below 1GHz Data:

802.11n (HT20)

CHANNEL	TX Channel 6	DETECTOR FUNCTION	Quasi-Peak (QP)
FREQUENCY RANGE	9kHz ~ 1GHz		

ANTENNA POLARITY & TEST DISTANCE: HORIZONTAL AT 3 M								
NO.	FREQ. (MHz)	EMISSION LEVEL (dBuV/m)	LIMIT (dBuV/m)	MARGIN (dB)	ANTENNA HEIGHT (m)	TABLE ANGLE (Degree)	RAW VALUE (dBuV)	CORRECTION FACTOR (dB/m)
1	37.74	29.9 QP	40.0	-10.1	1.00 H	360	39.3	-9.4
2	174.14	29.7 QP	43.5	-13.8	1.50 H	268	38.5	-8.8
3	250.31	30.0 QP	46.0	-16.0	1.00 H	247	38.3	-8.3
4	361.52	27.7 QP	46.0	-18.3	1.00 H	200	32.7	-5.0
5	518.15	29.3 QP	46.0	-16.7	1.00 H	105	30.3	-1.0
6	637.71	31.7 QP	46.0	-14.3	1.50 H	167	30.0	1.7

REMARKS:

1. Emission Level(dBuV/m) = Raw Value(dBuV) + Correction Factor(dB/m)
2. Correction Factor(dB/m) = Antenna Factor(dB/m) + Cable Factor(dB) – Pre-Amplifier Factor(dB)
3. Margin value = Emission Level – Limit value
4. The other emission levels were very low against the limit of frequency range 30MHz~1000MHz.
5. The emission levels were very low against the limit of frequency range 9kHz~30MHz: the amplitude of spurious emissions attenuated more than 20 dB below the permissible value to be report.

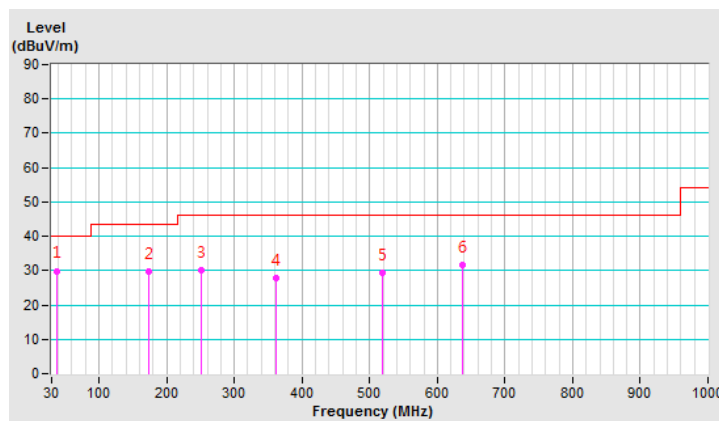

CHANNEL	TX Channel 6	DETECTOR FUNCTION	Quasi-Peak (QP)
FREQUENCY RANGE	9kHz ~ 1GHz		

ANTENNA POLARITY & TEST DISTANCE: VERTICAL AT 3 M

NO.	FREQ. (MHz)	EMISSION LEVEL (dBuV/m)	LIMIT (dBuV/m)	MARGIN (dB)	ANTENNA HEIGHT (m)	TABLE ANGLE (Degree)	RAW VALUE (dBuV)	CORRECTION FACTOR (dB/m)
1	30.15	31.5 QP	40.0	-8.5	1.50 V	304	40.8	-9.3
2	157.51	27.5 QP	43.5	-16.0	1.00 V	2	35.3	-7.8
3	257.05	30.3 QP	46.0	-15.7	1.00 V	178	38.4	-8.1
4	364.14	27.8 QP	46.0	-18.2	1.50 V	284	32.7	-4.9
5	456.97	29.1 QP	46.0	-16.9	2.00 V	354	31.8	-2.7
6	680.92	32.3 QP	46.0	-13.7	1.50 V	300	30.2	2.1

REMARKS:

1. Emission Level(dBuV/m) = Raw Value(dBuV) + Correction Factor(dB/m)
2. Correction Factor(dB/m) = Antenna Factor(dB/m) + Cable Factor(dB) – Pre-Amplifier Factor(dB)
3. Margin value = Emission Level – Limit value
4. The other emission levels were very low against the limit of frequency range 30MHz~1000MHz.
5. The emission levels were very low against the limit of frequency range 9kHz~30MHz: the amplitude of spurious emissions attenuated more than 20 dB below the permissible value to be report.

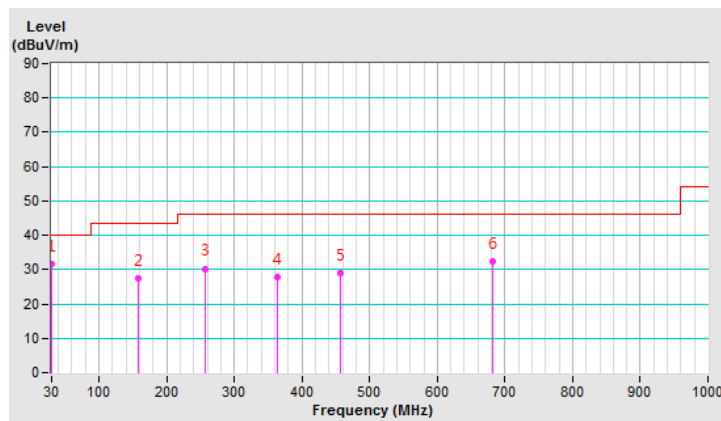

4.2 6dB Bandwidth Measurement

4.2.1 Limits of 6dB Bandwidth Measurement

The minimum of 6dB Bandwidth Measurement is 0.5 MHz.

4.2.2 Test Setup

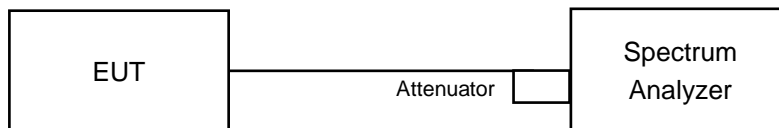

4.2.3 Test Instruments

Refer to section 4.1.2 to get information of above instrument.

4.2.4 Test Procedure

- a. Set resolution bandwidth (RBW) = 100kHz
- b. Set the video bandwidth (VBW) $\geq 3 \times$ RBW, Detector = Peak.
- c. Trace mode = max hold.
- d. Sweep = auto couple.
- e. Measure the maximum width of the emission that is constrained by the frequencies associated with the two amplitude points (upper and lower) that are attenuated by 6 dB relative to the maximum level measured in the fundamental emission

4.2.5 Deviation from Test Standard

No deviation.

4.2.6 EUT Operating Conditions

The software provided by client to enable the EUT under transmission condition continuously at lowest, middle and highest channel frequencies individually.

4.2.7 Test Result

802.11b

Channel	Frequency (MHz)	6dB Bandwidth (MHz)		Minimum Limit (MHz)	Pass / Fail
		Chain 0	Chain 1		
1	2412	10.12	10.12	0.5	Pass
6	2437	10.12	10.12	0.5	Pass
11	2462	10.12	10.12	0.5	Pass

802.11g

Channel	Frequency (MHz)	6dB Bandwidth (MHz)		Minimum Limit (MHz)	Pass / Fail
		Chain 0	Chain 1		
1	2412	16.65	16.63	0.5	Pass
2	2417	16.65	16.64	0.5	Pass
6	2437	16.66	16.65	0.5	Pass
10	2457	16.66	16.64	0.5	Pass
11	2462	16.65	16.62	0.5	Pass

802.11n (HT20)

Channel	Frequency (MHz)	6dB Bandwidth (MHz)		Minimum Limit (MHz)	Pass / Fail
		Chain 0	Chain 1		
1	2412	17.74	17.74	0.5	Pass
2	2417	17.76	17.74	0.5	Pass
6	2437	17.78	17.75	0.5	Pass
10	2457	17.75	17.73	0.5	Pass
11	2462	17.75	17.75	0.5	Pass

802.11n (HT40)

Channel	Frequency (MHz)	6dB Bandwidth (MHz)		Minimum Limit (MHz)	Pass / Fail
		Chain 0	Chain 1		
3	2422	36.62	36.57	0.5	Pass
4	2427	36.64	36.58	0.5	Pass
6	2437	36.63	36.59	0.5	Pass
8	2447	36.62	36.60	0.5	Pass
9	2452	36.63	36.60	0.5	Pass

Spectrum Plot of Worst Value

802.11b: Chain 0 / CH1

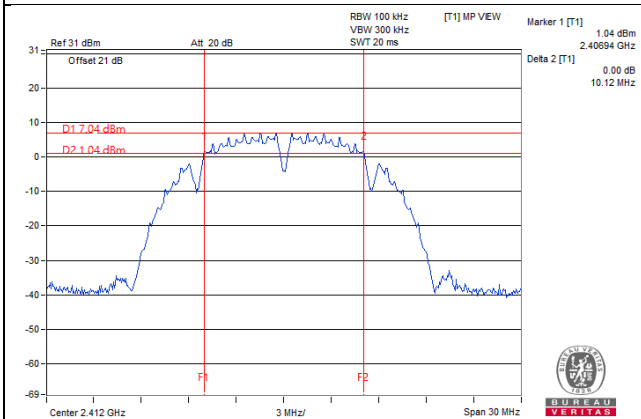

802.11g: Chain 1 / CH1

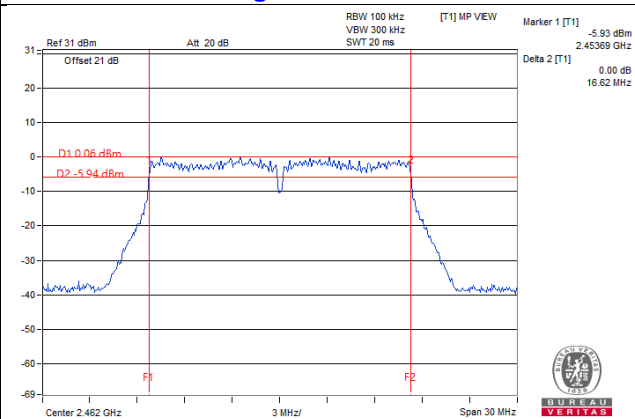

802.11n (HT20): Chain 1 / CH10

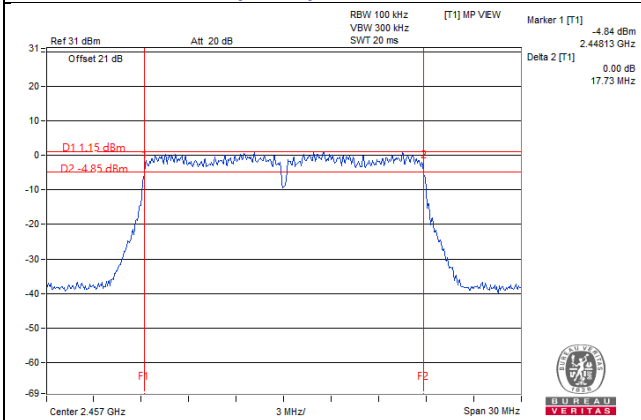

802.11n (HT40): Chain 1 / CH3

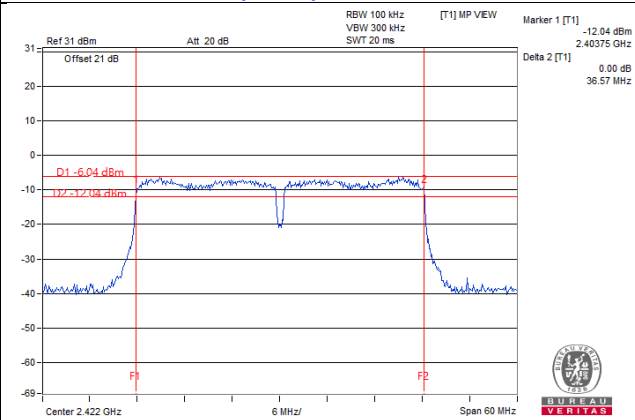

4.3 Conducted Output Power Measurement

4.3.1 Limits of Conducted Output Power Measurement

For systems using digital modulation in the 2400–2483.5 MHz bands: 1 Watt (30dBm)

4.3.2 Test Setup

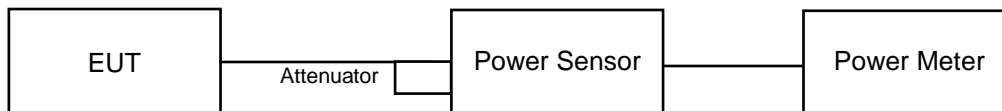

4.3.3 Test Instruments

Refer to section 4.1.2 to get information of above instrument.

4.3.4 Test Procedures

A peak power sensor was used on the output port of the EUT. A power meter was used to read the response of the peak power sensor. Record the power level.

Average power sensor was used to perform output power measurement, trigger and gating function of wide band power meter is enabled to measure max output power of TX on burst. Duty factor is not added to measured value.

4.3.5 Deviation from Test Standard

No deviation.

4.3.6 EUT Operating Conditions

Same as Item 4.2.6

4.3.7 Test Results

FOR PEAK POWER

802.11b

Chan.	Chan. Freq. (MHz)	Peak Power (dBm)		Total Power (mW)	Total Power (dBm)	Limit (dBm)	Pass / Fail
		Chain 0	Chain 1				
1	2412	20.18	20.39	213.628	23.30	30.00	Pass
6	2437	20.12	20.36	211.445	23.25	30.00	Pass
11	2462	20.05	20.28	207.818	23.18	30.00	Pass

802.11g

Chan.	Chan. Freq. (MHz)	Peak Power (dBm)		Total Power (mW)	Total Power (dBm)	Limit (dBm)	Pass / Fail
		Chain 0	Chain 1				
1	2412	21.25	21.66	279.907	24.47	30.00	Pass
2	2417	22.95	23.07	400.01	26.02	30.00	Pass
6	2437	26.58	26.34	885.515	29.47	30.00	Pass
10	2457	23.50	23.62	454.016	26.57	30.00	Pass
11	2462	21.78	22.01	309.516	24.91	30.00	Pass

802.11n (HT20)

Chan.	Chan. Freq. (MHz)	Peak Power (dBm)		Total Power (mW)	Total Power (dBm)	Limit (dBm)	Pass / Fail
		Chain 0	Chain 1				
1	2412	20.41	20.50	222.103	23.47	30.00	Pass
2	2417	23.11	22.73	392.143	25.93	30.00	Pass
6	2437	26.35	25.37	775.869	28.90	30.00	Pass
10	2457	21.79	21.72	299.602	24.77	30.00	Pass
11	2462	21.45	21.73	288.573	24.60	30.00	Pass

802.11n (HT40)

Chan.	Chan. Freq. (MHz)	Peak Power (dBm)		Total Power (mW)	Total Power (dBm)	Limit (dBm)	Pass / Fail
		Chain 0	Chain 1				
3	2422	18.23	18.29	133.98	21.27	30.00	Pass
4	2427	19.50	19.95	187.98	22.74	30.00	Pass
6	2437	23.11	23.10	408.818	26.12	30.00	Pass
8	2447	20.96	20.99	250.341	23.99	30.00	Pass
9	2452	19.05	19.06	160.891	22.07	30.00	Pass

FOR AVERAGE POWER
802.11b

Channel	Frequency (MHz)	Average Power (dBm)		Total Power (mW)	Total Power (dBm)
		Chain 0	Chain 1		
1	2412	17.86	17.91	122.896	20.90
6	2437	17.66	17.83	119.019	20.76
11	2462	17.64	17.82	118.61	20.74

802.11g

Channel	Frequency (MHz)	Average Power (dBm)		Total Power (mW)	Total Power (dBm)
		Chain 0	Chain 1		
1	2412	11.94	12.36	32.85	15.17
2	2417	13.94	14.07	50.301	17.02
6	2437	17.66	17.54	115.099	20.61
10	2457	13.83	15.16	56.965	17.56
11	2462	12.74	13.20	39.686	15.99

802.11n (HT20)

Channel	Frequency (MHz)	Average Power (dBm)		Total Power (mW)	Total Power (dBm)
		Chain 0	Chain 1		
1	2412	12.19	12.53	34.464	15.37
2	2417	13.02	14.22	46.469	16.67
6	2437	17.84	18.14	125.977	21.00
10	2457	14.08	14.27	52.316	17.19
11	2462	13.07	13.32	41.755	16.21

802.11n (HT40)

Channel	Frequency (MHz)	Average Power (dBm)		Total Power (mW)	Total Power (dBm)
		Chain 0	Chain 1		
3	2422	10.27	10.46	21.758	13.38
4	2427	11.75	12.29	31.905	15.04
6	2437	14.97	15.15	64.139	18.07
8	2447	12.70	12.93	38.255	15.83
9	2452	11.07	11.27	26.191	14.18

4.4 Power Spectral Density Measurement

4.4.1 Limits of Power Spectral Density Measurement

The Maximum of Power Spectral Density Measurement is 8dBm in any 3 kHz.

4.4.2 Test Setup

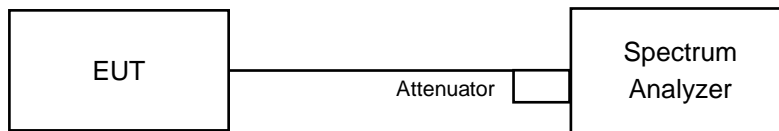

4.4.3 Test Instruments

Refer to section 4.1.2 to get information of above instrument.

4.4.4 Test Procedure

- a. Set analyzer center frequency to DTS channel center frequency.
- b. Set the span to 1.5 times the DTS bandwidth.
- c. Set the RBW to: $3 \text{ kHz} \leq \text{RBW} \leq 100 \text{ kHz}$.
- d. Set the VBW $\geq 3 \times \text{RBW}$.
- e. Detector = peak.
- f. Sweep time = auto couple.
- g. Trace mode = max hold.
- h. Allow trace to fully stabilize.
- i. Use the peak marker function to determine the maximum amplitude level within the RBW.

4.4.5 Deviation from Test Standard

No deviation.

4.4.6 EUT Operating Condition

Same as Item 4.2.6

4.4.7 Test Results

802.11b

TX chain	Channel	Freq. (MHz)	PSD (dBm/3kHz)	10 log (N=2) dB	Total PSD (dBm/3kHz)	Limit (dBm/3kHz)	Pass /Fail
0	1	2412	-11.24	3.01	-8.23	8.00	Pass
	6	2437	-11.24	3.01	-8.23	8.00	Pass
	11	2462	-11.25	3.01	-8.24	8.00	Pass
1	1	2412	-10.92	3.01	-7.91	8.00	Pass
	6	2437	-10.96	3.01	-7.95	8.00	Pass
	11	2462	-10.99	3.01	-7.98	8.00	Pass

Note: Directional gain = $2.98\text{dBi} + 10\log(2) = 5.99\text{dBi} < 6\text{dBi}$, so the power density limit shall not be reduced.

802.11g

TX chain	Channel	Freq. (MHz)	PSD (dBm/3kHz)	10 log (N=2) dB	Total PSD (dBm/3kHz)	Limit (dBm/3kHz)	Pass /Fail
0	1	2412	-15.62	3.01	-12.61	8.00	Pass
	2	2417	-14.11	3.01	-11.10	8.00	Pass
	6	2437	-9.70	3.01	-6.69	8.00	Pass
	10	2457	-13.16	3.01	-10.15	8.00	Pass
	11	2462	-14.55	3.01	-11.54	8.00	Pass
1	1	2412	-14.81	3.01	-11.80	8.00	Pass
	2	2417	-12.89	3.01	-9.88	8.00	Pass
	6	2437	-8.37	3.01	-5.36	8.00	Pass
	10	2457	-12.11	3.01	-9.10	8.00	Pass
	11	2462	-13.94	3.01	-10.93	8.00	Pass

Note: Directional gain = $2.98\text{dBi} + 10\log(2) = 5.99\text{dBi} < 6\text{dBi}$, so the power density limit shall not be reduced.

802.11n (HT20)

TX chain	Channel	Freq. (MHz)	PSD (dBm/3kHz)	10 log (N=2) dB	Total PSD (dBm/3kHz)	Limit (dBm/3kHz)	Pass /Fail
0	1	2412	-15.31	3.01	-12.30	8.00	Pass
	2	2417	-13.40	3.01	-10.39	8.00	Pass
	6	2437	-9.72	3.01	-6.71	8.00	Pass
	10	2457	-12.60	3.01	-9.59	8.00	Pass
	11	2462	-14.11	3.01	-11.10	8.00	Pass
1	1	2412	-15.06	3.01	-12.05	8.00	Pass
	2	2417	-12.50	3.01	-9.49	8.00	Pass
	6	2437	-9.46	3.01	-6.45	8.00	Pass
	10	2457	-12.30	3.01	-9.29	8.00	Pass
	11	2462	-12.82	3.01	-9.81	8.00	Pass

Note: Directional gain = $2.98\text{dBi} + 10\log(2) = 5.99\text{dBi} < 6\text{dBi}$, so the power density limit shall not be reduced.

802.11n (HT40)

TX chain	Channel	Freq. (MHz)	PSD (dBm/3kHz)	10 log (N=2) dB	Total PSD (dBm/3kHz)	Limit (dBm/3kHz)	Pass /Fail
0	3	2422	-18.90	3.01	-15.89	8.00	Pass
	4	2427	-17.97	3.01	-14.96	8.00	Pass
	6	2437	-13.79	3.01	-10.78	8.00	Pass
	8	2447	-17.34	3.01	-14.33	8.00	Pass
	9	2452	-18.96	3.01	-15.95	8.00	Pass
1	3	2422	-18.58	3.01	-15.57	8.00	Pass
	4	2427	-18.73	3.01	-15.72	8.00	Pass
	6	2437	-14.70	3.01	-11.69	8.00	Pass
	8	2447	-16.77	3.01	-13.76	8.00	Pass
	9	2452	-18.84	3.01	-15.83	8.00	Pass

Note: Directional gain = $2.98\text{dBi} + 10\log(2) = 5.99\text{dBi} < 6\text{dBi}$, so the power density limit shall not be reduced.

Spectrum Plot of Worst Value

802.11b: Chain 1 / CH1

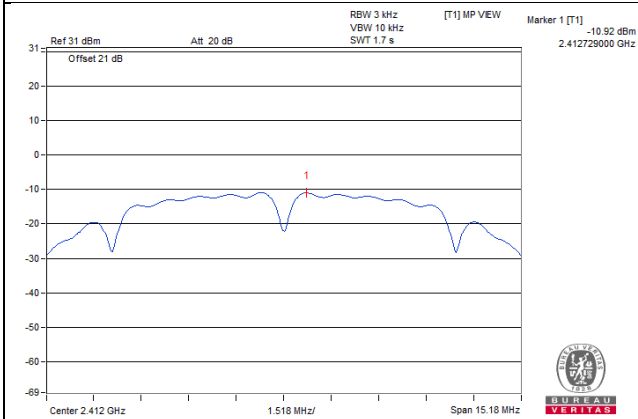

802.11g: Chain 1 / CH6

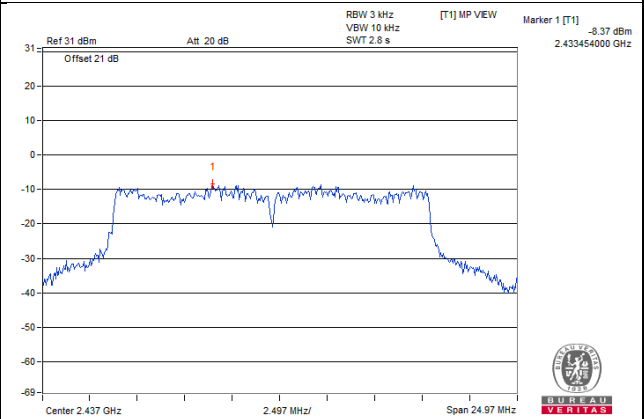

802.11n (HT20): Chain 1 / CH6

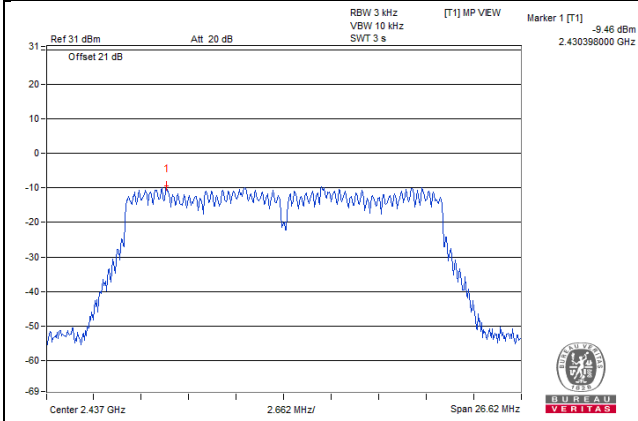

802.11n (HT40): Chain 0 / CH6

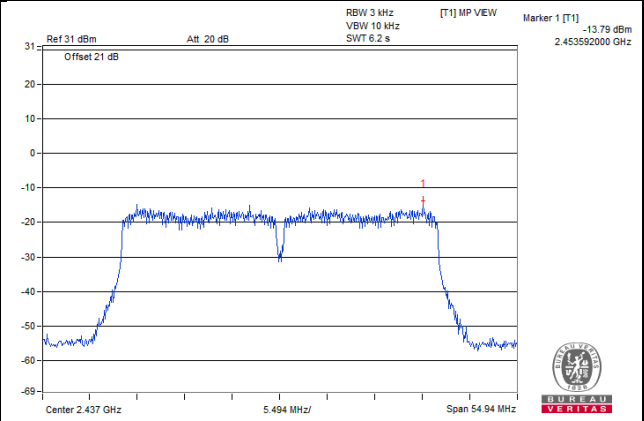

4.5 Conducted Out of Band Emission Measurement

4.5.1 Limits of Conducted Out of Band Emission Measurement

Below -20dB of the highest emission level of operating band (in 100kHz Resolution Bandwidth).

4.5.2 Test Setup

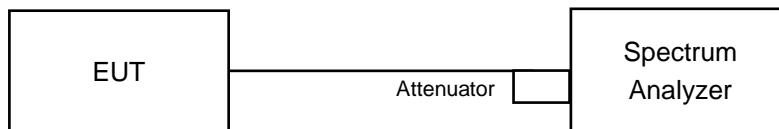

4.5.3 Test Instruments

Refer to section 4.1.2 to get information of above instrument.

4.5.4 Test Procedure

MEASUREMENT PROCEDURE REF

1. Set the RBW = 100 kHz.
2. Set the VBW \geq 300 kHz.
3. Detector = peak.
4. Sweep time = auto couple.
5. Trace mode = max hold.
6. Allow trace to fully stabilize.
7. Use the peak marker function to determine the maximum power level in any 100 kHz band segment within the fundamental EBW.

MEASUREMENT PROCEDURE OOB

1. Set RBW = 100 kHz.
2. Set VBW \geq 300 kHz.
3. Detector = peak.
4. Sweep = auto couple.
5. Trace Mode = max hold.
6. Allow trace to fully stabilize.
7. Use the peak marker function to determine the maximum amplitude level.

4.5.5 Deviation from Test Standard

No deviation.

4.5.6 EUT Operating Condition

Same as Item 4.2.6

4.5.7 Test Results

The spectrum plots are attached on the following pages. D1 line indicates the highest level, and D2 line indicates the 20dB offset below D1. It shows compliance with the requirement.

802.11b
Chain0

CH 1

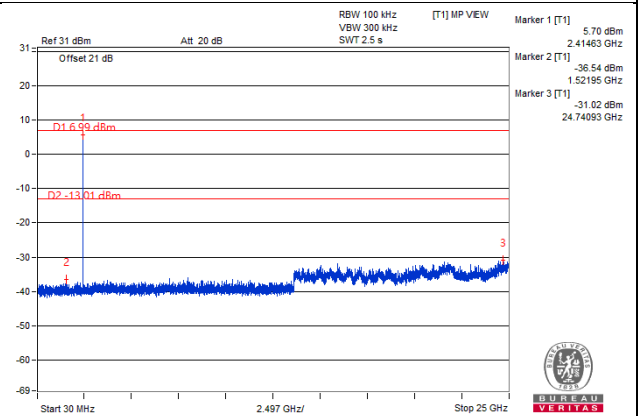
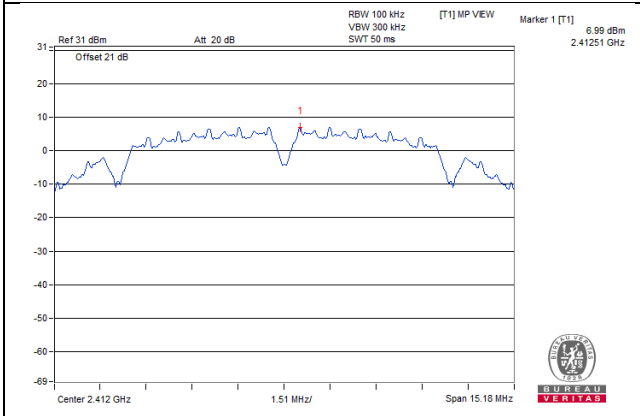

CH 6

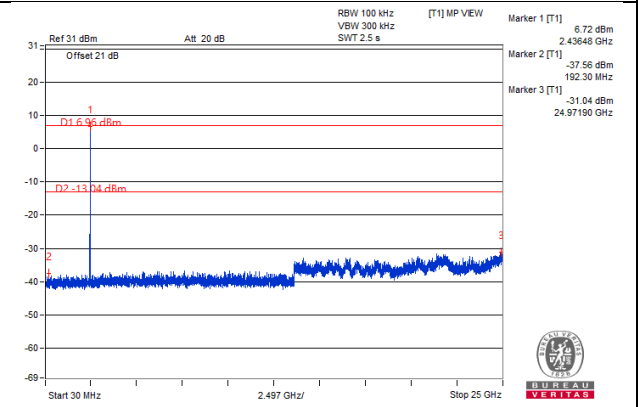
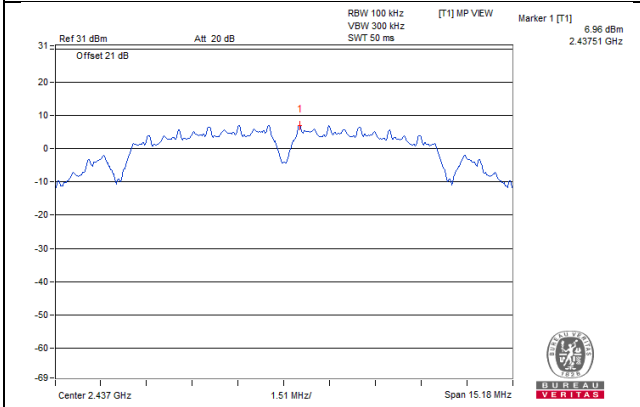

CH 11

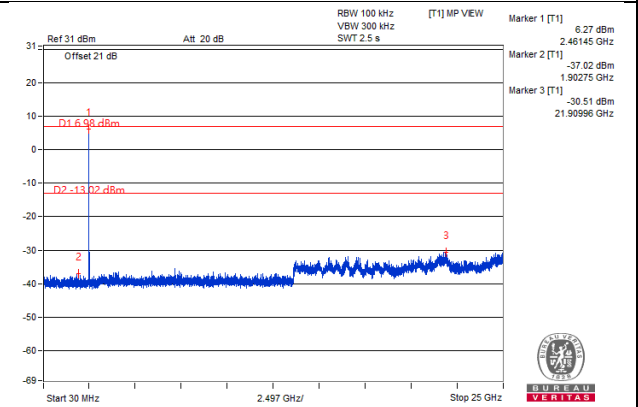
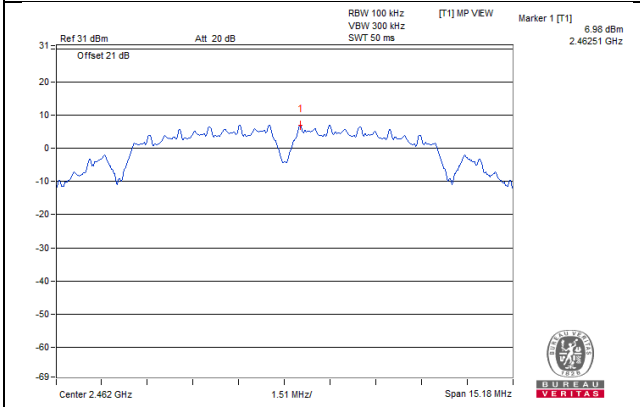

CH 1 Band edge

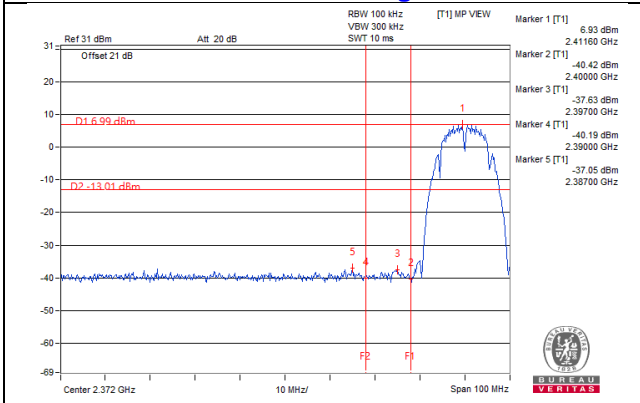

CH 11 Band edge

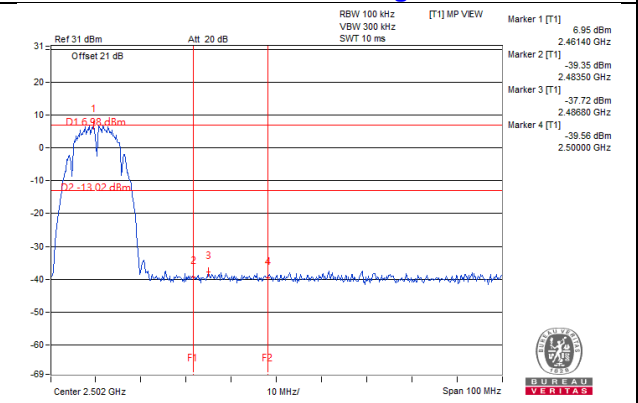

Chain1

CH 1

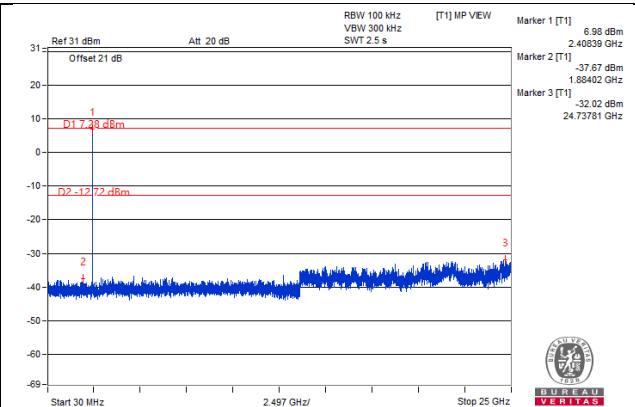
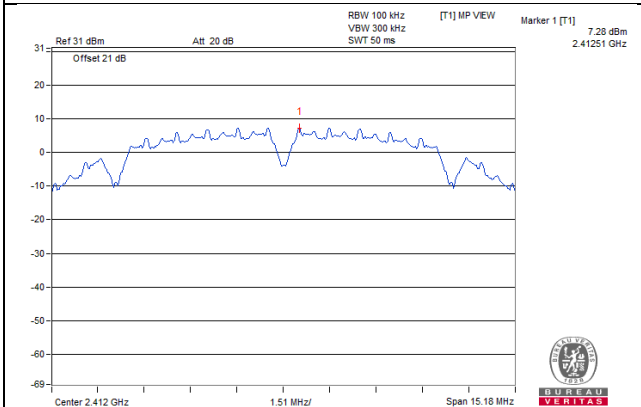

CH 6

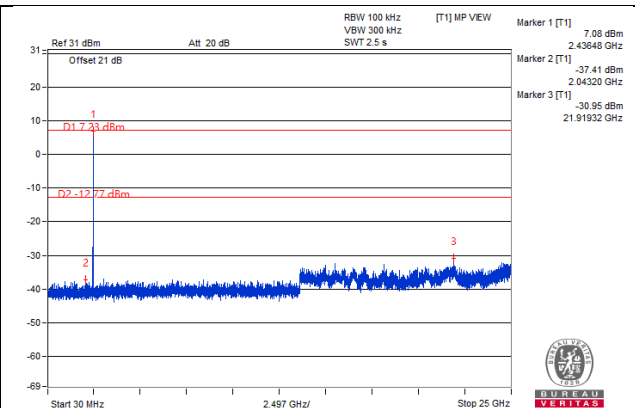
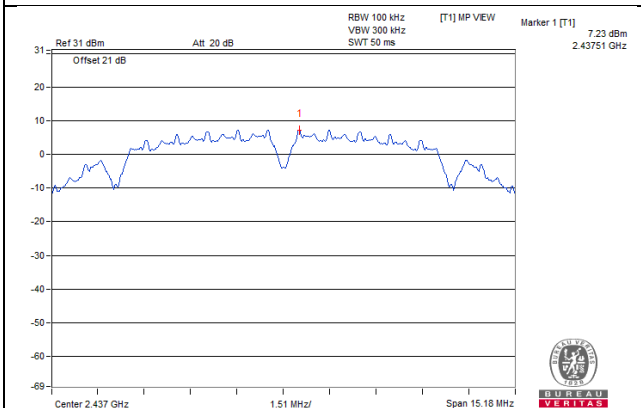

CH 11

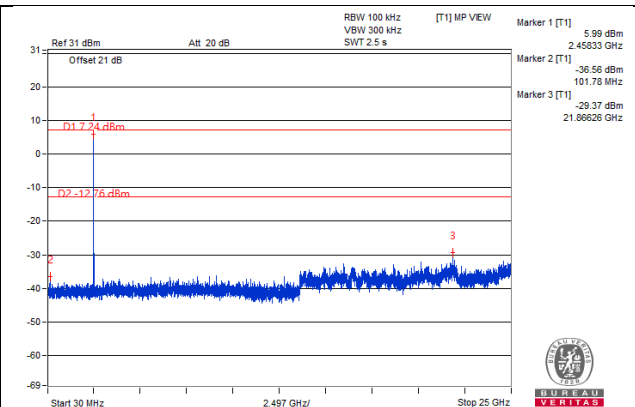
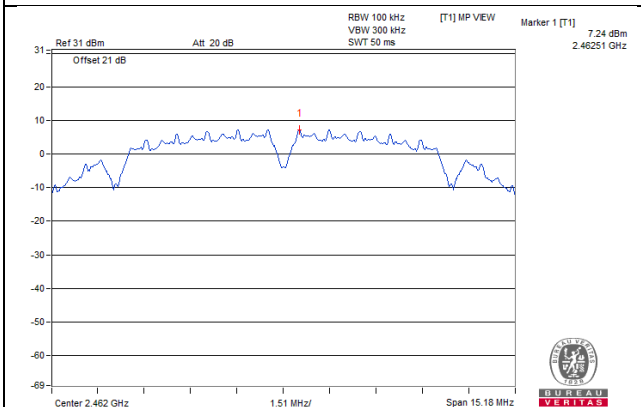

CH 1 Band edge

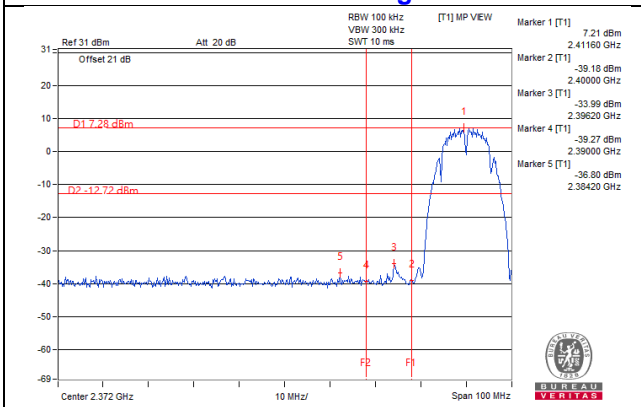

CH 11 Band edge

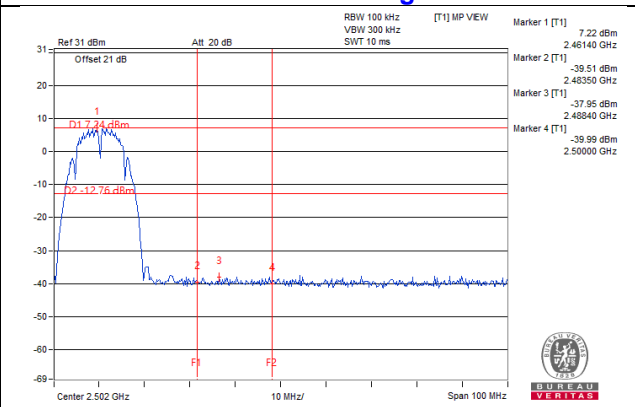

802.11g
Chain0

CH 1

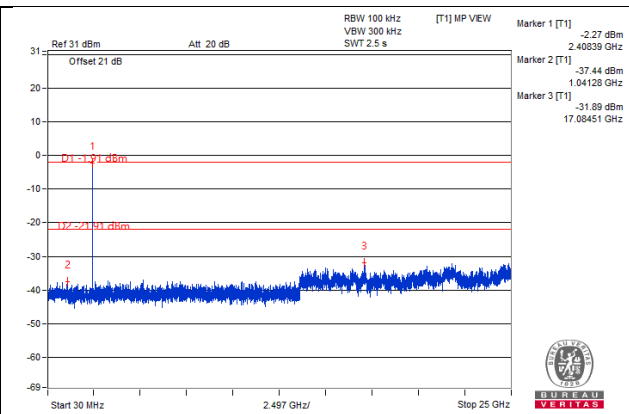
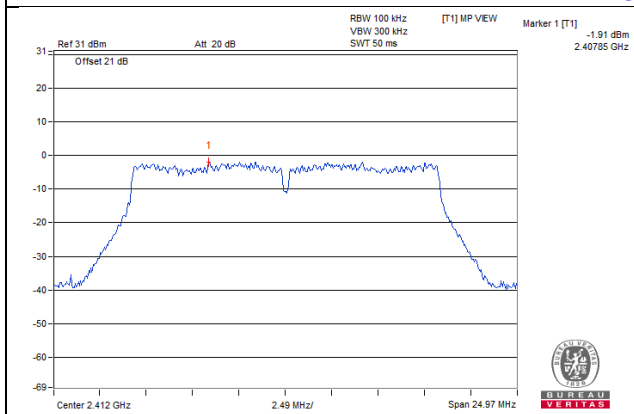

CH 6

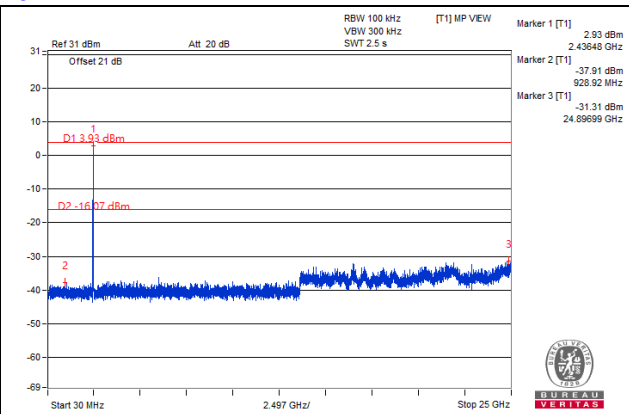
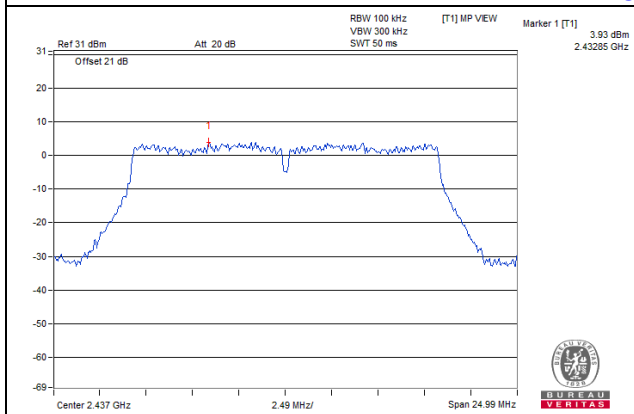

CH 11

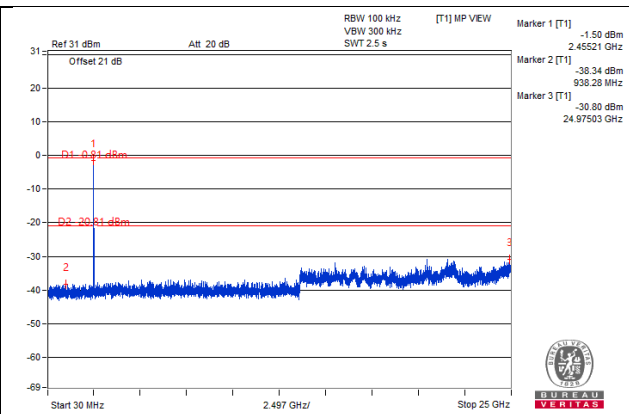
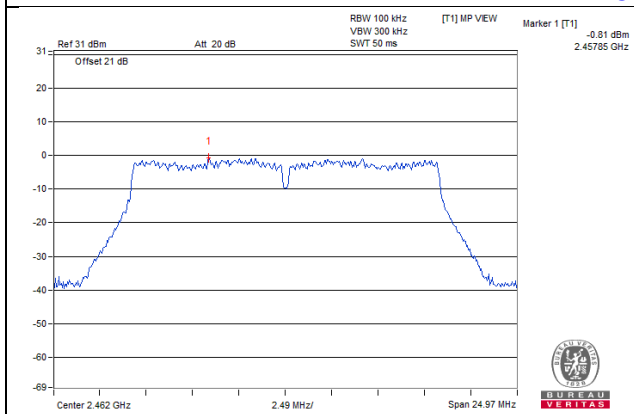

CH 1 Band edge

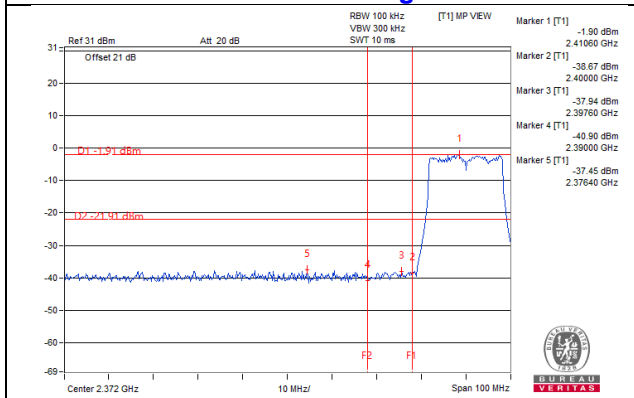

CH 11 Band edge

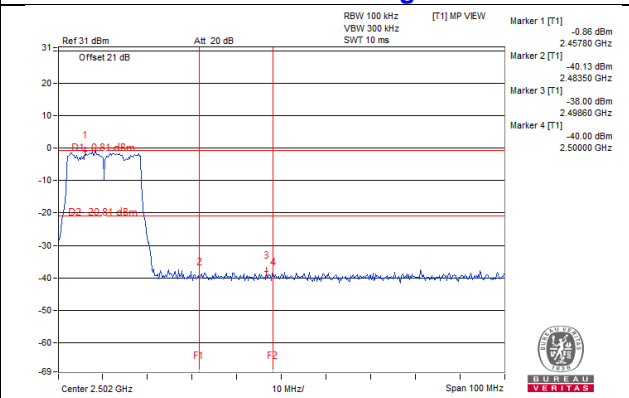

Chain1

CH 1

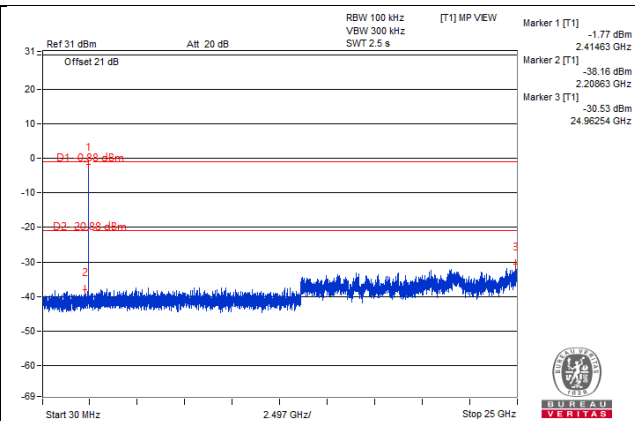
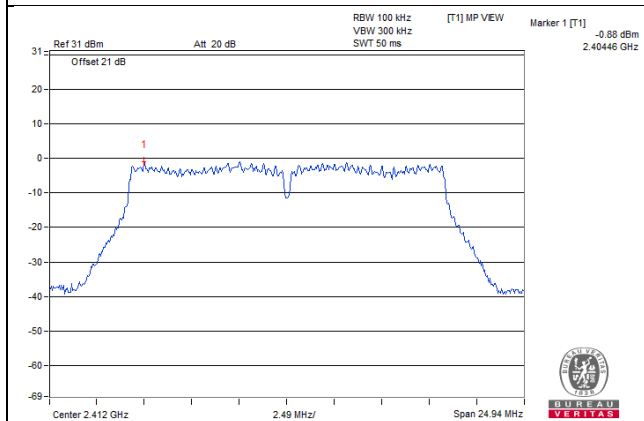

CH 6

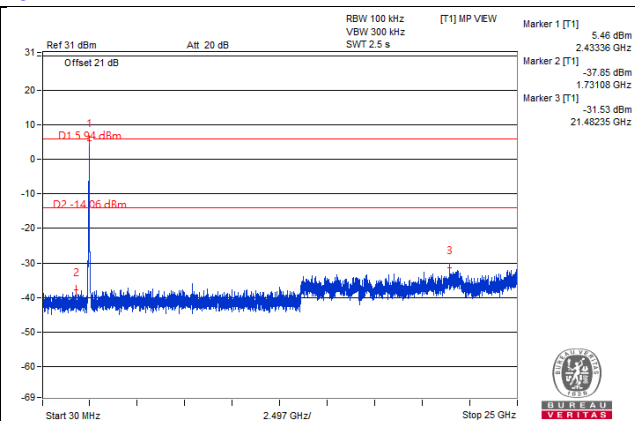
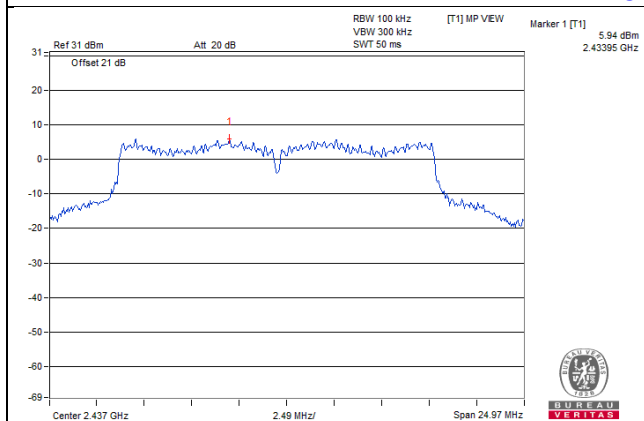

CH 11

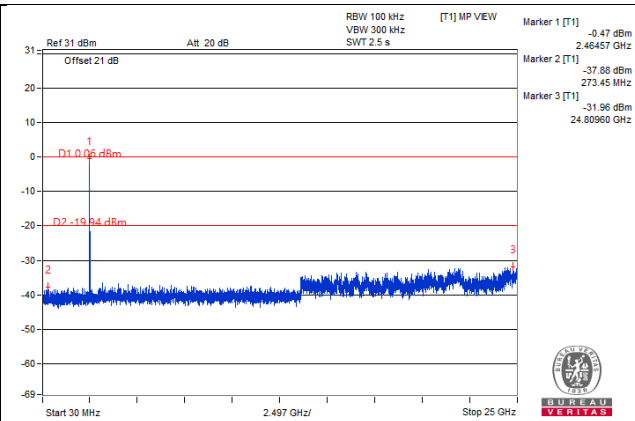
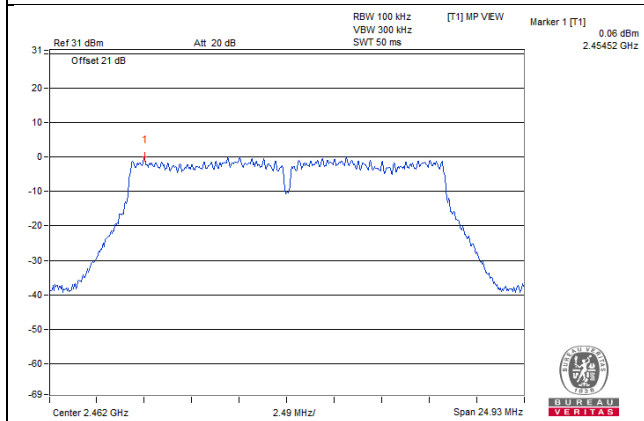

CH 1 Band edge

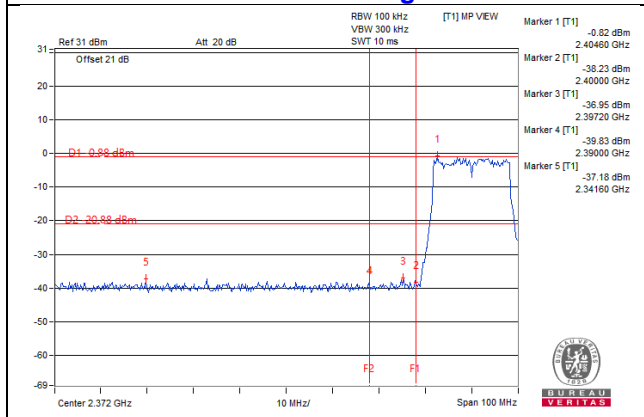

CH 11 Band edge

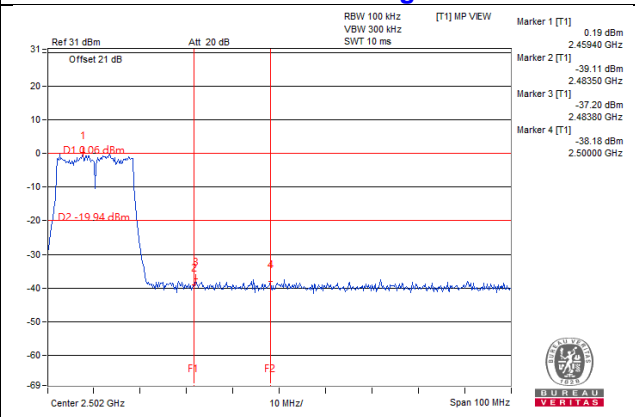

802.11n (HT20)
Chain0

CH 1

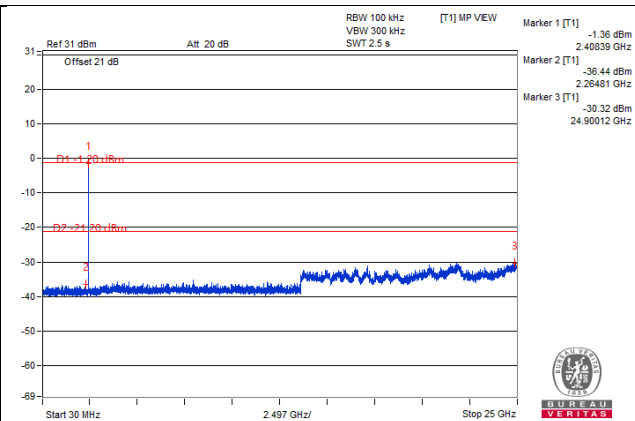
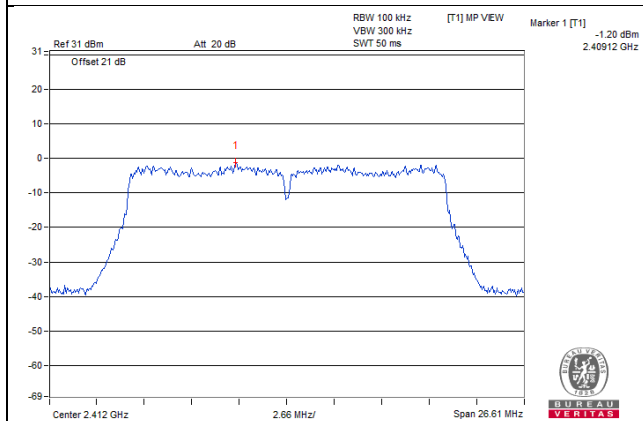

CH 6

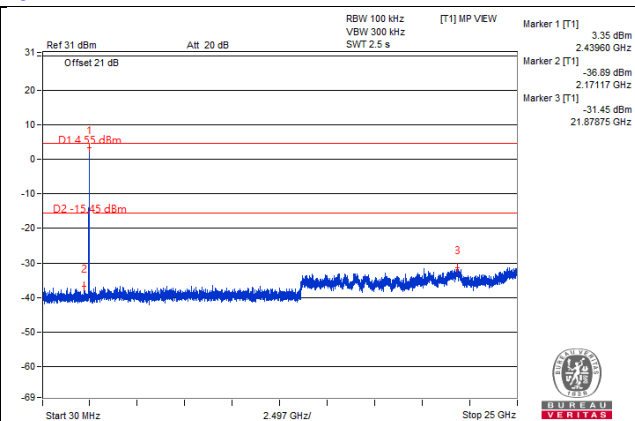
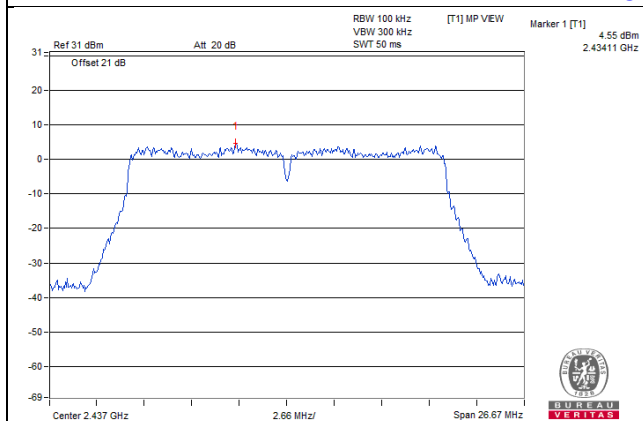

CH 11

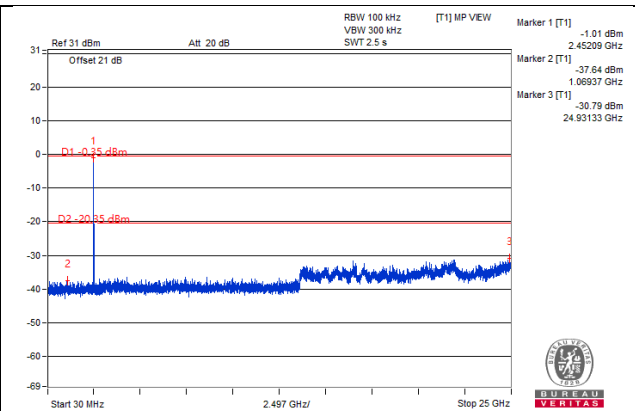
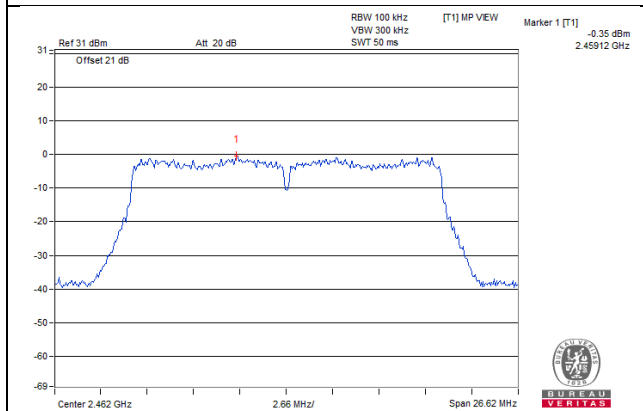

CH 1 Band edge

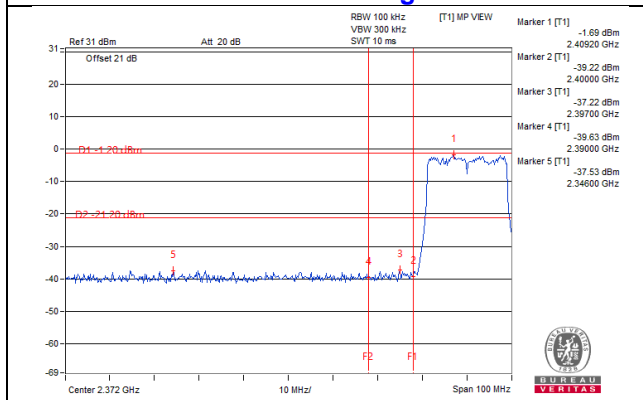

CH 11 Band edge

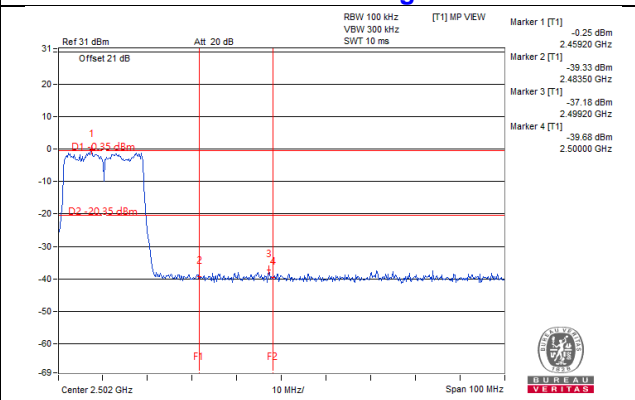

Chain1

CH 1

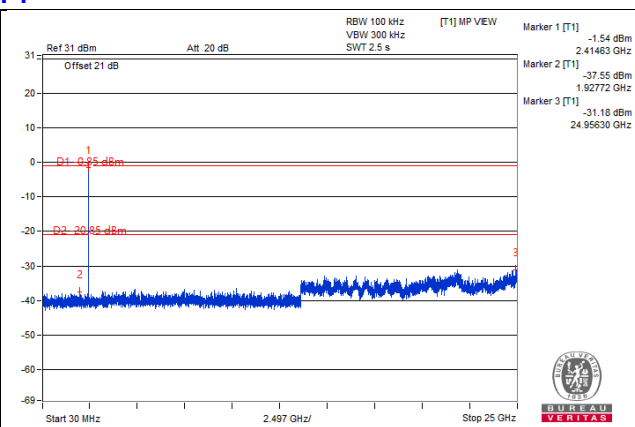
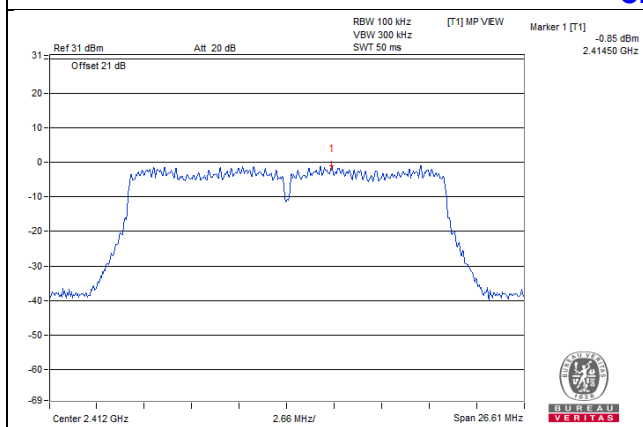

CH 6

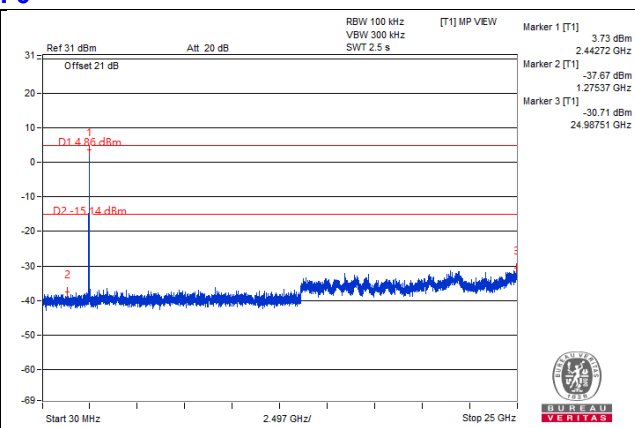
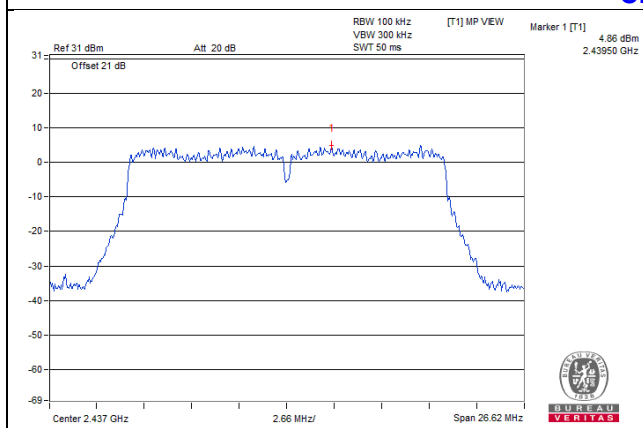

CH 11

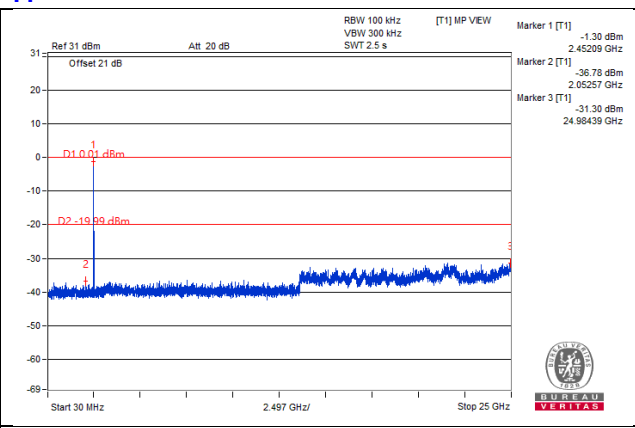
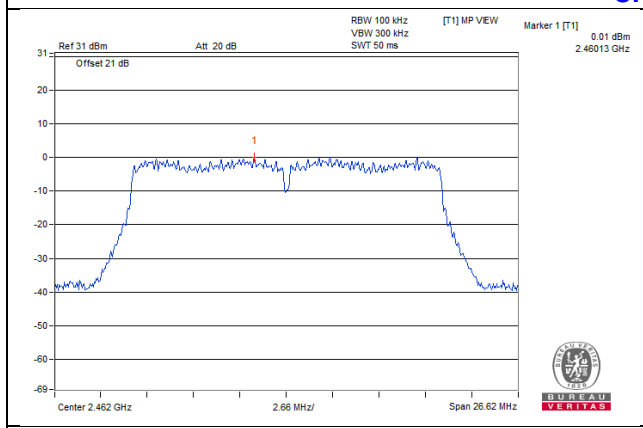

CH 1 Band edge

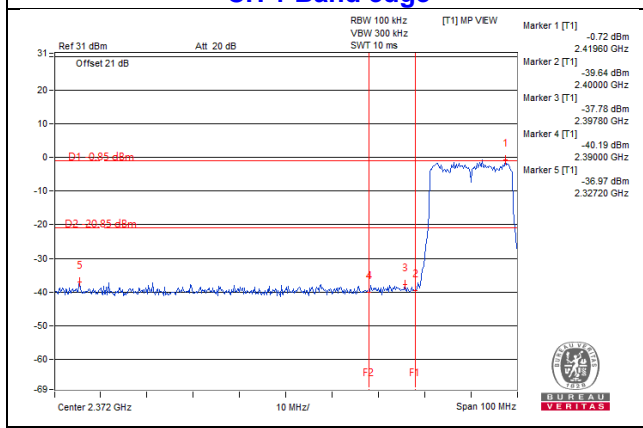

CH 11 Band edge

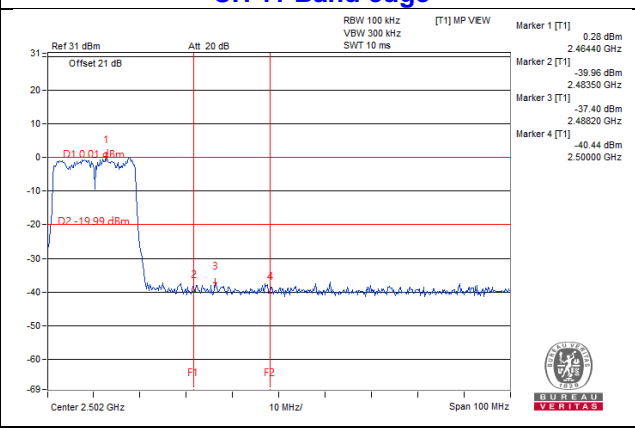

802.11n (HT40)
Chain0

CH 3

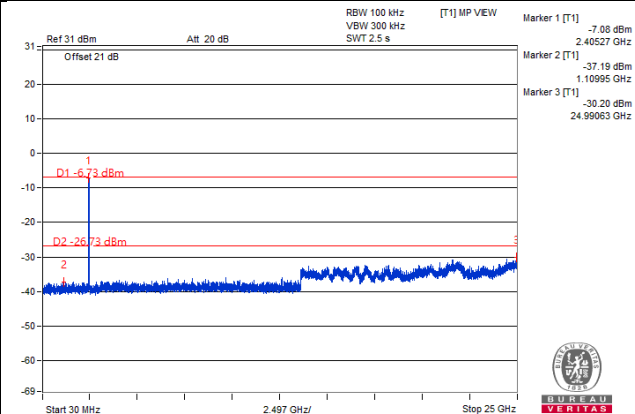
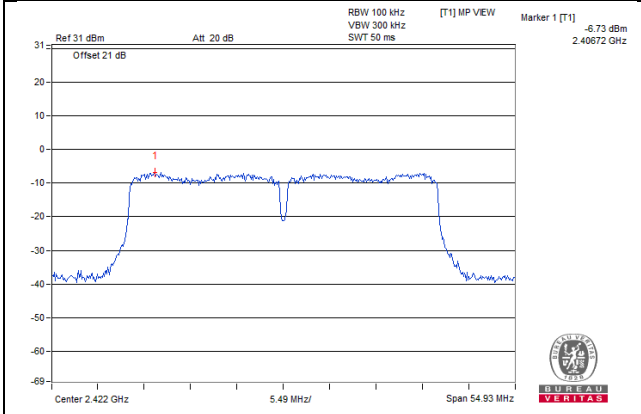

CH 6

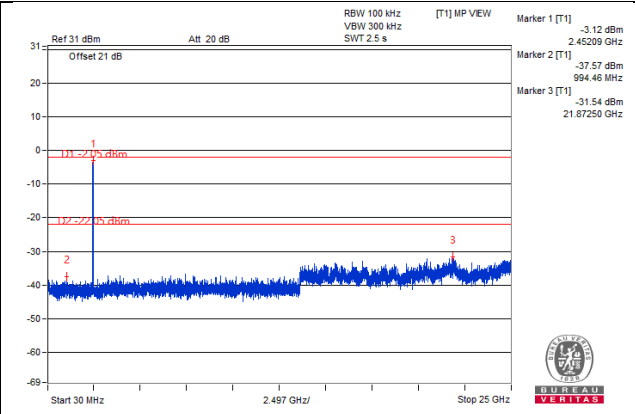
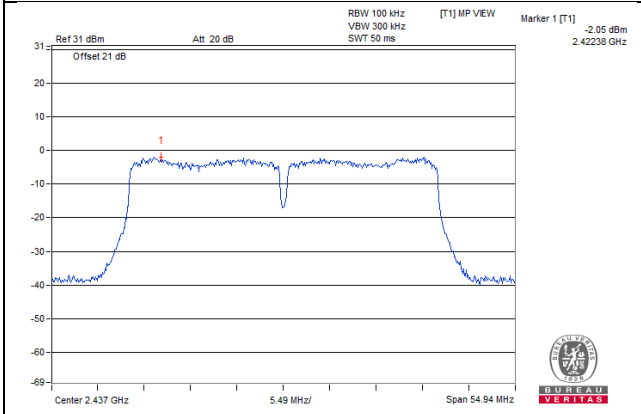

CH 9

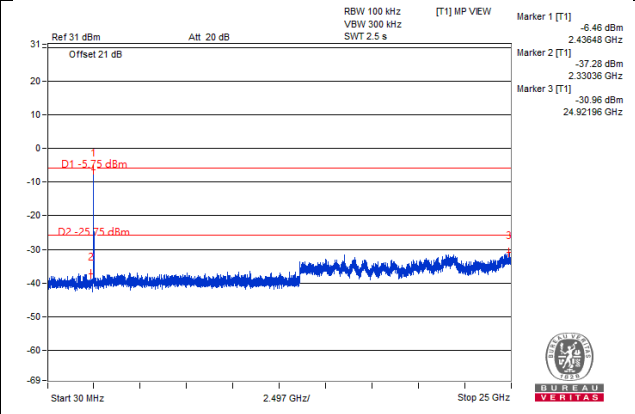
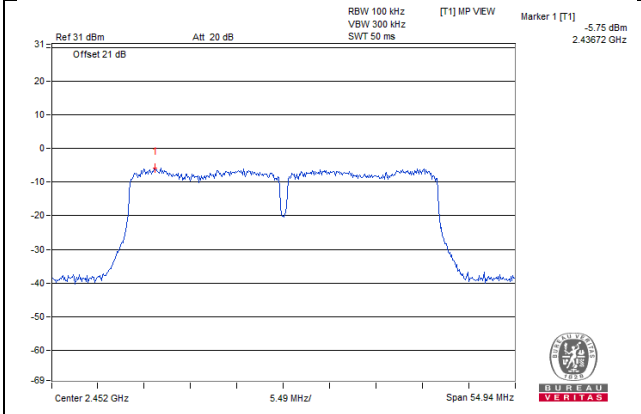

CH 3 Band edge

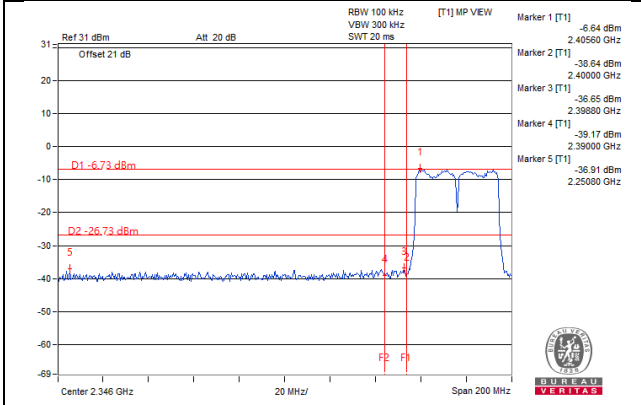

CH 9 Band edge

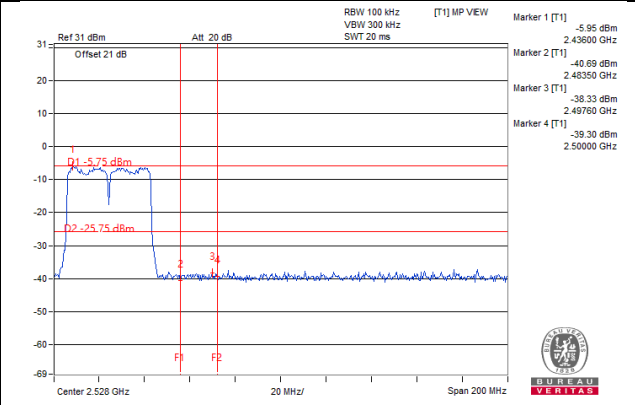

Chain1

CH 3

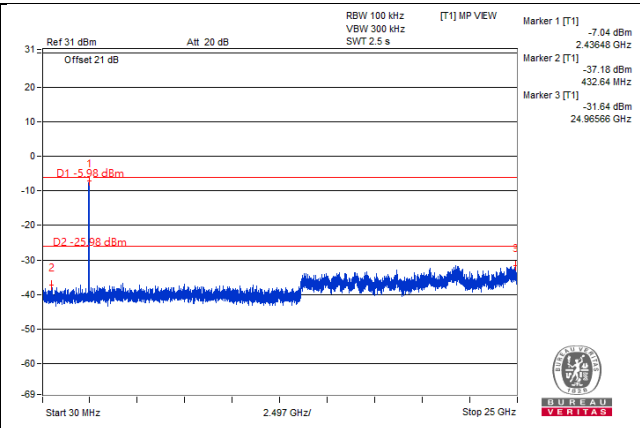
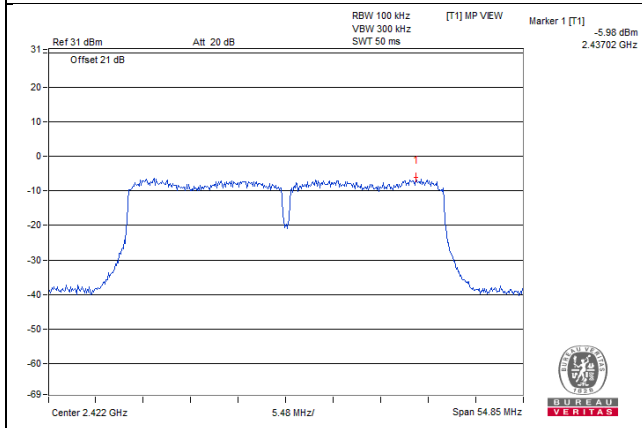

CH 6

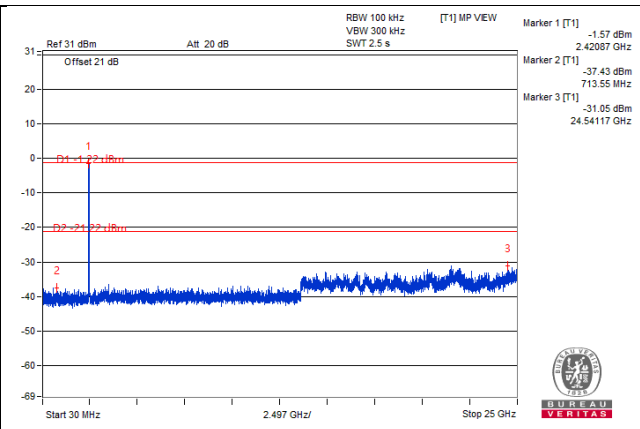
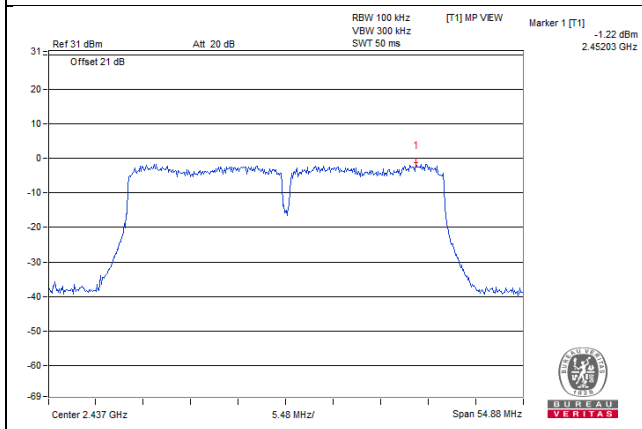

CH 9

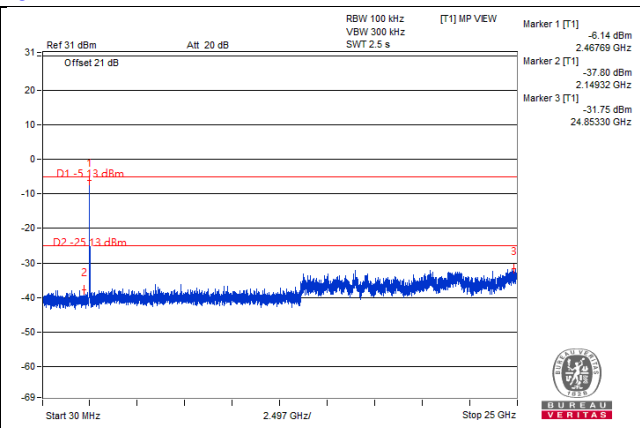
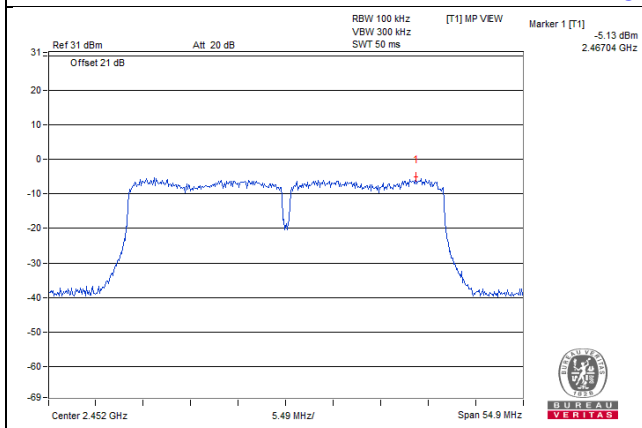

CH 3 Band edge

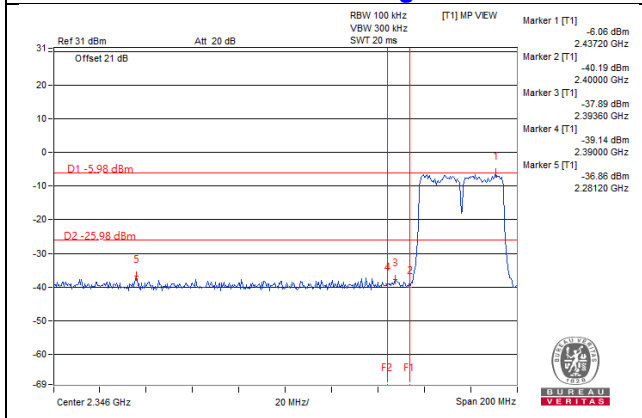

CH 9 Band edge

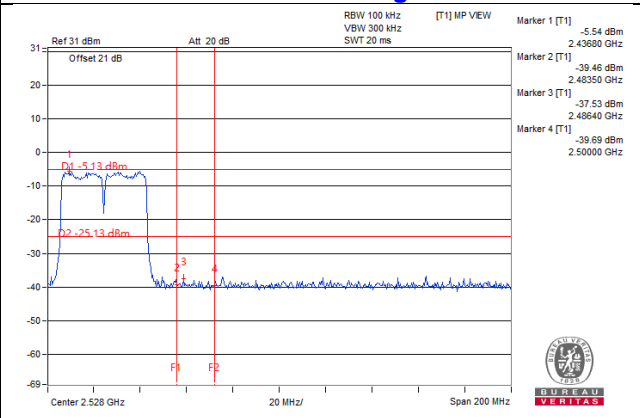

5 Pictures of Test Arrangements

Please refer to the attached file (Test Setup Photo).

Appendix – Information of the Testing Laboratories

We, Bureau Veritas Consumer Products Services (H.K.) Ltd., Taoyuan Branch, were founded in 1988 to provide our best service in EMC, Radio, Telecom and Safety consultation. Our laboratories are FCC recognized accredited test firms and accredited according to ISO/IEC 17025.

If you have any comments, please feel free to contact us at the following:

Lin Kou EMC/RF Lab

Tel: 886-2-26052180

Fax: 886-2-26051924

Hsin Chu EMC/RF/Telecom Lab

Tel: 886-3-6668565

Fax: 886-3-6668323

Hwa Ya EMC/RF/Safety Lab

Tel: 886-3-3183232

Fax: 886-3-3270892

Email: service.adt@tw.bureauveritas.com

Web Site: www.bureauveritas-adt.com

The address and road map of all our labs can be found in our web site also.

--- END ---