

FCC Test Report (WLAN)

Report No.: RF161216E08-1

FCC ID: UAY-W8997-M1216

Test Model: W8997-M1216

Received Date: Dec. 16, 2016

Test Date: Dec. 19 to 27, 2016

Issued Date: Jan. 18, 2017

Applicant: Marvell Semiconductor

Address: 5488 Marvell Lane, Santa Clara CA95054 USA

Issued By: Bureau Veritas Consumer Products Services (H.K.) Ltd., Taoyuan Branch
Hsin Chu Laboratory

Lab Address: E-2, No.1, Li Hsin 1st Road, Hsinchu Science Park, Hsinchu City 300,
Taiwan R.O.C.

Test Location (1): E-2, No.1, Li Hsin 1st Road, Hsinchu Science Park, Hsinchu City 300,
Taiwan R.O.C.

Test Location (2): No. 49, Ln. 206, Wende Rd., Shangshan Tsuen, Chiung Lin Hsiang, Hsin
Chu Hsien 307, Taiwan R.O.C.



This report is for your exclusive use. Any copying or replication of this report to or for any other person or entity, or use of our name or trademark, is permitted only with our prior written permission. This report sets forth our findings solely with respect to the test samples identified herein. The results set forth in this report are not indicative or representative of the quality or characteristics of the lot from which a test sample was taken or any similar or identical product unless specifically and expressly noted. Our report includes all of the tests requested by you and the results thereof based upon the information that you provided to us. You have 60 days from date of issuance of this report to notify us of any material error or omission caused by our negligence, provided, however, that such notice shall be in writing and shall specifically address the issue you wish to raise. A failure to raise such issue within the prescribed time shall constitute your unqualified acceptance of the completeness of this report, the tests conducted and the correctness of the report contents. Unless specific mention, the uncertainty of measurement has been explicitly taken into account to declare the compliance or non-compliance to the specification. The report must not be used by the client to claim product certification, approval, or endorsement by TAF or any government agencies.

Table of Contents

Release Control Record	4
1 Certificate of Conformity	5
2 Summary of Test Results	6
2.1 Measurement Uncertainty	6
2.2 Modification Record	6
3 General Information	7
3.1 General Description of EUT	7
3.2 Description of Test Modes	9
3.2.1 Test Mode Applicability and Tested Channel Detail	11
3.3 Duty Cycle of Test Signal	13
3.4 Description of Support Units	14
3.4.1 Configuration of System under Test	15
3.5 General Description of Applied Standard	16
4 Test Types and Results	17
4.1 Radiated Emission and Bandedge Measurement	17
4.1.1 Limits of Radiated Emission and Bandedge Measurement	17
4.1.2 Test Instruments	18
4.1.3 Test Procedure	20
4.1.4 Deviation from Test Standard	20
4.1.5 Test Setup	21
4.1.6 EUT Operating Condition	22
4.1.7 Test Results	23
4.2 Conducted Emission Measurement	62
4.2.1 Limits of Conducted Emission Measurement	62
4.2.2 Test Instruments	62
4.2.3 Test Procedure	63
4.2.4 Deviation from Test Standard	63
4.2.5 Test Setup	63
4.2.6 EUT Operating Condition	63
4.2.7 Test Results	64
4.3 Transmit Power Measurement	66
4.3.1 Limits of Transmit Power Measurement	66
4.3.2 Test Setup	66
4.3.3 Test Instruments	66
4.3.4 Test Procedure	67
4.3.5 Deviation from Test Standard	67
4.3.6 EUT Operating Condition	67
4.3.7 Test Result	68
4.4 Occupied Bandwidth Measurement	75
4.4.1 Test Setup	75
4.4.2 Test Instruments	75
4.4.3 Test Procedure	75
4.4.4 Test Results	76
4.5 Peak Power Spectral Density Measurement	81
4.5.1 Limits of Peak Power Spectral Density Measurement	81
4.5.2 Test Setup	81
4.5.3 Test Instruments	81
4.5.4 Test Procedure	81
4.5.5 Deviation from Test Standard	81
4.5.6 EUT Operating Condition	82
4.5.7 Test Results	83
4.6 Frequency Stability Measurement	89
4.6.1 Limits of Frequency Stability Measurement	89

4.6.2	Test Setup.....	89
4.6.3	Test Instruments	89
4.6.4	Test Procedure	89
4.6.5	Deviation from Test Standard	89
4.6.6	EUT Operating Condition	89
4.6.7	Test Results	90
4.7	6dB Bandwidth Measurement	91
4.7.1	Limits of 6dB Bandwidth Measurement.....	91
4.7.2	Test Setup.....	91
4.7.3	Test Instruments	91
4.7.4	Test Procedure	91
4.7.5	Deviation from Test Standard	91
4.7.6	EUT Operating Condition	91
4.7.7	Test Results	92
5	Pictures of Test Arrangements.....	94
	Annex A- Radiated Out of Band Emission (OOBE) Measurement (For U-NII-3 band)	95
	Appendix – Information on the Testing Laboratories	99

Release Control Record

Issue No.	Description	Date Issued
RF161216E08-1	Original release.	Jan. 18, 2017

1 Certificate of Conformity

Product: IEEE 802.11 2X2 MU-MIMO ac/a/b/g/n Wireless LAN + Bluetooth NGFF Module

Brand: Marvell

Test Model: W8997-M1216

Sample Status: ENGINEERING SAMPLE

Applicant: Marvell Semiconductor

Test Date: Dec. 19 to 27, 2016

Standard: 47 CFR FCC Part 15, Subpart E (Section 15.407)
ANSI C63.10: 2013

The above equipment has been tested by **Bureau Veritas Consumer Products Services (H.K.) Ltd., Taoyuan Branch**, and found compliance with the requirement of the above standards. The test record, data evaluation & Equipment Under Test (EUT) configurations represented herein are true and accurate accounts of the measurements of the sample's EMC characteristics under the conditions specified in this report.

Prepared by : Wendy Wu , **Date:** Jan. 18, 2017
Wendy Wu / Specialist

Approved by : May Chen , **Date:** Jan. 18, 2017
May Chen / Manager

2 Summary of Test Results

47 CFR FCC Part 15, Subpart E (Section 15.407)			
FCC Clause	Test Item	Result	Remarks
15.407(b)(6)	AC Power Conducted Emissions	Pass	Meet the requirement of limit. Minimum passing margin is -14.62dB at 24.00391MHz.
15.407(b) (1/2/3/4(i/ii)/6)	Radiated Emissions & Band Edge Measurement*	Pass	Meet the requirement of limit. Minimum passing margin is -0.1dB at 10360.00MHz, 10480.00MHz, 5350.00MHz, 5150.00MHz, 5470.00MHz.
15.407(a)(1/2/3)	Max Average Transmit Power	Pass	Meet the requirement of limit.
---	Occupied Bandwidth Measurement	-	Reference only.
15.407(a)(1/2/3)	Peak Power Spectral Density	Pass	Meet the requirement of limit.
15.407(e)	6dB bandwidth	Pass	Meet the requirement of limit. (U-NII-3 Band only)
15.407(g)	Frequency Stability	Pass	Meet the requirement of limit.
15.203	Antenna Requirement	Pass	No antenna connector is used. Antenna connector is N-Type. (The device is professionally installed) Antenna connector is RSMA not a standard connector.

*For U-NII-3 band compliance with rule part 15.407(b)(4)(i), the OOB test plots were recorded in Annex A.

2.1 Measurement Uncertainty

Where relevant, the following measurement uncertainty levels have been estimated for tests performed on the EUT as specified in CISPR 16-4-2:

Measurement	Frequency	Expanded Uncertainty (k=2) (\pm)
Conducted Emissions at mains ports	150kHz ~ 30MHz	1.83 dB
Radiated Emissions up to 1 GHz	30MHz ~ 1GHz	5.36 dB
Radiated Emissions above 1 GHz	1GHz ~ 6GHz	3.47 dB
	6GHz ~ 18GHz	3.75 dB
	18GHz ~ 40GHz	3.30 dB

2.2 Modification Record

There were no modifications required for compliance.

3 General Information

3.1 General Description of EUT

Product	IEEE 802.11 2X2 MU-MIMO ac/a/b/g/n Wireless LAN + Bluetooth NGFF Module
Brand	Marvell
Test Model	W8997-M1216
Status of EUT	ENGINEERING SAMPLE
Power Supply Rating	DC 3.3V from host equipment
Modulation Type	CCK, DQPSK, DBPSK for DSSS 64QAM, 16QAM, QPSK, BPSK for OFDM 256QAM for OFDM in 11ac mode
Modulation Technology	DSSS, OFDM
Transfer Rate	802.11b: up to 11Mbps 802.11a/g: up to 54Mbps 802.11n: up to 300Mbps 802.11ac: up to 866.7Mbps
Operating Frequency	2.4GHz: 2.412 ~ 2.462GHz 5GHz: 5.18~5.24GHz, 5.26~5.32GHz, 5.50~5.70GHz, 5.745~5.825GHz
Number of Channel	2.4GHz: 802.11b, 802.11g, 802.11n (HT20): 11 802.11n (HT40): 7 5GHz: 802.11a, 802.11n (HT20), 802.11ac (VHT20): 24 802.11n (HT40), 802.11ac (VHT40): 11 802.11ac (VHT80): 5
Output Power	2.4GHz: 931.528mW 5.18GHz ~ 5.24GHz: 151.716mW 5.26~5.32GHz 148.092mW 5.50~5.70GHz 136.98mW 5.745GHz ~ 5.825GHz: 194.363mW
Antenna Type	Refer to Note
Antenna Connector	Refer to Note
Accessory Device	NA
Data Cable Supplied	NA

Note:

1. There are WLAN, BT technology used for the EUT.
2. Simultaneously transmission condition.

Condition	Technology	
1	WLAN (2.4GHz)	Bluetooth
2	WLAN (5GHz)	Bluetooth

Note: The emission of the simultaneous operation has been evaluated and no non-compliance was found.

3. The antennas provided to the EUT, please refer to the following table:

Antenna Set	Brand	Model	Chain No.	Antenna Net. Gain(dBi)	Frequency range (MHz)	Antenna Type	Connector Type
1	MAG.LAYERS	MSA-4008-25GC1-A1	Chain 0(Aux)	2.98	2400~2500	PIFA	i-pex(MHF)
				5.16	4900~5900		
			Chain 1(Main)	2.98	2400~2500		
				5.16	4900~5900		

4. The EUT incorporates a MIMO function.

2.4GHz Band			
MODULATION MODE	DATA RATE (MCS)	TX & RX CONFIGURATION	
802.11b	1 ~ 11Mbps	2TX	2RX
802.11g	6 ~ 54Mbps	2TX	2RX
802.11n (HT20)	MCS 0~7	2TX	2RX
	MCS 8~15	2TX	2RX
802.11n (HT40)	MCS 0~7	2TX	2RX
	MCS 8~15	2TX	2RX
5GHz Band			
MODULATION MODE	DATA RATE (MCS)	TX & RX CONFIGURATION	
802.11a	6 ~ 54Mbps	2TX	2RX
802.11n (HT20)	MCS 0~7	2TX	2RX
	MCS 8~15	2TX	2RX
802.11n (HT40)	MCS 0~7	2TX	2RX
	MCS 8~15	2TX	2RX
802.11ac (VHT20)	MCS0~8 Nss=1	2TX	2RX
	MCS0~8 Nss=2	2TX	2RX
802.11ac (VHT40)	MCS0~9 Nss=1	2TX	2RX
	MCS0~9 Nss=2	2TX	2RX
802.11ac (VHT80)	MCS0~9 Nss=1	2TX	2RX
	MCS0~9 Nss=2	2TX	2RX

Note. : 1. The modulation and bandwidth are similar for 802.11n mode for 20MHz (40MHz) and 802.11ac mode for 20MHz (40MHz), therefore investigated worst case to representative mode in test report. (Final test mode refer section 3.2.1)

5. The above EUT information is declared by manufacturer and for more detailed features description, please refer to the manufacturer's specifications or user's manual.

3.2 Description of Test Modes

FOR 5180 ~ 5240MHz

4 channels are provided for 802.11a, 802.11n (HT20), 802.11ac (VHT20):

Channel	Frequency	Channel	Frequency
36	5180 MHz	44	5220 MHz
40	5200 MHz	48	5240 MHz

2 channels are provided for 802.11n (HT40), 802.11ac (VHT40):

Channel	Frequency	Channel	Frequency
38	5190 MHz	46	5230 MHz

1 channel is provided for 802.11ac (VHT80):

Channel	Frequency
42	5210MHz

FOR 5260 ~ 5320MHz

4 channels are provided for 802.11a, 802.11n (HT20), 802.11ac (VHT20):

Channel	Frequency	Channel	Frequency
52	5260 MHz	60	5300 MHz
56	5280 MHz	64	5320 MHz

2 channels are provided for 802.11n (HT40), 802.11ac (VHT40):

Channel	Frequency	Channel	Frequency
54	5270 MHz	62	5310 MHz

1 channel is provided for 802.11ac (VHT80):

Channel	Frequency
58	5290MHz

FOR 5500 ~ 5700MHz

11 channels are provided for 802.11a, 802.11n (HT20), 802.11ac (VHT20):

Channel	Frequency	Channel	Frequency
100	5500 MHz	124	5620 MHz
104	5520 MHz	128	5640 MHz
108	5540 MHz	132	5660 MHz
112	5560 MHz	136	5680 MHz
116	5580 MHz	140	5700 MHz
120	5600 MHz		

5 channels are provided for 802.11n (HT40), 802.11ac (VHT40):

Channel	Frequency	Channel	Frequency
102	5510 MHz	126	5630 MHz
110	5550 MHz	134	5670 MHz
118	5590 MHz		

2 channels are provided for 802.11ac (VHT80):

Channel	Frequency	Channel	Frequency
106	5530MHz	122	5610 MHz

FOR 5745 ~ 5825MHz:

5 channels are provided for 802.11a, 802.11n (HT20), 802.11ac (VHT20):

Channel	Frequency	Channel	Frequency
149	5745MHz	161	5805MHz
153	5765MHz	165	5825MHz
157	5785MHz		

2 channels are provided for 802.11n (HT40), 802.11ac (VHT40):

Channel	Frequency	Channel	Frequency
151	5755MHz	159	5795MHz

1 channel is provided for 802.11ac (VHT80):

Channel	Frequency
155	5775MHz

3.2.1 Test Mode Applicability and Tested Channel Detail

EUT Configure Mode	Applicable To				Description
	RE \geq 1G	RE<1G	PLC	APCM	
-	√	√	√	√	-

Where **RE \geq 1G**: Radiated Emission above 1GHz **RE<1G**: Radiated Emission below 1GHz
PLC: Power Line Conducted Emission **APCM**: Antenna Port Conducted Measurement

NOTE:

- The EUT's antenna had been pre-tested on the positioned of each 3 axis. The worst case was found when positioned on **Z-plane**.

Radiated Emission Test (Above 1GHz):

- Pre-Scan has been conducted to determine the worst-case mode from all possible combinations between available modulations, data rates and antenna ports (if EUT with antenna diversity architecture).
- Following channel(s) was (were) selected for the final test as listed below.

Mode	FREQ. Band (MHz)	Available Channel	Tested Channel	Modulation Technology	Modulation Type	Data Rate (Mbps)
802.11a	5180-5240	36 to 48	36, 40, 48	OFDM	BPSK	6
802.11ac (VHT20)		36 to 48	36, 40, 48	OFDM	BPSK	6.5
802.11ac (VHT40)		38 to 46	38, 46	OFDM	BPSK	13.5
802.11ac (VHT80)		42	42	OFDM	BPSK	29.3
802.11a	5260-5320	52 to 64	52, 60, 64	OFDM	BPSK	6
802.11ac (VHT20)		52 to 64	52, 60, 64	OFDM	BPSK	6.5
802.11ac (VHT40)		54 to 62	54, 62	OFDM	BPSK	13.5
802.11ac (VHT80)		58	58	OFDM	BPSK	29.3
802.11a	5500-5700	100 to 140	100, 116, 140	OFDM	BPSK	6
802.11ac (VHT20)		100 to 140	100, 116, 140	OFDM	BPSK	6.5
802.11ac (VHT40)		102 to 134	102, 110, 134	OFDM	BPSK	13.5
802.11ac (VHT80)		106 to 122	106, 122	OFDM	BPSK	29.3
802.11a	5745-5825	149 to 165	149, 157, 165	OFDM	BPSK	6
802.11ac (VHT20)		149 to 165	149, 157, 165	OFDM	BPSK	6.5
802.11ac (VHT40)		151 to 159	151, 159	OFDM	BPSK	13.5
802.11ac (VHT80)		155	155	OFDM	BPSK	29.3

Radiated Emission Test (Below 1GHz):

- Pre-Scan has been conducted to determine the worst-case mode from all possible combinations between available modulations, data rates and antenna ports (if EUT with antenna diversity architecture).
- Following channel(s) was (were) selected for the final test as listed below.

Mode	FREQ. Band (MHz)	Available Channel	Tested Channel	Modulation Technology	Modulation Type	Data Rate (Mbps)
802.11ac (VHT20)	5745-5825	149 to 165	157	OFDM	BPSK	6.5

Power Line Conducted Emission Test:

- Pre-Scan has been conducted to determine the worst-case mode from all possible combinations between available modulations, data rates and antenna ports (if EUT with antenna diversity architecture).
- Following channel(s) was (were) selected for the final test as listed below.

Mode	FREQ. Band (MHz)	Available Channel	Tested Channel	Modulation Technology	Modulation Type	Data Rate (Mbps)
802.11ac (VHT20)	5745-5825	149 to 165	157	OFDM	BPSK	6.5

Antenna Port Conducted Measurement:

- This item includes all test value of each mode, but only includes spectrum plot of worst value of each mode.
- Pre-Scan has been conducted to determine the worst-case mode from all possible combinations between available modulations, data rates and antenna ports (if EUT with antenna diversity architecture).
- Following channel(s) was (were) selected for the final test as listed below.

Mode	FREQ. Band (MHz)	Available Channel	Tested Channel	Modulation Technology	Modulation Type	Data Rate (Mbps)
802.11a	5180-5240	36 to 48	36, 40, 48	OFDM	BPSK	6
802.11ac (VHT20)		36 to 48	36, 40, 48	OFDM	BPSK	6.5
802.11ac (VHT40)		38 to 46	38, 46	OFDM	BPSK	13.5
802.11ac (VHT80)		42	42	OFDM	BPSK	29.3
802.11a	5260-5320	52 to 64	52, 60, 64	OFDM	BPSK	6
802.11ac (VHT20)		52 to 64	52, 60, 64	OFDM	BPSK	6.5
802.11ac (VHT40)		54 to 62	54, 62	OFDM	BPSK	13.5
802.11ac (VHT80)		58	58	OFDM	BPSK	29.3
802.11a	5500-5700	100 to 140	100, 116, 140	OFDM	BPSK	6
802.11ac (VHT20)		100 to 140	100, 116, 140	OFDM	BPSK	6.5
802.11ac (VHT40)		102 to 134	102, 110, 134	OFDM	BPSK	13.5
802.11ac (VHT80)		106 to 122	106, 122	OFDM	BPSK	29.3
802.11a	5745-5825	149 to 165	149, 157, 165	OFDM	BPSK	6
802.11ac (VHT20)		149 to 165	149, 157, 165	OFDM	BPSK	6.5
802.11ac (VHT40)		151 to 159	151, 159	OFDM	BPSK	13.5
802.11ac (VHT80)		155	155	OFDM	BPSK	29.3

Test Condition:

Applicable To	Environmental Conditions	Input Power (System)	Tested By
RE \geq 1G	23deg. C, 71%RH	120Vac, 60Hz	Weiwei Lo
RE $<$ 1G	24deg. C, 65%RH	120Vac, 60Hz	Terry Huang
PLC	25deg. C, 75%RH	120Vac, 60Hz	Andy Ho
APCM	25deg. C, 60%RH	120Vac, 60Hz	Anderson Chen

3.3 Duty Cycle of Test Signal

Duty cycle of test signal is 100 %, duty factor is not required.



3.4 Description of Support Units

The EUT has been tested as an independent unit together with other necessary accessories or support units. The following support units or accessories were used to form a representative test configuration during the tests.

ID	Product	Brand	Model No.	Serial No.	FCC ID	Remarks
A.	Laptop	DELL	E6420	B92T3R1	FCC DoC	Provided by Lab
B.	Laptop	DELL	E6440	F9LYQ32	FCC DoC	Provided by Lab
C.	SDIO to PCIE Card	AzureWave	NA	NA	NA	Supplied by client
D.	Test Tool	AzureWave	NA	NA	NA	Supplied by client
E.	USB 3.0 Dongle	Transcend	JF790	NA	NA	Supplied by client

Note:

1. All power cords of the above support units are non-shielded (1.8m).

ID	Descriptions	Qty.	Length (m)	Shielding (Yes/No)	Cores (Qty.)	Remarks
1.	RJ-45 Cable	1	10	No	0	Provided by Lab
2.	USB Cable	1	1.4	Yes	0	Provided by Lab

3.4.1 Configuration of System under Test

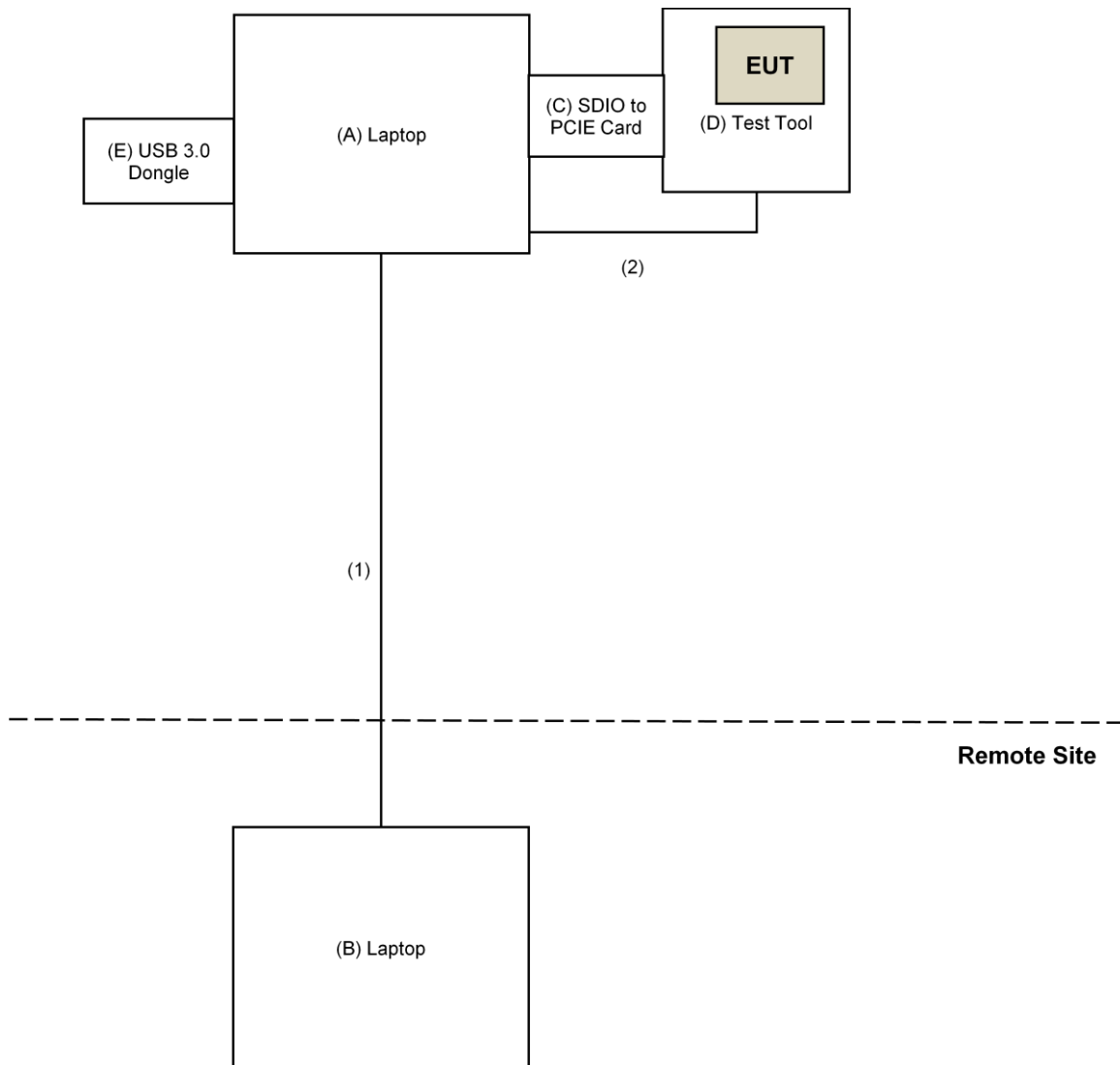

3.5 General Description of Applied Standard

The EUT is a RF Product. According to the specifications of the manufacturer, it must comply with the requirements of the following standards:

FCC Part 15, Subpart E (15.407)
KDB 789033 D02 General UNII Test Procedure New Rules v01r03
KDB 662911 D01 Multiple Transmitter Output v02r01
ANSI C63.10-2013

All test items have been performed and recorded as per the above standards.

4 Test Types and Results

4.1 Radiated Emission and Bandedge Measurement

4.1.1 Limits of Radiated Emission and Bandedge Measurement

Radiated emissions which fall in the restricted bands must comply with the radiated emission limits specified as below table.

Frequencies (MHz)	Field Strength (microvolts/meter)	Measurement Distance (meters)
0.009 ~ 0.490	2400/F(kHz)	300
0.490 ~ 1.705	24000/F(kHz)	30
1.705 ~ 30.0	30	30
30 ~ 88	100	3
88 ~ 216	150	3
216 ~ 960	200	3
Above 960	500	3

NOTE:

1. The lower limit shall apply at the transition frequencies.
2. Emission level (dBuV/m) = 20 log Emission level (uV/m).
3. For frequencies above 1000MHz, the field strength limits are based on average detector, however, the peak field strength of any emission shall not exceed the maximum permitted average limits, specified above by more than 20dB under any condition of modulation.

Limits of unwanted emission out of the restricted bands

Applicable To		Limit	
789033 D02 General UNII Test Procedure New Rules v01r03		Field Strength at 3m	
		PK:74 (dBuV/m)	AV:54 (dBuV/m)
Frequency Band	Applicable To	EIRP Limit	Equivalent Field Strength at 3m
5150~5250 MHz	15.407(b)(1)	PK:-27 (dBm/MHz)	PK:68.2(dBuV/m)
5250~5350 MHz	15.407(b)(2)		
5470~5725 MHz	15.407(b)(3)		
5725~5850 MHz	<input checked="" type="checkbox"/> 15.407(b)(4)(i)	PK:-27 (dBm/MHz) ^{*1} PK:10 (dBm/MHz) ^{*2} PK:15.6 (dBm/MHz) ^{*3} PK:27 (dBm/MHz) ^{*4}	PK: 68.2(dBuV/m) ^{*1} PK:105.2 (dBuV/m) ^{*2} PK: 110.8(dBuV/m) ^{*3} PK:122.2 (dBuV/m) ^{*4}
	<input type="checkbox"/> 15.407(b)(4)(ii)	Emission limits in section 15.247(d)	
^{*1} beyond 75 MHz or more above of the band edge.		^{*2} below the band edge increasing linearly to 10 dBm/MHz at 25 MHz above.	
^{*3} below the band edge increasing linearly to a level of 15.6 dBm/MHz at 5 MHz above.		^{*4} from 5 MHz above or below the band edge increasing linearly to a level of 27 dBm/MHz at the band edge.	

Note:

The following formula is used to convert the equipment isotropic radiated power (eirp) to field strength:

$$E = \frac{1000000\sqrt{30P}}{3} \mu\text{V/m, where P is the eirp (Watts).}$$

4.1.2 Test Instruments

DESCRIPTION & MANUFACTURER	MODEL NO.	SERIAL NO.	CALIBRATED DATE	CALIBRATED UNTIL
Test Receiver Agilent	N9038A	MY50010156	Aug. 18, 2016	Aug. 17, 2017
Pre-Amplifier ^(*) EMCI	EMC001340	980142	Jan. 20, 2016	Jan. 19, 2018
Loop Antenna ^(*) Electro-Metrics	EM-6879	264	Dec. 16, 2016	Dec. 15, 2018
RF Cable	NA	LOOPCAB-001 LOOPCAB-002	Jan. 18, 2016	Jan. 17, 2017
Pre-Amplifier Mini-Circuits	ZFL-1000VH2B	AMP-ZFL-05	May 07, 2016	May 06, 2017
Trilog Broadband Antenna SCHWARZBECK	VULB 9168	9168-156	Jan. 04, 2016	Jan. 03, 2017
RF Cable	8D	966-3-1 966-3-2 966-3-3	Apr. 02, 2016	Apr. 01, 2017
Fixed attenuator Mini-Circuits	UNAT-5+	PAD-3m-3-01	Oct. 05, 2016	Oct. 04, 2017
Horn_Antenna SCHWARZBECK	BBHA9120-D	9120D-406	Jan. 20, 2016	Jan. 19, 2017
Pre-Amplifier Agilent	8449B	3008A02465	Apr. 05, 2016	Apr. 04, 2017
RF Cable	EMC104-SM-SM-2000 EMC104-SM-SM-5000 EMC104-SM-SM-5000	150317 150321 150322	Mar. 30, 2016	Mar. 29, 2017
Spectrum Analyzer Keysight	N9030A	MY54490520	July 29, 2016	July 28, 2017
Pre-Amplifier EMCI	EMC184045	980143	Jan. 15, 2016	Jan. 14, 2017
Horn_Antenna SCHWARZBECK	BBHA 9170	BBHA9170608	Jan. 08, 2016	Jan. 07, 2017
RF Cable	SUCOFLEX 102	36432/2 36441/2	Jan. 16, 2016	Jan. 15, 2017
Software	ADT_Radiated_V8.7.08	NA	NA	NA
Antenna Tower & Turn Table Max-Full	MF-7802	MF780208406	NA	NA
Boresight Antenna Fixture	FBA-01	FBA-SIP01	NA	NA
Spectrum Analyzer R&S	FSv40	100964	June 28, 2016	June 27, 2017
Power meter Anritsu	ML2495A	1014008	May 5, 2016	May 4, 2017
Power sensor Anritsu	MA2411B	0917122	May 5, 2016	May 4, 2017
AC Power Source Extech Electronics	6205	1440452	NA	NA
Temperature & Humidity Chamber Giant Force	GTH-150-40-SP-AR	MAA0812-008	Jan. 15, 2016	Jan. 14, 2017
Digital Multimeter FLUKE	87III	73680266	Nov. 10, 2016	Nov. 09, 2017

Note:

1. The calibration interval of the above test instruments is 12 months and the calibrations are traceable to NML/ROC and NIST/USA.
2. *The calibration interval of the above test instruments is 24 months and the calibrations are traceable to NML/ROC and NIST/USA.
3. The test was performed in 966 Chamber No. 3.
4. The FCC Site Registration No. is 147459
6. The CANADA Site Registration No. is 20331-1
- 7 Loop antenna was used for all emissions below 30 MHz.
8. Tested Date: Dec. 19 to 22, 2016

4.1.3 Test Procedure

For Radiated emission below 30MHz

- a. The EUT was placed on the top of a rotating table 0.8 meters above the ground at a 3 meter chamber room. The table was rotated 360 degrees to determine the position of the highest radiation.
- b. The EUT was set 3 meters away from the interference-receiving antenna, which was mounted on the top of a variable-height antenna tower.
- c. Both X and Y axes of the antenna are set to make the measurement.
- d. For each suspected emission, the EUT was arranged to its worst case and the rotatable table was turned from 0 degrees to 360 degrees to find the maximum reading.
- e. The test-receiver system was set to Quasi-Peak Detect Function and Specified Bandwidth with Maximum Hold Mode.

NOTE:

1. The resolution bandwidth and video bandwidth of test receiver/spectrum analyzer is 9kHz at frequency below 30MHz.

For Radiated emission above 30MHz

- a. The EUT was placed on the top of a rotating table 0.8 meters (for 30MHz ~ 1GHz) / 1.5 meters (for above 1GHz) above the ground at 3 meter chamber room for test. The table was rotated 360 degrees to determine the position of the highest radiation.
- b. The EUT was set 3 meters away from the interference-receiving antenna, which was mounted on the top of a variable-height antenna tower.
- c. The height of antenna is varied from one meter to four meters above the ground to determine the maximum value of the field strength. Both horizontal and vertical polarizations of the antenna are set to make the measurement.
- d. For each suspected emission, the EUT was arranged to its worst case and then the antenna was tuned to heights from 1 meter to 4 meters and the rotatable table was turned from 0 degrees to 360 degrees to find the maximum reading.
- e. The test-receiver system was set to quasi-peak detect function and specified bandwidth with maximum hold mode when the test frequency is below 1 GHz.
- f. The test-receiver system was set to peak and average detect function and specified bandwidth with maximum hold mode when the test frequency is above 1 GHz. If the peak reading value also meets average limit, measurement with the average detector is unnecessary.

Note:

1. The resolution bandwidth and video bandwidth of test receiver/spectrum analyzer is 120kHz for Quasi-peak detection (QP) at frequency below 1GHz.
2. The resolution bandwidth of test receiver/spectrum analyzer is 1 MHz and the video bandwidth is 3 MHz for Peak detection (PK) at frequency above 1GHz.
3. The resolution bandwidth of test receiver/spectrum analyzer is 1MHz and the video bandwidth is $\geq 1/T$ (Duty cycle < 98%) or 10Hz (Duty cycle $\geq 98\%$) for Average detection (AV) at frequency above 1GHz.
4. All modes of operation were investigated and the worst-case emissions are reported.

4.1.4 Deviation from Test Standard

No deviation.

4.1.5 Test Setup

For Radiated emission below 30MHz

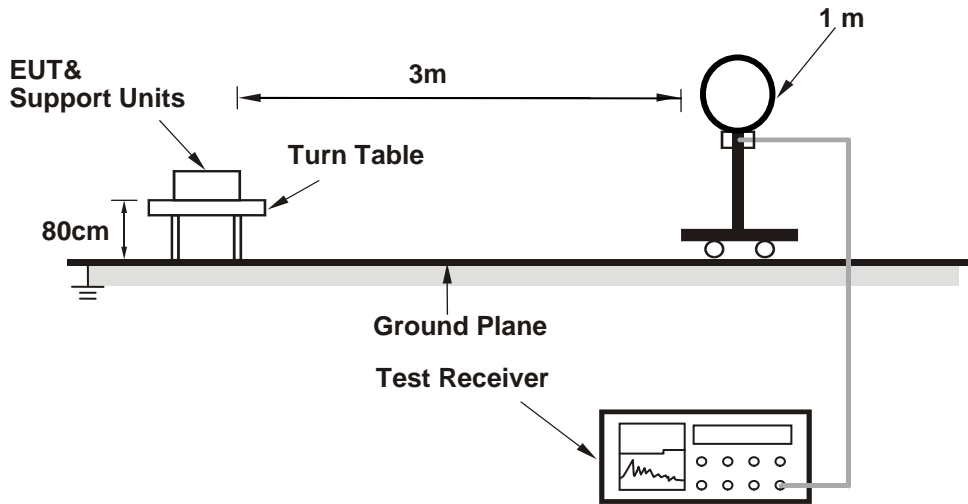

For Radiated emission 30MHz to 1GHz

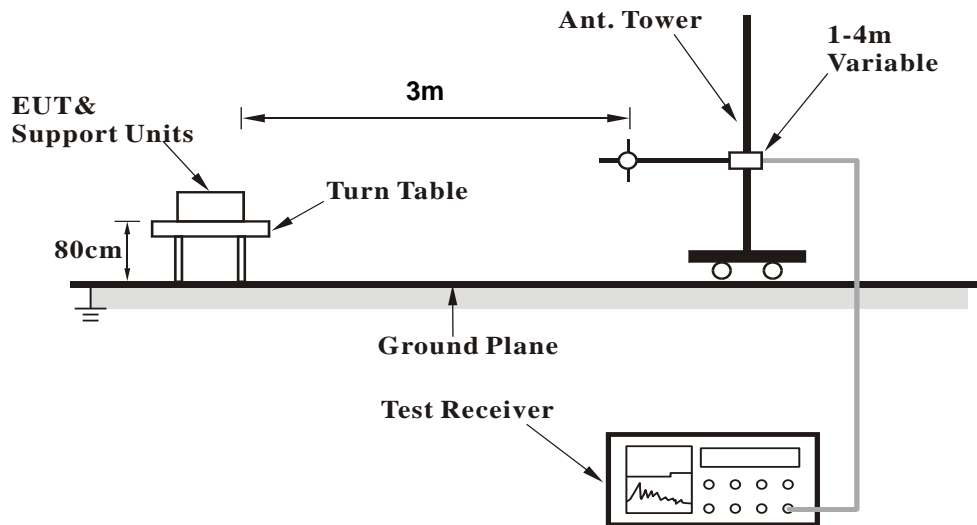

For Radiated emission above 1GHz

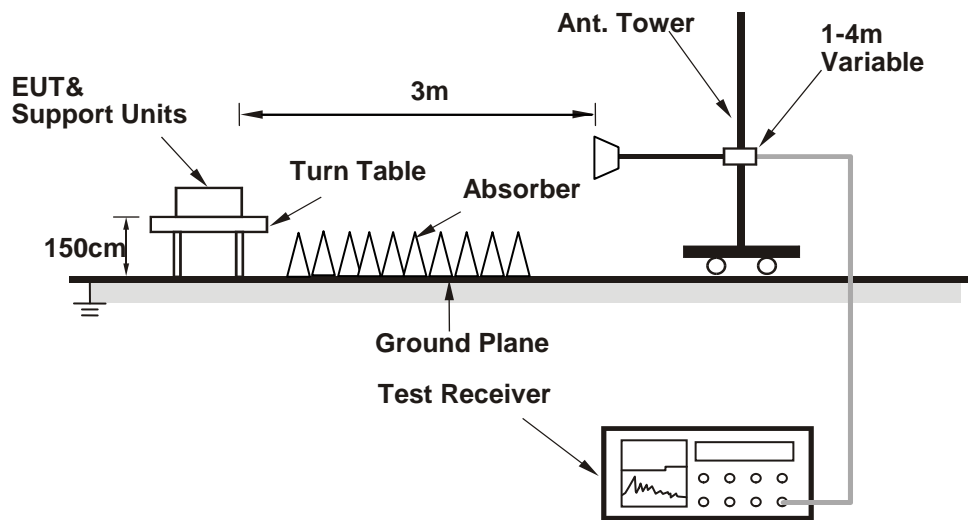

For the actual test configuration, please refer to the attached file (Test Setup Photo).

4.1.6 EUT Operating Condition

- a. Connected the EUT with the Laptop which is placed on table.
- b. Controlling software (DutApiMimoBt.exe[Ver1.0.0.109]) has been activated to set the EUT on specific status.

4.1.7 Test Results

Above 1GHz Data:

802.11a

CHANNEL	TX Channel 36	DETECTOR FUNCTION	Peak (PK)
FREQUENCY RANGE	1GHz ~ 40GHz		Average (AV)

ANTENNA POLARITY & TEST DISTANCE: HORIZONTAL AT 3 M

NO.	FREQ. (MHz)	EMISSION LEVEL (dBuV/m)	LIMIT (dBuV/m)	MARGIN (dB)	ANTENNA HEIGHT (m)	TABLE ANGLE (Degree)	RAW VALUE (dBuV)	CORRECTION FACTOR (dB/m)
1	5150.00	72.9 PK	74.0	-1.1	2.35 H	329	69.9	3.0
2	5150.00	50.3 AV	54.0	-3.7	2.35 H	329	47.3	3.0
3	*5180.00	112.9 PK			2.35 H	329	109.8	3.1
4	*5180.00	102.5 AV			2.35 H	329	99.4	3.1
5	#10360.00	65.0 PK	74.0	-9.0	1.77 H	285	51.4	13.6
6	#10360.00	50.3 AV	54.0	-3.7	1.77 H	285	36.7	13.6
7	15540.00	51.0 PK	74.0	-23.0	1.59 H	208	35.3	15.7
8	15540.00	39.2 AV	54.0	-14.8	1.59 H	208	23.5	15.7

ANTENNA POLARITY & TEST DISTANCE: VERTICAL AT 3 M

NO.	FREQ. (MHz)	EMISSION LEVEL (dBuV/m)	LIMIT (dBuV/m)	MARGIN (dB)	ANTENNA HEIGHT (m)	TABLE ANGLE (Degree)	RAW VALUE (dBuV)	CORRECTION FACTOR (dB/m)
1	5150.00	66.5 PK	74.0	-7.5	2.75 V	180	63.5	3.0
2	5150.00	45.5 AV	54.0	-8.5	2.75 V	180	42.5	3.0
3	*5180.00	106.9 PK			2.75 V	336	103.8	3.1
4	*5180.00	97.1 AV			2.75 V	336	94.0	3.1
5	#10360.00	68.2 PK	74.0	-5.8	1.78 V	173	54.6	13.6
6	#10360.00	53.9 AV	54.0	-0.1	1.78 V	173	40.3	13.6
7	15540.00	49.5 PK	74.0	-24.5	2.62 V	35	33.8	15.7
8	15540.00	37.7 AV	54.0	-16.3	2.62 V	35	22.0	15.7

REMARKS:

1. Emission Level(dBuV/m) = Raw Value(dBuV) + Correction Factor(dB/m)
2. Correction Factor(dB/m) = Antenna Factor(dB/m) + Cable Factor(dB) – Pre-Amplifier Factor(dB)
3. The other emission levels were very low against the limit.
4. Margin value = Emission Level – Limit value
5. " * ": Fundamental frequency.
6. " # ": The radiated frequency is out of the restricted band.

CHANNEL	TX Channel 40	DETECTOR FUNCTION	Peak (PK)
FREQUENCY RANGE	1GHz ~ 40GHz		Average (AV)

ANTENNA POLARITY & TEST DISTANCE: HORIZONTAL AT 3 M

NO.	FREQ. (MHz)	EMISSION LEVEL (dBuV/m)	LIMIT (dBuV/m)	MARGIN (dB)	ANTENNA HEIGHT (m)	TABLE ANGLE (Degree)	RAW VALUE (dBuV)	CORRECTION FACTOR (dB/m)
1	*5200.00	110.8 PK			2.47 H	151	107.7	3.1
2	*5200.00	101.1 AV			2.47 H	151	98.0	3.1
3	#10400.00	65.1 PK	74.0	-8.9	1.75 H	280	51.5	13.6
4	#10400.00	50.1 AV	54.0	-3.9	1.75 H	280	36.5	13.6
5	15600.00	51.4 PK	74.0	-22.6	1.65 H	214	35.7	15.7
6	15600.00	39.5 AV	54.0	-14.5	1.65 H	214	23.8	15.7

ANTENNA POLARITY & TEST DISTANCE: VERTICAL AT 3 M

NO.	FREQ. (MHz)	EMISSION LEVEL (dBuV/m)	LIMIT (dBuV/m)	MARGIN (dB)	ANTENNA HEIGHT (m)	TABLE ANGLE (Degree)	RAW VALUE (dBuV)	CORRECTION FACTOR (dB/m)
1	*5200.00	106.6 PK			2.75 V	329	103.5	3.1
2	*5200.00	96.9 AV			2.75 V	329	93.8	3.1
3	#10400.00	67.6 PK	74.0	-6.4	1.82 V	168	54.0	13.6
4	#10400.00	53.4 AV	54.0	-0.6	1.82 V	168	39.8	13.6
5	15600.00	51.4 PK	74.0	-22.6	1.45 V	98	35.7	15.7
6	15600.00	39.4 AV	54.0	-14.6	1.45 V	98	23.7	15.7

REMARKS:

1. Emission Level(dBuV/m) = Raw Value(dBuV) + Correction Factor(dB/m)
2. Correction Factor(dB/m) = Antenna Factor(dB/m) + Cable Factor(dB) – Pre-Amplifier Factor(dB)
3. The other emission levels were very low against the limit.
4. Margin value = Emission Level – Limit value
5. " * ": Fundamental frequency.
6. " # ": The radiated frequency is out of the restricted band.

CHANNEL	TX Channel 48	DETECTOR FUNCTION	Peak (PK)
FREQUENCY RANGE	1GHz ~ 40GHz		Average (AV)

ANTENNA POLARITY & TEST DISTANCE: HORIZONTAL AT 3 M

NO.	FREQ. (MHz)	EMISSION LEVEL (dBuV/m)	LIMIT (dBuV/m)	MARGIN (dB)	ANTENNA HEIGHT (m)	TABLE ANGLE (Degree)	RAW VALUE (dBuV)	CORRECTION FACTOR (dB/m)
1	*5240.00	116.5 PK			2.23 H	157	113.3	3.2
2	*5240.00	107.3 AV			2.23 H	157	104.1	3.2
3	5350.00	63.3 PK	74.0	-10.7	2.23 H	157	59.8	3.5
4	5350.00	48.6 AV	54.0	-5.4	2.23 H	157	45.1	3.5
5	#10480.00	65.4 PK	74.0	-8.6	1.79 H	273	51.4	14.0
6	#10480.00	52.0 AV	54.0	-2.0	1.79 H	273	38.0	14.0
7	15720.00	51.3 PK	74.0	-22.7	1.60 H	226	35.9	15.4
8	15720.00	39.3 AV	54.0	-14.7	1.60 H	226	23.9	15.4

ANTENNA POLARITY & TEST DISTANCE: VERTICAL AT 3 M

NO.	FREQ. (MHz)	EMISSION LEVEL (dBuV/m)	LIMIT (dBuV/m)	MARGIN (dB)	ANTENNA HEIGHT (m)	TABLE ANGLE (Degree)	RAW VALUE (dBuV)	CORRECTION FACTOR (dB/m)
1	*5240.00	112.3 PK			2.72 V	340	109.1	3.2
2	*5240.00	103.1 AV			2.72 V	340	99.9	3.2
3	5350.00	56.9 PK	74.0	-17.1	2.72 V	340	53.4	3.5
4	5350.00	43.8 AV	54.0	-10.2	2.72 V	340	40.3	3.5
5	#10480.00	68.2 PK	74.0	-5.8	1.82 V	163	54.2	14.0
6	#10480.00	53.9 AV	54.0	-0.1	1.82 V	163	39.9	14.0
7	15720.00	49.9 PK	74.0	-24.1	2.54 V	37	34.5	15.4
8	15720.00	38.3 AV	54.0	-15.7	2.54 V	37	22.9	15.4

REMARKS:

1. Emission Level(dBuV/m) = Raw Value(dBuV) + Correction Factor(dB/m)
2. Correction Factor(dB/m) = Antenna Factor(dB/m) + Cable Factor(dB) – Pre-Amplifier Factor(dB)
3. The other emission levels were very low against the limit.
4. Margin value = Emission Level – Limit value
5. " * ": Fundamental frequency.
6. " # ": The radiated frequency is out of the restricted band.

CHANNEL	TX Channel 52	DETECTOR FUNCTION	Peak (PK)
FREQUENCY RANGE	1GHz ~ 40GHz		Average (AV)

ANTENNA POLARITY & TEST DISTANCE: HORIZONTAL AT 3 M

NO.	FREQ. (MHz)	EMISSION LEVEL (dBuV/m)	LIMIT (dBuV/m)	MARGIN (dB)	ANTENNA HEIGHT (m)	TABLE ANGLE (Degree)	RAW VALUE (dBuV)	CORRECTION FACTOR (dB/m)
1	5150.00	63.5 PK	74.0	-10.5	2.29 H	163	60.5	3.0
2	5150.00	48.6 AV	54.0	-5.4	2.29 H	163	45.6	3.0
3	*5260.00	116.2 PK			2.29 H	163	112.9	3.3
4	*5260.00	107.0 AV			2.29 H	163	103.7	3.3
5	#10520.00	65.2 PK	74.0	-8.8	1.74 H	294	51.1	14.1
6	#10520.00	50.1 AV	54.0	-3.9	1.74 H	294	36.0	14.1
7	15780.00	51.1 PK	74.0	-22.9	1.62 H	225	35.9	15.2
8	15780.00	39.2 AV	54.0	-14.8	1.62 H	225	24.0	15.2

ANTENNA POLARITY & TEST DISTANCE: VERTICAL AT 3 M

NO.	FREQ. (MHz)	EMISSION LEVEL (dBuV/m)	LIMIT (dBuV/m)	MARGIN (dB)	ANTENNA HEIGHT (m)	TABLE ANGLE (Degree)	RAW VALUE (dBuV)	CORRECTION FACTOR (dB/m)
1	5150.00	56.8 PK	74.0	-17.2	2.77 V	329	53.8	3.0
2	5150.00	43.9 AV	54.0	-10.1	2.77 V	329	40.9	3.0
3	*5260.00	112.1 PK			2.77 V	329	108.8	3.3
4	*5260.00	102.9 AV			2.77 V	329	99.6	3.3
5	#10520.00	66.8 PK	74.0	-7.2	1.63 V	176	52.7	14.1
6	#10520.00	52.6 AV	54.0	-1.4	1.63 V	176	38.5	14.1
7	15780.00	50.4 PK	74.0	-23.6	2.59 V	24	35.2	15.2
8	15780.00	38.5 AV	54.0	-15.5	2.59 V	24	23.3	15.2

REMARKS:

1. Emission Level(dBuV/m) = Raw Value(dBuV) + Correction Factor(dB/m)
2. Correction Factor(dB/m) = Antenna Factor(dB/m) + Cable Factor(dB) – Pre-Amplifier Factor(dB)
3. The other emission levels were very low against the limit.
4. Margin value = Emission Level – Limit value
5. " * ": Fundamental frequency.
6. " # ": The radiated frequency is out of the restricted band.

CHANNEL	TX Channel 60	DETECTOR FUNCTION	Peak (PK)
FREQUENCY RANGE	1GHz ~ 40GHz		Average (AV)

ANTENNA POLARITY & TEST DISTANCE: HORIZONTAL AT 3 M

NO.	FREQ. (MHz)	EMISSION LEVEL (dBuV/m)	LIMIT (dBuV/m)	MARGIN (dB)	ANTENNA HEIGHT (m)	TABLE ANGLE (Degree)	RAW VALUE (dBuV)	CORRECTION FACTOR (dB/m)
1	*5300.00	116.9 PK			2.22 H	152	113.6	3.3
2	*5300.00	107.8 AV			2.22 H	152	104.5	3.3
3	10600.00	65.2 PK	74.0	-8.8	1.81 H	292	50.9	14.3
4	10600.00	50.0 AV	54.0	-4.0	1.81 H	292	35.7	14.3
5	15900.00	52.2 PK	74.0	-21.8	1.60 H	215	37.1	15.1
6	15900.00	40.0 AV	54.0	-14.0	1.60 H	215	24.9	15.1

ANTENNA POLARITY & TEST DISTANCE: VERTICAL AT 3 M

NO.	FREQ. (MHz)	EMISSION LEVEL (dBuV/m)	LIMIT (dBuV/m)	MARGIN (dB)	ANTENNA HEIGHT (m)	TABLE ANGLE (Degree)	RAW VALUE (dBuV)	CORRECTION FACTOR (dB/m)
1	*5300.00	112.6 PK			2.77 V	343	109.3	3.3
2	*5300.00	103.3 AV			2.77 V	343	100.0	3.3
3	10600.00	62.5 PK	74.0	-11.5	1.64 V	176	48.2	14.3
4	10600.00	49.1 AV	54.0	-4.9	1.64 V	176	34.8	14.3
5	15900.00	50.0 PK	74.0	-24.0	2.56 V	13	34.9	15.1
6	15900.00	38.1 AV	54.0	-15.9	2.56 V	13	23.0	15.1

REMARKS:

1. Emission Level(dBuV/m) = Raw Value(dBuV) + Correction Factor(dB/m)
2. Correction Factor(dB/m) = Antenna Factor(dB/m) + Cable Factor(dB) – Pre-Amplifier Factor(dB)
3. The other emission levels were very low against the limit.
4. Margin value = Emission Level – Limit value
5. " * ": Fundamental frequency.

CHANNEL	TX Channel 64	DETECTOR FUNCTION	Peak (PK)
FREQUENCY RANGE	1GHz ~ 40GHz		Average (AV)

ANTENNA POLARITY & TEST DISTANCE: HORIZONTAL AT 3 M

NO.	FREQ. (MHz)	EMISSION LEVEL (dBuV/m)	LIMIT (dBuV/m)	MARGIN (dB)	ANTENNA HEIGHT (m)	TABLE ANGLE (Degree)	RAW VALUE (dBuV)	CORRECTION FACTOR (dB/m)
1	*5320.00	110.1 PK			2.31 H	318	106.6	3.5
2	*5320.00	102.4 AV			2.31 H	318	98.9	3.5
3	5350.00	73.4 PK	74.0	-0.6	2.31 H	318	69.9	3.5
4	5350.00	47.3 AV	54.0	-6.7	2.31 H	318	43.8	3.5
5	10640.00	50.2 PK	74.0	-23.8	2.59 H	15	35.9	14.3
6	10640.00	38.5 AV	54.0	-15.5	2.59 H	15	24.2	14.3
7	15960.00	51.7 PK	74.0	-22.3	1.68 H	218	36.6	15.1
8	15960.00	39.5 AV	54.0	-14.5	1.68 H	218	24.4	15.1

ANTENNA POLARITY & TEST DISTANCE: VERTICAL AT 3 M

NO.	FREQ. (MHz)	EMISSION LEVEL (dBuV/m)	LIMIT (dBuV/m)	MARGIN (dB)	ANTENNA HEIGHT (m)	TABLE ANGLE (Degree)	RAW VALUE (dBuV)	CORRECTION FACTOR (dB/m)
1	*5320.00	104.3 PK			2.83 V	344	100.8	3.5
2	*5320.00	95.1 AV			2.83 V	344	91.6	3.5
3	5350.00	57.4 PK	74.0	-16.6	2.83 V	337	53.9	3.5
4	5350.00	44.1 AV	54.0	-9.9	2.83 V	337	40.6	3.5
5	10640.00	63.1 PK	74.0	-10.9	1.72 V	187	48.8	14.3
6	10640.00	49.0 AV	54.0	-5.0	1.72 V	187	34.7	14.3
7	15960.00	55.7 PK	74.0	-18.3	1.57 V	127	40.6	15.1
8	15960.00	42.1 AV	54.0	-11.9	1.57 V	127	27.0	15.1

REMARKS:

1. Emission Level(dBuV/m) = Raw Value(dBuV) + Correction Factor(dB/m)
2. Correction Factor(dB/m) = Antenna Factor(dB/m) + Cable Factor(dB) – Pre-Amplifier Factor(dB)
3. The other emission levels were very low against the limit.
4. Margin value = Emission Level – Limit value
5. " * ": Fundamental frequency.

CHANNEL	TX Channel 100	DETECTOR FUNCTION	Peak (PK)
FREQUENCY RANGE	1GHz ~ 40GHz		Average (AV)

ANTENNA POLARITY & TEST DISTANCE: HORIZONTAL AT 3 M

NO.	FREQ. (MHz)	EMISSION LEVEL (dBuV/m)	LIMIT (dBuV/m)	MARGIN (dB)	ANTENNA HEIGHT (m)	TABLE ANGLE (Degree)	RAW VALUE (dBuV)	CORRECTION FACTOR (dB/m)
1	#5470.00	73.6 PK	74.0	-0.4	2.27 H	316	69.9	3.7
2	#5470.00	50.6 AV	54.0	-3.4	2.27 H	316	46.9	3.7
3	*5500.00	112.4 PK			2.27 H	316	108.6	3.8
4	*5500.00	102.4 AV			2.27 H	316	98.6	3.8
5	11000.00	49.2 PK	74.0	-24.8	2.65 H	18	34.0	15.2
6	11000.00	37.8 AV	54.0	-16.2	2.65 H	18	22.6	15.2
7	#16500.00	51.0 PK	74.0	-23.0	1.60 H	212	33.6	17.4
8	#16500.00	39.1 AV	54.0	-14.9	1.60 H	212	21.7	17.4

ANTENNA POLARITY & TEST DISTANCE: VERTICAL AT 3 M

NO.	FREQ. (MHz)	EMISSION LEVEL (dBuV/m)	LIMIT (dBuV/m)	MARGIN (dB)	ANTENNA HEIGHT (m)	TABLE ANGLE (Degree)	RAW VALUE (dBuV)	CORRECTION FACTOR (dB/m)
1	#5470.00	57.3 PK	74.0	-16.7	2.72 V	332	53.6	3.7
2	#5470.00	43.9 AV	54.0	-10.1	2.72 V	332	40.2	3.7
3	*5500.00	106.3 PK			2.72 V	332	102.5	3.8
4	*5500.00	96.7 AV			2.72 V	332	92.9	3.8
5	11000.00	63.4 PK	74.0	-10.6	1.70 V	193	48.2	15.2
6	11000.00	49.2 AV	54.0	-4.8	1.70 V	193	34.0	15.2
7	#16500.00	55.4 PK	74.0	-18.6	1.58 V	146	38.0	17.4
8	#16500.00	41.8 AV	54.0	-12.2	1.58 V	146	24.4	17.4

REMARKS:

1. Emission Level(dBuV/m) = Raw Value(dBuV) + Correction Factor(dB/m)
2. Correction Factor(dB/m) = Antenna Factor(dB/m) + Cable Factor(dB) – Pre-Amplifier Factor(dB)
3. The other emission levels were very low against the limit.
4. Margin value = Emission Level – Limit value
5. " * ": Fundamental frequency.
6. " # ": The radiated frequency is out of the restricted band.

CHANNEL	TX Channel 116	DETECTOR FUNCTION	Peak (PK)
FREQUENCY RANGE	1GHz ~ 40GHz		Average (AV)

ANTENNA POLARITY & TEST DISTANCE: HORIZONTAL AT 3 M

NO.	FREQ. (MHz)	EMISSION LEVEL (dBuV/m)	LIMIT (dBuV/m)	MARGIN (dB)	ANTENNA HEIGHT (m)	TABLE ANGLE (Degree)	RAW VALUE (dBuV)	CORRECTION FACTOR (dB/m)
1	*5580.00	114.1 PK			2.35 H	147	110.2	3.9
2	*5580.00	104.8 AV			2.35 H	147	100.9	3.9
3	11160.00	64.1 PK	74.0	-9.9	1.77 H	105	48.9	15.2
4	11160.00	48.6 AV	54.0	-5.4	1.77 H	105	33.4	15.2
5	#16740.00	55.5 PK	74.0	-18.5	1.60 H	200	37.2	18.3
6	#16740.00	42.3 AV	54.0	-11.7	1.60 H	200	24.0	18.3

ANTENNA POLARITY & TEST DISTANCE: VERTICAL AT 3 M

NO.	FREQ. (MHz)	EMISSION LEVEL (dBuV/m)	LIMIT (dBuV/m)	MARGIN (dB)	ANTENNA HEIGHT (m)	TABLE ANGLE (Degree)	RAW VALUE (dBuV)	CORRECTION FACTOR (dB/m)
1	*5580.00	112.4 PK			2.75 V	335	108.5	3.9
2	*5580.00	103.0 AV			2.75 V	335	99.1	3.9
3	11160.00	63.4 PK	74.0	-10.6	1.76 V	169	48.2	15.2
4	11160.00	49.1 AV	54.0	-4.9	1.76 V	169	33.9	15.2
5	#16740.00	55.2 PK	74.0	-18.8	1.60 V	147	36.9	18.3
6	#16740.00	41.8 AV	54.0	-12.2	1.60 V	147	23.5	18.3

REMARKS:

1. Emission Level(dBuV/m) = Raw Value(dBuV) + Correction Factor(dB/m)
2. Correction Factor(dB/m) = Antenna Factor(dB/m) + Cable Factor(dB) – Pre-Amplifier Factor(dB)
3. The other emission levels were very low against the limit.
4. Margin value = Emission Level – Limit value
5. " * ": Fundamental frequency.
6. " # ": The radiated frequency is out of the restricted band.

CHANNEL	TX Channel 140	DETECTOR FUNCTION	Peak (PK)
FREQUENCY RANGE	1GHz ~ 40GHz		Average (AV)

ANTENNA POLARITY & TEST DISTANCE: HORIZONTAL AT 3 M

NO.	FREQ. (MHz)	EMISSION LEVEL (dBuV/m)	LIMIT (dBuV/m)	MARGIN (dB)	ANTENNA HEIGHT (m)	TABLE ANGLE (Degree)	RAW VALUE (dBuV)	CORRECTION FACTOR (dB/m)
1	*5700.00	108.7 PK			2.29 H	316	104.5	4.2
2	*5700.00	99.3 AV			2.29 H	316	95.1	4.2
3	#5725.00	73.2 PK	74.0	-0.8	2.29 H	316	69.0	4.2
4	#5725.00	47.6 AV	54.0	-6.4	2.29 H	316	43.4	4.2
5	11400.00	49.7 PK	74.0	-24.3	2.63 H	20	34.2	15.5
6	11400.00	37.7 AV	54.0	-16.3	2.63 H	20	22.2	15.5
7	#17100.00	50.9 PK	74.0	-23.1	1.65 H	209	30.8	20.1
8	#17100.00	39.2 AV	54.0	-14.8	1.65 H	209	19.1	20.1

ANTENNA POLARITY & TEST DISTANCE: VERTICAL AT 3 M

NO.	FREQ. (MHz)	EMISSION LEVEL (dBuV/m)	LIMIT (dBuV/m)	MARGIN (dB)	ANTENNA HEIGHT (m)	TABLE ANGLE (Degree)	RAW VALUE (dBuV)	CORRECTION FACTOR (dB/m)
1	*5700.00	104.6 PK			2.80 V	335	100.4	4.2
2	*5700.00	95.6 AV			2.80 V	335	91.4	4.2
3	#5725.00	58.1 PK	74.0	-15.9	2.80 V	335	53.9	4.2
4	#5725.00	44.5 AV	54.0	-9.5	2.80 V	335	40.3	4.2
5	11400.00	63.8 PK	74.0	-10.2	1.77 V	167	48.3	15.5
6	11400.00	49.3 AV	54.0	-4.7	1.77 V	167	33.8	15.5
7	#17100.00	55.1 PK	74.0	-18.9	1.62 V	127	35.0	20.1
8	#17100.00	41.7 AV	54.0	-12.3	1.62 V	127	21.6	20.1

REMARKS:

1. Emission Level(dBuV/m) = Raw Value(dBuV) + Correction Factor(dB/m)
2. Correction Factor(dB/m) = Antenna Factor(dB/m) + Cable Factor(dB) – Pre-Amplifier Factor(dB)
3. The other emission levels were very low against the limit.
4. Margin value = Emission Level – Limit value
5. " * ": Fundamental frequency.
6. " # ": The radiated frequency is out of the restricted band.

CHANNEL	TX Channel 149	DETECTOR FUNCTION	Peak (PK)
FREQUENCY RANGE	1GHz ~ 40GHz		Average (AV)

ANTENNA POLARITY & TEST DISTANCE: HORIZONTAL AT 3 M

NO.	FREQ. (MHz)	EMISSION LEVEL (dBuV/m)	LIMIT (dBuV/m)	MARGIN (dB)	ANTENNA HEIGHT (m)	TABLE ANGLE (Degree)	RAW VALUE (dBuV)	CORRECTION FACTOR (dB/m)
1	#5608.39	59.9 PK	68.2	-8.3	2.26 H	360	56.0	3.9
2	*5745.00	115.1 PK			2.26 H	317	110.9	4.2
3	*5745.00	105.6 AV			2.26 H	317	101.4	4.2
4	#5965.99	59.4 PK	68.2	-8.8	2.26 H	317	54.9	4.5
5	11490.00	63.1 PK	74.0	-10.9	1.73 H	134	47.9	15.2
6	11490.00	49.6 AV	54.0	-4.4	1.73 H	134	34.4	15.2
7	#17235.00	57.3 PK	74.0	-16.7	1.60 H	216	37.3	20.0
8	#17235.00	44.1 AV	54.0	-9.9	1.60 H	216	24.1	20.0

ANTENNA POLARITY & TEST DISTANCE: VERTICAL AT 3 M

NO.	FREQ. (MHz)	EMISSION LEVEL (dBuV/m)	LIMIT (dBuV/m)	MARGIN (dB)	ANTENNA HEIGHT (m)	TABLE ANGLE (Degree)	RAW VALUE (dBuV)	CORRECTION FACTOR (dB/m)
1	#5610.97	58.7 PK	68.2	-9.5	2.59 V	349	54.8	3.9
2	*5745.00	113.7 PK			2.59 V	349	109.5	4.2
3	*5745.00	104.6 AV			2.59 V	349	100.4	4.2
4	#5946.52	62.0 PK	68.2	-6.2	2.59 V	349	57.6	4.4
5	11490.00	64.4 PK	74.0	-9.6	1.65 V	130	49.2	15.2
6	11490.00	51.5 AV	54.0	-2.5	1.65 V	130	36.3	15.2
7	#17235.00	57.5 PK	74.0	-16.5	2.17 V	216	37.5	20.0
8	#17235.00	44.5 AV	54.0	-9.5	2.17 V	216	24.5	20.0

REMARKS:

1. Emission Level(dBuV/m) = Raw Value(dBuV) + Correction Factor(dB/m)
2. Correction Factor(dB/m) = Antenna Factor(dB/m) + Cable Factor(dB) – Pre-Amplifier Factor(dB)
3. The other emission levels were very low against the limit.
4. Margin value = Emission Level – Limit value
5. " * ": Fundamental frequency.
6. " # ": The radiated frequency is out of the restricted band.

CHANNEL	TX Channel 157	DETECTOR FUNCTION	Peak (PK)
FREQUENCY RANGE	1GHz ~ 40GHz		Average (AV)

ANTENNA POLARITY & TEST DISTANCE: HORIZONTAL AT 3 M

NO.	FREQ. (MHz)	EMISSION LEVEL (dBuV/m)	LIMIT (dBuV/m)	MARGIN (dB)	ANTENNA HEIGHT (m)	TABLE ANGLE (Degree)	RAW VALUE (dBuV)	CORRECTION FACTOR (dB/m)
1	#5600.59	61.1 PK	68.2	-7.1	2.21 H	317	57.2	3.9
2	*5785.00	114.6 PK			2.21 H	317	110.5	4.1
3	*5785.00	105.1 AV			2.21 H	317	101.0	4.1
4	#5943.56	63.0 PK	68.2	-5.2	2.21 H	317	58.6	4.4
5	11570.00	63.3 PK	74.0	-10.7	1.77 H	121	48.2	15.1
6	11570.00	49.9 AV	54.0	-4.1	1.77 H	121	34.8	15.1
7	#17355.00	57.0 PK	74.0	-17.0	1.65 H	214	36.5	20.5
8	#17355.00	43.8 AV	54.0	-10.2	1.65 H	214	23.3	20.5

ANTENNA POLARITY & TEST DISTANCE: VERTICAL AT 3 M

NO.	FREQ. (MHz)	EMISSION LEVEL (dBuV/m)	LIMIT (dBuV/m)	MARGIN (dB)	ANTENNA HEIGHT (m)	TABLE ANGLE (Degree)	RAW VALUE (dBuV)	CORRECTION FACTOR (dB/m)
1	#5584.08	60.0 PK	68.2	-8.2	2.63 V	343	56.1	3.9
2	*5785.00	113.8 PK			2.63 V	343	109.7	4.1
3	*5785.00	104.7 AV			2.63 V	343	100.6	4.1
4	#5935.85	60.7 PK	68.2	-7.5	2.63 V	343	56.3	4.4
5	11570.00	64.3 PK	74.0	-9.7	1.63 V	124	49.2	15.1
6	11570.00	51.1 AV	54.0	-2.9	1.63 V	124	36.0	15.1
7	#17355.00	57.3 PK	74.0	-16.7	2.14 V	208	36.8	20.5
8	#17355.00	44.2 AV	54.0	-9.8	2.14 V	208	23.7	20.5

REMARKS:

1. Emission Level(dBuV/m) = Raw Value(dBuV) + Correction Factor(dB/m)
2. Correction Factor(dB/m) = Antenna Factor(dB/m) + Cable Factor(dB) – Pre-Amplifier Factor(dB)
3. The other emission levels were very low against the limit.
4. Margin value = Emission Level – Limit value
5. " * ": Fundamental frequency.
6. " # ": The radiated frequency is out of the restricted band.

CHANNEL	TX Channel 165	DETECTOR FUNCTION	Peak (PK)
FREQUENCY RANGE	1GHz ~ 40GHz		Average (AV)

ANTENNA POLARITY & TEST DISTANCE: HORIZONTAL AT 3 M

NO.	FREQ. (MHz)	EMISSION LEVEL (dBuV/m)	LIMIT (dBuV/m)	MARGIN (dB)	ANTENNA HEIGHT (m)	TABLE ANGLE (Degree)	RAW VALUE (dBuV)	CORRECTION FACTOR (dB/m)
1	#5622.01	60.8 PK	68.2	-7.4	2.23 H	314	56.8	4.0
2	*5825.00	114.7 PK			2.23 H	314	110.5	4.2
3	*5825.00	105.3 AV			2.23 H	314	101.1	4.2
4	#5928.75	66.1 PK	68.2	-2.1	2.23 H	314	61.7	4.4
5	11650.00	63.4 PK	74.0	-10.6	1.71 H	137	48.4	15.0
6	11650.00	49.7 AV	54.0	-4.3	1.71 H	137	34.7	15.0
7	#17475.00	57.2 PK	74.0	-16.8	1.62 H	227	36.1	21.1
8	#17475.00	44.1 AV	54.0	-9.9	1.62 H	227	23.0	21.1

ANTENNA POLARITY & TEST DISTANCE: VERTICAL AT 3 M

NO.	FREQ. (MHz)	EMISSION LEVEL (dBuV/m)	LIMIT (dBuV/m)	MARGIN (dB)	ANTENNA HEIGHT (m)	TABLE ANGLE (Degree)	RAW VALUE (dBuV)	CORRECTION FACTOR (dB/m)
1	#5591.29	60.1 PK	68.2	-8.1	2.53 V	356	56.2	3.9
2	*5825.00	114.2 PK			2.53 V	356	110.0	4.2
3	*5825.00	104.9 AV			2.53 V	356	100.7	4.2
4	#5930.74	65.8 PK	68.2	-2.4	2.53 V	356	61.4	4.4
5	11650.00	64.1 PK	74.0	-9.9	1.66 V	112	49.1	15.0
6	11650.00	51.0 AV	54.0	-3.0	1.66 V	112	36.0	15.0
7	#17475.00	57.4 PK	74.0	-16.6	2.17 V	201	36.3	21.1
8	#17475.00	44.3 AV	54.0	-9.7	2.17 V	201	23.2	21.1

REMARKS:

1. Emission Level(dBuV/m) = Raw Value(dBuV) + Correction Factor(dB/m)
2. Correction Factor(dB/m) = Antenna Factor(dB/m) + Cable Factor(dB) – Pre-Amplifier Factor(dB)
3. The other emission levels were very low against the limit.
4. Margin value = Emission Level – Limit value
5. " * ": Fundamental frequency.
6. " # ": The radiated frequency is out of the restricted band.

802.11ac (VHT20)

CHANNEL	TX Channel 36	DETECTOR FUNCTION	Peak (PK)
FREQUENCY RANGE	1GHz ~ 40GHz		Average (AV)

ANTENNA POLARITY & TEST DISTANCE: HORIZONTAL AT 3 M

NO.	FREQ. (MHz)	EMISSION LEVEL (dBuV/m)	LIMIT (dBuV/m)	MARGIN (dB)	ANTENNA HEIGHT (m)	TABLE ANGLE (Degree)	RAW VALUE (dBuV)	CORRECTION FACTOR (dB/m)
1	5150.00	71.0 PK	74.0	-3.0	2.37 H	318	68.0	3.0
2	5150.00	51.1 AV	54.0	-2.9	2.37 H	318	48.1	3.0
3	*5180.00	112.7 PK			2.37 H	318	109.6	3.1
4	*5180.00	103.2 AV			2.37 H	318	100.1	3.1
5	#10360.00	49.5 PK	74.0	-24.5	2.65 H	32	35.9	13.6
6	#10360.00	37.9 AV	54.0	-16.1	2.65 H	32	24.3	13.6
7	15540.00	51.2 PK	74.0	-22.8	1.60 H	208	35.5	15.7
8	15540.00	39.1 AV	54.0	-14.9	1.60 H	208	23.4	15.7

ANTENNA POLARITY & TEST DISTANCE: VERTICAL AT 3 M

NO.	FREQ. (MHz)	EMISSION LEVEL (dBuV/m)	LIMIT (dBuV/m)	MARGIN (dB)	ANTENNA HEIGHT (m)	TABLE ANGLE (Degree)	RAW VALUE (dBuV)	CORRECTION FACTOR (dB/m)
1	5150.00	60.9 PK	74.0	-13.1	2.06 V	100	57.9	3.0
2	5150.00	45.6 AV	54.0	-8.4	2.06 V	100	42.6	3.0
3	*5180.00	102.0 PK			2.06 V	100	98.9	3.1
4	*5180.00	94.2 AV			2.06 V	100	91.1	3.1
5	#10360.00	69.4 PK	74.0	-4.6	1.79 V	173	55.8	13.6
6	#10360.00	53.7 AV	54.0	-0.3	1.79 V	173	40.1	13.6
7	15540.00	49.3 PK	74.0	-24.7	2.58 V	12	33.6	15.7
8	15540.00	37.7 AV	54.0	-16.3	2.58 V	12	22.0	15.7

REMARKS:

- Emission Level(dBuV/m) = Raw Value(dBuV) + Correction Factor(dB/m)
- Correction Factor(dB/m) = Antenna Factor(dB/m) + Cable Factor(dB) – Pre-Amplifier Factor(dB)
- The other emission levels were very low against the limit.
- Margin value = Emission Level – Limit value
- " * ": Fundamental frequency.
- " # ": The radiated frequency is out of the restricted band.

CHANNEL	TX Channel 40	DETECTOR FUNCTION	Peak (PK)
FREQUENCY RANGE	1GHz ~ 40GHz		Average (AV)

ANTENNA POLARITY & TEST DISTANCE: HORIZONTAL AT 3 M

NO.	FREQ. (MHz)	EMISSION LEVEL (dBuV/m)	LIMIT (dBuV/m)	MARGIN (dB)	ANTENNA HEIGHT (m)	TABLE ANGLE (Degree)	RAW VALUE (dBuV)	CORRECTION FACTOR (dB/m)
1	*5200.00	109.3 PK			2.17 H	249	106.2	3.1
2	*5200.00	102.0 AV			2.17 H	249	98.9	3.1
3	#10400.00	49.8 PK	74.0	-24.2	2.64 H	26	36.2	13.6
4	#10400.00	38.0 AV	54.0	-16.0	2.64 H	26	24.4	13.6
5	15600.00	51.1 PK	74.0	-22.9	1.62 H	215	35.4	15.7
6	15600.00	39.1 AV	54.0	-14.9	1.62 H	215	23.4	15.7

ANTENNA POLARITY & TEST DISTANCE: VERTICAL AT 3 M

NO.	FREQ. (MHz)	EMISSION LEVEL (dBuV/m)	LIMIT (dBuV/m)	MARGIN (dB)	ANTENNA HEIGHT (m)	TABLE ANGLE (Degree)	RAW VALUE (dBuV)	CORRECTION FACTOR (dB/m)
1	*5200.00	103.8 PK			1.02 V	110	100.7	3.1
2	*5200.00	94.6 AV			1.02 V	110	91.5	3.1
3	#10400.00	67.9 PK	74.0	-6.1	1.81 V	158	54.3	13.6
4	#10400.00	53.7 AV	54.0	-0.3	1.81 V	158	40.1	13.6
5	15600.00	51.2 PK	74.0	-22.8	1.48 V	106	35.5	15.7
6	15600.00	39.4 AV	54.0	-14.6	1.48 V	106	23.7	15.7

REMARKS:

1. Emission Level(dBuV/m) = Raw Value(dBuV) + Correction Factor(dB/m)
2. Correction Factor(dB/m) = Antenna Factor(dB/m) + Cable Factor(dB) – Pre-Amplifier Factor(dB)
3. The other emission levels were very low against the limit.
4. Margin value = Emission Level – Limit value
5. " * ": Fundamental frequency.
6. " # ": The radiated frequency is out of the restricted band.

CHANNEL	TX Channel 48	DETECTOR FUNCTION	Peak (PK)
FREQUENCY RANGE	1GHz ~ 40GHz		Average (AV)

ANTENNA POLARITY & TEST DISTANCE: HORIZONTAL AT 3 M

NO.	FREQ. (MHz)	EMISSION LEVEL (dBuV/m)	LIMIT (dBuV/m)	MARGIN (dB)	ANTENNA HEIGHT (m)	TABLE ANGLE (Degree)	RAW VALUE (dBuV)	CORRECTION FACTOR (dB/m)
1	*5240.00	118.0 PK			2.39 H	325	114.8	3.2
2	*5240.00	108.6 AV			2.39 H	325	105.4	3.2
3	5350.00	67.8 PK	74.0	-6.2	2.39 H	325	64.3	3.5
4	5350.00	50.4 AV	54.0	-3.6	2.39 H	325	46.9	3.5
5	#10480.00	49.4 PK	74.0	-24.6	2.66 H	39	35.4	14.0
6	#10480.00	37.7 AV	54.0	-16.3	2.66 H	39	23.7	14.0
7	15720.00	50.9 PK	74.0	-23.1	1.66 H	228	35.5	15.4
8	15720.00	39.1 AV	54.0	-14.9	1.66 H	228	23.7	15.4

ANTENNA POLARITY & TEST DISTANCE: VERTICAL AT 3 M

NO.	FREQ. (MHz)	EMISSION LEVEL (dBuV/m)	LIMIT (dBuV/m)	MARGIN (dB)	ANTENNA HEIGHT (m)	TABLE ANGLE (Degree)	RAW VALUE (dBuV)	CORRECTION FACTOR (dB/m)
1	*5240.00	108.1 PK			2.10 V	86	104.9	3.2
2	*5240.00	100.1 AV			2.10 V	86	96.9	3.2
3	5350.00	59.2 PK	74.0	-14.8	2.10 V	86	55.7	3.5
4	5350.00	45.3 AV	54.0	-8.7	2.10 V	86	41.8	3.5
5	#10480.00	68.2 PK	74.0	-5.8	1.76 V	161	54.2	14.0
6	#10480.00	53.7 AV	54.0	-0.3	1.76 V	161	39.7	14.0
7	15720.00	49.8 PK	74.0	-24.2	2.59 V	11	34.4	15.4
8	15720.00	38.3 AV	54.0	-15.7	2.59 V	11	22.9	15.4

REMARKS:

1. Emission Level(dBuV/m) = Raw Value(dBuV) + Correction Factor(dB/m)
2. Correction Factor(dB/m) = Antenna Factor(dB/m) + Cable Factor(dB) – Pre-Amplifier Factor(dB)
3. The other emission levels were very low against the limit.
4. Margin value = Emission Level – Limit value
5. " * ": Fundamental frequency.
6. " # ": The radiated frequency is out of the restricted band.

CHANNEL	TX Channel 52	DETECTOR FUNCTION	Peak (PK)
FREQUENCY RANGE	1GHz ~ 40GHz		Average (AV)

ANTENNA POLARITY & TEST DISTANCE: HORIZONTAL AT 3 M

NO.	FREQ. (MHz)	EMISSION LEVEL (dBuV/m)	LIMIT (dBuV/m)	MARGIN (dB)	ANTENNA HEIGHT (m)	TABLE ANGLE (Degree)	RAW VALUE (dBuV)	CORRECTION FACTOR (dB/m)
1	5150.00	52.8 PK	74.0	-21.2	2.35 H	336	49.8	3.0
2	5150.00	42.0 AV	54.0	-12.0	2.35 H	336	39.0	3.0
3	*5260.00	117.4 PK			2.35 H	336	114.1	3.3
4	*5260.00	108.2 AV			2.35 H	336	104.9	3.3
5	#10520.00	50.4 PK	74.0	-23.6	2.56 H	20	36.3	14.1
6	#10520.00	38.5 AV	54.0	-15.5	2.56 H	20	24.4	14.1
7	15780.00	51.8 PK	74.0	-22.2	1.65 H	201	36.6	15.2
8	15780.00	39.8 AV	54.0	-14.2	1.65 H	201	24.6	15.2

ANTENNA POLARITY & TEST DISTANCE: VERTICAL AT 3 M

NO.	FREQ. (MHz)	EMISSION LEVEL (dBuV/m)	LIMIT (dBuV/m)	MARGIN (dB)	ANTENNA HEIGHT (m)	TABLE ANGLE (Degree)	RAW VALUE (dBuV)	CORRECTION FACTOR (dB/m)
1	5150.00	51.9 PK	74.0	-22.1	1.92 V	98	48.9	3.0
2	5150.00	41.3 AV	54.0	-12.7	1.92 V	98	38.3	3.0
3	*5260.00	108.4 PK			1.92 V	98	105.1	3.3
4	*5260.00	101.7 AV			1.92 V	98	98.4	3.3
5	#10520.00	67.1 PK	74.0	-6.9	1.58 V	181	53.0	14.1
6	#10520.00	52.7 AV	54.0	-1.3	1.58 V	181	38.6	14.1
7	15780.00	49.8 PK	74.0	-24.2	2.65 V	35	34.6	15.2
8	15780.00	37.9 AV	54.0	-16.1	2.65 V	35	22.7	15.2

REMARKS:

1. Emission Level(dBuV/m) = Raw Value(dBuV) + Correction Factor(dB/m)
2. Correction Factor(dB/m) = Antenna Factor(dB/m) + Cable Factor(dB) – Pre-Amplifier Factor(dB)
3. The other emission levels were very low against the limit.
4. Margin value = Emission Level – Limit value
5. " * ": Fundamental frequency.
6. " # ": The radiated frequency is out of the restricted band.

CHANNEL	TX Channel 60	DETECTOR FUNCTION	Peak (PK)
FREQUENCY RANGE	1GHz ~ 40GHz		Average (AV)

ANTENNA POLARITY & TEST DISTANCE: HORIZONTAL AT 3 M

NO.	FREQ. (MHz)	EMISSION LEVEL (dBuV/m)	LIMIT (dBuV/m)	MARGIN (dB)	ANTENNA HEIGHT (m)	TABLE ANGLE (Degree)	RAW VALUE (dBuV)	CORRECTION FACTOR (dB/m)
1	*5300.00	118.1 PK			2.45 H	311	114.8	3.3
2	*5300.00	108.5 AV			2.45 H	311	105.2	3.3
3	10600.00	49.6 PK	74.0	-24.4	2.61 H	38	35.3	14.3
4	10600.00	38.1 AV	54.0	-15.9	2.61 H	38	23.8	14.3
5	15900.00	51.6 PK	74.0	-22.4	1.65 H	228	36.5	15.1
6	15900.00	40.0 AV	54.0	-14.0	1.65 H	228	24.9	15.1

ANTENNA POLARITY & TEST DISTANCE: VERTICAL AT 3 M

NO.	FREQ. (MHz)	EMISSION LEVEL (dBuV/m)	LIMIT (dBuV/m)	MARGIN (dB)	ANTENNA HEIGHT (m)	TABLE ANGLE (Degree)	RAW VALUE (dBuV)	CORRECTION FACTOR (dB/m)
1	*5300.00	110.2 PK			2.00 V	96	106.9	3.3
2	*5300.00	102.3 AV			2.00 V	96	99.0	3.3
3	10600.00	62.5 PK	74.0	-11.5	1.61 V	191	48.2	14.3
4	10600.00	49.1 AV	54.0	-4.9	1.61 V	191	34.8	14.3
5	15900.00	50.2 PK	74.0	-23.8	2.65 V	15	35.1	15.1
6	15900.00	38.3 AV	54.0	-15.7	2.65 V	15	23.2	15.1

REMARKS:

1. Emission Level(dBuV/m) = Raw Value(dBuV) + Correction Factor(dB/m)
2. Correction Factor(dB/m) = Antenna Factor(dB/m) + Cable Factor(dB) – Pre-Amplifier Factor(dB)
3. The other emission levels were very low against the limit.
4. Margin value = Emission Level – Limit value
5. " * ": Fundamental frequency.

CHANNEL	TX Channel 64	DETECTOR FUNCTION	Peak (PK)
FREQUENCY RANGE	1GHz ~ 40GHz		Average (AV)

ANTENNA POLARITY & TEST DISTANCE: HORIZONTAL AT 3 M

NO.	FREQ. (MHz)	EMISSION LEVEL (dBuV/m)	LIMIT (dBuV/m)	MARGIN (dB)	ANTENNA HEIGHT (m)	TABLE ANGLE (Degree)	RAW VALUE (dBuV)	CORRECTION FACTOR (dB/m)
1	*5320.00	111.0 PK			2.43 H	307	107.5	3.5
2	*5320.00	101.6 AV			2.43 H	307	98.1	3.5
3	5350.00	73.5 PK	74.0	-0.5	2.43 H	307	70.0	3.5
4	5350.00	50.6 AV	54.0	-3.4	2.43 H	307	47.1	3.5
5	10640.00	50.2 PK	74.0	-23.8	2.64 H	32	35.9	14.3
6	10640.00	38.2 AV	54.0	-15.8	2.64 H	32	23.9	14.3
7	15960.00	52.1 PK	74.0	-21.9	1.64 H	207	37.0	15.1
8	15960.00	40.0 AV	54.0	-14.0	1.64 H	207	24.9	15.1

ANTENNA POLARITY & TEST DISTANCE: VERTICAL AT 3 M

NO.	FREQ. (MHz)	EMISSION LEVEL (dBuV/m)	LIMIT (dBuV/m)	MARGIN (dB)	ANTENNA HEIGHT (m)	TABLE ANGLE (Degree)	RAW VALUE (dBuV)	CORRECTION FACTOR (dB/m)
1	*5320.00	104.6 PK			1.90 V	100	101.1	3.5
2	*5320.00	96.4 AV			1.90 V	100	92.9	3.5
3	5350.00	57.7 PK	74.0	-16.3	1.90 V	100	54.2	3.5
4	5350.00	44.5 AV	54.0	-9.5	1.90 V	100	41.0	3.5
5	10640.00	63.9 PK	74.0	-10.1	1.77 V	192	49.6	14.3
6	10640.00	49.7 AV	54.0	-4.3	1.77 V	192	35.4	14.3
7	15960.00	55.4 PK	74.0	-18.6	1.59 V	148	40.3	15.1
8	15960.00	42.2 AV	54.0	-11.8	1.59 V	148	27.1	15.1

REMARKS:

1. Emission Level(dBuV/m) = Raw Value(dBuV) + Correction Factor(dB/m)
2. Correction Factor(dB/m) = Antenna Factor(dB/m) + Cable Factor(dB) – Pre-Amplifier Factor(dB)
3. The other emission levels were very low against the limit.
4. Margin value = Emission Level – Limit value
5. " * ": Fundamental frequency.

CHANNEL	TX Channel 100	DETECTOR FUNCTION	Peak (PK)
FREQUENCY RANGE	1GHz ~ 40GHz		Average (AV)

ANTENNA POLARITY & TEST DISTANCE: HORIZONTAL AT 3 M

NO.	FREQ. (MHz)	EMISSION LEVEL (dBuV/m)	LIMIT (dBuV/m)	MARGIN (dB)	ANTENNA HEIGHT (m)	TABLE ANGLE (Degree)	RAW VALUE (dBuV)	CORRECTION FACTOR (dB/m)
1	#5470.00	73.6 PK	74.0	-0.4	2.36 H	309	69.9	3.7
2	#5470.00	52.1 AV	54.0	-1.9	2.36 H	309	48.4	3.7
3	*5500.00	111.1 PK			2.36 H	309	107.3	3.8
4	*5500.00	101.7 AV			2.36 H	309	97.9	3.8
5	11000.00	50.1 PK	74.0	-23.9	2.58 H	38	34.9	15.2
6	11000.00	38.5 AV	54.0	-15.5	2.58 H	38	23.3	15.2
7	#16500.00	51.2 PK	74.0	-22.8	1.67 H	230	33.8	17.4
8	#16500.00	39.2 AV	54.0	-14.8	1.67 H	230	21.8	17.4

ANTENNA POLARITY & TEST DISTANCE: VERTICAL AT 3 M

NO.	FREQ. (MHz)	EMISSION LEVEL (dBuV/m)	LIMIT (dBuV/m)	MARGIN (dB)	ANTENNA HEIGHT (m)	TABLE ANGLE (Degree)	RAW VALUE (dBuV)	CORRECTION FACTOR (dB/m)
1	#5470.00	62.7 PK	74.0	-11.3	2.05 V	94	59.0	3.7
2	#5470.00	45.5 AV	54.0	-8.5	2.05 V	94	41.8	3.7
3	*5500.00	105.5 PK			2.05 V	94	101.7	3.8
4	*5500.00	97.8 AV			2.05 V	94	94.0	3.8
5	11000.00	63.4 PK	74.0	-10.6	1.69 V	172	48.2	15.2
6	11000.00	49.4 AV	54.0	-4.6	1.69 V	172	34.2	15.2
7	#16500.00	55.1 PK	74.0	-18.9	1.61 V	132	37.7	17.4
8	#16500.00	41.8 AV	54.0	-12.2	1.61 V	132	24.4	17.4

REMARKS:

1. Emission Level(dBuV/m) = Raw Value(dBuV) + Correction Factor(dB/m)
2. Correction Factor(dB/m) = Antenna Factor(dB/m) + Cable Factor(dB) – Pre-Amplifier Factor(dB)
3. The other emission levels were very low against the limit.
4. Margin value = Emission Level – Limit value
5. " * ": Fundamental frequency.
6. " # ": The radiated frequency is out of the restricted band.

CHANNEL	TX Channel 116	DETECTOR FUNCTION	Peak (PK)
FREQUENCY RANGE	1GHz ~ 40GHz		Average (AV)

ANTENNA POLARITY & TEST DISTANCE: HORIZONTAL AT 3 M

NO.	FREQ. (MHz)	EMISSION LEVEL (dBuV/m)	LIMIT (dBuV/m)	MARGIN (dB)	ANTENNA HEIGHT (m)	TABLE ANGLE (Degree)	RAW VALUE (dBuV)	CORRECTION FACTOR (dB/m)
1	*5580.00	112.5 PK			2.07 H	244	108.6	3.9
2	*5580.00	104.6 AV			2.07 H	244	100.7	3.9
3	11160.00	64.5 PK	74.0	-9.5	1.80 H	110	49.3	15.2
4	11160.00	48.8 AV	54.0	-5.2	1.80 H	110	33.6	15.2
5	#16740.00	56.0 PK	74.0	-18.0	1.58 H	202	37.7	18.3
6	#16740.00	42.7 AV	54.0	-11.3	1.58 H	202	24.4	18.3

ANTENNA POLARITY & TEST DISTANCE: VERTICAL AT 3 M

NO.	FREQ. (MHz)	EMISSION LEVEL (dBuV/m)	LIMIT (dBuV/m)	MARGIN (dB)	ANTENNA HEIGHT (m)	TABLE ANGLE (Degree)	RAW VALUE (dBuV)	CORRECTION FACTOR (dB/m)
1	*5580.00	110.6 PK			2.00 V	90	106.7	3.9
2	*5580.00	102.6 AV			2.00 V	90	98.7	3.9
3	11160.00	64.1 PK	74.0	-9.9	1.79 V	165	48.9	15.2
4	11160.00	49.6 AV	54.0	-4.4	1.79 V	165	34.4	15.2
5	#16740.00	55.3 PK	74.0	-18.7	1.61 V	143	37.0	18.3
6	#16740.00	42.0 AV	54.0	-12.0	1.61 V	143	23.7	18.3

REMARKS:

1. Emission Level(dBuV/m) = Raw Value(dBuV) + Correction Factor(dB/m)
2. Correction Factor(dB/m) = Antenna Factor(dB/m) + Cable Factor(dB) – Pre-Amplifier Factor(dB)
3. The other emission levels were very low against the limit.
4. Margin value = Emission Level – Limit value
5. " * ": Fundamental frequency.
6. " # ": The radiated frequency is out of the restricted band.

CHANNEL	TX Channel 140	DETECTOR FUNCTION	Peak (PK)
FREQUENCY RANGE	1GHz ~ 40GHz		Average (AV)

ANTENNA POLARITY & TEST DISTANCE: HORIZONTAL AT 3 M

NO.	FREQ. (MHz)	EMISSION LEVEL (dBuV/m)	LIMIT (dBuV/m)	MARGIN (dB)	ANTENNA HEIGHT (m)	TABLE ANGLE (Degree)	RAW VALUE (dBuV)	CORRECTION FACTOR (dB/m)
1	*5700.00	110.1 PK			2.29 H	320	105.9	4.2
2	*5700.00	100.3 AV			2.29 H	320	96.1	4.2
3	#5725.00	73.3 PK	74.0	-0.7	2.29 H	320	69.1	4.2
4	#5725.00	49.6 AV	54.0	-4.4	2.29 H	320	45.4	4.2
5	11400.00	50.0 PK	74.0	-24.0	2.65 H	24	34.5	15.5
6	11400.00	38.0 AV	54.0	-16.0	2.65 H	24	22.5	15.5
7	#17100.00	51.5 PK	74.0	-22.5	1.65 H	223	31.4	20.1
8	#17100.00	39.4 AV	54.0	-14.6	1.65 H	223	19.3	20.1

ANTENNA POLARITY & TEST DISTANCE: VERTICAL AT 3 M

NO.	FREQ. (MHz)	EMISSION LEVEL (dBuV/m)	LIMIT (dBuV/m)	MARGIN (dB)	ANTENNA HEIGHT (m)	TABLE ANGLE (Degree)	RAW VALUE (dBuV)	CORRECTION FACTOR (dB/m)
1	*5700.00	103.6 PK			1.94 V	96	99.4	4.2
2	*5700.00	95.7 AV			1.94 V	96	91.5	4.2
3	#5725.00	59.8 PK	74.0	-14.2	1.94 V	96	55.6	4.2
4	#5725.00	45.4 AV	54.0	-8.6	1.94 V	96	41.2	4.2
5	11400.00	63.5 PK	74.0	-10.5	1.73 V	180	48.0	15.5
6	11400.00	49.2 AV	54.0	-4.8	1.73 V	180	33.7	15.5
7	#17100.00	55.2 PK	74.0	-18.8	1.58 V	141	35.1	20.1
8	#17100.00	41.8 AV	54.0	-12.2	1.58 V	141	21.7	20.1

REMARKS:

1. Emission Level(dBuV/m) = Raw Value(dBuV) + Correction Factor(dB/m)
2. Correction Factor(dB/m) = Antenna Factor(dB/m) + Cable Factor(dB) – Pre-Amplifier Factor(dB)
3. The other emission levels were very low against the limit.
4. Margin value = Emission Level – Limit value
5. " * ": Fundamental frequency.
6. " # ": The radiated frequency is out of the restricted band.

CHANNEL	TX Channel 149	DETECTOR FUNCTION	Peak (PK)
FREQUENCY RANGE	1GHz ~ 40GHz		Average (AV)

ANTENNA POLARITY & TEST DISTANCE: HORIZONTAL AT 3 M

NO.	FREQ. (MHz)	EMISSION LEVEL (dBuV/m)	LIMIT (dBuV/m)	MARGIN (dB)	ANTENNA HEIGHT (m)	TABLE ANGLE (Degree)	RAW VALUE (dBuV)	CORRECTION FACTOR (dB/m)
1	#5585.91	59.9 PK	68.2	-8.3	2.26 H	308	56.0	3.9
2	*5745.00	114.7 PK			2.26 H	308	110.5	4.2
3	*5745.00	105.5 AV			2.26 H	308	101.3	4.2
4	#5936.27	61.7 PK	68.2	-6.5	2.26 H	308	57.3	4.4
5	11490.00	50.2 PK	74.0	-23.8	2.61 H	17	35.0	15.2
6	11490.00	38.2 AV	54.0	-15.8	2.61 H	17	23.0	15.2
7	#17235.00	51.5 PK	74.0	-22.5	1.63 H	210	31.5	20.0
8	#17235.00	39.7 AV	54.0	-14.3	1.63 H	210	19.7	20.0

ANTENNA POLARITY & TEST DISTANCE: VERTICAL AT 3 M

NO.	FREQ. (MHz)	EMISSION LEVEL (dBuV/m)	LIMIT (dBuV/m)	MARGIN (dB)	ANTENNA HEIGHT (m)	TABLE ANGLE (Degree)	RAW VALUE (dBuV)	CORRECTION FACTOR (dB/m)
1	#5606.20	59.2 PK	68.2	-9.0	2.59 V	338	55.3	3.9
2	*5745.00	112.9 PK			2.59 V	338	108.7	4.2
3	*5745.00	103.7 AV			2.59 V	338	99.5	4.2
4	#5928.29	61.0 PK	68.2	-7.2	2.59 V	338	56.6	4.4
5	11490.00	64.5 PK	74.0	-9.5	1.81 V	172	49.3	15.2
6	11490.00	50.0 AV	54.0	-4.0	1.81 V	172	34.8	15.2
7	#17235.00	55.9 PK	74.0	-18.1	1.67 V	138	35.9	20.0
8	#17235.00	42.4 AV	54.0	-11.6	1.67 V	138	22.4	20.0

REMARKS:

1. Emission Level(dBuV/m) = Raw Value(dBuV) + Correction Factor(dB/m)
2. Correction Factor(dB/m) = Antenna Factor(dB/m) + Cable Factor(dB) – Pre-Amplifier Factor(dB)
3. The other emission levels were very low against the limit.
4. Margin value = Emission Level – Limit value
5. " * ": Fundamental frequency.
6. " # ": The radiated frequency is out of the restricted band.

CHANNEL	TX Channel 157	DETECTOR FUNCTION	Peak (PK)
FREQUENCY RANGE	1GHz ~ 40GHz		Average (AV)

ANTENNA POLARITY & TEST DISTANCE: HORIZONTAL AT 3 M

NO.	FREQ. (MHz)	EMISSION LEVEL (dBuV/m)	LIMIT (dBuV/m)	MARGIN (dB)	ANTENNA HEIGHT (m)	TABLE ANGLE (Degree)	RAW VALUE (dBuV)	CORRECTION FACTOR (dB/m)
1	#5578.88	61.6 PK	68.2	-6.6	2.20 H	329	57.7	3.9
2	*5785.00	114.2 PK			2.20 H	329	110.1	4.1
3	*5785.00	105.1 AV			2.20 H	329	101.0	4.1
4	#5964.62	60.9 PK	68.2	-7.3	2.20 H	329	56.4	4.5
5	11570.00	49.9 PK	74.0	-24.1	2.55 H	19	34.8	15.1
6	11570.00	38.0 AV	54.0	-16.0	2.55 H	19	22.9	15.1
7	#17355.00	51.3 PK	74.0	-22.7	1.66 H	228	30.8	20.5
8	#17355.00	39.2 AV	54.0	-14.8	1.66 H	228	18.7	20.5

ANTENNA POLARITY & TEST DISTANCE: VERTICAL AT 3 M

NO.	FREQ. (MHz)	EMISSION LEVEL (dBuV/m)	LIMIT (dBuV/m)	MARGIN (dB)	ANTENNA HEIGHT (m)	TABLE ANGLE (Degree)	RAW VALUE (dBuV)	CORRECTION FACTOR (dB/m)
1	#5591.12	59.3 PK	68.2	-8.9	2.56 V	356	55.4	3.9
2	*5785.00	112.7 PK			2.56 V	356	108.6	4.1
3	*5785.00	103.5 AV			2.56 V	356	99.4	4.1
4	#5925.23	61.7 PK	68.2	-6.5	2.56 V	356	57.3	4.4
5	11570.00	64.2 PK	74.0	-9.8	1.83 V	155	49.1	15.1
6	11570.00	49.8 AV	54.0	-4.2	1.83 V	155	34.7	15.1
7	#17355.00	55.5 PK	74.0	-18.5	1.65 V	134	35.0	20.5
8	#17355.00	42.4 AV	54.0	-11.6	1.65 V	134	21.9	20.5

REMARKS:

1. Emission Level(dBuV/m) = Raw Value(dBuV) + Correction Factor(dB/m)
2. Correction Factor(dB/m) = Antenna Factor(dB/m) + Cable Factor(dB) – Pre-Amplifier Factor(dB)
3. The other emission levels were very low against the limit.
4. Margin value = Emission Level – Limit value
5. " * ": Fundamental frequency.
6. " # ": The radiated frequency is out of the restricted band.

CHANNEL	TX Channel 165	DETECTOR FUNCTION	Peak (PK)
FREQUENCY RANGE	1GHz ~ 40GHz		Average (AV)

ANTENNA POLARITY & TEST DISTANCE: HORIZONTAL AT 3 M

NO.	FREQ. (MHz)	EMISSION LEVEL (dBuV/m)	LIMIT (dBuV/m)	MARGIN (dB)	ANTENNA HEIGHT (m)	TABLE ANGLE (Degree)	RAW VALUE (dBuV)	CORRECTION FACTOR (dB/m)
1	#5643.77	60.6 PK	68.2	-7.6	2.23 H	310	56.6	4.0
2	*5825.00	114.8 PK			2.23 H	310	110.6	4.2
3	*5825.00	105.6 AV			2.23 H	310	101.4	4.2
4	#5927.26	66.9 PK	68.2	-1.3	2.23 H	310	62.5	4.4
5	11650.00	49.8 PK	74.0	-24.2	2.63 H	16	34.8	15.0
6	11650.00	38.0 AV	54.0	-16.0	2.63 H	16	23.0	15.0
7	#17475.00	51.3 PK	74.0	-22.7	1.66 H	202	30.2	21.1
8	#17475.00	39.4 AV	54.0	-14.6	1.66 H	202	18.3	21.1

ANTENNA POLARITY & TEST DISTANCE: VERTICAL AT 3 M

NO.	FREQ. (MHz)	EMISSION LEVEL (dBuV/m)	LIMIT (dBuV/m)	MARGIN (dB)	ANTENNA HEIGHT (m)	TABLE ANGLE (Degree)	RAW VALUE (dBuV)	CORRECTION FACTOR (dB/m)
1	#5590.29	58.8 PK	68.2	-9.4	2.54 V	345	54.9	3.9
2	*5825.00	113.2 PK			2.54 V	345	109.0	4.2
3	*5825.00	103.7 AV			2.54 V	345	99.5	4.2
4	#5927.41	66.6 PK	68.2	-1.6	2.54 V	345	62.2	4.4
5	11650.00	63.6 PK	74.0	-10.4	1.84 V	162	48.6	15.0
6	11650.00	49.3 AV	54.0	-4.7	1.84 V	162	34.3	15.0
7	#17475.00	54.8 PK	74.0	-19.2	1.66 V	140	33.7	21.1
8	#17475.00	41.5 AV	54.0	-12.5	1.66 V	140	20.4	21.1

REMARKS:

1. Emission Level(dBuV/m) = Raw Value(dBuV) + Correction Factor(dB/m)
2. Correction Factor(dB/m) = Antenna Factor(dB/m) + Cable Factor(dB) – Pre-Amplifier Factor(dB)
3. The other emission levels were very low against the limit.
4. Margin value = Emission Level – Limit value
5. " * ": Fundamental frequency.
6. " # ": The radiated frequency is out of the restricted band.

802.11ac (VHT40)

CHANNEL	TX Channel 38	DETECTOR FUNCTION	Peak (PK)
FREQUENCY RANGE	1GHz ~ 40GHz		Average (AV)

ANTENNA POLARITY & TEST DISTANCE: HORIZONTAL AT 3 M

NO.	FREQ. (MHz)	EMISSION LEVEL (dBuV/m)	LIMIT (dBuV/m)	MARGIN (dB)	ANTENNA HEIGHT (m)	TABLE ANGLE (Degree)	RAW VALUE (dBuV)	CORRECTION FACTOR (dB/m)
1	5150.00	65.1 PK	74.0	-8.9	2.31 H	327	62.1	3.0
2	5150.00	53.4 AV	54.0	-0.6	2.31 H	327	50.4	3.0
3	*5190.00	108.5 PK			2.31 H	327	105.4	3.1
4	*5190.00	98.6 AV			2.31 H	327	95.5	3.1
5	5350.00	65.0 PK	74.0	-9.0	2.31 H	327	61.5	3.5
6	5350.00	48.7 AV	54.0	-5.3	2.31 H	327	45.2	3.5
7	#10380.00	50.3 PK	74.0	-23.7	2.54 H	28	36.6	13.7
8	#10380.00	38.3 AV	54.0	-15.7	2.54 H	28	24.6	13.7
9	15570.00	51.0 PK	74.0	-23.0	1.68 H	216	35.4	15.6
10	15570.00	39.3 AV	54.0	-14.7	1.68 H	216	23.7	15.6

ANTENNA POLARITY & TEST DISTANCE: VERTICAL AT 3 M

NO.	FREQ. (MHz)	EMISSION LEVEL (dBuV/m)	LIMIT (dBuV/m)	MARGIN (dB)	ANTENNA HEIGHT (m)	TABLE ANGLE (Degree)	RAW VALUE (dBuV)	CORRECTION FACTOR (dB/m)
1	5150.00	52.7 PK	74.0	-21.3	2.06 V	100	49.7	3.0
2	5150.00	40.8 AV	54.0	-13.2	2.06 V	100	37.8	3.0
3	*5190.00	97.9 PK			2.06 V	100	94.8	3.1
4	*5190.00	88.8 AV			2.06 V	100	85.7	3.1
5	5350.00	52.0 PK	74.0	-22.0	2.06 V	100	48.5	3.5
6	5350.00	41.0 AV	54.0	-13.0	2.06 V	100	37.5	3.5
7	#10380.00	64.2 PK	74.0	-9.8	1.81 V	170	50.5	13.7
8	#10380.00	49.7 AV	54.0	-4.3	1.81 V	170	36.0	13.7
9	15570.00	55.3 PK	74.0	-18.7	1.56 V	153	39.7	15.6
10	15570.00	42.3 AV	54.0	-11.7	1.56 V	153	26.7	15.6

REMARKS:

1. Emission Level(dBuV/m) = Raw Value(dBuV) + Correction Factor(dB/m)
2. Correction Factor(dB/m) = Antenna Factor(dB/m) + Cable Factor(dB) – Pre-Amplifier Factor(dB)
3. The other emission levels were very low against the limit.
4. Margin value = Emission Level – Limit value
5. " * ": Fundamental frequency.
6. " # ": The radiated frequency is out of the restricted band.

CHANNEL	TX Channel 46	DETECTOR FUNCTION	Peak (PK)
FREQUENCY RANGE	1GHz ~ 40GHz		Average (AV)

ANTENNA POLARITY & TEST DISTANCE: HORIZONTAL AT 3 M

NO.	FREQ. (MHz)	EMISSION LEVEL (dBuV/m)	LIMIT (dBuV/m)	MARGIN (dB)	ANTENNA HEIGHT (m)	TABLE ANGLE (Degree)	RAW VALUE (dBuV)	CORRECTION FACTOR (dB/m)
1	5150.00	68.6 PK	74.0	-5.4	2.35 H	324	65.6	3.0
2	5150.00	53.5 AV	54.0	-0.5	2.35 H	324	50.5	3.0
3	*5230.00	111.3 PK			2.35 H	324	108.1	3.2
4	*5230.00	102.7 AV			2.35 H	324	99.5	3.2
5	5350.00	65.0 PK	74.0	-9.0	2.35 H	324	61.5	3.5
6	5350.00	48.4 AV	54.0	-5.6	2.35 H	324	44.9	3.5
7	#10460.00	50.0 PK	74.0	-24.0	2.55 H	24	36.1	13.9
8	#10460.00	38.1 AV	54.0	-15.9	2.55 H	24	24.2	13.9
9	15690.00	51.5 PK	74.0	-22.5	1.66 H	202	35.9	15.6
10	15690.00	39.5 AV	54.0	-14.5	1.66 H	202	23.9	15.6

ANTENNA POLARITY & TEST DISTANCE: VERTICAL AT 3 M

NO.	FREQ. (MHz)	EMISSION LEVEL (dBuV/m)	LIMIT (dBuV/m)	MARGIN (dB)	ANTENNA HEIGHT (m)	TABLE ANGLE (Degree)	RAW VALUE (dBuV)	CORRECTION FACTOR (dB/m)
1	5150.00	51.8 PK	74.0	-22.2	2.02 V	95	48.8	3.0
2	5150.00	41.1 AV	54.0	-12.9	2.02 V	95	38.1	3.0
3	*5230.00	100.7 PK			2.02 V	95	97.5	3.2
4	*5230.00	92.7 AV			2.02 V	95	89.5	3.2
5	5350.00	52.9 PK	74.0	-21.1	2.02 V	95	49.4	3.5
6	5350.00	41.1 AV	54.0	-12.9	2.02 V	95	37.6	3.5
7	#10460.00	64.1 PK	74.0	-9.9	1.79 V	182	50.2	13.9
8	#10460.00	51.7 AV	54.0	-2.3	1.79 V	182	37.8	13.9
9	15690.00	50.0 PK	74.0	-24.0	2.65 V	11	34.4	15.6
10	15690.00	38.1 AV	54.0	-15.9	2.65 V	11	22.5	15.6

REMARKS:

1. Emission Level(dBuV/m) = Raw Value(dBuV) + Correction Factor(dB/m)
2. Correction Factor(dB/m) = Antenna Factor(dB/m) + Cable Factor(dB) – Pre-Amplifier Factor(dB)
3. The other emission levels were very low against the limit.
4. Margin value = Emission Level – Limit value
5. " * ": Fundamental frequency.
6. " # ": The radiated frequency is out of the restricted band.

CHANNEL	TX Channel 54	DETECTOR FUNCTION	Peak (PK)
FREQUENCY RANGE	1GHz ~ 40GHz		Average (AV)

ANTENNA POLARITY & TEST DISTANCE: HORIZONTAL AT 3 M

NO.	FREQ. (MHz)	EMISSION LEVEL (dBuV/m)	LIMIT (dBuV/m)	MARGIN (dB)	ANTENNA HEIGHT (m)	TABLE ANGLE (Degree)	RAW VALUE (dBuV)	CORRECTION FACTOR (dB/m)
1	*5270.00	111.6 PK			2.31 H	325	108.3	3.3
2	*5270.00	103.1 AV			2.31 H	325	99.8	3.3
3	5350.00	72.1 PK	74.0	-1.9	2.31 H	325	68.6	3.5
4	5350.00	53.9 AV	54.0	-0.1	2.31 H	325	50.4	3.5
5	#10540.00	50.1 PK	74.0	-23.9	2.60 H	8	35.9	14.2
6	#10540.00	38.5 AV	54.0	-15.5	2.60 H	8	24.3	14.2
7	15810.00	52.0 PK	74.0	-22.0	1.65 H	199	37.0	15.0
8	15810.00	39.9 AV	54.0	-14.1	1.65 H	199	24.9	15.0

ANTENNA POLARITY & TEST DISTANCE: VERTICAL AT 3 M

NO.	FREQ. (MHz)	EMISSION LEVEL (dBuV/m)	LIMIT (dBuV/m)	MARGIN (dB)	ANTENNA HEIGHT (m)	TABLE ANGLE (Degree)	RAW VALUE (dBuV)	CORRECTION FACTOR (dB/m)
1	*5270.00	100.2 PK			2.04 V	96	96.9	3.3
2	*5270.00	92.4 AV			2.04 V	96	89.1	3.3
3	5350.00	52.2 PK	74.0	-21.8	2.04 V	96	48.7	3.5
4	5350.00	41.0 AV	54.0	-13.0	2.04 V	96	37.5	3.5
5	#10540.00	63.5 PK	74.0	-10.5	1.79 V	175	49.3	14.2
6	#10540.00	49.3 AV	54.0	-4.7	1.79 V	175	35.1	14.2
7	15810.00	55.3 PK	74.0	-18.7	1.63 V	146	40.3	15.0
8	15810.00	41.7 AV	54.0	-12.3	1.63 V	146	26.7	15.0

REMARKS:

1. Emission Level(dBuV/m) = Raw Value(dBuV) + Correction Factor(dB/m)
2. Correction Factor(dB/m) = Antenna Factor(dB/m) + Cable Factor(dB) – Pre-Amplifier Factor(dB)
3. The other emission levels were very low against the limit.
4. Margin value = Emission Level – Limit value
5. " * ": Fundamental frequency.
6. " # ": The radiated frequency is out of the restricted band.

CHANNEL	TX Channel 62	DETECTOR FUNCTION	Peak (PK)
FREQUENCY RANGE	1GHz ~ 40GHz		Average (AV)

ANTENNA POLARITY & TEST DISTANCE: HORIZONTAL AT 3 M

NO.	FREQ. (MHz)	EMISSION LEVEL (dBuV/m)	LIMIT (dBuV/m)	MARGIN (dB)	ANTENNA HEIGHT (m)	TABLE ANGLE (Degree)	RAW VALUE (dBuV)	CORRECTION FACTOR (dB/m)
1	*5310.00	108.8 PK			2.30 H	360	105.4	3.4
2	*5310.00	99.8 AV			2.30 H	360	96.4	3.4
3	5350.00	70.1 PK	74.0	-3.9	2.30 H	326	66.6	3.5
4	5350.00	53.5 AV	54.0	-0.5	2.30 H	326	50.0	3.5
5	10620.00	49.7 PK	74.0	-24.3	2.63 H	9	35.4	14.3
6	10620.00	38.0 AV	54.0	-16.0	2.63 H	9	23.7	14.3
7	15930.00	52.1 PK	74.0	-21.9	1.65 H	204	37.0	15.1
8	15930.00	39.9 AV	54.0	-14.1	1.65 H	204	24.8	15.1

ANTENNA POLARITY & TEST DISTANCE: VERTICAL AT 3 M

NO.	FREQ. (MHz)	EMISSION LEVEL (dBuV/m)	LIMIT (dBuV/m)	MARGIN (dB)	ANTENNA HEIGHT (m)	TABLE ANGLE (Degree)	RAW VALUE (dBuV)	CORRECTION FACTOR (dB/m)
1	*5310.00	98.0 PK			2.02 V	94	94.6	3.4
2	*5310.00	88.7 AV			2.02 V	94	85.3	3.4
3	5350.00	52.0 PK	74.0	-22.0	2.00 V	101	48.5	3.5
4	5350.00	41.2 AV	54.0	-12.8	2.00 V	101	37.7	3.5
5	10620.00	64.3 PK	74.0	-9.7	1.73 V	175	50.0	14.3
6	10620.00	49.6 AV	54.0	-4.4	1.73 V	175	35.3	14.3
7	15930.00	54.6 PK	74.0	-19.4	1.64 V	155	39.5	15.1
8	15930.00	41.5 AV	54.0	-12.5	1.64 V	155	26.4	15.1

REMARKS:

1. Emission Level(dBuV/m) = Raw Value(dBuV) + Correction Factor(dB/m)
2. Correction Factor(dB/m) = Antenna Factor(dB/m) + Cable Factor(dB) – Pre-Amplifier Factor(dB)
3. The other emission levels were very low against the limit.
4. Margin value = Emission Level – Limit value
5. " * ": Fundamental frequency.

CHANNEL	TX Channel 102	DETECTOR FUNCTION	Peak (PK)
FREQUENCY RANGE	1GHz ~ 40GHz		Average (AV)

ANTENNA POLARITY & TEST DISTANCE: HORIZONTAL AT 3 M

NO.	FREQ. (MHz)	EMISSION LEVEL (dBuV/m)	LIMIT (dBuV/m)	MARGIN (dB)	ANTENNA HEIGHT (m)	TABLE ANGLE (Degree)	RAW VALUE (dBuV)	CORRECTION FACTOR (dB/m)
1	#5470.00	68.1 PK	74.0	-5.9	2.25 H	318	64.4	3.7
2	#5470.00	53.5 AV	54.0	-0.5	2.25 H	318	49.8	3.7
3	*5510.00	108.1 PK			2.25 H	318	104.3	3.8
4	*5510.00	98.9 AV			2.25 H	318	95.1	3.8
5	11020.00	50.1 PK	74.0	-23.9	2.63 H	34	35.0	15.1
6	11020.00	38.4 AV	54.0	-15.6	2.63 H	34	23.3	15.1
7	#16530.00	51.2 PK	74.0	-22.8	1.69 H	195	33.7	17.5
8	#16530.00	39.5 AV	54.0	-14.5	1.69 H	195	22.0	17.5

ANTENNA POLARITY & TEST DISTANCE: VERTICAL AT 3 M

NO.	FREQ. (MHz)	EMISSION LEVEL (dBuV/m)	LIMIT (dBuV/m)	MARGIN (dB)	ANTENNA HEIGHT (m)	TABLE ANGLE (Degree)	RAW VALUE (dBuV)	CORRECTION FACTOR (dB/m)
1	#5470.00	52.4 PK	74.0	-21.6	2.06 V	105	48.7	3.7
2	#5470.00	41.5 AV	54.0	-12.5	2.06 V	105	37.8	3.7
3	*5510.00	97.7 PK			2.04 V	110	93.9	3.8
4	*5510.00	88.5 AV			2.04 V	110	84.7	3.8
5	11020.00	63.9 PK	74.0	-10.1	1.74 V	154	48.8	15.1
6	11020.00	49.3 AV	54.0	-4.7	1.74 V	154	34.2	15.1
7	#16530.00	54.8 PK	74.0	-19.2	1.56 V	132	37.3	17.5
8	#16530.00	41.7 AV	54.0	-12.3	1.56 V	132	24.2	17.5

REMARKS:

1. Emission Level(dBuV/m) = Raw Value(dBuV) + Correction Factor(dB/m)
2. Correction Factor(dB/m) = Antenna Factor(dB/m) + Cable Factor(dB) – Pre-Amplifier Factor(dB)
3. The other emission levels were very low against the limit.
4. Margin value = Emission Level – Limit value
5. " * ": Fundamental frequency.
6. " # ": The radiated frequency is out of the restricted band.

CHANNEL	TX Channel 110	DETECTOR FUNCTION	Peak (PK)
FREQUENCY RANGE	1GHz ~ 40GHz		Average (AV)

ANTENNA POLARITY & TEST DISTANCE: HORIZONTAL AT 3 M

NO.	FREQ. (MHz)	EMISSION LEVEL (dBuV/m)	LIMIT (dBuV/m)	MARGIN (dB)	ANTENNA HEIGHT (m)	TABLE ANGLE (Degree)	RAW VALUE (dBuV)	CORRECTION FACTOR (dB/m)
1	#5470.00	70.1 PK	74.0	-3.9	2.26 H	310	66.4	3.7
2	#5470.00	53.0 AV	54.0	-1.0	2.26 H	310	49.3	3.7
3	*5550.00	111.0 PK			2.26 H	310	107.1	3.9
4	*5550.00	101.5 AV			2.26 H	310	97.6	3.9
5	11100.00	50.2 PK	74.0	-23.8	2.54 H	32	35.1	15.1
6	11100.00	38.2 AV	54.0	-15.8	2.54 H	32	23.1	15.1
7	#16650.00	51.4 PK	74.0	-22.6	1.67 H	198	33.4	18.0
8	#16650.00	39.7 AV	54.0	-14.3	1.67 H	198	21.7	18.0

ANTENNA POLARITY & TEST DISTANCE: VERTICAL AT 3 M

NO.	FREQ. (MHz)	EMISSION LEVEL (dBuV/m)	LIMIT (dBuV/m)	MARGIN (dB)	ANTENNA HEIGHT (m)	TABLE ANGLE (Degree)	RAW VALUE (dBuV)	CORRECTION FACTOR (dB/m)
1	#5470.00	52.7 PK	74.0	-21.3	2.02 V	114	49.0	3.7
2	#5470.00	41.5 AV	54.0	-12.5	2.02 V	114	37.8	3.7
3	*5550.00	100.5 PK			2.00 V	98	96.6	3.9
4	*5550.00	92.8 AV			2.00 V	98	88.9	3.9
5	11100.00	64.2 PK	74.0	-9.8	1.74 V	165	49.1	15.1
6	11100.00	49.4 AV	54.0	-4.6	1.74 V	165	34.3	15.1
7	#16650.00	55.8 PK	74.0	-18.2	1.67 V	150	37.8	18.0
8	#16650.00	42.3 AV	54.0	-11.7	1.67 V	150	24.3	18.0

REMARKS:

1. Emission Level(dBuV/m) = Raw Value(dBuV) + Correction Factor(dB/m)
2. Correction Factor(dB/m) = Antenna Factor(dB/m) + Cable Factor(dB) – Pre-Amplifier Factor(dB)
3. The other emission levels were very low against the limit.
4. Margin value = Emission Level – Limit value
5. " * ": Fundamental frequency.
6. " # ": The radiated frequency is out of the restricted band.

CHANNEL	TX Channel 134	DETECTOR FUNCTION	Peak (PK)
FREQUENCY RANGE	1GHz ~ 40GHz		Average (AV)

ANTENNA POLARITY & TEST DISTANCE: HORIZONTAL AT 3 M

NO.	FREQ. (MHz)	EMISSION LEVEL (dBuV/m)	LIMIT (dBuV/m)	MARGIN (dB)	ANTENNA HEIGHT (m)	TABLE ANGLE (Degree)	RAW VALUE (dBuV)	CORRECTION FACTOR (dB/m)
1	*5670.00	107.3 PK			2.22 H	326	103.3	4.0
2	*5670.00	98.5 AV			2.22 H	326	94.5	4.0
3	#5725.00	73.6 PK	74.0	-0.4	2.22 H	326	69.4	4.2
4	#5725.00	48.4 AV	54.0	-5.6	2.22 H	326	44.2	4.2
5	11340.00	50.2 PK	74.0	-23.8	2.57 H	14	34.9	15.3
6	11340.00	38.3 AV	54.0	-15.7	2.57 H	14	23.0	15.3
7	#17010.00	51.8 PK	74.0	-22.2	1.66 H	204	31.9	19.9
8	#17010.00	39.7 AV	54.0	-14.3	1.66 H	204	19.8	19.9

ANTENNA POLARITY & TEST DISTANCE: VERTICAL AT 3 M

NO.	FREQ. (MHz)	EMISSION LEVEL (dBuV/m)	LIMIT (dBuV/m)	MARGIN (dB)	ANTENNA HEIGHT (m)	TABLE ANGLE (Degree)	RAW VALUE (dBuV)	CORRECTION FACTOR (dB/m)
1	*5670.00	96.7 PK			2.02 V	94	92.7	4.0
2	*5670.00	88.7 AV			2.02 V	94	84.7	4.0
3	#5725.00	52.2 PK	74.0	-21.8	2.02 V	94	48.0	4.2
4	#5725.00	41.3 AV	54.0	-12.7	2.02 V	94	37.1	4.2
5	11340.00	64.3 PK	74.0	-9.7	1.78 V	171	49.0	15.3
6	11340.00	49.9 AV	54.0	-4.1	1.78 V	171	34.6	15.3
7	#17010.00	55.8 PK	74.0	-18.2	1.59 V	137	35.9	19.9
8	#17010.00	42.4 AV	54.0	-11.6	1.59 V	137	22.5	19.9

REMARKS:

- Emission Level(dBuV/m) = Raw Value(dBuV) + Correction Factor(dB/m)
- Correction Factor(dB/m) = Antenna Factor(dB/m) + Cable Factor(dB) – Pre-Amplifier Factor(dB)
- The other emission levels were very low against the limit.
- Margin value = Emission Level – Limit value
- " * ": Fundamental frequency.
- " # ": The radiated frequency is out of the restricted band.

CHANNEL	TX Channel 151	DETECTOR FUNCTION	Peak (PK)
FREQUENCY RANGE	1GHz ~ 40GHz		Average (AV)

ANTENNA POLARITY & TEST DISTANCE: HORIZONTAL AT 3 M

NO.	FREQ. (MHz)	EMISSION LEVEL (dBuV/m)	LIMIT (dBuV/m)	MARGIN (dB)	ANTENNA HEIGHT (m)	TABLE ANGLE (Degree)	RAW VALUE (dBuV)	CORRECTION FACTOR (dB/m)
1	#5600.03	64.2 PK	68.2	-4.0	2.29 H	326	60.3	3.9
2	*5755.00	111.7 PK			2.29 H	326	107.5	4.2
3	*5755.00	102.5 AV			2.29 H	326	98.3	4.2
4	#5926.47	65.4 PK	68.2	-2.8	2.29 H	326	61.0	4.4
5	11510.00	50.1 PK	74.0	-23.9	2.58 H	14	35.0	15.1
6	11510.00	38.3 AV	54.0	-15.7	2.58 H	14	23.2	15.1
7	#17265.00	51.4 PK	74.0	-22.6	1.70 H	187	31.5	19.9
8	#17265.00	39.7 AV	54.0	-14.3	1.70 H	187	19.8	19.9

ANTENNA POLARITY & TEST DISTANCE: VERTICAL AT 3 M

NO.	FREQ. (MHz)	EMISSION LEVEL (dBuV/m)	LIMIT (dBuV/m)	MARGIN (dB)	ANTENNA HEIGHT (m)	TABLE ANGLE (Degree)	RAW VALUE (dBuV)	CORRECTION FACTOR (dB/m)
1	#5603.76	62.4 PK	68.2	-5.8	2.63 V	335	58.5	3.9
2	*5755.00	110.4 PK			2.63 V	335	106.2	4.2
3	*5755.00	101.3 AV			2.63 V	335	97.1	4.2
4	#5935.27	64.9 PK	68.2	-3.3	2.63 V	335	60.5	4.4
5	11510.00	64.2 PK	74.0	-9.8	1.73 V	151	49.1	15.1
6	11510.00	49.4 AV	54.0	-4.6	1.73 V	151	34.3	15.1
7	#17265.00	55.7 PK	74.0	-18.3	1.63 V	139	35.8	19.9
8	#17265.00	42.3 AV	54.0	-11.7	1.63 V	139	22.4	19.9

REMARKS:

1. Emission Level(dBuV/m) = Raw Value(dBuV) + Correction Factor(dB/m)
2. Correction Factor(dB/m) = Antenna Factor(dB/m) + Cable Factor(dB) – Pre-Amplifier Factor(dB)
3. The other emission levels were very low against the limit.
4. Margin value = Emission Level – Limit value
5. " * ": Fundamental frequency.
6. " # ": The radiated frequency is out of the restricted band.

CHANNEL	TX Channel 159	DETECTOR FUNCTION	Peak (PK)
FREQUENCY RANGE	1GHz ~ 40GHz		Average (AV)

ANTENNA POLARITY & TEST DISTANCE: HORIZONTAL AT 3 M

NO.	FREQ. (MHz)	EMISSION LEVEL (dBuV/m)	LIMIT (dBuV/m)	MARGIN (dB)	ANTENNA HEIGHT (m)	TABLE ANGLE (Degree)	RAW VALUE (dBuV)	CORRECTION FACTOR (dB/m)
1	#5602.62	64.5 PK	68.2	-3.7	2.29 H	310	60.6	3.9
2	*5795.00	110.7 PK			2.29 H	310	106.6	4.1
3	*5795.00	101.4 AV			2.29 H	310	97.3	4.1
4	#5923.33	68.2 PK	69.4	-1.2	2.29 H	310	63.8	4.4
5	11590.00	49.8 PK	74.0	-24.2	2.58 H	25	34.7	15.1
6	11590.00	38.2 AV	54.0	-15.8	2.58 H	25	23.1	15.1
7	#17385.00	51.2 PK	74.0	-22.8	1.70 H	191	30.6	20.6
8	#17385.00	39.2 AV	54.0	-14.8	1.70 H	191	18.6	20.6

ANTENNA POLARITY & TEST DISTANCE: VERTICAL AT 3 M

NO.	FREQ. (MHz)	EMISSION LEVEL (dBuV/m)	LIMIT (dBuV/m)	MARGIN (dB)	ANTENNA HEIGHT (m)	TABLE ANGLE (Degree)	RAW VALUE (dBuV)	CORRECTION FACTOR (dB/m)
1	#5638.74	60.2 PK	68.2	-8.0	2.59 V	338	56.2	4.0
2	*5795.00	109.1 PK			2.59 V	338	105.0	4.1
3	*5795.00	100.6 AV			2.59 V	338	96.5	4.1
4	#5940.32	66.1 PK	68.2	-2.1	2.59 V	338	61.7	4.4
5	11590.00	64.5 PK	74.0	-9.5	1.74 V	179	49.4	15.1
6	11590.00	49.7 AV	54.0	-4.3	1.74 V	179	34.6	15.1
7	#17385.00	55.1 PK	74.0	-18.9	1.63 V	148	34.5	20.6
8	#17385.00	41.8 AV	54.0	-12.2	1.63 V	148	21.2	20.6

REMARKS:

1. Emission Level(dBuV/m) = Raw Value(dBuV) + Correction Factor(dB/m)
2. Correction Factor(dB/m) = Antenna Factor(dB/m) + Cable Factor(dB) – Pre-Amplifier Factor(dB)
3. The other emission levels were very low against the limit.
4. Margin value = Emission Level – Limit value
5. " * ": Fundamental frequency.
6. " # ": The radiated frequency is out of the restricted band.

802.11ac (VHT80)

CHANNEL	TX Channel 42	DETECTOR FUNCTION	Peak (PK)
FREQUENCY RANGE	1GHz ~ 40GHz		Average (AV)

ANTENNA POLARITY & TEST DISTANCE: HORIZONTAL AT 3 M

NO.	FREQ. (MHz)	EMISSION LEVEL (dBuV/m)	LIMIT (dBuV/m)	MARGIN (dB)	ANTENNA HEIGHT (m)	TABLE ANGLE (Degree)	RAW VALUE (dBuV)	CORRECTION FACTOR (dB/m)
1	5150.00	66.1 PK	74.0	-7.9	2.39 H	326	63.1	3.0
2	5150.00	53.9 AV	54.0	-0.1	2.39 H	326	50.9	3.0
3	*5210.00	103.4 PK			2.39 H	326	100.2	3.2
4	*5210.00	94.1 AV			2.39 H	326	90.9	3.2
5	5350.00	60.2 PK	74.0	-13.8	2.39 H	326	56.7	3.5
6	5350.00	45.2 AV	54.0	-8.8	2.39 H	326	41.7	3.5
7	#10420.00	49.4 PK	74.0	-24.6	2.65 H	18	35.6	13.8
8	#10420.00	37.9 AV	54.0	-16.1	2.65 H	18	24.1	13.8
9	15630.00	51.5 PK	74.0	-22.5	1.63 H	199	35.8	15.7
10	15630.00	39.5 AV	54.0	-14.5	1.63 H	199	23.8	15.7

ANTENNA POLARITY & TEST DISTANCE: VERTICAL AT 3 M

NO.	FREQ. (MHz)	EMISSION LEVEL (dBuV/m)	LIMIT (dBuV/m)	MARGIN (dB)	ANTENNA HEIGHT (m)	TABLE ANGLE (Degree)	RAW VALUE (dBuV)	CORRECTION FACTOR (dB/m)
1	5150.00	52.1 PK	74.0	-21.9	2.06 V	101	49.1	3.0
2	5150.00	40.4 AV	54.0	-13.6	2.06 V	101	37.4	3.0
3	*5210.00	98.8 PK			2.06 V	101	95.6	3.2
4	*5210.00	89.7 AV			2.06 V	101	86.5	3.2
5	5350.00	51.7 PK	74.0	-22.3	2.06 V	101	48.2	3.5
6	5350.00	40.9 AV	54.0	-13.1	2.06 V	101	37.4	3.5
7	#10420.00	63.7 PK	74.0	-10.3	1.83 V	180	49.9	13.8
8	#10420.00	49.2 AV	54.0	-4.8	1.83 V	180	35.4	13.8
9	15630.00	55.5 PK	74.0	-18.5	1.65 V	141	39.8	15.7
10	15630.00	42.0 AV	54.0	-12.0	1.65 V	141	26.3	15.7

REMARKS:

- Emission Level(dBuV/m) = Raw Value(dBuV) + Correction Factor(dB/m)
- Correction Factor(dB/m) = Antenna Factor(dB/m) + Cable Factor(dB) – Pre-Amplifier Factor(dB)
- The other emission levels were very low against the limit.
- Margin value = Emission Level – Limit value
- " * ": Fundamental frequency.
- " # ": The radiated frequency is out of the restricted band.

CHANNEL	TX Channel 58	DETECTOR FUNCTION	Peak (PK)
FREQUENCY RANGE	1GHz ~ 40GHz		Average (AV)

ANTENNA POLARITY & TEST DISTANCE: HORIZONTAL AT 3 M

NO.	FREQ. (MHz)	EMISSION LEVEL (dBuV/m)	LIMIT (dBuV/m)	MARGIN (dB)	ANTENNA HEIGHT (m)	TABLE ANGLE (Degree)	RAW VALUE (dBuV)	CORRECTION FACTOR (dB/m)
1	5150.00	60.1 PK	74.0	-13.9	2.23 H	322	57.1	3.0
2	5150.00	46.1 AV	54.0	-7.9	2.23 H	322	43.1	3.0
3	*5290.00	104.3 PK			2.23 H	322	101.0	3.3
4	*5290.00	94.5 AV			2.23 H	322	91.2	3.3
5	5350.00	68.1 PK	74.0	-5.9	2.23 H	322	64.6	3.5
6	5350.00	53.8 AV	54.0	-0.2	2.23 H	322	50.3	3.5
7	#10580.00	50.3 PK	74.0	-23.7	2.55 H	40	36.0	14.3
8	#10580.00	38.5 AV	54.0	-15.5	2.55 H	40	24.2	14.3
9	15870.00	50.9 PK	74.0	-23.1	1.71 H	206	35.9	15.0
10	15870.00	39.2 AV	54.0	-14.8	1.71 H	206	24.2	15.0

ANTENNA POLARITY & TEST DISTANCE: VERTICAL AT 3 M

NO.	FREQ. (MHz)	EMISSION LEVEL (dBuV/m)	LIMIT (dBuV/m)	MARGIN (dB)	ANTENNA HEIGHT (m)	TABLE ANGLE (Degree)	RAW VALUE (dBuV)	CORRECTION FACTOR (dB/m)
1	5150.00	52.9 PK	74.0	-21.1	2.11 V	91	49.9	3.0
2	5150.00	41.1 AV	54.0	-12.9	2.11 V	91	38.1	3.0
3	*5290.00	99.0 PK			2.11 V	91	95.7	3.3
4	*5290.00	89.5 AV			2.11 V	91	86.2	3.3
5	5350.00	51.7 PK	74.0	-22.3	2.11 V	91	48.2	3.5
6	5350.00	40.6 AV	54.0	-13.4	2.11 V	91	37.1	3.5
7	#10580.00	64.0 PK	74.0	-10.0	1.80 V	156	49.7	14.3
8	#10580.00	49.5 AV	54.0	-4.5	1.80 V	156	35.2	14.3
9	15870.00	55.5 PK	74.0	-18.5	1.58 V	135	40.5	15.0
10	15870.00	42.3 AV	54.0	-11.7	1.58 V	135	27.3	15.0

REMARKS:

1. Emission Level(dBuV/m) = Raw Value(dBuV) + Correction Factor(dB/m)
2. Correction Factor(dB/m) = Antenna Factor(dB/m) + Cable Factor(dB) – Pre-Amplifier Factor(dB)
3. The other emission levels were very low against the limit.
4. Margin value = Emission Level – Limit value
5. " * ": Fundamental frequency.
6. " # ": The radiated frequency is out of the restricted band.

CHANNEL	TX Channel 106	DETECTOR FUNCTION	Peak (PK)
FREQUENCY RANGE	1GHz ~ 40GHz		Average (AV)

ANTENNA POLARITY & TEST DISTANCE: HORIZONTAL AT 3 M

NO.	FREQ. (MHz)	EMISSION LEVEL (dBuV/m)	LIMIT (dBuV/m)	MARGIN (dB)	ANTENNA HEIGHT (m)	TABLE ANGLE (Degree)	RAW VALUE (dBuV)	CORRECTION FACTOR (dB/m)
1	5460.00	65.4 PK	74.0	-8.6	2.27 H	319	61.7	3.7
2	5460.00	53.8 AV	54.0	-0.2	2.27 H	319	50.1	3.7
3	#5470.00	65.6 PK	74.0	-8.4	2.27 H	319	61.9	3.7
4	#5470.00	53.9 AV	54.0	-0.1	2.27 H	319	50.2	3.7
5	*5530.00	102.0 PK			2.27 H	319	98.1	3.9
6	*5530.00	92.2 AV			2.27 H	319	88.3	3.9
7	11060.00	49.7 PK	74.0	-24.3	2.56 H	27	34.6	15.1
8	11060.00	37.9 AV	54.0	-16.1	2.56 H	27	22.8	15.1
9	#16590.00	51.5 PK	74.0	-22.5	1.61 H	189	33.8	17.7
10	#16590.00	39.8 AV	54.0	-14.2	1.61 H	189	22.1	17.7

ANTENNA POLARITY & TEST DISTANCE: VERTICAL AT 3 M

NO.	FREQ. (MHz)	EMISSION LEVEL (dBuV/m)	LIMIT (dBuV/m)	MARGIN (dB)	ANTENNA HEIGHT (m)	TABLE ANGLE (Degree)	RAW VALUE (dBuV)	CORRECTION FACTOR (dB/m)
1	5460.00	52.8 PK	74.0	-21.2	2.09 V	89	49.1	3.7
2	5460.00	40.8 AV	54.0	-13.2	2.09 V	89	37.1	3.7
3	#5470.00	51.2 PK	74.0	-22.8	2.09 V	89	47.5	3.7
4	#5470.00	40.5 AV	54.0	-13.5	2.09 V	89	36.8	3.7
5	*5530.00	98.9 PK			2.09 V	89	95.0	3.9
6	*5530.00	89.6 AV			2.09 V	89	85.7	3.9
7	11060.00	63.6 PK	74.0	-10.4	1.75 V	172	48.5	15.1
8	11060.00	49.3 AV	54.0	-4.7	1.75 V	172	34.2	15.1
9	#16590.00	55.9 PK	74.0	-18.1	1.58 V	128	38.2	17.7
10	#16590.00	42.5 AV	54.0	-11.5	1.58 V	128	24.8	17.7

REMARKS:

1. Emission Level(dBuV/m) = Raw Value(dBuV) + Correction Factor(dB/m)
2. Correction Factor(dB/m) = Antenna Factor(dB/m) + Cable Factor(dB) – Pre-Amplifier Factor(dB)
3. The other emission levels were very low against the limit.
4. Margin value = Emission Level – Limit value
5. " * ": Fundamental frequency.
6. " # ": The radiated frequency is out of the restricted band.

CHANNEL	TX Channel 122	DETECTOR FUNCTION	Peak (PK)
FREQUENCY RANGE	1GHz ~ 40GHz		Average (AV)

ANTENNA POLARITY & TEST DISTANCE: HORIZONTAL AT 3 M

NO.	FREQ. (MHz)	EMISSION LEVEL (dBuV/m)	LIMIT (dBuV/m)	MARGIN (dB)	ANTENNA HEIGHT (m)	TABLE ANGLE (Degree)	RAW VALUE (dBuV)	CORRECTION FACTOR (dB/m)
1	*5610.00	104.2 PK			2.22 H	317	100.3	3.9
2	*5610.00	94.8 AV			2.22 H	317	90.9	3.9
3	#5725.00	68.5 PK	74.0	-5.5	2.22 H	317	64.3	4.2
4	#5725.00	53.7 AV	54.0	-0.3	2.22 H	317	49.5	4.2
5	11220.00	49.5 PK	74.0	-24.5	2.58 H	24	34.3	15.2
6	11220.00	37.7 AV	54.0	-16.3	2.58 H	24	22.5	15.2
7	#16830.00	50.7 PK	74.0	-23.3	1.66 H	188	32.2	18.5
8	#16830.00	39.0 AV	54.0	-15.0	1.66 H	188	20.5	18.5

ANTENNA POLARITY & TEST DISTANCE: VERTICAL AT 3 M

NO.	FREQ. (MHz)	EMISSION LEVEL (dBuV/m)	LIMIT (dBuV/m)	MARGIN (dB)	ANTENNA HEIGHT (m)	TABLE ANGLE (Degree)	RAW VALUE (dBuV)	CORRECTION FACTOR (dB/m)
1	*5610.00	101.3 PK			2.11 V	84	97.4	3.9
2	*5610.00	92.1 AV			2.11 V	84	88.2	3.9
3	#5725.00	51.4 PK	74.0	-22.6	2.11 V	84	47.2	4.2
4	#5725.00	41.0 AV	54.0	-13.0	2.11 V	84	36.8	4.2
5	11220.00	63.9 PK	74.0	-10.1	1.75 V	169	48.7	15.2
6	11220.00	49.2 AV	54.0	-4.8	1.75 V	169	34.0	15.2
7	#16830.00	55.5 PK	74.0	-18.5	1.60 V	131	37.0	18.5
8	#16830.00	42.0 AV	54.0	-12.0	1.60 V	131	23.5	18.5

REMARKS:

1. Emission Level(dBuV/m) = Raw Value(dBuV) + Correction Factor(dB/m)
2. Correction Factor(dB/m) = Antenna Factor(dB/m) + Cable Factor(dB) – Pre-Amplifier Factor(dB)
3. The other emission levels were very low against the limit.
4. Margin value = Emission Level – Limit value
5. " * ": Fundamental frequency.
6. " # ": The radiated frequency is out of the restricted band.

CHANNEL	TX Channel 155	DETECTOR FUNCTION	Peak (PK)
FREQUENCY RANGE	1GHz ~ 40GHz		Average (AV)

ANTENNA POLARITY & TEST DISTANCE: HORIZONTAL AT 3 M

NO.	FREQ. (MHz)	EMISSION LEVEL (dBuV/m)	LIMIT (dBuV/m)	MARGIN (dB)	ANTENNA HEIGHT (m)	TABLE ANGLE (Degree)	RAW VALUE (dBuV)	CORRECTION FACTOR (dB/m)
1	#5592.94	63.0 PK	68.2	-5.2	2.29 H	310	59.1	3.9
2	*5775.00	105.1 PK			2.29 H	310	100.9	4.2
3	*5775.00	95.9 AV			2.29 H	310	91.7	4.2
4	#5933.60	66.3 PK	68.2	-1.9	2.29 H	310	61.9	4.4
5	11550.00	50.1 PK	74.0	-23.9	2.59 H	27	34.9	15.2
6	11550.00	38.4 AV	54.0	-15.6	2.59 H	27	23.2	15.2
7	#17325.00	51.1 PK	74.0	-22.9	1.71 H	212	30.8	20.3
8	#17325.00	39.3 AV	54.0	-14.7	1.71 H	212	19.0	20.3

ANTENNA POLARITY & TEST DISTANCE: VERTICAL AT 3 M

NO.	FREQ. (MHz)	EMISSION LEVEL (dBuV/m)	LIMIT (dBuV/m)	MARGIN (dB)	ANTENNA HEIGHT (m)	TABLE ANGLE (Degree)	RAW VALUE (dBuV)	CORRECTION FACTOR (dB/m)
1	#5645.77	60.3 PK	68.2	-7.9	2.59 V	337	56.3	4.0
2	*5775.00	102.5 PK			2.59 V	337	98.3	4.2
3	*5775.00	93.6 AV			2.59 V	337	89.4	4.2
4	#5936.72	63.7 PK	68.2	-4.5	2.59 V	337	59.3	4.4
5	11550.00	63.9 PK	74.0	-10.1	1.79 V	177	48.7	15.2
6	11550.00	49.4 AV	54.0	-4.6	1.79 V	177	34.2	15.2
7	#17325.00	55.4 PK	74.0	-18.6	1.57 V	154	35.1	20.3
8	#17325.00	42.3 AV	54.0	-11.7	1.57 V	154	22.0	20.3

REMARKS:

1. Emission Level(dBuV/m) = Raw Value(dBuV) + Correction Factor(dB/m)
2. Correction Factor(dB/m) = Antenna Factor(dB/m) + Cable Factor(dB) – Pre-Amplifier Factor(dB)
3. The other emission levels were very low against the limit.
4. Margin value = Emission Level – Limit value
5. " * ": Fundamental frequency.
6. " # ": The radiated frequency is out of the restricted band.

Below 1GHz Data:

802.11ac (VHT20)

CHANNEL	TX Channel 157	DETECTOR FUNCTION	Quasi-Peak (QP)
FREQUENCY RANGE	9kHz ~ 1GHz		

ANTENNA POLARITY & TEST DISTANCE: HORIZONTAL AT 3 M

NO.	FREQ. (MHz)	EMISSION LEVEL (dBuV/m)	LIMIT (dBuV/m)	MARGIN (dB)	ANTENNA HEIGHT (m)	TABLE ANGLE (Degree)	RAW VALUE (dBuV)	CORRECTION FACTOR (dB/m)
1	99.84	34.4 QP	43.5	-9.1	1.38 H	259	47.2	-12.8
2	166.60	39.0 QP	43.5	-4.5	2.39 H	267	47.8	-8.8
3	247.81	39.1 QP	46.0	-6.9	2.14 H	359	48.7	-9.6
4	497.93	37.7 QP	46.0	-8.3	3.58 H	4	40.3	-2.6
5	697.07	33.8 QP	46.0	-12.2	1.76 H	231	32.9	0.9
6	960.04	40.9 QP	54.0	-13.1	2.18 H	259	35.9	5.0

ANTENNA POLARITY & TEST DISTANCE: VERTICAL AT 3 M

NO.	FREQ. (MHz)	EMISSION LEVEL (dBuV/m)	LIMIT (dBuV/m)	MARGIN (dB)	ANTENNA HEIGHT (m)	TABLE ANGLE (Degree)	RAW VALUE (dBuV)	CORRECTION FACTOR (dB/m)
1	79.93	35.4 QP	40.0	-4.6	1.24 V	121	48.4	-13.0
2	99.96	37.1 QP	43.5	-6.4	2.03 V	242	49.9	-12.8
3	166.02	32.6 QP	43.5	-10.9	3.41 V	322	41.4	-8.8
4	298.76	41.8 QP	46.0	-4.2	3.82 V	18	49.1	-7.3
5	499.82	38.9 QP	46.0	-7.1	1.16 V	360	41.4	-2.5
6	960.04	42.7 QP	54.0	-11.3	1.70 V	240	37.7	5.0

REMARKS:

1. Emission Level(dBuV/m) = Raw Value(dBuV) + Correction Factor(dB/m)
2. Correction Factor(dB/m) = Antenna Factor(dB/m) + Cable Factor(dB) – Pre-Amplifier Factor(dB)
3. The other emission levels were very low against the limit.
4. Margin value = Emission Level – Limit value

4.2 Conducted Emission Measurement

4.2.1 Limits of Conducted Emission Measurement

Frequency (MHz)	Conducted Limit (dBuV)	
	Quasi-peak	Average
0.15 - 0.5	66 - 56	56 - 46
0.50 - 5.0	56	46
5.0 - 30.0	60	50

Note: 1. The lower limit shall apply at the transition frequencies.

2. The limit decreases in line with the logarithm of the frequency in the range of 0.15 to 0.50MHz.

4.2.2 Test Instruments

DESCRIPTION & MANUFACTURER	MODEL NO.	SERIAL NO.	CALIBRATED DATE	CALIBRATED UNTIL
Test Receiver R&S	ESCS 30	847124/029	Oct. 24, 2016	Oct. 23, 2017
Line-Impedance Stabilization Network (for EUT) R&S	ESH3-Z5	848773/004	Oct. 26, 2016	Oct. 25, 2017
Line-Impedance Stabilization Network (for Peripheral) R&S	ENV216	100072	June 13, 2016	June 12, 2017
RF Cable	5D-FB	COCCAB-001	Sep. 30, 2016	Sep. 29, 2017
10 dB PAD Mini-Circuits	HAT-10+	CONATT-004	June 20, 2016	June 19, 2017
Software BVADT	BVADT_Cond_ V7.3.7.4	NA	NA	NA

Note:

1. The calibration interval of the above test instruments are 12 months and the calibrations are traceable to NML/ROC and NIST/USA.
2. The test was performed in Shielded Room No. 1.
- 3 Tested Date: Dec. 19, 2016

4.2.3 Test Procedure

- The EUT was placed 0.4 meters from the conducting wall of the shielded room with EUT being connected to the power mains through a line impedance stabilization network (LISN). Other support units were connected to the power mains through another LISN. The two LISNs provide 50 ohm/ 50uH of coupling impedance for the measuring instrument.
- Both lines of the power mains connected to the EUT were checked for maximum conducted interference.
- The frequency range from 150kHz to 30MHz was searched. Emission levels under (Limit - 20dB) was not recorded.

NOTE: All modes of operation were investigated and the worst-case emissions are reported.

4.2.4 Deviation from Test Standard

No deviation.

4.2.5 Test Setup

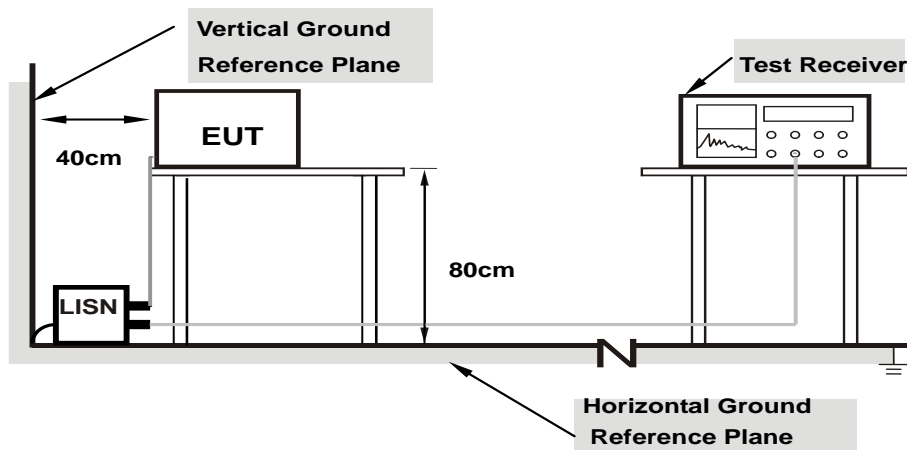

Note: 1.Support units were connected to second LISN.

For the actual test configuration, please refer to the attached file (Test Setup Photo).

4.2.6 EUT Operating Condition

Same as 4.1.6.

4.2.7 Test Results

Phase	Line (L)	Detector Function	Quasi-Peak (QP) / Average (AV)
-------	----------	-------------------	--------------------------------

No	Freq. [MHz]	Corr.	Reading Value		Emission Level		Limit		Margin	
		Factor (dB)	[dB (uV)]		[dB (uV)]		[dB (uV)]		(dB)	
			Q.P.	AV.	Q.P.	AV.	Q.P.	AV.	Q.P.	AV.
1	0.15000	10.19	25.12	9.52	35.31	19.71	66.00	56.00	-30.69	-36.29
2	0.22422	10.19	12.99	-3.19	23.18	7.00	62.66	52.66	-39.48	-45.66
3	0.48594	10.23	22.17	15.96	32.40	26.19	56.24	46.24	-23.84	-20.05
4	2.96484	10.24	19.11	12.77	29.35	23.01	56.00	46.00	-26.65	-22.99
5	10.13281	10.56	19.25	15.20	29.81	25.76	60.00	50.00	-30.19	-24.24
6	24.00391	11.42	23.24	22.26	34.66	33.68	60.00	50.00	-25.34	-16.32

REMARKS:

1. Q.P. and AV. are abbreviations of quasi-peak and average individually.
2. The emission levels of other frequencies were very low against the limit.
3. Margin value = Emission level - Limit value
4. Correction factor = Insertion loss + Cable loss
5. Emission Level = Correction Factor + Reading Value.

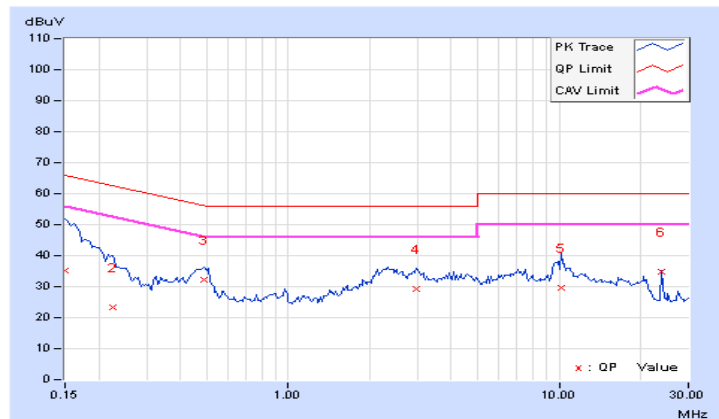

Phase	Neutral (N)	Detector Function	Quasi-Peak (QP) / Average (AV)
-------	-------------	-------------------	--------------------------------

No	Freq. [MHz]	Corr. Factor	Reading Value [dB (uV)]		Emission Level [dB (uV)]		Limit [dB (uV)]		Margin (dB)	
		(dB)	Q.P.	AV.	Q.P.	AV.	Q.P.	AV.	Q.P.	AV.
	1	0.15000	10.18	25.00	8.91	35.18	19.09	66.00	56.00	-30.82
2	0.17344	10.17	30.53	20.53	40.70	30.70	64.79	54.79	-24.09	-24.09
3	0.48203	10.21	21.50	14.98	31.71	25.19	56.30	46.30	-24.59	-21.11
4	2.47656	10.25	22.11	17.20	32.36	27.45	56.00	46.00	-23.64	-18.55
5	9.82031	10.48	21.21	15.72	31.69	26.20	60.00	50.00	-28.31	-23.80
6	24.00391	11.08	25.28	24.30	36.36	35.38	60.00	50.00	-23.64	-14.62

REMARKS:

1. Q.P. and AV. are abbreviations of quasi-peak and average individually.
2. The emission levels of other frequencies were very low against the limit.
3. Margin value = Emission level - Limit value
4. Correction factor = Insertion loss + Cable loss
5. Emission Level = Correction Factor + Reading Value.

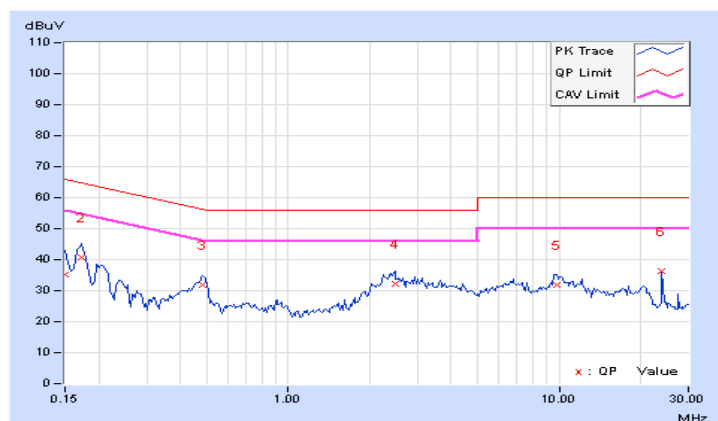

4.3 Transmit Power Measurement

4.3.1 Limits of Transmit Power Measurement

Operation Band	EUT Category		Limit
U-NII-1		Outdoor Access Point	1 Watt (30 dBm) (Max. e.i.r.p \leq 125mW(21 dBm) at any elevation angle above 30 degrees as measured from the horizon)
		Fixed point-to-point Access Point	1 Watt (30 dBm)
		Indoor Access Point	1 Watt (30 dBm)
	√	Mobile and Portable client device	250mW (24 dBm)
U-NII-2A		√	250mW (24 dBm) or 11 dBm+10 log B*
U-NII-2C		√	250mW (24 dBm) or 11 dBm+10 log B*
U-NII-3		√	1 Watt (30 dBm)

*B is the 26 dB emission bandwidth in megahertz

Per KDB 662911 Method of conducted output power measurement on IEEE 802.11 devices,

Array Gain = 0 dB (i.e., no array gain) for $N_{ANT} \leq 4$;

Array Gain = 0 dB (i.e., no array gain) for channel widths ≥ 40 MHz for any N_{ANT} ;

Array Gain = 5 log(N_{ANT}/N_{SS}) dB or 3 dB, whichever is less for 20-MHz channel widths with $N_{ANT} \geq 5$.

For power measurements on all other devices: Array Gain = 10 log(N_{ANT}/N_{SS}) dB.

4.3.2 Test Setup

FOR POWER OUTPUT MEASUREMENT

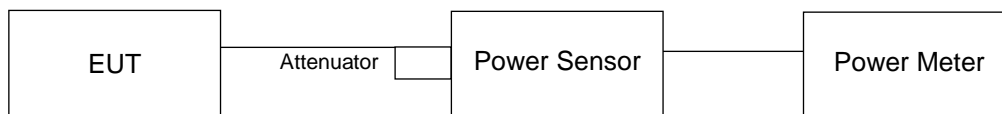

FOR 26dB OCCUPIED BANDWIDTH

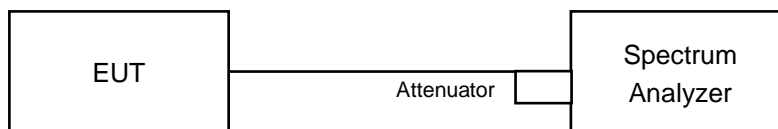

4.3.3 Test Instruments

Refer to section 4.1.2 to get information of above instrument.

4.3.4 Test Procedure

FOR AVERAGE POWER MEASUREMENT

Method PM is used to perform output power measurement, trigger and gating function of wide band power meter is enabled to measure max output power of TX on burst. Duty factor is not added to measured value.

FOR 26dB OCCUPIED BANDWIDTH

1. Set RBW = approximately 1% of the emission bandwidth.
2. Set the VBW > RBW.
3. Detector = Peak.
4. Trace mode = max hold.
5. Measure the maximum width of the emission that is 26 dB down from the peak of the emission. Compare this with the RBW setting of the analyzer. Readjust RBW and repeat measurement as needed until the RBW/EBW ratio is approximately 1%.

4.3.5 Deviation from Test Standard

No deviation.

4.3.6 EUT Operating Condition

The software provided by client to enable the EUT under transmission condition continuously at lowest, middle and highest channel frequencies individually.

4.3.7 Test Result

802.11a

Power Output:

CHAN.	FREQ. (MHz)	Maximum Conducted Power (dBm)		Total Power (mW)	Total Power (dBm)	Power Limit (dBm)	Pass/Fail
		CHAIN 0	CHAIN 1				
36	5180	15.28	15.31	67.692	18.31	24.00	Pass
40	5200	15.15	15.19	65.771	18.18	24.00	Pass
48	5240	18.80	18.80	151.716	21.81	24.00	Pass
52	5260	18.61	18.55	144.225	21.59	24.00	Pass
60	5300	18.55	18.58	143.725	21.58	24.00	Pass
64	5320	13.50	13.54	44.981	16.53	24.00	Pass
100	5500	14.25	14.03	51.9	17.15	24.00	Pass
116	5580	18.35	18.25	135.225	21.31	24.00	Pass
140	5700	13.54	13.42	44.573	16.49	24.00	Pass
149	5745	19.68	19.59	183.888	22.65	30.00	Pass
157	5785	19.67	19.56	183.048	22.63	30.00	Pass
165	5825	19.65	19.61	183.668	22.64	30.00	Pass

26dB OCCUPIED BANDWIDTH

Channel	Frequency (MHz)	26dBc Bandwidth (MHz)	
		Chain 0	Chain 1
52	5260	41.06	31.98
60	5300	39.06	28.50
64	5320	20.40	20.36
100	5500	20.37	20.29
116	5580	20.35	20.37
140	5700	20.26	20.23

Note: For U-NII-2A, U-NII-2C Band output power limitation is determined based on 26dBc bandwidth

Power Limit = 11dBm + 10logB < U-NII-2A, U-NII-2C >			
Channel Number	Freq.(MHz)	Min. B(MHz)	Determined Conducted Limit (dBm)
52	5260	31.98	26.04 > 24
60	5300	28.50	25.54 > 24
64	5320	20.36	24.08 > 24
100	5500	20.29	24.07 > 24
116	5580	20.35	24.08 > 24
140	5700	20.23	24.05 > 24

802.11ac (VHT20)
Power Output:

CHAN.	FREQ. (MHz)	Maximum Conducted Power (dBm)		Total Power (mW)	Total Power (dBm)	Power Limit (dBm)	Pass/Fail
		CHAIN 0	CHAIN 1				
36	5180	15.24	15.26	66.994	18.26	24.00	Pass
40	5200	15.22	15.18	66.227	18.21	24.00	Pass
48	5240	18.67	18.63	146.567	21.66	24.00	Pass
52	5260	18.71	18.68	148.092	21.71	24.00	Pass
60	5300	18.64	18.63	146.06	21.65	24.00	Pass
64	5320	14.11	14.09	51.408	17.11	24.00	Pass
100	5500	13.27	13.03	41.323	16.16	24.00	Pass
116	5580	18.46	18.25	136.98	21.37	24.00	Pass
140	5700	13.80	13.62	47.002	16.72	24.00	Pass
149	5745	19.95	19.78	193.915	22.88	30.00	Pass
157	5785	19.96	19.79	194.363	22.89	30.00	Pass
165	5825	19.93	19.81	194.12	22.88	30.00	Pass

26dB OCCUPIED BANDWIDTH

Channel	Frequency (MHz)	26dBc Bandwidth (MHz)	
		Chain 0	Chain 1
52	5260	30.66	27.46
60	5300	30.19	28.95
64	5320	20.32	20.29
100	5500	20.31	20.19
116	5580	20.40	20.12
140	5700	20.42	20.18

Note: For U-NII-2A, U-NII-2C Band output power limitation is determined based on 26dBc bandwidth

Power Limit = 11dBm + 10logB < U-NII-2A, U-NII-2C >			
Channel Number	Freq.(MHz)	Min. B(MHz)	Determined Conducted Limit (dBm)
52	5260	27.46	25.38 > 24
60	5300	28.95	25.61 > 24
64	5320	20.29	24.07 > 24
100	5500	20.19	24.05 > 24
116	5580	20.12	24.03 > 24
140	5700	20.18	24.04 > 24

802.11ac (VHT40)
Power Output:

CHAN.	FREQ. (MHz)	Maximum Conducted Power (dBm)		Total Power (mW)	Total Power (dBm)	Power Limit (dBm)	Pass/Fail
		CHAIN 0	CHAIN 1				
38	5190	13.24	13.41	43.014	16.34	24.00	Pass
46	5230	16.78	16.91	96.734	19.86	24.00	Pass
54	5270	16.91	17.05	99.79	19.99	24.00	Pass
62	5310	13.07	13.19	41.122	16.14	24.00	Pass
102	5510	13.09	13.21	41.311	16.16	24.00	Pass
110	5550	17.37	17.36	109.026	20.38	24.00	Pass
134	5670	13.80	13.84	48.198	16.83	24.00	Pass
151	5755	19.77	19.79	190.122	22.79	30.00	Pass
159	5795	18.90	18.96	156.33	21.94	30.00	Pass

26dB OCCUPIED BANDWIDTH

Channel	Frequency (MHz)	26dBc Bandwidth (MHz)	
		Chain 0	Chain 1
54	5270	42.17	64.63
62	5310	41.91	41.89
102	5510	41.94	41.73
118	5590	41.95	41.92
134	5670	42.08	41.92

Note: For U-NII-2A, U-NII-2C Band output power limitation is determined based on 26dBc bandwidth

Power Limit = 11dBm + 10logB < U-NII-2A, U-NII-2C >			
Channel Number	Freq.(MHz)	Min. B(MHz)	Determined Conducted Limit (dBm)
54	5270	42.17	27.25 > 24
62	5310	41.89	27.22 > 24
102	5510	41.73	27.2 > 24
110	5550	41.92	27.22 > 24
134	5670	41.92	27.22 > 24

802.11ac (VHT80)

Power Output:

CHAN.	CHAN. FREQ. (MHz)	Maximum Conducted Power (dBm)		Total Power (mW)	Total Power (dBm)	Power Limit (dBm)	Pass/Fail
		CHAIN 0	CHAIN 1				
42	5210	12.87	13.08	39.688	15.99	24.00	Pass
58	5290	12.89	13.02	39.499	15.97	24.00	Pass
106	5530	11.68	11.61	29.211	14.66	24.00	Pass
122	5610	14.55	14.52	56.824	17.55	24.00	Pass
155	5775	15.25	15.34	67.695	18.31	30.00	Pass

26dB OCCUPIED BANDWIDTH

Channel	Frequency (MHz)	26dBc Bandwidth (MHz)	
		Chain 0	Chain 1
58	5290	82.60	82.24
106	5530	82.73	82.05
122	5610	82.91	82.17

Note: For U-NII-2A, U-NII-2C Band output power limitation is determined based on 26dBc bandwidth

Power Limit = 11dBm + 10logB < U-NII-2A, U-NII-2C >			
Channel Number	Freq.(MHz)	Min. B(MHz)	Determined Conducted Limit (dBm)
58	5290	82.24	30.15 > 24
106	5530	82.05	30.14 > 24
122	5610	82.17	30.14 > 24

Spectrum Plot of Worst Value

802.11a_Chain 1 / CH140

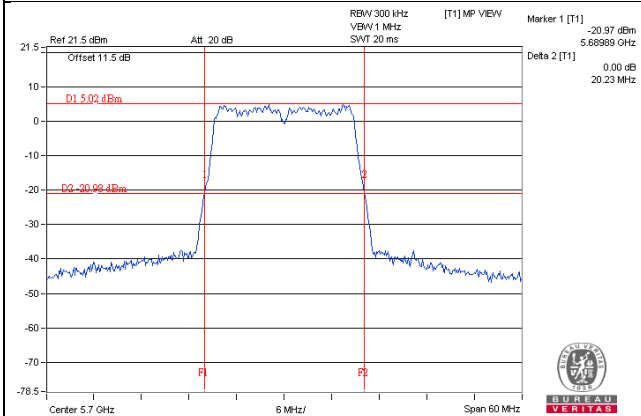

802.11ac (VHT20)_Chain 1 / CH116

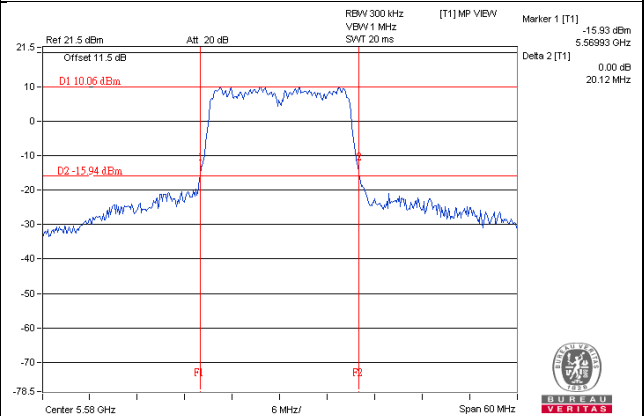

802.11ac (VHT40)_Chain 1 / CH102

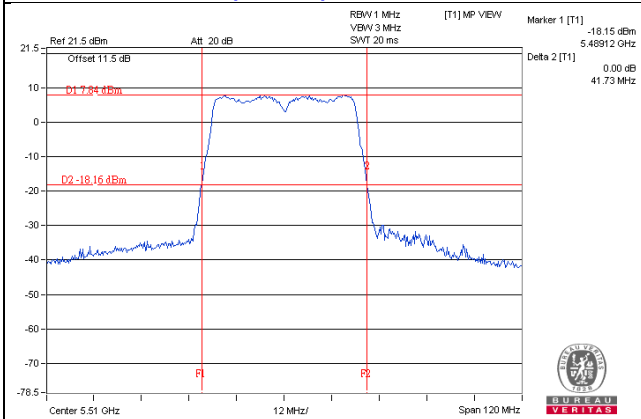

802.11ac (VHT80)_Chain 1 / CH106

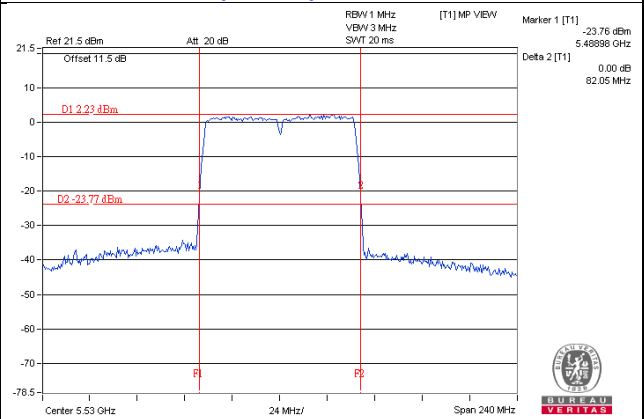

4.4 Occupied Bandwidth Measurement

4.4.1 Test Setup

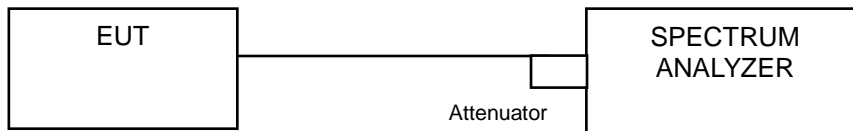

4.4.2 Test Instruments

Refer to section 4.1.2 to get information of above instrument.

4.4.3 Test Procedure

The transmitter output was connected to the spectrum analyzer through an attenuator. The bandwidth of the fundamental frequency was measured by spectrum analyzer with resolution bandwidth in the range of 1% to 5% of the anticipated emission bandwidth, and a video bandwidth at least 3x the resolution bandwidth and set the detector to SAMPLE. The width of a frequency band such that, below the lower and above the upper frequency limits, the mean powers emitted are each equal to a specified percentage 0.5 %of the total mean power of a given emission.

4.4.4 Test Results

802.11a

Channel	Channel Frequency (MHz)	Occupied Bandwidth (MHz)	
		CHAIN 0	CHAIN 1
36	5180	17.88	17.76
40	5200	17.88	17.76
48	5240	18.24	18.12
52	5260	18.12	17.88
60	5300	18.12	17.88
64	5320	17.76	17.64
100	5500	17.76	17.76
116	5580	17.88	17.76
140	5700	17.64	17.64
149	5745	18.00	19.92
157	5785	18.36	23.28
165	5825	18.24	25.56

802.11ac (VHT20)

Channel	Channel Frequency (MHz)	Occupied Bandwidth (MHz)	
		CHAIN 0	CHAIN 1
36	5180	17.76	17.76
40	5200	17.76	17.76
48	5240	17.88	17.88
52	5260	17.88	17.88
60	5300	17.88	17.88
64	5320	17.88	17.76
100	5500	17.88	17.76
116	5580	17.76	17.76
140	5700	17.76	17.64
149	5745	18.36	19.68
157	5785	18.36	22.92
165	5825	18.24	24.36

802.11ac (VHT40)

Channel	Channel Frequency (MHz)	Occupied Bandwidth (MHz)	
		CHAIN 0	CHAIN 1
38	5190	36.72	36.72
46	5230	36.72	36.72
54	5270	36.72	36.72
62	5310	36.72	36.72
102	5510	36.72	36.72
110	5550	36.72	36.48
134	5670	36.72	36.72
151	5755	37.20	41.52
159	5795	37.20	39.36

802.11ac (VHT80)

Channel	Channel Frequency (MHz)	Occupied Bandwidth (MHz)	
		CHAIN 0	CHAIN 1
42	5210	76.32	76.32
58	5290	76.32	76.32
106	5530	76.32	76.32
122	5610	76.32	76.32
155	5775	76.32	76.80

Spectrum Plot of Worst Value

802.11a_Chain1 / CH165

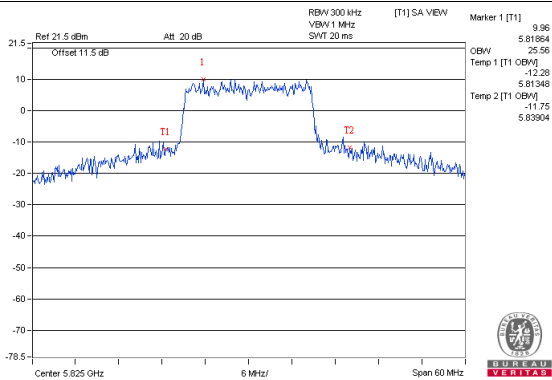

802.11ac (VHT20)_Chain1 / CH165

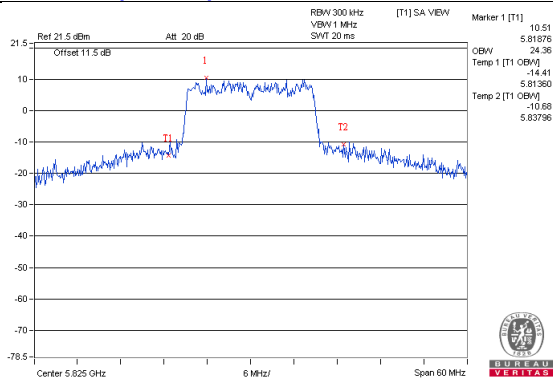

802.11ac (VHT40)_Chain1 / CH151

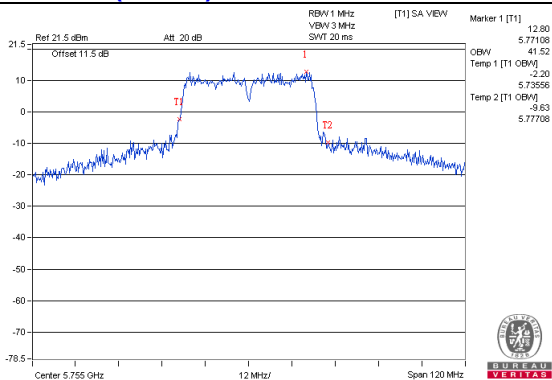

802.11ac (VHT80)_Chain1 / CH155

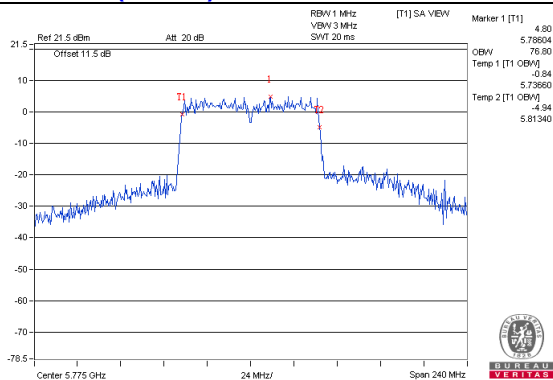

Spectrum Plot for near by DFS band (DFS is required, if 99% OCP straddle into U-NII-2A band)

802.11a_Chain0 / CH48

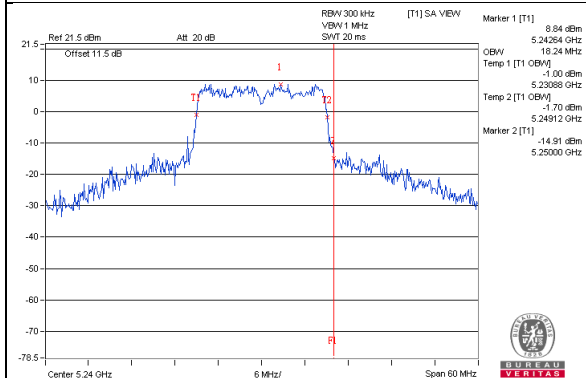

802.11a_Chain1 / CH48

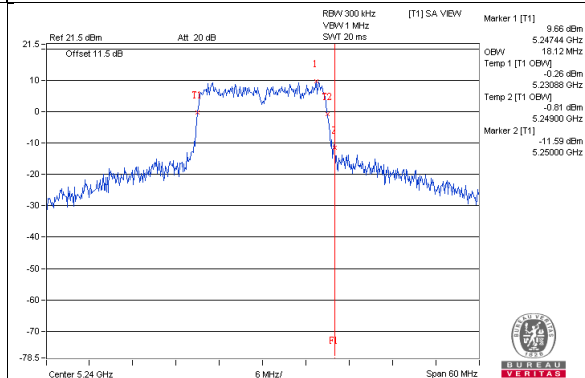

802.11ac(VHT20)_Chain0 / CH48

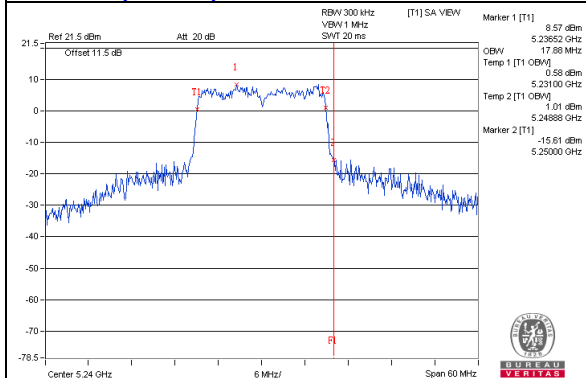

802.11ac(VHT20)_Chain1 / CH48

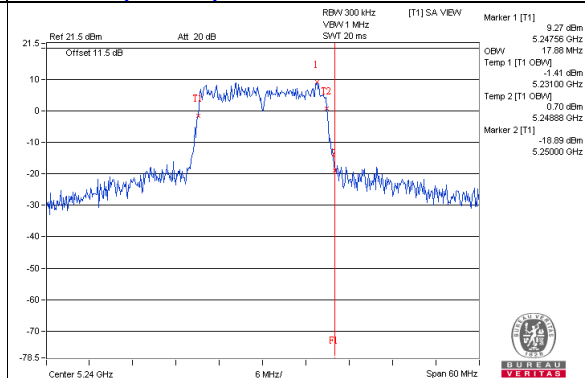

802.11ac(VHT40)_Chain0 / CH46

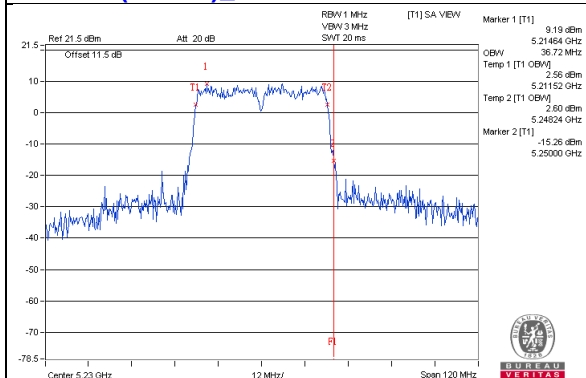

802.11ac(VHT40)_Chain1 / CH46

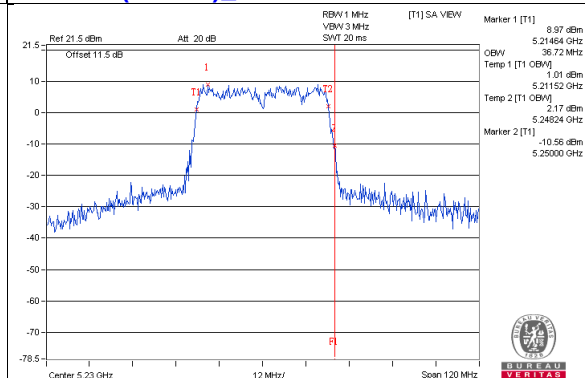

802.11ac(VHT80)_Chain0 / CH42

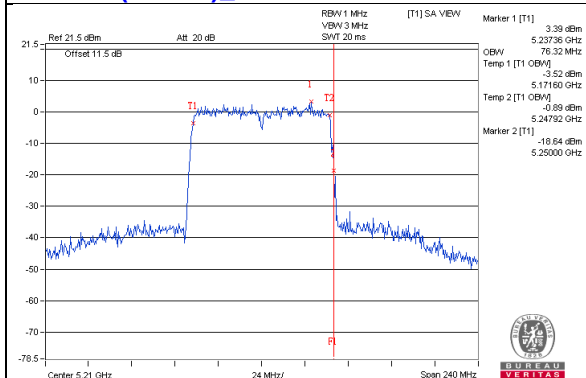

802.11ac(VHT80)_Chain1 / CH42

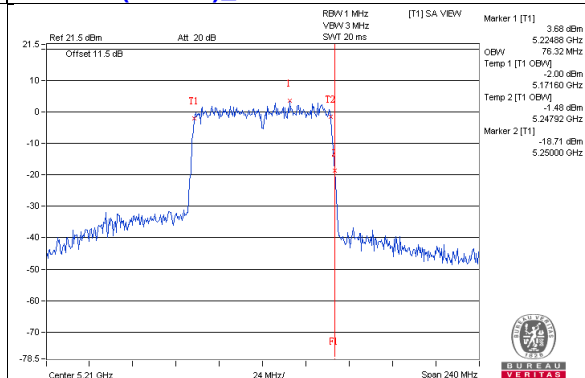

Spectrum Plot for near by DFS band (DFS is required, if 99% OCP straddle into U-NII-2C band)

802.11a_Chain0 / CH149

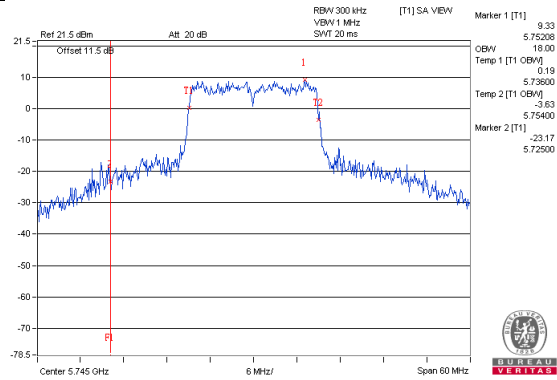

802.11a_Chain1 / CH149

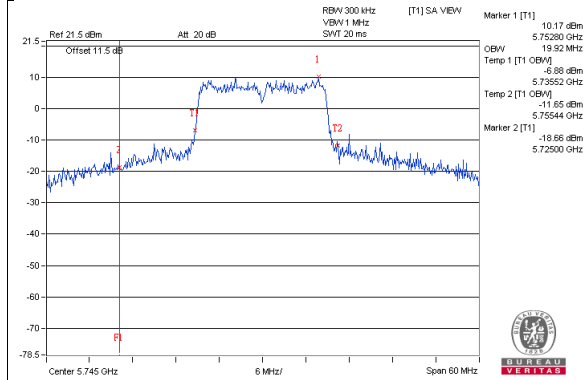

802.11ac(VHT20)_Chain0 / CH149

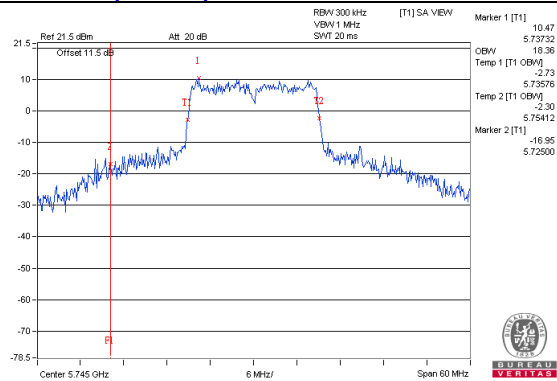

802.11ac(VHT20)_Chain1 / CH149

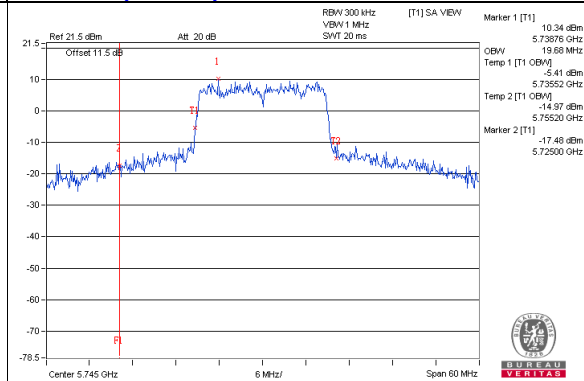

802.11ac(VHT40)_Chain0 / CH151

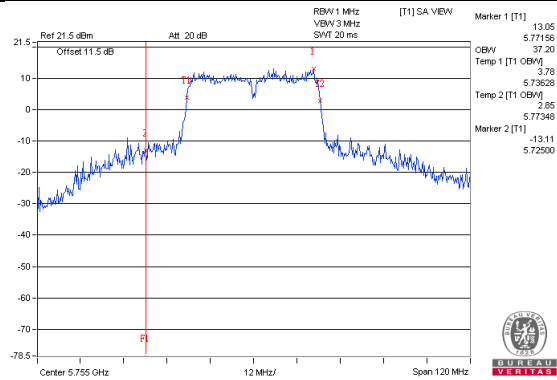

802.11ac(VHT40)_Chain1 / CH151

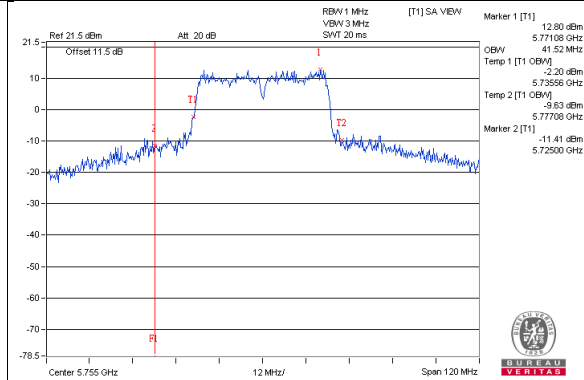

802.11ac(VHT80)_Chain0 / CH155

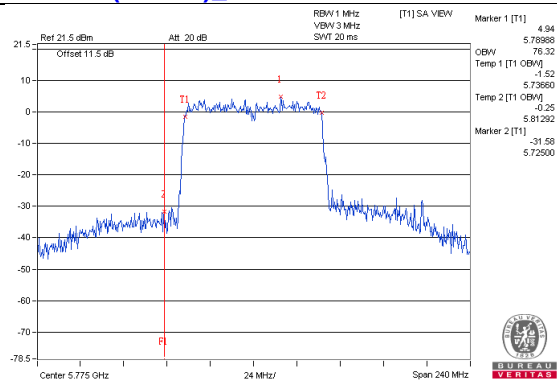

802.11ac(VHT80)_Chain1 / CH155

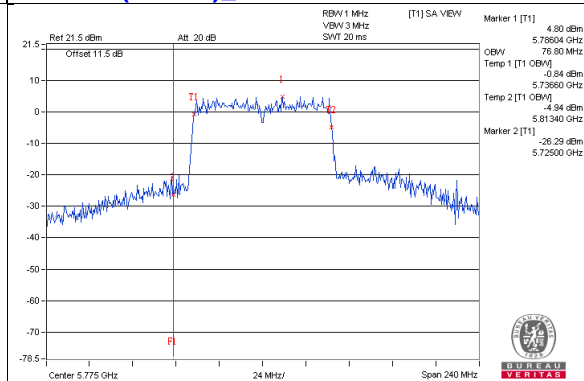

4.5 Peak Power Spectral Density Measurement

4.5.1 Limits of Peak Power Spectral Density Measurement

Operation Band	EUT Category		Limit
U-NII-1		Outdoor Access Point	17dBm/ MHz
		Fixed point-to-point Access Point	
		Indoor Access Point	
	√	Mobile and Portable client device	11dBm/ MHz
U-NII-2A		√	11dBm/ MHz
U-NII-2C		√	11dBm/ MHz
U-NII-3		√	30dBm/ 500kHz

4.5.2 Test Setup



4.5.3 Test Instruments

Refer to section 4.1.2 to get information of above instrument.

4.5.4 Test Procedure

For U-NII-1, U-NII-2A, U-NII-2C band:

1. Set span to encompass the entire emission bandwidth (EBW) of the signal.
2. Set RBW = 1 MHz, Set VBW \geq 3 MHz, Detector = RMS
3. Sweep time = auto, trigger set to "free run".
4. Trace average at least 100 traces in power averaging mode.
5. Record the max value

For U-NII-3:

1. Set span to encompass the entire emission bandwidth (EBW) of the signal.
2. Set RBW = 300 kHz, Set VBW \geq 1 MHz, Detector = RMS
3. Use the peak marker function to determine the maximum power level in any 300 kHz band segment within the fundamental EBW.
4. Scale the observed power level to an equivalent value in 500 kHz by adjusting (reducing) the measured power by a bandwidth correction factor (BWCF) where $BWCF = 10\log(500\text{ kHz}/300\text{kHz})$
5. Sweep time = auto, trigger set to "free run".
6. Trace average at least 100 traces in power averaging mode.
7. Record the max value

4.5.5 Deviation from Test Standard

No deviation.

4.5.6 EUT Operating Condition

Same as Item 4.3.6.

4.5.7 Test Results

For U-NII-1, UNII-2A, UNI-2C:

802.11a

Chan.	Chan. Freq. (MHz)	PSD (dBm/MHz)		Total Power Density (dBm/MHz)	MAX. Limit (dBm/MHz)	Pass / Fail
		Chain 0	Chain 1			
36	5180	1.68	1.98	4.84	8.83	Pass
40	5200	1.76	1.75	4.77	8.83	Pass
48	5240	5.35	5.29	8.33	8.83	Pass
52	5260	5.35	4.70	8.05	8.83	Pass
60	5300	5.40	4.68	8.07	8.83	Pass
64	5320	0.02	0.05	3.05	8.83	Pass
100	5500	1.13	0.33	3.76	8.83	Pass
120	5600	4.49	4.88	7.70	8.83	Pass
140	5700	0.40	-0.31	3.07	8.83	Pass

- Note:** 1. Method a) of power density measurement of KDB 662911 is using for calculating total power density. Total power density is summing entire spectra across corresponding frequency bins on the various outputs by computer.
2. Directional gain = $5.16\text{dBi} + 10\log(2) = 8.17\text{dBi} > 6\text{dBi}$, so the power density limit shall be reduced to $11 - (8.17 - 6) = 8.83\text{dBm}$.

802.11ac (VHT20)

Chan.	Chan. Freq. (MHz)	PSD (dBm/MHz)		Total Power Density (dBm/MHz)	MAX. Limit (dBm/MHz)	Pass / Fail
		Chain 0	Chain 1			
36	5180	2.06	1.98	5.03	8.83	Pass
40	5200	2.03	1.85	4.95	8.83	Pass
48	5240	4.77	4.59	7.69	8.83	Pass
52	5260	4.74	4.86	7.81	8.83	Pass
60	5300	4.69	4.82	7.77	8.83	Pass
64	5320	0.07	0.07	3.08	8.83	Pass
100	5500	0.20	-0.59	2.83	8.83	Pass
120	5600	4.64	4.75	7.71	8.83	Pass
140	5700	0.45	-0.31	3.10	8.83	Pass

- Note:** 1. Method a) of power density measurement of KDB 662911 is using for calculating total power density. Total power density is summing entire spectra across corresponding frequency bins on the various outputs by computer.
2. Directional gain = $5.16\text{dBi} + 10\log(2) = 8.17\text{dBi} > 6\text{dBi}$, so the power density limit shall be reduced to $11 - (8.17 - 6) = 8.83\text{dBm}$.

802.11ac (VHT40)

Chan.	Chan. Freq. (MHz)	PSD (dBm/MHz)		Total Power Density (dBm/MHz)	MAX. Limit (dBm/MHz)	Pass / Fail
		Chain 0	Chain 1			
38	5190	-2.91	-2.91	0.10	8.83	Pass
46	5230	0.25	-0.16	3.06	8.83	Pass
54	5270	0.15	0.97	3.59	8.83	Pass
62	5310	-2.81	-2.87	0.17	8.83	Pass
102	5510	-3.61	-2.54	-0.03	8.83	Pass
118	5590	0.60	0.56	3.59	8.83	Pass
134	5670	-3.30	-3.29	-0.28	8.83	Pass

- Note:** 1. Method a) of power density measurement of KDB 662911 is using for calculating total power density. Total power density is summing entire spectra across corresponding frequency bins on the various outputs by computer.
2. Directional gain = $5.16\text{dBi} + 10\log(2) = 8.17\text{dBi} > 6\text{dBi}$, so the power density limit shall be reduced to $11 - (8.17 - 6) = 8.83\text{dBm}$.

802.11ac (VHT80)

Chan.	Chan. Freq. (MHz)	PSD (dBm/MHz)		Total Power Density (dBm/MHz)	MAX. Limit (dBm/MHz)	Pass / Fail
		Chain 0	Chain 1			
42	5210	-6.86	-6.92	-3.88	8.83	Pass
58	5290	-7.91	-6.90	-4.37	8.83	Pass
106	5530	-8.65	-8.65	-5.64	8.83	Pass
122	5610	-5.60	-5.77	-2.67	8.83	Pass

- Note:** 1. Method a) of power density measurement of KDB 662911 is using for calculating total power density. Total power density is summing entire spectra across corresponding frequency bins on the various outputs by computer.
2. Directional gain = $5.16\text{dBi} + 10\log(2) = 8.17\text{dBi} > 6\text{dBi}$, so the power density limit shall be reduced to $11 - (8.17 - 6) = 8.83\text{dBm}$.

Spectrum Plot of Worst Value

802.11a_Chain 0 / CH60

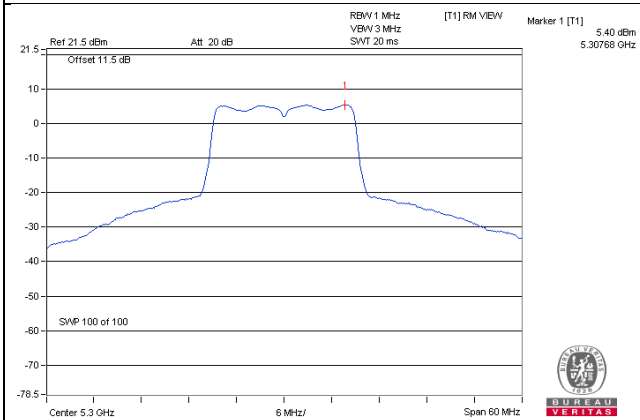

802.11ac (VHT20)_Chain 1 / CH52

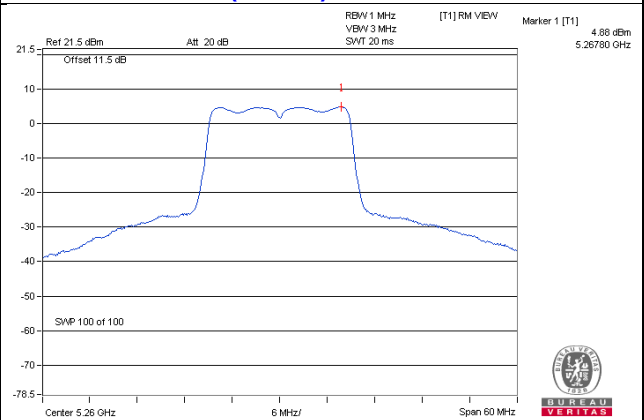

802.11ac (VHT40)_Chain 1 / CH54

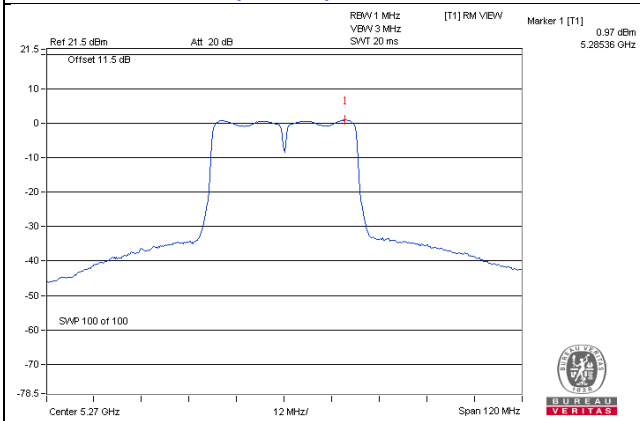

802.11ac (VHT80)_Chain 0 / CH122

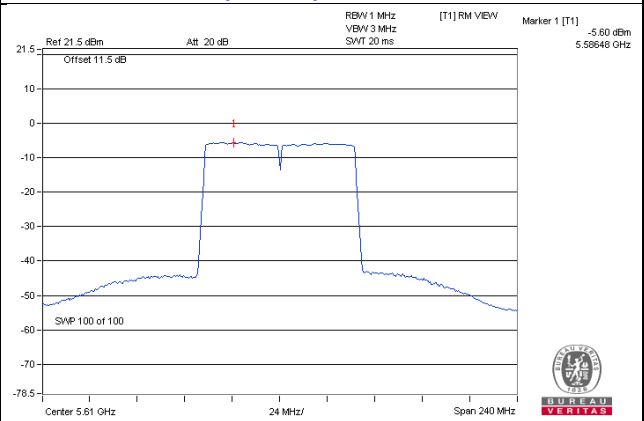

**For U-NII-3:
802.11a**

TX chain	Channel	Freq. (MHz)	PSD (dBm/300kHz)	PSD (dBm/500kHz)	10 log (N=2) dB	Total PSD (dBm/500kHz)	Limit (dBm/500kHz)	Pass /Fail
0	149	5745	-2.94	-0.72	3.01	2.29	27.83	Pass
	157	5785	-2.22	0.00	3.01	3.01	27.83	Pass
	165	5825	-2.19	0.03	3.01	3.04	27.83	Pass
1	149	5745	-2.43	-0.21	3.01	2.80	27.83	Pass
	157	5785	-2.00	0.22	3.01	3.23	27.83	Pass
	165	5825	-1.97	0.25	3.01	3.26	27.83	Pass

Note: 1. Directional gain = $5.16\text{dBi} + 10\log(2) = 8.17\text{dBi} > 6\text{dBi}$, so the power density limit shall be reduced to $30-(8.17-6) = 27.83\text{dBm}$.

802.11ac (VHT20)

TX chain	Channel	Freq. (MHz)	PSD (dBm/300kHz)	PSD (dBm/500kHz)	10 log (N=2) dB	Total PSD (dBm/500kHz)	Limit (dBm/500kHz)	Pass /Fail
0	149	5745	-1.86	0.36	3.01	3.37	27.83	Pass
	157	5785	-2.20	0.02	3.01	3.03	27.83	Pass
	165	5825	-2.31	-0.09	3.01	2.92	27.83	Pass
1	149	5745	-2.27	-0.05	3.01	2.96	27.83	Pass
	157	5785	-1.99	0.23	3.01	3.24	27.83	Pass
	165	5825	-1.99	0.23	3.01	3.24	27.83	Pass

Note: 1. Directional gain = $5.16\text{dBi} + 10\log(2) = 8.17\text{dBi} > 6\text{dBi}$, so the power density limit shall be reduced to $30-(8.17-6) = 27.83\text{dBm}$.

802.11ac (VHT40)

TX chain	Channel	Freq. (MHz)	PSD (dBm/300kHz)	PSD (dBm/500kHz)	10 log (N=2) dB	Total PSD (dBm/500kHz)	Limit (dBm/500kHz)	Pass /Fail
0	151	5755	-5.60	-3.38	3.01	-0.37	27.83	Pass
	159	5795	-6.02	-3.80	3.01	-0.79	27.83	Pass
1	151	5755	-5.48	-3.26	3.01	-0.25	27.83	Pass
	159	5795	-6.44	-4.22	3.01	-1.21	27.83	Pass

Note: 1. Directional gain = $5.16\text{dBi} + 10\log(2) = 8.17\text{dBi} > 6\text{dBi}$, so the power density limit shall be reduced to $30-(8.17-6) = 27.83\text{dBm}$.

802.11ac (VHT80)

TX chain	Channel	Freq. (MHz)	PSD (dBm/300kHz)	PSD (dBm/500kHz)	10 log (N=2) dB	Total PSD (dBm/500kHz)	Limit (dBm/500kHz)	Pass /Fail
0	155	5775	-14.02	-11.80	3.01	-8.79	27.83	Pass
1	155	5775	-13.48	-11.26	3.01	-8.25	27.83	Pass

Note: 1. Directional gain = $5.16\text{dBi} + 10\log(2) = 8.17\text{dBi} > 6\text{dBi}$, so the power density limit shall be reduced to $30-(8.17-6) = 27.83\text{dBm}$.

Spectrum Plot of Worst Value

802.11a – Chain 1: CH 165

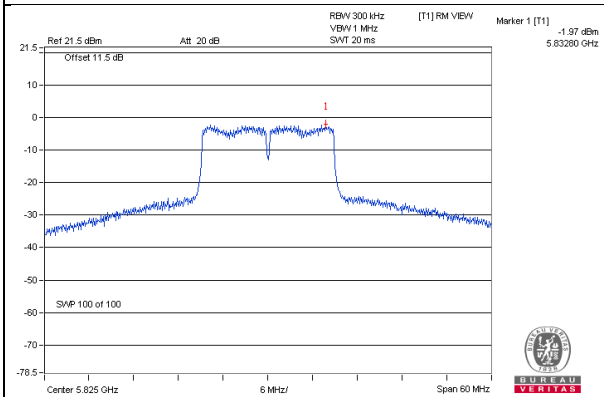

802.11ac (VHT20) – Chain 0: CH 149

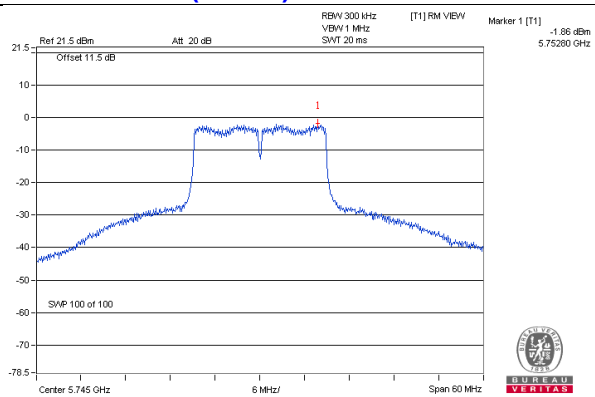

802.11ac (VHT40) – Chain 1: CH 151

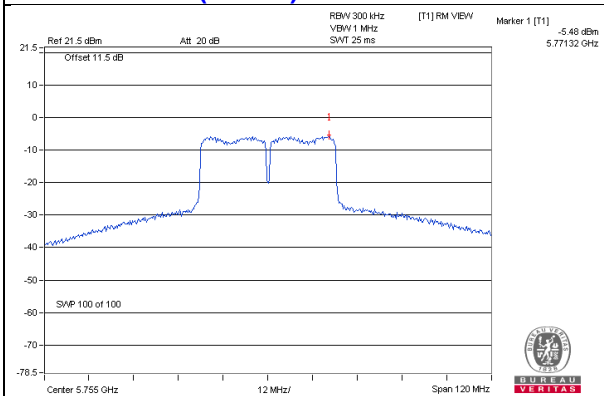

802.11ac (VHT80) – Chain 1: CH 155

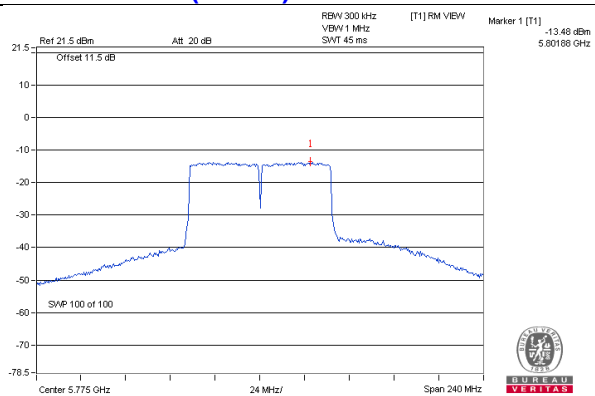

4.6 Frequency Stability Measurement

4.6.1 Limits of Frequency Stability Measurement

The frequency of the carrier signal shall be maintained within band of operation

4.6.2 Test Setup

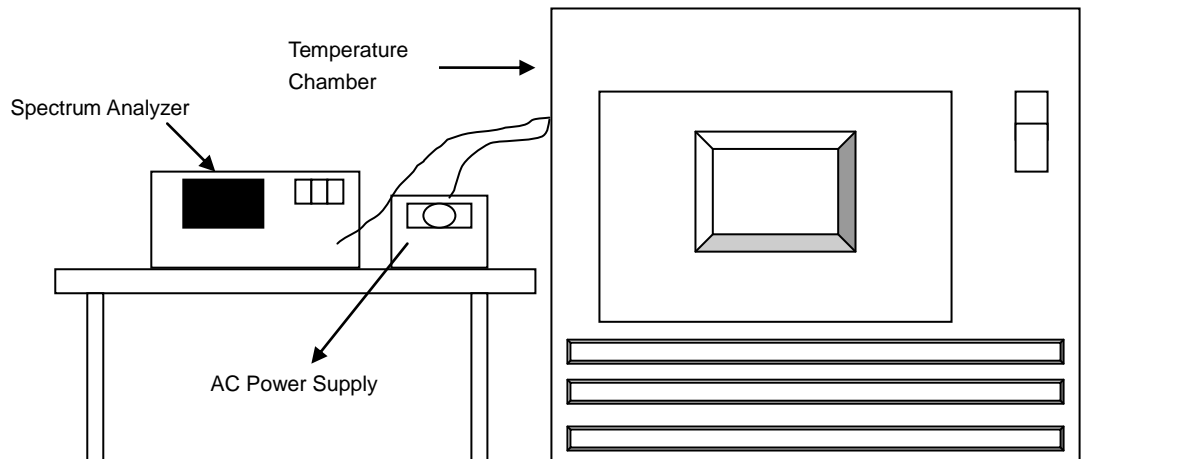

4.6.3 Test Instruments

Refer to section 4.1.2 to get information of above instrument.

4.6.4 Test Procedure

- The EUT was placed inside the environmental test chamber and powered by nominal AC voltage.
- Turn the EUT on and couple its output to a spectrum analyzer.
- Turn the EUT off and set the chamber to the highest temperature specified.
- Allow sufficient time (approximately 30 min) for the temperature of the chamber to stabilize, turn the EUT on and measure the operating frequency after 2, 5, and 10 Minutes.
- Repeat step 2 and 3 with the temperature chamber set to the lowest temperature.
- The test chamber was allowed to stabilize at +20 degree C for a minimum of 30 Minutes. The supply voltage was then adjusted on the EUT from 85% to 115% and the frequency record.

4.6.5 Deviation from Test Standard

No deviation.

4.6.6 EUT Operating Condition

Set the EUT transmit at un-modulation mode to test frequency stability.

4.6.7 Test Results

Frequency Stability Versus Temp.									
Operating Frequency: 5180 MHz									
TEMP. (°C)	Power Supply (Vac)	0 Minute		2 Minute		5 Minute		10 Minute	
		Measured Frequency (MHz)	Pass/Fail	Measured Frequency (MHz)	Pass/Fail	Measured Frequency (MHz)	Pass/Fail	Measured Frequency (MHz)	Pass/Fail
50	120	5179.9973	Pass	5179.9976	Pass	5179.9995	Pass	5179.9995	Pass
40	120	5180.001	Pass	5179.9994	Pass	5180.0001	Pass	5179.9993	Pass
30	120	5179.9881	Pass	5179.987	Pass	5179.9876	Pass	5179.9899	Pass
20	120	5180.0064	Pass	5180.0057	Pass	5180.002	Pass	5180.0017	Pass
10	120	5180.0068	Pass	5180.0029	Pass	5180.0046	Pass	5180.0019	Pass
0	120	5179.9881	Pass	5179.9863	Pass	5179.9846	Pass	5179.9849	Pass
-10	120	5179.9828	Pass	5179.9785	Pass	5179.9804	Pass	5179.9827	Pass
-20	120	5179.9949	Pass	5179.9958	Pass	5179.996	Pass	5179.9941	Pass
-30	120	5180.0046	Pass	5180.0073	Pass	5180.0046	Pass	5180.005	Pass

Frequency Stability Versus Voltage									
Operating Frequency: 5180 MHz									
TEMP. (°C)	Power Supply (Vac)	0 Minute		2 Minute		5 Minute		10 Minute	
		Measured Frequency (MHz)	Pass/Fail	Measured Frequency (MHz)	Pass/Fail	Measured Frequency (MHz)	Pass/Fail	Measured Frequency (MHz)	Pass/Fail
20	138	5180.006	Pass	5180.0063	Pass	5180.0012	Pass	5180.0014	Pass
	120	5180.0064	Pass	5180.0057	Pass	5180.002	Pass	5180.0017	Pass
	102	5180.007	Pass	5180.0053	Pass	5180.0025	Pass	5180.0018	Pass

4.7 6dB Bandwidth Measurement

4.7.1 Limits of 6dB Bandwidth Measurement

The minimum of 6dB Bandwidth Measurement is 0.5MHz.

4.7.2 Test Setup

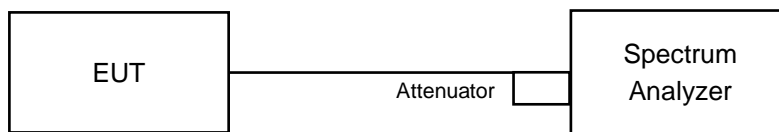

4.7.3 Test Instruments

Refer to section 4.1.2 to get information of above instrument.

4.7.4 Test Procedure

MEASUREMENT PROCEDURE REF

- Set resolution bandwidth (RBW) = 100kHz
- Set the video bandwidth (VBW) $\geq 3 \times$ RBW, Detector = Peak.
- Trace mode = max hold.
- Sweep = auto couple.
- Measure the maximum width of the emission that is constrained by the frequencies associated with the two amplitude points (upper and lower) that are attenuated by 6 dB relative to the maximum level measured in the fundamental emission

4.7.5 Deviation from Test Standard

No deviation.

4.7.6 EUT Operating Condition

The software provided by client to enable the EUT under transmission condition continuously at lowest, middle and highest channel frequencies individually.

4.7.7 Test Results

802.11a

Channel	Frequency (MHz)	6dB Bandwidth (MHz)		Minimum Limit (MHz)	Pass / Fail
		Chain 0	Chain 1		
149	5745	17.74	17.75	0.5	PASS
157	5785	17.75	17.77	0.5	PASS
165	5825	17.77	17.77	0.5	PASS

802.11ac (VHT20)

Channel	Frequency (MHz)	6dB Bandwidth (MHz)		Minimum Limit (MHz)	Pass / Fail
		Chain 0	Chain 1		
149	5745	17.80	17.75	0.5	PASS
157	5785	17.74	17.74	0.5	PASS
165	5825	17.74	17.73	0.5	PASS

802.11ac (VHT40)

Channel	Frequency (MHz)	6dB Bandwidth (MHz)		Minimum Limit (MHz)	Pass / Fail
		Chain 0	Chain 1		
151	5755	36.57	36.54	0.5	PASS
159	5795	36.59	36.54	0.5	PASS

802.11ac (VHT80)

Channel	Frequency (MHz)	6dB Bandwidth (MHz)		Minimum Limit (MHz)	Pass / Fail
		Chain 0	Chain 1		
155	5775	76.76	76.78	0.5	PASS

Spectrum Plot of Worst Value

802.11a_Chain 0 / CH149

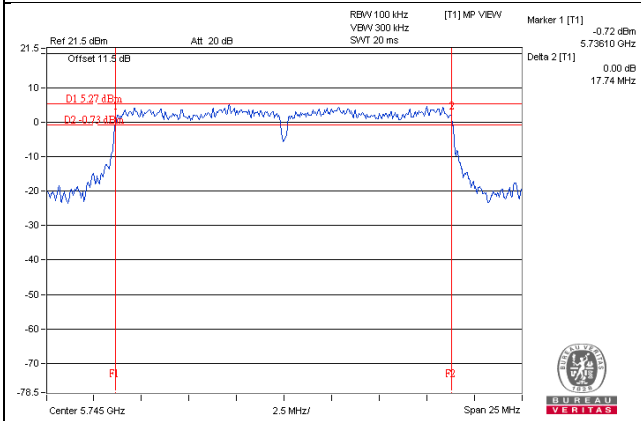

802.11ac (VHT20)_Chain 1 / CH165

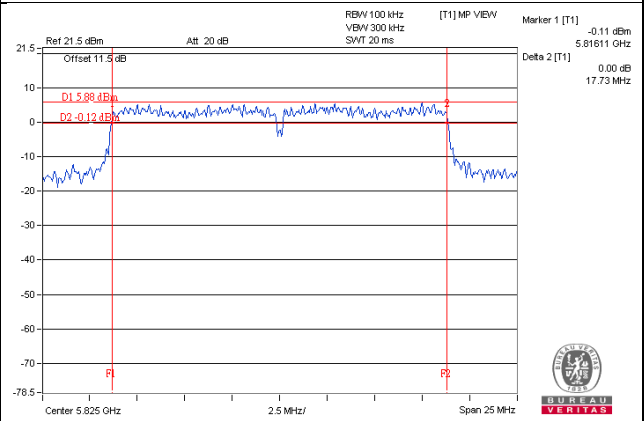

802.11ac (VHT40)_Chain 1 / CH151

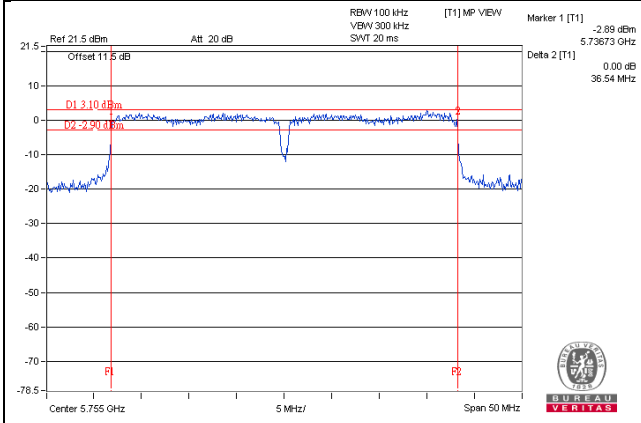

802.11ac (VHT80)_Chain 0 / CH155

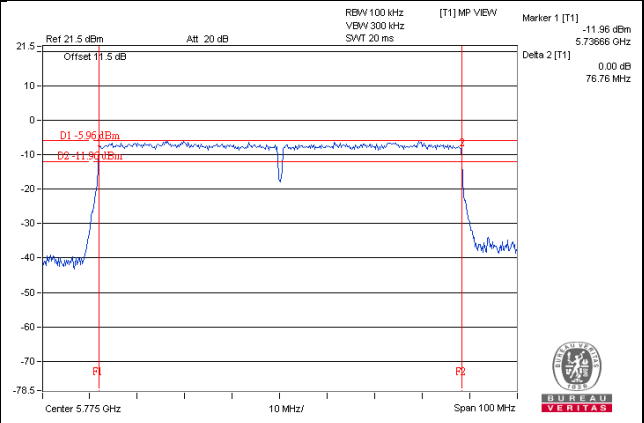

5 Pictures of Test Arrangements

Please refer to the attached file (Test Setup Photo).

Annex A- Radiated Out of Band Emission (OOBE) Measurement (For U-NII-3 band)

802.11a

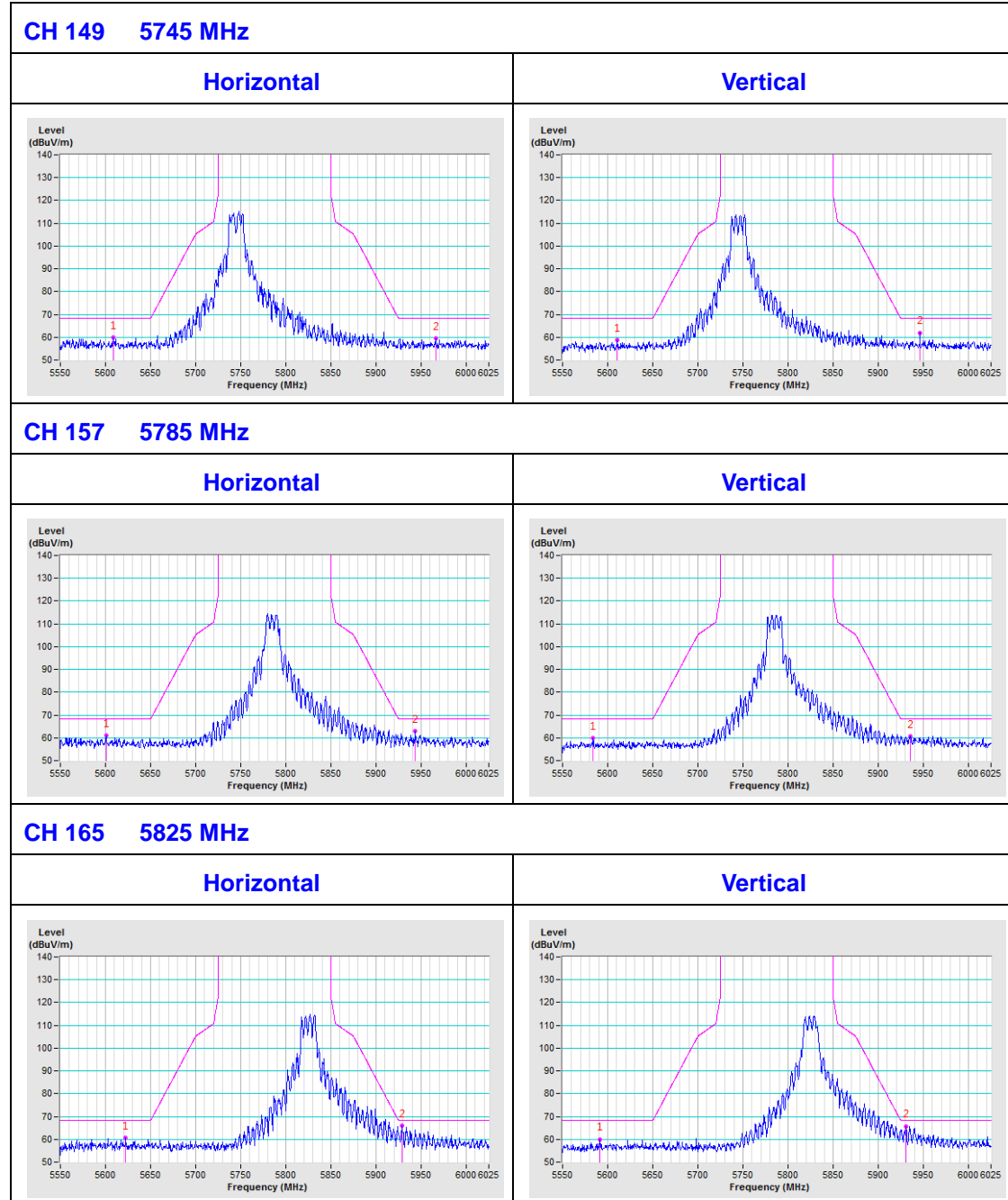

802.11ac (VHT20)

CH 149 5745 MHz

Horizontal

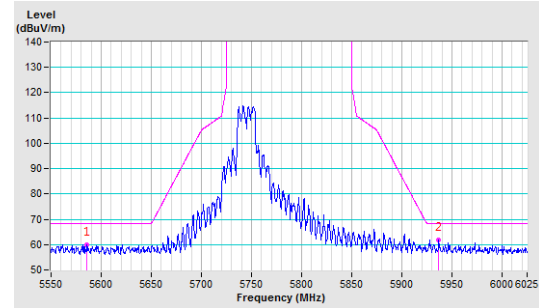

Vertical

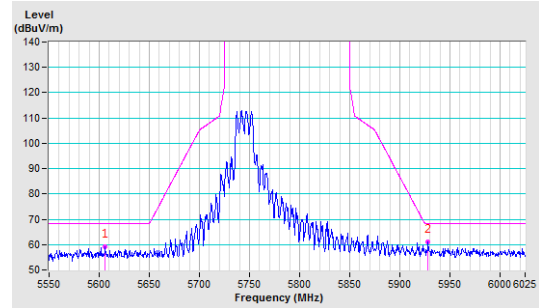

CH 157 5785 MHz

Horizontal

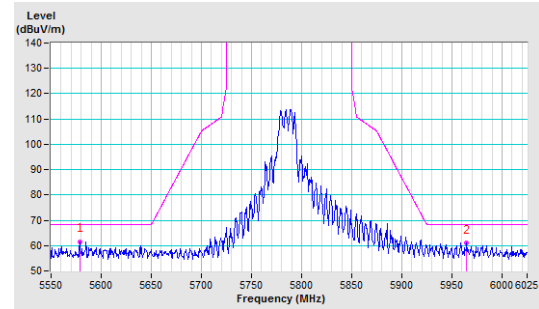

Vertical

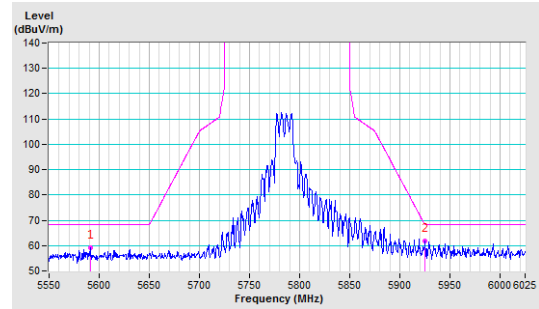

CH 165 5825 MHz

Horizontal

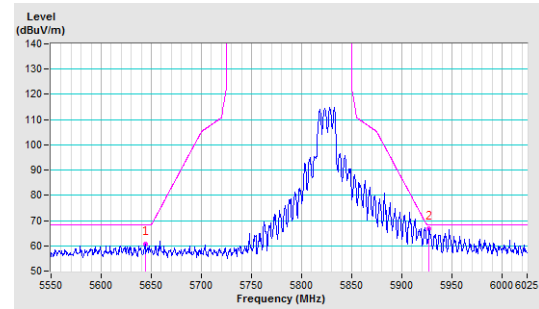

Vertical

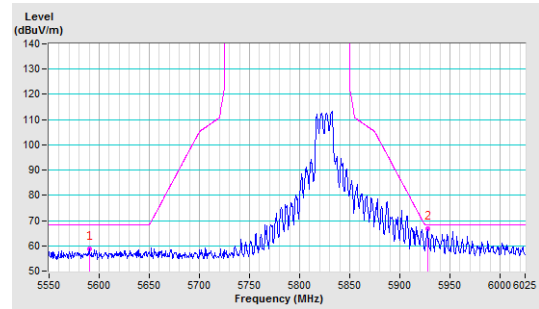

802.11ac (VHT40)

CH 151 5755 MHz

Horizontal

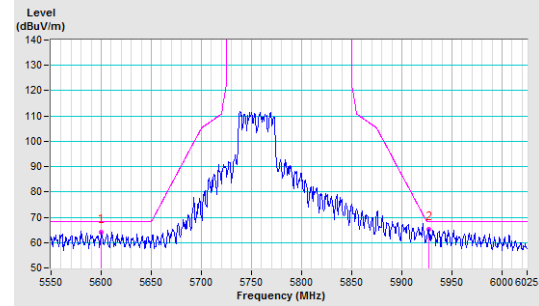

Vertical

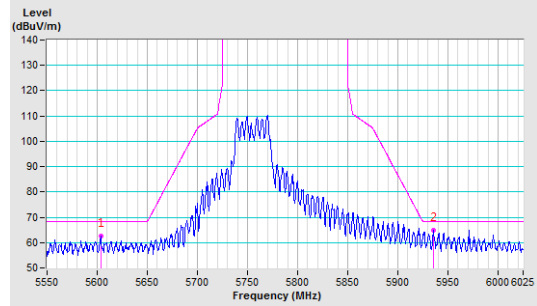

CH 159 5795 MHz

Horizontal

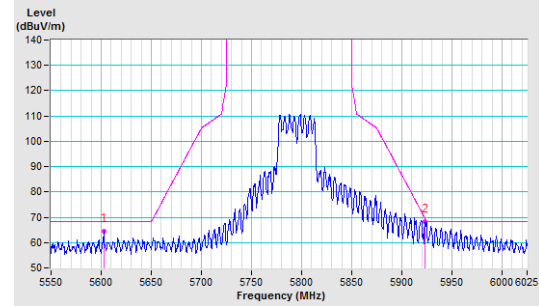

Vertical

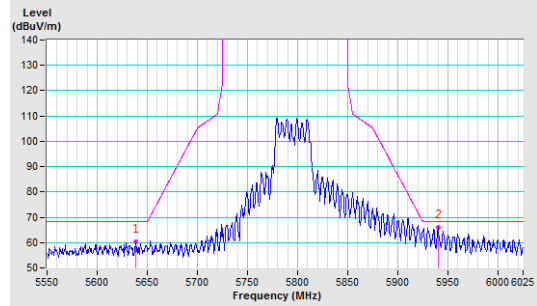

802.11ac (VHT80)

CH 155 5775 MHz

Horizontal

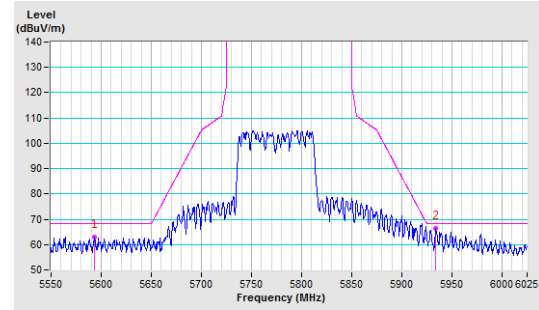

Vertical

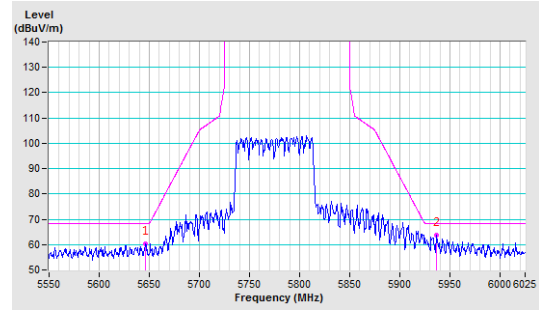

Appendix – Information on the Testing Laboratories

We, Bureau Veritas Consumer Products Services (H.K.) Ltd., Taoyuan Branch, were founded in 1988 to provide our best service in EMC, Radio, Telecom and Safety consultation. Our laboratories are accredited and approved according to ISO/IEC 17025.

If you have any comments, please feel free to contact us at the following:

Linko EMC/RF Lab

Tel: 886-2-26052180

Fax: 886-2-26051924

Hsin Chu EMC/RF/Telecom Lab

Tel: 886-3-6668565

Fax: 886-3-6668323

Hwa Ya EMC/RF/Safety Lab

Tel: 886-3-3183232

Fax: 886-3-3270892

Email: service.adt@tw.bureauveritas.com

Web Site: www.bureauveritas-adt.com

The address and road map of all our labs can be found in our web site also.

--- END ---