



**MET Laboratories, Inc.** *Safety Certification - EMI - Telecom Environmental Simulation*

914 WEST PATAPSCO AVENUE • BALTIMORE, MARYLAND 21230-3432 • PHONE (410) 354-3300 • FAX (410) 354-3313  
33439 WESTERN AVENUE • UNION CITY, CALIFORNIA 94587 • PHONE (510) 489-6300 • FAX (510) 489-6372  
3162 BELICK STREET • SANTA CLARA, CA 95054 • PHONE (408) 748-3585 • FAX (510) 489-6372  
13301 MCCALLEN PASS • AUSTIN, TX 78753 • PHONE (512) 287-2500 • FAX (512) 287-2513

July 19, 2012

Alereon Inc.  
7600-C Capitol of Texas Highway Suite 200  
Austin, TX 78731

Dear David Dickson,

Enclosed is the EMC Wireless test report for compliance testing of the Alereon Inc., Wireless USB Host Adapter as tested to the requirements of Title 47 of the CFR, Ch. 1 (10-1-06 ed.), Part 15, Subpart B for a Class B Digital Device and Part 15, Subpart F for Intentional Radiators.

Thank you for using the services of MET Laboratories, Inc. If you have any questions regarding these results or if MET can be of further service to you, please feel free to contact me.

Sincerely yours,  
MET LABORATORIES, INC.

Jennifer Warnell  
Documentation Department

Reference: (\Alereon Inc.\EMC35457-FCC519)

Certificates and reports shall not be reproduced except in full, without the written permission of MET Laboratories, Inc.

## **Electromagnetic Compatibility Criteria Test Report**

for the

**Alereon Inc.  
Wireless USB Host Adapter**

**Tested under**  
the FCC Certification Rules  
contained in  
Title 47 of the CFR, Parts 15 Subpart B  
for Class B Digital Devices  
&  
15.519 Subpart F for Intentional Radiators

**MET Report: EMC35457-FCC519**

July 19, 2012

**Prepared For:**

**Alereon Inc.  
7600-C Capitol of Texas Highway Suite 200  
Austin, TX 78731**

**Prepared By:**  
**MET Laboratories, Inc.**  
914 W. Patapsco Ave.  
Baltimore, MD 21230

## Electromagnetic Compatibility Criteria Test Report

for the

### Alereon Inc. Wireless USB Host Adapter

**Tested under**  
the FCC Certification Rules  
contained in  
Title 47 of the CFR, Parts 15 Subpart B  
for Class B Digital Devices  
&  
15.519 Subpart F for Intentional Radiators

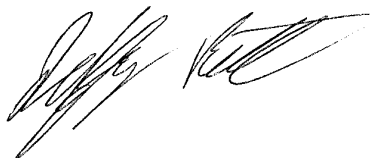

Jeff Pratt  
Project Engineer, Electromagnetic Compatibility Lab



Jennifer Warnell  
Documentation Department

**Engineering Statement:** The measurements shown in this report were made in accordance with the procedures indicated, and the emissions from this equipment were found to be within the limits applicable. I assume full responsibility for the accuracy and completeness of these measurements, and for the qualifications of all persons taking them. It is further stated that upon the basis of the measurements made, the equipment tested is capable of operation in accordance with the requirements of the FCC Rules Parts 15B, 15.519 under normal use and maintenance.



Shawn McMillen,  
Wireless Manager, Electromagnetic Compatibility Lab

## Report Status Sheet

Revision	Report Date	Reason for Revision
Ø	July 19, 2012	Initial Issue.

## Table of Contents

<b>I.</b>	<b>Executive Summary .....</b>	<b>1</b>
	A. Purpose of Test.....	2
	B. Executive Summary .....	2
<b>II.</b>	<b>Equipment Configuration .....</b>	<b>3</b>
	A. Overview .....	4
	B. References.....	5
	C. Test Site .....	5
	D. Description of Test Sample .....	6
	E. Equipment Configuration .....	8
	F. Support Equipment .....	8
	G. Mode of Operation.....	8
	H. Modifications.....	8
	a) Modifications to EUT .....	8
	b) Modifications to Test Standard .....	8
	I. Disposition of EUT .....	8
<b>III.</b>	<b>Electromagnetic Compatibility Criteria for Unintentional Radiators.....</b>	<b>9</b>
	§ 15.107(a) Conducted Emissions Limits .....	10
	§ 15.109(a) Radiated Emissions Limits .....	14
<b>IV.</b>	<b>Electromagnetic Compatibility Criteria for Intentional Radiators .....</b>	<b>17</b>
	§ 15.203 Antenna Requirement .....	18
	§ 15.207(a) Conducted Emissions Limits .....	19
	§ 15.519(a) Operational Limitations .....	23
	§ 15.519(b) UWB Bandwidth .....	24
	§ 15.519(c) Radiated Emissions .....	28
	§ 15.519(d) Radiated Emissions – GPS Bands .....	38
	§ 15.519(e) Peak Emissions .....	42
<b>V.</b>	<b>Test Equipment .....</b>	<b>44</b>
<b>VI.</b>	<b>Certification &amp; User’s Manual Information .....</b>	<b>46</b>
	A. Certification Information .....	47
	B. Label and User’s Manual Information .....	51

## List of Tables

Table 1. Executive Summary of EMC Part 15.519 Compliance Testing.....	2
Table 2. EUT Summary Table.....	4
Table 3. References .....	5
Table 4. Equipment Configuration .....	8
Table 5. Support Equipment .....	8
Table 6. Conducted Limits for Radio Frequency Devices calculated from FCC Part 15 Subsections 15.107(a) (b) .....	10
Table 7. Conducted Emissions - Voltage, AC Power, Phase Line (120 VAC, 60 Hz) .....	11
Table 8. Conducted Emissions - Voltage, AC Power, Neutral Line (120 VAC, 60 Hz).....	12
Table 9. Radiated Emissions Limits calculated from FCC Part 15, §15.109 (a) (b).....	14
Table 10. Radiated Emissions Limits, Test Results, 30 MHz – 1 GHz, FCC Limits .....	15
Table 11. Antenna List.....	18
Table 12. Conducted Limits for Intentional Radiators from FCC Part 15 § 15.207(a) .....	19
Table 13. Conducted Emissions, 15.207(a), Phase Line, Test Results.....	20
Table 14. Conducted Emissions, 15.207(a), Neutral Line, Test Results.....	21
Table 15. Test Equipment List .....	45

## List of Plots

Plot 1. Conducted Emission, Phase Line Plot.....	11
Plot 2. Conducted Emission, Neutral Line Plot .....	12
Plot 3. Radiated Emissions, 30 MHz - 1 GHz, FCC Limits .....	15
Plot 4. Conducted Emissions, 15.207(a), Phase Line .....	20
Plot 5. Conducted Emissions, 15.207(a), Neutral Line.....	21
Plot 6. UWB Bandwidth, $F_m$ , BG1 .....	25
Plot 7. UWB Bandwidth, $F_l$ , BG1.....	25
Plot 8. UWB Bandwidth, $F_h$ , BG1 .....	25
Plot 9. UWB Bandwidth, $F_m$ , BG3 .....	26
Plot 10. UWB Bandwidth, $F_l$ , BG3 .....	26
Plot 11. UWB Bandwidth, $F_h$ , BG3.....	26
Plot 12. UWB Bandwidth, $F_m$ , BG6.....	27
Plot 13. UWB Bandwidth, $F_l$ , BG6 .....	27
Plot 14. UWB Bandwidth, $F_h$ , BG6.....	27
Plot 15. Radiated Emissions, 30 MHz – 960 GHz, BG1 .....	29
Plot 16. Radiated Emissions, 960 MHz – 1 GHz, BG1 .....	29
Plot 17. Radiated Emissions, 1 GHz – 1.61 GHz, BG1 .....	29
Plot 18. Radiated Emissions, 1.61 GHz – 1.99 GHz, BG1.....	30
Plot 19. Radiated Emissions, 1.99 GHz – 3.1 GHz, BG1 .....	30
Plot 20. Radiated Emissions, 3.1 GHz – 10.6 GHz, BG1 .....	30
Plot 21. Radiated Emissions, 10.6 GHz – 18 GHz, BG1 .....	31
Plot 22. Radiated Emissions, 18 GHz – 40 GHz, BG1 .....	31
Plot 23. Radiated Emissions, 30 MHz – 960 GHz, BG3 .....	32
Plot 24. Radiated Emissions, 960 MHz – 1 GHz, BG3 .....	32
Plot 25. Radiated Emissions, 1 GHz – 1.61 GHz, BG3 .....	32
Plot 26. Radiated Emissions, 1.61 GHz – 1.99 GHz, BG3.....	33
Plot 27. Radiated Emissions, 1.99 GHz – 3.1 GHz, BG3 .....	33
Plot 28. Radiated Emissions, 3.1 GHz – 10.6 GHz, BG3 .....	33
Plot 29. Radiated Emissions, 10.6 GHz – 18 GHz, BG3 .....	34
Plot 30. Radiated Emissions, 18 GHz – 40 GHz, BG3 .....	34
Plot 31. Radiated Emissions, 30 MHz – 960 GHz, BG6 .....	35
Plot 32. Radiated Emissions, 960 MHz – 1 GHz, BG6 .....	35

Plot 33. Radiated Emissions, 1 GHz – 1.61 GHz, BG6 .....	35
Plot 34. Radiated Emissions, 1.61 GHz – 1.99 GHz, BG6.....	36
Plot 35. Radiated Emissions, 1.99 GHz – 3.1 GHz, BG6 .....	36
Plot 36. Radiated Emissions, 3.1 GHz – 10.6 GHz, BG6 .....	36
Plot 37. Radiated Emissions, 10.6 GHz – 18 GHz, BG6.....	37
Plot 38. Radiated Emissions, 18 GHz – 40 GHz, BG6 .....	37
Plot 39. Radiated Emissions, 1.164 GHz – 1.24 GHz, GPS Band, BG1 .....	39
Plot 40. Radiated Emissions, 1.559 GHz – 1.61 GHz, GPS Band, BG1 .....	39
Plot 41. Radiated Emissions, 1.164 GHz – 1.24 GHz, GPS Band, BG3 .....	39
Plot 42. Radiated Emissions, 1.559 GHz – 1.61 GHz, GPS Band, BG3 .....	40
Plot 43. Radiated Emissions, 1.164 GHz – 1.24 GHz, GPS Band, BG6 .....	40
Plot 44. Radiated Emissions, 1.559 GHz – 1.61 GHz, GPS Band, BG6 .....	40
Plot 45. Peak Emissions, Field Strength, BG1 .....	43
Plot 46. Peak Emissions, Field Strength, BG3 .....	43
Plot 47. Peak Emissions, Field Strength, BG6 .....	43

## List of Figures

Figure 1. Block Diagram of Test Configuration .....	7
---	---

## List of Photographs

Photograph 1. Alereon Inc. Wireless USB Host Adapter.....	6
Photograph 2. Conducted Emissions, Test Setup.....	13
Photograph 3. Radiated Emission, Test Setup.....	16
Photograph 4. Conducted Emissions, 15.207(a), Test Setup .....	22
Photograph 5. Radiated Emissions, Test Setup .....	41

## List of Terms and Abbreviations

AC	Alternating Current
ACF	Antenna Correction Factor
Cal	Calibration
<i>d</i>	Measurement Distance
dB	Decibels
dB $\mu$ A	Decibels above one <b>microamp</b>
dB $\mu$ V	Decibels above one <b>microvolt</b>
dB $\mu$ A/m	Decibels above one <b>microamp per meter</b>
dB $\mu$ V/m	Decibels above one <b>microvolt per meter</b>
DC	Direct Current
E	Electric Field
DSL	Digital Subscriber Line
ESD	Electrostatic Discharge
EUT	Equipment Under Test
<i>f</i>	Frequency
FCC	Federal Communications Commission
GRP	Ground Reference Plane
H	Magnetic Field
HCP	Horizontal Coupling Plane
Hz	Hertz
IEC	International Electrotechnical Commission
kHz	kilohertz
kPa	kilopascal
kV	kilovolt
LISN	Line Impedance Stabilization Network
MHz	Megahertz
$\mu$ H	microhenry
$\mu$	microfarad
$\mu$ s	microseconds
NEBS	Network Equipment-Building System
PRF	Pulse Repetition Frequency
RF	Radio Frequency
RMS	Root-Mean-Square
TWT	Traveling Wave Tube
V/m	Volts per meter
VCP	Vertical Coupling Plane



# I. Executive Summary

## A. Purpose of Test

An EMC evaluation was performed to determine compliance of the Alereon Inc. Wireless USB Host Adapter, with the requirements of Part 15, §15.519. All references are to the most current version of Title 47 of the Code of Federal Regulations in effect. In accordance with §2.1033, the following data is presented in support of the Certification of the Wireless USB Host Adapter. Alereon Inc. should retain a copy of this document which should be kept on file for at least two years after the manufacturing of the Wireless USB Host Adapter, has been **permanently** discontinued.

## B. Executive Summary

The following tests were conducted on a sample of the equipment for the purpose of demonstrating compliance with Part 15, §15.247, in accordance with Alereon Inc., purchase order number 060612-2. All tests were conducted using measurement procedure ANSI C63.4-2003.

<b>FCC Reference 47 CFR Part 15.519:2008</b>	<b>Description</b>	<b>Compliance</b>
47 CFR Part 15.107 (a)	Conducted Emission Limits for a Class B Digital Device	Compliant
47 CFR Part 15.109 (a)	Radiated Emission Limits for a Class B Digital Device	Compliant
Title 47 of the CFR, Part 15 §15.203	Antenna Requirement	Compliant
Title 47 of the CFR, Part 15 §15.207(a)	Conducted Emission Limits	Compliant
Title 47 of the CFR, Part 15 §15.519(a) & §15.521(a)	Operational Limitations	Client has been advised of the requirements.
Title 47 of the CFR, Part 15 §15.519(b)	UWB Bandwidth	Compliant
Title 47 of the CFR, Part 15 §15.519(c)	Radiated Emissions	Compliant
Title 47 of the CFR, Part 15 §15.519(d)	Radiated Emissions – GPS Bands	Compliant
Title 47 of the CFR, Part 15 §15.519(e)	Peak Emissions	Compliant

**Table 1. Executive Summary of EMC Part 15.519 Compliance Testing**

## II. Equipment Configuration

## A. Overview

MET Laboratories, Inc. was contracted by Alereon Inc. to perform testing on the Wireless USB Host Adapter, under Alereon Inc.'s purchase order number 060612-2.

This document describes the test setups, test methods, required test equipment, and the test limit criteria used to perform compliance testing of the Alereon Inc., Wireless USB Host Adapter.

The results obtained relate only to the item(s) tested.

<b>Model(s) Tested:</b>	Wireless USB Host Adapter (Model#: HS6618A)	
<b>Model(s) Covered:</b>	Wireless USB Host Adapter (Model#: HS6618A)	
<b>EUT Specifications:</b>	Primary Power: Powered from USB port	
	FCC ID: U9YHS6618A	
	Type of Modulations:	OFDM
	Equipment Code:	UWB
	Peak RF Output Power:	-25.45 dBm
	EUT Frequency Ranges:	3.180-4.737 GHz, 6.347-7.907 GHz, & 7.4-8.962 GHz
<b>Analysis:</b>	The results obtained relate only to the item(s) tested.	
<b>Environmental Test Conditions:</b>	Temperature: 15-35° C	
	Relative Humidity: 30-60%	
	Barometric Pressure: 860-1060 mbar	
<b>Evaluated by:</b>	Jeff Pratt	
<b>Report Date(s):</b>	July 19, 2012	

**Table 2. EUT Summary Table**

## B. References

<b>CFR 47, Part 15, Subpart F</b>	Federal Communication Commission, Code of Federal Regulations, Title 47, Part 15: Radio Frequency Devices
<b>ANSI C63.4:2003</b>	Methods and Measurements of Radio-Noise Emissions from Low-Voltage Electrical And Electronic Equipment in the Range of 9 kHz to 40 GHz
<b>ANSI/NCSL Z540-1-1994</b>	Calibration Laboratories and Measuring and Test Equipment - General Requirements
<b>ISO/IEC 17025:2005</b>	General Requirements for the Competence of Testing and Calibration Laboratories
<b>ANSI C63.10-2009</b>	American National Standard for Testing Unlicensed Wireless Devices

**Table 3. References**

## C. Test Site

All testing was performed at MET Laboratories, Inc., 914 W. Patapsco Ave., Baltimore, MD 21230. All equipment used in making physical determinations is accurate and bears recent traceability to the National Institute of Standards and Technology.

Radiated Emissions measurements were performed in a 3 meter semi-anechoic chamber (equivalent to an Open Area Test Site). In accordance with §2.948(a)(3), a complete site description is contained at MET Laboratories.

#### **D. Description of Test Sample**

The Wireless USB Host Adapter, Equipment Under Test (EUT), is a UWB radio link Host Adapter which connects directly to the host PC via a standard USB 2.0 port. The host adapter works in conjunction with a UWB device side unit to link the device side functionality to the host PC via a UWB radio link. This is also referred to as “Wireless USB”. Typical device-side unit could be: a wireless desktop monitor, a wireless mass-storage device, a wireless HDMI video extender.



**Photograph 1. Alereon Inc. Wireless USB Host Adapter**

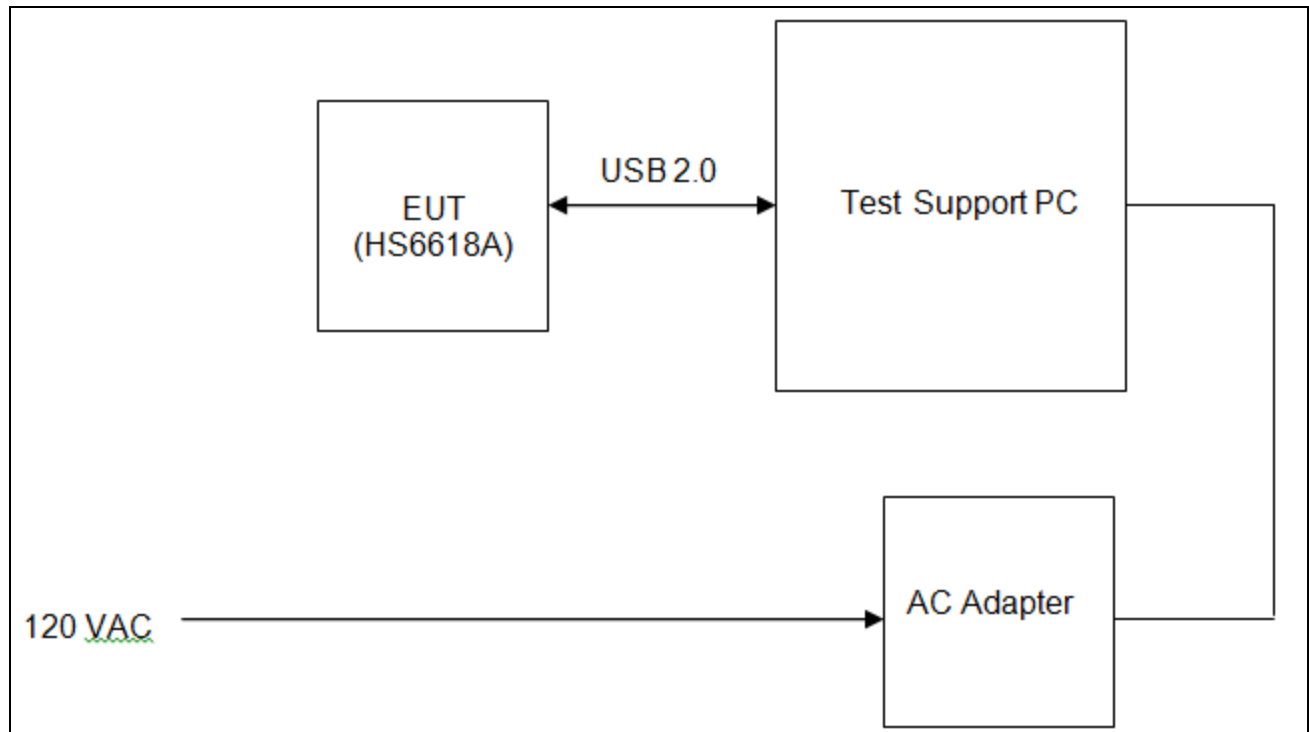

Figure 1. Block Diagram of Test Configuration

## E. Equipment Configuration

The EUT was set up as outlined in Figure 1, Block Diagram of Test Setup. All cards, racks, etc., incorporated as part of the EUT is included in the following list.

Name / Description	Model Number	Serial Number
Host Adapter Specimen	HS6618A	NSN

**Table 4. Equipment Configuration**

## F. Support Equipment

Support equipment necessary for the operation and testing of the EUT is included in the following list.

Name / Description	Manufacturer	Model Number
IBM T60 PC	Lenovo	T60

**Table 5. Support Equipment**

## G. Mode of Operation

The EUT connects directly to the test support PC. The test support PC runs Alereon testing software called the Regulatory RET tool. The software tool facilitates regulatory testing by:

1. Enabling continuous transmitter operation as required by the regulatory rule.
2. Permits selecting the operating frequency band, time frequency channel code and data rate so that variation of these parameters may be explored for compliance.

There is a single mode of operation: Transmit.

## H. Modifications

### a) Modifications to EUT

No modifications were made to the EUT.

### b) Modifications to Test Standard

No modifications were made to the test standard.

## I. Disposition of EUT

The test sample including all support equipment submitted to the Electro-Magnetic Compatibility Lab for testing was returned to Alereon Inc. upon completion of testing.



### **III. Electromagnetic Compatibility Criteria for Unintentional Radiators**

## Electromagnetic Compatibility Criteria

### § 15.107 Conducted Emissions Limits

**Test Requirement(s):** **15.107 (a)** Except for Class A digital devices, for equipment that is designed to be connected to the public utility (AC) power line, the radio frequency voltage that is conducted back onto the AC power line on any frequency or frequencies within the band 150 kHz to 30 MHz shall not exceed the limits in Table 6. Compliance with this provision shall be based on the measurement of the radio frequency voltage between each power line and ground at the power terminals.

**15.107 (b)** For a Class A digital device that is designed to be connected to the public utility (AC) power line, the radio frequency voltage that is conducted back onto the AC power line on any frequency or frequencies within the band 150 kHz to 30 MHz shall not exceed the limits in Table 6. Compliance with this provision shall be based on the measurement of the radio frequency voltage between each power line and ground at the power terminals. The lower limit applies at the band edges.

Frequency range (MHz)	Class A Conducted Limits (dB $\mu$ V)		*Class B Conducted Limits (dB $\mu$ V)	
	Quasi-Peak	Average	Quasi-Peak	Average
* 0.15- 0.45	79	66	66 - 56	56 - 46
0.45 - 0.5	79	66	56	46
0.5 - 30	73	60	60	50
Note 1 — The lower limit shall apply at the transition frequencies.				
Note 2 — The limit decreases linearly with the logarithm if the frequency in the range 0.15 MHz to 0.5 MHz.				

**Table 6. Conducted Limits for Radio Frequency Devices calculated from FCC Part 15 Subsections 15.107(a) (b)**

**Test Procedures:** The EUT was placed on a non-metallic table, 80 cm above the ground plane inside a semi-anechoic chamber. The method of testing, test conditions, and test procedures of ANSI C63.4 were used. The EUT was powered through a 50 $\Omega$ /50 $\mu$ H LISN. An EMI receiver, connected to the measurement port of the LISN, scanned the frequency range from 150 kHz to 30 MHz in order to find the peak conducted emissions. All peak emissions within 6 dB of the limit were re-measured using a quasi-peak and/or average detector as appropriate.

**Test Results:** The EUT was compliant with the Class B requirement(s) of this section.

**Test Engineer(s):** Jeff Pratt

**Test Date(s):** 06/27/12

**Conducted Emissions - Voltage, AC Power, Phase Line (120 VAC, 60 Hz)**

Frequency (MHz)	Uncorrected Meter Reading (dBuV) QP	Cable Loss (dB)	Corrected Measurement (dBuV) QP	Limit (dBuV) QP	Margin (dB) QP	Uncorrected Meter Reading (dBuV) Avg.	Cable Loss (dB)	Corrected Measurement (dBuV) AVG	Limit (dBuV) AVG	Margin (dB) AVG
0.165	41.28	0	41.28	65.21	-23.93	33.33	0	33.33	55.21	-21.88
0.214	34.56	0.02	34.58	63.05	-28.47	32.88	0.02	32.9	53.05	-20.15
0.273	40.58	0.05	40.63	61.03	-20.4	28.52	0.05	28.57	51.03	-22.46
0.68	37.74	0.04	37.78	56	-18.22	32.72	0.04	32.76	46	-13.24
0.838	33.9	0.05	33.95	56	-22.05	31.27	0.05	31.32	46	-14.68
15.97	36.42	0.47	36.89	60	-23.11	31.43	0.47	31.9	50	-18.1

**Table 7. Conducted Emissions - Voltage, AC Power, Phase Line (120 VAC, 60 Hz)**

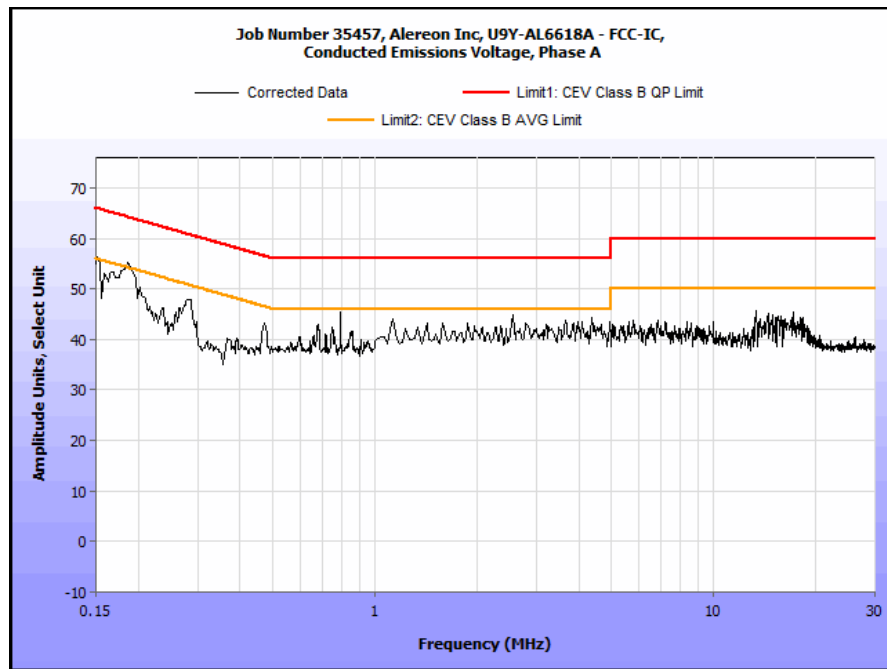

**Plot 1. Conducted Emission, Phase Line Plot**

**Conducted Emissions - Voltage, AC Power, Neutral Line (120 VAC, 60 Hz)**

Frequency (MHz)	Uncorrected Meter Reading (dBuV) QP	Cable Loss (dB)	Corrected Measurement (dBuV) QP	Limit (dBuV) QP	Margin (dB) QP	Uncorrected Meter Reading (dBuV) Avg.	Cable Loss (dB)	Corrected Measurement (dBuV) AVG	Limit (dBuV) AVG	Margin (dB) AVG
0.187	43.91	0	43.91	64.17	-20.26	28.82	0	28.82	54.17	-25.35
0.202	37.48	0.01	37.49	63.53	-26.04	25.54	0.01	25.55	53.53	-27.98
0.467	32.77	0.03	32.8	56.57	-23.77	29.22	0.03	29.25	46.57	-17.32
0.68	38.47	0.04	38.51	56	-17.49	34.33	0.04	34.37	46	-11.63
2.495	32.3	0.17	32.47	56	-23.53	29.03	0.17	29.2	46	-16.8
13.13	36.93	0.44	37.37	60	-22.63	32.99	0.44	33.43	50	-16.57

**Table 8. Conducted Emissions - Voltage, AC Power, Neutral Line (120 VAC, 60 Hz)**

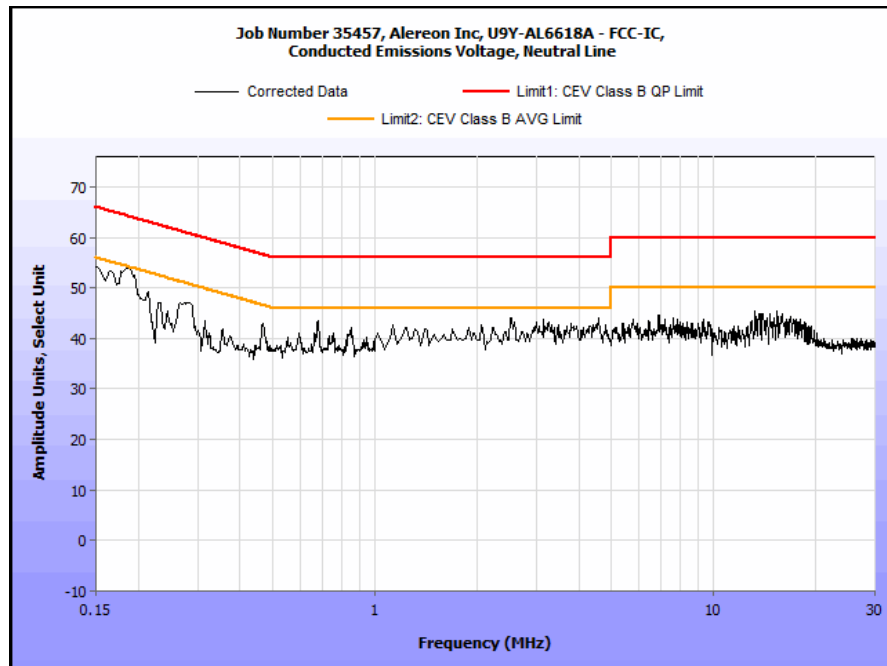

**Plot 2. Conducted Emission, Neutral Line Plot**

## Conducted Emission Limits Test Setup



Photograph 2. Conducted Emissions, Test Setup

## Radiated Emission Limits

### § 15.109 Radiated Emissions Limits

**Test Requirement(s):** **15.109 (a)** Except for Class A digital devices, the field strength of radiated emissions from unintentional radiators at a distance of 3 meters shall not exceed the Class B limits expressed in Table 9.

**15.109 (b)** The field strength of radiated emissions from a Class A digital device, as determined at a distance of 10 meters, shall not exceed the Class A limits expressed in Table 9.

Frequency (MHz)	Field Strength (dB $\mu$ V/m)	
	§15.109 (b), Class A Limit (dB $\mu$ V) @ 10m	§15.109 (a), Class B Limit (dB $\mu$ V) @ 3m
30 - 88	39.00	40.00
88 - 216	43.50	43.50
216 - 960	46.40	46.00
Above 960	49.50	54.00

**Table 9. Radiated Emissions Limits calculated from FCC Part 15, §15.109 (a) (b)**

**Test Procedures:** The EUT was placed on a non-metallic table, 80 cm above the ground plane inside a semi-anechoic chamber. The method of testing and test conditions of ANSI C63.4 were used. An antenna was located 3 m from the EUT on an adjustable mast. A pre-scan was first performed in order to find prominent radiated emissions. For final emissions measurements at each frequency of interest, the EUT was rotated and the antenna height was varied between 1 m and 4 m in order to maximize the emission. Measurements in both horizontal and vertical polarities were made and the data was recorded. Unless otherwise specified, measurements were made using a quasi-peak detector with a 120 kHz bandwidth.

**Test Results:** The EUT was compliant with the Class B requirement(s) of this section.

**Test Engineer(s):** Jeff Pratt

**Test Date(s):** 06/21/12

### Radiated Emissions Limits Test Results, Class B

Frequency (MHz)	EUT Azimuth (Degrees)	Antenna Polarity (H/V)	Antenna HEIGHT (m)	Uncorrected Amplitude (dBuV)	Antenna Correction Factor (dB) (+)	Cable Loss (dB) (+)	Distance Correction Factor (dB) (-)	Corrected Amplitude (dBuV/m)	Limit (dBuV/m)	Margin (dB)
129.43788	361	H	1.01	5.57	13.81	0.91	0.00	20.29	43.50	-23.21
129.43788	-1	V	1.01	8.57	13.81	0.91	0.00	23.29	43.50	-20.21
239.98221	78	H	1.02	16.37	12.20	1.16	0.00	29.73	46.00	-16.27
239.98221	14	V	1.02	15.04	12.20	1.16	0.00	28.40	46.00	-17.60
258.86623	305	H	1.02	15.29	12.66	1.31	0.00	29.26	46.00	-16.74
258.86623	361	V	1.02	9.04	12.66	1.31	0.00	23.01	46.00	-22.99
453.04499	80	H	1.87	14.67	17.26	1.75	0.00	33.68	46.00	-12.32
453.04499	29	V	1.02	16.77	17.26	1.75	0.00	35.78	46.00	-10.22

Table 10. Radiated Emissions Limits, Test Results, 30 MHz – 1 GHz, FCC Limits

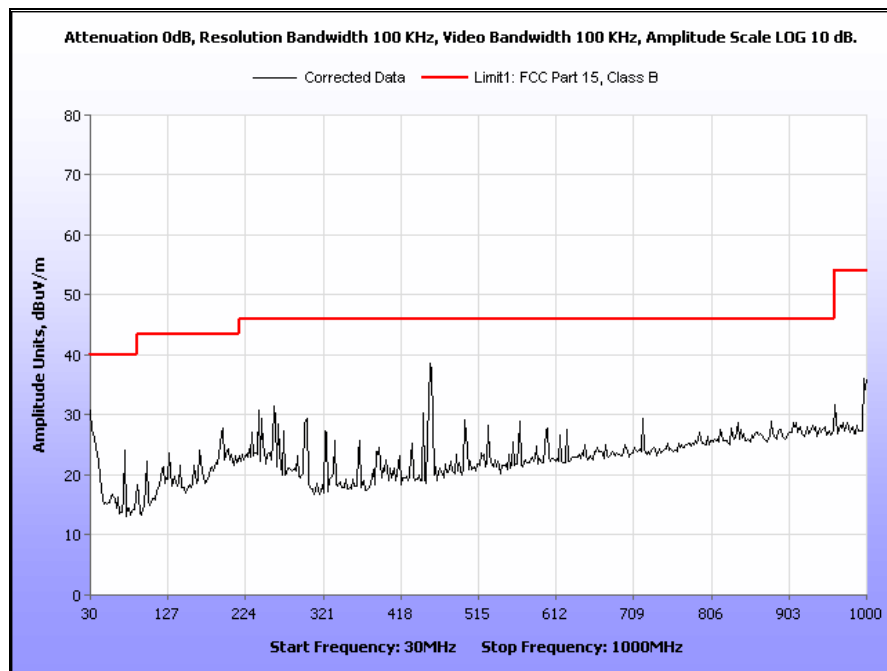

Plot 3. Radiated Emissions, 30 MHz - 1 GHz, FCC Limits

## Radiated Emission Limits Test Setup



Photograph 3. Radiated Emission, Test Setup



## **IV. Electromagnetic Compatibility Criteria for Intentional Radiators**

## Electromagnetic Compatibility Criteria for Intentional Radiators

### § 15.203 Antenna Requirement

**Test Requirement:** § 15.203: An intentional radiator shall be designed to ensure that no antenna other than that furnished by the responsible party shall be used with the device. The use of a permanently attached antenna or of an antenna that uses a unique coupling to the intentional radiator shall be considered sufficient to comply with the provisions of this section. The manufacturer may design the unit so that a broken antenna can be replaced by the user, but the use of a standard antenna jack or electrical connector is prohibited.

The structure and application of the EUT were analyzed to determine compliance with Section 15.203 of the Rules. Section 15.203 states that the subject device must meet at least one of the following criteria:

- a.) Antenna must be permanently attached to the unit.
- b.) Antenna must use a unique type of connector to attach to the EUT.
- c.) Unit must be professionally installed. Installer shall be responsible for verifying that the correct antenna is employed with the unit.

**Results:** The EUT as tested is compliant the criteria of §15.203. The EUT has an integral antenna.

**Test Engineer(s):** Jeff Pratt

**Test Date(s):** 06/26/12

Gain	Type	Part No.	Manufacturer
2.9 dBi	Microstrip Patch	BWT-UWBH-002	BlueWaveTel

**Table 11. Antenna List**

## Electromagnetic Compatibility Criteria for Intentional Radiators

### § 15.207(a) Conducted Emissions Limits

**Test Requirement(s):** § 15.207 (a): For an intentional radiator that is designed to be connected to the public utility (AC) power line, the radio frequency voltage that is conducted back onto the AC power line on any frequency or frequencies, within the band 150 kHz to 30MHz, shall not exceed the limits in the following table, as measured using a 50  $\mu$ H/50  $\Omega$  line impedance stabilization network (LISN). Compliance with the provisions of this paragraph shall be based on the measurement of the radio frequency voltage between each power line and ground at the power terminal. The lower limit applies at the boundary between the frequency ranges.

Frequency range (MHz)	§ 15.207(a), Conducted Limit (dB $\mu$ V)	
	Quasi-Peak	Average
* 0.15- 0.45	66 - 56	56 - 46
0.45 - 0.5	56	46
0.5 - 30	60	50

**Table 12. Conducted Limits for Intentional Radiators from FCC Part 15 § 15.207(a)**

**Test Procedure:** The EUT was placed on a 0.8 m-high wooden table inside a screen room. The EUT was situated such that the back of the EUT was 0.4 m from one wall of the vertical ground plane, and the remaining sides of the EUT were no closer than 0.8 m from any other conductive surface. The EUT was powered from a 50  $\Omega$ /50  $\mu$ H Line Impedance Stabilization Network (LISN). The EMC receiver scanned the frequency range from 150 kHz to 30 MHz. Conducted Emissions measurements were made in accordance with ANSI C63.4-2003 "Methods and Measurements of Radio-Noise Emissions from Low-Voltage Electrical and Electronic Equipment in the Range of 9kHz to 40 GHz". The measurements were performed over the frequency range of 0.15 MHz to 30 MHz using a 50  $\Omega$ /50  $\mu$ H LISN as the input transducer to an EMC/field intensity meter. For the purpose of this testing, the transmitter was turned on. Scans were performed with the transmitter on.

**Test Results:** The EUT was compliant with this requirement. Measured emissions were below applicable limits.

**Test Engineer(s):** Jeff Pratt

**Test Date(s):** 06/27/12

### 15.207(a) Conducted Emissions Test Results

Frequency (MHz)	Uncorrected Meter Reading (dBuV) QP	Cable Loss (dB)	Corrected Measurement (dBuV) QP	Limit (dBuV) QP	Margin (dB) QP	Uncorrected Meter Reading (dBuV) Avg.	Cable Loss (dB)	Corrected Measurement (dBuV) AVG	Limit (dBuV) AVG	Margin (dB) AVG
0.165	41.28	0	41.28	65.21	-23.93	33.33	0	33.33	55.21	-21.88
0.214	34.56	0.02	34.58	63.05	-28.47	32.88	0.02	32.9	53.05	-20.15
0.273	40.58	0.05	40.63	61.03	-20.4	28.52	0.05	28.57	51.03	-22.46
0.68	37.74	0.04	37.78	56	-18.22	32.72	0.04	32.76	46	-13.24
0.838	33.9	0.05	33.95	56	-22.05	31.27	0.05	31.32	46	-14.68
15.97	36.42	0.47	36.89	60	-23.11	31.43	0.47	31.9	50	-18.1

Table 13. Conducted Emissions, 15.207(a), Phase Line, Test Results

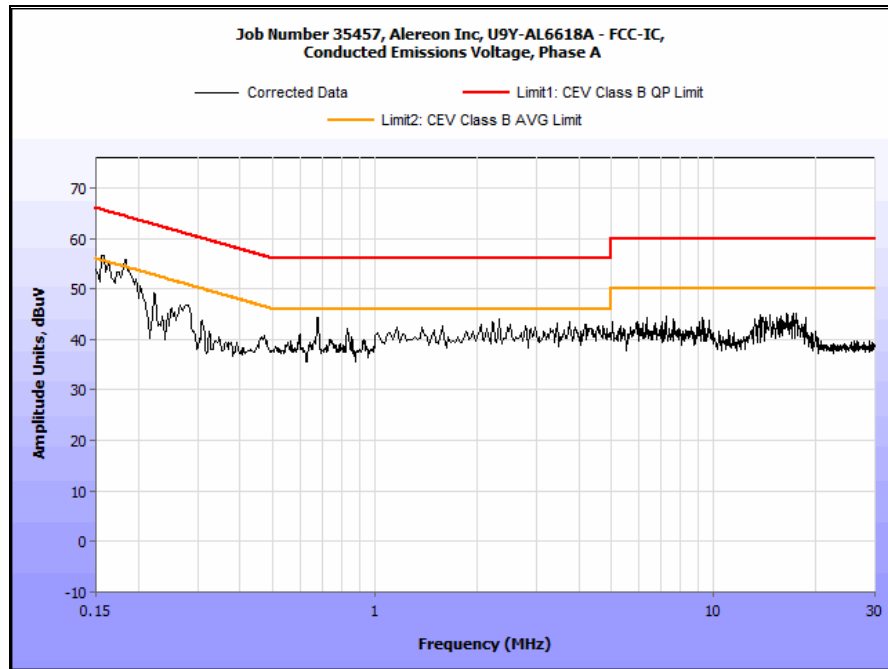

Plot 4. Conducted Emissions, 15.207(a), Phase Line

### 15.207(a) Conducted Emissions Test Results

Frequency (MHz)	Uncorrected Meter Reading (dBuV) QP	Cable Loss (dB)	Corrected Measurement (dBuV) QP	Limit (dBuV) QP	Margin (dB) QP	Uncorrected Meter Reading (dBuV) Avg.	Cable Loss (dB)	Corrected Measurement (dBuV) AVG	Limit (dBuV) AVG	Margin (dB) AVG
0.187	43.91	0	43.91	64.17	-20.26	28.82	0	28.82	54.17	-25.35
0.202	37.48	0.01	37.49	63.53	-26.04	25.54	0.01	25.55	53.53	-27.98
0.467	32.77	0.03	32.8	56.57	-23.77	29.22	0.03	29.25	46.57	-17.32
0.68	38.47	0.04	38.51	56	-17.49	34.33	0.04	34.37	46	-11.63
2.495	32.3	0.17	32.47	56	-23.53	29.03	0.17	29.2	46	-16.8
13.13	36.93	0.44	37.37	60	-22.63	32.99	0.44	33.43	50	-16.57

Table 14. Conducted Emissions, 15.207(a), Neutral Line, Test Results

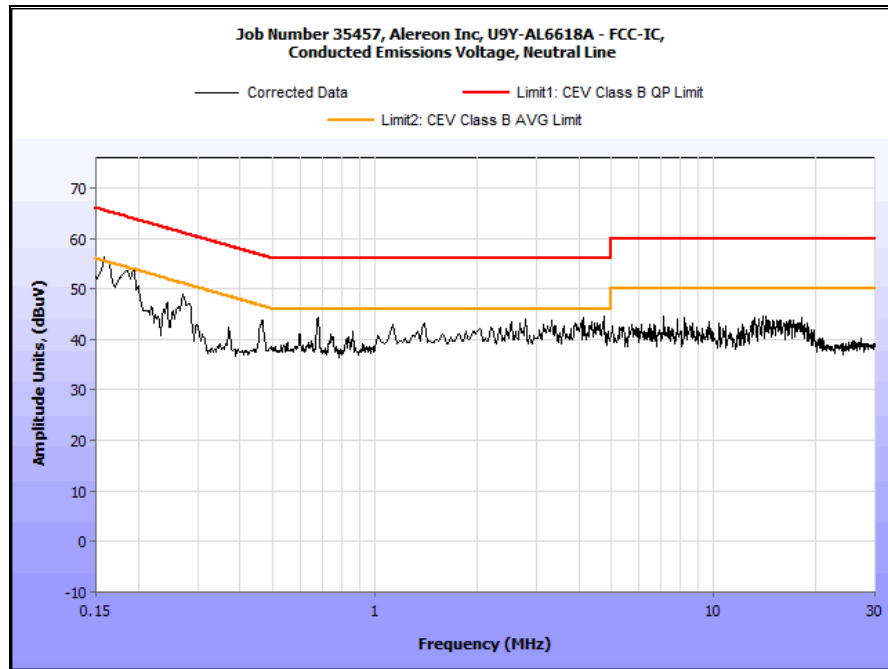

Plot 5. Conducted Emissions, 15.207(a), Neutral Line

**15.207(a) Conducted Emissions Test Setup Photo**



**Photograph 4. Conducted Emissions, 15.207(a), Test Setup**

## Electromagnetic Compatibility Criteria for Intentional Radiators

### § 15.519(a) Operational Limitations

**Test Requirements:** § 15.519(a): UWB devices operating under the provisions of this section must be hand held, i.e., they are relatively small devices that are primarily hand held while being operated and do not employ a fixed infrastructure.

- (1) A UWB device operating under the provisions of this section shall transmit only when it is sending information to an associated receiver. The UWB intentional radiator shall cease transmission within 10 seconds unless it receives an acknowledgement from the associated receiver that its transmission is being received. An acknowledgment of reception must continue to be received by the UWB intentional radiator at least every 10 seconds or the UWB device must cease transmitting.
- (2) The use of antennas mounted on outdoor structures, e.g., antennas mounted on the outside of a building or on a telephone pole, or any fixed outdoors infrastructure is prohibited. Antennas may be mounted only on the hand held UWB device.
- (3) UWB devices operating under the provisions of this section may operate indoors or outdoors.

§ 15.521(a): UWB devices may not be employed for the operation of toys. Operation onboard an aircraft, a ship or a satellite is prohibited.

**Test Procedure:** N/A

**Test Results** The EUT was compliant with § 15.519 (a). Client has been advised of these requirements.

**Test Engineer(s):** Jeff Pratt

**Test Date(s):** 06/21/12

## Electromagnetic Compatibility Criteria for Intentional Radiators

### § 15.519(b) UWB Bandwidth

**Test Requirements:** § 15.519(b): The UWB bandwidth of a device operating under the provisions of this section must be contained between 3100 MHz and 10,600 MHz.

**Test Procedure:** A horn antenna was placed 1m away from the EUT. A preamp was used for making measurements. The antenna correction factors, cable loss and preamp factors were programmed into spectrum analyzer.

**Test Results** The EUT was compliant with § 15.519 (b).

**Test Engineer(s):** Jeff Pratt

**Test Date(s):** 06/26/12

Mode	F <sub>m</sub>	F <sub>l</sub>	F <sub>h</sub>	10 dB Bandwidth (F <sub>h</sub> - F <sub>l</sub> )
BG1	3.793 GHz	3.180 GHz	4.737 GHz	1.557 GHz
BG3	6.937 GHz	6.347 GHz	7.907 GHz	1.560 GHz
BG6	7.821 GHz	7.400 GHz	8.962 GHz	1.562 GHz



## UWB Bandwidth Test Results

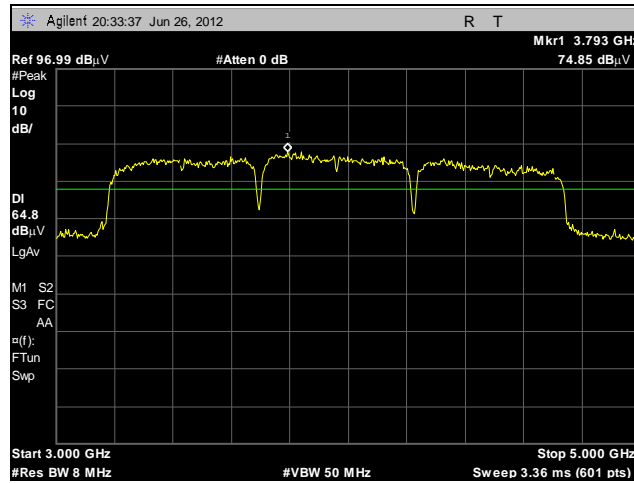

Plot 6. UWB Bandwidth,  $F_m$ , BG1

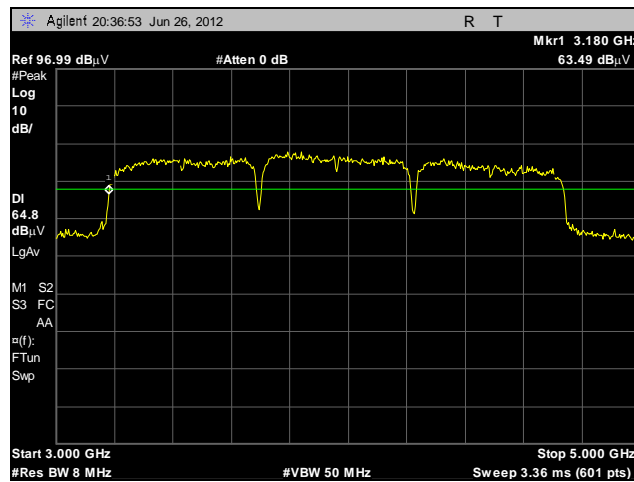

Plot 7. UWB Bandwidth,  $F_i$ , BG1

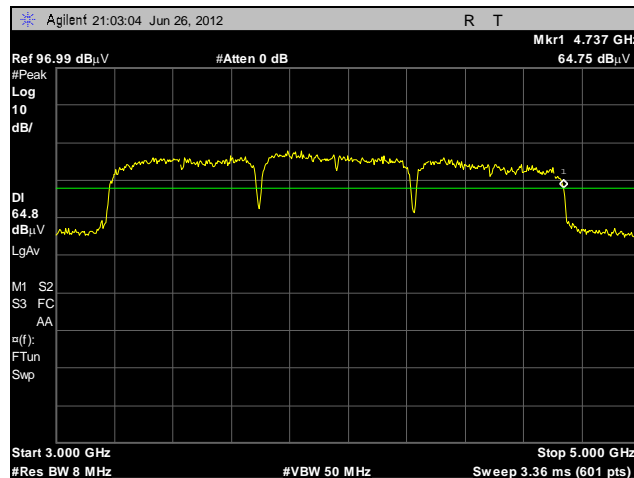

Plot 8. UWB Bandwidth,  $F_h$ , BG1

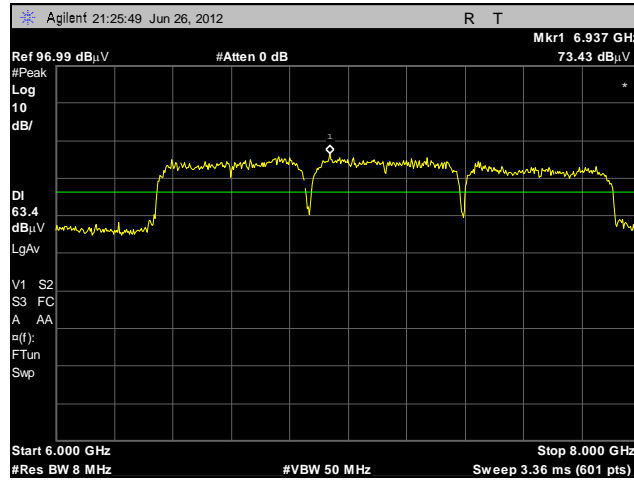

Plot 9. UWB Bandwidth,  $F_m$ , BG3

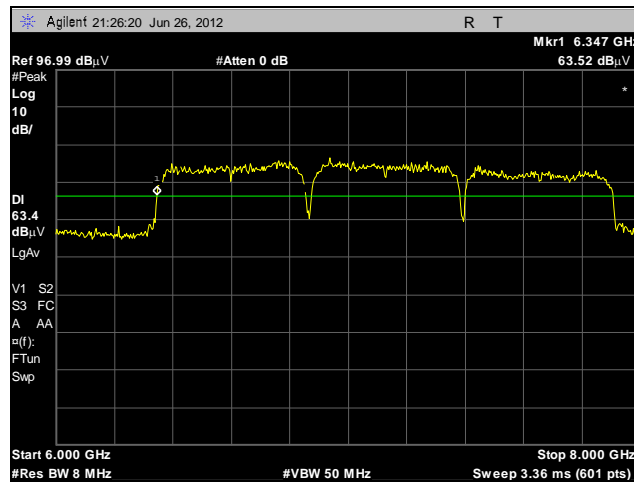

Plot 10. UWB Bandwidth,  $F_l$ , BG3

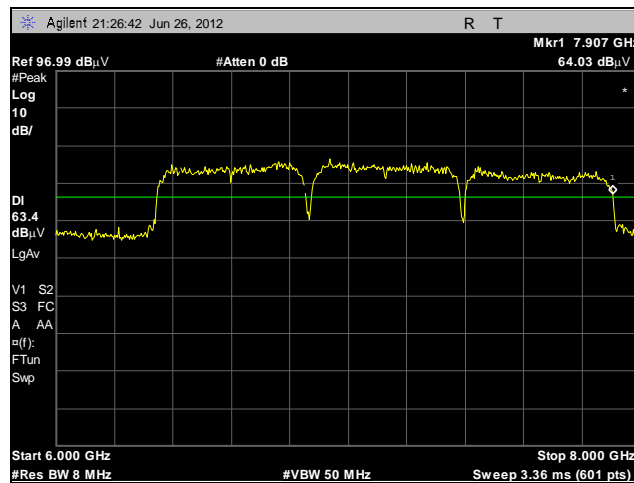

Plot 11. UWB Bandwidth,  $F_h$ , BG3

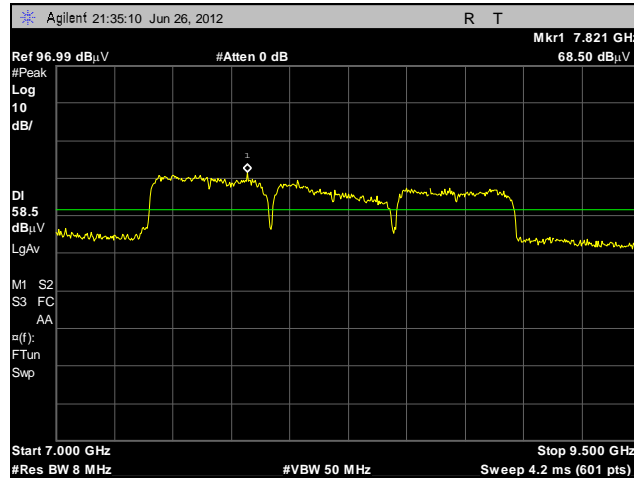

Plot 12. UWB Bandwidth,  $F_m$ , BG6

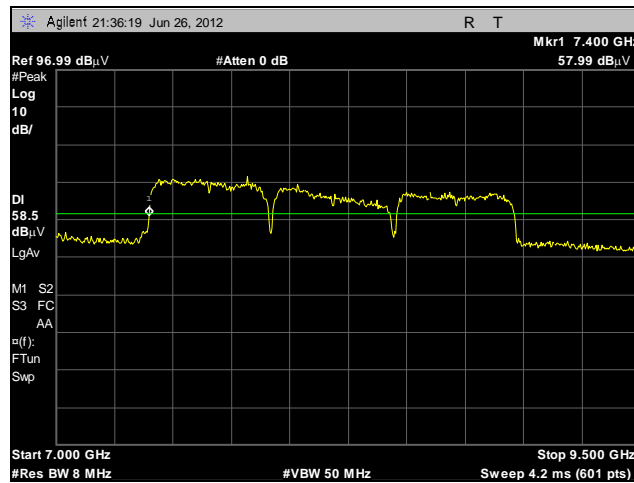

Plot 13. UWB Bandwidth,  $F_l$ , BG6

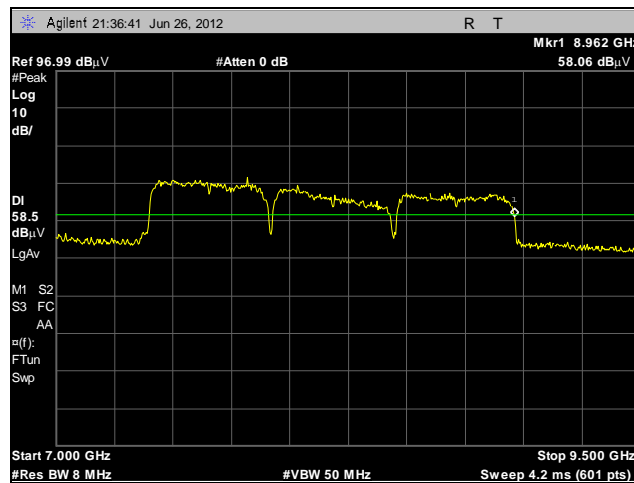

Plot 14. UWB Bandwidth,  $F_h$ , BG6

## Electromagnetic Compatibility Criteria for Intentional Radiators

### § 15.519(c) Radiated Emissions

**Test Requirements:** §15.519(c): The radiated emissions at or below 960 MHz from a device operating under the provisions of this section shall not exceed the emission levels in §15.209. The radiated emissions above 960 MHz from a device operating under the provisions of this section shall not exceed the following average limits when measured using a resolution bandwidth of 1 MHz:

Frequency in MHz	EIRP in dBm
960 – 1610	-75.3
1610 – 1990	-63.3
1990 -3100	-61.3
3100 – 10600	-41.3
Above 10600	-61.3

**Test Procedure:** A preamp was used for making measurements. Antenna correction factors, cable loss and Preamp factors were programmed in to spectrum analyzer. The following formula was used for Converting a field strength to EIRP based on the measurement distance

$$\text{EIRP (dBm)} = \text{Field Strength (dBuV/m)} + 20\log(D) - 104.77$$

To satisfy noise floor requirements, the following measurement distances were used:

30-960 MHz -> 3 m  
 960-1000 MHz -> 0.4 m  
 1-10.6 GHz -> 0.5 m  
 10.6-40 GHz -> 0.25 m

**Test Results:** The EUT was compliant with the Radiated Spurious Emission limits of § 15.519(c).

**Test Engineer(s):** Jeff Pratt

**Test Date(s):** 07/05/12

Mode	Field strength of fundamental (Avg)
BG1	55.46 dBuV/m
BG3	57.81 dBuV/m
BG6	58.99 dBuV/m

## Radiated Emissions Test Results, BG1

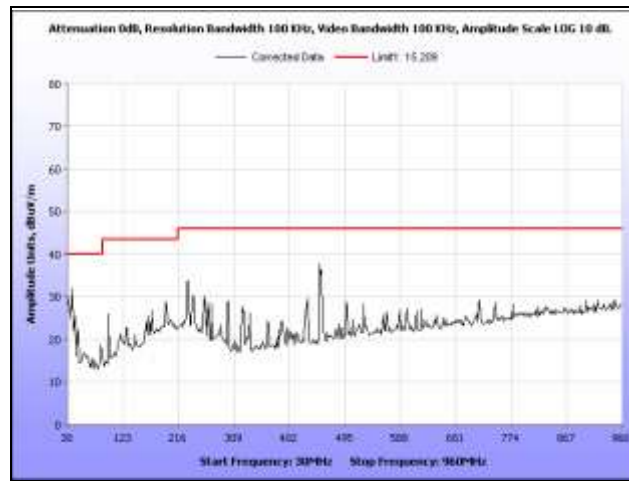

Plot 15. Radiated Emissions, 30 MHz – 960 GHz, BG1

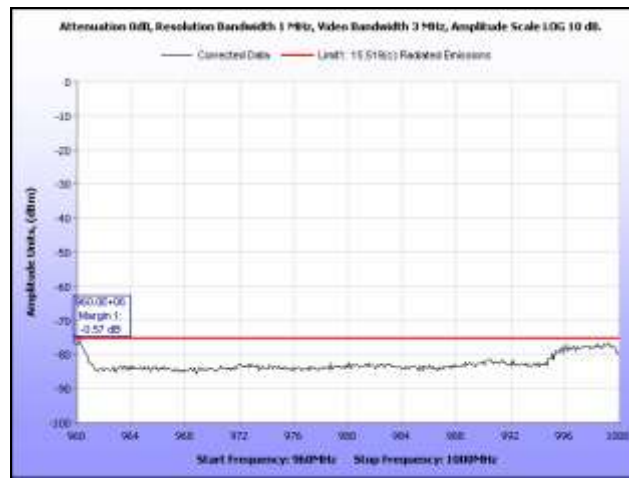

Plot 16. Radiated Emissions, 960 MHz – 1 GHz, BG1

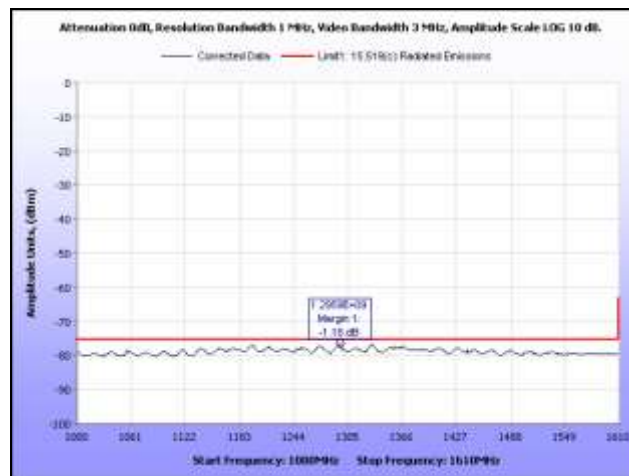

Plot 17. Radiated Emissions, 1 GHz – 1.61 GHz, BG1

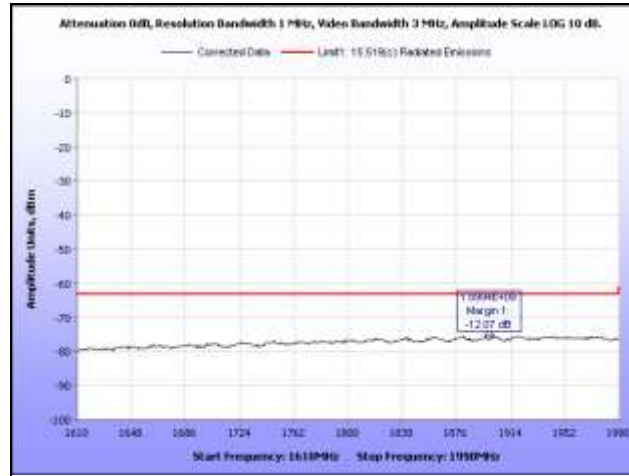

Plot 18. Radiated Emissions, 1.61 GHz – 1.99 GHz, BG1



Plot 19. Radiated Emissions, 1.99 GHz – 3.1 GHz, BG1

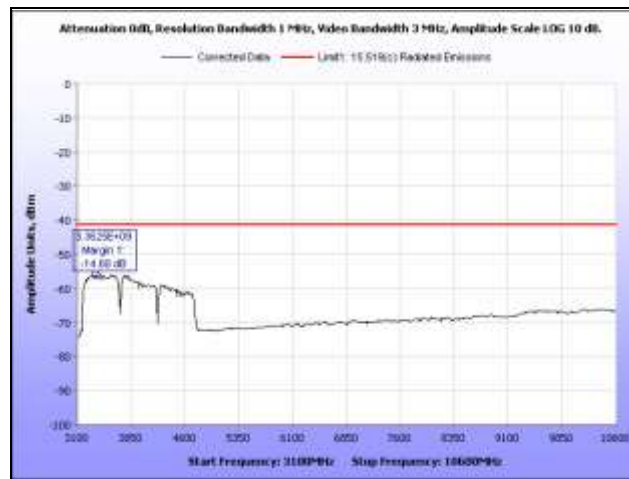

Plot 20. Radiated Emissions, 3.1 GHz – 10.6 GHz, BG1

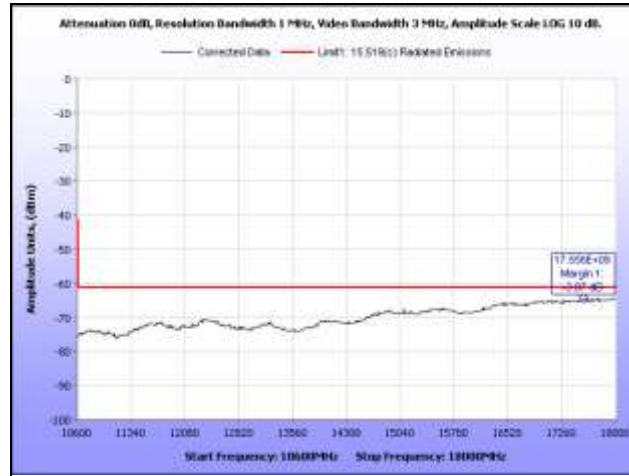

**Plot 21. Radiated Emissions, 10.6 GHz – 18 GHz, BG1**



**Plot 22. Radiated Emissions, 18 GHz – 40 GHz, BG1**

### Radiated Emissions Test Results, BG3

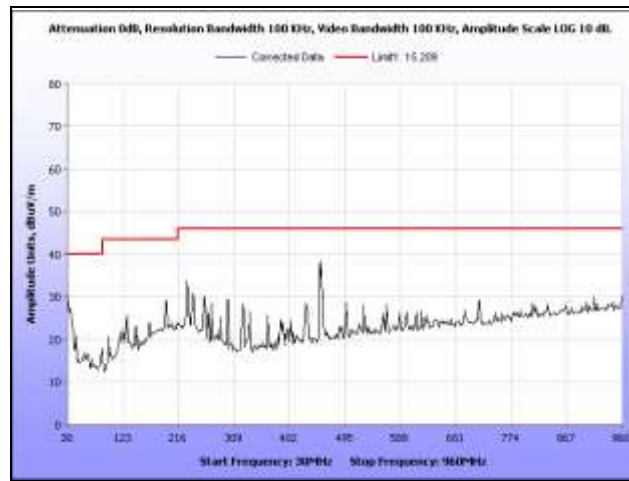

Plot 23. Radiated Emissions, 30 MHz – 960 GHz, BG3

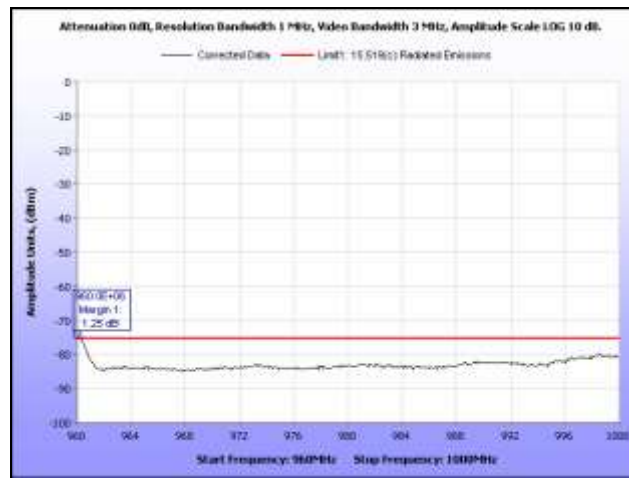

Plot 24. Radiated Emissions, 960 MHz – 1 GHz, BG3

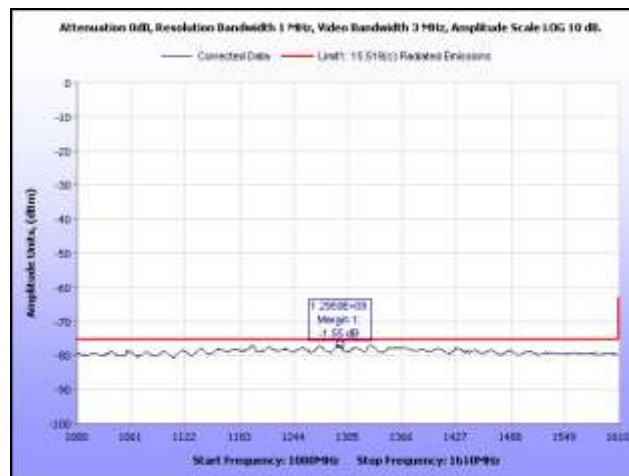

Plot 25. Radiated Emissions, 1 GHz – 1.61 GHz, BG3



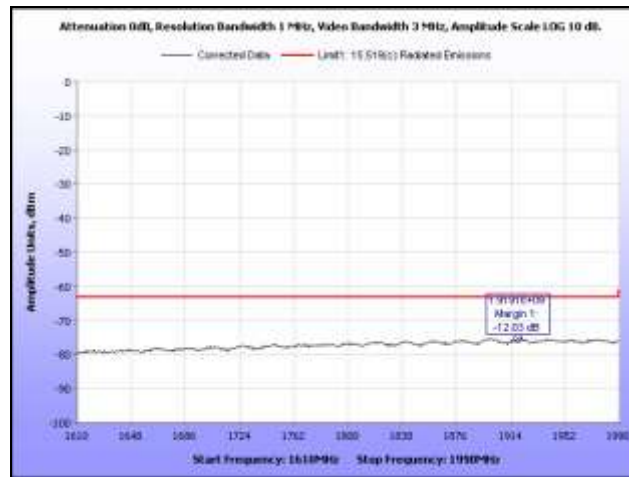

Plot 26. Radiated Emissions, 1.61 GHz – 1.99 GHz, BG3

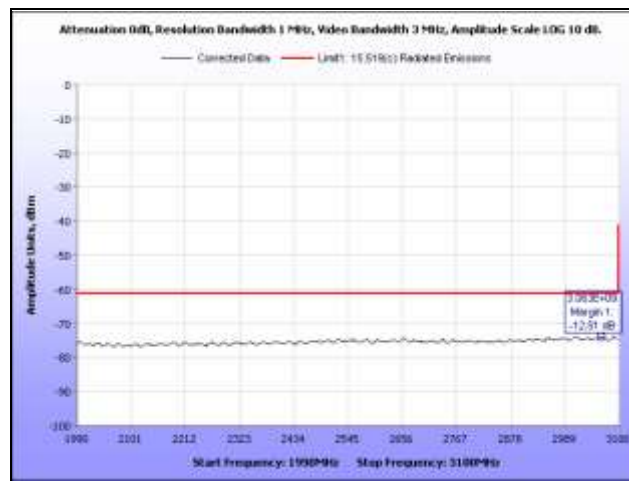

Plot 27. Radiated Emissions, 1.99 GHz – 3.1 GHz, BG3

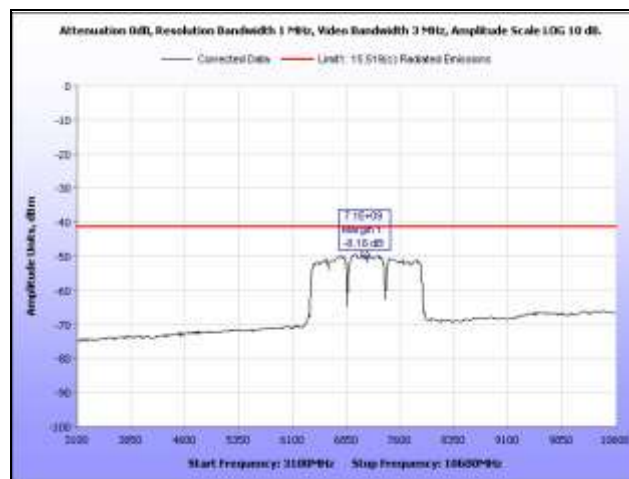

Plot 28. Radiated Emissions, 3.1 GHz – 10.6 GHz, BG3

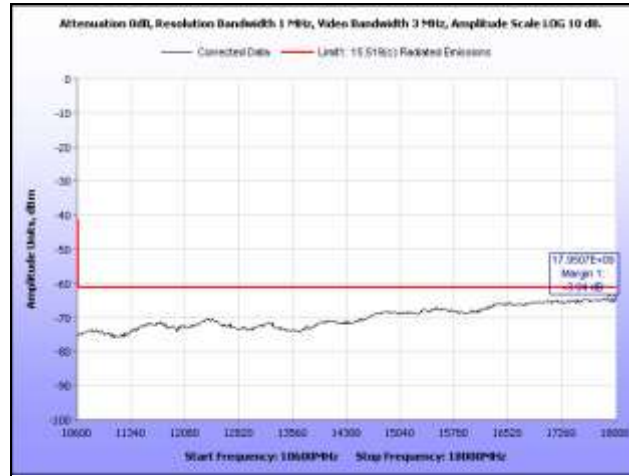

**Plot 29. Radiated Emissions, 10.6 GHz – 18 GHz, BG3**



**Plot 30. Radiated Emissions, 18 GHz – 40 GHz, BG3**

### Radiated Emissions Test Results, BG6

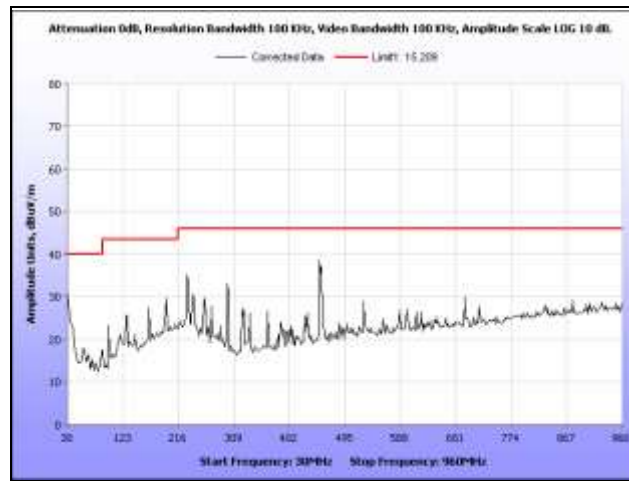

Plot 31. Radiated Emissions, 30 MHz – 960 GHz, BG6

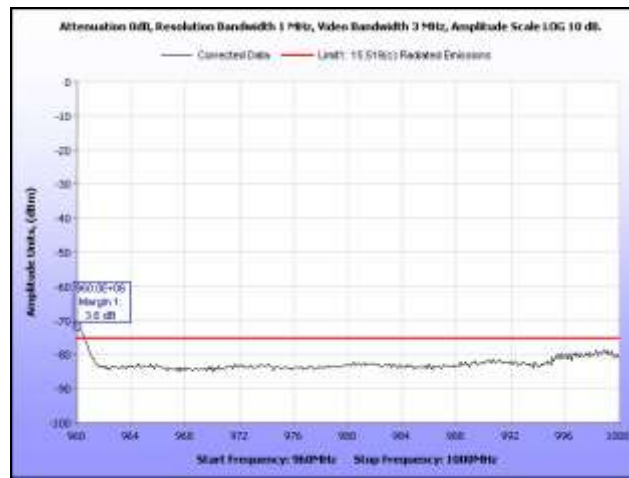

Plot 32. Radiated Emissions, 960 MHz – 1 GHz, BG6

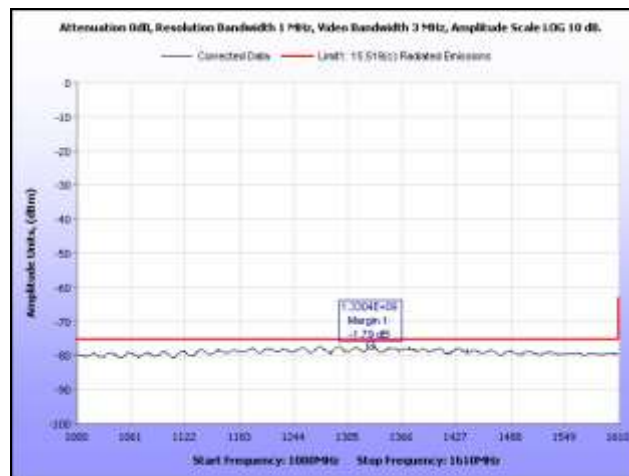

Plot 33. Radiated Emissions, 1 GHz – 1.61 GHz, BG6

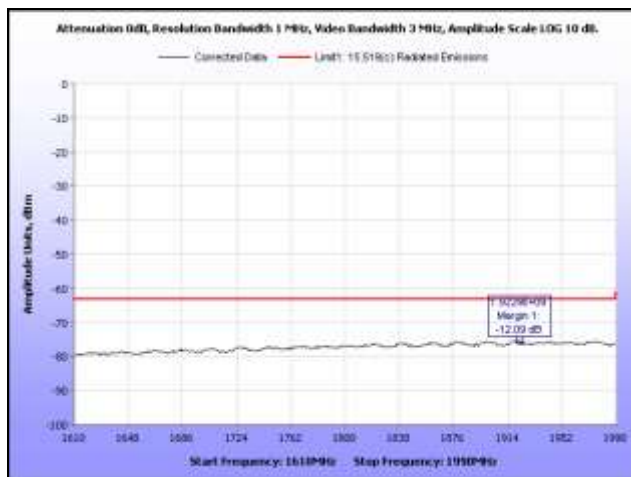

Plot 34. Radiated Emissions, 1.61 GHz – 1.99 GHz, BG6



Plot 35. Radiated Emissions, 1.99 GHz – 3.1 GHz, BG6



Plot 36. Radiated Emissions, 3.1 GHz – 10.6 GHz, BG6

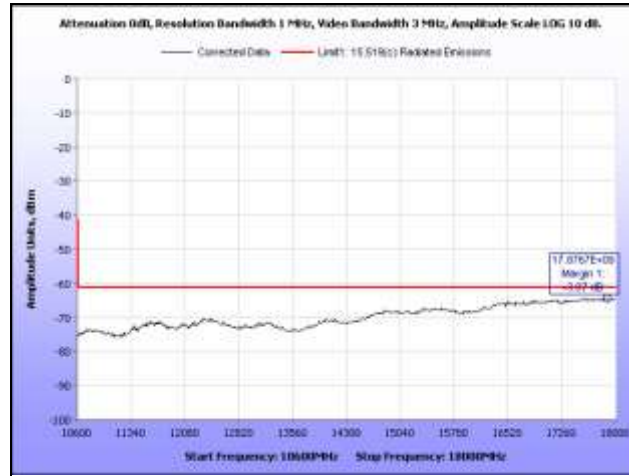

**Plot 37. Radiated Emissions, 10.6 GHz – 18 GHz, BG6**



**Plot 38. Radiated Emissions, 18 GHz – 40 GHz, BG6**

## Electromagnetic Compatibility Criteria for Intentional Radiators

### § 15.519(d) Radiated Emissions – GPS Bands

**Test Requirements:** §15.519(d): In addition to the radiated emission limits specified in the table in paragraph (c) of this section, UWB transmitters operating under the provisions of this section shall not exceed the following average limits when measured using a resolution bandwidth of no less than 1 kHz:

Frequency in MHz	EIRP in dBm
1164 – 1240	-85.3
1559 – 1610	-85.3

**Test Procedure:** A preamp was used for making measurements. Antenna correction factors, cable loss and Preamp factors were programmed in to spectrum analyzer. The following formula was used for converting a field strength to EIRP based on the measurement distance:

$$\text{EIRP (dBm)} = \text{Field Strength (dBuV/m)} + 20\log(D) - 104.77$$

The measurement distance was 0.4 m.

**Test Results:** The EUT was compliant with the Radiated Spurious Emission limits of § 15.519(d).

**Test Engineer(s):** Jeff Pratt

**Test Date(s):** 06/26/12

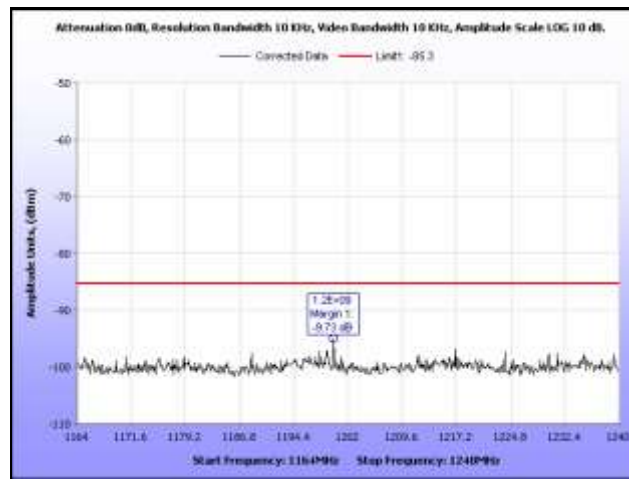

Plot 39. Radiated Emissions, 1.164 GHz – 1.24 GHz, GPS Band, BG1

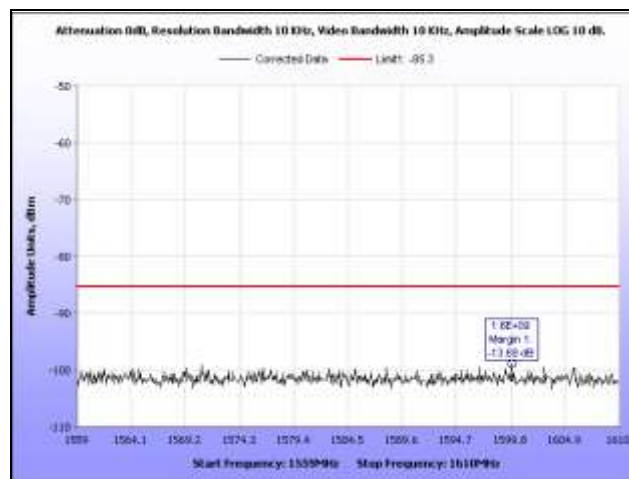

Plot 40. Radiated Emissions, 1.559 GHz – 1.61 GHz, GPS Band, BG1

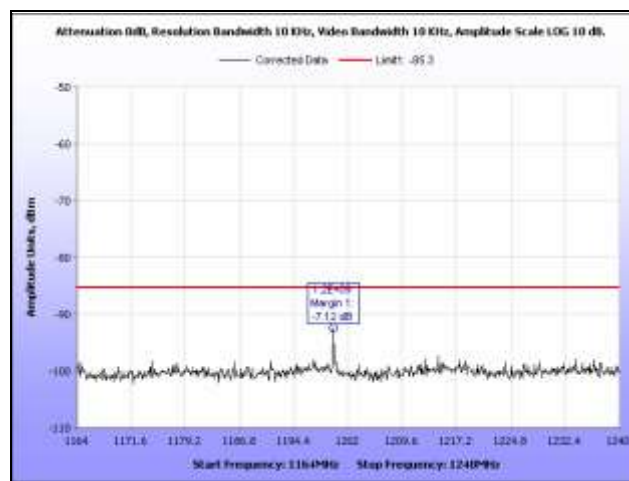

Plot 41. Radiated Emissions, 1.164 GHz – 1.24 GHz, GPS Band, BG3

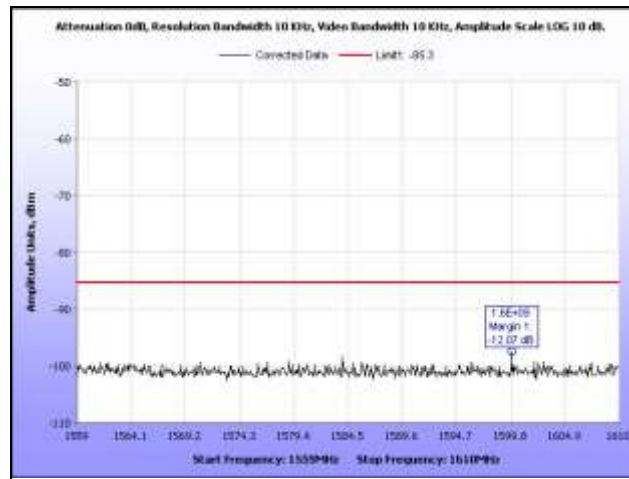

Plot 42. Radiated Emissions, 1.559 GHz – 1.61 GHz, GPS Band, BG3

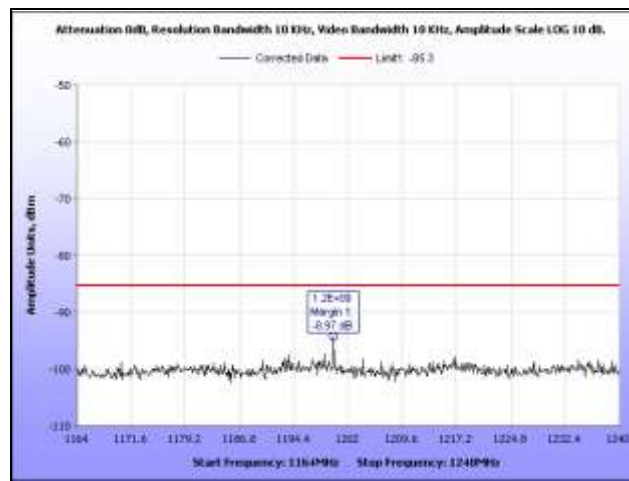

Plot 43. Radiated Emissions, 1.164 GHz – 1.24 GHz, GPS Band, BG6

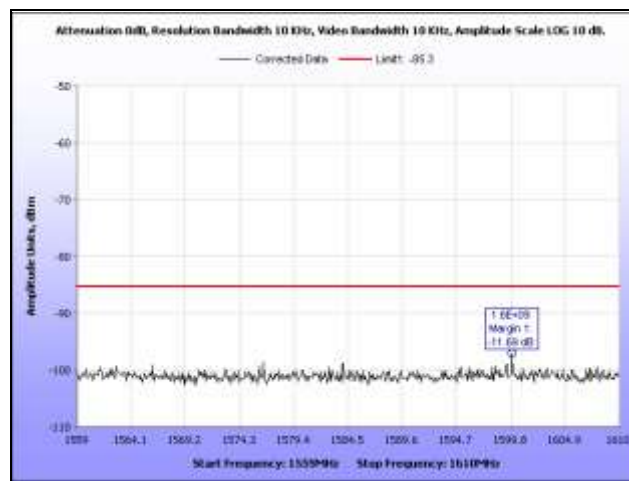

Plot 44. Radiated Emissions, 1.559 GHz – 1.61 GHz, GPS Band, BG6





**Photograph 5. Radiated Emissions, Test Setup**

---

## Electromagnetic Compatibility Criteria for Intentional Radiators

### § 15.519(e) Peak Emissions

**Test Requirements:** §15.519(e): There is a limit on the peak level of the emissions contained within a 50 MHz bandwidth centered on the frequency at which the highest radiated emission occurs, f[M]. That limit is 0 dBm EIRP. It is acceptable to employ a different resolution bandwidth, and a correspondingly different peak emission limit, following the procedures described in §15.521.

**Test Procedure:** A preamp was used for making measurements. Antenna correction factors, cable loss and Preamp factors were programmed in to spectrum analyzer. Measurements were made at 1m.

Measurements were made with PEAK detector activated to the spectrum analyzer and having the resolution bandwidth set to 8 MHz and video bandwidth set to 50 MHz.

Therefore, the limit calculated is  $20 \log (8/50) = -15.92$  dBm.

**Test Results:** The EUT was compliant with the Peak Power Output limits of §15.519(e).

**Test Engineer(s):** Jeff Pratt

**Test Date(s):** 06/26/12

**Peak Emissions Test Results**

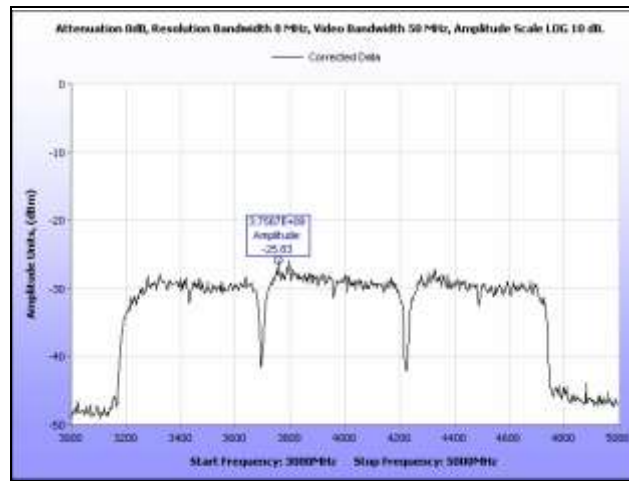

**Plot 45. Peak Emissions, Field Strength, BG1**

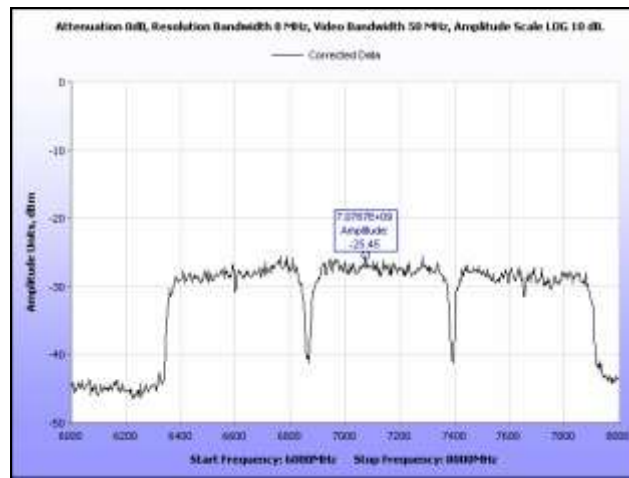

**Plot 46. Peak Emissions, Field Strength, BG3**

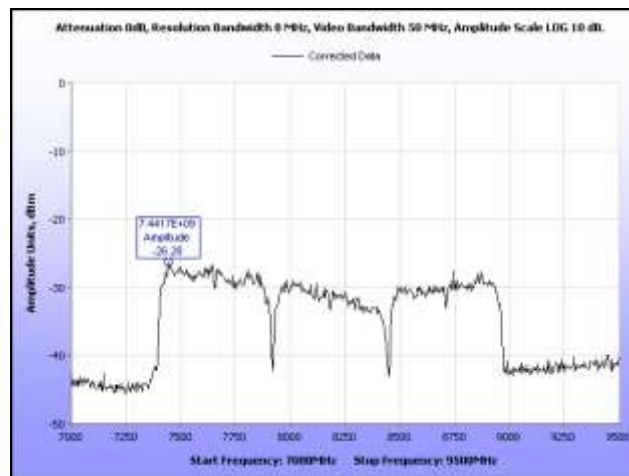

**Plot 47. Peak Emissions, Field Strength, BG6**

## IV. Test Equipment

## Test Equipment

Calibrated test equipment utilized during testing was maintained in a current state of calibration per the requirements of ANSI/NCSL Z540-1-1994 and ANSI/ISO/IEC 17025:2000.

MET Asset #	Equipment	Manufacturer	Model	Last Cal Date	Cal Due Date
1T4300	SEMI-ANECHOIC CHAMBER # 1 (NSA)	EMC TEST SYSTEMS	NONE	01/31/2012	01/31/2013
1T4442	PRE-AMPLIFIER, MICROWAVE	MITEQ	AFS42-01001800-30-10P	SEE NOTE	
1T2511	ANTENNA; HORN	EMCO	3115	09/22/2011	03/22/2013
1T4751	ANTENNA - BILOG	SUNOL SCIENCES	JB6	12/7/2011	12/7/2012
1T4745	ANTENNA, HORN	ETS-LINDGREN	3116	10/4/2011	10/4/2012
1T4149	HIGH-FREQUENCY ANECHOIC CHAMBER	RAY-PROOF	81	N/A	N/A
1T4771	SPECTRUM ANALYZER	AGILENT TECHNOLOGIES	E4446A	12/12/2011	12/12/2012
1T4354	SIGNAL GENERATOR	HEWLETT PACKARD	83752A	04/22/2011	10/22/2012
1T4752	PRE-AMPLIFIER	MITEQ	JS44-18004000-35-8P	SEE NOTE	

**Table 15. Test Equipment List**

Note: Functionally tested equipment is verified using calibrated instrumentation at the time of testing.

## **V. Certification & User's Manual Information**

## Certification & User's Manual Information

### A. Certification Information

The following is extracted from Title 47 of the Code of Federal Regulations, Part 2, Subpart I — Marketing of Radio frequency devices:

#### § 2.801 Radio-frequency device defined.

As used in this part, a radio-frequency device is any device which in its operation is capable of Emitting radio-frequency energy by radiation, conduction, or other means. Radio- frequency devices include, but are not limited to:

- (a) The various types of radio communication transmitting devices described throughout this chapter.
- (b) *The incidental, unintentional and intentional radiators defined in Part 15 of this chapter.*
- (c) The industrial, scientific, and medical equipment described in Part 18 of this chapter.
- (d) Any part or component thereof which in use emits radio-frequency energy by radiation, conduction, or other means.

#### § 2.803 Marketing of radio frequency devices prior to equipment authorization.

- (a) Except as provided elsewhere in this chapter, no person shall sell or lease, or offer for sale or lease (including advertising for sale or lease), or import, ship or distribute for the purpose of selling or leasing or offering for sale or lease, any radio frequency device unless:
  - (1) In the case of a device subject to certification, such device has been authorized by the Commission in accordance with the rules in this chapter and is properly identified and labeled as required by §2.925 and other relevant sections in this chapter; or
  - (2) In the case of a device that is not required to have a grant of equipment authorization issued by the Commission, but which must comply with the specified technical standards prior to use, such device also complies with all applicable administrative (including verification of the equipment or authorization under a Declaration of Conformity, where required), technical, labeling and identification requirements specified in this chapter.
- (d) Notwithstanding the provisions of paragraph (a) of this section, the offer for sale solely to business, commercial, industrial, scientific or medical users (but not an offer for sale to other parties or to end users located in a residential environment) of a radio frequency device that is in the conceptual, developmental, design or pre-production stage is permitted prior to equipment authorization or, for devices not subject to the equipment authorization requirements, prior to a determination of compliance with the applicable technical requirements *provided* that the prospective buyer is advised in writing at the time of the offer for sale that the equipment is subject to the FCC rules and that the equipment will comply with the appropriate rules before delivery to the buyer or to centers of distribution.

- (e)(1) Notwithstanding the provisions of paragraph (a) of this section, prior to equipment authorization or determination of compliance with the applicable technical requirements any radio frequency device may be operated, but not marketed, for the following purposes and under the following conditions:
- (i) *Compliance testing;*
  - (ii) Demonstrations at a trade show provided the notice contained in paragraph (c) of this section is displayed in a conspicuous location on, or immediately adjacent to, the device;
  - (iii) Demonstrations at an exhibition conducted at a business, commercial, industrial, scientific or medical location, but excluding locations in a residential environment, provided the notice contained in paragraphs (c) or (d) of this section, as appropriate, is displayed in a conspicuous location on, or immediately adjacent to, the device;
  - (iv) Evaluation of product performance and determination of customer acceptability, provided such operation takes place at the manufacturer's facilities during developmental, design or pre-production states; or
  - (v) Evaluation of product performance and determination of customer acceptability where customer acceptability of a radio frequency device cannot be determined at the manufacturer's facilities because of size or unique capability of the device, provided the device is operated at a business, commercial, industrial, scientific or medical user's site, but not at a residential site, during the development, design or pre-production stages.
- (e)(2) For the purpose of paragraphs (e)(1)(iv) and (e)(1)(v) of this section, the term *manufacturer's facilities* includes the facilities of the party responsible for compliance with the regulations and the manufacturer's premises, as well as the facilities of other entities working under the authorization of the responsible party in connection with the development and manufacture, but not the marketing, of the equipment.
- (f) For radio frequency devices subject to verification and sold solely to business, commercial, industrial, scientific and medical users (excluding products sold to other parties or for operation in a residential environment), parties responsible for verification of the devices shall have the option of ensuring compliance with the applicable technical specifications of this chapter at each end user's location after installation, provided that the purchase or lease agreement includes a proviso that such a determination of compliance be made and is the responsibility of the party responsible for verification of the equipment.



## Certification & User's Manual Information

The following is extracted from Title 47 of the Code of Federal Regulations, Part 2, Subpart J — Equipment Authorization Procedures:

### § 2.901 Basis and Purpose

- (a) In order to carry out its responsibilities under the Communications Act and the various treaties and international regulations, and in order to promote efficient use of the radio spectrum, the Commission has developed technical standards for radio frequency equipment and parts or components thereof. The technical standards applicable to individual types of equipment are found in that part of the rules governing the service wherein the equipment is to be operated.<sup>1</sup> *In addition to the technical standards provided, the rules governing the service may require that such equipment be verified by the manufacturer or importer, be authorized under a Declaration of Conformity, or receive an equipment authorization from the Commission by one of the following procedures: certification or registration.*
- (b) The following sections describe the verification procedure, the procedure for a Declaration of Conformity, and the procedures to be followed in obtaining certification from the Commission and the conditions attendant to such a grant.

### § 2.907 Certification.

- (a) Certification is an equipment authorization issued by the Commission, based on representation and test data submitted by the applicant.
- (b) Certification attaches to all units subsequently marketed by the grantee which are identical (see Section 2.908) to the sample tested except for permissive changes or other variations authorized by the Commission pursuant to Section 2.1043.

---

<sup>1</sup> In this case, the equipment is subject to the rules of Part 15. More specifically, the equipment falls under Subpart B (of Part 15), which deals with unintentional radiators.

## Certification & User's Manual Information

### § 2.948 Description of measurement facilities.

- (a) Each party making measurements of equipment that is subject to an equipment authorization under Part 15 or Part 18 of this chapter, regardless of whether the measurements are filed with the Commission or kept on file by the party responsible for compliance of equipment marketed within the U.S. or its possessions, shall compile a description of the measurement facilities employed.
- (1) If the measured equipment is subject to the verification procedure, the description of the measurement facilities shall be retained by the party responsible for verification of the equipment.
- (i) *If the equipment is verified through measurements performed by an independent laboratory, it is acceptable for the party responsible for verification of the equipment to rely upon the description of the measurement facilities retained by or placed on file with the Commission by that laboratory. In this situation, the party responsible for the verification of the equipment is not required to retain a duplicate copy of the description of the measurement facilities.*
- (ii) If the equipment is verified based on measurements performed at the installation site of the equipment, no specific site calibration data is required. It is acceptable to retain the description of the measurement facilities at the site at which the measurements were performed.
- (2) If the equipment is to be authorized by the Commission under the certification procedure, the description of the measurement facilities shall be filed with the Commission's Laboratory in Columbia, Maryland. The data describing the measurement facilities need only be filed once but must be updated as changes are made to the measurement facilities or as otherwise described in this section. At least every three years, the organization responsible for filing the data with the Commission shall certify that the data on file is current.

## Certification & User's Manual Information

### 1. Label and User's Manual Information

The following is extracted from Title 47 of the Code of Federal Regulations, Part 15, Subpart A — General:

#### § 15.19 Labeling requirements.

(a) *In addition to the requirements in Part 2 of this chapter, a device subject to certification or verification shall be labeled as follows:*

- (1) Receivers associated with the operation of a licensed radio service, e.g., FM broadcast under Part 73 of this chapter, land mobile operation under Part 90, etc., shall bear the following statement in a conspicuous location on the device:

This device complies with Part 15 of the FCC Rules. Operation is subject to the condition that this device does not cause harmful interference.

- (2) A stand-alone cable input selector switch, shall bear the following statement in a conspicuous location on the device:

This device is verified to comply with Part 15 of the FCC Rules for use with cable television service.

- (3) All other devices shall bear the following statement in a conspicuous location on the device:

*This device complies with Part 15 of the FCC Rules. Operation is subject to the following two conditions: (1) This device may not cause harmful interference, and (2) this device must accept any interference received, including interference that may cause undesired operation.*

- (4) Where a device is constructed in two or more sections connected by wires and marketed together, the statement specified under paragraph (a) of this section is required to be affixed only to the main control unit.

- (5) When the device is so small or for such use that it is not practicable to place the statement specified under paragraph (a) of this section on it, the information required by this paragraph shall be placed in a prominent location in the instruction manual or pamphlet supplied to the user or, alternatively, shall be placed on the container in which the device is marketed. However, the FCC identifier or the unique identifier, as appropriate, must be displayed on the device.

#### § 15.21 Information to user.

The user's manual or instruction manual for an intentional or unintentional radiator shall caution the user that changes or modifications not expressly approved by the party responsible for compliance could void the user's authority to operate the equipment.

## Verification & User's Manual Information

The following is extracted from Title 47 of the Code of Federal Regulations, Part 15, Subpart B — Unintentional Radiators:

### § 15.105 Information to the user.

- (a) For a Class A digital device or peripheral, the instructions furnished the user shall include the following or similar statement, placed in a prominent location in the text of the manual:

Note: This equipment has been tested and found to comply with the limits for a Class A digital device, pursuant to Part 15 of the FCC Rules. These limits are designed to provide reasonable protection against harmful interference when the equipment is operated in a commercial environment. This equipment generates, uses, and can radiate radio frequency energy and, if not installed and used in accordance with the instruction manual, may cause harmful interference to radio communications. Operation of this equipment in a residential area is likely to cause harmful interference in which case the user will be required to correct the interference at own expense.

- (b) For a Class B digital device or peripheral, the instructions furnished the user shall include the following or similar statement, placed in a prominent location in the text of the manual:

Note: This equipment has been tested and found to comply with the limits for a Class B digital device, pursuant to Part 15 of the FCC Rules. These limits are designed to provide reasonable protection against harmful interference when the equipment is operated in a residential environment. This equipment generates, uses, and can radiate radio frequency energy and, if not installed and used in accordance with the instruction manual, may cause harmful interference to radio communications. However, there is no guarantee that interference will not occur in a particular installation. If this equipment does cause harmful interference to radio or television reception, which can be determined by turning the equipment off and on, the user is encouraged to try to correct the interference by one or more of the following measures:

- Reorient or relocate the receiving antenna.
- Increase the separation between the equipment and receiver.
- Connect the equipment into an outlet on a circuit different from that to which the receiver is connected.
- Consult the dealer or an experienced radio/TV technician for help.

# End of Report