



# MIC23031

## 4MHz PWM 400mA Buck Regulator with HyperLight Load™

### General Description

The MIC23031 is a high efficiency 4MHz 400mA synchronous buck regulator with HyperLight Load™ mode. HyperLight Load™ provides very high efficiency at light loads and ultra-fast transient response which is perfectly suited for supplying processor core voltages. An additional benefit of this proprietary architecture is very low output ripple voltage throughout the entire load range with the use of small output capacitors. The tiny 1.6mm x 1.6mm Thin MLF® package saves precious board space and requires only three external components.

The MIC23031 is designed for use with a very small inductor, down to 0.47µH, and an output capacitor as small as 2.2 µF that enables a sub-1mm height.

The MIC23031 has a very low quiescent current of 21µA and achieves as high as 88% efficiency at 1mA. At higher loads, the MIC23031 provides a constant switching frequency around 4MHz while achieving peak efficiencies up to 93%.

The MIC23031 is available in a 6-pin 1.6mm x 1.6mm Thin MLF® package with an operating junction temperature range from -40°C to +125°C.

Data sheets and support documentation can be found on Micrel's web site at: [www.micrel.com](http://www.micrel.com).

### Features

- Input voltage: 2.7V to 5.5V
- 400mA output current
- Up to 93% efficiency and 88% at 1mA
- 21µA typical quiescent current
- 4MHz PWM operation in continuous mode
- Ultra fast transient response
- Low voltage output ripple
  - 20mVpp ripple in HyperLight Load™ mode
  - 3mV output voltage ripple in full PWM mode
- 0.01µA shutdown current
- Fixed and adjustable output voltage options available
- 6-pin 1.6mm x 1.6mm Thin MLF®
- -40°C to +125°C junction temperature range



HyperLight Load™

### Applications

- Mobile handsets
- Portable media/MP3 players
- Portable navigation devices (GPS)
- WiFi/WiMax/WiBro modules
- Digital Cameras
- Wireless LAN cards
- USB powered devices
- Portable applications

### Typical Application

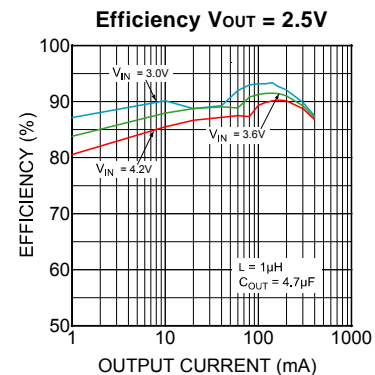
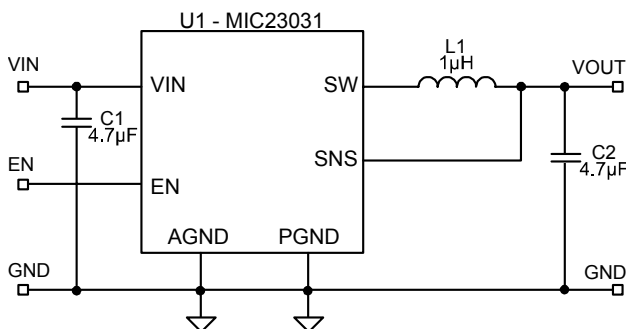

HyperLight Load is a trademark of Micrel, Inc  
MLF and MicroLead Frame are registered trademark Amkor Technology Inc.

Micrel Inc. • 2180 Fortune Drive • San Jose, CA 95131 • USA • tel +1 (408) 944-0800 • fax + 1 (408) 474-1000 • <http://www.micrel.com>

## Ordering Information

Part Number	Marking Code	Nominal Output Voltage	Junction Temperature Range	Package	Lead Finish
MIC23031-AYMT	GEA	ADJ	-40°C to +125°C	6-Pin 1.6x1.6 Thin MLF <sup>®</sup>	Pb-Free
MIC23031-GYMT	GEG	1.8V	-40°C to +125°C	6-Pin 1.6x1.6 Thin MLF <sup>®</sup>	Pb-Free
MIC23031-FYMT	GEF	1.5V	-40°C to +125°C	6-Pin 1.6x1.6 Thin MLF <sup>®</sup>	Pb-Free
MIC23031-4YMT	GE4	1.2V	-40°C to +125°C	6-Pin 1.6x1.6 Thin MLF <sup>®</sup>	Pb-Free
MIC23031-CYMT	GEC	1.0V	-40°C to +125°C	6-Pin 1.6x1.6 Thin MLF <sup>®</sup>	Pb-Free

### Notes:

- Other options available. Contact Micrel for details.
- Thin MLF<sup>®</sup> is GREEN RoHS compliant package. Lead finish is NiPdAu. Mold compound is Halogen Free.

## Pin Configuration

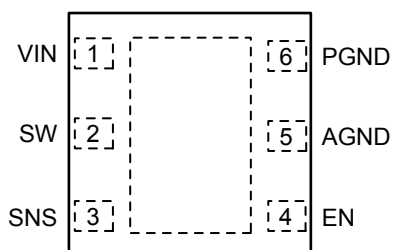

6-Pin 1.6 x 1.6mm Thin MLF (MT)  
Fixed (Top View)

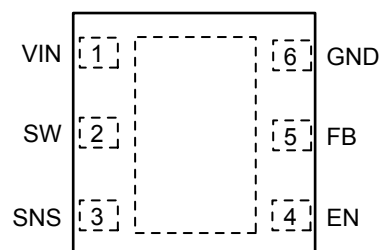

6-Pin 1.6 x 1.6mm Thin MLF (MT)  
Adjustable (Top View)

## Pin Description

Fixed Option	ADJ Option	Pin Name	Pin Function
1	1	VIN	Input Voltage: Connect a capacitor to ground to decouple the noise.
2	2	SW	Switch (Output): Internal power MOSFET output switches.
3	3	SNS	Sense: Connect to $V_{OUT}$ as close to output capacitor as possible to sense output voltage
4	4	EN	Enable (Input): Logic high enables operation of the regulator. Logic low will shut down the device. Do not leave floating.
5	-	AGND	Analog Ground: Connect to central ground point where all high current paths meet ( $C_{IN}$ , $C_{OUT}$ , PGND) for best operation.
-	5	FB	Feedback (Input): Connect resistor divider at this node to set output voltage. Resistors should be selected based on a nominal $V_{FB}$ of 0.62V.
6	-	PGND	Power Ground
-	6	GND	Ground
E-PAD	E-PAD	HS PAD	Connect to PGND or GND

### Absolute Maximum Ratings<sup>(1)</sup>

Supply Voltage ( $V_{IN}$ )	.....6V
Sense ( $V_{SNS}$ )	.....6V
Output Switch Voltage	.....6V
Enable Input Voltage ( $V_{EN}$ )	.....-0.3V to $V_{IN}$
Storage Temperature Range	.....-65°C to +150°C
ESD Rating <sup>(3)</sup>	.....ESD Sensitive

### Operating Ratings<sup>(2)</sup>

Supply Voltage ( $V_{IN}$ )	.....2.7V to 5.5V
Enable Input Voltage ( $V_{EN}$ )	.....0V to $V_{IN}$
Output Voltage Range ( $V_{SNS}$ )	.....0.7V to 3.6V
Junction Temperature Range ( $T_J$ )	.....-40°C ≤ $T_J$ ≤ +125°C
Thermal Resistance	
1.6 x 1.6mm Thin MLF <sup>®</sup> -6 ( $\theta_{JA}$ )	.....92.4°C/W

### Electrical Characteristics<sup>(4)</sup>

$T_A = 25^\circ\text{C}$ ;  $V_{IN} = V_{EN} = 3.6\text{V}$ ;  $L = 1\mu\text{H}$ ;  $C_{OUT} = 4.7\mu\text{F}$  unless otherwise specified.

**Bold** values indicate  $-40^\circ\text{C} \leq T_J \leq +125^\circ\text{C}$ , unless noted.

Parameter	Condition	Min	Typ	Max	Units
Supply Voltage Range		2.7		5.5	V
Under-Voltage Lockout Threshold	(turn-on)	<b>2.45</b>	2.55	<b>2.65</b>	V
Quiescent Current	$I_{OUT} = 0\text{mA}$ , $SNS > 1.2 * V_{OUT}$ Nominal		21	35	$\mu\text{A}$
Shutdown Current	$V_{EN} = 0\text{V}$ $V_{IN} = 5.5\text{V}$		0.01	<b>4</b>	$\mu\text{A}$
Output Voltage Accuracy	$V_{IN} = 3.6\text{V}$ ; $I_{LOAD} = 20\text{mA}$	<b>-2.5</b>		<b>+2.5</b>	%
Feedback Voltage	Adjustable Option Only		0.62		V
Current Limit	$SNS = 0.9 * V_{OUTNOM}$	<b>0.41</b>	0.7	<b>1</b>	A
Output Voltage Line Regulation	$V_{IN} = 3.0\text{V}$ to $5.5\text{V}$ , $V_{OUT} = 1.2\text{V}$ , $I_{LOAD} = 20\text{mA}$ ,		0.3		%/V
Output Voltage Load Regulation	$20\text{mA} < I_{LOAD} < 400\text{mA}$ , $V_{OUT} = 1.2\text{V}$ , $V_{IN} = 3.6\text{V}$		0.7		%
PWM Switch ON-Resistance	$I_{SW} = 100\text{mA}$ PMOS $I_{SW} = -100\text{mA}$ NMOS		0.65 0.8		$\Omega$
Frequency	$I_{OUT} = 120\text{mA}$		4		MHz
SoftStart Time	$V_{OUT} = 90\%$		100		$\mu\text{s}$
Enable Threshold		<b>0.5</b>	0.9	<b>1.2</b>	V
Enable Input Current			0.1	<b>2</b>	$\mu\text{A}$
Over-temperature Shutdown			160		$^\circ\text{C}$
Over-temperature Shutdown Hysteresis			20		$^\circ\text{C}$

1. Exceeding the absolute maximum rating may damage the device.
2. The device is not guaranteed to function outside its operating rating.
3. Devices are ESD sensitive. Handling precautions recommended. Human body model, 1.5k $\Omega$  in series with 100pF.
4. Specification for packaged product only.

# Typical Characteristics

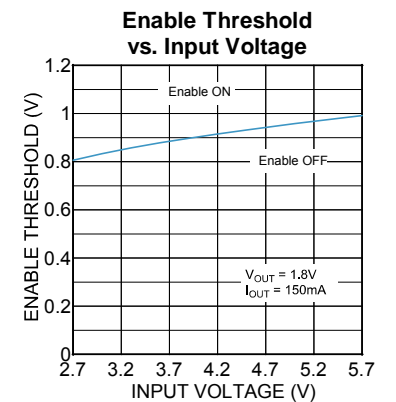
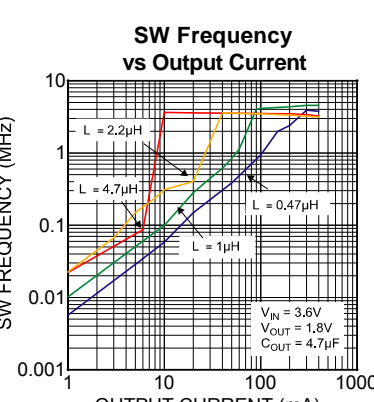
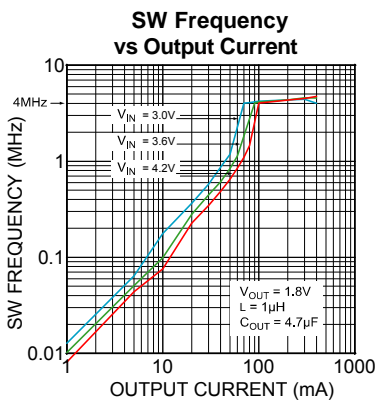
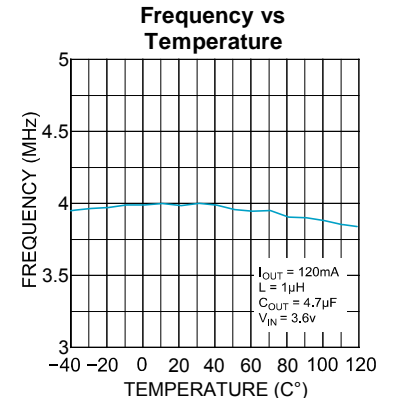
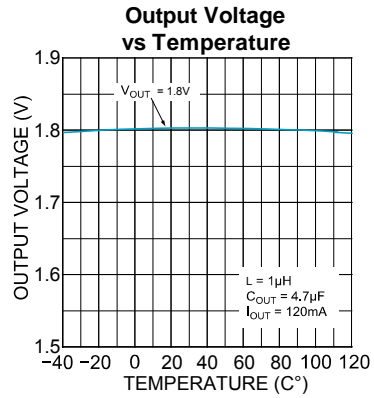
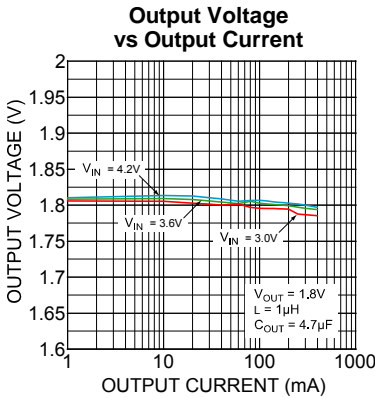
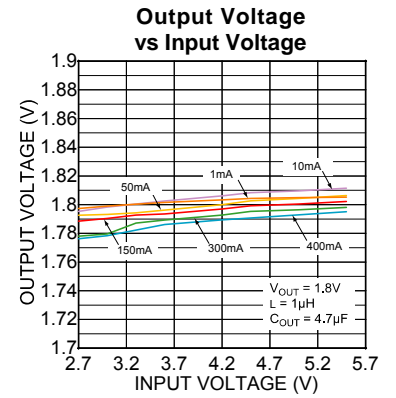
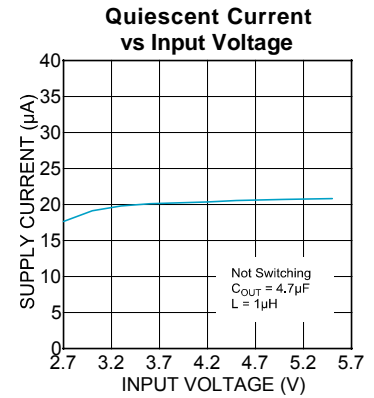
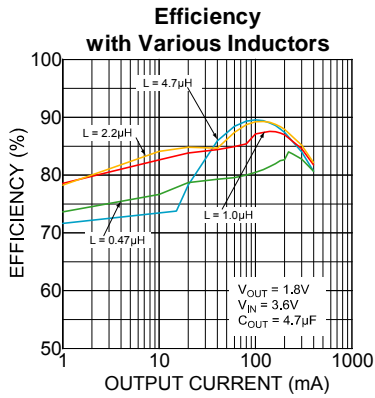
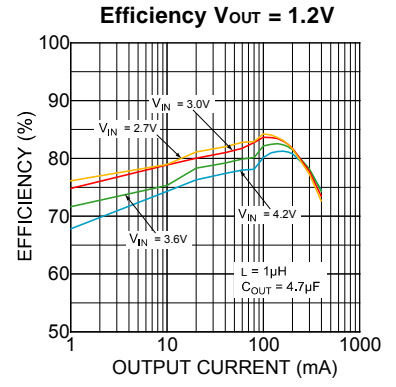
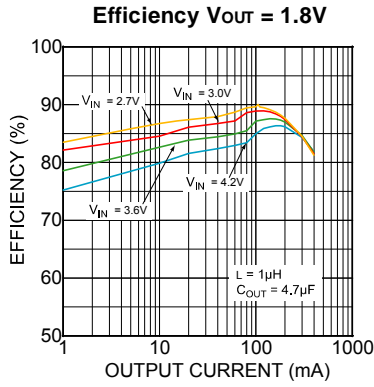
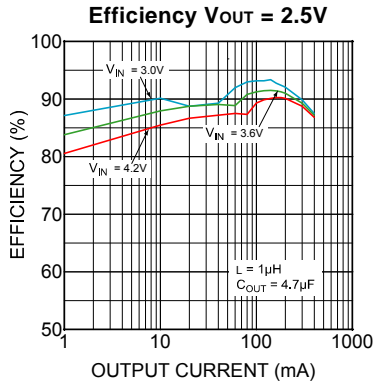

### Typical Characteristics (continued)

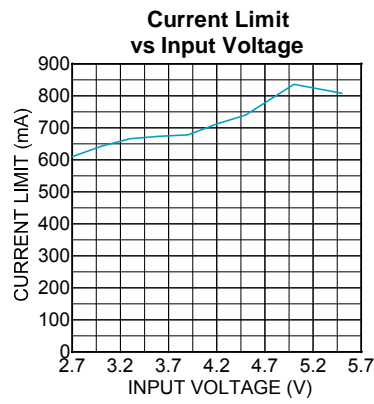
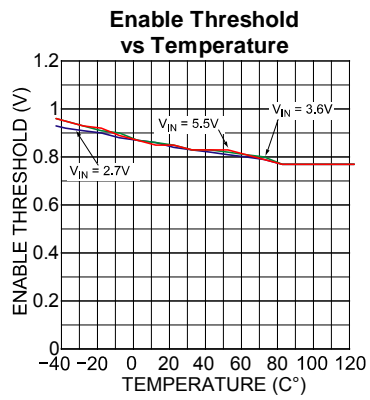

# Functional Characteristics

### Switching Waveform - Discontinuous Mode

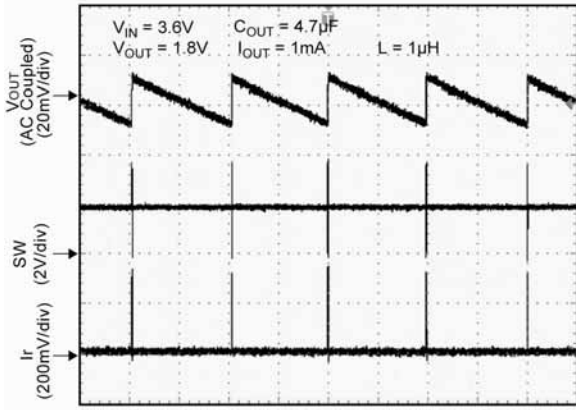

### Switching Waveform - Discontinuous Mode

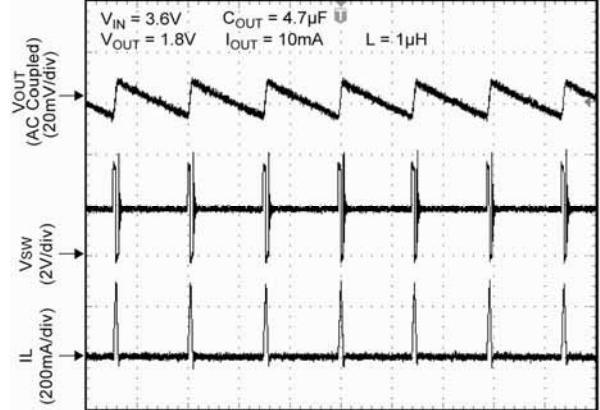

### Switching Waveform - Discontinuous Mode

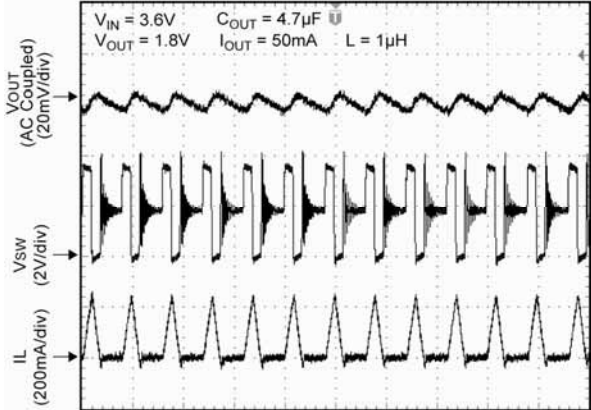

### Switching Waveform - Continuous Mode

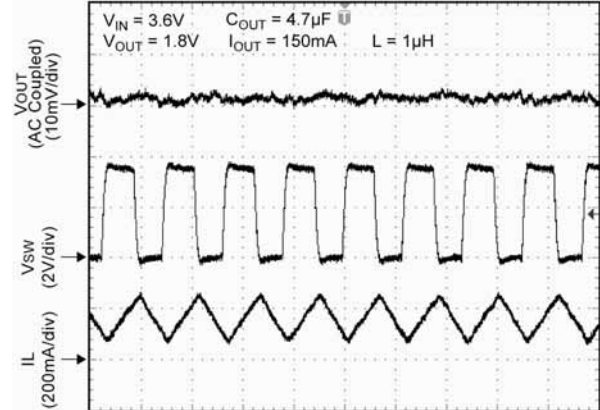

### Switching Waveform - Continuous Mode

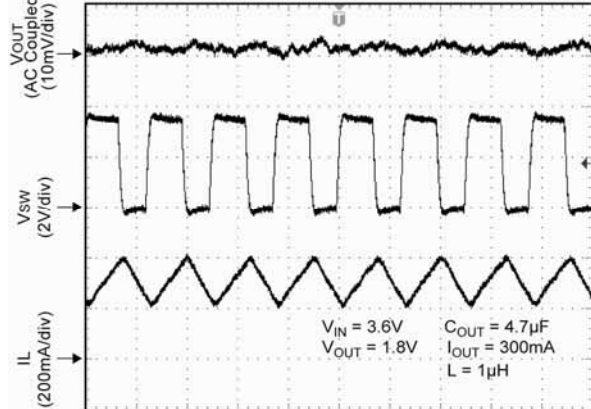

### Switching Waveform - Continuous Mode

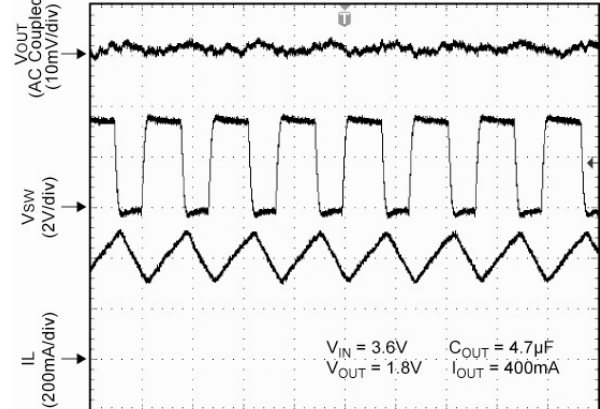

## Functional Characteristics (continued)

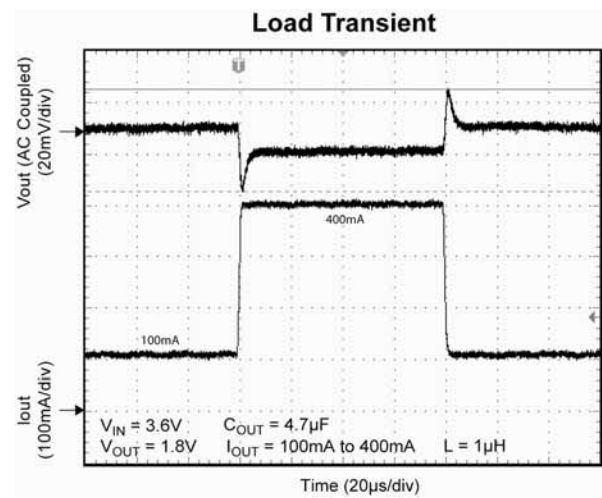
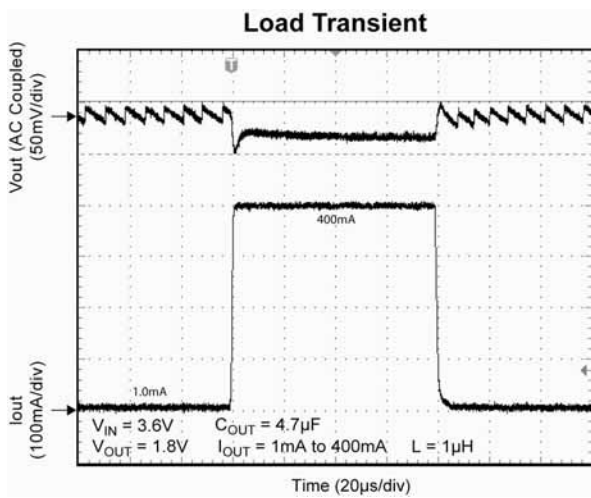
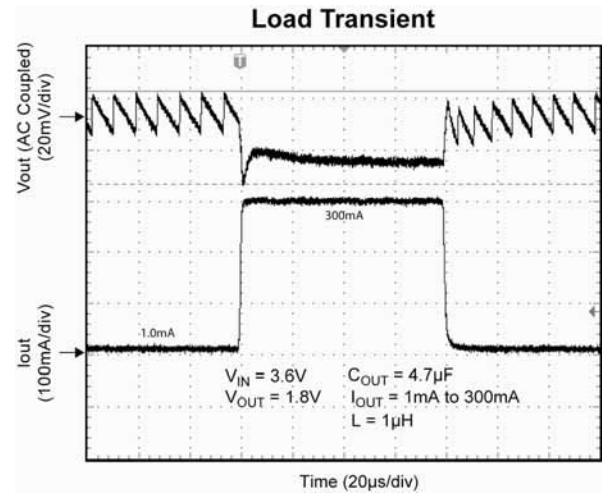
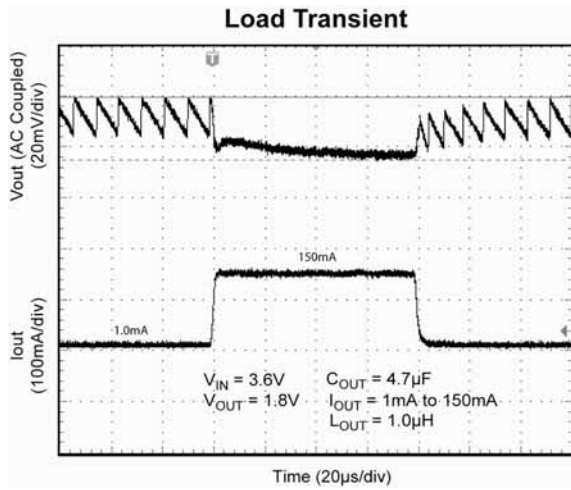
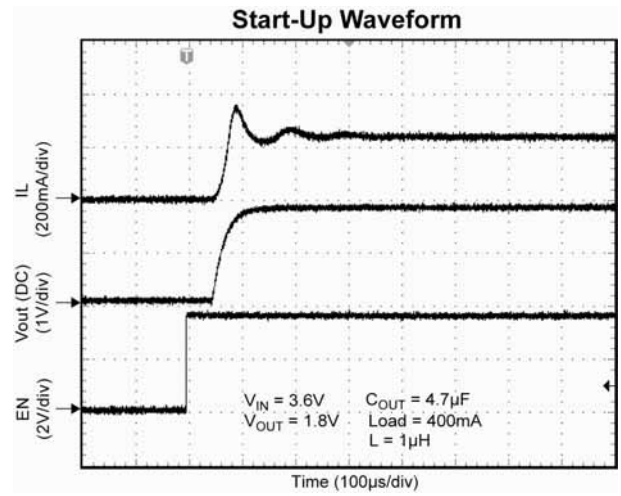
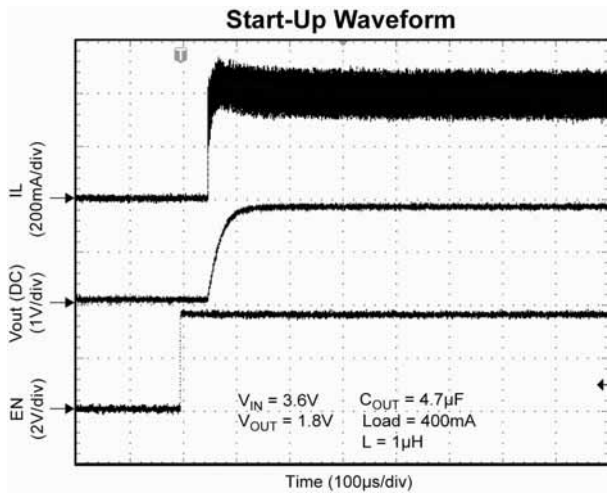

### Functional Characteristics (continued)

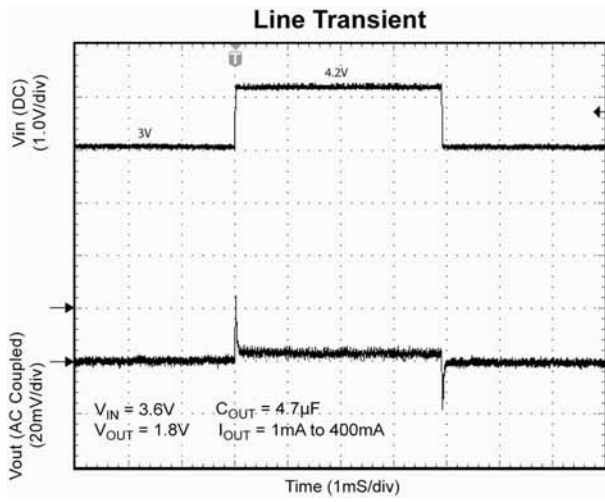



## Functional Diagram

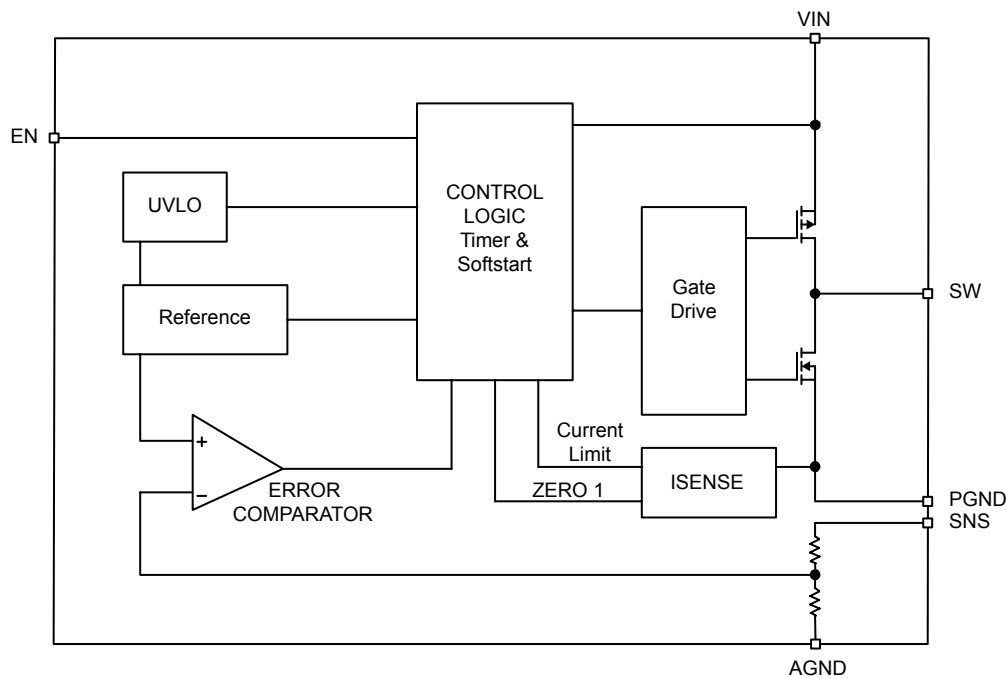

**Simplified MIC23031 Fixed Functional Block Diagram**

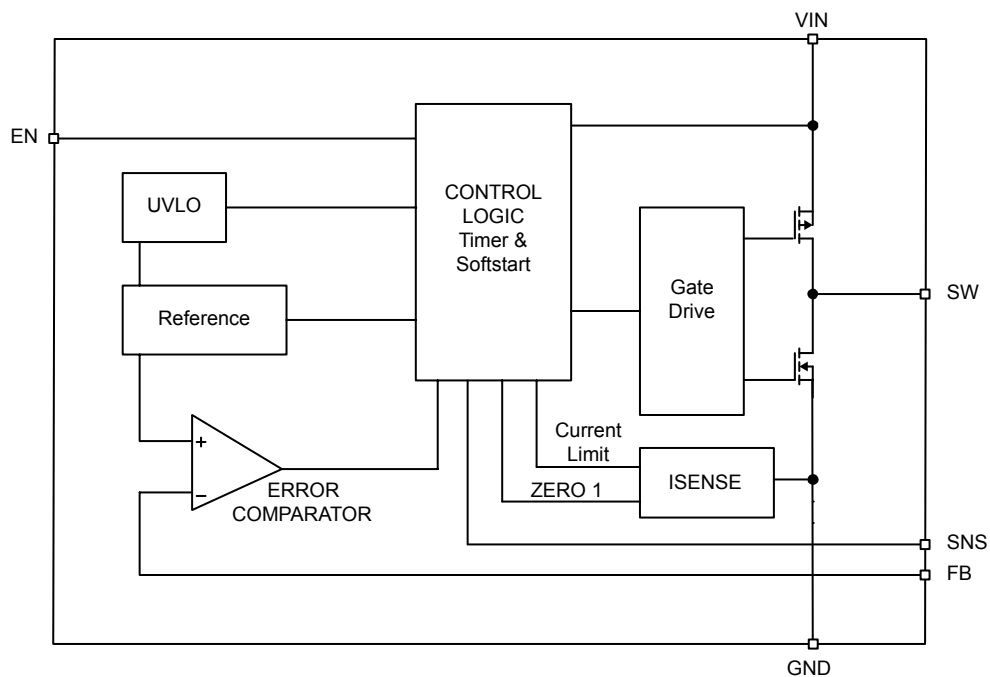

**Simplified MIC23031 Adjustable Functional Block Diagram**

## Functional Description

### VIN

The input supply (VIN) provides power to the internal MOSFETs for the switch mode regulator along with the internal control circuitry. The VIN operating range is 2.7V to 5.5V so an input capacitor, with a minimum voltage rating of 6.3V, is recommended. Due to the high switching speed, a minimum 2.2µF bypass capacitor placed close to VIN and the power ground (PGND) pin is required. Refer to the layout recommendations for details.

### EN

A logic high signal on the enable pin activates the output voltage of the device. A logic low signal on the enable pin deactivates the output and reduces supply current to 0.01µA. MIC23031 features built-in soft-start circuitry that reduces in-rush current and prevents the output voltage from overshooting at start up. Do not leave floating.

### SW

The switch (SW) connects directly to one end of the inductor and provides the current path during switching cycles. The other end of the inductor is connected to the load, SNS pin and output capacitor. Due to the high speed switching on this pin, the switch node should be routed away from sensitive nodes whenever possible.

### SNS

The sense (SNS) pin is connected to the output of the device to provide feedback to the control circuitry. The SNS connection should be placed close to the output capacitor. Refer to the layout recommendations for more details.

### AGND (Fixed Output Only)

The analog ground (AGND) is the ground path for the biasing and control circuitry. The current loop for the

signal ground should be separate from the power ground (PGND) loop. Refer to the layout recommendations for more details.

### FB (Adjustable Output Only)

The feedback pin (FB) allows the regulated output voltage to be set by applying an external resistor network. The internal reference voltage is 0.62V and the recommended value of R2 is 200kΩ. The output voltage is calculated from the equation below.

$$V_{OUT} = 0.62V \left( \frac{R1}{200k\Omega} + 1 \right)$$

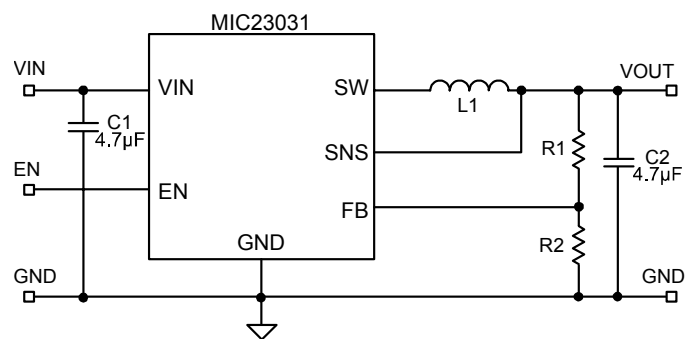

Figure 1. MIC23031-AYMT Schematic

### PGND / GND

The power ground pin is the ground path for the high current in PWM mode. The current loop for the power ground should be as small as possible and separate from the analog ground (AGND) loop as applicable. Refer to the layout recommendations for more details.

## Application Information

The MIC23031 is a high performance DC/DC step down regulator offering a small solution size. Supporting an output current up to 400mA inside a tiny 1.6mm x 1.6mm Thin MLF<sup>®</sup> package and requiring only three external components, the MIC23031 meets today's miniature portable electronic device needs. Using the HyperLight Load™ switching scheme, the MIC23031 is able to maintain high efficiency throughout the entire load range while providing ultra-fast load transient response. The following sections provide additional device application information.

### Input Capacitor

A 2.2μF ceramic capacitor or greater should be placed close to the VIN pin and PGND / GND pin for bypassing. A TDK C1608X5R0J475K, size 0603, 4.7μF ceramic capacitor is recommended based upon performance, size and cost. A X5R or X7R temperature rating is recommended for the input capacitor. Y5V temperature rating capacitors, aside from losing most of their capacitance over temperature, can also become resistive at high frequencies. This reduces their ability to filter out high frequency noise.

### Output Capacitor

The MIC23031 was designed for use with a 2.2μF or greater ceramic output capacitor. Increasing the output capacitance will lower output ripple and improve load transient response but could increase solution size or cost. A low equivalent series resistance (ESR) ceramic output capacitor such as the TDK C1608X5R0J475K, size 0603, 4.7μF ceramic capacitor is recommended based upon performance, size and cost. Both the X7R or X5R temperature rating capacitors are recommended. The Y5V and Z5U temperature rating capacitors are not recommended due to their wide variation in capacitance over temperature and increased resistance at high frequencies.

### Inductor Selection

When selecting an inductor, it is important to consider the following factors (not necessarily in the order of importance):

- Inductance
- Rated current value
- Size requirements
- DC resistance (DCR)

The MIC23031 was designed for use with an inductance range from 0.47μH to 4.7μH. Typically, a 1μH inductor is recommended for a balance of transient response, efficiency and output ripple. For faster transient response, a 0.47μH inductor will yield the best result. For lower output ripple, a 4.7μH inductor is recommended.

Maximum current ratings of the inductor are generally

given in two methods; permissible DC current and saturation current. Permissible DC current can be rated either for a 40°C temperature rise or a 10% to 20% loss in inductance. Ensure the inductor selected can handle the maximum operating current. When saturation current is specified, make sure that there is enough margin so that the peak current does not cause the inductor to saturate. Peak current can be calculated as follows:

$$I_{PEAK} = \left[ I_{OUT} + V_{OUT} \left( \frac{1 - V_{OUT}/V_{IN}}{2 \times f \times L} \right) \right]$$

As shown by the calculation above, the peak inductor current is inversely proportional to the switching frequency and the inductance; the lower the switching frequency or the inductance the higher the peak current. As input voltage increases, the peak current also increases.

The size of the inductor depends on the requirements of the application. Refer to the Typical Application Circuit and Bill of Materials for details.

DC resistance (DCR) is also important. While DCR is inversely proportional to size, DCR can represent a significant efficiency loss. Refer to the Efficiency Considerations.

### Compensation

The MIC23031 is designed to be stable with a 0.47μH to 4.7μH inductor with a minimum of 2.2μF ceramic (X5R) output capacitor.

### Duty Cycle

The typical maximum duty cycle of the MIC23031 is 80%.

### Efficiency Considerations

Efficiency is defined as the amount of useful output power, divided by the amount of power supplied.

$$\text{Efficiency \%} = \left( \frac{V_{OUT} \times I_{OUT}}{V_{IN} \times I_{IN}} \right) \times 100$$

Maintaining high efficiency serves two purposes. It reduces power dissipation in the power supply, reducing the need for heat sinks and thermal design considerations and it reduces consumption of current for battery powered applications. Reduced current draw from a battery increases the devices operating time and is critical in hand held devices.

There are two types of losses in switching converters; DC losses and switching losses. DC losses are simply the power dissipation of I<sup>2</sup>R. Power is dissipated in the high side switch during the on cycle. Power loss is equal to the high side MOSFET R<sub>DS(ON)</sub> multiplied by the Switch Current squared. During the off cycle, the low side N-channel MOSFET conducts, also dissipating power. Device operating current also reduces efficiency. The

product of the quiescent (operating) current and the supply voltage represents another DC loss. The current required driving the gates on and off at a constant 4MHz frequency and the switching transitions make up the switching losses.

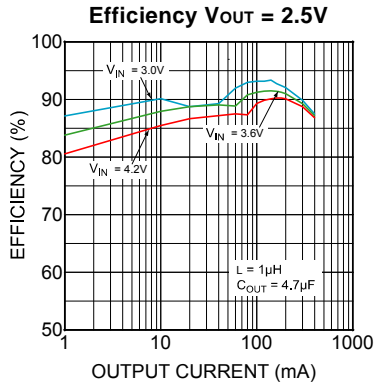

The figure above shows an efficiency curve. From no load to 100mA, efficiency losses are dominated by quiescent current losses, gate drive and transition losses. By using the HyperLight Load™ mode, the MIC23031 is able to maintain high efficiency at low output currents.

Over 100mA, efficiency loss is dominated by MOSFET  $R_{DSON}$  and inductor losses. Higher input supply voltages will increase the Gate-to-Source threshold on the internal MOSFETs, thereby reducing the internal  $R_{DSON}$ . This improves efficiency by reducing DC losses in the device. All but the inductor losses are inherent to the device. In which case, inductor selection becomes increasingly critical in efficiency calculations. As the inductors are reduced in size, the DC resistance (DCR) can become quite significant. The DCR losses can be calculated as follows:

$$L Pd = I_{OUT}^2 \times DCR$$

From that, the loss in efficiency due to inductor resistance can be calculated as follows:

$$Efficiency Loss = \left[ 1 - \left( \frac{V_{OUT} \times I_{OUT}}{V_{OUT} \times I_{OUT} + L_{-} P_D} \right) \right] \times 100$$

Efficiency loss due to DCR is minimal at light loads and gains significance as the load is increased. Inductor selection becomes a trade-off between efficiency and size in this case.

**HyperLight Load™ Mode**

MIC23031 uses a minimum on and off time proprietary control loop (patented by Micrel). When the output voltage falls below the regulation threshold, the error comparator begins a switching cycle that turns the PMOS on and keeps it on for the duration of the minimum-on-time. This increases the output voltage. If the output voltage is over the regulation threshold, then

the error comparator turns the PMOS off for a minimum-off-time until the output drops below the threshold. The NMOS acts as an ideal rectifier that conducts when the PMOS is off. Using a NMOS switch instead of a diode allows for lower voltage drop across the switching device when it is on. The asynchronous switching combination between the PMOS and the NMOS allows the control loop to work in discontinuous mode for light load operations. In discontinuous mode, the MIC23031 works in pulse frequency modulation (PFM) to regulate the output. As the output current increases, the off-time decreases, thus provides more energy to the output. This switching scheme improves the efficiency of MIC23031 during light load currents by only switching when it is needed. As the load current increases, the MIC23031 goes into continuous conduction mode (CCM) and switches at a frequency centered at 4MHz. The equation to calculate the load when the MIC23031 goes into continuous conduction mode may be approximated by the following formula:

$$I_{LOAD} = \left( \frac{(V_{IN} - V_{OUT}) \times D}{2L \times f} \right)$$

As shown in the previous equation, the load at which MIC23031 transitions from HyperLight Load™ mode to PWM mode is a function of the input voltage ( $V_{IN}$ ), output voltage ( $V_{OUT}$ ), duty cycle ( $D$ ), inductance ( $L$ ) and frequency ( $f$ ). This is illustrated in the graph below. Since the inductance range of MIC23031 is from 0.47µH to 4.7µH, the device may then be tailored to enter HyperLight Load™ mode or PWM mode at a specific load current by selecting the appropriate inductance. For example, in the graph below, when the inductance is 4.7µH the MIC23031 will transition into PWM mode at a load of approximately 4mA. Under the same condition, when the inductance is 1µH, the MIC23031 will transition into PWM mode at approximately 70mA.

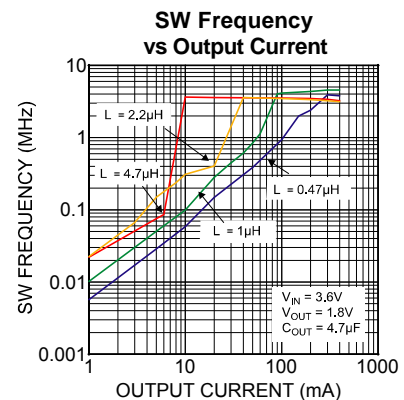

## MIC23031 Typical Application Circuit (Fixed 1.8V)

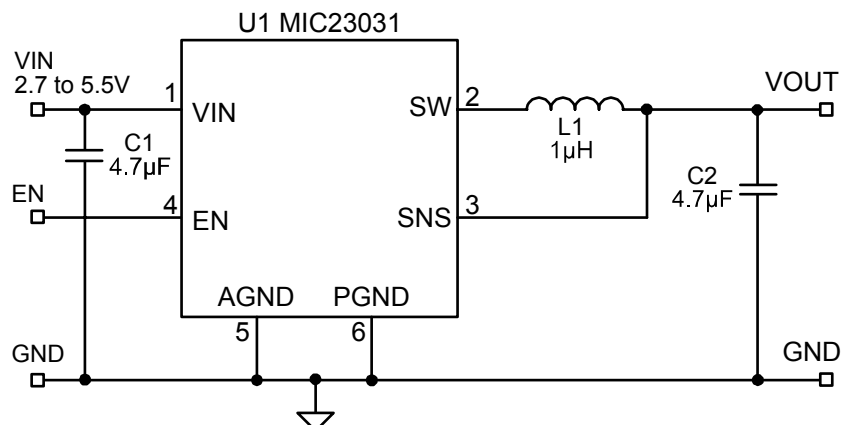

### Bill of Materials

Item	Part Number	Manufacturer	Description	Qty.
C1, C2	C1608X5R0J475K	TDK <sup>(1)</sup>	4.7µF Ceramic Capacitor, 6.3V, X5R, Size 0603	2
L1	LQM21PN1R0M00	Murata <sup>(2)</sup>	1µH, 0.8A, 190mΩ, L2mm x W1.25mm x H0.5mm	1
	LQH32CN1R0M33	Murata <sup>(2)</sup>	1µH, 1A, 60mΩ, L3.2mm x W2.5mm x H2.0mm	
	LQM31PN1R0M00	Murata <sup>(2)</sup>	1µH, 1.2A, 120mΩ, L3.2mm x W1.6mm x H0.95mm	
	GLF251812T1R0M	TDK <sup>(1)</sup>	1µH, 0.8A, 100mΩ, L2.5mm x W1.8mm x H1.35mm	
	LQM31PNR47M00	Murata <sup>(2)</sup>	0.47µH, 1.4A, 80mΩ, L3.2mm x W1.6mm x H0.85mm	
	MIPF2520D1R5	FDK <sup>(3)</sup>	1.5µH, 1.5A, 70mΩ, L2.5mm x W2mm x H1.0mm	
U1	MIC23031-xYMT	Micrel, Inc. <sup>(4)</sup>	4MHz 400mA Buck Regulator with HyperLight Load™ Mode	1

#### Notes:

1. TDK: [www.tdk.com](http://www.tdk.com)
2. Murata: [www.murata.com](http://www.murata.com)
3. FDK: [www.fdk.co.jp](http://www.fdk.co.jp)
4. Micrel, Inc.: [www.micrel.com](http://www.micrel.com)

## MIC23031 Typical Application Circuit (Adjustable 1.8V)

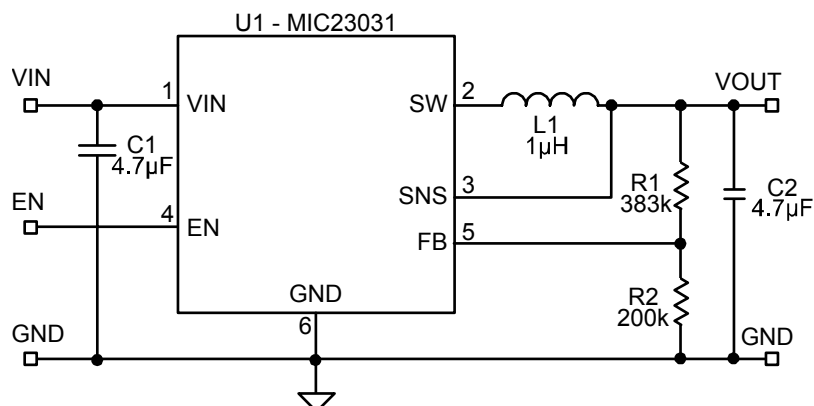

## Bill of Materials

Item	Part Number	Manufacturer	Description	Qty.
C1, C2	C1608X5R0J475K	TDK <sup>(1)</sup>	4.7µF Ceramic Capacitor, 6.3V, X5R, Size 0603	2
R1	CRCW06033833FT1	Vishay <sup>(2)</sup>	383kΩ, 1%, Size 0603	1
R2	CRCW06032003FT1	Vishay <sup>(2)</sup>	200kΩ, 1%, Size 0603	1
L1	LQM21PN1R0M00	Murata <sup>(3)</sup>	1µH, 0.8A, 190mΩ, L2mm x W1.25mm x H0.5mm	1
	LQH32CN1R0M33	Murata <sup>(3)</sup>	1µH, 1A, 60mΩ, L3.2mm x W2.5mm x H2.0mm	
	LQM31PN1R0M00	Murata <sup>(3)</sup>	1µH, 1.2A, 120mΩ, L3.2mm x W1.6mm x H0.95mm	
	GLF251812T1R0M	TDK <sup>(1)</sup>	1µH, 0.8A, 100mΩ, L2.5mm x W1.8mm x H1.35mm	
	LQM31PNR47M00	Murata <sup>(3)</sup>	0.47µH, 1.4A, 80mΩ, L3.2mm x W1.6mm x H0.85mm	
	MIPF2520D1R5	FDK <sup>(4)</sup>	1.5µH, 1.5A, 70mΩ, L2.5mm x W2mm x H1.0mm	
U1	MIC23031-AYMT	Micrel, Inc. <sup>(5)</sup>	4MHz 400mA Buck Regulator with HyperLight Load™ Mode	1

### Notes:

1. TDK: [www.tdk.com](http://www.tdk.com)
2. Vishay: [www.vishay.com](http://www.vishay.com)
3. Murata: [www.murata.com](http://www.murata.com)
4. FDK: [www.fdk.co.jp](http://www.fdk.co.jp)
5. Micrel, Inc.: [www.micrel.com](http://www.micrel.com)

### PCB Layout Recommendations (Fixed)

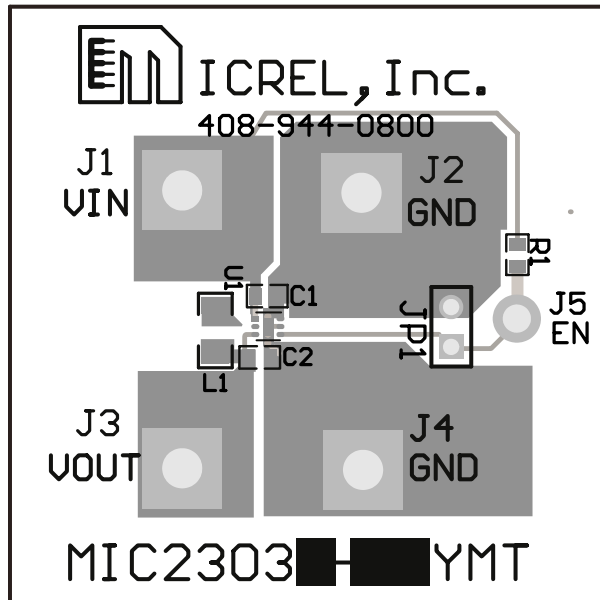

Fixed Top Layer

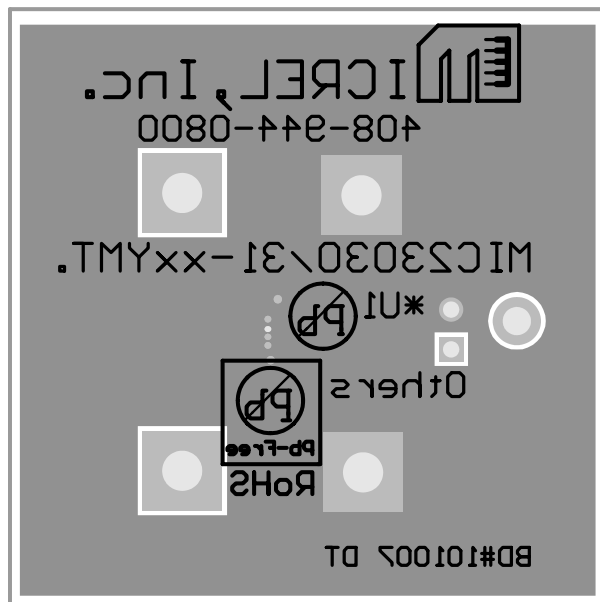

Fixed Bottom Layer

### PCB Layout Recommendations (Adjustable)

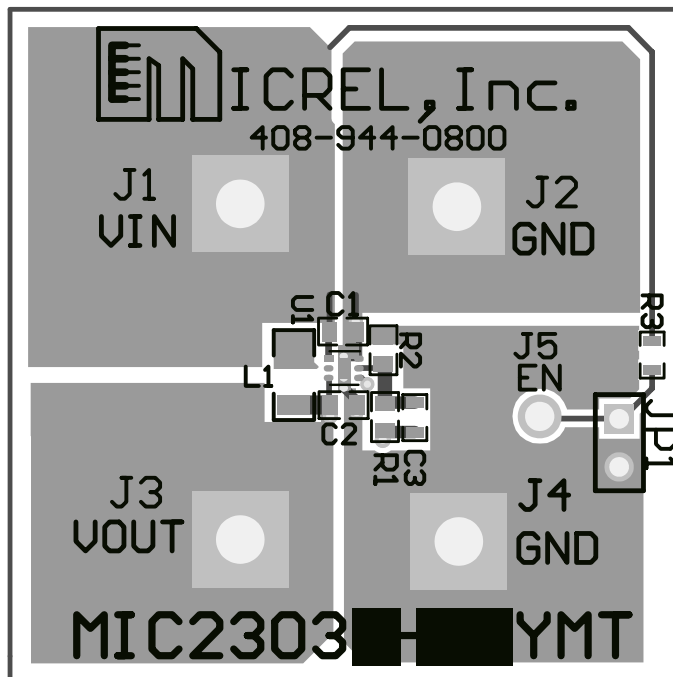

Adjustable Top Layer

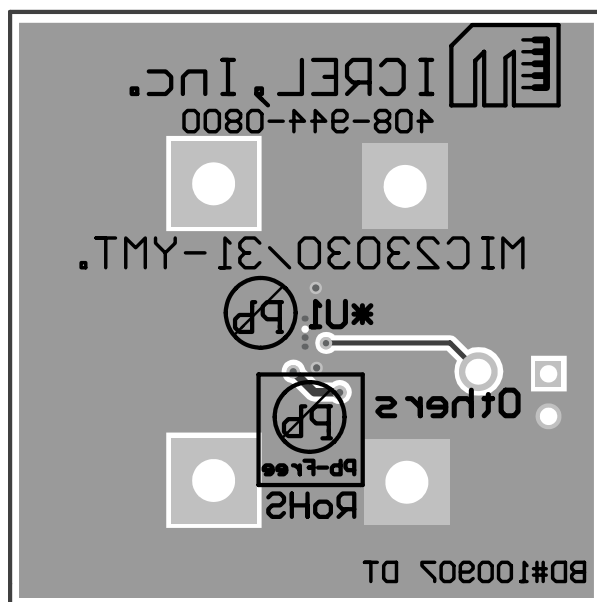

Adjustable Bottom Layer



**Package Information**

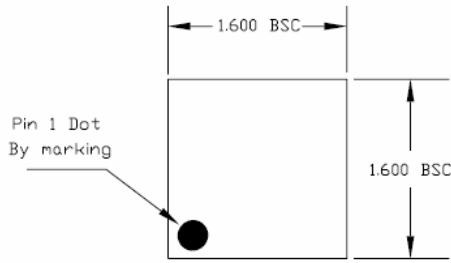

TOP VIEW

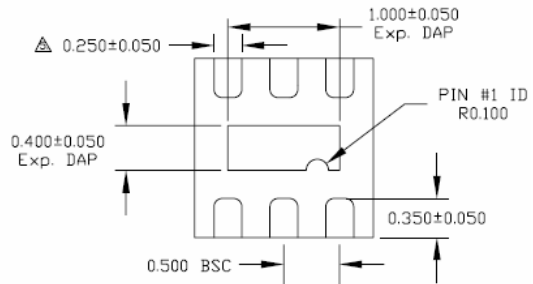

BOTTOM VIEW

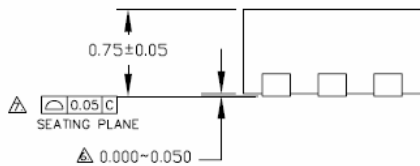

- NOTE:
1. ALL DIMENSIONS ARE IN MILLIMETERS.
  2. MAX. PACKAGE WARPAGE IS 0.05 mm.
  3. MAXIMUM ALLOWABLE BURRS IS 0.076 mm IN ALL DIRECTIONS.
  4. PIN #1 ID ON TOP WILL BE LASER/INK MARKED.
- ⚠ DIMENSION APPLIES TO METALIZED TERMINAL AND IS MEASURED BETWEEN 0.20 AND 0.25 mm FROM TERMINAL TIP.
- ⚠ APPLIED ONLY FOR TERMINALS.
- ⚠ APPLIED FOR EXPOSED PAD AND TERMINALS.

**6-pin 1.6mm x 1.6mm Thin MLF® (MT)**

**MICREL, INC. 2180 FORTUNE DRIVE SAN JOSE, CA 95131 USA**  
 TEL +1 (408) 944-0800 FAX +1 (408) 474-1000 WEB <http://www.micrel.com>

The information furnished by Micrel in this data sheet is believed to be accurate and reliable. However, no responsibility is assumed by Micrel for its use. Micrel reserves the right to change circuitry and specifications at any time without notification to the customer.

Micrel Products are not designed or authorized for use as components in life support appliances, devices or systems where malfunction of a product can reasonably be expected to result in personal injury. Life support devices or systems are devices or systems that (a) are intended for surgical implant into the body or (b) support or sustain life, and whose failure to perform can be reasonably expected to result in a significant injury to the user. A Purchaser's use or sale of Micrel Products for use in life support appliances, devices or systems is a Purchaser's own risk and Purchaser agrees to fully indemnify Micrel for any damages resulting from such use or sale.

© 2008 Micrel, Incorporated.