

# TEST REPORT

## CERTIFICATE OF CONFORMITY

**Standard:** 47 CFR FCC Part 15, Subpart C (Section 15.247)

**Report No.:** RFB DHL-WTW-P22030883

**FCC ID:** U9K-CM0060

**Product:** Smart Alarm Wireless Indoor Security Camera

**Brand:** **SimpliSafe**

**Model No.:** CM006

**Received Date:** 2022/3/22

**Test Date:** 2022/11/17 ~ 2022/11/30

**Issued Date:** 2022/12/15

**Applicant:** SimpliSafe Inc

**Address:** 294 Washington St  
Floor 9  
Boston 02108

**Issued By:** Bureau Veritas Consumer Products Services (H.K.) Ltd., Taoyuan Branch  
Lin Kou Laboratories

**Lab Address:** No. 47-2, 14th Ling, Chia Pau Vil., Lin Kou Dist., New Taipei City, Taiwan

**Test Location:** No. 47-2, 14th Ling, Chia Pau Vil., Lin Kou Dist., New Taipei City, Taiwan

**FCC Registration /** 198487 / TW2021

**Designation Number:**

**Approved by:** Jeremy Lin, **Date:** 2022/12/15  
Jeremy Lin / Project Engineer

This test report consists of 58 pages in total. It may be duplicated completely for legal use with the approval of the applicant. It should not be reproduced except in full, without the written approval of our laboratory. The test results in the report only apply to the tested sample. The test results in this report are traceable to the national or international standards.

Prepared by : Jessica Cheng / Senior Specialist



This report is governed by, and incorporates by reference, the Conditions of Testing as posted at the date of issuance of this report at <http://www.bureauveritas.com/home/about-us/our-business/cps/about-us/terms-conditions/> and is intended for your exclusive use. Any copying or replication of this report to or for any other person or entity, or use of our name or trademark, is permitted only with our prior written permission. This report sets forth our findings solely with respect to the test samples identified herein. The results set forth in this report are not indicative or representative of the quality or characteristics of the lot from which a test sample was taken or any similar or identical product unless specifically and expressly noted. Our report includes all of the tests requested by you and the results thereof based upon the information that you provided to us. Measurement uncertainty is only provided upon request for accredited tests. Statements of conformity are based on simple acceptance criteria without taking measurement uncertainty into account, unless otherwise requested in writing. You have 60 days from date of issuance of this report to notify us of any material error or omission caused by our negligence or if you require measurement uncertainty; provided, however, that such notice shall be in writing and shall specifically address the issue you wish to raise. A failure to raise such issue within the prescribed time shall constitute your unqualified acceptance of the completeness of this report, the tests conducted and the correctness of the report contents.

## Table of Contents

<b>Release Control Record .....</b>	<b>4</b>
<b>1 Certificate.....</b>	<b>5</b>
<b>2 Summary of Test Results .....</b>	<b>6</b>
2.1 Measurement Uncertainty .....	6
2.2 Supplementary Information .....	6
<b>3 General Information .....</b>	<b>7</b>
3.1 General Description .....	7
3.2 Antenna Description of EUT .....	8
3.3 Channel List.....	8
3.4 Power Setting .....	9
3.5 Test Mode Applicability and Tested Channel Detail.....	10
3.6 Duty Cycle of Test Signal.....	11
3.7 Test Program Used and Operation Descriptions .....	13
3.8 Connection Diagram of EUT and Peripheral Devices .....	13
3.9 Configuration of Peripheral Devices and Cable Connections .....	15
<b>4 Test Instruments .....</b>	<b>16</b>
4.1 RF Output Power.....	16
4.2 Power Spectral Density .....	16
4.3 6 dB Bandwidth .....	16
4.4 Conducted Out of Band Emissions .....	16
4.5 AC Power Conducted Emissions .....	17
4.6 Unwanted Emissions below 1 GHz .....	18
4.7 Unwanted Emissions above 1 GHz.....	19
<b>5 Limits of Test Items.....</b>	<b>20</b>
5.1 RF Output Power.....	20
5.2 Power Spectral Density .....	20
5.3 6 dB Bandwidth .....	20
5.4 Conducted Out of Band Emissions .....	20
5.5 AC Power Conducted Emissions .....	20
5.6 Unwanted Emissions below 1 GHz .....	20
5.7 Unwanted Emissions above 1 GHz.....	21
<b>6 Test Arrangements.....</b>	<b>22</b>
6.1 RF Output Power.....	22
6.1.1 Test Setup .....	22
6.1.2 Test Procedure.....	22
6.2 Power Spectral Density .....	22
6.2.1 Test Setup .....	22
6.2.2 Test Procedure.....	22
6.3 6 dB Bandwidth .....	23
6.3.1 Test Setup .....	23
6.3.2 Test Procedure.....	23
6.4 Conducted Out of Band Emissions .....	23
6.4.1 Test Setup .....	23
6.4.2 Test Procedure.....	23
6.5 AC Power Conducted Emissions .....	24
6.5.1 Test Setup .....	24
6.5.2 Test Procedure.....	24
6.6 Unwanted Emissions below 1 GHz .....	25
6.6.1 Test Setup .....	25
6.6.2 Test Procedure.....	26
6.7 Unwanted Emissions above 1 GHz.....	27
6.7.1 Test Setup .....	27
6.7.2 Test Procedure.....	27



<b>7</b>	<b>Test Results of Test Item .....</b>	<b>28</b>
7.1	RF Output Power .....	28
7.2	Power Spectral Density .....	30
7.3	6 dB Bandwidth .....	32
7.4	Conducted Out of Band Emissions .....	34
7.5	AC Power Conducted Emissions .....	37
7.6	Unwanted Emissions below 1 GHz .....	41
7.7	Unwanted Emissions above 1 GHz .....	45
<b>8</b>	<b>Pictures of Test Arrangements .....</b>	<b>57</b>
<b>9</b>	<b>Information of the Testing Laboratories .....</b>	<b>58</b>



## Release Control Record

Issue No.	Description	Date Issued
RFB DHL-WTW-P22030883	Original release.	2022/12/15

## 1 Certificate

**Product:** Smart Alarm Wireless Indoor Security Camera

**Brand:** **SimpliSafe**

**Test Model:** CM006

**Sample Status:** Engineering sample

**Applicant:** SimpliSafe Inc

**Test Date:** 2022/11/17 ~ 2022/11/30

**Standard:** 47 CFR FCC Part 15, Subpart C (Section 15.247)

**Measurement** ANSI C63.10-2013

**procedure:** KDB 558074 D01 15.247 Meas Guidance v05r02

The above equipment has been tested by **Bureau Veritas Consumer Products Services (H.K.) Ltd., Taoyuan Branch**, and found compliance with the requirement of the above standards. The test record, data evaluation & Equipment Under Test (EUT) configurations represented herein are true and accurate accounts of the measurements of the sample's RF characteristics under the conditions specified in this report.

## 2 Summary of Test Results

47 CFR FCC Part 15, Subpart C (Section 15.247)			
Standard / Clause	Test Item	Result	Remark
15.247(b)	RF Output Power	Pass	Meet the requirement of limit.
15.247(e)	Power Spectral Density	Pass	Meet the requirement of limit.
15.247(a)(2)	6 dB Bandwidth	Pass	Meet the requirement of limit.
15.247(d)	Conducted Out of Band Emissions	Pass	Meet the requirement of limit.
15.207	AC Power Conducted Emissions	Pass	Minimum passing margin is -12.90 dB at 0.44925 MHz
15.205 / 15.209 / 15.247(d)	Unwanted Emissions below 1 GHz	Pass	Minimum passing margin is -2.9 dB at 81.30 MHz
15.205 / 15.209 / 15.247(d)	Unwanted Emissions above 1 GHz	Pass	Minimum passing margin is -0.6 dB at 2390.00 MHz
15.203	Antenna Requirement	Pass	No antenna connector is used.

Note: Determining compliance based on the results of the compliance measurement, not taking into account measurement instrumentation uncertainty.

### 2.1 Measurement Uncertainty

Where relevant, the following measurement uncertainty levels have been estimated for tests performed on the EUT as specified in CISPR 16-4-2:

Measurement	Specification	Expanded Uncertainty (k=2) (±)
Conducted Out of Band Emissions	9 kHz ~ 40 GHz	2.63 dB
AC Power Conducted Emissions	150 kHz ~ 30 MHz	3.00 dB
Unwanted Emissions below 1 GHz	30 MHz ~ 1 GHz	5.7 dB
Unwanted Emissions above 1 GHz	1 GHz ~ 6 GHz	4.61 dB
	6 GHz ~ 18 GHz	5.41 dB
	18 GHz ~ 40 GHz	5.14 dB

The other instruments specified are routine verified to remain within the calibrated levels, no measurement uncertainty is required to be calculated.

### 2.2 Supplementary Information

There is not any deviation from the test standards for the test method, and no modifications required for compliance.

### 3 General Information

#### 3.1 General Description

Product	Smart Alarm Wireless Indoor Security Camera
Brand	<b>SimpliSafe</b>
Test Model	CM006
Status of EUT	Engineering sample
Power Supply Rating	4.2V Li battery 5Vdc from Micro USB port
Modulation Type	CCK, DQPSK, DBPSK for DSSS 64QAM, 16QAM, QPSK, BPSK for OFDM
Modulation Technology	DSSS, OFDM
Transfer Rate	802.11b: 11/5.5/2/1Mbps 802.11g: 54/48/36/24/18/12/9/6Mbps 802.11n: up to 72.2Mbps
Operating Frequency	2.412 GHz ~ 2.462 GHz
Number of Channel	802.11b, 802.11g, 802.11n (HT20): 11
Output Power	548.277 mW (27.39 dBm)
Data Cable Supplied	Micro-B USB cable (3m)

Note:

1. There are WiFi 2.4G and Sub-G 433MHz technology used for the EUT.
2. WiFi 2.4G and Sub-G 433MHz technologies cannot transmit at same time.
3. The above EUT information is declared by manufacturer and for more detailed features description, please refer to the manufacturer's specifications or user's manual.

### 3.2 Antenna Description of EUT

1. The antenna information is listed as below.

Antenna	Gain (dBi)	Antenna Type	Connector Type	Remark
ANT 1	1.35	FPC	IPEX	1TX Diversity
ANT 2	1.19	FPC	IPEX	

The maximum antenna gain is chosen for final test.

\* Detail antenna specification please refer to antenna datasheet and/or antenna measurement report.

2. The EUT provides 1 completed transmitter and 1 receiver.

Modulation Mode	TX Function	RX Function
802.11b	1TX	1RX
802.11g	1TX	1RX
802.11n (HT20)	1TX	1RX

### 3.3 Channel List

11 channels are provided for 802.11b, 802.11g, 802.11n (HT20):

Channel	Frequency	Channel	Frequency
1	2412 MHz	7	2442 MHz
2	2417 MHz	8	2447 MHz
3	2422 MHz	9	2452 MHz
4	2427 MHz	10	2457 MHz
5	2432 MHz	11	2462 MHz
6	2437 MHz		





### 3.4 Power Setting

#### Mode A

Mode: 11b							
Channel	Frequency (MHz)	Attribute	Power Setting (HEX)	Target_power (dBm)	per_rate_tbl (rate_index)	Channel offset (dBm)	Final Power FW setting (dBm)
		Source	QA Tool User input	$=(\text{Hex2Dec}(\text{Power Setting})) \times (1/2)$	QA Tool User input	efuse4 and efuse5 FW registers	$=\text{Target\_Power} + \text{rate index} + \text{Channel Offset}$
1	2412	-----	26	19	C0 == 0 dBm	0	19
6	2437	-----	26	19	C0 == 0 dBm	0	19
11	2462	-----	26	19	C0 == 0 dBm	0	19

Mode: 11g							
Channel	Frequency (MHz)	Attribute	Power Setting (HEX)	Target_power (dBm)	per_rate_tbl (rate_index)	Channel offset (dBm)	Final Power FW setting (dBm)
		Source	QA Tool User input	$=(\text{Hex2Dec}(\text{Power Setting})) \times (1/2)$	QA Tool User input	efuse4 and efuse5 FW registers	$=\text{Target\_Power} + \text{rate index} + \text{Channel Offset}$
1	2412	-----	26	19	82 == -1 dBm	0	18
6	2437	-----	26	19	82 == -1 dBm	0	18
11	2462	-----	26	19	82 == -1 dBm	0	18

Mode: 11n							
Channel	Frequency (MHz)	Attribute	Power Setting (HEX)	Target_power (dBm)	per_rate_tbl (rate_index)	Channel offset (dBm)	Final Power FW setting (dBm)
		Source	QA Tool User input	$=(\text{Hex2Dec}(\text{Power Setting})) \times (1/2)$	QA Tool User input	efuse4 and efuse5 FW registers	$=\text{Target\_Power} + \text{rate index} + \text{Channel Offset}$
1	2412	-----	26	19	84 == -2 dBm	0	17
6	2437	-----	26	19	84 == -2 dBm	0	17
11	2462	-----	24	18	84 == -2 dBm	0	16

### 3.5 Test Mode Applicability and Tested Channel Detail

Pre-Scan:	<p>1. For Conducted power WIFI setting of EUT is Diversity. Pre-scan ANT 1 / ANT 2 and find the worst case as a representative test condition.</p> <p>2. EUT can be used in the following ways: XYZ 3-axis. Pre-scan in these ways and find the worst case as a representative test condition.</p> <p>3. For Unwanted Emission below 1 GHz has Adapter / Laptop mode of power supply. Pre-scan these modes and find the worst charging case as a representative test condition.</p>
Worst Case:	<p>1. For Conducted power WIFI setting of EUT is Diversity. ANT 1 is the worst case as a representative test condition.</p> <p>2. X/ Y/ Z Worst Condition: Z Axis for Unwanted Emission above 1GHz and Unwanted Emission below 1GHz.</p> <p>3. For Unwanted Emission below 1 GHz Charging with Adapter mode is the worst charging case of power supply.</p>

Following channel(s) was (were) selected for the final test as listed below:

Test Item	EUT Configure Mode	Mode	Signal Mode	Tested Channel	Modulation	Data Rate Parameter
RF Output Power / Power Spectral Density	A	802.11b	CDD	1, 6, 11	DBPSK	1Mb/s
		802.11g	CDD	1, 6, 11	BPSK	6Mb/s
		802.11n (HT20)	CDD	1, 6, 11	BPSK	MCS0
6 dB Bandwidth / Conducted Out of Band Emissions	A	802.11b	CDD	1, 6, 11	DBPSK	1Mb/s
		802.11g	CDD	1, 6, 11	BPSK	6Mb/s
		802.11n (HT20)	CDD	1, 6, 11	BPSK	MCS0
AC Power Conducted Emissions	B	Charging	-	-	-	-
	C	Charging	-	-	-	-
Unwanted Emissions below 1 GHz	A	802.11g	CDD	1	BPSK	6Mb/s
	B	Charging	-	-	-	-
Unwanted Emissions above 1 GHz	A	802.11b	CDD	1, 6, 11	DBPSK	1Mb/s
		802.11g	CDD	1, 6, 11	BPSK	6Mb/s
		802.11n (HT20)	CDD	1, 6, 11	BPSK	MCS0
EUT Configure Mode:	A	Battery				
	B	Charging with Adapter				
	C	Charging with Laptop				

### 3.6 Duty Cycle of Test Signal

#### Mode A

**802.11b:** Duty cycle = 100 ms / 100 ms x 100% = 100.0%

**802.11g:** Duty cycle = 100 ms / 100 ms x 100% = 100.0%

**802.11n (HT20):** Duty cycle = 100 ms / 100 ms x 100% = 100.0%

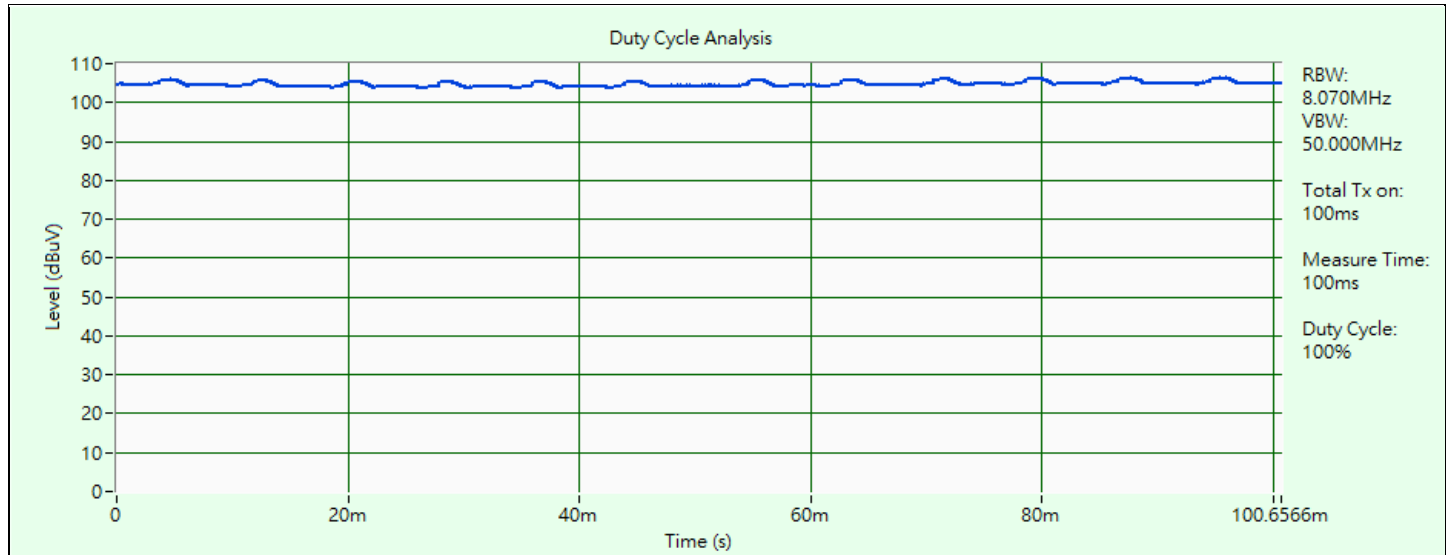

802.11b

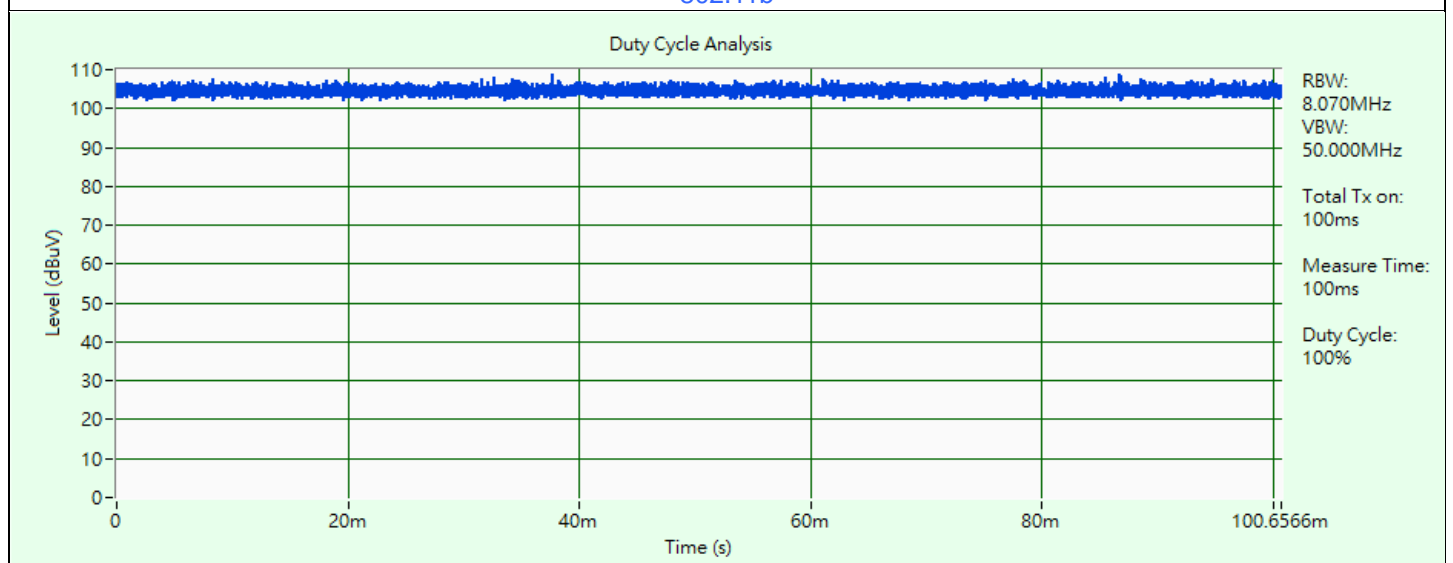

802.11g

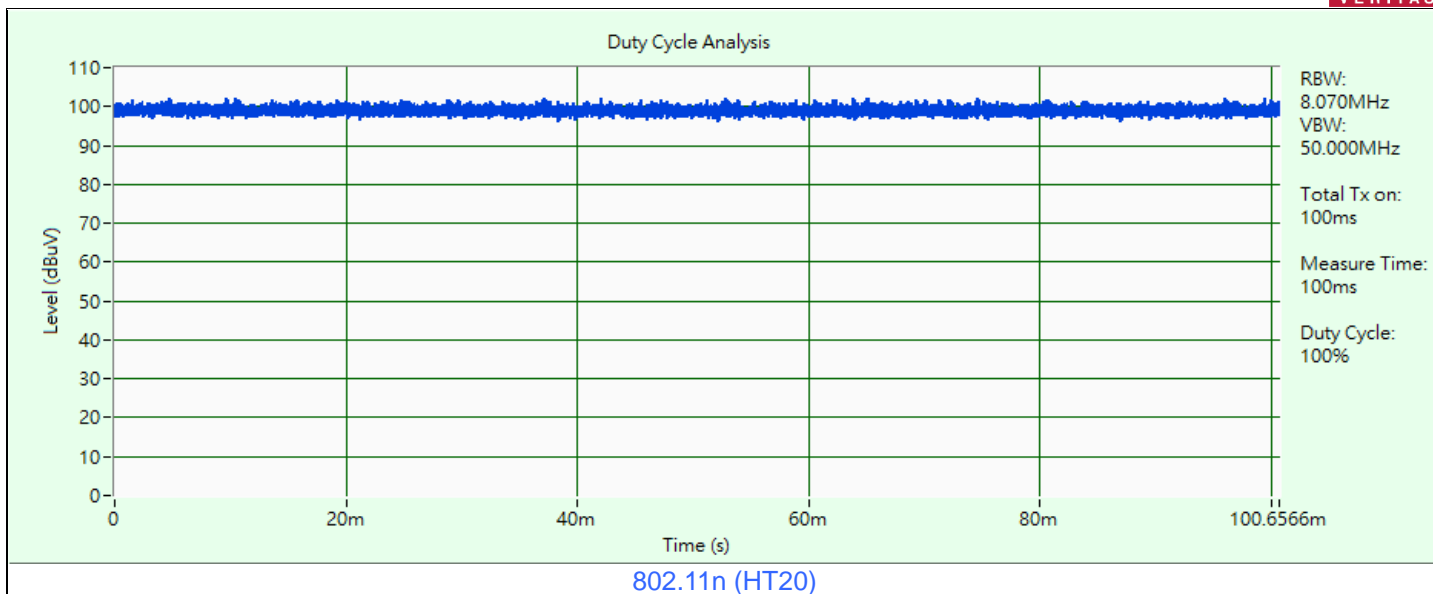

### 3.7 Test Program Used and Operation Descriptions

Controlling software (WiFi\_QA\_Tool\_v3.2.8) has been activated to set the EUT under transmission condition continuously at specific channel frequency.

### 3.8 Connection Diagram of EUT and Peripheral Devices

Mode A



-----  
**Under Table**

Mode B

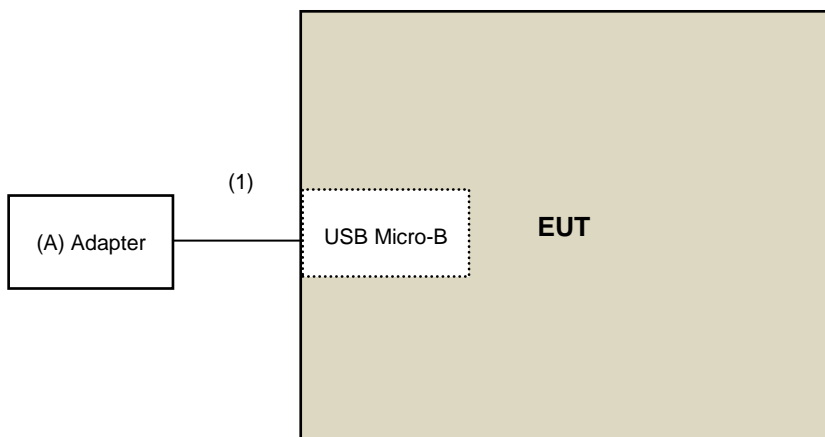

-----  
**Under Table**

Mode C

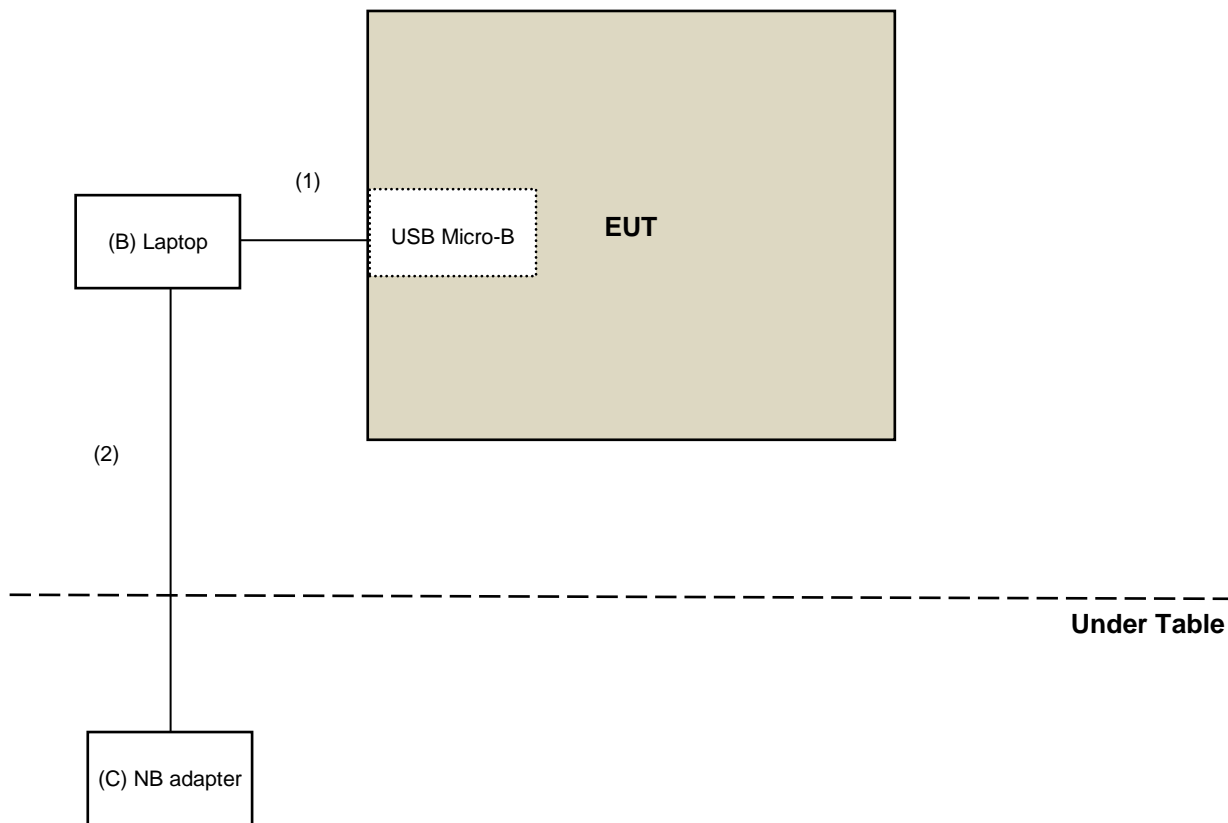

### 3.9 Configuration of Peripheral Devices and Cable Connections

ID	Product	Brand	Model No.	Serial No.	FCC ID	Remarks
A	Adapter	Ktec	KSC-10A-050150HU	N/A	N/A	Supplied by applicant
B	Laptop	Lenovo	80WG	YD01YRC9	N/A	Provided by Lab
C	NB adapter	Lenovo	PA-1450-55LL	N/A	N/A	Provided by Lab

ID	Cable Descriptions	Qty.	Length (m)	Shielding (Yes/No)	Cores (Qty.)	Remarks
1	Micro-B USB cable	1	3	N	0	Accessory of EUT
2	NB Adapter Cable	1	1.8	N	0	Provided by Lab

## 4 Test Instruments

The calibration interval of the all test instruments are 12 months and the calibrations are traceable to NML/ROC and NIST/USA.

### 4.1 RF Output Power

Description Manufacturer	Model No.	Serial No.	Calibrated Date	Calibrated Until
MIMO Powermeasurement Test set (4X4) KEYSIGHT	U2021XA	U2021XA_001	2022/6/13	2023/6/12
MXG Vector Signal Generator KEYSIGHT	N5182B	MY53052658	2022/5/9	2023/5/8
Power Meter Anritsu	ML2495A	1232003	2022/1/9	2023/1/8
Power Sensor Anritsu	MA2411B	1207333	2022/1/9	2023/1/8
Spectrum Analyzer KEYSIGHT	N9030A	MY54490260	2022/7/14	2023/7/13
Spectrum Analyzer R&S	FSV40	101042	2022/9/5	2023/9/4
		101544	2022/5/9	2023/5/8
Temperature & Humidity Chamber TERCHY	MHU-225AU	920409	2022/6/27	2023/6/26
Voltage Meter FLUKE	179	89610322	2022/10/3	2023/10/2

Notes:

1. The test was performed in LK - Oven
2. Tested Date: 2022/11/25

### 4.2 Power Spectral Density

Refer to section 4.1 to get information of the instruments.

### 4.3 6 dB Bandwidth

Refer to section 4.1 to get information of the instruments.

### 4.4 Conducted Out of Band Emissions

Refer to section 4.1 to get information of the instruments.



#### 4.5 AC Power Conducted Emissions

Description Manufacturer	Model No.	Serial No.	Calibrated Date	Calibrated Until
50 ohm terminal LYNICS	0900510	E1-011285	2022/9/19	2023/9/18
		E1-011286	2022/9/19	2023/9/18
50 Ohms Terminator LYNICS	0900510	E1-01-305	2022/2/9	2023/2/8
Attenuator STI	STI02-2200-10	NO.4	2022/9/2	2023/9/1
DC LISN R&S	ESH3-Z6	100219	2022/8/2	2023/8/1
		844950/018	2022/8/2	2023/8/1
DC LISN Schwarzbeck	NNLK 8121	8121-808	2022/4/29	2023/4/28
High Voltage Probe Schwarzbeck	TK9420	00982	2021/12/24	2022/12/23
Isolation Transformer Erika Fiedler	D-65396	017	2022/9/8	2023/9/7
LISN R&S	ENV216	101196	2022/5/24	2023/5/23
LISN Schwarzbeck	NNLK 8121	8121-731	2022/5/26	2023/5/25
		8121-00759	2022/8/18	2023/8/17
	NNLK8129	8129229	2022/6/8	2023/6/7
	NSLK 8128	8128-244	2022/11/8	2023/11/7
RF Coaxial Cable Commate	5D-FB	Cable-CO5-01	2022/1/28	2023/1/27
Software BVADT	Cond_V7.3.7.4	N/A	N/A	N/A
Test Receiver R&S	ESR3	102412	2022/1/22	2023/1/21

Notes:

1. The test was performed in Linkou Conduction 5.
2. Tested Date: 2022/11/30

#### 4.6 Unwanted Emissions below 1 GHz

Description Manufacturer	Model No.	Serial No.	Calibrated Date	Calibrated Until
* LOOP ANTENNA EMCI	LPA600	270	2021/9/2	2023/9/1
Bi_Log Antenna Schwarzbeck	VULB 9168	137	2022/10/21	2023/10/20
Coupling/Dcoupling Network Schwarzbeck	CDNE-M2	00097	2022/6/1	2023/5/31
	CDNE-M3	00091	2022/6/1	2023/5/31
Pre_Amplifier HP	8447D	2432A03504	2022/2/17	2023/2/16
RF Coaxial Cable Pacific	8D-FB	Cable-CH6-02	2022/6/30	2023/6/29
Software BVADT	Radiated_V7.7.1.1.1	N/A	N/A	N/A
	Radiated_V8.7.08	N/A	N/A	N/A
Spectrum Analyzer R&S	FSV40	101544	2022/5/9	2023/5/8
Test Receiver Agilent	N9038A	MY51210129	2022/4/8	2023/4/7
		MY51210137	2022/6/9	2023/6/8
Tower ADT	AT100	0306	N/A	N/A
Turn Table ADT	TT100	0306	N/A	N/A

Notes:

- \* The calibration interval of the above test instruments is 24 months and the calibrations are traceable to NML/ROC and NIST/USA
- The test was performed in Linkou 966 Chamber 6 (CH 6) , The test site validated date: 2021/11/4 (NSA)
- Tested Date: 2022/11/18 ~ 2022/11/28

#### 4.7 Unwanted Emissions above 1 GHz

Description Manufacturer	Model No.	Serial No.	Calibrated Date	Calibrated Until
Band Pass Filter MICRO-TRONICS	BRM17690	005	2022/5/26	2023/5/25
Boresight antenna tower fixture BV	BAF-02	6	N/A	N/A
High Pass Filter Wainwright Instruments	WHK 3.1/18G-10SS	SN 8	2022/5/26	2023/5/25
Horn Antenna EMCO	3115	00027024	2022/11/13	2023/11/12
		00028257	2022/11/13	2023/11/12
Horn Antenna ETS-Lindgren	3117-PA	00215857	2022/11/13	2023/11/12
Horn Antenna Schwarzbeck	BBHA 9170	212	2022/10/20	2023/10/19
Notch Filter MICRO-TRONICS	BRC50703-01	010	2022/5/26	2023/5/25
Pre-amplifier HP	8449B	3008A01201	2022/2/17	2023/2/16
Pre-amplifier (18GHz-40GHz) EMCI	EMC184045B	980175	2022/9/3	2023/9/2
Pre_Amplifier EMCI	EMC0126545	980076	2022/2/17	2023/2/16
	EMC184045B	980235	2022/2/17	2023/2/16
RF Coaxial Cable EM	EM102-KMKM-3.5+1M	EM102-KMKM-3.5+1M-01	2022/7/7	2023/7/6
RF Coaxial Cable HUBER SUHNER	SF-104	Cable-CH6-01	2022/9/20	2023/9/19
Software BVADT	Radiated_V7.7.1.1.1	N/A	N/A	N/A
	Radiated_V8.7.08	N/A	N/A	N/A
Spectrum Analyzer Agilent	E4446A	MY51100009	2022/6/27	2023/6/26
Spectrum Analyzer KEYSIGHT	N9030A	MY54490260	2022/7/14	2023/7/13
Spectrum Analyzer R&S	FSV40	101042	2022/9/5	2023/9/4
		101544	2022/5/9	2023/5/8
Test Receiver Agilent	N9038A	MY51210129	2022/4/8	2023/4/7
		MY51210137	2022/6/9	2023/6/8
Tower ADT	AT100	0306	N/A	N/A
Turn Table ADT	TT100	0306	N/A	N/A

Notes:

1. The test was performed in Linkou 966 Chamber 6 (CH 6).
2. Tested Date: 2022/11/17

## 5 Limits of Test Items

### 5.1 RF Output Power

For systems using digital modulation in the 2400–2483.5 MHz bands: 1 Watt (30 dBm)

### 5.2 Power Spectral Density

The Maximum of Power Spectral Density Measurement is 8 dBm in any 3 kHz.

### 5.3 6 dB Bandwidth

The minimum of 6 dB Bandwidth Measurement is 0.5 MHz.

### 5.4 Conducted Out of Band Emissions

Below 20 dB of the highest emission level of operating band (in 100 kHz Resolution Bandwidth).

### 5.5 AC Power Conducted Emissions

Frequency (MHz)	Conducted Limit (dBuV)	
	Quasi-peak	Average
0.15 - 0.5	66 - 56	56 - 46
0.50 - 5.0	56	46
5.0 - 30.0	60	50

Notes:

1. The lower limit shall apply at the transition frequencies.
2. The limit decreases in line with the logarithm of the frequency in the range of 0.15 to 0.50 MHz.

### 5.6 Unwanted Emissions below 1 GHz

Radiated emissions up to 1 GHz which fall in the restricted bands must comply with the radiated emission limits specified as below table. Other emissions shall be at least 20 dB below the highest level of the desired power:

Frequencies (MHz)	Field Strength (microvolts/meter)	Measurement Distance (meters)
0.009 ~ 0.490	2400/F(kHz)	300
0.490 ~ 1.705	24000/F(kHz)	30
1.705 ~ 30.0	30	30
30 ~ 88	100	3
88 ~ 216	150	3
216 ~ 960	200	3
Above 960	500	3

Notes:

3. The lower limit shall apply at the transition frequencies.
4. Emission level (dBuV/m) = 20 log Emission level (uV/m).

## 5.7 Unwanted Emissions above 1 GHz

Radiated emissions above 1 GHz which fall in the restricted bands must comply with the radiated emission limits specified as below table. Other emissions shall be at least 20 dB below the highest level of the desired power:

Frequencies (MHz)	Field Strength (microvolts/meter)	Measurement Distance (meters)
Above 960	500	3

### Notes:

5. The lower limit shall apply at the transition frequencies.
6. Emission level (dBuV/m) = 20 log Emission level (uV/m).
7. For frequencies above 1000 MHz, the field strength limits are based on average detector, however, the peak field strength of any emission shall not exceed the maximum permitted average limits, specified above by more than 20 dB under any condition of modulation.

## 6 Test Arrangements

### 6.1 RF Output Power

#### 6.1.1 Test Setup

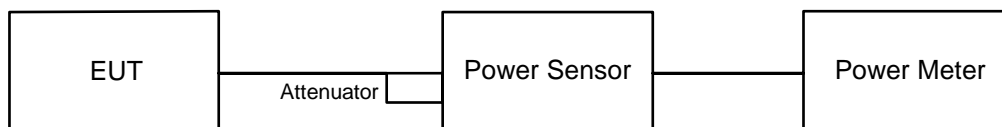

#### 6.1.2 Test Procedure

##### Peak Power:

A peak power sensor was used on the output port of the EUT. A power meter was used to read the response of the peak power sensor. Record the power level.

##### Average Power:

Average power sensor was used to perform output power measurement, trigger and gating function of wide band power meter is enabled to measure max output power of TX on burst. Duty factor is not added to measured value.

### 6.2 Power Spectral Density

#### 6.2.1 Test Setup

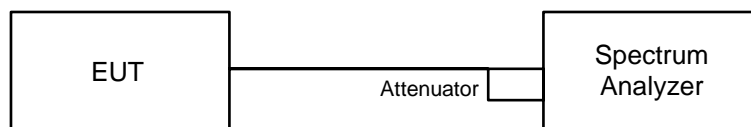

#### 6.2.2 Test Procedure

- a. Set analyzer center frequency to DTS channel center frequency.
- b. Set the span to 1.5 times the DTS bandwidth.
- c. Set the RBW to: 3 kHz.
- d. Set the VBW  $\geq 3 \times$  RBW.
- e. Detector = peak.
- f. Sweep time = auto couple.
- g. Trace mode = max hold.
- h. Allow trace to fully stabilize.
- i. Use the peak marker function to determine the maximum amplitude level within the RBW.

### 6.3 6 dB Bandwidth

#### 6.3.1 Test Setup

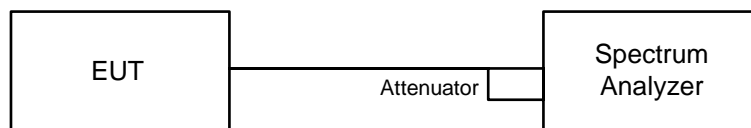

#### 6.3.2 Test Procedure

- Set resolution bandwidth (RBW) = 100 kHz.
- Set the video bandwidth (VBW)  $\geq 3 \times$  RBW, Detector = Peak.
- Trace mode = max hold.
- Sweep = auto couple.
- Measure the maximum width of the emission that is constrained by the frequencies associated with the two amplitude points (upper and lower) that are attenuated by 6 dB relative to the maximum level measured in the fundamental emission.

### 6.4 Conducted Out of Band Emissions

#### 6.4.1 Test Setup



#### 6.4.2 Test Procedure

##### MEASUREMENT PROCEDURE REF

- Set the RBW = 100 kHz.
- Set the VBW  $\geq 300$  kHz.
- Detector = peak.
- Sweep time = auto couple.
- Trace mode = max hold.
- Allow trace to fully stabilize.
- Use the peak marker function to determine the maximum power level in any 100 kHz band segment within the fundamental EBW.

##### MEASUREMENT PROCEDURE OOBE

- Set RBW = 100 kHz.
- Set VBW  $\geq 300$  kHz.
- Detector = peak.
- Sweep = auto couple.
- Trace Mode = max hold.
- Allow trace to fully stabilize.
- Use the peak marker function to determine the maximum amplitude level.

## 6.5 AC Power Conducted Emissions

### 6.5.1 Test Setup

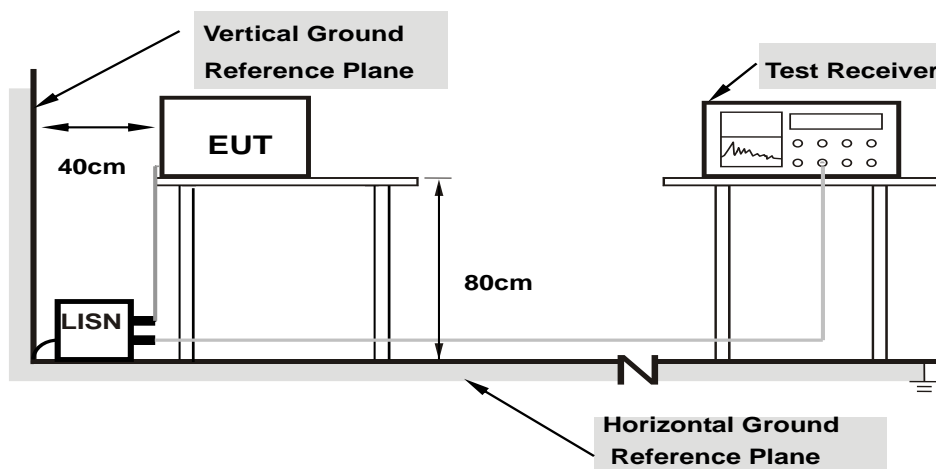

**Note: 1.Support units were connected to second LISN.**

For the actual test configuration, please refer to the attached file (Test Setup Photo).

### 6.5.2 Test Procedure

- The EUT was placed on a 0.8 meter to the top of table and placed 0.4 meters from the conducting wall of the shielded room with EUT being connected to the power mains through a line impedance stabilization network (LISN). Other support units were connected to the power mains through another LISN. The two LISNs provide 50 ohm/ 50 uH of coupling impedance for the measuring instrument.
- Both lines of the power mains connected to the EUT were checked for maximum conducted interference.
- The frequency range from 150 kHz to 30 MHz was searched. Emission levels under (Limit – 20 dB) was not recorded.

Note: The resolution bandwidth and video bandwidth of test receiver is 9 kHz for quasi-peak detection (QP) and average detection (AV) at frequency 0.15 MHz-30 MHz.



## 6.6 Unwanted Emissions below 1 GHz

### 6.6.1 Test Setup

#### For Radiated emission below 30 MHz

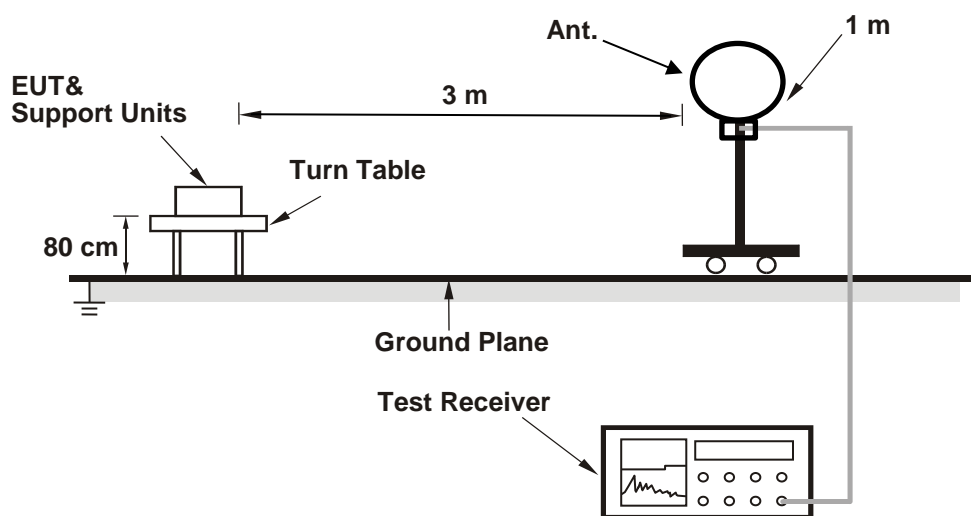

#### For Radiated emission above 30 MHz

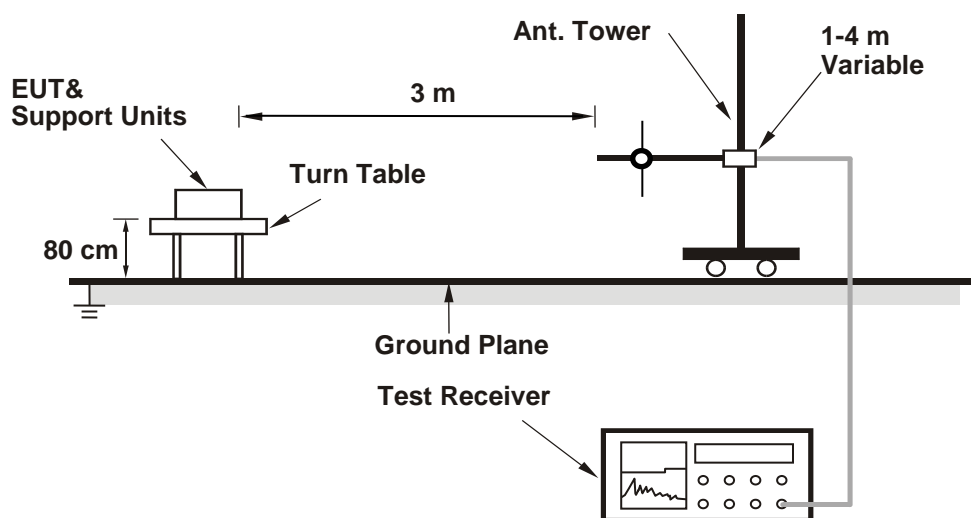

For the actual test configuration, please refer to the attached file (Test Setup Photo).

## 6.6.2 Test Procedure

### For Radiated emission below 30 MHz

- a. The EUT was placed on the top of a rotating table 0.8 meters above the ground at 3 meter chamber room for test. The table was rotated 360 degrees to determine the position of the highest radiation.
- b. The EUT was set 3 meters away from the interference-receiving antenna, which was mounted on the top of a variable-height antenna tower.
- c. Parallel, perpendicular, and ground-parallel orientations of the antenna are set to make the measurement.
- d. For each suspected emission, the EUT was arranged to its worst case and the rotatable table was turned from 0 degrees to 360 degrees to find the maximum reading.
- e. The test-receiver system was set to Quasi-Peak Detect Function and Specified Bandwidth with Maximum Hold Mode, except for the frequency band (9 kHz to 90 kHz and 110 kHz to 490 kHz) set to average detect function and peak detect function.

#### Notes:

1. The resolution bandwidth and video bandwidth of test receiver/spectrum analyzer is 200 Hz at frequency below 150 kHz.
2. The resolution bandwidth and video bandwidth of test receiver/spectrum analyzer is 9 kHz or 10 kHz at frequency (150 kHz to 30 MHz).
3. All modes of operation were investigated and the worst-case emissions are reported.

### For Radiated emission above 30 MHz

- a. The EUT was placed on the top of a rotating table 0.8 meters above the ground at 3 meter chamber room for test. The table was rotated 360 degrees to determine the position of the highest radiation.
- b. The EUT was set 3 meters away from the interference-receiving antenna, which was mounted on the top of a variable-height antenna tower.
- c. The height of antenna is varied from one meter to four meters above the ground to determine the maximum value of the field strength. Both horizontal and vertical polarizations of the antenna are set to make the measurement.
- d. For each suspected emission, the EUT was arranged to its worst case and then the antenna was tuned to heights from 1 meter to 4 meters and the rotatable table was turned from 0 degrees to 360 degrees to find the maximum reading.
- e. The test-receiver system was set to quasi-peak detect function and specified bandwidth with maximum hold mode when the test frequency is below 1 GHz.

#### Notes:

1. The resolution bandwidth and video bandwidth of test receiver/spectrum analyzer is 120 kHz for Quasi-peak detection (QP) at frequency below 1 GHz.
2. All modes of operation were investigated and the worst-case emissions are reported.

## 6.7 Unwanted Emissions above 1 GHz

### 6.7.1 Test Setup

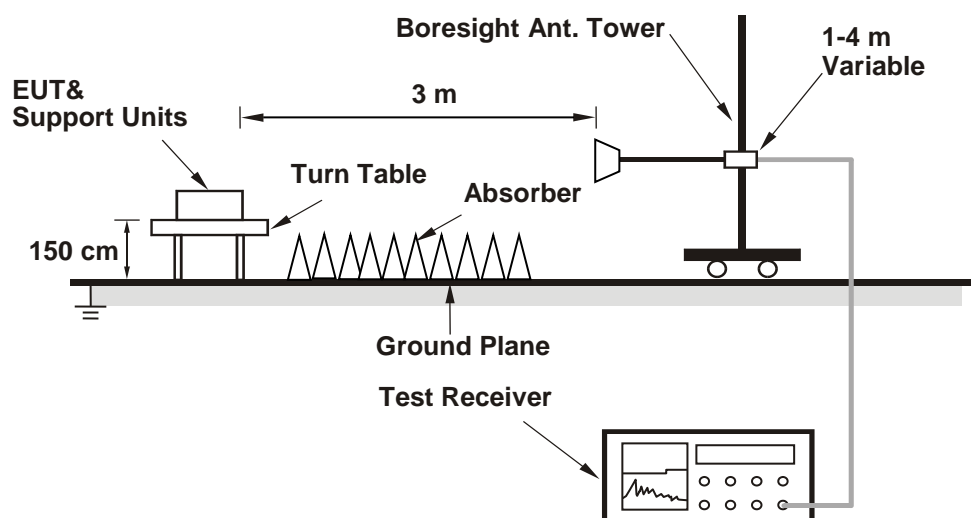

For the actual test configuration, please refer to the attached file (Test Setup Photo).

### 6.7.2 Test Procedure

- The EUT was placed on the top of a rotating table 1.5 meters above the ground at 3 meter chamber room for test. The table was rotated 360 degrees to determine the position of the highest radiation.
- The EUT was set 3 meters away from the interference-receiving antenna, which was mounted on the top of a variable-height antenna tower.
- The height of antenna is varied from one meter to four meters above the ground to determine the maximum value of the field strength. Both horizontal and vertical polarizations of the antenna are set to make the measurement.
- For each suspected emission, the EUT was arranged to its worst case and then the antenna was tuned to heights from 1 meter to 4 meters and the rotatable table was turned from 0 degrees to 360 degrees to find the maximum reading.
- The test-receiver system was set to peak and average detects function and specified bandwidth with maximum hold mode when the test frequency is above 1 GHz. If the peak reading value also meets average limit, measurement with the average detector is unnecessary.

#### Notes:

- The resolution bandwidth of test receiver/spectrum analyzer is 1 MHz and the video bandwidth is 3 MHz for Peak detection (PK) and Average detection (AV) at frequency above 1 GHz.
- For fundamental and harmonic signal measurement, the resolution bandwidth of test receiver/spectrum analyzer is 1 MHz and the video bandwidth is  $\geq 1/T$  (Duty cycle  $< 98\%$ ) or 10 Hz (Duty cycle  $\geq 98\%$ ) for Average detection (AV) at frequency above 1 GHz.
- All modes of operation were investigated and the worst-case emissions are reported.

## 7 Test Results of Test Item

### 7.1 RF Output Power

Input Power:	4.2 Vdc	Environmental Conditions:	25°C, 76% RH	Tested By:	Dalen Dai
--------------	---------	---------------------------	--------------	------------	-----------

#### Mode A

#### For Peak Power

##### 802.11b

Chan.	Chan. Freq. (MHz)	Peak Power (mW)	Peak Power (dBm)	Power Limit (dBm)	Test Result
1	2412	184.077	22.65	30	Pass
6	2437	170.216	22.31	30	Pass
11	2462	152.055	21.82	30	Pass

Note: The antenna gain is 1.35 dBi < 6 dBi, so the output power limit shall not be reduced.

##### 802.11g

Chan.	Chan. Freq. (MHz)	Peak Power (mW)	Peak Power (dBm)	Power Limit (dBm)	Test Result
1	2412	548.277	27.39	30	Pass
6	2437	538.27	27.31	30	Pass
11	2462	500.035	26.99	30	Pass

Note: The antenna gain is 1.35 dBi < 6 dBi, so the output power limit shall not be reduced.

##### 802.11n (HT20)

Chan.	Chan. Freq. (MHz)	Peak Power (mW)	Peak Power (dBm)	Power Limit (dBm)	Test Result
1	2412	447.713	26.51	30	Pass
6	2437	444.631	26.48	30	Pass
11	2462	274.789	24.39	30	Pass

Note: The antenna gain is 1.35 dBi < 6 dBi, so the output power limit shall not be reduced.

## For Average Power

### 802.11b

Chan.	Chan. Freq. (MHz)	Average Power (mW)	Average Power (dBm)
1	2412	113.24	20.54
6	2437	104.954	20.21
11	2462	93.541	19.71

### 802.11g

Chan.	Chan. Freq. (MHz)	Average Power (mW)	Average Power (dBm)
1	2412	86.099	19.35
6	2437	83.56	19.22
11	2462	71.614	18.55

### 802.11n (HT20)

Chan.	Chan. Freq. (MHz)	Average Power (mW)	Average Power (dBm)
1	2412	67.764	18.31
6	2437	67.608	18.30
11	2462	42.364	16.27

## 7.2 Power Spectral Density

Input Power:	4.2 Vdc	Environmental Conditions:	25°C, 76% RH	Tested By:	Dalen Dai
--------------	---------	---------------------------	--------------	------------	-----------

### Mode A

#### 802.11b

TX chain	Channel	Freq. (MHz)	PSD (dBm/3kHz)	PSD Limit (dBm/3kHz)	Pass / Fail
Chain 0	1	2412	-3.97	8	Pass
	6	2437	-5.65	8	Pass
	11	2462	-5.73	8	Pass

Note: The antenna gain is 1.35 dBi < 6 dBi, so the power density limit shall not be reduced.

#### 802.11g

TX chain	Channel	Freq. (MHz)	PSD (dBm/3kHz)	PSD Limit (dBm/3kHz)	Pass / Fail
Chain 0	1	2412	-7.79	8	Pass
	6	2437	-8.46	8	Pass
	11	2462	-8.2	8	Pass

Note: The antenna gain is 1.35 dBi < 6 dBi, so the power density limit shall not be reduced.

#### 802.11n (HT20)

TX chain	Channel	Freq. (MHz)	PSD (dBm/3kHz)	PSD Limit (dBm/3kHz)	Pass / Fail
Chain 0	1	2412	-6.9	8	Pass
	6	2437	-7.68	8	Pass
	11	2462	-9.55	8	Pass

Note: The antenna gain is 1.35 dBi < 6 dBi, so the power density limit shall not be reduced.

### Spectrum Plot of Maximum Value

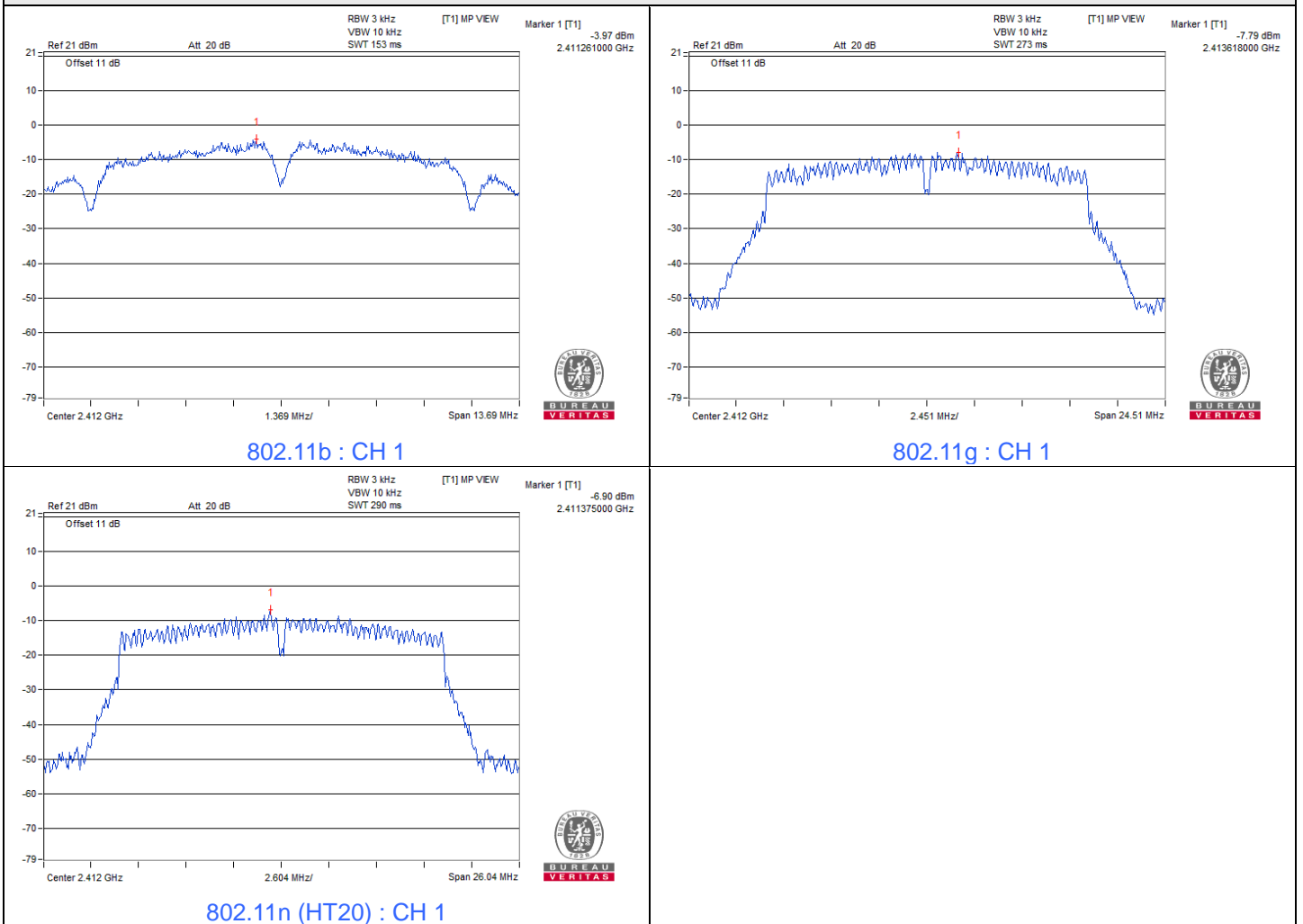

### 7.3 6 dB Bandwidth

Input Power:	4.2 Vdc	Environmental Conditions:	25°C, 76% RH	Tested By:	Dalen Dai
--------------	---------	---------------------------	--------------	------------	-----------

#### Mode A

##### 802.11b

Channel	Frequency (MHz)	6dB Bandwidth (MHz)	Minimum Limit (MHz)	Test Result
1	2412	9.13	0.5	Pass
6	2437	9.1	0.5	Pass
11	2462	9.13	0.5	Pass

##### 802.11g

Channel	Frequency (MHz)	6dB Bandwidth (MHz)	Minimum Limit (MHz)	Test Result
1	2412	16.34	0.5	Pass
6	2437	16.35	0.5	Pass
11	2462	16.36	0.5	Pass

##### 802.11n (HT20)

Channel	Frequency (MHz)	6dB Bandwidth (MHz)	Minimum Limit (MHz)	Test Result
1	2412	17.36	0.5	Pass
6	2437	17.6	0.5	Pass
11	2462	17.36	0.5	Pass





### Spectrum Plot of Minimum Value

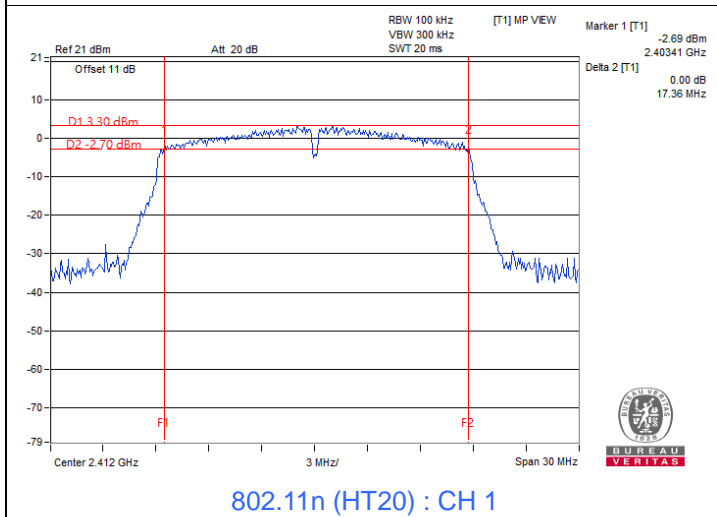
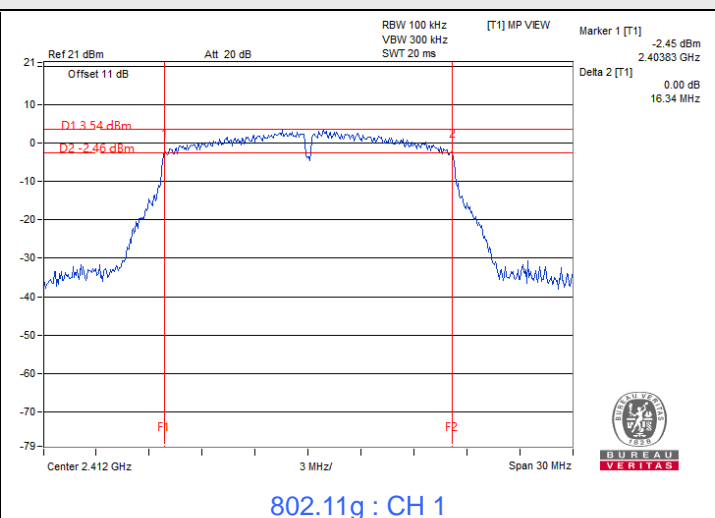
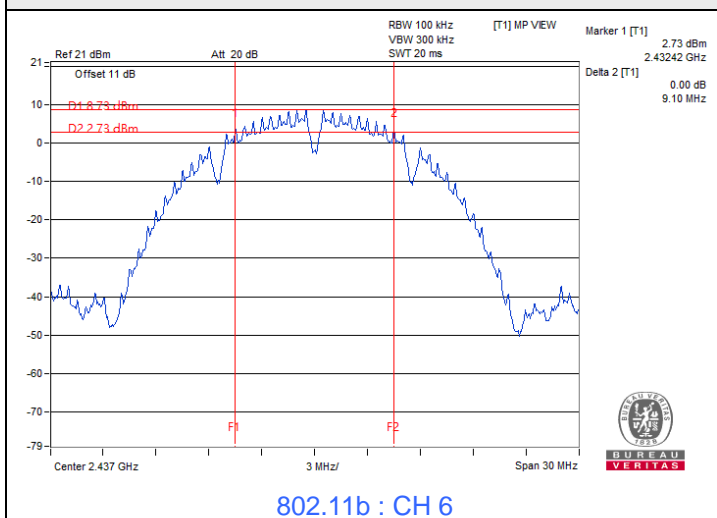



BUREAU VERITAS

### 7.4 Conducted Out of Band Emissions

Input Power:	4.2 Vdc	Environmental Conditions:	25°C, 76% RH	Tested By:	Dalen Dai
--------------	---------	---------------------------	--------------	------------	-----------

#### Mode A

#### 802.11b

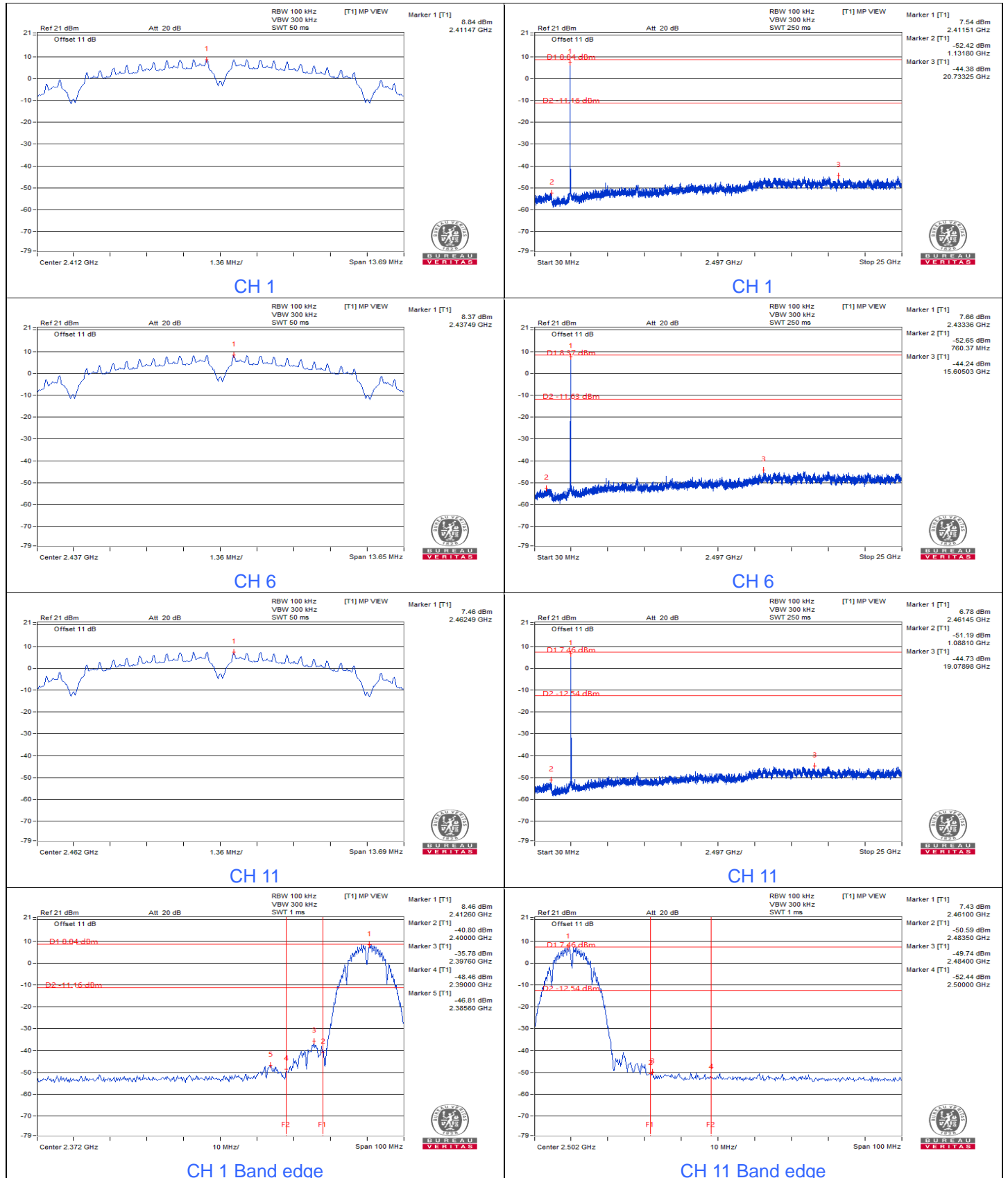

802.11g

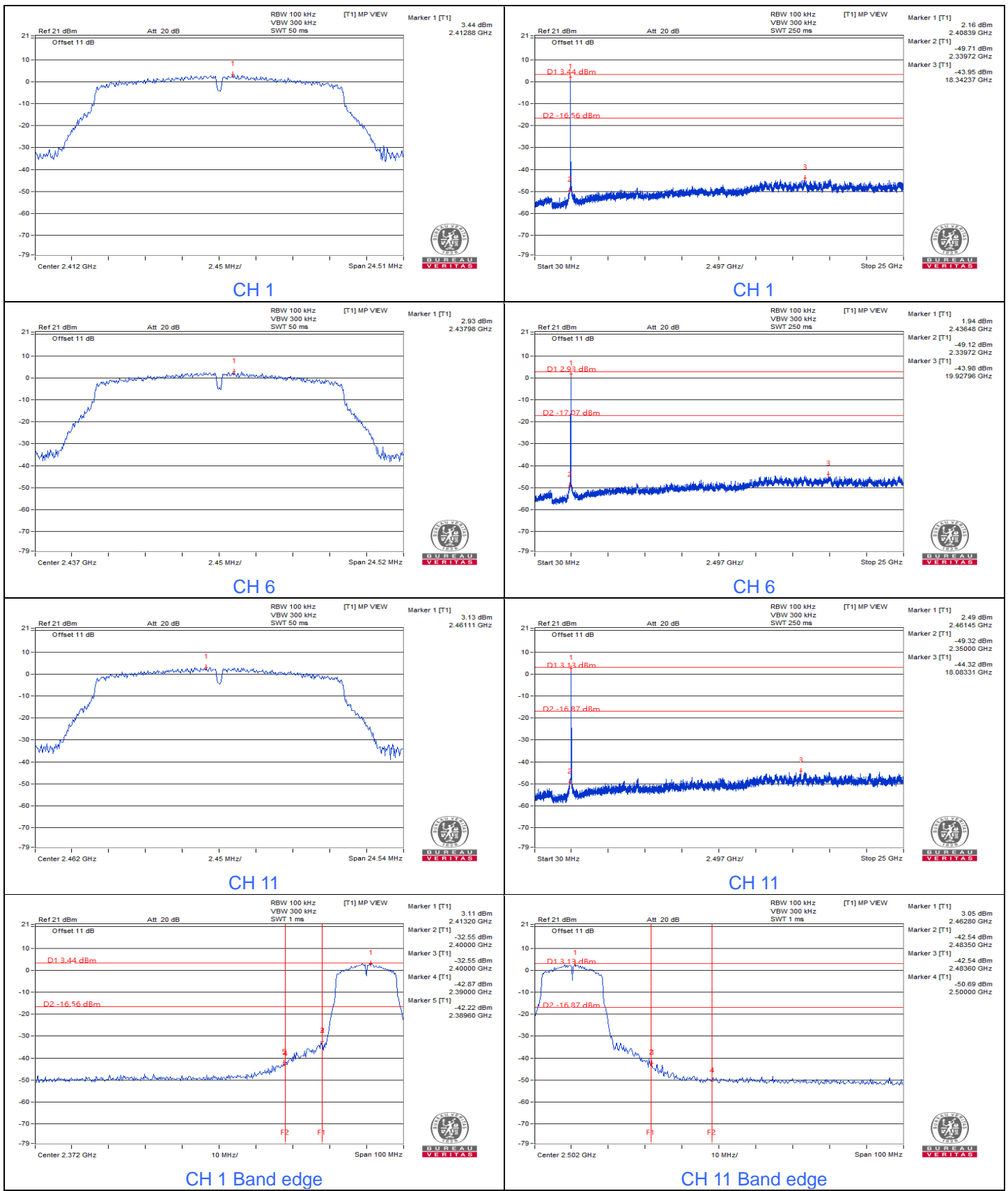



### 802.11n (HT20)

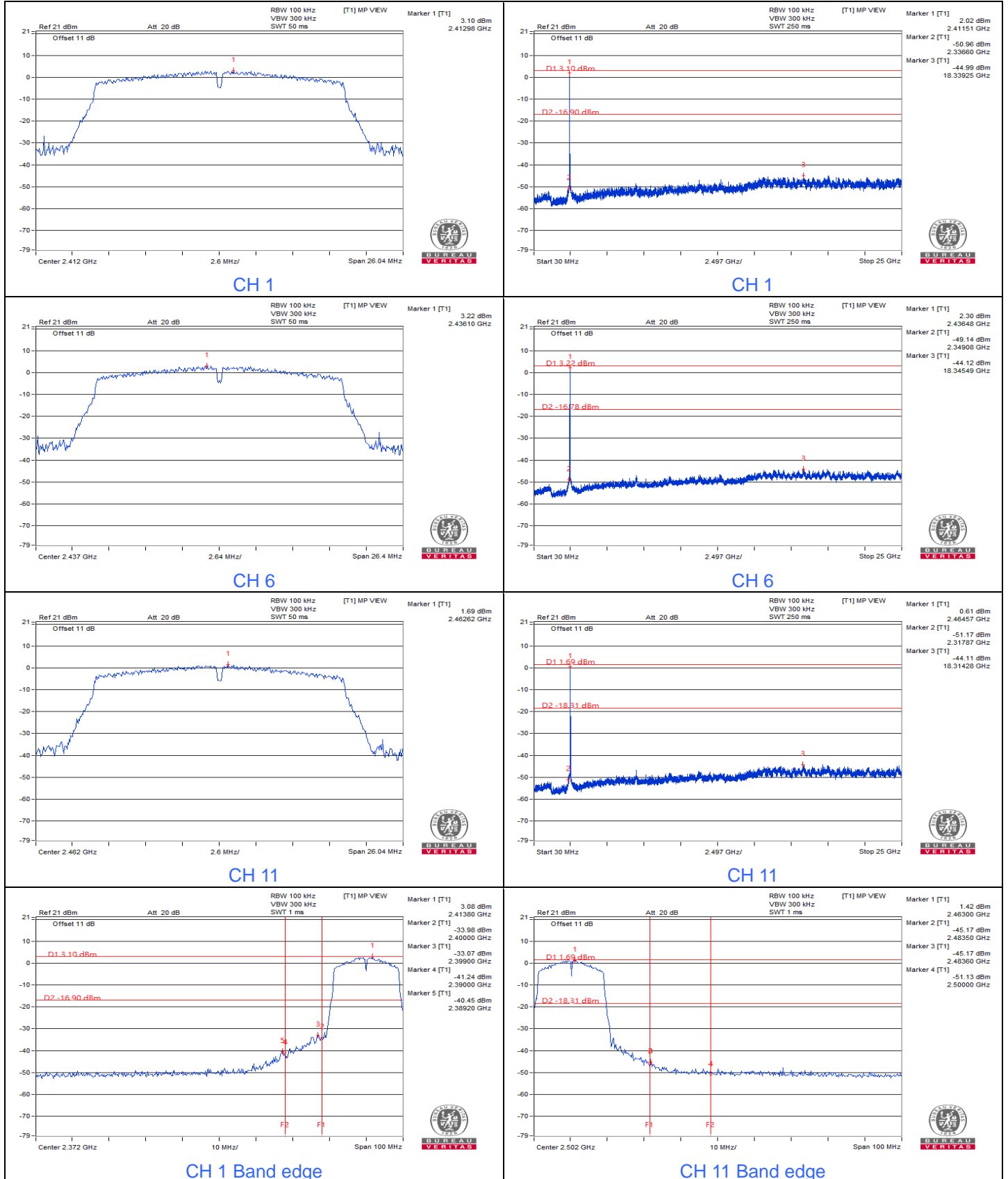

## 7.5 AC Power Conducted Emissions

### Mode B

Frequency Range	150 kHz ~ 30 MHz	Detector Function & Resolution Bandwidth	Quasi-Peak (QP) / Average (AV), 9 kHz
Input Power	120 Vac, 60 Hz	Environmental Conditions	25°C, 75% RH
Tested By	Ian Chang		

Phase Of Power : Line (L)										
No	Frequency (MHz)	Correction Factor (dB)	Reading Value (dBuV)		Emission Level (dBuV)		Limit (dBuV)		Margin (dB)	
			Q.P.	AV.	Q.P.	AV.	Q.P.	AV.	Q.P.	AV.
1	0.17394	9.93	31.49	16.78	41.42	26.71	64.77	54.77	-23.35	-28.06
2	0.56384	9.95	23.02	13.35	32.97	23.30	56.00	46.00	-23.03	-22.70
3	1.50548	10.01	17.41	7.48	27.42	17.49	56.00	46.00	-28.58	-28.51
4	2.57480	10.06	17.53	7.36	27.59	17.42	56.00	46.00	-28.41	-28.58
5	3.97928	10.12	16.96	6.80	27.08	16.92	56.00	46.00	-28.92	-29.08
6	17.00192	10.55	15.73	4.19	26.28	14.74	60.00	50.00	-33.72	-35.26

#### Remarks:

1. Q.P. and AV. are abbreviations of quasi-peak and average individually.
2. The emission levels of other frequencies were very low against the limit.
3. Margin value = Emission level – Limit value
4. Correction factor = Insertion loss + Cable loss
5. Emission Level = Correction Factor + Reading Value

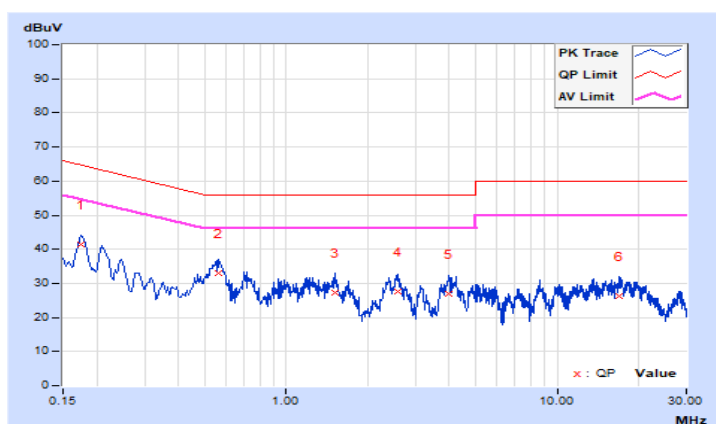

<b>Frequency Range</b>	150 kHz ~ 30 MHz	<b>Detector Function &amp; Resolution Bandwidth</b>	Quasi-Peak (QP) / Average (AV), 9 kHz
<b>Input Power</b>	120 Vac, 60 Hz	<b>Environmental Conditions</b>	25°C, 75% RH
<b>Tested By</b>	Ian Chang		

Phase Of Power : Neutral (N)										
No	Frequency (MHz)	Correction Factor (dB)	Reading Value (dBuV)		Emission Level (dBuV)		Limit (dBuV)		Margin (dB)	
			Q.P.	AV.	Q.P.	AV.	Q.P.	AV.	Q.P.	AV.
1	0.17793	9.94	32.54	17.25	42.48	27.19	64.58	54.58	-22.10	-27.39
2	0.57980	9.97	18.31	9.48	28.28	19.45	56.00	46.00	-27.72	-26.55
3	1.21817	10.00	12.99	4.21	22.99	14.21	56.00	46.00	-33.01	-31.79
4	2.39126	10.06	13.09	4.54	23.15	14.60	56.00	46.00	-32.85	-31.40
5	5.13167	10.18	20.64	6.70	30.82	16.88	60.00	50.00	-29.18	-33.12
6	28.36544	10.62	15.26	4.69	25.88	15.31	60.00	50.00	-34.12	-34.69

**Remarks:**

1. Q.P. and AV. are abbreviations of quasi-peak and average individually.
2. The emission levels of other frequencies were very low against the limit.
3. Margin value = Emission level – Limit value
4. Correction factor = Insertion loss + Cable loss
5. Emission Level = Correction Factor + Reading Value

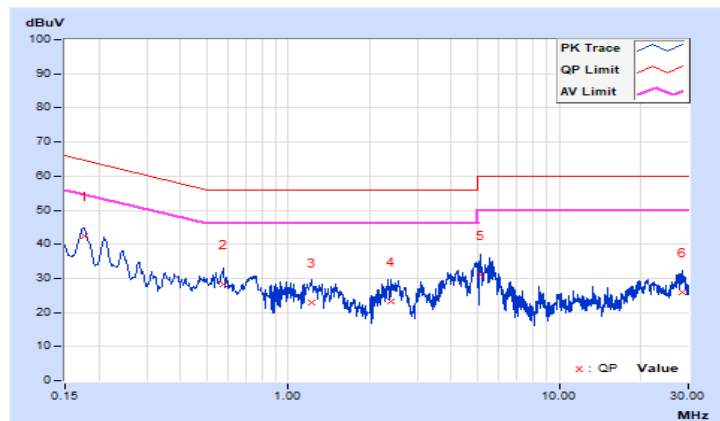

### Mode C

<b>Frequency Range</b>	150 kHz ~ 30 MHz	<b>Detector Function &amp; Resolution Bandwidth</b>	Quasi-Peak (QP) / Average (AV), 9 kHz
<b>Input Power</b>	120 Vac, 60 Hz	<b>Environmental Conditions</b>	25°C, 75% RH
<b>Tested By</b>	Ian Chang		

Phase Of Power : Line (L)										
No	Frequency (MHz)	Correction Factor (dB)	Reading Value (dBuV)		Emission Level (dBuV)		Limit (dBuV)		Margin (dB)	
			Q.P.	AV.	Q.P.	AV.	Q.P.	AV.	Q.P.	AV.
1	0.15399	9.93	41.07	22.70	51.00	32.63	65.78	55.78	-14.78	-23.15
2	0.44526	9.94	29.27	23.40	39.21	33.34	56.96	46.96	-17.75	-13.62
3	0.73142	9.96	19.51	13.56	29.47	23.52	56.00	46.00	-26.53	-22.48
4	2.04014	10.03	17.46	12.93	27.49	22.96	56.00	46.00	-28.51	-23.04
5	4.71344	10.15	16.06	7.71	26.21	17.86	56.00	46.00	-29.79	-28.14
6	13.92164	10.49	13.75	8.67	24.24	19.16	60.00	50.00	-35.76	-30.84

#### Remarks:

1. Q.P. and AV. are abbreviations of quasi-peak and average individually.
2. The emission levels of other frequencies were very low against the limit.
3. Margin value = Emission level – Limit value
4. Correction factor = Insertion loss + Cable loss
5. Emission Level = Correction Factor + Reading Value

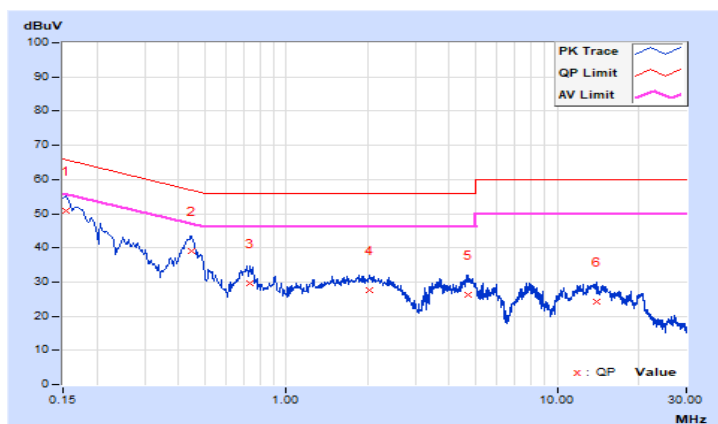

<b>Frequency Range</b>	150 kHz ~ 30 MHz	<b>Detector Function &amp; Resolution Bandwidth</b>	Quasi-Peak (QP) / Average (AV), 9 kHz
<b>Input Power</b>	120 Vac, 60 Hz	<b>Environmental Conditions</b>	25°C, 75% RH
<b>Tested By</b>	Ian Chang		

Phase Of Power : Neutral (N)										
No	Frequency (MHz)	Correction Factor (dB)	Reading Value (dBuV)		Emission Level (dBuV)		Limit (dBuV)		Margin (dB)	
			Q.P.	AV.	Q.P.	AV.	Q.P.	AV.	Q.P.	AV.
1	0.15000	9.94	41.60	23.25	51.54	33.19	66.00	56.00	-14.46	-22.81
<b>2</b>	<b>0.44925</b>	<b>9.96</b>	<b>29.41</b>	<b>24.03</b>	<b>39.37</b>	<b>33.99</b>	<b>56.89</b>	<b>46.89</b>	<b>-17.52</b>	<b>-12.90</b>
3	0.75137	9.98	19.54	13.50	29.52	23.48	56.00	46.00	-26.48	-22.52
4	1.38179	10.01	19.15	14.63	29.16	24.64	56.00	46.00	-26.84	-21.36
5	7.86931	10.28	16.60	9.76	26.88	20.04	60.00	50.00	-33.12	-29.96
6	19.88669	10.57	13.09	8.77	23.66	19.34	60.00	50.00	-36.34	-30.66

**Remarks:**

1. Q.P. and AV. are abbreviations of quasi-peak and average individually.
2. The emission levels of other frequencies were very low against the limit.
3. Margin value = Emission level – Limit value
4. Correction factor = Insertion loss + Cable loss
5. Emission Level = Correction Factor + Reading Value

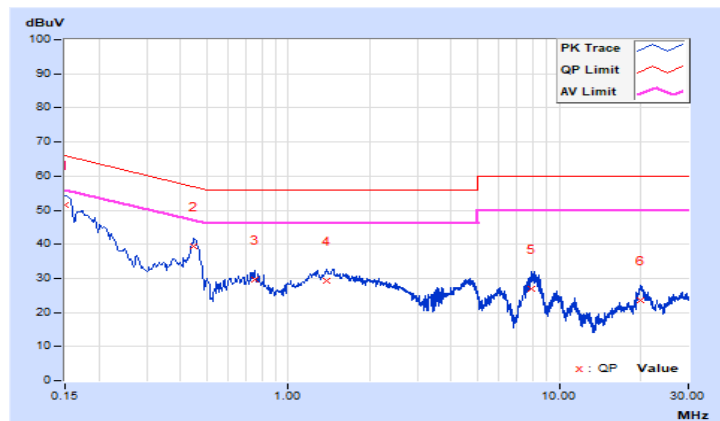



## 7.6 Unwanted Emissions below 1 GHz

### Mode A

<b>RF Mode</b>	802.11g	<b>Channel</b>	CH 1 : 2412 MHz
<b>Frequency Range</b>	30 MHz ~ 1 GHz	<b>Detector Function &amp; Bandwidth</b>	(QP) RB = 120kHz
<b>Input Power</b>	4.2 Vdc	<b>Environmental Conditions</b>	23°C, 66% RH
<b>Tested By</b>	Edison Lee		

#### Antenna Polarity & Test Distance : Horizontal at 3 m

No	Frequency (MHz)	Emission Level (dBuV/m)	Limit (dBuV/m)	Margin (dB)	Antenna Height (m)	Table Angle (Degree)	Raw Value (dBuV)	Correction Factor (dB/m)
1	69.36	30.0 QP	40.0	-10.0	2.00 H	3	40.4	-10.4
2	198.70	22.6 QP	43.5	-20.9	1.50 H	169	33.0	-10.4
3	313.97	18.4 QP	46.0	-27.6	1.00 H	77	23.6	-5.2
4	457.36	21.9 QP	46.0	-24.1	1.50 H	182	23.8	-1.9
5	592.32	23.2 QP	46.0	-22.8	1.00 H	299	22.2	1.0
6	687.91	22.8 QP	46.0	-23.2	1.00 H	224	19.8	3.0

#### Remarks:

1. Emission Level(dBuV/m) = Raw Value(dBuV) + Correction Factor(dB/m)
2. Correction Factor(dB/m) = Antenna Factor(dB/m) + Cable Factor(dB) – Pre-Amplifier Factor(dB)
3. Margin value = Emission Level – Limit value
4. The other emission levels were very low against the limit of frequency range 30 MHz ~ 1 GHz.
5. The emission levels were very low against the limit of frequency range 9 kHz ~ 30 MHz: the amplitude of spurious emissions attenuated more than 20 dB below the permissible value to be report.

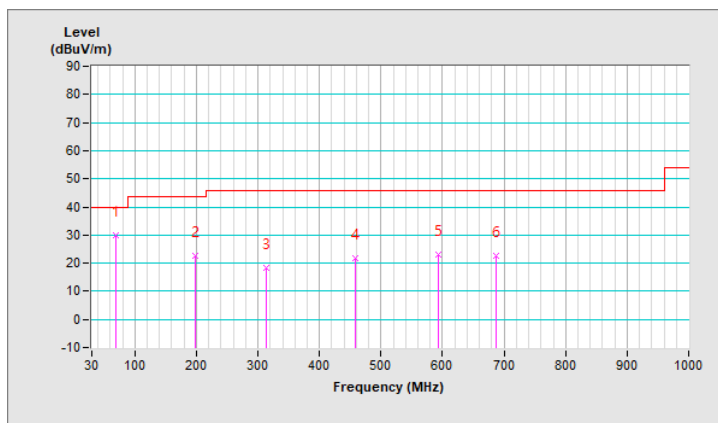

<b>RF Mode</b>	802.11g	<b>Channel</b>	CH 1 : 2412 MHz
<b>Frequency Range</b>	30 MHz ~ 1 GHz	<b>Detector Function &amp; Bandwidth</b>	(QP) RB = 120kHz
<b>Input Power</b>	4.2 Vdc	<b>Environmental Conditions</b>	23°C, 66% RH
<b>Tested By</b>	Edison Lee		

Antenna Polarity & Test Distance : Vertical at 3 m								
No	Frequency (MHz)	Emission Level (dBuV/m)	Limit (dBuV/m)	Margin (dB)	Antenna Height (m)	Table Angle (Degree)	Raw Value (dBuV)	Correction Factor (dB/m)
1	69.36	30.0 QP	40.0	-10.0	1.00 V	312	40.4	-10.4
2	170.58	24.9 QP	43.5	-18.6	1.00 V	181	33.1	-8.2
3	256.33	18.8 QP	46.0	-27.2	1.00 V	297	26.4	-7.6
4	375.83	20.7 QP	46.0	-25.3	1.00 V	230	24.5	-3.8
5	502.35	22.6 QP	46.0	-23.4	1.00 V	118	23.6	-1.0
6	679.48	23.0 QP	46.0	-23.0	1.00 V	155	20.0	3.0

**Remarks:**

1. Emission Level(dBuV/m) = Raw Value(dBuV) + Correction Factor(dB/m)
2. Correction Factor(dB/m) = Antenna Factor(dB/m) + Cable Factor(dB) – Pre-Amplifier Factor(dB)
3. Margin value = Emission Level – Limit value
4. The other emission levels were very low against the limit of frequency range 30 MHz ~ 1 GHz.
5. The emission levels were very low against the limit of frequency range 9 kHz ~ 30 MHz: the amplitude of spurious emissions attenuated more than 20 dB below the permissible value to be report.

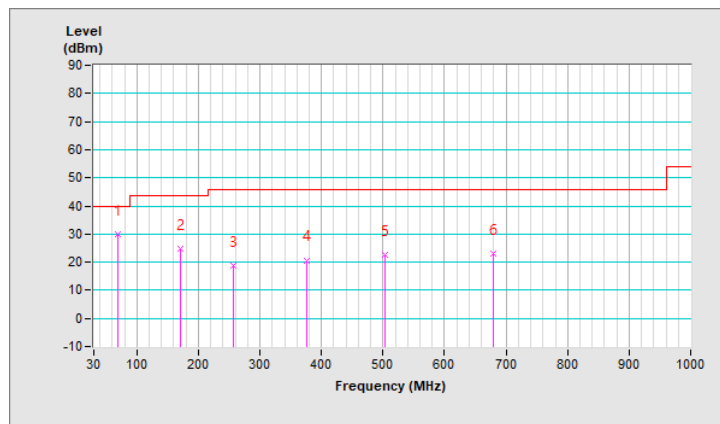

## Mode B

Frequency Range	30 MHz ~ 1 GHz	Detector Function & Bandwidth	(QP) RB = 120kHz
Input Power	5 Vdc	Environmental Conditions	21°C, 67% RH
Tested By	Ian Chang		

Antenna Polarity & Test Distance : Horizontal at 3 m								
No	Frequency (MHz)	Emission Level (dBuV/m)	Limit (dBuV/m)	Margin (dB)	Antenna Height (m)	Table Angle (Degree)	Raw Value (dBuV)	Correction Factor (dB/m)
1	44.44	31.8 QP	40.0	-8.2	2.00 H	101	40.5	-8.7
2	<b>81.30</b>	<b>37.1 QP</b>	<b>40.0</b>	<b>-2.9</b>	<b>2.38 H</b>	<b>140</b>	<b>50.6</b>	<b>-13.5</b>
3	207.40	39.8 QP	43.5	-3.7	2.60 H	161	50.2	-10.4
4	392.24	30.3 QP	46.0	-15.7	1.54 H	188	33.9	-3.6
5	599.28	28.4 QP	46.0	-17.6	3.86 H	285	27.3	1.1
6	946.54	37.3 QP	46.0	-8.7	2.90 H	191	29.3	8.0

### Remarks:

1. Emission Level(dBuV/m) = Raw Value(dBuV) + Correction Factor(dB/m)
2. Correction Factor(dB/m) = Antenna Factor(dB/m) + Cable Factor(dB) – Pre-Amplifier Factor(dB)
3. Margin value = Emission Level – Limit value
4. The other emission levels were very low against the limit of frequency range 30 MHz ~ 1 GHz.
5. The emission levels were very low against the limit of frequency range 9 kHz ~ 30 MHz: the amplitude of spurious emissions attenuated more than 20 dB below the permissible value to be report.

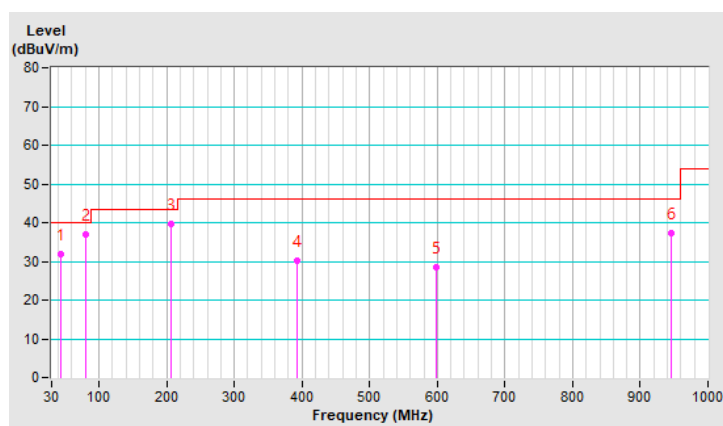

<b>Frequency Range</b>	30 MHz ~ 1 GHz	<b>Detector Function &amp; Bandwidth</b>	(QP) RB = 120kHz
<b>Input Power</b>	5 Vdc	<b>Environmental Conditions</b>	21°C, 67% RH
<b>Tested By</b>	Ian Chang		

Antenna Polarity & Test Distance : Vertical at 3 m								
No	Frequency (MHz)	Emission Level (dBuV/m)	Limit (dBuV/m)	Margin (dB)	Antenna Height (m)	Table Angle (Degree)	Raw Value (dBuV)	Correction Factor (dB/m)
1	36.68	34.4 QP	40.0	-5.6	3.63 V	337	44.2	-9.8
2	100.70	32.8 QP	43.5	-10.7	3.27 V	302	45.5	-12.7
3	201.58	39.7 QP	43.5	-3.8	2.99 V	274	50.3	-10.6
4	317.98	36.2 QP	46.0	-9.8	2.01 V	177	41.5	-5.3
5	444.26	29.9 QP	46.0	-16.1	1.96 V	230	32.1	-2.2
6	618.68	35.1 QP	46.0	-10.9	2.60 V	235	33.6	1.5

**Remarks:**

1. Emission Level(dBuV/m) = Raw Value(dBuV) + Correction Factor(dB/m)
2. Correction Factor(dB/m) = Antenna Factor(dB/m) + Cable Factor(dB) – Pre-Amplifier Factor(dB)
3. Margin value = Emission Level – Limit value
4. The other emission levels were very low against the limit of frequency range 30 MHz ~ 1 GHz.
5. The emission levels were very low against the limit of frequency range 9 kHz ~ 30 MHz: the amplitude of spurious emissions attenuated more than 20 dB below the permissible value to be report.

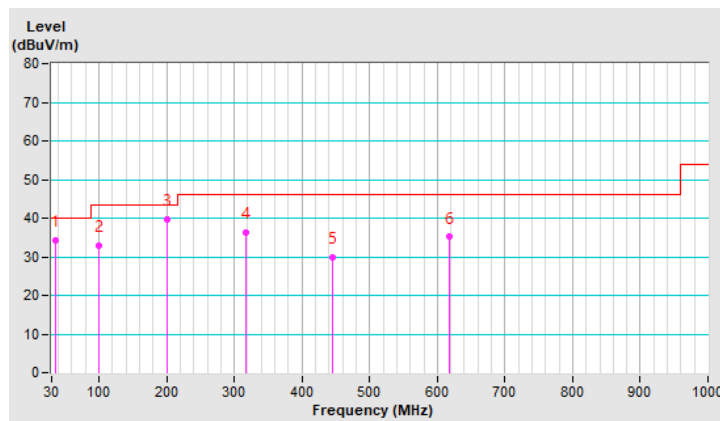

## 7.7 Unwanted Emissions above 1 GHz

### Mode A

<b>RF Mode</b>	802.11b	<b>Channel</b>	CH 1 : 2412 MHz
<b>Frequency Range</b>	1 GHz ~ 25 GHz	<b>Detector Function &amp; Bandwidth</b>	(PK) RB = 1 MHz, VB = 3 MHz (AV) RB = 1 MHz, VB = 10 Hz
<b>Input Power</b>	4.2 Vdc	<b>Environmental Conditions</b>	23°C, 66% RH
<b>Tested By</b>	Greg Lin		

Antenna Polarity & Test Distance : Horizontal at 3 m								
No	Frequency (MHz)	Emission Level (dBuV/m)	Limit (dBuV/m)	Margin (dB)	Antenna Height (m)	Table Angle (Degree)	Raw Value (dBuV)	Correction Factor (dB/m)
1	2390.00	57.9 PK	74.0	-16.1	2.77 H	165	59.2	-1.3
2	2390.00	45.8 AV	54.0	-8.2	2.77 H	165	47.1	-1.3
3	*2412.00	102.6 PK			2.77 H	165	103.6	-1.0
4	*2412.00	99.9 AV			2.77 H	165	100.9	-1.0
5	4824.00	55.2 PK	74.0	-18.8	1.97 H	201	48.5	6.7
6	4824.00	51.5 AV	54.0	-2.5	1.97 H	201	44.8	6.7
7	14472.00	63.8 PK	74.0	-10.2	1.84 H	237	40.3	23.5
8	14472.00	52.9 AV	54.0	-1.1	1.84 H	237	29.4	23.5

Antenna Polarity & Test Distance : Vertical at 3 m								
No	Frequency (MHz)	Emission Level (dBuV/m)	Limit (dBuV/m)	Margin (dB)	Antenna Height (m)	Table Angle (Degree)	Raw Value (dBuV)	Correction Factor (dB/m)
1	2390.00	59.4 PK	74.0	-14.6	1.15 V	56	60.7	-1.3
2	2390.00	49.1 AV	54.0	-4.9	1.15 V	56	50.4	-1.3
3	*2412.00	107.0 PK			1.15 V	56	108.0	-1.0
4	*2412.00	104.6 AV			1.15 V	56	105.6	-1.0
5	4824.00	53.2 PK	74.0	-20.8	2.15 V	72	46.5	6.7
6	4824.00	48.2 AV	54.0	-5.8	2.15 V	72	41.5	6.7
7	14472.00	62.8 PK	74.0	-11.2	1.85 V	7	39.3	23.5
8	14472.00	51.9 AV	54.0	-2.1	1.85 V	7	28.4	23.5

#### Remarks:

1. Emission Level(dBuV/m) = Raw Value(dBuV) + Correction Factor(dB/m)
2. Correction Factor(dB/m) = Antenna Factor(dB/m) + Cable Factor(dB) – Pre-Amplifier Factor(dB)
3. Margin value = Emission Level – Limit value
4. The other emission levels were very low against the limit.
5. " \* " : Fundamental frequency, the limit was restricted at the RF Output Power.



<b>RF Mode</b>	802.11b	<b>Channel</b>	CH 6 : 2437 MHz
<b>Frequency Range</b>	1 GHz ~ 25 GHz	<b>Detector Function &amp; Bandwidth</b>	(PK) RB = 1 MHz, VB = 3 MHz (AV) RB = 1 MHz, VB = 10 Hz
<b>Input Power</b>	4.2 Vdc	<b>Environmental Conditions</b>	23°C, 66% RH
<b>Tested By</b>	Greg Lin		

**Antenna Polarity & Test Distance : Horizontal at 3 m**

No	Frequency (MHz)	Emission Level (dBuV/m)	Limit (dBuV/m)	Margin (dB)	Antenna Height (m)	Table Angle (Degree)	Raw Value (dBuV)	Correction Factor (dB/m)
1	*2437.00	101.2 PK			2.73 H	161	102.2	-1.0
2	*2437.00	98.6 AV			2.73 H	161	99.6	-1.0
3	4874.00	55.0 PK	74.0	-19.0	2.11 H	236	48.1	6.9
4	4874.00	51.5 AV	54.0	-2.5	2.11 H	236	44.6	6.9

**Antenna Polarity & Test Distance : Vertical at 3 m**

No	Frequency (MHz)	Emission Level (dBuV/m)	Limit (dBuV/m)	Margin (dB)	Antenna Height (m)	Table Angle (Degree)	Raw Value (dBuV)	Correction Factor (dB/m)
1	*2437.00	105.8 PK			1.07 V	67	106.8	-1.0
2	*2437.00	103.2 AV			1.07 V	67	104.2	-1.0
3	4874.00	53.8 PK	74.0	-20.2	2.18 V	73	46.9	6.9
4	4874.00	49.2 AV	54.0	-4.8	2.18 V	73	42.3	6.9

**Remarks:**

1. Emission Level(dBuV/m) = Raw Value(dBuV) + Correction Factor(dB/m)
2. Correction Factor(dB/m) = Antenna Factor(dB/m) + Cable Factor(dB) – Pre-Amplifier Factor(dB)
3. Margin value = Emission Level – Limit value
4. The other emission levels were very low against the limit.
5. " \* " : Fundamental frequency, the limit was restricted at the RF Output Power.



<b>RF Mode</b>	802.11b	<b>Channel</b>	CH 11 : 2462 MHz
<b>Frequency Range</b>	1 GHz ~ 25 GHz	<b>Detector Function &amp; Bandwidth</b>	(PK) RB = 1 MHz, VB = 3 MHz (AV) RB = 1 MHz, VB = 10 Hz
<b>Input Power</b>	4.2 Vdc	<b>Environmental Conditions</b>	23°C, 66% RH
<b>Tested By</b>	Greg Lin		

**Antenna Polarity & Test Distance : Horizontal at 3 m**

No	Frequency (MHz)	Emission Level (dBuV/m)	Limit (dBuV/m)	Margin (dB)	Antenna Height (m)	Table Angle (Degree)	Raw Value (dBuV)	Correction Factor (dB/m)
1	*2462.00	102.4 PK			2.78 H	169	103.3	-0.9
2	*2462.00	99.8 AV			2.78 H	169	100.7	-0.9
3	2483.50	58.3 PK	74.0	-15.7	2.78 H	169	59.2	-0.9
4	2483.50	47.7 AV	54.0	-6.3	2.78 H	169	48.6	-0.9
5	4924.00	55.8 PK	74.0	-18.2	1.98 H	236	48.9	6.9
6	4924.00	51.4 AV	54.0	-2.6	1.98 H	236	44.5	6.9

**Antenna Polarity & Test Distance : Vertical at 3 m**

No	Frequency (MHz)	Emission Level (dBuV/m)	Limit (dBuV/m)	Margin (dB)	Antenna Height (m)	Table Angle (Degree)	Raw Value (dBuV)	Correction Factor (dB/m)
1	*2462.00	107.0 PK			1.05 V	76	107.9	-0.9
2	*2462.00	104.5 AV			1.05 V	76	105.4	-0.9
3	2483.50	59.5 PK	74.0	-14.5	1.05 V	76	60.4	-0.9
4	2483.50	48.8 AV	54.0	-5.2	1.05 V	76	49.7	-0.9
5	4924.00	53.9 PK	74.0	-20.1	2.12 V	75	47.0	6.9
6	4924.00	49.2 AV	54.0	-4.8	2.12 V	75	42.3	6.9

**Remarks:**

1. Emission Level(dBuV/m) = Raw Value(dBuV) + Correction Factor(dB/m)
2. Correction Factor(dB/m) = Antenna Factor(dB/m) + Cable Factor(dB) – Pre-Amplifier Factor(dB)
3. Margin value = Emission Level – Limit value
4. The other emission levels were very low against the limit.
5. " \* ": Fundamental frequency, the limit was restricted at the RF Output Power.



<b>RF Mode</b>	802.11g	<b>Channel</b>	CH 1 : 2412 MHz
<b>Frequency Range</b>	1 GHz ~ 25 GHz	<b>Detector Function &amp; Bandwidth</b>	(PK) RB = 1 MHz, VB = 3 MHz (AV) RB = 1 MHz, VB = 10 Hz
<b>Input Power</b>	4.2 Vdc	<b>Environmental Conditions</b>	23°C, 66% RH
<b>Tested By</b>	Greg Lin		

**Antenna Polarity & Test Distance : Horizontal at 3 m**

No	Frequency (MHz)	Emission Level (dBuV/m)	Limit (dBuV/m)	Margin (dB)	Antenna Height (m)	Table Angle (Degree)	Raw Value (dBuV)	Correction Factor (dB/m)
1	2390.00	68.0 PK	74.0	-6.0	2.70 H	162	69.3	-1.3
2	2390.00	47.7 AV	54.0	-6.3	2.70 H	162	49.0	-1.3
3	*2412.00	105.9 PK			2.70 H	162	106.9	-1.0
4	*2412.00	95.8 AV			2.70 H	162	96.8	-1.0
5	4824.00	51.5 PK	74.0	-22.5	2.04 H	238	44.8	6.7
6	4824.00	38.7 AV	54.0	-15.3	2.04 H	238	32.0	6.7

**Antenna Polarity & Test Distance : Vertical at 3 m**

No	Frequency (MHz)	Emission Level (dBuV/m)	Limit (dBuV/m)	Margin (dB)	Antenna Height (m)	Table Angle (Degree)	Raw Value (dBuV)	Correction Factor (dB/m)
1	2390.00	73.0 PK	74.0	-1.0	1.00 V	71	74.3	-1.3
2	2390.00	51.4 AV	54.0	-2.6	1.00 V	71	52.7	-1.3
3	*2412.00	110.0 PK			1.00 V	71	111.0	-1.0
4	*2412.00	99.9 AV			1.00 V	71	100.9	-1.0
5	4824.00	50.7 PK	74.0	-23.3	2.23 V	79	44.0	6.7
6	4824.00	38.4 AV	54.0	-15.6	2.23 V	79	31.7	6.7

**Remarks:**

1. Emission Level(dBuV/m) = Raw Value(dBuV) + Correction Factor(dB/m)
2. Correction Factor(dB/m) = Antenna Factor(dB/m) + Cable Factor(dB) – Pre-Amplifier Factor(dB)
3. Margin value = Emission Level – Limit value
4. The other emission levels were very low against the limit.
5. " \* ": Fundamental frequency, the limit was restricted at the RF Output Power.





<b>RF Mode</b>	802.11g	<b>Channel</b>	CH 6 : 2437 MHz
<b>Frequency Range</b>	1 GHz ~ 25 GHz	<b>Detector Function &amp; Bandwidth</b>	(PK) RB = 1 MHz, VB = 3 MHz (AV) RB = 1 MHz, VB = 10 Hz
<b>Input Power</b>	4.2 Vdc	<b>Environmental Conditions</b>	23°C, 66% RH
<b>Tested By</b>	Greg Lin		

**Antenna Polarity & Test Distance : Horizontal at 3 m**

No	Frequency (MHz)	Emission Level (dBuV/m)	Limit (dBuV/m)	Margin (dB)	Antenna Height (m)	Table Angle (Degree)	Raw Value (dBuV)	Correction Factor (dB/m)
1	*2437.00	105.8 PK			2.71 H	163	106.8	-1.0
2	*2437.00	95.6 AV			2.71 H	163	96.6	-1.0
3	4874.00	51.5 PK	74.0	-22.5	1.97 H	239	44.6	6.9
4	4874.00	38.7 AV	54.0	-15.3	1.97 H	239	31.8	6.9

**Antenna Polarity & Test Distance : Vertical at 3 m**

No	Frequency (MHz)	Emission Level (dBuV/m)	Limit (dBuV/m)	Margin (dB)	Antenna Height (m)	Table Angle (Degree)	Raw Value (dBuV)	Correction Factor (dB/m)
1	*2437.00	110.1 PK			1.06 V	73	111.1	-1.0
2	*2437.00	100.0 AV			1.06 V	73	101.0	-1.0
3	4874.00	50.7 PK	74.0	-23.3	2.13 V	74	43.8	6.9
4	4874.00	38.4 AV	54.0	-15.6	2.13 V	74	31.5	6.9

**Remarks:**

1. Emission Level(dBuV/m) = Raw Value(dBuV) + Correction Factor(dB/m)
2. Correction Factor(dB/m) = Antenna Factor(dB/m) + Cable Factor(dB) – Pre-Amplifier Factor(dB)
3. Margin value = Emission Level – Limit value
4. The other emission levels were very low against the limit.
5. " \* " : Fundamental frequency, the limit was restricted at the RF Output Power.



<b>RF Mode</b>	802.11g	<b>Channel</b>	CH 11 : 2462 MHz
<b>Frequency Range</b>	1 GHz ~ 25 GHz	<b>Detector Function &amp; Bandwidth</b>	(PK) RB = 1 MHz, VB = 3 MHz (AV) RB = 1 MHz, VB = 10 Hz
<b>Input Power</b>	4.2 Vdc	<b>Environmental Conditions</b>	23°C, 66% RH
<b>Tested By</b>	Greg Lin		

**Antenna Polarity & Test Distance : Horizontal at 3 m**

No	Frequency (MHz)	Emission Level (dBuV/m)	Limit (dBuV/m)	Margin (dB)	Antenna Height (m)	Table Angle (Degree)	Raw Value (dBuV)	Correction Factor (dB/m)
1	*2462.00	105.9 PK			2.82 H	157	106.8	-0.9
2	*2462.00	95.7 AV			2.82 H	157	96.6	-0.9
3	2483.50	70.9 PK	74.0	-3.1	2.82 H	157	71.8	-0.9
4	2483.50	50.7 AV	54.0	-3.3	2.82 H	157	51.6	-0.9
5	4924.00	51.5 PK	74.0	-22.5	1.96 H	242	44.6	6.9
6	4924.00	38.7 AV	54.0	-15.3	1.96 H	242	31.8	6.9

**Antenna Polarity & Test Distance : Vertical at 3 m**

No	Frequency (MHz)	Emission Level (dBuV/m)	Limit (dBuV/m)	Margin (dB)	Antenna Height (m)	Table Angle (Degree)	Raw Value (dBuV)	Correction Factor (dB/m)
1	*2462.00	110.0 PK			1.01 V	77	110.9	-0.9
2	*2462.00	99.9 AV			1.01 V	77	100.8	-0.9
3	2483.50	72.5 PK	74.0	-1.5	1.01 V	77	73.4	-0.9
4	2483.50	51.2 AV	54.0	-2.8	1.01 V	77	52.1	-0.9
5	4924.00	50.7 PK	74.0	-23.3	2.18 V	71	43.8	6.9
6	4924.00	38.4 AV	54.0	-15.6	2.18 V	71	31.5	6.9

**Remarks:**

1. Emission Level(dBuV/m) = Raw Value(dBuV) + Correction Factor(dB/m)
2. Correction Factor(dB/m) = Antenna Factor(dB/m) + Cable Factor(dB) – Pre-Amplifier Factor(dB)
3. Margin value = Emission Level – Limit value
4. The other emission levels were very low against the limit.
5. " \* ": Fundamental frequency, the limit was restricted at the RF Output Power.



<b>RF Mode</b>	802.11n (HT20)	<b>Channel</b>	CH 1 : 2412 MHz
<b>Frequency Range</b>	1 GHz ~ 25 GHz	<b>Detector Function &amp; Bandwidth</b>	(PK) RB = 1 MHz, VB = 3 MHz (AV) RB = 1 MHz, VB = 10 Hz
<b>Input Power</b>	4.2 Vdc	<b>Environmental Conditions</b>	23°C, 66% RH
<b>Tested By</b>	Greg Lin		

**Antenna Polarity & Test Distance : Horizontal at 3 m**

No	Frequency (MHz)	Emission Level (dBuV/m)	Limit (dBuV/m)	Margin (dB)	Antenna Height (m)	Table Angle (Degree)	Raw Value (dBuV)	Correction Factor (dB/m)
1	2390.00	69.1 PK	74.0	-4.9	2.72 H	166	70.4	-1.3
2	2390.00	47.8 AV	54.0	-6.2	2.72 H	166	49.1	-1.3
3	*2412.00	105.5 PK			2.72 H	166	106.5	-1.0
4	*2412.00	95.4 AV			2.72 H	166	96.4	-1.0
5	4824.00	51.4 PK	74.0	-22.6	1.94 H	237	44.7	6.7
6	4824.00	38.6 AV	54.0	-15.4	1.94 H	237	31.9	6.7

**Antenna Polarity & Test Distance : Vertical at 3 m**

No	Frequency (MHz)	Emission Level (dBuV/m)	Limit (dBuV/m)	Margin (dB)	Antenna Height (m)	Table Angle (Degree)	Raw Value (dBuV)	Correction Factor (dB/m)
1	2390.00	73.4 PK	74.0	-0.6	1.00 V	66	74.7	-1.3
2	2390.00	50.8 AV	54.0	-3.2	1.00 V	66	52.1	-1.3
3	*2412.00	109.6 PK			1.00 V	66	110.6	-1.0
4	*2412.00	99.4 AV			1.00 V	66	100.4	-1.0
5	4824.00	50.5 PK	74.0	-23.5	2.24 V	79	43.8	6.7
6	4824.00	38.3 AV	54.0	-15.7	2.24 V	79	31.6	6.7

**Remarks:**

1. Emission Level(dBuV/m) = Raw Value(dBuV) + Correction Factor(dB/m)
2. Correction Factor(dB/m) = Antenna Factor(dB/m) + Cable Factor(dB) – Pre-Amplifier Factor(dB)
3. Margin value = Emission Level – Limit value
4. The other emission levels were very low against the limit.
5. " \* ": Fundamental frequency, the limit was restricted at the RF Output Power.



<b>RF Mode</b>	802.11n (HT20)	<b>Channel</b>	CH 6 : 2437 MHz
<b>Frequency Range</b>	1 GHz ~ 25 GHz	<b>Detector Function &amp; Bandwidth</b>	(PK) RB = 1 MHz, VB = 3 MHz (AV) RB = 1 MHz, VB = 10 Hz
<b>Input Power</b>	4.2 Vdc	<b>Environmental Conditions</b>	23°C, 66% RH
<b>Tested By</b>	Greg Lin		

Antenna Polarity & Test Distance : Horizontal at 3 m								
No	Frequency (MHz)	Emission Level (dBuV/m)	Limit (dBuV/m)	Margin (dB)	Antenna Height (m)	Table Angle (Degree)	Raw Value (dBuV)	Correction Factor (dB/m)
1	*2437.00	105.6 PK			2.82 H	163	106.6	-1.0
2	*2437.00	95.5 AV			2.82 H	163	96.5	-1.0
3	4874.00	51.5 PK	74.0	-22.5	1.93 H	246	44.6	6.9
4	4874.00	38.5 AV	54.0	-15.5	1.93 H	246	31.6	6.9

Antenna Polarity & Test Distance : Vertical at 3 m								
No	Frequency (MHz)	Emission Level (dBuV/m)	Limit (dBuV/m)	Margin (dB)	Antenna Height (m)	Table Angle (Degree)	Raw Value (dBuV)	Correction Factor (dB/m)
1	*2437.00	109.8 PK			1.03 V	68	110.8	-1.0
2	*2437.00	99.7 AV			1.03 V	68	100.7	-1.0
3	4874.00	50.5 PK	74.0	-23.5	2.15 V	83	43.6	6.9
4	4874.00	38.2 AV	54.0	-15.8	2.15 V	83	31.3	6.9

**Remarks:**

1. Emission Level(dBuV/m) = Raw Value(dBuV) + Correction Factor(dB/m)
2. Correction Factor(dB/m) = Antenna Factor(dB/m) + Cable Factor(dB) – Pre-Amplifier Factor(dB)
3. Margin value = Emission Level – Limit value
4. The other emission levels were very low against the limit.
5. " \* " : Fundamental frequency, the limit was restricted at the RF Output Power.



<b>RF Mode</b>	802.11n (HT20)	<b>Channel</b>	CH 11 : 2462 MHz
<b>Frequency Range</b>	1 GHz ~ 25 GHz	<b>Detector Function &amp; Bandwidth</b>	(PK) RB = 1 MHz, VB = 3 MHz (AV) RB = 1 MHz, VB = 10 Hz
<b>Input Power</b>	4.2 Vdc	<b>Environmental Conditions</b>	23°C, 66% RH
<b>Tested By</b>	Greg Lin		

**Antenna Polarity & Test Distance : Horizontal at 3 m**

No	Frequency (MHz)	Emission Level (dBuV/m)	Limit (dBuV/m)	Margin (dB)	Antenna Height (m)	Table Angle (Degree)	Raw Value (dBuV)	Correction Factor (dB/m)
1	*2462.00	104.0 PK			2.87 H	173	104.9	-0.9
2	*2462.00	93.9 AV			2.87 H	173	94.8	-0.9
3	2483.50	68.3 PK	74.0	-5.7	2.87 H	173	69.2	-0.9
4	2483.50	49.3 AV	54.0	-4.7	2.87 H	173	50.2	-0.9
5	4924.00	51.4 PK	74.0	-22.6	1.94 H	226	44.5	6.9
6	4924.00	38.7 AV	54.0	-15.3	1.94 H	226	31.8	6.9

**Antenna Polarity & Test Distance : Vertical at 3 m**

No	Frequency (MHz)	Emission Level (dBuV/m)	Limit (dBuV/m)	Margin (dB)	Antenna Height (m)	Table Angle (Degree)	Raw Value (dBuV)	Correction Factor (dB/m)
1	*2462.00	107.8 PK			1.00 V	72	108.7	-0.9
2	*2462.00	97.8 AV			1.00 V	72	98.7	-0.9
3	2483.50	70.9 PK	74.0	-3.1	1.00 V	72	71.8	-0.9
4	2483.50	50.7 AV	54.0	-3.3	1.00 V	72	51.6	-0.9
5	4924.00	50.5 PK	74.0	-23.5	2.19 V	78	43.6	6.9
6	4924.00	38.2 AV	54.0	-15.8	2.19 V	78	31.3	6.9

**Remarks:**

1. Emission Level(dBuV/m) = Raw Value(dBuV) + Correction Factor(dB/m)
2. Correction Factor(dB/m) = Antenna Factor(dB/m) + Cable Factor(dB) – Pre-Amplifier Factor(dB)
3. Margin value = Emission Level – Limit value
4. The other emission levels were very low against the limit.
5. " \* ": Fundamental frequency, the limit was restricted at the RF Output Power.

Mode A\_Plot of Band Edge

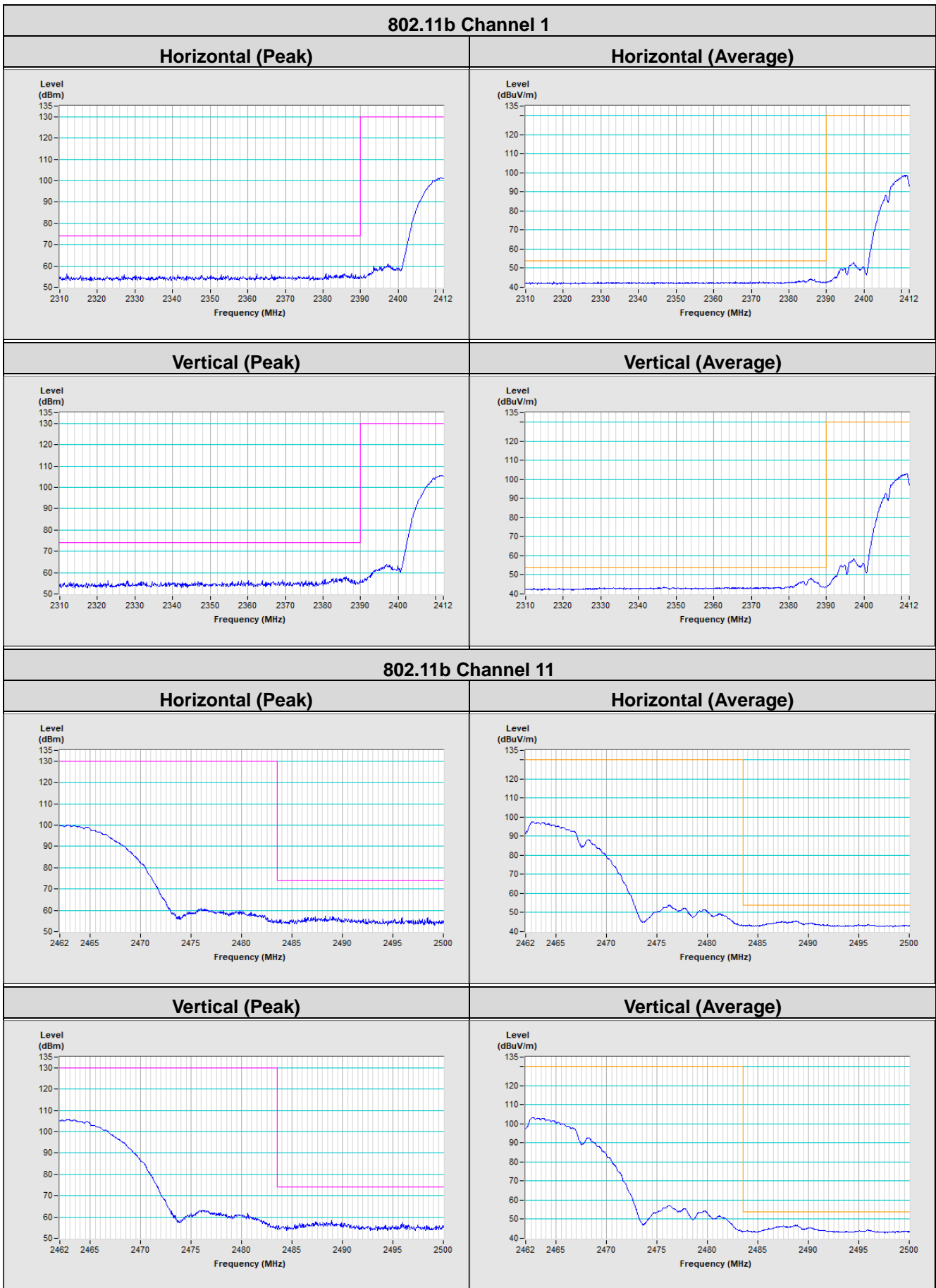



### 802.11g Channel 1

#### Horizontal (Peak)

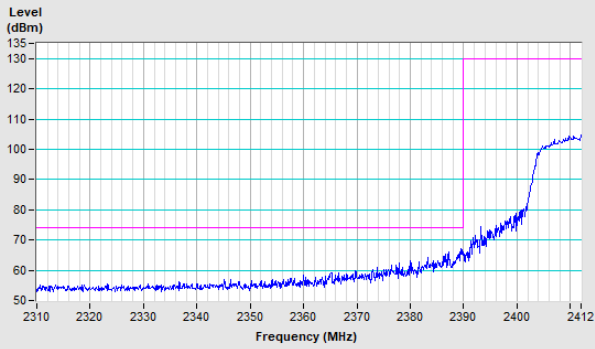

#### Horizontal (Average)

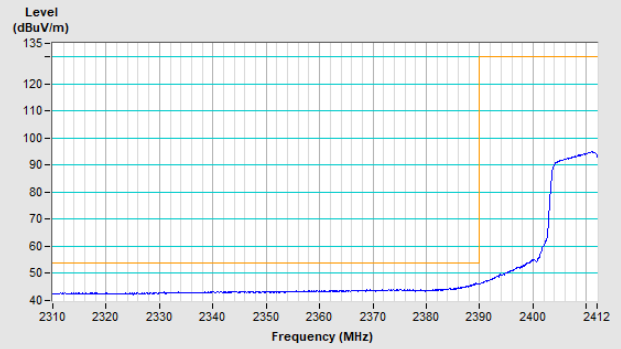

#### Vertical (Peak)

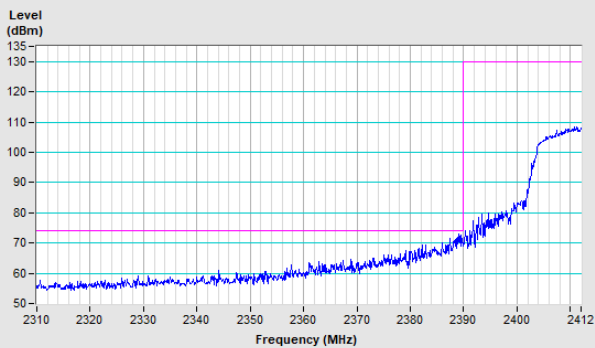

#### Vertical (Average)

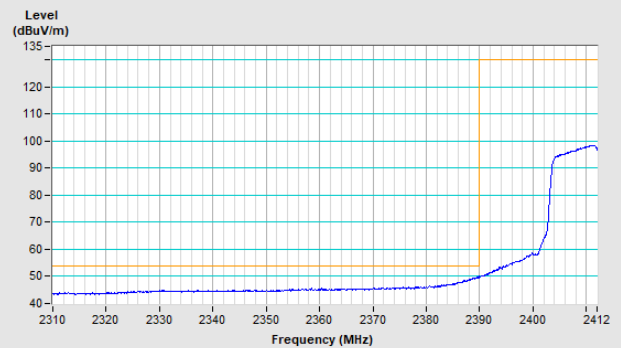

### 802.11g Channel 11

#### Horizontal (Peak)

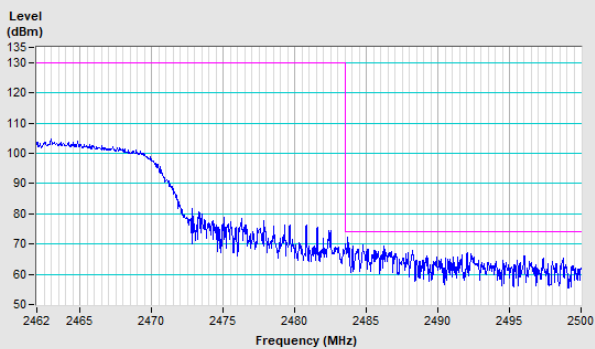

#### Horizontal (Average)

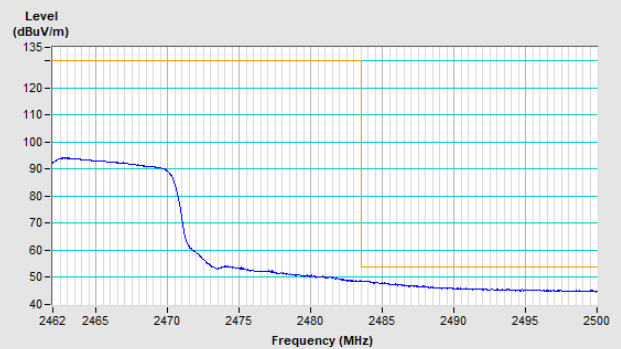

#### Vertical (Peak)

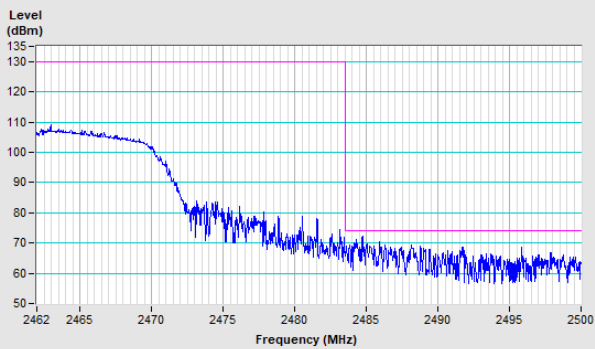

#### Vertical (Average)

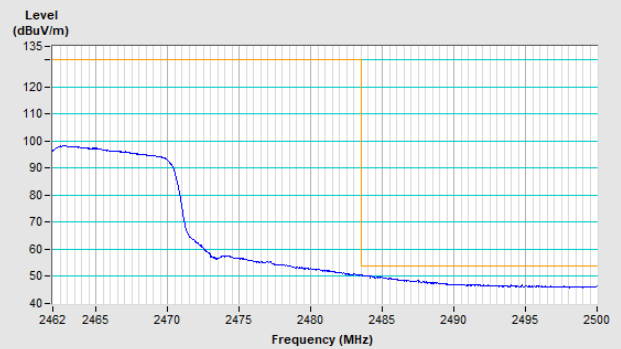

### 802.11n (HT20) Channel 1

**Horizontal (Peak)**

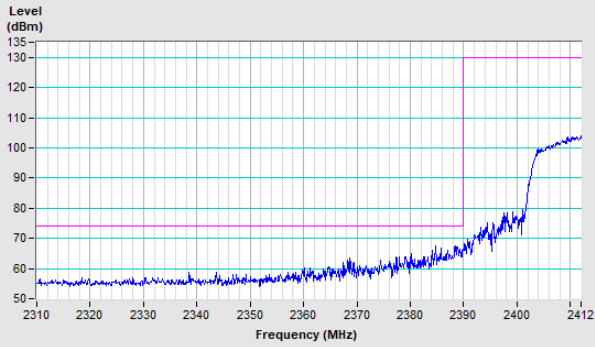

**Horizontal (Average)**

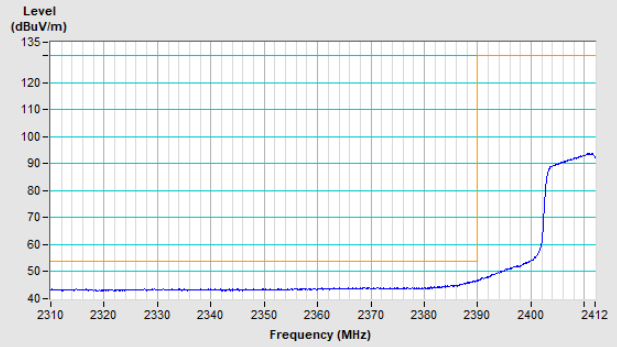

**Vertical (Peak)**

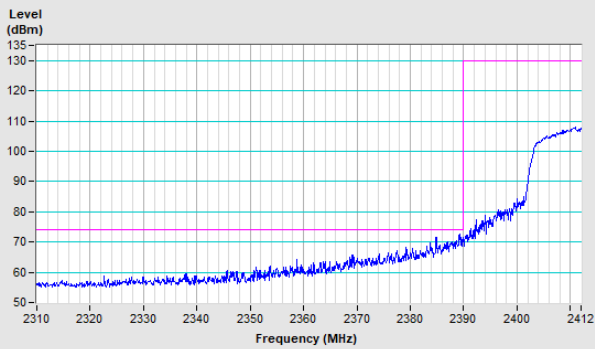

**Vertical (Average)**

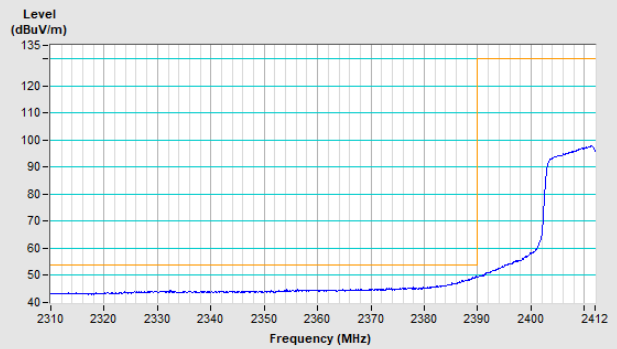

### 802.11n (HT20) Channel 11

**Horizontal (Peak)**

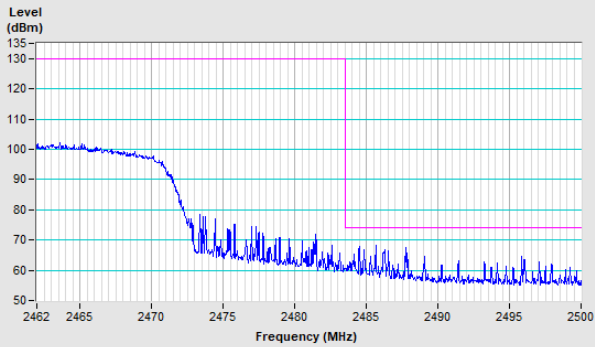

**Horizontal (Average)**

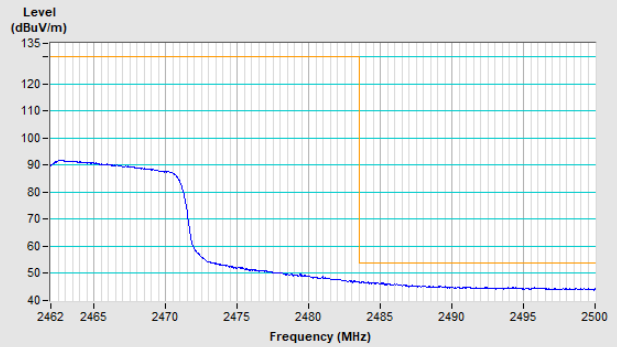

**Vertical (Peak)**

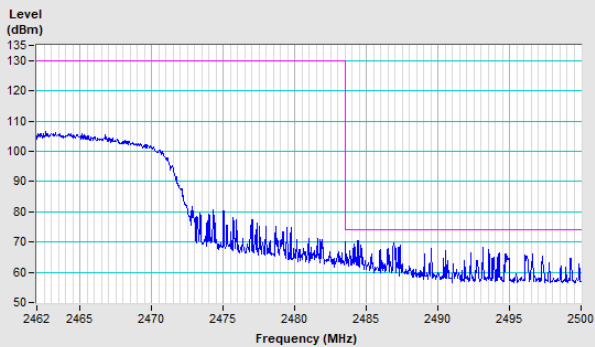

**Vertical (Average)**

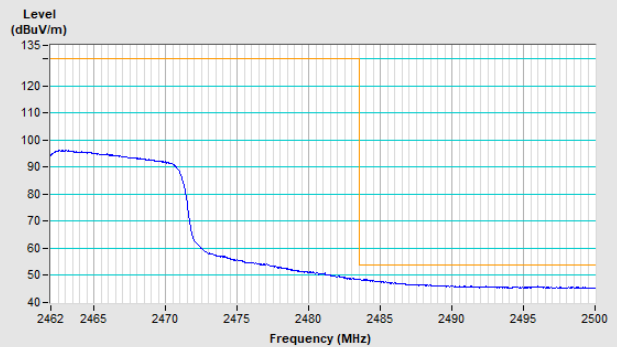



## 8 Pictures of Test Arrangements

Please refer to the attached file (Test Setup Photo)

## 9 Information of the Testing Laboratories

We, Bureau Veritas Consumer Products Services (H.K.) Ltd., Taoyuan Branch, were founded in 1988 to provide our best service in EMC, Radio, Telecom and Safety consultation. Our laboratories are FCC recognized accredited test firms and accredited according to ISO/IEC 17025.

If you have any comments, please feel free to contact us at the following:

**Lin Kou EMC/RF Lab**

Tel: 886-2-26052180

Fax: 886-2-26051924

**Hsin Chu EMC/RF/Telecom Lab**

Tel: 886-3-6668565

Fax: 886-3-6668323

**Hwa Ya EMC/RF/Safety Lab**

Tel: 886-3-3183232

Fax: 886-3-3270892

**Email:** [service.adt@bureauveritas.com](mailto:service.adt@bureauveritas.com)

**Web Site:** <http://ee.bureauveritas.com.tw>

The address and road map of all our labs can be found in our web site also.

--- END ---