

SIEMENS

SIMATIC HMI

HMI device

Mobile Panel 277F IWLAN V2,
Mobile Panel 277F IWLAN (RFID Tag)



Operating Instructions

Preface	
Overview	1
Safety instructions and standards	2
Planning the use	3
Mounting and connection	4
Operator controls and displays	5
Configuring the HMI device	6
Safety-related configuration	7
Commissioning a project	8
Commissioning the plant	9
Fail-safe operation	10
Operating a project	11
Service and maintenance	12
Technical specifications	13
Appendix	A
Abbreviations	B

Legal information

Warning notice system

This manual contains notices you have to observe in order to ensure your personal safety, as well as to prevent damage to property. The notices referring to your personal safety are highlighted in the manual by a safety alert symbol, notices referring only to property damage have no safety alert symbol. These notices shown below are graded according to the degree of danger.

 DANGER
indicates that death or severe personal injury will result if proper precautions are not taken.
 WARNING
indicates that death or severe personal injury may result if proper precautions are not taken.
 CAUTION
with a safety alert symbol, indicates that minor personal injury can result if proper precautions are not taken.
CAUTION
without a safety alert symbol, indicates that property damage can result if proper precautions are not taken.
NOTICE
indicates that an unintended result or situation can occur if the corresponding information is not taken into account.

If more than one degree of danger is present, the warning notice representing the highest degree of danger will be used. A notice warning of injury to persons with a safety alert symbol may also include a warning relating to property damage.

Qualified Personnel

The product/system described in this documentation may be operated only by **personnel qualified** for the specific task in accordance with the relevant documentation for the specific task, in particular its warning notices and safety instructions. Qualified personnel are those who, based on their training and experience, are capable of identifying risks and avoiding potential hazards when working with these products/systems.

Proper use of Siemens products

Note the following:

 WARNING
Siemens products may only be used for the applications described in the catalog and in the relevant technical documentation. If products and components from other manufacturers are used, these must be recommended or approved by Siemens. Proper transport, storage, installation, assembly, commissioning, operation and maintenance are required to ensure that the products operate safely and without any problems. The permissible ambient conditions must be adhered to. The information in the relevant documentation must be observed.

Trademarks

All names identified by ® are registered trademarks of the Siemens AG. The remaining trademarks in this publication may be trademarks whose use by third parties for their own purposes could violate the rights of the owner.

Disclaimer of Liability

We have reviewed the contents of this publication to ensure consistency with the hardware and software described. Since variance cannot be precluded entirely, we cannot guarantee full consistency. However, the information in this publication is reviewed regularly and any necessary corrections are included in subsequent editions.

Preface

Purpose of the operating instructions

These operating instructions provide information for manuals derived from the requirements for mechanical engineering documentation according to DIN EN 62079. This information relates to the place of use, transport, storage, mounting, use and maintenance.

These operating instructions are intended for:

- Users
- Commissioning engineers
- Maintenance personnel

Pay particular attention to the section "Safety instructions and standards (Page 41)".

You can find more information such as operating instructions, examples and reference information in the online help of WinCC flexible.

Required knowledge

General knowledge of automation technology and process communication is needed to understand the operating instructions.

It is also assumed that those using the manual have experience in using personal computers and an understanding of Microsoft operating systems.

Scope of this manual

The manual applies for the HMI devices "Mobile Panel 277F IWLAN V2" and "Mobile Panel 277F IWAN (RFID Tag)" in connection with the following software:

- STEP 7 V5.4, starting with SP2
- S7 Distributed Safety V5.4, SP3
- WinCC flexible 2008, SP2 with HSP "Mobile Panel 277 Wireless V2.0"

NOTICE

Manual belongs to HMI device

The supplied manual belongs to the HMI device and is also required to repeat commissioning. Keep all supplied and supplementary documentation for the entire service life of the HMI device.

Provide all stored documents to subsequent owners of the HMI device.

Trademarks

The following names marked with the ® symbol are registered trademarks of Siemens AG:

- HMI®
- SIMATIC®
- WinCC®

Style conventions

Style Convention	Scope
"Add screen"	<ul style="list-style-type: none"> • Terminology that appears in the user interface, for example dialog names, tabs, buttons, menu commands • Required input, for example, limits, tag values. • Path information
"File > Edit"	Operational sequences, for example, menu commands, shortcut menu commands.
<F1>, <Alt+P>	Keyboard operation

Please observe notes labeled as follows:

Note

A note contains important information about the product described in the manual and its use, or a specific section of the manual to which you should pay particular attention.

Naming conventions

Term	Applies to
Plant	<ul style="list-style-type: none"> • System • Machining center • One or more machines
Actuate	<ul style="list-style-type: none"> • By means of the touch screen on the HMI device • By operating a mouse on the HMI device
Mobile Panel 277F IWLAN V1	<ul style="list-style-type: none"> • Previous version of the Mobile Panel 277F IWLAN
Mobile Panel 277F IWLAN	<ul style="list-style-type: none"> • Mobile Panel 277F IWLAN V2 • Mobile Panel 277F IWLAN (RFID Tag)
Range name	<ul style="list-style-type: none"> • Describes an effective range which is recognized by an HMI device

Figures

This manual contains illustrations of the described devices. The illustrations can deviate from the particularities of the delivered device.

Technical Support

Technical support for the products covered in the manual is available in the Internet at:

- Technical Support (<http://support.automation.siemens.com>)
- Support Request (<http://support.automation.siemens.com/WW/view/en/16605654>)
- Service (<http://support.automation.siemens.com/WW/view/en/16604318>)
- Contacts and office locations (<http://www.automation.siemens.com/mcms/aspa-db/en/Pages/default.aspx>)
- Training center (<http://sitrain.automation.siemens.com/sitrain/default.aspx?AppLang=en>)

Additional information on SIMATIC products is available in the Internet at:

- Industry Portal (http://www.automation.siemens.com/_en/portal/index.htm)
- Overall SIMATIC documentation (http://www.automation.siemens.com/simatic/portal/html_76/techdoku.htm)

Recycling and disposal

The products described in this manual are recyclable because of the low level of contaminants in their components. Contact a certified disposal service company for environmentally sound recycling and disposal of your old devices.

Used batteries and rechargeable batteries

Used batteries and lithium ion batteries are hazardous waste. Always dispose of used batteries and lithium ion batteries properly in accordance with the regulations in effect. Identify the container provided for this purpose with the label, "Used batteries and rechargeables".

Note

Batteries and rechargeables do not belong in the garbage. The user is legally obliged to return used batteries and rechargeable batteries. You can deposit used batteries and rechargeables at any public collection site and anywhere batteries or rechargeables of similar type are sold.

You can also send batteries and rechargeables to the following address:

Siemens AG
Industry Sector
Returns Center
Siemensstr. 2
90766 Fürth
Germany

Table of contents

	Preface	3
1	Overview.....	15
1.1	Product overview	15
1.2	Scope of delivery	15
1.3	Mobile Panel 277F IWLAN.....	16
1.4	Accessory kit.....	18
1.5	Accessories.....	18
1.6	Equipment for HMI device and plant.....	19
1.6.1	Charging station	20
1.6.2	Power supply unit.....	21
1.6.3	RFID tag.....	22
1.6.4	Transponder.....	23
1.6.5	Access point.....	23
1.7	Compatibility of equipment.....	24
1.8	Communication and approved controllers	25
1.9	Software requirements.....	25
1.10	Supported WinCC flexible objects	26
1.11	Configuration and process control phases	30
1.12	Ranges in a transponder system	31
1.13	Areas in a RFID tag system	34
1.14	Rapid roaming.....	36
1.15	Terms for fail-safe operation	38
2	Safety instructions and standards.....	41
2.1	Safety instructions.....	41
2.2	Approvals	42
2.3	Standards on operating safety	45
2.4	Operating conditions	47
2.5	Risk analysis of the plant	48
2.6	Safety functions of the EMERGENCY STOP button	48
2.7	Safety functions of the enabling mechanism	49
2.8	Electromagnetic compatibility	51
3	Planning the use.....	53
3.1	Checklist.....	53
3.2	Ambient conditions for transportation and storage	54

Table of contents

3.3	Ambient conditions for operation	55
3.4	Insulation resistance, protection class and degree of protection	58
3.5	WLAN properties	59
3.6	Equipping a plant with tags	59
3.6.1	Equipping a plant with transponders	59
3.6.1.1	Dividing plant into effective ranges	59
3.6.1.2	Dividing plant into zones	63
3.6.2	Equipping a plant with RFID tags	64
3.7	Mounting location and clearance of charging station	66
3.8	Planning the installation location of transponders	67
3.9	Planning an installation location for RFID tags	68
3.10	Planning the installation location of signal lamps	69
3.11	Protection zone for the "Override" mode	69
3.12	Planning protection zones in the RFID tag system	69
3.13	Coexistence of the frequency bands	71
3.14	Planning information security	72
4	Mounting and connection	77
4.1	Check the scope of delivery	77
4.2	Mounting the charging station	77
4.3	Connecting the charging station	77
4.4	Mounting the transponder	79
4.5	Setting the transponder ID and inserting the batteries	79
4.6	Installing an RFID tag	82
4.7	Connecting the HMI device	83
4.7.1	Safety instructions	83
4.7.2	Opening and closing the battery and terminal compartment	84
4.7.3	Ports and reset button	87
4.7.4	Inserting a memory card	87
4.7.5	Replacing and charging the main rechargeable battery	89
4.7.5.1	Safety instructions	89
4.7.5.2	Replacing the main rechargeable battery	91
4.7.5.3	Charging the main rechargeable battery	92
4.7.5.4	Displaying the battery charge status	93
4.7.6	Connecting the PLC	94
4.7.7	Connecting the configuration PC	95
4.7.8	Connecting a printer	96
4.7.9	Connecting a USB device	97
4.7.10	Connecting the power supply unit	98
4.8	Switching on and testing the HMI device	98
4.9	Switching off the HMI device	100
5	Operator controls and displays	101
5.1	Overview	101
5.2	LED display	103

5.3	Power management.....	105
5.4	Safety-related operator controls.....	107
5.4.1	EMERGENCY STOP button.....	107
5.4.2	Enabling button.....	109
5.4.3	Testing the function.....	111
5.5	Operator controls.....	111
5.5.1	Operating the handwheel.....	111
5.5.2	Operating the key-operated switch.....	111
5.5.3	Operating the illuminated push-button.....	112
5.5.4	Evaluating operator controls.....	112
5.5.4.1	Overview.....	112
5.5.4.2	Evaluating operator controls as direct keys.....	113
5.5.4.3	Controlling the LEDs of the function keys via system functions.....	116
5.5.4.4	Controlling the handwheel via system functions.....	116
5.5.4.5	Controlling key-operated switches via system functions.....	117
5.5.4.6	Controlling and evaluating illuminated mushroom pushbuttons via system functions.....	117
5.6	Labeling the function keys.....	118
5.7	Holding, operating and setting down the HMI device.....	120
5.8	Using the charging station.....	122
5.8.1	Charging the main battery in the charging compartment.....	122
5.8.2	LED-displays on the charging station.....	123
5.8.3	Locking the charging station.....	124
6	Configuring the HMI device.....	127
6.1	Desktop and Loader.....	127
6.2	Operatig desktop and loader.....	130
6.3	Enabling and disabling SecureMode.....	130
6.4	Control Panel.....	131
6.4.1	Overview.....	131
6.4.2	Functions in the Control Panel.....	132
6.4.3	Operating the Control Panel.....	133
6.4.4	Using the screen keyboard in the Control Panel.....	133
6.4.5	Configuring operation.....	136
6.4.5.1	Configuring the screen keyboard.....	136
6.4.5.2	Changing display brightness.....	137
6.4.5.3	Setting the character repeat rate of the screen keyboard.....	137
6.4.5.4	Setting the double-click.....	139
6.4.5.5	Calibrating the touch screen.....	140
6.4.5.6	Starting the HMI device again.....	142
6.5	Entering and deleting a password.....	143
6.6	Configuring the WLAN connection.....	145
6.7	General configuration.....	155
6.7.1	Setting the date and time.....	155
6.7.2	Backing up registry information and temporary data.....	156
6.7.3	Displaying information about the HMI device.....	158
6.7.4	Displaying the charge status of the batteries.....	158
6.7.5	Activating vibration alarm.....	159
6.7.6	Configuring the printer connection.....	160
6.7.7	Regional and language settings.....	162

Table of contents

6.7.8	Setting the screen saver	162
6.7.9	Displaying general system properties	164
6.7.10	Displaying memory distribution	165
6.7.11	Setting the location of the project.....	166
6.7.12	Setting the delay time for the project	167
6.8	Enabling PROFINET IO	168
6.9	Setting the PROFIsafe address	169
6.10	Programming the data channel.....	171
6.11	Configuring network operation	173
6.11.1	Overview	173
6.11.2	Specifying the computer name of the HMI device	174
6.11.3	Specifying the IP address and name server	175
6.11.4	Specifying the logon data.....	176
6.11.5	Configuring e-mail	177
6.12	Changing Internet settings	180
6.12.1	Changing general settings	180
6.12.2	Setting the proxy server	181
6.12.3	Changing privacy settings.....	182
6.12.4	Importing, displaying and deleting certificates	183
6.13	Saving to external storage medium – backup	185
6.14	Restoring from external storage medium – Restore	186
6.15	Activate memory management	189
7	Safety-related configuration	191
7.1	General procedure	191
7.2	Checklist for configuration.....	192
7.3	SIMATIC STEP 7	193
7.3.1	Configuring in STEP 7.....	193
7.3.2	Assigning parameters for communication between the HMI device and the controller	194
7.3.3	"SIMATIC S7 Distributed Safety" add-on.....	196
7.3.4	Checklist for EMERGENCY STOP configuration.....	197
7.3.5	Using F-FBs	198
7.3.6	F_FB_MP.....	201
7.3.7	F_FB_RNG_4 and F_FB_RNG_16.....	204
7.4	Configuration in WinCC flexible	209
8	Commissioning a project.....	211
8.1	Using an existing project.....	211
8.2	Operating modes.....	212
8.3	Available data channels	213
8.4	Preparing and backing up a project	213
8.4.1	Overview	213
8.4.2	Transfer	214
8.4.2.1	Overview	214
8.4.2.2	Starting manual transfer.....	215
8.4.2.3	Starting automatic transfer	216
8.4.2.4	Starting backtransfer	217
8.4.3	Testing a project.....	218

8.4.4	Backup and restore	220
8.4.4.1	Overview	220
8.4.4.2	Backing up with WinCC flexible	220
8.4.4.3	Backing up with ProSave	221
8.4.4.4	Restoring with WinCC flexible.....	222
8.4.4.5	Restoring with ProSave	223
8.4.5	Updating the operating system	224
8.4.5.1	Overview	224
8.4.5.2	Updating the operating system using WinCC flexible.....	224
8.4.5.3	Updating the operating system using ProSave.....	225
8.4.6	Restoring factory settings	226
8.4.6.1	Overview	226
8.4.6.2	Restoring the factory settings using WinCC flexible.....	227
8.4.6.3	Restoring the factory settings with ProSave	229
8.4.7	Installing and removing software options.....	232
8.4.7.1	Overview	232
8.4.7.2	Installing with WinCC flexible	232
8.4.7.3	Removing with WinCC flexible.....	233
8.4.7.4	Installing with ProSave.....	234
8.4.7.5	Removing with ProSave.....	234
8.4.8	Transferring and transferring back license keys	235
8.4.8.1	Overview	235
8.4.8.2	Transfer license keys	235
8.4.8.3	Transfer license keys back	236
8.5	Commissioning an RFID tag	237
8.6	Replacing an RFID tag.....	240
9	Commissioning the plant	241
9.1	Overview	241
9.2	Acceptance of the plant	241
9.3	Transponder system	242
9.3.1	Accepting effective range.....	242
9.3.2	Test effective range	245
9.3.3	Testing zones.....	246
9.4	RFID tag system	247
9.4.1	Commissioning an RFID tag.....	247
9.4.2	Replacing an RFID tag.....	249
9.5	Diagnostics.....	251
10	Fail-safe operation	253
10.1	Organizational measures	253
10.2	Integrating the HMI device	254
10.3	Operating the transponder system in a fail-safe mode	255
10.3.1	Switch-off behavior	255
10.3.2	Determine the current effective range and current zone	256
10.3.3	Logging onto a machine.....	257
10.3.4	Logging off the machine.....	259
10.3.5	Activating and deactivating "Override" mode.....	260
10.4	RFID tag system run in a fail-safe manner	263
10.4.1	Switch-off behavior	263

Table of contents

10.4.2	Logging onto a machine.....	264
10.4.3	Logging off the machine.....	266
10.4.4	Replacing an RFID tag.....	267
10.5	Removing the HMI device.....	268
11	Operating a project.....	271
11.1	Starting the project.....	271
11.2	Operator input options.....	273
11.3	Direct keys.....	275
11.4	Setting the project language.....	276
11.5	Operating the screen keyboard in the project.....	277
11.6	Device-specific displays.....	280
11.6.1	Showing the battery charge.....	280
11.6.2	Displaying WLAN quality.....	281
11.6.3	Display "effective range name" object.....	282
11.6.4	Displaying the "Effective range name (RFID)" object.....	283
11.6.5	Display "effective range quality" object.....	283
11.6.6	Display "zone name" object.....	284
11.6.7	Display "zone quality" object.....	284
11.7	Project security.....	285
11.7.1	Overview.....	285
11.7.2	User View.....	287
11.7.3	User logon.....	288
11.7.4	User logoff.....	289
11.7.5	Creating users.....	289
11.7.6	Changing user data.....	291
11.7.7	Deleting users.....	292
11.8	Function keys.....	292
11.9	Bar.....	293
11.10	Gauge.....	293
11.11	Operating the slider control.....	294
11.12	Operating the switch.....	295
11.13	Operating the Trend View.....	295
11.14	Operating the status force.....	298
11.15	Operating the Sm@rtClient view.....	300
11.16	Error cases in the project operation.....	303
11.17	Operate alarm view and alarm window.....	304
11.17.1	Overview.....	304
11.17.2	Recognizing pending alarms.....	306
11.17.3	Alarm view.....	306
11.17.3.1	Overview.....	306
11.17.3.2	Displaying alarms.....	306
11.17.3.3	Display alarm window.....	308
11.17.4	Display infotexts for an alarm.....	308
11.17.5	Acknowledge alarm.....	309
11.17.6	Edit alarm.....	310

11.18	Operating recipes.....	310
11.18.1	Overview.....	310
11.18.2	Structure of a recipe.....	311
11.18.3	Recipes in the Project.....	313
11.18.4	Recipe displays.....	315
11.18.5	Recipe Values in the HMI Device and the PLC.....	317
11.18.6	Operating the recipe view.....	319
11.18.6.1	Overview.....	319
11.18.6.2	Creating a recipe data record.....	320
11.18.6.3	Editing a recipe data record.....	321
11.18.6.4	Deleting a recipe data record.....	321
11.18.6.5	Synchronizing tags.....	322
11.18.6.6	Reading a recipe data record from the PLC.....	323
11.18.6.7	Transferring a recipe data record to the PLC.....	323
11.18.7	Using the simple recipe view.....	324
11.18.7.1	Overview.....	324
11.18.7.2	Creating a recipe data record.....	326
11.18.7.3	Editing a recipe data record.....	327
11.18.7.4	Deleting a recipe data record.....	327
11.18.7.5	Reading a recipe data record from the PLC.....	328
11.18.7.6	Transferring a recipe data record to the PLC.....	329
11.18.8	Exporting a recipe data record.....	329
11.18.9	Importing a recipe data record.....	330
11.18.10	Examples.....	331
11.18.10.1	Entering a recipe data record.....	331
11.18.10.2	Manual production sequence.....	332
11.19	Closing the project.....	333
12	Service and maintenance.....	335
12.1	Maintenance and care.....	335
12.2	Spare parts and repairs.....	336
13	Technical specifications.....	337
13.1	Dimension drawings.....	337
13.1.1	Mobile Panel 277F IWLAN.....	337
13.1.2	Charging station.....	339
13.1.3	Transponder.....	340
13.1.4	RFID tag.....	340
13.2	Specifications.....	342
13.2.1	Mobile Panel 277F IWLAN.....	342
13.2.2	Interface description.....	345
13.2.3	Main battery.....	347
13.2.4	Charging station.....	347
13.2.5	Transponder.....	348
13.2.6	RFID tag.....	348
13.3	WLAN radiation characteristics of the HMI device.....	349
13.3.1	Radiation characteristics in the 2.4 GHz band.....	349
13.3.2	Radiation characteristics in the 5 GHz band.....	350
13.4	Radiation characteristics of the transponder system.....	352
13.4.1	Radiation characteristic of HMI device.....	352
13.4.2	Radiation characteristic of the transponder.....	355
A	Appendix.....	359

Table of contents

A.1	ESD guideline	359
A.2	Typical operating procedures and potential fault scenarios.....	361
A.2.1	Overview	361
A.2.2	Switch on the HMI device.....	362
A.2.3	Integrating the HMI device	363
A.2.4	Operating the transponder system.....	364
A.2.4.1	Detecting the effective range	364
A.2.4.2	Logging onto a machine.....	365
A.2.4.3	Exiting the effective range without log off	366
A.2.4.4	Logging off the machine.....	367
A.2.4.5	Activating "override" mode	369
A.2.4.6	Terminating "override" mode.....	370
A.2.5	Operating RFID tag system.....	371
A.2.5.1	Logging onto a machine.....	371
A.2.5.2	Leaving a protection zone without logging off.....	373
A.2.5.3	Logging off the machine.....	374
A.2.6	Faulty operating states.....	375
A.2.6.1	Communication error for the integrated HMI device	375
A.2.6.2	Communication errors with logged on HMI device	377
A.2.6.3	Internal error.....	378
A.2.7	Discrepancy error during agreement or panic.....	379
A.2.7.1	The enabling button is askew	379
A.2.7.2	The enabling button is defective.	381
A.2.8	Removing the HMI device.....	382
A.2.9	Switching off the HMI device.....	384
A.3	Example of application for transponder system.....	385
A.3.1	Configuration and operation.....	385
A.3.2	Configuring the controller and HMI device in STEP 7	388
A.3.3	Safety program S7 Distributed Safety.....	393
A.4	Application example RFID tag system	398
A.4.1	Configuration and operation.....	398
A.4.2	Configuring the controller and HMI device in STEP 7	401
A.4.3	Safety program S7 Distributed Safety.....	405
A.5	Safety-related messages	409
A.5.1	Transponder system	409
A.5.2	RFID tag system	413
A.6	System alarms	416
B	Abbreviations.....	451
	Glossary	453
	Index.....	461

Overview

1.1 Product overview

Expanded possible fields of application – with Mobile Panel 277F IWLAN

The Mobile Panel 277F IWLAN is used as a HMI device in fail-safe automation systems. A fail-safe automation system is required in systems with increased safety requirements.

With the Mobile Panel 277F IWLAN, the system can be operated in the fail-safe mode with EMERGENCY-STOP button and enabling button without disrupting lines.

The HMI device communicates with the F-CPU via WLAN.

With the Mobile Panel 277F IWLAN V2 is equipped with an effective range system. Depending on the location, the operator receives a secure, electronically monitored operator control enable for a machine.

With Mobile Panel 277F IWLAN (RFID Tag), the logging on to the machine occurs through an RFID-Tag.

The Mobile Panel 277F IWLAN is characterized by short commissioning times, a large user memory and high performance, and is optimized for projects based on WinCC flexible.

The Mobile Panel 277F IWLAN has the following features:

- Safety-related operator controls
 - EMERGENCY STOP button
 - Enabling button
- Wireless operation with:
 - IWLAN interface via PROFINET
 - Battery operation
- High-Color-7,5"-TFT-Display
- 18 function keys with LED
- Extended HMI functions

1.2 Scope of delivery

Scope of delivery

The scope of delivery includes:

- 1 Mobile Panel 277F IWLAN
- 1 main rechargeable battery
- 1 accessory kit

Additional documents may be included in the scope of delivery.

1.3 Mobile Panel 277F IWLAN

The Mobile Panel 277F IWLAN is available in two design variations:

- With enabling button and EMERGENCY STOP button
- With enabling button, EMERGENCY STOP button, handwheel, key-operated switch and two illuminated pushbuttons

The Mobile Panel 277F IWLAN works wireless in battery mode or plugged into a charging station.

Front view

The following figure shows the Mobile Panel 277F IWLAN with its maximum equipment.



- ① Handwheel, optional
- ② EMERGENCY STOP button
- ③ LED display
- ④ Membrane keyboard
- ⑤ Display with touch screen
- ⑥ Key "ON/OFF"
- ⑦ Covers for the labeling strips for the slot openings
- ⑧ Illuminated pushbutton, optional
- ⑨ Key-operated switch, optional

Side view



- ① Fall protection for the EMERGENCY STOP button
- ② Enabling buttons, positioned on both sides of the Mobile Panel 277F IWLAN
- ③ Handle

Rear view

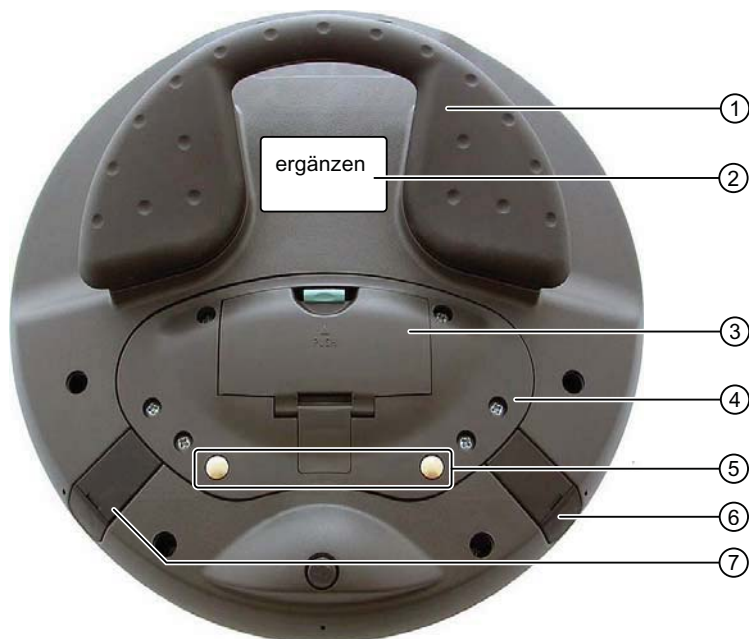

- ① Handle
- ② Nameplate
- ③ Battery compartment cover
- ④ Connection compartment cover
- ⑤ Contacts for charging station
- ⑥ USB connection
- ⑦ Connection for power supply

1.4 Accessory kit

The accessory kit contains:

- 1 cover cap with rubber seal
- 1 screw for fixing the cover cap
- 1 label for cover caps
- 1 data carrier with the following content:
F-modules (F-FBs) for a safety-related project

Additional documents may be enclosed with the accessory kit.

1.5 Accessories

The accessory can be ordered from the Internet at Industry Mall (<http://mall.automation.siemens.com>).

- Labeling strips

Labeling strips serve for the project-oriented labeling of function keys on the HMI device. Stickers for the cover caps can also be supplied, in addition to the labeling strips. The cover caps cover the slot openings for the labeling strips.

Order number: 6AV6671-5BF00-0AX0

- Replacement key set

The replacement key set contains two keys for the key switch.

Order number: 6AV6574-1AG04-4AA0

- Main battery

The main rechargeable battery supplies power to the HMI device.

Order number: 6AV6671-5CL00-0AX0

- Protective foil

The protective foil prevents the touch screen from becoming scratched or soiled.

Order number: 6AV6671-5BC00-0AX0

- Service package for the HMI device

Order number: 6AV6671-5CA00-0AX2

The service pack includes:

- Cover caps
- Battery compartment cover

- Memory card

Only use SD memory cards tested and approved by Siemens AG or MicroMemory cards.

Note

The MicroMemory card of the SIMATIC S7 controller is not suited for use with this HMI device.

- USB Flash drive for SIMATIC PC

The USB Flash drive for SIMATIC PC is a mobile data storage device with a high data throughput, designed for industrial use.

1.6 Equipment for HMI device and plant

The following devices are needed for the HMI device and for fail-safe operation of a plant:

- HMI device
 - Charging station
 - Power supply unit, optional
- Plant
 - RFID-tag or transponder
 - Access point
 - Signal lamp, optional
 - Security systems, optional

The devices listed are not included in the scope of delivery of the HMI device. Order these devices separately.

You can find order information on the Internet at Industry Mall (<http://mall.automation.siemens.com>).

Overview

1.6 Equipment for HMI device and plant

1.6.1 Charging station

The charging station is used to charge the main battery in the HMI device and to safely store the HMI device. The charging station is designed to be used in the system.

Order number: 6AV6671-5CE00-0AX0

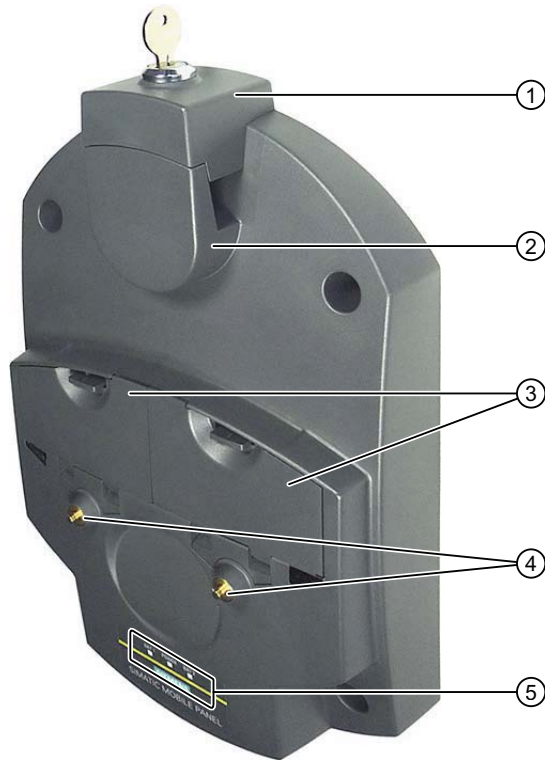

- ① Lock
- ② Hook for hooking in the HMI device
- ③ Charging compartment for one main battery
- ④ Charging contact for the HMI device
- ⑤ LED display
- ⑥ Power supply connector

On the underside of the charging station you will find the slot for power supply.

Accessory kit

The accessory kit contains:

- 1 lock
- 1 key set for lock
- 1 cable connector

The accessory kit can include documents.

1.6.2 Power supply unit

The power supply unit ensures the power supply of the charging station. The power supply unit can be used in 120 and 230 V AC power networks. The setting of the voltage range takes place automatically. The output voltage is 24 VDC.



- ① "Power" LED
- ② Connecting cable
- ③ Power supply unit
- ④ Power supply cable

Order number: 6AV6671-5CN00-0TA0

The power supply unit is provided with four power supply cables with plugs for the following regions:

- Europe
- Asia
- North America
- United Kingdom of Great Britain and Northern Ireland

Read the relevant documentation.

1.6.3 RFID tag

The RFID tag is required to log onto a machine. The RFID tag is a MDS D100 mobile data storage unit.



Order number: 6GT2600-0AD10

The RFID tag includes the following accessories:

- Spacer

Order number: 6GT2190-0AA00

- Fixing pocket

Order number: 6GT2190-0AB00

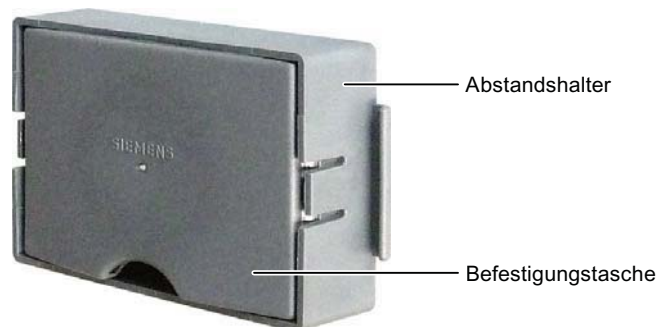

Alternative

Alternative to the mobile data medium MDS D100, you can also use the mobile data medium MDS D124 with the order number 6GT2600-0AC00.

The effective range of the MDS D124, in connection with the HMI device, is only 2 cm. Thus, the MDS D100 is preferred. All of the following description of an RFID tag system in this document require the usage of the mobile data medium MDS D100.

1.6.4 Transponder

A transponder is required for setting up effective ranges in plants with fail safe operation and for configured zones.



Order number: 6AV6671-5CE00-0AX1

Accessory kit

The accessory kit contains:

- 3 AA mignon batteries, 1.5 V

The accessory kit can include documents.

1.6.5 Access point

The access point is needed for the WLAN. The access point serves as a gateway between the wireless and wired network.



Overview

1.7 Compatibility of equipment

To use the function iPCF-MC for Rapid Roaming, you need an access point with two radio interfaces of the type SCALANCE W78x-2RR and firmware version V4.3.

We recommend the following access points for operation with the HMI device.

Designation	Number of WLAN interfaces	Antenna	iPCF-MC / Rapid roaming	Order number
SCALANCE W784-1	1	External	No	6GK5 784-1AA30-2AA0 6GK5 784-1AA30-2AB0 ¹⁾
SCALANCE W786-1PRO	1	Internal	No	6GK5 786-1BA60-2AA0 6GK5 786-1BA60-2AB0 ¹⁾
SCALANCE W786-2RR	2	Internal	Yes	6GK5 786-2BA60-6AA0 6GK5 786-2BA60-6AB0 ¹⁾
SCALANCE W788-1PRO	1	External	No	6GK5 788-1AA60-2AA0 6GK5 788-1AA60-2AB0 ¹⁾
SCALANCE W788-2RR	2	External	Yes	6GK5 788-2AA60-6AA0 6GK5 788-2AA60-6AB0 ¹⁾
SCALANCE W786-1PRO	1	Internal	No	6GK5 786-1BA60-2AA0 6GK5 786-1BA60-2AB0 ¹⁾
SCALANCE W786-2RR	2	Internal	Yes	6GK5 786-2BA60-6AA0 6GK5 786-2BA60-6AB0 ¹⁾
SCALANCE W786-2RR	2	External	Yes	6GK5 786-2AA60-6AA0 6GK5 786-2AA60-6AB0 ¹⁾

1) US version

Read the relevant documentation.

Additional access points and WLAN products are available in the Internet at: Industry Mall (<http://mall.automation.siemens.com>)

1.7 Compatibility of equipment

For all versions of the mobile panel 227F IWLAN, the following devices are compatible:

- Charging station
- Main battery
- Power supply unit

The following applies for the transponder:

- Transponder for the Mobile Panel 277F IWLAN V2
These cannot be used for a Mobile Panel 277F IWLAN V1.
- Transponder for the Mobile Panel 277F IWLAN V1
These can be used without limitations.

1.8 Communication and approved controllers

Number of communication connections

Communication link	Mobile Panel 277F IWLAN
Quantity, max.	6

Approved PLCs

The HMI device has been enabled for use with the following type of PLC:

- SIMATIC S7
- Allen-Bradley, E/IP C.Logix

NOTICE

Safety-related communication

A non-fail-safe controller cannot ensure safety-related communication.

A SIMATIC S7F PLC is required for safety-related communication.

Approved protocols

The HMI device uses the following protocol for communication with the PLC:

- PROFI-safe Mode V2.0

1.9 Software requirements

You need the following software for fail-safe operation:

- WinCC flexible 2008, SP2 with HSP "Mobile Panel 277 Wireless V2"
- SIMATIC STEP 7 V5.4, as of SP2
- "SIMATIC S7 Distributed Safety V5.4" as of SP4 option package

Software options for the HMI device:

- WinCC flexible/Sm@rtService

The Sm@rtService option enables you to access a remote HMI device from the HMI device or PC via Ethernet. Read-only access on the removed HMI device is possible.

- WinCC flexible/Sm@rtAccess

The Sm@rtAccess option enables you to set up communication between different HMI systems.

- WinCC flexible /Audit

The Audit option extends the HMI device to include functions for recording operations in an audit trail and electronic signature.

1.10 Supported WinCC flexible objects

The following tables contain the maximum number of objects you can use with the HMI device in a project.

Note

The maximum number of multiple objects used simultaneously can affect the performance of the active WinCC flexible project.

Alarms

Object	Specification	HMI device
Alarm	Number of discrete alarms	4 000
	Number of analog alarms	200
	Length of the alarm text	80 characters
	Number of tags in an alarm	Max. 8
	LEDs	Alarm line, Alarm window, Alarm view
	Acknowledge error alarms individually	Yes
	Acknowledge several error alarms simultaneously (group acknowledgment of alarm groups)	16 alarm groups
	Edit alarm	Yes
	Alarm indicator	Yes
ALARM_S	Display S7 alarms	Yes
Alarm buffer, retentive	Alarm buffer capacity	512 alarms
	Simultaneously queued alarm events	Max. 250
	View alarm	Yes
	Delete alarm buffer	Yes
	Line-by-line printing of alarms	Yes

Tags, values and lists

Object	Specification	HMI device
Tag	Number	2 048
Limit value monitoring	Input/Output	Yes
Linear scaling	Input/Output	Yes
Text list	Number	500 ¹⁾
Graphics list	Number	400 ¹⁾

¹⁾ The maximum total of text and graphics lists is 500.

Screens

Object	Specification	HMI device
Screen	Number	500
	Fields per screen	200
	Tags per screen	200
	Complex objects per screen (for example bars)	10
	Template	Yes

Recipes

Object	Specification	HMI device
Recipe	Number	300
	Data records per recipe	500
	Entries per recipe	1 000
	Recipe memory	64 KB
	Location ¹⁾	Memory card USB stick Network drive

- 1) The number of recipe data records might be restricted by the capacity of the storage medium.

Logs

NOTICE
<p>Logging</p> <p>The HMI device is suitable for logging small volumes of data. The use of a large circular log has a negative effect on performance.</p> <p>In order to log larger amounts of data, use segmented circular logs with multiple sequential logs.</p>

Object	Specification	HMI device
Logs	Number of logs	20
	Number of partial logs in a segmented circular log	400
	Entries in each log including all partial logs	10 000
	Filing format	CSV with ANSI character set

Overview

1.10 Supported WinCC flexible objects

Object	Specification	HMI device
	Location ¹⁾	Memory card USB stick Network drive

- 1) The number of entries in the log may be restricted by the capacity of the storage medium.

Safety

Object	Specification	HMI device
User administration	Number of user groups	50
	Number of users	50
	Number of authorizations	32

Infotexts

Object	Specification	HMI device
Infotext	Length (no. of characters)	320 (depending on font)
	For alarms	Yes
	For screens	Yes
	For screen objects (for example for I/O field, switch, button, invisible button)	Yes

Additional functions

Object	Specification	HMI device
Monitor setting	Touch screen calibration	Yes
	Brightness setting	Yes
Language change	Number of languages	16
VBScript	User-specific extension of the functionality	Yes
	Number of scripts	50
Graphic object	Vector and pixel graphics	Yes
Trend	Number	300
Task planner	Number of tasks	48
Text object	Number	10 000
Direct key	PROFINET IO direct keys	Yes

Device-specific functions

Object	Specification	HMI device
Main battery	Displaying the battery charge status	Yes
WLAN quality	Displaying WLAN quality	Yes
Effective range (RFID) name ¹	Display effective range name	Yes
Effective range name ¹	Display effective range name	Yes
Effective range quality ²	Displaying the effective range quality	Yes
Zone name ²	Displaying zone names	Yes
Zone quality ²	Displaying zone quality	Yes

- 1 Applies for Mobile Panel 277F IWLAN (RFID Tag)
- 2 Applies for Mobile Panel 277F IWLAN

Functions for transponder system

Configuration	
Number of transponders in the project, maximum	127
Number of effective ranges in the project, maximum	127
Number of transponders in the effective range, maximum	127
Number of HMI devices with logon authorization per effective range, when using F_FB_RNG_4, maximum	4 HMI devices
Number of HMI devices with logon authorization per effective range, when using F_FB_RNG_16, maximum	16 HMI devices

Functions for RFID tag system

Configuration	
Number of RFID tags in the project, maximum	127
Number of protection zones in the project, maximum	127
Number of RFID tags per protection zone, maximum	127
Number of HMI devices with logon authorization per protection zone, when using F_FB_RNG_4 ¹⁾ , maximum	4 HMI devices
Number of HMI devices with logon authorization per protection zone, when using F_FB_RNG_16 ¹⁾ , maximum	16 HMI devices

- 1 F_FB: Fail-safe function block

1.11 Configuration and process control phases

You must follow the phases below in order to use an HMI device in the system:

- Configuration phase
- Process control phase

Configuration phase

The configuration phase consists of the following operations:

- Create project
- Transferring a project

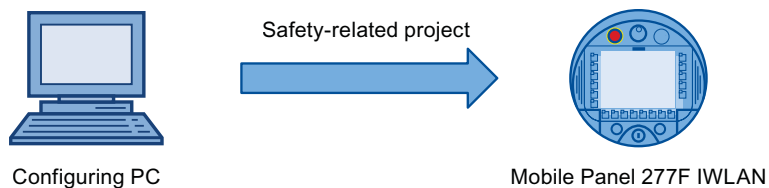

- Accept project – determine checksum
- Test project
- Simulate project
- Save project

Process control phase

The process control phase includes operation and monitoring of active production processes with the HMI device. The HMI screens on the HMI device visualize the production process.

The following figure shows an example configuration of a plant control system which is operated with a Mobile Panel 277F IWLAN.

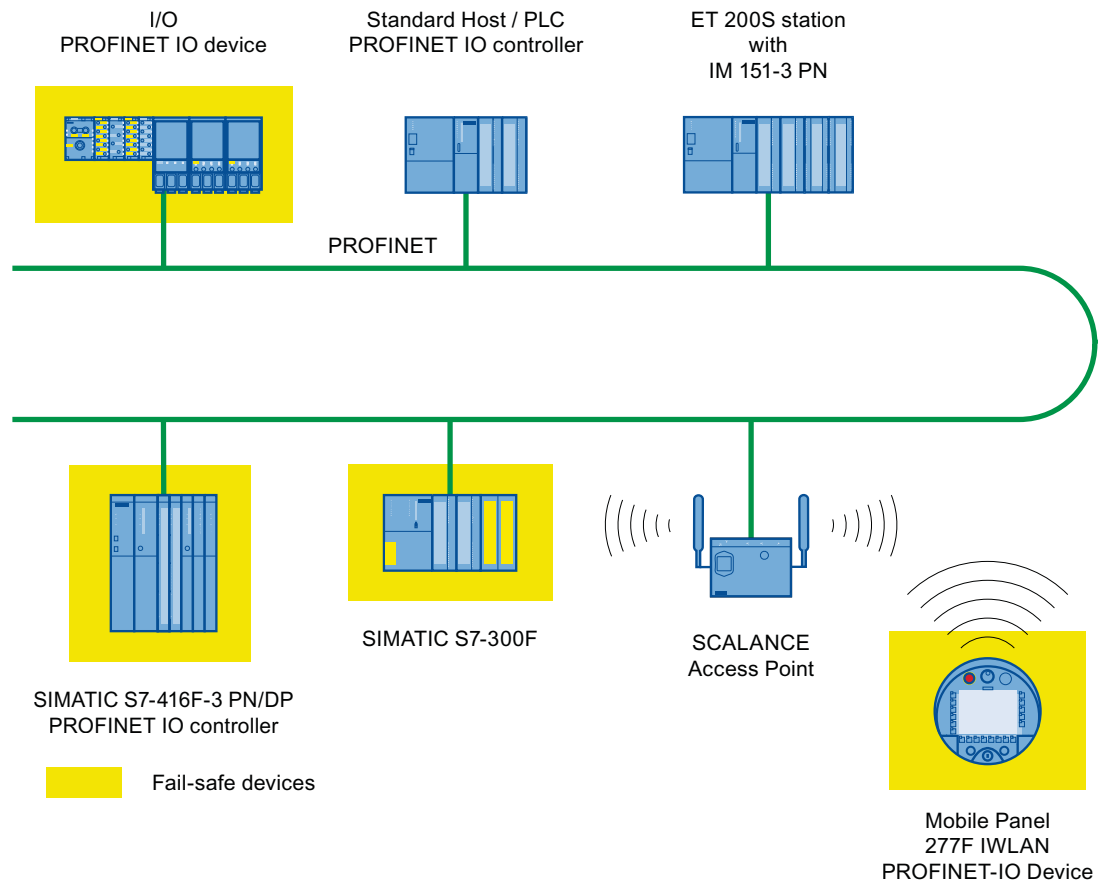

1.12 Ranges in a transponder system

In a plant for fail-safe operation with transponder log ons, there are the following ranges:

- WLAN for communication between a fail-safe controller and HMI device
- Effective range of the transponder for logging onto a machine
- Transmission and reception range of an HMI device for logging onto a machine

WLAN/iWLAN

Fail-safe controller and HMI device communicate over the radio cell of the access point. The access point serves as a gateway between the wireless and wired network.

The WLAN or iWLAN in the plant is provided by at least one access point.

The figure below shows an example of the various areas.

Overview

1.12 Ranges in a transponder system

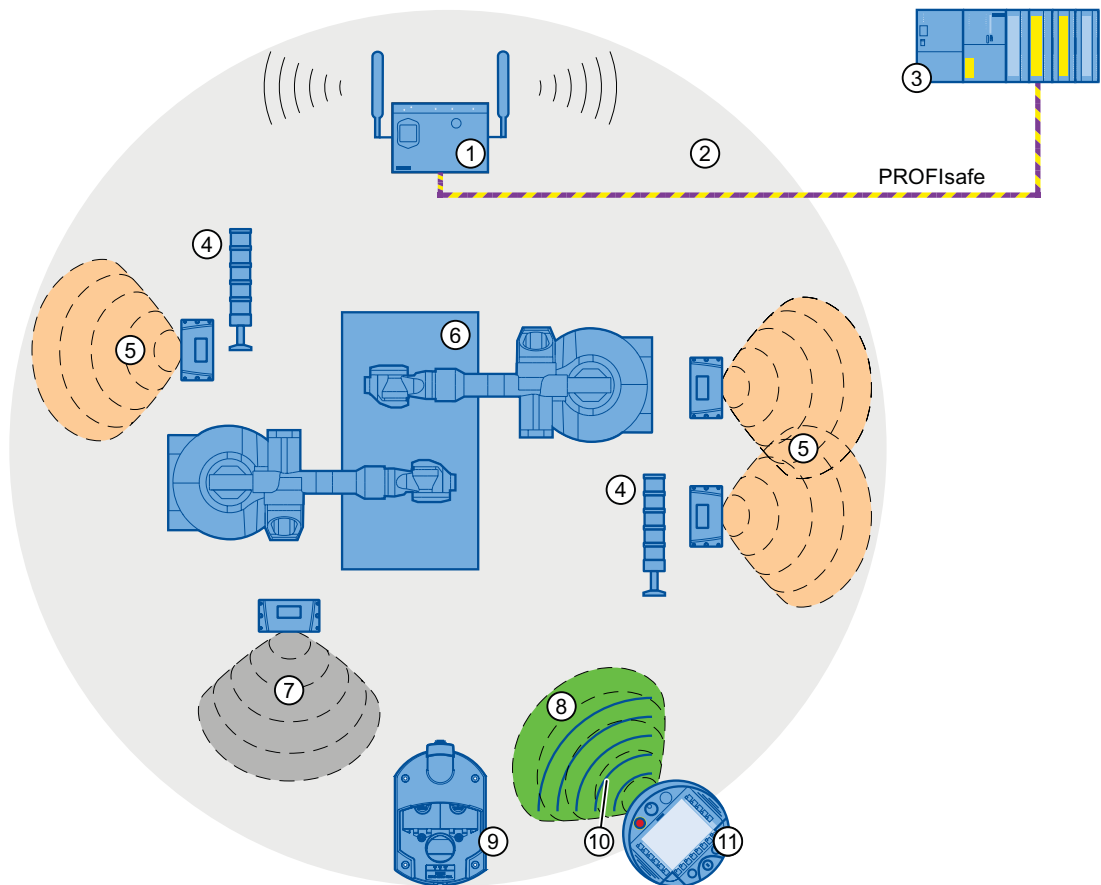

- ① SCALANCE W access point
- ② Cell of the access point
- ③ Fail-safe controller
- ④ Signal lamp
- ⑤ Transponder with effective range
- ⑥ Plant
- ⑦ Transponder with zone
- ⑧ Wireless range of the HMI device
- ⑨ Charging station
- ⑩ Transmission and reception range of the HMI device
- ⑪ HMI device

Transponder

Transponders are used to span the effective ranges and zones within the plant.

The wireless range of the transponder corresponds with the effective range or zone in its expansion. See section "Radiation characteristic of the transponder (Page 355)".

Effective range

An effective range is the range in which sections of the system, for example a machine, can be operated fail-safe with the enabling buttons and the EMERGENCY-STOP button. Operating with the enabling button is not possible outside of the effective range.

Fail-safe operation is only possible after successfully logging on to a machine. A signal lamp indicates whether an HMI device is logged onto a machine.

The effective range is a configurable object. The size of the effective range is defined in the project.

Zone

A zone is used to operate and observe depending on the location of the operator. For example, a screen change can be configured for entering or exiting a zone. The enabling buttons are not effective.

Fail-safe operation is not possible in a zone.

The zone is a configurable object within a transponder system.

Note

The zone and effective range are independent of each other. For fail-safe operation, at least one effective range must be configured. A zone cannot be configured for fail-safe operation.

Transponder system in the "override" mode

In the "override" mode, the effective range monitoring is disabled and fail-safe operation is possible throughout the entire WLAN range. The components that are operated fail-safe must be separated through a safety system, for example, a protective gate.

The "override" mode is used in the following cases:

- Components should undergo fail-safe operation if they cannot be reached from the wireless range of one or multiple transponders.
- A component should be operated fail-safe for which there is already a safety system.

Protection zone

The protection zone is the area in the plant in which one or more machines are operated in fail-safe mode. The protection zone of the plant is demarcated by a security system and organizational measures.

The protection zone is **not** an object that can be configured.

Security system and organizational measures

The security system consists of one or more technical protection devices for the protection zone, e.g.:

- Mesh fence with access
- Light barrier
- Contact safety shut-off mat

The security system can be controlled by a safety program, such as a program for robot control conforming to a robotics directive.

See also

Areas in a RFID tag system (Page 34)

1.13 Areas in a RFID tag system

The following areas are available in a plant for fail-safe operation with RFID tag logon:

- WLAN for communication between a fail-safe controller and HMI device
- Effective range of the RFID tag for logging onto a machine
- RFID transmission and reception range of an HMI device for logging onto a machine

WLAN/iWLAN

Fail-safe controller and HMI device communicate over the radio cell of the access point. The access point serves as a gateway between the wireless and wired network.

The WLAN or iWLAN in the plant is provided by at least one access point.

The figure below shows an example of the various areas.

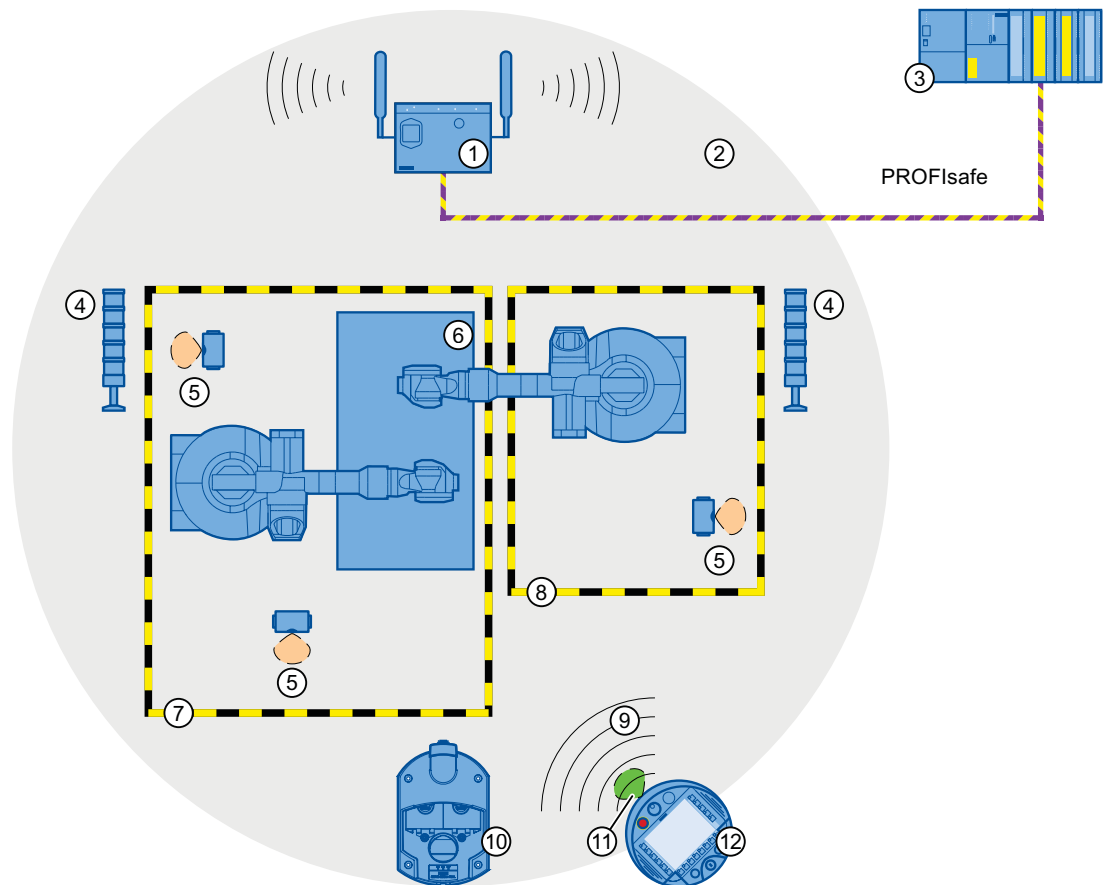

- ① SCALANCE W access point
- ② Cell of the access point
- ③ Fail-safe controller
- ④ Signal lamp
- ⑤ RFID tag with effective range
- ⑥ Plant
- ⑦ Protection zone limit of protection zone 1
- ⑧ Protection zone limit of protection zone 2
- ⑨ WLAN of the HMI device
- ⑩ Charging station
- ⑪ RFID transmission and reception range of the HMI device
- ⑫ HMI device

RFID tag with effective range

The RFID tag is a storage device for a configured ID. The ID of the RFID tag is required for a HMI device to log onto a machine. The RFID transmission and reception range of the HMI device is brought into the effective range of the RFID tag in order to log on.

A signal lamp indicates whether an HMI device is logged onto a machine.

Protection zone

The protection zone is the area in the plant in which one or more machines are operated in fail-safe mode. The protection zone of the plant is demarcated by a security system and organizational measures.

The protection zone is **not** an object that can be configured.

Security system and organizational measures

The security system consists of one or more technical protection devices for the protection zone, e.g.:

- Mesh fence with access
- Light barrier
- Contact safety shut-off mat

The security system can be controlled by a safety program, such as a program for robot control conforming to a robotics directive.

1.14 Rapid roaming

The wireless range of an iWLAN system can be expanded through the use of multiple access points. If an HMI device moves beyond the range of a SCALANCE W78x and into the range of another SCALANCE W78x, the wireless connection remains intact (roaming).

Capabilities provided by iPCF

In the industrial environment, there are applications that require deterministic behavior for a large number of participants and high data throughput in a cell. In addition, deterministic behavior is required for cell cross-overs with handover times of less than 100 milliseconds.

The iPCF extension (Industrial Point Coordination Function) was developed to meet these requirements.

iPCF ensures that all data traffic runs in coordinated fashion in a wireless cell, controlled by the access point. It also optimizes the throughput with a high number of participants by avoiding collisions. iPCF also facilitates very fast cell changes.

Special features provided by iPCF-MC

iPCF-MC was designed to enable free-moving participants to exploit the special advantages provided by iPCF, which allows communication independent of an RCoax line or directional antennas. With iPCF-MC, the client looks for potentially suitable access points even when it is receiving iPCF queries from the access point and the existing connection to an access point is functioning correctly. This makes it possible to switch to another access point very quickly if it becomes necessary. Unlike iPCF, with iPCF-MC the handover times do not depend on the number of radio channels in use.

The following figure shows an example of a plant with four WLAN areas.

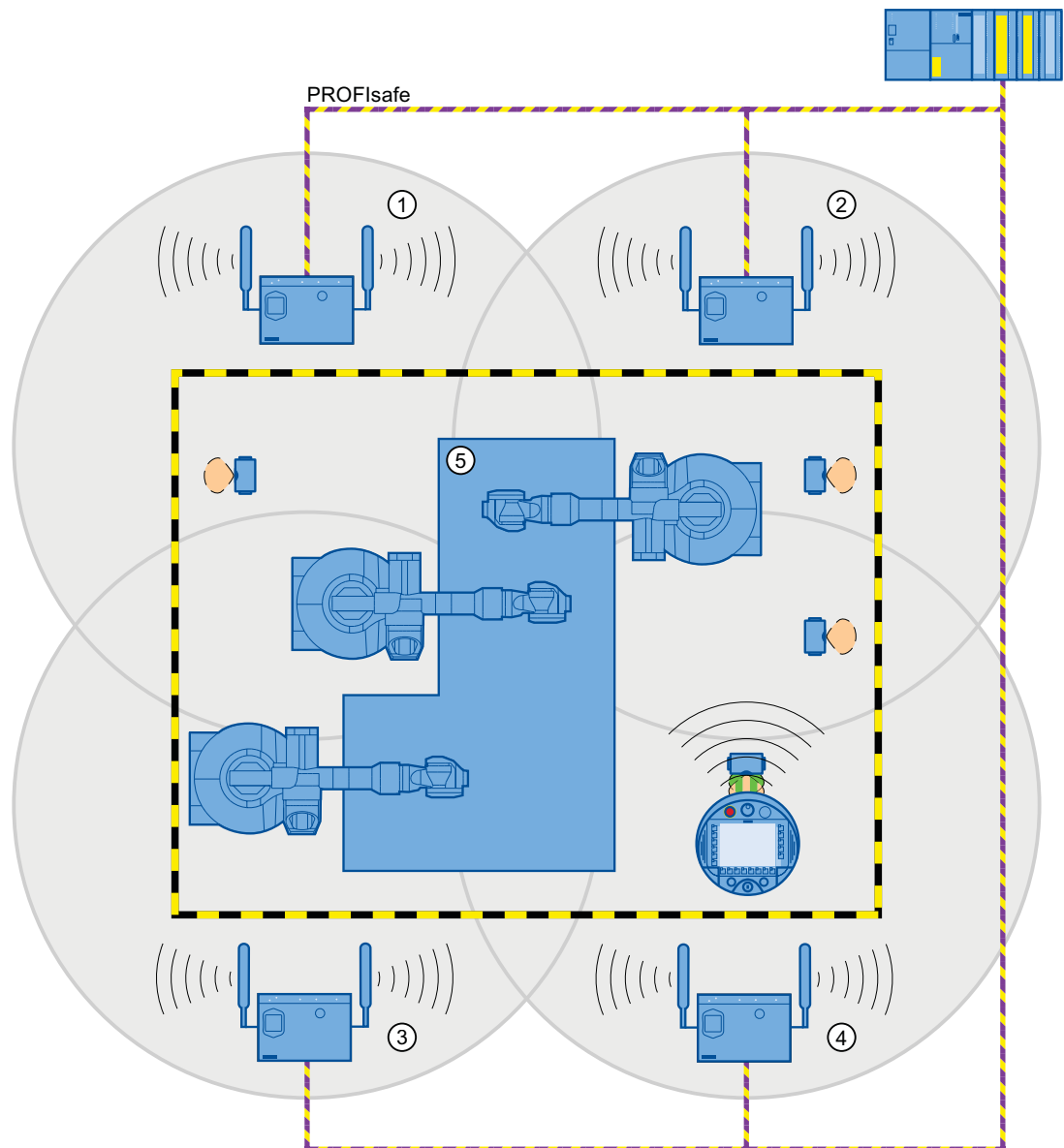

- ① Radio cell of access point 1
- ② Radio cell of access point 2
- ③ Radio cell of access point 3
- ④ Radio cell of access point 4
- ⑤ Plant

For rapid roaming with iPCF-MC, you will require a suitable access point – see section "Access point (Page 23)".

We always recommend that you activate iPCF or iPCF-MC mode for PNIO communication.

For stable PNIO communication, a WLAN client should be located at all times in a radio cell with a signal strength $> 60\%$ or > -65 dBm. This can be checked by switching the various segments on and off.

This does not mean that the client needs to change over at a signal strength $< 60\%$ or < -65 dBm. Make sure that a segment is available with a sufficiently powerful signal.

Limitations due to iPCF-MC

iPCF-MC is an in-house development of the Siemens AG that will only work with participants in which iPCF-MC has been installed.

Operating principle of iPCF-MC

iPCF-MC uses both radio interfaces of the access point differently: One interface works as management interface and sends a beacon every five milliseconds. The other interface transmits the user data.

The following requirements have to be met to use iPCF-MC:

- All "RR" versions of the SCALANCE W-700 access points with at least two WLAN interfaces can be used as access point. The HMI device and all SCALANCE W-700 "RR" versions are suited as clients.
- You have to operate the management interface and the data interface in the same frequency band; they also have to match in their radio coverage. iPCF-MC will not work if both radio interfaces are equipped with directional antenna the cover different areas.
- The management interfaces of all access points that a client is to access must use the same channel. A client will only scan this one channel to find all available access points.
- You cannot use the transmission method to IEEE 802.11h for the management interface. 802.11h can be used for the data interface.

1.15 Terms for fail-safe operation

Fail-safe automation system

A fail-safe automation system is required in a plant with high safety requirements.

In an EMERGENCY STOP, the fail-safe automation system brings the plant to a safe operating state regardless of the situation. Shutdown of the plant therefore does not pose a danger to people or the plant.

Fail-safe operation

The HMI device registers signals from the EMERGENCY STOP button and the enabling button during fail-safe operation. The controller and the HMI device communicate with each other via PROFIsafe.

Configuration of the safety functions in STEP 7 with the "SIMATIC S7 Distributed Safety" add-on package can achieve fail-safe operation according to SIL 3 or Performance Level e and Category 4 for the HMI device.

Integration and removal

- Integrating

Integration means to establish safety-related communication between the HMI device and the fail-safe controller via PROFIsafe.

The EMERGENCY STOP button is enabled in integrated operating mode.

- Removing

Removal means to intentionally stop safety-related communication between the HMI device and the fail-safe controller via PROFIsafe.

Logging on the HMI device

The HMI device must be logged onto a machine in order to operate the machine after integration in fail-safe operation with the enabling button. Logging on to the machine occurs through a transponder or through an RFID tag.

Logging off an HMI device

Logging off an HMI device from a machine terminates fail-safe operation with the enabling button.

- Forced logoff

If the security system is triggered, for example by the operator leaving the protection zone without logging off, a forced logoff is performed by the machine. The HMI device revokes the operator authorization for the enabling button. The operator is prompted to confirm the "Forced logoff" dialog.

- Automatic logoff in the event of a communication error

If a communication error occurs, the HMI device is removed from the safety-related communication. The HMI device is automatically logged off the machine. The fail-safe controller brings the plant to a safe operating state.

Shutdown response of the plant

- The following shutdown response of the plant applies regardless of whether or not the HMI device is logged onto a machine.
 - EMERGENCY STOP

EMERGENCY STOP is a procedure that is intended to stop a process or movement associated with danger in accordance to EN 60204-1, Appendix D. An EMERGENCY STOP immediately stops all parts of the plant controlled by the fail-safe controller via a safety program. The EMERGENCY STOP button is always enabled when there is PROFIsafe communication between HMI device and fail-safe controller, i.e. when the HMI device is integrated in the PROFIsafe communication.
 - Global rampdown

A global rampdown is the intentional stopping of the plant. The global rampdown is independent of the area.

The global rampdown is triggered by the fail-safe controller, for example, if an error occurs with an HMI device integrated in the PROFIsafe communication.
- The following shutdown response of the plant applies when the HMI device is logged onto a machine.
 - Local rampdown

A local rampdown is the intentional stopping of a plant section by the fail-safe controller. The local rampdown is triggered, for example, when the operator leaves the protection zone without logging off via a security system.
 - Shutdown

The shutdown is triggered when the F-CPU has detected a communication error with an HMI device that is logged onto a machine. Shutdown is the immediate stop of all machinery being operated in fail-safe mode.

Communication error

A communication error occurs when the communication between HMI device and fail-safe controller is interrupted. Additional information is available in the section "Communication errors with logged on HMI device (Page 377)".

See also

Scope of delivery (Page 15)

Fail-safe operation (Page 253)

Safety instructions and standards

2.1 Safety instructions

 WARNING
Injury or material damage If you do not exactly adhere to the safety regulations and procedural instructions contained in this manual, hazards may arise and safety features be rendered ineffective. This can result in personal injuries or material damage. Closely follow closely the safety regulations and procedural instructions in each situation.

Observe the regulations for safety and accident prevention applicable to your application in addition to the safety instructions given in this manual.

Project security

 WARNING
Injury or material damage The configuration engineer for plant control must take precautions to ensure that an interrupted program will be correctly integrated again after communication failures, voltage dips or power outages. A dangerous operating state must not be allowed to occur - not even temporarily - during the entire execution of the control program, even during a troubleshooting.

Safety during commissioning and operation

 WARNING
Installation according to the instructions Commissioning of the HMI device is prohibited until it has been absolutely ensured that the machine to be operated with the HMI device complies with Directive 2006/42/EC. Verify before commissioning that the provisions of Directive 2006/42/EC are fulfilled.

Safety during operation

 **WARNING**

HMI device failure

A strong shock or impact can impede the functionality of the HMI device.

After a strong mechanical action, ensure the HMI device and the safety-related parts are in working order.

Danger of injury

Manual movements controlled with the HMI should only be executed in conjunction with the enabling buttons and at reduced velocity.

Exclusive operating right

The simultaneous operation of the plant with multiple HMI devices is not allowed.

Prevent simultaneous operation through the appropriate configuration.

Note

The function of the EMERGENCY STOP button must be checked periodically.

High-frequency radiation, for example from cellular phones, can lead to undesirable operating states in a plant.

2.2 Approvals

Note

The following overview shows possible approvals.

The only valid approvals for the HMI device, charging station, power supply unit, transponder and RFID tag are those shown on the label on the rear panel.

CE approval



The HMI device, charging station, power supply unit, and transponder comply with the European standards published in the Official Journals of the European Union for programmable controllers:

- 2004/108/EC "Electromagnetic Compatibility" (EMC Directive)
- 1999/5/ECG "Directive of the European Parliament and of the Council from March 9, 1999 relating to Radio Equipment and Telecommunications Terminal Equipment and the Mutual Recognition of their Conformity"

EC Declaration of Conformity

The EC Declarations of Conformity are available to the relevant authorities at the following address:

Siemens AG
Industry Sector
I IA AS RD ST
PO Box 1963
92209 Amberg
Germany

UL approval



Underwriters Laboratories Inc. in accordance with:

- UL 60950 (Safety of Information Technology Equipment)
- CAN/CSA-C22.2 No. 60950-00 (Safety of Information Technology Equipment)

The approval is only valid in the case of battery operation or when stationary in the charging station.

Marking for Australia



The HMI device, charging station, power supply unit, and transponder satisfy the requirements of Standard AS/NZS 2064 (Class A).

Approval according to FCC

This device complies with Part 15 of the FCC Rules

Operation is subject to the following two conditions:

- (1) this device may not cause harmful interference, and
- (2) this device must accept any interference, including interference that may cause undesired operation.

IEEE802.11b or g operation of this product in the USA is firmware-limited to channels 1 through 11.

Notice

Changes or modifications made to this equipment not expressly approved by SIEMENS may void the FCC authorization to operate this equipment.

This equipment has been tested and found to comply with the limits for a Class B digital device, pursuant to Part 15 of the FCC Rules. These limits are designed to provide reasonable protection against harmful interference in a residential installation. This equipment generates, uses and can radiate radio frequency energy and, if not installed and used in accordance with the instructions, may cause harmful interference to radio communications. However, there is no guarantee that interference will not occur in a particular installation. If this equipment does cause harmful interference to radio or television reception, which can be determined by turning the equipment off and on, the user is encouraged to try to correct the interference by one or more of the following measures:

- Reorient or relocate the receiving antenna.
- Increase the separation between the equipment and receiver.
- Connect the equipment into an outlet on a circuit different from that to which the receiver is connected.

Consult the dealer or an experienced radio/TV technician for help.

This transmitter must not be co-located or operating in conjunction with any other antenna or transmitter.

Professional Installation Notice:

To comply with FCC Part 15 rules in the United States, the system must be professionally installed to ensure compliance with the Part 15 certification. It is the responsibility of the operator and professional installer to ensure that only certified systems are deployed in the United States. The use of the system in any other combination (such as co-located antennas transmitting the same information) is expressly forbidden. .

RSS-210 of Industry Canada

"Operation is subject to the following two conditions:

(1) this device may not cause interference, and

(2) this device must accept any interference, including interference that may cause undesired operation of the device."

"This device has been designed to operate with internal antennas with a maximum gain of 2 dBi and an antenna impedance of 50 Ohms. Other antennas are strictly prohibited for use with this device."

"To reduce potential radio interference to other users, the antenna type and its gain should be so chosen that the equivalent isotropically radiated power (e.i.r.p.) is not more than that permitted for successful communication."

"That the device for the band 5150-5250 MHz is only for indoor usage to reduce potential for harmful interference to co-channel mobile satellite systems."

"Users should also be cautioned to take note that high power radars are allocated as primary users (meaning they have priority) of 5250-5350 MHz and 5650-5850 MHz and these radars could cause interference and/or damage to LE-LAN devices."

Wireless approval

The national approvals for the HMI device are listed on the back of the device and in the product information for "Mobile Panel 277F IWLAN V2, Mobile Panel 277F IWLAN (RFID tag)" online at:

Total documentation Mobile Panels 277 Wireless
(<http://support.automation.siemens.com/WW/view/en/26268960/133300>)

Requesting certificates

A copy of the certificates and associated reports is available upon request from the following address:

Siemens AG
Industry Sector
I IA AS RD ST
PO Box 1963
92209 Amberg
Germany

2.3 Standards on operating safety

The HMI device meets the following standards for use in a plant:

Standard	Title	Version
EN 12417	Machine Tools - Safety - Machining Centres	01.07.2009
EN 60950	Information Technology Equipment (General Requirements)	01.11.2006
UL 60950	Safety of Information Technology Equipment	11.12.2000
CAN/CSA-C22.2 No. 60950-00	Safety of Information Technology Equipment	01.12.1990

EMC testing

The values of the EMC test for the HMI device conform to the following standards:

Standard	Title	Version
EN 61000-6-2	EMC – Part 6-2: Generic standards - Immunity for industrial environments	01.05.2006
EN 61000-6-4	EMC – Part 6-4: Generic standards - Emission standard for industrial environments	01.11.2007
DIN EN 50360	Product standard to demonstrate the compliance of mobile phones with the basic restrictions related to human safety in electromagnetic fields (300 MHz to 3 GHz)	01.05.2002
DIN EN 50371	Generic standard to demonstrate compliance of low power electronic and electrical apparatus with the basic restrictions related to human exposure to electromagnetic fields (10 MHz to 300 GHz)	01.11.2002

Safety instructions and standards

2.3 Standards on operating safety

Standard	Title	Version
DIN EN 61131-2	Programmable Logic Controllers – Part 2: Equipment requirements and testing	01.01.2009
DIN EN 300440-1	Electromagnetic compatibility and radio spectrum matters	01.08.2009
DIN EN 301893	Broadband Radio Access Networks (BRAN)	01.05.2009
EN 50385	Product standard to demonstrate the compliance of radio base stations and fixed terminal stations for wireless telecommunication systems	01.05.2003
EN 300328	Electromagnetic compatibility and radio spectrum matters	01.03.2009
EN 300330	Electromagnetic compatibility and radio spectrum matters (ERM)	01.08.2006
EN 301489-1	Electromagnetic compatibility and radio spectrum matters (ERM)	01.01.2010
EN 301489-3	Electromagnetic compatibility and radio spectrum matters (ERM)	01.01.2003
EN 301489-17	Electromagnetic compatibility and radio spectrum matters	01.07.2009
FCC	OET 65, RSS-210, Part 15247, 15407 radio authorization	
FCC	RFID 15225, RSS 210	

TÜV

The TÜV confirms that the HMI device satisfies the requirements of the following standards with regard to its safety functions.

Standard	Title	Version
DIN EN 60204-1	Safety of machinery – Electrical equipment of machines – Part 1: General Requirements	01.10.2009
DIN IEC 62061	Safety of machinery – Functional safety of electrical, electronic and programmable control systems for machinery	01.04.2009
IEC 61508-1 to 4	Safety Integrity Level 3	01.01.2005
ISO 13850	Safety of machinery - EMERGENCY STOP - Principles for design	01.01.2009
ISO 13849-1	Performance Level e and Category 4	01.09.2009

Additional measurements

Additional measurements were made for:

- Japan
 - Table/Annex No 43,44,45 – Test Method for Radio Equipment mentioned in Certification Regulations Article, Item 19, 19-2, 19-3 and 19-3-2
 - Table/Annex No 47 – Test Method for Radio Equipment mentioned in Certification Regulations Article, Item 19-5 and 19-11
 - RFID – ARIB STD T-82
- Taiwan
 - LP0002

2.4 Operating conditions

NOTICE
Wireless control device A wireless control device may cause interference. If a wireless control device is used, the following must be ensured: <ul style="list-style-type: none">• That other systems at the site are not disturbed by the wireless control device• That other systems at the site do not disturb the wireless control device

Use in industry

The HMI device is designed for industrial use. For this reason, the following standards are met:

- Interference emission requirements, paragraph 7.3, DIN EN 60947-1, Environment A
- Interference immunity requirements DIN EN 61326

Residential use

NOTICE
Interference to radio and TV reception The HMI device is not suitable for use in residential areas: Operation of HMI devices in residential areas can cause interference to radio and television reception. If the HMI device is used in a residential area, you must take measures to achieve Limit Class B conforming to EN 55016 for RF interference.

To achieve radio interference suppression class B, for example, install filters in power supply lines.

Individual acceptance is required.

2.5 Risk analysis of the plant

The following rules apply to the risk analysis of the plant:

- ISO 12100-1 and ISO 12100-2, General design guidelines for machines
- ISO 13849-1, Safety of machinery - Safety-related parts of control systems - General principles for design
- ISO 14121-1, Safety of machinery – Risk assessment – Part 1: Principles

These considerations result in a performance levels a to e in accordance with ISO 13849-1, which dictate how the safety-related parts of the system must be furnished.

The safety-related parts of the HMI device meet:

- SIL 3 in accordance with IEC 61508
- Performance level e and Category 4 in accordance with ISO 13849-1

Take the plant configuration as a whole into consideration in the risk analysis and not just the separate sections. For additional information on risk analysis and risk mitigation, refer to the "Safety Technology in SIMATIC S7" system manual

(<http://support.automation.siemens.com/WW/view/en/12490443>).

See also

Safety-related operator controls (Page 107)

2.6 Safety functions of the EMERGENCY STOP button

The EMERGENCY STOP button on the HMI device brings about a safety-related stop of the plant in accordance with IEC 60204-1, Section 9.2.5.3. You can implement a Category 0, 1, or 2 stop function in accordance with IEC 60204-1, Section 9.2.2. The stop function category must be selected on the basis of a risk assessment.

The following requirements must be met in order to render the EMERGENCY STOP button effective:

- The HMI device must be operated in the charging station or with the main rechargeable battery.
- A project is running on the HMI device.
- The HMI device must be integrated in the safety program of the F-CPU.

If these prerequisites are satisfied the following applies:

- The "SAFE" LED on the HMI device is lit.
- The EMERGENCY STOP button of the HMI device is enabled.

As soon as the PROFIsafe communication between the HMI device and controller is established within the WLAN range, the EMERGENCY STOP button on the HMI device becomes active. The EMERGENCY STOP button is enabled within the WLAN regardless of whether or not the HMI device is logged onto a machine.

 **WARNING**

EMERGENCY STOP button not available

The EMERGENCY STOP button on the HMI device may not be used as a replacement for a permanently-wired EMERGENCY STOP or EMERGENCY OFF on the machine.

Install stationary EMERGENCY STOP buttons that will be available at all times on the configured system.

EMERGENCY STOP button not enabled

If a communication error triggers a global rampdown, the EMERGENCY STOP button will no longer be available on the affected HMI device.

You have the option of interconnecting the "Global Rampdown" signal so that an EMERGENCY STOP is triggered.

EMERGENCY STOP button out of service when HMI device is removed

If the HMI device is not integrated in the safety program of the F-CPU, the EMERGENCY STOP button will be out of service.

To avoid confusion between HMI devices with enabled and disabled EMERGENCY STOP buttons, only one integrated HMI device should be freely accessible.

If an HMI device is not integrated and not in use, store the HMI device in a location with protected access.

Category 0 or 1 Stop

If a Category 0 or 1 stop circuit is implemented, the stop function must be effective regardless of the operating mode. A Category 0 stop must have precedence. Release of the EMERGENCY STOP button must not cause a hazardous situation (see also EN 60204-1, Section 9.2.5.3).

The stop function is not to be used as a replacement for safety equipment.

Note

The EMERGENCY STOP button is evaluated when the HMI device is integrated in the safety program of the F-CPU. The EMERGENCY STOP button can be triggered unintentionally in the following situations:

- If the HMI device falls down
- When opening one of the coverings on the rear of the HMI device

2.7 Safety functions of the enabling mechanism

In a numerically controlled system, the "Special mode" operating mode requires an enabling mechanism. The enabling mechanism is comprised of two enabling buttons mounted on both sides of the HMI device.

Special mode

During special mode, safety has to be ensured in a different manner than in automatic mode. During special mode, personnel enter danger zones of the plant in which controlled movements must be possible.

Depending on the risk assessment of the plant, movement needs to occur at reduced speed for special mode. Movement of the plant parts should only be possible when the enabling mechanism is activated. The operator must be accordingly qualified and know details of use in accordance with safety regulations.

Safety instructions

The safety-related parts of the controller for speed reduction and those for the enabling mechanism are designed in such a way that they satisfy the requirements for the safety category as determined by the risk assessment.

The operating principles of enabling devices are described in EN 60204. Through the findings from accident investigations and the existence of technical solutions, the 3-stage enabling button became state of the art. Positions 1 and 3 of the enabling button are Off functions. Only the middle position allows the enabling function. EN 60204-1 is identical to IEC 60204-1, whereby the 3-stage enabling button is gaining international importance.

The Stop category of the enabling device must be selected on the basis of a risk assessment and correspond to a Category 0 or 1 Stop.

WARNING

Injury or material damage

Enabling buttons should only be used when the following applies for the person activating the enabling button:

- The person can see the danger zone.
- The person is capable of recognizing personal injury hazards in good time.
- The person is capable of taking immediate measures to avoid danger.

The only person allowed to remain in the danger zone is the person who is activating the enabling button.

Commands for unsafe conditions are not permitted to be issued with one enabling button alone. To accomplish this, a secondary, conscious start command using a button on the HMI device is required.

NOTICE

Risk from improper use

An enabling button can be fixed without permission.

To avoid the risk of unauthorized fixation, fully press both enabling buttons each time the project starts. Release the enabling buttons.

Note

The enabling button only has an effect when the HMI device is logged onto a machine and the "RNG" LED on the HMI device is lit.

See also

Risk analysis of the plant (Page 48)

2.8 Electromagnetic compatibility

The HMI device, the charging station, the transponder, the power supply and the RFID tag satisfy, among other things, the requirements of the EMC laws pertaining to the European domestic market. The enhanced testing and limit value levels defined by CDV 61326-3-1/Ed. 1 have been taken into account during the type test

EMC-compliant installation

Conditions for fault-free operation include EMC-conform assembly of the charging station, a transponder and RFID tag, as well as the use of interference-proof cables. The following documents also apply to the installation of the charging station:

- Description "Directives for interference-free installation of PLCs" (<http://support.automation.siemens.com/WW/view/de/1064706>), German
- System manual "Basics on Setting up an Industrial Wireless LAN" (<http://support.automation.siemens.com/WW/view/en/9975764>)

Pulse-shaped disturbance

The following table shows the electromagnetic compatibility of modules with regard to pulse-shaped interference. The table applies to the charging station, with and without an attached HMI device.

Pulse-shaped disturbance	Tested with	Degree of severity
Electrostatic discharge in accordance with IEC 61000-4-2	Air discharge: 8 kV Contact discharge: 6 kV	3
Burst pulses (high-speed transient interference) in accordance with IEC 61000-4-4	2 kV supply line	3

An external safety circuit is required for the "Surge immunity test according to IEC 61000-4-5". The safety circuit is described in the Installation manual "Automation System S7-300 – Installation" (<http://support.automation.siemens.com/WW/view/en/15390415>), section "Lightning and overvoltage protection".

Safety instructions and standards

2.8 Electromagnetic compatibility

Pulse-shaped disturbance	Tested with	Degree of severity
Asymmetrical coupling	2 kV power cable DC voltage with protective elements	3
Symmetrical coupling	1 kV power cable DC voltage with protective elements	3

Sinusoidal interference

The following table shows the EMC behavior of the modules with respect to sinusoidal interference.

The table applies to the HMI device, charging station and power supply unit.

Sinusoidal interference	Test values	Degree of severity
HF radiation (in electromagnetic fields) in accordance with IEC 61000-4-3	80% amplitude modulation at 1 kHz <ul style="list-style-type: none"> Up to 10 V/m in the 80 MHz to 1 GHz range Up to 10 V/m in the 1,4 GHz to 2 GHz range Up to 1 V/m in the 2 GHz to 2,7 GHz range 	3
RF interference current on cables and cable shielding conforming to IEC 61000-4-6	Test voltage 10 V, with 80% amplitude modulation of 1 kHz in the 9 kHz to 80 MHz range	3

Emission of radio interference

The following table shows the unwanted emissions from electromagnetic fields in accordance with EN 55016, Limit Value Class A, Group 1, measured at a distance of 10 m.

30 to 230 MHz	< 40 dB (V/m) quasi-peak
230 to 1,000 MHz	< 47 dB (V/m) quasi-peak

Note

Before you connect the HMI device to the public electrical network, ensure that it is compliant with Limit Value Class B in accordance with EN 55022.

Specific absorption rate SAR

The following applies to specific absorption rate:

- Recommendation 1999/519/EC; Exposure of the public to EMF
- Limit values for Europe according to EN 50932
- Limit values for USA in accordance with FCC OET Bulletin 65 Supplement C
 - 2.0 W/kg within 10 g of tissue (in accordance with ICNIRP guideline)
 - 1.6 W/kg within 1 g of tissue (in accordance with IEEE/FCC)

Planning the use

3.1 Checklist

Perform the following tasks for system planning: Confirm each task by checking it off in the following list.

Task	Additional information	Check
Check the ambient conditions at the site.	Ambient conditions for operation (Page 55)	
Plan access routes to the plant.	–	
Plan operator locations at the plant where WLAN will be needed.	WLAN properties (Page 59)	
Plan the WLAN. Determine the installation locations for the access points based on this. Special programs are available for planning the WLAN. We strongly recommend you check the local wireless conditions before beginning start-up.	System manual "Basics on Setting up an Industrial Wireless LAN" (http://support.automation.siemens.com/WW/view/en/9975764) "SINEMA E" planning program (http://www.siemens.com/sinema) Guideline for the Use of Industrial Wireless LAN in a PROFINET IO Environment (http://support.automation.siemens.com/WW/view/en/31938420)	
Plan for information security.	Planning information security (Page 72)	
Plan the configuration of the PROFINET and PROFIsafe communication.	System manual "Communication with SIMATIC" (http://support.automation.siemens.com/WW/view/en/25074283) Programming and operation manual "S7 Distributed Safety - Configuring and Programming" (http://support.automation.siemens.com/WW/view/en/22099875)	
Plan the effective ranges for operating the plant in a fail-safe mode.	Equipping a plant with transponders (Page 59) Equipping a plant with RFID tags (Page 64)	
Plan the location for the transponders.	Planning the installation location of transponders (Page 67)	
Plan the installation locations for the RFID tags.	Planning an installation location for RFID tags (Page 68)	
Plan a security system for the "override" mode.	Protection zone for the "Override" mode (Page 69)	
Plan the installation location and clearance for the charging station.	Mounting location and clearance of charging station (Page 66)	
Plan the location for the signal lamps.	Planning the installation location of signal lamps (Page 69)	

3.2 Ambient conditions for transportation and storage

The permissible ambient conditions of this HMI device exceed requirements in accordance with IEC 61131-2. The following specifications apply to devices that are shipped and stored in the original packaging.

- The climatic conditions are compliant with IEC 60721-3-2, Class 2K4.
- The mechanical conditions are compliant with IEC 60721-3-2, Class 2M2

The following table shows the permissible ambient conditions for the HMI device, charging station, power supply unit, RFID tag and transponder.

Type of condition	Permitted range
Drop test (in transport package)	≤ 1 m
Temperature	-20 to +60 °C
Atmospheric pressure	1140 hPa to 660 hPa, corresponds to an elevation of –1000 to 3500 m
Humidity, relative	Applies to HMI device: 10 to 90%, without condensation Applies to charging station and transponder 35% to 85%, without condensation
Sinusoidal vibration in accordance with IEC 60068-2-6	5 Hz to 9 Hz: 3.5 mm 9 Hz to 500 Hz: 9.8 m/s ²
Shock in accordance with IEC 60068-2-29	250 m/s ² , 6 ms, 1000 shocks

NOTICE

Equipment failure

Moisture in the form of condensation on or in the device is formed:

- When transporting a device at low temperatures
- Under extreme temperature variations

Moisture and condensation lead to malfunction.

Bring the device to room temperature before operating.

Condensation

When condensation is on the device, do not expose the HMI device to direct radiation from a heater.

If condensation has developed, wait approximately 4 hours until the HMI device has dried completely before switching it on.

The following points must be adhered to in order to ensure a fault-free and safe operation of the HMI device:

- Proper transportation and storage
- Proper installation and mounting
- Careful operation and maintenance

The warranty for the HMI device will be deemed void if these stipulations are not heeded.

3.3 Ambient conditions for operation

Mechanical and climatic ambient conditions

The HMI device is designed for use in a location protected from the effects of the weather. The ambient conditions meet the requirements for DIN IEC 60721-3-3:

- Mechanical requirements according to class 3M3
- Climatic requirements according to class 3K3

Use with additional protective measures

You may only use the HMI device at the following locations with additional measures:

- In locations with a high degree of ionizing radiation
- In locations with difficult operating conditions, for example due to:
 - Corrosive vapors, gases, oils or chemicals
 - Electrical or magnetic fields of high intensity
- In systems that require special monitoring, for example:
 - Elevators
 - Systems in especially hazardous rooms

Damping shock and vibration

If the HMI device is subjected to impermissibly strong shocks or vibrations, you must take appropriate measures to reduce amplitudes or acceleration. In such situations, use vibration damping or vibration absorber systems for the HMI device and accessories.

NOTICE
<p>Setting down the HMI device</p> <p>If you place the HMI device on a surface with a high natural frequency, malfunctions may occur as a result.</p> <p>When storing the HMI device, make sure that the HMI device is only stored on a surface that does not exceed the permissible ambient conditions.</p>

Planning the use

3.3 Ambient conditions for operation

Testing mechanical ambient conditions

The following table provides information on the type and scope of tests for mechanical ambient conditions performed for the HMI device.

Test	Physical variable	Value
Vibrations IEC 60068-2-6 Test Fc	Vibration	1 octave/min 10 cycles per axis
	Frequency band	5 to 8.4 Hz: Deflection 3.5 mm
		8.4 to 150 Hz Vibration acceleration 9.8 m/s
Shock IEC 60068-2-27	Shock form	half-sine
	Acceleration	30 g
	Duration	11 ms
	Number of shocks	3 per axis
Permanent shock IEC 60068-2-27	Shock form	half-sine
	Acceleration	10 g
	Duration	16 ms
	Shock cycle	1 s to 3 s.
	Number of shocks	1000 ± 10
Impact IEC 60068-2-75	Impact stress	1 Nm, once With an impact test device similar to DIN VDE 0740, Part 1, Section 19.2 at room temperature.
Drop EN 60068-2-32	Fall height	1,2 m Applies to the HMI device, with and without battery

Climatic ambient conditions for the HMI device

The following table shows the permitted ambient climatic conditions for operation of the HMI device.

Ambient conditions	Permitted range	Comment
Operating temperature	0 to 40° C	–
Humidity, relative	5 to 85 %, no condensation	Stress level 2 according to IEC 61131-2
Humidity, absolute	1 to 25 g/m ³	–
Atmospheric pressure	1 060 to 700 hPa	Corresponds to an elevation of –1000 to 2 000 m
Pollutant concentration	SO ₂ < 0.5 vpm, relative humidity < 60%, no condensation	Test: 10 cm ³ /m ³ ; 10 days
	H ₂ S < 0.1 vpm, relative humidity < 60%, no condensation	Test: 1 cm ³ /m ³ ; 10 days

Climatic ambient conditions for the charging station

The following table shows the permitted climatic ambient conditions for use of the charging station.

Ambient conditions	Permitted range	Comment
Operating temperature	0 to 40° C	–
Storage/transport temperature	–20 to 60° C	–
Humidity, relative	5 to 85 %, no condensation	Stress level 2 according to IEC 61131-2
Humidity, absolute	1 to 25 g/m ³	–
Atmospheric pressure	1060 to 700 hPa	Corresponds to an elevation of –1000 to 2 000 m
Pollutant concentration	SO ₂ < 0.5 vpm, relative humidity < 60%, no condensation	Test: 10 cm ³ /m ³ ; 10 days
	H ₂ S < 0.1 vpm, relative humidity < 60%, no condensation	Test: 1 cm ³ /m ³ ; 10 days

Ambient climatic conditions for the transponder

The following table shows the permitted ambient climatic conditions for operation of the transponder.

Ambient conditions	Permitted range	Comment
Operating temperature	0 to 50° C	–
Storage/transport temperature	–20 to 60° C	–
Humidity, relative	5 to 85 %, no condensation	Stress level 2 according to IEC 61131-2
Humidity, absolute	1 to 25 g/m ³	–
Atmospheric pressure	1060 to 700 hPa	Corresponds to an elevation of –1000 to 2 000 m
Pollutant concentration	SO ₂ < 0.5 vpm, relative humidity < 60%, no condensation	Test: 10 cm ³ /m ³ ; 10 days
	H ₂ S < 0.1 vpm, relative humidity < 60%, no condensation	Test: 1 cm ³ /m ³ ; 10 days

Ambient climatic conditions for the RDIF tag

The following table shows the permitted ambient climatic conditions for operation of the RFID tag.

Ambient conditions	Permitted range	Comment
Operating temperature	–25 to 80 °C	–

3.4 Insulation resistance, protection class and degree of protection

insulation resistance

Insulation resistance is demonstrated in the type test with the following test voltages in accordance with IEC 61131-2:

Circuits with a nominal voltage of U_n to other circuits or ground	Test voltage
< 50 V	500 VDC

Protection class of the HMI device



HMI device	Protection class according to IEC 60417-DB-HS
Front and rear panel	Protection class III

Degree of protection of the HMI device

NOTICE
<p>Degree of protection IP65 for HMI device</p> <p>When enclosure openings or the connection compartment are not closed, the HMI device does not meet the specified degree of protection.</p> <p>Ensure that the enclosure is closed as specified by the regulations.</p>

Device	Degree of protection in accordance with IEC 60529
HMI device, front and rear panel	IP65
Charging station	IP65
Transponder	IP65
RFID tag	IP65

3.5 WLAN properties

Adhere to the installation guidelines when installing the WLAN. You can find more additional information in the System manual "Basics on Setting up an Industrial Wireless LAN" (<http://support.automation.siemens.com/WW/view/en/9975764>).

Plan the WLAN for a maximum of four HMI devices.

When adding a WLAN participant, make sure that you observe the conditions described in the document "Wireless LAN in a PROFINET IO Environment". The conditions vary depending on the operating mode and the requirement for PNIO refresh times. See Guideline for the Use of Industrial Wireless LAN in a PROFINET IO Environment (<http://support.automation.siemens.com/WW/view/en/31938420>).

NOTICE

Communication interference possible

Communication interference cannot be excluded if you do not check the local wireless conditions prior to start-up.

Check your local wireless conditions prior to start-up. When planning the wireless channels, mode 802.11a is preferable.

Ad hoc network

An ad hoc network cannot be used in conjunction with the HMI device.

3.6 Equipping a plant with tags

Within a project, the transponder and RFID tags are labeled as tags.

3.6.1 Equipping a plant with transponders

3.6.1.1 Dividing plant into effective ranges

Effective ranges within a plant can be configured. After logging on to an effective range, the affiliated machine can be operated in fail-safe mode.

Within an effective range, an unobstructed view from the operator is required for the system.

Note

If fail-safe operation is not required, you can operate the HMI device without having an effective range set up in the system. Transponders in the system are then unnecessary.

The following figure shows a plant with three effective ranges.

Planning the use

3.6 Equipping a plant with tags

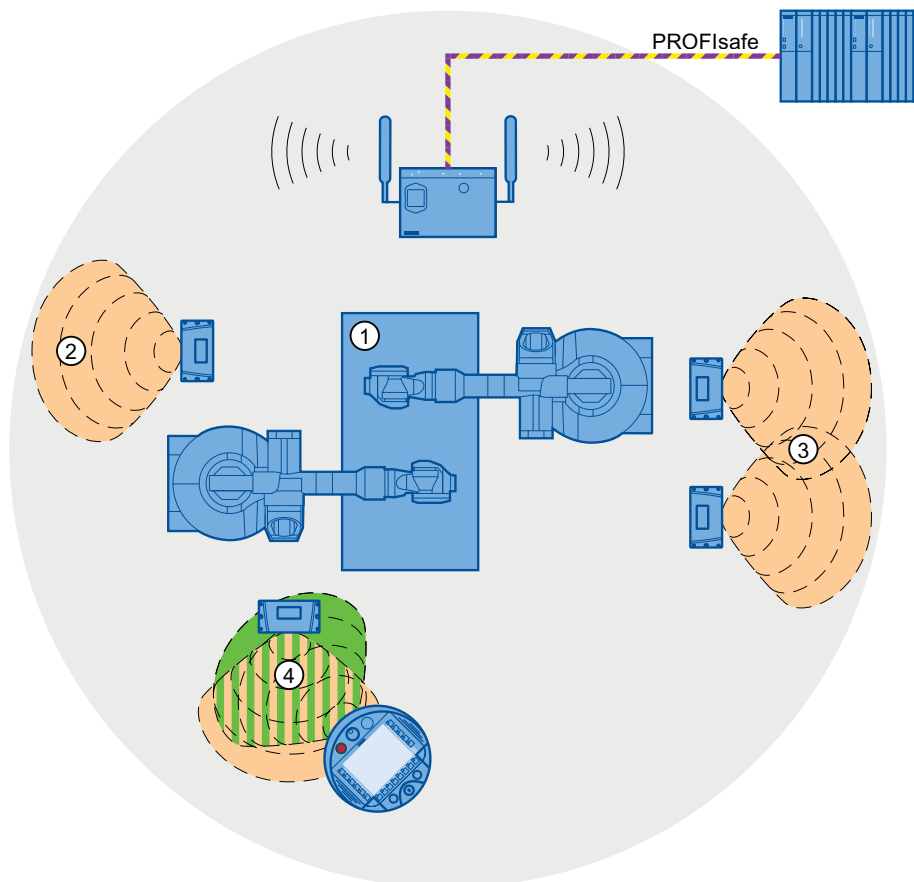

- ① System that will be operated from within the effective range
- ② Effective range 1, formed by a transponder
- ③ Effective range 2, formed by two transponders
- ④ The HMI device is in the middle of the effective range.

Relationship between the effective range and transponder

Transponders must be mounted in the perimeter around the machine in such a manner that the planned effective range is covered by the transmitting range of the transponders assigned to it.

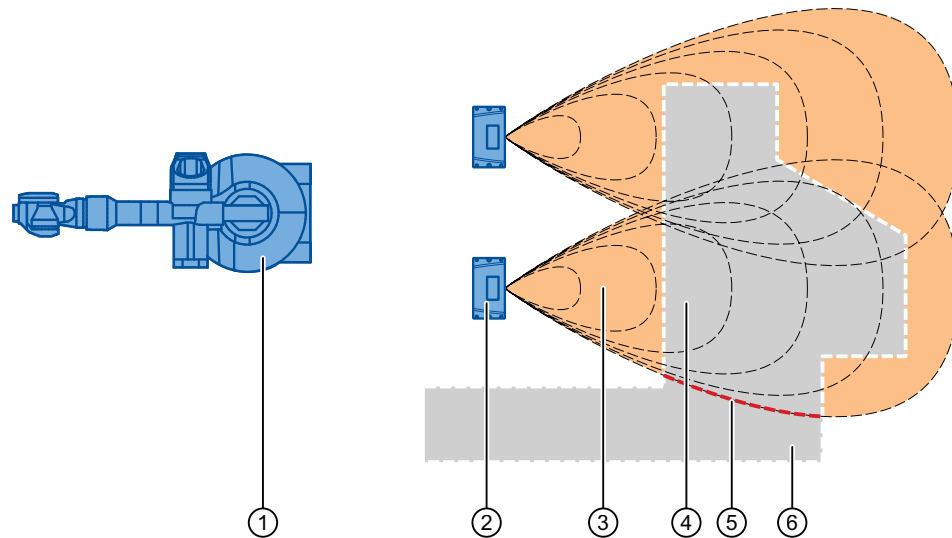

- ① System that will be operated from within the effective range
- ② Transponder
- ③ Effective range
In this range, fail-safe operation is possible. The area cannot be entered by the operator.
- ④ The area of maintenance and movement of the operator in the effective range
The room limited by the local circumstances in which fail-safe operation is possible.
- ⑤ Effective range limits
- ⑥ The area of maintenance and movement of the operator
The operator left the effective range.

An image of the radiating characteristics of the HMI device and transponder can be found in the chapter "Radiation characteristics of the transponder system (Page 352)".

Planning the use

3.6 Equipping a plant with tags

Quality of the effective range

The transponder sends its ID a maximum of 8 m wide depending on configuration. The following image shows the changing quality within the wireless range. The quality of the effective range depends on this.

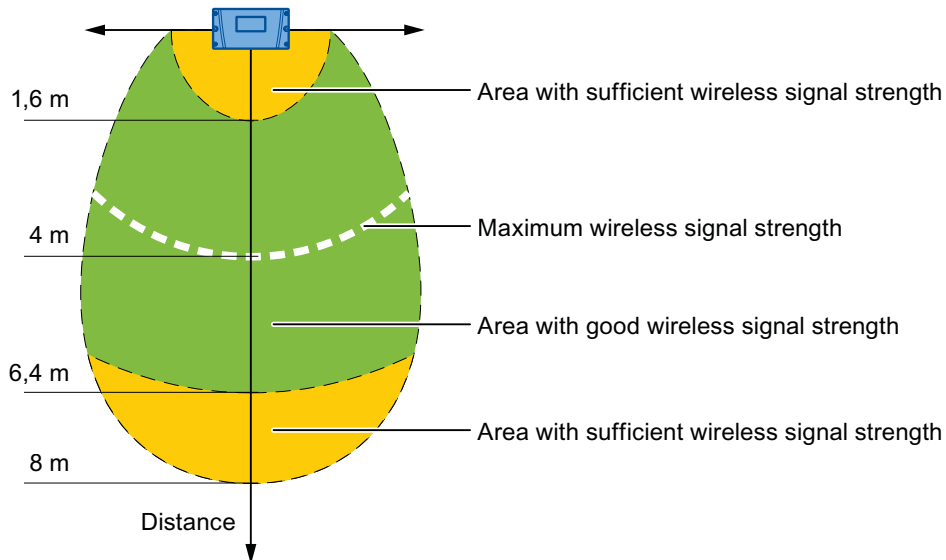

The radio signal strength is at its strongest along the white-dotted line. Thus, the effective range quality is 100 %. Starting with this limit, the effective range quality decreases with growing or lowering distance to the transponder. There is an abrupt transition of the effective range quality from "good" to "No effective range detected" along the longitudinal axis of the transmission range.

If the size of the effective range, for example, was configured to 4 m, the illustrated ranges in the image decrease proportionately.

Planning the effective range

The following rules apply:

- An effective range requires at least one transponder.
- A maximum of 127 effective ranges can be configured.
- A maximum of 127 RFID tags can be configured for each effective range.
- The size of an effective range can be configured in 1-m steps from 1 m to 8 m.
- Effective ranges may not overlap.

An effective range is formed through the wireless range of one or multiple transponders. If multiple transponders form an effective range, then each individual effective range must be equal in its size.

- Set the effective range so that a place of danger can be seen from each point of the effective range.
An effective range that is too large or unclear hinders the operator's view.
- Set an effective range so that the distance between the system - operator corresponds with the system requirements.
A distance to the system that is too small causes a risk of injury for the operator.
The mapping of the effective range - transponder is defined in the project.

Planning the transponder assignment

The following rules apply:

- Maximum distance between the transponder - HMI device is 8 m.
A minimum distance between the transponder - HMI device cannot be configured.
- The transponder and HMI device must be aligned with each other.
The HMI device must be able to check the distance to the transponder during operation. Aligning the HMI device to the transponder is required for this.
- Effective ranges may not overlap.
A transponder can only be assigned to one effective range.
Transponders in **different** effective ranges must be far enough away from each other that their wireless ranges do not overlap. Assignment of effective range to the machine that will be operated must be unique.
- A transponder may not be assigned to two systems.

See also

Ranges in a transponder system (Page 31)

3.6.1.2 Dividing plant into zones

A system in a project can be divided into zones. A zone is a divided area for local operation and monitoring. A configured zone is independently recognized by the HMI device. For example, a change of the process image can be configured for entering or leaving a zone.

A certain production process is executed in a configured zone, for example, parts assembly. Zone-bound process images are displayed for this on the HMI device.

Planning zones in the project

The following rules apply:

- 254 zones can be configured.
- A zone requires at least one transponder.
- A zone can be formed by a maximum of 255 transponders.
- Zones must not overlap.

Planning the use

3.6 Equipping a plant with tags

A zone is defined by the maximum permitted distance of the HMI device from one or more transponders. The same maximum distance applies to all transponders in a zone. The assignment of transponders to zones is defined in the project.

The following image shows a packaging system with two zones:

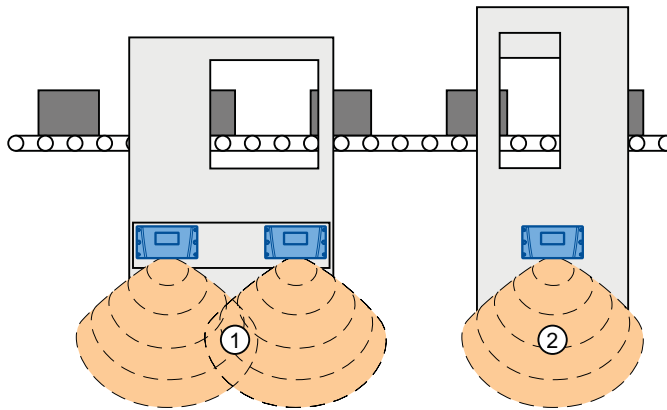

- ① Zone 1, formed by 2 transponders
- ② Zone 2, formed by 1 transponder

Planning the transponder assignment

The following rules apply:

- Each transponder can only be assigned to one zone.
- A transponder can be assigned to a zone and an effective range simultaneously.

See also

Ranges in a transponder system (Page 31)

3.6.2 Equipping a plant with RFID tags

Function of the RFID tag

The HMI device uses the RFID tag to log onto a machine within a protected area.

Effective range of the RFID tag

The radius of the effective range of an RFID tag MDS D100 is a maximum of 5 cm.

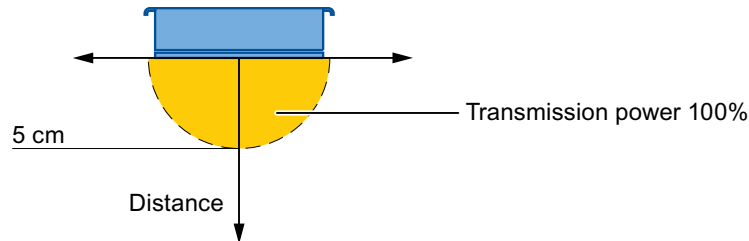

Planning the number of RFID tags

The following rules apply in a WinCC flexible project:

- A maximum of 127 effective ranges can be configured.

Specify a name and a plant-wide unique ID for each effective range - in a values range from 1 to 65534. Write down the name and ID of the effective ranges on the plant map for the commissioning.

- A maximum of 127 RFID tags can be configured for each effective range.

The mapping of the protected area to the RFID tag is defined in the project.

Planning the RFID tag mapping

The following rules apply:

- Safe access is required to the RFID tag.
- The distance between two RFID tags must be at least 10 cm.
- An RFID tag cannot be assigned to two machines.
- To log onto a machine, the distance between the HMI device and the RFID tag may not be more than 5 cm.

See also

Areas in a RFID tag system (Page 34)

3.7 Mounting location and clearance of charging station

Selecting the mounting location

The charging station is designed for vertical installation.

WARNING

Installing the charging station

When the HMI device is operated in the plant and the charging station is mounted, the EMERGENCY STOP button must be enabled. The EMERGENCY STOP button is not enabled when the charging station is in a plant area with insufficient WLAN coverage.

The charging station must be installed in either a plant section with sufficiently wide WLAN coverage or a separate service area.

CAUTION

Stopping the plant

The HMI device can fall down if it is not securely hooked in. This can accidentally trigger the EMERGENCY STOP button.

Install the charging station on a vertical surface or one that is slightly inclined towards the back.

Mount location of the charging station

If the permissible ambient conditions are exceeded at the mounting location of the charging station, functional disruptions may result.

During the selection of the mounting location, observe the permissible ambient conditions for operation.

NOTICE

Charging the rechargeable battery

When charging a rechargeable battery, the ambient temperature or battery temperature should not exceed 40 °C. The higher the temperature, the longer it will take for the rechargeable battery to fully charge.

Select a location with a low ambient temperature for the charging station.

Select a location with the following characteristics for installing the charging station:

- Not directly below an access point
- Easily and safely accessible
- No exposure to direct sunlight
- It is easy to hook in and remove the HMI device in the charging station
- Ergonomic operation of the HMI device in the charging station is ensured

Maintaining clearances

The following clearance is required around the charging station:

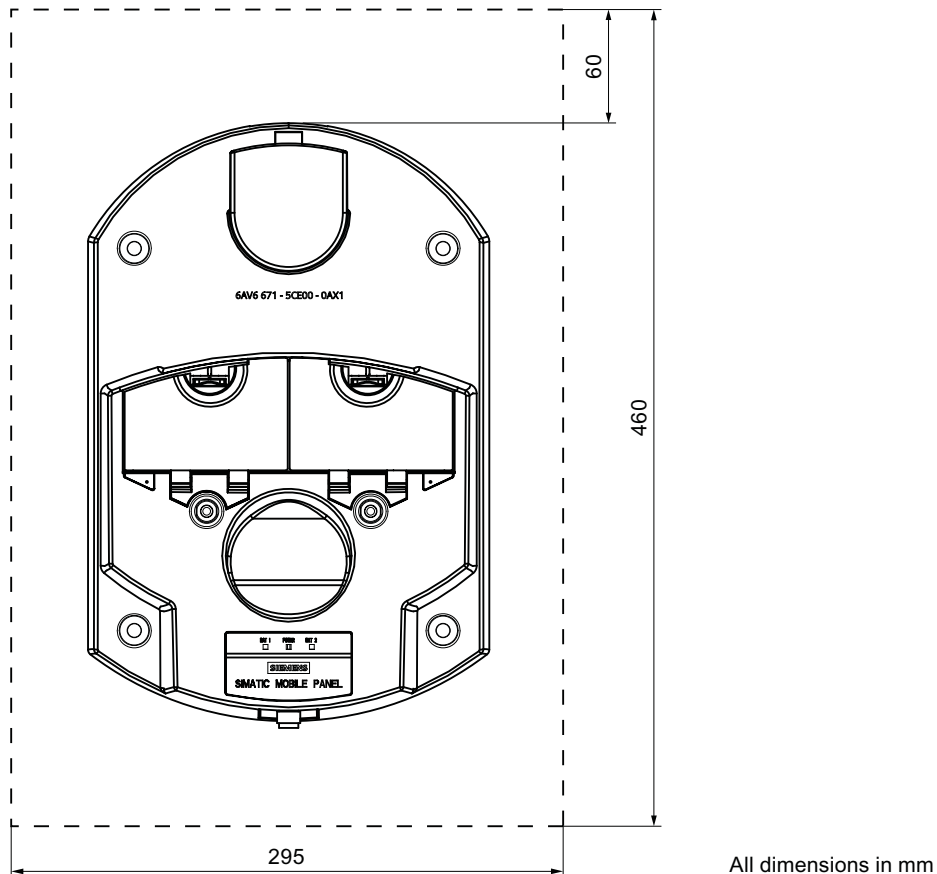

See also

Ambient conditions for operation (Page 55)

3.8 Planning the installation location of transponders

Procedure

Proceed as follows:

1. In the system plan, determine which system ranges should be operated with the enabling buttons.
You need an effective range for each of these system areas.
2. Specify the spatial expansion of the individual effective ranges.

The operator must be located within the limits of the respective effective range in order to operate the corresponding plant unit with the enabling buttons. Comply with the rules for the definition of an effective range.

3. If needed, plan for more than one transponder for an effective range.
Make sure that the effective range can be seen and is free of danger.
4. Determine:
 - A name and a plant-unique ID for each transponder from the value range 1 to 65,534.
 - A name and a plant-unique ID for each effective range from the value range 1 to 127.
 - The size of the effective range.
The effective ranges must be the same size for all transponders that form an effective range together.
5. Note the name and ID of the effective ranges on the system plan for commissioning.
6. Select an installation location that is clearly visible for the signs of the effective ranges with the associated ID.

3.9 Planning an installation location for RFID tags

Installation location for the RFID tag

Observe the following when selecting the RFID tag installation location:

- You will need at least one RFID tag for each machine operated in fail-safe mode with the enabling button.
- The installation surface of the RFID tag must have a level foundation.
- The installation surface must be non-metallic.
When mounting on metallic base, a spacer is required.
- Select an installation location that is clearly visible for the signs of the RFID tags with an associated ID.

Influence on communication

Note the following:

- The use of an MDS D100 directly on metal is not permitted.
Metal influences the field data and thus the communication.
- Flush installation of a MDS D100 in metal reduces the field data.
- Metallic objects must not reduce the effective range.
- A test is necessary in critical applications.

You can find more information in the manual "MOBY D, System Manual, Edition 11/2006".

3.10 Planning the installation location of signal lamps

You will need a signal lamp for a machine operated in fail-safe mode with the enabling button. The signal lamp notifies the operator that he/she has logged on to the machine.

Plan a clearly visible installation location for the signal lamp that is assigned to a machine.

3.11 Protection zone for the "Override" mode

The following security systems are required:

- A limited and secured protection range.

The protection zone must be fully visible to the operating personnel. A hazardous location must be visible from every point of the protection zone.

- Within the effective range, a switch independent of the HMI device must be installed.

After logging on to a HMI device on the effective range, the operator must press the switch in order to enable the "override" mode.

You can find a configuration example in the chapter "Activating and deactivating "Override" mode (Page 260)".

You must also plan security systems in order to avoid a misuse or faulty use of the HMI device. The additional security systems must have a safety category that is commensurate with the plant requirements.

The following security systems are suitable:

- Grate with protective door

If you use a grating with a protective door, you have to protect against access to the protection zone using a further protective measure, e.g a light barrier or a foot grating.

This enables you to leave the protective door open as an escape route during operation of the plant in "override" mode.

- Light barrier
- Foot grating / safety shutdown mat
- Additional plant-typical security measures

3.12 Planning protection zones in the RFID tag system

At least one protected area must be set up in an RFID tag system. The protection zone is the area of the plant in which a plant section is operated in fail-safe mode.

Planning the use

3.12 Planning protection zones in the RFID tag system

The protection zone requires low-barrier access for the operator to the plant section that is located within the protection zone. The HMI device must be logged onto a machine within the protection zone in order to operate the machine after integration in the fail-safe mode with the enabling button.

Note

You can also operate the HMI device outside a protection zone without logging onto a machine. However, operation in the fail-safe mode with the enabling button is then not possible.

The following figure shows a plant with a protection zone.

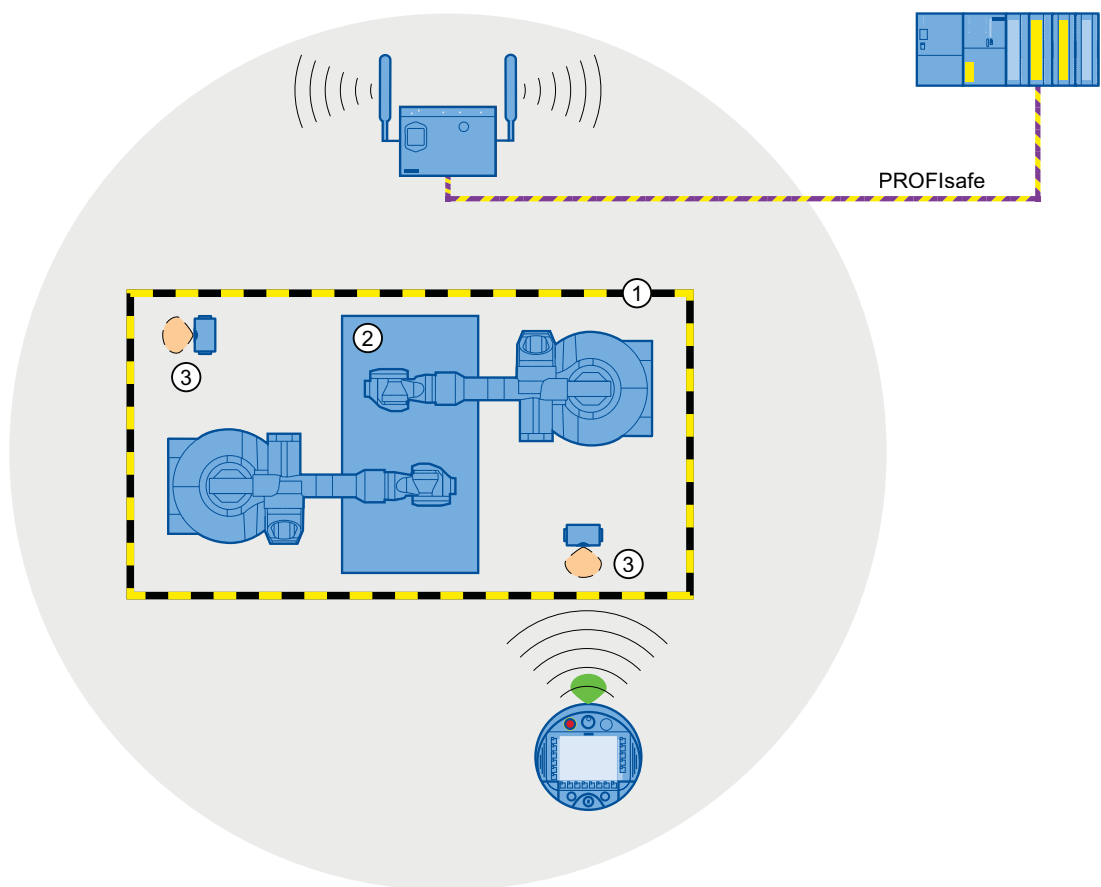

- ① Protection zone limit
- ② Plant section in the protection zone
- ③ RFID tag with effective range

Relationship between protection zone and RFID tag

The protection zone limit is defined by a clear spatial demarcation.

If the HMI device is logged onto a machine in the protected area with a RFID tag, it is possible to operate the machine in fail-safe mode with an enabling button within the protected area.

Requirements for the protection zone

The protection zone must meet the following requirements:

- The protection zone must be completely demarcated and protected.
- Protection zones may not overlap.
- The protection zone must be fully visible to the operating personnel.
- A hazardous location must be visible from every point of the protection zone.

You can find a configuration example in the Appendix.

- The protection zone must be protected by a security system that prevents unauthorized or erroneous use of the HMI device. The security system must have a safety category that is sufficient to meet the plant requirements.

The following security systems are suitable:

- Mesh fence with access

If you use a mesh fence for the protection zone, you can protect access through an additional security system, for example, a light barrier or a contact pressure mat. This allows open access for an escape route during operation of the plant.

- Light barrier
- Contact pressure mat

The security system can be controlled by a safety program, such as a program for robot control conforming to a robotics directive.

3.13 Coexistence of the frequency bands

Coexistence in the 2.4-GHz-band

The use of the HMI device does not affect the communication with other devices or only negligibly so. This applies to the following communication networks:

- WLAN

When adding a WLAN participant, make sure that you observe the conditions described in the document "Wireless LAN in a PROFINET IO Environment". The conditions vary depending on the operating mode and the requirement for PNIO refresh times. See "Guideline for the Use of Industrial Wireless LAN in a PROFINET IO Environment (<http://support.automation.siemens.com/WW/view/en/31938420>)".

- Standard RFID system according to ISO 15693
- Communication protocols that are used for office networks, smoke detectors, bar code scanners etc. in the 2.4 GHz range

You need to plan the radio channels when operating such devices simultaneously in the 2.4 GHz band – see Configuration handbook "SCALANCE W-700" (<http://support.automation.siemens.com/WW/view/en/32816761>). Otherwise sufficient bandwidth for communications cannot be guaranteed.

- ZigBee devices

Coexistence with other communication networks

Moreover, coexistence is ensured for the following communication networks:

- Coexistence in the 5-GHz-band

Planning for the radio channels of all WLAN systems in use is required to ensure sufficient bandwidth for communication.

- WirelessHART

You need to plan for the radio channels for simultaneous operation of Industrial Wireless LAN systems and WirelessHART systems in the 2.4 GHz band. Avoid simultaneous use of overlapping frequency ranges. There is overlapping between Industrial Wireless LAN and WirelessHART – see Configuration manual "SCALANCE W-700" (<http://support.automation.siemens.com/WW/view/en/32816761>), chapter 2.3.

See also

WLAN properties (Page 59)

3.14 Planning information security

Information security is a vital aspect in automation engineering particularly to ensure the availability and interference-free operation of industrial plants. To ensure communication and information security via WLAN for the HMI device, you need to protect the communication system from attack.

Expect:

- Attacks from the outside

To protect against external attacks, you must protect the WLAN in the same way you would protect office communication, namely with a firewall.

- Attacks from the inside

Investigations have shown that the majority of attacks on information security are executed from inside the plant. To ensure information security, you need to take action for:

- Configuration and parameter settings

Possible objectives of an attack are the project and the parameter settings of the HMI device.

- Productive operation data

The productive data can be manipulated, for example by sending a series of false PROFIsafe message frames which prevent the plant from being switched off.

Data transfer between HMI device and access point is protected by the AES encryption mechanism. Manipulation of productive data is prevented in this manner.

Organizational measures

The organizational measures to ensure information security are described in the following documents:

- IEC 61784-3-3:2007 Functional safety field busses – Additional specifications for CPF 3
- PROFIsafe - Environmental Requirements

Specify the organizational measures you must implement in accordance with your plant's requirements to achieve the highest possible information security for communication via WLAN. In doing so, take into consideration:

- Configuration phase
- Process control phase

Check the interplay of the specified measures.

Checklist

Perform the following tasks for application planning and confirm the implementation of each step in the following checklist. The tasks only conditionally required for PROFIsafe compliance are marked *italic* in the checklist.

- **Access point**

Task	Additional information	Check
<i>Select the installation site and antenna characteristics of the access point in such a manner that only the desired area is supplied with wireless capacity. In this regard note that wireless waves spread out horizontally as well as vertically.</i>	Access point operating instructions "SINEMA E" planning program (http://www.siemens.com/sinema)	
Install the access points at locations secured against attack, for example, in suspended ceilings. This can prevent manipulation at the access point or at the Ethernet connection to the LAN.	–	
Always use cable connections to configure access points.	–	
<i>Change the administrative password set.</i>	"SCALANCE W-700" configuration manual (http://support.automation.siemens.com/WW/view/en/32816761)	
Hidden SSID Configure the access point so that the SSID of the radio cell remains hidden.	"SCALANCE W-700" configuration manual (http://support.automation.siemens.com/WW/view/en/32816761)	
Change the SSID setting.	Entering and deleting a password (Page 143)	

Planning the use

3.14 Planning information security

- **Communication network**

Task	Additional information	Check
Examine the application environment with a spectrum analyzer and via WLAN measurement programs for possible radio interference. If you detect sources of interference, specify the appropriate remedial measures. Log the results.	–	
Only operate the communication network in the infrastructure mode.	System manual "Basics on Setting up an Industrial Wireless LAN" (http://support.automation.siemens.com/WW/view/en/9975764), "Network architecture" section	
Isolate the automation networks from all other networks. Use routers and firewalls or VPNs at points where connections to these networks are needed. Limit the communication between the networks to the absolute minimum required.	Operating Instructions "SCALANCE X-400" (http://support.automation.siemens.com/WW/view/en/19625216) Operating Instructions "SCALANCE S and SOFTNET Security Client" (http://support.automation.siemens.com/WW/view/en/21719299)	
Prevent unauthorized participation in the wireless communication using authentication mechanisms.	"SCALANCE W-700" configuration manual (http://support.automation.siemens.com/WW/view/en/32816761)	

- **HMI device**

Task	Additional information	Check
Use a password to protect the Control Panel and Taskbar of the HMI device against unauthorized access.	Section "Entering and deleting a password (Page 143)"	
Enable the data channel used to transfer the project to the HMI device only during the transfer of the project.	Section "Programming the data channel (Page 171)"	
Enable encryption for data transmission in the WLAN configuration. Change the default password for accessing the WLAN configuration in the Web Based management.	Section "Configuring the WLAN connection (Page 145)"	

- **F-CPU and safety program**

Task	Additional information	Check
Use passwords to protect access to the F CPU and safety program.	Programming and operation manual "S7 Distributed Safety - Configuring and Programming" (http://support.automation.siemens.com/WW/view/en/22099875), section "Protection against attack"	

- **WinCC flexible ES**

Task	Additional information	Check
<p><i>Protect WinCC flexible Es with general IT technologies.</i></p> <p><i>Examples:</i></p> <ul style="list-style-type: none"> • <i>Protect the PC where the ES is installed on the operating system level with a password.</i> • <i>Use a suitable encryption program to encrypt files, folders, and partitions.</i> • <i>Assign the access right for a drive only to a specific group of people.</i> • <i>Encrypt the data with mechanisms provided by MS Windows.</i> 	–	
<p><i>Use a password to protect the "Effective range name" object.</i></p>	WinCC flexible Information System	

You can find addition information on the topic of data security in the following publications:

- System manual "Fundamentals - Industrial Wireless LAN", section "Information security of wireless communication in accordance with IEEE 802.11".
- Brochure "Wireless Communication Systems and their Security Aspects" published by the German Federal Agency for Security in Information Technology

Planning the use

3.14 Planning information security

4

Mounting and connection

4.1 Check the scope of delivery

Check the scope of delivery for completeness and visible signs of transport damage.

NOTICE

Do not use damaged parts

If you use defective parts from the scope of delivery, you may experience malfunctions.

If you find defective parts in the scope of delivery, contact your Siemens partner. Only install undamaged parts.

4.2 Mounting the charging station

Requirements

- 4 x M6 cylinder head screws, with nuts if required
- An ideal mounting location with an adequate amount of free space was selected for the charging station, see "Mounting location and clearance of charging station (Page 66)"

Procedure

Proceed as follows:

1. Place the charging station onto the mounting surface.
2. Mark the fastening holes with a marking-off tool.
3. Drill 4 through holes or 4 x M6 threaded holes.
4. Mount the charging station.

4.3 Connecting the charging station

Requirements

- The charging station is mounted according to the specifications in this document.
- Three-core cable, flexible, 0.75 mm²
- End sleeves
- 1 connector, included in accessories pack of the charging station

Mounting and connection

4.3 Connecting the charging station

Structure of connector

The following figure shows the structure of the connector:

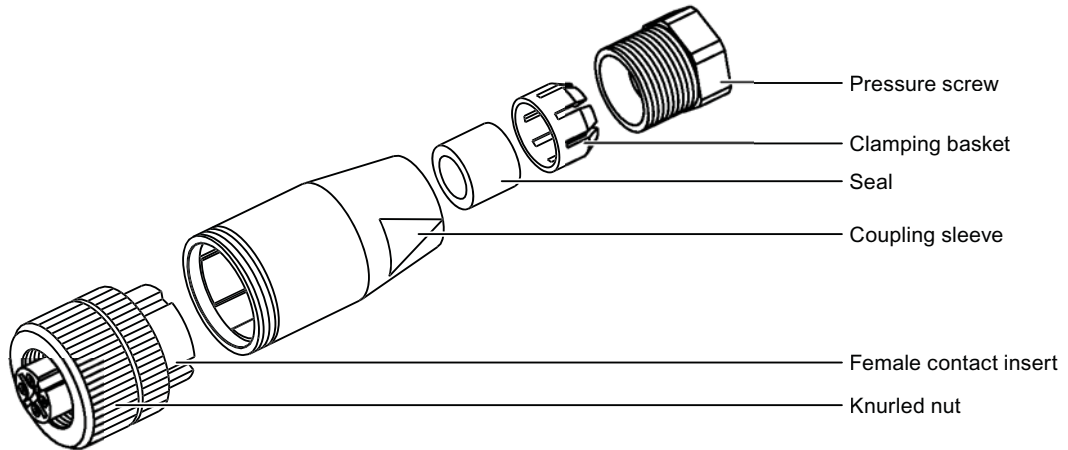

Pin	Assignment of female contact insert
1	+24 VDC
2	n. c.
3	GND 24 V
4	PE

Procedure – Installing the connector

Proceed as follows:

1. Fit end sleeves on the wire ends.
2. Push the pressure screw, clamping basket, seal, and coupling sleeve onto the cable.
3. Fasten the wires to the contacts in the female contact insert.
4. Install the connector.

Procedure – Connecting the charging station

Proceed as follows:

1. Connect the cable to the power supply.
2. Plug the connector into the socket on the charging station.
3. Secure the connector with the knurled nut.

4.4 Mounting the transponder

Requirements

- 2 x M4 cylinder head screws, with nuts if required
- An ideal position was selected for the transponder, see chapter "Planning the installation location of transponders (Page 67)"

Procedure

Proceed as follows:

1. Place the transponder onto the mounting surface.
2. Mark the fastening holes with a marking-off tool.
3. Drill two through-holes or two threaded holes, M4.
4. Attach the transponder.

4.5 Setting the transponder ID and inserting the batteries

Requirements

- Torx screwdriver, size T10
- Screwdriver, size 0
- 3 1.5 V AA mignon batteries – included in the transponder accessory kit

Procedure – opening the transponder

Note

Observe the notes about the EGB in chapter "ESD guideline (Page 359)!"

Proceed as follows:

Mounting and connection

4.5 Setting the transponder ID and inserting the batteries

- 1. Loosen the four marked screws.



- 2. Lay the cover aside.

The screws are in the cover so that they cannot be lost.

The following image shows the location of the rotary coding switch and the battery component.

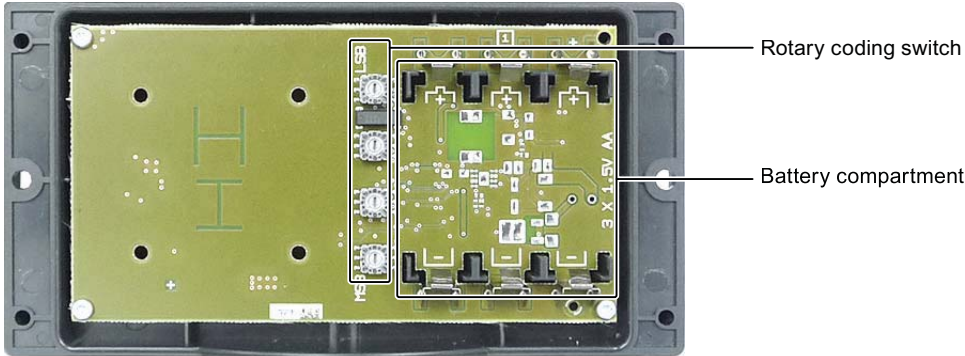

Example for an ID

The following image shows the example of the ID 3A27H - 14 887 in a decimal format.

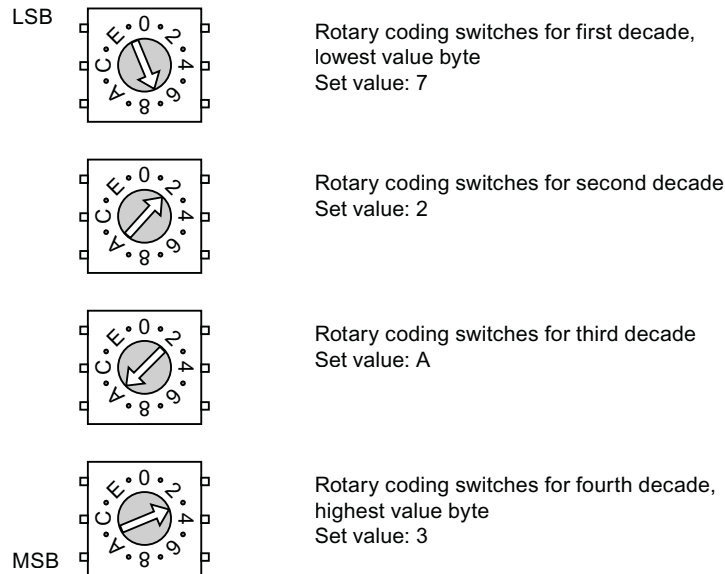

Procedure – inserting the battery and setting ID

Proceed as follows:

1. Insert the batteries in the battery compartment corresponding with the polarity label.
2. Set the assigned ID with the help of a screwdriver.

The values permitted are 1 to FFFE, i.e. 1 to 65,534 in decimal format. Please note the MSB and LSB markings on the printed circuit board. Refer to your plant documentation for additional information.

Procedure – closing the transponder

Proceed as follows:

1. Place the cover on the transponder.
2. Tighten the four screws.

NOTICE
Damage to treading possible
The transponder housing is made of plastic. Therefore, the mounting hole threads cannot handle the same amount of stress as a comparable metallic housing. If the screws are tightened more than 20 times, there is risk of damage to the threads.
Do not exceed 0.4 to 0.5 Nm of torque when tightening the screws.

4.6 Installing an RFID tag

Requirement

- 1 RFID tag
- 1 fixing pocket
- 2 M4 cylinder head screws with nuts, if required
- An installation location has been selected for the RFID tag as described in the chapter "Planning an installation location for RFID tags (Page 68)".

If installing on a metallic base:

- 1 spacer
- 4 M4 cylinder head screws with nuts, if required

Note

The mounting brackets on both sides of the spacer permit fixation with cable ties.

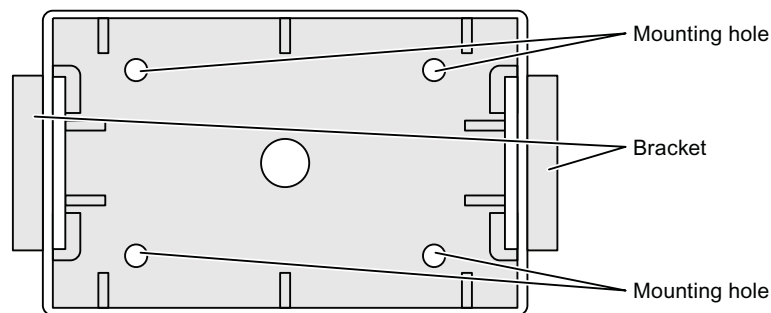

Procedure- with a metallic installation location

Proceed as follows:

1. Position the spacer on the installation location.
2. Mark the fastening holes with a marking-off tool.
3. Drill two through-holes or two threaded holes, M4.
4. Mount the spacer.
5. Bend the tabs on the fixing pocket to the rear at right angles.
6. Slide the RFID tag into the fixing pocket.
7. Slide the tabs of the fixing pocket into the spacer.

The tabs snap into place and are secured by studs.

Procedure – with a non-metallic installation location

Proceed as follows:

1. Position the fixing pocket on the installation location.
2. Mark the fastening holes with a marking-off tool.
3. Drill two through-holes or two threaded holes, M4.
4. Fasten the fixing pocket.
5. Slide the RFID tag into the fixing pocket.

4.7 Connecting the HMI device

4.7.1 Safety instructions

CAUTION

Only use for approved devices

Non-approved devices may cause malfunctions.

Operate the HMI device exclusively with the approved devices, see chapter:

- Scope of delivery (Page 15)
- Accessories (Page 18)

Malfunction possible

If the HMI device is switched on and lying on its front, any one of the operator controls can trigger a malfunction.

Switch off the HMI device whenever possible.

Damage to the HMI device by foreign objects and liquids

Damage may occur to the HMI device if it is opened by unauthorized personnel. Foreign bodies and liquids may not get into the interior

of the HMI device and on the printed circuit board.

The connection and battery compartments therefore may only be opened by professional personnel for servicing.

NOTICE

Do not exceed the bridging time

If the main rechargeable battery is removed, the HMI device supplied by the rechargeable buffer battery. The maximum buffer time is 20 seconds. If you exceed the bridging time, the HMI device may switch off automatically. This triggers a shutdown or rampdown of an integrated HMI device.

Do not exceed the buffer time.

Opening the connection or battery compartment

The HMI device does not meet degree of protection IP65 when the connection or battery compartment is open.

Do not open the connection or battery compartment if dust or moisture can enter the device. Close an open compartment completely.

4.7.2 Opening and closing the battery and terminal compartment

The connection compartment may not be opened while the HMI device is in operation. This will not interrupt the power supply to the HMI device.

Requirement

- Cross-head screwdriver, size 2

Procedure – opening the terminal compartment

CAUTION

Power supply

If the power supply unit is connected, the parts of the HMI device will be under voltage.

Disconnect the power supply from the HMI device.

Wiring to charging contacts

The connection bay cover is connected to the HMI device's housing by wiring. This can be damaged during opening.

Carefully open the connection bay cover.

Note

First open the battery compartment cover and take out the main battery. Remove the connection bay cover.

Proceed as follows:

1. Pull up the locking latch on the battery compartment cover.

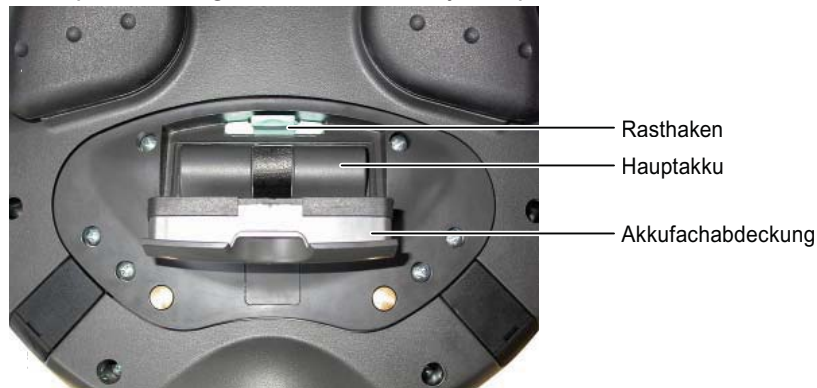

2. Open the battery compartment cover.
3. Remove the battery compartment cover.
The battery compartment is open. The main battery is visible.
4. Remove the main battery using the ribbon.
5. Unscrew the six screws approximately 1 cm out of the connection bay cover.
The connection bay cover is designed in such a way that the screws cannot be lost.
6. Remove the connection bay cover.

Result

The connection bay is open.

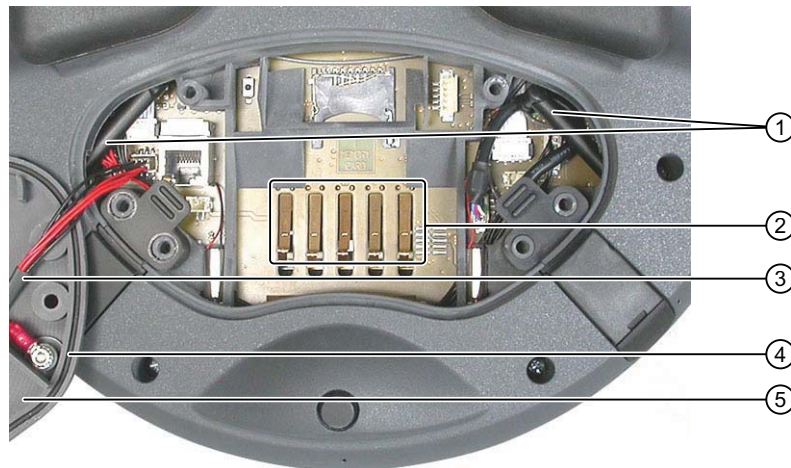

- ① Antenna
- ② Contacts for the main battery
- ③ Wiring to charging contacts
- ④ Rubber seal
- ⑤ Connection bay cover

Procedure for closing the connection bay and battery compartment

CAUTION

Degree of protection IP65

Ensure that the seals belonging to the connection bay cover and battery compartment cover are present during mounting.

After completing the connections, check whether the covers are fitted on the USB interface and the terminal for the power supply unit.

Wiring to charging contacts

If the line to the charging contacts is stuck, this may result in functional problems.

When closing the connection bay cover, be careful not to trap the wiring at the charging contacts.

Connection compartment

If parts other than the main battery and memory card remain in the connection bay, this may result in functional problems.

Only use the connection bay to insert the memory card and main battery!

Mounting hole threads

The HMI device housing is made of plastic. Therefore, the mounting hole threads cannot handle the same amount of stress as a comparable metallic housing. If the screws are tightened more than 20 times, there is risk of damage to the threads.

Do not exceed 0.4 to 0.5 Nm of torque when tightening the screws.

Proceed as follows:

1. Place the connection bay cover on the connection bay.
Be careful with the wiring to the charging contacts.
2. Tighten the 6 screws on the connection bay cover.
3. Insert the main battery.
4. Insert the battery compartment cover.

The fastener of the battery compartment cover must engage below the locking latch.

Result

The connection bay and battery compartment of the HMI device are now closed.

See also

ESD guideline (Page 359)

4.7.3 Ports and reset button

The following figure shows the interfaces and reset button of the HMI device.

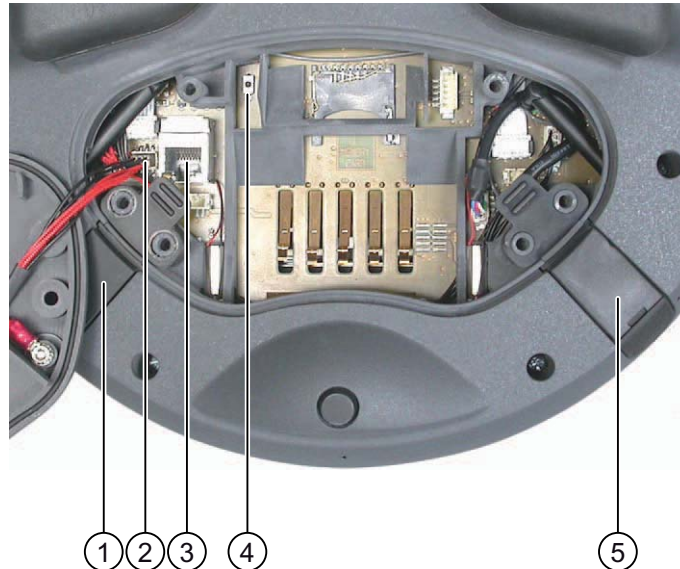

- ① Connection for power supply
- ② Cable connector for wiring to charging contacts
- ③ RJ45 socket
- ④ Reset button
- ⑤ USB interface

The USB socket and the connector for the power supply unit are shown as plugs.

All unsaved data will be lost when you press the reset button. Press the reset button only when the HMI device is no longer working properly and no longer responds to input.

4.7.4 Inserting a memory card

The following can be saved to the memory card of the HMI device:

- Logs
- Recipes
- Operating system
- Applications
- Additional specifications

The memory card can be inserted and removed during operation. Do not remove the memory card while data is being accessed by an application, for example during backup or recipe transfer.

Note

The micro memory card of the SIMATIC S7 PLC cannot be used.

Requirement

- The battery compartment of the HMI device is open.
- The main rechargeable battery has been removed.
- The connection bay on the HMI device is open.

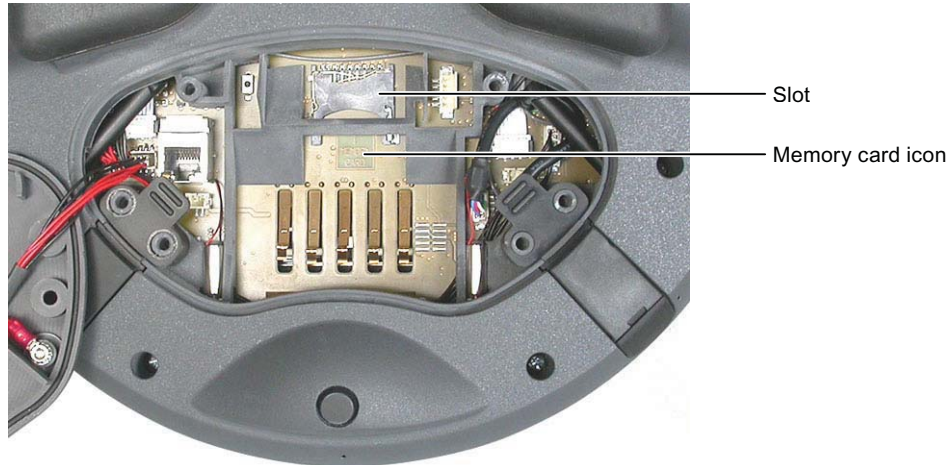

Procedure for inserting a memory card

Note

Read the information provided in chapter "Opening and closing the battery and terminal compartment (Page 84)".

Observe the notes about the EGB in chapter "ESD guideline (Page 359)".

Proceed as follows:

1. Insert the memory card into the slot.

Pay attention to the memory card symbol when inserting the memory card. An arrow on the memory card indicates the front side and the direction of insertion. When the memory card is correctly inserted into the slot, it stands approx. 3 mm proud of the slot.

Procedure – using a memory card for the first time

Note

The first time you use a memory card, the HMI device will prompt you to format it. All data is lost on the memory card during formatting.

Back up existing data, if necessary, before you use the memory card in the HMI device.

Proceed as follows:

1. Cancel the formatting procedure by pressing "ESC".
2. Remove the memory card from the slot.

3. Back up data that are still needed.
4. Insert the memory card into the slot.
5. Format the memory card.

Procedure for unplugging a memory card

Proceed as follows:

1. Pull the memory card out of the slot.
2. Close the connection bay.
3. Insert the main battery.
4. Close the HMI device's battery compartment.
5. Store the memory card in a safe place.

4.7.5 Replacing and charging the main rechargeable battery

4.7.5.1 Safety instructions

 CAUTION
Charging and discharging the rechargeable battery
There is a risk of fire and, in extreme cases, explosion in the following situations!
<ul style="list-style-type: none">• Incorrect charging and discharging of the rechargeable battery• Reverse polarity• Short-circuit
Only charge the rechargeable battery in the HMI device or in a charger approved for the HMI device.
Contact with battery fluid
If used incorrectly, fluid can leak from the battery.
Avoid contact with the battery fluid. If battery fluid comes in contact with skin, rinse it off with water. If battery fluid comes into contact with the eyes, seek medical advice.

NOTICE

Use only approved batteries

If you use non-approved batteries, malfunctions may occur as a result.

Only use batteries that are approved for the HMI device.

Fully charge the main rechargeable battery before first use

If you attempt to use a main rechargeable battery in the HMI device in its factory state, the HMI device will not start.

Fully charge the main rechargeable battery before inserting it in the HMI device.

Note

The following applies to lithium-ion rechargeable batteries:

- Do not crush
- Do not heat or burn
- Do not short-circuit
- Do not disassemble
- Do not immerse in liquids – the rechargeable battery may rupture or burst
- Store unused rechargeable batteries away from the following items which can cause the contacts to be bridged.

These include:

- Paper clips
 - Coins
 - Keys
 - Nails
 - Screws or other small metal objects
-

See also

ESD guideline (Page 359)

Opening and closing the battery and terminal compartment (Page 84)

4.7.5.2 Replacing the main rechargeable battery

You can replace the main rechargeable battery during operation. A capacitor takes over power supply duties while the main rechargeable battery is being replaced. The maximum buffer time is 50 seconds.

If you exceed the buffer time, the HMI device will switch off.

NOTICE

Effective range

If the HMI device is integrated, this leads to a shutdown or rampdown of the plant if the bridging time is exceeded.

Do not exceed the buffer time.

The following features are disabled during the buffer time:

- Display backlighting
- The function keys and associated LEDs
- All LEDs except for "SAFE" and "RNG"
- The illuminated pushbuttons and handwheel
- USB interface

Note

Read the section "Safety instructions (Page 83)".

If the capacity of a rechargeable battery drops to 50 percent of the original capacity, use a new rechargeable battery. A new rechargeable battery is needed after 500 full charge cycles.

Example of a full charge cycle:

The charge status of a rechargeable battery decreases from 100 percent to 80 percent. The rechargeable battery is charged again in this state and then reaches 100 percent. Discharging to 80 percent and recharging to 100% adds up to a full charge cycle.

Keep main rechargeable batteries in stock.

Requirement

- The HMI device is logged off the machine.
- The battery compartment is open.

Procedure

Proceed as follows:

1. Remove the main battery using the ribbon.
2. Insert a new main battery.
3. Close the battery compartment.

4.7.5.3 Charging the main rechargeable battery

The main battery is delivered uncharged. The main battery is loaded as soon as the HMI device is in the charging station.

You can replace the main rechargeable battery during operation. A capacitor takes over power supply duties while the main rechargeable battery is being replaced. The bridging time is a maximum of 50 s. If you exceed the bridging time, the HMI device turns off

Note

Read the information provided in chapter "Safety instructions (Page 83)".

Observe the notes about the EGB in chapter "ESD guideline (Page 359)".

Please note that a battery is subject to a natural self-discharge. Self-discharge will eventually lead to complete discharge if the battery is not used for a long time. Read the chapter "Maintenance and care (Page 335)".

Requirement

- The connection compartment is open.
- The battery compartment is open.

Procedure

Note

When charging a rechargeable battery, the ambient temperature or battery temperature should not exceed 40 °C. The higher the temperature, the longer it will take for the rechargeable battery to fully charge.

Select a location with a low ambient temperature for the charging station. Let the rechargeable battery cool before charging it.

Proceed as follows:

1. Place the main battery into the battery compartment.

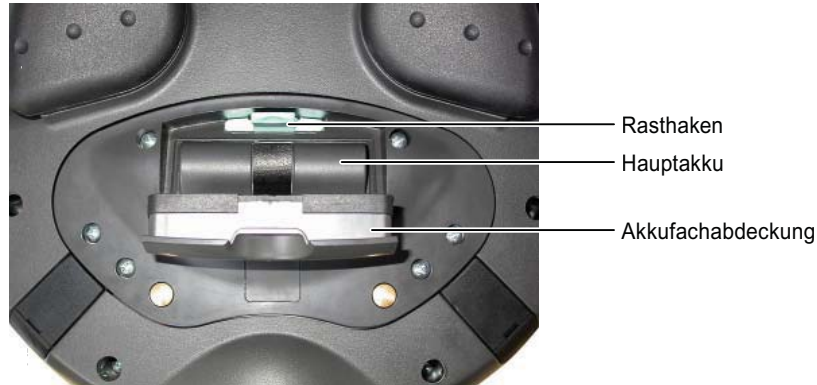

2. Close the battery compartment.
3. Insert the HMI device into the charging station.

The battery is charged once the HMI device illuminates the "BAT" LED. See chapter "LED display (Page 103)".

4.7.5.4 Displaying the battery charge status

The main rechargeable battery features an LED display. The respective LEDs indicate the battery charge status.



Requirement

- The main battery has been removed.

Procedure

Proceed as follows:

1. Press the button.

The LED display lights up when the button is released after approximately 5 seconds. The number of lit LEDs indicates the charge status.

Number of LEDs	Flashes for	Lights for
1	0 to 19 % of the charge capacity	20 to 39 % of the charge capacity
2	-	40 to 59 % of the charge capacity
3	-	60 to 79 % of the charge capacity

Mounting and connection

4.7 Connecting the HMI device

Number of LEDs	Flashes for	Lights for
4	-	80 to 96 % of the charge capacity
5	-	97 to 100% of the charge capacity

If all the LEDs light up, the main rechargeable battery is fully charged.

Note

When storing batteries, pay attention to the notes in the chapter "Maintenance and care (Page 335)".

4.7.6 Connecting the PLC

Introduction

Only use approved components to connect a SIMATIC S7 PLC. You can find more information on this on the Internet in Industry Mall (<http://mall.automation.siemens.com>).

Configuration graphic

The following figure shows the possible connection between the HMI device and the PLC.

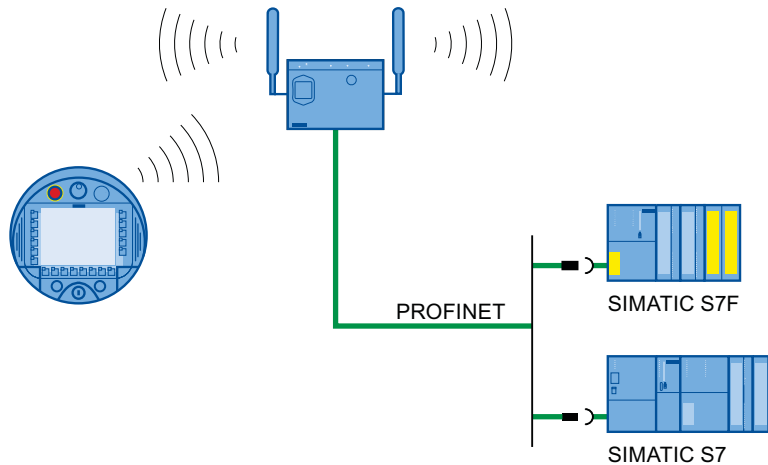

See also

System manual "Basics on Setting up an Industrial Wireless LAN" (<http://support.automation.siemens.com/WW/view/en/9975764>)

4.7.7 Connecting the configuration PC

The HMI device and configuration PC must be in an area with sufficient WLAN quality.

Note

You must connect the HMI device to the configuring PC in infrastructure mode. An ad hoc network is not possible.

Configuration graphic

The following figure illustrates the possible connections between the HMI device and the configuring PC.

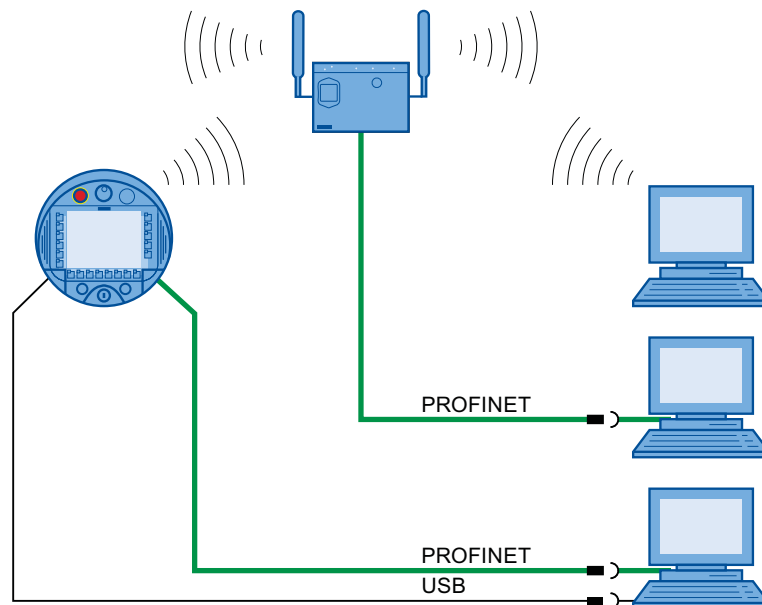

NOTICE

Adhere to the USB connection sequence

You will not be able to transfer a project to the HMI device if you do not adhere to the connection sequence.

Observe the following sequence when connecting by USB:

1. HMI device
2. PC

USB host-to-host cable

You will not be able to transfer a project to the HMI device if you use the driver for the USB host-to-host cable.

Use only the driver for the USB host-to-host cable that is included in the WinCC flexible package.

Note

Point-to-point connection

Use a cross cable for a point-to-point connection. The HMI device and the PC can also be subscribers in a local area network.

Connection via WLAN

In its factory state, the WLAN interface of the HMI device is disabled. Before you access the HMI device from the configuration PC via WiFi, you need to appropriately configure the access point and HMI device in infrastructure mode. An ad hoc wireless network is not possible.

Restoring the factory settings

To update the operating system and reset to factory settings, you must connect the HMI device to the configuring PC via the RJ45 interface. Only connect a configuration PC directly to the HMI device as long as it is necessary. Additional information is available in the "Restoring factory settings (Page 226)" section.

See also

Opening and closing the battery and terminal compartment (Page 84)

4.7.8 Connecting a printer

A printer is connected to the HMI device through WLAN. It is not possible to connect a printer to the HMI device's USB interface.

Information about printers that were tested and approved with HMI devices can be found online under "Printers approved for SIMATIC Panels and Multi Panels (<http://support.automation.siemens.com/WW/view/en/11376409>)".

Configuration graphic

The following figure illustrates the possible connections between the HMI device and a printer.

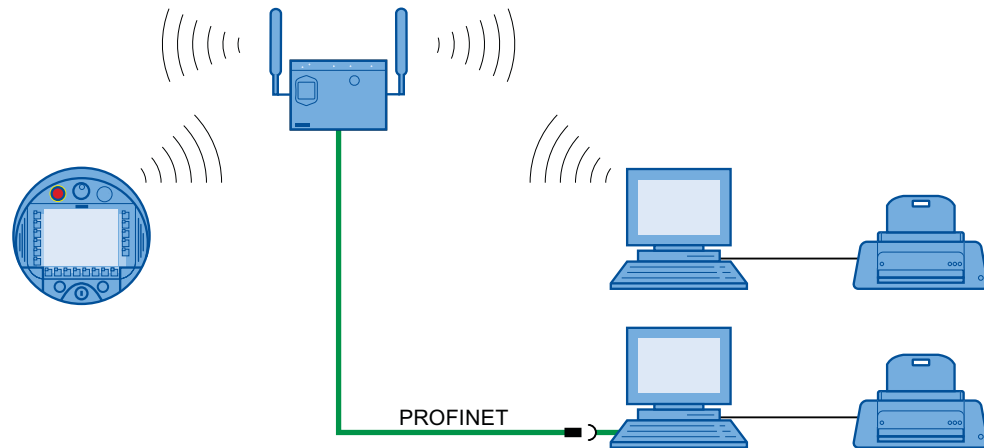

Observe the documentation for the respective printer during connection.

4.7.9 Connecting a USB device

You can connect the following devices to the USB port of the HMI device:

- External mouse
- External keyboard
- USB memory stick

Only connect industrial devices.

NOTICE

Device with a separate power supply

If you connect a device with a separate power supply to the USB port, this may result in functional disruptions.

Only connect a configuration PC or PC to the USB port.

Load of USB interface

Malfunctions may occur on a USB device that presents an electrical overload to the USB port.

Adhere to the values for the maximum load on the USB port. You can find the values in the chapter "Specifications (Page 342)".

Access to USB port

The USB port is disabled while the main battery is being changed. The data transmission to a USB memory stick is not possible.

Ensure no one tries to access the USB port while the main rechargeable battery is being replaced.

Note

Devices without a separate power supply connected to the USB port increase the power load. This will reduce the service life of the HMI device.

See also

Interface description (Page 345)

4.7.10 Connecting the power supply unit

The power supply unit ensures the power supply for the charging station.

NOTICE

Use only approved power supplies

If you use an unapproved power supply, damage may occur to the HMI device.

Only use the power supply approved for the HMI device.

Danger of overheating

There is a risk of overheating if you cover the power supply and thereby inhibit the air circulation.

Do not cover the power supply unit.

Note

Unplug the mains connector of the power supply to ensure complete electrical isolation.

The power supply unit is designed for operation on grounded power supply networks (TN systems to VDE 0100, Part 300, or IEC 364-3).

Operation is not authorized on ungrounded or impedance-grounded power networks (IT systems).

Procedure

Proceed as follows:

1. Connect the power supply unit to the charging station or charger.
2. Connect the power supply unit to the mains with the correct power supply cable.

4.8 Switching on and testing the HMI device

When the HMI device is initially put into operation, there is no project. Ethernet is set as the data transfer channel.

Requirement

- A charged main rechargeable battery is inserted in the HMI device.

Procedure

Proceed as follows:

1. Briefly press the "ON/OFF" button.

The "PWR" LED lights up – see section "LED display (Page 103)". The display then lights. A progress bar is displayed during startup.

The loader is displayed once the operating system has started.

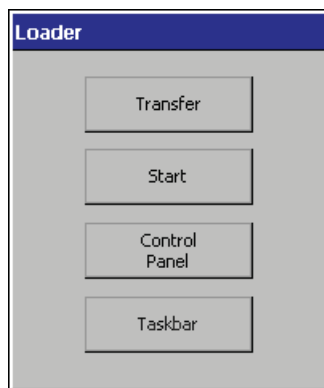

If a charged main rechargeable battery is inserted, the "BAT" LED lights up. The HMI device automatically switches to "Transfer" mode if the following two requirements are met:

- No project is loaded on the device.
- At least one data channel has been configured.

The following dialog appears:

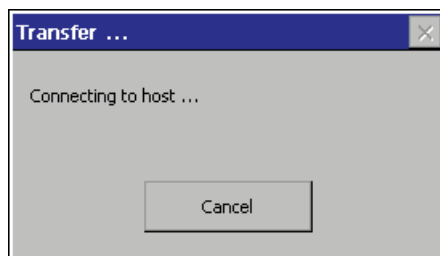

2. Press the "Cancel" button.

The transfer is canceled. The Loader appears.

Result

The HMI device is ready for operation when the loader displays one of the following dialogs:

- "Transfer" dialog
- "Testing enabling button" dialog

4.9 Switching off the HMI device

The following procedure applies to an HMI device on which there is no project. The way the device is switched off therefore differs from that of an integrated HMI device.

Procedure

Proceed as follows:

1. Press the "ON/OFF" button on the HMI device at least 4 seconds.
The HMI device switches off.

See also

Switch-off behavior (Page 255)

Operator controls and displays

5.1 Overview

The standard input unit on the HMI device is the touch screen. All operator controls required for operation appear in one or more HMI screens on the display after the project starts.

NOTICE

Damage to the touch screen

Never press the touch screen with a pointed or sharp object. Avoid applying sudden pressure to the touch screen with a hard object. Both these will substantially reduce the service life of the touch screen and can even lead to total failure.

Only press the operating objects on the touch screen of the HMI device with a finger or a touch pen.

Damage to the keyboard

Do not touch the keys with a pointed or sharp object. Avoid applying sudden pressure to the keys with a hard object. Both these will substantially reduce the service life of the keyboard and can even lead to total failure.

Use only your fingers to operate the keys of your HMI device.

Operator controls and their functions

The following image shows the operating elements and the display on the HMI device. Depending on the delivered HMI device, differences to the following image may exist.



- ① EMERGENCY STOP button
- ② LED display
- ③ Display with touch screen
- ④ Key "ON/OFF"
- ⑤ Covers for the labeling strip guides
- ⑥ Key-operated switch, optional
- ⑦ Illuminated pushbutton, optional
- ⑧ Membrane keyboard
- ⑨ Handwheel, optional

The functions assigned to the function keys, the handwheel, the key-operated switch and the illuminated pushbuttons are determined during configuration. The above-mentioned operator controls do not function outside of a project.

5.2 LED display

An LED display consisting of five LEDs is located on the front of the HMI device. The LED display shows the operating states for the HMI device and the communication.

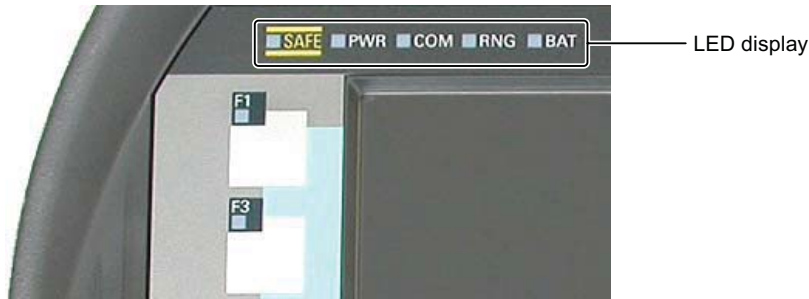

Meaning of LEDs



























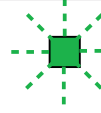

The LED display is activated when the HMI device is switched on.

LED	Color	Functions	Meaning
SAFE	Yellow	PROFIsafe communication	Lights: If the HMI device is integrated in the safety program of the F-CPU. The requirement for this is that PROFIsafe communication has been established. If the LED "SAFE" lights up, the EMERGENCY STOP button is effective.
PWR	Green	Power	Lights or blinks: If the HMI device is turned on. Lights up in the following cases: <ul style="list-style-type: none"> The main rechargeable battery is inserted and charged. The HMI device is in the charging station. The HMI device is connected to the power supply unit. Blinks: If the HMI device is in the "POWER SAVE 2" operating mode.
COM	Green	Communication	Off: If no WLAN exists on the HMI device. Blinks: If the HMI device tries to establish a connection to the WLAN. Lights up: If a connection between the HMI device and WLAN exists.
RNG	Green	Effective range Protection range	Lights up: If the HMI device is logged onto the effective range or protection zone. If a communication error occurs after the HMI device has logged on to a machine, the "RNG" lights up until PROFIsafe communication is reestablished and the communication error has been acknowledged. Off: If the HMI device from a machine is logged off.

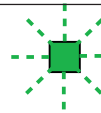
Operator controls and displays
5.2 LED display

Refer to the plant documentation for additional information on the meaning of the LEDs.

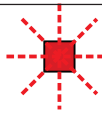
The "BAT" LED signals the following states based on the type of power supply:

Power supply	BAT LED					
	①	②	③	④	⑤	⑥
Rechargeable battery operation, HMI device on					-	
Rechargeable battery operation, HMI device off						
Power supply unit, HMI device on						
Power supply unit, HMI device off						
Charging station						

- ① Charge at < 6% of charge capacity
- ② Charge at ≥ 6% of the charge capacity
- ③ Maximum charge
- ④ Rechargeable battery not in the HMI device
- ⑤ Rechargeable battery temperature too high
- ⑥ Possible faults:
Short circuit, discharge current > 8.0 A
Overload, discharge current > 4.0 A
Overload, charge current > 2.8 A
Charging error, cell voltage > 4.3 V
Charging error, cell voltage < 3.0 V

Please observe the following:

- An error event always has priority.
If an error occurs, the "BAT" LED signals according to column ⑥.
- If the battery is **not** fully charged, the "BAT" LED signals according to column ⑤.
- If the main rechargeable battery is fully charged, the "BAT" LED signals according to column ③.

See also

Displaying the charge status of the batteries (Page 158)

5.3 Power management

The HMI device is equipped with a power management function. If you do not operate the HMI device within a configured time period, power management will switch the HMI device to power saving mode. This extends the operating period of the HMI device until the next time the main rechargeable battery is replaced or the next time it is charged.

Operating modes in power management

Power management has two operating modes:

- "Power Save 1"
 - Reduces the brightness of the touch screen.
 - The EMERGENCY STOP button remains available.
 - As long as the HMI device is logged on, the enabling button remains enabled.

Note

When you place the HMI device in the charging station, it will automatically assume the operating state "Power Save 1" after 2 minutes.

If a time period of less than 2 minutes has been specified for activation of "Power Save 1" mode in the WinCC flexible project, then this time period will be applied.

- "Power Save 2"
 - The touch screen is switched off.
 - Other power save measures are activated.
The online help for WinCC flexible describes how to configure power management.
 - The EMERGENCY STOP button remains available.
 - The rotary switch remains available.

Operator controls and displays

5.3 Power management

- "Power Save 1" corresponds to the "Reduce brightness" setting.
- "Power Save 2" corresponds to the "Switch off screen" setting.

Note

When the HMI device is logged on to a machine, "Power Save 2" operating mode is not available.

Power management for the HMI device provides the following operating modes:

Operating mode	LED	Action	Follow-up operating mode
OFF	"PWR" is off. "BAT" is off.	Briefly press Taste "ON/OFF"	ON
ON	"PWR" lights up.	Automatically, if no actions are performed within a configured time period.	"Power Save 1"
		Briefly press Taste "ON/OFF"	"Power Save 2"
		Press Taste "ON/OFF" for at least 4 seconds.	OFF
"Power Save 1"	"PWR" lights up. The brightness of the touch screen is reduced.	Operation on the touch screen	ON
		Briefly press Taste "ON/OFF"	"Power Save 2"
		Automatically, after a configured time interval if no operations are carried out	"Power Save 2"
		Press Taste "ON/OFF" for at least 4 seconds.	OFF
"Power Save 2"	"PWR" flashes. The touch screen is switched off.	Briefly press Taste "ON/OFF"	ON
		Briefly press Taste "ON/OFF" and then press it for at least 4 seconds.	OFF

See also

Setting the screen saver (Page 162)

5.4 Safety-related operator controls

5.4.1 EMERGENCY STOP button

The EMERGENCY STOP button is designed with 2-channels and enables an EMERGENCY STOP of the plant unit with which safety-related communication is taking place. The EMERGENCY STOP button satisfies the requirements specified in DIN IEC 60947-5-5,1997 Annex K. You can find additional information in the section "Safety functions of the EMERGENCY STOP button (Page 48)".



Due to its profiled design, the emergency stop button is easily accessible. A collared enclosure serves as protection if the device falls. Thus if the Mobile Panel 277F IWLAN should fall down, the emergency stop button will not be activated. However the emergency stop button is extensively protected against damage.

Due to its position, the EMERGENCY STOP button is equally accessible for both left-handed and right-handed persons.

Storing a non-integrated HMI device

<p>⚠ WARNING</p> <p>Non-functional emergency stop button</p> <p>If the HMI device is not integrated in the safety program of the F-CPU, the EMERGENCY STOP button will be out of service.</p> <p>To avoid confusion between HMI devices with enabled and disabled EMERGENCY STOP buttons, only one integrated HMI device should be freely accessible.</p>

If an HMI device is not integrated and not being used, make sure the HMI device cannot be accessed.

Requirements

The EMERGENCY STOP button is evaluated under the condition that the HMI device is integrated in the safety program of the F-CPU. The following fail-safe FBs must be implemented in the safety program accordingly:

- F_FB_MP
- F_FB_RNG_4 or
- F_FB_RNG_16

Procedure – Operating the EMERGENCY STOP button

 **WARNING**

Function of the EMERGENCY STOP button

The EMERGENCY STOP button has no effect if the HMI device is without power or removed from the safety program.

Operate the HMI device in mobile mode using the main rechargeable battery or in stationary mode in the charging station and integrate it in safe-related communication. Do not operate the HMI device in the plant with the power supply unit.

NOTICE

Unintentional triggering of the EMERGENCY STOP button

The emergency stop button can be triggered unintentionally in the following cases and bring the monitored system to a standstill:

- When the HMI device is dropped.
- When the HMI device is laid on its front

Handle the HMI device with care!

Proceed as follows:

1. Press the EMERGENCY STOP button fully if a dangerous situation develops.

The EMERGENCY STOP button engages in the EMERGENCY STOP position. The associated plant unit is stopped.

Procedure – Releasing the EMERGENCY STOP button

 **WARNING**

EMERGENCY STOP button released

If you have pressed the EMERGENCY STOP button and thereby brought the plant unit to a standstill, you should only release the EMERGENCY STOP button under the following conditions:

- The reasons for the EMERGENCY STOP have been eliminated.
- A safe restart is possible.
- The restart should not be performed by releasing the EMERGENCY STOP button.
The project should force the operator to perform an action for restarting independent of the EMERGENCY STOP button. The safety program must specify that no automatic restart of the plant is possible simply by releasing the EMERGENCY STOP button.

Proceed as follows:

1. Turn the EMERGENCY STOP button clockwise to its original position.

The EMERGENCY STOP button is released.

5.4.2 Enabling button

The enabling mechanism consists of two enabling buttons which are installed on both sides of the HMI device. Additional information is available in the "Safety functions of the enabling mechanism (Page 49)" section.

The enabling button is required to confirm axis movements, for example.



The enabling button has three switch settings:

- Neutral position
The enabling button is not pressed.
- Enable
The enabling button is pressed to a middle switch position. The switch position has a noticeable pressure point. This switch position is used to confirm an entry, for example.
- Panic
The "Panic" switch position is reached as soon as one of the two enabling buttons is fully pressed. To do this, the pressure point of the "Enable" switching position must be overcome. An audible switching noise is then heard.

The switch position of the other enabling button is unimportant in this case. The "Panic" switch position has the same effect as releasing the enabling button. In both switch positions, the enable is revoked.

Requirement

- The enabling button is evaluated under the condition that the HMI device is integrated in the safety program of the F-CPU. See section "Safety-related configuration (Page 191)".

Procedure

<p>⚠ WARNING</p> <p>Press the enabling button only as long as necessary</p> <p>Enabling is a conscious operator action. It is not permitted to continuously press the enabling button or to fasten it in place.</p> <p>Press the enabling button only until the operation you wish to enable is completed.</p>
--

Note

The enabling button only has an effect when the HMI device is logged on to a machine and the "RNG" LED on the HMI device is lit.

Proceed as follows:

1. Press at least one of the enabling button to reach the "Enable" position.

You only have to activate one enabling button. The controller receives the same signal, regardless of whether one or both enabling buttons have been pressed.

NOTICE

Enabling button can tilt

If you do not press the center of the enabling button, the enabling button may tilt. The switching process is delayed by this. A discrepancy error may occur – see section "Diagnostics (Page 251)".

Press the enabling button in the middle.

Switch settings

The following figure shows the switching sequence for enable.

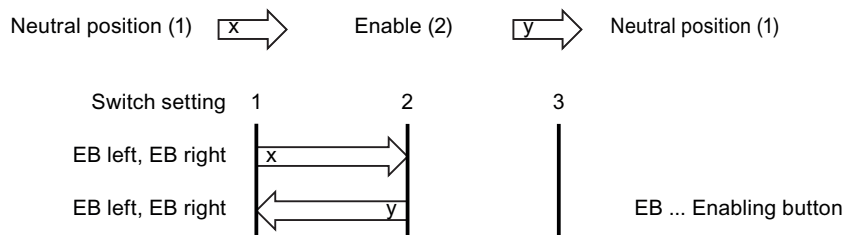

The following figure shows the switching sequence during panic usage.

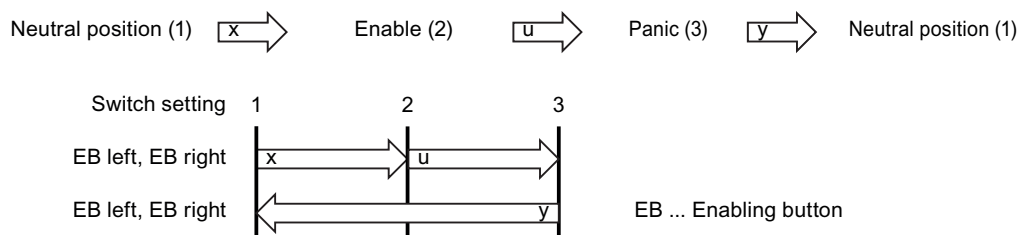

If the operator presses the enabling button in the "Panic" switch position, the "Enable" switch position will not be evaluated when leaving the panic setting. A new enable can only be triggered by releasing the enabling button.

Note

The HMI device analyzes the switch settings of the two enabling buttons in the form of an OR gate.

The enabling button and membrane keyboard can be operated simultaneously.

5.4.3 Testing the function

Perform an annual function test for the enabling button and EMERGENCY STOP button during commissioning.

Procedure

Proceed as follows:

1. Switch on the HMI device.
2. Press both enabling buttons when the "Test Enabling Button" dialog is shown.
3. Press the EMERGENCY STOP button.

5.5 Operator controls

5.5.1 Operating the handwheel

The handwheel is an optional operator control. The handwheel can be turned without a stop and does not have a zero position. To facilitate operation, the handwheel has a small recess.



5.5.2 Operating the key-operated switch

Introduction

The key-operated switch is an optional operator control. The key-operated switch is used to lock functions that can be triggered via the Mobile Panel 277F IWLAN.

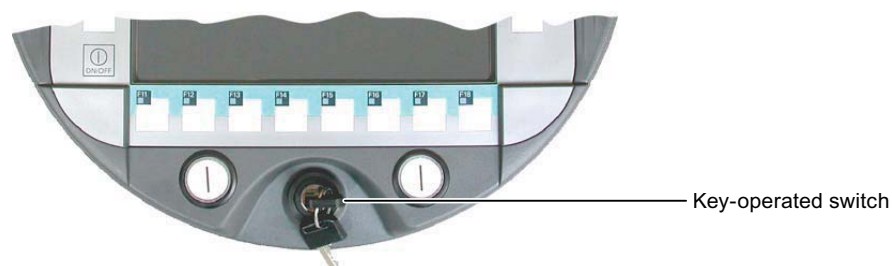

Operating the key-operated switch

The following figure shows the three switch positions of the key-operated switch, I-0-II.

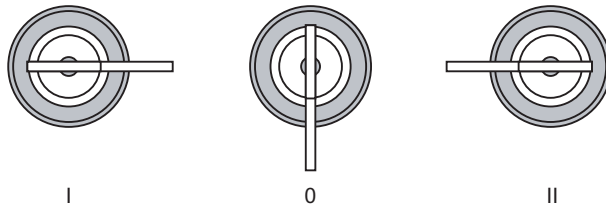

The key can be removed in the switch setting 0.

Remove the key after use. If the HMI device falls down, you can avoid damaging the key through this.

Note

The key to the key-operated switch is supplied together with the HMI device. The key does not have an HMI device-dependent coding. This means the key can be used on any Mobile Panel 277F IWLAN.

5.5.3 Operating the illuminated push-button

The function of the illuminated pushbutton is defined in the current project. Refer to the plant documentation for additional information on the function.

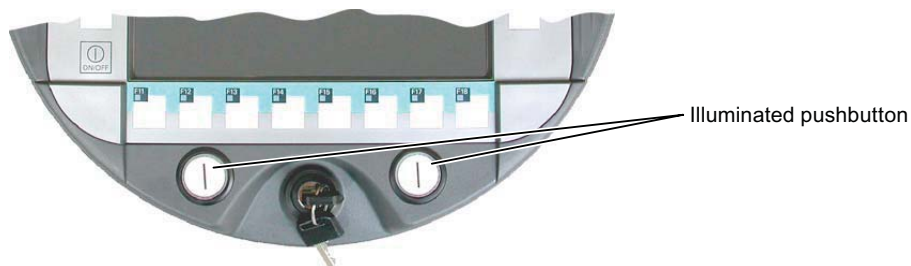

5.5.4 Evaluating operator controls

5.5.4.1 Overview

The following information can be transferred between the HMI device and the PLC:

- Direction pulses of the handwheel
- Switching state of the function keys
- Key operated switch state
- Switching state of the illuminated pushbutton
- Switching state of the function keys and illuminated pushbutton LEDs

There are two ways of transmitting information:

- Direct keys
- System functions of WinCC flexible

Note

The following sections are intended for the configuration engineer.

5.5.4.2 Evaluating operator controls as direct keys

You can configure the operator controls of the HMI device as direct keys. The switching state of the following operator controls are available directly in the IO area of the PLC:

- Direction pulses of the handwheel
- The switching state of the function keys
- The switching state of the key-operated switch
- The switching state of the illuminated pushbuttons

Byte assignment

The following figure shows the assignment of the keys (inputs) and LEDs (outputs) to the bytes in the PLC process image.

Button bits								Byte	LED bits							
7	6	5	4	3	2	1	0		7	6	5	4	3	2	1	0
F8	F7	F6	F5	F4	F3	F2	F1	n	F8	F7	F6	F5	F4	F3	F2	F1
F16	F15	F14	F13	F12	F11	F10	F9	n + 1	F16	F15	F14	F13	F12	F11	F10	F9
						F18	F17	n + 2						F18	F17	
			T2		T1	S1	S0	n + 3					T2	T1		
I7	I6	I5	I4	I3	I2	I1	I0	n + 4								
D7	D6	D5	D4	D3	D2	D1	D0	n + 5								
7	6	5	4	3	2	1	0	n + 6								
15	14	13	12	11	10	9	8	n + 7								
23	22	21	20	19	18	17	16	n + 8								
31	30	29	28	27	26	25	24	n + 9								

- F Bit for function key
- S Bit for key-operated switch
- T1 Bit for left illuminated pushbutton
- T2 Bit for right illuminated pushbutton
- I Bit for handwheel pulses, forwards
- D Bit for handwheel pulses, backwards

The bytes "n+6" to "n+9" contain the direct key bits for the touchscreen buttons.

Refer to your plant documentation for additional information.

Bit assignment

The following tables show the bit coding for function keys, key-operated switch, illuminated pushbutton and handwheel:

- Bit coding of function keys

Switch state	F1 to F18
Not pressed	0
Pressed	1

- Bit coding of function key LEDs

Switch state	F1 to F18
LED not illuminated	0
LED is illuminated	1

- Bit coding of key-operated switch

Switch state	S1	S0	Key position
Position 0	0	0	In middle position
Position I	0	1	Turned in clockwise direction up to stop
Position II	1	0	Turned counter-clockwise up to stop

- Bit coding of illuminated pushbuttons

Switch state	T1	T2
Not pressed	0	0
Pressed	1	1

- Bit coding of illuminated pushbutton LEDs

Switching state LED	T1	T2
Off	0	0
On permanently	1	1

- Bit coding of handwheel

- A setpoint is not specified for the handwheel.
- After start-up of the HMI device, the bytes "n+4" to "n+5" are set to zero.

Rotation of the handwheel produces positive or negative pulses depending on the rotation direction. The number of positive pulses are stored in bits I0 to I7. The number of negative pulses are stored in bits D0 to D7. The values are entered in binary format, where bit 0 is the lowest and bit 7 is the highest valued bit.

A complete handwheel revolution yields 50 pulses.

- Every pulse of the handwheel is added to byte "n+4" or "n+5" depending on the direction of rotation. There are no negative values. When the possible value range is exceeded, there is an overflow:

If a value of 255 is increased by one pulse, a value of 0 results.

Example of bit assignment for handwheel

The following table includes an example for rotation direction determination. The pulses are stored in bytes "n+4" and "n+5" and are measured during the points in time t_1 to t_4 .

The numbers in the following table represent a byte in the PLC.

Evaluation time	Handwheel		Evaluation
	Pulses, forwards	Pulses, backwards	
t_1	255 ($\Delta -1$)	245 ($\Delta -11$)	--
t_2	10	245 ($\Delta -11$)	Pulses, forwards: 11 Pulses, backwards: 0 Resulting value: +11
t_3	10	4	Pulses, forwards: 0 Pulses, backwards: 15 Resulting value: -15
t_4	15	5	Pulses, forwards: 5 Pulses, backwards: 1 Resulting value: +4

The difference in pulses at times t_n and t_{n+1} allows you to determine the resulting value and thus the direction of rotation.

Establish the following values:

- Number of pulses, forwards
 - At time t_n
 - At time t_{n+1}
- Number of pulses, backwards
 - At time t_n
 - At time t_{n+1}

From this, you determine the resulting value. This is calculated as:

$$\begin{aligned}
 & \text{Pulses, forwards, } t_{n+1} \\
 - & \text{Pulses, forwards, } t_n \\
 - & \text{Pulses, backwards, } t_{n+1} \\
 + & \text{Pulses, backwards, } t_n \\
 = & \text{Resulting value}
 \end{aligned}$$

Consider the response time

NOTICE
<p>Sample cycle time</p> <p>If the scan cycle is large, the entered impulses will not immediately have an effect on the PLC. A reaction in the system is not caused.</p> <p>In the PLC, set a scan cycle ≤ 100 ms.</p>

The bytes "n+4" and "n+5" must be retrieved on the PLC side within a second and cyclically. This ensures that no more than 256 pulses can be added between two scans of the handwheel. For 256 pulses, approximately 4.5 revolutions of the handwheel are required.

The rotary pulse encoder supplies a maximum of 200 pulses per second.

5.5.4.3 Controlling the LEDs of the function keys via system functions

Introduction

LEDs are integrated in the HMI device's function keys F1 to F18. The PLC can be directly communicated with the integrated LEDs.

An LED can transmit the following light signals:

- Off
- Flashing slowly
- Flashing quickly
- On

In the expiring project, the light signals can signalize to the operator that the function key should be pressed.

Bit assignment

The following table shows the possible light signals and the corresponding entries in bit n+1 and bit n of the LED tags.

Bit n+1	Bit n	Light signal
0	0	Off
0	1	Flashing quickly
1	0	Flashing slowly
1	1	ON (continuous)

5.5.4.4 Controlling the handwheel via system functions

Introduction

The handwheel is an optional operator control of the HMI device. You can enter incremental values in a running project with the handwheel.

Note

Do not configure limit values in WinCC flexible for tags assigned to the handwheel.

Evaluate incremental values

If the signals of the handwheel are assigned to a WinCC flexible tag, then the forward and backward increments will be set off against each other. The absolute value of the increments is given. The maximum or minimum value of increments entered until the overflow is reached depends on the type of tag assigned.

A complete handwheel revolution yields 50 pulses. The rotary pulse encoder supplies a maximum of 200 pulses per second.

Example

- The handwheel has a starting value of 120 increments.
 - You rotate the wheel 10 increments forwards and 3 increments backwards.
- This results in a new value of 127 increments.

5.5.4.5 Controlling key-operated switches via system functions

Introduction

The key-operated switch is an optional operator control of the HMI device. The key-operated switch serves to lock functions in a running project which can be triggered by means of the HMI device.

Bit assignment

The following table shows the bit assignment for the tag of the key-operated switch:

Bit 1	Bit 0	Switch setting
0	0	Central position
0	1	Turned in clockwise direction up to stop
1	0	Turned counter-clockwise up to stop

Note

If you use a tag of the "Boolean" type for the key-operated switch, the following assignment applies:

- Status "0": Central position of the key-operated switch
- Status "1": Key-operated switch turned clockwise or counter-clockwise to the stop

5.5.4.6 Controlling and evaluating illuminated mushroom pushbuttons via system functions

Introduction

The illuminated pushbuttons are optional operator controls of the HMI device. The PLC can be directly communicated with the integrated LED.

An LED can transmit the following light signals:

- Off
- Flashing slowly
- Flashing quickly
- On

In the expiring project, the light signals can signalize to the operator that the illuminated pushbutton should be pressed.

Bit assignment

The following table shows the bit assignment for the state variables:

Bit 0	Status of the illuminated pushbutton
0	Not pressed
1	Pressed

The following table shows the bit assignment for the LED variables:

Bit n+1	Bit n	Light signal
0	0	Off
0	1	Flashing quickly
1	0	Flashing slowly
1	1	ON (continuous)

5.6 Labeling the function keys

Introduction

You can label the function keys as required for your project. Use labeling strips to do so.

Note

Do not write on the keyboard to label the function keys.

Printing labeling strips

WinCC flexible comes with a range of labeling strip templates. You will find further information regarding the location of the templates in the WinCC flexible Online Help.

Any printable and writable foil can be used as labeling strips. Use transparent foil so that the LEDs of the function keys can be seen. The permitted thickness of the labeling strip is 0.13 mm. Paper should not be used as labeling strips.

Labeling strip dimensions

Labeling strip on right:

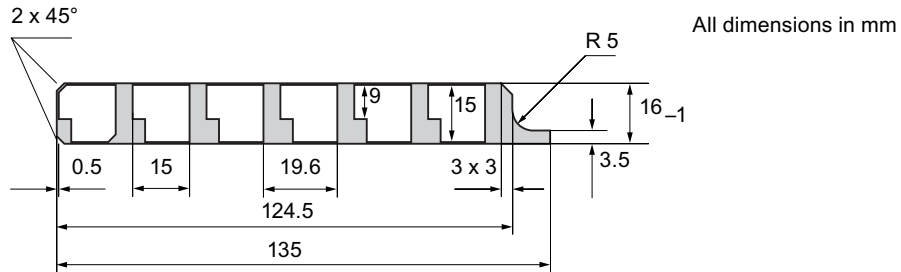

Labeling strip on left:

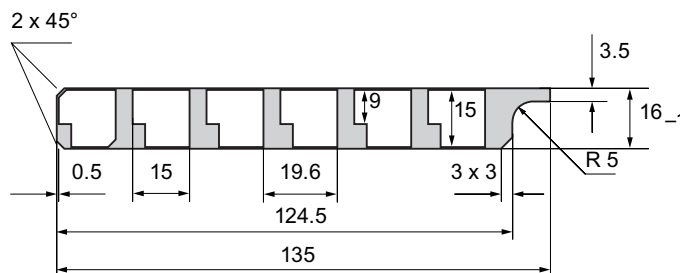

Labeling strip at bottom:

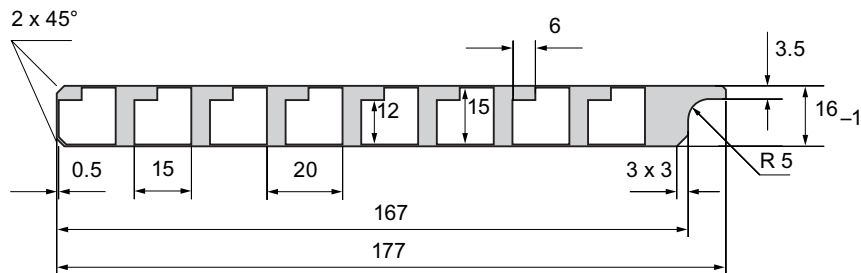

Procedure

The following steps apply for the initial attaching of labeling strips.

Proceed as follows:

1. Lay the HMI device on its reverse side.
2. Remove the label from the cover caps.

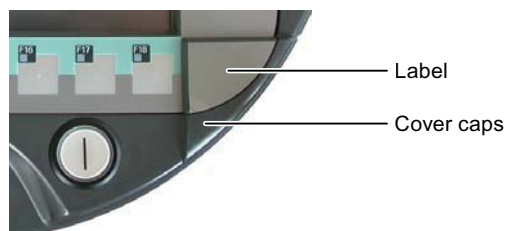

3. Unscrew both cover caps.
4. Pull the labeling strips out of the guides.

5. Inscribe the labeling strips in accordance with the system.
Wait for the printed labeling strips to dry before you insert them.
6. Push the labeling strips into the guides.
7. Screw both cover caps back on.
Screwed on cover caps with inserted rubber seals satisfy degree of protection IP65.
8. Place the label on to the cover caps.

Note

Should the exchange of labeling strips become necessary, these can be reordered from your Siemens representative.

5.7 Holding, operating and setting down the HMI device

Holding and operating the HMI device

The HMI device is equally easy to hold and operate for right-handers and left-handers because it is designed symmetrically. The free hand can be used to operate the operator controls on the front side.

Note

Read the section "Safety-related operator controls (Page 107)".

The method of holding the HMI device shown in the following figure enables you to control movements in the plant to be monitored during servicing, for example.



The hand holding the HMI device can also be used to activate the enabling button. The enabling button is optimally accessible. In a dangerous situation, a safety shutdown is triggered in a panic reaction by releasing or fully pressing the enabling button.

The EMERGENCY STOP button can also be quickly reached with your free hand.

NOTICE

Holding the HMI device

If you do not carry the HMI device as shown, you cannot operate the EMERGENCY STOP button or enabling button quickly enough in a dangerous situation.

Hold the HMI device as shown. This especially applies to all hazardous movements that you control manually. You can then engage the EMERGENCY STOP button or enabling button as fast as possible in a dangerous situation.

Setting down the HMI device

A charging station is available for safe accommodation of the HMI device.

NOTICE

Pressing the EMERGENCY STOP button

If the HMI device is placed in an unsuitable holder, the operability of the EMERGENCY STOP button will be impaired.

Only use the belonging charging station for storing the HMI device.

The HMI device can be used as a stationary device when it is placed in the charging station. The following figure shows how the HMI device is placed in the charging station.



5.8 Using the charging station

5.8.1 Charging the main battery in the charging compartment

The charging station has two charging compartments, each of which can charge one main battery. The main batteries are charged independently of each other.

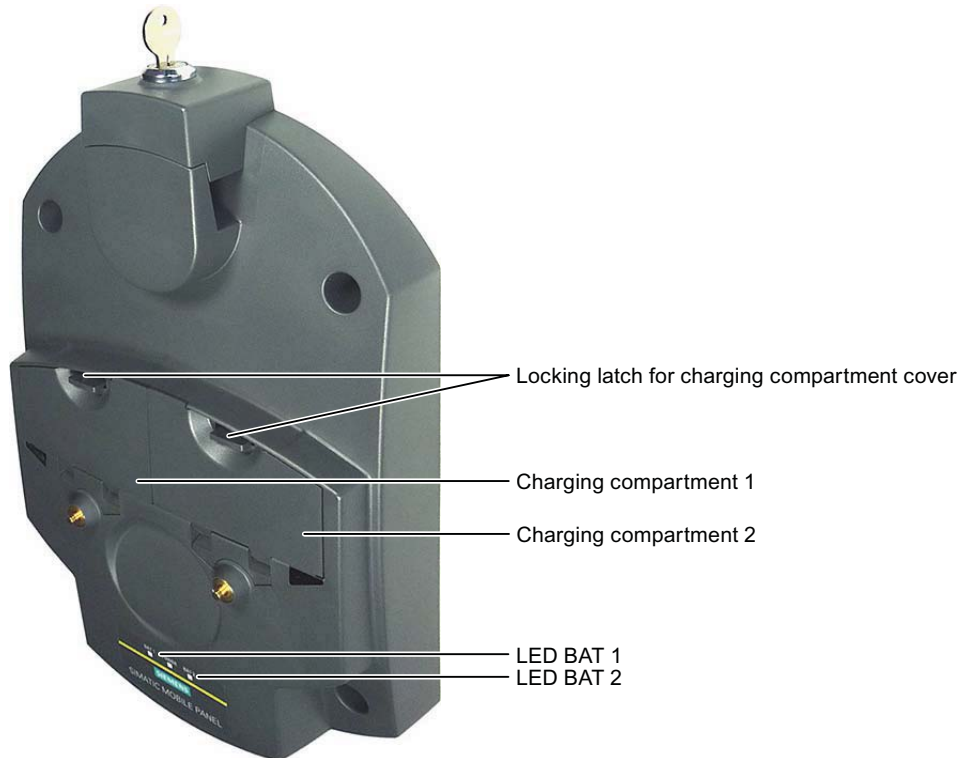

Procedure for inserting the battery into the charging compartment

Proceed as follows:

1. Pull up the locking latch on the charging compartment cover.
The cover can now be opened.
2. Place the main battery into the charging compartment.
3. Close the charging compartment.

The main battery is charged whenever the charging station is connected to the power supply unit.

Procedure for removing the battery from the charging compartment

Proceed as follows:

1. Pull up the locking latch on the charging compartment cover.
The cover can now be opened.
2. Remove the main battery using the ribbon.
3. Test the charge state of the LED display of the main battery.
4. Close the charging compartment.

5.8.2 LED-displays on the charging station

The LED display consists of three LEDs.



The LEDs have the following meaning:

LED	Color	Meaning
BAT 1	Green	The LED is off when there is no battery in charging compartment 1. The LED flashes when the battery in charging compartment 1 is being charged. The LED lights up when the main battery in charging compartment 1 is 95% charged.
POWER	Green/red	The LED is off when there is no voltage supply to the charging station. The LED blinks if an HMI device is correctly inserted in the charging station and has a charging contact. The LED lights up green when the power supply to the charging station is within the nominal range. The LED is red when there is an overvoltage or undervoltage at the charging station.
BAT 2	Green	The LED is off when there is no battery in charging compartment 2. The LED flashes when the battery in charging compartment 2 is being charged. The LED lights up when the main battery in charging compartment 2 is 95% charged.

NOTICE

LEDs switched off with overvoltage

If there is an overvoltage on the charging station, then all LEDs will expire.

If all LEDs are off, then check the power supply of the charging station for overvoltage.

5.8.3 Locking the charging station

Introduction

The lock prevents unauthorized removal of the HMI device from the charging station.



Procedure for locking the charging station

Proceed as follows:

1. Slide the lock down to the appropriate cut-out in the charging station.
2. Turn the key by 90 degrees.
3. Remove the key.

The charging station is locked. You cannot remove the HMI device. The main battery in the HMI device is charged whenever the charging station is connected to the power supply unit.

Procedure for unlocking the charging station

Proceed as follows:

1. Insert the key into the lock barrel.
2. Turn the key by 90 degrees.
3. Slide the lock upwards.

You can remove the HMI device.

6

Configuring the HMI device

6.1 Desktop and Loader

Once the HMI device is switched on and booted, the display shows the desktop with the Loader.

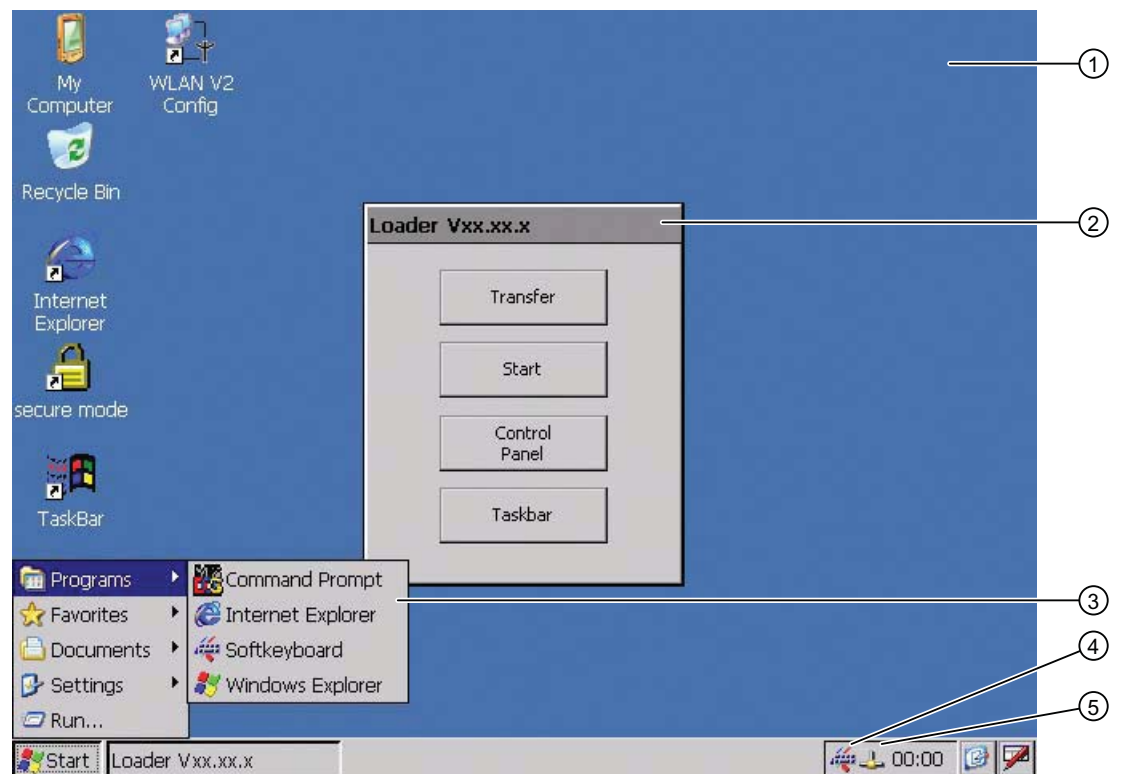

- ① Desktop
- ② Loader
- ③ Start menu
- ④ Icon for screen keyboard
- ⑤ Icon for displaying IP information about the WLAN/LAN connection

Loader

The following figure shows the Loader.

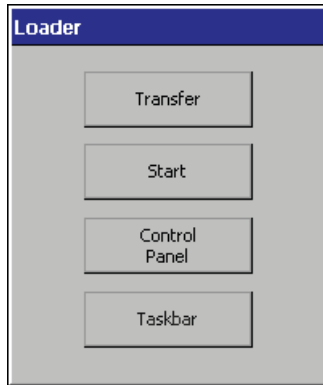

The buttons on the Loader have the following function:

- "Transfer" button – This switches the HMI device to "Transfer" mode.
The transfer mode can only be activated when at least one data channel has been enabled for the transfer.
- "Start" button – This starts the project on the HMI device.
When you do not perform any operation, the project starts automatically based on the settings in the Control Panel after a delay time.
- "Control Panel" button – This opens the Control Panel.
You can make a variety of settings in the Control Panel, for example, the settings for the transfer.
- "Taskbar" button – This opens the taskbar and the Windows CE Start menu.

The Loader will reappear when the project is closed on the HMI device.

Password protection

You can protect the Control Panel and taskbar from unauthorized access.

If password protection is configured, the "secure mode" message is displayed on the desktop. If the password is not entered, only the "Transfer" and "Start" buttons are operable. You can find additional information on Secure Mode in the section "Enabling and disabling SecureMode (Page 130)."

NOTICE

Keeping the password

If the password is no longer available, you are forced to update the operating system to regain access to the Control Panel and the Windows CE taskbar.

Backup password to protect it against loss. You can find additional information on updating the operating system in the section "Updating the operating system (Page 224)."

Internet Explorer

Internet Explore for Windows CE is installed on the HMI device.



Note

Internet Explorer for Windows CE and the Internet Explorer on a PC differ in terms of functionality.

Internet Explorer for Windows CE has separate proxy settings that are independent of the settings in the Control Panel of the HMI device.

For more detailed information, refer to the Microsoft website.

Status bar



When you click the icon in the status bar, the following dialog appears:

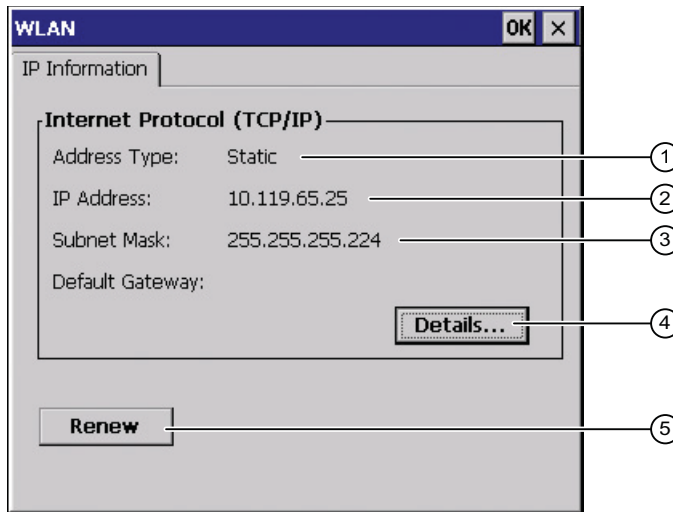

- ① Address type
- ② IP address
- ③ Subnet mask
- ④ Button for details
- ⑤ Button to refresh the display

The dialog contains information on the current WLAN or LAN connection

6.2 Operating desktop and loader

The following operator control options are made available for the Windows CE interface and Control Panel:

- Touch screen

The operator controls shown in the dialogs are touch-sensitive. Touch objects are operated in the same way as mechanical keys. You activate an operator control by pressing on it with your finger. To double-click them, touch an operator control twice in succession.

- USB keyboard

You can operate the Windows CE interface and Control Panel with an external keyboard in exactly the same manner as with the screen keyboard of the HMI device.

- USB mouse

You can operate the Windows CE interface and Control Panel with an external mouse in exactly the same manner as with the touch screen of the HMI device.

6.3 Enabling and disabling SecureMode

SecureMode prevents unauthorized access to the desktop and the taskbar of the HMI device. In SecureMode, all functions on the desktop and the taskbar of the HMI device are locked.

Enabling SecureMode

You have the following options for enabling SecureMode:

- Assign a password in the Control Panel for the HMI device.
- If no password has been assigned for the HMI device, double-click the following icon on the desktop.



SecureMode is enabled. The text "secure mode" appears on the desktop.

Disabling SecureMode

You can disable SecureMode as follows:

- If a password is assigned for the HMI device, then delete it.
- If no password has been assigned for the HMI device, operate the "Taskbar" button once in the Loader.

6.4 Control Panel

6.4.1 Overview

You have the following options for opening the Control Panel:

- During the startup phase
Open the Control Panel in the Loader by pressing the "Control Panel" button.
- In the Windows CE start menu
 - Press the following key on the alphanumeric screen keyboard twice:







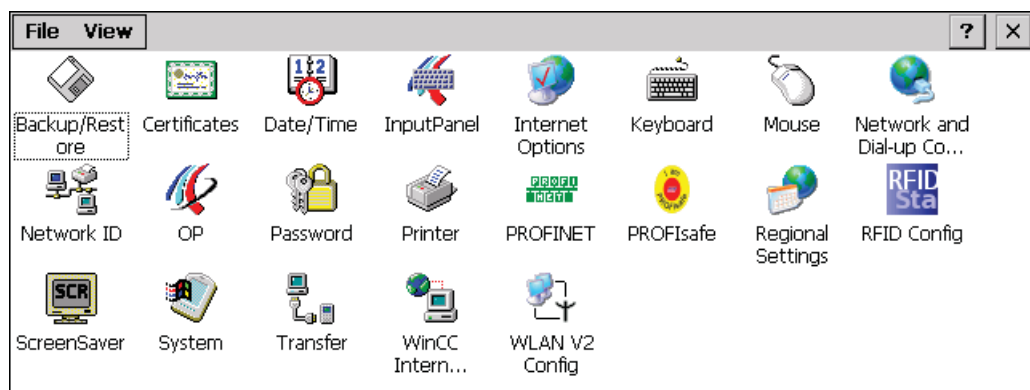













- Open the Control Panel with "Settings > Control Panel".



The following figure shows the open Control Panel.



6.4.2 Functions in the Control Panel

The following table shows references to the functional descriptions.

Icon	Functional description
	Saving to external storage medium – backup (Page 185)
	Restoring from external storage medium – Restore (Page 186)
	Importing, displaying and deleting certificates (Page 183)
	Setting the date and time (Page 155)
	Using the screen keyboard in the Control Panel (Page 133)
	Changing general settings (Page 180)
	Setting the proxy server (Page 181)
	Changing privacy settings (Page 182)
	Setting the character repeat rate of the screen keyboard (Page 137)
	Setting the double-click (Page 139)
	Specifying the IP address and name server (Page 175)
	Specifying the logon data (Page 176)
	Backing up registry information and temporary data (Page 156)
	Changing display brightness (Page 137)
	Starting the HMI device again (Page 142)
	Displaying information about the HMI device (Page 158)
	Calibrating the touch screen (Page 140)
	Activating vibration alarm (Page 159)
	Activate memory management (Page 189)
	Displaying the charge status of the batteries (Page 158)
	Entering and deleting a password (Page 143)
	Configuring the printer connection (Page 160)
	Enabling PROFINET IO (Page 168)
	Setting the PROFIsafe address (Page 169)
	Regional and language settings (Page 162)
	Commissioning an RFID tag (Page 237)
	Setting the screen saver (Page 162)
	Displaying general system properties (Page 164)
	Specifying the computer name of the HMI device (Page 174)
	Displaying memory distribution (Page 165)
	Programming the data channel (Page 171)
	Setting the location of the project (Page 166)
	Setting the delay time for the project (Page 167)

Icon	Functional description
	Configuring e-mail (Page 177)
	Configuring the WLAN connection (Page 145)

6.4.3 Operating the Control Panel

You operate the Control Panel with the touch screen of the HMI device or a USB mouse.

Requirement

- The current project is closed.
- The loader appears.

Procedure

Proceed as follows:

1. Open the Control Panel.
2. Execute the function by double-clicking on the icon.
The corresponding dialog is displayed.
3. Open a tab.
The content of the dialog changes.
4. Press the required operator control.
5. Use the **OK** button to confirm your entries. The entry is applied.
To cancel the entry, press the **X** button. The dialog closes.
6. Press **X**.
The Control Panel closes. The loader appears.

6.4.4 Using the screen keyboard in the Control Panel

If you do not use an external keyboard, use the screen keyboard to enter numeric and alphanumeric characters. As soon as you touch a text box, a numeric or alphanumeric screen keyboard is displayed, depending on the type of the text box.

Display methods for the screen keyboard

You can change the type of display for the screen keyboard and move the position on the screen.

- Numerical screen keyboard



- Alphanumerical screen keyboard



The alphanumerical screen keyboard has the following levels.

- Normal level
- Shift level
The shift level includes uppercase letters.
- Special character level

Note



The ' character (button between ";" and "\") appears only when followed by a space. If the ' character is followed by a letter, then the result will be an accent, such as "á".

- Reduced screen keyboard



Procedure for moving the screen keyboard

Proceed as follows:



1. Touch the icon .
2. Without lifting your finger, move the screen keyboard on the touch screen.
3. When the desired position is reached, release the icon .

Procedure for adjusting the size of the screen keyboard







Note

The  icon only appears on the screen keyboard if in the "Siemens HMI InputPanel" dialog you have selected the "Show Resize button" check box.





Proceed as follows:

1. Touch the icon .
2. To adjust the size of the screen keyboard, maintain contact.
3. When the size you want is reached, release contact with the  icon.

Changing the display of the screen keyboard

Key	Function
	Switching between the numerical and alphanumerical keyboard
	Switching between the normal level and Shift level of the alphanumerical screen keyboard
	Switchover to special characters
	Switching from full display to reduced display
	Switching from reduced display to full display
	Closing of reduced display of the screen keyboard

Entering data

Key	Function
	Delete character left of cursor
	Delete character right of cursor
	Confirm input
	Cancel input

Opening the Windows CE taskbar

You open the Windows CE taskbar with the  key.

6.4.5 Configuring operation

6.4.5.1 Configuring the screen keyboard

You can use this function to change the layout and the position of the screen keyboard.

Requirement



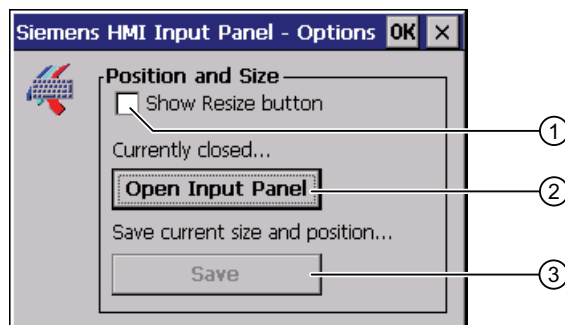

You have opened the "Siemens HMI Input Panel - Options" dialog with the "InputPanel" icon.



- ① Check box for displaying the  button in the screen keyboard
- ② Button for displaying the screen keyboard
- ③ Button for saving the screen keyboard settings

Procedure

Proceed as follows:

1. If you want to change the size of the screen keyboard, select the "Show Resize Button" check box.
The  button is displayed in the screen keyboard you want to open.
2. If you want to prevent the size of the screen keyboard from being changed, clear the "Show Resize Button" check box.
The  button is removed from the screen keyboard you want to open.
3. You can use the "Open Input Panel" button to open the screen keyboard.
4. If you want to switch between the numeric and alphanumeric screen keyboard, press the  key.
5. If you want to change the position of the screen keyboard, use the mouse pointer to select a free space between the keys.

Release the mouse pointer when the required position has been reached.

6. If you want to increase or decrease the size of the keyboard screen, place the mouse pointer over the  button.
7. Change the size of the screen keyboard by dragging it with the mouse pointer.
8. Release the mouse pointer when the required size has been reached.
9. If you want to save the settings, press "Save".
10. Confirm your entries.

The dialog closes. The screen keyboard settings have been modified.

6.4.5.2 Changing display brightness

You can use this function to change the brightness of the display.

Requirement



You have opened the "Display" tab in the "OP Properties" dialog using the "OP" icon.

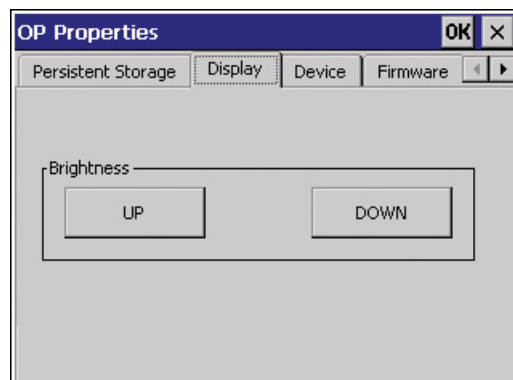

Procedure

Proceed as follows:

1. If you want to increase the brightness, press the "UP" button.
The brightness changes in steps each time you press the key.
2. If you want to decrease the brightness, press the "DOWN" button.
3. Confirm your entries.

The dialog closes.

Result

The brightness of the display has been changed.

6.4.5.3 Setting the character repeat rate of the screen keyboard

You can use this function to set the character repeat and associated delay for the screen keyboard.

Requirement



You have opened the "Keyboard Properties" dialog using the "Keyboard" icon.

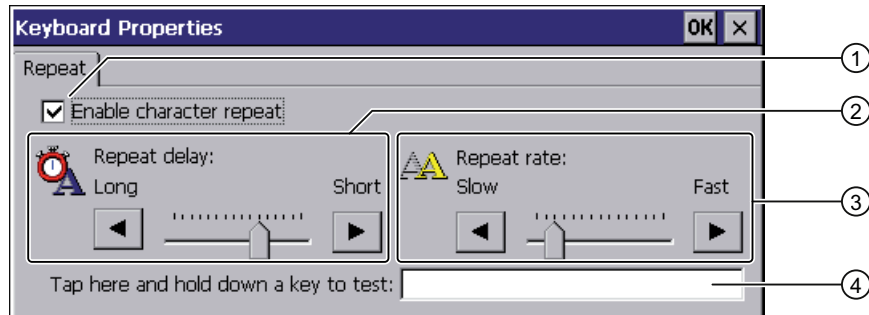

- ① Check box for selecting the character repeat
- ② Slider control and buttons for the delay time before character repeat
- ③ Slider control and buttons for the rate of the character repeat
- ④ Test box

Procedure

Proceed as follows:

1. If you want to enable character repetition, select the "Enable character repeat" check box.
2. If you want to change the delay, press a button or the slider in the "Repeat delay" group.
Moving the slider to the right will shorten the delay. Moving to the left will extend the delay.
3. If you want to change the repeat rate, press a button or the slider in the "Repeat rate" group.
Moving the slider to the right will accelerate the repeat rate. Moving to the left will slow down the repeat rate.
4. Check the settings for the touch control by touching the test field.
The screen keyboard is displayed.
5. Move the screen keyboard as needed.
6. Press an alphanumeric key and keep it pressed down.
Check the implementation of the character repetition and the rate of the character repetition in the test box.
7. If the settings are not perfect, correct them.
8. Confirm your entries.
The dialog closes. The character repetition and delay are set.

6.4.5.4 Setting the double-click

You start applications in the Control Panel and in Windows CE with a double-click. A double-click corresponds to two brief touches.

In the "Mouse Properties" dialog, make the following adjustments for operation with the touch screen or external mouse:

- Interval between two touch contacts on the touch screen
- Interval between the two clicks of a double-click

Requirement



You have opened the "Mouse Properties" dialog using the "Mouse" icon.

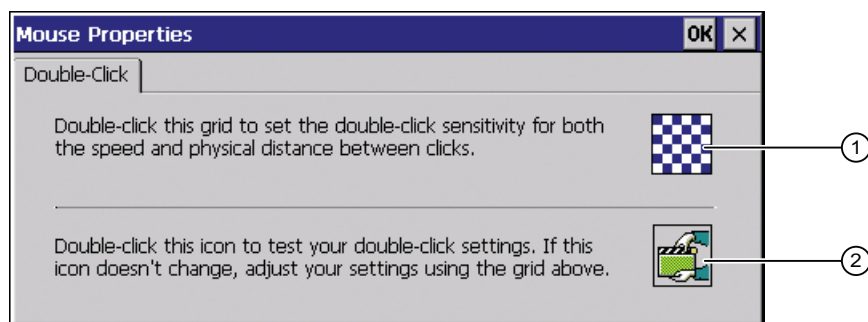

- ① Pattern
- ② Icon

Procedure

Proceed as follows:

1. Double-click the pattern.

After the double-click the grid is shown in inverse colors. White boxes become gray. The timeframe for the double-click is saved.



2. Check the double-click.

Press on the icon twice in succession to do this. If the double-click is recognized, the icon is displayed as follows:



3. If the settings are not perfect, correct them.

To do this, repeat steps 1 and 2.

4. Confirm your entries.

The dialog closes. The double-click adjustment is completed.

6.4.5.5 Calibrating the touch screen

Depending on the mounting position and viewing angle, parallax may occur on the touch screen. To prevent any resulting operating errors, you may need to calibrate the touch screen during the startup phase or during runtime.

Requirement



You have opened the "Touch" tab of the "OP Properties" dialog using the "OP" icon.



Procedure

Proceed as follows:

1. Press "Recalibrate".

The following dialog appears:

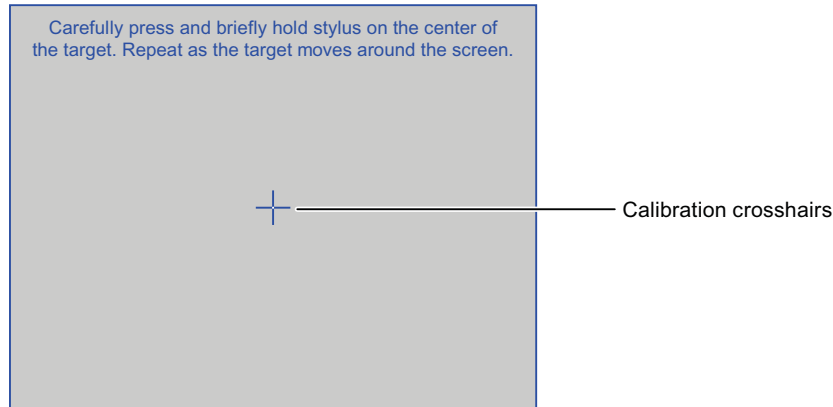

2. Briefly touch the center of the calibration crosshairs.

The calibration crosshairs are then displayed at four more positions. Briefly touch the middle of the calibration crosshairs for each position.

Once you have touched all the positions of the calibration crosshairs, the following dialog appears:

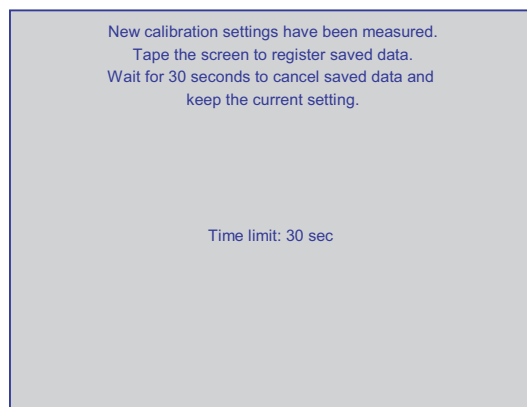

3. Touch the touch screen.

The calibration is saved. The "Touch" tab is displayed once again in the "OP Properties" dialog. If you do not touch the touch screen within the time shown, your original setting will be retained.

4. Close the dialog.

The touch screen of the HMI device is calibrated.

6.4.5.6 Starting the HMI device again

You need to start the HMI device again in the following situations:

- You have enabled or disabled the PROFINET IO direct keys – see section "".
- You have changed the time zone and activated daylight saving time – see section "Setting the date and time (Page 155)".
- You have enabled the screen saver again – see section "".

Note

All volatile data are lost when the HMI device is started again. Check the following:

- The project on the HMI device is complete
- No data is being written to the flash memory

Requirement



- You have opened the "Device" tab in the "OP Properties" dialog using the "OP" icon.

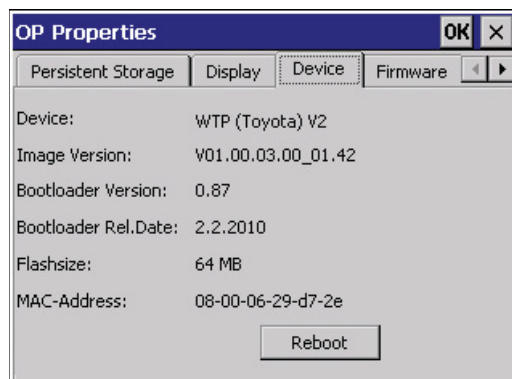

- If you want to restore the factory setting:
The HMI device is connected to a configuration PC via PROFINET.

Procedure

Proceed as follows:

1. If you want to restart the HMI device, press "Reboot".

The following message is displayed:

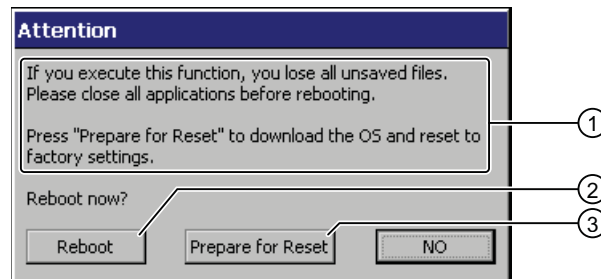

- ① If you run this function, all data which has not been backed up will be lost. Please close all applications before restarting.
- ② Button for restart
- ③ Button for restoring factory settings and subsequent restart

2. Press one of the buttons.

- If you want to restart the HMI device, press "Reboot".

The HMI device restarts without delay.

- If you want to restore the factory settings on the HMI device and then restart, press "Prepare for Reset".

You are given the option of restoring the factory settings on the HMI device using ProSave. The HMI device then restarts.

- If you do not want to restart the HMI device, press "No".

The message closes. There will be no restart.

6.5 Entering and deleting a password

You can use this function to set and remove password protection. The password protection is based on the access to the Control Panel and Windows CE taskbar.

Requirement



You have opened the "Password Properties" dialog using the "Password" icon.

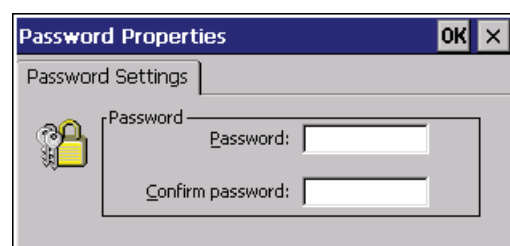

NOTICE

Keeping the password

If the password is no longer available, you have no access to the Control Panel and the Windows CE taskbar.

Backup password to protect it against loss.

Procedure for configuring a password

Note

The following characters are prohibited in passwords:

- Blank
 - The two special characters ' "
-

Proceed as follows:

1. Enter a password in the "Password" text box.
2. Repeat the password entry in the "Confirm password" text box.
3. Confirm your entries.

The dialog closes.

Result

You cannot open the Control Panel or Windows CE taskbar without entering a password.
SecureMode is enabled.

Procedure for removing a password

Proceed as follows:

1. Delete the information in the "Password" and "Confirm password" text boxes.
2. Confirm your deletions.

The dialog closes.

Result

Password protection for the Control Panel and Windows CE taskbar has been removed.
There is no open access to the Control Panel and Windows CE taskbar.

SecureMode is disabled.

6.6 Configuring the WLAN connection

Similar to an access point, you configure the WLAN parameters of the HMI device in Web Based Management. You have the following options for configuration:

- Setting the parameters for WLAN communication using wizards.
- Advanced settings for all parameters in the "System", "Interfaces", "Security" and "I-Features" menus.

This section describes:

- Setting the WLAN parameters using wizards
- Setting the iPCF-MC parameters for rapid roaming in the "I-Features" menu of Web Based Management.

You can find a full description of all advanced settings with all WLAN parameters in "SCALANCE W-700" configuration manual

(<http://support.automation.siemens.com/WW/view/en/32816761>).







Note

Set the parameters for all access points that communicate with the HMI device before you begin configuration of the WLAN connection of the HMI device.



Buttons in Web Based Management

The following buttons are provided in Web Based Management of the HMI device to facilitate data input:

- Browser buttons

Button	Function in Web Based Management
	One page back
	One page forward
	Stop loading page
	Refresh page
	Go to home page
	Open screen keyboard for data input
	Close Web Based Management

- Buttons to display and hide the menu tree

Icon	Function
	Hiding the menu tree
	Displaying the menu tree

When you start one of the wizards in the menu tree, the menu tree will automatically be minimized.

Requirement



You have opened the "Authorization" dialog using the "WLAN Settings" icon.

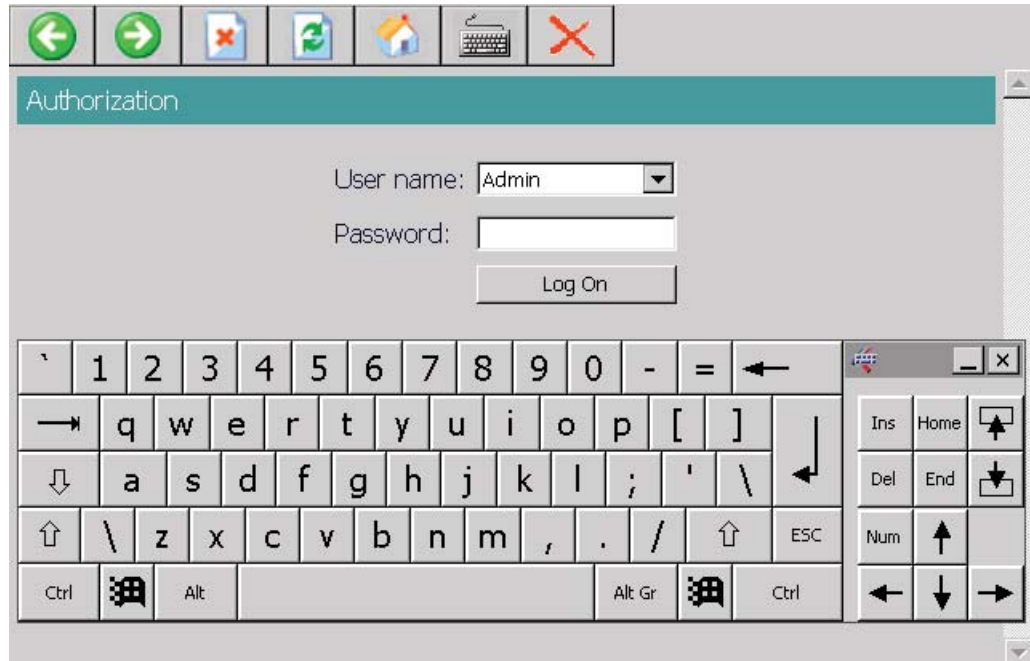

Procedure

Proceed as follows:

1. If you want to change settings of the WLAN device, select the "Admin" entry in the "User name" selection box.

If you select the "User" entry, you only have read access to the configuration data of the WLAN device.

Enter your password. If no password is set, the default passwords of the factory state will be in effect:

- If you have selected "Admin", enter "admin".
- If you have selected "User", enter "user".

2. Press "Log On".

Logon starts.

Note

The password for the "admin" user is different for the U.S. version of the WLAN device. You can obtain the required password from the Siemens support personnel.

Configuring the HMI device

6.6 Configuring the WLAN connection

- After initial logon as "Admin", change the password for the administrator under "System > Passwords".



The password may consist of up to 31 characters.

The ASCII code 0x20 to 0x7e is used for creating passwords.

The following characters are supported:

- Numbers 0 to 9
- Letters abcdefghijklmnopqrstuvwxyz ABCDEFGHIJKLMNOPQRSTUVWXYZ
- The special characters !\$"#%&'()*+,-./:;<=>?@[\\]^_`{|}~ and the space character

- Apply the settings with the "Set Value" button.

5. Select "Wizards > Basic".



Make the following settings in the "Basic" Wizard. Go to the next text window using the "Next" button.

- Selection list "Country Code"

Select the country in which you are operating the HMI device. The corresponding channel allocation and setting for power level is automatic.

NOTICE

Country code

The country setting is required for operation complying with the approvals. Selecting a country that does not match the country in which the HMI device is being used can have criminal consequences. The national approvals for the HMI device are listed on the back of the device and in the product information for "Wireless Teach Pendant F IWLAN" in the Internet.

Under "Country code", select the country in which you are operating the HMI device.

- "Connect to any SSID" check box

If this box is checked, the HMI device connects to the access point which provides the best possible data transfer and to which a connection is permitted based on the security settings specified under "Security".

- "SSID" text box

Enter the name of the network in this text box. The network name must match the network name that is entered in the configuration of access points, with which the HMI device communicates.

Note

The HMI device allows the use of all characters except the percent sign for the SSID. For reasons of compatibility, do not use language-specific characters such as German umlauts or special characters. The character string for the SSID may not contain more than 32 characters.

Configuring the HMI device

6.6 Configuring the WLAN connection

- Selection list "Wireless mode"

Use the transfer procedure, which is set in the configuration of access points, with which the HMI device communicates.

- "Outdoor Client mode" check box

You can use the HMI device to operate in either indoor or outdoor mode. In indoor mode, all nationally approved channels and power levels for operation in a building are available. In outdoor mode, the selection of country-specific channels and power levels for operation outdoors is restricted.

Select the "Outdoor Client mode" check box if you want to operate the HMI device outdoors.

6. Press "Finish".

The settings in the "Basic" Wizard are saved.

7. Select "Wizards > Security".

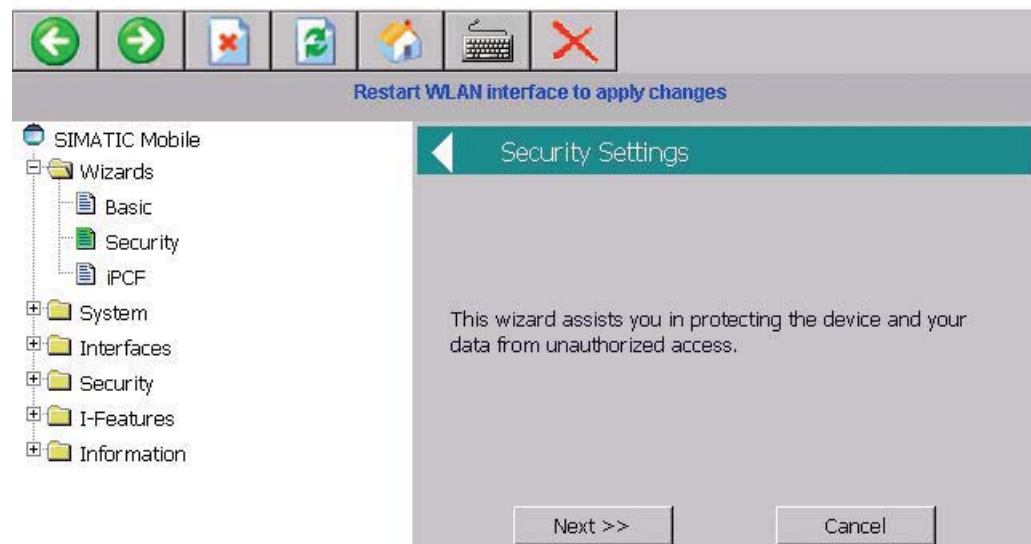

The Security Wizard enables you to set security-related parameters without detailed knowledge of security technologies in wireless networks.

Note

The HMI device can be operated without configuration of security-related parameters. Depending on the properties of your network, this will increase the risk of unauthorized access. Therefore, go through every page of the Security Wizard to enable the basic security features.

In the "Security" Wizard, apply the following settings from the configuration of access points, with which the HMI device communicates.

- Select the security level for the WLAN from the "Security level" selection list.
For information about the individual security levels, refer to .
- Select the encryption method from the "Cipher" selection list.
The encryption protects the data to be transferred from interception and manipulation. You can disable encryption in the "Encryption" option box only if you have selected "Open System" for authentication in the "Basic WLAN" menu. All other security procedures include both authentication and encryption.
- If you have selected a security level that requires a key, specify the initialization key in the "Pass phrase" text box.

Go to the next input window using the "Next" button.

8. Press "Finish".

The settings in the "Security" Wizard are saved.

9. If you want to operate the HMI device in the "iPCF mode (industrial Point Coordination Function)", select "Wizards > iPCF".

Go directly to Step 10 if you intend to operate the HMI device in "iPCF-MC" mode.

iPCF and iPCF-MC are mutually incompatible and cannot be used simultaneously for an HMI device.

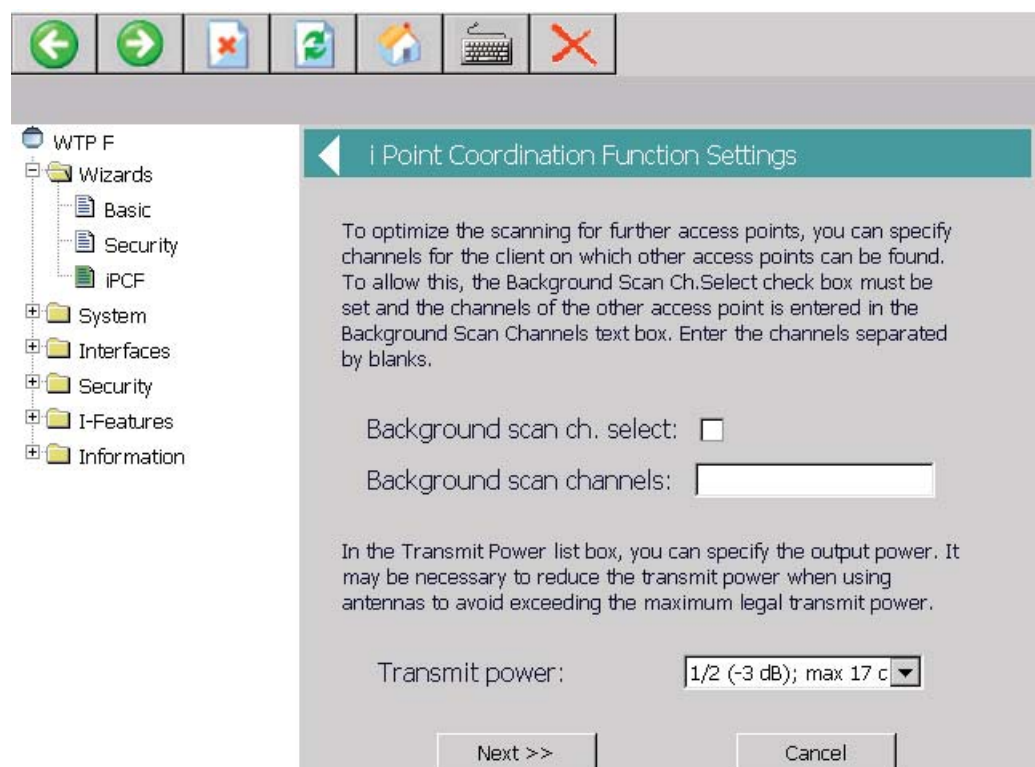

Set the parameters required for iPCF in the "iPCF" Wizard. Use the respective parameters to improve roaming times and reduce the interference from other systems or segments.

- "Background scan ch. select" check box

The "Background scan ch. select" check box limits the number of channels the HMI device scans to find an access point. The result is faster handover times and reduced risk of a real-time violation.

If you have enabled the "Background scan ch. select" option, you have to specify the channels with access points within range that are in iPCF mode in the following "Background scan channels" text box. If you do not define the channels, the HMI device will have to perform a time-consuming scan of the entire band.

- "Background scan channels" text box

Here you specify the channels in which there are actually access points in iPCF mode within the range of the HMI device. If you specify several channels, the individual entries have to be separated by spaces.

- Selection list "Transmit power"

When using antennas, it may be necessary to reduce the transmission power so as not to exceed the maximum statutory power or to restrict the visibility of the radio field. If necessary, select the level of reduced transmission power here.

A reduction in the transmission power may also be necessary to avoid interference of other radio cells, because a lower power level will result in a smaller cell.

- Selection list "Security level"

Use this field to select the required level of security for your wireless network. The security level must match the setting of an access point in iPCF mode, with which the HMI device communicates.

You have the following options:

- None (No Encryption) An open system without encryption.
- Medium (Encryption) Static keys are used. This is the recommended setting, whereby you should use a 128-bit key.

Go to the next text window using the "Next" button.

10. Press "Finish".

The iPCF Wizard closes. You need to restart the WLAN connection to apply the settings, see step 12.

11. If you want to operate the HMI device in the "iPCF-MC mode (industrial Point Coordination Function with Management Channel)" for rapid roaming, select "I-Features > iPCF-MC".

iPCF was developed to achieve fast handover times when moving between radio cells. However, iPCF achieves optimum performance only with RCoax cables. The iPCF-MC procedure provides fast handover times, even for freely mobile clients and numerous cells or when a large number of channels is used.

iPCF and iPCF-MC are incompatible and cannot be used simultaneously for an HMI device.

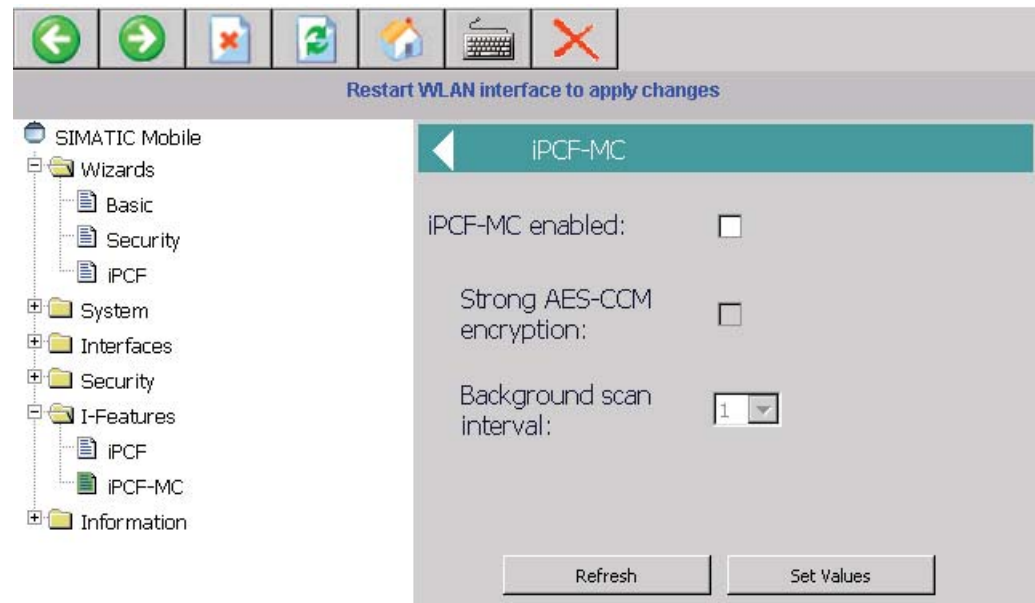

Make the following settings in the "iPCF-MC" menu.

- Select the "iPCF-MC enabled" check box.
- Select the "Strong AES-CCM" check box if you want to use "Strong AES-CCM" encryption.

The AES-CCM encryption method is only possible in iPCF mode. Make sure that a 128-bit WEP key is defined with the "Security > Keys" menu command. After you have selected the "Strong AES-CCM encryption" check box, the display changes to "128 bit AES" in the "Security > Keys" menu command. The device uses AES-CCM.

- Enter a value for "Background scan interval".

This parameter determines the time between two background scans of the HMI device. The setting is made in iPCF cycles.

For example, if you select two, the client performs a background scan only every second iPCF cycle. A small value for the background scan interval is the basis for fast roaming. However, high throughput cannot be achieved with this setting. A high value should be selected for higher data throughput.

Apply the settings with the "Set Values" button.

12. Select "System > Restart".

You can use the "Restart WLAN interface to apply changes" link for quick navigation to this menu command.

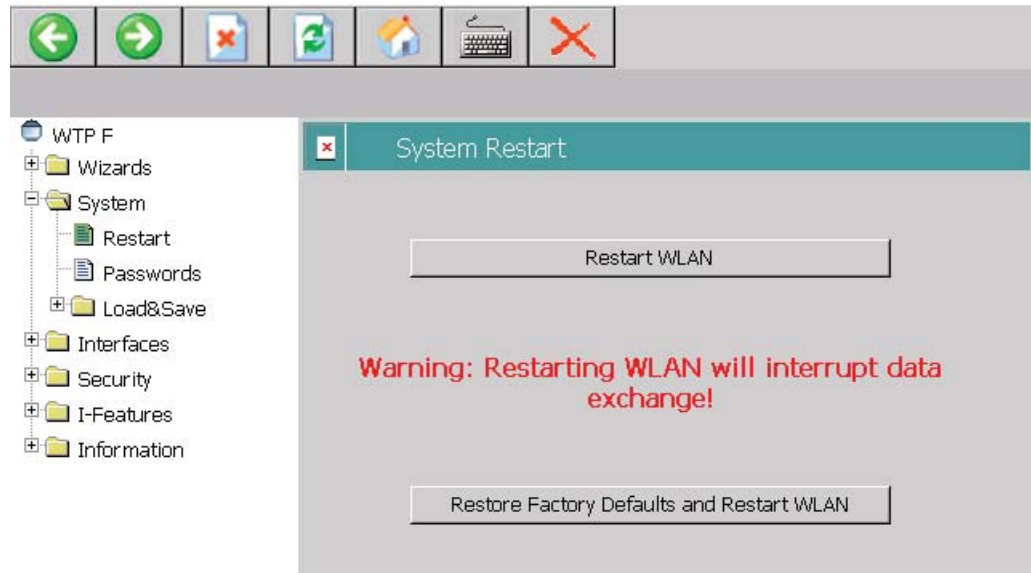

13. Press "Restart WLAN".

The restart of the WLAN interface is performed.

Note

The "Restore Factory Defaults and Restart WLAN" button resets all parameters of the WLAN interface to their factory state. The WLAN interface is then restarted.

14. Close Web Based Management with the "Exit" button.



Result

The WLAN connection was configured. When the configuration of the access points and wireless HMI device match, the wireless connection is successfully established.

The MAC address of the HMI device is registered in the access point under the menu command "Inform > Wireless > Client List".

6.7 General configuration

6.7.1 Setting the date and time

Introduction

You can use this function to set the date and time. The HMI device has an internal buffered clock.

Requirement



You have opened the "Date/Time Properties" dialog using the "Date/Time Properties" icon.

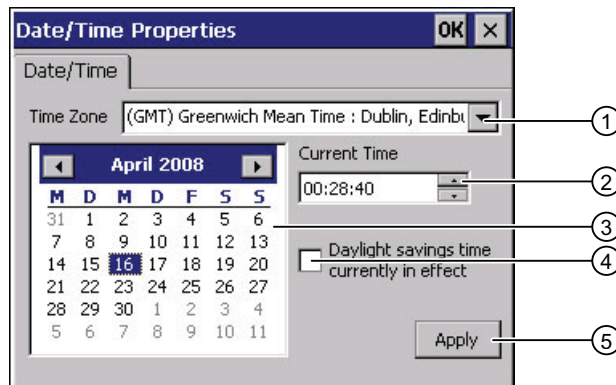

- ① Time zone selection box
- ② Text box for the time
- ③ Date selection box
- ④ When the check box is selected, the displayed time is daylight saving time.
- ⑤ Button for applying changes

Procedure

Proceed as follows:

1. Select the appropriate time zone for the HMI device from the "Time Zone" selection box.
2. Touch the "Apply" button to confirm your entry.

The time of day shown in the "Current Time" box is adjusted correspondingly to the selected time zone.

3. Set the date in the selection box.
4. Set the current time of day in the "Current Time" text box.

5. Touch the "Apply" button to confirm your input.

The values you have set are now in effect.

Note

The system does not automatically switch between winter and summer time.

6. If you want to switch from winter to summer time, select the "Daylight savings time currently in effect" check box.

When you press the "Apply" button, the time is brought forward by one hour.

7. If you want to switch from summer to winter time, clear the "Daylight savings time currently in effect" check box.

When you press the "Apply" button, the time is moved backwards by one hour.

8. Confirm your entries.

The dialog closes.

Result

The settings for the date and time of day have now been changed.

The HMI device must be restarted after changes in the following cases:

- You have changed the time zone setting
- You have changed the "Daylight savings time currently in effect" check box setting

See section "Starting the HMI device again (Page 142)".

Synchronizing the date and time with the PLC

The date and time of the HMI device can be synchronized with the PLC if this has been configured in the project and the PLC program.

Additional information on this subject is available in the "WinCC flexible" system manual.

NOTICE

Synchronizing the date and time

If the date and time is not synchronized and time-based reactions are triggered by the HMI device, malfunctions in the PLC may occur.

Synchronize the date and time if time-based reactions are triggered in the open-loop control.

6.7.2 Backing up registry information and temporary data

You can install and remove your own programs on the HMI devices under Windows CE. You need to back up the registry settings to flash memory after installation or removal.

You can also save the data in the memory buffer to flash memory.

Requirement



You have opened the "Persistent Storage" tab in the "OP Properties" dialog using the "OP" icon.

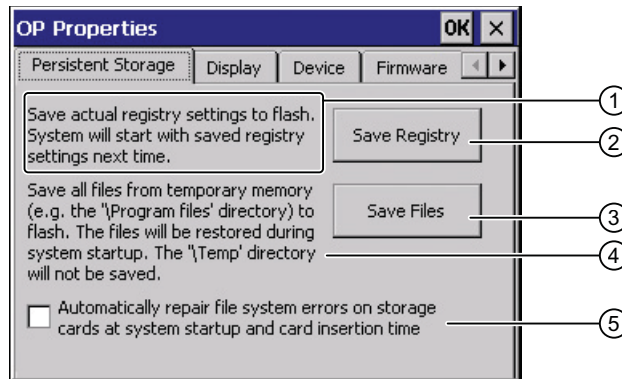

- ① Backs up the current registry information to the flash memory. The HMI device loads the saved registry information the next time it boots.
- ② Button for saving registry information
- ③ Button for saving temporary files
- ④ Backs up all the files in temporary storage to the flash memory (for example, from the "Program Files" directory). These files are written back when the HMI device is started. The "\\Temp" directory is not saved.
- ⑤ Automatically repairs the file system errors on the memory card when the HMI device starts up and when a memory card is inserted.

Procedure

Proceed as follows:

1. If you want the file system errors to be repaired automatically, select the "Automatically repair file system errors ..." check box.
If the check box is cleared, the file system will only be repaired after prompting.
2. Click the necessary buttons.
3. Confirm your entries.
The dialog closes.

Result

At the next startup, the HMI device will use the registry entries and temporary files and the specifications they contain.

6.7.3 Displaying information about the HMI device

You can use this function to display device-specific information. You will need this information if you contact Technical Support

(<http://support.automation.siemens.com/WW/llisapi.dll?aktprim=99&lang=en&referer=%2fWW%2f&func=cslib.csinfo2&siteid=csius&extranet=standard&viewreg=WW>).

Requirement



You have opened the "Device" tab in the "OP Properties" dialog using the "OP" icon.

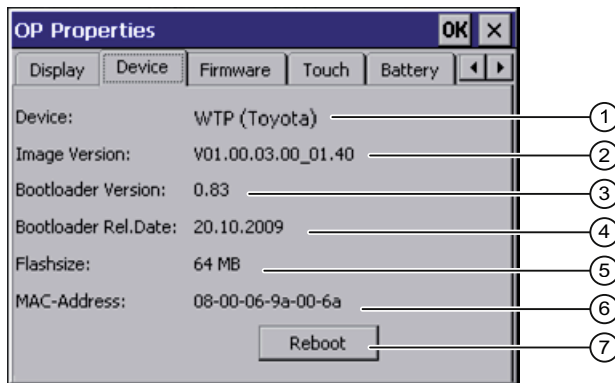

- ① HMI device name
- ② Version of the HMI device image
- ③ Version of the boot loader
- ④ Boot loader release date
- ⑤ Size of the internal flash memory in which the HMI device image and project are stored
- ⑥ MAC address of the HMI device
- ⑦ See section "Starting the HMI device again (Page 142)."

Note

The size of the internal flash memory does not correspond to the available working memory for a project.

6.7.4 Displaying the charge status of the batteries

You can use this function to show the charge and temperature of the main rechargeable battery and the buffer battery. The charge level is only shown if batteries are inserted or connected.

Requirement



- The main rechargeable battery is installed.
- The bridge battery is connected.
- You have opened the "Battery" tab in the "OP Properties" dialog using the "OP" icon.

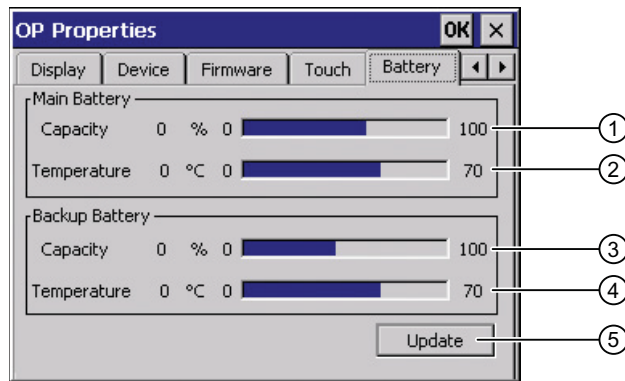

- ① Charge level of the main rechargeable battery
- ② Temperature of the main rechargeable battery
- ③ Charge level of the bridge battery
- ④ Temperature of the bridge battery
- ⑤ Button to update the display

Procedure

If you want to refresh the display, press the "Update" button.

See also

LED display (Page 103)

6.7.5 Activating vibration alarm

Introduction

You can activate a vibration alarm for the HMI device. The vibration alarm will be triggered in the current project under the following circumstances:

- You leave the effective range with the HMI device without logging the HMI device off from the effective range.
- You leave the protection zone with the HMI device without logging the HMI device off from the protection zone.
- The charge status of the main battery is low.

Requirement



You have opened the dialog "OP Properties", dialog box "Vibration Alarm" tab by touching the "OP" icon.

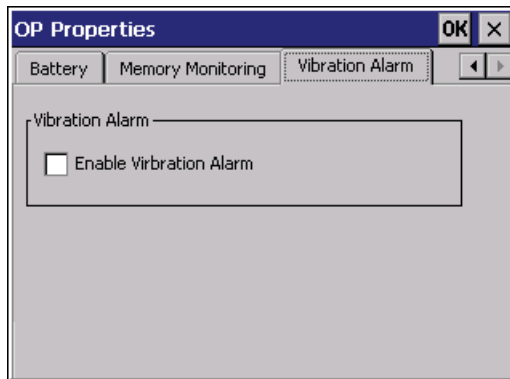

Procedure

Proceed as follows:

1. Select the "Enable Vibration Alarm" check box.
2. Confirm your entries.

The dialog closes.

Result

The vibration alarm is activated.

6.7.6 Configuring the printer connection

You can print hardcopies and reports on a network printer. Line printing of alarms is not possible on a network printer.

The list of current printers and required settings for the HMI device is available in the Internet under "Printers approved for SIMATIC Panels and Multi Panels (<http://support.automation.siemens.com/WW/view/en/11376409>)".

Requirement



You have opened the "Printer Properties" dialog box using the "Printer" icon.

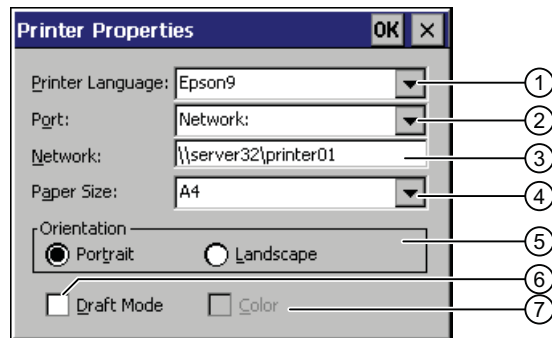

- ① Selection box for the printer
- ② Interface selection box
- ③ Network address of the printer
- ④ Paper format selection box
- ⑤ "Orientation" group with radio buttons for print orientation
- ⑥ Print quality check box
- ⑦ Color printing check box

Procedure

Proceed as follows:

1. Select a printer from the "Printer Language:" selection box.
2. In the "Port:" selection box, select the "Network:" interface.
3. In the "Network:" text box, enter the network address of the printer.
4. Select the paper format from the "Paper Size:" selection box.
5. Select the required option button in the "Orientation" group.
 - "Portrait" for portrait
 - "Landscape" for landscape
6. Select the print quality.
 - Select the "Draft Mode" check box if you wish to print in draft mode.
 - Clear the "Draft Mode" check box if you wish to print with higher quality.
7. If the selected printer can print in color, select the "Color" check box.
8. Confirm your entries.

The dialog closes.

Result

The settings for the printer have now been changed.

6.7.7 Regional and language settings

Information such as the date, time and decimal points are displayed differently in different countries. You can adapt the display format to meet the requirements of various regions.

The country-specific settings apply to the current project. If the project language is changed, the country-specific settings are also changed.

Requirement



You have opened the "Regional Settings" tab in the "Regional and Language Settings" dialog box using the "Regional Settings" icon.



Procedure

Proceed as follows:

1. Select the region from the selection box ①.
2. Navigate to the "Number", "Currency", "Time" and "Date" tabs one after the other.
3. Set the required regional settings in the selection field of these tabs.
4. Confirm your entries.

The dialog closes.

Result

The required regional settings for the HMI device have been changed.

6.7.8 Setting the screen saver

Power management settings in the WinCC flexible project

To save power, the HMI device has a power management function with the following states:

- "Power Save 1"
- "Power Save 2"

The relevant time intervals are set in the WinCC flexible project. Power management is automatically activated if the HMI device is not operated within the specified period of time.

You can clear the "Power Save 1" state by pressing the touch screen.

You can clear the "Power Save 2" state by briefly pressing the ON/OFF button.

Settings in the Control Panel

In addition to the settings in the WinCC flexible project, you can set the following time periods in the Control Panel:

- For the automatic activation of the screen saver
- For the automatic reduction in the display's backlighting.

The screen saver and backlighting are automatically activated if the display is not touched within the specified period of time.

The screen saver switches off with the following events:

- By touching the touch screen

The reduction of the backlighting is also canceled. The function assigned to the button is not triggered in this case.

NOTICE
<p>Reducing backlighting</p> <p>The brightness of the backlighting decreases incrementally during its operational life. You can activate backlighting reduction to not shorten the service life of the backlighting unnecessarily.</p> <p>Activating the screen saver</p> <p>The display contents that do not change for long periods can remain dimly visible in the background. This effect is reversible, however.</p> <p>Activate the screen saver. When the screen saver is active, the backlighting is also reduced.</p>

Requirement



You have opened the "Screensaver" dialog using the "ScreenSaver" icon.

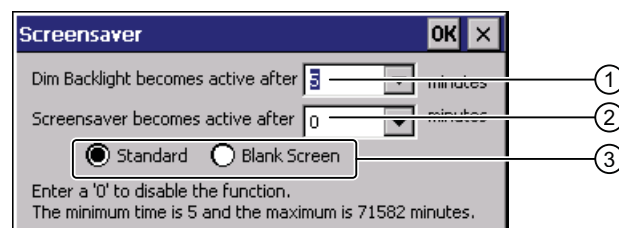

- ① Time interval in minutes until backlighting is reduced
- ② Period of time in minutes before the screen saver is activated
- ③ Option buttons for the screensaver

Procedure

Proceed as follows:

1. Enter the interval in minutes after which the backlighting is to be reduced. With reduced backlighting, the HMI device operates in the "Power Save 1" mode.

Note

If a time is set for activating "Power Save 1" mode, the setting in Control Panel is only effective when the configured time is shorter than the time set in the project for "Power Save 1" mode.

The value "0" in the Control Panel means:

- If a time for activation of "Power Save 1" mode is specified in the project, this time period will be applied.
 - If no time is specified in the project for activation of "Power Save 1" mode, reduced backlighting will be disabled.
2. Enter the number of minutes before the screen saver is to be activated.
The minimum time is 5 minutes and the maximum time is 71582 minutes.
Entering "0" disables the screen saver.
 3. Select the type of screen saver:
 - Use the "Standard" option to enable the default screen saver for Windows CE.
 - Use the "Blank Screen" option to enable an empty screen as the screen saver.
 4. Confirm your entries.
The dialog closes.

Result

The screen saver and the reduced backlighting for the HMI device is set. You need to restart the HMI device after you have reset the screen saver. The selection of the screen saver takes effect following a restart.

6.7.9 Displaying general system properties

Use this function to display the general system information relating to the operating system, processor and memory.

Requirement



You have opened the "General" tab in the "System Properties" dialog box using the "System" icon.

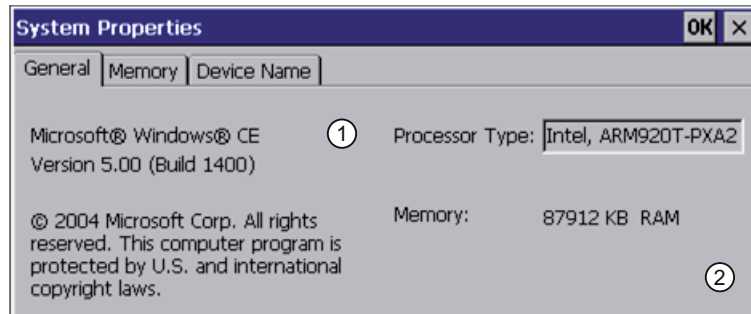

- ① Information on the version and copyright of Microsoft Windows CE
- ② Details on processor and size of internal Flash memory

The displayed data relates to the specific device. The information ② may therefore deviate from this HMI device.

6.7.10 Displaying memory distribution

You can use this function to display the allocation and thereby the size of the individual memory areas on the HMI device.

Requirement



You have opened the "Memory" tab in the "System Properties" dialog using the "System" icon.

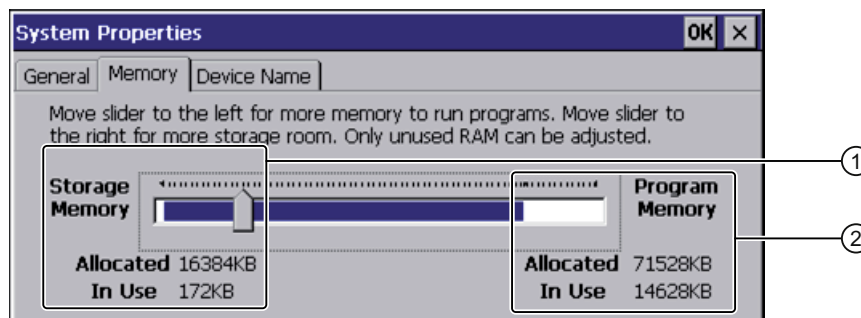

- ① Cache memory, available and used
- ② RAM, available and used

<p>NOTICE</p> <p>Malfunction possible</p> <p>If you change the allocation of the memory, malfunctions may occur.</p> <p>Do not change the memory allocation in the "Memory" tab.</p>
--

When using WinCC flexible options, a change to the memory allocation can be required. For additional information, refer to the online help of WinCC flexible.

6.7.11 Setting the location of the project

There are various storage locations available for storing the compressed source file of your project. The following describes how you can set the storage location.

Requirement



You have opened the "Directories" tab in the "Transfer Settings" dialog box using the "Transfer" icon.

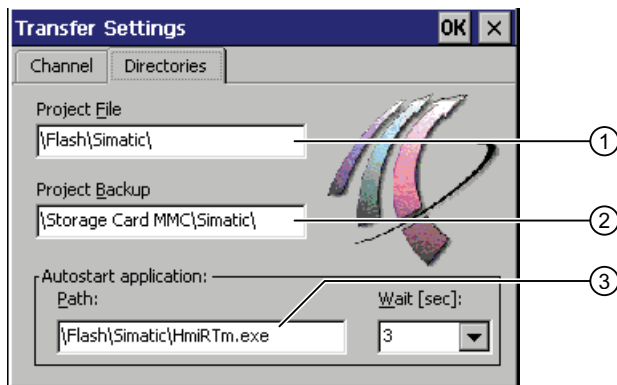

- ① Directory where the project file is saved
- ② Directory where the compressed source file of your project is saved
- ③ Storage location and initialization file of the HMI device for process operation

<p>NOTICE</p> <p>Project does not start</p> <p>If you change the entry in the "Project File" and "Path" text boxes, the project may not open the next time the HMI device starts.</p> <p>Do not change the entries in the "Project File" and "Path" text boxes.</p>

Procedure

Proceed as follows:

1. Select a memory location from the "Project Backup" text box.
The storage location can be a memory card or a location in the local network. During the next backup process, the project's source file is stored in the specified location.
2. Confirm your entries.
The dialog closes.

Result

The storage location for the HMI device is now set.

6.7.12 Setting the delay time for the project

You can use this function to set a delay time. The delay time determines how long the loader appears after the HMI device starts and before the project opens.

Requirement



You have opened the "Directories" tab in the "Transfer Settings" dialog box using the "Transfer" icon.

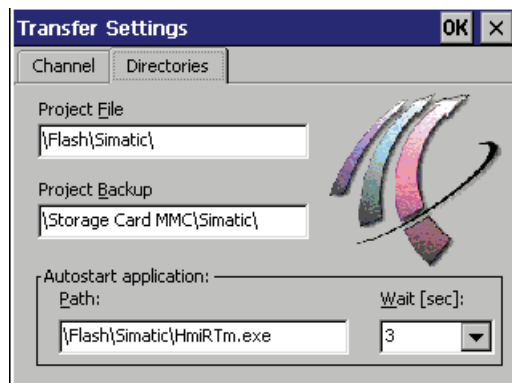

NOTICE

Project does not start

If you change the entry in the "Project File" and "Path" text boxes, the project may not open the next time the HMI device starts.

Do not change the entries in the "Project File" and "Path" text boxes.

Procedure

Proceed as follows:

1. Select the desired delay time in seconds from the "Wait [sec]" selection box.

The project starts immediately with the value "0".

Note

To launch the Loader after the project opens, an operator control must be configured in the project with the "Close project" function.

2. Confirm your entries.

The dialog closes.

Result

The delay time for the HMI device is now set.

6.8 Enabling PROFINET IO

The HMI device communicates with the PLC via Ethernet. PROFINET IO must be enabled so that you can use the following functions:

- Fail-safe operation with EMERGENCY STOP button and enabling button
- Use of PROFINET IO direct keys

Requirement



You have opened the "PROFINET" dialog using the "PROFINET" icon.

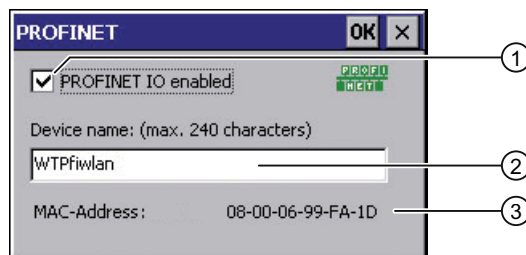

- ① Enabling or disabling the PROFINET IO direct keys
- ② Text box for the device name
- ③ MAC address of the HMI device

Procedure

Proceed as follows:

1. Select the "PROFINET IO enabled" check box.
2. Enter the device name of the HMI device.

NOTICE

Device name must match the HW Config

If the device name does not match the device name entered in the HW Config of STEP 7, the project opens but there will be no PROFIsafe connection.

Use the device name from the HW Config of STEP 7.

The device name must be unique and satisfy the DNS conventions within the local network. These include:

- Restriction to 127 characters in total (letters, digits, hyphen or point)
- A name component within the device name, e.g. a string between two points, may not exceed 63 characters.
- Special characters such as umlauts, brackets, underscores, slashes, spaces etc. are not permitted. The hyphen is the one exception.
- The device name must not start or end with the "-" character.
- The device name must not take the form n.n.n.n (n = 0 to 999).
- The device name must not start with the character string "port-xyz-" (x, y, z = 0 to 9).

1. Confirm your entries.

The dialog closes.

2. Restart the HMI device – see section "Starting the HMI device again (Page 142)".

Result

PROFINET IO is enabled.

See also

Direct keys (Page 275)

6.9 Setting the PROFIsafe address

The PROFIsafe protocol is used to send safety message frames between the HMI device and the F-CPU. This means each station in the PROFIsafe communication must be assigned a unique PROFIsafe address.

At the start of the project, the HMI device is automatically integrated into the safety program. The "SAFE" LED lights up to indicate that integration is complete.

You can enter the PROFIsafe address at the following locations:

Configuring the HMI device

6.9 Setting the PROFIsafe address

- In the HMI device Control Panel
- In the WinCC flexible project

Loading the PROFIsafe address

<p>NOTICE</p> <p>Unique PROFIsafe address required</p> <p>If a PROFIsafe address is not unique, you may experience malfunctions.</p> <p>Assign a PROFIsafe address to the HMI device that is unique within the corresponding local network segment.</p> <p>Integration in PROFIsafe communication is not possible</p> <p>The following PROFIsafe addresses must match to ensure that the HMI device can be integrated in PROFIsafe communication:</p> <ul style="list-style-type: none"> • The PROFIsafe address set in HW Config by STEP 7 • The PROFIsafe address set in the "PROFIsafe" dialog
--

The PROFIsafe address that the HMI device loads depends on the configuration in the Control Panel:

- A valid PROFIsafe address is entered in the Control Panel.
The HMI device then loads the registered PROFIsafe address. The PROFIsafe address of a project is not loaded.
- The invalid PROFIsafe address "65535" is entered in the Control Panel.
The HMI device loads the PROFIsafe address set in the project.

Note

The default PROFIsafe address for the HMI device is 65535.

Requirement



You have opened the "PROFIsafe" dialog using the "PROFIsafe" icon.

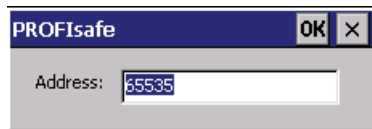

Procedure

Proceed as follows:

1. If you want the HMI device to load the PROFIsafe address of the Control Panel, enter a value from 1 to 65534 in the "Address:" text box.
2. If you want the HMI device to load the PROFIsafe address of the project, enter the value 65535 in the "Address:" text box.

The address obtained from the project will not be displayed in the dialog.

Result

The PROFIsafe address is set.

6.10 Programming the data channel

You can use this function to configure the transfer mode. A project can only be transferred from the configuration PC to the HMI device when at least one data channel is configured and enabled on the HMI device.

If you block all data channels, the HMI device is protected against unintentional overwriting of the project data and HMI device image.

Requirement



The "Channel" tab in the "Transfer Settings" dialog has been opened with the "Transfer Settings" icon.

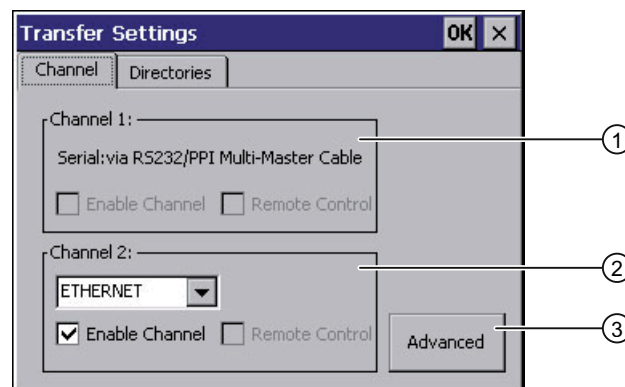

- ① Group for data channel 1
The data channel 1 is not available with Wireless Teach Pendant F IWLAN.
- ② Group for data channel 2
- ③ Button for the "Network and Dial-Up Connections" dialog

Note

If you change the transfer settings during "Transfer", the new settings only go into effect the next time the transfer function is started.

This may occur if the Control Panel is opened to change the transfer properties in an active project.

Procedure

Proceed as follows:

1. Select the "Enable Channel" check box in the "Channel 2" group to enable the data channel.
2. Select the interface for the data channel from the selection list.
3. Enter further parameters if required.
 - Applies to "ETHERNET":

You can use the "Advanced" button to open the settings for addressing the HMI device. You can find the required information in the section "Specifying the IP address and name server (Page 175)".
 - Applies to "USB"

No information is needed for "USB".
4. Confirm your entries.

The dialog closes.

Result

The data channel is configured.

6.11 Configuring network operation

6.11.1 Overview

You can use this function to configure the HMI device for data communication in a PROFINET network via the Ethernet port.

Note

The HMI device can only be used in PROFINET networks.

The HMI device has client functionality in the local network. This means that users can access files of a node with TCP/IP server functionality from the HMI device via the local network. However, you cannot access data on the HMI device from a PC via the local network, for example.

Information on communication using SIMATIC S7 via PROFINET is provided in the following manual: User manual "WinCC flexible Communication Part 1" (<http://support.automation.siemens.com/WW/view/en/18797552>).

The connection to a local network offers the following options, for example:

- Exporting or importing of recipe data records on or from a server
- Storing alarm and data logs
- Transferring a project
- Printing via the local network
- Backing up data

Addressing computers

Computers are usually addressed using computer names within a PROFINET network. These computer names are translated from a DNS or WINS server to TCP/IP addresses. This is why a DNS or WINS server is needed for addressing via computer names when the HMI device is in a PROFINET network.

The corresponding servers are generally available in PROFINET networks.

Note

The use of TCP/IP addresses to address PCs is not supported by the operating system. Contact your network administrator for more information.

Determine the following parameters:

- Does the local network use DHCP for dynamic assignment of addresses?
If not, get a TCP/IP address for the HMI device.
- Which TCP/IP address does the default gateway have?
- If a DNS network is used, what is the address of the name server?
- If a WINS network is used, what is the address of the name server?

Configuration includes:

- Specifying the computer name of the HMI device
- Specifying the IP address and name server
- Specifying the logon data
- Configuring e-mail

The configuration work is described in the following sections.

6.11.2 Specifying the computer name of the HMI device

You can use this function to assign a computer name to the HMI device. The computer name is used to identify the HMI device in the local network.

Requirement



You have opened the "Device Name" tab in the "System Properties" dialog box using the "System" icon.

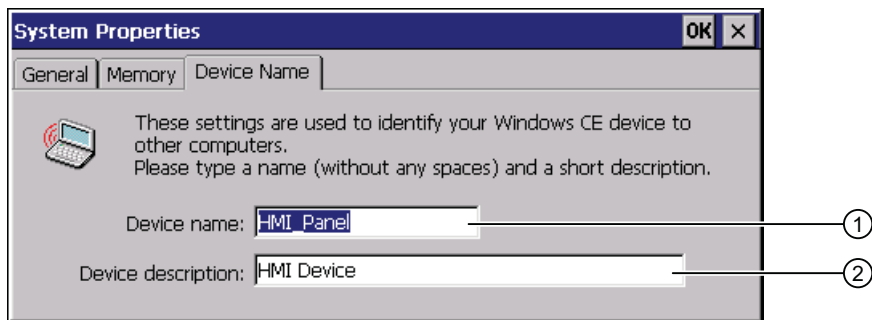

- ① Computer name of the HMI device
- ② Description for the HMI device (optional)

NOTICE

Computer name must be unique

Communication errors may occur in the local network if you assign a computer name more than once.

Enter a unique computer name in the ""Device name"" text box.

Procedure

Proceed as follows:

1. Enter the computer name for the HMI device in the "Device name" text box.
Enter the name without spaces.
2. If necessary, enter a description for the HMI device in the "Device description" text box.
3. Confirm your entries.
The dialog closes.

Result

The computer name for the HMI device is now set.

6.11.3 Specifying the IP address and name server

You can use this function to make the settings for addressing the HMI device in the local network. Ask your network administrator for the required information.

Requirement



You have opened the following display using the "Network&Dial-Up Connections" icon.



Procedure

Proceed as follows:

1. Press the "WLAN" icon.

The 'WLAN' Settings dialog is displayed.

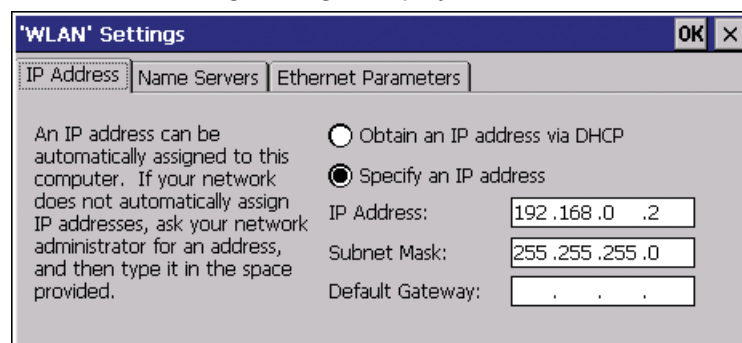

2. If you need automatic address assignment, select the "Obtain an IP address via DHCP" radio button.

- If you need manual address assignment, select the "Specify an IP address" radio button.

<p>NOTICE</p> <p>IP address must be unique</p> <p>An address conflict will occur if more than one device is assigned the same IP address in the local network.</p> <p>Assign a unique IP address to each HMI device in the local network.</p> <p>Reserved IP addresses</p> <p>The following IP addresses are reserved for internal communication with the WLAN module:</p> <ul style="list-style-type: none"> • 169.254.2.253 • 169.254.2.254 <p>Do not use these reserved IP addresses.</p>

- If you have selected manual address assignment, enter the corresponding addresses in the "IP Address," "Subnet Mask" text boxes and if necessary in "Default Gateway."
- If a name server is used in the local network, open the "Name Servers" tab.

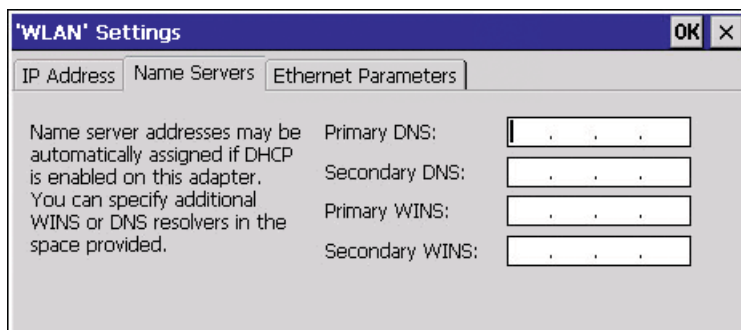

- Enter the respective addresses in the text boxes.
- Confirm your entries.
The dialog closes.
- If you want to change the Ethernet parameters, open the "Ethernet Parameters" tab.
- Close the "Network&Dial-Up Connections" display.
The Control Panel is displayed again.

Result

The address parameters of the HMI device have been set.

6.11.4 Specifying the logon data

Use this function to enter the information for logging on to the local network.

Ask your network administrator for the required information.

Requirement



You have opened the "Network ID" dialog box using the "Network ID" icon.

Network ID

Identification

Windows CE uses this information to gain access to network resources. Enter the user name, password, and domain provided by your network administrator.

User name:

Password:

Domain:

Procedure

Proceed as follows:

1. Enter your user name in the "User name" text box.
2. Enter your password in the "Password" text box.
3. In the "Domain" input field, enter the name of your assigned domain.
4. Confirm your entries.

The dialog closes.

Result

The logon data has now been set.

6.11.5 Configuring e-mail

You can use this function to set the SMTP server, sender name and e-mail account for e-mail service. Ask your network administrator for the required information.

Requirement



You have opened the "Email" tab in the "WinCC flexible Internet Settings" dialog using the "WinCC Internet Settings" icon.

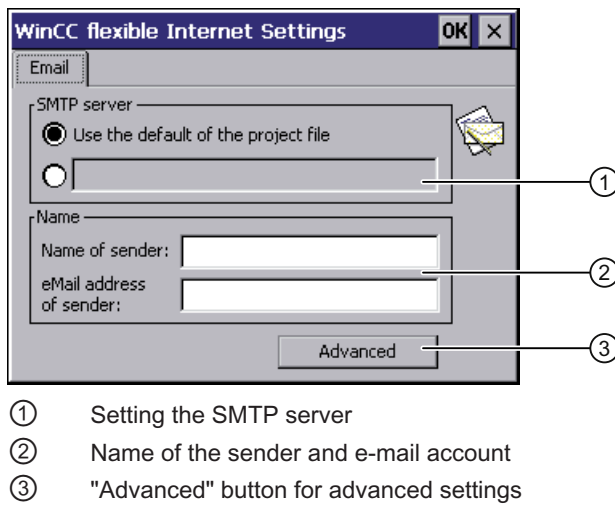

Note

Additional tabs may appear in the "WinCC flexible Internet Settings" dialog. This depends on the options that have been enabled for operating the local network in the project.

Procedure

Proceed as follows:

1. Specify the SMTP server.
 - Select the "Use the default of the project file" option if you want to use the SMTP server configured in the project.
 - Clear the "Use the default of the project file" option if you do not want to use the SMTP server configured in the project. Specify the required SMTP server.
2. Enter the name for the sender in the "Name of sender" text box.

The computer name is practical as the sender name – see section "Specifying the computer name of the HMI device (Page 174)".
3. Enter the e-mail account for your e-mail in the "eMail address of sender" text box.

Some e-mail providers will only let you send e-mails if you specify the e-mail account. The "eMail address of sender" text box can remain empty if your e-mail provider lets you send e-mails without checking the account.

4. Use the "Advanced" button to open advanced settings for the sending of e-mails via an SMTP server.

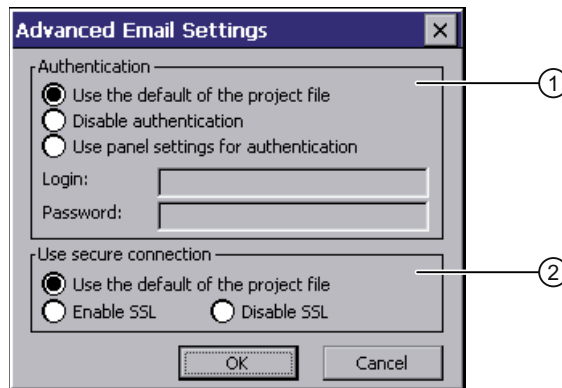

- ① Options for authentication on the SMTP server
- ② Encryption options

Specify an option for authentication on the SMTP server.

- Select the "Use the default of the project file" option if you want to use authentication data specified in the project.
- If you use an SMTP server that does not require authentication, select the "Disable authentication" option.
- Select the "Use panel settings for authentication" option if you want to use the authentication data specified in the settings of the HMI device instead of those in the project.

Specify the encryption method.

- Select the "Use the default of the project file" option if you want to use the encryption method specified in the project.
- Select the "Enable SSL" option if you want to use SSL encryption.
- Select the "Disable SSL" option if you do not want to use encryption.

5. Apply the advanced settings with the "OK" button.

6. Confirm your entries.

The dialog closes.

Result

The e-mail settings have been changed.