

Königswinkel 10

32825 Blomberg, Germany

Phone +49 (0) 52 35 95 00-0

Fax +49 (0) 52 35 95 00-10

office@phoenix-testlab.de

www.phoenix-testlab.de

Test Report

Report Number:

F160307E1

Equipment under Test (EUT):

EWLAN1

Applicant:

Hirschmann Automation and Control GmbH

Manufacturer:

Hirschmann Automation and Control GmbH



Deutsche
Akkreditierungsstelle
D-PL-17186-01-01
D-PL-17186-01-02
D-PL-17186-01-03

References

- [1] **ANSI C63.10-2013**, American National Standard of Procedures for Compliance Testing of Unlicensed Wireless Devices
- [2] **FCC CFR 47 Part 15 (June 2015)**, Radio Frequency Devices

Test Result

The requirements of the tests performed as shown in the overview (clause 4) were fulfilled by the equipment under test.

The complete test results are presented in the following.

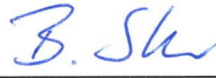
Test engineer:	Paul NEUFELD <small>Name</small>	 <small>Signature</small>	20.05.2016 <small>Date</small>
Authorized reviewer:	Bernd STEINER <small>Name</small>	 <small>Signature</small>	20.05.2016 <small>Date</small>

This test report is only valid in its original form.

Any reproduction of its contents in extracts without written permission of the accredited test laboratory PHOENIX TESTLAB GmbH is prohibited.

The test results herein refer only to the tested sample. PHOENIX TESTLAB GmbH is not responsible for any generalisations or conclusions drawn from these test results concerning further samples. Any modification of the tested samples is prohibited and leads to the invalidity of this test report. Each page necessarily contains the PHOENIX TESTLAB Logo and the TEST REPORT NUMBER.

This test report is valid in hardcopy form as well as in electronic form.

Contents	Page
1 Identification	4
1.1 Applicant	4
1.2 Manufacturer	4
1.3 Test Laboratory	4
1.4 EUT (Equipment Under Test)	5
1.5 Technical Data of Equipment.....	6
1.6 Dates	8
2 Operational States.....	8
3 Additional Information.....	9
4 Overview	9
5 Results.....	10
5.1 Duty cycle	10
5.2 Maximum conducted output power	10
5.2.1 Method of measurement	10
5.2.2 Test results	11
5.3 UNII Bandwidth	12
5.3.1 Method of measurement	12
5.3.2 Test result.....	12
5.4 Peak Power Spectral Density	14
5.4.1 Method of measurement	14
5.4.2 Test result.....	15
5.5 Frequency Stability.....	17
5.6 Band-edge compliance.....	17
5.6.1 Method of measurement (band edges next to unrestricted bands (radiated))	17
5.6.2 Test results	18
5.6.3 Method of measurement (band edges next to restricted bands (radiated))	29
5.6.4 Test results	29
5.7 Maximum unwanted emissions.....	34
5.7.1 Method of measurement (conducted emissions in the restricted bands).....	34
5.7.2 Method of measurement (conducted emissions in the unrestricted bands).....	36
5.7.3 Test results (conducted emissions)	37
5.7.4 Method of measurement (radiated emissions)	39
5.7.5 Test results (radiated emissions) – antenna emissions with each antenna type	46
5.7.6 Test results (radiated emissions) – cabinet emissions	95
5.8 Conducted emissions on power supply lines (150 kHz to 30 MHz).....	100
6 Test equipment and ancillaries used for tests.....	100
7 Report History	101

8 List of Annexes.....101

1 Identification

1.1 Applicant

Name:	Hirschmann Automation and Control GmbH
Address:	Stuttgarter Straße 45-51, 72654 Neckartenzlingen
Country:	Germany
Name for contact purposes:	Bernd GAISSERT
Phone:	+49 7127 14 1750
Fax:	+49 7127 14 1600
eMail Address:	bernd.gaissert@belden.com
Applicant represented during the test by the following person:	-

1.2 Manufacturer

Name:	Hirschmann Automation and Control GmbH
Address:	Stuttgarter Straße 45-51, 72654 Neckartenzlingen
Country:	Germany
Name for contact purposes:	Bernd GAISSERT
Phone:	+49 7127 14 1750
Fax:	+49 7127 14 1600
eMail Address:	bernd.gaissert@belden.com
Applicant represented during the test by the following person:	-

1.3 Test Laboratory

The tests were carried out by: **PHOENIX TESTLAB GmbH**
Königswinkel 10
32825 Blomberg
Germany

Accredited by *Deutsche Akkreditierungsstelle GmbH* in compliance with
DIN EN ISO/IEC 17025 under Reg. No. < **D-PL-17186-01-02** >.

1.4 EUT (Equipment Under Test)

Test object: *	Wireless LAN Module
Type: *	EWLAN1
FCC ID: *	U99EWLAN1
IC: *	4019A-EWLAN1
Serial number: *	837599005030501094
PCB identifier: *	742386001 G03
Hardware version: *	Z03S06
Software version: *	HiLCOS 8.60.024

Channel 1	RX:	2412 MHz	TX:	2412 MHz
Channel 2	RX:	2417 MHz	TX:	2417 MHz
Channel 3	RX:	2422 MHz	TX:	2422 MHz
Channel 4	RX:	2427 MHz	TX:	2427 MHz
Channel 5	RX:	2432 MHz	TX:	2432 MHz
Channel 6	RX:	2437 MHz	TX:	2437 MHz
Channel 7	RX:	2442 MHz	TX:	2442 MHz
Channel 8	RX:	2447 MHz	TX:	2447 MHz
Channel 9	RX:	2452 MHz	TX:	2452 MHz
Channel 10	RX:	2457 MHz	TX:	2457 MHz
Channel 11	RX:	2462 MHz	TX:	2462 MHz

Channel 36	RX:	5180 MHz	TX:	5180 MHz
Channel 40	RX:	5200 MHz	TX:	5200 MHz
Channel 44	RX:	5220 MHz	TX:	5220 MHz
Channel 48	RX:	5240 MHz	TX:	5240 MHz
Channel 38	RX:	5190 MHz	TX:	5190 MHz
Channel 46	RX:	5230 MHz	TX:	5230 MHz

Channel 149	RX:	5745 MHz	TX:	5745 MHz
Channel 153	RX:	5765 MHz	TX:	5765 MHz
Channel 157	RX:	5785 MHz	TX:	5785 MHz
Channel 161	RX:	5805 MHz	TX:	5805 MHz
Channel 165	RX:	5825 MHz	TX:	5825 MHz
Channel 151	RX:	5755 MHz	TX:	5755 MHz
Channel 159	RX:	5795 MHz	TX:	5795 MHz

1.5 Technical Data of Equipment

Fulfills WLAN specification: *	IEEE, 802.11b, 802.11g, 802.11n, 802.11a
Antenna type: *	See Table 1
Antenna gain: *	See Table 1
Antenna connector: *	See Table 1
Power supply - EUT	3.3 V & 1.2 V
Type of modulation: *	802.11a: OFDM 802.11b: CCK, DQPSK, DBPSK 802.11g: OFDM 802.11n: OFDM
Operating frequency range:*	2412 MHz to 2462 MHz, 5180 MHz to 5240 MHz, 5745 to 5825 MHz
Number of channels: *	18
Temperature range: *	0 °C to +40 °C
Lowest / highest Internal clock frequency: *	12 MHz / 5825 MHz

Ancillary devices (supplied by the applicant)

Host device *	BAT-R Access Point					
Power supply Host (supply option W) used for test	$U_{nom} =$	24 V DC	$U_{min} =$	18 V DC	$U_{max} =$	36 V DC
Power supply Host (supply option type C)	$U_{nom} =$	24 - 48 V DC	$U_{min} =$	18 V DC	$U_{max} =$	60 V DC
Power supply Host (supply option type K)	$U_{nom} =$	60 - 250 V DC	$U_{min} =$	48 V DC	$U_{max} =$	320 V DC
	$U_{nom} =$	110 - 230 V AC 50 – 60 Hz	$U_{min} =$	88 V AC 47 – 63 Hz	$U_{max} =$	265 V AC 47 – 63 Hz

Ancillary device (supplied by the laboratory)

Notebook Fujitsu

Table 1 Antenna specifications

Antenna name	Manufacturer	Type	Comment	Gain [dBi]
BAT-ANT-N-3AGN-IP67	Joymax Electronics Co., Ltd.	Monopole	Connector: N male	2 @ 2.4 GHz 2 @ 5 GHz
BAT-ANT-RSMA-2AGN-R	Joymax Europe GmbH	Monopole	Connector: SMA Reverse male ,	3 @ 2.4 GHz 5 @ 5 GHz
BAT-ANT-N-MiMoDB-5N-IP65	Huber+Suhner	Patch Array	Connector: N male,	3.5 @ 2.4 GHz 5.5 @ 5 GHz
BAT-ANT-N-9A-DS-IP65	Huber+Suhner	Patch	Connector: N male,	9 @ 5 GHz

The following external I/O cables were used:

Identification	Connector		Length
	EUT	Ancillary	
AC/DC Adapter to host	DC plug	-	2 m *
Ethernet cable to host	Ethernet plug	-	-
PCI Express cable from host to EUT	PCI Express plug	PCI Express plug	30 cm ^{*2}

*: Length during the test if no other specified.

*² Cable connects EUT and host device.

1.6 Dates

Date of receipt of test sample:	01.03.2016
Start of test:	02.03.2016
End of test:	12.04.2016

2 Operational States

The equipment under test (EUT) is a WLAN module with a PCI express interface and 3 antenna ports. To set this module into operation it was connected to a Hirschmann Belden BAT-R Access Point via ribbon cable with a length of 30 cm.

The tests were carried out with an unmodified sample of the EUT. Parts of the tests were carried out conducted at the antenna ports. If these tests did not pass, the measurements were repeated as radiated tests, with the dedicated antennas attached.

Additionally a radiated measurement of the cabinet emission was performed while the antenna ports are terminated by 50 Ω .

The BAT-R Access Point was connected via an Ethernet connection to a laptop computer. With a test-software running on the laptop the operation mode as shown in the table below could be chosen.

During the tests, the test samples were powered with 3.3 V and 1.2 V via PCI Express interface from the BAT-R Access-point. This Access-point was powered with 24 VDC from a laboratory power supply.

The following operation modes were identified as worst case condition and used during the tests:

Operation mode	Description of the operation mode	WLAN mode	WLAN channel	Modulation	Data rate / Mbps
1	Continuous transmitting on 5180 MHz	a	36	OFDM	6 MBit/s
2	Continuous transmitting on 5200 MHz	a	40	OFDM	6 MBit/s
3	Continuous transmitting on 5240 MHz	a	48	OFDM	6 MBit/s
4	Continuous transmitting on 5745 MHz	a	149	OFDM	6 MBit/s
5	Continuous transmitting on 5785 MHz	a	157	OFDM	6 MBit/s
6	Continuous transmitting on 5825 MHz	a	165	OFDM	6 MBit/s
7	Continuous transmitting on 5180 MHz	n 20 MHz	36	OFDM	6.5 MBit/s
8	Continuous transmitting on 5200 MHz	n 20 MHz	40	OFDM	6.5 MBit/s
9	Continuous transmitting on 5240 MHz	n 20 MHz	48	OFDM	6.5 MBit/s
10	Continuous transmitting on 5745 MHz	n 20 MHz	149	OFDM	6.5 MBit/s
11	Continuous transmitting on 5785 MHz	n 20 MHz	157	OFDM	6.5 MBit/s
12	Continuous transmitting on 5825 MHz	n 20 MHz	165	OFDM	6.5 MBit/s
13	Continuous transmitting on 5190 MHz	n 40 MHz	38	OFDM	13.5 MBit/s
14	Continuous transmitting on 5230 MHz	n 40 MHz	46	OFDM	13.5 MBit/s
15	Continuous transmitting on 5755 MHz	n 40 MHz	151	OFDM	13.5 MBit/s
16	Continuous transmitting on 5795 MHz	n 40 MHz	159	OFDM	13.5 MBit/s

3 Additional Information

The power of the EUT was reduced by 6 dB on channel 149 for all modulations to be compliant to the band edge limits. The power table below shows the power settings which were set by the manufacturer. The settings are the same for all modulations and bandwidths.

WLAN channel	36	40	44	48	149	153	157	161	165
Power setting / dBm	8	8	8	8	9	20.5	20.5	20.5	20.5

The antennas BAT-ANT-RSMA-2AGN-R and BAT-ANT-N-9A-DS-IP65 were measured with antenna cables that had an attenuation of maximum 3.5 dB in the frequency range from 5 – 6 GHz. Since some test results are very close to the limit, these antennas can only be used with these appropriate antenna cables.

4 Overview

Application	Frequency range [MHz]	FCC 47 CFR Part 15 section [2]	RSS 247 [4] or RSS-Gen, Issue 3 [5]	Status	Refer page
Maximum Output Power	5150 – 5250 5250 – 5350 5470 - 5725 5725 - 5850	15.407 (a)	6.2.1 (1)[4] 6.2.2 (1)[4] 6.2.3 (1)[4] 6.2.4 (1)[4]	Passed	10 et seq
UNII Bandwidth	5150 – 5250 5250 – 5350 5470 - 5725 5725 - 5850	15.403 (i)	- - - 6.2.4 (1) [4]	Passed	12 et seq
Peak Power Spectral Density	5150 – 5250 5250 – 5350 5470 - 5725 5725 - 5850	15.407 (a)(5)	6.2.1 (1)[4] 6.2.2 (1)[4] 6.2.3 (1)[4] 6.2.4 (1)[4]	Passed	14 et seq
Frequency Stability	5150 – 5250	15.407 (g)	-	Passed	17 et seq
Band edge compliance	5150 – 5250 5250 – 5350 5470 - 5725 5725 - 5850	15.407 (b)	6.2.1 (2)[4] 6.2.2 (2)[4] 6.2.3 (2)[4] 6.2.4 (2)[4]	Passed	17 et seq.
Radiated emissions (transmitter)	0.009 - 40,000	15.407 (b) 15.205 (a) 15.209 (a)	7.2.2 [5], 6.2.1 (2)[4] 6.2.2 (2)[4] 6.2.3 (2)[4] 6.2.4 (2)[4]	Passed	34 et seq.
Conducted emissions on supply line	0.15 - 30	15.207 (a)	7.2.4 [5]	Passed	100 et seq.

5 Results

5.1 Duty cycle

The EUT was transmitting in testmode with 100 % duty cycle, therefore no duty cycle measurements and duty cycle related reductions needed to be performed for the following test cases.

5.2 Maximum conducted output power

5.2.1 Method of measurement

The EUT has to be connected to the power meter via a low loss cable.

Acceptable measurement configurations

The measurement procedures described herein are based on the use of an antenna-port conducted test configuration.

“Measurement using a power meter (PM)” was used for this test. The procedure is described in chapter 12.3.3.1 of document [1].

The measurement will be performed at the upper and lower end and the middle of the assigned frequency band.

Test set-up:

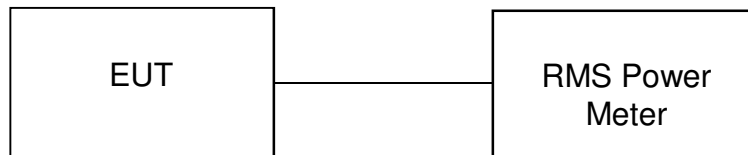

5.2.2 Test results

Ambient temperature	22 °C	Relative humidity	62 %
---------------------	-------	-------------------	------

The highest array gain is given for the BAT-ANT-N-MiMoDB-5N-IP65 antenna, which has a gain of 5.5. dBi, which results in an array gain of 10.3 dBi. Therefore the Peak power limit is reduced by 4.3 dB.

Operation Mode	Antenna gain combined [dBi]	Maximum RMS output power – port 1 [dBm]	Maximum RMS output power – port 2 [dBm]	Maximum RMS output power – port 3 [dBm]	Maximum RMS output power – sum (all ports) [dBm]	Margin [dB]	RMS limit [dBm]
1	10.3	7.6	7.5	8.0	12.5	13.2	25.7
2	10.3	7.6	7.8	8.5	12.8	12.9	25.7
3	10.3	7.7	8.1	8.2	12.8	12.9	25.7
4	10.3	11.1	12.0	12.1	16.5	9.2	25.7
5	10.3	11.4	13.7	13.2	17.6	8.1	25.7
6	10.3	11.5	14.2	14.1	18.2	7.5	25.7
7	10.3	7.8	8.3	8.6	13.0	12.7	25.7
8	10.3	7.9	8.2	8.6	13.0	12.7	25.7
9	10.3	7.9	8.1	8.4	12.9	12.8	25.7
10	10.3	13.3	14.2	14.7	18.9	6.8	25.7
11	10.3	13.2	15.2	15.2	19.4	6.3	25.7
12	10.3	12.4	14.5	14.6	18.7	7.0	25.7
13	10.3	8.1	8.1	8.5	13.0	12.7	25.7
14	10.3	7.5	8.2	8.4	12.8	12.9	25.7
15	10.3	11.8	12.6	13.5	17.5	8.2	25.7
16	10.3	11.5	13.8	13.8	17.9	7.8	25.7
Measurement uncertainty			+0.66 dB / -0.72 dB				

Test: Passed

TEST EQUIPMENT USED FOR THE TEST:

60, 61

5.3 UNII Bandwidth

5.3.1 Method of measurement

The relating measurements were carried out in a conducting manner. Therefore, the antenna connector was directly connected to a spectrum analyser. The measurement procedure refers to part 12.4.1 of document [1].

- Set RBW = approximately 1% of the emission bandwidth.
- Set the VBW > RBW.
- Detector = Peak.
- Trace mode = max hold.
- Measure the maximum width of the emission that is 26 dB or 6 dB down from the peak of the emission. Compare this with the RBW setting of the analyser. For the measurement of the 99 % bandwidth the corresponding measurement function of the spectrum analyser was used.

Readjust RBW and repeat measurement as needed until the RBW/EBW ratio is approximately 1%.

The measurements did not vary depending on the antenna port, therefore the results of an exemplary port are submitted below.

5.3.2 Test result

Ambient temperature	22 °C	Relative humidity	59 %
---------------------	-------	-------------------	------

The following results were measured at the antenna port of the EUT. The plot shows an exemplary measurement result for the worst documented case. The other results are listed in the following table.

ELWAN 1 6dB-BW a 157.wmf: 6-dB Bandwidth (operation mode 5):

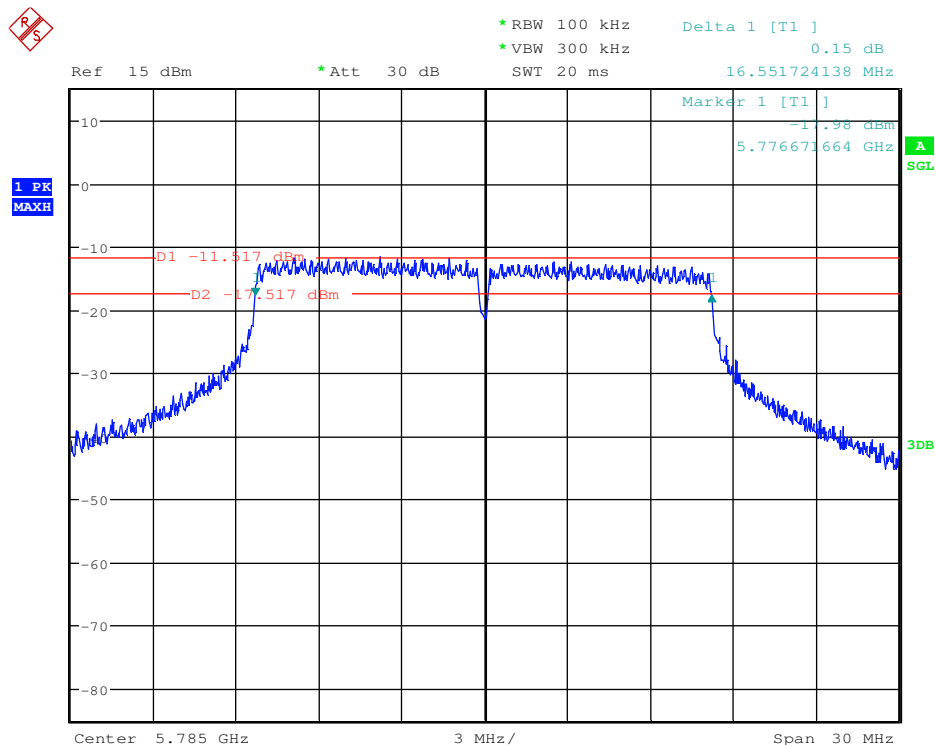

Operation Mode	Nominal Channel frequency [MHz]	26 dB Bandwidth [MHz]
1	5180 MHz	26.214
2	5200 MHz	25.894
3	5240 MHz	26.494
7	5180 MHz	28.492
8	5200 MHz	27.772
9	5240 MHz	27.133
13	5200 MHz	51.648
14	5260 MHz	51.648
Measurement uncertainty		+0.66 dB / -0.72 dB

Operation Mode	Nominal Channel frequency [MHz]	99% Bandwidth [MHz]	6 dB Bandwidth [MHz]	Limit 6 dB Bandwidth [MHz]	Result
4	5745 MHz	19.100	16.582	0.5	Passed
5	5785 MHz	18.850	16.552	0.5	Passed
6	5825 MHz	19.200	16.612	0.5	Passed
10	5745 MHz	20.500	17.841	0.5	Passed
11	5785 MHz	21.500	17.856	0.5	Passed
12	5825 MHz	20.300	17.841	0.5	Passed
15	5755 MHz	39.680	36.557	0.5	Passed
16	5795 MHz	41.040	36.607	0.5	Passed
Measurement uncertainty		+0.66 dB / -0.72 dB			

Test: Passed

TEST EQUIPMENT USED FOR THE TEST:

30

5.4 Peak Power Spectral Density

5.4.1 Method of measurement

The relating measurements were carried out in a conducting manner. Therefore, the antenna connector was directly connected to a spectrum analyser. The measurement procedure refers to part 12.5 of document [1].

Method SA-2 was used for this measurement.

- Measure the duty cycle D of the transmitter output signal as described in 12.2.
- Set span to encompass the entire 26 dB EBW or 99% OBW of the signal.
- Set RBW = 1 MHz (500 kHz for the U-NII 3 Band).
- Set VBW \geq 3 MHz (3 MHz for the U-NII 3 Band).
- Number of points in sweep \geq $[2 \times \text{span} / \text{RBW}]$. (This gives bin-to-bin spacing \leq $\text{RBW} / 2$, so that narrowband signals are not lost between frequency bins.)
- Sweep time = auto.
- Detector = RMS (i.e., power averaging), if available. Otherwise, use sample detector mode. Do not use sweep triggering. Allow the sweep to “free run.”
- Trace average at least 100 traces in power averaging (rms) mode; however, the number of traces to be averaged shall be increased above 100 as needed such that the average accurately represents the true average over the ON and OFF periods of the transmitter.
- Use the peak search function on the instrument to find the peak of the spectrum.
- add $[10 \log (1 / D)]$, where D is the duty cycle, to the peak of the spectrum.
- The result is the PPSD.

The measurements were carried out at each antenna port separately. The spectra were summed across outputs as described in 14.3.2.2 in [1].

5.4.2 Test result

Ambient temperature	22 °C	Relative humidity	59 %
---------------------	-------	-------------------	------

The following results were measured at the antenna port of the EUT. The plot shows an exemplary measurement result for the worst documented case. The other results are listed in the following table.

The highest array gain is given for the BAT-ANT-N-MiMoDB-5N-IP65 antenna, which has a gain of 5.5. dBi, which results in an array gain of 10.3 dBi. Therefore the maximum power spectral density limit is reduced by 4.3 dB.

EWLAN 1_PwrSpecDens_a_40.wmf: Power Spectral Density (operation mode 2):

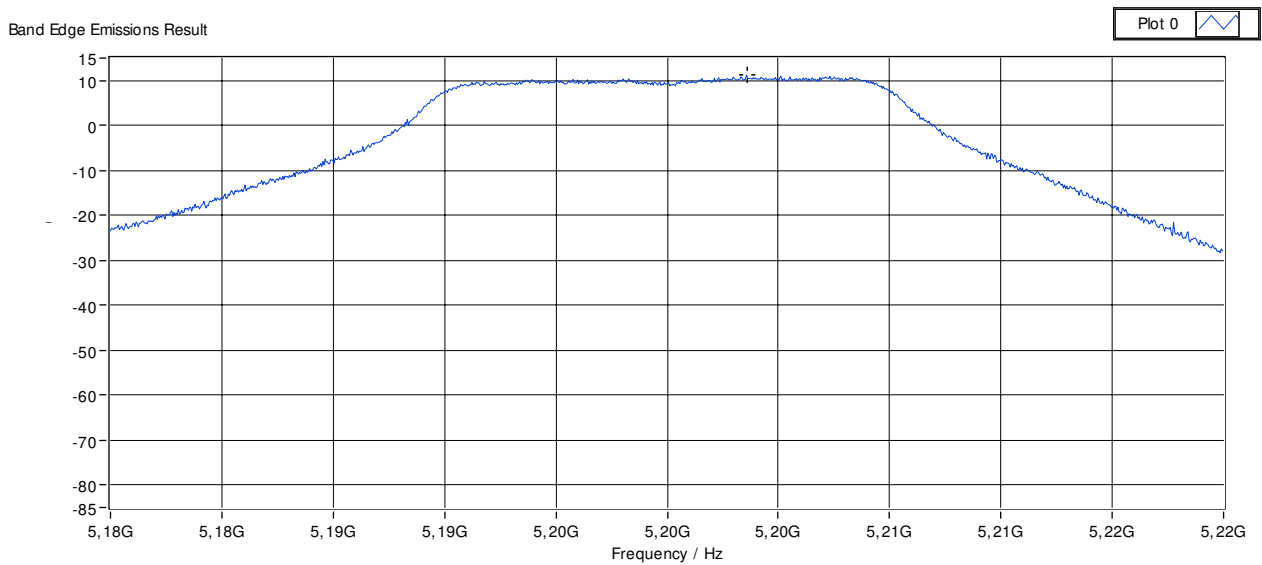

Operation Mode	Nominal Channel frequency [MHz]	Peak Frequency [MHz]	Power Spectral Density Limit [dBm / MHz]	Peak Power Spectral Density Level [dBm / MHz]	Margin [dB]	Result
1	5180 MHz	5176.543	12.3	10.5	1.8	Passed
2	5200 MHz	5202.857	12.3	11.2	1.1	Passed
3	5240 MHz	5243.616	12.3	10.8	1.5	Passed
7	5500 MHz	5183.976	12.3	7.4	4.9	Passed
8	5580 MHz	5202.018	12.3	11.2	1.1	Passed
9	5700 MHz	5235.145	12.3	10.9	1.4	Passed
13	5180 MHz	5195.185	12.3	9.0	3.3	Passed
14	5200 MHz	5241.598	12.3	8.4	3.9	Passed
Operation Mode	Nominal Channel frequency [MHz]	Peak Frequency [MHz]	Power Spectral Density Limit [dBm / 500 kHz]	Peak Power Spectral Density Level [dBm / 500 kHz]	Margin [dB]	Result
4	5745 MHz	5740.584	25.7	11.0	14.7	Passed
5	5785 MHz	5780.624	25.7	11.4	14.3	Passed
6	5825 MHz	5820.504	25.7	11.6	14.1	Passed
10	5745 MHz	5739.905	25.7	12.3	13.4	Passed
11	5785 MHz	5781.144	25.7	13.2	12.5	Passed
12	5825 MHz	5818.107	25.7	12.3	13.4	Passed
15	5755 MHz	5739.985	25.7	9.0	16.7	Passed
16	5795 MHz	5783.941	25.7	9.9	15.8	Passed

Test: Passed

TEST EQUIPMENT USED FOR THE TEST:

30

5.5 Frequency Stability

The frequency stability was already performed and documented in the test reports F133448E2 and F133448E3 by PHOENIX TESTLAB GmbH. The test procedures did not change compared to the new procedures, therefore these tests were not repeated in this report.

5.6 Band-edge compliance

5.6.1 Method of measurement (band edges next to unrestricted bands (radiated))

The conducted measurements at the band-edges were failed, therefore these measurements were repeated as radiated measurements with each antenna type.

The same settings as described in chapter 5.7.2 of this report was used to perform the measurements. The test setup was arranged as described in chapter 5.7.4.

The Limit were calculated according to 12.7.2 [1], therefore:

- $-17dBm \rightarrow 78.3 \frac{dB\mu V}{m} @ 3m$
- $-27dBm \rightarrow 68.3 \frac{dB\mu V}{m} @ 3m$

If any out of band emission from the band-edge to 10 MHz is below -27dBm or the restricted band limit, whichever is less, only these values are reported.

5.6.2 Test results

Only the plot of the worst case emission is submitted below.

160307_#1_a_ch165_UpperBandEdge1_-0dB0°.wmf: Band-edge compliance on channel 165 in a mode, BAT-ANT-N-9A-DS-IP65 antenna, Plot < 10 MHz to the band-edge

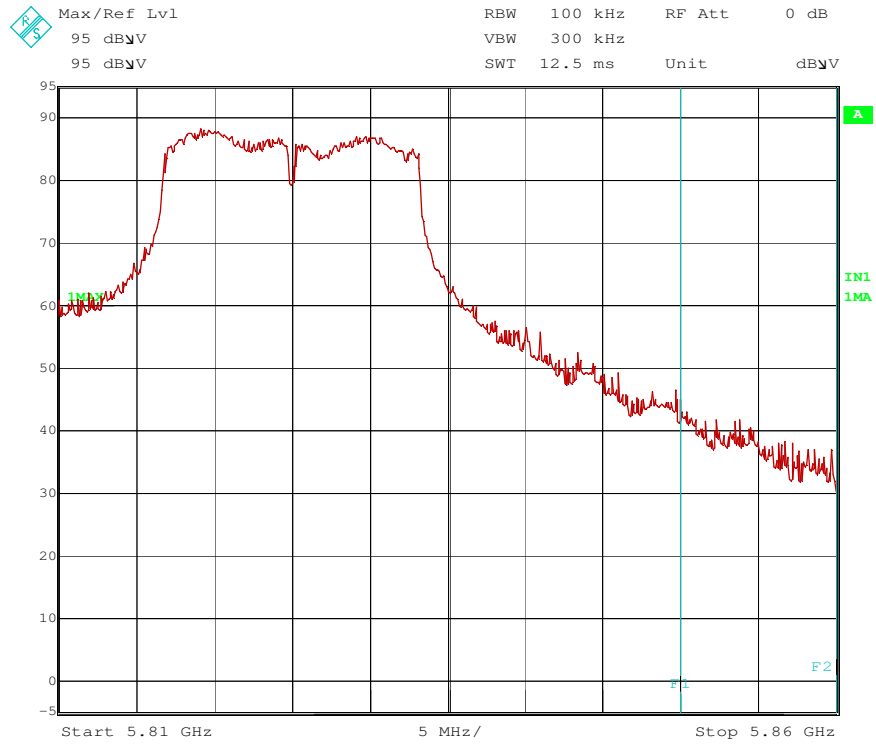

160307_#1_n20_ch165_UpperBandEdge2_-0dB0°wmf: Band-edge compliance on channel 165 in n20 mode, BAT-ANT-N-9A-DS-IP65 antenna, Plot > 10 MHz to the band-edge

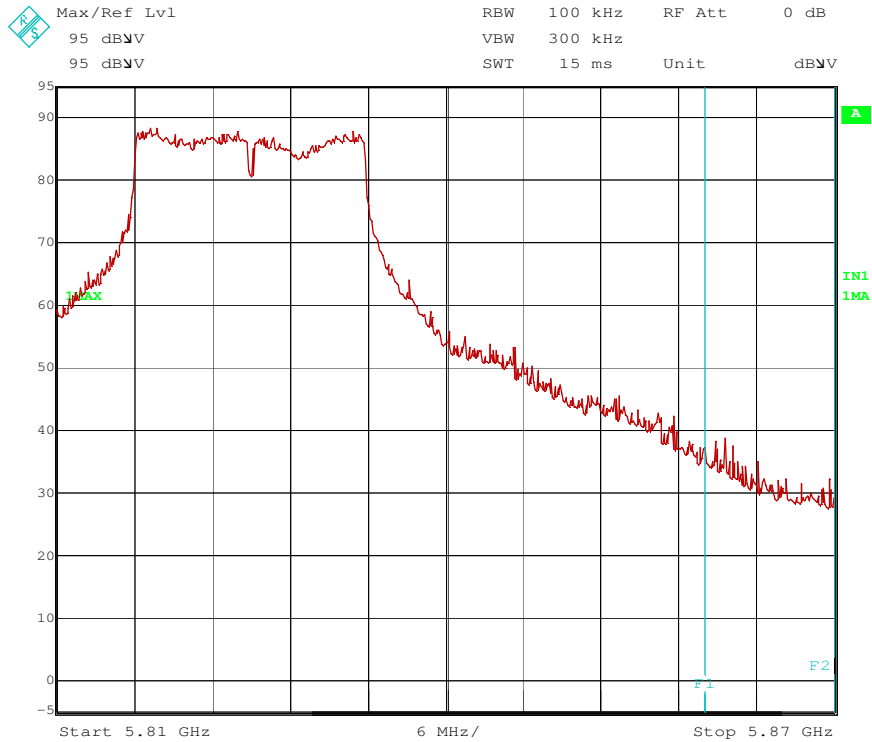

5.6.2.1 Results for cabinet emissions

No emissions at the band edges were found during the cabinet emission measurements with terminated antenna ports.

5.6.2.2 Results for monopole antenna

Used antenna: BAT-ANT-RSMA-2AGN-R with 5 dBi gain

Transmitter operates at the lower end of the assigned frequency band (operation mode 4)

Result measured with the peak detector:

Frequency MHz	Meas. Result dB μ V/m	Limit dB μ V/m	Margin dB	Readings dB μ V	Antenna factor 1/m	Preamp dB	Cable loss dB	Height cm	Pol.	TT Pos.
5724.1	69.3	74.0	4.7	55.7	33.8	25.0	4.8	150	Vert.	323°
Measurement uncertainty				+2.2 dB / -3.6 dB						

Result measured with the average detector:

Frequency MHz	Meas. Result dB μ V/m	Limit dB μ V/m	Margin dB	Readings dB μ V	Antenna factor 1/m	Preamp dB	Cable loss dB	Height cm	Pol.	TT Pos.
5724.10	48.2	54.0	5.8	34.6	33.8	25.0	4.8	150	Vert.	312°
Measurement uncertainty				+2.2 dB / -3.6 dB						

Transmitter operates at the upper end of the assigned frequency band (operation mode 6)

Result measured with the peak detector:

Frequency MHz	Meas. Result dB μ V/m	Limit dB μ V/m	Margin dB	Readings dB μ V	Antenna factor 1/m	Preamp dB	Cable loss dB	Height cm	Pol.	TT Pos.
5850.6	72.2	74.0	1.8	58.1	33.9	24.7	4.9	150	Vert.	328°
Measurement uncertainty				+2.2 dB / -3.6 dB						

Result measured with the average detector:

Frequency MHz	Meas. Result dB μ V/m	Limit dB μ V/m	Margin dB	Readings dB μ V	Antenna factor 1/m	Preamp dB	Cable loss dB	Height cm	Pol.	TT Pos.
5850.60	49.4	54.0	4.6	35.3	33.9	24.7	4.9	150	Vert.	328°
Measurement uncertainty				+2.2 dB / -3.6 dB						

Transmitter operates at the lower end of the assigned frequency band (operation mode 10)

Result measured with the peak detector:

Frequency MHz	Meas. Result dB μ V/m	Limit dB μ V/m	Margin dB	Readings dB μ V	Antenna factor 1/m	Preamp dB	Cable loss dB	Height cm	Pol.	TT Pos.
5724.5	64.1	74.0	9.9	50.5	33.8	25.0	4.8	150	Vert.	320°
Measurement uncertainty				+2.2 dB / -3.6 dB						

Result measured with the average detector:

Frequency MHz	Meas. Result dB μ V/m	Limit dB μ V/m	Margin dB	Readings dB μ V	Antenna factor 1/m	Preamp dB	Cable loss dB	Height cm	Pol.	TT Pos.
5724.50	44.7	54.0	9.3	31.1	33.8	25.0	4.8	150	Vert.	343°
Measurement uncertainty				+2.2 dB / -3.6 dB						

Transmitter operates at the upper end of the assigned frequency band (operation mode 12)

Result measured with the peak detector:

Frequency MHz	Meas. Result dB μ V/m	Limit dB μ V/m	Margin dB	Readings dB μ V	Antenna factor 1/m	Preamp dB	Cable loss dB	Height cm	Pol.	TT Pos.
5850.5	72.7	74.0	1.3	58.6	33.9	24.7	4.9	150	Vert.	343°
Measurement uncertainty				+2.2 dB / -3.6 dB						

Result measured with the average detector:

Frequency MHz	Meas. Result dB μ V/m	Limit dB μ V/m	Margin dB	Readings dB μ V	Antenna factor 1/m	Preamp dB	Cable loss dB	Height cm	Pol.	TT Pos.
5850.50	49.3	54.0	4.7	35.2	33.9	24.7	4.9	150	Vert.	346°
Measurement uncertainty				+2.2 dB / -3.6 dB						

Transmitter operates at the lower end of the assigned frequency band up to 10 MHz from the band edge (operation mode 15)

Result measured with the peak detector:

Frequency MHz	Meas. Result dB μ V/m	Limit dB μ V/m	Margin dB	Readings dB μ V	Antenna factor 1/m	Preamp dB	Cable loss dB	Height cm	Pol.	TT Pos.
5724.5	73.9	78.3	4.4	60.3	33.8	25.0	4.8	150	Vert.	285°
Measurement uncertainty				+2.2 dB / -3.6 dB						

Transmitter operates at the lower end of the assigned frequency band more than 10 MHz from the band edge (operation mode 15)

Result measured with the peak detector:

Frequency MHz	Meas. Result dB μ V/m	Limit dB μ V/m	Margin dB	Readings dB μ V	Antenna factor 1/m	Preamp dB	Cable loss dB	Height cm	Pol.	TT Pos.
5714.5	61.4	74.0	12.6	47.8	33.8	25.1	4.8	150	Vert.	41°
Measurement uncertainty				+2.2 dB / -3.6 dB						

Result measured with the average detector:

Frequency MHz	Meas. Result dB μ V/m	Limit dB μ V/m	Margin dB	Readings dB μ V	Antenna factor 1/m	Preamp dB	Cable loss dB	Height cm	Pol.	TT Pos.
5714.50	43.3	54.0	10.7	29.8	33.8	25.1	4.8	150	Vert.	41°
Measurement uncertainty				+2.2 dB / -3.6 dB						

Transmitter operates at the upper end of the assigned frequency band (operation mode 16)

Result measured with the peak detector:

Frequency MHz	Meas. Result dB μ V/m	Limit dB μ V/m	Margin dB	Readings dB μ V	Antenna factor 1/m	Preamp dB	Cable loss dB	Height cm	Pol.	TT Pos.
5851.6	67.0	74.0	7.0	52.9	33.9	24.7	4.9	150	Hor.	360°
Measurement uncertainty				+2.2 dB / -3.6 dB						

Result measured with the average detector:

Frequency MHz	Meas. Result dB μ V/m	Limit dB μ V/m	Margin dB	Readings dB μ V	Antenna factor 1/m	Preamp dB	Cable loss dB	Height cm	Pol.	TT Pos.
5851.60	48.3	54.0	5.7	34.2	33.9	24.7	4.9	150	Hor.	352°
Measurement uncertainty				+2.2 dB / -3.6 dB						

5.6.2.3 Results for patch antenna

Used antenna: BAT-ANT-N-9A-DS-IP65 with 9 dBi gain

Transmitter operates at the lower end of the assigned frequency band (operation mode 4)

Result measured with the peak detector:

Frequency MHz	Meas. Result dB μ V/m	Limit dB μ V/m	Margin dB	Readings dB μ V	Antenna factor 1/m	Preamp dB	Cable loss dB	Height cm	Pol.	TT Pos.
5724.5	69.0	74.0	5.0	55.4	33.8	25.0	4.8	150	Hor.	0°
Measurement uncertainty				+2.2 dB / -3.6 dB						

Result measured with the average detector:

Frequency MHz	Meas. Result dB μ V/m	Limit dB μ V/m	Margin dB	Readings dB μ V	Antenna factor 1/m	Preamp dB	Cable loss dB	Height cm	Pol.	TT Pos.
5724.50	50.0	54.0	4.0	36.5	33.8	25.0	4.8	150	Hor.	4°
Measurement uncertainty				+2.2 dB / -3.6 dB						

Transmitter operates at the upper end of the assigned frequency band (operation mode 6)

Result measured with the peak detector:

Frequency MHz	Meas. Result dB μ V/m	Limit dB μ V/m	Margin dB	Readings dB μ V	Antenna factor 1/m	Preamp dB	Cable loss dB	Height cm	Pol.	TT Pos.
5850.5	73.7	74.0	0.3	59.6	33.9	24.7	4.9	150	Vert.	360°
Measurement uncertainty				+2.2 dB / -3.6 dB						

Result measured with the average detector:

Frequency MHz	Meas. Result dB μ V/m	Limit dB μ V/m	Margin dB	Readings dB μ V	Antenna factor 1/m	Preamp dB	Cable loss dB	Height cm	Pol.	TT Pos.
5850.50	49.6	54.0	4.4	35.5	33.9	24.7	4.9	150	Vert.	360°
Measurement uncertainty				+2.2 dB / -3.6 dB						

Transmitter operates at the lower end of the assigned frequency band (operation mode 10)

Result measured with the peak detector:

Frequency MHz	Meas. Result dB μ V/m	Limit dB μ V/m	Margin dB	Readings dB μ V	Antenna factor 1/m	Preamp dB	Cable loss dB	Height cm	Pol.	TT Pos.
5723.7	68.8	74.0	5.2	55.2	33.8	25.0	4.8	150	Hor.	1°
Measurement uncertainty				+2.2 dB / -3.6 dB						

Result measured with the average detector:

Frequency MHz	Meas. Result dB μ V/m	Limit dB μ V/m	Margin dB	Readings dB μ V	Antenna factor 1/m	Preamp dB	Cable loss dB	Height cm	Pol.	TT Pos.
5723.70	47.1	54.0	6.9	33.5	33.8	25.0	4.8	150	Hor.	5°
Measurement uncertainty				+2.2 dB / -3.6 dB						

Transmitter operates at the upper end of the assigned frequency band up to 10 MHz from the band edge (operation mode 12)

Result measured with the peak detector:

Frequency MHz	Meas. Result dB μ V/m	Limit dB μ V/m	Margin dB	Readings dB μ V	Antenna factor 1/m	Preamp dB	Cable loss dB	Height cm	Pol.	TT Pos.
5850.5	75.4	78.3	2.9	61.3	33.9	24.7	4.9	150	Vert.	0°
Measurement uncertainty				+2.2 dB / -3.6 dB						

Transmitter operates at the upper end of the assigned frequency band more than 10 MHz from the band edge (operation mode 12)

Result measured with the peak detector:

Frequency MHz	Meas. Result dB μ V/m	Limit dB μ V/m	Margin dB	Readings dB μ V	Antenna factor 1/m	Preamp dB	Cable loss dB	Height cm	Pol.	TT Pos.
5861.6	68.6	74.0	5.4	54.8	33.9	25.0	4.9	150	Hor.	0°
Measurement uncertainty				+2.2 dB / -3.6 dB						

Result measured with the average detector:

Frequency MHz	Meas. Result dB μ V/m	Limit dB μ V/m	Margin dB	Readings dB μ V	Antenna factor 1/m	Preamp dB	Cable loss dB	Height cm	Pol.	TT Pos.
5861.60	41.7	54.0	12.3	27.9	33.9	25.0	4.9	150	Hor.	356
Measurement uncertainty				+2.2 dB / -3.6 dB						

Transmitter operates at the lower end of the assigned frequency band up to 10 MHz from the band edge (operation mode 15)

Result measured with the peak detector:

Frequency MHz	Meas. Result dB μ V/m	Limit dB μ V/m	Margin dB	Readings dB μ V	Antenna factor 1/m	Preamp dB	Cable loss dB	Height cm	Pol.	TT Pos.
4824.5	71.2	78.3	7.1	59.6	32.6	25.4	4.3	150	Vert.	10°
Measurement uncertainty				+2.2 dB / -3.6 dB						

Transmitter operates at the lower end of the assigned frequency band more than 10 MHz from the band edge (operation mode 15)

Result measured with the peak detector:

Frequency MHz	Meas. Result dB μ V/m	Limit dB μ V/m	Margin dB	Readings dB μ V	Antenna factor 1/m	Preamp dB	Cable loss dB	Height cm	Pol.	TT Pos.
5714.3	68.3	74.0	5.7	54.7	33.8	25.1	4.8	150	Hor.	7°
Measurement uncertainty				+2.2 dB / -3.6 dB						

Result measured with the average detector:

Frequency MHz	Meas. Result dB μ V/m	Limit dB μ V/m	Margin dB	Readings dB μ V	Antenna factor 1/m	Preamp dB	Cable loss dB	Height cm	Pol.	TT Pos.
5714.30	48.2	54.0	5.8	34.6	33.8	25.1	4.8	150	Hor.	5°
Measurement uncertainty				+2.2 dB / -3.6 dB						

Transmitter operates at the upper end of the assigned frequency band (operation mode 16)

Result measured with the peak detector:

Frequency MHz	Meas. Result dB μ V/m	Limit dB μ V/m	Margin dB	Readings dB μ V	Antenna factor 1/m	Preamp dB	Cable loss dB	Height cm	Pol.	TT Pos.
5850.6	66.5	74.0	7.5	52.4	33.9	24.7	4.9	150	Hor.	341°
Measurement uncertainty				+2.2 dB / -3.6 dB						

Result measured with the average detector:

Frequency MHz	Meas. Result dB μ V/m	Limit dB μ V/m	Margin dB	Readings dB μ V	Antenna factor 1/m	Preamp dB	Cable loss dB	Height cm	Pol.	TT Pos.
5850.60	48.8	54.0	5.2	34.7	33.9	24.7	4.9	150	Hor.	0°
Measurement uncertainty				+2.2 dB / -3.6 dB						

5.6.2.4 Results for patch array antenna

Used antenna: BAT-ANT-N-MiMoDB-5N-IP65 with 5.5 dBi gain

Transmitter operates at the lower end of the assigned frequency band (operation mode 4)

Result measured with the peak detector:

Frequency MHz	Meas. Result dB μ V/m	Limit dB μ V/m	Margin dB	Readings dB μ V	Antenna factor 1/m	Preamp dB	Cable loss dB	Height cm	Pol.	TT Pos.
5724.5	72.3	74.0	1.7	58.7	33.8	25.0	4.8	150	Hor.	327°
Measurement uncertainty				+2.2 dB / -3.6 dB						

Result measured with the average detector:

Frequency MHz	Meas. Result dB μ V/m	Limit dB μ V/m	Margin dB	Readings dB μ V	Antenna factor 1/m	Preamp dB	Cable loss dB	Height cm	Pol.	TT Pos.
5724.50	51.3	54.0	2.7	37.7	33.8	25.0	4.8	150	Hor.	325°
Measurement uncertainty				+2.2 dB / -3.6 dB						

Transmitter operates at the upper end of the assigned frequency band (operation mode 6)

Result measured with the peak detector:

Frequency MHz	Meas. Result dB μ V/m	Limit dB μ V/m	Margin dB	Readings dB μ V	Antenna factor 1/m	Preamp dB	Cable loss dB	Height cm	Pol.	TT Pos.
5851	68.4	74.0	5.6	54.3	33.9	24.7	4.9	150	Hor.	296°
Measurement uncertainty				+2.2 dB / -3.6 dB						

Result measured with the average detector:

Frequency MHz	Meas. Result dB μ V/m	Limit dB μ V/m	Margin dB	Readings dB μ V	Antenna factor 1/m	Preamp dB	Cable loss dB	Height cm	Pol.	TT Pos.
5851.0	43.2	54.0	10.8	29.1	33.9	24.7	4.9	150	Hor.	313°
Measurement uncertainty				+2.2 dB / -3.6 dB						

Transmitter operates at the lower end of the assigned frequency band (operation mode 10)

Result measured with the peak detector:

Frequency MHz	Meas. Result dB μ V/m	Limit dB μ V/m	Margin dB	Readings dB μ V	Antenna factor 1/m	Preamp dB	Cable loss dB	Height cm	Pol.	TT Pos.
5724.5	69.8	74.0	4.2	56.2	33.8	25.0	4.8	150	Hor.	308°
Measurement uncertainty				+2.2 dB / -3.6 dB						

Result measured with the average detector:

Frequency MHz	Meas. Result dB μ V/m	Limit dB μ V/m	Margin dB	Readings dB μ V	Antenna factor 1/m	Preamp dB	Cable loss dB	Height cm	Pol.	TT Pos.
5724.50	47.9	54.0	6.1	34.3	33.8	25.0	4.8	150	Hor.	312°
Measurement uncertainty				+2.2 dB / -3.6 dB						

Transmitter operates at the upper end of the assigned frequency band up to 10 MHz from the band edge (operation mode 12)

Result measured with the peak detector:

Frequency MHz	Meas. Result dB μ V/m	Limit dB μ V/m	Margin dB	Readings dB μ V	Antenna factor 1/m	Preamp dB	Cable loss dB	Height cm	Pol.	TT Pos.
5850.5	77.6	78.3	0.7	63.5	33.9	24.7	4.9	150	Hor.	49°
Measurement uncertainty				+2.2 dB / -3.6 dB						

Transmitter operates at the upper end of the assigned frequency band more than 10 MHz from the band edge (operation mode 12)

Result measured with the peak detector:

Frequency MHz	Meas. Result dB μ V/m	Limit dB μ V/m	Margin dB	Readings dB μ V	Antenna factor 1/m	Preamp dB	Cable loss dB	Height cm	Pol.	TT Pos.
5860.5	60.6	78.3	17.7	46.8	33.9	25.0	4.9	150	Hor.	316°
Measurement uncertainty				+2.2 dB / -3.6 dB						

Result measured with the average detector:

Frequency MHz	Meas. Result dB μ V/m	Limit dB μ V/m	Margin dB	Readings dB μ V	Antenna factor 1/m	Preamp dB	Cable loss dB	Height cm	Pol.	TT Pos.
5860.50	37.5	54.0	16.5	23.7	33.9	25.0	4.9	150	Hor.	313°
Measurement uncertainty				+2.2 dB / -3.6 dB						

Transmitter operates at the lower end of the assigned frequency band (operation mode 15)

Result measured with the peak detector:

Frequency MHz	Meas. Result dB μ V/m	Limit dB μ V/m	Margin dB	Readings dB μ V	Antenna factor 1/m	Preamp dB	Cable loss dB	Height cm	Pol.	TT Pos.
5724.5	71.3	74.0	2.7	57.7	33.8	25.0	4.8	150	Hor.	321°
Measurement uncertainty				+2.2 dB / -3.6 dB						

Result measured with the average detector:

Frequency MHz	Meas. Result dB μ V/m	Limit dB μ V/m	Margin dB	Readings dB μ V	Antenna factor 1/m	Preamp dB	Cable loss dB	Height cm	Pol.	TT Pos.
5724.50	49.6	54.0	4.4	36.0	33.8	25.0	4.8	150	Hor.	321°
Measurement uncertainty				+2.2 dB / -3.6 dB						

Transmitter operates at the upper end of the assigned frequency band (operation mode 16)

Result measured with the peak detector:

Frequency MHz	Meas. Result dB μ V/m	Limit ⁸ dB μ V/m	Margin dB	Readings dB μ V	Antenna factor 1/m	Preamp dB	Cable loss dB	Height cm	Pol.	TT Pos.
5852	69.3	74.0	4.7	55.2	33.9	24.7	4.9	150	Hor.	319°
Measurement uncertainty				+2.2 dB / -3.6 dB						

Result measured with the average detector:

Frequency MHz	Meas. Result dB μ V/m	Limit dB μ V/m	Margin dB	Readings dB μ V	Antenna factor 1/m	Preamp dB	Cable loss dB	Height cm	Pol.	TT Pos.
5852.0	49.3	54.0	4.7	35.2	33.9	24.7	4.9	150	Hor.	304°
Measurement uncertainty				+2.2 dB / -3.6 dB						

5.6.3 Method of measurement (band edges next to restricted bands (radiated))

The conducted measurements at the band-edges were failed, therefore these measurements were repeated as radiated measurements with each antenna type.

The test setup and the measurement procedures were the same as the ones described in 5.7.4.

5.6.4 Test results

5.6.4.1 Results for cabinet emissions

No emissions at the band edges were found during the cabinet emission measurements.

5.6.4.2 Results for monopole antenna

Used antenna: BAT-ANT-RSMA-2AGN-R with 5 dBi gain

Transmitter operates at the lower end of the assigned frequency band (operation mode 1)

Result measured with the peak detector:

Frequency MHz	Meas. Result dB μ V/m	Limit dB μ V/m	Margin dB	Readings dB μ V	Antenna factor 1/m	Preamp dB	Cable loss dB	Height cm	Pol.	TT Pos.
5143.5	54.3	74.0	19.7	40.9	33.6	24.8	4.5	150	Vert.	15°
Measurement uncertainty				+2.2 dB / -3.6 dB						

Result measured with the average detector:

Frequency MHz	Meas. Result dB μ V/m	Limit dB μ V/m	Margin dB	Readings dB μ V	Antenna factor 1/m	Preamp dB	Cable loss dB	Height cm	Pol.	TT Pos.
5143.50	39.1	54.0	14.9	25.7	33.6	24.8	4.5	150	Vert.	5°
Measurement uncertainty				+2.2 dB / -3.6 dB						

Transmitter operates at the lower end of the assigned frequency band (operation mode 7)

Result measured with the peak detector:

Frequency MHz	Meas. Result dB μ V/m	Limit dB μ V/m	Margin dB	Readings dB μ V	Antenna factor 1/m	Preamp dB	Cable loss dB	Height cm	Pol.	TT Pos.
5147.4	39.5	74.0	34.5	26.1	33.6	24.8	4.5	150	Vert.	5°
Measurement uncertainty				+2.2 dB / -3.6 dB						

Result measured with the average detector:

Frequency MHz	Meas. Result dB μ V/m	Limit dB μ V/m	Margin dB	Readings dB μ V	Antenna factor 1/m	Preamp dB	Cable loss dB	Height cm	Pol.	TT Pos.
5147.40	39.2	54.0	14.8	25.8	33.6	24.8	4.5	150	Vert.	7°
Measurement uncertainty				+2.2 dB / -3.6 dB						

Transmitter operates at the lower end of the assigned frequency band (operation mode 13)

Result measured with the peak detector:

Frequency MHz	Meas. Result dB μ V/m	Limit dB μ V/m	Margin dB	Readings dB μ V	Antenna factor 1/m	Preamp dB	Cable loss dB	Height cm	Pol.	TT Pos.
5143.5	54.3	74.0	19.7	40.9	33.6	24.8	4.5	150	Vert.	15°
Measurement uncertainty				+2.2 dB / -3.6 dB						

Result measured with the average detector:

Frequency MHz	Meas. Result dB μ V/m	Limit dB μ V/m	Margin dB	Readings dB μ V	Antenna factor 1/m	Preamp dB	Cable loss dB	Height cm	Pol.	TT Pos.
5143.50	39.1	54.0	14.9	25.7	33.6	24.8	4.5	150	Vert.	5°
Measurement uncertainty				+2.2 dB / -3.6 dB						

5.6.4.3 Results for patch antenna

Used antenna: BAT-ANT-N-9A-DS-IP65 with 9 dBi gain

Transmitter operates at the lower end of the assigned frequency band (operation mode 1)

Result measured with the peak detector:

Frequency MHz	Meas. Result dB μ V/m	Limit dB μ V/m	Margin dB	Readings dB μ V	Antenna factor 1/m	Preamp dB	Cable loss dB	Height cm	Pol.	TT Pos.
5139.3	54.2	74.0	19.8	40.7	33.6	24.6	4.5	150	Hor.	5°
Measurement uncertainty				+2.2 dB / -3.6 dB						

Result measured with the average detector:

Frequency MHz	Meas. Result dB μ V/m	Limit dB μ V/m	Margin dB	Readings dB μ V	Antenna factor 1/m	Preamp dB	Cable loss dB	Height cm	Pol.	TT Pos.
5139.30	38.2	54.0	15.8	24.7	33.6	24.6	4.5	150	Vert.	9°
Measurement uncertainty				+2.2 dB / -3.6 dB						

Transmitter operates at the lower end of the assigned frequency band (operation mode 7)

Result measured with the peak detector:

Frequency MHz	Meas. Result dB μ V/m	Limit dB μ V/m	Margin dB	Readings dB μ V	Antenna factor 1/m	Preamp dB	Cable loss dB	Height cm	Pol.	TT Pos.
5149.5	58.8	74.0	15.2	45.4	33.6	24.8	4.5	150	Hor.	0°
Measurement uncertainty				+2.2 dB / -3.6 dB						

Result measured with the average detector:

Frequency MHz	Meas. Result dB μ V/m	Limit dB μ V/m	Margin dB	Readings dB μ V	Antenna factor 1/m	Preamp dB	Cable loss dB	Height cm	Pol.	TT Pos.
5149.50	38.8	54.0	15.2	25.4	33.6	24.8	4.5	150	Vert.	9°
Measurement uncertainty				+2.2 dB / -3.6 dB						

Transmitter operates at the lower end of the assigned frequency band (operation mode 13)

Result measured with the peak detector:

Frequency MHz	Meas. Result dB μ V/m	Limit dB μ V/m	Margin dB	Readings dB μ V	Antenna factor 1/m	Preamp dB	Cable loss dB	Height cm	Pol.	TT Pos.
5146.6	63.2	74.0	10.8	49.8	33.6	24.8	4.5	150	Hor.	0°
Measurement uncertainty				+2.2 dB / -3.6 dB						

Result measured with the average detector:

Frequency MHz	Meas. Result dB μ V/m	Limit dB μ V/m	Margin dB	Readings dB μ V	Antenna factor 1/m	Preamp dB	Cable loss dB	Height cm	Pol.	TT Pos.
5146.60	44.1	54.0	9.9	30.7	33.6	24.8	4.5	150	Hor.	0°
Measurement uncertainty				+2.2 dB / -3.6 dB						

5.6.4.4 Results for patch array antenna

Used antenna: BAT-ANT-N-MiMoDB-5N-IP65 with 5.5 dBi gain

Transmitter operates at the lower end of the assigned frequency band (operation mode 1)

Result measured with the peak detector:

Frequency MHz	Meas. Result dB μ V/m	Limit dB μ V/m	Margin dB	Readings dB μ V	Antenna factor 1/m	Preamp dB	Cable loss dB	Height cm	Pol.	TT Pos.
5148.2	57.2	74.0	16.8	43.8	33.6	24.8	4.5	150	Hor.	289°
Measurement uncertainty				+2.2 dB / -3.6 dB						

Result measured with the average detector:

Frequency MHz	Meas. Result dB μ V/m	Limit dB μ V/m	Margin dB	Readings dB μ V	Antenna factor 1/m	Preamp dB	Cable loss dB	Height cm	Pol.	TT Pos.
5148.20	39.8	54.0	14.2	26.4	33.6	24.8	4.5	150	Hor.	316°
Measurement uncertainty				+2.2 dB / -3.6 dB						

Transmitter operates at the lower end of the assigned frequency band (operation mode 7)

Result measured with the peak detector:

Frequency MHz	Meas. Result dB μ V/m	Limit dB μ V/m	Margin dB	Readings dB μ V	Antenna factor 1/m	Preamp dB	Cable loss dB	Height cm	Pol.	TT Pos.
5146.9	46.9	74.0	27.1	33.5	33.6	24.8	4.5	150	Hor.	316°
Measurement uncertainty				+2.2 dB / -3.6 dB						

Result measured with the average detector:

Frequency MHz	Meas. Result dB μ V/m	Limit dB μ V/m	Margin dB	Readings dB μ V	Antenna factor 1/m	Preamp dB	Cable loss dB	Height cm	Pol.	TT Pos.
5146.90	39.6	54.0	14.4	26.2	33.6	24.8	4.5	150	Hor.	316°
Measurement uncertainty				+2.2 dB / -3.6 dB						

Transmitter operates at the lower end of the assigned frequency band (operation mode 13)

Result measured with the peak detector:

Frequency MHz	Meas. Result dB μ V/m	Limit dB μ V/m	Margin dB	Readings dB μ V	Antenna factor 1/m	Preamp dB	Cable loss dB	Height cm	Pol.	TT Pos.
5147.9	66.6	74.0	7.4	53.2	33.6	24.8	4.5	150	Hor.	309°
Measurement uncertainty				+2.2 dB / -3.6 dB						

Result measured with the average detector:

Frequency MHz	Meas. Result dB μ V/m	Limit dB μ V/m	Margin dB	Readings dB μ V	Antenna factor 1/m	Preamp dB	Cable loss dB	Height cm	Pol.	TT Pos.
5147.90	46.8	54.0	7.2	33.4	33.6	24.8	4.5	150	Hor.	309°
Measurement uncertainty				+2.2 dB / -3.6 dB						

TEST EQUIPMENT USED FOR THE TEST:M20

29, 31 – 36, 41, 42

5.7 Maximum unwanted emissions

5.7.1 Method of measurement (conducted emissions in the restricted bands)

The relating measurements were carried out in a conducting manner. Therefore, the antenna connector was directly mounted to a spectrum analyser. The measurement procedure refers to parts 12.7.5, 12.7.6 and 12.7.7.2 [1].

If emissions were detected during the preliminary measurements, they were measured using the following measurement procedures:

Peak measurement procedure:

- Set the analyzer span to encompass the entire unwanted emission bandwidth.
- Set the RBW = specified in Table 2.
- Set the VBW $\geq [3 \times \text{RBW}]$.
- Set sweep time = auto.
- Detector = peak.
- Trace mode = max hold.
- Allow the trace to stabilize.
- Use the peak marker function to determine the peak power over the emission bandwidth.

Average measurement procedure:

- RBW = 1 MHz.
- VBW $\geq [3 \times \text{RBW}]$.
- Detector = RMS (power averaging), if $[\text{span} / (\# \text{ of points in sweep})] \leq \text{RBW} / 2$. Satisfying this condition can require increasing the number of points in the sweep or reducing the span. If the condition is not satisfied, then the detector mode shall be set to peak.
- Averaging type = power (i.e., rms)
- Sweep time = auto.
- Perform a trace average of at least 100 traces if the transmission is continuous. If the transmission is not continuous, then the number of traces shall be increased by a factor of $1 / D$, where D is the duty cycle. For example, with 50% duty cycle, at least 200 traces shall be averaged. (If a specific emission is demonstrated to be continuous—i.e., 100% duty cycle—then rather than turning ON and OFF with the transmit cycle, at least 100 traces shall be averaged.)
- Add the correction factor $[10 \log (1 / D)]$, where D is the duty cycle to the measured value (if the EUT transmitting at a duty cycle less than 98%)

Table 2 RBW as a function of frequency

Frequency	RBW
9-150 kHz	200-300 Hz
0.15-30 MHz	9-10 kHz
30-1000 MHz	100-120 kHz
> 1000 MHz	1 MHz

The measurements were carried out at each antenna port.

If an emission fails the conducted test, the measurement will be repeated in a radiated manner.

5.7.1.1 Limit calculations

The following general procedure is described in chapter 12.7.2 of [1].

- a) Measure the conducted output power (in dBm).
- b) Add the maximum transmit antenna gain (in dBi) to the measured output power level to determine the EIRP level
- c) Add the appropriate maximum ground reflections factor to the EIRP level (6 dB for frequencies \leq , 30 MHz, 4.7 for frequencies between 30 MHz and 1000 MHz, inclusive and 0 dB for frequencies $>$ 1000 MHz)
- d) For devices with multiple antenna ports, measure the power of each individual chain and sum the EIRP of all chains in linear terms (e.g., Watts, mW)
- e) Convert the resultant level to an equivalent electric field strength using the following relationships:

$$E. = EIRP - 20\log(d) + 104.8 \quad (1)$$

Where:

E. = electric field strength, in dB μ V/m

EIRP = equivalent isotropic radiated power, in dBm

d = specified measurement distance, in meters

- f) Compare the resultant electric field strength to the applicable limit

Document [1] states in chapter 14, that for transmitters with multiple outputs in the same band, summing of emissions and accounting for array gain have to be considered.

For combining emissions from multiple outputs, the emissions from each port were measured separately and the traces were summed for each frequency for the final plot as described in 14.3.2.2 in [1].

To account for directional gain which might occur in case of N transmit antennas, the directional gain has to be calculated as

$$G_{Dir} = G_{Ant} + 10\log(N) dBi,$$

whereby N is the number of antennas.

The highest array gain is given for the BAT-ANT-N-MiMoDB-5N-IP65 antenna, which has a gain of 5.5. dBi, which results in an array gain of 10.3 dBi.

5.7.2 Method of measurement (conducted emissions in the unrestricted bands)

The measurement was performed as described in H)2) in document [3].

5.7.2.1 Emission level measurement

Measurement Procedure – Unwanted Emissions

- Set the center frequency and span to encompass the frequency range to be measured.
- RBW = 1 MHz. (100 kHz for frequencies below 1 GHz)
- VBW \geq 3 MHz. (300 kHz for frequencies below 1 GHz)
- Detector = Peak.
- Sweep time = auto couple.
- Trace Mode = max hold.
- Use the peak marker function to determine the maximum amplitude level. Allow sweeps to continue until the trace stabilizes. Note that if the transmission is not continuous, then the time required for the trace to stabilize will increase by a factor of approximately 1/D, where D is the duty cycle. For example, at 50% duty cycle, the measurement time will increase by a factor of two, relative to measurement time for continuous transmission.

The limit of -27 dBm/MHz was specified in 15.407 (b) (1).

For transmitters operating in the frequency band 5.725 – 5.85 all emissions within the frequency range from the band edge to 10 MHz above or below the band edge shall not exceed an e.i.r.p. of -17 dBm/MHz; for frequencies 10 MHz or greater above or below the band edge, emissions shall not exceed an e.i.r.p. of -27 dBm/MHz.

5.7.3 Test results (conducted emissions)

5.7.3.1 Emissions below 1 GHz

No significant emissions were found in the frequency range below 1 GHz, therefore no results are submitted below.

5.7.3.2 Emissions above 1 GHz

Ambient temperature	22 °C	Relative humidity	59 %
---------------------	-------	-------------------	------

The following results were measured at antenna port of the EUT. The plots show exemplary measurement results for the worst documented case. Only emissions around the intended signal were found during the preliminary measurements. These emissions all failed the conducted tests and were repeated as radiated tests with each dedicated antenna type.

EWLAN 1 SpurEmiss1-12G a 36.emf: conducted spurious emissions (operation mode 1):

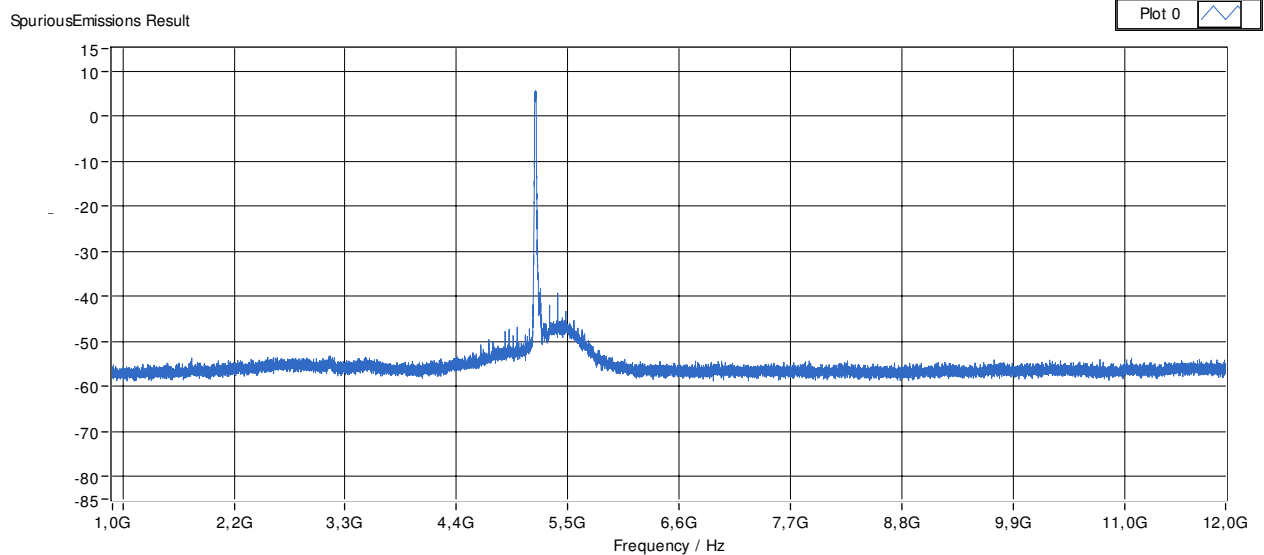

EWLAN 1 SpurEmiss12-26G a 36.emf: conducted spurious emissions (operation mode 1):

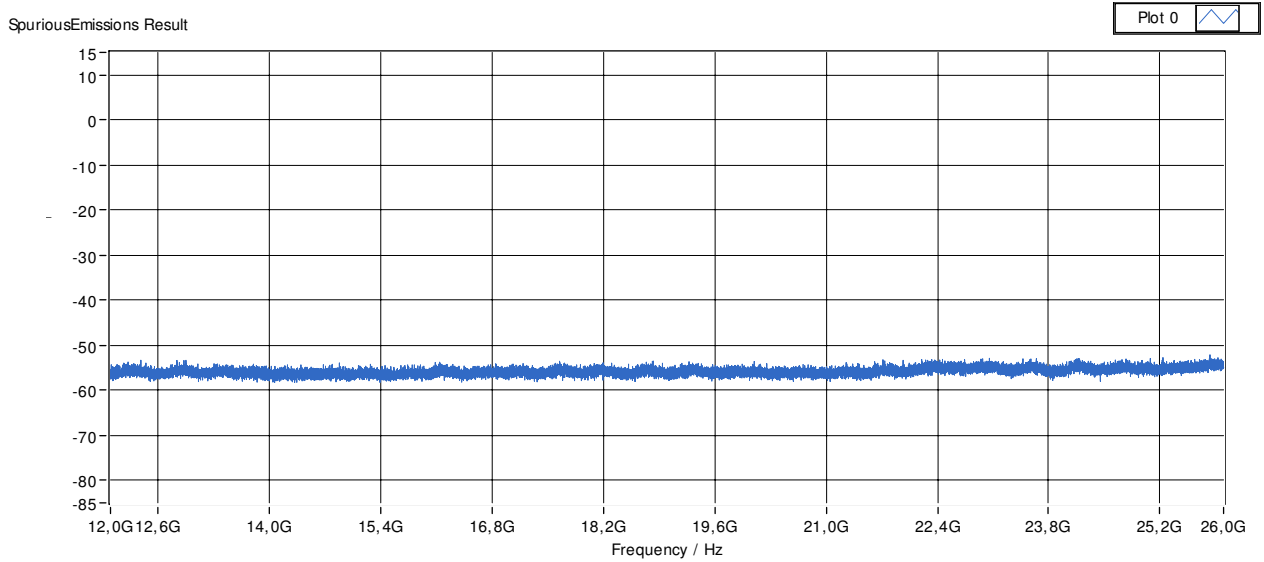

EWLAN 1 SpurEmiss26-40G a 36.emf: conducted spurious emissions (operation mode 11):

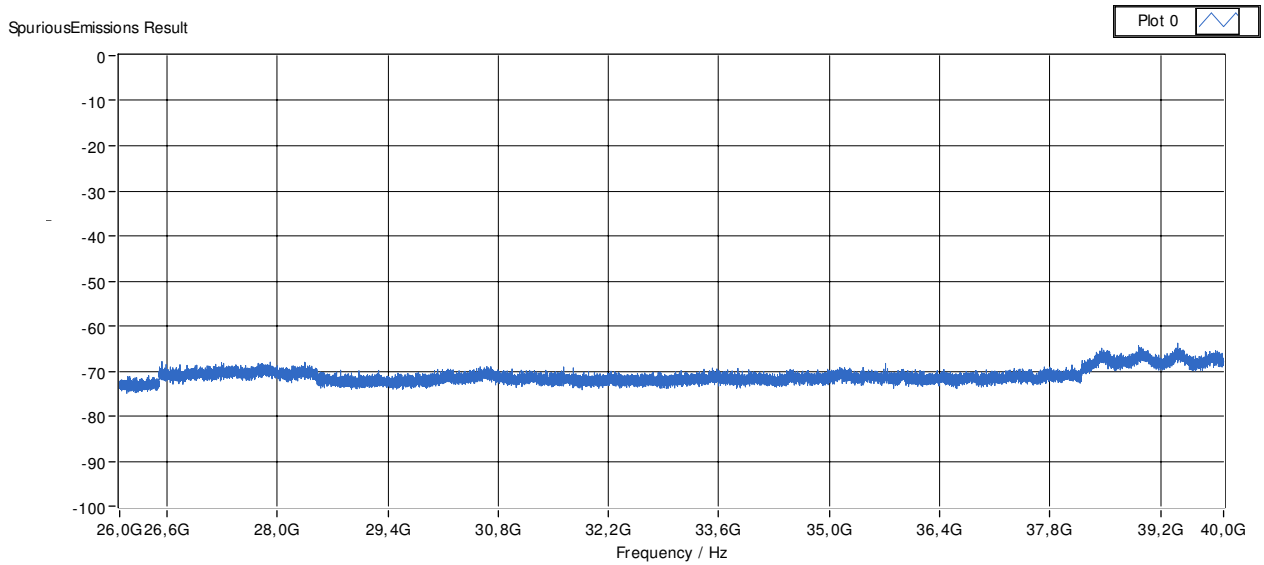

TEST EQUIPMENT USED FOR THE TEST:
30, 80

5.7.4 Method of measurement (radiated emissions)

The radiated emission measurement is subdivided into five stages.

- A preliminary measurement carried out in a fully anechoic chamber with a fixed antenna height in the frequency range 9 kHz to 1 GHz.
- A final measurement carried out on an outdoor test site without reflecting ground plane and a fixed antenna height in the frequency range 9 kHz to 30 MHz.
- A final measurement carried out on an open area test site with reflecting ground plane and various antenna height in the frequency range 30 MHz to 1 GHz.
- A preliminary measurement carried out in a fully anechoic chamber with a variable antenna distance and height in the frequency range above 1 GHz.
- A final measurement carried out in a fully anechoic chamber with a fixed antenna height in the frequency range above 1 GHz.

Preliminary measurement (9 kHz to 30 MHz):

In the first stage a preliminary measurement will be performed in a shielded room with a measuring distance of 3 meters. Tabletop devices will set up on a non-conducting support with a size of 1 m by 1.5 m and a height of 80 cm. Floor-standing devices will be placed directly on the turntable/ground plane. The set-up of the Equipment under test will be in accordance to [1].

The frequency range 9 kHz to 30 MHz will be monitored with a spectrum analyser while the system and its cables will be manipulated to find out the configuration with the maximum emission levels if applicable. The EMI Receiver will be set to MAX Hold mode. The EUT and the measuring antenna will be rotated around their vertical axis to found the maximum emissions.

The resolution bandwidth of the spectrum analyser will be set to the following values:

Frequency range	Resolution bandwidth
9 kHz to 150 kHz	200 Hz
150 kHz to 30 MHz	10 kHz

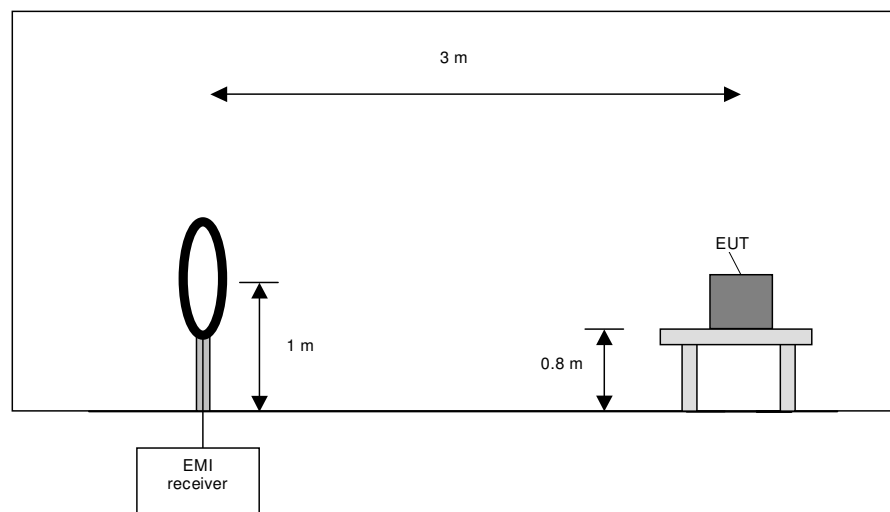

Preliminary measurement procedure:

Prescans were performed in the frequency range 9 kHz to 150 kHz and 150 kHz to 30 MHz.

The following procedure will be used:

- 1) Monitor the frequency range at horizontal polarisation and a EUT azimuth of 0 °.
- 2) Manipulate the system cables within the range to produce the maximum level of emission.
- 3) Rotate the EUT by 360 ° to maximize the detected signals.
- 4) Make a hardcopy of the spectrum.
- 5) Measure the frequencies of highest detected emission with a lower span and resolution bandwidth to increase the accuracy and note the frequency value.
- 6) Repeat steps 1) to 5) with the other orthogonal axes of the EUT (because of EUT is a module and might be used in a handheld equipment application).
- 7) Rotate the measuring antenna and repeat steps 1) to 5).

Final measurement (9 kHz to 30 MHz):

In the second stage a final measurement will be performed on an open area test site with no conducting ground plane in a measuring distances of 3 m, 10 m and 30 m. In the case where larger measuring distances are required the results will be extrapolated based on the values measured on the closer distances according to Section 15.31 (f) (2) [2]. The final measurement will be performed with a EMI Receiver set to Quasi Peak detector except for the frequency bands 9 kHz to 90 kHz and 110 kHz to 490 kHz where an average detector will be used according Section 15.209 (d) [2].

On the frequencies, which were detected during the preliminary measurements, the final measurement will be performed while rotating the EUT and the measuring antenna in the range of 0 ° to 360 ° around their vertical axis until the maximum value is found.

The resolution bandwidth of the EMI Receiver will be set to the following values:

Frequency range	Resolution bandwidth
9 kHz to 150 kHz	200 Hz
150 kHz to 30 MHz	9 kHz

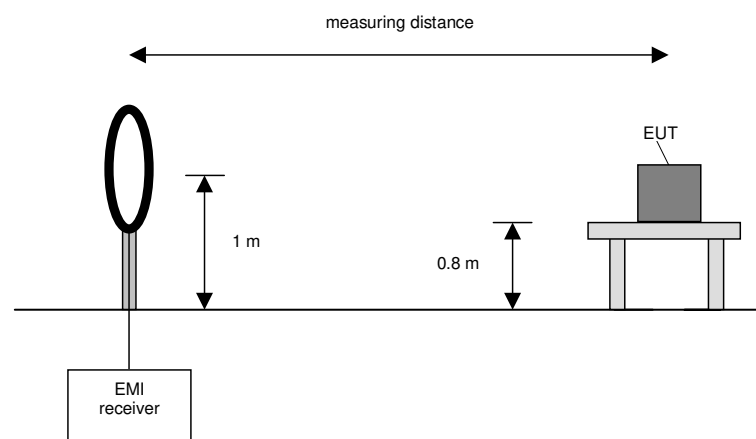

Final measurement procedure:

The following procedure will be used:

- 1) Monitor the frequency range with the measuring antenna at vertical orientation parallel to the EUT at an azimuth of 0 °.
- 2) Rotate the EUT by 360 ° to maximize the detected signals and note the azimuth and orientation.
- 3) Rotate the measuring antenna to find the maximum and note the value.
- 4) Rotate the measuring antenna and repeat steps 1) to 3) until the maximum value is found.
- 5) Repeat steps 1) to 4) with the other orthogonal axes of the EUT (if the EUT is a module and might be used in a handheld equipment application).

Preliminary measurement (30 MHz to 1 GHz)

In the first stage a preliminary measurement will be performed in a fully anechoic chamber with a measuring distance of 3 meter. Table top devices will set up on a non-conducting turn device on the height of 1.5m. Floor-standing devices will be placed directly on the turntable/ground plane. The set up of the Equipment under test will be in accordance to [1].

The frequency range 30 MHz to 1 GHz will be measured with an EMI Receiver set to MAX Hold mode and a resolution bandwidth of 100 kHz. The measurement will be performed in horizontal and vertical polarisation of the measuring antenna and while rotating the EUT in its vertical axis in the range of 0 ° to 360 °. This measurement is repeated after raising the EUT in 30° steps according 6.6.5.4 in [1].

The resolution bandwidth of the EMI Receiver will be set to the following values:

Frequency range	Resolution bandwidth
30 MHz to 230 MHz	100 kHz
230 MHz to 1 GHz	100 kHz

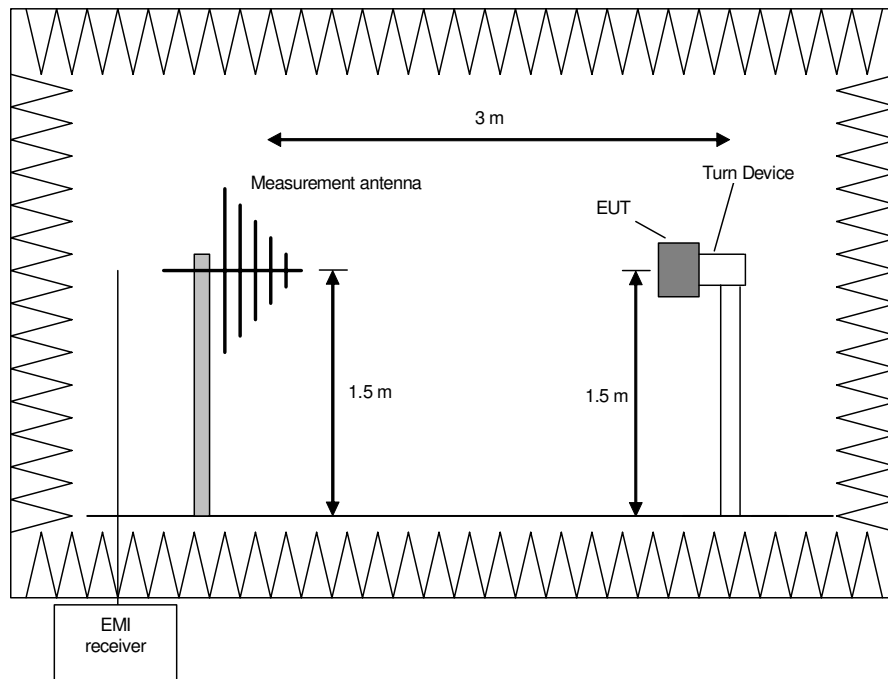

Procedure preliminary measurement:

Prescans were performed in the frequency range 30 MHz to 230 MHz and 230 MHz to 1 GHz.

The following procedure will be used:

1. Monitor the frequency range at horizontal polarisation and a EUT azimuth of 0 °.
2. Manipulate the system cables within the range to produce the maximum level of emission.
3. Rotate the EUT by 360 ° to maximize the detected signals.
4. Repeat 1) to 3) with the vertical polarisation of the measuring antenna.
5. Make a hardcopy of the spectrum.
6. Repeat 1) to 5) with the EUT raised by an angle of 30° (60°, 90°, 120° and 150°) according to 6.6.5.4 in [1].
7. Measure the frequency of the detected emissions with a lower span and resolution bandwidth to increase the accuracy and note the frequency value.

Final measurement (30 MHz to 1 GHz)

A final measurement on an open area test site will be performed on selected frequencies found in the preliminary measurement. During this test the EUT will be rotated in the range of 0 ° to 360 °, the measuring antenna will be set to horizontal and vertical polarisation and raised and lowered in the range from 1 m to 4 m to find the maximum level of emissions.

The resolution bandwidth of the EMI Receiver will be set to the following values:

Frequency range	Resolution bandwidth
30 MHz to 1 GHz	120 kHz

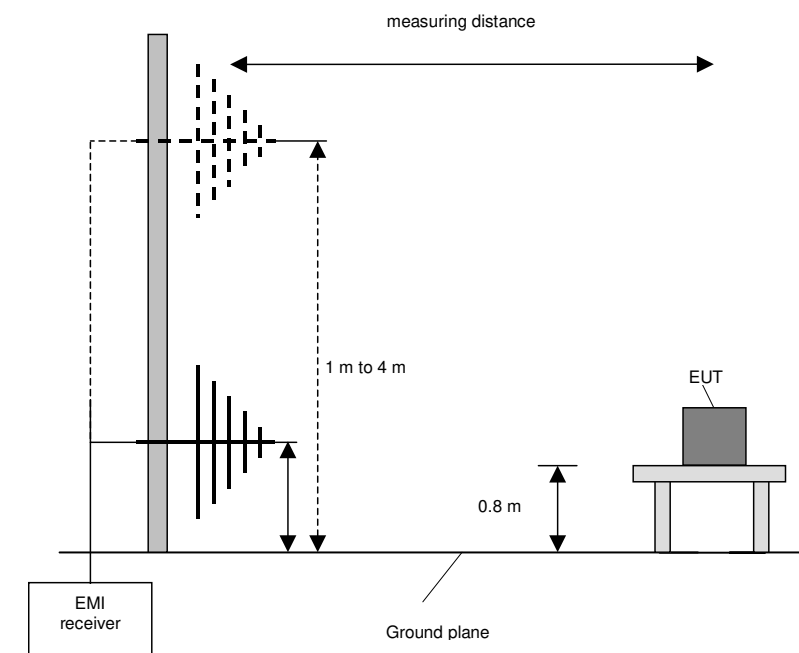

Procedure final measurement:

The following procedure will be used:

- 1) Measure on the selected frequencies at an antenna height of 1 m and a EUT azimuth of 23 °.
- 2) Move the antenna from 1 m to 4 m and note the maximum value at each frequency.
- 3) Rotate the EUT by 45 ° and repeat 2) until an azimuth of 337 ° is reached.
- 4) Repeat 1) to 3) for the other orthogonal antenna polarization.
- 5) Move the antenna and the turntable to the position where the maximum value is detected.
- 6) Measure while moving the antenna slowly +/- 1 m.
- 7) Set the antenna to the position where the maximum value is found.
- 8) Measure while moving the turntable +/- 45 °.
- 9) Set the turntable to the azimuth where the maximum value is found.
- 10) Measure with Final detector (QP and AV) and note the value.
- 11) Repeat 5) to 10) for each frequency.
- 12) Repeat 1) to 11) for each orthogonal axes of the EUT (because of EUT is a module and might be used in a handheld equipment application).

Preliminary and final measurement (1 GHz to 40 GHz)

This measurement will be performed in a fully anechoic chamber. Table top devices will set up on a non-conducting turn device on the height of 1.5m. The set-up of the Equipment under test will be in accordance to [1].

Preliminary measurement (1 GHz to 40 GHz)

The frequency range will be divided into different sub ranges depending of the frequency range of the used horn antenna. The spectrum analyser set to MAX Hold mode and a resolution bandwidth of 100 kHz. The measurement will be performed in horizontal and vertical polarisation of the measuring antenna and while rotating the EUT in its vertical axis in the range of 0 ° to 360 °. This measurement is repeated after raising the EUT in 30° steps according 6.6.5.4 in [1].

The resolution bandwidth of the EMI Receiver will be set to the following values:

Frequency range	Resolution bandwidth
1 GHz to 4 GHz	100 kHz
4 GHz to 12 GHz	100 kHz
12 GHz to 18 GHz	100 kHz
18 GHz to 25 / 26.5 GHz	100 kHz
26.5 GHz to 40 GHz	100 kHz

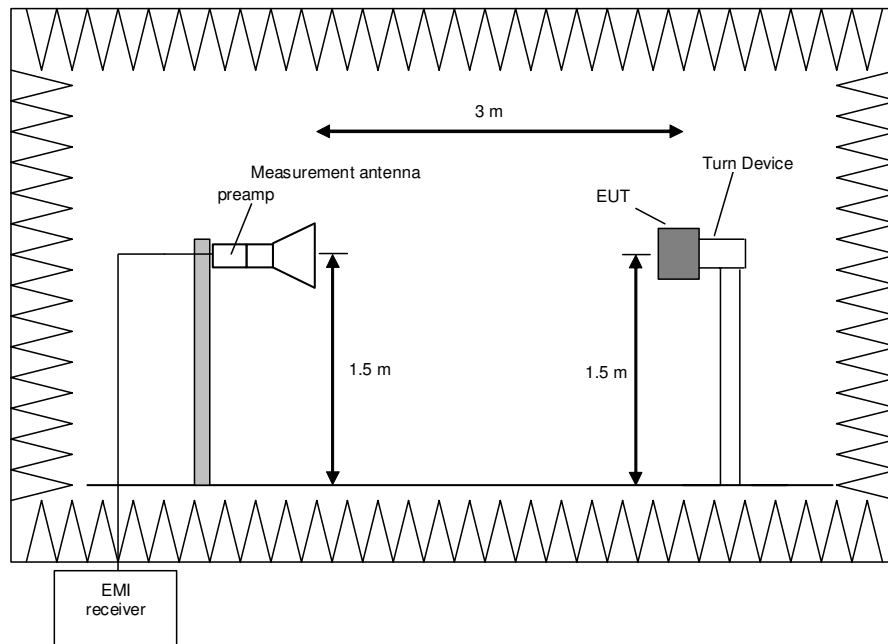

Procedure preliminary measurement:

Prescans were performed in the frequency range 1 to 40 GHz.

The following procedure will be used:

1. Monitor the frequency range at horizontal polarisation and a EUT azimuth of 0 °.
2. Rotate the EUT by 360° to maximize the detected signals.
3. Repeat 1) to 2) with the vertical polarisation of the measuring antenna.
4. Make a hardcopy of the spectrum.
5. Repeat 1) to 4) with the EUT raised by an angle of 30° (60°, 90°, 120° and 150°) according to 6.6.5.4 in [1].
6. Measure the frequency of the detected emissions with a lower span and resolution bandwidth to increase the accuracy and note the frequency value.
7. The measurement antenna polarisation, with the according EUT position (Turntable and Turn device) which produces the highest emission for each frequency will be used for the final measurement. The six closest values to the applicable limit will be used for the final measurement.

Final measurement (1 GHz to 40 GHz)

The frequency range will be divided into different sub ranges depending of the frequency range of the used horn antenna. The EMI Receiver set to peak and average mode and a resolution bandwidth of 1 MHz. The measurement will be performed by rotating the turntable through 0 to 360° in the worst-case EUT orientation which was obtained during the preliminary measurements.

The resolution bandwidth of the EMI Receiver will be set to the following values:

Frequency range	Resolution bandwidth
1 GHz to 4 GHz	1 MHz
4 GHz to 12 GHz	1 MHz
12 GHz to 18 GHz	1 MHz
18 GHz to 25 / 26.5 GHz	1 MHz
26.5 GHz to 40 GHz	1 MHz

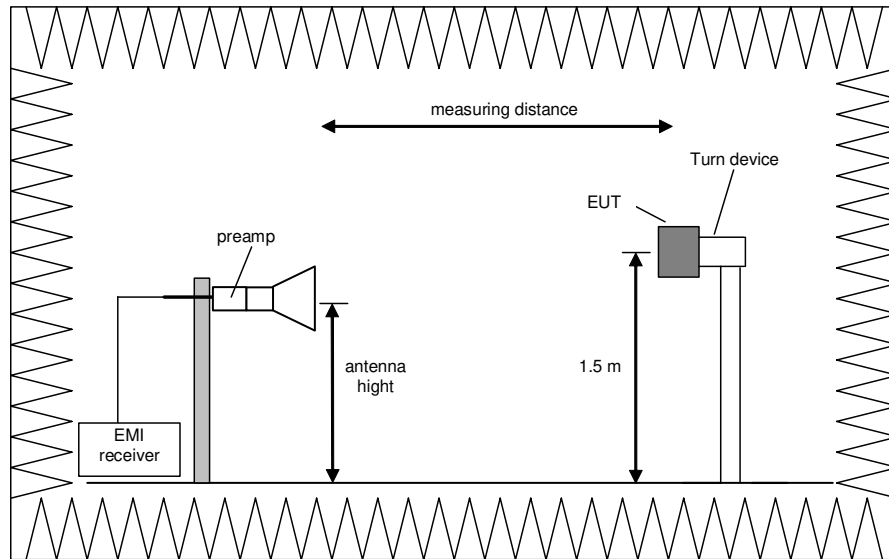

Procedure of measurement:

The measurements were performed in the frequency ranges 1 GHz to 4 GHz, 4 GHz to 12 GHz, 12 GHz to 18 GHz, 18 GHz to 25 /26.5 GHz and 26.5 GHz to 40 GHz.

The following procedure will be used:

- 1) Set the turntable and the turn device to obtain the worst-case emission for the first frequency identified in the preliminary measurements.
- 2) Set the measurement antenna polarisation to the orientation with the highest emission for the first frequency identified in the preliminary measurements.
- 3) Set the spectrum analyser to EMI mode with peak and average detector activated.
- 4) Rotate the turntable from 0° to 360° to find the TT Pos. that produces the highest emissions.
- 5) Note the highest displayed peak and average values
- 6) Repeat the steps 1) to 5) for each frequency detected during the preliminary measurements.

5.7.5 Test results (radiated emissions) – antenna emissions with each antenna type

5.7.5.1 Preliminary radiated emission measurement

The preliminary tests were performed during the conducted testing. In this test case only the final tests for the frequencies identified was failed during the conducted measurements are repeated as radiated tests. Since no emissions below 1 GHz were failed during the conducted measurement, no radiated retests for frequencies below 1 GHz were necessary.

5.7.5.2 Final radiated emission measurement (1 GHz to 25 GHz)

Ambient temperature	22 °C	Relative humidity	55 %
---------------------	-------	-------------------	------

Position of EUT:	The EUT was set-up on an EUT turn device of a height of 1.5 m. The distance between EUT and antenna was 3 m.
Cable guide:	For detail information of test set-up and the cable guide refer to the pictures in test setup photos.
Test record:	All results are shown in the following.
Supply voltage:	During all measurements the host of the EUT was powered with 24.0 V DC via a laboratory power supply.
Remark:	<p>The following measurements were failed during the conducted measurements and are repeated with each antenna type incorporating the highest gain for its type.</p> <p>If the test according to the restricted values is failed, the results are compared against unrestricted limits (if applicable).</p>

5.7.5.2.1 Results for monopole antenna

Used antenna: BAT-ANT-RSMA-2AGN-R with 5 dBi gain

Transmitter operates at the lower end of the assigned frequency band (operation mode 1)

Result measured with the peak detector:

Frequency MHz	Meas. Result dB μ V/m	Limit dB μ V/m	Margin dB	Readings dB μ V	Antenna factor 1/m	Preamp dB	Cable loss dB	Height cm	Pol.	TT Pos.
4920.0	52.4	74.0	21.6	40.1	32.8	25.0	4.4	150	Vert.	354°
5080.0	53.3	74.0	20.7	40.4	33.4	25.0	4.5	150	Vert.	0°
5000.0	55.9	74.0	18.1	43.1	33.1	24.8	4.5	150	Vert.	354°
5400.0	59.1	74.0	14.9	45.4	33.8	24.8	4.7	150	Vert.	254°
5320.0	55.9	74.0	18.1	42.8	33.6	25.1	4.6	150	Vert.	232°
5480.0	59.1	74.0	14.9	45.0	34.0	24.6	4.7	150	Hor.	257°
Measurement uncertainty				+2.2 dB / -3.6 dB						

Result measured with the average detector:

Frequency MHz	Meas. Result dB μ V/m	Limit dB μ V/m	Margin dB	Readings dB μ V	Antenna factor 1/m	Preamp dB	Cable loss dB	Height cm	Pol.	TT Pos.
4920.0	45.8	54.0	8.2	33.5	32.8	25.0	4.4	150	Vert.	360
5080.0	44.5	54.0	9.5	31.6	33.4	25.0	4.5	150	Vert.	3
5000.0	47.6	54.0	6.4	34.8	33.1	24.8	4.5	150	Vert.	357
5400.0	52.9	54.0	1.1	39.2	33.8	24.8	4.7	150	Vert.	254
5320.0	48.2	54.0	5.8	35.1	33.6	25.1	4.6	150	Hor.	213
5480.0	51.7	54.0	2.3	37.6	34.0	24.6	4.7	150	Hor.	249
Measurement uncertainty				+2.2 dB / -3.6 dB						

Transmitter operates at the middle of the assigned frequency band (operation mode 2)

Result measured with the peak detector:

Frequency MHz	Meas. Result dB μ V/m	Limit dB μ V/m	Margin dB	Readings dB μ V	Antenna factor 1/m	Preamp dB	Cable loss dB	Height cm	Pol.	TT Pos.
4920.0	54.8	74.0	19.2	42.5	32.8	25.0	4.4	150	Vert.	3°
4880.0	52.8	74.0	21.2	40.7	32.8	25.1	4.4	150	Vert.	0°
5000.0	55.4	74.0	18.6	42.6	33.1	24.8	4.5	150	Vert.	360°
5400.0	58.7	74.0	15.3	45.0	33.8	24.8	4.7	150	Vert.	253°
5480.0	58.3	74.0	15.7	44.2	34.0	24.6	4.7	150	Vert.	245°
5320.0	55.7	74.0	18.3	42.6	33.6	25.1	4.6	150	Hor.	218°
Measurement uncertainty				+2.2 dB / -3.6 dB						

Result measured with the average detector:

Frequency MHz	Meas. Result dB μ V/m	Limit dB μ V/m	Margin dB	Readings dB μ V	Antenna factor 1/m	Preamp dB	Cable loss dB	Height cm	Pol.	TT Pos.
4920.0	49.6	54.0	4.4	37.3	32.8	25.0	4.4	150	Vert.	3°
4880.0	46.4	54.0	7.6	34.3	32.8	25.1	4.4	150	Vert.	0°
5000.0	47.5	54.0	6.5	34.7	33.1	24.8	4.5	150	Vert.	354°
5400.0	51.9	54.0	2.1	38.2	33.8	24.8	4.7	150	Vert.	253°
5480.0	51.1	54.0	2.9	37.0	34.0	24.6	4.7	150	Hor.	245°
5320.0	47.5	54.0	6.5	34.4	33.6	25.1	4.6	150	Hor.	218°
Measurement uncertainty				+2.2 dB / -3.6 dB						

Transmitter operates at the upper end of the assigned frequency band (operation mode 3)

Result measured with the peak detector:

Frequency MHz	Meas. Result dB μ V/m	Limit dB μ V/m	Margin dB	Readings dB μ V	Antenna factor 1/m	Preamp dB	Cable loss dB	Height cm	Pol.	TT Pos.	
4920.0	51.9	74.0	22.1	39.6	32.8	25.0	4.4	150	Vert.	1°	
5080.0	51.0	74.0	23.0	38.1	33.4	25.0	4.5	150	Vert.	6°	
5000.0	54.6	74.0	19.4	41.8	33.1	24.8	4.5	150	Vert.	0°	
5400.0	58.0	74.0	16.0	44.3	33.8	24.8	4.7	150	Vert.	254°	
5480.0	57.2	74.0	16.8	43.1	34.0	24.6	4.7	150	Vert.	250°	
5320.0	54.7	74.0	19.3	41.6	33.6	25.1	4.6	150	Hor.	10°	
Measurement uncertainty				+2.2 dB / -3.6 dB							

Result measured with the average detector:

Frequency MHz	Meas. Result dB μ V/m	Limit dB μ V/m	Margin dB	Readings dB μ V	Antenna factor 1/m	Preamp dB	Cable loss dB	Height cm	Pol.	TT Pos.	
4920.0	44.9	54.0	9.1	32.6	32.8	25.0	4.4	150	Vert.	3°	
5080.0	39.7	54.0	14.3	26.8	33.4	25.0	4.5	150	Vert.	0°	
5000.0	47.2	54.0	6.8	34.4	33.1	24.8	4.5	150	Vert.	23°	
5400.0	53.0	54.0	1.0	39.3	33.8	24.8	4.7	150	Vert.	250°	
5480.0	50.2	54.0	3.8	36.1	34.0	24.6	4.7	150	Hor.	243°	
5320.0	46.1	54.0	7.9	33.0	33.6	25.1	4.6	150	Hor.	219°	
Measurement uncertainty				+2.2 dB / -3.6 dB							

Transmitter operates at the lower end of the assigned frequency band (operation mode 4)

Result measured with the peak detector:

Frequency MHz	Meas. Result dB μ V/m	Limit dB μ V/m	Margin dB	Readings dB μ V	Antenna factor 1/m	Preamp dB	Cable loss dB	Height cm	Pol.	TT Pos.
5160.0	54.9	74.0	19.1	41.9	33.7	25.2	4.6	150	Vert.	224°
5400.0	57.9	74.0	16.1	44.2	33.8	24.8	4.7	150	Vert.	360°
4920.0	52.1	74.0	21.9	39.8	32.8	25.0	4.4	150	Vert.	357°
5000.0	54.1	74.0	19.9	41.3	33.1	24.8	4.5	150	Vert.	288°
4880.0	50.9	74.0	23.1	38.8	32.8	25.1	4.4	150	Vert.	0°
4960.0	51.8	74.0	22.2	39.7	32.9	25.3	4.5	150	Hor.	358°
Measurement uncertainty				+2.2 dB / -3.6 dB						

Result measured with the average detector:

Frequency MHz	Meas. Result dB μ V/m	Limit dB μ V/m	Margin dB	Readings dB μ V	Antenna factor 1/m	Preamp dB	Cable loss dB	Height cm	Pol.	TT Pos.
5160.0	50.6	54.0	3.4	37.6	33.7	25.2	4.6	150	Vert.	224°
5400.0	50.9	54.0	3.1	37.2	33.8	24.8	4.7	150	Vert.	360°
4920.0	46.1	54.0	7.9	33.8	32.8	25.0	4.4	150	Vert.	360°
5000.0	46.4	54.0	7.6	33.6	33.1	24.8	4.5	150	Vert.	292°
4880.0	44.0	54.0	10.0	31.9	32.8	25.1	4.4	150	Hor.	0°
4960.0	45.8	54.0	8.2	33.7	32.9	25.3	4.5	150	Hor.	358°
Measurement uncertainty				+2.2 dB / -3.6 dB						

Transmitter operates at the middle of the assigned frequency band (operation mode 5)

Result measured with the peak detector:

Frequency MHz	Meas. Result dB μ V/m	Limit dB μ V/m	Margin dB	Readings dB μ V	Antenna factor 1/m	Preamp dB	Cable loss dB	Height cm	Pol.	TT Pos.
4920.0	53.9	74.0	20.1	41.6	32.8	25.0	4.4	150	Vert.	358°
5160.0	55.8	74.0	18.2	42.8	33.7	25.2	4.6	150	Vert.	230°
5000.0	55.5	74.0	18.5	42.7	33.1	24.8	4.5	150	Vert.	357°
5440.0	59.4	74.0	14.6	45.8	33.9	25.0	4.7	150	Vert.	251°
5400.0	56.3	74.0	17.7	42.6	33.8	24.8	4.7	150	Vert.	230°
5360.0	56.6	74.0	17.4	43.2	33.7	24.9	4.6	150	Hor.	360°
Measurement uncertainty				+2.2 dB / -3.6 dB						

Result measured with the average detector:

Frequency MHz	Meas. Result dB μ V/m	Limit dB μ V/m	Margin dB	Readings dB μ V	Antenna factor 1/m	Preamp dB	Cable loss dB	Height cm	Pol.	TT Pos.
5160.0	51.9	54.0	2.1	38.9	33.7	25.2	4.6	150	Vert.	360°
5000.0	47.8	54.0	6.2	35.0	33.1	24.8	4.5	150	Vert.	230°
5440.0	53.6	54.0	0.4	40.0	33.9	25.0	4.7	150	Vert.	286°
5400.0	47.3	54.0	6.7	33.6	33.8	24.8	4.7	150	Hor.	251°
5360.0	50.5	54.0	3.5	37.1	33.7	24.9	4.6	150	Hor.	244°
5160.0	51.9	54.0	2.1	38.9	33.7	25.2	4.6	150	Vert.	238°
Measurement uncertainty				+2.2 dB / -3.6 dB						

Transmitter operates at the upper end of the assigned frequency band (operation mode 6)

Result measured with the peak detector:

Frequency MHz	Meas. Result dB μ V/m	Limit dB μ V/m	Margin dB	Readings dB μ V	Antenna factor 1/m	Preamp dB	Cable loss dB	Height cm	Pol.	TT Pos.
5400.0	59.0	74.0	15.0	45.3	33.8	24.8	4.7	150	Vert.	249°
5160.0	52.3	74.0	21.7	39.3	33.7	25.2	4.6	150	Vert.	0°
5000.0	55.4	74.0	18.6	42.6	33.1	24.8	4.5	150	Vert.	293°
4920.0	52.4	74.0	21.6	40.1	32.8	25.0	4.4	150	Vert.	3°
5480.0	58.7	74.0	15.3	44.6	34.0	24.6	4.7	150	Vert.	245°
5320.0	55.7	74.0	18.3	42.6	33.6	25.1	4.6	150	Hor.	0°
Measurement uncertainty				+2.2 dB / -3.6 dB						

Result measured with the average detector:

Frequency MHz	Meas. Result dB μ V/m	Limit dB μ V/m	Margin dB	Readings dB μ V	Antenna factor 1/m	Preamp dB	Cable loss dB	Height cm	Pol.	TT Pos.
5400.0	50.9	54.0	3.1	37.2	33.8	24.8	4.7	150	Vert.	149°
5160.0	41.6	54.0	12.4	28.6	33.7	25.2	4.6	150	Vert.	282°
5000.0	48.2	54.0	5.8	35.4	33.1	24.8	4.5	150	Vert.	293°
4920.0	44.7	54.0	9.3	32.4	32.8	25.0	4.4	150	Vert.	1°
5480.0	48.7	54.0	5.3	34.6	34.0	24.6	4.7	150	Hor.	245°
5320.0	44.2	54.0	9.8	31.1	33.6	25.1	4.6	150	Hor.	358°
Measurement uncertainty				+2.2 dB / -3.6 dB						

Transmitter operates at the lower end of the assigned frequency band (operation mode 7)

Result measured with the peak detector:

Frequency MHz	Meas. Result dB μ V/m	Limit dB μ V/m	Margin dB	Readings dB μ V	Antenna factor 1/m	Preamp dB	Cable loss dB	Height cm	Pol.	TT Pos.
5000.0	55.4	74.0	18.6	42.6	33.1	24.8	4.5	150	Vert.	0°
4920.0	54.6	74.0	19.4	42.3	32.8	25.0	4.4	150	Vert.	3°
5400.0	58.2	74.0	15.8	44.5	33.8	24.8	4.7	150	Vert.	243°
5480.0	58.8	74.0	15.2	44.7	34.0	24.6	4.7	150	Vert.	249°
5320.0	55.2	74.0	18.8	42.1	33.6	25.1	4.6	150	Vert.	232°
5560.0	55.7	74.0	18.3	41.7	34.0	24.7	4.7	150	Hor.	153°
Measurement uncertainty				+2.2 dB / -3.6 dB						

Result measured with the average detector:

Frequency MHz	Meas. Result dB μ V/m	Limit dB μ V/m	Margin dB	Readings dB μ V	Antenna factor 1/m	Preamp dB	Cable loss dB	Height cm	Pol.	TT Pos.
5000.0	47.5	54.0	6.5	34.7	33.1	24.8	4.5	150	Vert.	357°
4920.0	49.7	54.0	4.3	37.4	32.8	25.0	4.4	150	Vert.	5°
5400.0	52.1	54.0	1.9	38.4	33.8	24.8	4.7	150	Vert.	246°
5480.0	51.3	54.0	2.7	37.2	34.0	24.6	4.7	150	Vert.	249°
5320.0	47.5	54.0	6.5	34.4	33.6	25.1	4.6	150	Hor.	212°
5560.0	46.2	54.0	7.8	32.2	34.0	24.7	4.7	150	Hor.	249°
Measurement uncertainty				+2.2 dB / -3.6 dB						

Transmitter operates at the middle of the assigned frequency band (operation mode 8)

Result measured with the peak detector:

Frequency MHz	Meas. Result dB μ V/m	Limit dB μ V/m	Margin dB	Readings dB μ V	Antenna factor 1/m	Preamp dB	Cable loss dB	Height cm	Pol.	TT Pos.
4920.0	54.4	74.0	19.6	42.1	32.8	25.0	4.4	150	Vert.	360°
5080.0	52.6	74.0	21.4	39.7	33.4	25.0	4.5	150	Vert.	0°
5000.0	55.4	74.0	18.6	42.6	33.1	24.8	4.5	150	Vert.	0°
5400.0	58.3	74.0	15.7	44.6	33.8	24.8	4.7	150	Vert.	149°
5480.0	59.4	74.0	14.6	45.3	34.0	24.6	4.7	150	Vert.	249°
5320.0	55.6	74.0	18.4	42.5	33.6	25.1	4.6	150	Hor.	212°
Measurement uncertainty				+2.2 dB / -3.6 dB						

Result measured with the average detector:

Frequency MHz	Meas. Result dB μ V/m	Limit dB μ V/m	Margin dB	Readings dB μ V	Antenna factor 1/m	Preamp dB	Cable loss dB	Height cm	Pol.	TT Pos.
4920.0	49.7	54.0	4.3	37.4	32.8	25.0	4.4	150	Vert.	360°
5080.0	43.7	54.0	10.3	30.8	33.4	25.0	4.5	150	Vert.	1°
5000.0	47.4	54.0	6.6	34.6	33.1	24.8	4.5	150	Vert.	27°
5400.0	52.4	54.0	1.6	38.7	33.8	24.8	4.7	150	Vert.	149°
5480.0	53.3	54.0	0.7	39.2	34.0	24.6	4.7	150	Hor.	249°
5320.0	48.5	54.0	5.5	35.4	33.6	25.1	4.6	150	Hor.	212°
Measurement uncertainty				+2.2 dB / -3.6 dB						

Transmitter operates at the upper end of the assigned frequency band (operation mode 9)

Result measured with the peak detector:

Frequency MHz	Meas. Result dB μ V/m	Limit dB μ V/m	Margin dB	Readings dB μ V	Antenna factor 1/m	Preamp dB	Cable loss dB	Height cm	Pol.	TT Pos.
4920.0	52.4	74.0	21.6	40.1	32.8	25.0	4.4	150	Vert.	360°
5080.0	52.3	74.0	21.7	39.4	33.4	25.0	4.5	150	Vert.	218°
5000.0	52.5	74.0	21.5	39.7	33.1	24.8	4.5	150	Vert.	358°
5400.0	53.1	74.0	20.9	39.4	33.8	24.8	4.7	150	Vert.	360°
5480.0	55.4	74.0	18.6	41.3	34.0	24.6	4.7	150	Vert.	262°
5320.0	53.2	74.0	20.8	40.1	33.6	25.1	4.6	150	Hor.	246°
Measurement uncertainty				+2.2 dB / -3.6 dB						

Result measured with the average detector:

Frequency MHz	Meas. Result dB μ V/m	Limit dB μ V/m	Margin dB	Readings dB μ V	Antenna factor 1/m	Preamp dB	Cable loss dB	Height cm	Pol.	TT Pos.
4920.0	45.3	54.0	8.7	33.0	32.8	25.0	4.4	150	Vert.	360°
5080.0	44.8	54.0	9.2	31.9	33.4	25.0	4.5	150	Vert.	218°
5000.0	44.2	54.0	9.8	31.4	33.1	24.8	4.5	150	Vert.	26°
5400.0	41.9	54.0	12.1	28.2	33.8	24.8	4.7	150	Vert.	152°
5480.0	46.6	54.0	7.4	32.5	34.0	24.6	4.7	150	Hor.	244°
5320.0	44.5	54.0	9.5	31.4	33.6	25.1	4.6	150	Hor.	238°
Measurement uncertainty				+2.2 dB / -3.6 dB						

Transmitter operates at the lower end of the assigned frequency band (operation mode 10)

Result measured with the peak detector:

Frequency MHz	Meas. Result dB μ V/m	Limit dB μ V/m	Margin dB	Readings dB μ V	Antenna factor 1/m	Preamp dB	Cable loss dB	Height cm	Pol.	TT Pos.
5160.0	55.1	74.0	18.9	42.1	33.7	25.2	4.6	150	Vert.	262°
5400.0	57.2	74.0	16.8	43.5	33.8	24.8	4.7	150	Vert.	360°
4920.0	52.2	74.0	21.8	39.9	32.8	25.0	4.4	150	Vert.	357°
5000.0	54.6	74.0	19.4	41.8	33.1	24.8	4.5	150	Vert.	5°
4880.0	50.5	74.0	23.5	38.4	32.8	25.1	4.4	150	Vert.	0°
4960.0	50.5	74.0	23.5	38.4	32.9	25.3	4.5	150	Hor.	360°
Measurement uncertainty				+2.2 dB / -3.6 dB						

Result measured with the average detector:

Frequency MHz	Meas. Result dB μ V/m	Limit dB μ V/m	Margin dB	Readings dB μ V	Antenna factor 1/m	Preamp dB	Cable loss dB	Height cm	Pol.	TT Pos.
5160.0	50.8	54.0	3.2	37.8	33.7	25.2	4.6	150	Vert.	224°
5400.0	50.3	54.0	3.7	36.6	33.8	24.8	4.7	150	Vert.	360°
4920.0	46.4	54.0	7.6	34.1	32.8	25.0	4.4	150	Vert.	360°
5000.0	46.4	54.0	7.6	33.6	33.1	24.8	4.5	150	Vert.	4°
4880.0	43.3	54.0	10.7	31.2	32.8	25.1	4.4	150	Hor.	0°
4960.0	42.3	54.0	11.7	30.2	32.9	25.3	4.5	150	Hor.	358°
Measurement uncertainty				+2.2 dB / -3.6 dB						

Transmitter operates at the middle of the assigned frequency band (operation mode 11)

Result measured with the peak detector:

Frequency MHz	Meas. Result dB μ V/m	Limit dB μ V/m	Margin dB	Readings dB μ V	Antenna factor 1/m	Preamp dB	Cable loss dB	Height cm	Pol.	TT Pos.
4920.0	52.0	74.0	22.0	39.7	32.8	25.0	4.4	150	Vert.	359°
5160.0	56.4	74.0	17.6	43.4	33.7	25.2	4.6	150	Vert.	231°
5000.0	55.4	74.0	18.6	42.6	33.1	24.8	4.5	150	Vert.	0°
5440.0	59.4	74.0	14.6	45.8	33.9	25.0	4.7	150	Vert.	251°
5400.0	56.7	74.0	17.3	43.0	33.8	24.8	4.7	150	Vert.	5°
5360.0	56.9	74.0	17.1	43.5	33.7	24.9	4.6	150	Hor.	242°
Measurement uncertainty				+2.2 dB / -3.6 dB						

Result measured with the average detector:

Frequency MHz	Meas. Result dB μ V/m	Limit dB μ V/m	Margin dB	Readings dB μ V	Antenna factor 1/m	Preamp dB	Cable loss dB	Height cm	Pol.	TT Pos.
4920.0	43.7	54.0	10.3	31.4	32.8	25.0	4.4	150	Vert.	360°
5160.0	52.0	54.0	2.0	39.0	33.7	25.2	4.6	150	Vert.	231°
5000.0	47.7	54.0	6.3	34.9	33.1	24.8	4.5	150	Vert.	287°
5440.0	53.6	54.0	0.4	40.0	33.9	25.0	4.7	150	Vert.	251°
5400.0	45.2	54.0	8.8	31.5	33.8	24.8	4.7	150	Hor.	241°
5360.0	50.6	54.0	3.4	37.2	33.7	24.9	4.6	150	Hor.	238°
Measurement uncertainty				+2.2 dB / -3.6 dB						

Transmitter operates at the upper end of the assigned frequency band (operation mode 12)

Result measured with the peak detector:

Frequency MHz	Meas. Result dB μ V/m	Limit dB μ V/m	Margin dB	Readings dB μ V	Antenna factor 1/m	Preamp dB	Cable loss dB	Height cm	Pol.	TT Pos.
5400.0	57.3	74.0	16.7	43.6	33.8	24.8	4.7	150	Vert.	250°
5160.0	56.1	74.0	17.9	43.1	33.7	25.2	4.6	150	Vert.	225°
5000.0	55.5	74.0	18.5	42.7	33.1	24.8	4.5	150	Vert.	199°
4920.0	54.4	74.0	19.6	42.1	32.8	25.0	4.4	150	Vert.	5°
5480.0	58.1	74.0	15.9	44.0	34.0	24.6	4.7	150	Vert.	242°
5320.0	54.5	74.0	19.5	41.4	33.6	25.1	4.6	150	Hor.	1°
Measurement uncertainty				+2.2 dB / -3.6 dB						

Result measured with the average detector:

Frequency MHz	Meas. Result dB μ V/m	Limit dB μ V/m	Margin dB	Readings dB μ V	Antenna factor 1/m	Preamp dB	Cable loss dB	Height cm	Pol.	TT Pos.
5400.0	50.8	54.0	3.2	37.1	33.8	24.8	4.7	150	Vert.	212°
5160.0	51.7	54.0	2.3	38.7	33.7	25.2	4.6	150	Vert.	225°
5000.0	48.1	54.0	5.9	35.3	33.1	24.8	4.5	150	Vert.	292°
4920.0	49.5	54.0	4.5	37.2	32.8	25.0	4.4	150	Vert.	1°
5480.0	51.1	54.0	2.9	37.0	34.0	24.6	4.7	150	Hor.	246°
5320.0	46.1	54.0	7.9	33.0	33.6	25.1	4.6	150	Hor.	236°
Measurement uncertainty				+2.2 dB / -3.6 dB						

Transmitter operates at the lower end of the assigned frequency band (operation mode 13)

Result measured with the peak detector:

Frequency MHz	Meas. Result dB μ V/m	Limit dB μ V/m	Margin dB	Readings dB μ V	Antenna factor 1/m	Preamp dB	Cable loss dB	Height cm	Pol.	TT Pos.
4920.0	52.9	74.0	21.1	40.6	32.8	25.0	4.4	150	Vert.	360°
5080.0	53.5	74.0	20.5	40.6	33.4	25.0	4.5	150	Vert.	0°
5000.0	55.5	74.0	18.5	42.7	33.1	24.8	4.5	150	Vert.	350°
5400.0	59.4	74.0	14.6	45.7	33.8	24.8	4.7	150	Vert.	250°
5480.0	58.4	74.0	15.6	44.3	34.0	24.6	4.7	150	Vert.	246°
5320.0	55.0	74.0	19.0	41.9	33.6	25.1	4.6	150	Hor.	218°
+2.2 dB / -3.6 dB				+2.2 dB / -3.6 dB						

Result measured with the average detector:

Frequency MHz	Meas. Result dB μ V/m	Limit dB μ V/m	Margin dB	Readings dB μ V	Antenna factor 1/m	Preamp dB	Cable loss dB	Height cm	Pol.	TT Pos.
4920.0	45.8	54.0	8.2	33.5	32.8	25.0	4.4	150	Vert.	360°
5080.0	44.4	54.0	9.6	31.5	33.4	25.0	4.5	150	Vert.	4°
5000.0	47.5	54.0	6.5	34.7	33.1	24.8	4.5	150	Vert.	357°
5400.0	53.6	54.0	0.4	39.9	33.8	24.8	4.7	150	Vert.	253°
5480.0	51.4	54.0	2.6	37.3	34.0	24.6	4.7	150	Hor.	246°
5320.0	47.6	54.0	6.4	34.5	33.6	25.1	4.6	150	Hor.	238°
Measurement uncertainty				+2.2 dB / -3.6 dB						

Transmitter operates at the upper end of the assigned frequency band (operation mode 14)

Result measured with the peak detector:

Frequency MHz	Meas. Result dB μ V/m	Limit dB μ V/m	Margin dB	Readings dB μ V	Antenna factor 1/m	Preamp dB	Cable loss dB	Height cm	Pol.	TT Pos.	
4920.0	52.7	74.0	21.3	40.4	32.8	25.0	4.4	150	Vert.	7°	
5080.0	50.8	74.0	23.2	37.9	33.4	25.0	4.5	150	Vert.	360°	
5000.0	52.7	74.0	21.3	39.9	33.1	24.8	4.5	150	Vert.	356°	
5400.0	57.6	74.0	16.4	43.9	33.8	24.8	4.7	150	Vert.	285°	
5480.0	56.9	74.0	17.1	42.8	34.0	24.6	4.7	150	Vert.	241°	
5320.0	54.2	74.0	19.8	41.1	33.6	25.1	4.6	150	Hor.	246°	
Measurement uncertainty				+2.2 dB / -3.6 dB							

Result measured with the average detector:

Frequency MHz	Meas. Result dB μ V/m	Limit dB μ V/m	Margin dB	Readings dB μ V	Antenna factor 1/m	Preamp dB	Cable loss dB	Height cm	Pol.	TT Pos.	
4920.0	47.2	54.0	6.8	34.9	32.8	25.0	4.4	150	Vert.	4°	
5080.0	39.3	54.0	14.7	26.4	33.4	25.0	4.5	150	Vert.	360°	
5000.0	46.1	54.0	7.9	33.3	33.1	24.8	4.5	150	Vert.	25°	
5400.0	52.1	54.0	1.9	38.4	33.8	24.8	4.7	150	Vert.	253°	
5480.0	50.5	54.0	3.5	36.4	34.0	24.6	4.7	150	Hor.	245°	
5320.0	46.9	54.0	7.1	33.8	33.6	25.1	4.6	150	Hor.	253°	
Measurement uncertainty				+2.2 dB / -3.6 dB							

Transmitter operates at the lower end of the assigned frequency band (operation mode 15)

Result measured with the peak detector:

Frequency MHz	Meas. Result dB μ V/m	Limit dB μ V/m	Margin dB	Readings dB μ V	Antenna factor 1/m	Preamp dB	Cable loss dB	Height cm	Pol.	TT Pos.
5160.0	52.8	74.0	21.2	39.8	33.7	25.2	4.6	150	Vert.	353°
5400.0	57.5	74.0	16.5	43.8	33.8	24.8	4.7	150	Vert.	359°
4920.0	50.9	74.0	23.1	38.6	32.8	25.0	4.4	150	Vert.	360°
5000.0	54.1	74.0	19.9	41.3	33.1	24.8	4.5	150	Vert.	292°
4880.0	51.2	74.0	22.8	39.1	32.8	25.1	4.4	150	Vert.	1°
4960.0	52.8	74.0	21.2	40.7	32.9	25.3	4.5	150	Hor.	360°
Measurement uncertainty				+2.2 dB / -3.6 dB						

Result measured with the average detector:

Frequency MHz	Meas. Result dB μ V/m	Limit dB μ V/m	Margin dB	Readings dB μ V	Antenna factor 1/m	Preamp dB	Cable loss dB	Height cm	Pol.	TT Pos.
5160.0	46.2	54.0	7.8	33.2	33.7	25.2	4.6	150	Vert.	348°
5400.0	50.5	54.0	3.5	36.8	33.8	24.8	4.7	150	Vert.	360°
4920.0	43.5	54.0	10.5	31.2	32.8	25.0	4.4	150	Vert.	360°
5000.0	46.2	54.0	7.8	33.4	33.1	24.8	4.5	150	Vert.	292°
4880.0	45.1	54.0	8.9	33.0	32.8	25.1	4.4	150	Hor.	1°
4960.0	46.6	54.0	7.4	34.5	32.9	25.3	4.5	150	Hor.	358°
Measurement uncertainty				+2.2 dB / -3.6 dB						

Transmitter operates at the upper end of the assigned frequency band (operation mode 16)

Result measured with the peak detector:

Frequency MHz	Meas. Result dB μ V/m	Limit dB μ V/m	Margin dB	Readings dB μ V	Antenna factor 1/m	Preamp dB	Cable loss dB	Height cm	Pol.	TT Pos.	
4920.0	52.4	74.0	21.6	40.1	32.8	25.0	4.4	150	Vert.	9°	
5160.0	50.1	74.0	23.9	37.1	33.7	25.2	4.6	150	Vert.	359°	
5000.0	54.4	74.0	19.6	41.6	33.1	24.8	4.5	150	Vert.	349°	
5440.0	59.0	74.0	15.0	45.4	33.9	25.0	4.7	150	Vert.	277°	
5400.0	58.6	74.0	15.4	44.9	33.8	24.8	4.7	150	Vert.	241°	
5360.0	57.4	74.0	16.6	44.0	33.7	24.9	4.6	150	Hor.	3°	
Measurement uncertainty				+2.2 dB / -3.6 dB							

Result measured with the average detector:

Frequency MHz	Meas. Result dB μ V/m	Limit dB μ V/m	Margin dB	Readings dB μ V	Antenna factor 1/m	Preamp dB	Cable loss dB	Height cm	Pol.	TT Pos.	
4920.0	46.0	54.0	8.0	33.7	32.8	25.0	4.4	150	Vert.	1°	
5160.0	37.9	54.0	16.1	24.9	33.7	25.2	4.6	150	Vert.	289°	
5000.0	47.6	54.0	6.4	34.8	33.1	24.8	4.5	150	Vert.	288°	
5440.0	51.5	54.0	2.5	37.9	33.9	25.0	4.7	150	Vert.	250°	
5400.0	50.2	54.0	3.8	36.5	33.8	24.8	4.7	150	Hor.	241°	
5360.0	49.4	54.0	4.6	36.0	33.7	24.9	4.6	150	Hor.	238°	
Measurement uncertainty				+2.2 dB / -3.6 dB							

5.7.5.2.2 Results for patch antenna

Used antenna: BAT-ANT-N-9A-DS-IP65 with 9 dBi gain

Transmitter operates at the lower end of the assigned frequency band (operation mode 1)

Result measured with the peak detector:

Frequency MHz	Meas. Result dB μ V/m	Limit dB μ V/m	Margin dB	Readings dB μ V	Antenna factor 1/m	Preamp dB	Cable loss dB	Height cm	Pol.	TT Pos.
4920.0	54.5	74.0	19.5	42.2	32.8	25.0	4.4	150	Vert.	4°
5080.0	52.6	74.0	21.4	39.7	33.4	25.0	4.5	150	Vert.	4°
5000.0	53.6	74.0	20.4	40.8	33.1	24.8	4.5	150	Vert.	349°
5400.0	57.6	74.0	16.4	43.9	33.8	24.8	4.7	150	Vert.	0°
5320.0	54.4	74.0	19.6	41.3	33.6	25.1	4.6	150	Vert.	0°
5480.0	58.6	74.0	15.4	44.5	34.0	24.6	4.7	150	Hor.	4°
Measurement uncertainty				+2.2 dB / -3.6 dB						

Result measured with the average detector:

Frequency MHz	Meas. Result dB μ V/m	Limit dB μ V/m	Margin dB	Readings dB μ V	Antenna factor 1/m	Preamp dB	Cable loss dB	Height cm	Pol.	TT Pos.
4920.0	49.8	54.0	4.2	37.5	32.8	25.0	4.4	150	Vert.	9°
5080.0	43.9	54.0	10.1	31.0	33.4	25.0	4.5	150	Vert.	1°
5000.0	45.3	54.0	8.7	32.5	33.1	24.8	4.5	150	Vert.	346°
5400.0	50.2	54.0	3.8	36.5	33.8	24.8	4.7	150	Vert.	0°
5320.0	45.8	54.0	8.2	32.7	33.6	25.1	4.6	150	Hor.	5°
5480.0	51.9	54.0	2.1	37.8	34.0	24.6	4.7	150	Hor.	6°
Measurement uncertainty				+2.2 dB / -3.6 dB						

Transmitter operates at the middle of the assigned frequency band (operation mode 2)

Result measured with the peak detector:

Frequency MHz	Meas. Result dB μ V/m	Limit dB μ V/m	Margin dB	Readings dB μ V	Antenna factor 1/m	Preamp dB	Cable loss dB	Height cm	Pol.	TT Pos.
5000.0	53.2	74.0	20.8	40.4	33.1	24.8	4.5	150	Vert.	344°
5400.0	57.6	74.0	16.4	43.9	33.8	24.8	4.7	150	Vert.	0°
5480.0	58.1	74.0	15.9	44.0	34.0	24.6	4.7	150	Vert.	12°
5320.0	55.6	74.0	18.4	42.5	33.6	25.1	4.6	150	Vert.	0°
4920.0	52.4	74.0	21.6	40.1	32.8	25.0	4.4	150	Vert.	2°
5000.0	53.2	74.0	20.8	40.4	33.1	24.8	4.5	150	Vert.	0°
Measurement uncertainty				+2.2 dB / -3.6 dB						

Result measured with the average detector:

Frequency MHz	Meas. Result dB μ V/m	Limit dB μ V/m	Margin dB	Readings dB μ V	Antenna factor 1/m	Preamp dB	Cable loss dB	Height cm	Pol.	TT Pos.
5180.0	13.2				33.7	25.1	4.6	150	Hor.	341°
5000.0	45.2	54.0	8.8	32.4	33.1	24.8	4.5	150	Vert.	0°
5400.0	50.4	54.0	3.6	36.7	33.8	24.8	4.7	150	Vert.	3°
5480.0	50.6	54.0	3.4	36.5	34.0	24.6	4.7	150	Vert.	358°
5320.0	48.3	54.0	5.7	35.2	33.6	25.1	4.6	150	Vert.	8°
4920.0	46.6	54.0	7.4	34.3	32.8	25.0	4.4	150	Hor.	3°
Measurement uncertainty				+2.2 dB / -3.6 dB						

Transmitter operates at the upper end of the assigned frequency band (operation mode 3)

Result measured with the peak detector:

Frequency MHz	Meas. Result dB μ V/m	Limit dB μ V/m	Margin dB	Readings dB μ V	Antenna factor 1/m	Preamp dB	Cable loss dB	Height cm	Pol.	TT Pos.
5000.0	51.5	74.0	22.5	38.7	33.1	24.8	4.5	150	Vert.	345°
5400.0	57.7	74.0	16.3	44.0	33.8	24.8	4.7	150	Vert.	12°
5480.0	54.7	74.0	19.3	40.6	34.0	24.6	4.7	150	Vert.	0°
5320.0	52.9	74.0	21.1	39.8	33.6	25.1	4.6	150	Vert.	360°
4920.0	53.2	74.0	20.8	40.9	32.8	25.0	4.4	150	Vert.	12°
5080.0	49.6	74.0	24.4	36.7	33.4	25.0	4.5	150	Hor.	27°
Measurement uncertainty				+2.2 dB / -3.6 dB						

Result measured with the average detector:

Frequency MHz	Meas. Result dB μ V/m	Limit dB μ V/m	Margin dB	Readings dB μ V	Antenna factor 1/m	Preamp dB	Cable loss dB	Height cm	Pol.	TT Pos.
5000.0	43.3	54.0	10.7	30.5	33.1	24.8	4.5	150	Vert.	345°
5400.0	52.2	54.0	1.8	38.5	33.8	24.8	4.7	150	Vert.	12°
5480.0	44.2	54.0	9.8	30.1	34.0	24.6	4.7	150	Vert.	0°
5320.0	42.6	54.0	11.4	29.5	33.6	25.1	4.6	150	Vert.	360°
4920.0	47.7	54.0	6.3	35.4	32.8	25.0	4.4	150	Hor.	7°
5080.0	37.6	54.0	16.4	24.7	33.4	25.0	4.5	150	Hor.	360°
Measurement uncertainty				+2.2 dB / -3.6 dB						

Transmitter operates at the lower end of the assigned frequency band (operation mode 4)

Result measured with the peak detector:

Frequency MHz	Meas. Result dB μ V/m	Limit dB μ V/m	Margin dB	Readings dB μ V	Antenna factor 1/m	Preamp dB	Cable loss dB	Height cm	Pol.	TT Pos.	
5160.0	56.0	74.0	18.0	43.0	33.7	25.2	4.6	150	Vert.	3°	
5400.0	58.3	74.0	15.7	44.6	33.8	24.8	4.7	150	Vert.	360°	
5480.0	60.0	74.0	14.0	45.9	34.0	24.6	4.7	150	Vert.	19°	
4920.0	52.7	74.0	21.3	40.4	32.8	25.0	4.4	150	Vert.	5°	
5320.0	56.2	74.0	17.8	43.1	33.6	25.1	4.6	150	Vert.	0°	
5000.0	52.7	74.0	21.3	39.9	33.1	24.8	4.5	150	Hor.	3°	
Measurement uncertainty				+2.2 dB / -3.6 dB							

Result measured with the average detector:

Frequency MHz	Meas. Result dB μ V/m	Limit dB μ V/m	Margin dB	Readings dB μ V	Antenna factor 1/m	Preamp dB	Cable loss dB	Height cm	Pol.	TT Pos.	
5160.0	51.0	54.0	3.0	38.0	33.7	25.2	4.6	150	Vert.	7°	
5400.0	51.3	54.0	2.7	37.6	33.8	24.8	4.7	150	Vert.	360°	
5480.0	53.2	54.0	0.8	39.1	34.0	24.6	4.7	150	Vert.	12°	
4920.0	46.8	54.0	7.2	34.5	32.8	25.0	4.4	150	Vert.	360°	
5320.0	49.8	54.0	4.2	36.7	33.6	25.1	4.6	150	Hor.	0°	
5000.0	44.9	54.0	9.1	32.1	33.1	24.8	4.5	150	Hor.	0°	
Measurement uncertainty				+2.2 dB / -3.6 dB							

Transmitter operates at the middle of the assigned frequency band (operation mode 5)

Result measured with the peak detector:

Frequency MHz	Meas. Result dB μ V/m	Limit dB μ V/m	Margin dB	Readings dB μ V	Antenna factor 1/m	Preamp dB	Cable loss dB	Height cm	Pol.	TT Pos.
5320.0	53.8	74.0	20.2	40.7	33.6	25.1	4.6	150	Vert.	360°
5440.0	59.8	74.0	14.2	46.2	33.9	25.0	4.7	150	Vert.	1°
5360.0	57.6	74.0	16.4	44.2	33.7	24.9	4.6	150	Vert.	12°
5400.0	57.5	74.0	16.5	43.8	33.8	24.8	4.7	150	Vert.	18°
5480.0	59.4	74.0	14.6	45.3	34.0	24.6	4.7	150	Vert.	0°
5160.0	54.2	74.0	19.8	41.2	33.7	25.2	4.6	150	Hor.	3°
Measurement uncertainty				+2.2 dB / -3.6 dB						

Result measured with the average detector:

Frequency MHz	Meas. Result dB μ V/m	Limit dB μ V/m	Margin dB	Readings dB μ V	Antenna factor 1/m	Preamp dB	Cable loss dB	Height cm	Pol.	TT Pos.
5320.0	44.4	54.0	9.6	31.3	33.6	25.1	4.6	150	Vert.	0°
5440.0	53.4	54.0	0.6	39.8	33.9	25.0	4.7	150	Vert.	14°
5360.0	51.7	54.0	2.3	38.3	33.7	24.9	4.6	150	Vert.	9°
5400.0	48.9	54.0	5.1	35.2	33.8	24.8	4.7	150	Vert.	12°
5480.0	49.3	54.0	4.7	35.2	34.0	24.6	4.7	150	Hor.	360°
5160.0	49.1	54.0	4.9	36.1	33.7	25.2	4.6	150	Hor.	0°
Measurement uncertainty				+2.2 dB / -3.6 dB						

Transmitter operates at the upper end of the assigned frequency band (operation mode 6)

Result measured with the peak detector:

Frequency MHz	Meas. Result dB μ V/m	Limit dB μ V/m	Margin dB	Readings dB μ V	Antenna factor 1/m	Preamp dB	Cable loss dB	Height cm	Pol.	TT Pos.
5320.0	56.2	74.0	17.8	43.1	33.6	25.1	4.6	150	Vert.	0°
5440.0	60.4	74.0	13.6	46.8	33.9	25.0	4.7	150	Vert.	359°
5360.0	54.7	74.0	19.3	41.3	33.7	24.9	4.6	150	Vert.	0°
5400.0	59.0	74.0	15.0	45.3	33.8	24.8	4.7	150	Vert.	15°
5480.0	60.0	74.0	14.0	45.9	34.0	24.6	4.7	150	Vert.	360°
5160.0	55.8	74.0	18.2	42.8	33.7	25.2	4.6	150	Hor.	0°
Measurement uncertainty				+2.2 dB / -3.6 dB						

Result measured with the average detector:

Frequency MHz	Meas. Result dB μ V/m	Limit dB μ V/m	Margin dB	Readings dB μ V	Antenna factor 1/m	Preamp dB	Cable loss dB	Height cm	Pol.	TT Pos.
5320.0	48.0	54.0	6.0	34.9	33.6	25.1	4.6	150	Vert.	0°
5440.0	53.9	54.0	0.1	40.3	33.9	25.0	4.7	150	Vert.	359°
5360.0	43.4	54.0	10.6	30.0	33.7	24.9	4.6	150	Vert.	0°
5400.0	48.8	54.0	5.2	35.1	33.8	24.8	4.7	150	Vert.	11°
5480.0	50.0	54.0	4.0	35.9	34.0	24.6	4.7	150	Hor.	360°
5160.0	49.9	54.0	4.1	36.9	33.7	25.2	4.6	150	Hor.	0°
Measurement uncertainty				+2.2 dB / -3.6 dB						

Transmitter operates at the lower end of the assigned frequency band (operation mode 7)

Result measured with the peak detector:

Frequency MHz	Meas. Result dB μ V/m	Limit dB μ V/m	Margin dB	Readings dB μ V	Antenna factor 1/m	Preamp dB	Cable loss dB	Height cm	Pol.	TT Pos.	
5000.0	53.2	74.0	20.8	40.4	33.1	24.8	4.5	150	Vert.	0°	
5400.0	57.1	74.0	16.9	43.4	33.8	24.8	4.7	150	Vert.	0°	
5480.0	58.6	74.0	15.4	44.5	34.0	24.6	4.7	150	Vert.	0°	
5320.0	55.0	74.0	19.0	41.9	33.6	25.1	4.6	150	Vert.	0°	
5560.0	54.9	74.0	19.1	40.9	34.0	24.7	4.7	150	Vert.	357°	
4920.0	53.4	74.0	20.6	41.1	32.8	25.0	4.4	150	Hor.	4°	
Measurement uncertainty				+2.2 dB / -3.6 dB							

Result measured with the average detector:

Frequency MHz	Meas. Result dB μ V/m	Limit dB μ V/m	Margin dB	Readings dB μ V	Antenna factor 1/m	Preamp dB	Cable loss dB	Height cm	Pol.	TT Pos.	
5000.0	44.7	54.0	9.3	31.9	33.1	24.8	4.5	150	Vert.	346°	
5400.0	49.2	54.0	4.8	35.5	33.8	24.8	4.7	150	Vert.	0°	
5480.0	50.5	54.0	3.5	36.4	34.0	24.6	4.7	150	Vert.	0°	
5320.0	48.3	54.0	5.7	35.2	33.6	25.1	4.6	150	Vert.	15°	
5560.0	45.0	54.0	9.0	31.0	34.0	24.7	4.7	150	Hor.	7°	
4920.0	46.2	54.0	7.8	33.9	32.8	25.0	4.4	150	Hor.	357°	
Measurement uncertainty				+2.2 dB / -3.6 dB							

Transmitter operates at the middle of the assigned frequency band (operation mode 8)

Result measured with the peak detector:

Frequency MHz	Meas. Result dB μ V/m	Limit dB μ V/m	Margin dB	Readings dB μ V	Antenna factor 1/m	Preamp dB	Cable loss dB	Height cm	Pol.	TT Pos.	
4920.0	54.1	74.0	19.9	41.8	32.8	25.0	4.4	150	Vert.	1°	
5080.0	50.5	74.0	23.5	37.6	33.4	25.0	4.5	150	Vert.	1°	
5000.0	52.2	74.0	21.8	39.4	33.1	24.8	4.5	150	Vert.	344°	
5400.0	59.0	74.0	15.0	45.3	33.8	24.8	4.7	150	Vert.	8°	
5480.0	58.3	74.0	15.7	44.2	34.0	24.6	4.7	150	Vert.	360°	
5320.0	55.8	74.0	18.2	42.7	33.6	25.1	4.6	150	Hor.	356°	
Measurement uncertainty				+2.2 dB / -3.6 dB							

Result measured with the average detector:

Frequency MHz	Meas. Result dB μ V/m	Limit dB μ V/m	Margin dB	Readings dB μ V	Antenna factor 1/m	Preamp dB	Cable loss dB	Height cm	Pol.	TT Pos.	
4920.0	49.7	54.0	4.3	37.4	32.8	25.0	4.4	150	Vert.	3°	
5080.0	39.0	54.0	15.0	26.1	33.4	25.0	4.5	150	Vert.	10°	
5000.0	44.0	54.0	10.0	31.2	33.1	24.8	4.5	150	Vert.	0°	
5400.0	53.5	54.0	0.5	39.8	33.8	24.8	4.7	150	Vert.	17°	
5480.0	51.5	54.0	2.5	37.4	34.0	24.6	4.7	150	Hor.	7°	
5320.0	49.1	54.0	4.9	36.0	33.6	25.1	4.6	150	Hor.	12°	
Measurement uncertainty				+2.2 dB / -3.6 dB							

Transmitter operates at the upper end of the assigned frequency band (operation mode 9)

Result measured with the peak detector:

Frequency MHz	Meas. Result dB μ V/m	Limit dB μ V/m	Margin dB	Readings dB μ V	Antenna factor 1/m	Preamp dB	Cable loss dB	Height cm	Pol.	TT Pos.
4920.0	50.9	74.0	23.1	38.6	32.8	25.0	4.4	150	Vert.	357
5080.0	50.5	74.0	23.5	37.6	33.4	25.0	4.5	150	Vert.	352
5000.0	51.4	74.0	22.6	38.6	33.1	24.8	4.5	150	Vert.	8
5480.0	58.7	74.0	15.3	44.6	34.0	24.6	4.7	150	Vert.	3
5400.0	59.0	74.0	15.0	45.3	33.8	24.8	4.7	150	Vert.	0
5320.0	56.3	74.0	17.7	43.2	33.6	25.1	4.6	150	Hor.	0
Measurement uncertainty				+2.2 dB / -3.6 dB						

Result measured with the average detector:

Frequency MHz	Meas. Result dB μ V/m	Limit dB μ V/m	Margin dB	Readings dB μ V	Antenna factor 1/m	Preamp dB	Cable loss dB	Height cm	Pol.	TT Pos.
4920.0	43.6	54.0	10.4	31.3	32.8	25.0	4.4	150	Vert.	360
5080.0	41.1	54.0	12.9	28.2	33.4	25.0	4.5	150	Vert.	360
5000.0	43.6	54.0	10.4	30.8	33.1	24.8	4.5	150	Vert.	0°
5480.0	51.5	54.0	2.5	37.4	34.0	24.6	4.7	150	Vert.	0°
5400.0	53.2	54.0	0.8	39.5	33.8	24.8	4.7	150	Hor.	17
5320.0	49.3	54.0	4.7	36.2	33.6	25.1	4.6	150	Hor.	0°
Measurement uncertainty				+2.2 dB / -3.6 dB						

Transmitter operates at the lower end of the assigned frequency band (operation mode 10)

Result measured with the peak detector:

Frequency MHz	Meas. Result dB μ V/m	Limit dB μ V/m	Margin dB	Readings dB μ V	Antenna factor 1/m	Preamp dB	Cable loss dB	Height cm	Pol.	TT Pos.	
5160.0	54.0	74.0	20.0	41.0	33.7	25.2	4.6	150	Vert.	9°	
5400.0	59.6	74.0	14.4	45.9	33.8	24.8	4.7	150	Vert.	15°	
5480.0	59.2	74.0	14.8	45.1	34.0	24.6	4.7	150	Vert.	10°	
4920.0	53.2	74.0	20.8	40.9	32.8	25.0	4.4	150	Vert.	1°	
5320.0	56.1	74.0	17.9	43.0	33.6	25.1	4.6	150	Vert.	359°	
5000.0	52.7	74.0	21.3	39.9	33.1	24.8	4.5	150	Hor.	4°	
Measurement uncertainty				+2.2 dB / -3.6 dB							

Result measured with the average detector:

Frequency MHz	Meas. Result dB μ V/m	Limit dB μ V/m	Margin dB	Readings dB μ V	Antenna factor 1/m	Preamp dB	Cable loss dB	Height cm	Pol.	TT Pos.	
5160.0	48.4	54.0	5.6	35.4	33.7	25.2	4.6	150	Vert.	360°	
5400.0	53.8	54.0	0.2	40.1	33.8	24.8	4.7	150	Vert.	12°	
5480.0	52.0	54.0	2.0	37.9	34.0	24.6	4.7	150	Vert.	360°	
4920.0	47.9	54.0	6.1	35.6	32.8	25.0	4.4	150	Vert.	360°	
5320.0	49.4	54.0	4.6	36.3	33.6	25.1	4.6	150	Hor.	3°	
5000.0	44.7	54.0	9.3	31.9	33.1	24.8	4.5	150	Hor.	360°	
+2.2 dB / -3.6 dB				+2.2 dB / -3.6 dB							

Transmitter operates at the middle of the assigned frequency band (operation mode 11)

Result measured with the peak detector:

Frequency MHz	Meas. Result dB μ V/m	Limit dB μ V/m	Margin dB	Readings dB μ V	Antenna factor 1/m	Preamp dB	Cable loss dB	Height cm	Pol.	TT Pos.	
5320.0	53.3	74.0	20.7	40.2	33.6	25.1	4.6	150	Vert.	1°	
5440.0	59.5	74.0	14.5	45.9	33.9	25.0	4.7	150	Vert.	6°	
5360.0	57.4	74.0	16.6	44.0	33.7	24.9	4.6	150	Vert.	0°	
5400.0	60.0	74.0	14.0	46.3	33.8	24.8	4.7	150	Vert.	17°	
5480.0	59.9	74.0	14.1	45.8	34.0	24.6	4.7	150	Vert.	359°	
5160.0	56.0	74.0	18.0	43.0	33.7	25.2	4.6	150	Hor.	0°	
Measurement uncertainty				+2.2 dB / -3.6 dB							

Result measured with the average detector:

Frequency MHz	Meas. Result dB μ V/m	Limit dB μ V/m	Margin dB	Readings dB μ V	Antenna factor 1/m	Preamp dB	Cable loss dB	Height cm	Pol.	TT Pos.	
5320.0	43.5	54.0	10.5	30.4	33.6	25.1	4.6	150	Vert.	2°	
5440.0	52.8	54.0	1.2	39.2	33.9	25.0	4.7	150	Vert.	12°	
5360.0	51.3	54.0	2.7	37.9	33.7	24.9	4.6	150	Vert.	7°	
5400.0	53.9	54.0	0.1	40.2	33.8	24.8	4.7	150	Vert.	15°	
5480.0	52.6	54.0	1.4	38.5	34.0	24.6	4.7	150	Hor.	12°	
5160.0	51.1	54.0	2.9	38.1	33.7	25.2	4.6	150	Hor.	0°	
Measurement uncertainty				+2.2 dB / -3.6 dB							

Transmitter operates at the upper end of the assigned frequency band (operation mode 12)

Result measured with the peak detector:

Frequency MHz	Meas. Result dB μ V/m	Limit dB μ V/m	Margin dB	Readings dB μ V	Antenna factor 1/m	Preamp dB	Cable loss dB	Height cm	Pol.	TT Pos.
5320.0	54.3	74.0	19.7	41.2	33.6	25.1	4.6	150	Vert.	0°
5440.0	59.4	74.0	14.6	45.8	33.9	25.0	4.7	150	Vert.	12°
5360.0	57.8	74.0	16.2	44.4	33.7	24.9	4.6	150	Vert.	359°
5400.0	57.7	74.0	16.3	44.0	33.8	24.8	4.7	150	Vert.	15°
5480.0	58.7	74.0	15.3	44.6	34.0	24.6	4.7	150	Vert.	0°
5160.0	54.3	74.0	19.7	41.3	33.7	25.2	4.6	150	Hor.	3°
Measurement uncertainty				+2.2 dB / -3.6 dB						

Result measured with the average detector:

Frequency MHz	Meas. Result dB μ V/m	Limit dB μ V/m	Margin dB	Readings dB μ V	Antenna factor 1/m	Preamp dB	Cable loss dB	Height cm	Pol.	TT Pos.
5320.0	46.1	54.0	7.9	33.0	33.6	25.1	4.6	150	Vert.	0°
5440.0	52.7	54.0	1.3	39.1	33.9	25.0	4.7	150	Vert.	12°
5360.0	51.4	54.0	2.6	38.0	33.7	24.9	4.6	150	Vert.	9°
5400.0	49.7	54.0	4.3	36.0	33.8	24.8	4.7	150	Vert.	12°
5480.0	49.6	54.0	4.4	35.5	34.0	24.6	4.7	150	Hor.	13°
5160.0	49.2	54.0	4.8	36.2	33.7	25.2	4.6	150	Hor.	0°
Measurement uncertainty				+2.2 dB / -3.6 dB						

Transmitter operates at the lower end of the assigned frequency band (operation mode 13)

Result measured with the peak detector:

Frequency MHz	Meas. Result dB μ V/m	Limit dB μ V/m	Margin dB	Readings dB μ V	Antenna factor 1/m	Preamp dB	Cable loss dB	Height cm	Pol.	TT Pos.
4920.0	53.4	74.0	20.6	41.1	32.8	25.0	4.4	150	Vert.	0°
5080.0	51.3	74.0	22.7	38.4	33.4	25.0	4.5	150	Vert.	359°
5000.0	52.5	74.0	21.5	39.7	33.1	24.8	4.5	150	Vert.	2°
5400.0	59.1	74.0	14.9	45.4	33.8	24.8	4.7	150	Vert.	360°
5480.0	59.6	74.0	14.4	45.5	34.0	24.6	4.7	150	Vert.	8°
5320.0	55.6	74.0	18.4	42.5	33.6	25.1	4.6	150	Hor.	358°
Measurement uncertainty				+2.2 dB / -3.6 dB						

Result measured with the average detector:

Frequency MHz	Meas. Result dB μ V/m	Limit dB μ V/m	Margin dB	Readings dB μ V	Antenna factor 1/m	Preamp dB	Cable loss dB	Height cm	Pol.	TT Pos.
4920.0	48.2	54.0	5.8	35.9	32.8	25.0	4.4	150	Vert.	0°
5080.0	41.0	54.0	13.0	28.1	33.4	25.0	4.5	150	Vert.	10°
5000.0	44.0	54.0	10.0	31.2	33.1	24.8	4.5	150	Vert.	341°
5400.0	53.8	54.0	0.2	40.1	33.8	24.8	4.7	150	Vert.	12°
5480.0	53.0	54.0	1.0	38.9	34.0	24.6	4.7	150	Hor.	5°
5320.0	47.9	54.0	6.1	34.8	33.6	25.1	4.6	150	Hor.	12°
Measurement uncertainty				+2.2 dB / -3.6 dB						

Transmitter operates at the upper end of the assigned frequency band (operation mode 14)

Result measured with the peak detector:

Frequency MHz	Meas. Result dB μ V/m	Limit dB μ V/m	Margin dB	Readings dB μ V	Antenna factor 1/m	Preamp dB	Cable loss dB	Height cm	Pol.	TT Pos.
5400.0	56.5	74.0	17.5	42.8	33.8	24.8	4.7	150	Vert.	0°
5000.0	50.8	74.0	23.2	38.0	33.1	24.8	4.5	150	Vert.	337°
5480.0	56.4	74.0	17.6	42.3	34.0	24.6	4.7	150	Vert.	2°
5320.0	53.7	74.0	20.3	40.6	33.6	25.1	4.6	150	Vert.	359°
4920.0	52.1	74.0	21.9	39.8	32.8	25.0	4.4	150	Vert.	358°
5080.0	50.0	74.0	24.0	37.1	33.4	25.0	4.5	150	Hor.	22°
Measurement uncertainty				+2.2 dB / -3.6 dB						

Result measured with the average detector:

Frequency MHz	Meas. Result dB μ V/m	Limit dB μ V/m	Margin dB	Readings dB μ V	Antenna factor 1/m	Preamp dB	Cable loss dB	Height cm	Pol.	TT Pos.
5400.0	49.7	54.0	4.3	36.0	33.8	24.8	4.7	150	Vert.	0°
5000.0	43.5	54.0	10.5	30.7	33.1	24.8	4.5	150	Vert.	343°
5480.0	48.2	54.0	5.8	34.1	34.0	24.6	4.7	150	Vert.	0°
5320.0	45.6	54.0	8.4	32.5	33.6	25.1	4.6	150	Vert.	17°
4920.0	46.7	54.0	7.3	34.4	32.8	25.0	4.4	150	Hor.	360°
5080.0	38.4	54.0	15.6	25.5	33.4	25.0	4.5	150	Hor.	7°
Measurement uncertainty				+2.2 dB / -3.6 dB						

Transmitter operates at the lower end of the assigned frequency band (operation mode 15)

Result measured with the peak detector:

Frequency MHz	Meas. Result dB μ V/m	Limit dB μ V/m	Margin dB	Readings dB μ V	Antenna factor 1/m	Preamp dB	Cable loss dB	Height cm	Pol.	TT Pos.
5160.0	56.4	74.0	17.6	43.4	33.7	25.2	4.6	150	Vert.	12°
5400.0	57.1	74.0	16.9	43.4	33.8	24.8	4.7	150	Vert.	4°
5480.0	59.8	74.0	14.2	45.7	34.0	24.6	4.7	150	Vert.	0°
4920.0	52.6	74.0	21.4	40.3	32.8	25.0	4.4	150	Vert.	8°
5320.0	56.2	74.0	17.8	43.1	33.6	25.1	4.6	150	Vert.	359°
5000.0	52.2	74.0	21.8	39.4	33.1	24.8	4.5	150	Hor.	359°
Measurement uncertainty				+2.2 dB / -3.6 dB						

Result measured with the average detector:

Frequency MHz	Meas. Result dB μ V/m	Limit dB μ V/m	Margin dB	Readings dB μ V	Antenna factor 1/m	Preamp dB	Cable loss dB	Height cm	Pol.	TT Pos.
5160.0	52.1	54.0	1.9	39.1	33.7	25.2	4.6	150	Vert.	0°
5400.0	48.5	54.0	5.5	34.8	33.8	24.8	4.7	150	Vert.	15°
5480.0	53.3	54.0	0.7	39.2	34.0	24.6	4.7	150	Vert.	12°
4920.0	47.1	54.0	6.9	34.8	32.8	25.0	4.4	150	Vert.	360°
5320.0	49.8	54.0	4.2	36.7	33.6	25.1	4.6	150	Hor.	360°
5000.0	44.9	54.0	9.1	32.1	33.1	24.8	4.5	150	Hor.	0°
Measurement uncertainty				+2.2 dB / -3.6 dB						

Transmitter operates at the upper end of the assigned frequency band (operation mode 16)

Result measured with the peak detector:

Frequency MHz	Meas. Result dB μ V/m	Limit dB μ V/m	Margin dB	Readings dB μ V	Antenna factor 1/m	Preamp dB	Cable loss dB	Height cm	Pol.	TT Pos.
5320.0	53.3	74.0	20.7	40.2	33.6	25.1	4.6	150	Vert.	359°
5440.0	59.7	74.0	14.3	46.1	33.9	25.0	4.7	150	Vert.	20°
5360.0	58.3	74.0	15.7	44.9	33.7	24.9	4.6	150	Vert.	359°
5400.0	56.4	74.0	17.6	42.7	33.8	24.8	4.7	150	Vert.	2°
5480.0	59.0	74.0	15.0	44.9	34.0	24.6	4.7	150	Vert.	12°
5160.0	53.3	74.0	20.7	40.3	33.7	25.2	4.6	150	Hor.	3°
Measurement uncertainty				+2.2 dB / -3.6 dB						

Result measured with the average detector:

Frequency MHz	Meas. Result dB μ V/m	Limit dB μ V/m	Margin dB	Readings dB μ V	Antenna factor 1/m	Preamp dB	Cable loss dB	Height cm	Pol.	TT Pos.
5320.0	43.0	54.0	11.0	29.9	33.6	25.1	4.6	150	Vert.	0°
5440.0	53.1	54.0	0.9	39.5	33.9	25.0	4.7	150	Vert.	12°
5360.0	51.5	54.0	2.5	38.1	33.7	24.9	4.6	150	Vert.	9°
5400.0	46.1	54.0	7.9	32.4	33.8	24.8	4.7	150	Vert.	15°
5480.0	47.2	54.0	6.8	33.1	34.0	24.6	4.7	150	Hor.	12°
5160.0	46.9	54.0	7.1	33.9	33.7	25.2	4.6	150	Hor.	0°
Measurement uncertainty				+2.2 dB / -3.6 dB						

5.7.5.2.3 Results for patch array antenna

Used antenna: BAT-ANT-N-MiMoDB-5N-IP65 with 5.5 dBi gain

Transmitter operates at the lower end of the assigned frequency band (operation mode 1)

Result measured with the peak detector:

Frequency MHz	Meas. Result dB μ V/m	Limit dB μ V/m	Margin dB	Readings dB μ V	Antenna factor 1/m	Preamp dB	Cable loss dB	Height cm	Pol.	TT Pos.
5400.0	57.1	74.0	16.9	43.4	33.8	24.8	4.7	150	Vert.	300°
5320.0	52.2	74.0	21.8	39.1	33.6	25.1	4.6	150	Vert.	308°
4920.0	49.1	74.0	24.9	36.8	32.8	25.0	4.4	150	Vert.	20°
5000.0	52.4	74.0	21.6	39.6	33.1	24.8	4.5	150	Vert.	327°
5080.0	50.8	74.0	23.2	37.9	33.4	25.0	4.5	150	Vert.	359°
5480.0	58.4	74.0	15.6	44.3	34.0	24.6	4.7	150	Hor.	290°
Measurement uncertainty				+2.2 dB / -3.6 dB						

Result measured with the average detector:

Frequency MHz	Meas. Result dB μ V/m	Limit dB μ V/m	Margin dB	Readings dB μ V	Antenna factor 1/m	Preamp dB	Cable loss dB	Height cm	Pol.	TT Pos.
5400.0	51.3	54.0	2.7	37.6	33.8	24.8	4.7	150	Vert.	333°
5320.0	42.7	54.0	11.3	29.6	33.6	25.1	4.6	150	Vert.	51°
4920.0	39.6	54.0	14.4	27.3	32.8	25.0	4.4	150	Vert.	23°
5000.0	45.3	54.0	8.7	32.5	33.1	24.8	4.5	150	Vert.	293°
5080.0	41.6	54.0	12.4	28.7	33.4	25.0	4.5	150	Hor.	27°
5480.0	47.4	54.0	6.6	33.3	34.0	24.6	4.7	150	Hor.	304°
Measurement uncertainty				+2.2 dB / -3.6 dB						

Transmitter operates at the middle of the assigned frequency band (operation mode 2)

Result measured with the peak detector:

Frequency MHz	Meas. Result dB μ V/m	Limit dB μ V/m	Margin dB	Readings dB μ V	Antenna factor 1/m	Preamp dB	Cable loss dB	Height cm	Pol.	TT Pos.
4920.0	51.7	74.0	22.3	39.4	32.8	25.0	4.4	150	Vert.	357°
5000.0	53.2	74.0	20.8	40.4	33.1	24.8	4.5	150	Vert.	336°
5400.0	56.7	74.0	17.3	43.0	33.8	24.8	4.7	150	Vert.	304°
5320.0	53.7	74.0	20.3	40.6	33.6	25.1	4.6	150	Vert.	290°
4880.0	53.4	74.0	20.6	41.3	32.8	25.1	4.4	150	Vert.	304°
5480.0	59.9	74.0	14.1	45.8	34.0	24.6	4.7	150	Hor.	299°
Measurement uncertainty				+2.2 dB / -3.6 dB						

Result measured with the average detector:

Frequency MHz	Meas. Result dB μ V/m	Limit dB μ V/m	Margin dB	Readings dB μ V	Antenna factor 1/m	Preamp dB	Cable loss dB	Height cm	Pol.	TT Pos.
4920.0	46.1	54.0	7.9	33.8	32.8	25.0	4.4	150	Vert.	332°
5000.0	45.3	54.0	8.7	32.5	33.1	24.8	4.5	150	Vert.	289°
5400.0	50.5	54.0	3.5	36.8	33.8	24.8	4.7	150	Vert.	330°
5320.0	44.8	54.0	9.2	31.7	33.6	25.1	4.6	150	Vert.	336°
4880.0	46.9	54.0	7.1	34.8	32.8	25.1	4.4	150	Hor.	304°
5480.0	49.0	54.0	5.0	34.9	34.0	24.6	4.7	150	Hor.	304°
Measurement uncertainty				+2.2 dB / -3.6 dB						

Transmitter operates at the upper end of the assigned frequency band (operation mode 3)

Result measured with the peak detector:

Frequency MHz	Meas. Result dB μ V/m	Limit dB μ V/m	Margin dB	Readings dB μ V	Antenna factor 1/m	Preamp dB	Cable loss dB	Height cm	Pol.	TT Pos.
5400.0	55.5	74.0	18.5	41.8	33.8	24.8	4.7	150	Vert.	293°
5320.0	49.9	74.0	24.1	36.8	33.6	25.1	4.6	150	Vert.	19°
4920.0	48.4	74.0	25.6	36.1	32.8	25.0	4.4	150	Vert.	359°
5000.0	50.3	74.0	23.7	37.5	33.1	24.8	4.5	150	Vert.	292°
5080.0	49.1	74.0	24.9	36.2	33.4	25.0	4.5	150	Vert.	23°
5480.0	55.9	74.0	18.1	41.8	34.0	24.6	4.7	150	Hor.	305°
Measurement uncertainty				+2.2 dB / -3.6 dB						

Result measured with the average detector:

Frequency MHz	Meas. Result dB μ V/m	Limit dB μ V/m	Margin dB	Readings dB μ V	Antenna factor 1/m	Preamp dB	Cable loss dB	Height cm	Pol.	TT Pos.
5400.0	50.6	54.0	3.4	36.9	33.8	24.8	4.7	150	Vert.	336°
5320.0	41.7	54.0	12.3	28.6	33.6	25.1	4.6	150	Vert.	23°
4920.0	38.6	54.0	15.4	26.3	32.8	25.0	4.4	150	Vert.	34°
5000.0	43.4	54.0	10.6	30.6	33.1	24.8	4.5	150	Vert.	292°
5080.0	37.7	54.0	16.3	24.8	33.4	25.0	4.5	150	Hor.	332°
5480.0	44.5	54.0	9.5	30.4	34.0	24.6	4.7	150	Hor.	302°
Measurement uncertainty				+2.2 dB / -3.6 dB						

Transmitter operates at the lower end of the assigned frequency band (operation mode 4)

Result measured with the peak detector:

Frequency MHz	Meas. Result dB μ V/m	Limit dB μ V/m	Margin dB	Readings dB μ V	Antenna factor 1/m	Preamp dB	Cable loss dB	Height cm	Pol.	TT Pos.	
5360.0	59.9	74.0	14.1	46.5	33.7	24.9	4.6	150	Vert.	300°	
5400.0	60.0	74.0	14.0	46.3	33.8	24.8	4.7	150	Vert.	312°	
5160.0	54.4	74.0	19.6	41.4	33.7	25.2	4.6	150	Vert.	309°	
5480.0	61.1	74.0	12.9	47.0	34.0	24.6	4.7	150	Vert.	300°	
5440.0	54.4	74.0	19.6	40.8	33.9	25.0	4.7	150	Vert.	291°	
4920.0	52.1	74.0	21.9	39.8	32.8	25.0	4.4	150	Hor.	15°	
Measurement uncertainty				+2.2 dB / -3.6 dB							

Result measured with the average detector:

Frequency MHz	Meas. Result dB μ V/m	Limit dB μ V/m	Margin dB	Readings dB μ V	Antenna factor 1/m	Preamp dB	Cable loss dB	Height cm	Pol.	TT Pos.	
5360.0	52.9	54.0	1.1	39.5	33.7	24.9	4.6	150	Vert.	307°	
5400.0	52.9	54.0	1.1	39.2	33.8	24.8	4.7	150	Vert.	312°	
5160.0	48.4	54.0	5.6	35.4	33.7	25.2	4.6	150	Vert.	295°	
5480.0	53.9	54.0	0.1	39.8	34.0	24.6	4.7	150	Vert.	312°	
5440.0	44.1	54.0	9.9	30.5	33.9	25.0	4.7	150	Hor.	23°	
4920.0	46.8	54.0	7.2	34.5	32.8	25.0	4.4	150	Hor.	15°	
Measurement uncertainty				+2.2 dB / -3.6 dB							

Transmitter operates at the middle of the assigned frequency band (operation mode 5)

Result measured with the peak detector:

Frequency MHz	Meas. Result dB μ V/m	Limit dB μ V/m	Margin dB	Readings dB μ V	Antenna factor 1/m	Preamp dB	Cable loss dB	Height cm	Pol.	TT Pos.
5440.0	58.1	74.0	15.9	44.5	33.9	25.0	4.7	150	Vert.	27°
5360.0	60.5	74.0	13.5	47.1	33.7	24.9	4.6	150	Vert.	300°
5200.0	53.7	74.0	20.3	39.7	33.8	24.3	4.6	150	Vert.	23°
5520.0	56.4	74.0	17.6	42.5	34.0	24.9	4.7	150	Vert.	298°
4920.0	53.5	74.0	20.5	41.2	32.8	25.0	4.4	150	Vert.	304°
5124.0	48.1	74.0	25.9	34.7	33.6	24.7	4.5	150	Hor.	18°
Measurement uncertainty				+2.2 dB / -3.6 dB						

Result measured with the average detector:

Frequency MHz	Meas. Result dB μ V/m	Limit dB μ V/m	Margin dB	Readings dB μ V	Antenna factor 1/m	Preamp dB	Cable loss dB	Height cm	Pol.	TT Pos.
5440.0	52.3	54.0	1.7	38.7	33.9	25.0	4.7	150	Vert.	23°
5360.0	53.5	54.0	0.5	40.1	33.7	24.9	4.6	150	Vert.	307°
5200.0	46.6	54.0	7.4	32.6	33.8	24.3	4.6	150	Vert.	23°
5520.0	45.8	54.0	8.2	31.9	34.0	24.9	4.7	150	Vert.	340°
4920.0	47.2	54.0	6.8	34.9	32.8	25.0	4.4	150	Hor.	301°
5124.0	32.6	54.0	21.4	19.2	33.6	24.7	4.5	150	Hor.	22°
Measurement uncertainty				+2.2 dB / -3.6 dB						

Transmitter operates at the upper end of the assigned frequency band (operation mode 6)

Result measured with the peak detector:

Frequency MHz	Meas. Result dB μ V/m	Limit dB μ V/m	Margin dB	Readings dB μ V	Antenna factor 1/m	Preamplifier dB	Cable loss dB	Height cm	Pol.	TT Pos.
5440.0	57.1	74.0	16.9	43.5	33.9	25.0	4.7	150	Vert.	45°
5200.0	64.0	74.0	10.0	50.0	33.8	24.3	4.6	150	Vert.	353°
5520.0	66.7	74.0	7.3	52.8	34.0	24.9	4.7	150	Vert.	224°
5125.0	47.6	74.0	26.4	34.2	33.6	24.7	4.5	150	Vert.	312°
4920.0	51.9	74.0	22.1	39.6	32.8	25.0	4.4	150	Vert.	23°
5360.0	58.0	74.0	16.0	44.6	33.7	24.9	4.6	150	Hor.	308°
Measurement uncertainty				+2.2 dB / -3.6 dB						

Result measured with the average detector:

Frequency MHz	Meas. Result dB μ V/m	Limit dB μ V/m	Margin dB	Readings dB μ V	Antenna factor 1/m	Preamplifier dB	Cable loss dB	Height cm	Pol.	TT Pos.
5440.0	50.9	54.0	3.1	37.3	33.9	25.0	4.7	150	Vert.	53°
5200.0	39.2	54.0	14.8	25.2	33.8	24.3	4.6	150	Vert.	40°
5520.0	44.2	54.0	9.8	30.3	34.0	24.9	4.7	150	Vert.	27°
5125.0	34.4	54.0	19.6	21.0	33.6	24.7	4.5	150	Vert.	23°
4920.0	46.8	54.0	7.2	34.5	32.8	25.0	4.4	150	Hor.	20°
5360.0	49.7	54.0	4.3	36.3	33.7	24.9	4.6	150	Hor.	312°
Measurement uncertainty				+2.2 dB / -3.6 dB						

Transmitter operates at the lower end of the assigned frequency band (operation mode 7)

Result measured with the peak detector:

Frequency MHz	Meas. Result dB μ V/m	Limit dB μ V/m	Margin dB	Readings dB μ V	Antenna factor 1/m	Preamp dB	Cable loss dB	Height cm	Pol.	TT Pos.
5400.0	58.3	74.0	15.7	44.6	33.8	24.8	4.7	150	Vert.	335°
5320.0	51.1	74.0	22.9	38.0	33.6	25.1	4.6	150	Vert.	24°
5560.0	53.6	74.0	20.4	39.6	34.0	24.7	4.7	150	Vert.	308°
4920.0	50.1	74.0	23.9	37.8	32.8	25.0	4.4	150	Vert.	0°
5000.0	52.5	74.0	21.5	39.7	33.1	24.8	4.5	150	Vert.	329°
5400.0	58.3	74.0	15.7	44.6	33.8	24.8	4.7	150	Hor.	49°
Measurement uncertainty				+2.2 dB / -3.6 dB						

Result measured with the average detector:

Frequency MHz	Meas. Result dB μ V/m	Limit dB μ V/m	Margin dB	Readings dB μ V	Antenna factor 1/m	Preamp dB	Cable loss dB	Height cm	Pol.	TT Pos.
5400.0	54.0	54.0	0.0	40.3	33.8	24.8	4.7	150	Vert.	332°
5320.0	42.3	54.0	11.7	29.2	33.6	25.1	4.6	150	Vert.	24°
5560.0	42.9	54.0	11.1	28.9	34.0	24.7	4.7	150	Vert.	55°
4920.0	42.2	54.0	11.8	29.9	32.8	25.0	4.4	150	Vert.	24°
5000.0	45.4	54.0	8.6	32.6	33.1	24.8	4.5	150	Hor.	293°
5400.0	53.6	54.0	0.4	39.9	33.8	24.8	4.7	150	Hor.	45°
Measurement uncertainty				+2.2 dB / -3.6 dB						

Transmitter operates at the middle of the assigned frequency band (operation mode 8)

Result measured with the peak detector:

Frequency MHz	Meas. Result dB μ V/m	Limit dB μ V/m	Margin dB	Readings dB μ V	Antenna factor 1/m	Preamp dB	Cable loss dB	Height cm	Pol.	TT Pos.
5400.0	57.5	74.0	16.5	43.8	33.8	24.8	4.7	150	Vert.	304°
5320.0	53.8	74.0	20.2	40.7	33.6	25.1	4.6	150	Vert.	296°
4920.0	52.7	74.0	21.3	40.4	32.8	25.0	4.4	150	Vert.	18°
5000.0	52.9	74.0	21.1	40.1	33.1	24.8	4.5	150	Vert.	296°
5080.0	51.0	74.0	23.0	38.1	33.4	25.0	4.5	150	Vert.	27°
5480.0	60.3	74.0	13.7	46.2	34.0	24.6	4.7	150	Hor.	304°
Measurement uncertainty				+2.2 dB / -3.6 dB						

Result measured with the average detector:

Frequency MHz	Meas. Result dB μ V/m	Limit dB μ V/m	Margin dB	Readings dB μ V	Antenna factor 1/m	Preamp dB	Cable loss dB	Height cm	Pol.	TT Pos.
5400.0	51.5	54.0	2.5	37.8	33.8	24.8	4.7	150	Vert.	332°
5320.0	46.7	54.0	7.3	33.6	33.6	25.1	4.6	150	Vert.	336°
4920.0	47.4	54.0	6.6	35.1	32.8	25.0	4.4	150	Vert.	18°
5000.0	45.3	54.0	8.7	32.5	33.1	24.8	4.5	150	Vert.	286°
5080.0	42.7	54.0	11.3	29.8	33.4	25.0	4.5	150	Hor.	27°
5480.0	50.5	54.0	3.5	36.4	34.0	24.6	4.7	150	Hor.	304°
Measurement uncertainty				+2.2 dB / -3.6 dB						

Transmitter operates at the upper end of the assigned frequency band (operation mode 9)

Result measured with the peak detector:

Frequency MHz	Meas. Result dB μ V/m	Limit dB μ V/m	Margin dB	Readings dB μ V	Antenna factor 1/m	Preamp dB	Cable loss dB	Height cm	Pol.	TT Pos.	
5400.0	55.3	74.0	18.7	41.6	33.8	24.8	4.7	150	Vert.	27°	
5320.0	50.9	74.0	23.1	37.8	33.6	25.1	4.6	150	Vert.	287°	
5000.0	51.5	74.0	22.5	38.7	33.1	24.8	4.5	150	Vert.	293°	
4920.0	49.0	74.0	25.0	36.7	32.8	25.0	4.4	150	Vert.	24°	
5080.0	49.0	74.0	25.0	36.1	33.4	25.0	4.5	150	Vert.	312°	
5480.0	58.1	74.0	15.9	44.0	34.0	24.6	4.7	150	Hor.	292°	
Measurement uncertainty				+2.2 dB / -3.6 dB							

Result measured with the average detector:

Frequency MHz	Meas. Result dB μ V/m	Limit dB μ V/m	Margin dB	Readings dB μ V	Antenna factor 1/m	Preamp dB	Cable loss dB	Height cm	Pol.	TT Pos.	
5400.0	48.7	54.0	5.3	35.0	33.8	24.8	4.7	150	Vert.	27°	
5320.0	41.0	54.0	13.0	27.9	33.6	25.1	4.6	150	Vert.	27°	
5000.0	45.2	54.0	8.8	32.4	33.1	24.8	4.5	150	Vert.	293°	
4920.0	40.8	54.0	13.2	28.5	32.8	25.0	4.4	150	Vert.	20°	
5080.0	38.6	54.0	15.4	25.7	33.4	25.0	4.5	150	Hor.	22°	
5480.0	50.4	54.0	3.6	36.3	34.0	24.6	4.7	150	Hor.	304°	
Measurement uncertainty				+2.2 dB / -3.6 dB							

Transmitter operates at the lower end of the assigned frequency band (operation mode 10)

Result measured with the peak detector:

Frequency MHz	Meas. Result dB μ V/m	Limit dB μ V/m	Margin dB	Readings dB μ V	Antenna factor 1/m	Preamp dB	Cable loss dB	Height cm	Pol.	TT Pos.
5440.0	58.9	74.0	15.1	45.3	33.9	25.0	4.7	150	Vert.	294°
5200.0	54.2	74.0	19.8	40.2	33.8	24.3	4.6	150	Vert.	18°
5520.0	53.5	74.0	20.5	39.6	34.0	24.9	4.7	150	Vert.	297°
5125.0	47.4	74.0	26.6	34.0	33.6	24.7	4.5	150	Vert.	16°
5280.0	51.0	74.0	23.0	37.3	33.6	24.5	4.6	150	Vert.	27°
5360.0	57.7	74.0	16.3	44.3	33.7	24.9	4.6	150	Hor.	298°
Measurement uncertainty				+2.2 dB / -3.6 dB						

Result measured with the average detector:

Frequency MHz	Meas. Result dB μ V/m	Limit dB μ V/m	Margin dB	Readings dB μ V	Antenna factor 1/m	Preamp dB	Cable loss dB	Height cm	Pol.	TT Pos.
5440.0	52.2	54.0	1.8	38.6	33.9	25.0	4.7	150	Vert.	336°
5200.0	48.0	54.0	6.0	34.0	33.8	24.3	4.6	150	Vert.	18°
5520.0	40.7	54.0	13.3	26.8	34.0	24.9	4.7	150	Vert.	297°
5125.0	34.4	54.0	19.6	21.0	33.6	24.7	4.5	150	Vert.	23°
5280.0	41.1	54.0	12.9	27.4	33.6	24.5	4.6	150	Hor.	20°
5360.0	50.2	54.0	3.8	36.8	33.7	24.9	4.6	150	Hor.	301°
Measurement uncertainty				+2.2 dB / -3.6 dB						

Transmitter operates at the middle of the assigned frequency band (operation mode 11)

Result measured with the peak detector:

Frequency MHz	Meas. Result dB μ V/m	Limit dB μ V/m	Margin dB	Readings dB μ V	Antenna factor 1/m	Preamp dB	Cable loss dB	Height cm	Pol.	TT Pos.
5440.0	59.1	74.0	14.9	45.5	33.9	25.0	4.7	150	Vert.	23
5200.0	53.8	74.0	20.2	39.8	33.8	24.3	4.6	150	Vert.	340
5280.0	50.5	74.0	23.5	36.8	33.6	24.5	4.6	150	Vert.	331°
4960.0	52.3	74.0	21.7	40.2	32.9	25.3	4.5	150	Vert.	17°
5480.0	61.9	74.0	12.1	47.8	34.0	24.6	4.7	150	Vert.	312°
5400.0	60.4	74.0	13.6	46.7	33.8	24.8	4.7	150	Hor.	321°
Measurement uncertainty				+2.2 dB / -3.6 dB						

Result measured with the average detector:

Frequency MHz	Meas. Result dB μ V/m	Limit dB μ V/m	Margin dB	Readings dB μ V	Antenna factor 1/m	Preamp dB	Cable loss dB	Height cm	Pol.	TT Pos.
5440.0	53.3	54.0	0.7	39.7	33.9	25.0	4.7	150	Vert.	19
5200.0	48.3	54.0	5.7	34.3	33.8	24.3	4.6	150	Vert.	336
5280.0	39.5	54.0	14.5	25.8	33.6	24.5	4.6	150	Vert.	331°
4960.0	47.3	54.0	6.7	35.2	32.9	25.3	4.5	150	Vert.	23°
5480.0	53.3	54.0	0.7	39.2	34.0	24.6	4.7	150	Hor.	308°
5400.0	53.7	54.0	0.3	40.0	33.8	24.8	4.7	150	Hor.	312°
Measurement uncertainty				+2.2 dB / -3.6 dB						

Transmitter operates at the upper end of the assigned frequency band (operation mode 12)

Result measured with the peak detector:

Frequency MHz	Meas. Result dB μ V/m	Limit dB μ V/m	Margin dB	Readings dB μ V	Antenna factor 1/m	Preamp dB	Cable loss dB	Height cm	Pol.	TT Pos.
5360.0	57.3	74.0	16.7	43.9	33.7	24.9	4.6	150	Vert.	312°
5400.0	59.0	74.0	15.0	45.3	33.8	24.8	4.7	150	Vert.	297°
5480.0	61.5	74.0	12.5	47.4	34.0	24.6	4.7	150	Vert.	316°
5440.0	57.9	74.0	16.1	44.3	33.9	25.0	4.7	150	Vert.	340°
5200.0	54.4	74.0	19.6	40.4	33.8	24.3	4.6	150	Vert.	23°
4960.0	52.5	74.0	21.5	40.4	32.9	25.3	4.5	150	Hor.	35°
Measurement uncertainty				+2.2 dB / -3.6 dB						

Result measured with the average detector:

Frequency MHz	Meas. Result dB μ V/m	Limit dB μ V/m	Margin dB	Readings dB μ V	Antenna factor 1/m	Preamp dB	Cable loss dB	Height cm	Pol.	TT Pos.
5360.0	48.9	54.0	5.1	35.5	33.7	24.9	4.6	150	Vert.	312°
5400.0	49.4	54.0	4.6	35.7	33.8	24.8	4.7	150	Vert.	312°
5480.0	54.0	54.0	0.0	39.9	34.0	24.6	4.7	150	Vert.	308°
5440.0	52.5	54.0	1.5	38.9	33.9	25.0	4.7	150	Vert.	24°
5200.0	49.5	54.0	4.5	35.5	33.8	24.3	4.6	150	Hor.	19°
4960.0	43.5	54.0	10.5	31.4	32.9	25.3	4.5	150	Hor.	34°
Measurement uncertainty				+2.2 dB / -3.6 dB						

Transmitter operates at the lower end of the assigned frequency band (operation mode 13)

Result measured with the peak detector:

Frequency MHz	Meas. Result dB μ V/m	Limit dB μ V/m	Margin dB	Readings dB μ V	Antenna factor 1/m	Preamp dB	Cable loss dB	Height cm	Pol.	TT Pos.
5400.0	57.2	74.0	16.8	43.5	33.8	24.8	4.7	150	Vert.	304°
5320.0	53.3	74.0	20.7	40.2	33.6	25.1	4.6	150	Vert.	297°
4920.0	52.2	74.0	21.8	39.9	32.8	25.0	4.4	150	Vert.	334°
5000.0	53.0	74.0	21.0	40.2	33.1	24.8	4.5	150	Vert.	286°
5080.0	51.1	74.0	22.9	38.2	33.4	25.0	4.5	150	Vert.	332°
5480.0	59.9	74.0	14.1	45.8	34.0	24.6	4.7	150	Hor.	308°
Measurement uncertainty				+2.2 dB / -3.6 dB						

Result measured with the average detector:

Frequency MHz	Meas. Result dB μ V/m	Limit dB μ V/m	Margin dB	Readings dB μ V	Antenna factor 1/m	Preamp dB	Cable loss dB	Height cm	Pol.	TT Pos.
5400.0	51.3	54.0	2.7	37.6	33.8	24.8	4.7	150	Vert.	26°
5320.0	45.4	54.0	8.6	32.3	33.6	25.1	4.6	150	Vert.	339°
4920.0	46.9	54.0	7.1	34.6	32.8	25.0	4.4	150	Vert.	18°
5000.0	45.2	54.0	8.8	32.4	33.1	24.8	4.5	150	Vert.	286°
5080.0	42.7	54.0	11.3	29.8	33.4	25.0	4.5	150	Hor.	332°
5480.0	47.8	54.0	6.2	33.7	34.0	24.6	4.7	150	Hor.	308°
Measurement uncertainty				+2.2 dB / -3.6 dB						

Transmitter operates at the upper end of the assigned frequency band (operation mode 14)

Result measured with the peak detector:

Frequency MHz	Meas. Result dB μ V/m	Limit dB μ V/m	Margin dB	Readings dB μ V	Antenna factor 1/m	Preamp dB	Cable loss dB	Height cm	Pol.	TT Pos.
5400.0	54.9	74.0	19.1	41.2	33.8	24.8	4.7	150	Vert.	295°
5320.0	51.8	74.0	22.2	38.6	33.6	25.1	4.6	150	Vert.	300°
4920.0	49.6	74.0	24.4	37.3	32.8	25.0	4.4	150	Vert.	23°
5000.0	52.2	74.0	21.8	39.4	33.1	24.8	4.5	150	Vert.	296°
5080.0	49.3	74.0	24.7	36.4	33.4	25.0	4.5	150	Vert.	328°
5480.0	58.1	74.0	15.9	44.0	34.0	24.6	4.7	150	Hor.	308°
Measurement uncertainty				+2.2 dB / -3.6 dB						

Result measured with the average detector:

Frequency MHz	Meas. Result dB μ V/m	Limit dB μ V/m	Margin dB	Readings dB μ V	Antenna factor 1/m	Preamp dB	Cable loss dB	Height cm	Pol.	TT Pos.
5400.0	48.0	54.0	6.0	34.3	33.8	24.8	4.7	150	Vert.	31°
5320.0	43.2	54.0	10.8	30.1	33.6	25.1	4.6	150	Vert.	332°
4920.0	42.9	54.0	11.1	30.6	32.8	25.0	4.4	150	Vert.	23°
5000.0	45.2	54.0	8.8	32.4	33.1	24.8	4.5	150	Vert.	293°
5080.0	39.1	54.0	14.9	26.2	33.4	25.0	4.5	150	Hor.	335°
5480.0	50.5	54.0	3.5	36.4	34.0	24.6	4.7	150	Hor.	311°
Measurement uncertainty				+2.2 dB / -3.6 dB						

Transmitter operates at the lower end of the assigned frequency band (operation mode 15)

Result measured with the peak detector:

Frequency MHz	Meas. Result dB μ V/m	Limit dB μ V/m	Margin dB	Readings dB μ V	Antenna factor 1/m	Preamp dB	Cable loss dB	Height cm	Pol.	TT Pos.
5440.0	56.7	74.0	17.3	43.1	33.9	25.0	4.7	150	Vert.	285°
5200.0	51.5	74.0	22.5	37.5	33.8	24.3	4.6	150	Vert.	316°
5520.0	57.1	74.0	16.9	43.2	34.0	24.9	4.7	150	Vert.	290°
5280.0	54.9	74.0	19.1	41.2	33.6	24.5	4.6	150	Vert.	292°
5120.0	50.4	74.0	23.6	37.1	33.5	24.7	4.5	150	Vert.	313°
5360.0	57.0	74.0	17.0	43.6	33.7	24.9	4.6	150	Hor.	309°
Measurement uncertainty				+2.2 dB / -3.6 dB						

Result measured with the average detector:

Frequency MHz	Meas. Result dB μ V/m	Limit dB μ V/m	Margin dB	Readings dB μ V	Antenna factor 1/m	Preamp dB	Cable loss dB	Height cm	Pol.	TT Pos.
5440.0	47.6	54.0	6.4	34.0	33.9	25.0	4.7	150	Vert.	67°
5200.0	42.4	54.0	11.6	28.4	33.8	24.3	4.6	150	Vert.	316°
5520.0	49.6	54.0	4.4	35.7	34.0	24.9	4.7	150	Vert.	286°
5280.0	47.8	54.0	6.2	34.1	33.6	24.5	4.6	150	Vert.	292°
5120.0	41.5	54.0	12.5	28.2	33.5	24.7	4.5	150	Hor.	313°
5360.0	44.6	54.0	9.4	31.2	33.7	24.9	4.6	150	Hor.	309°
Measurement uncertainty				+2.2 dB / -3.6 dB						

Transmitter operates at the upper end of the assigned frequency band (operation mode 16)

Result measured with the peak detector:

Frequency MHz	Meas. Result dB μ V/m	Limit dB μ V/m	Margin dB	Readings dB μ V	Antenna factor 1/m	Preamplifier dB	Cable loss dB	Height cm	Pol.	TT Pos.	
5440.0	58.9	74.0	15.1	45.3	33.9	25.0	4.7	150	Vert.	23°	
5200.0	54.6	74.0	19.4	40.6	33.8	24.3	4.6	150	Vert.	22°	
5360.0	56.4	74.0	17.6	43.0	33.7	24.9	4.6	150	Vert.	308°	
5400.0	58.4	74.0	15.6	44.7	33.8	24.8	4.7	150	Vert.	301°	
4920.0	51.7	74.0	22.3	39.4	32.8	25.0	4.4	150	Vert.	300°	
5480.0	62.0	74.0	12.0	47.9	34.0	24.6	4.7	150	Hor.	290°	
Measurement uncertainty				+2.2 dB / -3.6 dB							

Result measured with the average detector:

Frequency MHz	Meas. Result dB μ V/m	Limit dB μ V/m	Margin dB	Readings dB μ V	Antenna factor 1/m	Preamplifier dB	Cable loss dB	Height cm	Pol.	TT Pos.	
5440.0	52.9	54.0	1.1	39.3	33.9	25.0	4.7	150	Vert.	23°	
5200.0	49.7	54.0	4.3	35.7	33.8	24.3	4.6	150	Vert.	22°	
5360.0	45.8	54.0	8.2	32.4	33.7	24.9	4.6	150	Vert.	312°	
5400.0	47.7	54.0	6.3	34.0	33.8	24.8	4.7	150	Vert.	305°	
4920.0	43.6	54.0	10.4	31.3	32.8	25.0	4.4	150	Hor.	297°	
5480.0	52.1	54.0	1.9	38.0	34.0	24.6	4.7	150	Hor.	302°	
Measurement uncertainty				+2.2 dB / -3.6 dB							

TEST EQUIPMENT USED FOR THE TEST:M20

29, 31 – 36, 41, 42

5.7.6 Test results (radiated emissions) – cabinet emissions

5.7.6.1 Preliminary radiated emission measurement

Ambient temperature	22 °C	Relative humidity	59 %
---------------------	-------	-------------------	------

- Position of EUT: The EUT was set-up on an EUT turn device of a height of 1.5 m. The distance between EUT and antenna was 3 m.
- Cable guide: For detail information of test set-up and the cable guide refer to the pictures in the annex A in the test report.
- Test record: Since the measurement procedures for frequencies < 1 GHz were not changed when comparing the old ANSI 63.4 2009 and the recent ANSI 63.10-2013, the measurements below 1 GHz were not repeated in this test report.
- Supply voltage: During all measurements the host of the EUT was powered with 24 V via an AC/DC Adapter.
- Remark: Document [3] states in 12.7.4.2, that in case of conducted measurements, additional radiated cabinet emission measurements must be performed. The documented measurements show the worst case, namely 802.11n20 mode with at channel 157.

Transmitter operates at the middle of the assigned frequency band (operation mode 11)

160307 #1 n20_ch157_SpurEm1-4G_0°.wmf: Spurious emissions from 1 GHz to 4 GHz' (operation mode 11):

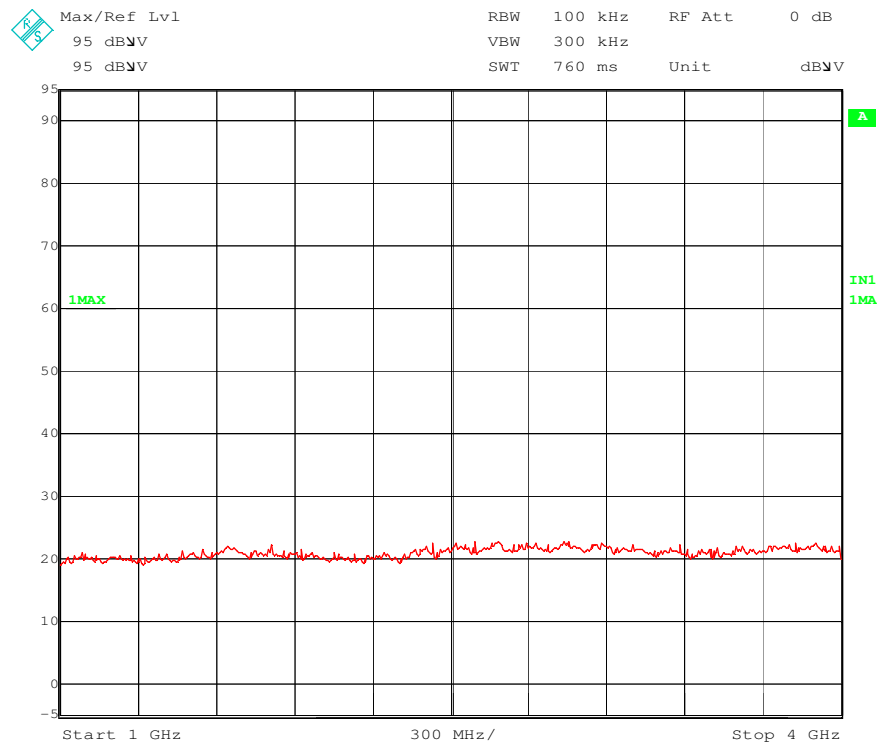

5.7.6.2 Final radiated measurements

Ambient temperature	23 °C	Relative humidity	59 %
---------------------	-------	-------------------	------

Position of EUT: The EUT was set-up on an EUT turn device of a height of 1.5 m. The distance between EUT and antenna was 3 m.

Cable guide: For detail information of test set-up and the cable guide refer to the pictures in the annex A in the test report.

Test record: All results are shown in the following.

Supply voltage: During all measurements the host of the EUT was powered with 24 V via an AC/DC Adapter.

Remark: For simplification, all emissions were tested using the restricted band limits.

Transmitter operates at the middle of the assigned frequency band (operation mode 5)

Result measured with the peak detector:

Frequency MHz	Meas. Result dB μ V/m	Limit dB μ V/m	Margin dB	Readings dB μ V	Antenna factor 1/m	Preamp dB	Cable loss dB	Height cm	Pol.	Turntable Angle
17355.0	50.4	74.0	23.6	41.0	33.9	28.4	3.9	150	Vert.	78°
Measurement uncertainty						+2.2 dB / -3.6 dB				

Result measured with the average detector:

Frequency MHz	Meas. Result dB μ V/m	Limit dB μ V/m	Margin dB	Readings dB μ V	Antenna factor 1/m	Preamp dB	Cable loss dB	Height cm	Pol.	Turntable Angle
17355.0	35.8	54.0	18.2	26.4	33.9	28.4	3.9	150	Hor.	74°
Measurement uncertainty						+2.2 dB / -3.6 dB				

Transmitter operates at the middle of the assigned frequency band (operation mode 6)

Result measured with the peak detector:

Frequency MHz	Meas. Result dB μ V/m	Limit dB μ V/m	Margin dB	Readings dB μ V	Antenna factor 1/m	Preamp dB	Cable loss dB	Height cm	Pol.	Turntable Angle
17475.0	45.5	74.0	28.5	35.8	33.9	28.0	3.9	150	Vert.	78°
Measurement uncertainty						+2.2 dB / -3.6 dB				

Result measured with the average detector:

Frequency MHz	Meas. Result dB μ V/m	Limit dB μ V/m	Margin dB	Readings dB μ V	Antenna factor 1/m	Preamp dB	Cable loss dB	Height cm	Pol.	Turntable Angle
17475.0	31.1	54.0	22.9	21.4	33.9	28.0	3.9	150	Hor.	73°
Measurement uncertainty						+2.2 dB / -3.6 dB				

Transmitter operates at the middle of the assigned frequency band (operation mode 11)

Result measured with the peak detector:

Frequency MHz	Meas. Result dB μ V/m	Limit dB μ V/m	Margin dB	Readings dB μ V	Antenna factor 1/m	Preamp dB	Cable loss dB	Height cm	Pol.	Turntable Angle
17355.0	55.2	74.0	18.8	41.2	33.9	28.4	8.6	150	Hor.	77°
Measurement uncertainty						+2.2 dB / -3.6 dB				

Result measured with the average detector:

Frequency MHz	Meas. Result dB μ V/m	Limit dB μ V/m	Margin dB	Readings dB μ V	Antenna factor 1/m	Preamp dB	Cable loss dB	Height cm	Pol.	Turntable Angle
17355.0	40.9	54.0	13.1	26.9	33.9	28.4	8.6	150	Vert.	74°
Measurement uncertainty						+2.2 dB / -3.6 dB				

TEST EQUIPMENT USED FOR THE TEST:

29, 31 – 51

5.8 Conducted emissions on power supply lines (150 kHz to 30 MHz)

Since the measurement procedures for conducted emission on power supply lines were not changed when comparing the old ANSI 63.4 2009 and the recent ANSI 63.10-2013, these measurements were not repeated in this test report.

6 Test equipment and ancillaries used for tests

No.	Test equipment	Type	Manufacturer	Serial No.	PM. No.	Cal. Date	Cal. Due
29	Fully anechoic chamber M20	-	Albatross Projects	B83107-E2439-T232	480303	Weekly verification (system cal.)	
30	Spectrum analyser	FSU	Rohde & Schwarz	200125	480956	17.02.2016	17.02.2017
31	Measuring receiver	ESI 40	Rohde & Schwarz	100064	480355	16.04.2016	16.04.2017
32	Controller	MCU	Maturo	MCU/043/971107	480832	-	-
33	Turntable	DS420HE	Deisel	420/620/80	480315	-	-
34	Antenna support	AS615P	Deisel	615/310	480187	-	-
36	Antenna	3115 A	EMCO	9609-4918	480183	10.11.2014	10.11.2016
37	Standard Gain Horn 11.9 GHz – 18 GHz	18240-20	Flann Microwave	483	480294	Six month verification (system cal.)	
39	Standard Gain Horn 17.9 GHz – 26.7 GHz	20240-20	Flann Microwave	411	480297	Six month verification (system cal.)	
40	Standard Gain Horn Antenne 26.4 – 40.1 GHz	22240-20	Flann Microwave	469	480299	Six month verification (system cal.)	
41	RF-cable No. 3	Sucoflex 106B	Huber&Suhner	0563/6B / Kabel 3	480670	Weekly verification (system cal.)	
42	RF-cable No. 40	Sucoflex 106B	Huber&Suhner	0708/6B / Kabel 40	481330	Weekly verification (system cal.)	
46	RF-cable 2 m	KPS-1533-800-KPS	Insulated Wire	-	480302	Six month verification (system cal.)	
49	Preamplifier	JS3-00101200-23-5A	Miteq	681851	480337	18.02.2016	18.02.2018
50	Preamplifier	JS3-12001800-16-5A	Miteq	571667	480343	18.02.2016	18.02.2018
51	Preamplifier	JS3-18002600-20-5A	Miteq	658697	480342	17.02.2016	17.02.2018
60	Power Meter	NRVD	Rohde & Schwarz	833697/030	480589	18.02.2016	18.02.2018
61	Thermal Power Sensor	NRV-Z51	Rohde & Schwarz	825948/004	480247	18.02.2016	18.02.2018
72	4 GHz High Pass Filter	WHKX4.0/18 G-8SS	Wainwright Instruments	1	480587	Weekly verification (system cal.)	
80	High-pass Filter	H26G40G1	Microwave Circuits, Inc.	33471	480593	Six month verification (system cal.)	

